

**QST**

*december, 1940*

*25 cents*

*35c in Canada*

# amateur radio



**25<sup>TH</sup>**

**ANNIVERSARY**

# Collins 231D Autotune Transmitter

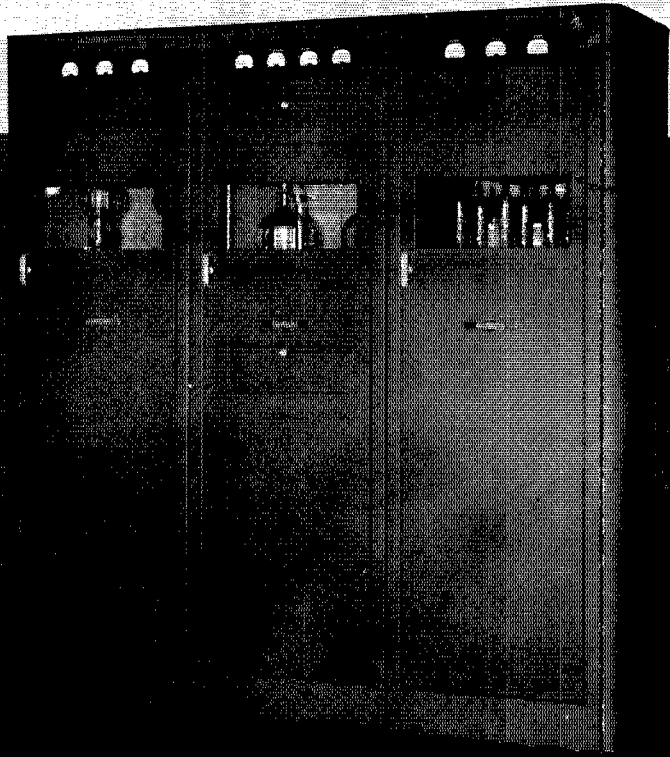

**T**HE 231D 3000 watt Transmitter is basically similar to the 231C Transmitter except that the output is increased by means of appropriate modifications in certain units. Many of the units are identical in both transmitters and the same control arrangements are used.

**Power Output:** 3000 watts nominal rating. For continuous duty (h-f broadcast) service the actual carrier output power may be set at 3000 watts over the entire frequency range. For intermittent duty (airline, military, etc.) the output may be set as high as 5000 watts at frequencies below 8000 kc and as high as 3500 watts at frequencies above 8000 kc.

**Frequency Range:** 2500-15,000 kc or 4000-20,000 kc.

**Antenna Impedance:** Either unbalanced or balanced output connections can be supplied, but provision for both unbalanced and balanced termination is not possible. When unbalanced output is specified, the frequency range is limited to 2500-15,000

kc and antenna impedances of 70-600 ohms up to 60° phase angle can be accommodated. When balanced output is specified, the frequency range of the transmitter is 4000-20,000 kc and permissible antenna impedances are 300-1200 ohms with up to 60° phase angle.

**Power Requirements:** For 3000 watts nominal output (4000 watts Class C input).

A <sub>1</sub> Key Open	2.1 kw	2.5 kva
A <sub>1</sub> Key Closed	6.5 kw	6.7 kva
A <sub>2</sub> or A <sub>3</sub> Carrier Off	2.6 kw	3.0 kva
A <sub>2</sub> or A <sub>3</sub> Carrier On	7.0 kw	7.3 kva
A <sub>2</sub> or A <sub>3</sub> 100% Mod.	9.6 kw	10.0 kva

**Weights and Dimensions:**

Power Bay—Size 24"x24"x78" high; weight 700 lbs.

Autotune R. F. Bay — Size 24"x24"x78" high; weight 540 lbs.

Modulator Bay — Size 24"x24"x78" high; weight 570 lbs.

404B Power & Control Unit—Size 27<sup>3</sup>/<sub>4</sub>"x 22<sup>1</sup>/<sub>8</sub>"x30<sup>5</sup>/<sub>8</sub>" high; weight 580 lbs.

# COLLINS RADIO COMPANY

EDDAR RAPIDS, IOWA U.S.A. NEW YORK, N.Y. (WEST 42 STREET)

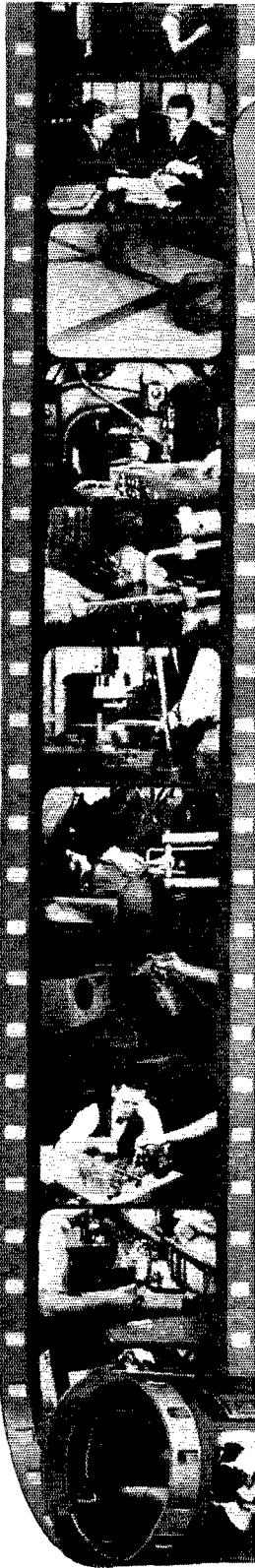

# *How* **COMMUNICATIONS EQUIPMENT** *is Made*

How would you like to go behind the scenes on a personally escorted Motion Picture Tour to see how amateur communications equipment is made?

Here is your opportunity to see each step in precision production, from the raw material to the finished receiver with each step photographed from actual work in the factory of the "World's Largest Builders of Amateur Communications Equipment."

At your next "Ham-Fest," show this interesting 1000 foot Motion Picture—know how communications equipment is built. There is no charge. Here is all you do: secure a projector which will project a 16mm. motion picture at "sound" speed, then drop us a line saying when and where the "fest" is to be held and the individual to ship the film to, and we will have it sent. We know you will enjoy the showing.

the **hallicrafters** inc.  
CHICAGO, U. S. A.

USED BY 33  
GOVERNMENTS

SOLD IN 89  
COUNTRIES



ONCE again Hallicrafters lead the amateur communications field with quality and performance in one of the greatest values ever offered. The New 1941 15 Tube Super Sky rider, "the best selling quality communications receiver," gives you *all* the features, even the ones usually found on higher priced receivers, including electrical band-spread over entire range of the receiver.

Check these points: Rigid girder construction chassis, 15 tubes—6 Bands—Frequency range 550kc. to 43mc.—Large, calibrated main dial—Band-spread dial calibrated

for the 10, 20, 40, 80 meter amateur bands also on the International short wave Broadcast Channels—Tone Control—Send-Receive switch—ANL Switch—RF Gain Switch—AVC-BFO Switch—2 stages preselection—Improved adjustable noise limiter—Beat Frequency Oscillator—antenna trimmer—AF Gain switch—6 position selectivity control—Bass boost switch—Wide Angle "S" meter—Band pass audio filter—Phone jack! Cabinet dimensions 20½" x 14½" x 9½"—Price, with crystal and tubes, less only speaker, \$159.50. (Hallicrafters-Jensen Bass Reflex Speakers Available.)

**THE BEST SELLING**

*Quality*

**RECEIVER**

the hallicrafters inc.  
CHICAGO, U. S. A.

USED BY 33 GOVERNMENTS  
SOLD IN 89 COUNTRIES

DECEMBER 1940

VOLUME XXIV

NUMBER 12



STAFF

Editorial

KENNETH B. WARNER, W1EB  
Editor and Business Manager

CLARK C. RODIMON, W1SE  
Managing Editor

GEORGE GRAMMER, W1DF  
Technical Editor

DONALD H. MIX, W1TS  
BYRON GOODMAN, W1JPE  
Assistant Technical Editors

EDW. P. TILTON, W1HDQ  
Contributing Editor, U.H.F.

VERNON CHAMBERS, W1JEQ  
Technical Information Service

JAMES J. LAMB, W1AL  
Research Engineer, A.R.R.L.

Advertising

F. CHEYNEY BEEKLEY, W1GS  
Advertising Manager

CHARLES BRUNELLE  
Asst. Advertising Manager

Circulation

DAVID H. HOUGHTON  
Circulation Manager

RALPH T. BEAUDIN, W1BWA  
Asst. Circulation Manager



OFFICES

38 La Salle Road  
West Hartford, Connecticut

Subscription rate in United States and Possessions, \$2.50 per year, postpaid; all other countries, \$3.00 per year, postpaid. Single copies, 25 cents. Foreign remittances should be by international postal or express money order or bank draft negotiable in the U. S. and for an equivalent amount in U. S. funds.

Entered as second-class matter May 29, 1919, at the post office at Hartford, Connecticut, under the Act of March 3, 1879. Acceptance for mailing at special rate of postage provided for in section 1103, Act of October 3, 1917, authorized September 9, 1922. Additional entry at Concord, N. H., authorized February 21, 1929, under the Act of February 28, 1925. Additional second-class entries to cover sectional editions authorized March 20, 1935.

Copyright 1940 by the American Radio Relay League, Inc. Title registered at United States Patent Office.

# QST

devoted entirely to

# AMATEUR RADIO

PUBLISHED, MONTHLY, AS ITS OFFICIAL ORGAN, BY THE AMERICAN RADIO RELAY LEAGUE, INC., AT WEST HARTFORD, CONN., U. S. A.:  
OFFICIAL ORGAN OF THE INTERNATIONAL AMATEUR RADIO UNION



## CONTENTS

Editorial . . . . .	9
A Quarter of a Century With QST . . . . .	12
QST's Diary, Volume I . . . . . Clarence D. Tuska	22
Rotten QRM . . . . . The Old Man	25
Amateur Radio in 1882 . . . . . J. S. V. Allen, W8PME	28
Harry Hick, Fred Davis . . . . .	29
Raising the Efficiency of Short Vertical Radiators W. C. Hilgedick and Millett G. Morgan, W6QQJ	30
What the League Is Doing . . . . .	34
A Microwave Superhet . . . . . Frank D. Lewis, W1LKV	36
A Double Beam-Power U.H.F. Transmitter Byron Goodman, W1JPE	40
Eighth A.R.R.L. Field Day Results . . . . .	44
December 14th-15th U.H.F. Contest . . . . .	46
Noise Rejection in Frequency Modulation D. C. Hierath, W1LAC	47
On the Ultra Highs . . . . . E. P. Tilton, W1HDQ	50
New Amateur Television Records on 112 Mc. . . . .	53
The 6L6 as a Crystal Oscillator . . . . . Don Mix, W1TS	54
Naval Communication Reserve Notes . . . . .	56
4th Annual A.R.R.L. QSO Party . . . . .	57
Improving Crystal Filter Performance . Dana Bacon, W1BZR	58
WVW Schedules . . . . .	60
Correspondence from Members . . . . .	61
Operating News . . . . .	62
How's DX? . . . . .	66
A.R.R.L. QSL Bureau . . . . .	86
Hamads . . . . .	119
QST's Index of Advertisers . . . . .	122
QST 1940 Index . . . . .	125

We extend our warm congratulations to QST and to the ARRL on its Silver Anniversary. We feel a personal interest in this birthday celebration because it coincides, in a way, with the foundation of the Hallicrafters.



It was just 25 years ago that Walter Butterworth (WIGM) in the Boston RI's office, told this writer that we had passed the examination for our first "ham" ticket. It was a thrill as LAEH to have our first "CQ" answered by a station all of three miles away.

We remember how scared we were when we bought a blue uniform and walked up the gangplank of the old S.S. Dorothy Bradford to take over the radio shack—Commercial Ticket in hand! The next blue uniform was a gift. Uncle Sam gave it to us when the Naval Reserve was called out. Ours showed the insignia of a Third Class Radioman.

We cut our first real whiskers on the U.S.S. Illinois. And laying mines in the submarine infested North Sea on the U.S.S. Canonicus made us almost wish we had taken up some less hazardous profession. But, looking back, we wouldn't have missed it for anything.

After the war we were off the air for several years—while Uncle Sam again took us in hand and tried to make a soldier of us. But you do not have much time for "hamming" at West Point and we

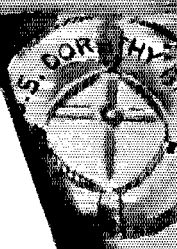

the hallicrafters inc.

CHICAGO, U. S. A.

USED BY 33 GOVERNMENTS

# Salute!



were back on the air as soon as we could, with a new license—1UL this time. We could go on and on piling up the thrills and fun we've had in radio. It is great to reminisce—to look back on 25 interesting years. So much has happened. So many new fists and voices have come on the air. The ARRL and QST have been a powerful factor through it all in preserving our hobby and shaping its growth. The staff at Hartford has been a source of encouragement and inspiration to us as well as to every other amateur, not alone in the United States, but in all the countries of the world. It is with real pleasure, therefore, that we at Hallcrafters salute the League for its accomplishments and look forward with interest to another twenty-five years.

*W. J. Halligan*  
WSWZE



## Section Communications Managers of the A.R.R.L. Communications Department

All appointments in the League's field organization are made by the proper S.C.M., elected by members in each Section listed. Mail your S.C.M. (on the 16th of each month) a postal covering your radio activities for the previous 30 days. Tell him your DX plans for experimenting, results in 'phone and traffic. He is interested, whether you are an A.R.R.L. member or get your QST at the newsstands; he wants a report from every active ham. If interested and qualified for O.R.S., O.P.S. or other appointments he can stand you about them, too.

ATLANTIC DIVISION				
Eastern Pennsylvania	W3BES	Jerry Mathis	6042 Master St. 9701 Monroe St.	Philadelphia
Maryland-Delaware-District of Columbia	W3CIZ	Hermann E. Hobbs	Silver Spring P.O.	Linden, Maryland
Southern New Jersey	W3CCO	Lester H. Allen	704 Quinton Ave.	Trenton
Western New York	W8PLA	Fred C. Chester		Soyevs
Western Pennsylvania	W8CKO	E. A. Krall	703 Broadway	East McKeesport
CENTRAL DIVISION				
Illinois	W9ILH	Mrs. Carrie Jones	2407 Central Ave.	Alton
Indiana	W9AB	Harry B. Miller	729 E. Lowell Ave.	Mishawaka
Kentucky	W9ARU	Darrell A. Downard	116 N. Longworth Ave.	Louisville
Michigan	W8DPE	Harold C. Bird	R.F.D. 2	Pontiac
Ohio	W8AQ	E. H. Gibbs	405 Broad St.	Wadsworth
Wisconsin	W9UIT	Aldrich C. Krone	2702 So. 46th St.	Milwaukee
DAKOTA DIVISION				
North Dakota	W9WWL	Anton C. Theodos	Box 444	Williston
South Dakota	W9ADJ	E. C. Mohler	Box 149	Rapid City
Northern Minnesota	W9IGZ	Edwin L. Wicklund	R.F.D. 3	Kensington
Southern Minnesota	W9YNO	Millard L. Bender	608 N. Huron Ave.	Spring Valley
DELTA DIVISION				
Arkansas	WSABI	H. E. Vette	4415 West 12th St.	Little Rock
Louisiana	WD4W	W. J. Wilkinson, Jr.	1523 Laurel St.	Shreveport
Mississippi	W5EWD	Jewell W. Cole	% City of McComb Water Dept.	McComb City
Tennessee	W4DWS	William Harold Walker	1901 Cedar Lane	Nashville
HUDSON DIVISION				
Eastern New York	W2LU	Robert E. Haight	511 South Holmes St.	Scotia
N. Y. C. & Long Island	W2AZV	E. L. Baunach	102 Central Ave.	Massapequa, L. I.
Northern New Jersey	W2LMN	Edward Gursky, Jr.	367 Van Winkle Ave.	Hawthorne
MIDWEST DIVISION				
Iowa	W9PFR	L. B. Vennard	1113 So. 9th St.	Burlington
Kansas	W9AWP	A. B. Unruh	1617 S. Seneca St.	Wichita
Missouri	W9OUD	Miss Letha Allendorf	1015 W. 3rd St.	Joplin
Nebraska	W9DI	William J. Bamer		Tobias
NEW ENGLAND DIVISION				
Connecticut	W1CTI	Frederick Ella, Jr.	19 Merrill Rd.	Norwalk
Maine	W1IIE	H. W. Castner	147 Church	Damariscotta
Eastern Massachusetts	W1ALP	William L. Baker, Jr.	71 Colby Road	North Quincy
Western Massachusetts	W1IAH	William J. Barrett	239 Columbia St.	Amherst
New Hampshire	W1FTJ	Mrs. Dorothy W. Evans	163 South Main St.	Concord
Rhode Island	W1HRC	Clayton C. Gordon	70 Columbia Ave., Gaspee	Plateau, Warwick
Vermont	W1KJG	Clifton G. Parker	Box 537	Morrisville
NORTHWESTERN DIVISION				
Alaska	K7GNN	James G. Sherry		Chichagof
Idaho	W7CRL	Clifford A. Jessup	803 E. Seventh St.	Mooscow
Montana	W7CPY	Rex Roberts	Box 1088	Glendive
Oregon	W7GNJ	Carl Austin	1137 Federal	Bend
Washington	W7FCG	W. Beale	R. 4, School Ave.	Walla Walla
PACIFIC DIVISION				
Hawaii	K6ETF	Francis T. Blatt	837 16th Ave.	Honolulu
Nevada	W6BIC	Edward W. Heim	509 Claremont St.	Reno
Santa Clara Valley	W6HJZ	Earl E. Sanderson	101 Claremont Ave.	San Jose
East Bay	W6TI	Horace B. Greer	414 Fairmont Ave.	Oakland
San Francisco	W6CIS	Kenneth E. Hughes	622-36th Ave.	San Francisco
Sacramento Valley	W6MDI	Vincent N. Feldhausen	113 South Quincy St.	McCloud
Philippines	KA1GR	George L. Rickard	Box 849	Manila
San Joaquin Valley	W6KUT	Edwin A. Andress	2921 North Van Ness Blvd.	Fresno
ROANOKE DIVISION				
North Carolina	W4CYB	W. J. Workman	P. O. Box 566	Morganton
South Carolina	W4BOE/ANG	Test Ferguson	1213 College St.	Columbia
Virginia	W3GWQ	Frank S. Anderson, Jr.	4703 New Kent Ave.	Richmond
West Virginia	W8OXO	W. D. Tabler	1004 So. Davis Ave.	Elkins
ROCKY MOUNTAIN DIVISION				
Colorado	W9EHC	Carl C. Drumeller	819 East Dale St.	Colorado Springs
Utah-Wyoming	W7GZG	Henry L. Schroeder	P. O. Box 731	Laramie, Wyoming
SOUTHEASTERN DIVISION				
Alabama	W4DGS	James F. Thompson	12 Clanton Ave.	Montgomery
Eastern Florida	W4PEI	Carl G. Schaal	Waucoma Apts.	Clermont
Western Florida	W4AXP	Oscar Cederstrom	Lakeview Hotel	San Jose
Georgia	W4AGI	Leland W. Smith	Second St. & Bruce Ave.	De Funiak Springs
West Indies (Cuba-Puerto Rico-Virgin Islands)	CM2OP	Mario de la Torre	Escobar 110 (Altos)	Augusta
				Habana, Cuba
SOUTHWESTERN DIVISION				
Los Angeles	W6MQM	Ralph S. Click	1038 Milwaukee Ave.	Los Angeles
Arizona*	W6KOL	John K. Oliver		Nogales
San Diego	W6BKZ	Louis A. Cartwright	370 Nautilus	La Jolla
WEST GULF DIVISION				
Northern Texas	W5DXA	Lee Hughes	125 N. Main St.	Childress
Oklahoma	W5GFT	Russell W. Battern	Box 290	Enid
Southern Texas	W5MN	Horace E. Biddy	1746 Schley Ave.	San Antonio
New Mexico	W5EN1	Dr. Hilton W. Gillett		Lovington
MARITIME DIVISION				
Maritime	VE1DQ	A. M. Crowell	69 Dublin St.	Halifax, N. S.
ONTARIO DIVISION				
Ontario	VE3EF	Flying Officer Donald R. Gunn	% Canadian Bank of Commerce	New Toronto, Ont.
QUEBEC DIVISION				
Quebec	VE2CO	Lindsey G. Morris	Apt. 6, 4510 Girouard Ave., N.D.G.	Montreal, P. Q.
VANALTA DIVISION				
Alberta	VE4GE	C. S. Jamieson	581 W. Riverside Drive	Drumheller, Alta.
British Columbia	VE5DD	C. O. I. Sawyer	2634 West 31st Ave.	Vancouver
PRAIRIE DIVISION				
Manitoba	VE4AAW	A. W. Morley	747 McMillan Ave.	Winnipeg
Saskatchewan	VE4SY	Arthur Chesworth	1071 4th Ave., N. W.	Moose Jaw

\* Officials appointed to act until the membership of the Section choose permanent S.C.M.s by nomination and election.



# 7 WATTS DRIVES 'EM

## GL-805

High-Mu Triode

### RATINGS

Fil. Volts ..... 10  
Fil. Amp. .... 3.25  
Max. Frequency, Mc:  
at Max. Ratings ... 30  
at Reduced Ratings 80

### CLASS B AUDIO

(2 tubes)

Plate Volts ..... 1500  
Plate Milliamp .... 400  
Grid Voltage ..... -16  
Driving Power (Watts) 7

### CLASS C PHONE

Plate Modulated

Plate Volts ..... 1250  
Plate Milliamp .... 160  
Grid Volts ..... -160  
Driving Power (Watts) 16

### CLASS C TELEGRAPH

Plate Volts ..... 1500  
Plate Milliamp .... 200  
Grid Volts ..... -105  
Driving Power (Watts) 8.5

**\$13.50**

These GL-805's  
modulate W2DC's  
750-watt final on 80  
and 20.

for **370** WATTS  
AUDIO  
OUTPUT

GL-805—man, what a tube for class B service! 370-watt output (two tubes)—low plate voltage (1500)—grid bias only 16 volts! And you can drive a pair with a mere 7 watts. That's performance in any rig, amateur or commercial.

GL-805's pack a wallop in r-f service, too. Just run your eye over the ratings. However you put these tubes to work, you can count on long, dependable service—the kind you can always expect from G-E tubes.

Ask your dealer for complete dope on the G-E line. *Try G.E. and measure the difference!* General Electric, Schenectady, N. Y.

GENERAL  ELECTRIC

# THE AMERICAN RADIO RELAY LEAGUE

## Directors

*President*  
GEORGE W. BAILEY, W1KH  
74 Webster Road, Weston, Mass.

*Vice-President*  
CHARLES E. BLALACK, W6GG  
1700 Foothill Blvd., Altadena, Calif.

*Canadian General Manager*  
ALEX REID, VE3RE  
169 Logan Ave., St. Lambert, P. Q.

*Atlantic Division*  
WALTER BRADLEY MARLIN, W3QV  
Box 612, Roslyn, Pa.

*Central Division*  
E. H. G. MATHEWS, ex-W9ZN  
1634 Dover St., Chicago

*Dakota Division*  
FRED W. YODING, W9MZN  
107 Hanover St., Mankato, Minn.

*Delta Division*  
E. RAY ALLEDGE, W8SH  
P.O. Box 286, Blue Bluff, Ark.

*Hudson Division*  
KENNETH T. HILL, W2AHC  
115 Willow St., Douglass, L. I., N. Y.

*Mitwest Division*  
FLOYD E. NORWINE, JR., W2ERC  
7405 Hawatha Ave., Richmond Heights, Mo.

*New England Division*  
PERCY C. NOBLE, W1BVR  
37 Broad St., Westfield, Mass.

*Northeastern Division*  
RALPH J. GIBBONS, W7KY  
3/6 Dilled Air Lines, Portland, Ore.

*Pacific Division*  
J. L. MCCARGAR, W5RY  
66 Hamilton Pl., Oakland, Calif.

*Pennsylv. Division*  
H. L. CAYENDESS, W4DW  
2307 Vanderbilt Ave., Halden, N. C.

*Rocky Mountain Division*  
GLEN B. GLASSCOCK, W8FA  
2164 So. Corona St., Denver

*Southeastern Division*  
WILLIAM C. SHELTON, W4AHR  
Box 652, Daytona Beach, Fla.

*Southwestern Division*  
JOHN E. BICKEL, W8BKY  
301 E. California St., Whittier, Calif.

*West Gulf Division*  
WILLIAM A. GREEN, W8BRH  
801 Ross St., Abilene, Texas

THE AMERICAN RADIO RELAY LEAGUE, INC., is a non-commercial association of radio amateurs, bonded for the promotion of interest in amateur radio communication and experimentation, for the relaying of messages by radio, for the advancement of the radio art and of the public welfare, for the representation of the radio amateur in legislative matters, and for the maintenance of fraternalism and a high standard of conduct.

It is an incorporated association without capital stock, chartered under the laws of Connecticut. Its affairs are governed by a Board of Directors, elected every two years by the general membership. The officers are elected or appointed by the Directors. The League is non-commercial and no one commercially engaged in the manufacture, sale or rental of radio apparatus is eligible to membership on its board.

"Of, by and for the amateur," it numbers within its ranks practically every worth-while amateur in the nation and has a history of glorious achievement as the standard-bearer in amateur affairs.

Inquiries regarding membership are solicited. A bona fide interest in amateur radio is the only essential qualification; ownership of a transmitting station and knowledge of the code are not prerequisite. Correspondence should be addressed to the Secretary.



## Past Presidents

HIRAM PERCY MAXIM, 1914-1936  
EUGENE C. WOODRUFF, 1936-1940

## Officers

*President*.....GEORGE W. BAILEY, W1KH  
Weston, Mass.  
*Vice-President*.....CHARLES E. BLALACK, W6GG  
Altadena, Calif.  
*Secretary*.....KENNETH B. WARNER, W1EIH  
West Hartford, Connecticut  
*Treasurer*.....ARTHUR A. HEBERT, W1ES  
West Hartford, Connecticut  
*Communications Mgr.*.....F. EDWARD HANDY, W1BDI  
West Hartford, Connecticut

*General Counsel*.....PAUL M. SEGAL  
1026 Woodward Building, Washington, D. C.

Address all general correspondence to the administrative headquarters at West Hartford, Connecticut.

# "IT SEEMS TO US—"

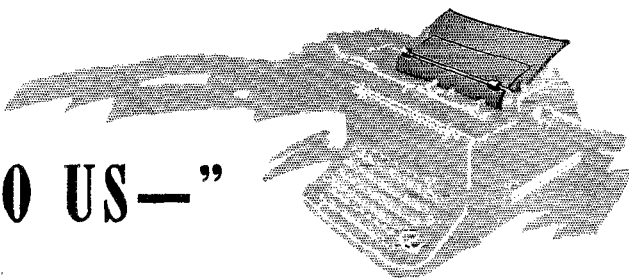

## SILVER ANNIVERSARY

**T**WENTY-FIVE years ago this month, when the American Radio Relay League was nineteen months old and numbered 635 members, the first issue of *QST* appeared. The magazine was first published at the private expense of A.R.R.L.'s founders, Hiram Percy Maxim and Clarence D. Tuska, because they had decided that we absolutely had to have some sort of regular bulletin if our movement were to grow. Its objects were "to maintain the organization of the American Radio Relay League and to keep the amateur wireless operators of the country in constant touch with each other" — to which twin aims it has been constantly dedicated to this day.

How mighty have been the changes we have witnessed since that day: in the whole way of life, in the very political geography of the earth, and within the walls of our own art! It is sufficient of a span to warrant the production of a special issue of *QST* to celebrate the occasion. It justifies us, too, in looking backwards long enough to sketch a little of the background of those early days which saw our birth.

Despite extremely modest beginnings, we remember that *QST* was instantaneously accepted as pure manna from heaven by the amateur of those days. We remember because your present editor was then a young lad back in Illinois, struggling with the intricacies of "wireless" and worried about his nonexistent DX. The publishers announced their hope that, after financing three issues, *QST* would attract enough response to carry itself. They advertised that "Every amateur will help himself and help his fellows by sending in twenty-five cents for a three-months' trial subscription." Our two bits, we remember, started for Hartford the very day we read those lines, and there were enough others who thought the same way to give *QST* its start towards its present indispensable position in our radio lives.

Our first editor and business manager, Tuska, was then a college day student in his late 'teens, *QST*'s office an attic room in his home, his office hours what he could spare from study. His fundamental management policy

was to cast up a month's cash receipts, find out how many copies he needed to print, and ask the printer how many pages could be printed in that quantity for that money. Because *QST* really was "of, by and for the amateur" it grew quickly, soon was invaluable. It reached its pre-war peak in April of 1917, at that time sported both a part-time stenographer and a part-time advertising manager. Then came the war and, after a few issues devoted largely to recruiting, Tuska got out a final September issue and himself joined the Signal Corps, heavily in debt for those last few months of operation.

Came 1919 and the post-war reopening of the League. Tuska wanted to go into manufacturing and the League wanted to own *QST*. With money borrowed from its members, the League acquired the magazine, enabled Tuska to pay off his debts. Since that day, every member of A.R.R.L. has had *QST* sent him monthly. How vividly we remember our first post-war office! For the League had a regular office now, even if it was only two windowless and airless rooms in a wretched rookery. With the June 1919 reopening issue staring us in the face, we were the whole staff. We remember deciding, at the end of the first week, that we'd simply have to hire a stenographer even if we didn't know how the League could find the money. We hired a girl, let her go at the end of a week in favor of a boy who wouldn't mind getting his hands dirty at that other three-legged table which constituted the circulation department. It was grand fun, traversing most of the road that Tuska had gone over before us, until finally, with acquired momentum, we outstripped his pre-war records and dimensions and came gradually into the magazine you know to-day. Looking back at that last sentence, we think it rather a model for compact writing — reflecting, as it does, 21½ of the 25 years we are talking about to-day. Do statistics interest you? There have been over fifteen million copies of *QST* printed. *QST* belongs to the DX Century Club, with 117 countries on its mailing list at the last count. The headquarters staff now numbers 40 people, counting those who have only indirect associa-

tion with *QST*. In this generation the activities of the League have created and have disbursed upon the advancement of amateur radio something like five million dollars. To an age inured to government figures these statistics may have a very low audibility but we think they're of pretty respectable proportions for a hobby.

It wasn't always that way. Our first number had only twenty-four pages in a blue paper cover, and only ten of those pages reading matter; seven were advertisements and the rest notices and data. But for all the humble dimensions of *QST* and the League in those days, there was one close parallel to to-day: the World War was on in Europe and the United States was becoming national-defense conscious. We find the President of the League writing to the Secretary of War and the Secretary of the Navy, offering the facilities of the League. Editor Tuska commented:

"... We are confronted with extremely serious national defense questions. Our country has never before faced a more serious situation. National defense has become a question which every American realizes concerns him personally. The President is preparing plans and the Army and the Navy are both studying carefully every phase of the problem. One of the most important factors is radio communication. The great possibilities of the American Radio Relay League, with its organization of over six hundred relay stations in nearly every state of the Union, are bound to attract prominent attention. The directors of the League have anticipated this, as will be noted on another page."

Multiply this figure of 600 to to-day's terms and the editorial might well have been written this year. In fact, the very next issue reported work towards the formation of a Volunteer Radio Corps:

"The idea seems to be to have the owners of the best relay stations offer their stations to the government in time of need, and bind themselves to comply with certain regulations regarding secrecy, permanence, drills and regular listening hours, and log records, just as owners of automobiles and trucks in England and France join in a Corps and offer their cars and services to the government on demand. . . . What is said upon this subject on another page should be carefully considered by those of us who look upon our country as something to serve to the best of our individual abilities. . . ."

And the advertisements in that first issue! You folks who know ham radio only in terms of tube transmitters and umpteenth-tube receivers and are interested in no DX this side of the Philippines — you really missed a lot. When our first issue appeared, the amount of money you have in your present rig would just about pay for a one-inch spark-coil transmitter and a two-slide tuner, normal DX five city blocks if you were lucky. We find just one advertisement of vacuum tube equipment, an audion detector. Prominent is the rotary gap, "required in every transmitting station" because "this type of gap produces a pure wave of low damping decrement" and gives a note that "cannot be mistaken for static." There was a

key with "straight-line" contacts that had the merit that "fading signals caused by varying resistance of contact points are entirely eliminated." There was a Universal Detector Stand "capable of holding crystals up to and including  $\frac{3}{4}$  inch." No, not quartz plates but rectifying crystals. This one was a complicated gadget with a hollow standard, a ball, a spring, a thumb-screw, an arm, a set-screw and a few more jiggers. It was something really nifty. You have missed a precious part of amateur life who did not live through the days of hot arguments over whether it was better to use a silicon detector with a hard blunt point or a galena crystal with a cat-whisker made of a strand of iron "picture wire"!

The advanced amateur station of those days was something fearful and wonderful, a combination of witchcraft and execution chamber. The transmitter had to contain a condenser and inductance, and a spark gap to discharge it. Since the energy in the condenser depended upon the voltage to which it was charged, and since the size of the condenser was limited by the wavelength and was "too small" even when the inductance was reduced to a single turn, voltages were enormous — 20,000 to 40,000 volts at a kilowatt. Because the instantaneous currents were high, perhaps several hundred amperes, this primary circuit was connected up with copper strap at least an inch wide and the heavy plate-glass condensers were frequently immersed in oil for cooling and to stop brush discharge. This circuit was discharged by a motor-driven rotary spark gap that was pure hell-on-wheels. But ah, what a beautiful thing a well-made rotary was! Here was where dreams were made. Here, in its crashing blue-white spark, was tangible evidence of its might. No matter if it could be heard for blocks — as indeed it could, unless it were put in a double box. No matter if it blinded the operator as well as made him deaf, and gave him red-rimmed eyes from its vaporized zinc electrodes. What if it did lose most of the energy in light, heat and sound; was it not the visible and mighty heart of radio? We hold it up to you to-day in sweet nostalgia as something whose marvelous symbolism we shall never know again.

The output of this remarkable device was coupled to a pancake inductance two feet or so in diameter which was in the aerial circuit. No linear antennas cut to 95.461% of a half-wave. Marconi antennas. That meant that one side was grounded. Grounded to driven pipes and wells and buried tanks and plates and to whole systems of plowed-in wires. Because the instantaneous currents to be handled were large and the voltages terrific, the antennas were of big wire and made into a "flat top" having

relatively high capacity to earth. Say four to twelve wires, spaced about four feet apart on spreaders. Large wire, too. Some of us used aluminum but No. 9 solid copper was a favorite. (No wonder the telegraph companies had deficits!) And this antenna had to be high; none of your 40-foot stuff. Amateur masts in those days were real structures, running 80 to 200 feet high and surrounded by forests of guy wires. Huge electrose insulators were the favorite insulation. Such an antenna system was an engineering job of no mean magnitude. We well remember that our antenna was so much heavier than we were that it would pull us right off the ground, three-quarter-inch halyard and all, and we had to get our dad to help us hoist it.

On the receiving side the modern 1915 station would have junked the slide tuner for the loose-coupler, which had separate primary and secondary and could vary the coupling by sliding the secondary in and out. Navy type, too — meaning switches to vary the number of turns — and a variable condenser across the secondary for fine tuning. Run from amateur wavelengths all the way up to 3500 meters, too, right on one instrument. The detector would be a genuine deForest round audion, hung from a gooseneck socket on a little cabinet that contained the B battery. You made your own battery by soldering up flash-light cells; none of these block jobs on the market until after the war. The audion was a “soft” tube; it worked on a kink in its characteristic curve which you found by careful fiddling with A and B voltages, so you had a potentiometer across your B battery and some fool-proof system of disconnecting it when you closed down the station, else you’d need a new set of cells to-morrow. And because the tube was soft, it would do wonders in a magnetic field, so most stations possessed a strong bar magnet that could be adjusted to a critical position near the tube. Sometimes the tubes got too hard with the passage of time, got too good a vacuum in them, lost their sensitivity — because the gas occluded to the walls of the glass bulb. So an important instrument in most shacks was an alcohol lamp over which the audion could be cooked to drive the gas off the walls and make it “ionic” again. (But, shucks! any of us old-timers could do the job with a match and think nothing of it!) A very rare station sometimes possessed a stage of audio amplification but it was practically unheard of. Moreover, it wasn’t needed. Don’t feel too sorry for the sensitivity of these detectors. The tuning apparatus was crude and the spark method highly inefficient but actually the sensitivity of a good soft audion, operating at the right blue-glow point and under the stimulus of the left pole of a mag-

net taken from a telephone ringer, was simply enormous. We’ve often thought that many multi-tube rigs of to-day don’t touch it in sheer sensitivity to modulated signals. Trouble was you couldn’t hold it in adjustment for long.

Well, there you were, except for the gadgets such as blocking condensers, ‘phones, kick-back preventor, change-over switch and a key with contacts as big as dimes to carry the heavy current. What could you do with it? You couldn’t do much in the summer, particularly at night, because of the static. You couldn’t hear anything when anybody else was sending in the same town, because a nearby signal occupied the whole tuner. But given a break, you could talk for miles, many miles. And given a really good break, a crisp clear winter night in the wee hours after the young squirts with spark-coils had gone to bed, you could have the time of your life and actually work for hundreds of miles . . . if the signals didn’t fade out, if interference didn’t start up, if you didn’t blow a condenser, or if you didn’t lose that critical adjustment. Or if the cops didn’t run you in for maintaining a nuisance, or a wind blow down your masts. And you could investigate the phenomenon known as kickbacks-into-the-power-wiring and, as we twice did, set the house on fire. Or the phenomenon known as corona losses, watching the great fuzzy caterpillars on the high-voltage points of your antenna system. Or involve yourself in endless arguments over high note versus low, what the power factor is in a freely-oscillating circuit, or how loose the coupling ought to be to obtain a “pure” wave.

Those, our friends, were the days from which amateur radio has come — come a great long distance in this past quarter-century. You can see it all mirrored in *QST*, a complete file of which will bulge the ends right off a Five Foot Shelf of Radio Knowledge. We look back with some measure of pride upon the job that *QST* has done in chronicling these twenty-five years of progress, and we also like to think that our magazine has left its own impress upon the development of the art and helped to shape its course. The editorial staff here hasn’t done that alone, of course: it has been possible only because of the unique position of *QST* as the technical forum and centralizing point for amateur investigation. That has resulted only from the fact that ours is a coöperatively-owned magazine, with every member of the League feeling a personal interest in *QST* and wanting to do his bit to help. The first twenty-five years are supposed to be the hardest. We can say that we look forward with nothing but unalloyed eagerness to the next twenty-five.

K. B. W.

**ANNOUNCEMENT**

QST is published by the American Radio Relay League, 221 North Dearborn Street, Chicago, Ill. 60610. It is published quarterly, except for a double issue in December. The subscription price is \$3.00 per year in advance. Single copies are 75¢. There is no charge for a change of address. Send old address label and new address to: QST, American Radio Relay League, 221 North Dearborn Street, Chicago, Ill. 60610.

THE MAGAZINE OF QST



**A Most Wise Engineering Journal**

Published by the American Radio Relay League, 221 North Dearborn Street, Chicago, Ill. 60610. It is published quarterly, except for a double issue in December. The subscription price is \$3.00 per year in advance. Single copies are 75¢. There is no charge for a change of address. Send old address label and new address to: QST, American Radio Relay League, 221 North Dearborn Street, Chicago, Ill. 60610.

QST

**Transcontinental Traffic Report**

**Q**ST is published by the American Radio Relay League, 221 North Dearborn Street, Chicago, Ill. 60610. It is published quarterly, except for a double issue in December. The subscription price is \$3.00 per year in advance. Single copies are 75¢. There is no charge for a change of address. Send old address label and new address to: QST, American Radio Relay League, 221 North Dearborn Street, Chicago, Ill. 60610.

**QST**

A Magazine Devoted Exclusively to the Radio Amateur

**WAR!**

Published by the American Radio Relay League, 221 North Dearborn Street, Chicago, Ill. 60610. It is published quarterly, except for a double issue in December. The subscription price is \$3.00 per year in advance. Single copies are 75¢. There is no charge for a change of address. Send old address label and new address to: QST, American Radio Relay League, 221 North Dearborn Street, Chicago, Ill. 60610.

# A Quarter of a

We were wondering what to write for this anniversary issue of QST. Time was growing short, and we still lacked something "up front" to provide the historical touch the issue needed. So we came back to the office rather late one evening to wrestle the thing out. To our amazement there was a light in our window and voices issued from our transom. Who could be in our office? We peeped in and saw the Old Timer and the Young Squirt, surrounded by piled-high copies of QST. It seems they had an argument to settle, and had come to our file of QST to look up a reference in one of the early issues. One word led to another, and before the evening was out they went through those old issues from the very first. Unobserved, we made notes on their conversation—and when we transcribed those notes we found, to our pleasant surprise, that our article was written!

The cool weather has arrived. "Static" is getting better every night, and the owners of relay stations are returning to their instruments. It is time to send out another official QST from headquarters. There is much to tell not only our membership, but also every amateur in the country. . . .

THE OLD TIMER looked up from the pale blue-covered volume he was reading and peered over his glasses at the Young Squirt.

"You know, son, a lot of history has been made since this first issue of QST was published." He rifled the pages. "Doesn't seem that long ago, somehow. Seems more like last year, or even last month—sometimes. Other times it seems like a century. A long road we've traveled since then. . . ."

He turned the pages musingly, and then began to read again.

First issue of QST. Nr. 1 December, 1915.

After considering the matter for several months, it has finally been decided to issue regularly some kind of a bulletin to League members. During last winter, the need for this was very apparent. Many stations would have been brought together which never got together, if there had been a regular circular distributed which contained general information. . . .

"I REMEMBER it like it was yesterday," the Old Timer said. "The A.R.R.L. had been going for about a year and a half. Growing all the time, I guess, and doing a lot of good, too. But we needed that bulletin—needed something to hold us together. And then Hiram Percy Maxim and Clarence Tuska went ahead and paid for that first issue out of their own pockets. . . ."

The Young Squirt spoke up then. "That *was* real amateur spirit, wasn't it?"

"That's just what it was, all right," the Old Timer acknowledged. "The ham fraternity responded right well, too. 'Twasn't long before we had a real, honest-to-goodness wireless magazine—filled with technical articles and operating dope and even station descriptions and trunk line reports."

He turned the yellowing pages of those first issues slowly, the Young Squirt peering over his shoulder.

"Rotary gaps . . . crystal detectors . . . loose couplers . . . they were the last word, then. Some of us were beginning to use deForest's audion. . . ."

"That was the first triode vacuum tube, wasn't it?"

"That's right. We didn't know much about it, though—

**QST for**

# Century With QST

that is, until . . . hmmm — yes, here it is. August and September, 1916. Paul Godley's famous articles on 'Applications of the Audion,' from his paper before the Radio Club of America. That was where we got our first practical dope on circuits and operation. . . ."

The Old Timer's voice trailed away, and he was silent for a moment as he studied the pages before him. "Doesn't seem possible a man could have known so much about radio then. He had everything in those articles — high-Q coils (only we didn't know the term Q then), audio transformer design, regeneration, oscillation, heterodyne detection — all that at a time when they were still calling the plate of a tube the 'wing'!"

The Young Squirt was impressed, but also a little puzzled. "They didn't have much actual constructional dope in those days, did they?" he asked. "Seems to me there was more general theory and station descriptions than anything else, except the humorous articles and operating stuff."

"Well, here's a real constructional article," the Old Timer answered, turning to the December, 1916 issue. "'A Short-wave Regenerative Receiver' — short-waves being from 200 to 600 meters! 'The QST Tuner,' we came to call it. A famous old set it was, too — probably made a deeper impress on amateur work than any single development since that time except the single-signal idea. Proportionately more of them were built than any other receiver design in our history!"

"Not that those days really amounted to so much in the way of technical progress," he continued. "We were kind of inclined to take it easy — rest on our laurels, so to speak. We took it for granted that the only worth-while way to get better performance was to increase power — and spent most of our time operating."

"How about operating? Did you take it easy in that, too?"

"We did not! Competitive spirit was mighty high, and we added miles to our records almost every night. Here — look at this January, 1917 editorial. . . ."

. . . In no previous year has amateur wireless advanced so much as it did in 1916. Instead of a mere handful of stations having the distinction of working 500 miles, we now have several hundred able to work close to 1,000 miles. . . .

"THE RELAY IDEA had caught on in a big way, too, and we were shooting messages all around the country. Even got so we tried to relay a message from the Atlantic to the Pacific in a single evening."

"You did it, too, didn't you?" the Young Squirt prompted.

"You bet we did!" the Old Timer assented proudly. "Oh, we were going great guns, then. As Tuska said, amateur radio was ready for the biggest year of its career in 1917. . . ."

"Then came the war. The May, 1917 issue — the cover printed in red ink, with 'WAR NUMBER' splashed in big letters across it. . . . The June issue, calling for amateurs who could take twenty words a minute and operate a station to join the services. . . . The July issue, calling for 2,000 amateurs to volunteer. . . ."

"And so you all went to war?"

## December 1940

# QST

GETTING TOGETHER AGAIN

The radio world has been through a long and trying period. The war has taken away our normal life, and we have been forced to live in a state of constant alertness. But now, as the war draws to a close, we are beginning to see the light at the end of the tunnel. We are beginning to see that we can get on with our lives again, and that we can enjoy the same pleasures that we once enjoyed. We are beginning to see that we can get on with our lives again, and that we can enjoy the same pleasures that we once enjoyed.

A. E. L. BROWN

### The Famous VT-1

By A. E. L. BROWN

The VT-1 is a famous receiver. It is a short-wave regenerative receiver. It is a famous receiver. It is a short-wave regenerative receiver. It is a famous receiver. It is a short-wave regenerative receiver. It is a famous receiver. It is a short-wave regenerative receiver.



### QST

A Magazine Devoted Exclusively to the Radio Amateur

#### A New Method for the Reception of Weak Signals of Short Wave Lengths

This is a new method for the reception of weak signals of short wave lengths. It is a new method. It is a new method. It is a new method. It is a new method. It is a new method. It is a new method.

### QST

A Magazine Devoted Exclusively to the Radio Amateur

#### New Apparatus For C. W.

This is a new apparatus for C. W. It is a new apparatus. It is a new apparatus. It is a new apparatus. It is a new apparatus. It is a new apparatus. It is a new apparatus.



This is a new apparatus for C. W. It is a new apparatus. It is a new apparatus. It is a new apparatus. It is a new apparatus. It is a new apparatus. It is a new apparatus.

Station Performance During the Bureau of Standards - A.R.R.L. QSS Tests of June and July, 1920

By S. K. Koser

Technical Editor, QST

The following is a summary of the results of the QSS tests conducted by the Bureau of Standards during the months of June and July, 1920.

The performance of the individual stations was generally good, and the results were very satisfactory. The tests were conducted under the supervision of the Bureau of Standards, and the results were published in the QST.

THE RECORDS

The following are the records of the QSS tests conducted during the months of June and July, 1920.

QST A Magazine Devoted Exclusively to the Radio Amateur

A Receiving Tuner for C.W.

It is not likely that any amateur who has been interested in the C.W. receiving tuner will be surprised to find that the author has been successful in his attempt to design a receiving tuner for C.W. which will give the best results.



The following is a description of the receiving tuner for C.W. It consists of a tuned circuit with a variable capacitor and a coil, connected to a detector and amplifier.

QST A Magazine Devoted Exclusively to the Radio Amateur

Super-Regeneration

An Invention of Tremendous Importance to the Amateur

By E. H. Warner

BEFORE an amateur undertakes to attempt a super-regenerative circuit, he should first understand the principles of super-regeneration. This is a circuit which gives a very high gain and is very sensitive to the input signal.

"Well — most of us did. Just about every ham who could qualify did — some 4,000 of us out of a grand total of 6,000 or so, of all ages."

"You did a great job, too," the Young Squirt told him. "I know — I've read the story. But the government didn't seem to remember that when the war was over and you wanted to get back on the air, did they?"

"No, it looked for a time as though they didn't. It was almost a year after the war ended before the ban on transmitting was lifted — and then only because the A.R.R.L. forced the administration to take action by working through the Congress."

"I'll bet there was plenty of excitement then." "Say, son, you've never seen excitement to compare with it! The October issue of QST was in the mail when the announcement came, but they sent this special 1-page supplement to all members. . . ."

BAN OFF!

The job is done, and the A.R.R.L. did it. . . .

COMING! The biggest boom in amateur radio history. . . .

WE'RE OFF!

"THAT MEANS the A.R.R.L. had been reorganized, then?"

"Oh, yes. I've told you before about that post-war reorganization, haven't I? About how they tried to write our death warrant as hams in 1918, before we got back from 'over there,' with the Alexander bill — and how the A.R.R.L. with the 'little blue card' sent to 'Any member of the family of;' every pre-war amateur, plus H.P.M.'s testimony at the hearings, licked it?"

"And how a bunch of loyal members met in New York in March, 1919, and went into their pockets and brought up enough cash to pay for the first post-war bulletin-size issue of QST?"

"Yes, I remember now," the Young Squirt said. "It must have taken plenty of courage to do that, when they had no assurance that amateur radio would reopen or that the League could be brought to life again."

"These fellows figured out that the best way to get the League going again was to get out one issue of QST, as a sort of rallying cry and call for help. The help came, all right — we all chipped in as much as we could and pretty soon \$5700 worth of bonds had been subscribed. They bought QST from Tuska, who was going into the radio manufacturing business."

"And then they got the transmitting ban lifted, and soon amateur radio and the A.R.R.L. were booming again. Is that it?"

The Old Timer grinned. "That's about it, all right. Stations came back on the air faster than you could count 'em."

"But, son, how things had changed! Two years made an awful lot of difference, especially with all the research that had gone on during the war. We started getting fairly decent vacuum tubes, for one thing. Even began to think about using them for transmitting — continuous-wave stuff — undamped, no less. We found out about loop aerials and honeycomb coils and other novel gadgets, and we fought the old 'high-tone vs. low-tone' spark battle all over again."

The Young Squirt's finger halted the Old Timer as the latter picked up another volume of QST and leaved rapidly through its pages.

"Wait a minute — didn't I see Major Armstrong's paper on the superheterodyne back there?"

Exploring 100 Meters By E. Koser, Technical Editor

When you have a radio that is capable of receiving signals from 100 meters, you are in a position to receive signals from a large number of stations. This is a very important part of the amateur radio hobby.

March, 1923

Received of QST for the last part of the year, and I have been very interested in the articles. The QST is a very good magazine and I have learned a great deal from it.

QST for

The Young Squirt's finger halted the Old Timer as the latter picked up another volume of QST and leaved rapidly through its pages.

QST for

QST for



"Yes, that was one of a real series of firsts we got through QST's arrangement with the Radio Club of America to publish papers presented before it. QST soon became one of the best-respected technical journals of the radio art. It got bigger and better all the time. See, there are a few more pages almost every issue — up to 120 by the end of 1920."

"It was growing, all right," the Young Squirt agreed a bit absently, turning the pages. "Look — here's an interesting thing. According to this November, 1920 issue hams provided the first police radio service!"

"That's right. The idea was first tried out in Hartford. . . ."

Have any of you fellows ever thought of the possibilities of amateur radio in helping recover stolen automobiles? The matter was brought up here at headquarters recently, and we took it up with the Chief of Police of Hartford. . . . It would be the first time that amateur radio stations would be put to a real practical use all over the country . . . let's do something with it. . . .

"And did you?"

"Yes, we did. Quite a few amateurs cooperated in police networks for a period in the early '20's. It was our first practical contribution to public service."

"By that you mean, of course, the first contribution through operating activity. You had a reputation for technical achievement by then, didn't you?" asked the Young Squirt.

"Yes — but we had to work for it, though. Here is our first big job after the war — the A.R.R.L. Bureau of Standards QSS Tests."

"QSS? I didn't know there was such a Q signal."

"There isn't, now. Then it meant fading. The idea was to get amateurs all over the country to make observations on 250-meter fading, with data from selected stations turned over to the Bureau of Standards for correlation and interpretation."

"Were these spark or c.w. stations?"

"Oh, spark, of course. A few of us were playing with c.w. rigs then, but it wasn't very satisfactory. The receivers we used mostly had plate-variometer tuning; the slightest shift in the position of the hands or body — the least swinging of the antenna by wind — and a c.w. signal would be lost. There were so many controls it took an expert to tune a signal in."

"But then a lad in Manchester, Connecticut — John Reinartz was his name — built a tuned-grid tuner with tickler feedback that would hold a c.w. signal almost as well as spark."

"That gave you what you needed to go ahead, then, I suppose?"

"That was the first thing we needed — a good c.w. tuner. The next was a good transmitting tube. The VT2's and the Navy 'P' tubes were about all we had, and they were scarce and hard to get. But in early 1921 RCA announced the UV-202 — the historic old 5-watt — and later the UV-203 and UV-204 — rated at 50 and 250 watts."

"Gosh, look at those prices!" marvelled the Young Squirt. "\$8.00 for a 202 — \$30.00 for a 203!"

"Yes, we had to save a lot of pennies to put a 50-watt c.w. rig on the air in those days," the Old Timer smiled. "But it was worth it!"

"Oh, sure — I don't doubt that. Even to-day a good ham will scrape and skimp in order to get something new!"

"With those tubes the spark-c.w. war really began. QST began to plug c.w. harder and harder. Even so, it took the transatlantic tests of 1921 to turn the tide — when over two-thirds of the stations heard across the Atlantic were using c.w. Spark was

**Transatlantic Tests Successful**

**O**n the 10th of December, 1921, the first successful transatlantic radio communication was achieved. The feat was accomplished by a group of amateur radio operators who were participating in a series of tests arranged by the Radio Club of America. The tests were conducted over a period of several days, and the results were most encouraging. The first successful communication was made between a station in New York and a station in London. The message was received in London at 12:45 P.M. on December 10th. The test was a great success, and it proved that amateur radio operators were capable of making long-distance communications. The tests were arranged by the Radio Club of America, and they were conducted over a period of several days. The results were most encouraging, and they proved that amateur radio operators were capable of making long-distance communications. The first successful communication was made between a station in New York and a station in London. The message was received in London at 12:45 P.M. on December 10th. The test was a great success, and it proved that amateur radio operators were capable of making long-distance communications.



**10,000 Miles in 4 Minutes**

**O**n the 10th of December, 1921, the first successful transatlantic radio communication was achieved. The feat was accomplished by a group of amateur radio operators who were participating in a series of tests arranged by the Radio Club of America. The tests were conducted over a period of several days, and the results were most encouraging. The first successful communication was made between a station in New York and a station in London. The message was received in London at 12:45 P.M. on December 10th. The test was a great success, and it proved that amateur radio operators were capable of making long-distance communications. The tests were arranged by the Radio Club of America, and they were conducted over a period of several days. The results were most encouraging, and they proved that amateur radio operators were capable of making long-distance communications. The first successful communication was made between a station in New York and a station in London. The message was received in London at 12:45 P.M. on December 10th. The test was a great success, and it proved that amateur radio operators were capable of making long-distance communications.

**Amateur Radio Shoves Off for the Pole**

**A** party of radio amateurs has just completed a successful expedition to the North Pole. The party, led by a radio amateur, was equipped with a radio set and other necessary equipment. They were able to maintain communication with their base throughout the entire trip. The expedition was a great success, and it proved that amateur radio operators were capable of making long-distance communications. The tests were arranged by the Radio Club of America, and they were conducted over a period of several days. The results were most encouraging, and they proved that amateur radio operators were capable of making long-distance communications. The first successful communication was made between a station in New York and a station in London. The message was received in London at 12:45 P.M. on December 10th. The test was a great success, and it proved that amateur radio operators were capable of making long-distance communications.

**T**he 1924 tests were a great success. The tests were arranged by the Radio Club of America, and they were conducted over a period of several days. The results were most encouraging, and they proved that amateur radio operators were capable of making long-distance communications. The first successful communication was made between a station in New York and a station in London. The message was received in London at 12:45 P.M. on December 10th. The test was a great success, and it proved that amateur radio operators were capable of making long-distance communications.

**Transatlantic Amateurl Communication Accomplished!**

**T**he 1924 tests were a great success. The tests were arranged by the Radio Club of America, and they were conducted over a period of several days. The results were most encouraging, and they proved that amateur radio operators were capable of making long-distance communications. The first successful communication was made between a station in New York and a station in London. The message was received in London at 12:45 P.M. on December 10th. The test was a great success, and it proved that amateur radio operators were capable of making long-distance communications.

king for a few months more, but then it began to die and soon c.w. was supreme."

"Those were the days, all right," the Young Squirt paid tribute. "Wish I had been a ham then!"

"It was fun. More than that, we were accomplishing something, and we knew it. All of the time amateur radio was growing, both in members and in the respect of the radio world. And you can bet we were proud when recognition of this came with the January, 1922 issue of *QST*. . . ."

We have the honor of announcing that Secretary of Commerce Herbert Hoover has offered a cup to be competed for by us amateurs annually during the present administration, under such conditions as the Board of Direction of the American Radio Relay League may lay down. . . .

"**WE WERE MIGHTY GLAD** of the support of the Commerce Department in the next few years. The broadcast boom was just getting under way then. During the last few months of 1921 thousands of broadcasting stations — many of them commercials, but a lot of them just plain amateurs — went on the air. By 1922 it was bedlam. So Secretary Hoover called the first of his series of National Radio Conferences. We had a tough time of it, now and then — fighting against the demands of hundreds of thousands of b.c.l.'s whom we interfered with on their single-circuit tuners. But we had the Commerce Department's support and the A.R.R.L. and *QST* went to bat for us, and we pulled through."

"Those must have been exciting times — always something new."

The Old Timer became philosophic. "These times we're living in now will seem exciting when we look back at them through the eyes of a swift-moving, sketchy reviewer."

"Yes, I know. Distance lends enchantment — or something."

"We were doing a lot of new things at that, though — making front-page newspaper headlines almost every day. We sent Godley to Scotland and shot signals at him for the first successful transatlantic tests — spanning the Atlantic on 200 meters. We organized tests with Australia and New Zealand, and licked the Pacific. We sent Don Mix to the Arctic with MacMillan and WNP and provided an expedition with radio communication for the first time in history. The highspot came when 1MO and 1XAM worked 8AB in Nice, France — the first transatlantic two-way amateur communication — on November 27, 1923."

"I'll bet nobody ever had a bigger thrill than that!"

"You never said a truer word. The signal from France came through, perfectly clear and readable, from the very first dot — sent on the exact second of the schedule."

"That's striking in itself, isn't it? That the first transatlantic contact was made not by accident but as the result of careful planning, I mean," the Young Squirt emphasized. "How did they work out the plan, anyway?"

"It was at the A.R.R.L. National Convention in Chicago, which 8AB attended when he visited the United States. They worked out the plan and carried it through — that's all there was to it!"

"Speaking of conventions — were they holding them as early as that?"

"Yes, we were building up the fraternal side of amateur then, too. Ham conventions became an institution starting with a big Central Division meeting in Chicago in September, 1920, with

**QST for**

nearly 400 amateurs from seven districts there. The Midwest Division was next. These and similar gatherings in the other divisions led to the First A.R.R.L. National Convention, held in Chicago a year later. Gosh, what a time! Twelve hundred wild men from every district and almost every state! We just took that town over for about four days."

The Young Squirt grinned appreciatively. Then his voice grew serious again. "This was a period of great research, too, wasn't it?"

"Well, sometimes we wondered whether there wasn't more time spent in dictionary research looking up fancy names for the thousand and one trick circuits than was spent in the laboratory! But a lot of worth-while things were coming out, at that. Hazeltine made tuned r.f. amplification practical with his Neurodyne circuit. Grimes inflicted his Inverse Duplex on the rising army of home set-builders. Dozens of experimenters were working persistently, adding bit by bit to our knowledge."

The Old Timer's voice grew solemn. "And it was then *QST* came to something like a fork in the road. To the left stretched the broad, inviting avenue of the broadcast craze, a road down which practically all the popular radio publications had already started. Straight ahead lay the road of transmitting amateur radio, narrow, but running true and unswerving on to the distant horizon."

"And *QST* took the right road?"

"It did, my boy, it did. It disregarded the innumerable -dynes and -plexes and high-flown commercial exploitation and went about developing the serious phases of radio. Here, in the June, 1922 issue. . . ."

With all the other magazines turning eagerly to popular radio because of the greater financial reward to be obtained in the big field of broadcast fans, we are more than ever determined that *QST* shall remain a magazine "of, by and for the amateur." . . .

"IT WASN'T LONG before this policy was proved right. *QST* found itself with a job to do, a big one — the development of the short waves.

"Up to 1924 about 98% of amateur radio was to be found on 200 meters. Some of us occasionally got down to 150, especially after the Second Hoover Conference gave us a band running from 150 to 200. A few hardy souls had even tried 100. But it was not until the u1MO-f8AB transatlantic QSO on 100 meters in November, 1923 that hams generally caught on to the value of the short waves. Then we started down — and we didn't stop until we reached 20 meters and had worked the world from one end to the other, all in hardly more than a year's time!"

"Was 20 meters the lowest you could work then?"

"Oh, no. We had a 5-meter band along with the other short-wave bands from the time they were first assigned domestically, in July of '24. Quite a few of the boys even got rigs working on five. But they had the wrong slant — they thought that since each successive drop in wavelength before had brought them better DX, 'five' ought to just about reach Mars. It didn't, of course, and their unstable self-excited rigs and regenerative receivers didn't work well even over short distances. They were bad enough on 20 and 40; on five they were unworkable."

"Those self-excited rigs were pretty bad, eh?"

"Yes, I'm afraid they were. But we didn't know it, then. We thought they were just about the last word, in fact. *QST* brought us Shaw's original article on crystal control in 1924, but it didn't catch hold until 1926 and '27."

December 1940

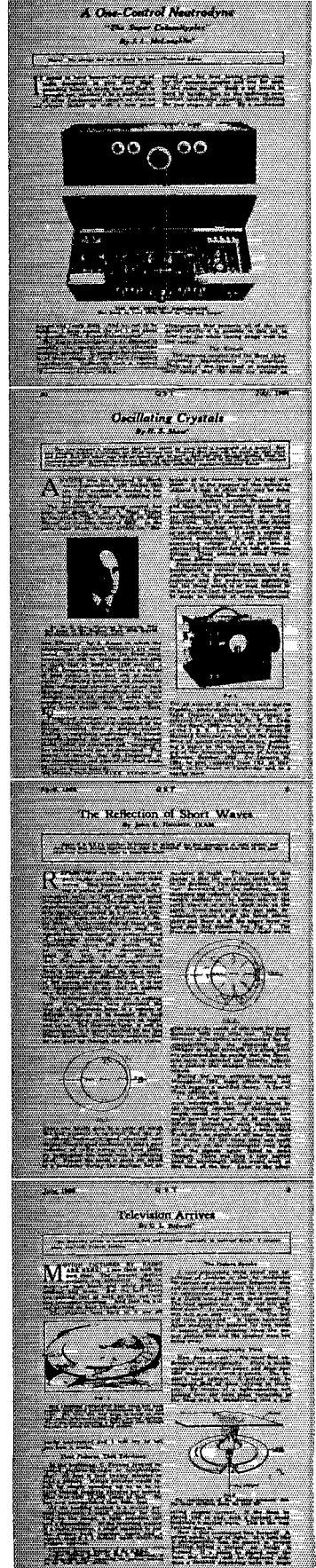

By Robert S. Knew, Technical Editor

THE answer for the UX-221 is in the shield-rotor design... The shield-rotor is a type of rotor which is shielded from the antenna...



It is well known that the UX-221 is a shield-rotor... The shield-rotor is a type of rotor which is shielded from the antenna...

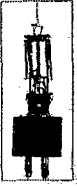

Overhauling the Transmitter for 1929

Some Modifications Which Permit Substantial Advances in Self-Excited Circuit Performance.

By Ross A. Hull

It is well known that the UX-221 is a shield-rotor... The shield-rotor is a type of rotor which is shielded from the antenna...

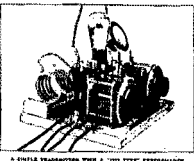

A shield-rotor antenna system... The shield-rotor is a type of rotor which is shielded from the antenna...

Modern Practice in High-Frequency Radiotelephony

A Discussion of Improved Methods Which Virtually Revolutionize Amateur Phone Transmission.

By Ross A. Hull

It is well known that the UX-221 is a shield-rotor... The shield-rotor is a type of rotor which is shielded from the antenna...

The Status of 28,000-kc Communication

A Review of Recent Attained a Discussion of Some Practical Suggestions Which Present Theories and a Presentation of Several Practical Suggestions.

By Ross A. Hull

It is well known that the UX-221 is a shield-rotor... The shield-rotor is a type of rotor which is shielded from the antenna...

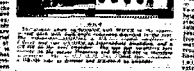

It is well known that the UX-221 is a shield-rotor... The shield-rotor is a type of rotor which is shielded from the antenna...

"Because it was too difficult, or because you just couldn't be bothered with it?"

"Mostly because we didn't realize how badly we needed it. We thought what we had was plenty good enough. Oh, yes — we thought we were pretty well advanced in radio in those days. Knew just about everything there was! McLaughlin had shown us that single-control neutrodynes and superheterodynes could be built. 'Low-loss' was our keynote — it made us suckers for trick coils and condensers. Pickard introduced us to the Zepp antenna. Mercury arcs, chemical rectifiers, motor-generators — these were the common power sources. Broadcast receivers were all t.r.f.; short-wave receivers almost all a simple detector and one- or two-step.

"We even had television — the scanning disc kind!"

"That was about fifteen years ahead of its time, wasn't it?"

"In other fields we were pretty well satisfied with ourselves, too. We had reached what Warner once called 'the ultimate limits of terrestrial DX'; there were no new DX records in mile-ages to be made, but there were new countries coming on the air all the time, and there was always competition to be had in working DX with low power. In Australia a2CM worked 1500 miles to New Zealand with 0.004 watt; u8GZ covered the 10,100 miles to Australia (and similar distances to New Zealand and South Africa) with 0.567 watts to a UV-199!

"It was at about this time, too, that Reinartz propounded the reflecting-layer skip-distance theory and added an amateur page to some of those big books on pure physics.

"And then, in the February, 1925 issue of QST, Hiram Percy Maxim wrote this. . . ."

Not since that memorable day in 1917 when the telephone rang and "long distance" told me that the New York Navy Yard wanted me, have I had as much kick as I have just got out of a letter from the Director of Naval Communications . . . [which] asks if the A.R.R.L. will assist the Navy Department in the organization of a top-notch A-Number-One Radio Naval Reserve. . . .

"AND THAT was the beginning of the N.C.R.?" the Young Squirt asked.

"That's right. The Army Amateur Radio System was organized that year, too. There was a big achievement, my boy — the first purely amateur affiliation with the military forces.

"If the Naval Reserve and A.A.R.S. didn't show us how we stood with the military forces of our country, Traffic Manager Fred Schnell's trip with NRRL on the Navy cruise to Australia did. It was on that trip he demonstrated short waves to the Navy, you know."

"A grand job, wasn't it?"

"And it was in 1925, too, that the International Amateur Radio Union was founded in Paris."

The Young Squirt picked up the volume of QST the Old Timer had just laid down. "Say, these QST covers by 8ZZ caught the spirit of amateur radio in grand fashion, didn't they?"

"Son, they were masterpieces! Good ol' Clyde Darr had a rare understanding of amateur radio. They added a lot to the magazine in those days."

"Course, we've had some fine covers since then, too . . . the Podunk Hollow gang, and Ross Hull's famous trick camera shots," the Young Squirt acknowledged.

"Look at this 8ZZ cover for May, 1926, showing a ham warming his hands before an old pot-bellied stove in a railroad

station, after delivering an emergency message to the station agent! You can just see the agent, his glasses on the tip of his nose, grunting around the stem of his pipe as he takes the message." The Old Timer chuckled.

"Amateurs give emergency service for railroads when wires are down," the Young Squirt read the caption. "Was there much ham emergency work then?"

"Quite a bit. The PRR — Pennsylvania R. R. net — was doing a fine job. Now and then a flood or hurricane would come along, and we'd help as best we could."

"How about general operating activity? What did you concentrate on most?"

"Anything and everything, just about. We were handling quite a bit of traffic, plus a lot of ragchewing, of course, and there was some 160-meter 'phone. We even had a new 80-meter 'phone band 'on trial' for a few months. But the big activity in amateur radio up to and including 1927 was DX.

"Then, in 1927, the rest of the nations of the world ganged up on us at the International Radio Conference at Washington and voted about 75 or 80 to 1 to establish international high-frequency bands that were narrower than those we had temporarily been allowed to use in this country. When this treaty went into effect, the first of 1929, a lot of us began thinking more about some of these other phases of ham radio, and domestic traffic-handling and 'phone both began to attract a lot more of the gang."

"Did the narrower bands prove quite a hardship?"

"Well, for a while it looked like they would, but the League and QST were in there plugging as always. They started the A.R.R.L. 1929 Technical Development Program to find the answer to some of our problems. Ross Hull headed it up. They soon showed us how to make our lousy self-excited rigs decently stable, and how to get selectivity and stability and easy tuning with nothing but a little old regenerative receiver. Fortunately, we had screen-grid tubes by then, which helped the receiver problem.

"The program ran for something like a year, and it probably produced more down-to-earth practical advances in ham radio's constructional technique than any equivalent period of twice that time in our history. They even gave us the first practical short-wave superhets, and applied 100% modulation and Class B linear r.f. amplification for the first time. Those last two were new even to the broadcast boys, and within the next few months something like 49 out of every 50 b.c. stations in the country were torn down and rebuilt à la QST!"

"Swell! And this new gear — it really helped in working in the 1929 bands, then?"

"Oh, yes — enormously. Another idea that proved of considerable help — especially when the big boom in the number of hams came along in the early '30's — appeared in the June, 1929 QST editorial. . . ."

In the "net" system of communication used by the Army and Navy . . . there is an idea which, it seems to us, is worth investigating with a view to giving it a wider application in amateur radio generally. We refer to the basic fact that all the stations in any one such net use the same frequency. Thus the ultimate economy in frequency channels is realized. . . .

"HARD TO REALIZE isn't it, that of the hundreds of spot-frequency nets of all kinds we have now, virtually not one existed ten years ago?"

# December 1940

**Push-Pull** with Motor-Driven Transmitter

It is the aim of this transmitter to be a simple, rugged, and efficient design. It is designed to be used for transmitting on the 160-meter band, and is capable of transmitting 100 watts of power. The transmitter is built around a push-pull modulator, which is driven by a motor. The motor is connected to the modulator through a transformer. The transmitter is built around a push-pull modulator, which is driven by a motor. The motor is connected to the modulator through a transformer. The transmitter is built around a push-pull modulator, which is driven by a motor. The motor is connected to the modulator through a transformer.

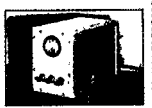

Fig. 1931

### The Class B Push-Pull Modulator

An Efficient System for Complete Modulation in Amateur Radio Transmitters

By Roy E. Saxon

The Class B push-pull modulator is a simple and efficient system for complete modulation in amateur radio transmitters. It is designed to be used for transmitting on the 160-meter band, and is capable of transmitting 100 watts of power. The modulator is built around a push-pull modulator, which is driven by a motor. The motor is connected to the modulator through a transformer. The modulator is built around a push-pull modulator, which is driven by a motor. The motor is connected to the modulator through a transformer.



Fig. 1932

### What's Wrong With Our C.W. Receivers?

Overlooking Our Ideas of How They Work—Double-Beat Response—RF Selectivity—Pulsing—The "Key" Effect

By James J. Leah, Technical Editor

It is the aim of this article to discuss the various problems that are encountered in the operation of C.W. receivers. The article discusses the double-beat response, RF selectivity, and the "key" effect. The article is intended for amateur radio operators who are interested in improving their C.W. receiving techniques.

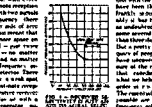

Fig. 1933

### A 14-Mc. Rotary Beam Antenna for Transmitting and Receiving

An Effective Way of Increasing Transmitted and Received Signal Strength

By John P. Dunlap, W2CZL

The 14-Mc. rotary beam antenna is a simple and effective way of increasing transmitted and received signal strength. It is designed to be used for transmitting and receiving on the 14-Mc. band. The antenna is built around a rotary beam antenna, which is driven by a motor. The antenna is built around a rotary beam antenna, which is driven by a motor. The antenna is built around a rotary beam antenna, which is driven by a motor.



Fig. 1934

The Amateur and the International Radiotelegraph Conference



The Young Squirt nodded, and the Old Timer went on. "There's one thing I'll be eternally grateful to the Washington conference for. It gave us our 10-meter band. Almost as soon as it was assigned in this country W1CCZ and W6UF worked across the continent on ten, but 1929 was on a bad part of the solar cycle and the band did not see widespread general use until some six or seven years after. Then, of course, it turned out to be a sort of miracle band, and vitalized the DX craze that was coming to life again."

"I'll say you should be grateful for that! Imagine what a loss it would have been not to have had the 10-meter band the past few years. The only thing I don't understand is why it took so long to get hams generally to use it."

"You know, it seems like all of our new bands sort of have to age awhile before they get good. The same thing was true of five, and it has recently been true of 2 1/2, and now you can see it working out at 1 1/4. The 5-meter band was dead as a doornail from 1927 or thereabouts until 1931. Then it took hold all of a sudden, and almost overnight there were stations by the hundreds on in most all the big cities."

"Why did it take hold then and not before?" the Young Squirt asked.

"Well, a full answer to that question would be a long story and involve more -ologies than I've got time for. It boils down to the fact that the boys liked the novelty of talking around town on 'phone, and were willing to abandon the use of c.w. and the idea of super-DX on the band. From the technical standpoint, the secret lay in the application of the superregenerative receiver — making frequency stability unimportant and the equipment simple and inexpensive."

"That sounds logical enough."

"Then, too, we were in the middle of the cycle of technical advance that was inaugurated by the 1929 Development Program. This cycle led to some of the greatest advances in amateur radio's history — the application of Class B modulation, the development of the Single-Signal superheterodyne, the use of directive antenna arrays on both u.h.f. and DX bands, and other developments of narrower scope such as the electron-coupled oscillator, the Tri-tet circuit, suppressor-grid modulation, and split-stator neutralization. Plus such things as Kolster hats and linear oscillators and other gadgets for improving u.h.f. stability — and the Lamb noise silencer, too."

"Speaking of u.h.f., I noticed Hull's articles on air-mass bending and lower atmosphere reflection as you were going through those issues. That was important, too, wasn't it?"

"I'll say it was. It represented one of the major contributions by amateurs to radio propagation theory, by gum!"

"Like the Reinartz skip distance theory and the A.R.R.L. Bureau of Standards QSS Tests, I suppose."

"That's right. There were a lot of other technical ideas presented originally in QST about that time and since, too. Some of them were just passing fancies; others are taking their place in our picture. Let's see — skimming through we see such things

The Madrid Conference



The First Interamerican Radio Conference



The Battle of Cairo



as the pi-section antenna coupler (the thing we called the Collins coupler), the dual-triode exciter circuit, controlled-carrier modulation, the super-infragenerator receiver, the single-control diversity receiver, the see-saw noise silencer . . ."

"Wait a minute," the Young Squirt broke in. "You skipped inductive neutralization and the Heterotone there in 1936."

"Well, yes — although we don't hear so much of them now. But here is the wide-range crystal filter, which *did* catch on, and the first successful radio control of model aircraft."

"Yes, and infinite i.f. rejection and infinite image rejection and the extended double-zepp antenna and . . ."

"Whoa, hold on there, young fellow. I know that list as well as you do! Next thing you'll be telling me that amateurs discovered frequency modulation and television."

The Young Squirt smiled to show that he knew he was being kidded, but his reply was serious. "Well, we didn't discover them — but we are applying them, and we've already uncovered a few things that help out the commercial engineers, haven't we?"

"I suppose you're right. Sometimes it seems to me we hams don't do as much original technical work as we did fifteen or twenty years ago — but when you take into consideration all the research laboratories with elaborate equipment that are working on radio now compared with twenty years ago, the ham shows up pretty well at that."

"One thing we've got is numbers, anyway. When it comes to practical applications or development under actual use, we've got them all beat," the Old Timer concluded.

"Of course, there's more emphasis now on operating proficiency than on technical development or DX or some of these other ham activities," said the Young Squirt reflectively.

"Well — yes, and no. We can stand plenty of technical development now, too. But you're right about the other things."

"You know, looking back through these *QST*'s covering twenty-five years, there's one thing that stands out."

"What's that?"

"That all the progress and all the change has been in details alone — the fundamental principles are still the same. We used receivers and transmitters then — we use them now. The first issues of *QST* contained much the same sort of articles and departments that we have to-day. We have modern typography, now — and cleaner diagrams and clearer photographs — but we still talk about hams and ham radio just as we did then. . . ."

"And good operating practices, and code proficiency, and cleaner signals are just as important now as they were then. Our internal resistance to change makes us just as slow to take on f-m and facsimile and television as we were slow to give up spark or tackle the short waves 15 or 20 years ago."

The Old Timer smiled a bit sheepishly, and wagged his greying head. "And after all this preaching — so what?"

"Why — so that you win the argument," the Young Squirt conceded. "I'm going to get to work on that micro-wave set tomorrow!"

"Now let's go home."

December 1940

Extending the Range of Ultra-High-Frequency Amateur Stations

The Story of Some Experiments Made During the Summer Months of 1939

By Paul A. Lee

It is well known that the range of ultra-high-frequency amateur stations is limited by the absorption of the atmosphere. The amount of absorption is dependent upon the frequency and the distance. The higher the frequency, the greater the absorption. The distance also has a bearing on the absorption, as the signal has to travel a longer path through the atmosphere.



The author's experiments were conducted during the summer months of 1939. The results showed that the range of ultra-high-frequency amateur stations can be extended by using certain techniques. These techniques include the use of a directional antenna, a high-gain antenna, and a high-power transmitter. The author also discusses the importance of proper antenna placement and the use of a ground plane.

Practical Communication on the 224-Mc. Band

The New Type and Design of Amateur Band's World of Possibilities

By Paul A. Lee

The 224-Mc. band is a very interesting and useful band for amateur radio operators. It offers a wide range of possibilities for practical communication. The new type and design of amateur band's world of possibilities is a result of the author's experiments and research.



The author provides a detailed description of the circuit and its operation. The circuit is designed for practical communication on the 224-Mc. band. It includes a high-gain antenna and a high-power transmitter. The author also discusses the importance of proper antenna placement and the use of a ground plane.



The author's experiments were conducted during the summer months of 1939. The results showed that the range of ultra-high-frequency amateur stations can be extended by using certain techniques. These techniques include the use of a directional antenna, a high-gain antenna, and a high-power transmitter. The author also discusses the importance of proper antenna placement and the use of a ground plane.

Stabilizing the Ultra-High-Frequency Transmitter

Recent Researches Reported at the 1940 and 1939 Conventions

By Paul A. Lee

The stability of an ultra-high-frequency transmitter is a critical factor in practical communication. The author's researches reported at the 1940 and 1939 conventions show that the range of ultra-high-frequency amateur stations can be extended by using certain techniques.



The author provides a detailed description of the circuit and its operation. The circuit is designed for practical communication on the 224-Mc. band. It includes a high-gain antenna and a high-power transmitter. The author also discusses the importance of proper antenna placement and the use of a ground plane.

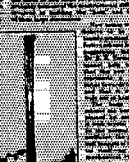

The author's experiments were conducted during the summer months of 1939. The results showed that the range of ultra-high-frequency amateur stations can be extended by using certain techniques. These techniques include the use of a directional antenna, a high-gain antenna, and a high-power transmitter. The author also discusses the importance of proper antenna placement and the use of a ground plane.

A Noise-Reducing I.F. Circuit for Superhet Receivers

A Method of Reducing Copying Noise, Tone Spikes and Other Unwanted Interference in I.F. and Phone Receivers

By Paul A. Lee

The noise-reducing I.F. circuit is a critical factor in practical communication. The author's method of reducing copying noise, tone spikes and other unwanted interference in I.F. and phone receivers is a result of the author's experiments and research.



The author provides a detailed description of the circuit and its operation. The circuit is designed for practical communication on the 224-Mc. band. It includes a high-gain antenna and a high-power transmitter. The author also discusses the importance of proper antenna placement and the use of a ground plane.



The author's experiments were conducted during the summer months of 1939. The results showed that the range of ultra-high-frequency amateur stations can be extended by using certain techniques. These techniques include the use of a directional antenna, a high-gain antenna, and a high-power transmitter. The author also discusses the importance of proper antenna placement and the use of a ground plane.

# QST's Diary, Volume I

## Our First Editor Describes Our Early Days

BY CLARENCE D. TUSKA\*

Fall, 1915

Will I ever see the light of day? Maxim and Tuska have been talking about a magazine for amateur wireless operators. Tuska says that the American Radio Relay League needs something more than the relaying of messages to hold its membership. He argues that a magazine would serve the members of the A.R.R.L. in many ways. Maxim agrees, but his mature vision foresees many difficulties. Once a magazine is started, it either succeeds or fails. If it fails, it is a reflection on the starters. And if it should succeed, the grind is as unending as the months. Tuska is a youth of just nineteen. Youth doesn't anticipate failures; it only envisions success. What most worries him is the possibility of running short of publishable material.

With some misgivings, they decide to launch me. My name will be *QST*, the general call to all stations, taken from the International Abbreviations. Little do they suspect that I shall become international. Somewhat skeptical that I may not survive, they decide to begin things on a trial basis. If only three months' subscriptions are taken, the worst will be three more monthly issues. Maxim will advance some money and assist as his time permits. Tuska will select and arrange the material, supervise the printing, solicit advertising and subscriptions, and become my first editor. No objection to his assuming a whole lot of titles because he will have all the responsibilities that go with them.

December, 1915

At last my birthday arrives. I appear in a blue cover designed — gratis, of course — by George B. Ruddell, who is Tuska's uncle. Within the cover are twenty-four pages: eleven of magazine proper; three listing new A.R.R.L. stations; two pages forming an application blank; about six pages of advertising; and the balance announcements. I was printed by the Chapman Printing Company and mailed by the combined efforts of the Maxim and Tuska families, aided by Miss Cecil Powell, who was Maxim's secretary, Ethel Reardon, now Mrs. George Herriot, and others. This memorable issue is being sent to all the League members and to all the other amateurs listed in the government call book.

\* Patent Department, Radio Corporation of America, Camden, N. J.; ex-1ST and 1AY, Hartford. First secretary of A.R.R.L., co-founder and first editor of *QST*.

January, 1916

Before the returns of my first number were recorded, a second issue was in preparation. The Editor wrote an article on "The Oscillating Audion" and drew the diagram, but that is not all: he sketched the *QST* heading on page 5; the Amateur Radio Stations antenna device on page 7; and he made the diagram on page 14. Why in the name of art did he put a black border around it? It would have been better had he spent the time soliciting advertising, which fell short. Perhaps I should not criticize. Where would he, a freshman at Trinity College, have found the time? Now, I suspect, he should have studied harder on foreign languages. Anyway, they promised a February *QST*!

February, 1916

This issue begins to look more like a magazine. If only we could afford an art editor! Tuska's map-drawing for Maxim's article is passable, but the diagram borders make me shudder. Bob Miner's article recites receiving signals from transmitters located at distances of 60 to 600 miles. Looking back, I am not at all satisfied with the answer to Kathis Kathan's queries of December. That clever Jap (Maxim in his first disguise) wanted to know: If the charge resides in the dielectric of a condenser, what happens to the charge if all the air in a charged air-dielectric condenser is blown away? My sponsors are becoming confident; no timid three-months' subscriptions — for a dollar you can buy me for a whole year.

March, 1916

Nothing shows better how subscriptions have been coming in than my application for entry as second-class mailing matter. Tuska had to buy an Addressograph to solve the mailing problem. Speaking of mailing, Mrs. Tuska, whose oak dining room table has become the mailing desk, objects to the paste on the table. Wrapping is a nasty mess; at first it was a kind of party; now it is work. Maxim is getting tired of turning his Franklin motor car into a truck to take the four or five mail bags to the Post Office. He thinks it is about time *QST* paid for a professional carting job. As for growth, notice the jump from 24 to 32 pages.



April, 1916

I am worried. The entry as second-class mail matter helps on the postage bill, but I must have advertising to survive. Mr. Chapman has been carrying most of my printing bill and does not seem to worry just as long as Tuska digs up enough money to meet the weekly pay-rolls. Somehow — I haven't yet discovered the secret — Tuska makes the grade. Miss Reardon gets paid occasionally for actual typing time, but no one else gets anything. Perhaps I should not complain — my rent is free in Tuska's attic, and the old furniture did not cost a cent.

May, 1916

A new cover, a new *QST* page, a new heading for Amateur Radio Stations — for these I am everlastingly grateful to Harry R. Hick, an artist and an amateur wireless operator. Within my proud covers are thirty-six pages. There's a picture of A. A. Hebert. How it hurt to tell Mrs. Hebert that the photoengraver had spoiled the only picture of Arthur she had! Would she mind if he turned half purple where they tried to fix him up? And there on page 97 is a picture of R. H. G. Mathews — Matty — still an enthusiast. And is that not the second article by The Old Man? How long and how well we kept his secret! How loved were the articles!

it strange how hard it is to defeat a man who does not know he is beaten? The subscription list grows; so do the accounts payable; and the advertising falls off. I can't prosper that way.

July, 1916

The middle of the summer, and advertising shows a small gain. That is encouraging. Moreover, I am proud to note an editorial improvement: An article by Ellery Stone entitled, "An Impulse Excitation Transmitter," reprinted from the *I.R.E.*, appears. There is a paper by Harry Sadenwater on "Distributive Capacity and Dead End Effect" — a truly important subject in those days — written by one who was to prove an amateur's worth on the transatlantic flight of the Navy's NC flying boats. Not only that, but an announcement that the A.R.R.L. and *QST* had made a deal with the Radio Club of America to publish papers presented before the club.

August, 1916

The cover design and the date recall Uncle Sam's expedition to the Border and into Mexico. Many of our amateurs served then, as they are ready to serve now. A. Hoyt Taylor was observing transmission variations, daylight effects, and skip distances. If you want a laugh, turn back and read "Rotten Luck" by The Old Man. Paul F.

◆  
The founders of *QST*, C. D. Tuska and Hiram Percy Maxim, and the old Franklin that used to carry *QST* to the post office, about 1916.  
◆

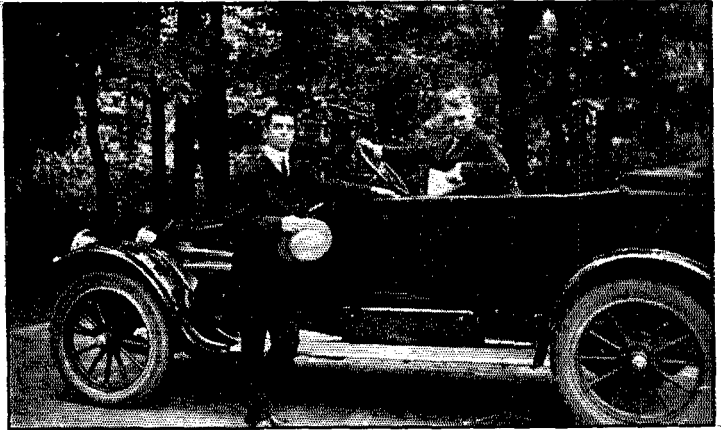

June, 1916

The seventh issue of *QST* comes off the press. I notice I am copyrighted, apparently for the first time. As I look back over the previous issues, the names of the contributors, correspondents, and those mentioned read like a "Who's Who" for the early-day amateurs. I only wish I could list all the names of all who helped make the hard going easier. It is becoming harder and harder to pay the bills, and I don't know where we'll wind up. If you think there is any doubt about this, just glance over the editorial on page 129. It is well that Tuska does not know he is licked. Isn't

Godley writes a timely article, "Applications of the Audion." Why, that article alone was worth the price of a year's subscription! S. Kruse makes some pertinent remarks on "Summer Working." Harry Hick's heading for the editorials was just too brilliant. For the truth, see the editorial "Ourselves." What we lacked in office furniture, we made up in pages — 52 of them, if I counted correctly.

September, 1916

The shining light of 13 payable pages of advertising this month eclipses all else. Yes, even the conclusion of Paul Godley's "Applications of

the Audion," where you can see outside and inside views of what a well-dressed amateur station of 1916 should include but couldn't afford. You see, they spend all the money I bring them to give me more pages. Prof. Hazeltine told us then, as now, some of the engineering reasons why our devices were good or bad. I can't pass M. B. West's photograph on page 262 without recalling his unending enthusiasm. Last month I plumb forgot to record in my diary about *QST*'s subscription contest. First prize, a \$25 deForest audion; second prize, a \$14 Brandes headset (does anyone use them to-day?); third prize, a \$14 deForest audion, and among the seventeen other prizes a Crystalloi detector. (Remember?)

#### October, 1916

Two things stand out this month. First, a H. R. Hick cover in *two colors*, either the bosses splurged or Mr. Chapman ran out of the blue cover stock. Second, the *QST* Publishing Company, Incorporated, takes over the burden. I do not recall all the reasons but perhaps a partnership was a dangerous liability. I think the editor himself undertook the excursion into the law and formed the corporation. Remember Mrs. Emma Candler? Her photograph appears in *Who's Who*. Notice the picture of deForest's air-cooled Oscillion on page 322. Rated at 250 watts, I now wonder what kind or where they were measured. Who does not remember Radio Inspector Harry Gawler? *QST* reports he was with the Massachusetts Militia at the Mexican Border.

#### November, 1916

Volume I, Number XII! Many a time I thought I should not live that long. There are 60 pages in this issue. Even an abstract of the 60 pages would take more space than my diary affords. Fifteen and a half paid pages of advertising — I mean payable; sometimes we can't collect. That makes it bad because every cent is poured back into me. Our old postman is beginning to growl about how much business mail he has to carry on a residential route. I suppose we should have an office, but besides not being able to afford one, the editor would not have time to go to one. He works at any and all hours when he isn't attending his college classes. I wouldn't confess to anyone but a *QST* reader, but even to-day — twenty-five years later — I am not sure whether he should have spent more time on me, *QST*, or more on his college work.

#### December, 1916

December 1916 — Anniversary Number — 74 pages. A year ago it was 24 pages. I have arrived! Joe Morgan, Jr., and Charlie Service tied for first place in the subscription contest. Morgan reminded your first editor about that memorable contest, when the contest leader, the other day, nicked the old editor for a new G. E. furnace.

#### January, 1917

We hold all gains. C. S. Ballantine had started telling us how to make reliable measurements of high-frequency currents. Where did J. O. Smith get that good-looking Godley set?

#### February, 1917

My diary would be incomplete if I failed to recommend that you get me out and read Irving Vermilya's account of "Amateur Number One." When I last saw him, he assured me the article represented the truth, the whole truth and nothing but the truth!

#### March, 1917

Prof. Morecroft indulges in some fancy math. Vermilya concludes his article. We begin to wonder about war, but don't suspect how near it really is.

#### April, 1917

The peak is reached under my first editor, 96 pages of interesting magazine. The cover by Clyde Darr shows the rising spirit of war and is a picture prophecy of the amateurs' part. Just as we reach our peak, war is about to be declared.

#### May to September, 1917

War comes. *QST* shrinks in size, but does its job for Uncle Sam. A ham named K. B. Warner crashes the pages of *QST* for the first time — he got two letters published. The need for radio operators is great. The U. S. Army and Navy will welcome every able-bodied amateur. *QST* urges them to do their bit. The Navy requests us to keep up the good work; it is bringing results. The editor takes his own advice and goes into service in the Air Section, U. S. Signal Corps. *QST* is left alone, unpublished, but not unsung, waiting for the peace that will enable a new beginning to be made in June of 1919.

— . . . —

#### WOULDN'T IT BE WONDERFUL —

If "wireless" was really what the name implies? If Ma could find her paraffin now that she wants it?



Clarence D. Tuska, the first editor, as he appears to-day.

# Rotten QRM

BY THE OLD MAN

**T**HIS QRM business is getting my nanny. Here it is midnight, and this msg. from the fellow whose girl has not had a letter from him for a full twenty-four hours is still stalled. I have smoked myself into a state of funk, the floor is covered with burnt matches, I am losing a perfectly good temper, and there is no sign that this will not continue all night long. How long do these radio bugs sit up at night, anyway? Right now, as I write, there is that old gink 2AGJ up in York state fluttering along with that bird-in-the-cage spark of his, 8YO is yelling his darned head off for somebody over on the Pacific Coast apparently, 8NH is still trying her best to be lady-like in spite of a full hour of trouble, old 8AEZ is booming out QSA-but-QRM-bad-CUL, 9PC is trying to do something to 5BV, I distinctly heard 4DI say a bad word, and to the best of my knowledge and belief, no one has got anywhere.

What are we going to do about this business? It used to be that we were perfectly satisfied to listen to SLI and once in a while on Saturday night when we could stay up that late we would listen to Arlington send time. When we heard some commercial say QRM, we had to look it up on the chart to see what it meant. Later, we began talking to the fellow over on the other side of town and then was born our amateur QRM. Sometimes the "little boy with the spark coil" (the latter is all right but dog-gone the hide of the former) would try to call us at the same time, and we used to think we were in trouble. Still later we used to think we were bothered when we were in the middle of a conversation with a fellow in the next town and some whop would butt in. It was about this era that we began to organize radio clubs with high-faluting ambitions about "promoting radio communication and controlling interference."

But when we have a fellow who has not written to his girl for a full twenty-four hours and who positively must get the msg. to her over in Illinois, it becomes a serious matter to have some one else

getting gay with the ether, especially when the latter has no conception of the existence of the word "brevity." One thing I will say, and that is that good old 8AEZ is brief. His spark may drown out everybody in the western hemisphere when he sends but he is brief. He says what he has to say in a few words in a few signals and he stops. He also does not go in for long technical discussions about gap speed and condenser construction while forty or fifty others of us are waiting with



five or six messages each, many of which have been stuck on the pin a week. Far be it from even me, a real blown-in-the-bottle radio grouch, to find any fault or mention any names, but some of the young gentlemen who burn up valuable time every night and thereby multiply this QRM business ought to look up in the dictionary the definition of that particular combination of letters indicated by B-R-I-E-F. I could call off a dozen of them right now, and I would if I thought that editor down east would print them.

The trouble is that the young squirts don't stop to think. They start out and call somebody some-

Ever hear of a wouff hong? Know what it is? Sure, you say, it's some kind of a mythical instrument of torture. But do you know where it came from, how the word got into the language of the American ham? "The Old Man" coined the expression, at the same time he discovered the rettysnitch and the ugerumf in a story in *QST* away back in January of 1917. *QST* was just about a year old then and there must be thousands of you fellows to-day who have never heard the story. So here it is reprinted, just as it appeared in *QST* years ago. You may know nothing of the technique of spark days, but we are sure you will get a boot out of the old story.

where every three minutes. Everybody they hear they immediately call. If they can't hear anybody, they send a QST something like this: QST QST QST QST QST DE INUT INUT INUT INUT INUT INUT INUT. ANY STATION MORE THAN FIFTY MILES DISTANT HEARING THESE SIGS PLEASE SEND POSTAL TO WILLIE LE NUT, NUTVILLE. Willie repeats each word of this msg. three times. Each letter is sent so slowly it puts you to sleep. He uses up just exactly twelve valuable minutes sending out this hog-wash, and drives an old-timer to the point where he radiates brush discharge from every hair on his head. These fellows ought to be limited to hours between supper time and 8:30, and any one of them slopping over ought to get a letter from every respectable amateur within his range threatening to spank him if he ever transgresses again. I know a certain someone who will put his bid for election to the office of Chairman of the Committee on Chastisement.

Here is a sample coming in right now. Listen to this slop: COLUMBUS CO 2PP 18CO ALL SIGS CHARLES 9VY U NO HF A MOTOR LITTLE HEAVIER THAN THE RACINE SORRY SORRY OM QRM QRM PSE QTA QTA K FISH SMELL ROTTEN YES YES WYD BOSTON HOW DO YOU GET ME GAP BUM BUM RUBBER BAND QTA PWF ABOUT MOTORS (Bad squeaks here — sick spark coil near at hand — wheezes terribly) WANT TO HEAR TONE LIKE COMMERCIAL? ARK R R R YES ARK R R R LISTEN NV.

Here begins ten minutes of the darndest scratching, screeching, groaning, blowing off steam, and blubbering that ever mortal ear heard. At its worst it goes into ----- FINE FINE HOW DO U DO IT? ARK R R R RUBBER BAND ON VIBRATOR . . . BANG! My friend with the 1 k.w. over on the other side of town explodes. He calls an 8-station. When he finishes the scratches reduce. Then we get the long distance QRM again: CUL OM SK SPFSCITY BUNK ALLEMO BISH MELA HASH BREAKFAST WUNKEY WUNKEY LAIA LAIA 2 ASJ QRM BAD QSL 3ZW MUST GO TO BED NOW HW HW HW ABT ABT ABT MSG MSG MSG PSE PSE PSE

κ κ κ. This is the way my log-book this evening looks. It's enough to raise a blister on a wooden leg.

Here is another sample of QRM slush: v v v v v v v v----- (somebody sitting on his key) ----- v v v v v v v LINNEG SE WITH THE WLCE SORE FEET COMMERCIAL WIRLH. Now what in heaven's name would you make out of this? Is it to the effect that somebody has a line on a commercial who is on the warpath for some amateur with sore feet? One cannot be sure of these matters. It might be that it is the commercial who has the sore feet, chasing some poor amateur around town probably.

Listen to this: YES YES JST WYD GLUCKY WAIT A MT MUDDY WOUFF HONG BLIFTSKY MONKEY MOTOR. We assume from this msg. that Glucky is being asked to wait a minute while Blifsky seeks a wouff hong with which to wallop a monkey the next time the latter faces toward the motor. I do not think I know just exactly what a wouff hong is. Probably some piece of apparatus used in the southern states to beat monkeys with.

It is this form of uninteresting "conversation" which clutters up the air with QRM. Of what moment is it to the rest of the world that this fellow Blifsky is going to smear somebody's monkey with a wouff hong? When anybody relapses into such mental slop as to want to operate with a thing named a "wouff hong" he ought to keep his trouble to himself and not compel all of us respectable amateurs to listen to his drool. To put out a lot of foolish twaddle like this, when that poor girl out in Illinois has not had a letter since yesterday, is plain wicked.

SORRY OM QRM QRM 9VY FEW WORDS SCHLIPSH NUZZLE HIS MUCKET FADED UNDERSHIRT CFRISH REPTG PAIN IN NECK SUS GUP OM CUL ARK. This is a real relay, evidently. 9VY over in Fort Wayne is mixed up in it some way. Whose undershirt they are talking about and what schlipshing one over is, I do not know exactly, altho I have a rough idea. Whether the signals faded or the



undershirt faded, or what was the matter with the sus-sup of the neck of the undershirt, I'll be darned if I know.

Just cast a lingering look at this: BIIRGRMP BRU ROTARY GE GE UGERUMF OM WITH MY SET RETTYSNITCH SPITTY TONE HIT IN POTIMUS? Now what do you suppose the poor gink was trying to say when he unreeled that? You have to guess a lot in wireless, and how would you guess this? Something is wrong with this fellow's biir-grmph, his rotary also has a bad case of the ugerumf and somebody around the place must have spit on his retty-snitch, because his tone was so rotten it hit him on his potimus. Sounds bad to me. Why will some people send such personal matter by wireless when the whole country can overhear it? It isn't decent, and it makes the QRM more rotten than ever, and just think of the way it makes a perfectly good log-book appear.

I spent the better part of an hour trying to make out what ailed the poor fellow's biirgrmph, but had to give it up while I listened to a child with a spark coil scratch this out at a rate of around three words a minute: HOW DO S . . . . . E . . . . . ? HOW BE . . . ? HOW DO I COWP . . . . . CW . . . V V V V -- -- COME IN ? ? ? ARK. After a long wait another trouble-maker with a bad cold in his head stumbled back with: R R R R R R R QRA QRA QRA PSE RAT . . . . VE . . . . ? PSE TTT . . . . QTA PSE REPEAT ARK. These brats kept this up for twenty minutes and they ended up just where they began.

What we ought to do is to organize an Anti-QRM Association. Then let us elect for chairman the worst plug-ugly we can find in these U. S. A. Then let us chip in a little money and hire a clerk with a bad disposition who will write letters threatening the life of everybody whom the members report as causing needless QRM. If anybody gets balky we will all join together and swear the



The Original Wouff Hong — a well preserved and absolutely authentic specimen forwarded to the Editor of *QST* by The Old Man, shortly after the last armistice. It now hangs in the headquarters office of the A.R.R.L. where the Secretary guards it with his life. It seems that T.O.M. chanced upon this mysterious instrument some months after writing this story, and thought that the Editor ought to have it. As all old-timers know, the wouff hong was a peculiarly efficacious instrument in the elimination of unnecessary QRM. Exact details concerning the method of operating it have been lost in the dim corridors of time, but may be guessed with a little imagination. This is the tool which was the inspiration and is the symbol of the Royal Order of the Wouff Hong, the amateur secret society of A.R.R.L. conventions.

gink is sending with a decrement greater than two tenths, and so report to the local Radio Inspector. If the latter does not within twenty-four hours have the boy arrested and sentenced to life imprisonment, we will all band together and find another job for said Radio Inspector. Let us rise, fellow bugs; rise and crush this octopus which is engulfing and overwhelming us. Eight hours a day and triple time for overtime is death and starvation to our families. Hash for breakfast, rotten smelling fish, and QRM — we will have naught of it. Down with the fellow with the scratchy spark coil, down with the fellow who calls three-times-three, down with the fellow who calls everybody he hears, and down-down-down with that unspeakable lid who calls somebody and sends a long relay message repeating each word three times when the station to which he is sending is sending something himself.

There, by heck, I have that off my chest. Now you, over there in Illinois, get this call. Let everybody else stand back from now on. I'm tired and sleepy and cross, and I don't care who I QRM until I get this pin cleared off.

T. O. M.

— . . . . —

**WOULDN'T IT  
BE WONDERFUL —**

If you could break NAA and say, "QRT pse, half hour"?

If Bell telephones had 2000-ohm receivers on them, instead of 75?

If you didn't have to get out of bed when a thunderstorm came up, and sit in the parlor until it passed, for fear of it coming down the aerial and jumping to your feet which stick out of the foot of the bed just far enough to reach to the lead-in where it connects to the loose coupler?

If the traction companies would supply us with 550 d.c.?

# Amateur Radio in 1882

BY J. S. V. ALLEN, WSPME, WBUN

ALMOST sixty years ago Professor Amos E. Dolbear was covering all bands with a spark-coil. His best DX was thirteen miles, probably the world's record at that time. He never worked a VK6, but he accomplished something vastly more difficult. At a time when the underlying principle of wireless was unknown, Professor Dolbear was playing with high voltage discharges and kites with attached wires for antennae; and he was actually sending signals over short distances. He even painted his kites with gilt, and we may well assume that this was not for ornamental purposes.

In his "Story of Wireless Telegraphy" A. T. Stony says of Professor Amos E. Dolbear:

"He did actually send signals through space without wires, and came very near the achievement which is now so indelibly associated with the name of Marconi. In the early days of his investigations Dolbear put the distance at which he could make his sounds heard at half a mile, but later it was affirmed that he obtained results so far as thirteen miles away. At times a gilt kite was employed, carrying a fine wire from the secondary coil. The discharges were then nearly as strong as if there was an ordinary circuit. There were some striking resemblances between his method and that of Marconi. Dolbear showed that he was groping his way toward the real thing in attributing some of his results to the action of the ether. There can be no doubt that Dolbear was working with Hertzian waves, although he did not know it, six years having still to elapse before their existence was discovered, and to that extent, therefore, was anticipating Marconi."

Although Professor Dolbear missed the underlying principle of radio, he was able to communicate over a distance of a quarter of a mile without wires in 1882. This antedates Hertz's experiment with high-frequency electrical oscillations by nine years and Marconi's work by fifteen years. And later, the thirteen mile DX must have been more of a thrill to Dolbear than the first transatlantic amateur communication.

Amos E. Dolbear is perhaps better known for his invention of the electrostatic telephone. While teaching at Bethany College (1868-1874) he was working on the conversion of sound waves into electrical impulses; later, he completed this work and his wireless at Tufts College.

When asked by the Western Union Telegraph Company what he would take for his interests in the telephone, Professor Dolbear first thought of

asking two or three hundred dollars. He boosted this figure when he remembered how much he had spent from his own funds for experimental equipment. Finally he asked for \$10,000 and promptly received a check for that amount. He was quite elated until he learned some months later that the Board of Directors of the company had voted to pay him any amount up to \$100,000 for his interests in the telephone!

Editor's Note: The fundamental distinction between the work performed by Dolbear and that of Hertz and his followers was that the former understood and employed only inductive effects, while the latter utilized radiation. Other experimenters to establish work with inductive communication over considerable distances include Dr. Mahlon Loomis, Alexander Graham Bell, Professor Trowbridge of Harvard, Professor Oliver Lodge, Sir William H. Preece, Thomas A. Edison, Professor Hughes and A. W. Heaviside.

*The Story of Wireless Telegraphy*, by A. T. Stony, New York, 1904.

*Textbook on Wireless Telegraphy*, by Robert Stanley, London, 1919.

*Let Us Forget*, by Albert Stetson, "The Tufts College Graduate," March-May, 1923.

*Professor Amos E. Dolbear*, by J. S. V. Allen, 1933.

— — — — —

## WOULDN'T IT BE WONDERFUL—

If you could only hear someone when you invite your neighbors in?

If ship operators complaining about not hearing NAM on 600 meters would tune down to 200 meters?

If you could plant a broomhandle and have it grow over night into a 100-foot mast?

If 6ADA would tell us how far he can blow a condenser?

If we knew how to build those Swiss d.c. transformers?

If 2 — and 2 — would talk about something else beside girls?

If people enjoyed having their lights blinked?

If they would pass a law against sideswipers?

If ITS reported calls *not* heard to save valuable space in QST?

If the R.C.A. would buy up all the arc stations so it could shut 'em all down so it could sell lots of tubes so we could all use c.w. so we could all be happy at once?

If a lot of fellows would run the durned thing either entirely synchronous or else frankly non-synchronous?

\* Bethany College, Bethany, W. Va.

\*\* Trustee of the Bethany College Radio Club Station, WSPME.

**Harry R. Hick** has been a contributor to every issue of *QST* since April, 1916! He is best known for his ability to draw *QST* diagrams, which he has been doing since . . . let him tell you the story: Saw *QST* on the newsstand in 1916 and went to Tuska and asked to make covers for it. First work was illustrating First Washington Birthday Relay message in the fifth issue, April, 1916. Made the cover of following issue. Designed the square *QST* letters and the electric flash that is still used to-day. First hookups were done for the July, 1919, issue. Used to be I.E.S.S. with small spark and second grade ham license before the War. After the War never got a chance to get set up again. *QST*'s needs have gobbled up my spare time.

Regular job is working for Aetna Life Insurance Co. as commercial artist. Am married and have three children. Member of A.F. & A.M., No. 81, and held Finance Offices in American Legion for past ten years. Designed first Handbook cover as well as made designs for practically all A.R.R.L. publications at one time or another. Estimate I have drawn over 5000 schematics for *QST* and Handbook. Some difference to-day with multi-element tubes from those old Audions.

Really enjoy drawing hookups — like landscapes or paintings they take careful planning for proper balance and design. Sometimes a drawing is laid out two or three times before it passes. Hope to keep at it until the lines get wavy and nicks. Then there'll be time for hamming again!



**Fred Davis** has collected regularly from *QST* for 17 years. He has been our printer and says:

After seventeen years it's still screwy — tin ears — AM — CW — RF — FM — WPA. I still don't understand.

Why should a brass-pounder be a pain in the neck to a 'phone man and why should a glass arm enthusiast look down from the heights of his rhombic and scorn the bird who modulates a mike?

Honest, I've been places and seen things. Sure, I've talked to Australia at seven A.M., so what? I have frozen to death in shacks where they took the hay wire and barbed-wire fences to make a rig. I have squinted along a chimney to get a line for a V and thrown ropes over trees to rig a squirter aimed at a VK, and damned if we didn't bag him! What hair I have has been singed walking under hot r.f. feeders and what patience I had has been exhausted trying to figure out who lives behind a billboard in Scotia. Surely all these hams have names, but who knows them? It's just like jail, they take away your name and give you a number.

I'm just a farmer from New Hampshire. I don't comprehend these things at all. The Old Man of the Mountains is still here, the sky and the ground they don't change, but the guy you had lunch with yesterday becomes One Everybody Happy at seven-thirty and somebody calls on the phone and says, "Is that you, BIZ?" Me for the farm and use the wire for fences!



The antenna described in this article was developed for mobile transmitters of the National Park Service. Although low-frequency mobile operation never has been permitted in amateur work, and portable operation on the same frequencies is considerably restricted at present, there is no reason why an emergency setup cannot be designed along the same lines. And the principles described here are applicable to antennas installed in fixed locations where the requisite height for a quarter-wave vertical cannot be obtained or where space does not permit the use of a flat-top antenna.

# Raising the Efficiency of Short Vertical Radiators

## Recent Developments in the Top-Loaded Antenna

BY W. C. HILGEDICK\* AND MILLETT G. MORGAN,\*\* W6QQJ

THE ranger patrol cars in the National Parks need two-way communication for the protection of life and property and for the prompt detection and suppression of forest fires. Ultra-high-frequency equipment functions efficiently in mobile installations, but its application to ranger patrol cars is not satisfactory, due to mountainous regions of the National Parks and to the high percentage of blind area which results from the use of these frequencies. Therefore, the lower frequencies of 2 to 4 megacycles must be used where the terrain can, within reason, be disregarded.

The investigation work of developing an efficient radiator for mounting on an automobile was done by the writers for the National Park Service at Stanford University in May and June, 1939. The mobile antennas being used at that time were of the whip type, loaded at the base to resonate as a quarter wave. Their efficiency was very low and their reliable coverage area was limited to about 15 miles with a 15-watt transmitter. With the antenna finally developed, and using the same transmitter, this coverage was increased to a radius of 25 miles regardless of ter-

rain, and to 40 miles over more or less open country.

In general, the radiation efficiency is given by

$$\eta = \frac{\text{Radiation resistance}}{\text{Radiation resistance} + \text{loss resistance}} \times 100\%$$

When the radiation resistance is greater than the loss resistance, the efficiency is seen to be high, but when the radiation resistance is low compared with the loss resistance, the efficiency is low. Furthermore, when the radiation resistance is low, the radiation efficiency is then approximately proportional to the radiation resistance. Hence it is apparent that the problem is to increase the ratio of radiation resistance to loss resistance and that the advantage obtained by a small increase in this ratio will be greatest when the ratio is small, as in the case of short antennas with loading coil losses in addition to the usual sources of loss.

The loss resistance consists of ground losses, ground connection losses, and wire losses in the radiator and resonating circuits. Since losses in a resistance are proportional to the square of the current in the resistance, it is apparent that the loss produced by each of the sources mentioned above is proportional to the square of the current at that point as well as to the magnitude of the resistance itself. This fact must be taken into account in computing the "equivalent" loss

\* U. S. National Park Service Radio Engineer, 601 Sheldon Building, San Francisco, Calif.

\*\* Stanford University, California.

<sup>1</sup> R. B. Dome, "Increased Radiating Efficiency for Short Antennas," *QST*, September, 1934.

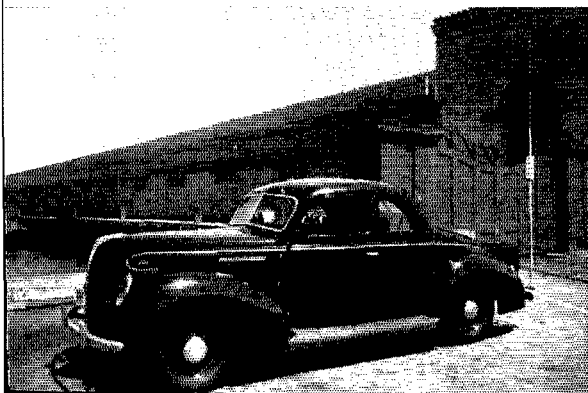

A loaded antenna designed as described in the text, installed on a National Park Service Car. Operating on a frequency of approximately 2500 kc., this type of antenna gave a 12 db boost in signal strength over the base-loaded whip antenna (of the same height) previously used.



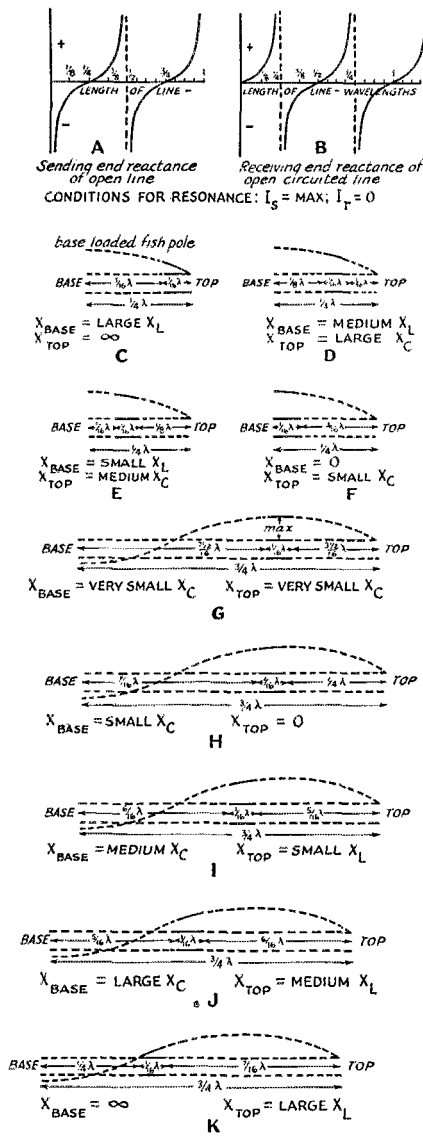

**Fig. 1** — Showing how the current in a short antenna can be changed by insertion of various reactance values at the top, along with proper values at the base for tuning. Quantities are as follows:  
 $X_{\text{base}}$  reactance which must be placed in series with antenna at its base ( $X_s$  of auxiliary line at the base).  
 $X_{\text{top}}$  reactance which must appear between top of antenna and ground ( $X_r$  of auxiliary line at the top).  
 $X_r$  receiving-end reactance of line (reactance looking into the line toward the source of energy).  
 $X_s$  sending-end reactance of line (reactance looking into the line away from the source of energy).  
 Reactance values are expressed relative to the surge impedance of the antenna, which for ordinary wire sizes may be taken as approximately 400 ohms.<sup>1</sup>

resistance and has been pointed out by an earlier writer.<sup>1</sup> This author indicates that the primary source of lumped loss resistance is in the ground connection and that reduction of the current at that point will lower the equivalent loss resistance. Such may be the case with regard to the ground connection itself, but controlling the current distribution in this manner will increase the current flowing in the ground a quarter wave or so from the antenna and so the net gain depends upon how much greater the ground connection resistance is than the resistance of the ground itself in the high current density region surrounding the antenna. The method of controlling current distribution by a series combination of reactances at the top of the antenna is ingenious. However, it adds an additional source of loss resistance and the problem is further complicated. It is evident that the principle applied to the elimination of the ground connection resistance loss must simultaneously be applied to the effective ground resistance, the base resonating coil, and the top current-distribution-control coil. This means then that the best current distribution, on this basis, is the one which most nearly weighs the magnitude of current at each point in inverse proportion to the actual resistance at that point, still maintaining an approximately sinusoidal distribution. The problem is further complicated by the fact that the size of the top coil, and hence its resistance, controls the current distribution; and that the size of the bottom coil is also affected by the current distribution since its job is to keep the system in resonance. Another factor is the effect of changing effective height on the field strength as the current distribution is changed. Hence we have such an interdependence of variables that the possibilities of obtaining an analytical solution are indeed remote. By adopting only semi-analytical methods, however, it is

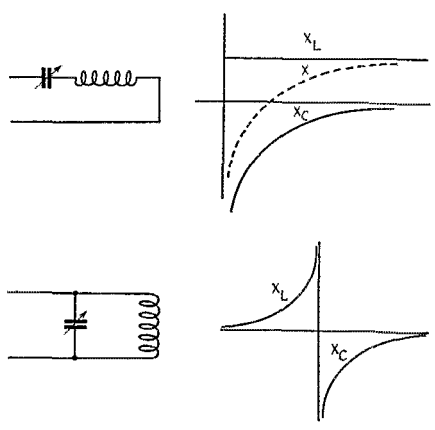

**Fig. 2** — Methods of inserting reactance at the base, or tuning the antenna, with curves showing corresponding reactance variation.

possible to obtain a satisfactory solution to the problem.

In general, we may liken an antenna to a transmission line since together with its ground image it forms an open-wire line whose spacing, in the case of a vertical antenna, varies linearly along its length. As a matter of fact, this change of spacing only causes insignificant reflection losses for the lengths commonly encountered in vertical antennas. The point of feed corresponds to the sending end of the line and the top of the antenna and the bottom of the image represent the receiving end. This analogy allows us to use certain transmission line concepts as valuable tools in solving antenna problems. Fig. 1 shows how any desired current distribution may be obtained on a short antenna by considering it as part of a longer, open-circuited line. From the graphs of the sending end and receiving end reactance of an open-circuited line, it is possible by inspection of the auxiliary sections of the line to find out what value of reactance must be placed across each end of the "antenna" section in order to obtain the particular current distribution. These values of reactance have been tabulated under each illustration. The diagrams are somewhat idealized in that they neglect the effect of resistance. However, they do show the main factors controlling the current distribution and so are an excellent guide to a better understanding of the problem.

Any amateur should be familiar with the

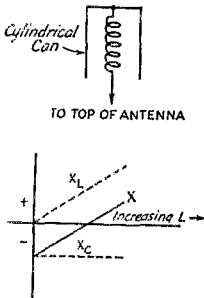

Fig. 3—Method of inserting reactance at the top of the antenna, with curve showing net reactance variation as the value of  $L$  is increased, the top capacity being fixed. For a cylinder with diameter equal to length, the capacity in  $\mu\text{mf.}$  is 2.04 times the diameter in inches.

These theoretical curves do not show the effect of coil resistance on the performance of the antenna system. When the coil is large, this resistance becomes predominant in determining the field strength, even though the reactance values are correct. Generally, it is advisable to make the top capacitance as large as possible so that a small coil, with low resistance, can be used. This does not lead to unreasonable sizes. Fig. 4 illustrates the difference in field strengths with two antennas using different sizes of top capacitances; it can be seen that the larger capacitor gives but little more improvement than the smaller. In the installations discussed, it was found that cans larger than 9 by 9 inches were not justified.

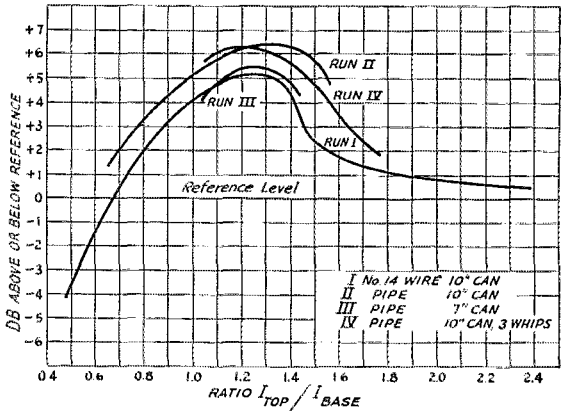

Fig. 4—Comparison of field strengths with four types of top-loaded antennas to a base-loaded whip, as a function of the ratio of current at the top of the antenna to current at the base. Power input constant in all cases.

method of inserting the indicated reactance at the base (sending end) of the antenna with a parallel or series circuit. The reactance across these circuits is shown in Fig. 2. Where large values of either sign are required as indicated by Fig. 1, the parallel circuit is used. For small values, the series circuit is used. It might be well though, to review the method of placing the required reactance across the "receiving end" of the antenna, since this is made up of the top of the antenna and the bottom of the image. The bottom of the image being rather intangible, we reach it by placing a metal area on the top of the antenna, thus forming a capacity to ground and terminating the "line" in a capacitive reactance. We cannot connect a coil across these same points if it happens that we want an inductive reactance across the end of our line. Instead we place a coil in series with the capacitance as shown in Fig. 3. This, then, gives us values of reactance from  $X_C$  (fixed by the size of the capacitance) through zero to as large inductive values as we wish by controlling the inductance of the coil. Greater negative values of  $X_C$  can be obtained only with less capacity.

A convenient form for this top capacity to take is that of a cylinder, as shown in Fig. 3. This provides the greatest capacity for comparable size of any simple configuration<sup>1</sup> and provides an excellent place to locate the coil as well.

The picture is now taking form. We control the current distribution with the top coil, maintaining resonance each time with the series or parallel circuit at the base. Of course a further complication is the matching of the feed line each time. Following these methods, however, a complete run may be made through the entire range of current distribution shown by Fig. 1. Measuring relative field strengths, we readily find optimum

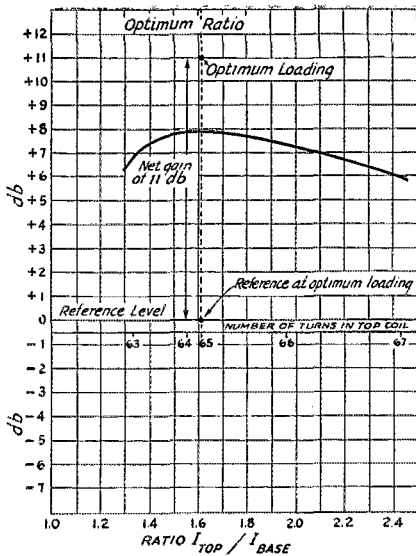

Fig. 5 — Variation of field strength as a function of ratio of current at top to current at base in the antenna system actually used on the car. Number of turns in the loading coil are indicated. The reference level for the adjustment curve is arbitrary, and is not the same as the reference for the net gain points. In the latter case, a base-loaded whip, with the same power input, is the reference.

conditions. It must be remembered though, that any change in loss distribution will in general dictate a new current distribution for optimum performance. Changes in the top capacity will change the size of top coil necessary to produce the same values of reactance across the receiving end of the antenna. This in turn will change the resistance of the top coil and dictate a new optimum distribution. Hence, a rigid procedure, embracing relative field strength measurements, must be adhered to in every case unless the installation is similar in every respect to a previously tuned one. In mobile installations, the capacity to ground and the ground conductivity will change as the position of the car is changed. However, little difficulty will be experienced if the original tuning is done over reasonably typical ground.

Fig. 4 shows several runs made under slightly different conditions to determine the relative magnitudes of several factors. This was a four-foot radiating section on 2496 kc. Comparison was made each time with a typical base-loaded whip of the same overall height and with the same input power. This is shown as the reference level. Current distribution is plotted along the X axis in terms of the ratio of current at the top of the radiating section to current at the bottom of the radiating section. Hence a value of 1.0 indicates that the current loop is standing on the middle of the antenna. It is seen that the curves all reach a

maximum value when the antenna looks like somewhat more than a quarter wave as viewed from the bottom or sending end. Reference to Fig. 1 (h) shows that resonance is obtained under these conditions with a series-tuned resonating circuit at the base. This has the further advantage of eliminating the loss of circulating currents in the parallel circuit. As the half-wave condition shown by Fig. 1 (k) is approached (increasing ratio of top to bottom current) the curve is seen to approach the reference. This would indicate that the ground connection resistance is by no means the one controlling factor. Runs made with somewhat longer radiating sections on boats indicate that the optimum is still in the same region as indicated by Fig. 4. Run 2 compared with Run 1 shows approximately 1.3 db increase by the use of a 3-inch dural pipe for the radiating section instead of No. 12 wire. This represents an increase in diameter of 47 times and results from the increased current flowing in the antenna by lowering its surge impedance. Furthermore, for short sections, the pipe offers distinct mechanical advantages for support of the can and coil as shown by the photographs.

Run 3 shows a falling off of approximately 1 db (compared with Run 2) by going to a 7-inch can from a 10-inch can. As previously indicated, this results from the increased size of the top coil. On the car, a whip is used on top of the can, since the height of the rigid portion is limited to about 4 feet for absolutely unrestricted mobile operation. The overall height is brought up to that of the standard fish-pole antenna with addition of a 3-foot whip. This adds to the top capacity and carries some current to greater heights.

Fig. 5 shows the tuning of the final antenna on the car. The number of turns in the top coil is indicated also for the purpose of showing that this coil must be adjusted to within one or two turns for optimum performance. This can be done only by taking a run through the maximum to establish its location definitely. In taking such a run, it is extremely important to introduce the same amount of power into the antenna each time. This requires careful matching of the feed line each time at the base.

Fig. 5 also indicates the gain of the antenna over the fish-pole type at optimum transmitter loading. A net gain of 11 db is shown and 12 db was ultimately obtained. Since this is equivalent to increasing the transmitter power 16 times, it is apparent that here lies a real step forward in the application of the low frequencies to mobile work. Although amateurs cannot operate mobile on the low frequencies, operation may be made from mobile units not under motion. Furthermore, the principles herein described are all directly applicable to stationary vertical radiators of somewhat greater length.

# ★ WHAT THE LEAGUE IS DOING ★

## ELECTION NOTICE

To ALL members of the Northwestern Division:

You are hereby advised that no candidate for Northwestern Division alternate director has been nominated under the call published August 1, 1940. By-Law 21 provides that if no eligible nominee be named, the procedure of soliciting and nominating is to be repeated. Pursuant to that by-law you are again solicited to name a member of the Northwestern Division as a candidate for alternate director. See the original solicitation published at page 22 of September *QST* and page 30 of October *QST*, which remains in full effect except as to dates mentioned therein: Nominating petitions must now be filed at the headquarters office of the League in West Hartford, Conn., by noon E.S.T. of the 20th day of January, 1941. Voting will take place between February 1 and March 20, 1941, on ballots to be mailed from the headquarters office the first week of February. The new alternate will take office as quickly as the result of the election can be determined after February 20, 1941, and will serve for the remainder of the 1941-42 term. The present alternate is W. N. Wintler, W7KL.

You are urged to take the initiative and file nominating petitions.

For the Board of Directors:

K. B. WARNER,  
*Secretary*

November 1, 1940

## LICENSE ISSUANCE

UNTIL middle October F.C.C. continued far behind in the issuing of amateur tickets because of the extra work brought about by the order requiring proof of citizenship. At that time, at the suggestion of the League, some extraordinary actions were taken to break the log-jam.

*Renewals.* Scores of amateurs were off the air because of the expiration of their licenses before the receipt of renewals. To solve this problem the Commission adopted the following order effective October 15th:

### ORDER NO. 76

The Commission having under consideration its Rules Governing Amateur Radio Stations and Operators, with particular reference to the provisions concerning renewals, and its Order No. 75:

*It is ordered,* That all amateur radio station and amateur radio operator licenses which by their terms have expired or will expire during the period July 1, 1940, to March 1, 1941, and for which applications for renewal have not been granted or denied prior to the effective date hereof, be, and

they are hereby, extended, in respect to each such license until such further action as the Commission may take upon application for renewal or otherwise, but in no event beyond April 1, 1941;

*Provided, however,* That this extension is granted only to such amateur licensees as have submitted or do submit a proper application for renewal in accordance with the Rules and Regulations of the Commission and have complied or do comply with the requirements of Commission Order No. 75.

*Provided further,* That this extension shall not apply to licensees whose licenses have been or, prior to March 1, 1941, may be revoked, suspended or designated for hearing.

By this action all amateurs temporarily off the air because of nonreceipt of renewal licenses were instantly permitted to resume. And if you, any time up to March 1, 1941, have your license expire and do not get your renewal back in time, you may continue operating until April 1, 1941, without a new license — provided you properly filed your application for renewal and provided your proof of citizenship and fingerprints are on file — and, of course, provided you are not in some trouble that has caused F.C.C. to notify you that your license is suspended.

Not all the trouble in getting out renewals is F.C.C.'s fault. Much of it is caused because amateurs have not filed renewal applications at least 60 days in advance of expiration, as provided by regulations. Those who were late suffered most. To take advantage of the extension offered by Order 76, you are supposed to file renewal application 60 days or more before expiration.

*Modifications.* Regulations have provided that an amateur moving to a new permanent location and applying for modified license may operate in that new location under portable status for not to exceed 60 days while awaiting the return of his modified license. Lately the Commission has been unable to return the licenses within the 60 days and some amateurs have been forced off the air even with licenses having perhaps two years to run.

To solve this situation F.C.C. on October 22nd, temporarily modified our Rule 12.93 (a) to change the 60-day period to 4 months. Thus the amateurs temporarily off the air were permitted to return for the remainder of their 4 months, before which modified licenses may be expected. If you change your address, and apply for modification of license to that end, you may operate at the new location up to 4 months, provided your license has that long to run. Remember that such operation must employ the portable indicator of diagonal and call area and that you must file a notice of such operation every 30 days with the district inspector. Point out to him that this is operation of a fixed station

under Sec. 12.93 (a), not operation of portable gear.

*New Applications.* The respite granted by the two extension actions will permit F.C.C. to concentrate on the applications for new licenses, a large number of which have been pending since middle summer.

The Commission's slowness in licensing caused the fear to arise that this was a deliberate policy of tapering off on amateur radio. It cannot be too strongly emphasized that this was by no means the case. The result was accidental, flowing from the sudden and tremendous load of the citizenship proofs. The special actions reported above were major acts on the Commission's part and proof of their good faith toward the amateur. There has been no deliberate slow-down whatever. It is believed that the situation is now well in hand.

*Active Service.* The rules normally provide for renewal only when activity can be shown within 90 days preceding request for renewal. Amateurs have been wondering what would happen if their licenses expired while they were in service. A.R.R.L. has now received definite assurances from the Commission that they will shortly enact a provision waiving the customarily-required proof of use as a condition to renewal of amateur licenses in the case of National Guardsmen, conscripts and reservists on active duty, renewing the licenses promptly upon application if the man is in the military service of the United States. Thus license continuity will be preserved, new examinations avoided and no inconvenience offered the amateur who is unable to be active because he is in service.

#### ELECTION RESULTS

THE Executive Committee found a goodly number of eligible candidates nominated for director and alternate director when it met on November 1st to examine the petitions in the 1940 elections. In the Central Division seven candidates for director and two for alternate will be battling it out; two for director in the Hudson; two for each office in the New England, and two for director in the Rocky Mountain.

But, as generally occurs, there were several cases in which there was but a single eligible nominee, with the result that he has been declared elected without balloting by the membership. The majority of such cases involved incumbents. Thus, the Roanoke Division named only its present director, H. L. Caveness, W4DW, and its present alternate director, J. Frank Key, W3ZA, and so they succeed themselves in those respective offices for the 1941-42 term. Similarly, William A. Green, W5BKH, had no competition and continues as the director of the West Gulf Division. Two incumbent alternate directors were similarly fortunate: Robert M. Morris, W2LV, in the Hudson Division, and Charles W. Duree, W9EII,

in the Rocky Mountain. In the Southwestern Division, where the election was only for alternate director, both Charles E. Stuart, W6GRL, and Eldridge E. Wyatt, Jr., W6MYO, were nominated; but Dr. Stuart withdrew his name, with the result that Mr. Wyatt becomes the alternate of the division on January 1st.

The only newsworthy change occurs in the Northwestern Division, where the incumbent, Ralph J. Gibbons, was not a candidate for reelection. Only one nomination was received and that for Karl W. Weingarten, W7BG, who, being eligible, was thereupon declared reelected without membership balloting.

Mr. Weingarten is no stranger to this division, having been its director from 1923 to 1932. An amateur since 1916, he has served several terms as president or vice-president of his home club, the Radio Club of Tacoma, and is at present a member of its executive committee. By occupation he is a machinist and locomotive inspector for the C. M. St. P. & P. Railroad.

This division made no nomination for alternate director and attention is invited to the advertisement found elsewhere in this issue again soliciting nominations.

#### THOSE BIG ENVELOPES

REMEMBER the big envelopes in which you returned the proof of citizenship to F.C.C.? It seems that some amateurs, having need to file application for renewal or modification at that same time, returned the application in the same big envelope. It also seems that some Class C applicants, having received all the material at the same time from the inspector, sent their examination papers and applications back in the big envelope. This was unexpected because it was improper, inasmuch as the applications are not entitled to be franked in the penalty envelopes, and F.C.C. supplies a separate envelope for the examination papers. Although watch was kept for these hidden applications after the first were noticed, it is possible that many of them are buried in earlier receipts. If you filed any kind of application in the same big envelope with your proof of citizenship, and haven't heard from it, write F.C.C. in explanation and tell them where your application is to be found.

#### MISCELLANY

F.C.C. ADVISES that some violations of Order 72 have occurred through misinterpretation of call letters of foreign stations, reading UK4AC as K4ACU, for example, either through poor sending or poor reception. It is well to be cautious about even American DX and to drop a contact at once if it takes on a fishy appearance. . . . Nothing to report up to this writing on the new Defense Communications Board. . . . The League of course continues extensive Washington contact. The news remains all good news.

# A Microwave Superhet

## M.I.T. 700-Mc. Blind-Landing Receiver

BY FRANK D. LEWIS,\* WILKV

FOR many years, microwave equipment has been considered as "laboratory apparatus" — all right in the lab, perhaps, but too flimsy for daily use. The microwave receiving equipment developed for the CAA-MIT Instrument Landing Research Project<sup>1</sup> (a research under the sponsorship of the Civil Aeronautics Authority) was designed to demonstrate that, at least as far as 700 Mc. went, u.h.f. receivers were no more erratic than longer wave sets. A receiver for such

A diode second detector provided a small amount of a.v.c. to prevent overloading in the i.f. stages, but the real a.v.c. occurred in the audio system. Four gain-controlled audio stages were used, three ahead of and one following the point from which was taken the input voltage to the amplified a.v.c. This a.v.c. arrangement provided a constant audio voltage to apply to the 90–150 cycle separation filter. The output of the filter was amplified, rectified, and applied to a zero-

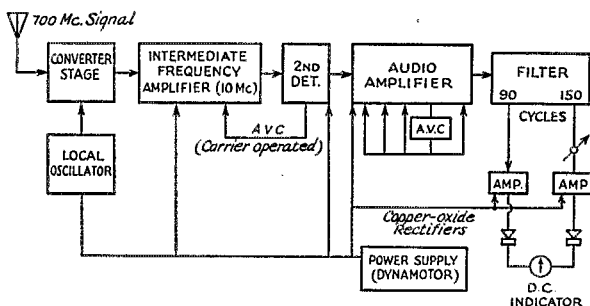

Fig. 1 — Block diagram of the instrument-landing receiver. The audio system is especially designed for use in the blind-landing system; for ordinary reception a conventional audio amplifier could be substituted.

a specialized purpose as instrument landing of airplanes is of such design that it is unsuited for many other uses. However, many of its features are of interest to amateurs, especially those working in the u.h.f. field.

A block diagram showing the general layout of the receiver is shown in Fig. 1. It will be seen from this diagram that no r.f. stage is used. There are two reasons for this omission: first, r.f. amplifiers come hard at 700 Mc., and second, no interfering signals were anticipated, hence selectivity was a minor consideration. Ten megacycles was chosen as the intermediate frequency for a number of reasons, none of which is ironclad. The same reasons govern the choice of this frequency range for television i.f. — i.e., freedom from ham-band interference, reasonable separation of heterodyning-oscillator frequency from received carrier to give good image ratio and freedom from locking-in tendencies on strong signals, and ease of amplification combined with a broad pass-band.

\* o/o Prof. E. L. Bowles, Mass. Inst. of Technology, Cambridge, Mass.

<sup>1</sup> For a more technical description see Bowles, Barrow, Hall, Lewis and Kerr, "The CAA-MIT Microwave Instrument Landing System," *Electrical Engineering*, December, 1939.

center d.c. meter. Some of the amplified filter output was also supplied to a cathode-ray tube indicator, which was part of the instrument landing system. A dynamotor was used to supply a plate voltage of approximately 200 volts.

The u.h.f. circuits and the i.f. amplifier-second detector were mounted on one chassis, the audio and filter circuits on another. These two units

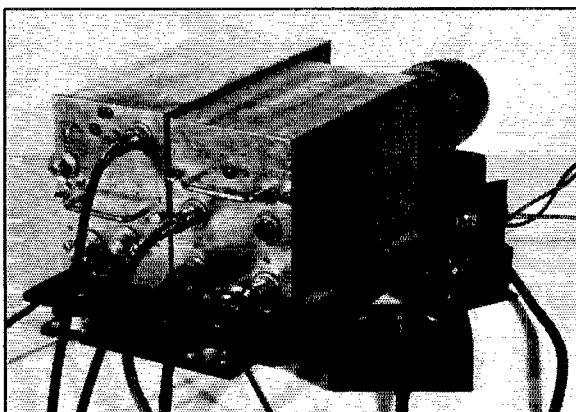
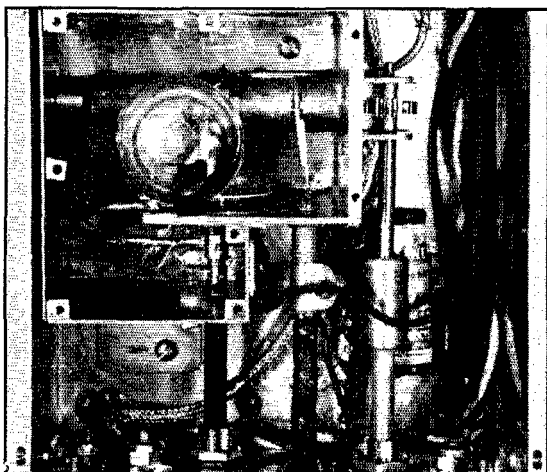
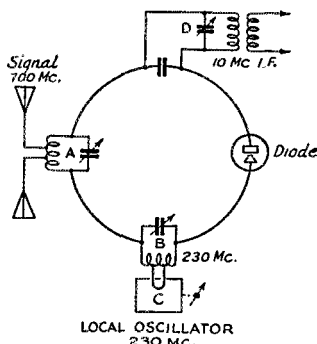

Fig. 2 — The complete receiving installation. The r.f. and i.f. sections are in the left-hand box; audio amplifiers and tone-separation filters at the right.

**Fig. 4** — The r.f. layout is shown in this view. The special diode is in a knob-shaped bulb, mounted over the inner conductor of the concentric-line tuner. The tuned circuit through which the oscillator output is introduced is just below it. Input tuning is accomplished by means of the rack and pinion at the right, which drives the movable section of the line back and forth.



were suspended together on a shockproof mounting and the dynamotor was bolted solidly to the wooden base carrying the shock mount. A photograph of this unit with control box and cables is shown in Fig. 2.



**Fig. 3** — The front-end circuit diagram. The actual apparatus, shown in Fig. 4, bears little physical resemblance to this electrical equivalent.

### U.H.F. Circuits

The parts of the receiver of greatest interest to the amateur are doubtless the u.h.f. circuits and the audio a.v.c. The u.h.f. circuits are a combination of several developments which first became available about the time the receiver was constructed. The converter or mixer circuit is shown

From the mixer on, superhet receiver design for centimeter waves is not difficult. But what to use for converting the signal to an intermediate frequency which can be handled by ordinary methods? Here's an ingenious answer — and a practical one.

schematically (very schematically) in Fig. 3. The oscillator is a development of the one described by Arnold Peterson<sup>2</sup> using a 955 acorn tube, and with a plate by-pass condenser installed to permit grounding the negative high voltage. The diode is a Western Electric D-157653, a type which became available as a result of its use in the Western Electric Terrain Clearance Indicator.

The input or antenna circuit, *A*, on 700 Mc. is a concentric line, and the tank circuit *B* coupled to the oscillator is a  $\frac{3}{4}$ -turn coil of  $\frac{1}{8}$ -inch copper tubing about  $1\frac{1}{4}$  inches in diameter tuned by a rebuilt two-plate Cardwell Trim-Air condenser with most of its inductance amputated. The i.f. tank circuit, *D*, is fed by a short length of concentric line or shielded lead which is "unity coupled" to the inductance (center-post of *A*) in such a manner that the only voltage appearing in *D* comes in across the condenser at the input end of the shielded lead. This condenser forms part of the tuning capacity for the i.f. transformer primary.

A photograph of this converter layout with the cover removed is shown in Fig. 4. The diode is prominent in the center of the picture. The center-post of the "coaxial-line" tuner for the 700-Mc. signal is partly obscured by the diode. This post is in two pieces, one fixed, bearing the diode plate (i.f. input) condenser and the antenna connection, the other movable for tuning by means of a rack and pinion operated by a shaft from the front panel. The movable plate of the Trim-Air condenser has been mounted against the bearing which in turn is set in the wall of the coaxial line. This plate may be seen protruding underneath the lower right edge of the diode. The  $\frac{3}{4}$  turn coil which connects to the stator plate (not visible) of the Trim-Air completes tank circuit *B*. This coil also connects to the diode

<sup>2</sup> Peterson, "High-Q Tank Circuit for Ultra-High Frequencies," *QST*, September, 1939.

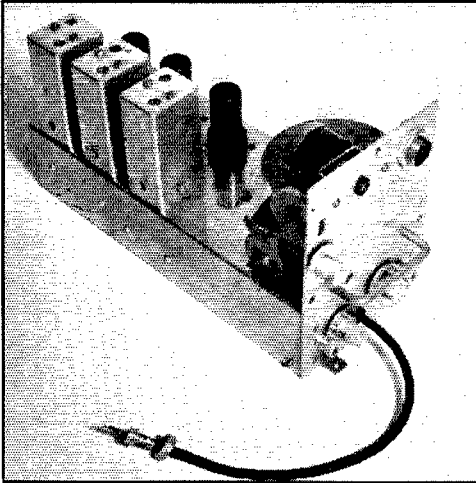

Fig. 5—The r.f.-i.f. chassis. The "pot" oscillator is on top of the chassis, the mixer assembly (shown in detail in Fig. 4) underneath.

cathode and one filament, and has inside it, "unity coupled," the other filament lead. The output of the converter to the i.f. may be seen as a small copper tube soldered to the fixed center-post of the coaxial tuner. It will be noted that the hot end of the 700-Mc. line is capacity loaded by means of a small plug soldered to the end of the shield. This was found necessary to obtain resonance with the dimensions used. The resonant cavity, or coaxial tuner, is 3 inches in length.

In order to explain the operation of the mixer circuit, the schematic diagram of Fig. 3 was evolved. The signal comes in from the antenna to the tuned circuit *A*. It is applied through the "by-pass" condenser in tank *D* to the plate of the diode. It is also applied through the condenser in tank *B* to the cathode. Since the 700-Mc. signal is at much higher frequency than that to which *B* is tuned, the condenser of *B* looks like a low impedance or by-pass for the signal, much as did the condenser in *D*. This would be obviously untrue if the condenser in *B* had appreciable inductance. The oscillator voltage is induced at the oscillator fundamental in tank *B* at 230 Mc. by means of a coupling loop inserted through a slot in the bottom of the oscillator tank (this loop is not in evidence in the photo). The inductance of circuit *A*, actually the fixed portion of the center-post of the coaxial line, is not appreciable at 230 Mc., since it is less than 1/30 wavelength long, so that the oscillator voltage encounters very little impedance in tank *A*. The condenser of

*D* is likewise a low impedance at 230 Mc., and the oscillator voltage is applied to the diode substantially undiminished. The diode generates in itself a series of harmonics of the oscillator voltage. These harmonics are present in the electron stream in the diode, since they are generated inside the diode. The 690-Mc. third harmonic of the 230-Mc. oscillator beats in the diode with the 700-Mc. incoming signal to give the 10-Mc. i.f. The 10-Mc. i.f. is taken out across the by-pass condenser in tank *D*, as mentioned previously.

The principal advantage of this particular circuit consists in its generation and utilization of the oscillator harmonic, without the losses incurred in the usual injection systems at ultra-high frequencies. This permits the use of a low-frequency, stable oscillator. As a suggestion for ham use, it might be possible to use one of the oscillators described by Byron Goodman in November *QST*,<sup>3</sup> and a 6H6 or equivalent diode to build a low-cost superhet mixer for 1 1/4 meters on down. Images might give some trouble, but with the present occupancy of that frequency range, QRM would be welcome.

### The Audio Amplifier

The audio a.v.c. circuits are worthy of mention mainly because they employ some circuits which are not in general use. Four 6SK7's are used as gain-controlled amplifiers, with grid-bias control. The first one is connected as a triode, the next two as pentodes, and the fourth as a triode feeding an audio transformer with balanced output to the separating filter. The a.v.c. control voltage is obtained from a 6R7 which amplifies the audio voltage and rectifies it with its diode. The grid of the 6R7 is excited in parallel with the grid

<sup>3</sup> Goodman, "A Stabilized 2 1/4 Meter Oscillator," *QST*, November, 1940.

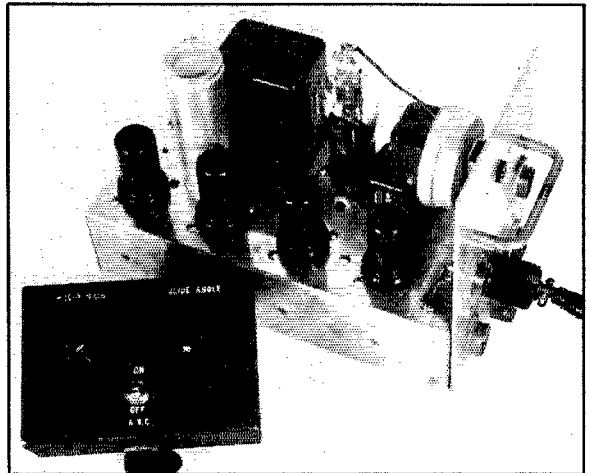

Fig. 6—The audio and filter unit, with control box.



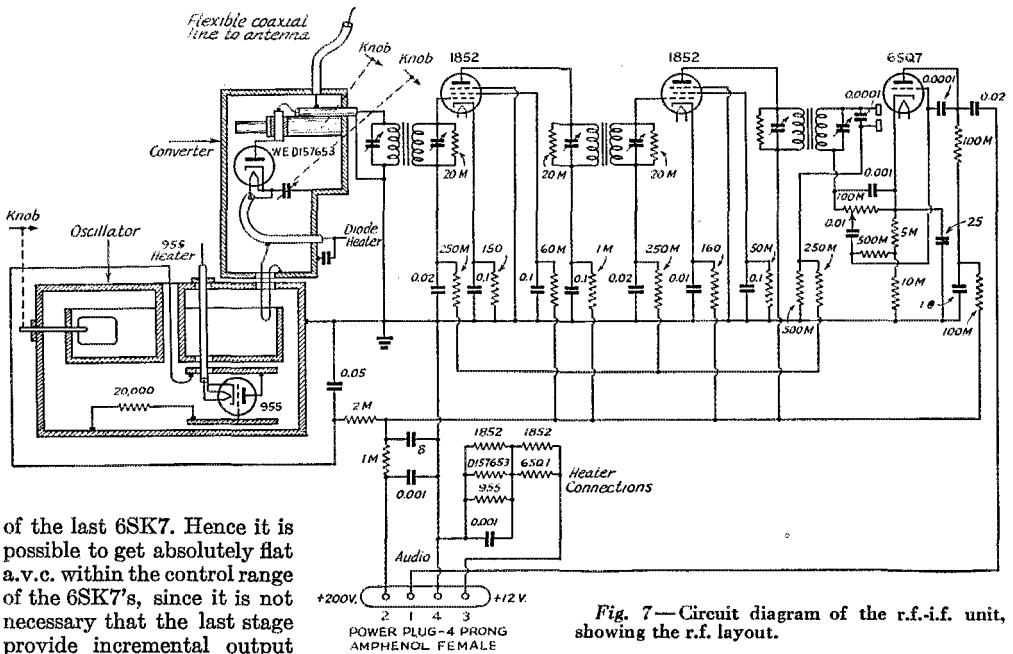

Fig. 7—Circuit diagram of the r.f.-i.f. unit, showing the r.f. layout.

of the last 6SK7. Hence it is possible to get absolutely flat a.v.c. within the control range of the 6SK7's, since it is not necessary that the last stage provide incremental output to drive the a.v.c. rectifier

when the input to the amplifier is increased. It was found that the 6SK7's work nicely as pentodes with a 2000-ohm cathode resistor, by-passed, a 250,000-ohm plate load resistor, and with screen voltage obtained at the junction of a 1-meg. and

250,000-ohm resistor as a voltage divider, with screen by-passed with 0.1  $\mu$ f. or so. The plate voltage and grid resistors were not critical, 200 volts and 250,000 ohms being the values used. Slightly better performance was obtained with higher voltage. With this amplifier, it was possible

(Continued on page 116)

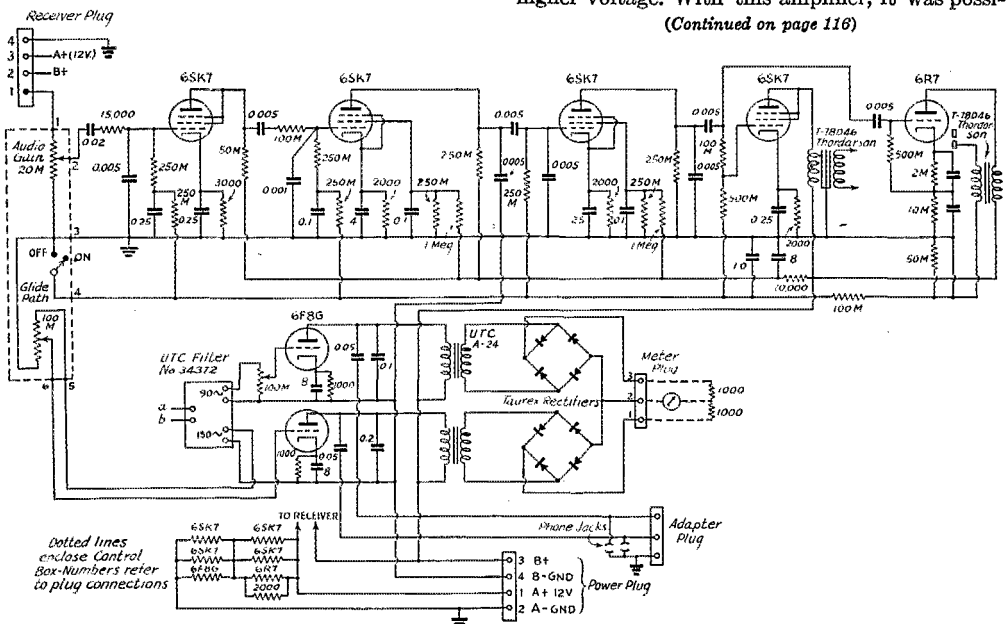

Fig. 8 — The audio amplifier-filter circuit.

# A Double Beam-Power U.H.F. Transmitter

Using the 815 on 28, 56 and 112 Mc.

BY BYRON GOODMAN,\* WJPE

ANYONE who has used beam-power tubes, such as the 6L6 and 807, on the lower frequencies is familiar with the almost negligible driving power requirements of these tubes. However, their effectiveness starts to drop off rapidly above 30 Mc. and, while they can be used at 56 and even 112 Mc., they no longer have the characteristics that make them so popular on the lower frequencies. The advantages and desirability of an inexpensive beam-power tube that will operate normally in the 5- and 2½-meter bands are obvious, and that is why the new RCA 815 double beam tube is so likely to become a favorite among u.h.f. men. During the past two months several rigs have been built using the tube, and the operation of the tube in the u.h.f. range has been a revelation, particularly to those who have struggled with the excitation requirements of other tubes. As one observer put it, "You could probably drive it by waving your hand at it!"

There were troubles, too, as might well be expected. It had been assumed that the tube would require no neutralization, and considerable time was spent in trying to operate it without neutral-

\* Assistant Technical Editor, QST.

ization. However, the high gain of the tube together with the grid-plate capacity of 0.2  $\mu\text{fd}$ . makes any such operation out of the question in the u.h.f. region when "good" tank circuits are used. No doubt the tube could be used on lower frequencies without neutralization, but neutralization was required in the rigs in which the tube has been used in the laboratory here (all of them in the u.h.f. range). It presents no particular problem and does yield an amplifier that can be modulated 100% at full ratings without a trace of regeneration, with no fixed bias necessary to hold the tube down. No trouble was encountered with parasitic oscillations except in one instance, when it was cured by a small by-pass condenser from the center-tap of the grid coil to ground. The amplifier described in this story gave no such trouble, and hence the condenser is not included.

## The Circuit

The transmitter to be described is designed for output in the 28-, 56- and 112-Mc. bands. While there are any number of tube and circuit combinations for getting excitation at these frequencies, it has been found rather generally true that the most straightforward systems are the best and least likely to give trouble. For this reason, regenerative frequency multipliers were ruled out, and a straight crystal oscillator followed by two doubler stages are used throughout. As can be seen in Fig. 1, a 7N7 double triode is used as the oscillator and first doubler, and this is followed by a 7C5 (loktal 6V6) second doubler which drives the 815 as a neutralized amplifier on the three bands. A 7N7 double triode was tried in place of the 7C5 both as a push-push doubler and a push-pull tripler, but was discarded. In both cases it required more drive than the 7C5 and, as a tripler, required that a self-excited oscillator be used (so that the frequencies would work out correctly). With the arrangement as shown, a 7-Mc. crystal is used for 28-Mc. operation, a 14-Mc. crystal for 56-Mc. operation, and a 28-Mc. crystal for 112-Mc. operation. Anyone interested in using only 7-Mc. crystals could include the necessary extra doubler stages without any

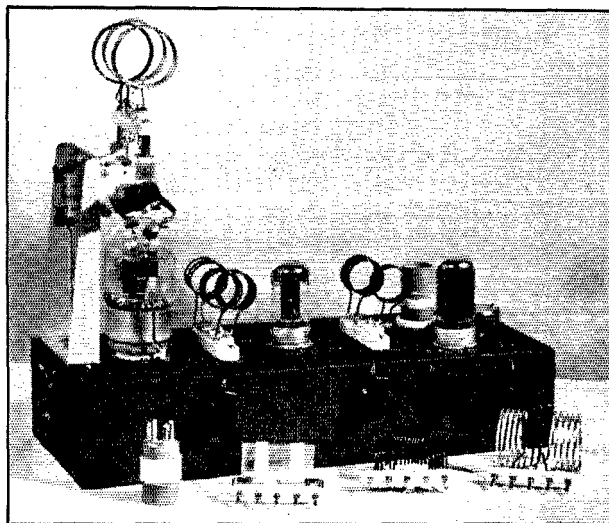

The 815 transmitter with the 56-Mc. coils in place. The 815 amplifier is at the left, the 7C5 driver in the center, and the 7N7 oscillator-doubler at the right. The panel controls, from left to right, are final grid, second doubler grid, first doubler plate and oscillator plate.

The spare set of coils is used on 28 Mc.

trouble. It is possible to quadruple in the stage following the crystal oscillator, and thus use a 7-Mc. crystal for 56-Mc. operation, but everything has to be cranked up to the last notch and it is hardly worth while. As it is, the 7N7 and 7C5 run smoothly with 275 volts on the plate (dropped to 200 on the oscillator) and no crowding is necessary. More than enough excitation is obtained on 28 and 56 Mc., but this is easily controlled by adjusting the coupling between coils, as will be explained later.

The final tank circuit uses the usual coil-and-condenser combination for 10- and 5-meter operation and a parallel-line tank for 112 Mc. The tuning condenser used on the lower frequencies is mounted on a bracket of aluminum which plugs into the chassis, thus making it possible to remove this assembly and plug in the parallel lines used on the highest frequency. The parallel lines are tuned by adjusting a sliding jumper, and the antenna line taps on to the tank lines through small fixed condensers. The first line that was tried used insulated wires running through the copper tubing so that the d.c. voltage would be isolated from the lines as a safety precaution. However, the no-load plate current dip was hardly a dip at all, and the output was considerably below what could be obtained with a coil and condenser circuit. The lines were very nearly a quarter-wavelength long at resonance and, since the output capacity of the tube should be far from negligible, we tried to account for the unlikely length of the line and the lack of efficiency. A pair of condensers between the plates of the tubes and the ends of the tubing boosted the output considerably and required a five-inch shortening of the line, so the poor performance can be blamed on the looseness of coupling between the d.c. wires to the plates and the parallel-line tank. Rather than complicate the construction, it was decided to use the tank to carry the d.c. as well, with a mental note to observe all safety precautions while tuning the tank. While a coil and condenser can be used with fair efficiency at 112 Mc., the parallel-line tank results in lower losses and consequently higher output.

The tube is readily neutralized by using small tabs of copper supported on stiff wires close to the plates of the tube. The plate acts as the other half of the neutralizing condenser, and the com-

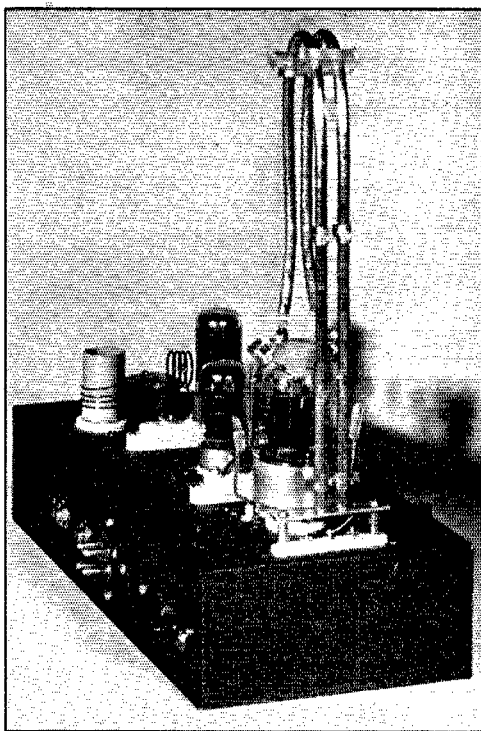

Another view of the transmitter with the 112-Mc. coils and final tank in place. Note the small tabs alongside the 815 that are used for neutralizing and the meter jacks and power-supply terminals at the rear of the chassis.

bination gives about the shortest leads possible. This construction adds no expense to the unit, unless one considers the two small ceramic bushings (Millen 32150) through which the wires are run. Neutralizing consists simply of moving the copper tabs with respect to the tube plates until the stage is neutralized, as indicated by no reaction on the grid current when the plate circuit is tuned through resonance (with plate and screen voltage off).

Jacks are provided for metering grid and plate current in the driver and final stages.

### Construction

The transmitter is built on a 6- by 14- by 3-inch chassis, and reference to the photographs will show how the various components are arranged. The tuning condensers on the chassis are mounted on the small brackets that are available for the Cardwell Trim-Air condensers. Low-loss bakelite loktal sockets are used for the exciter portion, and a ceramic octal socket is used for the 815. The oscillator coil,  $L_1$ , plugs into a four-prong ceramic socket, and Millen 41205 sockets, mounted above the chassis, are provided for coils  $L_2$ - $L_3$  and  $L_4$ -

Many a u.h.f. man has gazed longingly at the u.h.f. beam-power tubes but has usually been discouraged by the price. The new 815 double beam tube carries full ratings at 150 Mc. and, better yet, a price that puts it within the reach of everyone. This story relates some experiences with the 815 and shows how the tube simplifies u.h.f. transmitter design.

$L_5$ . A third 41205 socket, mounted below the chassis, is used to plug in the final tank assembly.

The condenser used to tune the final tank is mounted on a bracket of aluminum that will support the condenser just over the top of the 815. Two copper straps, wrapped around the center of the rotor and fastened to the end-plate spacer bars, provide a central rotor contact that keeps the final tank circuit perfectly symmetrical. Another 41205 socket, supported on this condenser by brass brackets and spacers, provides a socket for the final amplifier coils. A Millen 40205 plug fastened to the bottom of the aluminum bracket holds the assembly in place and provides a connection for the d.c. plate voltage and a ground connection for the aluminum bracket. The 112-Mc. parallel-line tank similarly is mounted on a 40205 plug.

The heater current and low-voltage plate current are introduced at the rear of the set through

a four-prong plug, while the high voltage plus modulation is introduced through a separate safety terminal. The two grid-current jacks are mounted directly on the rear of the chassis, and the two plate-current jacks are mounted on a strip of bakelite supported away from the chassis by brass pillars, for safety and better insulation than could be provided by fibre washers.

### Coils and Adjustment

The adjustment of the coils is similar to that of any other transmitter, with a few minor modifications. The oscillator plate coil,  $L_1$ , is wound as specified, and the crystals should oscillate with the condenser  $C_1$  about half meshed. Coils  $L_2$  and  $L_3$  are next wound and plugged in, with a 0-10 milliammeter plugged in the grid circuit of the 7C5. With the crystal oscillating (as indicated by a neon bulb touched to the "hot" end of  $L_1$  or by monitoring the signal in the receiver),  $C_2$  and  $C_3$

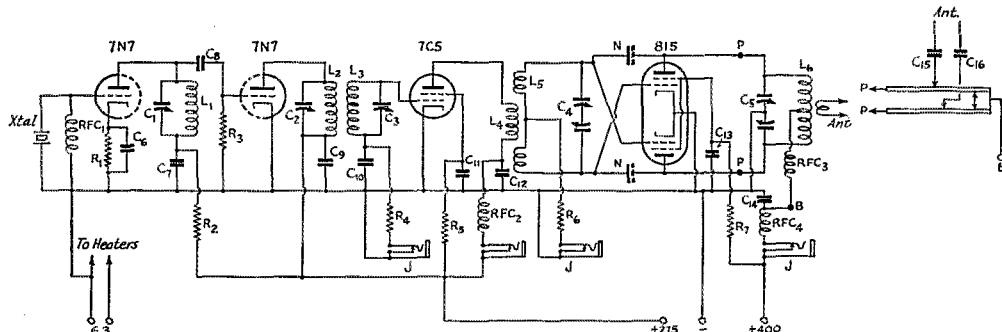

Fig. 1 — Circuit diagram of the 815 u.h.f. transmitter.

$C_1, C_2$  — 75- $\mu$ fd. midget variable (Cardwell ZU-75-AS).

$C_3$  — 25- $\mu$ fd. midget variable (Cardwell ZR-25-AS).

$C_4$  — 15- $\mu$ fd. per section dual midget variable (Cardwell ER-15-AD).

$C_5$  — 15- $\mu$ fd. per section dual midget variable, 0.07 spacing, modified. (Cardwell ET-15-AD.) See text.

$C_6, C_7, C_9, C_{10}, C_{11}$  — 0.005- $\mu$ fd. midget mica.

$L_1$  — 7-Mc. crystal: 18 turns No. 22 d.c.c. closewound.

14-Mc. crystal: 7 turns No. 22 d.c.c. closewound.

28-Mc. crystal: 4 turns No. 18 enam., spaced to occupy  $\frac{3}{4}$  inch.

All  $L_1$  wound on 1-inch diam. plug-in form (National XR-1).

$L_2$  — 14 Mc.: 8 turns No. 22 d.c.c. closewound on  $1\frac{1}{4}$ -inch diam. form.

28 Mc.: 5 turns No. 14 enam., spaced to occupy  $\frac{1}{2}$  inch, self-supporting, 1-inch diam.

56 Mc.: 4 turns No. 14 enam., spaced to occupy  $\frac{1}{2}$  inch, self-supporting,  $\frac{3}{4}$ -inch diam.

$L_3$  — 14 Mc.: 9 turns No. 22 d.c.c. closewound  $\frac{3}{8}$  inch from  $L_2$ . (Wound on Millen 43001 form.)

28 Mc.: 7 turns No. 14 enam. spaced to occupy 1 inch, self-supporting, 1-inch diam.

56 Mc.: Same as  $L_2$ .

$L_4$  — 28 Mc.: 9 turns No. 14 enam., spaced to occupy 1 inch, self-supporting, 1-inch diam.

$C_8$  — 100- $\mu$ fd. midget mica.

$C_{12}$  — 250- $\mu$ fd. midget mica.

$C_{13}, C_{15}, C_{16}$  — 0.001- $\mu$ fd. mica.

$C_{14}$  — 0.001- $\mu$ fd. mica, 2500-volt rating.

N — Small copper tabs,  $\frac{1}{2}$ - by  $\frac{3}{4}$ -inch. See text.

$R_1$  — 300 ohms.

$R_2$  — 5000 ohms, 10-watt wire-wound.

$R_3$  — 50,000 ohms.

$R_4$  — 75,000 ohms.

$R_5$  — 12,000 ohms.

$R_6$  — 15,000 ohms.

$R_7$  — 15,000 ohms, 10-watt wire-wound.

All resistors 1 watt unless otherwise mentioned.

RFC1 — 2.5-mh. r.f. choke (National R-100).

RFC2, RFC3, RFC4 — U.h.f. r.f. choke (Ohmite Z-1).

J — Closed-circuit jack.

56 Mc.: 5 turns No. 14 enam., spaced to occupy  $\frac{7}{8}$  inch, self-supporting, 1-inch diam.

112 Mc.: 3 turns No. 12, spaced diam. of wire, self-supporting,  $\frac{3}{4}$ -inch diam.

$L_5$  — 28 Mc.: 5 turns No. 14 enam. each side of  $L_4$ , self-supporting, same diam. and spaced to occupy  $\frac{1}{2}$  inch.

56 Mc.: 3 turns No. 14 enam. each side of  $L_4$ , self-supporting, same diam. and spaced to occupy  $\frac{1}{4}$  inch.

112 Mc.: 1 turn No. 14 each side of  $L_4$ , same diam.

$L_6$  — 28 Mc.: 10 turns No. 12, spaced wire diam., self-supporting, split in center for  $\frac{3}{4}$  inch for coupling link  $1\frac{3}{4}$ -inch diam.

56 Mc.: 4 turns No. 12 spaced twice wire diam., self-supporting, split in center for  $\frac{1}{2}$  inch for coupling link,  $1\frac{3}{4}$ -inch diam.

112 Mc.: 17 inches  $\frac{1}{4}$ -inch copper tubing spaced  $\frac{1}{4}$  inch.

A view underneath the chassis shows the placement of parts. By-pass condenser leads are made as short as possible, and most of the r.f. leads are made with heavy wire.

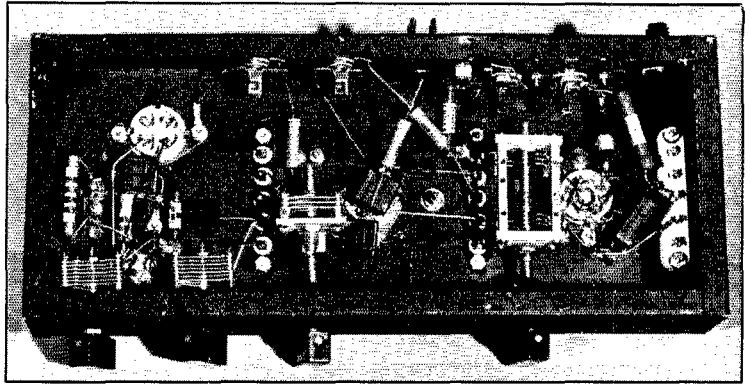

should be tuned for grid current to the 7C5. It will be found that there is some interlocking of the tuning of these two condensers when the coupling is too tight between  $L_2$  and  $L_3$ , and the two coils should be moved in relation to each other until practically "one-spot" tuning is obtained. The grid current to the 7C5 should run from 1.5 to 2 ma., with 275 volts applied to the 7N7. Next,  $L_4$  should be wound, leaving off  $L_5$  for the time being, since  $L_4$  is to be made self-resonant. If it is self-resonant, as indicated by a neon bulb touched to the plate end,  $L_5$  can be wound on, but if it isn't, the turns should be pushed together or pulled apart until signs of r.f. can be seen. When  $L_5$  is added, the coupling should be made rather loose at first, since it will be found that there is more than enough drive available, as indicated by the grid current to the 815. The coils can be coupled until about 6 or 7 ma. of grid current flow in the 815. It will not normally be possible to obtain more than 4 to 5 ma. of grid current on 112 Mc., even with the coils tightly coupled, but this is still sufficient to drive the 815. The plate current of the 7C5 will run from 35 to 40 ma.

When grid current has been obtained in the 815 stage (with no plate or screen voltage applied), the tank circuit can be tuned through resonance, as indicated by a sharp flicker of the grid current. The plates of the neutralizing condensers can then be moved in relation to the tube until no flicker can be seen, indicating that the tube is neutralized. Neutralization should always be checked when shifting from one band to another, since an accidental jar of the tube or some unbalance in the stage may affect the adjustment. If the stage is correctly neutralized, it will be possible to apply several hundred volts (more might injure the tube) to the screen and plate and, with no bias, excitation off and the plate tank unloaded, have no signs of r.f. anywhere in the circuit with any setting of the tank condenser. Unless the stage is neutralized, it will be impossible to modulate the amplifier fully

without distortion, as is the case in any modulated amplifier.

When the amplifier has been neutralized, plate voltage can be applied with the excitation on, and the amplifier can be loaded up to its rating of 150 ma. at 400 volts. About thirty watts of audio power will be required to modulate the stage.

The linear tank is tuned by sliding the shorting bar (two National metal-tube grid caps soldered together) up and down the bar until resonance is indicated. The bar has plate voltage on it, and all tuning should be carefully done with an insulated screwdriver. The antenna coupling is obtained from two similar grid caps that are slid up and down the lines until proper loading is obtained.

If f.m. is to be used on the 5- or  $2\frac{1}{2}$ -meter band, the frequency-modulated oscillator can be coupled in through several turns around  $L_1$ , with the crystal removed from its socket. F.m. oscillators have been described in previous issues of *QST*.<sup>1</sup>

As mentioned before, more than enough excitation is available on the 10- and 5-meter bands, but there is no advantage in running the grid current above 4 or 5 ma., since the output will not increase and the linearity of the amplifier is good with only 3 to 4 ma. grid current. The output of the transmitter could not be measured accurately at anything higher than 28 Mc. (where it was close to 40 watts) but, with the lamp loads used, it appears to be about 35 watts on 56 Mc. and 30 on 112 Mc., at the rated input of 60 watts.

<sup>1</sup> Grammer, "Getting on 56-Mc. F.M.," *QST*, June, 1940.

#### PAYING BASIS

West Middletown, Ohio

Editor, *QST*:

W4EZK, Coral Gables, Fla., who operates on 28 Mc. only, tells me his station is on a paying basis. He received a s.w.l. card and ten cents in money from a short-wave listener in Wisconsin giving him a report of 385 on his signals and asking for a QSL card. W4EZK figured that a 385 report wasn't worth a dime, so he returned the money along with his card. I wonder what he expects from a 589 report?

— John C. Hunt, W8QIE

# Eighth A.R.R.L. Field Day Results

**A**S RELATED last month, the 1940 A.R.R.L. Field Day smashed all previous records and set a new high in operating activity. In these days when service to country and preparedness for any eventuality are so much in the minds of everyone, it is very heartening indeed to note the zeal with which our American radio amateurs plunge into projects designed to increase efficiency in the carrying on of emergency communication.

For information showing the specific standings of groups in the various transmitter classifications, we refer you to the score listings in the November issue of *QST*. Due to space limitations, we are unable to run descriptions of leaders in each of these classifications. However, the box in this write-up presents a concise picture of their accomplishments. Congratulations are in order to the individuals in these groups for helping to put their gang on top! The selection of photos used was made not to show the layouts of leaders in any particular classification, but rather were chosen for their suitability to reproduction and to show various phases of Field Day activity. To those responsible for sending us the many excellent reports of participation, many thanks.

Indicative of the manner in which amateurs take to the idea of testing portable self-powered

equipment is the fact that six F.D. stations broke the record of 5508 points set in last year's affair!

The Frankford Radio Club (well known in club competitions) operated W3BKX/3 at Philadelphia and earned a total of 8406 points; 22 operators were in attendance and 306 of their 601 contacts were with other portables. A breakdown of their work by bands shows 39 QSO's on the 1.75-Mc. band, 230 on 3.5 Mc., 228 on 7 Mc., 70 on 14 Mc., 24 on 28 Mc., and 10 on 56 Mc. It is of interest to note that 87.85% of all contacts were made by the use of c.w.; this figure for the high-scoring group in the 1939 F.D. was 87.5%. Power supply for the various units consisted of five gas-driven generators, two vibrator supplies, and several storage batteries. A live-wire gang, the F.R.C. crowd is to be commended on their FB performance.

Second in number of points scored was the Jersey Shore Amateur Radio Association, W2AER/2. With five transmitters in simultaneous operation, 596 stations were worked for a total of 8253 points. 295 contacts with other portables were made. The majority of QSO's took place on 7 Mc. with 3.5-Mc. c.w., 1.75-Mc. 'phone and 3.9-Mc. 'phone following in that order; 56 Mc., 14 Mc., and 28 Mc. were also used; 27 operators helped to perform the numerous duties



*Upper left:* Three rigs were used by the W5FOP/5 group. Pictured is W5FOP at the key of the 14-Mc. unit. The receiver is an FB7 with preselector and the transmitter the popular 6L6-807 combination. *Upper center:* Members of the Rubber City Radio Club operated W8UMJ/8 in the one transmitter classification. Left to right: Bob Lyman, W8NXI, W8TOL. *Upper right:* The Cuyahoga Radio Association, W8URA/8, were situated in a 25-foot trailer for their F.D. work. W8WV (l.) and W8EBJ (r.) are shown keeping things humming. *Lower left:* Six simultaneously operated units were used by the St. Paul Radio Club, W9KYC/9. Seated at four of the positions are: W9QDF, W9QPL, W9OCN (monitoring operator), W9YCR and W9QPG. *Lower center:* Sixteen of the eighteen members present for the Prairie Dog Emergency Crew's participation in Field Day. Their station, W9JU/9, placed first in the four transmitter classification of the non-club groups. *Lower right:* Members of the Norfolk Radio Club hard at work raising a pole to support antennas at W3BEK/3.



*Upper left:* One of the units at W6CIS/6, operated by members of the San Francisco Radio Amateur Emergency Corps. Ken Hughes, W6CIS, does the "miking" while Bill Ladley, W6RBQ, keeps the log. *Upper center:* Twelve operators manned W9ARU/9. Pictured is the "Graveyard Shift" with W9YQN (r.) at the bug, and W9SFD (l.) and W9ARU, Kentucky S.C.M. (center) trying to keep awake. *Upper right:* Interior of the cook shack at W6CIS/6. W6WN pours the java while W6SDT looks to see how the stew is coming along. *Center right:* The 3.5-7-Mc. position of the W9ERU/9 group. The NC-101X receiver and 6SK7-6V6-6AG7-6L6 e.c.o. transmitter were completely powered from a 6-volt storage battery and several "B" blocks. Photo by W9GKS. *Lower left:* "Brad" Martin, president of the York Road Radio, officially starts Field Day operations for W3QV/3 by spinning the gas-driven generator. *Left to right:* W3ERF, W3AKB, W3DGC, W3AJF, W3ALB, W3QV and W3KF. *Lower right:* Fifteen operators were present for the F.D. doings of the Westlake Amateur Radio Association, W8GYR/8. Four units were in simultaneous operation; juice for all equipment was obtained directly from batteries.

necessary to keep things moving. A 3-kw. portable generator furnished voltage for operation



The Mike and Key Club of Ithaca, W8QLU/8, used balloon-supported antennas. Two of the gang are shown preparing to launch one of the "bubbles."

of all transmitters, receivers, lights, etc. Much of W2AER's success was attributed to the excellent antennas employed. Several of them were erected over salt water, providing excellent conditions for radiation. Having placed second last year also, the J.S.A.R.A. continues to hold its own against increasingly stiff competition!

Following closely behind W2AER/2, the Tri-County Radio Association came through with 8154 as their final score; 648 stations were worked, 235 of them being portables; 40 operators were present to assist in keeping ten transmitter installations on the air. A 3½-kw. generator, a 300-watt generator, and Vibrapacks supplied all necessary power. All receiving antennas were half-wave doublets, and those for transmitting ranged from a 1.75-Mc. Zepp to 14-Mc. Vees. All bands from 1.75 to 56 Mc. were used.

In twenty-first place last year, the St. Paul Radio Club piled up enough points to have the fourth highest score in this year's F.D. Under the club call, W9KYC/9, ten licensed amateurs operating rigs on 'phone and c.w. bands from 1.75 to 28 Mc. had 505 contacts (228 with Field Day stations) for a score of 6853.5. Four e.c.o. and two

crystal rigs were used simultaneously. A novel feature of the S.P.R.C. set-up was the monitor station, equipped with a 100-ke. frequency standard, multivibrators, harmonic amplifiers and

RME9D receiver, whose duty it was to keep a constant check to see that all units operated within the amateur band limits, and with good notes.

(Continued on page 82)

# December 14th-15th U.H.F. Contest

## New Multipliers to Credit Multi-Band Work, States Use of C.W. and Field Operation

**H**ERE'S a chance to roll up your last big bunch of points for the December 1940 Marathon report, to work some brand new u.h.f. stations (perhaps and new states), to pioneer in showing what can be done in handling short test messages across country *entirely by u.h.f.* The December u.h.f. Contest also is week-end fun in its own right, with a separate scoring plan all its own, a report of individual work and contest results to appear in *QST*, and certificate recognition (awards) by the League to participants guaranteed. If you can work on 56, 112, 224, or 448 Mc., plan how to get into the u.h.f. game to the full December 14th and 15th. Enjoy the operating fun and report results to A.R.R.L. for credit!

The Contest Period: December 14th (Saturday), 3 P.M. local time, to December 15th (Sunday), 7:59 P.M. local time.

Scoring of Contacts: List all *different* stations worked in the contest period, and besides the calls show the *location* of the stations obtained as you work them for the claimed points. In a given band, a fixed or portable station may be worked but once *for contact credit* regardless of location. Contact points depend on the transmitter frequency of the station for which the claim is entered, and the distance covered, in line with the table below:

Distance of Station Worked	Number of Points Score, for Contacts Using Transmitter on		
	56-80 Mc.	112-118 Mc.	Above 224 Mc.
Under 25 miles....	1	2	10
25 to 75 miles.....	2	4	20
75 to 275 miles....	5	10	50
Over 250 miles....	10	20	100

Scoring Message Credits: To the contact points computed as above add points *for message copies submitted, which show proper handling data* such as the station from which message was received, station to which the message was sent by radio, and the time and date of each such transfer of acknowledgments of receipt between stations. (The call of the reporting amateur should of course be indicated on each message, too.)

For originating and sending a test message of approximately five to ten words, specifically addressed to remote sections of the country and submitting copy with handling data (but one such message per station be credited) — 10 points.

For relaying such messages away from the

starting point toward destination and submitting full copies (1 for receiving by radio, 2 for relay onward) — 3 points.

Reply and 3rd party messages *relayed*, with copies submitted, also count as just explained, but for originating stations, but — 1 point.

### Multipliers

Points may be multiplied in turn by multipliers designed to credit (a) ability to use more than one ultra-high frequency band; (b) ability to contact stations in different states; (c) ability to use c.w. or m.c.w. as well as A-3 (voice) emission; (d) ability to work from field locations under portable designation.

(a) If one or more contacts are made, with contestants transmitter fundamental on 56-, 112-, 224-, or 448-Mc. assignments, the sum of scoring points may be multiplied by the *number* of such bands on which work is thus demonstrated (not to exceed four).

(b) The sum of scoring points may, in addition, be multiplied by the number of states represented in the "worked list," without respect to the bands used. (District of Columbia counts for Maryland. No state may count more than once.)

(c) Those contact points specifically made with the transmitter using c.w. or m.c.w., and those message points similarly made, may be multiplied by *two* before other multipliers are applied. (C.w. has been previously recommended to aid identification at distant points and add to accuracy, hence the additional credit to those following the recommendation, and for demonstration of ability in its use.)

(d) Stations under portable indicator, may multiply all points made while operating portable or portable mobile by *two*.

— • • • —

After you get your test message off, the aim is to work as many as possible, and push other test communications on their way in a responsible manner.

If you transmit in different u.h.f. bands, the same station may be worked *more than once* to count in the contact score.

Be sure we get your report, with claimed score and message copies, promptly.

— F. E. H.



# Noise Rejection in Frequency Modulation

## A Simplified Explanation of the Factors Involved

BY D. C. HIERATH; WILAC\*

This article, it strikes us, gives as understandable an explanation of f.m. noise reduction as any we have seen — much more so than most. The use of vectors — presented in painless fashion — helps considerably in clearing up some of the knottier points, especially as to the need for wide-band f.m.

**WE** ARE all fairly well acquainted with the advantages to be gained in radio telephone communications work through the use of the relatively new system known as "frequency modulation." To the amateur, the most important of these advantages is the reduction of interfering noises, which this system accomplishes in a highly effective manner.

The rejection of noise in the frequency-modulation system is brought about mainly by a combination of the effects of three different expedients, one of which is employed in the transmitter and the other two in the receiver. This fact has lent somewhat of an air of complication to the workings of the system, insofar as the noise-rejecting properties are concerned. It is the writer's purpose to remove this feeling of complication by presenting a simple explanation of the actions which take place to secure the desired degree of noise elimination.

We are all quite familiar with the workings of the older and commonly used system of amplitude modulation. For the purpose of an easy start, it will be best to review briefly that system, showing why it is particularly susceptible to noise disturbances.

### Amplitude Modulation

In an amplitude-modulated system we send out a carrier wave of a certain amplitude at a fixed frequency. The greater the power of the station, the greater the amplitude of the wave. We vary the amplitude of the transmitter output in accordance with the pitch and loudness of the audio signal. Our receiver tells us about these variations through the loudspeaker. We hear it and recognize it as music or speech.

Noise caused by lightning, unshielded electric

devices, or other sources of "static" has a whole family of frequencies and the amplitudes vary in all sorts of random ways. Our amplitude-modulation receiver picks up some of this "hash" too.

Let's draw a picture—see Fig. 1.

The length of the arrow *AB* represents the power of the station. It rotates around point *A* at a constant speed which corresponds to the frequency of the carrier wave—one revolution per cycle. We vary the length of the arrow *AB* according to the signal we want to send out, thus varying the power output of the station. We call it

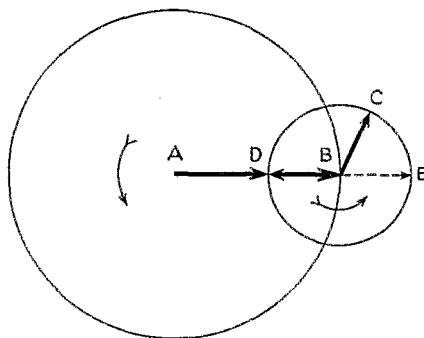

Fig. 1—Ordinary amplitude modulation, showing the effect of noise superimposed on the incoming carrier.

"amplitude modulation." We are limited in the amount we can vary the length of *AB* by the length of *AB* itself. If we pull the head of the arrow any amount to the left of point *A*, our transmitter is putting out zero power during short intervals and the carrier is then being "over-modulated." Zero power constitutes carrier cut-off, which is bad.

Some static noise exists. Its power at any given instant is, say, the length of the arrow *BC*. It fastens itself on point *B* and rotates around that point (the noise carrier frequency), while the whole combination rotates around point *A*. When the noise arrow is in position *BD*, it cancels some of the station power *AB*. When the noise arrow is in position *BE* it adds to arrow *AB*. Thus the noise, too, causes the arrow *AB* to vary. This variation is from *AD* to *AE*, and we can call this "Noise Modulation." Usually it is called static.

### Frequency Modulation — The Limiter

Now for "frequency modulation." Here we send out a carrier of a constant amplitude and

\*Radio & Television Specialist, General Electric Company, 570 Lexington Ave., New York, N. Y.

varying frequency. The amplitude represents the power of the station. We hold the amplitude constant, but the frequency varies in accordance with the sound being transmitted. The frequency-modulation receiver detects these frequency variations and advises the listener about them via the loudspeaker. The frequency-modulation receiver contains a device called a "limiter" or "clipper" that clips off the rough edges of the power in case it, too, starts to vary due to any cause whatsoever.

This "limiter" device therefore keeps any power variations from arriving at the loudspeaker.

We'll draw another picture — see Fig. 2.

The length of the arrow *AB* represents the power of the frequency-modulation station, just as in amplitude modulation. A noise signal, arrow *BC*, fastens itself on the end of *AB* and rotates around point *B* at a rate corresponding to the noise frequency. As in amplitude modulation, the carrier power gets varied from *AD* to *AE* because of the subtracting and adding effects of the noise *BC*. Our receiver can't hear it, though, because the "limiter" in the receiver shaves the power down to the length *AF* before it is allowed to get to the loudspeaker. Result: No amplitude-modulation noise.

We said that we vary the frequency in accordance with the signal to be transmitted. The whole combination in the diagram is rotating around point *A* at a speed which is called the carrier frequency. This speed is varied in accordance with the music or speech being transmitted. That is, from the normal speed at which the arrow *AB* rotates around point *A*, it is speeded up a little and then slowed down a little, alternately, in unison with the various sounds being sent out. The magnitude of the speed-ups and slow-downs is made proportional to the loudness of the sound. The rate at which these speed changes are made is proportional to the pitch of the sound.

A frequency-modulation receiver is an instru-

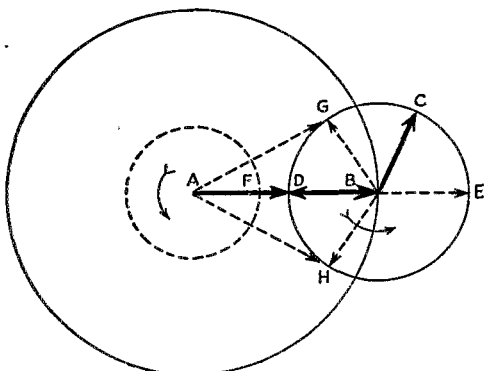

Fig. 2—The frequency-modulation picture. As described in the text, this drawing shows the effect of the limiter and the frequency "wobble" caused by noise.

ment that recognizes these speed changes of the arrow *AB* and tells us about them through the loud-speaker. The speed changes represent changes in frequency and therefore we call it "frequency modulation."

### Effect of Wide Frequency Swing

The noise arrow *BC* does a little more damage than just changing the length of the signal arrow *AB* from *AD* to *AE*, which effect was wiped out by the "limiter" in the receiver, as described above. The noise arrow *BC* rotates around point *B*, as mentioned before. When it is in the position *BG* it adds up with the signal arrow *AB* to produce a combined result represented by arrow *AG*. Likewise when it is in the position *BH*, it adds up with the signal arrow *AB* to produce the resulting arrow *AH*. Thus, the resulting signal that arrives at our receiver is the combination of noise and signal represented by the arrow *AB* which is fluttering back and forth from *G* to *H*. This all happens while the whole combination is rotating at signal frequency speed and while this speed is being varied according to the music or speech being sent. It is convenient to think of the paper on which the diagram is printed as rotating clockwise at the same speed that the arrow *AB* is rotating counter-clockwise. The arrow *AB* will then appear to be standing still except for the rotations first in one direction and then in the other direction caused by the frequency modulation of the signal. It is easy to see that the "flutter" of arrow *AB* from *G* to *H* represents a speed flutter and therefore represents frequency flutter. This is "frequency-modulation noise."

How do we get around it? Simply this: The intentional modulation variations (speed-ups and slow-downs) in the speed of the rotating arrow *AB* are made large in comparison with the "flutter" of *AB* from *G* to *H*. The speed changes of the arrow represent the loudness of the signals being transmitted and the "flutter" of the arrow represents the loudness of the noise that is trying to sneak in. By making one large compared to the other, a high ratio of signal to noise is obtained. Result: Unnoticeable static.

For general voice communications work, where the maximum speech frequency to be transmitted does not exceed 3000 cycles per second, a maximum carrier frequency swing of  $\pm 15$  kc. seems to be about right for the "100% Modulation" condition.

The changes of speed of arrow *AB* are purposely made relatively large. Speed corresponds to frequency. Therefore, frequency modulation makes use of relatively large frequency variations. Hence the name, "wide-band frequency modulation," as invented by Major Edwin H. Armstrong.

### Noise Balancing in the Discriminator

A device called a "frequency discriminator" is used in the conventional frequency-modulation

receiver to detect the frequency variations of the carrier wave and change them into voltage variations which, after amplification, drive the loud-speaker. The output voltages produced by the balanced discriminator for various frequencies impressed on it are represented by curve A in Fig. 3. The device is adjusted so that its response to the mean frequency of the carrier produces zero output voltage and the straight-line portion of the curve fully covers the range of frequency excursions of the carrier caused by modulation.

Examination of the diagram will show that an increase in carrier frequency will produce a positive output voltage from the discriminator and a decrease in frequency will produce a negative voltage. The greater the deviation of the carrier frequency from its mean value, the greater will be the magnitude of the output voltage from the dis-

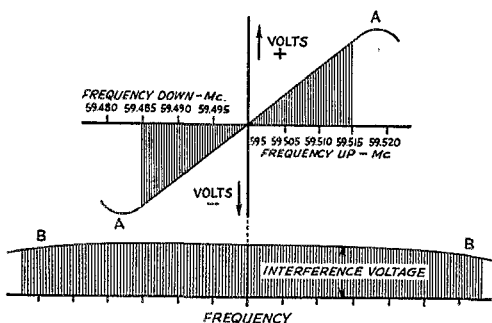

Fig. 3—Illustrating discriminator operation on frequency-modulated signals and on noise which is equally distributed in frequency and amplitude over the pass-band of the receiver.

criminator. This, together with the fact that the device is adjusted to utilize only the straight line portion of its frequency-vs.-voltage curve, makes possible a true undistorted reproduction of all tone volumes, from the loudest to the softest. The rate at which the frequency shifts above and below its mean value determines the rapidity of variation in the output voltage of the discriminator and is related only to the pitch or frequency of the tone being received. So much for the intended function of the discriminator to serve as a detector of frequency-modulated signals.

Fortunately, the balanced discriminator also possesses the important capability of eliminating certain types of interfering noise signals. As an example, a lightning discharge will produce simultaneously a whole series of noise frequencies, as represented by curve B in the diagram. It can be seen readily that when all these noise frequencies are fed into the discriminator simultaneously, the result will be complete cancellation so far as their effect on the output voltage of the discriminator is concerned. That is, all of the noise frequencies above the mean frequency of

the discriminator will tend to produce just as much total positive voltage as the total negative voltage caused by the noise frequencies below the mean frequency. Since these positive and negative voltages are added, by the nature of the electrical circuit of the discriminator, the total output of the device due to the noise frequencies is zero.

### Summary of Noise Rejection Functions

Thus, the successful rejection of noise in the frequency-modulation system of radio signal transmission depends upon the three major factors which have just been described, viz.:

1. The use of a current limiter or "clipper" in the f.m. receiver to remove any amplitude modulation on the received signal carrier wave.
2. The employment of a relatively large frequency swing for modulation of the signal at the f.m. transmitter.
3. The cancelling effect of the second detector or "frequency discriminator" in the f.m. receiver on those interfering noise signals whose frequencies are distributed more or less uniformly over the frequency acceptance range of the device.

### Interfering Stations

Throughout the foregoing discussion it has been implied that the objectionable "noise signals" are usually of the type produced by atmospheric disturbances or certain classes of unshielded electrical devices. However, interfering signals from unwanted stations operating at, or near, the same frequency as the desired station will be eliminated in the f.m. system by the same processes, providing the maximum magnitude of the undesired carrier is never greater than one-half the magnitude of the desired station carrier. To fully realize this effect, it is essential that both the limiter and frequency discriminator stages in the receiver be of properly balanced design and that all components be in correct adjustment.

### ~~Strays~~

We hear frequent stories of near-by amateur transmissions being picked up on various electronic devices, such as electric organs, "talkie" amplifiers and electric guitars. Another unusual case is the one where a loose connection in the oven of a gas range was responsible for picking up the signals of W9JII in a neighboring apartment. The signals were strong enough so that the neighbor complained that he couldn't sleep and it was necessary to enforce quiet hours. After the stove was fixed it showed up on near-by neighbor's bedsprings!



# ON THE ULTRA HIGHS



CONDUCTED BY E. P. TILTON,\* W1HDQ

**F**ROM the earliest days, one of the basic functions of Amateur Radio has been the handling of traffic. Our League was founded for this purpose a generation ago, and though the means by which relays are accomplished have changed completely, the old thrill of relaying a message through a chain of stations to a point beyond the range of most of the intermediates remains with us.

Except for brief periods of local emergency when they have rendered invaluable service, most u.h.f. enthusiasts have had little interest in this phase of amateur endeavor. Most operators recognize the fact that, because of their consistently reliable coverage and freedom from QRM, the Ultra-Highs present an opportunity for emergency service not afforded by any other means of amateur communication; but as for handling traffic for fun — well, they just couldn't see it.

Participation in a series of regularly scheduled U.H.F. Relay Contests has served to awaken interest in message handling on the u.h.f. bands, and recent developments point to the possibility that the organization of networks for traffic

handling may well be the solution to the problem of maintaining an active population on 56 Mc. during this season of the year, when activity on Five is often sadly diminished.

Incentive for the formation of an Atlantic Seaboard Five-Meter Net has been supplied by the removal of W1DEI from Natick, Mass., to Washington, D. C. The famous station at Natick is not to be lost to us, as it is being taken over by Mel's brother, "Web," W1QB, who is licensed for the same location. With nearly ten years of exclusively u.h.f. work to his credit, the idea of migrating to a low-frequency band in order to maintain contact over the 400 miles which separate Natick and Washington did not appeal to Mel in the least. With a continuous line of five-meter stations just waiting for something to happen, why not organize a network if the fellows were interested?

Several operators had expressed the opinion, during the September relay, that a definite program of network organization would be of benefit to all. Here, certainly, was the logical opportunity for the launching of such a program. Letters were written to a number of operators along the line announcing that the first attempt to link the Brothers Wilson by a 56-Mc. relay chain would be made on October 18th at 7:30 p.m., and that henceforth Friday would be Relay Night on Five.

Started under the severe handicap of competition with the distractions of the political campaign, the relay idea has apparently taken hold surprisingly well. Already lined up for active participation are W1's QB, HDQ, KLJ, and KTF; W2's AMJ, COT, and MEU; W3's HOH, GNA, GUF, GGR, WA, AWM, and W1DEI/3. In just about that order, and with the assistance of many others along the line, these stations should constitute a line which could be counted upon to furnish Boston-to-Washington relay service on Five; not only for the primary purpose, the connecting link between two brothers, but for any possible emergency. All 56-Mc. enthusiasts are invited to participate, not only in the handling of the messages originated by Web and Mel, but in originating traffic for friends at either end or at intervening points.

After getting off his traffic for W1DEI/3, W1QB will be standing by for other stations north of Boston. With the help of W1EKT, W1HXP, and others in Northeastern Massachusetts and the boys in New Hampshire, it is hoped that some regular activity can be developed in the state of Maine. If then a few volunteers could be rounded up in North and South Carolina to tie in with

\* 329 Central St., Springfield, Mass.

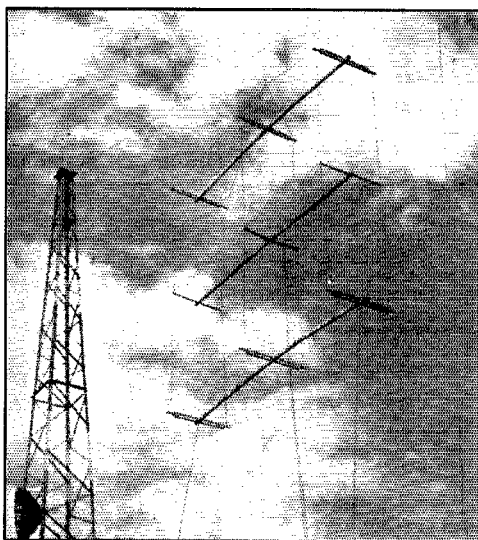

Suspended 110 feet above ground, from a 75-meter flat-top on the roof of the Institute of Geographical Exploration at Harvard University, this 12-element rotary array is largely responsible for the excellent coverage enjoyed by frequency-modulated W1ELP.

W3CYW and W3FJ in Richmond and W3BZ in Danville, Va., on the north, and the boys in Atlanta, Marietta, and Macon, Ga., on the south, the long-awaited Maine-to-Florida five-meter relay might become an actuality.

In addition to the north and south route which is already well under way, an attempt is being made to open up for regular work the east-west circuit which functioned during recent relays. Messages addressed to stations in the middle west will be originated by various east-coast operators each Friday night. These messages will follow the north-south route as far as Philadelphia. From here on it is up to W3BKB, W3HWN, W3BRZ, W8OKC, W8CIR, W8QDU, W8CVQ, and any others who would like to participate in connecting the east with the middle west. It has long been felt that consistent activity on Five is all that is required to make operation on this band every bit as interesting in the winter season as it is during the summer months. It is hoped that this program of "activity with a purpose" will furnish the incentive for the fellows who in the past have worked Five only during the spring and summer months to keep their rigs operative on the band, for one night each week at least, throughout the winter season.

Looking back over the record for October we find that just about everything that can happen on Five in the way of unusual conditions was available to the few who were active regularly on the band. Aurora effect was in evidence on October 7th. At about 8 p.m., W3BZJ, Glenside, Pa., noticed that characteristic flutter on the signals of W2AMJ. Going over the band carefully, several carriers were heard with unintelligible modulation. A "CQ DX" on c.w. brought a reply from W8QDU at Detroit, a distance of 450 miles. Bob reports that a number of other DX contacts could have been made if the fellows had been using c.w. At 9:55 the same evening, W1KTF heard W8SLU, Auburn Heights, Mich., calling W3BZJ. Distortion of 'phone signals was reported by a number of operators on this date, but the above instances are the only cases of DX reported.

During most of the early part of October inversion bending of unusual proportions was in evidence in the east. Peak for this sort of work was reached on October 14th, when conditions for work between the Boston and New York areas

#### 1941 U.H.F. MARATHON

The Marathon which proved so popular during 1940 is being brought up to date for 1941. The rules will appear in January QST. However, reporting must be done on special forms and it is desirable that all those planning to take part write to W1HDQ at once for these forms which will be furnished without charge.

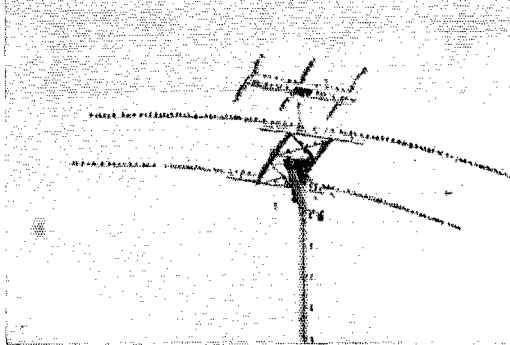

The 10-20 "W8JK" and 3-element 56-Mc. "Q" array of W9BDL, Marshall, Ill., load up easily in the summer months! Prospects for a "hot-foot" are Martins.

were just about as good as they ever get to be. W2CUZ and W2AMJ had a "field day" on this occasion, each making a number of contacts in the Boston area, distances covered ranging up to 200 miles. W2CUZ reported the f.m. signals of W1ELP, Cambridge, Mass., as the loudest ever heard from the Boston area. Portable and low-powered stations in Boston and vicinity were heard with good strength in Hartford, while W1KJL, with his 375 watts and 12-element rotary array atop Fall Mountain, Bristol, Conn., was paralyzing the receivers in New Hampshire and northeastern Massachusetts. This was one of those nights when your conductor stayed home to get caught up on his correspondence!

To prove that sporadic-E skip can happen anytime, we had a brief flurry of this sort of thing on October 21st. Note that the three "hot nights" mentioned thus far were all Mondays — a night that many of the gang take to do things other than operate on Five! Ten was hot with short skip of summertime proportions during the entire evening, but the only reports of skip on Five received to date came from W1DA, Lynnfield, Mass., and W1HXP of Newton; both of whom heard W9VHG, Glenview, Ill., and W9GHW, Kirkwood, Mo., for a short time around 8 p.m. Another instance of 56-Mc. skip was reported by W6QLZ, Phoenix, Ariz., who worked W5EEX, Houston, Texas, on October 3rd. Clyde also heard signals from W7 and W9 on this date.

#### HERE AND THERE:

The Ultra-Highs must have been mighty quiet in New England on October 5th. Nearly 200 enthusiasts showed up at the u.h.f. session held at the annual Boston Hamfest on this date. A demonstration of the advantages of f.m. transmission as compared with a.m. of similar power, when received through local noise, was afforded by two-way work with W1ELP. Bill used both types of transmission while noise from an electric razor furnished ample proof for the assembled gathering that f.m. will get through definitely better under noisy conditions than will an a.m. signal of similar strength. A talk on f.m. technique and a demonstration of the "pot" oscillator for 2½ were provided by Byron Goodman of Headquarters, and judging from the swarm of hams on deck to ply him with questions at the conclusion of the session he must have started something.

If, through reading of his 3764-foot elevation atop Glasbury Mountain, Vt., you have been envious of the good fortune of State Fire Warden W1MEP, you can take the

## U.H.F. DX RECORDS

### Two-Way Work

- 56 Mc.: W1EYM — W6DNS, July 22, 1938.  
2500 miles.  
112 Mc.: W6BJI/6 — W6KIN/6, July 4, 1940.  
255 miles.  
224 Mc.: W6IOJ/6 — W6LFN/6, August 18,  
1940 — 135 miles.  
400 Mc.: W6IOJ/6 — W6MYJ, September 23,  
1940 — 11 miles.

word of your conductor (and Mrs. Conductor) that a mountain-top QTH five country miles from the nearest road is no bed of roses! We negotiated that portion of Vermont's famous "Long Trail" which goes up over Chet's mountain from Woodford, Vt., and we can assure anyone that the five miles mentioned is no lie! Chet has an option on a Wind-charger and, barring a call to military service, will be on deck next year with "high power." About 40 different stations in 7 states was the score of W1MEF/1 for the 1940 season which ended, with heavy snows and zero temperatures, on November 1st.

In a cockeyed QSO on 28 Mc., when both stations had to use east-west beams (though we both have rhombics aimed at each other), W4FBH of Decatur, Ga., informs us that the Atlanta gang still maintain their Friday-night sessions on Five. W4MV and W4FKN join with Roy regularly, and hope is held that activity may be developed in Rome and Cartersville, Ga., and Chattanooga, Tenn., with a view to tying in with the Atlantic Seaboard Net in the Friday-night relays.

The Great Lakes Amateur Radiophone Association is sponsoring an Ultra-High Frequency Contest which got under way on November 1st, running until midnight, January 31, 1941. Serial numbers of six digits will be exchanged by contestants for purposes of checking and scoring. This number will consist of the RST report and the contact number; as, for instance: 579001, 589002, etc. For 'phone work five digits will be used, including only the readability-strength report and the contact number. The contest will be divided into groups as follows: (1) 56 Mc., fixed; (2) 56 Mc., mobile; (3) 112 Mc., fixed; (4) 112 Mc., mobile; (5) 224 Mc., fixed or mobile. Scoring will be on a basis of mileage. The contest is open to members of the association only. Information may be obtained from the contest committee, composed of W8QDU, W8KQC, W8MCD, and W8QQS; or the president or secretary of the association, W8JDG and W8QIX, respectively.

Several of our regular u.h.f. reporters have mentioned attending the Central Division convention at Indianapolis in late September. An illustrated talk on the doings of the various middle-western 56-Mc. nets was presented by Russ Planck, W9RGH. We understand that W8QDU, ardent champion of vertical polarization, had quite a time of it in this, the center, of "Horizontal Land." We hear that the any-position array of W9ZHB is now completed, and the big news can be expected from Zearing 'most any day now. If nothing is heard, we'll take that as evidence that the array brought in strong signals in the vertical position!

Can you actually work anything on Five? This question is still asked by budding u.h.f. prospects. Take a peek at the log of W9BDL, Marshall, Ill. Though operation is confined to noon and supper-hour periods, or after 11 p.m., Elmer had 510 contacts on Five with 38 different stations in the period from May through September. The rig at W9BDL is a pair of T-55's at 160 watts, the receiver a Lester Converter ahead of a "Deluxe S.S." super. W9BDL is one of the recent converts to 56 Mc. who have had such excellent success with 3-element horizontal "Q" arrays, made popular by the efforts of W9ZHB. Work up to 250 miles and more was done frequently during the summer months. We would be very much interested to know how this sort of work is progressing during the winter season. What say, fellows? How far can you work out consistently during winter's adverse conditions? In the east we find that there are nights

when 100 miles is just about the limit that can be covered, if you exclude those who are blessed with high-altitude locations. A day-to-day comparison of signal strengths in winter with those obtaining in the summer months represents a nice project for the Ozark and Illinois nets. How about it?

### 112 MC.:

WHAT undoubtedly rates as a new record for 112-Mc. work between two fixed stations was set on October 5th by W2LAU of Summit, N. J., and W1MON, Holbrook, Mass. A limiting factor which has heretofore been in the way of Boston-New York work on 112 Mc. has been the local QRM which operators in both of these areas have to contend with. The Boston Hamfest had attracted practically the entire 112-Mc. population of the metropolitan area, and W1MON had a clear field. The possibility of aurora effect is indicated here, too. W1MON reports a visible display on this evening, and evidence points to the presence of some sort of skip, as the signals of W1MON were not heard by any of the New York City or Long Island stations. W2LAU is located 21 miles west of lower Manhattan. The rig is a linear oscillator with HK-24's running 85 watts input, feeding a 3-element rotary beam. The receiver is a National 1-10. At Holbrook, 20 miles south of Boston, W1MON uses a single 45 oscillator, modulated with 42's. The antenna is also a 3-element vertical array.

It is interesting to note that the first instances of aurora effect on Five were noted only after the general adoption of selective receivers. It seems that the broadness and distortion which appear on a signal which is being received by means of aurora reflection simulate frequency modulation of the signal. It may well be that this effect is not noticeable when super-regenerative receivers are used; hence, the general lack of aurora DX, as such, in our 112-Mc. picture. The presence of the opportunity for this sort of work can often be detected by listening on 28 Mc. or by monitoring commercial signals in the range between 28 and 112 Mc. Normal skip in an east-west direction is usually missing on Ten during these periods. Signals from beyond the average distances, 50-200 miles, will often be heard on Ten, usually with a rapid-swinging fade and "rain-barrel" quality. Signals such as the NBC television station, W2XPS, on 55.75 Mc. may also have the same characteristics, even sounding as though frequency-modulated.

To all who operate on 112 Mc., we urge that you be on the lookout for these unusual conditions. Watch the northern sky for visual indication of aurora at night. If you have a beam, swing it on every station you hear coming through from beyond a purely visual distance. You may have a new world's record for 112 Mc. dumped in your lap for your trouble!

During the evening of October 14th when the hot condition mentioned in the five-meter news was on, W1LH of Hartford worked W1HXP of Newton, Mass. They decided to change to 112 Mc. at 11:30 p.m., with the result that HXP was heard in Hartford as strong as S-7. The signals of L1H could barely be made out at Newton when George went to 2¼, but W1MBS of West Roxbury, near-by, heard L1H with good strength. In addition to W1HXP, L1H also heard W1KSA and W1LLS.

The "Horsetraders" of 56-Mc. fame now have a 112-Mc. section. Each Thursday night at 8 p.m., W1LH calls the roll. All the boys who have portable gear make for some hill-top for this session, and frequently up to 10 stations join in the weekly roundtable discussion of 112-Mc. news and problems. Regular participants include W1's MSJ/1, VK/1, LEP, HDQ, MPB, LAL, HWH, MGT, and MPO/1. That this list grew from a start a few weeks back with only three stations, proves the value of organized effort in promoting activity on any u.h.f. band.

From W9ZD, attending the Boston Hamfest, we learn that Kansas City, Mo., is becoming 112-Mc. conscious. W9DDX was the first one on the band, with W9GK at Overland Park, Kansas, and W9ZD joining him. All use horizontal antennas, and good signals are exchanged over distances up to 25 miles, this being the range of activity at present. W9ZD is en route to Florida at this writing, with a portable set-up in his car. He looks forward to contacts with

# New Amateur Television Records on 112 Mc.

**R**IGHT on the heels of the two-way television "first" reported in November *QST*, we now have two new records for reception of amateur television signals over distances greater than the eight-mile path spanned in the two-way communication between W2USA and W2DKJ/2 during the last month of the New York World's Fair. These reception records of 17 and 29 miles were made by D. A. Griffin, W2AOE, with a newly designed receiver having improved sensitivity as compared to the sets used at W2USA and W2DKJ/2, both of which are duplicates of the basic model described by J. B. Sherman in June, 1940, *QST*.

First tests with the new design at W2DKJ/2, receiving the 20-watt 112-Mc. television signals from W2USA, showed its marked superiority over the earlier model and indicated that useful signals should be easily receivable at distances considerably greater than eight miles. Accordingly, arrangements were made to make a test on Oct. 15th at Albertson, Long Island, the QRA of the Northern Nassau Radio Association clubhouse, which is 17 miles from W2DKJ/2. With 45 of the gang as witnesses, excellent reception of the "show" put on by W2HID at the Ike of W2DKJ/2 was enjoyed and signal strength proved to be more than adequate.

For the 29-mile record, made on the night of October 19th, the receiving location was W3FRE at Denville, N. J. Transmission again was from W2DKJ/2, with the simple 3-element directive antenna swung around in the other direction. In the presence of 15 hams, including several well-known u.h.f. engineers, excellent reception of good-quality pictures was conclusively demonstrated. Observers experienced in commercial television were especially surprised at the capability of the simple amateur television system in delivering good picture reproduction over so long a path without resort to especially high elevation for either transmitting or receiving antennas. The antennas at both ends were only 400 feet above sea level, with typical metropolitan and suburban areas intervening.

The receiver employed in these tests is in regular use at W2AOE's home station in Plainfield, N. J., 24 miles from W2DKJ/2 and behind a range of intervening hills, where the picture still rolls in although New York 112-Mc. 'phone stations are rarely heard on an ordinary receiver. Realizing that many u.h.f. enthusiasts, both 'phone and television, would find good use for the circuit improvements "Griff" has worked into his new receiver, we have persuaded him to prepare a complete constructional description with all the details. This article will appear in an early issue.

—J. J. L.

## U.H.F. MARATHON SEPTEMBER WINNER: W2DZA, TEANECK, N. J., 66 POINTS

Call	Contacts Through September			Cumulative Score	States in 1940
	66	112	224		
W1AIX	23		3	68	2
W1BCT		10		22	2
W1CGY	50			135	5
W1CLH	72			264	13
W1EHT	57			87	3
W1EKT	114			310	12
W1ELP <sup>1</sup>	82	51		237	11
W1GJZ	118			485	12
W1HDF	81	12	4	374	13
W1HDD <sup>2</sup>	201	56	1	1408	24
W1HXP	23			—	20
W1JIS				65	4
W1JJE	110	4	3	588	17
W1JLK	90	28		203	6
W1JJP	1	30		73	3
W1KIJ	239	7	5	1291	24
W1LLL	143			326	20
W1LFP	64			152	6
W1LSN	54			128	13
W1MBS		142		306	6
W1MEP	28			90	7
W2ADW	14	27		163	3
W2AMJ	185			353	24
W2BYM	42	7		245	15
W2BZB	32	115		314	5
W2COT	127	12		285	7
W2DZA	127	104		250	5
W2GHV	122			590	21
W2LAL	87			210	11
W2LXO		131		300	4
W3BYF	58			314	18
W3BZJ	216	48		1318	25
W3CGV	75			213	11
W3EBS	22	11	1	93	5
W3FSM		29		60	2
W3FX	37	28		107	3
W3HOH	211	19		701	16
W3RL	69	1		562	21
W4BLZ	31			280	12
W4FBH	82			738	18
W5AJG	163	6		1761	25
W5VV	59			662	18
W5YF	11			101	5
W6IOJ	8	95		393	3
W6OVK	19			194	7
W6PGO	7			16	6
W6QG	24	4	2	186	4
W6QLZ	35	2		1051	18
W6RVL	1	180		493	1
W8MHM	32	16		113	7
W8NKJ	53	23		397	11
W8QDU	113	47		795	20
W8QCS	62			435	15
W8RKE	72			591	19
W8RUE	73	16		328	15
W8SNN		21		42	1
W9ARN	81			702	20
W9DQH	44			297	17
W9ZJB	137			1351	26

<sup>1</sup> Frequency modulation used exclusively at W1ELP.

<sup>2</sup> Not eligible for award.

<sup>3</sup> To conserve space, stations not reporting for two consecutive months have been deleted. These will be re-listed upon receipt of further reports.

W4EDD at Coral Gables, Fla., who is getting his high-power crystal-controlled rig in order for the anticipated influx of 112-Mc. mobile stations with the winter migration. The 6E6 home rig of W9ZD is now in use at W9AHZ, and rumor has it that the 1940 Marathon score of W9ZJB is about to be fattened by the addition of some contacts on 112 Mc.

W6QZA, Santa Barbara, Cal., reports via 28 Mc. that he has shipped all his 112-Mc. gear to Fort Smith, Arkansas; where W5HCQ is expecting to do big things on 2½. We know the equipment works — Elliot, you may remember, is co-holder, with W6MKS, of the 216-mile record for two on-the-ground stations. The gear consists of two transmitters, a midget HY-75 mobile rig, and a concentric-line oscillator using a 75-T. Both units have been described in *Radio* by W6QZA.

# The 6L6 As a Crystal Oscillator

*Combination Circuit for Best Results on Fundamental and Harmonic*

BY DON MIX\*, WITS

Two of the most popular crystal-oscillator circuits in use these days are the Tri-tet and "grid-plate" circuits. Their popularity is well deserved, because they have several desirable features. In the first place, they are frequency-multiplying oscillators; that is, they will deliver output at the harmonics of the crystal frequency as well as the fundamental. This is not only of importance in the simple oscillator transmitter, where it makes it possible to operate in more than one band with one crystal, but also in the multi-stage transmitter, where the number of required stages may be reduced. This is particularly desirable when there is no provision in the transmitter for cutting out doubler stages which must be well stabilized for fundamental operation.

Another feature of these circuits is that they exhibit characteristics similar to those of an oscillator-amplifier combination. In a true Tri-tet or grid-plate oscillator, in which the screen serves as the plate of a triode oscillator, the functioning of the oscillator circuit proper is, for most practical purposes, independent of loading and tuning of the plate circuit. The nuisance of critical adjustments of loading and tuning may be eliminated entirely. This is in contrast to the familiar behavior of the triode, tetrode or pentode "X"-grid, tuned-plate circuits where the plate circuit must be detuned to a rather critical point off resonance where less than maximum output is obtained for the sake of reliable starting and maintenance of oscillations.

As pointed out by James Lamb in his excellent treatment of crystal oscillators,<sup>1</sup> the more complete the screening between control grid and plate, the more independent becomes the loading and tuning of the plate circuit. Such tubes as the 802 and RK23-25 are recommended as the best tubes for the purpose. Unfortunately, the popular, less expensive 6L6 is an audio tube and is not so well screened and invariably its performance does not conform to that usually predicted for the circuit in use. While it works beautifully in the Tri-tet circuit with the plate circuit tuned to the crystal harmonic, it invariably exhibits characteristics resembling more those of the tetrode circuit at the fundamental, particularly when the circuit is unloaded.

With this condition, crystal current will run

high near plate-circuit resonance and oscillation will cease at exact resonance, whereas with the true Tri-tet, crystal current is low when the circuit is not loaded and the circuit oscillates without interruption as the plate circuit is tuned through resonance. This high crystal current with the 6L6 explains the frequent crystal fractures which are often experienced with this arrangement. However, as the loading is increased the crystal current does not drop off rapidly as might be expected with tetrode operation, indicating that excitation is being held up by Tri-tet action. In spite of this, however, the plate circuit cannot be tuned on the nose, in fact the circuit must be detuned so far to the high-frequency side of resonance for reliable keying or starting of oscillation that we actually end up with less output and poorer efficiency at the fundamental than at the harmonic.

In a multi-stage transmitter or an exciter, this may not always be of great consequence, since the oscillator is often followed by a stage of high power-amplification requiring less than maximum output from the oscillator for adequate excitation. In the simple oscillator transmitter, however, it may become of greater importance, since tests have shown that it may be necessary to detune the plate circuit to such an extent for good keying that the output is reduced to as low as twenty percent of the maximum obtainable. Such operation, of course, increases enormously the power which the tube is required to dissipate.

With the grid-plate oscillator circuit, we find conditions reversed. The circuit performs well at the fundamental with the oscillating circuit proper functioning quite independently of the plate circuit. The circuit does not perform as well as the Tri-tet at the second harmonic, however. In fact, it is only by virtue of the fact that the screening of the 6L6 is incomplete that any appreciable even harmonic output may be obtained. This may be demonstrated by the substi-

Most of us have found, from experience with crystal oscillators, that the 6L6 does not always perform according to predictions based upon the use of well-screened tubes. This article tells how to get the most satisfactory results with the 6L6 both at the crystal fundamental and at the second harmonic.

\* Assistant Technical Editor

<sup>1</sup> Lamb, "A Practical Survey of Pentode and Beam Tube Crystal Oscillators for Fundamental and Second Harmonic Output," *QST*, April 1937.



tution of a well-screened tube such as the 802. Under similar circumstances, the harmonic output even with the 6L6 will not exceed 60 percent or so of that obtainable with the Tri-tet arrangement and considerable difficulty may be encountered in obtaining an adjustment which will permit satisfactory keying of the circuit. Experience has shown that it is seldom possible to obtain any second harmonic output from a 1.7-Mc. crystal in this circuit.

We now come to the conclusion that what we want is a combination of the two circuits — the grid-plate circuit for fundamental output and the Tri-tet for harmonic operation. This can be accomplished by a switching system in the cathode circuit, or perhaps preferably by a plug-in arrangement, which will permit changing the circuit as well as circuit values to optimum figures for each band.

In selecting the best circuit values, several series of tests were made. These tests showed several interesting things. In the Tri-tet circuit, the values of inductance and capacity to be used for each band are fairly critical. For instance, it was found that 7- and 1.75-Mc. crystals operated well with a capacity of 100  $\mu\text{mfd}$ . Improvement was shown, however, by increasing this capacity to 200  $\mu\text{mfd}$ . for 3.5-Mc. crystal. With the inductance in use (approximately 3.7 mh.) the circuit resonated at about 6 Mc. A new coil was wound to resonate at 6 Mc. with the 100- $\mu\text{mfd}$ . capacity, but this resulted in much reduced output and greatly increased crystal current. The coil sizes given for  $L_2$  should be followed closely.

The cathode resistance is quite essential for good keying and ready starting of the oscillator. Its value should not be too high, however, since it results in reduced output, especially when operating at the crystal fundamental. Higher values of grid leak up to 0.1 megohm will result in somewhat better plate-circuit efficiency, especially at the harmonic, but the higher values make it impossible to obtain maximum power output and result in much higher orders of crystal current.

With 7-Mc. crystals, it is possible to reduce crystal current appreciably without affecting the output in the least by inserting a small capacity,  $C_1$ , in series with the crystal. With lower-frequency crystals, however, this condenser must be short-circuited for satisfactory operation. Since crystal currents do not run so high with lower-frequency crystals, the series condenser is unnecessary.

Screen-voltage adjustments did not prove to be critical once optimum circuit values were determined. There seems to be no point in running the screen voltage higher than about sixty per cent of the plate voltage, since the output does not increase appreciably and the only results may be unnecessary heating of the screen and increased crystal current.

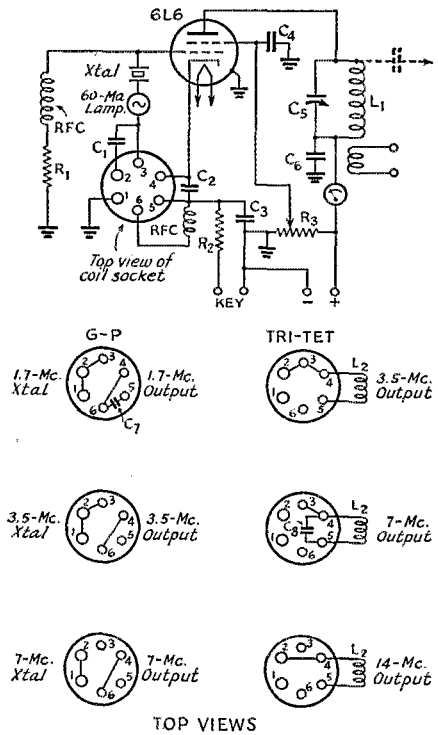

Fig. 1 — Circuit diagram of the combination 6L6 oscillator. Crystal frequencies for each combination are shown in column to right of plug-in-unit diagrams.

- $C_1$  — 50- $\mu\text{mfd}$ . mica.
- $C_2$  — 100- $\mu\text{mfd}$ . mica.
- $C_3$  — 0.01- $\mu\text{mfd}$ . paper.
- $C_4$  — 0.01- $\mu\text{mfd}$ . paper.
- $C_5$  — 250- $\mu\text{mfd}$ . variable.
- $C_6$  — 0.01- $\mu\text{mfd}$ . paper.
- $C_7$  — 100- $\mu\text{mfd}$ . mica.
- $C_8$  — 100- $\mu\text{mfd}$ . mica.
- $R_1$  — 20,000 ohms, 1-watt.
- $R_2$  — 200 ohms, 10-watts.
- $R_3$  — 50,000 ohms, 50-watt, with slider.
- $L_1$  — 1.7 Mc. — 26 turns, 1½-in. diam., 1-in. long.
- 3.5 Mc. — 13 turns, 1½-in. diam., 1-in. long.
- 7 Mc. — 9 turns, 1½-in. diam., 1½-in. long.
- 14 Mc. — 7 turns 1½-in. diam., 1-in. long.
- $L_2$  — 1.7-Mc. crystal — 31 turns, 1½-in. diam., 1-in. long.
- 3.5-Mc. crystal — 10 turns, 1½-in. diam., 1-in. long.
- 7-Mc. crystal — 6½ turns, 1½-in. diam., ¾-in. long.

The same values of grid-leak resistance, cathode resistance and screen voltage seemed to give about optimum output when working at the crystal fundamental with the grid-plate circuit. Somewhat greater output may be obtained by eliminating the grid-leak resistance entirely, but the efficiency suffers.

While the usually recommended value of 100  $\mu\text{mfd}$ . for the capacity shunting the cathode choke in the grid-plate circuit seemed to be op-

(Continued on page 84)



# NAVAL COMMUNICATION RESERVE NOTES

## NCR Notes in Eighth Naval District

BY ENSIGN NORMAN B. DRAKE,  
C-V(S), USNR

(The opinions expressed are those of the writer and do not necessarily reflect those of the Navy Department.)

The Eighth Naval District is composed of the states of Alabama, Arkansas, Florida (west of the Apalachicola River), Louisiana, Mississippi, Oklahoma, Tennessee, and Texas. The District Commandant is located at Charleston, South Carolina.

The organization of the Naval Communication Reserve within the district under the District Commandant comes under the District Communication Officer and the NCR Commander of the district. It is subdivided into sections and units as follows:

Section	Area	Units located at
1.	Louisiana & Mississippi	*New Orleans, La.; Baton Rouge, La.; Vicksburg, Miss.; Jackson, Miss.; Laurel, Miss.
2.	Florida	*Pensacola, Fla.
3.	Alabama	*Gadsden, Mobile, Birmingham, Florence.
4.	Arkansas	*Little Rock, Pine Bluff, Fort Smith.
5.	Tennessee	*Knoxville, Memphis.
6.	Texas (S. of 31° N. and E. of 100° W.)	*Houston, Beaumont, Port Arthur, Brownsville, San Antonio.
7.	Texas (N. of 31° N. and E. of 100° W.)	*Abilene, Dallas. Wichita Falls, Fort Worth, El Paso.
8.	Oklahoma	*Ponca City, Tulsa, Ardmore.
9.	Texas (W. of 100° W.)	Unorganized.

A Section Control Station for each of the above sections is located at the points starred (\*). In addition, District and Alternate District Control Stations are located at Pensacola, Fla., Memphis, Tenn., and Dallas, Texas. There are 43 officers and 332 enlisted men in the NCR organization of the Eighth Naval District. Reserve Radio facilities of the district include 27 Unit Control Stations, 8 Section Control Stations and 3 District Control Stations.

During the annual National Competition season lasting from each September to the following June, it is difficult to find an unoccupied NCR member in the district any Tuesday evening. All district, section, and unit radio drills as well as a district intercept schedule have been consolidated and scheduled weekly on that evening. The result is a concentration of training for a fully mobilized organization, making for the best efficiency in training. As a result of this drill schedule, many

control stations operate simultaneously on two frequencies during the drill period, thus providing technical as well as operating problems for solution.

Running concurrently with the National Competition season, it has been the practice in this District during the past several years to conduct an intra-district contest among the various sections. Rules for this contest vary from year to year according to the need for strengthening existing weaknesses of the organization. An appropriate trophy is awarded to the winning section. The 1939-40 contest stressed factors based on knowledge of Naval Communication Procedure, individual improvement in operating ability, and proper attention of unit and section commands to routine reports and correspondence.

Training duty is available to officers and men of the district as funds permit in several general forms: annual training cruise with units of the organized reserve; duty at Naval Radio Station NAS, Pensacola, Fla.; duty at the Navy Direction Finder Station NKB, Galveston, Texas; and duty at the Naval Air Station, Miami, Fla. The annual training cruise is, of course, the favorite, and ports of call for the past several years have included one of the following: Miami, Fla.; Cristobal, Canal Zone; Kingston, Jamaica; Port-au-Prince, Haiti, and Habana, Cuba.

Situated as it is, so as to encompass areas subject to flood, tropical storm, and sleet storms, the NCR men of this district occupy important positions with regard to emergency communications. A number of its members have a "storm net" organized along the Texas coastline, prepared to function on short notice. Members at Pensacola, Fla., supported by the U. S. Naval Radio Station NAS, and the facilities of the Naval Air Station located there are prepared to cope with the emergency of tropical storms. The most northerly members in the district, although situated well away from the hazards of coastal storms, must handle the problems of the heavy sleet "loading" area of northern Oklahoma. They have, accordingly, formed and on two occasions mobilized their emergency organization to supplant failing wire communication. Early in the stages of its organization, the NCR of the Eighth Naval District performed noteworthy work by furnishing operators to the Coast Guard during the Choctawhatchee flood, and providing the only means of communication from Pensacola, Fla., during the hurricane of 1926.

Perhaps the most outstanding large scale

### Recognize Any Friends Here?

Here are the Naval Reserve radio-men, Class V-3, who were graduated from the U. S. Naval Training Station at San Diego, Calif., on September 20th, the picture being taken just prior to their sea assignment. They've signed up for a year, have just completed four months of schooling, and now go to sea for eight months as radio operators.

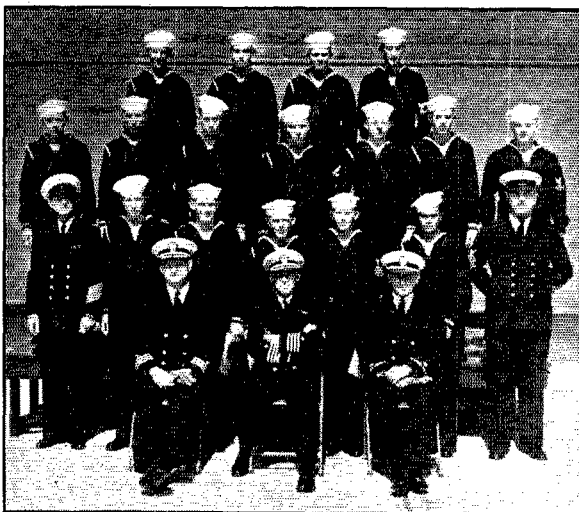

emergency accomplishment was performed by the staff of NDD, Memphis, during the Mississippi Valley Flood of 1937. Operators were provided for a number of National Park Service transmitters installed aboard river craft and NDD served as a communication center for these as well as U. S. Army Engineer Corp and amateur stations.

All hands of the district receive the monthly publication "The Volunteer," prepared and published by the staff of the District Communication Office in collaboration with district members. Its function is to create a close liaison within the district and to disseminate news of timely interest. The articles, technical and official, are timely, pithy, and reflect the mission of the Reservist which has been so adequately described thus:

"To fit myself by attendance at drills and lectures, by study of official publications pertaining to the duties of my future employment in the Navy, by completion of correspondence courses; by an active interest in Naval Reserve affairs, by loyalty and helpfulness to my brother officers and men, both regular and reserve, by personal conduct above reproach in daily life, by patriotic

activity in civil affairs during time of peace, so as to make myself efficient in the discharge of the duties of my rank or rate in time of war to insure a strong defense for my country through a victorious Navy."

### Strays

Hams as a whole probably are unaware of the fact that the facilities of the various frequency-measurement laboratories are available for measurements of amateur frequencies as well as those of their regular commercial customers. One of the latest announcements along this line comes from the Frequency-Measuring Division of Press Wireless, Inc., at Little Neck, L. I. Special measurements will be made at any time (except between 12 midnight and 8 a.m. E.S.T. Sundays) (on request by telephone or telegraph), at a cost of \$2.00 per measurement; routine measurements, on a regularly-scheduled basis, at the rate of \$1.50 per measurement. Accuracy is to one part in a million or better.

### 4TH ANNUAL A.R.R.L. QSO PARTY

Notice! This major Member Party Activity of the League will be held this year on the dates of January 18th and 19th. The general plan of activity will follow that of other years in most particulars . . . fun and fraternalism assured!

One fixed-credit factor (new) in the scoring will depend on either having received a League Code Proficiency Award or submitting copy made during the Member activity January 19th for qualification. *This advance notice* is to permit every ham, and all will want to take part, to (1) check up on his League membership to be sure it's all in order for January doings; (2) submit qualifying copy on the W1AW run of December 17th in order to get a Code Proficiency Award in advance, to make it possible to claim that particular 50-points-before-multiplier in connection with the January Party without taking the time from Party operations.

Get your station in A-1 shape today for the January 18th-19th A.R.R.L. Party!

— F. E. H.

# Improving Crystal Filter Performance

**A 455-Kc. Filter with Wide-Range Selectivity Variation**

**BY DANA BACON, WIBZR\***

To give you the ultimate in operating satisfaction, your crystal filter these days must be capable of widely-variable selectivity to suit the signal and the conditions existing at the moment. The new circuit described here has this and other features — among the latter, the fact that it's not hard to construct.

ONE of the first attempts to use a crystal filter commercially in this country was in the Stenode broadcast receiver of 1931. This filter operated at 175 kc. in a circuit of such design that selectivity was fixed at an extremely high value; in fact, the filter itself had an effective band width of only about 100 cycles — almost too sharp for single-signal reception of c.w. signals. Naturally, selectivity of this order attenuated modulation sidebands so much that audio frequencies above a few hundred cycles would have been inaudible but for an elaborate system of audio compensation which boosted highs in the neighborhood of 5000 cycles about 70 db. Such compensation gave flat overall response and was satisfactory from the standpoint of fidelity, but the system was impractical because the receiver required very precise tuning, with attendant difficulties from frequency drift.

James Lamb, in 1932, provided a method of varying the actual band width of the crystal filter used in his original "Single-Signal" receiver.<sup>1</sup> The filter was sufficiently flexible to permit the audio compensation of the Stenode to be discarded, and represented a real advance in practical filter design, even though the maximum band width available was not enough for good quality 'phone reception. Soon after this filter was popularized improvements and refinements appeared. The chief improvement desired was increased selectivity range, particularly in the region of band widths suitable for 'phone reception. Several filters were developed, among them a 1560-kc. design described in the September, 1937, issue of *QST*.<sup>2</sup>

The new filter to be described provides a wider range of selectivity than has previously been available in filters built for amateur communica-

\* 41 Bellington Street, Arlington, Mass.

<sup>1</sup> Lamb, "Short-Wave Receiver Selectivity to Match Present Conditions," *QST*, August, 1932.

<sup>2</sup> Bacon, "A New Quartz Crystal Filter of Wide-Range Selectivity," *QST*, September, 1937.

tion receivers. Furthermore, the particular method of obtaining this wide range has important advantages. For instance, the i.f. gain of the filter stage is essentially independent of band width, and the filter, with crystal disconnected, functions as an i.f. transformer having almost the same gain and selectivity characteristics as those obtainable in the broadcast crystal adjustment. This means that the gap between crystal "on" and "off" operation has been satisfactorily bridged, with the result that the full advantages of the filter circuit phasing, etc., may be utilized in 'phone reception without appreciable sacrifice in audio fidelity, and without requiring an impractical degree of stability as in the case of the Stenode.

The family of selectivity curves in Fig. 2 shows the performance of the new filter, as incorporated in the National NC-200 receiver. These are "overall" curves and include the effects of two conventional i.f. transformers, the latter being most important in determining the shape of the "off" curve. The minimum band width at 10 times down is about 200 cycles while the maximum band width with crystal off is nearly 8 kc., indicating a practical and usable selectivity range of almost forty to one. It will be shown that the positions of the curves between 1 and 5 may be chosen or altered at will as a design matter. The present arrangement provides six nearly uniform arithmetical selectivity steps, and consequently provides a number of band widths in the selectivity range which is most used, i.e., from 2 to 8 kc.

The signal transfer through the filter is, as

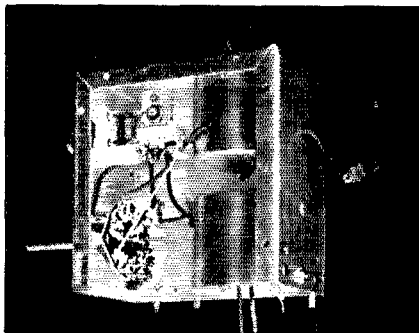

Inside view of the filter showing the polystyrene crystal holder mounted just in back of the phasing condenser.

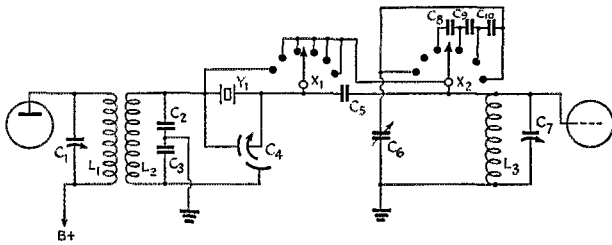

Fig. 1—Schematic diagram of the wide-range filter for 455-kc. operation.

- $C_1, C_7$  — 85- $\mu$ fd. max.
- $C_2, C_3$  — 50  $\mu$ fd.
- $C_4$  — 5-1-5  $\mu$ fd.
- $C_5$  — 1  $\mu$ fd. approx.
- $C_6$  — 15  $\mu$ fd. max.
- $C_8$  — 5  $\mu$ fd.
- $C_9, C_{10}$  — 10  $\mu$ fd.
- $C_{11}, C_{12}$  — 1.25 mh.
- $L_2$  — 0.3 mh. approx.

mentioned above, largely independent of selectivity adjustment, but fortunately the variation that does occur is practically ideal. As the selectivity of the filter increases, the signal-to-noise ratio of the receiver also increases. It is possible, therefore, to use more receiver gain with greater selectivity, since noise is always the final factor in limiting overall gain. With the new filter, signal transfer goes up about six decibels as selectivity increases from that of Curve 1 to that of Curve 5. Anyone who has worked with wide range filters in communications service will appreciate this feature, as it overcomes the psychological effect which makes flat-gain filters appear to have a drooping characteristic just the opposite of that described above.

### The Filter Circuit

Inspection of the schematic diagram, Fig. 1, will show that the new filter is not complicated; on the contrary, its simplicity recommends it for construction in the home workshop. In addition, the circuit constants are not nearly so critical as might have been expected. Probably the best way of covering the new circuit is to describe it piecemeal, with a minimum of theory.

The input circuit,  $C_1 L_1$ , is similar in construction and design to any i.f. tuned circuit. Permeability tuning may be used if desired. The secondary winding  $L_2$  is not critical, provided it does not resonate with  $C_2, C_3$ , etc., at or near the operating frequency. In general,  $L_2$  should be large enough to provide efficient signal coupling, but not so large that it adds appreciable impedance (and damping) to the crystal circuit. It is tightly coupled, inductively, to the primary coil  $L_1$ .

The crystal bridge comprises fixed condensers  $C_2$  and  $C_3$ , differential phasing condenser  $C_4$  and the crystal  $Y_1$ . The first two condensers must be large enough to show but little impedance at the signal frequency, since their primary purpose is to center-tap the input circuit. The crystal holder may be clearly seen in the photograph, and is considerably more compact than those ordinarily employed. This is desirable since shunt capacity is reduced, improving crystal efficiency and extending phasing range. Inasmuch as the minimum separation of the crystal frequency and the phasing or rejection notch depends upon the maximum permissible amount of capacity unbalance in the

crystal bridge circuit, stray fixed capacities such as that of the crystal holder should be made as small as possible. By so doing, a fairly small phasing condenser will give good phasing range and will not introduce so much capacity that signals may be shunted across either output arm of the crystal bridge to an objectionable degree. In other words, the impedance of the phasing condenser sections should be high compared to that of the crystal at resonance.

The output portion of the filter is of special interest since its design will determine the range of selectivity. The two switches  $X_1$  and  $X_2$  are actually one assembly, as shown in the photograph, and work together. In the counter-clockwise position,  $X_1$  short circuits the crystal and the signal is coupled to the output tuned circuit  $L_3 C_7$  by a small condenser,  $C_5$ ;  $X_2$  has connected condenser  $C_6$  in parallel with  $C_7$ . As the switch  $X_1$  is turned clockwise, the crystal short is removed, and the crystal bridge is connected directly to the tuned circuit, condenser  $C_5$  being shorted out;  $X_2$  in the blank position disconnects  $C_6$  from  $C_7$  and then progressively detunes the circuit  $L_3 C_7$  more and more by means of condensers  $C_8, C_9, C_{10}$  and  $C_{11}$ .

### Filter Operation

The action is as follows: With the switch set so that  $X_2$  is on its blank contact, condenser  $C_7$  is adjusted so the coil  $L_3$  is tuned to resonance, and thus provides the minimum crystal selectivity indicated by Curve 1, as explained later. If the switch is now thrown to the initial position, crystal off, circuit  $L_3 C_7$  will resonate at a higher frequency, since condenser  $C_5$  is not now shorted and consequently reduces the capacity loading effect of  $C_2, C_3$  and  $C_4$  on  $L_3$ . The tuned circuit should, of course, resonate at the intermediate frequency and compensation is made by adjusting condenser  $C_6$ . It should be noted that this compensation does not affect the adjustment which produced the selectivity of Curve 1. With the switch in the third position, condensers  $C_8, C_9, C_{10}$ , and  $C_{11}$  are all connected in series across  $L_3$ , detuning it slightly and producing the selectivity of Curve 2. In the fourth position, condenser  $C_8$  is disconnected, detuning  $L_3$  further and producing the selectivity of Curve 3. This process continues until  $C_8$  only is connected directly across  $L_3$  and  $C_7$ , detuning the circuit sufficiently

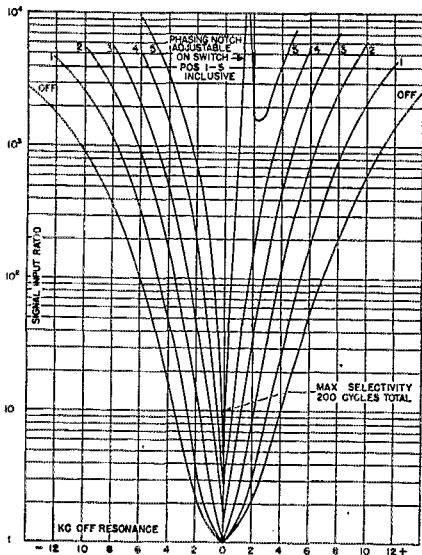

Fig. 2—Overall selectivity curves. The phasing notch shown on Curve 5 is illustrative of the phasing action. Actually the phasing notch can be moved about at will on any of Curves 1 to 5 inclusive.

to produce the selectivity of Curve 5. It is to some extent a coincidence that the value of capacity at  $C_6$  which provides correct compensation in the "crystal-off" switch position is the proper value to produce the maximum selectivity of Curve 5. However, the output circuit adjustment for maximum selectivity is not critical.

The theory of operation of the selectivity control system described above is similar to that of the Lamb filter in that the resistive component of an adjustable tuned circuit impedance damps the crystal circuit. In this case maximum damping — minimum selectivity — will occur when the output circuit is tuned to resonance as indicated by the selectivity of Curve 1. In the Lamb filter,

damping was obtained from the tuned input circuit of the crystal bridge, and since this circuit was center-tapped, only about one quarter of the resistive component of the tuned circuit impedance was available. In the new filter, the full impedance of the tuned output circuit is utilized and this fact probably accounts to a considerable extent for the increased range of selectivity adjustment that can be obtained.

Contrary to a popular misconception, detuning the output load circuit of the filter does not produce distorted or non-symmetrical selectivity curves. This point is proved by the curves themselves and can further be checked experimentally simply by detuning the output circuit on the other side of resonance, when another identical set of curves will be obtained.

(Continued on page 89)

## WWV Schedules

THE standard frequency station WWV of the National Bureau of Standards was destroyed by fire on November 6th. A temporary transmitter has been established in another building and is carrying on a reduced service which will be in effect for the several months required for establishing a new permanent station.

In the interim, a 1-kilowatt transmitter (the old transmitter was 20 kw.) is broadcasting continuously from 10 A.M. to midnight, E.S.T., every day except Sunday. Transmissions are continuous-wave only, with telegraphic announcements of the call letters WWV every 20 minutes. The accuracy is the same as before, better than one part in ten million.

Until the new permanent station is complete, the 10- and 20-Mc. transmissions will be discontinued as will also the standard second pulses, the 440-cycle musical pitch standard, and the 1000-cycle standard frequency.



### Got Your Code Certificate Yet?

Have you got your code attainment award certificate from A.R.R.L.? This League award is available to every United States amateur licensed. The program aims to recognize your code ability. W1AW practice transmissions take place on 1761, 3825, 7280, 14,253 and 28,510 kc. daily except Friday starting at 9:15 p.m. C.S.T. These will help you add to your ability to read code the knack of copying code. It is time now to prepare for the next official qualifying run from W1AW which will take place Tuesday, December 17th at 9:30 p.m. C.S.T. Aim to get your certificate or endorsement sticker for higher speed on that date.



# CORRESPONDENCE FROM MEMBERS

The Publishers of *QST* assume no responsibility for statements made herein by correspondents.

## GRATEFUL FOR IONOSPHERE DATA

4229 S. Carrollton Ave., New Orleans, La.

Editor, *QST*:

May I take this opportunity to express my appreciation for the very interesting and educational information on the Ionosphere predictions.

I for one can appreciate the amount of work involved to prepare these charts and feel certain a good number of us are deriving useful information.

Won't the gang respond and let Messrs. Smith and Kirby know how much we appreciate their efforts? A little encouragement and appreciation will go a long way.

— A. F. Korson, *W5HUT*

## NOVEMBER EDITORIAL

448 W. Clapier St., Phila., Pa.

Editor, *QST*:

I can't help but think that your editorial on "Confidence" was rather badly executed. I am wondering whether it will be one of those impulsive acts which must be "repented at leisure."

I am unable at the moment to put into writing a better way to broach the subject which you presented, but I feel that it could have been done in a more subtle manner. The outright plea to "buy now" was, I think, a tactical blunder which will have sad consequences for the A.R.R.L. in general. The editorial will certainly lay *QST* wide open to the old cry of commercialism and it will, I fear, bring about a wave of dissatisfaction in League policies at a time when unified effort and spirit are more needed than ever before.

Maybe I have the wrong slant. I can't help but think that others will react the same way I did, however.

— E. E. Pearson, *W3QY*

**EDITOR'S NOTE.** — The editorial in question was written in response to inquiries indicating a fairly general concern over the stability of amateur radio in present times, and was intended as an answer to such inquiries. Its theme, rather than being a "plea to buy now," is best stated by reiterating these excerpts: "Are you one of those amateurs who are holding off from buying some needed or much-desired piece of gear because of fear that amateur radio in this country is going to be closed up soon? . . . [If so] we consider that you are safe in investing in it; hop to it."

103 Second Ave., Cedar Rapids, Ia.

Editor, *QST*:

I have just received my November copy of *QST*, and the editorial really sparkles of a thought that I personally have wondered why you at *QST* haven't mentioned before — namely, the manufacturers who make such wonderful merchandise available to the amateurs. I have been in radio and had a license for 26 years and I deeply appreciate the fact that today I have beautiful commercial equipment whereas a few years ago I had to make whatever I wanted to use. . . .

While on the subject of amateur radio: How about that wider 'phone band on 20 and 80 meters?

Just a little thought along the same lines as your editorial will convince you fellows at headquarters that the 'phone men are the ones that sponsor more expensive equipment and better layouts. . . . I'd say that the theme of your editorial is the first step in really building a 'phone band that was in step with at least the progress of these manufacturers. . . .

In a previous editorial you quote that the Commission is down on an enlargement of the 20 and 80 'phone bands, and

in this same issue of November there is the enlargement of the 160-meter band and the thought that amateur radio is a permanent fixture in the eyes of the government. Why defer this poll on the 20- and 80-meter bands, then? We want to at least believe one thing or the other that you state in *QST* — which is the right thing for us to believe? . . .

— Chas. W. Boegel, Jr., *W9CVU*

**EDITOR'S NOTE.** — The change in the 1750-2050 kc. band has been in process since 1938, although regulatory difficulties involving other services delayed its actual execution until now. This change was not affected one way or the other by the current situation.

## HAMS AND JOBS

Editor, *QST*:

In the September and October issues of *QST* appear some highly questionable statements regarding employment opportunities available to amateurs. I believe these statements should be properly qualified and corrected in an early issue either by a reprint of this letter or editorial comment on the subject. If not you will have been guilty of falsely raising the hopes of thousands of young hams regarding their chances in the radio labor market.

*QST* says, in effect, that in the near future any ham worth his salt will be able to step into a well-paid job doing what practically every ham wants to do: work at his hobby. This is far from the truth. It shows a lack of understanding of the subject. The cause of your optimism is unknown to me; the statements made in this letter are based on personal experience.

In the radio industry there are five principal fields in which amateurs may hope to find employment. These are manufacturing, marine operating, broadcasting, aviation and servicing. I have had no experience in any of these; but I have had the experience of trying to get a job in these fields.

Here is the equipment I take with me when I look for a job: Five years study and amateur experience (representing a sizeable investment in cold cash); Class A, first class 'phone, second class telegraph licenses. Fair personality and exterior. High school education.

To date my success in attempting to crash radio is represented by the decimal figure point zero zero.

From this, one of two conclusions is possible. Either the writer is a dodo of the first water and has no business in radio anyway, or getting a job in radio is not the easy matter you imply. For the benefit of anyone who thinks the first premise to be true, I shall examine the subject more in detail. . . .

Let's look at the fields mentioned above:

**Manufacturing:** Manufacturers want, generally speaking, two kinds of people: engineers and unskilled workers. If the job seeker has an E. E. degree plus radio training he should have no difficulty getting a place with a large organization. If the radio-amateur-job-seeker does not have such a degree he stands only slightly better chance of employment than does any person entirely ignorant of the subject. The best kind of job he can hope to get is that of assembler, wireman, checker, etc. These jobs pay little and offer slim chance for advancement.

Here are two quotations which stick in my mind:

**RCA employment interviewer:** "We have a number of hams working here but the fact is unimportant. We are not particularly interested in your technical knowledge. We can use graduate engineers, production people, machinists and toolmakers."

(Continued on page 38)



# OPERATING NEWS



F. E. HANDY, WIBDI, Communications Mgr.

J. A. MOSKEY, WJMY, Asst. to the Coms. Mgr.

**F.C.C. Warning.** The Federal Communications Commission calls attention to the fact that it has noticed certain violations of Order Number 72, due to the apparent misinterpretation of the call letters of the foreign stations by United States amateurs. Page 54, August *QST*, gives an example of the practice the F.C.C. objects to. Order Number 72 of course is the one that washes out any sort of radio communication with foreign countries. Whether the foreign sending might be claimed at fault, or whether carelessness or intentional violations occur, the Commission wants us to know that it will *not* tolerate any violations of Order Number 72. The Commission letter is frank warning to radio amateurs that Order No. 72 will be rigidly enforced. *Any communication whatsoever with a foreign country will be subject to official citations!*

**Code Proficiency Award Runs.** Our certificate awards for *at least one minute of perfect copy* of the monthly W1AW qualifying runs have now been received by thousands of amateurs. Every United States licensed amateur who hasn't yet participated in this program, and received the A.R.R.L. recognition of individual code attainment in *any one* of the speed ranges is invited to note the next possible qualifying date to get fixed up! Space will no longer permit us to run the lists of certificate winners. The October run showed a substantial increase in interest in the program over September. Following each run it takes a very substantial staff effort to get certificates back in the hands of all who have earned them, in advance of the coming qualifying date! We always aim to complete these awards promptly, for in the majority of cases individual hams want to know how they came out in time to bend their efforts to the *next higher speed* in order to qualify for the additional Silver Endorsement Sticker. All who get certificates become at once eligible for the "rating badge" or sticker that shows further advance over the initial recognition from the League.

Whether your interest is in the Progress Award Sticker or the CODE PROFICIENCY CERTIFICATE granted in recognition of your meeting the national amateur standard established by the W1AW program, please take advantage of the following information. Our code *practise* daily-except-Friday runs will continue to start at 9:15 P.M. CST and progress through the 15-, 20-, 25-, 30-, and 35-w.p.m. ranges with plain language copy from W1AW. 1762-3825-7280-14253-28510 kcs. will be used simultaneously, so you can pick

the best frequency for reception in your locality. The next official qualifying runs will take place following explanatory transmissions at the usual practice time, copy for qualification, however, starting at 9:30 P.M. CST on:

December 17th, Tuesday  
January 19th, Sunday  
February 21st, Friday

March 21st, Friday  
April 17th, Thursday  
May 14th, Wednesday

Underline the consecutive minute that represents your best speed which you believe to be perfectly accurate copy, attach a statement that you copied the material by ear without external aid other than typewriter or pencil (mention which), mail us your original copy for greatest chance of qualifying. State if you are working for a first Certificate or for Endorsement. Don't miss taking part in one of the monthly qualifying runs!

There should be *no ham shack in the land* without its Certificate in recognition of Code Proficiency. It should be a matter of pride that we can now do 15 words and 20 words per minute, *not* just the speed at which the F.C.C. first tested us for license! For those asking us for runs at 40-50 w.p.m. we suggest the Press-Weather schedules that appear on page 84, October *QST*, and page 68, November *QST*. There's fun and profit in continuing above 35 w.p.m. (for those who can). On the other hand our program is aimed directly at that bigger job of giving recognition and incentive for progress in copying proficiency through the practical 15-to-35 word per minute levels at which such a high percentage of the world's communication business is handled. Not until nearly all licensees have a certificate at *some* speed can we think of adding facilities and personnel for *speed limit* determinations. This is not the purpose of our program. The objective of the program is to assure the constituted authorities that our fraternity is *progressive to the last man* in this matter of having a deep interest, and a recognized level of code attainment. It is also an aim to add something to the initial qualifying proficiency of every amateur who starts lower than our upper limit if possible. To attain the all important first Code Proficiency objective, and in spite of a good start, we still have some distance to go. More hundreds and thousands of ham shacks must be equipped to give mute but glorious testimony to true amateur defense-mindedness. Their owners should be sporting a shiny new 15 w.p.m. certificate at this time!



Preparedness, Patriotism, and Proficiency are wrapped up together in this program dedicated to the defense needs of the nation, and the strengthening of our fraternity by increased objectivity along training school lines. The potential value of amateur radio has as one measure, the degree of proficiency of all the individuals who make it up. The Attainment Certificates are a direct incentive and recognition for Proficiency. One way to do your combined bit for Amateur Radio and the nation is: (a) to get your certificate, (b) to start somebody else on the road to getting one.

Help this A.R.R.L.-proficiency defense program; let us add your call to the list of those having Certificate Awards; *get the recognition due you* for ability above the government requirement for amateurs. Keep with us until you "graduate" from the A.R.R.L. program at 35 w.p.m. Don't let this program go by another month without taking part. Get started right now. **BE SURE TO GET YOUR CERTIFICATE FOR THAT EMPTY SPACE ON YOUR WALL SOON!**

**December-January Activities.** By the time you read this another "SS" will have passed into amateur history . . . quite likely it will be the biggest in history. Here is a brief résumé of A.R.R.L. scheduled activities for the next sixty days. Notices concerning the first two named events appear elsewhere in this issue.

- Dec. 3rd (Tues.) Frequency Measuring Test  
(Members start measurements of W1AW at 9:45 P.M. CST)
- Dec. 14th-15th U.H.F. Contest  
(Streamlined rules, new multipliers, Starts Sat. 3 P.M., Ends Sun. 7:59 P.M. your local time.)
- Dec. 17th W1AW Code Proficiency Qualifying Run.  
Jan. 18th-19th 4th Annual A.R.R.L. Member QSO Party.  
Jan. 19th W1AW Code Proficiency Qualifying Run.

Fifty points fixed credit will be granted in the January Member Party (4th annual) for holding an A.R.R.L. Code Proficiency Certificate. Those not having one yet will get *full credit* if they *make one* on December 17th and report the speed and date of any such award they hold, or if they submit copy made during the Party on the 19th of January.

**Staff Changes.** The Communications Department's loss is Uncle Sam's gain! Ensign Everett L. Battey, U.S.N.R., left us in mid-October for one year's active service, during which time the A.C.M. is on leave of absence from A.R.R.L. "Ev" has already assumed his duties as an officer and instructor at the new Navy school for Radiomen and Signalmen at Noroton, Conn. Our first casualty to national defense requirements, all hams of his exceptionally wide acquaintance will share with us pride in the knowledge that his efforts and good operating example will be imparted to those many new recruits that will be needed to man our expanded defense forces. As a continuing staff member on

leave, W1UE of course stays on the organization call listings. He promises that he'll shortly have the sky wire up at the new location and be in on all the usual radio doings!

Mr. J. A. Moskey (Joe), W1JMY, will be Assistant to the Communications Manager in Ev's absence. His two years of experience in handling the heavy detail of League awards, and in analytical and checking work on many A.R.R.L. program activities, make him well fitted to assume a larger share of departmental responsibility. A whale of a good traffic man, the League Trunklines will not suffer while Joe is on the job as the National Trunk Line Manager — one of the inherited posts.

Mr. James R. Buckler Jr. (Jim), W9NFL, comes to the Communications Department from Decatur, Illinois, to hold down the vacant desk and assume a share in the organization administrative work. Mr. Buckler has had experience in a variety of field organization posts. Illinois loses him as its representative on TL "L," and the National Trunk Line and as active Route Manager, Official Observer, O.R.S., and O.P.S. The A.A.R.S. must find another Corps Area monitoring station. Jim, holder of A-1 Operator and R.C.C. certificates, already has plans for his first district station. You will be hearing more from him, via the C.D. and on the air, as well. He needs no introduction at all to a host of A.R.R.L. friends and members who wish him success.

**Amateurs Invited to Work NAA.** On November first NAA inaugurated a program making possible direct contacts between 3.5 Mc. and 7 Mc. amateur stations and Radio Washington (NAA). The first contact of this program was between NAA and W1AW. A message of greeting and regards to radio amateurs from Rear Admiral Leigh Noyes was conveyed. President George Bailey, W1KH, was at the key of W1AW and Lt.-Comdr. John L. Reinartz, N.C.R. Liaison Officer (JL, W3IBS) was operating NAA. NAA on 5865 kc. was kept busy with a flood of 3500-3900 kc. calls between 8 and 9 P.M. EST following this first contact. Nine to 10 P.M. EST was spent by NAA (on the same frequency) contacting 7-Mc. amateurs. This schedule of 5865 kc. work will be continued every Monday, Tuesday, Wednesday and Friday through November and December. A handsomely designed QSL will be available for all amateurs worked. This is a rare opportunity for radio amateurs to contact the one-and-only NAA. To us it is reminiscent of the days in amateur wireless when ulMK used to work and test with NSF and NKF. The present series of contacts undoubtedly will have for thousands of today's practicing amateurs the future ability to arouse warm and friendly recollections of our association with the Navy, as time goes on and these QSO's likewise become history. We're proud of the fact that we can now work two-way direct

with NAA. We hope as many hams as can do so will get a thrill from cranking up the receiver on 5865 kc. at the proper hour and working NAA.

It is expected that Naval Communication Reserve personnel will be at NAA for this schedule with the amateur fraternity. Speaking of the Reserve, we're getting many inquiries about the N.C.R. in our mail these days. To answer the inevitable question (so you don't have to write) on what the reserve does and how to get in it, we suggest that you review *QST's* department "Naval Communication Reserve Notes" for the last four issues of *QST*. For information on joining the U.S.N.R. see the Navy page in August, 1940, *QST*. There's fine account of radio activity in the training circuits of the Reserve in the October number. As an active member of the N.C.R. participating in the radio problems for several years, we'll give you our personal word for the fascination and individual satisfaction that you can achieve . . . by becoming a member of the U.S.N.R. and going into the activities for all you are worth. Page 72 of November *QST* mentions the new radio schools opened by the Navy. These represent training-with-pay for radio amateurs who can qualify for membership in the U.S.N.R. who then request active duty for assignment to the radio schools.

— F. E. H.

#### ARTICLE CONTEST

The article by George W. Brooks, W1JNO, wins the C.D. article contest prize this month. We invite entries for this monthly contest. Regarding subject matter, we suggest that you tell about what activity you find most interesting in amateur radio. Here you will find an almost limitless variety of subjects. Perhaps you would like to write on working for code proficiency, Emergency Corps planning, traffic work, working in Section Nets, 'Phone and Telegraph operating procedures, holding a League appointment, working on radio club committees, organizing or running a radio club, the most interesting band or type of ham activity, or some other subject near to your heart.

Each month we will print the most interesting and valuable article received. Please mark your contribution "for the C.D. contest." Prize winners may select a bound *Handbook*, *QST* Binder and League Emblem, six logs, eight pads radiogram blanks, DX Map and three pads, or any other combination of A.R.R.L. supplies of equivalent value. Try your luck!

## The Most Interesting Band

BY GEORGE W. BROOKS, W1JNO\*

AFTER careful thought and quite a bit of operating on the various amateur bands, I have come to the conclusion that my chief interest is the One Hundred-Sixty Meter C.W. band. I can hear practically everyone shout, "That guy is either crazy or the world's biggest liar." I profess to be neither. Let's try to find out why I should pick this band, as

\* 23 Friendship St., Newport, R. I.

truth to tell, I have done very little operating on c.w. in this territory.

First a few facts. In the past few years I have operated 'phone or c.w. on every amateur band from One-Sixty to Five meters. I don't want to be classed as a one-band-man. Each of these bands have their good and bad points.

Starting with Five, with modulated oscillators I used to enjoy this band, because of the get-togethers at any time with the local gang. It was better than the telephone. We all used to get on about the same time at night, chin, and have a good time.

Ten is spotty, sometimes good for DX, quite good for U. S. contacts, and for the unexpected to happen is well worth it.

Twenty 'phone and c.w. at times have felt my touch. I could do better on Ten 'phone and DX c.w. doesn't interest me too much.

Forty is a fine band, always something doing, a contact can generally be made at some time, provided you don't object to QRM, etc.

Seventy-Five 'phone has much to recommend it. Many a very pleasant hour has been spent chatting with the gang. But for the low power 'phone man, at times he is pretty badly licked.

Eighty c.w. has its merits. I enjoy getting on and having a rag chew, but I find many non-ragchewers on it.

One-Sixty 'phone I enjoy and many a contact has been made, friends have been made. Were it not for the BCL troubles I believe that I would do a large part of my operating there.

That leaves me with One-Sixty c.w. How would you like to pay a visit there with me, and see why I like it.

First off this band from 1750 to 1800 kc. has very little activity during the days, but as night begins to fall a few faithful stations begin to come on. During the day I can go on any band and be pretty well assured of a contact not marred by too much QRM. With the arrival of night and the increased operating activity, I strive to still enjoy my QSO with the minimum work possible.

The stations on One-Sixty c.w. generally want to chew the rag. They are good talkers, most have good fists. There is only an occasional bit of QRM, although QRN may take its toll. Most there don't use high power. Five watts to twenty-five seems the rule, with a hundred being considered high power. The antenna question can be solved easier than most think. I use a Seventy-Five meter Zepp and get out swell.

Most of us use s.c.o. instead of crystal, and most are One-Sixty 'phone men. If QRM bothers us a twist of the dial and we are in the clear. With about two dozen stations on during the height of the evening the band isn't cluttered up and a QSO very seldom has in it, "Sorry, OM, but you were QRM'd that time by So-and-So."

For real operating pleasure, practically free from QRM, a swell gang of fellows, an interesting evening, may I suggest that you explore that unexplored part on most receiver dials, the territory between 1750 and 1800 kc. I can promise you a thrill of new acquaintances, and real operating pleasure.

#### BRIEFS

Classes for all wishing to learn or brush up on code are being conducted each Monday evening at 9:00 p.m. E.S.T. over WRUL, the station of the World-Wide Broadcasting Foundation. Frequencies used are 8.04 and 11.73 Mc. Members are also being enrolled for an advanced radio course covering Radio Mathematics, Impedance Matching, Frequency Modulation, and many other radio engineering problems. Anyone interested should write the World Radio University, Care University Club, Boston, Mass.

The N. Y. A., Legion Post 701, and the Amsterdam Radio Club are co-operating in code and radio theory classes held each Tuesday evening at 7 p.m. The program is being conducted in the interest of National Defense. The instructors are W8URP, W8UID, W8FU, W8UIC, W8JOZ and F. Carbone. Further details may be obtained by writing J. C. Nelson, 75 Minaville St., Amsterdam, N. Y.

## Meet the S.C.M.'s



Carl C. Drumeller, W9EFC

The Colorado S.C.M. has had an interest in amateur radio since 1921. It wasn't until 1932, however, that he finally broke down and procured his first license. Since then, he has held the calls W9ZKT and W9KWJ in addition to the present one. A pair of 812's driven by crystal and c.c. exciters is used for work on all 'phone and c.w. bands from 1.75 to 28 Mc. The receiver, an SX16, is adapted for emergency-powered operation as is the exciter in the main rig. Activity is confined mostly to 'phone on 14,230-kc. S.C.M. Drumeller is an O.R.S., a former member of the A.A.R.S., Secretary-Treasurer and Past President of the Pikes Peak Amateur Radio Association. Active participation in target shooting and swimming are thoroughly enjoyed. He has had several years of experience in the commercial field, and is currently employed as a radio operator by the Outwest Broadcasting Co.

★ ★



Fred A. Ells, Jr., W1CTI

S.C.M. Connecticut, has for many years been an enthusiastic traffic handler. An active O.R.S., he is responsible for a large share of the success enjoyed by the Nutmeg Net. W1CTI manages to spend some time in most contests, and can usually be found on 3.5-Mc. c.w., his favorite band. The transmitter in his shack is an e.c.o. and 807 amplifier with ganged tuning; power input varies between 20 and 30 watts. Receivers used are an FBXA and an SW-3. S.C.M. Ells is Vice-President of the Connecticut Brasspounders Association, and has served as its President in the past; he's also an Assistant Director and ex-Alternate Director of the League. He received his first license in the early "twenties." His favorite recreation, aside from amateur radio, is bowling. Occupation: Teller in the National Bank of Norwalk.

## Brass Pounders' League

(September 16th—October 15th)

Call	Orig.	Del.	Rel.	Extra Del. Credit	Total
W4PL	9	53	1535	38	1635
W5OW	117	93	854	52	1116
W3GKO	14	41	861	38	954
W3BWT	78	86	705	77	946
W8GZ	19	56	784	53	912
W9ILH	9	107	688	78	882
W6ROZ	38	40	725	35	838
W8SJF	12	19	756	5	792
W3CIZ	19	53	677	41	790
W8JIW	194	133	322	53	702
W5FDR	28	179	288	164	659
W2MIY	66	103	453	36	658
W6LUJ	131	198	116	192	637
W7EBQ	0	0	603	0	603
W9GFF	31	29	506	26	592
W6PGB	39	96	356	82	573
W2LZR	66	95	296	91	548
W1KKS	83	37	410	6	536
W3EEW	54	69	366	47	536
W5MNN	23	71	366	49	509

### MORE-THAN-ONE-OPERATOR STATIONS

Call	Orig.	Del.	Rel.	Extra Del. Credit	Total
W4FCU	10	13	464	13	500

These stations "make" the B.P.L. with total of 500 or over. One hundred deliveries + Ex. Del. Credits also rate B.P.L. standing. The following one-operator stations make the B.P.L. on deliveries. Deliveries count.

W9CRO, 318	W9QIL, 166	W8PCN, 115
W2SC, 316	W3BXE, 140	W8FCG, 104
W7GVH, 200	W7APS, 122	More-than-one-opr.
W2KI, 197	W9QG, 117	W1AW, 168
W1MEC, 170		

### A.A.R.S.

Call	Orig.	Del.	Rel.	Extra Del. Credit	Total
WLN (W2SC)	55	125	294	96	570

WLTW (W9QIL) made the B.P.L. on 151 deliveries.

### MORE-THAN-ONE-OPERATOR STATIONS

Call	Orig.	Del.	Rel.	Extra Del. Credit	Total
WLM (W3CXL)	185	191	2443	141	2960

A total of 500 or more or 100 deliveries + Ex. D. Cr. will put you in line for a place in the B.P.L.

## BEGINNERS' CODE PRACTICE

The following is a supplement to the list of 1.75-Mc. code practice stations schedules on page 68, November QST.

- W5TG/W5CCU, Texas, 2045 kc., Mon. through Fri., 8:00-9:00 P.M. C.S.T.
- W6QJH, Nevada, 1775 kc., daily except Sun., 7:00-7:30 P.M. P.S.T.
- W9BSP, Kansas, 1903 kc., daily, 7:30-8:30 P.M. C.S.T.
- W9NAA, Indiana, 1875 kc., Mon. through Fri., 6:30-7:30 P.M. C.S.T.
- W7IGZ, Washington, 1978.5 kc., Tues. and Thurs., 2:00-4:00 P.M. P.S.T.

## HAMS INVITED TO WORK NAA!

Where? ..... 5865 kcs.  
 When? ..... 8 to 9 P.M. EST  
 (if you use 3500-3900 kc. band)  
 9 to 10 P.M. EST  
 (if you use 7000-7300 kc. band)  
 Monday, Tuesday, Wednesday, Friday, throughout  
 November and December

# How's DX?

## HOW:

ELSEWHERE in this issue will be found the last listing of the DXCC until world conditions again become such as to make it worthwhile to run it. Some of the gang may take this a bit hard at first, because they have feelers out for those last few cards and were hoping to make the grade with them if and when they came through, but for the most part it should work no particular hardship. The only cards that will be credited are those that come in before this issue reaches the membership, and those will be noted in this department next month. After that, we'd like to hear of fellows receiving additional cards, and we'll be glad to note it here, but the powers-that-count-the-cards inform us that any submitted, until further notice to the contrary, will be returned without being counted.

When you look at the list, you'll see that W2GT finally managed to squeeze ahead of Doc Stuart for once. Farther along in this stuff you'll find a list of the countries Ed has that W6GRL doesn't (W6GRL's list was run last month).

Our overseas friends with the uncontrollable fists haven't been quite as active this month, according to reports, but W9QJR has an incident that proves that virtue is its own reward or something. Letting out an optimistic CQ early one yawning, he heard the band dead except for a station calling R9ZPR and signing D5GZR. Finally the D gave up and called a CQ which soon changed to "CZ." No soap, so W9QJR moved up into the band about 30 kc. for another CQ, with the only result another "R9ZPR de D5GZR." Tired of this folderol, QJR moved 40 kc. more and let out another CQ, but the D5 was persistent and again called R9ZPR. The signal was up, and apparently the coal was being poured on, but our W9 was strong-willed and not tempted, as is smart. Tuning across the band, Jim found a weak signal calling W9QJR. Half suspecting it was another one of those guys, he kept one ear on it and it turned out to be — yes, it was — KB6GJX, and a fine 35-minute QSO resulted. Which definitely proves that virtue has its place in our scheme of things. (Then why did you make me vote three times in November? — Jeeves) (Jeeves, this is not a political column, and what you did had nothing to do with DX — W1JPE) (When they find out, you won't have anything to do with DX either — Jeeves.)



The elusive and much sought-for KH6SHS, Jerry Petranek, about to light a cigarette before contemplating the sad fates that prevent his getting on the air from Samoa.

## WHERE:

AFTER all these months of wondering, the dope on KH6SHS finally came through. In a recent letter, Jerry says that ham radio has again been curtailed in U. S. Samoa, with no chance for its resumption until some distant time in the future. The reason for curtailing all amateur activity is based entirely on administration difficulties arising from duties which the Governor of American Samoa must perform (mainly the censorship angle). Jerry goes on to say that there never was a KH6ODD licensed in Samoa, and that the only other ham station there was KH6MDE, whose only activity on the air was on 56 Mc. (Those groans are coming from the DX men who didn't work any KH6.) W6RRQ and W4GHH (Navy men) have requested ham licenses in Samoa, but they haven't yet been granted, so SHS and MDE are the only ones licensed there. Jerry goes to the mainland in January . . . . Another letter, this time from LA6U, informs us that he has returned from Jan Mayen, where he has been the past thirteen months. Due to the world conditions, he was unable to get on with LB6U as planned, but he listened and had all the gang spotted. He hopes to return there at some future date when the international situation is ironed out and things settle down again.

## DXCC ROUND UP:

Don't forget the gabfest scheduled for the weekend of November 30th that goes under the name of the "DXCC Round Up." All stations listed in the DXCC and 75-or-better are invited to get on the high end of 20 and swap lies and conscription numbers and, incidentally, find out what some of your former arch-rivals are like to talk to. If 20 folds, the low end of 40 should be a good spot to scare up the guys who have been out watching their favorite football team polish off a bitter enemy. See last month's column for starting times and post positions, but don't miss the party, or else Jeeves will have to finish all that cake and punch by himself. (And I can do it, too! — Jeeves.) Nothing like winning an election bet to give a guy confidence.

## WHEN:

THE dope on frequencies is slim this month, but, oddly enough, it's always that way when no one sends in anything. W7HIF found KCAUSB at 7075 and W7GUP found him at 7140, at around midnight P.S.T. . . . . W9DIB scared up KB6GJX (14,330), W2LZR added K6QMC (7250) at 2:30 A.M., and W2MEM got K6PIT

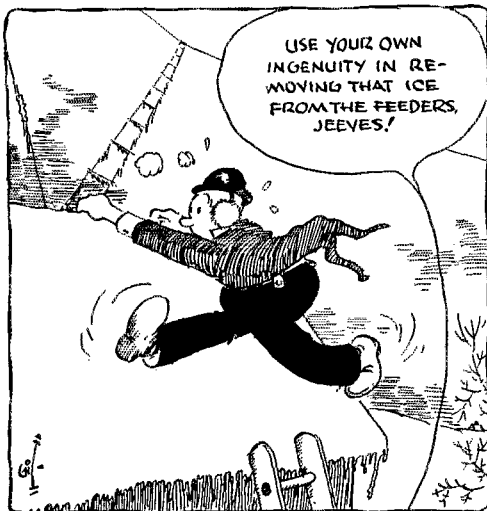

# Achievement!

A Record for Efficiency and Endurance

Established by

NATIONAL CONDENSERS and VELVET VERNIER DIALS

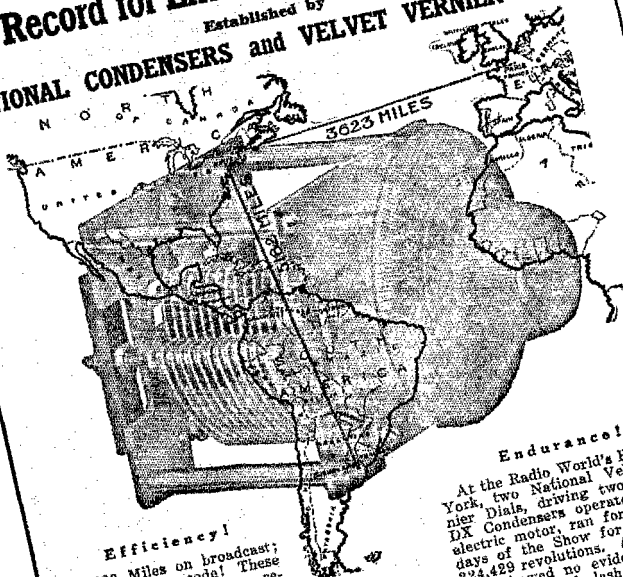

### Efficiency!

3623 Miles on broadcast; 5182 miles on code! These records were made by recording sets of which National DX Condensers and Velvet Vernier Dials were parts. Nationals made the achievement possible. To get distance clearly by Nationals. They give supreme satisfaction.

Sizes: .001  
Prices: 7.00

.0005 6.00

.00035 5.75

.00025 5.50

Complete with Velvet Vernier Dials. Write for Bulletin No. 104 Q

Made by NATIONAL COMPANY, INC.  
Engineers and Manufacturers  
110 BROOKLINE ST.,

Estab. 1914  
CAMBRIDGE, MASS.

### Endurance!

At the Radio World's Fair, New York, two National Velvet Vernier Dials, driving two National DX Condensers operated by an electric motor, ran for the seven days of the Show for a total of 324,429 revolutions. At the finish they showed no evidence of lost motion or back lash. And they still possessed that velvety smoothness that makes Nationals so desirable.

**BACK IN  
1924**

this advertisement  
appeared in

**Q S T**

Back in the early issues of *QST*, 16 years ago, you will find the names of many almost-forgotten manufacturers. But you will also find a few names that have survived through the excellence of their products. In this select group, National has a special distinction, for with National even the products themselves have survived.

The Velvet Vernier Dial has survived the greatest endurance test of all, and is *still* the most popular of all dials for amateur work. The DX Condenser has passed the toughest of all efficiency tests; it is *still* manufactured for commercial and industrial use.

The design features that made these products outstanding 16 years ago have become standard practice. But building to stand the test of time is still, we think, National's most exclusive feature.

James J. Freeley



# Send Your QSL Card for Technical Data on MALLORY GRID BIAS CELLS

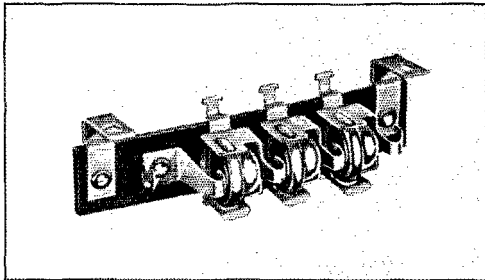

## They Insure Better Phone Quality at a Saving

Use Mallory Bias Cells to bias the high gain tubes in your speech amplifier. They provide constant, unfailing "C" bias that is independent of your power supply. Mallory Bias Cells offer an easy way to lower hum level, reduce electrical feed-back and generally improve the frequency response of your speech amplifier.

To get anything like equivalent results with other circuits, you would have to invest a great deal more for resistors and condensers. Mallory Grid Bias Cells are available in 1-volt and 1½-volt types at only 30c each list. Convenient holders are available to hold from one to four cells at prices ranging from 10c to 35c list.

Form B-303 tells how to use Mallory Grid Bias Cells—gives valuable data on designing speech amplifiers, improving AVC systems of receivers, and bettering audio amplifier performance.

Ask your distributor for a copy—or send your request on your QSL card to

**P. R. MALLORY & CO., Inc.**  
INDIANAPOLIS INDIANA  
Cable Address—Pelmallo

Use  
**P. R. MALLORY & CO. Inc.**  
**MALLORY**  
APPROVED  
PRECISION PRODUCTS

(7060), **K5AG** (7160) and **K5AY** (7155) . . . . Ex-VK4SN sends in a list of signals heard on 7 Mc. on July 25th and August 21st: K6SNA, W4PL, W7GBW, W6KW, K6QUJ, K6RQO, K7HZM, W9LZN, W5EWZ, W2HVR, W5HQN, W7GT . . . . Jean Lips, ex-HB9J, has an ear to the band and, listening somewhere in Switzerland in September heard on 3.5 Mc.:

W1AW, W1GE, W1TD, W1JZD, W1JET, W3FFD, W3FPR, W8TIB.

On 7 Mc.:

W1ETC, W1LGW, W1MSO, W1WI, W1AW, W1KJU, W1MMD, W1SM, W1BQR, W2KZF, W2MQX, W2KDT, W2DDC, W2KSSQ, W2LFL, W2CIQ, W2LPJ, W2NEJ, W2MQL, W2LEJ, W2GCD, W2AR, W2MPS, W2MEL, W2FA, W2MWE, W2JAW, W2BZJ, W2OB, W3HML, W3HMO, W3AOJ, W3UD, W3EWI, W3GRW, W3ACY, W3FHS, W3TF, W3DVD, W3ON, W3HGD, W3ISF, W3GOF, W4GWN, W4WX, W4BLV, W4GVE, W4GQV, W4FKY, W4CLO, W4EFL, W4GRD, W4CNN, W4GGT, W4GCW, W4GBV, W4BZH, W4GKX, W4GTR, W4GKW, W4RLY, W5IWI, W5RXL, W5TZE, W5VBA, W5RFL, W5SML, W5MOA, W5SYN, W5TK, W5TWC, W5TLD, W5HLD, W5FAR, W5UKU, W5HUK, W5MQX, W5UHG, W5EHW, W5RCC, W5TOL, W5TXQ, W5TXB, W5UTE, W5THS, W5VZR, W5CRM, W5JBC, W5IDU, LZ3WW, SV1XA, UK3AA, UK3AH, UK5RA, U8IL, UK6AA, U9MI, ZA1C, UK5AA, U4ON.

### WHAT:

The confirmations that W2GT has that W6GRL doesn't number eleven: LZ1ID, TI5FI (Cocos Island), Y12BA, LX1RB, FP8PX, VPU2 (now ZD1 — Sierra Leone), UP8AD (South Georgia), U6ST, U8IB, VQ5ELD and TS4SAZ (Saar). That makes, between Ed and Doc, a total of 162 different countries, with KD4GYM and AC4YN lurking in the background for a total of 164.

### WHO:

CF1CO, Manual Antunes, 77 Luis Bivar Ave., Lisbon, writes to say that he is very proud of his 100% QSL record, and that anyone who hasn't received his card for one reason or another (if there is another reason) can get one by dropping him a card. It will help him for WAS, too . . . . W9CWW is mighty proud of his card from AC4YN received recently. Charley passes along the dirt on some of the DX gang out his way: W9KG is now in Jefferson City, Mo., operating radio for the Missouri Highway Patrol, W9ARL is on 80 c.w., and W9GDH seems to have disappeared . . . . W1KKS ran into HB9D at the New York World's Fair one weekend . . . . W8JIW relays the dope that K4KD finally snared those last two cards and will be applying for his coveted three-band WAS shortly . . . . W6TI tells us, from dope garnered from W6DHS, that KF6ROV is now at Canton Island. The gear that ROV had is being used by W7DBR/KF6 on 10- and 20-meter 'phone, after some folding money changed hands. KF6ROV should be QSL-ing soon . . . . W2UK and W1APA spent a couple of weeks in New Brunswick "just for ducks." To hear them tell it, a couple of inexperienced birds got in the way of the guns just as they went off accidentally . . . . Our spies tell us that W8JSU is planning to take the step with a gal who already knows the code . . . . W4MR says KB6GJX is looking for Alabama for WAS. The Guam station comes through on 14,360 around 11 p.m. E.S.T. . . . W7AVM has one for the books. In the extreme northwest corner of Washington, on the tip of the Olympic Peninsula, on Clallam Bay on the Strait of Juan de Fuca, is the little Indian town of Sekiu. They pronounce it "CQ" — and, as a QTH, would that be a natural for a 'phone ham!

— W1JPE

-----

## Frequency Measuring Test, December 3rd

W1AW WILL transmit signals for purposes of frequency measurement starting at 10.45 p.m. EST (7.45 p.m. PST), Tuesday evening, December 3rd. The signals for measurement will be sent simultaneously on five frequency bands consisting of dashes interspersed with station identification. These will follow a general message sent by tape to enable listeners with frequency meters to locate the signals before the measurement transmission starts. The approximate frequencies used will be 1758, 3820, 7285, 14,250 and

(Continued on page 72)

# DXCC Station W8OXO

AMATEUR  
RADIO STATION  
W 8 O X O

## MORE PROOF THAT THE OUTSTANDING LEADERS CHOOSE EIMAC TUBES

.....W. D. "Taber" Tabler uses 35T, 100TH and 250TH tubes. DX Century Club Member with 114 countries to his credit, "Taber" also holds WAS, WAC and A-1 Club memberships with appointments as ORS and RM and elected SCM of West Virginia.

"Taber's" record of achievement is not the result of mere chance. It came through the intelligent use of good equipment the most important of which is

# Eimac TUBES

Eitel-McCullough, Inc.  
San Bruno, Calif.

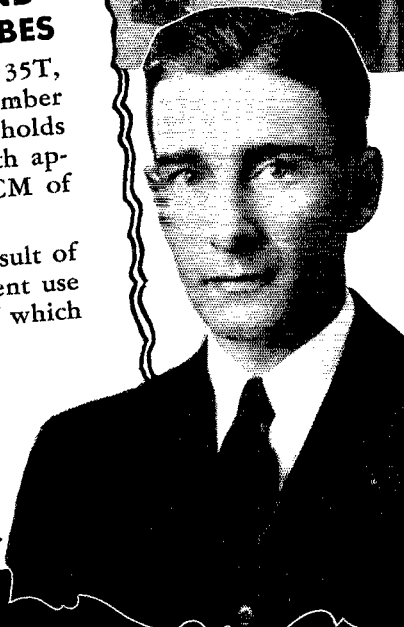

### EIMAC REPRESENTATIVES

California, Nevada  
HERB BECKER, 1530 W.  
104th St., Los Angeles, Cal.

N. Y., N. J., Penn., Md., Del.,  
Dist. of Col., Maine, N. H.  
R. I., Conn., Mass.

ADOLPH SCHWARTZ,  
14726 Elm Ave., Flushing,  
New York.

Wash., Ore., Idaho, Mont.  
GENERAL SALES CO.,  
Verner O. Jensen, 2605-07  
Second Ave., Seattle, Wash.

Colo., Wyo., New Mexico,  
Arizona, Utah

RICHARD A. HYDE, 4253  
Quitman St., Denver, Colo.

Chicago, Illinois, Wisconsin  
G. G. RYAN, 549 W.  
Washington Blvd., Chicago,  
Ill.

N. Caro., S. Caro., Georgia,  
Tenn., Flor., Ala., Miss.

JAMES MILLAR, 316 Ninth  
St. N. E., Atlanta, Georgia.

Texas, La., Okla., Ark.  
J. EARL SMITH, 2821 Live  
Oak St., Dallas, Texas.

Ohio, Mich., Ky., Ind., Minn.,  
Mo., Kan., Neb., Iowa

PEEL SALES ENGINEER-  
ING CO., E. R. Peel, 154  
E. Erie St., Chicago, Ill.

# NATIONAL HAS

AR-16  
COIL

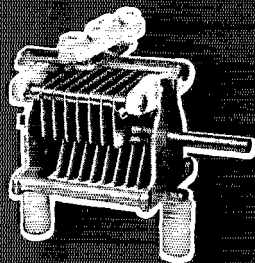

TMK CONDENSER

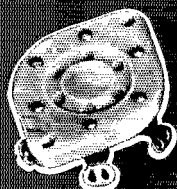

LOW  
LOSS  
SOCKET

RF  
CHOKE  
R-175

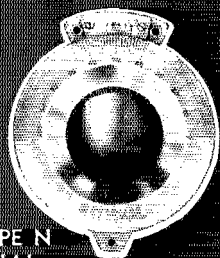

TYPE N  
DIAL



National products are designed for performance, built to last, and priced for economy. Even more important, they go together in a well-matched team that makes construction quicker, easier and neater. National's line is complete. Transmitting condensers, for instance, are built in six types and sixty-six stock sizes, not counting neutralizing, receiving and padding condensers.

Coils and coil forms are designed to mount directly on the condenser frames for compactness and convenience. Low-loss sockets, flexible couplings and smooth-running, accurate dials contribute to clean construction and extra performance.

Right down the line, whether you need an RF Choke that is suitable for parallel feed or an oscilloscope for checking the rig, you will find the ideal answer in the big 1941 National Catalogue No. 400. National has what it takes.

**NATIONAL COMPANY, INC.**

**MALDEN, MASSACHUSETTS**



NEW  
CATALOG

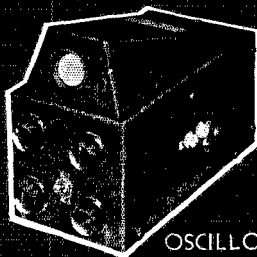

OSCILLOSCOPE

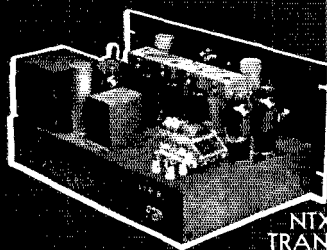

NTX-30  
TRANSMITTER



# WHAT IT TAKES

National Receivers give maximum performance in every price range, at all frequencies. There is the HRO which has become the standard of comparison among fine communication receivers for performance, versatility and reliability. There is the little SW-3 which is still a favorite after ten years, noted for three-tube simplicity combined with proven capability.

There is the brand new NC-200, which is making a reputation for itself week by week. There are older favorites like the NC-100 and the NC-44, each bringing top performance to its price class.

For ultra high frequencies, the One-Ten with coverage from one to ten meters, is still the receiver for work at 112 Mc. and 224 Mc. The de luxe NHU brings communication receiver performance to the 5-meter band as well as 10 and 20 meters.

This is the roll call of National Receivers for amateur use. Different models in each of the above types make a total of more than twenty receivers to choose from. Regardless of your needs, you will find a National Receiver to fill them.

**NATIONAL COMPANY, INC.**  
**MALDEN, MASSACHUSETTS**

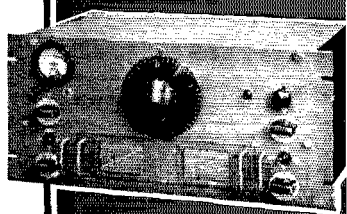

HRO

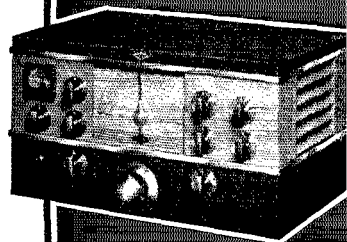

NC 200

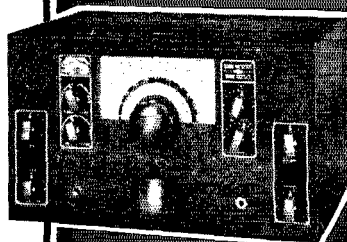

NC 100



NC 44



NHU

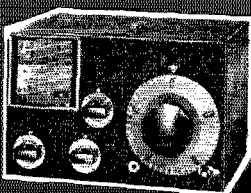

ONE-TEN

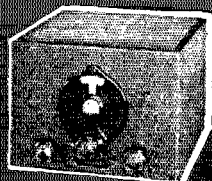

SW-3

# "WHAT! NO PYRANOL CAPACITORS?"



**Don't** let it happen  
**this year, OM!**

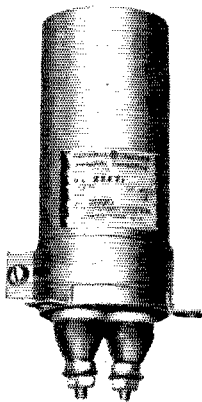

Christmas AM without Pyranol capacitors would be a pretty rude awakening . . . so much so that you should take steps to avoid it.

And it's no myth either that "Pyranols" will fit in your sock. The 2-mfd, 2000-volt unit at the left, for example, is only 2 inches across and 5 inches high.

Your dealer can supply these top-quality capacitors in cylindrical or rectangular cases, for

upright or inverted mounting, and in a wide variety of ratings. You can operate them *continuously* at 10% above rated voltage.

*Just let the family find  
your marked copy of . . .*

Bulletin GEA-2021B—which gives complete dope on the entire line—and your Christmas worries will be over. Ask your dealer for a copy—or write to General Electric Company, Schenectady, New York.

**GENERAL ELECTRIC**



407-6

(Continued from page 68)

28,500 kcs. About 4½ minutes will be allowed for measuring each frequency, and it is suggested frequencies be measured in the order listed.

Individual reports on results will be sent A.R.R.L. members who take part, with copies to S.C.M.s. When the average accuracy reported shows errors less than 71.43 parts per million, or falling between limits of 71.43 and 357.15 parts per million, the participants will become eligible for appointment by S.C.M.s as Class I or Class II Official Observers, respectively, by their Section Communications Managers, provided the individual amateurs have the interest and other qualifications for carrying forward in such League organization posts.

All League Members (and only Members) who take part, who are not connected with the Official Observing system, and not attached to the A.R.R.L. staff at Hq., will compete for an **ELECTRIC CLOCK AWARD** by submitting their best measurements on the December 3rd F.M.T. The Clock is a Model 705 Penwood, direct reading, about 3" x 3½" x 7¼" in size, with a brown finished case. It will be presented to the Member whose readings show the highest average accuracy, when compared with the official report from the Frequency Measuring Bureau. To be considered for the Clock Award it is necessary to attach a statement that you, as operator, alone handled your equipment in making the readings submitted to the Communications Department of the League.

## A.R.R.L. Official Broadcasting Stations

THE following listed stations address information regularly "to all amateurs" rendering a distinct service to fellow amateurs. First information on F.C.C. orders, regulations, special tests and activities and timely data to the amateur world reaches amateurs first through League weekly Official Messages. Stations in all districts assure good coverage on the information which in many cases is so well sent it is used for code practice. Listen for the "QST" from these stations.

W1APK, W1ASI, W1AW, W1BKQ, W1BVR, W1BWY, W1EAW, W1EHT, W1GAG, W1GOJ, W1GZL, W1HDJ, W1IDY, W1IE, W1JAH, W1KFN, W1KIN, W1KTB, W1LBY, W1LHA, W1LKP, W1LMB, W1LMO, W1LOP, W1LVK, W1VYF, W1WR, W1ZE.

W2AZV, W2EKU, W2FF, W2HXQ, W2HZL, W2IOP, W2LXY, W2JDC, W2JGC, W2KHA, W2KUD, W2KXT, W2MHW, W2MIO, W2SN.

W3AEJ, W3AJA, W3AOJ, W3AQ, W3AQN, W3ASQ, W3BBV, W3BHE, W3BIG, W3BWT, W3CDQ, W3DNU, W3EKK, W3EUH, W3FJU, W3FMR, W3GCU, W3GRW, W3GSV, W3GWQ, W3HAZ, W3HNX, W3HWJ, W3IDZ, W3ITU, W3IU.

W4ACZ, W4ASR, W4AXP, W4AZT, W4BHY, W4BMM, W4BOW, W4BQE/ANG, W4DGS, W4DLK, W4DSY, W4EEE, W4EFD, W4ERX, W4FUM, W4FWD, W4FYB, W4GQH, W4PB, W4QL, W4TO.

W5BLQ, W5DKR, W5DWW, W5ECE, W5ERV, W5FAR, W5FZJ, W5GED, W5GHF, W5GWL, W5HHV, W5HME, W5HNF, W5HVN, W5HWG, W5HXI, W5IGX, W5JC, W5KC, W5MH.

W6AM, W6CFN/CVC, W6CIS, W6FBW, W6FHQ, W6HOE, W6IGO, W6ITH, W6KKL, W6MCQ, W6OJB, W6OMC, W6OQX, W6RIU, W6SPQ, W6TT, W6ZM.

W7AYO, W7CZJ, W7EKT, W7GPP, W7GVH, W7GYO, W7HHH, W7HXX, W7YG.

W8AHV, W8AQ, W8BWP, W8DED, W8DXB, W8DZO, W8FGV, W8FTW, W8FZE, W8GJM, W8IAI, W8IOH, W8JQE, W8JTW, W8NDE, W8NEU, W8OQU, W8OUT, W8PX, W8RAT, W8RBD, W8RBI, W8REC, W8RIS, W8SES, W8SWF, W8TJY, W8VAN.

W9ARI, W9AXH, W9BPC, W9CGK, W9DDF, W9DEI, W9DUD, W9DUX, W9ECY, W9EDU, W9EEY, W9EEZ, W9ERV, W9FA, W9FUZ, W9FWN, W9FXM, W9GAW, W9GLI, W9GMJ, W9HIC, W9HPF, W9HUX, W9IAV, W9IBC, W9JWC, W9KEI, W9MWR, W9NWQ, W9OAV, W9OXC, W9QLZ, W9QNP, W9RGK, W9RH, W9RIL, W9RPJ, W9SCE, W9TBF, W9UEU, W9UNQ, W9VMI, W9WKP, W9WMI, W9WTD, W9WVQ, W9WWL, W9UQH, W9YVF, W9YYA, W9ZGR, W9ZVO.

(Continued on page 76)

# Centralab's New Trimmer CERAMIC CONDENSER

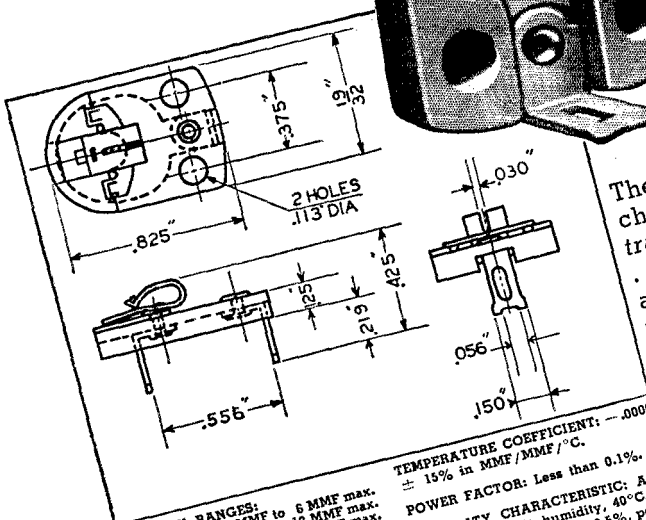
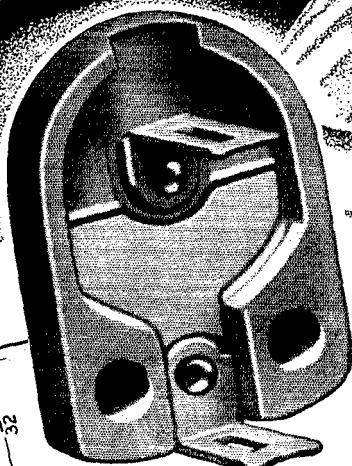

**CAPACITY RANGES:**  
 (a) Less than 2 MMF to 6 MMF max.  
 (b) Less than 3 MMF to 12 MMF max.  
 (c) Less than 7 MMF to 30 MMF max.  
 (d) Less than 60 MMF to 75 MMF max.  
 Other ranges may be manufactured if in demand.  
**RETRACTING:** After repeated cycles of heating and cooling, capacity change is less than 0.5%.

**TEMPERATURE COEFFICIENT:**  $-.0006 \pm 15\%$  in MMF/MMF/ $^{\circ}\text{C}$ .  
**POWER FACTOR:** Less than 0.1%.

**HUMIDITY CHARACTERISTIC:** After 100 hours at 90% humidity,  $40^{\circ}\text{C}$ . capacity change is less than 0.5%, power factor reading less than 0.15%.

There are no erratic capacity changes with the new Centralab Trimmer Condensers ... the dielectric and base are all one piece moulded under pressure with a ceramic so dense that no temperature or humidity changes can affect it. The stationary plate is silver, bonded to the ceramic with no air film between. The movable plate is metal, rotatable on the flat ground surface of the ceramic ... a worthy companion ... and a new member of the famous CENTRALAB family.

**CENTRALAB Div. of Globe-Union Inc., Milwaukee, Wis.**

QST's 25<sup>th</sup>

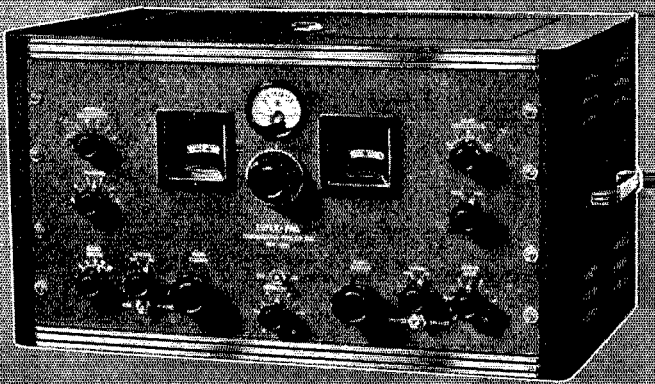

# Speaking of

We, of Hammarlund, salute QST on its twenty-fifth anniversary. During these twenty-five years of inspiring leadership, amateur radio has come a long way. Many storms have been weathered and we *know* that no matter what the future may hold for us—amateur radio and QST will come through with colors flying. Now, more than ever before, the full significance of amateur radio becomes apparent. . . . It is a living, breathing part of that indomitable American Spirit.

H A M M A R L U N D

OUR 30<sup>th</sup>



*Anniversaries!*

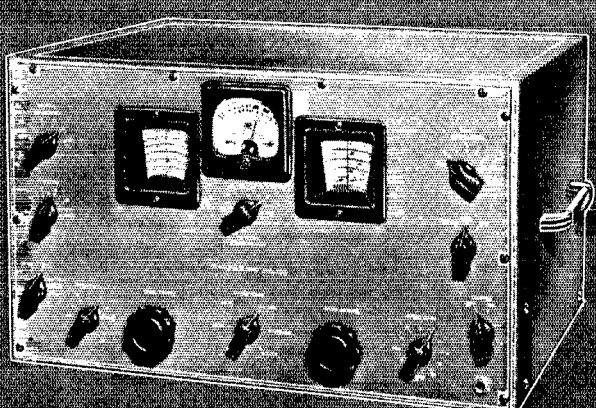

Hammarlund, also, is celebrating an anniversary. This is our thirtieth, and we too have come a long way. Each year has offered continuous advancement and expansion, for which we are most grateful. At present, practically the entire facilities of our organization are given over to National Defense—a program to insure those principles which made our growth possible. Our "Super-Pro" and "HQ-120-X" receivers, as well as a host of specially designed equipment, are playing important roles in National Defense.



## 4 important books covering a wide range of radio and television fundamentals

### UNDERSTANDING RADIO

By WATSON, WELCH and EBY, Stockton Junior College. Presents the principles and fundamental circuits of radio in an exceptionally clear, step-by-step manner, for home study. The practical treatment includes picture layouts, circuit diagrams, instructions for making apparatus, etc. 601 pp., illus., \$2.80.

### TELEVISION ENGINEERING

By D. G. FINK, Managing Editor, *Electronics*. Beginning with the camera, and continuing through the amplifying and transmission equipment, radiation through space, reception and amplification, detection, and image reproduction, this book describes fundamental processes of television. 541 pp., illus., \$5.00.

### RADIO SERVICE TRADE KINKS

By LEWIS S. SIMON. A useful manual for radio service and repair men, giving them quick reference to common radio ailments and practical methods of correcting them. The book lists hundreds of specific makes and models of receivers, and indicates symptoms, treatment, and remedy of common troubles of each. 269 pp., illus., \$3.00.

### TELEVISION BROADCASTING

By LENOX R. LOHR, Formerly Pres., National Broadcasting Co. Here are the results of foremost American experience with television, its set-up and methods of operation, its problems, economical, technical and legal. Illustrated with pictures, diagrams, and working scripts. 274 pp., \$3.00.

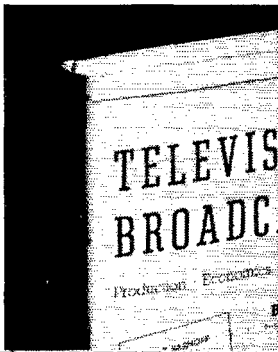

#### SEND THIS ON-APPROVAL COUPON

McGRAW-HILL BOOK CO., INC.  
330 W. 42nd St., New York, N. Y.

Send me the books checked below for 10 days' examination on approval. In 10 days I will pay for the books plus few cents postage or return them postpaid. (We pay postage on orders accompanied by remittance.)

- Watson, Welch and Eby — Understanding Radio, \$2.80  
 Fink — Television Engineering, \$5.00  
 Simon — Radio Service Trade Kinks, \$3.00  
 Lohr — Television Broadcasting, \$3.00

Name .....

Address .....

City and State .....

Position .....

Company ..... QST 12-40  
(Books sent on approval in U. S. and Canada only.)

(Continued from page 72)

## W1AW Operating Schedule

Effective November 25, 1940

#### OPERATING-VISITING HOURS:

3:00 P.M.—3:00 A.M. E.S.T. daily, except Saturday-Sunday  
 Saturday — 8:30 P.M.—2:30 A.M. E.S.T.  
 Sunday — 7:00 P.M.—1:00 A.M. E.S.T.

OFFICIAL BROADCAST SCHEDULE (for sending addressed information to all radio amateurs).

#### Frequencies

C.W.: 1761-3825-7280-14,254-28,510 kcs. (simultaneously)

Starting Times (P.M.)		Speeds (W.P.M.)									
E.S.T.	C.S.T.	M.S.T.	P.S.T.	M	T	W	Th	F	Sat	Sun	
8:30	7:30	6:30	5:30	30	15	25	15	20	—	20	—
Midnight	11:00	10:00	9:00	15	25	15	20	15	15	—	—

PHONE: 1806, 3950.5, 14,237, 28,510 kcs.

Each code transmission will be followed in turn by voice transmission on each of the above frequencies.

#### CODE PRACTICE:

Besides the O.B.S. times and word speeds given above, W1AW will adhere to a schedule for sending code practice transmissions at progressively increasing speeds (15 to 35 w.p.m. in 5 w.p.m. steps) daily except Friday, starting at 10:15 P.M. E.S.T. Proficiency Certificate Award qualifying runs start 15 minutes later than practice schedules on a date announced for each month. (Nov. 20th, Dec. 17th, Jan. 19th.)

#### GENERAL OPERATION:

Besides specific schedules in different bands, W1AW devotes the following periods, except Saturday and Sundays, to GENERAL work in the following bands:

Time E.S.T.	Frequency
4:00 P.M.—4:30 P.M.	28,510-kc. 'phone/c.w.
4:30 P.M.—5:00 P.M.	14,237-kc. 'phone
6:00 P.M.—6:30 P.M.	14,237-kc. 'phone
6:30 P.M.—7:00 P.M.	14,254-kc. c.w.
8:00 P.M.—8:30 P.M.	14,254-kc. c.w.
9:15 P.M.—9:45 P.M.	3950-kc. 'phone
12:45 A.M.—1:15 A.M.	1806/1760-kc. 'phone/c.w.
1:15 A.M.—2:00 A.M.	3825-kc. c.w.
2:00 A.M.—3:00 A.M.	7280-kc. c.w.

7:00 P.M.—8:00 P.M.: Schedules on 3500-ko. band  
 10:15 P.M.—11:00 P.M.: Code Practice all c.w. freqs.  
 11:00 P.M.—Midnight: National Trunk Line Net N.C.S.  
 At other times, and on Saturdays and Sundays, operation is devoted to the most profitable use of bands for general contacts and to participation in special week-end operating activities. The station is not operated on legal national holidays.

## DX CC Listings Suspended

ALL changes since our September DX CC listing are included in the following list. This will be our last official listing of DX Century Club Awards until further notice.

All amateurs interested should continue to follow up earlier DX radio contacts to get written confirmations. Effective with the appearance of this QST, however, Headquarters is discontinuing the checking of claims for either added credits or new DX CC awards until further notice. One fine day we shall hope to be able to announce ourselves open for new DX CC evidence again, but there is little present excuse for repeating the same listings month after month. Also personnel time is required for attention to national defense and field organization programs that justify our amateur operating and add to our standing as amateurs.

Other fields of amateur radio endeavor offer much greater attractiveness to the operating amateur this season. Every F.C.C. licensee ought to go after the Code Proficiency Awards unless top recognition in that field has been reached. Every active ham should aim too at holding a field organiza-



## "The Season's Best!"

Whether it's a matter of being your own Santa Claus or of tipping off someone in the family as to what would bring the biggest smile to your face on Christmas morning, we suggest the AR-77. Whether you judge it by eye appeal, ease of operation, simplicity of tuning with the Uni-view Dial, or any one of countless technical features from the adjustable Noise Limiter to its amazing sensitivity and stability, you'll quickly agree that the AR-77 reigns supreme.

Here's to the Merriest Christmas ever to you and your station!



# AR-77 COMMUNICATION RECEIVER

*Net Price \$139.50 f. o. b. factory. 8" Speaker in matched cabinet \$8.00*

RCA MANUFACTURING COMPANY, INC., Amateur Division, CAMDEN, N. J. • A Service of the Radio Corporation of America



# Check THESE POINTS BEFORE YOU BUY YOUR NEXT CRYSTAL

## POWER

Has it been fully tested in a loaded oscillator? Each Bliley Crystal is checked in a special oscillator which readily reveals its power capabilities.

## ACTIVITY

Has it been ground for maximum activity? Every Bliley Crystal must accurately follow rapid keying in a loaded oscillator.

## CALIBRATION

Can you depend upon its calibrated frequency? All Bliley Crystals are measured against a primary standard of frequency, accurate to 2 parts in 10 million.

## OVERLOAD

Will it stand up under adverse operating conditions? Bliley Crystals are subjected to an overload test to insure complete reliability.

BLILEY ELECTRIC CO., ERIE, PA.

**FOR BETTER CRYSTAL CONTROL**

tion appointment (ORS or OPS) and registration in the Emergency Corps.

DX CC claims received after appearance of this issue of QST will be returned unchecked . . . to be held and added to by your mail efforts until such time as we can be open to those claims again. We hope this can be soon.

### DX CENTURY CLUB AWARDS

These have been made to the first-listed amateurs, based on contacts with 100 or more countries, the credits all certified by examination of written evidence under the award rules.

W2GT.....	152	W2BHW....	134	G5RV.....	122
W6GRL.....	151	W5BB.....	133	W8NJP....	122
W8CRA.....	149	W2CMY....	133	W9TB....	122
W2GTZ....	148	W8OQF....	132	W6GAL....	121
W2GW.....	146	G6RH.....	132	W9FS....	121
G6WY.....	145	W4BPD....	132	W2GVZ....	121
W9TJ.....	144	W3CHE....	132	W1ADM....	121
W1TW....	143	W2HHF....	130	J5CC.....	120
W1BUX....	141	H89J.....	129	W9ADN....	120
G2ZQ....	141	W8LEC....	128	W1JPE....	120
W6KIP....	140	W2UK....	128	W7AMX....	119
W8DFH....	139	W3EPV....	128	W9PST....	119
ON4AU....	139	W2ZA....	127	G5BD....	119
W8BTI....	138	W9KG....	126	W1IAS....	119
W1FH....	138	W8JMP....	126	ZL1HY....	118
W1SZ....	137	W8DWW....	125	W2BYP....	118
W5VV....	137	W9ARL....	125	W1HX....	118
W3EMM....	137	W1DF....	125	W8MTY....	118
W1LZ....	136	W3FRY....	124	VK5WR....	117
W8ADG....	136	W4CEN....	123	W8QXT....	117
W6CXW....	135	W5KC....	123	W9EFL....	116
W1TS....	135	D4AFF....	123	W3EVV....	116
W8OSL....	135	W1AXA....	123	W1WV....	116
W2JT....	135	W9GDH....	122	W4CYU....	116
W8DHC....	134	W3EDP....	122	W4DRD....	116

- 115: W6ADP, W2CYS, W1CH, W3FPQ  
 114: W9KA, W8BKF, W2DC, G2DH, G5BY, W3BES  
 113: G6CL, W2CIM, W2DSB, W2GRG  
 112: W6FZL, W3EVI, W3GAU, W2ARB  
 111: W2AAL, W1DUK, VE2AX  
 110: ON4AU, PA0XF, W9UM, W3AER, W8IW1, W1ICA, W1BXC, W5QI, W2AV, W2YQ  
 109: W3DDM, W6FZY, G2MI, W9CWW, W9RBI, W8LFE  
 108: W6HX, W6TJ, Z5ZX, H9B9G, W1BGY, W3BEN, VE3QD, HB9CE, VK3QK, W2GNQ  
 107: W2CBO, G5BJ, W3AQ, W2GDQ, VK3CX, W7DL, W2IOP, W6MVK, W3AGV, W6AHZ, W8PQQ  
 106: G2TR, W8EUY, W8JAH, W1OZ, W9UQT, J2JJ, W1ZL, W9VY, W3GEH, W9VDY  
 105: W2OA, G5OY, W1GDT, HB9X, W8DOD, W4TO, W4IO, W1GNE, W2BMX, W4BYD, W8LYQ, W3ZX, VK6SA, W8AAJ  
 104: E1SF, W1ZB, W4AJX, F8RR, W6KRI, W1GXC, W3KT, W6BAM, W8JTW, W8HGW, LU8EN  
 103: G6KP, W8KKG, W5CUJ, W9RCQ, W9NNZ, LY1J  
 102: W4C8Y, W8AU, W8OXO, W1FTR, VE2EE, W2BXA  
 101: F8RJ, VK3KY, W6DOB, SUIWM, W1CC, SUI5G, G6MK, W4MR, W6GHU, W6KWA, W4EQK, LU7AZ, W1AB, W1AVK, W6ADT, W1CBZ, W2BJ, W4TZ  
 100: G6NF, VK2ADE, ZL1GX, ZL1MR, PA0QF, W8BSF, D3BMP, W9LBB, W4CCH, W8KTW, W5ASG, W8JIN, W8QDU, G6GH, W3AU, W9LQ, W2JME, K4FCV, W6TT, W4FIJ, W2WC  
 Radiotelephone: W2AZ 106; W2GW 105; W2JT 103; W6OCH 101.

The following have submitted proof of contact with 75-or-more countries: W1KHE, W3GHD, W9AJA, W8JDP 99; G3JR, W2ALO, W3AOC, W2CTO 98; W4TP, W8E8, W8LZK 97; G6BG, W1COI, W3FLH, W4DMB, W8BOX, W8DPS, W8IQB 96; F8LJ, F8SAB, G6XL, W3EMA, W3OP 95; K4ESH, W8CJJ, W9AEH, W9BEZ 94; G6ZO, ON4CK, PA0QZ, W6FKZ, W9GBJ 93; W1KID, SP1LP 92; W1BGC, W1DOW, W8AJT, W1KCF 91; D3C8C, G6YE, ON4FE, SP1AR, W6NLZ, W8LAV, W90VU 90; VK3KG, W2BZB, W2CQU, W6AM, W8JFC 89; G2DZ, W3JM, W6LJD, W8CED, W9FGS 88; PY2DN, W1APA, W6CPB 87; W2PLG, W8DAE, W8OUK, W9PLH 86; VK2TI, W4A8F, W4CFD, W6GK, W8BWC, W8GMI, W9CKS 85; BM8WL, W1EFT, W1RPN, W2AYJ, W8HBB 84; E1JJ, OZ7CC, VE2GA, W2AWF, W8DTB, W6KUT, W8BFG, W9DIR 83; W1EVD, W2HTV, W3AYS, W3FUF 82; J2LL, W3EIJ, W6GY 81; G3BS, LA2X, W2BNX, W3BVN, W3EPE, W4OG, W6MHI, W8DGH, W8TEK, W9GMV, W9MRW 80; W4ZZ 79; W3DRD, W4EPE, W8EJN, W9YNB 78; W1NI, W6QAP, W9HUV 77; PA0JMV, W1EH, W3BSB, W3CRW, W3FHY, W9ERU, ZELI 76; HI2MC, VE3DA 75.  
 Radiotelephone: W4CYU 98; G5RV 92; W1ADM, W1LZ 90; W3EMM 89; W1AK 84; W1JFG, W3LKV 80; W8IKQ, W8QXT 78; W1BLO 77; W1KJ, W9TIZ 76; W2GRG 75.



# ADMIT IT!..

.. (to someone who cares)

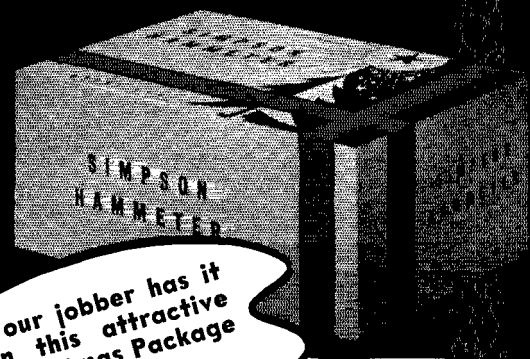

Your jobber has it  
in this attractive  
Christmas Package  
**SEE IT!**

## There is only one **HAMMETER**

Standard (no external multipliers necessary) A. C. volts: 0-15-150-750-3000; D. C. volts: 0-15-75-300-750-3000; D. C. milliamperes: 0-15-150-750; ohms: 0-3000 (center scale 30) and 0-300-3000 (center scale 3,000)

The greatest thing a ham can own is not a costly gift.

Only..... **\$14.75**

If you have as many friends as we think you have, you may also want to mention some of the Simpson Panel Instruments—today's greatest instruments at lower prices.

## — Christmas won't be Christmas without the **HAMMETER**

**S**OMEBODY is just aching for a gentle hint from you concerning the Christmas present you want. Whoever it is—wife, sweetheart, dad, mother, sister, brother, aunt or uncle—knows mighty well that it will have a ham flavor, but you're the one person who can clear up the problem completely.

So take a good long look at the Simpson Hammeter and you will drop that hint today. As you probably know, the Hammeter is the first self-contained pocket sized tester built from meter to prods for you. A great light will break on you when you get the Hammeter. It will give you the answer to all your problems of checking high voltage, shooting trouble, and checking steps of construction.

The Simpson D'Arsonval movement with the expensive bridge-type construction and soft-iron pole pieces makes the Hammeter a *lasting* gift. The ranges, listed opposite, tell their own story. Both A.C. and D.C. have resistance of 1000 ohms per volt. It's a shock-proof tester all the way through, with cables insulated for 5000 V. and clips also heavily insulated.

Its handsome black and gold formica panel and red bakelite meter and case, give it the class that makes it a real piece of electrical "jewelry". If someone doesn't think of it for you, you'll want to buy it yourself. But remember that "A hint to the wise is sufficient".

**SIMPSON ELECTRIC CO.**  
5210 Kinzie St., Chicago, Ill.

# SIMPSON

INSTRUMENTS THAT *Stay* ACCURATE

★ ★ ★ ★ ★ ★ ★ ★ ★

# YOU CAN HAVE A PROMISING CAREER in the ARMY, NAVY or COMMERCIAL FIELD

You can begin now to prepare yourself for such an interesting position through Candler Home Training, even if you know nothing of radio code or fundamentals. Or, if you know code but are compelled to copy "letter-for-letter" and send jerkily, we will smooth this out by giving you that "Coordinative Knack"



WALTER H. CANDLER  
Founder

necessary to speed and copying behind.

You may be practicing wrong, pursuing antiquated methods that are long, slow, tedious. We will set you RIGHT in a few days—will make the process of learning code or acquiring speed and skill easy and interesting. When you can read code as easily as you read print, copying behind and acquiring speed cease to be a factor.

## CANDLER SPECIALIZED TRAINING

Backed by over a quarter century of success, makes possible a wonderful career for you. The New BOOK OF FACTS gives you the whole, interesting story. Send for it TODAY. A postal will do. No obligations.

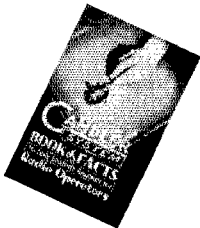

## CANDLER SYSTEM COMPANY

DEPT. Q-12 — ASHEVILLE, NORTH CAROLINA

★ ★ ★ ★ ★ ★ ★ ★ ★

## Southern N. J. Flood

ON THE morning of September 1st, about 3 A.M., a torrential rain commenced, which developed into a cloudburst in Southern N. J., south of Camden. This, following one week of steady rain, so soaked the South Jersey flat regions, the creeks and rivers were totally unable to provide sufficient drainage, consequently overflowing their banks, causing untold property damage. Although for the most part communication facilities remained intact, it was thought good policy to investigate the needs. Consequently, on the morning of Sept. 1st, W3BAQ, Section Emergency Coördinator for S.N.J., and Assistant Emergency Coördinator, W3ZI, held a conference and it was decided to send a truck radio unit, complete with gas-driven generator into the flooded area. At 10 A.M., W3BAQ/3 left Trenton for Mount Holly, arriving there and reporting to the local police. With him was James Hassall, who acted as assistant and antenna man. In the meantime W3ZI kept a continuous watch, calling "SNJ" at intervals of ten minutes. In a short time W3BM in Minotola was raised and a fairly complete picture of flood conditions obtained from him. A tentative schedule was made and kept throughout the entire 7½-hour period. 3ZI acted as Net Control for all information and as contact station for the mobile unit. 2BGO, N.Y.C., 3 FNI, Wilmington, Del., and 3 FXN, Collingswood, all offered their help. In the meantime 3BAQ/3 had arrived in the Camden Area and picked up 3FXN, as assistant operator. 3KW, E.C. for Haddonfield Area, was telephoned and asked to get on the air with his portable radio truck unit. A net was formed with these two mobile units and W3ZI, the control station. In this manner information was exchanged between both cars and W3BM, who stood by all day giving information on road conditions and dam breaks. In one case a fleet of trucks needed information as to whether Route 39 was open through to Trenton. They had become stalled at Vineland and wanted to move north. 3ZI telephoned the State Police Hdq. and received the report, passing it along to W3BM who, in turn, notified the fleet. A guard watch was kept all day on the N.J. State A.A.R.S. channel of 3535 kc. and 3700 kc. the S.N.J. O.R.S. Net. What might have developed into a major flood, where emergency communications would have been needed, did not actually happen, but the need for everyone being on the job, and ready, will always exist. It gave the new E.C. organization in S.N.J. a grand opportunity to test facilities and see just where our weak points are. Thanks to everyone who stood by for us and lent a hand.

— Ed. G. Raser, W3ZI, Asst. SCM, So. N. J.

J. R. Foran, radio operator during the cruise of the Yacht *Haida* along the Mexican Coast and up to Alaskan waters, has returned to California. He is on the air from his station W6KVA and would appreciate a call from any of his old acquaintances.

### A.R.R.L. CODE OF CONDUCT FOR ALL U. S. RADIO AMATEURS

1. Do not talk about the war over the air, even among ourselves, or discuss any happenings that might have a military significance (our signals may be intercepted by belligerents).
2. Do not use any code or cipher\*; use plain language, English recommended.
3. Do not permit anyone except members of your immediate family, or other licensed amateurs who at the time are in possession of their F.C.C. licenses, to use the microphone of your phone station.
4. Sign each transmission with your assigned call; follow every F.C.C. regulation with utmost care.
5. Scrutinize domestic traffic offered you by strangers; if you are approached by any agent of a subversive group or an agent of a foreign country, communicate immediately with the nearest office of the F.B.I. or via A.R.R.L.

\*One exception, authorized AARS/NCR drills.

# BRUSH

## BRUSH CRYSTAL PHONOGRAPH PICKUPS

—for the finest reproduction of both soft and hard record materials, with virtually no record wear. Adopted by leading broadcast stations and recording studios after the most exacting tests.

BRUSH CRYSTAL HEADPHONES—the long recognized standard of fidelity and wide frequency response. —professional quality at a very moderate price. Technical Bulletins gladly furnished on request.

THE BRUSH DEVELOPMENT COMPANY  
3311 PERKINS AVE.  
CLEVELAND  
OHIO

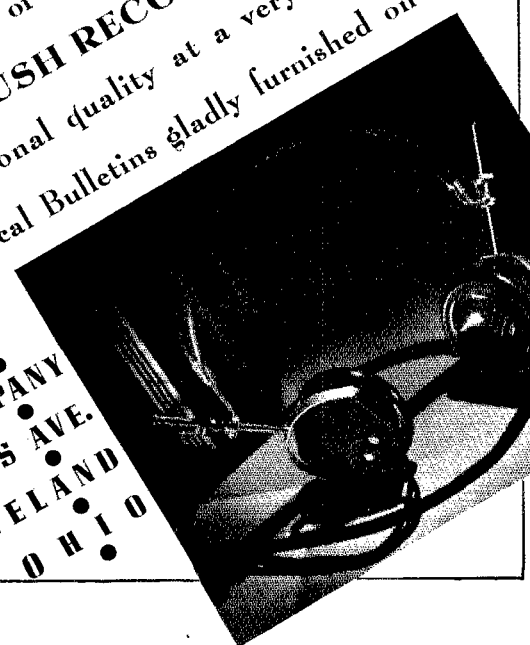
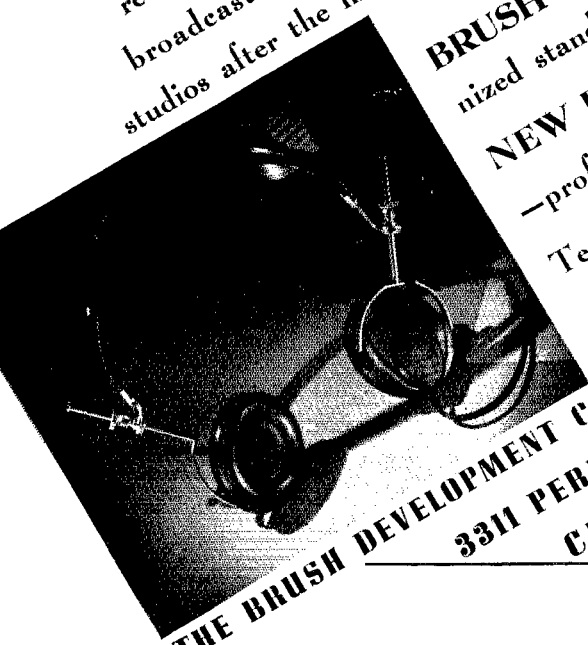



## ELECTION NOTICES

To all A.R.R.L. Members residing in the Sections listed below:

(The list gives the Sections, closing date for receipt of nominating petitions for Section Manager, the name of the present incumbent and the date of expiration of his term of office.) This notice supersedes previous notices.

In cases where no valid nominating petitions have been received from A.R.R.L. members residing in the different Sections in response to our previous notices, the closing dates for receipt of nominating petitions are set ahead to the dates given herewith. In the absence of nominating petitions from Members of a Section, the incumbent continues to hold his official position and carry on the work of the Section subject, of course, to the filing of proper nominating petitions and the holding of an election by ballot or as may be necessary. Petitions must be in West Hartford on or before noon of the dates specified.

Due to a resignation in the Arizona Section, nominating petitions are hereby solicited for the office of Section Communications Manager in this Section, and the closing date for receipt of nominations at A.R.R.L. Headquarters is herewith specified as noon, Monday, December 16, 1940.

Section	Closing Date	Present SCM	Present Term of Office	Ends
Georgia	Nov. 15, 1940	Leland W. Smith	Nov. 29, 1940	
Philippines	Dec. 2, 1940	George L. Eickard	Oct. 15, 1938	
Alberta *	Dec. 2, 1940	C. S. Jameson	Feb. 18, 1940	
Kentucky	Dec. 2, 1940	Darrell A. Downard	April 15, 1940	
Maritime *	Dec. 2, 1940	Arthur M. Crowell	June 15, 1940	
Michigan	Dec. 2, 1940	Harold C. Bird	Oct. 15, 1940	
Quebec *	Dec. 2, 1940	Lindsay G. Morris	Dec. 14, 1940	
West Indies	Dec. 16, 1940	Mario de la Torre	Oct. 28, 1940	
Arizona	Dec. 16, 1940	Marson B. Hull (resigned)	.....	
Arkansas	Feb. 3, 1941	Henry E. Vette	Feb. 15, 1941	
San Joaquin Valley	Feb. 3, 1941	Edwin A. Andress	Feb. 15, 1941	
Vermont	Feb. 3, 1941	Clifton G. Parker	Feb. 15, 1941	
Mississippi	Feb. 3, 1941	Jewell W. Cole	Feb. 15, 1941	
Hawaii	Feb. 17, 1941	Francis T. Blatt	Feb. 28, 1941	
N. Carolina	Mar. 3, 1941	W. J. Wortman	Mar. 18, 1941	

\* In Canadian sections nominating petitions for Section Managers must be addressed to Canadian General Manager, Alex Reid, 169 Logan Ave., St. Lambert, Quebec. To be valid such petitions must be filed with him on or before the closing dates named.

1. You are hereby notified that an election for an A.R.R.L. Section Communications Manager for the next two-year term of office is about to be held in each of these Sections in accordance with the provisions of the By-Laws.

2. The elections will take place in the different Sections immediately after the closing date for receipt of nominating petitions as given opposite the different Sections. The Ballots mailed from Headquarters will list in alphabetical sequence the names of all eligible candidates nominated for the position by A.R.R.L. members residing in the Sections concerned. Ballots will be mailed to members as of the closing dates specified above, for receipt of nominating petitions.

3. Nominating petitions from the Sections named are hereby solicited. Five or more A.R.R.L. members residing in any Section have the privilege of nominating any member of the League as candidate for Section Manager. The following form for nomination is suggested:

(Place and date)

Communications Manager, A.R.R.L.,  
38 La Salle Road, West Hartford, Conn.

We, the undersigned members of the A.R.R.L. residing in the ..... Section of the ..... Division hereby nominate ..... as candidate for Section Communications Manager for this Section for the next two-year term of office.

(Five or more signatures of A.R.R.L. members are required.)

The candidates and five or more signers must be League members in good standing or the petition will be thrown out as invalid. Each candidate must have been a licensed amateur operator for at least two years and similarly, a member of the League for at least one continuous year, immediately prior to his nomination or the petition will likewise be invalidated. The complete name, address, and station call of the candidate should be included. All such petitions must be filed at the headquarters office of the League in West Hartford, Conn., by noon of the closing date given for receipt of nominating petitions. There is no limit to the number of petitions that may be filed, but no member shall sign more than one.

4. Members are urged to take initiative immediately, filing petitions for the officials for each Section listed above. This is your opportunity to put the man of your choice in office to carry on the work of the organization in your Section.

— F. E. Handy, Communications Manager

## ELECTION RESULTS

Valid petitions nominating a single candidate as Section Manager were filed in a number of Sections, as provided in our Constitution and By-Laws, electing the following officials, the term of office starting on the date given.

Idaho	Clifford A. Jessup, W7CRL	Oct. 1, 1940
Utah-Wyoming	Henry L. Schroeder, W7GZG	Oct. 1, 1940
Ontario	Flying Officer D. R. Gunn, VE3EF	Oct. 15, 1940
N. New Jersey	Edward Gursky, Jr., W2LMN	Oct. 15, 1940
Kansas	A. B. Unruh, W9AWP	Oct. 29, 1940

In the Western Pennsylvania Section of the Atlantic Division, Mr. Elmer Krall, W8CKO, and Mr. Kendall Speer, Jr., W8OFO, were nominated. Mr. Krall received 112 votes and Mr. Speer received 77 votes. Mr. Krall's term of office began September 20, 1940.

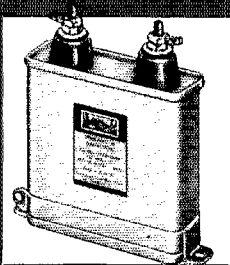

**CORNELL-DUBILIER**  
ELECTRIC CORPORATION

1013 HAMILTON BLVD. • SO. PLAINFIELD, N. J.

# LET'S SHARPEN OUR PENCILS

*and  
do some figuring*

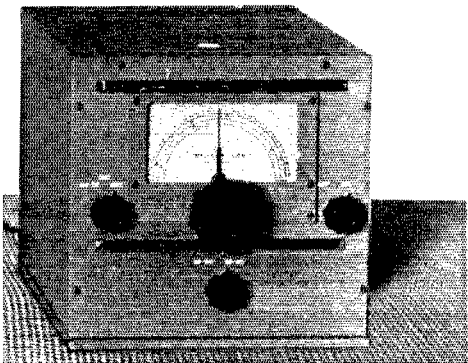

IT'S really amazing the number of 10 meter stations we have heard using a \$50 communications receiver in conjunction with an inexpensive DM-36 for reception. Used in this manner, of course, the little DM takes care of the vital work of

reception, while the complete receiver acts only as an i.f. amplifier stage at either 10 or 7 megacycles.

There must be a reason why so many DM's are used in conjunction with communications receivers of all types, for 10 meter reception . . . even the types which, normally tune the 10 meter band! Well, there is a reason! In fact there are several reasons.

Consider your own receiver. Do you have to dodge loud image signals when tuning the 10 meter band? Does your receiver have a real, calibrated bandspread dial on 10 meters? Does it have uniform sensitivity across the entire band? Does it provide high gain 5 meter reception?

If the answer is in the negative, then it is high time you investigated the possibilities offered by the addition of a DM-36 . . . for, just as hundreds of operators have already discovered, this remarkable EXPANDER UNIT really produces the goods, even when used in conjunction with only an average communications receiver.

No matter how much pencil sharpening or head scratching we do, we can't think of a simpler or more economical way to improve 10 meter reception than by the addition of the DM. Better write today for the extremely low prices on the DM models, or better still drop into your jobber's and see for yourself. Incidentally, this is a good time to learn about another unit of unusual characteristics, the RME-99 COMMUNICATIONS RECEIVER.

**Latest Issue of the RME  
News Now Ready**

*See your jobber, or write  
us for your free copy*



**RADIO  
MFG.**

**ENGINEERS, INC. PEORIA, ILLINOIS**

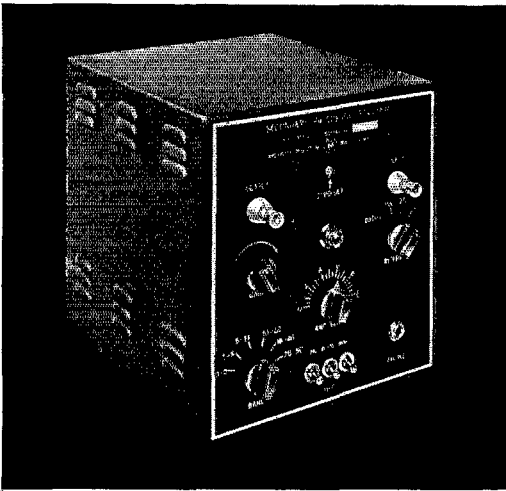

## A NEW Precision Crystal Secondary Frequency Standard

THAT HAS BEEN

“Designed for Application”

A precision frequency standard capable of being adjusted to WWV or some other primary standard and putting out uniformly accurate calibrating signals with 10, 100, 1000 KC intervals. Uses the new GENERAL ELECTRIC No. 18A 1000 KC crystal having a frequency temperature coefficient of less than one cycle /Mc/C°. The crystal is sealed in Helium in a standard metal tube envelope.

The self-contained AC power supply has VR150-30 voltage regulator tube.

In addition to oscillator, multivibrators, and harmonic amplifier, a built-in mixer with phone jack and gain control on panel is incorporated.

The August 1940 issue of the magazine *QST* contains a detailed technical description by the designer, Mr. George M. Brown.

- New GE No. 18A Crystal
- Harmonic Amplifier
- Built-in Mixer
- Tone Generator
- 10-100-1000 KC Intervals
- Compact—Complete
- Extremely low price for a high precision instrument — Only \$75.00 for No. 90505, 110 V. AC model complete with GE tubes and crystal.

JAMES MILLEN  
150 EXCHANGE ST.



MFG. CO. INC.  
MALDEN, MASS.

## The 6L6 as a Crystal Oscillator

(Continued from page 55)

timum for 3.5- and 7-Mc. crystals, best operation with 1.7-Mc. crystals was obtained with a value of 200  $\mu\text{fd}$ .

In the circuit of Fig. 1, an arrangement is shown for shifting the circuit, as well as circuit values for each band, by plugging in the appropriate unit. The extra 100- $\mu\text{fd}$ . cathode-circuit capacity for fundamental operation with a 1.7-Mc. crystal and 7-Mc. output with a 3.5-Mc. crystal are soldered to the appropriate pins. Contacts 2 and 3 are strapped together when either 1.7- or 3.5-Mc. crystals are in use thereby short-circuiting the crystal series condenser,  $C_1$ . The cathode-circuit choke is short-circuited when the Tri-tet circuit is in use to eliminate loss in output which was especially noticeable with 1.7-Mc. crystals.

With the arrangement shown, it has been possible to operate the 6L6 at inputs up to 55 watts at 600 volts (measured between plate and ground) without exceeding crystal-current ratings; in most cases, the crystal current did not exceed 60 ma. under any adjustment. A 60-ma. dial lamp, which will burn out at about 100 ma., in series with the crystal is good insurance against damage to the crystal from excessive current which may result should the wrong cathode-circuit unit be plugged in by mistake.

When either circuit is operating properly there should be no cessation of oscillation at any point over the tuning range of the plate tank condenser. Unloaded, the plate current will run high until resonance is approached when the customary dip will be found, the minimum value of plate current depending upon the frequency, less dip being obtained at the higher frequencies. As the loading is increased, the dip will become less pronounced and, in fact, will disappear entirely when heavily loaded so that the plate-current reading no longer serves as a reliable indicator of the tuning of circuit. The rectified grid current of a following stage, or antenna ammeter when the oscillator is coupled to an antenna, should be used to tune for maximum output. Since the tank condenser is large enough to cover both the fundamental and harmonic frequencies of any crystal, care should be taken that the circuit is tuned to the desired frequency. Resonance will occur at high capacity for the 1.7- and 3.5-Mc. bands, medium capacity at 7 Mc. and low capacity at 14 Mc.

Outputs as high as 35 to 40 watts at the fundamental and 25 watts at the second harmonic, 14 Mc. included, with good keying characteristics should not be difficult to obtain with a proper power supply.

**SWITCH  
TO SAFETY!**



# 35 WATTS

## Build It Yourself!

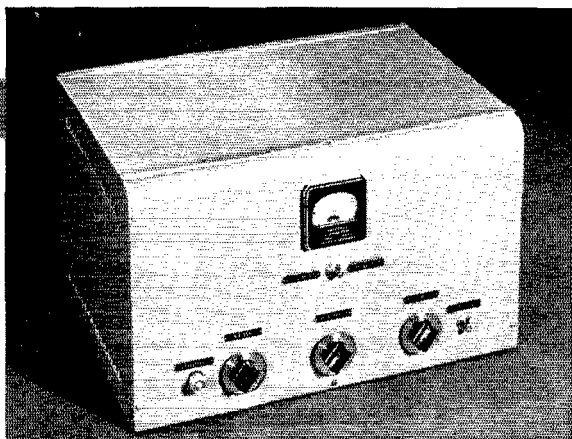

35 Watt Phone-CW Transmitter

**T**HIS new Thordarson kit makes a flexible, easy to build, single-unit phone & CW transmitter. It covers the 160, 80, 40, 20 and 10 meter bands by means of stock plug-in coils. The power supply and Class B audio amplifier are included on the same chassis as the RF section.

A 6V6-G harmonic crystal oscillator circuit easily provides enough driving power for the 6L6-G final modulated amplifier. Harmonic operation of the crystal oscillator may be obtained when using 160, 80, and 40 meter crystals.

When properly loaded for phone operation the power input to the final amplifier stage is 35 watts. The modulator consists of a 6A6 operating in Class B.

This stage is driven by another 6A6 triode with its two sections in parallel. Sufficient gain is realized in this stage to obtain 100% modulation when using a high quality carbon microphone. A low impedance variable link is provided to couple the transmit-

Available in complete Kit form at your local Thordarson Distributors. Ask for free Bulletin SD464.

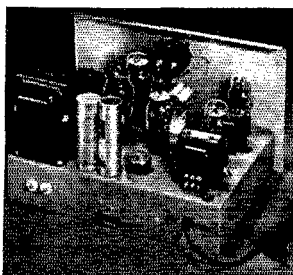

ter to doublet antenna or to an antenna matching network.

Amateur's net price, less coils, crystal, meter and tubes:

\$43.50

### NEW TRANSMITTER GUIDE

14 designs— from a 20 w. CW to a 1000 w. model, including 2 mobile types— pictured and described in fine detail in the new Thordarson Transmitter Guide. Just off the press! Obtain your copy now from your Thordarson Distributor. Or write the factory. Ask for Guide No. 344-E, 15c Postpaid.



*Transformer Specialists*

# THORDARSON

Since 1895

500 W. HURON ST., CHICAGO

# OHMITE Ohm's Law Calculator

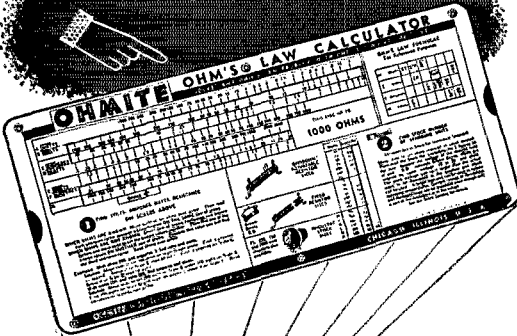

**solves any Ohm's law problem  
with one setting of the slide**

**IT'S  
NEW**

**SIMPLE  
EASY**



#### USE OHMITE

Brown Devils  
Dividohms  
Rheostats  
Dummy Antennas  
R. F. Chokes  
Band Switches  
Parasitic  
Suppressors

You'll be amazed how easily you can get the answer to any Ohm's Law problem with this handy new Calculator. There's nothing else like it. Specially designed by Ohmite Engineers. All values are direct reading. Requires no slide rule knowledge. Covers the range of currents, resistances, wattages, and voltages commonly used in radio and commercial work. A setting of the slide also tells the stock number of resistor or rheostat you may need. This new Calculator is available to you for only 10¢ to cover handling cost. At your Jobber or send 10¢ in coin now.

*Improve your rig with famous Ohmite resistance units. Proved right the world over. Get them at your Jobber or write for free Catalog 17.*

OHMITE MANUFACTURING CO.  
4865 Flournoy Street, Chicago, U. S. A.  
10¢ in coin enclosed. Send  
Ohm's Law Calculator.

Name \_\_\_\_\_  
Street \_\_\_\_\_  
City \_\_\_\_\_ State \_\_\_\_\_  
QST—Dec.

# OHMITE

RHEOSTATS RESISTORS TAP SWITCHES

## Crystal Filter Performance

(Continued from page 60)

The reactance characteristic of the crystal near resonance is so extremely steep as compared to that of the output circuit that the only effect of the varying reactance of the latter is to change the frequency of the crystal a few cycles — not nearly enough to cause noticeable detuning with respect to the i. f. amplifier. This fact checks with the operation of the Lamb filter.

## ★ A.R.R.L. QSL BUREAU ★

For the convenience of its members, the League maintains a QSL-card forwarding system which operates through volunteer "District QSL Managers" in each of the nine United States and five Canadian districts. In order to secure such foreign cards as may be received for you, send your district manager a standard No. 10 stamped envelope (standard business size, 9½" x 4½"). If you have reason to expect a considerable number of cards, put on an extra stamp so that it has a total of six cents postage. Your own name and address go in the customary place on the face, and your station call should be printed prominently in the upper left-hand corner.

- W1 — J. T. Steiger, W1BGY, 35 Call Street, Williamansett, Mass.
- W2 — H. W. Yahnel, W2SN, Lake Ave., Helmetta, N. J.
- W3 — Maurice Downs, W3WU, 1311 Sheridan St., N. W., Washington, D. C.
- W4 — G. W. Hoke, W4DYB, 328 Mell Ave., N. E., Atlanta, Ga.
- W5 — James F. Manship, W5ALE, 910 So. Boston, Tulsa, Okla.
- W6 — Horace Greer, W6TI, 414 Fairmount Ave., Oakland, Calif.
- W7 — Frank E. Pratt, W7DXZ, 5023 So. Ferry St., Tacoma, Wash.
- W8 — F. W. Allen, W8GER, 450 Fountain Ave., Dayton, Ohio.
- W9 — Alva A. Smith, W9DMA, 238 East Main St., Caledonia, Minn.
- VE1 — L. J. Fader, VE1FQ, 125 Henry St., Halifax, N. S.
- VE2 — C. W. Skarstedt, VE2DR, 236 Elm Ave., Westmount, P. Q.
- VE3 — Bert Knowles, VE3QB, Lanark, Ont.
- VE4 — George Behrends, VE4RO, 186 Oakdean Blvd., St. James, Winnipeg, Manitoba.
- VE5 — H. R. Hough, VE5HR, 1785 First St., Victoria, B. C.
- K4 — F. McCown, K4RJ, Family Court 7, San-turce, Puerto Rico.
- K5 — Fourth Coast Artillery, K5AA, Radio Section, Fort Amador, Balboa, C. Z.
- K6 — James F. Pa, K6LBH, 1416D Lunalilo St., Honolulu, T. H.
- K7 — Jerry McKinley, K7GSC, Box 1533, Juneau, Alaska.
- KA — George L. Rickard, KA1GR, P. O. Box 849, Manila, P. I.



# GET Your HAMMARLUND For Christmas

THE famous H-Q 120 X... dual stabilized with voltage regulation and drift correction! Strictly up-to-the-minute with the kind of performance demanded by the exacting professional, amateur, or short wave listener. Special high gain RF stage with antenna compensator; 3 IF stages with silvered mica condensers and permeability tuned transformers. Covers 9.7 to 555 meters in 6 bands. See picture and price at right! Decide NOW to GET YOURS for Christmas!



**only \$13.80**  
\$10.97 Per Month for 12 Months\*  
Cash price, including tubes, 10" PM Dynamic speaker and crystal. .... \$138.00

**YOUR CALL LETTERS  
IN GOLD ... 10c**

Put these big shadowed decalomania letters on your Ham Shack door, auto window, etc. Nearly 2" high. Send dime for yours today.

Be sure to give call letters

**How to  
Order**

Send down payment with your order. We ship immediately upon credit approval. You pay balance plus 6% carrying charge in equal monthly payments of \$5 or more

**FREE ... a book every  
BIG NEW CATALOG**

Just out ... with many more items than we've ever put between the covers of any catalog. Thousands of bargains, sets, parts, accessories, supplies, of best known makes. Hundreds of illustrations. This book belongs in every "ham" shack, ready for instant reference.

**WRITE FOR IT!**

Just a little bit more  
buys the ... **SUPER-PRO**

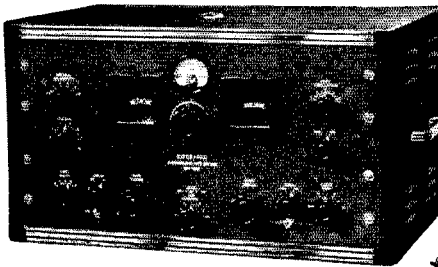

**HAMMARLUND SERIES 200**  
**\$27.90 DOWN**  
**1 YEAR TO PAY**  
(\$22.18 Per Month for 12 Months)

18-tube "super" with improved noise limiter, two stages tuned RF, variable selectivity crystal filter, S meter, and continuous bandspread tuning through entire frequency range. Tuning unit has 20 laboratory adjusted coils on Isolantite bases, four gang main tuning condenser, and 12 to 1 ratio direct reading dials. A host of other exclusive features make the Super Pro one of the most desirable sets on the market.

Available in two tuning ranges ... SP210X, 15 to 560 meters, and SP 210 SX 7 1/2 to 240 meters. Cash price, complete with crystal, tubes, 10" speaker, and separate power supply ..... \$279.00

Order direct from this ad!

LIKE THE  
TURKEY'S HEAD  
ON THANKSGIVING...

We  
**CHOPPED!**  
**OUR PRICES!**

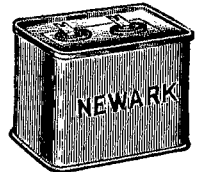

Oil Filled, Oil Impregnated

**Filter Condensers**  
As low as **59c**

Thousands now in use by "hams" who are still wondering how we can sell such dependable quality condensers at such low prices. No compromise with quality. Made by a leading manufacturer and **GUARANTEED** at rated voltages.

Mfd.	Volts DC.	Size	Price
1	1000	5 x 3 1/4 x 1 1/2	\$ .59
1.5	1500	Misc.	.69
2	1500	Misc.	.99
4.4	1500	5 x 3 1/4 x 1 1/4	1.50
5	1500	3 1/2 x 3 1/4 x 2	1.60
5	2000	4 3/4 x 3 1/4 x 1 1/4	1.50
8	2000	5 x 3 1/4 x 3 1/4	2.75
4	3000	5 x 3 1/4 x 3 1/4	3.75

**NEWARK** Electric Company  
323 W. MADISON ST.  
Dept. Q CHICAGO, ILL.

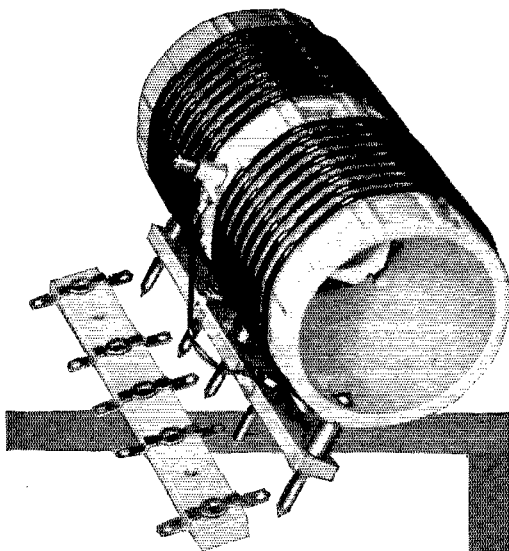

# JOHNSON

*has the answers*

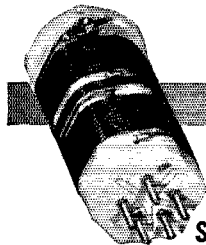

**EFFICIENT DESIGN**

**STURDY CONSTRUCTION**

For permanent installations, **Broadcast Stations, Airlines, Police Stations, and other Commercial Services** prefer JOHNSON.

Built for applications requiring high efficiency, correct electrical design, frequency stability and long life—these Hi-Q inductors cost no more because of JOHNSON'S quantity production for manufacturers using these inductors.

Investigate their many advantages. Ask your jobber for the **New Catalog 966J**.



**E. F. JOHNSON CO**

WASECA, MINNESOTA

EXPORT: 25 WARREN ST., NEW YORK, N. Y.

"MANUFACTURERS OF RADIO TRANSMITTING EQUIPMENT"

## Correspondence

(Continued from page 81)

Western Electric employment interviewer: "We have had some experience with radio-amateurs. They are generally unsatisfactory for our purpose and lacking in technical background."

I doubt if the majority of hams would consider themselves "in radio" if they had a job wiring in the same identical grid-lead hour after hour, day after day.

**Marine Operating:** Unless you are a graduate of a recognized school which will materially assist you in achieving this goal, keep away from it and save yourself time and money.

**Broadcasting:** Broadcasters use engineers and technicians with good technical school backgrounds. If one has relations or friends in the field it is possible to "break in" to a job. Crashing the gates cold is out.

**Aviation:** Aviation companies need a limited number of men, good men. The expression "good men" applies solely to graduates of recognized training schools, as far as I can see. All others steer clear.

**Servicing:** The fact that the amateur is treated with contempt in the service field is well known. If you are prepared to set up your own business or to go to work for relatives or friends, fine. Otherwise keep away. (Unless you are 17 years old and care to "hang around" the shop long hours for 12 dollars per.)

Regarding the Radio Operator Exam recently held by the U. S. Civil Service Commission, your statement "they really want amateurs" is not strictly true. It should be amended to read, "They really want commercial men who also, and incidentally, know something of amateur work." My application was disapproved for lack of "education and experience."

Regarding the F.C.C. exam for Radio Monitoring Officer: Do you suppose more than one-half of one per cent of the country's hams have the experience stipulated in the examination announcement?

The point I wish to make by all the above is simply this: a self-acquired radio education (the kind most hams have) is useless as far as "breaking into radio" is concerned. For factory production work no technical knowledge is required. For operating work only two kinds of proof of competence are acceptable: (1) graduation from a recognized school; (2) previous commercial experience. For engineering work in even its most elemental forms, an E.E. degree is needed.

In fairness to the thousands of your readers who are figuring on going to work "in radio" in the near future, you should have something to say about this.

In conclusion, if I sign this letter I shall be branded a cry-baby; if not, an anonymous coward. I prefer the latter.

From now on,

— *Strictly Ham*

**EDITOR'S NOTE** — *QST's* firm policy against the publication of anonymous communications is suspended in this instance in view of the public-interest aspect of this letter. Without attempting to rebut the anonymous writer's statements, it is well known that at least half a dozen large radio manufacturers do give amateurs preferment in employment, that a large proportion of the 200 radio operators recently added to its staff by F.C.C. were amateurs (many without commercial experience of any kind). It is a fact that there is a shortage of skilled radio personnel; it is also true that the mere possession of an amateur license does not necessarily qualify an individual for one of the better-paying jobs in engineering, production, etc.

c/o *The Hartford Courant*, Hartford, Conn.

Editor, *QST*:

I read your editorial in the September issue of *QST* in which you mention the lack of trained radio men and I should like to express my views on the subject, feeling qualified in a way to do so.

You state that there is a crying need for such trained men in the services and that in the future the industry will afford opportunities galore for the right men.

I quite agree with you, Mr. Warner, there are opportunities galore in radio — if you are willing to work for starvation wages!

Although not really an old-timer, I nevertheless grew up with radio, building my first set in 1919. You may remember

# Here's the Winning Combination—

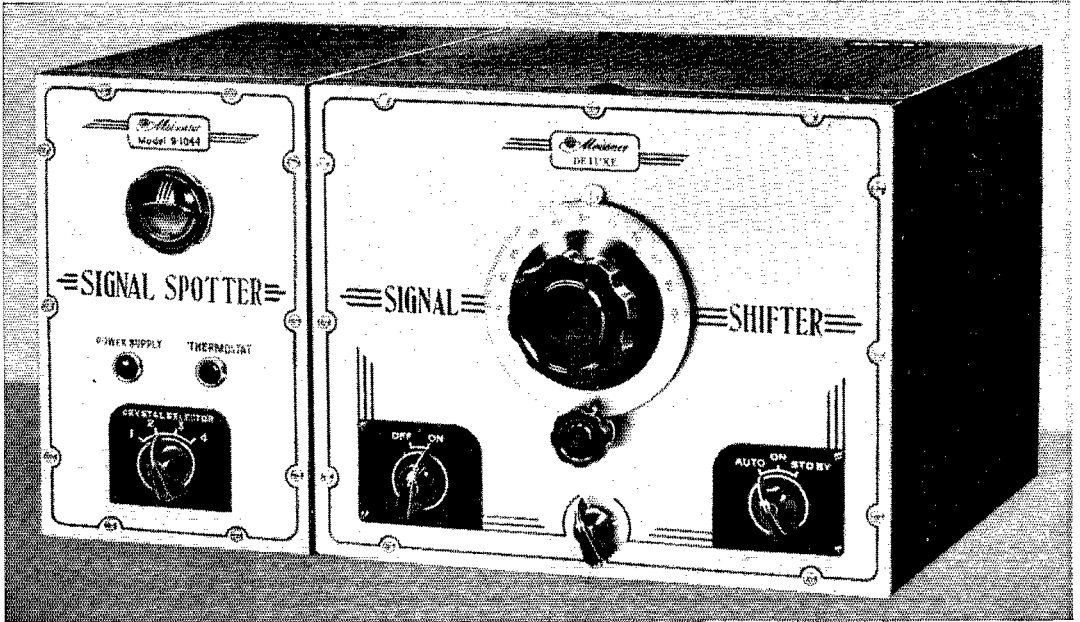

## Four X'tals and a Precision E-C-O!

*The New Meissner*

### SIGNAL SPOTTER

- ★ Four "Spot-Frequency" Crystals
- ★ Front Panel Crystal Switching
- ★ Pre-Tuned Tank Circuits
- ★ Provision for Crystal Oven and Thermostat Temperature Control

In response to unprecedented demand, we present a companion unit to the popular Meissner Signal Shifter—the Signal Spotter. Basically, the Signal Spotter is a crystal-controlled oscillator, operating from the voltage-regulated power supply of the Signal Shifter. Four crystals may be used and the desired "spot frequency" is instantly selected by a front panel control knob. A separate control on the Signal Shifter panel enables the operator to switch to either ECO or Crystal excitation. The four crystals can be placed on any one amateur band or may be divided over any two bands. Provision is made for installation of a Meissner Crystal Oven, designed to accurately control temperature of the crystals. Independent, pre-tuned tank circuits; designed for operation with any type amateur crystal.

SIGNAL SPOTTER, Complete with tubes and coils  
 No. 9-1044 Amateur Net . . . . . \$22.45

*The Improved Meissner*

### SIGNAL SHIFTER

- ★ Positive ECO Stability-Flexibility
- ★ Oscillator Keying for Break-In
- ★ Instant Switching from Crystal to ECO
- ★ Complete Voltage Regulation and Temperature Compensation

The popular Meissner Signal Shifter, universally used and accepted as the outstanding standard of ECO design, now features oscillator keying for perfect "break-in" operation. The Signal Shifter is so well known that it is hardly necessary to repeat the story about its many points of merit. Positive PROOF of dependability, accuracy, stability and flexibility is clearly shown by the widespread acceptance of the precision-built Signal Shifter—throughout the amateur fraternity! The Signal Shifter—Signal Spotter Combination provides a COMPLETE SYSTEM for positive frequency control and selection: the Signal Shifter for full-band flexibility—the Signal Spotter for extreme band-edge operation, network frequencies, etc. This team deserves a place in every modern amateur station.

SIGNAL SHIFTER, Complete with tubes and coils  
 No. 9-1028 Amateur Net . . . . . \$47.50

*Write Today for Complete Amateur Catalog!*

ADDRESS DEPT. Q-12



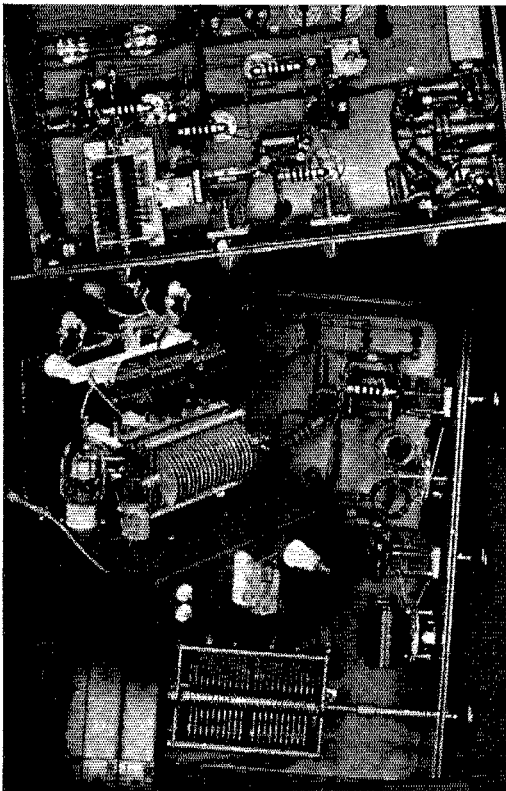

## "ACCEPTANCE"

★ That **CARDWELL CONDENSERS** are specified by leaders in industry is a recognized fact.

★ That **CARDWELL CONDENSERS** are specified because of their merit is attested by the fact that they are incorporated in gear that must measure up to most exacting standards.

★ **CARDWELLS** are conspicuous in **THORDARSON'S 1941 Transmitter Guide, No. 344-E.**

**THE ALLEN D. CARDWELL MANUFACTURING CORPORATION**  
63 PROSPECT STREET, BROOKLYN, NEW YORK



the spunky kid at the Hartford Radio Club who disagreed with everything. Since that time I have seen the game progress to a high point technically, but I have also seen the chances to make a living in it drop to a miserable low. There was a time when a man who could fix sets could get himself a good week's pay, but look at the picture now: A radio serviceman (I never could get used to "radiotriician") is expected to work for anything from \$15 to \$30 a week, the latter being with few exceptions, a high figure.

And is radio any simpler today? Oh, no. Back in 1922 a set usually consisted of two stages of tuned R.F., a detector and two-step. Now look at them. And what is the serviceman's status today? It is that of a putterer, or, at best, an electrician. He is ordered about like an insurance clerk and is expected to do perfect work under the most trying conditions and with a maximum of speed. In a word, he is forever under pressure. I have been a radio serviceman in my time, although I never made a living at it. Most of the servicemen I know are neurotics, and look as if they needed a good rest.

Now taking the radio operator side of it: Just what does the average broadcast operator make? He makes anywhere from \$15 up, depending on the station. In the case of the average old-time employee he might get as high as \$35 or better, but it takes a long time to get it. There are of course exceptions. In my own case, I held a radiotelephone first class ticket six years before I heard of a job open and when I applied for it the chief engineer remarked: "I don't know why you tried so hard to get this job. It only pays \$18 a week." And so, after two trips to New York to get and renew my license, I turned the position down, and I'm sure mine was not an unusual case. Jobs in stations are scarce and pay very little when you do get them. The peak at the station mentioned was \$25. And it must be remembered that it is not possible to become chief engineer of a broadcast station in most states now, in spite of the Federal license, because of the laws on engineers. In other words, you have to hold an engineering degree to become chief operator. That is the law in Connecticut and in most other states. . . .

The disinclination to pay a man a living wage and leave him alone is the main reason why young men do not turn to radio to-day for a living. . . .

— Frederic L. Stafford

### IMPROVED COPYING SPEED

1000 Kensington Road, Grosse Pointe Park, Mich.  
Editor, *QST*:

Don't imagine that this is a prescription for boosting the copying ability of the individual. A great many amateurs copy nicely, when given a fair break. It is, rather, the ancient plea for improved sending. I have watched fellows here at W8QBW copy easily and accurately and then when hooking some other station see the pencil falter and stop. "Can't copy him — slow enough, but he's sending hash." With improved sending we will at once have improved reception.

Now, this is so elementary, my dear Watson, that only an overpowering urge leads me to stick in my oar.

We all know that hash is of several kinds. First, with the straight key there is the jerky sending of the nervous temperament. Then second, the sloppy style of the chap who tries to send 25 when 15 is really all he should attempt. The remedy for both of these conditions is the same, to wit; sending painstakingly and slowly, gradually acquiring more speed. This is easily done if practiced from the outset, but is more difficult if sloppy habits are of long standing.

The third class of hash, truly a huge class, arises from the use of that Idiot's Delight, the Bug. There ought to be a law prohibiting Santa Claus from sticking a bug in the new ham's Xmas sock. Is it necessary to be more explicit? Hardly, for we all know bug hash — the errors in the formation of characters, the repetition of about every third word, and worst of all, those long, long dashes and the blur of dots. And on top of this, as in other kinds of hash, poor spacing or none at all so that words and characters are strung together like Nellie's beads. The remedy is proper adjustment, in line with advice recently given *QST*, and also, as already indicated, painstaking sending until accuracy becomes a habit.

Don't worry lest your contact be impatient over your slow but accurate sending. It is quite otherwise. Listen in to both sides now and then, and see how quickly the hash artist is told, "Well, OM, I have to answer the 'phone," or that other old life saver, "I have to go to the store for Mother."



# Taylor Tubes and amateur radio

Worthy of each other and the company they keep!

The "American Radio Relay League" and "QST" can rightly be proud of their twenty-five years of Amateur Radio Achievement. We of Taylor Tubes are proud both of being amateurs and to have had a part in the development of amateur radio.

Since the founding of Taylor Tubes, Inc., eight years ago, our sole policy has been to give the amateur, "More Watts Per Dollar." This aim, perhaps more than any other single factor, accounts for our rapid growth, sales leadership and the thousands of Taylor Tube boosters heard nightly on the amateur bands.

Undeniable is the fact that more and more amateurs are daily discovering the merits of Taylor Tubes and that it pays to get

*"More Watts Per Dollar"*

Taylor **HEAVY CUSTOM BUILT DUTY** Tubes

TAYLOR TUBES, INC., 2341 WABANSIA AVE.

## THE Taylor LOG

### T-40 and TZ-40

Plate Voltage ..... 300  
 Heater Current, watts ..... 20  
 Plate Dissipation, watts ..... 35  
 Safety Factor  
 250 watts ..... **\$35**

### TW-75

Plate Voltage ..... 300  
 Heater Current, watts ..... 20  
 Plate Dissipation, watts ..... 75  
 Safety Factor  
 250 watts ..... **\$80**

### TW-150

Plate Voltage ..... 300  
 Heater Current, watts ..... 20  
 Plate Dissipation, watts ..... 150  
 Safety Factor  
 250 watts ..... **\$150**

### T-20 and TZ-20

Plate Voltage ..... 250  
 Heater Current, watts ..... 6  
 Plate Dissipation, watts ..... 20  
 Safety Factor  
 20 watts ..... **\$22**

### T-55

Plate Voltage ..... 300  
 Heater Current, MA ..... 15  
 Plate Dissipation, watts ..... 55  
 Safety Factor  
 250 watts ..... **\$69**

### New Shielded 866

Over 20,000 Taylor 866's in use  
 known the world over to be the  
 most reliable and most trouble-free  
 vacuum tubes  
 250 watts ..... **\$15**

### Other Taylor Tubes

- T-21    203-A    872-A
- 203-2    211    249-B
- 805    845    204-A
- T-125    822    814
- T-200    875-B    866-J
- T-450

### TAYLOR MANUAL

FREE! At your store distributor  
 send 2c in postage stamps direct  
 Taylor Tubes, Inc.

CHICAGO, ILL.

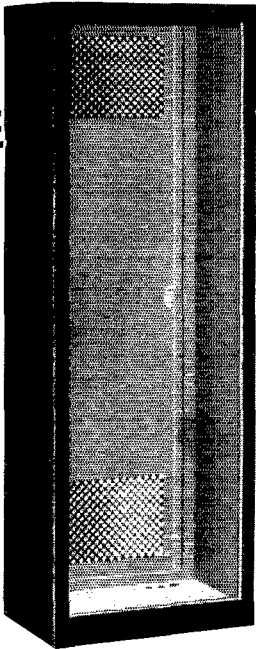

## A Double Bargain in RELAY CABINETS

- Give Your Rig A  
*Professional Appearance*
- Save Money on Low  
*Factory-To-You Price*

**H**ERE'S a grand chance to modernize your rig at low cost. LeFebure De Luxe Model Relay Cabinets are shipped completely set up . . . no assembling required on your part. Flush panel mounting assures a clean, professional appearance. Style strips, which are furnished at no extra charge, cover unsightly mounting screws.

LeFebure Relay Cabinets are fabricated from suitable weights and gauges of high grade furniture steel, electrically welded and rigidly reinforced. Double side wall construction provides for mounting chassis without drilling through the outer wall. One piece hinged rear door is perforated for ventilation and equipped with nickel plated latch handle.

Made in 3 stock sizes to meet varying needs. And you can have this exceptionally fine cabinet at a real saving. The sale is made direct from the manufacturer to you. Don't put up with a "make-shift" Cabinet. Grab this chance to have a professional cabinet you can easily afford. Write today for *low prices* and full details.

*Designed and Manufactured by*

### LEFEBURE CORPORATION

Cedar Rapids, Iowa

And so, it seems to me, our copying speed will be stepped up probably directly as the square of better sending. Take it easy, or, as the traffic cop says when you pull over to the curb, "Where's the fire, Buddy?" You are not on piece work, nor is what you say of vital importance to a jittery republic. So what's the rush?

The A.R.R.L. sending schedules have, I think, surprised some of us when we noticed we could copy much faster when the sending is one hundred per cent.

— Fred Sutter, W3QBW

### HUMAN ANTENNA POLES

Muncie, Ind.

Editor, *QST*:

I am enclosing a snapshot of myself and of W3DEK of Camden, N. J., who is just about five feet tall. As you can readily see there is quite a comparison in height. I should



like to issue a challenge to any and all radio amateurs in a battle of height. I am 6 ft. 6 in. tall and I have already a pretty good start. I weigh 187 lbs. and am 31 years old, a member of A.R.R.L., O.B.S. and R.C.C. I operate 160 'phone and 40 c.w. and have never contacted anyone that could compare in height. I would like to issue my challenge through *QST*. Any and all correspondence will be answered and if I find a ham who is taller than I, will withdraw to my shell and say no more. But you gotta show me. Hi!

— Herb "Shorty" Green, W9ARI

(Continued on page 110)

### Eighth A.R.R.L. Field Day Results

(Continued from page 46)

Veterans of many Field Days, the Egyptian Radio Club signing W9AIU/9, placed next in line. With twenty operators participating they scored 6804 points. Contacts were established with 509 stations (278 portables) using five transmitters on 1.75, 3.5, 7, and 14 Mc., and the use of c.w. was responsible for 91% of all QSO's.

The following scored more than 5000 points, and their performances are worthy of mention. Beacon Radio Amateurs, W3ATR/3, 5690; Bridgeport Amateur Radio Association, W1JHT/1, 5562; Tri-States Radio Club, W3GKI/3, 5449.5; Delaware Valley Radio Association, W3AQ/3, 5400.

Highest-scoring in the non-club group was W6CIS/6, operated by the San Francisco Radio Amateur Emergency Corps. The eighteen individuals present for the doings ran up a total of 3519 points. They were followed closely by two groups, one the Prairie Dog Emergency Crew



# IT'S IN THE BAG!

Boy, wouldn't you smack your lips if you could have one of these latest receivers lined up in your "ham" shack on Xmas morn! Fun, thrills galore at your fingertips. Start working on Santa, today. Who knows, a hint or two dropped in the right direction might do wonders. It worked for us — once. However, if you like to be doubly sure of getting what you want, why not present yourself with a gift? We'll make it very easy and simple for you to purchase. Write, phone or come in for our liberal terms.

**SUN** has  
*Everything!!*

ALL THE LATEST  
RECEIVERS  
CARRIED IN STOCK!

ONE OF THE  
OLDEST and LARGEST  
"HAM" HEADQUARTERS  
in the EAST

Ask about our  
LIBERAL  
PAYMENT  
TERMS  
and  
GENEROUS  
TRADE-IN  
ALLOWANCES

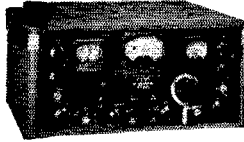

## HALLICRAFTERS SX-28

*The set that has everything!* Designed and built to conform with U. S. Government specifications. Calibrated main and bandspread dials, 540 Kc. to 43 Mc. coverage, 15 tubes, 2 tuned R.F. stages, 6-step variable selectivity.

AMATEUR NET, less \$159.50

Other Hallicrafters models from \$29.50 up.



## RME-99

*Actually 2 receivers in 1!* Precision-built for commercial or amateur requirements. Full tuning range of 550 to 33,000 Kc. Complete with tubes and speaker.

AMATEUR NET.... \$139.20

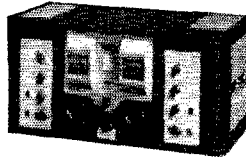

## HOWARD "490"

*"Plus" Performance all the Way!* 14 tubes, 2 stages R.F. Pre-selection, calibrated bandspread. Complete with crystal and speaker to match.

AMATEUR NET \$149.50



## RCA AR-77

*Enjoy foreign reception at its best!* 540 to 31,000 Kc. in six ranges, calibrated 10, 20, 40 and 80 meter bandspread, noise limiter.

AMATEUR NET..... \$139.50

Matched speaker, extra, \$8.00

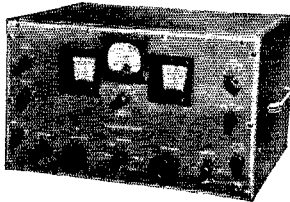

## HAMMARLUND HQ-120-X

Wins the popular vote amongst hams and engineers alike. Nothing we can say would be as convincing as an actual demonstration. Come in today. Notice how effectively each control functions. Furnished complete with 10" speaker and 12 tubes.

AMATEUR NET..... \$138.00

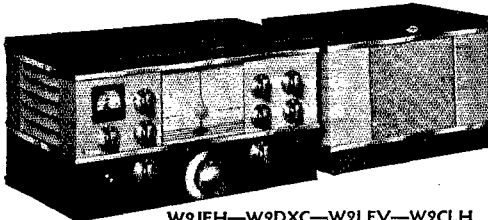

## NEW! NATIONAL NC-200

*Just out and already a smashing hit!* Features galore! Four uniform bandspread ranges with fixed calibration, plus 10 general coverage ranges. Series valve noise limiter. Complete with 10" speaker in separate cabinet.

AMATEUR NET..... \$147.50

W2JEH—W2DXC—W2LFV—W2CLH

USE COUPON FOR ADDITIONAL FREE INFORMATION:

SUN RADIO CO.

212 Fulton St., Dept. OT, New York City

Kindly send full information on the following: —

- Hallicrafters SX-28       RCA AR-77  
 RME-99       Hammarlund HQ-120-X  
 Howard "490"       National NC-200

NAME.....

STREET.....

CITY.....STATE.....

**SUN** RADIO CO.  
212 Fulton Street, Dept. OT New York  
Cable Address SUNRADIO NEW YORK

**YOU PAY LESS FOR**

**RCP**  
dependable  
**TEST**  
instruments

**COMBINATION TUBE—SET TESTER**

**MODEL 803**



This portable "service shop" tests all latest tubes, miniature and bantam, Jr., all filament voltages (at standard R.M.A.). Hot interelement short and leakage tests for individual elements. Individual section tests of multi-purpose tubes. Line voltage regulation 103 to 135 volts meter indication. Noise test for tubes which otherwise test good. Exclusive A.C. measurement method eliminates large errors.

DC voltmeter 0/10/50/500/1000 (at 1000 ohms per volt)  
Four range AC voltmeter 0/10/50/500/1000  
DC milliammeter 0/1/10/100/1000  
DC ammeter 0/10  
Ohmmeter 0/500/5000/1,000,000/10,000,000  
D.B. meter -8 15/15 to 29/29 to 49/32 to 55 decibels  
Four range output meter same as AC volts

Complete, ready to use with test leads. Net... **\$32.95**

**"25-in-1" MODEL 446  
MULTI-RANGE  
TESTER**

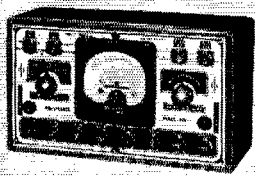

3 inch square D'Arsonval meter accurate within 2%.  
DC voltmeter 0/5/50/250/500/2500 ● DC milliammeter 0/1/10/100/1000 ● DC ammeter 0/10 ● AC voltmeter 0/10/100/500/1000 ● 3 range ohmmeter 0/500/100,000/1 Meg. bullet Meter sensitivity 1 Milliampere or 1000 ohms per volt.

In a class with testers selling for twice the low RCP price. Selector switch operated, complete with batteries. Net... **\$9.95**

Send for the new RCP catalog No. 124

**RADIO CITY PRODUCTS CO., INC.**  
88 PARK PLACE - NEW YORK CITY

**RCP**

**CLUB GROUPS**

<i>One Transmitter</i>	
Merrimack Valley Amateur Radio Assn. W1DMD/1	3366
Associated Radio Amateurs of So. N. E. W1AQ/1	2322
<i>Two Transmitters</i>	
Trenton Radio Society	W3AIR/3 3033
Queens Radio Amateur Club	W2CWE/2 2835
<i>Three Transmitters</i>	
Radio Oprs. Assn. of New Bedford	W1UIJ/1 4914
Chester Radio Club	W3DRQ/3 3798
<i>Four Transmitters</i>	
Beacon Radio Amateurs	W3ATR/3 5670
Bridgeport Amateur Radio Assn.	W1JHT/1 5562
<i>Five Transmitters</i>	
Jersey Shore Amateur Radio Assn.	W2AER/2 8253
Egyptian Radio Club	W9AIU/9 6804
<i>Six Transmitters</i>	
St. Paul Radio Club	W9KYC/9 6853.5
Dells Region Radio Club	W9RBI/9 4941
<i>Seven Transmitters</i>	
Frankford Radio Club	W3BKK/3 8406
<i>Ten Transmitters</i>	
Tri-County Radio Assn.	W2GW/3 8154
<i>Eleven Transmitters</i>	
Tri-States Radio Club	W3GKI/2 5449.5

**NON-CLUB GROUPS**

<i>One Transmitter</i>		<i>Operators</i>	<i>Score</i>
W3FVJ/3	W3FEW-FFC-FVJ-HQU-GOA-Shenton		3267
W8QOK/8	W8OFN-NAB-QOK-Reiter		2831
<i>Two Transmitters</i>			
W3GGC/3	W3ISE-FVC-FWH-LN-GGC-Sheckler-Almond		3438
W2IYQ/3	W2IYQ-IGT-JFB-JSE-KMK-MNT		2727
<i>Three Transmitters</i>			
W9ERU/9	W9AGV-AIC-ASB-BNO-CCO-CZB-ERU-FFQ-JK-MAP-PGQ-TET-Miller		2502
W2FUV/2	Woodbridge Amateur Radio Emergency Corps		2439
<i>Four Transmitters</i>			
W9JU/9	Prairie Dog Emergency Crew		3473
<i>Five Transmitters</i>			
W8CIS/6	San Francisco Radio Amateur Emergency Corps		3519
<i>Six Transmitters</i>			
W9VXS/9	W9FIB-FWU-GFB-GPS-HWN-HXW-HTZ-IMB-IMN-IMV-KBO-KKH-MRQ-MUZ-R RC-SXZ-TJD-TUV-VSX-YZV-Wood-Kimbal-Huston		3114

who, under the call W9JU/9, made 3474, and the other W3GGC/3 with seven operators making 3438 points.

All who participated in the 1940 F.D., regardless of how large or small a score they made, are responsible for the tremendous success of this most popular of operating activities. Congratulations on the splendid job you did to demonstrate the value of amateur radio in this country!

— J. A. M.

**WOULDN'T IT BE WONDERFUL—**

If the op at 3 — would get his toes manicured before he went on watch so they wouldn't get mixed up in the set-screws on the key?

If NAD would get up off 200 meters?

If some inventive genius would get out an air cushion to put under your left elbow when tuning a regenerative receiver?

If 9 — 's second operator would sign off with "ARK" instead of using "SK" every time?





# A "LIFE SAVER" FOR ADJUSTABLE RESISTORS

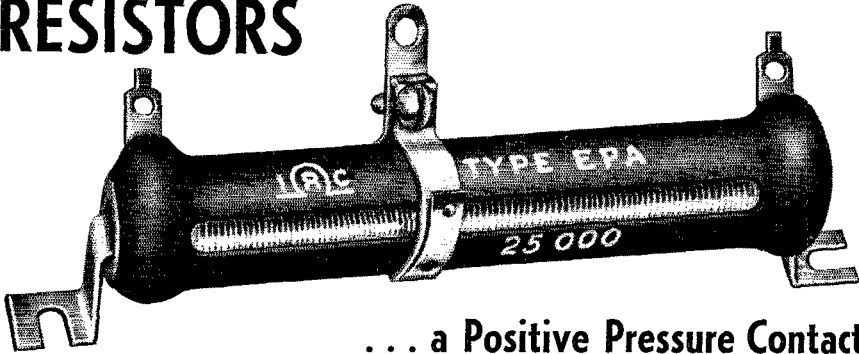

... a Positive Pressure Contact Band for IRC Adjustable Power Wire Wounds

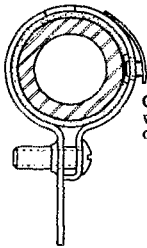

Cross section view of band on resistor.

Threaded band — no loose nut.

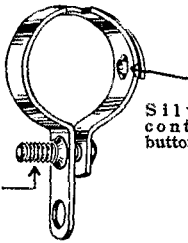

Silver contact button.

Extra heavy steel band with flexible section for easy installation on resistor.

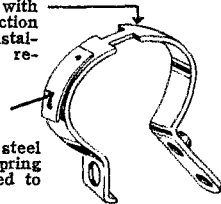

Stainless steel contact spring spot welded to band.

- Fool-proof adjustment.
- Prevents oxidation and corrosion at contact.
- Eliminates wire damage and breakage.
- Designed to stand high temperatures.

NOW AVAILABLE AT NO EXTRA CHARGE ON ALL IRC ADJUSTABLE POWER WIRE WOUND RESISTORS, 25 WATTS AND UP

Bands for your old resistors sold separately by IRC jobbers

## WHAT'S TRACKWALKING TO DO WITH TRANSFORMERS?



After living twenty-five years alongside the railroad and secretly harboring the ambition to become a track-walker, Mike O'Flaherty decided to make a try for it.

"Suppose," asked the examining official, "that two freight trains are approaching from opposite directions on a single track road. What would you do?"

"What would I do?" exclaimed Mike, "I'd run for me lantern and wave it like fury."

"And if you had no kerosene for the lantern, what would you do then?" asked the examiner.

Mike thought for a moment. "Oid build me a bonfire square on the tracks, the like of which ye've niver seen."

"But it's a rainy night, Mike, and the flame won't take," suggested the official.

Mike scratched his head, then clucking his tongue, said, "Begorra, I'd run and git me wife, Maggie!"

"What would she be able to do?" asked the puzzled executive.

"Wal, now," replied Mike, "she mightn't be able to do much but I'd say, "Maggie come quick and feast yer eyes on the beautifullest wreck ye iver saw in yer whole life!"

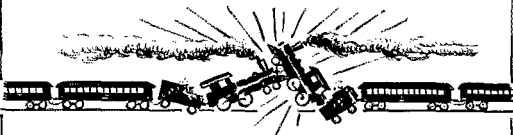

You may well ask, "What has Track-walking got to do with Transformers?"

Simply this — whether in railroading or in radio, knowledge and experience are the precious ingredients that widen the margin of safety.

The careful engineering and accurate workmanship that goes into Kenyon Transformers is your assurance that your products will perform safely and satisfactorily under even the most adverse conditions. Hot or cold, wet or dry, on land or sea — wherever there's a "Dead Man's Curve" — specify Kenyon Transformers for that "Margin of Safety."

**KENYON TRANSFORMER CO., INC.**  
840 Barry Street, New York, N. Y.

If someone invented an "unblowable" condenser?

If some of the stations whose signals are heard over a large range would get receiving sets to work as efficiently?

If the lights wouldn't flicker when drawing 10 amps off a 5-amp service line?

If we all had money instead of brains?

If the radio inspector never came around?

If somebody would invent a circuit breaker (or a jaw breaker) for the control of QRM?

If two syzygy dogadjits and a wheel-puller in series would cut out QRN?

If Ben Franklin and Morse could see the mess they started?

If *QST* increased to 5260 pages?

If we could renew our burnt-out tubes at the electric light company free of charge?

If 3 — could send a 3?

If some guys in the vicinity of New York would take some morning to tune up their sets instead of wearing out their ammeters at night?

If you could burn up all the juice you wanted free of charge and the light company would charge it up to the "advancement of science" and let it go at that?

If aerials grew on skyhooks?

If attics weren't hot in summer and cold in winter?

If some of these radiophone operators would loose their false teeth for one night?

If we didn't always run out of matches about 1 A.M.?

If some 'phone operators would turn mutes or put a pebble in their mouths or would spit out the mush or something?

If we could send half as well at 200 meters when we try to, as NAM does when he is trying to use 952?

If 9ALG could discover an iceproof condenser oil that wouldn't freeze?

If hens laid audions?

If NSF would cut out relaying transatlantic stuff on our over-worked amateur wavelengths?

If 8XK's buzzer was as loud as his generator hum?

If 3BV would try both feet some time so DX men could get his call before the 99th time?

If 3DH would get down to 200 meters where a general amateur station belongs?

If the fellow who borrows our *QST* wouldn't give it to the baby to play with?

If 8 . . . — Q would tell us what letter . . . — is?

If all radio inspectors were like Charles Kolster?

If 9LR would sell his coherer and buy a receiving set?

If your best girl was an operator and nobody but you could understand her?

If the other guy seemed to need his sleep worse than you did, and would go to bed instead of sitting you out?

If we could go to a meeting of the I.R.E. and get some actual constructional details instead of being drowned in a sea of higher math?

If a pair of Murdock 'phones could be put on with one hand?

# PAR-METAL

*Stands for Quality*

Whether you contemplate a simple amplifier or a complete P.A. system; a mobile transceiver or a Kilowatt transmitter — be sure that you get a professional looking job — streamlined, handsomely finished, accurately machined. You can get them all if you specify Par-Metal.

## Chassis • Cabinets • Racks • Panels

Par-Metal Parts Are Available in Both Standard and DeLuxe Qualities

Catalog No. 40 describes our complete line. At your jobber or write direct

### PAR-METAL PRODUCTS CORP.

3262, 49th Street LONG ISLAND CITY, N. Y.

Export Address: 100 Varick St., New York, N. Y.

## LEARN RADIO • TELEVISION

60-page catalog on request. Oldest, largest and best equipped in New England. New classes now forming. Write for new catalog.

### MASS. RADIO SCHOOL

18 Boylston Street

Boston, Massachusetts

## MICROMETER

### FREQUENCY METER

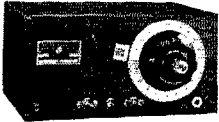

... a precision, heterodyne-type, band spread instrument for police, relay-broadcast, aviation

stations • will monitor several transmitters, from 1.5 to 56 mc. • calibrations give percentage deviation • accuracy better than 0.01% • net price, Type 103, \$90.00; Type 105 with crystal calibrator, \$135.00 • ask for Engineering Data sheets.

LAMPKIN LABORATORIES • BRADENTON FLA., U.S.A.

## READ SEND CODE LIKE AN EXPERT!

Learn Quickly at Home, Get Real Speed

It's easy, fascinating, to become a good op with the NEW ALL ELECTRIC MASTER TELEPLEX CODE TEACHER to help you. Only instrument ever produced which records your sending in visible dots and dashes — then sends back to you at any speed you desire. Also sends practice work, recorded by an expert. That is why so many schools teaching code prefer Master Teleplex.



That is why thousands agree this method is surest, quickest — has taught more ops in the past few years than all other methods. We furnish Complete Course, lend you Master Teleplex, give you personal instruction with a MONEY-BACK GUARANTEE. Low cost. Send today for booklet Q-12; no obligation.

### THE "HAM" SPECIAL

Standard Teleplex — a highly efficient code teacher using heavy specially prepared waxed paper tape, having two rows of perforations. Write for Free folder QT-12.

We are the originators of this type instrument

TELEPLEX CO., 67-69 Park Place, N. Y.

In Canada, Write

Canadian Electronic Institute, Toronto, Ontario

## GENERAL COMMUNICATIONS CRYSTALS HOLDERS AND OVENS

Precision Made by *Bliley*

WRITE FOR CATALOG G-11

BLILEY ELECTRIC CO., ERIE, PA.

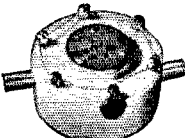
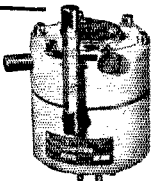

# Station Activities



## ATLANTIC DIVISION

**EASTERN PENNSYLVANIA** — SCM, Jerry Mathis, W3BES — 3AGV received his three band WAS certificate. 3AKB is back in the traffic rush again and hopes for time to build an ECO. 3AOC is doing some heavy pounding from WLMB. 3AQN invites all to join the E. Pa. net on 3950 kc. 3BES helped the Frankford Radio Club prepare for the SS. 3BRZ worked a W6 on 3.9 Mc. with one end of his antenna tied to a fence. 3BEX is N.C.S. of the C.O.P. net. 3DRO reports new officers of the Lancaster Radio Transmitting Society elected at the last meeting are: FWB, president; EWR, vice-pres.; APO, secy.; DRO, treas. DXC wants 7-Mc. traffic schedules after 8 A.M. EEW now has a 3.5-Mc. antenna which makes him a definite threat in contests. EON can work all over the states on 7 Mc. with his new 807. EFH is back with us and skeds TLC and NTL. FPC hopes to show in the next OPS Party. FXZ schedules the YLRL twice a week. Things are stirring again at GDI. GKO is making the BPL again. The A.A.R.S. PA1 net wants members in the following counties: Delaware, Berks, Bucks and Chester. The Phila. Wireless Ass'n conducted an auction which attracted a large crowd. HCT expects a busy season with the E. Pa. net. HXA is spending all his spare nickels on a super-handspread e.c.o. rig. HZK received his class A ticket. INH is on 1.75-Mc. 'phone. 8EU has his 35 w.p.m. code proficiency sticker. 8HKS joined the E. Pa. net. 8NNY is looking for more 3.9-Mc. 'phone stations for the E. Pa. army net. 8UQM is a new ORS in Plymouth.

Traffic: W3AGV 1 3AKB 263 3AOC 111 3AQN 134 3BES 68 3BRZ 352 3DRO 16 3DXC 4 3EEW 536 3EON 11 3EFH 17 3FPC 4 3FXZ 15 3GDI 24 3GKO 954 3GYK 95 3HCT 11 3HFE 6 3HQE 46 3HRD 44 3HRS 182 3HXA 8 3HZK 30 3IAY 21 3ILK 9 3INH 11 8ASW 87 8ATF 14 8EU/8 76 8HKS 9 8NNY 56 8OML 10 8UQM 1.

**MARYLAND-DELAWARE-DISTRICT OF COLUMBIA** — SCM, Hermann E. Hobbs, W3CIZ — DOG is back on the air. CDQ, third district chairman of the YLRL is on the air every Tuesday at 10 p.m. for the YLRL Net on 7220 kc. and says she has worked more YL's in the past month than in the past 18 years. Mr. K. B. Warner visited her station recently. DRD is a new ORS, has schedules with 3MA/2 at Camp Upton and is on T.L. "C" for Delaware. EQK is on the A.A.R.S. phone net Sunday mornings. He needs Arizona and Utah for WAS and would like some one in those states to schedule him on either 3.9 or 1.75 Mc. BLX has a rig going on 3.5-Mc. 'phone with 225 watts to a pair of 8I2's. FIO, formerly GJY, reports the army very FB and the Md. gang tops. HUM reports TL AP going OK coast-to-coast on 3630 kc. IVT, another new ORS in this section, is attending the Naval Radio School and keeps schedules with the Central California, Conn., and Va. nets. WU is still swamped with requests for SL cards.

Traffic: W3BWT 946 3CIZ 790 3CXL 40 (WLM 2960) 3DRD 21 3EQK 5 3FIO 88 3HUM 159 3WU 11.

**SOUTHERN NEW JERSEY** — SCM, Lester H. Allen, W3CCO — Ass't SCM and AARS Liaison R.M., Ed. G. Raser, W3ZI — NCR Liaison R.M., Ed. B. Kerr, W3CCC — Regional Coördinator in charge of Emergency Coördination, Ted Toretti, W3BAQ — R.M.'s; 3BEI, 3BYR, 3EUH — P.A.M., 3GNU: Section Net Frequencies: O.R.S., 3700 kcs. O.P.S., 1980 kcs. If I may, I would like to offer this suggestion. If you are a member of any radio club, see to it that you find out when the next regular meeting is scheduled and attend. If you are not a member of any radio club, look up some of your friends and find out what group they belong to. Ask if you may accompany them to their next meeting. If you have petty jealousies or misunderstandings as an excuse for not attending a meeting, I suggest you either forget about them completely or shake and make up. Radio Clubs have definite plans for progress in mind. If you don't lend your support, little can be accomplished. Let's all get together like one big happy family. Individual organizations lend much to our Section and without the support the Section cannot give its all to the League. 3HEO is back on 160 'phone with 26 watts input and doing mighty well for himself. Among the leaders in the A.R.R.L. Code Proficiency race in the C.V.R.A. are ARN with a 35 wpm sticker, HAZ, GRW and IOK with 25 wpm endorsements. FDI has an FB phone sig on 1.75 Mc. HOS, HHY, HUZ

and EXV are having a WAS contest among themselves. IFT is busy looking for the 112-Mc. band. CCC reports the new rig nearly finished. GCU needs 5 states for WAS. Ray received his 20 w.p.m. code proficiency sticker. EWK will report with the S.J. ORS, shortly. 3ABS is rebuilding his 6-element beam for 14-Mc. 'phone. BZX is starting to send in those high totals for traffic. DNU expects to report in the ORS net shortly. KW has been re-elected as E.C. for the Camden area. GMY is new E.C. for Vineland. HSL has renewed his ORS for another year. FMR has renewed his appointment as OPS for another year. CCO recently erected a 3 element rotary beam for 28 Mc. and with 25 watts input worked 3 K6's and K7ATD. CFS and AFH are again busy this year working 28 Mc. AWE, HW, CHO and IDY have new portable emergency transmitters which perk out FB. The Southern New Jersey ORS Net is off to a good start this year and working well under the following NCS: GMY on Tuesday, BEI for Thursday, AVJ on Saturday. The OPS Net is also off to an early start this year under the leadership of our PAM, GNU. If any other members of our section are desirous of joining these nets, communicate with your SCM, EXI of Arlington, Va., was a recent visitor at FMR, and kept his daily skeds with KC4USA from there. The latest addition to our section is Bob Welsh, COT. New members in the AEC are, GMY, AMP, HPE, DEA and EQF. ITU is still ticking off new states toward his WAS. HKY has a new 75-foot tower supporting his 4-element 14 and 28 Mc. rotary. TL is active on 7- and 14-Mc. c.w. GLZ of Mullica Hill is erecting a 14-Mc. beam. QL is working on 3610 kc. from his new QTH at Clinton, Md. BFH once again has his 1-kw. rig going. BAY gave talk on Amateur Television at the October S.J.R.A. meeting. The S.J.R.A. has organized a club net on 3700 kc. DAD is using his exciter on 3600 kcs. and works out FB. BGP is keeping daily schedules with 9AQE at the Great Lakes Naval Station. EBA is experimenting on 112 Mc. D.V.R.C. recently issued Club Certificates to all its members. AQ has two 40-foot poles for his new antenna experiments. EED has new 6L6, 807, 812 exciter finished. The D.V.R.A. put on its feature motion picture at the October meeting of the S.J.R.A. The film proved quite popular. They will be glad to show it to any club which might wish to see it. Contact the D.V.R.A., Trenton, N. J., for a date. BAQ gave talk on Emergency Development for the S. N. J. Section at the October meeting of the S.J.R.A. As a reminder, our Southern New Jersey Section takes in the following counties: ATLANTIC, BURLINGTON, CAMDEN, CAPE MAY, CUMBERLAND, GLOUCESTER, HUNTERDON, MERCER, MORRIS, SALEM, SOMERSET, SUSSEX and WARREN. If you or your friends have never been mentioned in these columns, and live in one of the above-mentioned counties your SCM will be glad to hear from you. Also, there are lots of openings for appointments in the above-mentioned counties. Some don't have as much as one appointee. How about it fellows? Your cooperation is requested. Activity is what makes the wheels go around! The heartiest Christmas greetings to all. Until next month, 73.

Traffic: W3BZX 167 IFT 140 CCC 82 2I 55 EDP-GCU 52 EUH 50 ASQ 49 IDZ 40 LH 37 HAZ 35 GRW 34 ITU 25 CCO 17 EWK 14 BEI 12 DNU 11 ACC-ABS 10.

**WESTERN NEW YORK** — SCM, Fred Chichester, W8PLA — R.M.'s: BJO, CSE, DSS, FCG, PCN, P.A.M.'s: CGU, RVM, UNY. E.C.'s: FNT, GWY, KYR, RVM, SBV, SMH, THC. Net frequency 3720 Kcs. JTW, with 17 watts input, made the BPL this month with points to spare. Most of the rest of the net members have gotten back into the harness and will soon be going strong. The KBT Club opened the season Sept. 27 by electing the following officers: Pres., QZP; sec'y, NNP; treas., PQC. Directors appointed by the president are: PQC, LQC, NWY, NNJ and MQX. NNJ was put in charge of the club paper "QRM." The club will be affiliated with the A.R.R.L. this season and a drive is on for League members. PCN gave a talk at the Oct. 11th meeting on the advantages of belonging to the A.R.R.L. and 16 of the present members are joining up. Mr. Kratkovil, the local R. I., gave a talk on regulations and commercial examinations. The club is promoting action for better operators. The Buffalo Mike & Key Club report a good time was had by all at their hamfest Oct. 5th. The club will hold its election early in December and is sponsoring a drive for new members. KYR, recently appointed E.C., announces appointment of LIY, of Batavia, and KHO, of Niagara Falls, as assistant E.C.'s. Any amateurs in these counties interested in emergency work are asked to get in touch with

KYR. The W.N.Y. Radio Council held a meeting in November. R.A.W.N.Y. has consolidated with the Five Meter Club. DXE is moving into his newly built QTH with his recently acquired X.Y.L. FQS, Medina, won a loving cup for his Niagara Falls contact on 112 Mc. The award was presented by the Five Meter Club. QBD and RRO have returned from a training trip with the Naval Reserve. DYX was married recently. TPA is operating 1.75-Mc. fone from Grand Island (N. Y.). OMD is now on 7 Mc. telling the gang about his operating 2USA's 28-Mc. rig. UXT, vice-president of the Midland group of banks, is very active on 3.5 Mc. handling traffic. Bill is an FB op. PCN entertained EKM, JTT, KYR, MQX at his QTH for Army drill Oct. 7th. OWE is passing out smokes, having just been presented with a new junior op. IIE is rebuilding for 1.75- and 3.5-Mc. 'phone. RNG is attending Buffalo State Teachers College. UDD is all pepped up over 112 Mc. AOM blew up another power supply and is rebuilding. MQX, married Nov. 16th, will move to his new QTH in Lockport. PSL is now with the army at Camp Dix, N. J. PQC has a new rig on 7 Mc. with an HF100 final. NOR is trying out his new FM rig on 112 and 56 Mc. and wants schedules. UEP has a 6L6 that really goes places on 7 and 14 Mc. SBN is using 8P808's on 1985 kc. VEX is trying both 3.5 Mc. c.w. and 1.75-Mc. 'phone. OSN is now on 3.9-Mc. 'phone and 7-Mc. c.w. with a 211D. UBR is experimenting with constant level, narrow band, speech modulation, using 809's on 1.75 Mc. HSS gets through with a 45 on 1.75-Mc. 'phone. YD is on 1.75 Mc. from the Buffalo Teachers College. KDX has a half kw. on 3.5-Mc. 'phone and c.w. and is a U.S.N.R. member. LFQ has a kw. on 14-Mc. 'phone and c.w. New A.A.R.S. appointments in the section are JTT NCS1, BJO, NCS2 and PCN NCS3. DSS sent the code for the speed contest at the Schenectady Hamfest in the absence of a tape machine. MIY won the contest. DHU is now operating in the second call area at Albany. RVM has moved to Lowville. The Sidney Amateur Radio Club has elected the following officers: Pres., LUR; vice-pres.; treas., UPT, and sec'y, URG. The club is conducting a contest to see who can work the greatest number of miles during the month. They are also giving code practice for the members who are not already licensed. VEF is newly licensed ham in the Section. He is on 1.75-Mc. 'phone. SOW had a new YL added to his family Sept. 29th. PSQ expects to leave for camp with the National Guard soon and is building a portable to take with him. PSW has returned home from school and expects to be on the air soon. SZB, Watertown, is a new OPS in the section. JIW, with his 17 watter, has 15 states to go for WAS on 3.5 Mc. IITX and XYL and 3ABS visited SZB. SBV has had to leave net temporarily.

Traffic: W8DSS 42 UJF 39 SMI 53 RKM 109 BJO 163 AQE 234 JIW 702 FCG 280 PCN 344 RM 36 SFD 55 CSE 43 AQE 234 UHI 10 PLA 125.

WESTERN PENNSYLVANIA — SCM, E. A. Krall, W8CKO, Assistant SCM in charge of Emergency Coordination, W8AVY, Stations interested in 3.5-Mc. traffic work are requested to notify KWA, or the SCM. KWA says that the W. Pa. net meets daily at 8:30 P.M. to clear traffic. Code proficiency will improve if you operate in a traffic net as an O.R.S. NCJ sent in a good traffic report and says that Beth, his xyl, received a 35 w.p.m. Code Proficiency Certificate. JSU will soon be an ORS. BHN, Erie, has been appointed S.N.C. for Pa. A.A.R.S. 'phone nets. RTU is home again after a cruise on the S.S. *Wyoming*. RFH moved in from Parma, Ohio. We would like to hear from A.A.R.S. and N.C.R. representatives. RBI was reappointed P.A.M. We need more O.O., O.B.S. and O.P.S. in W. Pa. PX conducts the Upper Ohio River WX Bureau net. Drills are held once a month. CKO operates as alternate N.C.S. on 3590 kc. PX also works the 'phone net on 3965 kc. UUG and MPO have moved to Ingomar, Pa. GJM is one of our best O.P.S. and O.B.S. CIR is still going to town on u.h.f. TWI will be active at State College. The Fort Necessity Radio Club of Uniontown, Pa., boasts one of the best club rooms in the U. S. A. UT works out with same unique apparatus of 1930 vintage. FCO is still adding directors and reflectors to his 28-Mc. antenna. Radio clubs of W. Pa. are invited to join the Pittsburgh Area Radio Club Council. A letter to AVY will bring details. Mon-Youth Radio Club of McKeesport held an excellent hamfest. Movies and eats were the highlights. O.R.S. are asked to note dates of expiration on their certificates, and request endorsement when necessary.

Traffic: W8NCJ 203 KWA 137 PX 63 JSU 50 CKO 24 OKK 16 RAT10 CMP 4 TTD-PER 2.

## HUDSON DIVISION

EASTERN NEW YORK — SCM, Robert E. Haight, W2LU — Congrats to Dot, MIY, for making her first B.P.L. She reports following new officers elected for Albany Radio Club: pres., ITQ; vice-pres., MTF; secy. and treas., MIY. MHW reports new officers Del. Valley Brass Pounders: KXF, pres.; MHW, chief opr.; R. Perison, secy.; C. Gilbert, treas. We welcome DHU as new ORS; he's active in E.N.Y. Net. JRG reports EGI now on 3.5 Mc. with e.c.o. HNH is serving with the U. S. Navy on U.S.S. *Wyoming*; he's enjoying the service very much and his ham experience has come in handy. IJC operates on 7187 kc. with 25 watts. MZR received his R.C.C. Certificate. LLU is going strong and schedules IMBN and 3FDF. NHP, IHM and KPH are leaving for a year of service with Hq. Co. 53rd Inf. Brigade at Anniston, Ala., and will look for schedules with home. KFB is on 1.75-Mc. 'phone with PP 1Z20's final running 100 watts. IVB visited 2LU and attended the S.A.R.A. hamfest.

Traffic: W2MIY 658 MHW 66 LU 35 8DHU/2 12 JRG 9.

NEW YORK CITY & LONG ISLAND — SCM, Ed. L. Baunach, W2AZV — DOG is now O.P.S. AV is now O.R.S. PF is now a major in the Signal Reserve and is going on active duty in Washington, D. C., for one year. AXZ now operates SC at Governors Island and is in the regular army. LGK is a member of the A.A.R.S. 3MA/2 is now operating at Camp Upton and wants schedules. LZR has been appointed NCG of the S.N.Y. 7-Mc. A.A.R.S. net. DJP is now in Las Vegas, New Mexico, with the F.C.C. MQB/1 is with the U.S.S. *Semmes* at New London, Conn. FLD is C.R.M. in the N.C.R. IOP is completely rebuilding his entire station. KDC is working on a 50-watt crystal controlled 112 Mc. rig. HNJ is experimenting with crystal oscillator circuits. CHEK finished his 6L6 c.w. job for 3710 kc. KTA is again active on 1987 kc. NHD is a new station in Massapequa Park, L. I., operating on 1852 kc. AYJ moved to Bayville. VG has been spending his spare time building speech equipment. MUR installed a new 130 foot single wire antenna. IYX is changing his 4-element beam to a 3 element affair. NAZ is looking for YL's trying for W.A.S. — YL's. FAQ had a two hour QSO with IWB in order to get his R.C.C. ELK finds his new QTH best ever. LXQ is operating on 1.75-Mc. 'phone at Fishers Island. DOG is going places with his 180 watts on 3.9-Mc. 'phone. JBL attended the Vermont State Convention and won a power transformer. IXZ is operating on 7190 kc. using p.p. 25L6 crystal driving p.p. 48's in the final powered from 110 volt d.c. MZB is located in Islip, N. Y. The following were elected at a recent meeting of the Queens Radio Amateurs: LPJ, Pres.; LUX Vice Pres., KPA Sec. EC reports that the A.P. trunk line is in full operation on 3630 kc. every night at 9:30 P.M. E.S.T. Monday thru Friday. CUD finally finished the erection of two 130-foot steel towers. Unit three of section six of the N.C.R. has the largest number of active members of any unit in the whole N.C.R. HGO is looking for more schedules on 7 Mc. MRO is busy grinding xtals for 2744 kc. for the N.C.R. gang. ADW is on regularly with the Fishermans net on 1980 kc. every day at 12:30 P.M. BGO and HYJ worked on the amateur television booth at U.S.A. and on Oct. 20th for the first time in the history of amateur 112-Mc. television two deaf mutes conversed with each other by radio between U.S.A. and a station operated by HID at 220 E. 42nd St., N.Y.C. The video was on 112 Mc. and voice on 56 Mc. AOE had his television receiver at the Oct. 15th meeting of the N.N.W.A. and successful signals were received from HID, a distance of about 17½ miles. KI gets all his traffic on two schedules. JAU operates regularly on 7014 kc. LR, ITX, GDF, MT and DBQ are on regularly for the section net every night at 7:30 P.M. on 3710 kc.

Traffic: W2LZR 548 SC 386 (WLN 570) KI 286 DBQ 187 LPJ 148 MT-LR 102 ITX-EC 82 BWC 64 3MA/2 62 AZV 58 LGK 30 NAZ 22 CCD 16 BGO 15 BYL 14 PF 13 CET 12 CIT 11 LBI 18 IYX 10 AA 9 KDC 8 IOP-ADW 7 DOG 6 LYC 5 AEU-CHK-HNJ 4 FF 3 DLR-GDF-ELK-AZM-NHD 2 HGO-LID-FLD 1.

NORTHERN NEW JERSEY — SCM, Fred C. Read, W2GMN — New hours of operation of the N.N.J. Net are 8:30 to 9:30 every evening. The frequency is 3630. All N.N.J. traffic men are urged to participate. HXI is

(Continued on page 102)

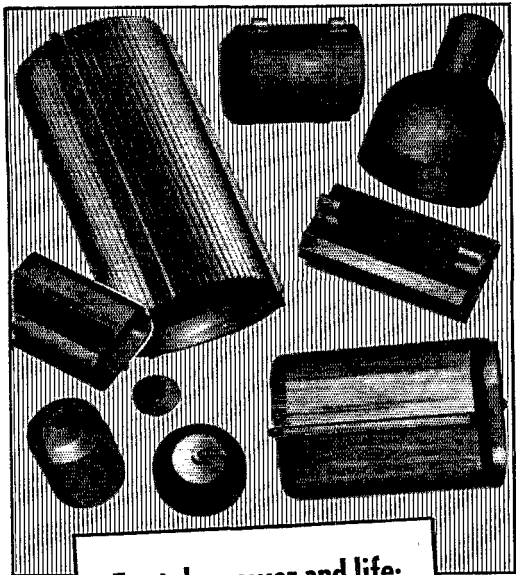

For tube power and life:  
**SPEER**  
 Graphite Anodes

Tubes with Speer Graphite Anodes handle high power because their relative heat dissipating value exceeds that of all other anode materials. At 510° it exceeds that of Tungsten by 233%, Molybdenum by 316%, Tantalum by 354%, Nickel by 3,500% to 9,990%.

Tubes with Speer Graphite Anodes have long service-life because the anodes cannot be damaged by overloading. The anodes cannot warp, fuse, blow out or soften; they emit no gas; they absorb gases given off by other tube elements.

For power and life, use tubes with Speer Graphite Anodes. List of tube makers and Anode Data Book sent on request. Write for your copy.



**SPEER**  
*Carbon Company*

ST. MARYS, PA.

CHICAGO • CLEVELAND • DETROIT • MILWAUKEE  
 NEW YORK • PITTSBURGH

*Speer Graphite Anodes Make Good Tubes Better*

## The Knights of the Kilocycles

CHRISTMAS DAY, 1931, three Florida 'phone men were working 80-meter 'phone in a three-way QSO, W4AAAX, W4WS and W4AMQ. One of them suggested that they meet every Sunday at 8 A.M. for a round table. It was also suggested that they call themselves the "Knights of the Kilocycles" and that a net control station be appointed to be called the Master Oscillator. This was carried out and W4WS, M. L. Patterson of DeLand, Fla., was appointed to run this embryo net. The next Sunday more stations were added, including W4AKI, W4DU, W4AII, W4TQ, W4ACZ, W4AHK and W4QP. From this humble beginning there grew an over-the-air club, which has met every Sunday morning since that date. On August 4, 1940, the group celebrated its 500th meeting without missing a single Sunday. Arrangements were made to record the entire proceedings, and to get out all the old-timers for this meeting. Talks were given by all of the former Master Oscillators, and the meeting was headed by W4WS, the first M.O. The following have served as M.O.: W4GS, W4ASR, W4CLW, W4DDB and W4ACZ. To-day the job is held by W4AHK, Kenneth Glass. The meetings are started promptly at 7 A.M. in the summer and at 8 A.M. in the winter. Usually there is a good technical talk or travel experience by one of the members. However, on the date of the 500th meeting all this was dispensed with and all the old-timers were introduced and all the newcomers were welcomed into the fold.

The club is unique in that it holds all of its meetings over the air, collects no dues and has never failed to hold a meeting, with one exception, and that due to the Ohio flood and the F.C.C. ban on all operation other than emergency. The Knights of the Kilocycles sponsor from three to five hamfests a year, and also hold contests. Most members are affiliated with the A.A.R.S. or N.C.R. There are over 45 members to-day, and the usual Sunday meeting will find 20 to 30 answering the roll call. Their operating standards are high and they represent the usual cross section of ham radio from doctors to farmers, from oldsters to youngsters. Good fellowship is the rule. The K. of K. is affiliated with A.R.R.L. A certificate of membership in the "Knights" is issued when a station reports at ten consecutive meetings. Every worth-while cause receives due consideration from its members. The emergency communication accomplishments of the group are legion.

One of the outstanding accomplishments of the Knights of the Kilocycles, through the help of QST, was the purchase of a Braille A.R.R.L. Handbook and later a Braille License Manual for one of its members, who is making good use of them and now has a Class "A" ticket. This is W4DWI, "Hank" Lehman of Orlando, Fla. The Knights have become a tradition in Florida among the hams, and every youngster who is starting out to get his ticket seems to be an S.W.L. of the Knights. We believe that our club represents the true spirit of ham radio. The following were in attendance at our 500th meeting: W4AHK, QP, DU, DCF, GPG, AKI, WS, DEN, ACZ, COZ, CXL, CZ, EIK, AQU, BYY, EWL, NN, AGB, CQZ, TQ, KB, EPW, ASR, FGP, ES, AFQ, DUW, AII, CLW, PT, AMQ and W3ZD, besides some of the old-timers who no longer hold calls and who sat in at other stations.

— Bill Shelton, W4ASR,  
 Director, Southeastern Division, A.R.R.L.

### New Members—O.M.R.C.

The Old Man Radio Club consists of radio amateurs who are fifty years of age or older. See April QST (page 84) and June QST (page 86) for earlier listings of the O.M.R.C. WIJIS sends the calls of new members, with ages indicated: W9BJA 73; W6DLA 65; W9ZAK PY5AG 64; W8PJB 62; W8HXB W6ON W7GUX 61; W9YS/YOL 60; W6SNE 58; W1HUV 57; W8GET 56; W9KXJ W9HKKI 54; W2MIE W6SQC W6POD 52; W5LZW W6QJJ W9VJH 51; W1ZE W6RBJ W8SBV W8CD 50. If you are fifty years of age, or older, send a card to WIJIS with your date of birth. Address Charles F. Loud, 48 Beals Court, Rockland, Mass.

Greater Cleveland Y.L.R.L. members (W8ODI, TLE, SBB, PZA, UCY and TAY) have organized a local club to meet monthly at each others' homes. There are no officers. A second local unit of Y.L.R.L. has been formed in Cincinnati, with W8TPZ as organizer. . . . G2YL and G8YL recently joined the national Y.L. organization.

# Be Santa Claus to Your Friends!

Each year an increasing number of individuals find *QST* to be the ideal gift. A subscription present is unique, too. It serves as a monthly reminder of your thoughtfulness. A yearly subscription, including League membership, costs only \$2.50, little enough for the ones you have in mind. And . . . we'll send an appropriate gift-card conveying your Christmas Greetings at the proper time.

A MONTHLY REMINDER OF YOUR  
THOUGHTFULNESS AND GOOD JUDGMENT

*QST*

38 La Salle Road . . . West Hartford, Connecticut

## AMATEUR RADIO LICENSES

Day and Evening Classes in Code and Theory  
HOME STUDY COURSES

Reasonable, Efficient and Thorough, Hundreds of  
Licensed Students Now on the Air

American Radio Institute, 1123 Broadway, New York, N. Y.

## RADIO

**ENGINEERING**, broadcasting, aviation and radio telegraphy and telephony, Morse telegraphy and railway accounting taught thoroughly. 48 weeks' engineering course, equivalent to three years of college radio work. School established 1874. All expenses low. Catalog free.

DODGE'S INSTITUTE, Day Street, Valparaiso, Indiana

## EASY TO LEARN CODE

It is easy and pleasant to learn the modern way—with an Instructograph Code Teacher. Ideal for the beginner or advanced student. ■ Many tapes available ranging from alphabet for beginners to typical messages on all subjects. Speed range 5 to 40 WPM. ■ Always ready, no QRM, beats having someone send to you.

**FOR SALE OR RENT**  
STANDARD with 10 tapes and book of instructions, A.C. motor, . . . \$24.50  
With spring-wound motor . . . \$18.50  
JUNIOR with 5 tapes and book of instructions (not rented) . . . \$12.00  
RENTAL Standard with 10 tapes and book of instructions \$3.00 first month, \$2.25 each additional month. References or \$10 deposit required. All rental payments may be applied on the purchase price should you decide to buy the equipment.

Write for details today

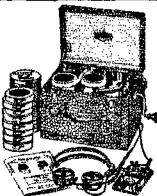

## INSTRUCTOGRAPH COMPANY

Dept. Q, 4701 Sheridan Road, Chicago, Illinois  
Representative for Canada:  
Radio College of Canada, 54 Bloor St. West, Toronto

## FB REPORTS KEEP ROLLING IN on the NEW PRECISION #832 31 Range Rotary Selective AC/DC Multi-Range Tester

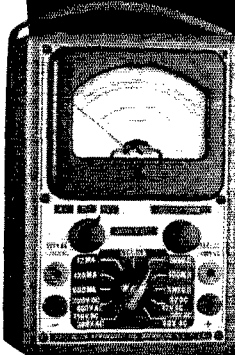

★ LARGEST METER ever provided (3 1/2 inches is the ACTUAL WIDTH, in such a compact instrument only 7" x 4 1/2" x 3" overall.

★ A single Master Rotary Range Selector allows ALL measurements to be made from ONLY TWO polarized tip jacks, except for the two highest voltage ranges.

★ RANGES • 6 DC voltage ranges at 1000 ohms per volt: 0-6, 30/150/300/600/1200 volts • 6 AC voltage ranges at 500 ohms per volt: 0-12/60/300/600/1200/2400 volts • 3 OHMMETER ranges to 600 ohms • 3 OHMMETER ranges to 6 MEGS, up to 500M ohms on internal battery • 6 DECIBEL ranges (-10 to +62 DB) • 6 OUTPUT ranges to 2400 volts.

★ ITS "PRECISION" BUILT! — 1% wire wound bobbins — 1% matched metallized multipliers — individually sealed calibrating controls — telephone cabled wiring, etc.

COMPARE THIS "PRECISION" VALUE at only \$14.95 net  
This is only one of the more than 40 models comprising the complete "Precision" line of dynamic mutual conductance tube testers, combination set testers, multi-range testers, signal generators, etc. Prices start as low as \$10.95.

Ask for the PRECISION TEST EQUIPMENT 1941 CATALOG

## PRECISION TEST EQUIPMENT

Standard of Accuracy SEE THEM AT YOUR JOBBER  
**PRECISION APPARATUS COMPANY**  
647 Kent Avenue Brooklyn, New York  
Export Div.: 458 Broadway, New York, U.S.A. — Cables: Morhanex

(Continued from page 99)

determined to make the BPL; he is getting close. Bob is an e.c.o. specialist. MNT received his Code Proficiency Certificate and has his highest traffic total this month. The North Newark Amateur Radio Club held its annual banquet Nov. 23rd at the Hotel Douglas. IYQ is secretary of the club. We received word that Pat Jessup, GVZ, is married and living at Glen Rock. MKW is a prospective O.R.S. HXI is new Alternate for TLA. MTZ is a new station at Irvington High School. KSR is anxious to contact any traffic men on 7 Mc. MRJ received his R.C.C. and is prospective O.R.S. MAX has started an amateur radio course in his high school. MRX has a new antenna and is adding a new final to his rig. LYV has been working on a new modulator. LVT is on 28-Mc. 'phone with a beam antenna. LZZ is a newcomer on 1.8 Mc. DBY met several New England amateurs on a visit to New Hampshire. KWE, of Matawan, old 2BCO, is now located at Washington's Crossing, N. J. Seton High Prep, with NCU, and Weequahic High with LGO are on 1.8-Mc. 'phone. Riding around in the 22-foot air-conditioned trailer station of the 119th Observation Squadron, a fully equipped mobile station, with call W2QC, are DYO, ILS, IIA, JGW and DYP. KXT has been active on the Army Amateur Phone Net, which holds regular drills on Mondays at 7:30 p.m. The net invites new members. IOZ has a 2-element beam on 28 Mc. and worked his first K6 on 'phone. MRJ is prospective O.R.S. There has been some demand for a 7-Mc. traffic net. Please communicate with LMN if you are interested.

Traffic: W2HXI 389 CGG 281 MNT 227 IYQ 96 LMN 94 (WLNX 86) MEW 62 BZJ 50 HCO 48 LXI 42 MAX 25 KSR 24 MRJ 14 MRX 7 CJX-KWK 6 IZV 4 JIY 2 CIZ 1 (Aug.-Sept. MAX 8).

#### NEW ENGLAND DIVISION

**CONNECTICUT** — SCM, Frederick Ellis, Jr., WICTI — KKS takes top place on the list this month with nice B.P.L. total. New officers of the Manchester Radio Club are: Pres., KOY; vice-pres., BEQ; secy. and treas., LZR. AW makes B.P.L. on deliveries. Traffic is picking up at MEC and Bill joins the gang in B.P.L. TD completed his W.A.S. and is now waiting for cards so he can get the certificate. UE, Assistant Communications Manager, is on a year's leave of absence from A.R.R.L. Hq. and is now an instructor at the N.C.R. Radio School at Noroton Heights, Conn. Sorry to see you leave Headquarters if only for a year, but glad you are still in the Nutmeg state. "Ev." MY is another Nutmegger on duty at Noroton Heights. KAT received O.P.S. appointment. IJ is new to the 1.75-Mc. band. After all these years, he made his first 160 meter contact with 2KOA. 2MQB/1 was home on leave and operated with the Fisherman's Net on 1.75-Mc. phone. IKE is at Bates College, Lewiston, Maine. Watch for him. EFW has been busy on the 2916-kc. N.C.R. frequency. The Southern Conn. Emergency Network meets once every month at 1GB. The grape vine reports that HSX will be on the air again soon. New officers at 1GB are: Pres., KDO; vice-pres., KQY; secy., ATH; treas., JQK; directors, BYW, FMV and LTZ. WR has been appointed E.C. for Litchfield County.

Traffic: WIKKS 536 AW 435 MEC 402 KQY 274 KYQ 130 TD 112 CTI 86 UE 65 MHF 41 CJD 20 ES 11 KAT 10 FMV 7 LQK-JTD 6 KFN 3 GB 2.

**MAINE** — SCM, H. W. Castner, WIIIE — The way this season has started out, it promises to be one of the most active and interesting ever. FV is teaching electrical subjects to the P.W.A. class at Portland High School. IKE has arrived at Bates College and is joining the Pine Tree Net and working from Carnegie Science Hall. Ames Millett (ex-WILRP) has his old call, BAV, back. KLH is on the air after a long absence during which he took unto himself a wife. Congratulations Mrs. Nason! It is reported that LHA and LYC report that they are going to join the Navy. KAS has moved to Wells and visited me recently with his XYL. We hear that INW is located in Wollaston, Mass., with the Monitoring stations. CRP is now active in the P.T.N. and says the Portland Amateur Wireless Association expect a lot of activity this season. ASQ recently "centeraised." Our congratulations to you, Charlie. MFK and LZI joined the U.H.F. Relay from Walnut Hill, North Yarmouth on 56 and 112 Mc. GXY is a regular member of the P.T.N. and has daily schedules with BNG. Sundays, Ed is on 28.684 kc. IST is active again

and reports into the P.T.N. LYJ is taking HSE's place on the net Thursday nights from Fairfield, VB in Newtown, Conn. has daily schedules with K5AH in Panama and is handling a lot of traffic from members of the Fifth Infantry to friends in Portland and vicinity. Walter breaks the P.T.N. and a lot of traffic has taken only a matter of hours in being delivered. We put a birthday message into Fort Sherman from a father in Portland to his son in record time. Both were very grateful for the service. KVK is taking lessons on a mill. LWX is on 1.7-Mc. 'phone and 3.5-Mc. c.w. MAP is also on 1.7-Mc. 'phone. DPJ is using 1.7-Mc. 'phone and 28 Mc. CMO uses all bands with 250 watts to a pair of 814's. DRZ is coming on with a new rig soon. LML's traffic total this month is fine. LIP writes that there is a great interest around Calais in improving code speed. He says the W1AW practice code is very popular and they come in fine down there. LER has enlisted in the Naval Reserve and is preparing to go to the new Navy Radio school. LAP has enlisted and BZR, LPA, LTM and LOZ are all prepared to leave with the National Guard for a year's training. JTH is on 3.5 Mc. again. DEG has put up a 75-foot pole for his 3.5 Mc. work and has another antenna going up for 28 Mc. MFJ has rebuilt and has 450 watts on c.w. and 300 watts on 'phone. VF, FCI, LYK and LRQ attended the Hamfest at Manchester, N. H., and had a swell time. Have any of you learned of the "Haywire Net?" The boys meet every day at 1:30 p.m. between 1803 and 1840 kc. for regular old rag chews; KNJ is president; MDG, vice-pres.; KRZ, weather forecaster; GQ, treas.; ILU, diction director, and MGP, secy. GXY has set up with BNG to relay messages for the boys in Bath's Co. D who are in service. An editorial on this amateur service in the Bath Times was most complimentary to amateur radio. LWG at U. of M. says he is going to talk up another ALL MAINE QSO PARTY sponsored by the U. of M. Radio Society. AIS has started a new rig. HYC is on occasionally and APX is building him a new portable receiver. BOR is building over his receiver. HSE has a schedule with 1VB to take all Maine traffic except that for Portland which is taken by WIGQJ. BTG in Waterville received his qualifying certificate for 300 w.p.m. Fine business. KSL is on 28 Mc. MNI is active on 1.7 Mc. again. EOP does a fine job as usual on 3.9 Mc. 'phone. FJP has been on 28 Mc. recently. LIP used 28-Mc. 'phone for a week and had some fine contacts, but is now back on 1.7 'phone.

Traffic: WIGXY 22 CRP 8 IIE 53 DEH 2 LML 124 LYK 15 GOJ 119 HSE 38.

**EASTERN MASSACHUSETTS** — SCM, Frank L. Baker, Jr., W1ALP — I was glad to have met many of the gang at the Boston Hamfest. Sorry I couldn't have met more of you, but it is hard to meet everyone with about 1000 present. Hi. BVL's XYL was a receiver at the Boston Hamfest. Teach her the code now, Dick. LBY is a new O.B.S. LZW has a new rig on 7 Mc. and is going to get on 1.75 Mc. MQO is active on 28 Mc. LO has a new QTH in Somerville. HOB, the Parkway Radio Club, is going to have code practice on 3900 kc. FB, gang. The East Mass. Club had its annual election. New officers are: pres., IQ; vice-pres., EHT; secy.; Dms, treas.; CTW, board of directors. FSK, IYK and ILR. The Lowell Radio Operators Club is now affiliated with A.R.R.L. FB. New OPS: LGH, HUP, IXL, EVJ. New ORS: EVJ, KXU. Two new E.C.'s: LVN for Falmouth and MME for Hull. This is what we want. Send in all the applications you want. HUP is working on a radio controlled boat and took Class A exam. LMB has new kw. final. LEU and SI worked KCAUSC on 28 Mc. (FW is experimenting on 112 Mc. IYG has a new junior op. Congrats. WV is now on 28 Mc. at his new QTH in Brookline. JXU has 160 watts on 3.5-Mc. 'phone and has e.c.o. on 3.5- and 7-Mc. c.w. TZ worked his 43rd state on 28 Mc. EKT has f.m. on 56 Mc. EHT has a new QTH in Stoneham, and will have a better U.H.F. location. IPS and RP applied for O.P.S., and KB for O.R.S. MCR has new QTH and is on 7- and 14-Mc. c.w. MDN has a new 56-Mc. beam and enjoyed the last U.H.F. relay. The 56-Mc. Minute-men have resumed schedules on 56.2 Mc. at 10 a.m. on Sundays. JNU is having luck; at Manchester (N. H.) Hamfest he won an SX24, and at Boston an HK54. IXL won a Browning Monitor and Freq. Meter at Manchester. KXU joined the East Mass. Net. M.V.A.R.C. has new HQ's at the Recreation Center in Lawrence. EVJ has schedules with his brother 5IYG on 14-Mc. c.w. and 28-Mc. 'phone. HSS has a new QTH in Plaistow, N. H. KB and SCW want a Phillips Code net on 7 Mc. If interested,



write to KB. Welcome to a new ham in Quincy, MYL. Don't forget, gang, to check all of your certificates of appointment. These have to be endorsed once a year. Check yours now, and send them to me for endorsement. Merry Xmas and a Happy New Year.

Traffic: W1BDU 238 AKS 201 JCK 167 (WLVG 48) AAR 110 KZT 86 KXU 73 AGX 67 HWE 47 LBY 38 LNN 26 LZW 12 KTE 11 KB 5 MDN 12 GAG 3 MQO 5 IXL 3. (Aug.-Sept.): W1JCK 164 (WLVG 67).

WESTERN MASSACHUSETTS — SCM, William J. Barrett, W1JAH — BIV has been keeping busy as control on the WLVG net as his total shows. EOB expects to leave soon for a year of active duty with the N.C.R. AZW is moving back to Pittsfield. IOR keeps busy with A.A.R.S. and P.C.N. drills. Chet reports BKQ has a quarter kw. on 1.75-Mc. 'phone. BVR had a busy month, attending NH State Convention, Mass. State Convention, the Vt. State Convention. Perce was active at all three in his dual rôle as N.E. Division Director and First Corps Area Radio Aide in A.A.R.S. DUZ is getting back into the swing of A.A.R.S. after summer layoff. AJ has been getting acquainted again on 3.5 Mc. after a long sojourn on 7 Mc. KK and LRE are now working on a radio-controlled model airplane. BNO made up a signal shifter, and reports more fun than he's had in years. He is also laying out a new 100-watt c.w. rig, between hamfests. GRZ is getting set for 28 Mc. The Fitchburg W.P.A. radio club is fully prepared for any communications emergency. That's a fine example to the rest of the clubs. LTY is installing new rig for 1.75 Mc. The Fitchburg gang took in the conventions at Boston, Manchester and Rutland. JAH took in the N. H. Convention. We hope you are all taking a shot at the Code Proficiency tests. For those seriously interested in improving their operating ability, there is nothing better than taking part in organized traffic nets. Western Massachusetts has an assigned frequency of 3732 kc. for a section O.R.S. net. Don't feel that you are too slow to join. Just send a message or card to ye S.C.M. indicating that you are interested and willing to take part in the net. 73.

Traffic: W1BIV 248 (WLVG 106) EOB 186 AZW 138 L1F 106 JAH 110 (WLVG 24) IOR 71 (WLVG 15) BVR 18 (WLVG 132) DCH 17 DUZ 9. (Aug.-Sept.): W1EOB 15).

NEW HAMPSHIRE — SCM, Dorothy W. Evans, W1FTJ — Your S.C.M. has been "hamfesting" lately (Boston, Mass., and Rutland, Vt.), but is now settling down and digging in for the winter months. BVR has appointed FTJ as Asst. Director for the New England Division, and if we can help you in any way, please don't hesitate to get in touch with us. JCA is now on active duty with the Navy. KLV has received his W.A.S. certificate. Congrats. I.VK, the club station of the Manchester Radio Club, is being rebuilt. MXO is a new ham in Manchester. While working on a new rack and panel job, MMG is pounding out c.w. on 7 and 3.5 Mc. MLW can also be found on these bands as well as on 112 Mc. KIN is still doing a good job holding down busy A.A.R.S. nets. GEY is working 3.5 and 7 Mc. with an FB e.c.o. rig. AFD is building a new shack. LLD is on 28 and 112-Mc. 'phone. DUB is rebuilding. MCB works 3.5 c.w. and 112-Mc. 'phone. FGC is running a new 811 on 14, 7 and 3.5 Mc. and is getting quite a ven for traffic. IP expects to start work on a new rig shortly. Annual meeting of the Coos Radio Club was held Oct. 9th, with JXC chosen president; KBE, vice-pres., and IVE, secy.-treas. LLP is celebrating the arrival of a YL Jr. Op named Nancy. CFG now has rank of Ensign in U.S.N.R. FB; Speed! BWR is now located in Concord as instructor with N.Y.A.

Traffic: W1KIN 200 GMM 82 BFT 58 GEY 53 MOP/1 45 IP-MMG 44 JDP-JKB 42 HFO 14 FTJ 2.

RHODE ISLAND — SCM, Clayton C. Gordon, W1HRC — LWA is getting into F.T.S. QR is on looking for traffic schedules. EOF keeps F.T.S. sckeds every Monday night and now has a half-wave indoors on 3.5 Mc. MJL has a new rig with 6K7 e.c., 807 dbl., 812 final at 100 watts on 3.5 and 7 Mc. KYK has new rig with 24-A e.c., 6F6 xtal. 807 bfr., T-40 final. Norm gets around pretty well now and wants to resume old schedules. KCS is back on c.w. LWA has another new rig with 6sk7, 807, 809 and 7 Mc. zepp which works fine. MO has new final with 810 running 430 watts. LDL is control station for the P.R.A. Net which runs every Monday night at 9:30 p.m. on 3625 kc. JP is on 3.5 Mc. in the P.R.A. Net. MUH has completed a power supply for his 120 watt ZB-120 rig for 3.5 and 7 Mc. MWY and MBM (The Twins) are on 40 c.w. with a new half-wave

center-fed zepp. FUB is on 112 Mc. with I.C.W. and on 3.5 with c.w. LVE is on the 3.5-Mc. P.C.N. Net and also works 112 Mc. GTS is back on 3.9-Mc. 'phone with 250 watts. HRC got the ladder out and tightened up the skywire for winter's radio activities.

Traffic: W1LDL 99 LWA 62 EOF 13 HRC 9 QR 6 LVE 4.

VERMONT — SCM, Clifton G. Parker, W1KJG — The annual hamfest at Rutland was very well attended with an excellent time reported by all. A pleasant surprise occurred in the timely visit of Secretary Warner and Mrs. Warner. The thanks of the entire Section are extended to the Rutland Club. MMU has been appointed O.R.S. FPS has a new position with the F.C.C. AD schedules 2NAA. KXY visited KJG and KTB and also attended N. H. hamfest with FSV. MJU reports completion of electronic bug. IQG is now located at Burlington. LVP is now living in Burlington. He was formerly located at Woodsville, N. H. The Burlington Amateur Radio Club is holding regular meetings with much interest manifested. JXS is temporarily at Medford attending Tufts but reports has completed 6F6-6L6 signal shifter and acquired an SX9 Skyrider. KXL is on 3.5-Mc. c.w. The 1941 season promises increased activity for this Section. The following is list of appointees. OBS: KTB. OO: AVP, BJP. OPS: AVP, GAN, AD. DQK, MCQ. ORS: FSV, KOO, KTB, KVB, BNS, MJU, MLJ, KWB, MMU, RM's: Eastern Vt., BNS; Western Vt., FSV. With the vacancy caused by FPS being temporarily absent, some station to act as O.B.S. is desired. If you are interested, please advise your S.C.M. promptly. We request more monthly reports. A lot of activity is occurring and traffic being handled which our Section should have credit for.

Traffic: W1KXY 73 KJG 76 MJU 28 MMU 9.

#### ROANOKE DIVISION

NORTH CAROLINA — SCM, W. J. Wortman, W4CYB — Quite a number of the fellows are going off to army camps, and some have enlisted in the service. We hate to lose you even temporarily, but good luck in the new venture. W4AKC handled most traffic this month. Congratulations, Joe! CDQ is on again with a 3.9-Mc. 'phone. DWB is operating WE at the University of N. C. DXG at Fort Bragg is busy handling traffic thru the Post, and decries the lack of e.w. men in the state. DLX is busy on Trunk Line C. DGU has three schedules lined up on Thursday nights. 9HDZ has moved to Greensboro, and will have a W4 call soon. 4GNF is giving 1.7 Mc. a try and plans some 3.9-Mc. work shortly. AJT is an instructor at N. Y. A. Girls' Center and is teaching 30 YL's how to read code. EIW has built a Class B modulator with 809's, for his 1.8-Mc. 'phone. ZH is on 1.75-Mc. 'phone consistently. AGD is on 14 Mc., but has his eyes on 3.9 Mc. GXB works 7 and 14 Mc. with a pair of HK24's. EFI is attending State College. AFP and EAK are active on 1.7-Mc. 'phone. MR sticks to C.W. on 7 and 14 Mc. and has raised his code speed to 30 W.P.M. I wonder how many Code Proficiency Certificates we have in North Carolina? Lets all go after one! EYH has applied for OPS. Did you know that North Carolina had high ORS and OPS in the last quarterly parties? Good luck, gang, and keep us informed.

Traffic: W4AKC 210 DWB 105 DXG 102 DLX 89 MR-DGU 4.

SOUTH CAROLINA — SCM, Ted Ferguson, W4BQE/ANG: 4GCJ operates 1.75-Mc. 'phone and 7-Mc. c.w. DPN is heard mostly on 3.9-Mc. 'phone. FKZ has gone to Panama. GMO is adding PP 1623's and will run about 150 watts. EXJ reports his PP 809's with 200 watts work FB. BFD reports a YL Jr. op. GFP is rebuilding and increasing power. FVF can be heard on 1.75-Mc. 'phone. FHE is increasing his power to a Kw. DGD is now located at Charleston. CZA has his new license and has returned to the air for traffic work. FFH has his class A ticket and can be heard on 3.9-Mc. 'phone. DXF has a new exciter unit. AFQ is playing with flea power on 1.75-Mc. 'phone and 3.5-Mc. c.w. DFC is building a new rig. CXE is rebuilding. GOQ has been transferred to Camp Beauregard, La. CKW is heard on 1.75-Mc. 'phone again. DAM lost his HK 254. EDQ has a new rig. FNS is helping with code classes at Greenville. FAL is now operating at the University of S. C. EZF spent a week end with GCW and GZL. HAZ is a new ham on 1.75-Mc. 'phone. Welcome, OM. GZL operates 7-Mc. c.w. We have heard the following fellows are at Fort Jackson: FUI, FCW, EKA, DWG, and 3BND. We welcome these fellows to the South Carolina Section and shall be glad to meet any others.

# RADIO TRAINING



**P**ORT ARTHUR COLLEGE—not privately owned, not operated for profit, a college built and endowed by the late capitalist-philanthropist, John W. Gates—offers the most thorough practical Radio training in America. P. A. C. owns Radio Station KPAC, which is equipped with the very latest type 1000-Watt high fidelity RCA transmitter, operating on 1220 kc. with directional antenna system. The college is authorized to teach RCA texts. Additional equipment consists of the latest type Marine and Airways Transmitter installation complete; SOS Automatic Alarm; Marine Direction Finder, two-way Television Transmitter and Receiver; Trans-radio Press Receiving Equipment; laboratory facilities where every phase of practical radio assembly technique is taught. Students assemble composite transmitters, audio amplifiers, RF amplifiers, etc. The Radio training covers thoroughly Airways, Press, Announcing, Teletype, Typewriting, Laboratory and practical experience at KPAC transmitter, control room and studios. Announcing is an optional part of this training; nevertheless a number of students annually make successful announcers.

Port Arthur College pioneered the teaching of radio with its first classes in 1909, and for thirty-one years has maintained an active Employment Bureau that is successful in placing graduates in airways, broadcast and marine radio industries.

*If interested in details about the Radio Course, write for Bulletin R*

**PORT ARTHUR COLLEGE**  
**PORT ARTHUR (World-Known Port)**  
**TEXAS**

## A-1 Operator Club Roster

C.W.:

W1ABG ABQ AEF AF AFA AFB AJ AJB AJL AMG  
 AMQ ANC APR APW ARB ATJ ATO AV BB BD BDI  
 BDW BEF BEU BFT BHM BIT BLI BMP BMW BNC  
 BPO BPY BUX BVG BVV BVR BXC BYW CAA CDX  
 CFG CH CHF CJD CMX CNU CPS CPT CRA CRP  
 CTI DAV DDK DF DGG DKO DOW DUK DVV EBM  
 EBO EBT EF EFA EH EOB EPE ERQ ES EVJ EZ EZR  
 FFI FH FIO FM FOV FRO FTJ GC GKM GMM GOG  
 GOJ HLE HRC HSE HX IEG IGN INW IP ISH IWC  
 JFN JMY JPE JPJ JTD KFN KH KHE KIV KL KOH  
 KQY KV LHE LVQ LYG LZ NE OR QW SZ TA TS UE  
 VB VS WV ZK ZL ZQ ZS.

W2ACD AEN AEF AGL AHC AIQ AIW AMP ARY  
 AXL AWX AYN BAS BCR BCX BFB BG BGO BHW  
 BHZ BJX BMX BPH BST BJZ BZZ CC CGG CHK CJP  
 CO CVJ CWC CWK DBE DBQ DRV DTB DUP DXO  
 DYO EGF ELK ETH EVA EWQ EYQ FFL FIS GFW  
 GGE GGV GNK GVZ GWE HCO HEB HFS HHG HMJ  
 HYC HZY IOP JHB JUW JWT JWX KI KTR KWQ  
 KXF KYO LA LMN LR LU LW MHW MIY MO NB OC  
 PY QY SC SN TP UL VH VY WP ZC.

W3ABA ADE ADM AG AGV AHD AIR AKB AKN  
 ALX AMR ANH AQN ARV ATJ ATR BAI BBB BDF  
 BES BEY BFH BGI BJX BLN BNS BND BNH BWT  
 BXE BYA BYR BYS BZX CAH CDG CDQ CFL CHH  
 CIC CJT CL CLV CML CQQ COG CTD CVU CWE CWL  
 CXL (CB, YL, YX, HC & White) DD DEH DFK DGC  
 DGM DK DML DMR DNU DUK DVO DXG DZ ECA  
 (Bill & John) ECP EDC EDP EFM EIC EML EMM  
 ENH ENX EOP ER ETM EWT EWL EWR EZ EZN  
 FBM FED FJ FLH FQG FRY GDI GE GET GGX GHD  
 GHM GJY GKO GOW GPC GQW GRF GRV GS GTS  
 GUB GYV HC HDQ HFE HQE HRS HXA HZH HZS  
 IKG KT KU LA MC MD MG NF NO NR NT (RC) OK  
 OM OZ QN QP QR SR SI SN (FX) UVA WM WO WS  
 WU ZI ZL.

W4ABT AFI AFM AG AGI AGR AJX AJY AKH AKI  
 AKN ALK ANZ AVD AVT AXU AYW BDT BJA BNI  
 BOU BOZ BRK BTU BV CE CEN CXY CZA DAI DHZ  
 DW DWB DZS EC EG FDT FJR FT GL GNQ HK IR  
 JR KK MI MS MU NG OI (Dave & Mac) PEI PL PM  
 TO TR UT UX ZH MR.

W5AAX AFI ALZ ANU AQ AUL AVF AVG AYZ  
 BAM BB BCW BDB BED BFA BIH BKH BMI BMM  
 BMU BQZ BYO BZR CBL CEN CEZ CIJ CFB CVQ  
 CXH DKR DLD DWW DXA DZU EB EES EGP ENI  
 EOE FAJ FDR GED GYZ HAA MN NW OW (RL & H)  
 QL SI VV VQ WG ZC.

W6AAN ADP AJP AKW ALU AM AOJ AOR AUT AX  
 BHV BLP BMC BNA BPM BSV CDA CGJ CIS CKO  
 CRF CUH CUU CVL CW CXW DEP DKN DPJ DUC  
 DVD DVV DZN EGS ELU ENV ETL ETM EWB EXH  
 FEX FII FQU FRN FS FVU FYR FZL GAL GDX GHU  
 GQC GQR GRL GRX GXM HG HLJ HRY HT HUA  
 IIK IOX KFC KGO KIP KWA LBB LLW LM LMD  
 LRN LUJ MQM MV MXN NLL OJ PGB PJR PQ (CV)  
 PZW QA QD RJ RN SU UD UO WB ZG.

W7AAT AIJ AMX AOD AQN ASN AWH AXJ BAA  
 BB BJZ BME BMF BPJ BRU BSU BSX BVE BXX  
 CCR COH COX CRH DL DUE DXZ EBQ FL FVK GEE  
 JC KO LD NH SO TS WY.

W8AAT AJE AJL AKV ANO APC APQ AQ ARR ARX  
 ASW AU AVK AXD AXH AXV BAH BAS BBH BGY  
 BHK BJO BKE BKH BME BMG BMK BQ BRC BTI  
 BTK BTW BVL BWL BWT CAT CCD CDK CEO CEU CFR  
 CGS CIO CJJ CLL CLQ CMI CNC CNZ CPE CPY  
 CQA CRA CSE CTX CUG CVS DBX DDS DED DFH  
 DHC DHT DHU DLG DNU DPE DSA DSS DVC DVL  
 DWB DYH DYV DZ DZU EDG EEZ EGI EIK ELJ EPY  
 EQC ERJ ESY EU EYU EVC FCB FDI FFK FGV  
 FLA FTW FWX FX FYF GBC GBF GEG GLX GGD  
 GPS GQB GRZ GSO GUC GUF GUS GZ HCS HD HGG  
 HMH HSH IAW ICM IKZ INQ IOR IWT IXJ JAK JE  
 JES (Paul) JIN JIW JM JO JTT JZ KD KJW KKG  
 KQQ KR KUN KWA KZZ LCY LSF LZK MOT MQO  
 NCJ (Ray & Beth) NCU NUA NUW OB OFO ONK  
 OXO PAF PIH PL PLA PNG PO PP PQQ PSF PSR PWY  
 QAN QHL QT QV RKR RER RY SQE SS UV UW VD  
 VP WE YA (NOR & Faries) ZG.

W9ABB ABE ACL ADN ADY AET AIO AJA ALI  
 AMB AND ASV AUH AZN AZR BAU BAZ BBP BBS

**Now Ready!!**  
**SEVENTH (1940) EDITION**  
 Nilson & Hornung's  
**RADIO OPERATING**  
**QUESTIONS AND ANSWERS**

Covers all elements, 1 to 6, of the sample questions published by the F.C.C. in their Study Guide for Commercial Operators. Ideal handbook. Pocket size, flexible. Price \$2.50, postpaid. Money back if not satisfied and book is returned in 10 days. Send check or money order . . . not cash. C.O.D. charges extra. Free circular on request.



**NILSON RADIO SCHOOL**  
 51 East 42nd St., New York, N. Y.

# WHERE EVER YOU ARE YOU WILL LIKE TO BUY FROM BOB HENRY

"I WANT TO EXPRESS MY APPRECIATION FOR THE FINE OFFER YOU MADE ON THE TRADE-IN, THE SPEED OF DELIVERY AND THE FAST EFFICIENT SERVICE FROM YOU" W6QQU

"ONCE MORE I WANT TO THANK YOU FOR A REAL SQUARE DEAL, BOB! YOU CERTAINLY DID YOUR PART TO HELP ME GET THE RECEIVER I WANT" W8EUY

CALIF.

IOWA

N.Y.

"NEEDLESS TO SAY YOUR SERVICE ETC, AND OUR RELATIONS HAVE BEEN OF THE BEST" W9AFQ

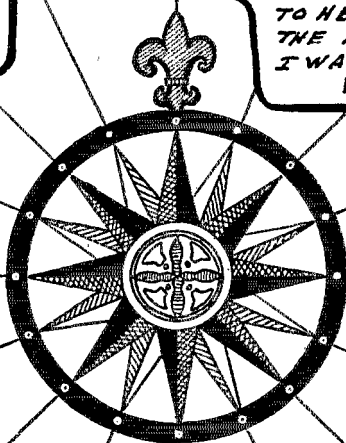

"I LIKE THE FACT THAT YOU FINANCE ALL TERMS YOURSELF SO THAT THE MATTER IS ENTIRELY BETWEEN US AND I FIND THE TERMS VERY CONVENIENT AND REASONABLE" W9NIP

MISSOURI

"STILL OPERATING STATION ON PARTS, RECEIVER, ETC. FROM 9ARA AND STILL HAPPY" --W8OXO

W.VA.

"THANKS FOR YOUR PROMPT SERVICE.. I SHALL REMEMBER W9ARA WHEN PURCHASING.." W5ICR

"... YOUR KNOWLEDGE AND UNDERSTANDING OF AMATEUR RADIO, YOUR STOCK IS SO COMPLETE ...YOUR PRICES ARE FAIR AND CONSISTANT WITH THE HIGH QUALITY OF GOODS YOU CARRY" W4DSY

TEXAS

"...SURE IS A RELIEF TO DEAL WITH AN HONEST MAN WHOSE STUFF IS GOOD OR EVEN BETTER THAN HE ADVERTISES"

ALA.

N.CAR.



THESE FELLOWS PUT IN THEIR OWN WORDS THE BIG FEATURES OF MY WAY OF DOING BUSINESS. I WANT TO SEE YOU SATISFIED WHERE EVER YOU ARE. WRITE ME ABOUT YOUR NEEDS AND WISHES.

Bob Henry W9ARA  
BUTLER, MO.

# hallicrafters Best Sellers!

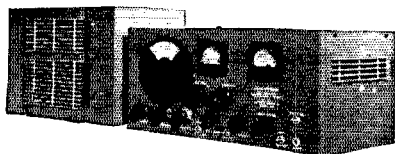

## SUPER DEFIANT (SX-25)

Here is the receiver-speaker combination that so many stations installed as their major piece of front-line receiving equipment as soon as it was announced. It is still tops at the price, which is only \$99.50 complete.

## TIME PAY. FOR CONN. HAMS

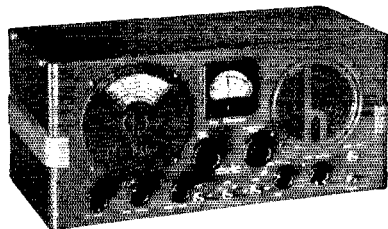

## SKY BUDDY (S19R)

We believe this receiver is owned by more amateur than any other communications receiver. Covering everything from 44 mc. to 545 kc., with electrical bandspread, pitch control, BFO, AVC switch, phone jack and built-in speaker, it is truly a "band-wagon" job for only \$29.50 complete.

## SAVE EXPRESS CHARGES

Hatry & Young is organized to give you quick, dependable service from three Connecticut stores. Save delay and express charges.

# HATRY & YOUNG

1172 Chapel St., New Haven, Connecticut  
177 Cannon St., Bridgeport, Connecticut

## 2 CONVENIENT STORES

106

BCF BCX BKJ BKK BNA BNT (Red & B) BWJ CAA  
CDA CFL CJR CNE CRK CSI CSY CUY CWR CYD  
DDE DEF DEI DFF DGS DHA DHN DI DMY DNC  
DNU DOU DQT DTM DXY EBX EC (E. L. Benfer)  
EDI EDQ EEW EYA EGG EGU EHW EII EJC EKQ  
EKY ENH EPJ ERU ESA ESU EW EWO FA FAA FAM  
FFD FJV FLG FP FQ FQQ FRA FUW FVM FVV FXP  
GCX GDU GJX GLI GNG GPGRA GWKHFCHJCHML  
HPG HSK HSN HTU HUM HUU HUY HVA HYR IFD  
IFZ IHH ILH IOL IYA JGS JO JRK JUC JZY KEH KG  
KJA KKT KNZ KPA LCX LEZ LHQ LLN LUC LW  
MUY MZD NDB NFL NJS NNM NNZ NUF NVF OLC  
OUD OX PCU (Vi & Vee) PDE PDL PLL PLM POB  
PTU QIL QMD RCQ RHM RSO SEB SGP TA TB TDR  
TO UHT UZ VDQ VES VS WAM WIN WR WVB WWT  
YB (Booth/8DDF-PV) YDJ YRS ZAW ZJS.

K4BRN BU PCV PFR KD RJ SA. K5AA (Turcotte)  
AC AG AM AY NYIAE. K6AIU AJA AKA CGO CQV  
EWQ HZI JPD MEG (CW) MXM OJG. K7AOA PQ.  
KALAN HR.

VE1DR EP ER ET EX HG 2BU DR EE FJ LC 3AU  
CP GT HC JI NM NO QK SG TM WA WX 4AG BB BZ  
DK GP HM KX LQ MH MW 5AG AM EO EU FG GT  
HC HP HQ HR QA QP.

OE7AA CMSUS CP1AA 3AAA CT1AZ 3AB D3DSR  
4ARR 4DTC TKP XCG EALAS 4AO AV BE EI5F 8B  
E5SC FASBG F8SAB F8EO EX GG PK TQ WB G2LB  
LZ MA PL YY ZQ 5BW BY FA GQ QY RI SR YH YV  
ZZ 6HB MK NF NJ QB QX RV VP WU WY 8FF GI5QX  
UR 6TK G6BNX HA3H 8D HB9AD AQ AT 9J J2GW  
GX HG 5CC LA1G LUL1EP 6AP 7AZ EF 8EN OA4U  
OE1ER FH 7EJ OH3NP 5NG OK1AW BC 2AK OP VA  
ON4AC AU AW BZ DX FE RX OZ8D 8J PA0DC GO  
LL QQ XF ZK PK3ST PY1AW AZ 2BX CD SM5XW  
6UA SPIDE SUICH SG WM SV1RX U1BL 3QE VK2AE  
AP DA EO HF 3CP EG GQ HL HM ML MR NG OR 4AP  
GK 5HG KO WG 6SA 7CL VO3X VPIJR 5PZ VQ1CRL  
VR4AD VS6AH VU2AN XE1AA AM AY 2C YM1AA  
ZE1JJ ZLIAR DI FT GU 2BN CI JA 3CC 4AI AO BQ  
FK FR ZS1AH 1H 2A 6AH.

## \*PHONE:

W1AQM AUJ AVK CCZ SZ W2AWR BYM DC IXY  
JN KAP TP W8AHR AQR AVL AXT BSY BUY CCO  
CKD CKT CNY DF DQ EMM FJU FN GY LN MD  
NK WX ZA ZX W4DLH DYP JB OC RV TR W5AOT  
BDB BMM UN ZA W6CIN CNE KT ZH W8AOM APN  
CPC DLD FFE IKE KIR LUQ RD UD W9ARE CJJ  
CPD DRD VE3JI 2HV K6FJF G5BY 5ML 6WU.

The A-1 Operator Club is to promote a high calibre of operating in the amateur bands. To become a member, one must be nominated by two operators who already "belong." In choosing operators for the club, the following points are considered by members: (1) General keying, and good voice operating technique. Well formed characters and good spacing are considered before "speed," and clearness, brevity, cooperation with other operators, etc. count much toward 'phone nominations. (2) Procedure. Use of correct procedure is a natural qualification. (3) Copying ability. This is judged by proficiency in copying through QRM, QRN and other difficulties, and accuracy of copy, as well as speed. (4) Judgment and courtesy. An operator should be courteous and willing to consider the other fellow's viewpoint. The matter of "good notes," lack of frequency "wabulation," good quality ('phone), use of sound technical arrangement and proper adjustment, while not directly points of operating ability, are certainly concerned directly with courtesy and judgment, and as such these things must be weighed under (4).

A-1 Operators, grading candidates, consider each of the four qualifications. Each counts a possible 25 points (of 100 total). No operator nominated should have a rating of less than 15 on any qualification. The total must be 80 or over to warrant a recommendation. Members are always on the watch for suitable candidates for the club. Aim to keep your operating of such calibre that you will be eligible for the A-1 Operator Club and that you will receive the necessary nominations for membership.

## WOULDN'T IT BE WONDERFUL —

If I — wouldn't use a full kilowatt to work a certain 18-watt spark coil around the corner from his station?

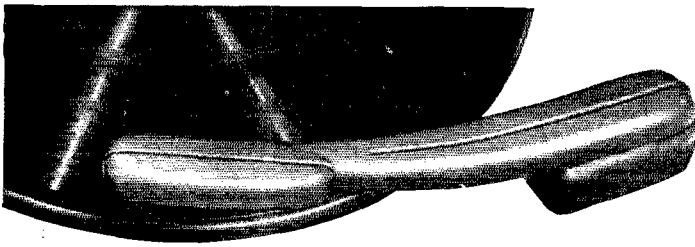

## LOW PRESSURE CRYSTAL PICKUPS

### *In Two Models*

Model FP-18, 30 to 7,000 cycles, for use on commercial records, and Model FP-38, 30 to 10,000 cycles for hi-fidelity applications. Overall length, 9 $\frac{3}{8}$ " with 8" mounting centers for 10" and 12" records. Complete with shielded cable and arm rest. List Price \$16.50.

## Eliminate Record Wear and Needle Loading

Feather-weight pressure of only one ounce upon the permanent, built-in sapphire stylus of these units prevents valuable and cherished records from ever growing old and worn. This is scarcely more than one-third the needle pressure necessary in conventional pickups and results in so little wear that records, generally speaking, never wear out. The genuine sapphire stylus used in Astatic Low Pressure Pickups maintains its highly polished and accurate contour indefinitely, eliminating once and for all the buying and changing of needles. Fidelity of reproduction is increased with the elimination of surface noise and distortion due to wear. Modernize your phonograph with the installation of an Astatic Low Pressure Crystal Pickup.

See Your Astatic Jobber or Write for Special Bulletin No. 40-B



**ASTATIC**  
ASTATIC CRYSTAL PRODUCTS LICENSED UNDER  
BRUSH DEVELOPMENT CO. PATENTS

**ASTATIC MICROPHONE**

IN CANADA: CANADIAN  
ASTATIC Ltd., TORONTO, ONT.



YOUNGSTOWN  
OHIO  
*Laboratory Inc.*

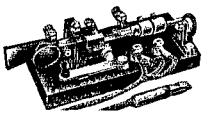

### TELEGRAPH SPEED KEYS

Radio Type in Kits—\$2.89

Send Card for Complete Information

**ELECTRIC SPECIALTY MFG. COMPANY**  
Box 645, Cedar Rapids, Iowa

### Piezo-Electric Crystals Exclusively

- Quality crystals of all practical frequencies supplied SINCE 1925. Prices quoted upon receipt of your specifications.

Our Pledge: **QUALITY FIRST**

#### SCIENTIFIC RADIO SERVICE

"The Crystal Specialists Since 1925" University Park, Hyattsville, Md.

## RECORDING CHASSIS



LIST \$39.50

Efficient but low priced. For amateurs, experimenters, p. a. and service men, schools, etc. Small, compact, rugged, easily installed. Hooks up to any amplifier or receiving set. Ultra efficient. Constant speed induction motor (not synchronous). 78 rpm. Requires two watts of audio. Cuts out to in at 118 lines to 10 in. blanks. Net wt. 12 $\frac{1}{2}$  or packed 18 lbs. For 60, 50 or 25 cy. (state which). If not available at your jobber or dealer, write direct.

### UNIVERSAL MICROPHONE CO., LTD.

INGLEWOOD, CALIFORNIA, U. S. A.

## MEMORANDUM

- ✓ You need a copy of the new 1941 Handbook.
- ✓ You need a binder for your 1940 QST's—and another for 1941.

★



Xmas suggestion — give a membership-subscription or a new Handbook.

## DECEMBER, 1940

# FULFILL YOUR AMBITION IN RADIO

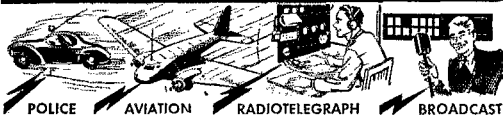

Train yourself at home for that radio job or promotion you want. Study under the personal direction of Arthur R. Nilson, co-author of Nilson and Horning radio textbooks. Up-to-the-minute, low-cost, home-study courses will help you increase your technical knowledge or fit you for license examinations. As the next step toward your success, send for descriptive literature on these courses.

- 1. Essentials of Radio Communication:** includes all technical essentials for 2nd class radiotelephone license and radiotelegraph permit. A complete foundation course.
- 2. Advanced Radiotelegraphy:** covers the scope of Element 6 when combined with course *Essentials of Radio Communication*. Twelve supplementary lessons, mainly on marine radio and mathematics. Cover requirements of 1st and 2nd class licenses.
- 3. Broadcast Operating:** covers the scope of Element 4. Mathematics, circuits and equipment, and rules and regulations. Ideal course for the experienced man who wishes to increase his knowledge or prepare for broadcast license or job.

SEND FOR FREE 16-PAGE BOOKLET "What the Modern Radioman Must Know." Make this step toward your successful radio career . . . now!

**NILSON RADIO SCHOOL**  
51 East 42nd St., New York, N. Y.



## TWO HUNDRED METERS AND DOWN: The Story of Amateur Radio

tells in detail the story of amateur radio from twenty-five years ago — yes, and back to the beginning days of the radio art — up to modern times. A fast-moving, exciting account of the fascinating days when radio was new. Old Timer and Young Squirt alike will find **TWO HUNDRED METERS AND DOWN** entertaining, informative and readable.

PAPER BOUND EDITION

\$1.00 postpaid

BUCKRAM BOUND EDITION

\$2.00 postpaid



### American Radio Relay League

WEST HARTFORD  
CONNECTICUT

## 2½ Meters at Model Airplane Meet

AMATEUR radio participated in the 1940 National Model Airplane Championship Meet held in Chicago, July 1-6, 1940. Results of previous Model meets have brought to light one serious defect — the loss of valuable planes by contestants through failure to locate when they have landed out of sight, and stealing. At a conference between Meet officials and representatives of the Chicago Area Radio Club Council, the idea of having radio-equipped roving cars in the field was born and the groundwork laid for subsequently putting the plan to work. On the 4th and again on the 6th of July, amateur radio provided two-way communication between the control station set up near the officials' stand and roving cars in the field; the fundamental purpose being to retrieve and return to their rightful owners models that would have under other circumstances been lost or stolen by the failure of retrievers to reach the point of landing quickly enough. In addition, two-way communication was provided between the Field Judges and the Public Address Announcer, so that the general public could be advised of special events as they were taking place.

Operation was confined to 2½ meters, in order to promote greater interest in this ultra-high ham band and to eliminate interference with the radio-controlled models which were operating on 5 meters. The control station rig was a pair of T-20's using plate rods and running approximately 60 watts input, and a home-grown super-regen. receiver. All equipment was powered by a 1-kw. gas generator. The antenna consisted of a half-wave tube fed by a matched impedance line. Three of the mobile units were equipped with separate 78 oscillators mounted in shield cans and set on the car hood with suction cups. These were modulated by the one-stage audio used in the receiver and were powered by either a vibrator pack or genemotor. Transmitting antennas were mounted directly on the oscillator shield cans and were quarter-wave rods, while the half-wave receiving antennas were mounted at the rear of the cars and fed with a single wire line. Another car was equipped with a pair of TZ-40's using long line plate and tuned filament lines and running approximately 100 watts input, this layout together with the super-regen. receiver being powered by a gas-driven generator in the trunk. The other car used a battery-operated transceiver similar to those used in the Field-Judges-P.A. Announcer set-up.

At the "call to duty" from Operator-in-Charge W9TXU, practically all of Chicago's radio-equipped 2½-meter mobile units responded eagerly. The control station was supplied by W9BAN and was manned by himself, W9SXX, W9YZV and W9YDV. Roving units were supplied by W9ADF, W9KLB, W9PNV, W9ZHR and W9TXU and were manned by themselves, W9AYL, W9PEQ, W9AFF, W9MUE, W9GPF, W9PDU and Willy Hess, ex-9VPC, two operators being assigned to each car. The Field-Judges-P.A. Announcer set-up was supplied by W9TLQ and was manned by W9AI, W9MD, W9NQN, W9UJR, W9SGA and W9MTW. The operators at the control station were more than busy in keeping contact with the roving units, giving them information as to planes headed in their general direction, moving them about as the winds shifted but always keeping them located on the master map on the operating table for quick glance spotting, giving the cars plane numbers, color, etc., of models reported as having gone out of sight in a given direction, receiving reports of planes recovered, etc., by each car, passing said information on the P.A. Announcer for public distribution, besides the routine job of answering questions, taking data from contestants on lost planes and running the station generally. All this while the fellows in the cars were attempting to spot reported lost models, chasing those that landed close by, and innumerable other tasks. While this group was busy on the low end of the band, the other group on the high end were busy no end, getting last-minute news from the Field Judges to the P.A. Announcer as to official flights, broken records, etc. This news was passed along to the some 50,000 persons who witnessed the Meet. It was generally agreed by the Park Board officials, the *Daily Times* officials, the Meet officials and the 1200 contestants themselves that Amateur Radio had proven its usefulness in pioneering this new field. In the two days of operations some two hundred planes were recovered by the roving cars, and it is estimated by "those in the know" that better than a third of that number would have been lost or stolen had it not been for amateur radio.

During the 15 hours of actual operating, no ordinary ham-



We maintain a staff of experts who will be glad to assist you in selecting and building your equipment. This friendly service has made HARVEY'S headquarters for ham gear in this part of the country. When you are in the vicinity of New York, pay us a visit and you too will agree HARVEY'S is a nice outfit.

## The NEW Series 200 "SUPER-PRO"

**\$28.00**

**DOWN**

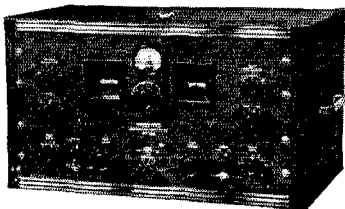

**\$22.00 PER MONTH**

Without question, the top receiver. In it you will find everything necessary for the most perfect high-frequency reception. "BCL", "Ham" and professional will be amazed at the ease with which stations can be pulled in through QRM. This is the receiver which you can buy with full confidence that you won't need to return it to us next year. HARVEY'S new payment plan permits you to own this receiver outstanding receiver for only a few dollars a month. Send \$28.00 with order and pay the balance in 12 monthly installments of \$22.00 a month. What could be easier — if you have a trade-in, let us know about it. We make liberal trade-in allowances.

## "HQ-120-X"

The "HQ-120-X" has won the admiration of everyone coming in contact with it. Its superb receiver performance has put it definitely in the high price class. . . yet, this receiver can be purchased for only a few dollars a month.

**EXCELLENT**

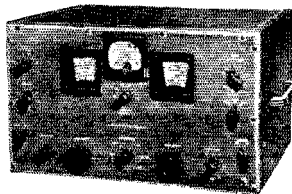

**VALUE**

**W21JL  
W2LJA  
W2KWY**

OUR *Best* VALUE IS OUR RECORD OF LOYAL SERVICE

**HARVEY**  
*Radio Company of New York*

**CABLE  
ADDRESS  
"HARADIO"**

103 WEST 43rd STREET • NEW YORK, N. Y.

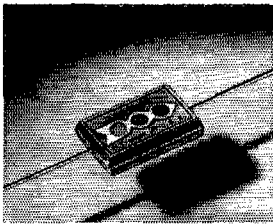

Silver coating bonded to mica for permanent stability.

immune to temperature, humidity, time.

Sections thoroughly impregnated and molded in red low-loss bakelite.

Average temperature co-efficient of only .002% per deg. C.

Q's as high as 3000 to 5000.

.000005 to .005 mfd. 1000 v. D.C. Test, or 500 v. D.C. Working.

## SILVERED MICA Capacitors

● These precision mica capacitors, molded in red low-loss bakelite for ready identification, are being used more and more. Meet the critical requirements of modern reception, particularly push-button tuning and oscillator padding circuits. Also used for capacity standards and other instrument work.

**Ask for CATALOG . . .**  
Our latest catalog features and lists silver mica capacitors. Ask jobber for copy — or write direct.



ming whatsoever was done. All calling and answering was done in a brief, snappy and businesslike manner with 100 per cent contacts all around and with a minimum of "small talk" entering into the picture (all were much too busy for that). In appreciation for their splendid job throughout the Meet, the *Daily Times* and the Chicago Park District invited all operators to the Victory Banquet at the Sherman Hotel on Saturday evening and, in addition, presented the Chicago Area Radio Club Council with a beautiful plaque suitably engraved. Anyone desiring additional information as to set-up, operations, results, etc., can get same by addressing the Council, Sherman Hotel, Chicago, Ill.

Chicago Area Radio Club Council,  
M. Warren Clark, W9YDY, Chairman

## Correspondence Department

(Continued from page 98)

### CODE PRACTICE STATIONS

1404 Ave. A, Plattsmouth, Neb.

Editor, *QST*:

. . . In going back through the April issue I noticed a letter from some fellow who was kicking about code practice stations.

I don't know the code, and I surely am trying to learn it. I have a code practice machine and study one to three hours a day, and find it hard going. I made fine progress while W9BSP and W9UA were giving code practice, and I wish they were still giving it. I believe that this method of code practice is better than others.

I want to be a ham and believe I will, in time. These fellows talking about learning code the hard way. I did not know there was an easy way; let me know if there is, as I surely need it.

I want to thank you for sponsoring these code practice stations. Keep it up.

— Edward H. Young

### QSL's

Bowbells, N. Dak.

Editor, *QST*:

Out in North Dakota is a wee small voice, otherwise known as chief operator of radio station W9LEM. This voice is wee but frequently heard on most of the ham bands. Here is my problem: You have all heard of every kind of "national week" of one kind or another. Why not have a "National QSL Week," when every good ham sits down, looks his log over very carefully and mails out all those QSL's he's been going to attend to for the past three months? I know my log could stand a little going over now, and I surely would appreciate some of those long-awaited cards for WAS and stuff.

— Kenneth J. Stenrude, W9LEM

### IT'S THE ANTENNA

2639 East Overlook Rd., Cleveland Heights, Ohio

Editor, *QST*:

I have read the letter from W9DZG in which he bellittles low power. . . .

Well, I have tried both high and low power, and power is not the question at all. The antenna is the factor which must be taken into account, because this factor, in my estimation, accounts for 99% of the signal put out. Give me a good antenna, well in the clear which tunes up well on the operating frequency, and a FB QSO can be had with any rig.

I won't go into detail about my use of flea power with various degrees of success and failure, but I have had some good results and sour results — depending upon the antenna. Of course the boob who puts his flea-power rig on 7000.001 kc. or 14,399.998 kc. because he "wants to work DX" will of course be squelched by the so-called DX boys droming for their mates.

The best territory for flea power consists of the following: 1750-1800, 3500-3800, 7200-7300, 14,270-14,340. Get yourself a good antenna and you will have FB QSO's whether you use a single '30 on the verge of freezing to death or a pair of 04-As roasting in Hades.

— Lloyd W. Frohring, W8PML

**PATENTED JEWEL MOVEMENT DELUXE**  
Genuine

# VIBROPLEX

*"World's Finest Semi-Automatic Key"*

This Patented JEWEL Movement De Luxe Vibroplex key places at your command a degree of sending performance which we believe is unapproachable by any other make of key. Operators who have used it say it is unquestionably a smart looking key that will outperform other keys you will be particularly delighted with the brilliant sending, polished chromium parts and base, colorful red switch knob, finger and thumb pieces, green silk cord and, above all, the "feather-touch" action of these JEWEL movement De Luxe Vibroplex keys.

**THE VIBROPLEX CO., Inc.**  
832 Broadway  
New York, N. Y.

Mail coupon for catalog of Vibroplex keys priced from \$9.95 to \$19.50

**THE VIBROPLEX CO., Inc.**  
832 Broadway, New York, N. Y.  
Please send me your New FREE Catalog of Vibroplex keys.

Name.....  
Address.....  
City..... State.....



BUY ON EASY TERMS · MAIL ORDERS PROMPTLY FILLED · WRITE FOR FREE CATALOG

*Congratulations QST on your 25th Birthday*

*Twenty-Five Years*

This month of December will long be a memorable one in the story of QST. Twenty-five years is a short time when we measure time in a historical sense, yet QST in this short period has become the guide of amateur radio the world over.

We here stand in awe at the accomplishments of QST. The pages of this sturdy lighthouse of amateur radio have been replete with the best in both amateur and experimental radio.

The editorial policy, honest and wise, has welded together in a bond of fellowship the whole amateur fraternity the world over. We know that the voice of amateur radio is raised in complete harmony in wishing QST many, many more years of continued success.

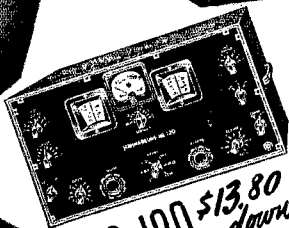

HQ-120 \$13.80  
*down*

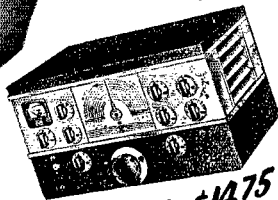

NC-200 \$14.75  
*down*

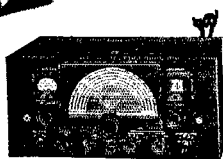

RME-99 \$13.74  
*down*



SX-24 \$6.95  
*down*

*Send for our New  
and Bigger Catalog  
with Exceptional Values*

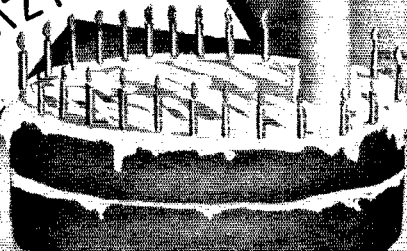

**The RADIO SHACK**  
167 WASHINGTON ST., BOSTON, MASS., U.S.A.

# Pocket Tester FOR THE AMATEUR

TRIPLETT  
Model 666-H

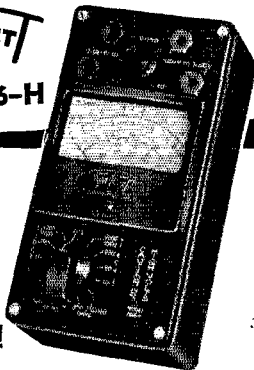

**\$14.50**

Net Price

**5000 VOLTS**

**SELF-CONTAINED!**

Size:  
3-1/16"  
x 5 3/8"  
x 2 3/8"

Model 666-H Volt-Ohm-Milliammeter is a complete pocket size tester — with AC and DC Voltage ranges to 5000 Volts (self-contained), AC and DC Voltage at 1000 ohms per volt 0-10-50-250-1000-5000; DC Milliamperes 0-10-100-500; Resistance 0-300 ohms; shunt type circuit, 10 ohms reading at center scale; 0-250,000 ohms, series type circuit, 3700 ohms at center scale. Higher resistance measurements available by using external batteries. Selector switch for all instrument readings. The ideal Pocket Volt-Ohm-Milliammeter for amateurs, radio technicians, industrial engineers, research, Black Molded case and Panel. Completely Insulated... with RED DOT Lifetime Guaranteed Measuring Instrument. . . . . **\$14.50** Dealer Net Price. . . . .

Section 2512 WRITE FOR CATALOGI Harmon Drive

THE TRIPLETT ELECTRICAL INSTRUMENT CO.

Buffalo, Ohio



DYNAMOTORS



SMALL MOTORS



HIGH FREQUENCY CONVERTERS



POWER PLANTS

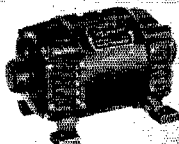

*Satisfied* SAY  
**THOUSANDS OF PINCOR  
CONVERTER USERS**

Where uninterrupted operation of such A.C. electrical equipment as gas-discharge signs, power amplifiers, motors, radios, musical instruments, etc., depend upon your converters, play safe by using Pincor Rotary Converters. They give thousands of hours of trouble-free service, even under the most adverse conditions.

Available with or without filter for converting 3, 12, 32, 115, 230 or special voltages D.C. to 110 or 230 volts A.C. up to 300 KVA. Quiet, smooth, light weight and compact. Send for NEW complete catalog today.

**PIONEER GEN-E-MOTOR CORPORATION**

Dept. R-47, 466 WEST SUPERIOR ST., Chicago, Ill.  
Cable: SIMONTRICE, New York

**PINCOR Products**  
FOR AIRCRAFT • SOUND • POWER SUPPLY USES

## "THREE"-GANG CONDENSER

1949 1st Ave., E., Cedar Rapids, Iowa

Editor, QST:

. . . I was an unfortunate 75-meter 'phone operator, and received the usual notice to investigate a Mr. So and So's radio who was hearing my station on his broadcast receiver. This was my second notice of this nature in 26 years on the air and I wanted to keep my record as clear as possible, so I immediately got in touch with the party in question and took a look at the set. It was a beautiful console, a year old in design, and very well shielded. This particular radio set is manufactured by one of the leading radio and electrical manufacturers in the business and a company of long standing in the field. Upon investigation there was a three-gang condenser all right, but only two sections of the condenser were connected in the set, thus affording *absolutely no preselection* at all. The set cost well over a hundred dollars, so what???

I installed a Meissner wave-trap in the set and the 75-meter interference was gone. I have a Collins 32G transmitter and I have tested with people right next door to this one complainant, and there is not a peep throughout the broadcast band on a truly selective set, so I have proved to my satisfaction that it isn't my transmitter or signal that is not according to regulations.

Now here is the payoff and the irony of the whole deal. The customer who bought the broadcast set says it was built by a responsible company, they paid over \$100 for it, and it is only a year old, so it must be the fault of the amateur. The customer not only refuses to pay the wholesale cost of the wave-trap (\$4.75) but, on top of it all, will not even write a letter to the amateur to the effect that the interference from his ham station has been eliminated after installing the wave-trap.

The whole gist of this letter of course comes down to the facts as to who is responsible for the condition of the "ham interference" in the broadcast set — the manufacturer who cheated on the false condenser in the set, which leaves the customer to believe he has a really selective set, when it really hasn't even a preselection stage — or the amateur for having an amateur station on the air, that meets all the requirements of the government? Then, who is supposed to pay for the wave-trap, labor, etc., in order that this one customer is satisfied with the broadcast set he purchased from a manufacturer who kidded this owner into thinking he did buy a fine selective set for his \$100?

— Chas. W. Boegel, W9CVU

## HERE'S HOW

Oakland, Calif.

Editor, QST:

As soon as I read the letter from John F. Lee, I dashed for the paper and pen. I know exactly how he feels; I had the same trouble. I followed advice of some other hams and did a little experimenting of my own on an a.c.-d.c., no-aerial midget set that went into convulsions every time I put my carrier on the air.

There were three things which I did, and I will mention them in the order of their importance and results. The first thing to do is to by-pass both sides of the a.c. line right at the chassis. The size of the condenser should be about .1 mfd.; but if the audio quality is impaired after this change, one of the condensers may be exchanged for a different value.

If the b.c.l. trouble still persists, an r.f. choke in the grid lead of one or the other of the audio stages should be tried.

I have taken for granted that Mr. Lee already tried wave-traps, shielded grid-leads in the r.f. and converter stages just as I did, and to no avail.

The difference in QRM before these changes and after them is as great as possible. Whereas before, there would be feedback with the receiver about 20 feet from the mike, there is now not even a squeal with the speech gain of the transmitter and the audio gain of the receiver wide open, even though the mike is placed right against the speaker.

I hope these pointers help W3CWG out, and that we don't see his call listed in "Silent Keys" for a good many years to come. Personally, I'd rather see listed the handle of the fellow who invented a.c.-d.c. midget sets!

— Lee Shaklee, W6PQV

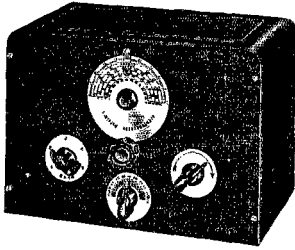

## MORE SIGNAL LESS NOISE

- Using an 1852 tube, a gain of 1000 or more and image rejection ratios of 500 or more may be obtained
- Coverage from 1.6 to 64 MC with band switching
- Electrical bandspread • Regenerative circuit with exceptionally smooth control • Built-in filament transformer • May be used as Short Wave Converter
- Completely wired and tested, Type 5DXP, Net Price \$19.80, less tube • Also available in kit form, Type 5DXK, Net Price \$16.50 complete except for tube • Send for Bulletin 103-A

**Browning Laboratories, Inc.**  
WINCHESTER, MASS.



**TURNER Microphones**  
Write for free new literature to  
The TURNER CO. Cedar Rapids, Iowa

Crystals licensed under patents Brush Development Co.

## LEARN CODE IT—BY HEARING IT

**Type S - \$17.50**

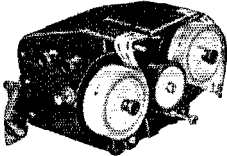

Sends from 4 to 60 words per minute. Higher speeds if desired. Complete with 10 rolls of double-perforated lesson tape of carefully selected and arranged matter for speediest results in learning code. Most compact and practical code teacher on market.

## Type J - \$12.50

Double-purpose instrument—code teacher and automatic sender. Sends from 6 to 70 words per minute. Built-in tape perforator. Cut your own code-practice tapes and message tapes. Complete with already cut practice tape and 5 rolls of blank tape. Repeats calls and messages indefinitely. Length of messages practically unlimited.

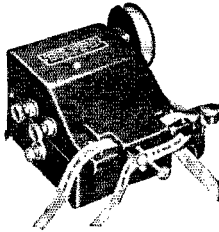

If your dealer can't supply you, write us

**FULLY GUARANTEED**

**GARDINER-LEVERING CO.** Haddon Heights  
New Jersey, U. S. A.

# B & W JUNIORS

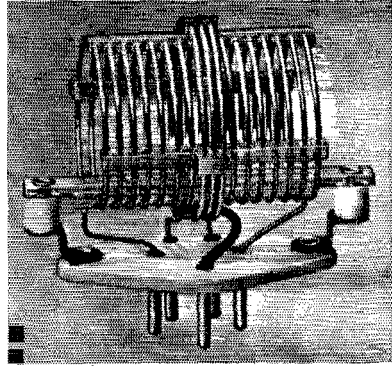

Amateur  
Net  
\$1.00  
Each

## NEW! HUSKIER! "TOPS" FOR MOST LIMITED-SPACE APPLICATIONS!

These new B&W JUNIORS far surpass, in ruggedness and efficiency, most of the larger, more bulky coils of comparable rating. Designed for optimum performance in many types of applications at input powers up to 75 watts and plate voltage to 850 volts, JUNIORS are available end linked, center linked and variable center linked. Get the whole story — at your jobber's or write direct.

Price Reductions Effective Oct. 1st

All Types B&W "BABIES" ..... 75c net  
"Baby" Coil Turrets ..... \$5.25 net

**BARKER & WILLIAMSON**

Radio Manufacturing Engineers • ARDMORE, PENNSYLVANIA

## Get Thru with the New SHURE STRATOLINER



You'll get a real thrill when you use this new "Stratoliner" Crystal Microphone. Distinctive new beauty. Famous Shure speech characteristic. High output level (29.7 db below 1 volt for 10 bar speech signal). Clear crisp signals. Cuts thru noise and static. Built-in R.F. filter protects

against burnouts. Swivel head. Iridescent Gray with bright chrome bars. Built-in cable connector. 7-ft. cable.

Model 708SH—Crystal Microphone without desk mount. List Price..... \$17.50

Model 708S—Same, complete with Model S36A Iridescent Gray Desk Mount.

List Price..... \$20.50

Shure Patents Pending. Licensed under patents of the Brush Development Company

**SHURE**

**M** SHURE BROTHERS • 222 W. HURON ST., CHICAGO, U.S.A.  
CABLE ADDRESS: SHUREMICRO  
**MICROPHONES & ACOUSTIC DEVICES**

# RECEIVERS FEATURED THIS MONTH AT TERMINAL'S

Two Conveniently Located Stores

- 68 WEST 45TH ST. (MIDTOWN)
- 80 CORTLANDT ST. (DOWNTOWN)

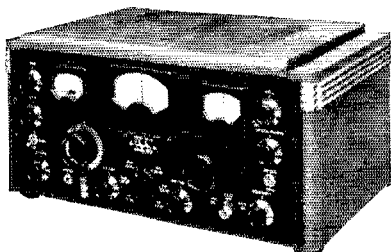

Hallicrafters SX28	.....	\$159.50
Hallicrafters SX25	.....	99.50
Hallicrafters SX24	.....	69.50
Hallicrafters S20R	.....	49.50
Hallicrafters S19R	.....	29.50

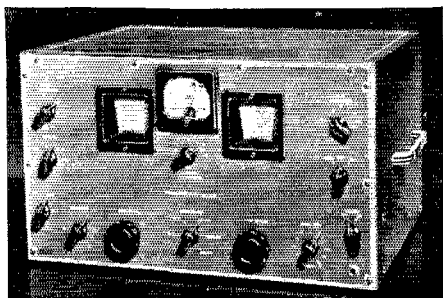

Hammarlund HQ-120X	.....	\$138.00
Hammarlund Super-Pro	.....	279.00
National NC-200	.....	147.50
National NC101X	.....	129.00
National HRO	.....	205.50
National NC100XA	.....	142.50
RME 99	.....	137.40
RCA AR77	.....	147.50
Echophone EC-1	.....	19.95

*If you wish, receivers ordered now  
will be held till Christmas*

**TERMINAL** Radio Corp.

68 West 45th St. • 80 Cortlandt St.  
2 stores in NEW YORK CITY  
Vanderbilt 6-5050 • Cable: TERMRADIO

## PLEA FOR RURAL HAM GEAR

Emmet, Ark.

Editor, QST:

... Since, unfortunately, rural electrification is not available in all localities—in fact, in relatively few—there is a great army of amateurs, or would-be amateurs, throughout the country who live in isolated districts far removed from the feeders of commercial power companies; and ironically enough, these are the fellows who need and would derive 100 per cent satisfaction from amateur radio communication, but who are so situated that, to them, contact by air is made the most difficult. For instance, the city chap need only step down the block a short distance to visit with a fellow human, while in many cases the rural chap must even walk perhaps several miles for this purpose. Just be reminded that all the U. S. does not lie within the city limits of Boston or Chicago or New York.

Radio manufacturing concerns apparently almost entirely disregard the needs of the country ham in supplying the needs of amateur radio; or at any rate their efforts along this line are at best diffident. Like the city ham, they seem to think in terms of readily available a.c. or d.c. supply. . . .

As is common knowledge, an extremely economical power system, from the standpoint of upkeep, is a small dynamotor driven by a storage battery of high ampere-hour capacity, which is in turn kept charged by either a wind driven unit or a small single-cylinder gas engine. The wind charger, while the more economical, cannot of course be employed in areas where the wind velocity is not of a rate sufficient to drive it.

The greatest objection to this system, or to any similar system, is the power limitation; that is, unless it is possible to step into the 200- or 300-watt gasoline-driven generator class. However, the initial cost of these latter units is usually prohibitive to the fellow who wrests a livelihood from the soil, which is in the main the occupation of the American rurality.

Herein lies a field of experimentation for those fellows with an experimental complex who supposedly have nothing more on which to vent their experimentative spleen. The need is a transmitter capable of fairly high, very economical output from a fairly low-power supply. "Can't be done?" . . . Seems we recall that not so long ago there came on the market a new one-and-one-half-volt radio receiver for the rural public which had theretofore undreamed of battery life.

No doubt there were a number who thought of such a receiver long before, but who dismissed the thought with a "It can't be done," and it was left up to the ones who said, "We'll see about it." Of course an angle such as this would largely be up to tube designers and manufacturers. But this is only one angle. The possibilities for improvement along many lines are too numerous to mention. . . .

The cause is worth while, and we invite your united efforts in behalf of the great host of country hams who lift their voice in vast litany to the rhythmic tempo of "Economy!"

— Bryan H. Erwin, W6HWT

## BRIEFS

Nearly 300 registered at the Cuyahoga Radio Association (Cleveland, Ohio) for its free code and theory class. So large was the crowd that the meeting had to be held on the lawn at Red Cross Headquarters. The Association then took over space in the American Legion Headquarters, and this space also was filled to overflowing. Many registrants and club members had to sit on the steps and listen to the amplifier for information as to what was going on! As 10 YL's were in the group, there was no lack of volunteer code instructors. Hi. It looks like a busy season for C.R.A.!!

— . . . —

A feature of a recent meeting of the York Road Radio Club was that President Martin, W3QV, used a code oscillator in order to run the meeting. The various committee reports were requested in c.w., as well as comments regarding the same. President Martin had no occasion to say one word by voice! Recordings were played of c.w. and 'phone signals made on the amateur bands, including many of the club's own members. Later in the evening a recording was made of a dozen c.w. members all keying the same sentence. In the play-back it was agreed that W3EEW was outstanding in his spacing and letter-forming.

# Your Nearby Dealer Is Your Best Friend

Your nearby dealer is entitled to your patronage. He is equipped with a knowledge and understanding of amateur radio. He is your logical source of advice and counsel on what equipment you should buy. His stock is complete. He can supply your needs without delay. His prices are fair and consistent with the high quality of the goods he carries. He is responsible to you and interested in you.

One of these dealers is probably in your city — Patronize him!

## ATLANTA, GEORGIA

Radio Wire Television Inc.  
265 Peachtree Street  
"The World's Largest Radio Supply House"

## JAMAICA, L. I., NEW YORK

Radio Wire Television Inc.  
90-08 166th Street (Merrick Road)  
"The World's Largest Radio Supply House"

## BALTIMORE, MARYLAND

Radio Electric Service Co.  
3 N. Howard St.  
Everything for the Amateur

## MONTREAL, CANADA

Canadian Electrical Supply Co., Ltd.  
285 Craig Street West  
Largest Distributors of Radio Parts & Testers in British Empire

## BOSTON, MASS.

Radio Wire Television Inc.  
110 Federal Street  
"The World's Largest Radio Supply House"

## NEWARK, N. J.

Radio Wire Television Inc.  
24 Central Avenue  
"The World's Largest Radio Supply House"

## BRONX, NEW YORK

Radio Wire Television Inc.  
542 East Fordham Road  
"The World's Largest Radio Supply House"

## NEW YORK, N. Y.

Radio Wire Television Inc.  
100 Sixth Avenue  
"The World's Largest Radio Supply House"

## BUFFALO, NEW YORK

Radio Equipment Corp.  
326 Elm Street  
W8PMC and W8NEL — Ham, service and sound equipment

## NEW YORK, N. Y.

Harrison Radio Company  
12 West Broadway  
Harrison Has It! Phone WO 2-6276 for information or rush service

## BUFFALO, NEW YORK

Dymac Radio  
1531 Main Street — Cor. Ferry  
Open Evenings GA. 0252

## PHILADELPHIA, PENNSYLVANIA

Eugene G. Wile  
10 S. Tenth Street  
Complete Stock of Quality Merchandise

## HARTFORD, CONNECTICUT

Radio Inspection Service Company  
227 Asylum Street  
What do you want? We have it. Radio exclusively

## PROVIDENCE, RHODE ISLAND

W. H. Edwards Company  
85 Broadway  
National, Hammarlund, Hallicrafter, Thordarson, Taylor, RCA

## HARTFORD, CONNECTICUT

Hatry & Young, Inc.  
203 Ann Street  
Stores also in Bridgeport and New Haven

## RICHMOND, VIRGINIA

The Arnold Company  
Broad at Harrison St.  
W3EQQ — "The Virginia Ham Headquarters" — W3FBL

## HOUSTON, TEXAS

R. C. & L. F. Hall  
1021 Caroline Street (C 0721)  
"Specialists in Amateur Supplies"

## SCRANTON, PENNSYLVANIA

Scranton Radio & Television Supply Co.  
519-521 Mulberry Street  
Complete Stock of Quality Amateur Supplies

# CRYSTAL TALK

## By HIPOWER

The Hipower Crystal Company, one of America's oldest and largest manufacturers of precision crystal units, is able to offer the amateur and manufacturer attractive prices because of their large production and the exclusive Hipower grinding process. Numbered among Hipower's customers are:

U. S. Army and U. S. Navy  
National Broadcasting Co.  
Columbia Broadcasting System  
Mutual Broadcasting System  
United States Airlines

Such satisfied customers provide assurance that whatever the need may be, Hipower can supply it. For the amateur, we offer the following world famous crystals.



### "EMERALDS"

Guaranteed to have a drift with temperature change of less than 10 CY. per °C. per MC. With holder.  
160-80-40 meters . . . \$3.35  
Special 20 meter unit . . . \$5.50

### "RUBIES"

One of the finest amateur crystal units available. Guaranteed drift of less than 4 CY. per °C. per MC. With holder.  
160-80-40 meters . . . \$4.50  
Special 20 meter unit . . . \$7.25

AVAILABLE AT YOUR PARTS DISTRIBUTOR

Manufacturers Write for Prices

## HIPOWER CRYSTAL COMPANY

2035 CHARLESTON ST.

CHICAGO, ILL.



## CREI Graduates, As a Group, Are The HIGHEST PAID in the Industry!

CREI Provides Advanced Practical Engineering Training for Professional Radiomen to Qualify for Better Jobs in Every Branch of the Industry

● The success of CREI men in every branch of radio should prove an incentive to investigate thoroughly the opportunities that await you through CREI training in Practical Radio Engineering. We are not interested in bringing "beginners" into the industry, but WE ARE interested in helping professional radiomen NOW in radio to advance to better-paying jobs. 5,000 students and graduates prove we are doing it — surveys show that CREI men, as a group, are the HIGHEST PAID! New opportunities for trained men are being created constantly. Now is the time for you to advance yourself with advanced practical training.

Write for Details and Free Book Now!

If you are a professional radioman and want to make more money — let us prove to you we have something you need to qualify for job opportunities that can be yours. To help us intelligently answer your inquiry, please state briefly your education, radio experience and present position.



## Capitol Radio Engineering Institute

Dept. Q-12

3224 16th St. N. W., Washington, D. C.

## A Microwave Superhet

(Continued from page 59)

ble to obtain 18 volts r.m.s., constant as closely as it could be read on the vacuum tube voltmeter, with inputs varying from 0.003 to 3 volts. Above 3 volts, something overloaded, the output went up and the waveform went haywire, but up to this input voltage, distortion was not serious.

### I.F. Section

The i.f. amplifier used two 1852's. The i.f. transformers were constructed mainly from Sickles parts, except for the iron-core coils which came from old Aladdin units around the lab. It is doubtful if the iron cores were at all useful since the coils were coupled tightly and loaded with resistors to get a 300-kc. pass band.

A photo of the complete r.f.-i.f. chassis is shown in Fig. 5. The oscillator is mounted on top of the chassis with the mixer directly beneath it. The oscillator was tunable over a small range by means of a paddle controlled from the front panel. This paddle was rotated by a preloaded worm drive taken from an auto-radio condenser.

A photo of the audio-filter unit is shown in Fig. 6.

This receiver was designed to operate in conjunction with two modulated-oscillator transmitters using W.E. 316-A tubes. The transmitters supplied power to two horn-type antennas, radiating one beam modulated at 90 cycles directed above the approach path and another beam modulated at 150 cycles directed below the approach path. The two oscillators were operated on very nearly the same frequency (approximately 10 kc. apart) and were received simultaneously and continuously. The relative outputs of the two beams were separated after demodulation by the audio filter. A usable signal was provided at about 4½ miles with this arrangement.

This receiver operated in a very satisfactory manner. The reliability and stability of the u.h.f. circuits apparently equal those of the lower frequency equipment used in the receiver. And aircraft service isn't considered the easiest in the world either!

### BRIEFS

At the joint Pacific-Southwestern Division Convention held in Long Beach, August 31st, September 1st-2d, all amateurs present were afforded the opportunity to try for A.R.R.L. Club Award Code Proficiency Certificates. The following qualified at the speeds indicated: 15 w.p.m. — W6MNS, AOT, W. Omgen; 20 w.p.m. — W6BPP, PNV, RKD; 25 w.p.m. — W6NGK, OEJ, DAJ, PDK, PYA, W9HKB, C. A. Hill, A. R. Van Compernelle; 30 w.p.m. — W6BKZ, PKX, QIL, QKB, DOU, RDR, W7GLK; 35 w.p.m. — W6BIP, BP, KFC, AGF, NEZ, CIS, BPM, OLR, AM, GTM, W9TMM.

Winners in the various code contests held at the convention were as follows. Amateur Receiving: W6AGF (40 w.p.m.), W6NHZ and W6BPM (35 w.p.m.). Commercial Receiving: W6RJH, W9TMM and W6BP (40 w.p.m.). Ladies Receiving: W7GLK (30 w.p.m.) and W6OEJ. Amateur Sending: W6RDR (42 w.p.m.), W6HJT (40 w.p.m.), W6BPM (38 w.p.m.). Commercial Sending: W6BP (50 w.p.m.), W6NKR (47 w.p.m.), W6RJH (42 w.p.m.). Don Wallace, W6AM, was in charge of the code contests, and his committee graded some 250 papers right while the convention went on. Certificates were awarded at the banquet, where 635 were in attendance.

★ ★ ★ ★ ★

# The radio amateur's handbook

THE STANDARD MANUAL OF AMATEUR  
RADIO COMMUNICATION



# 1941

PUBLISHED BY THE  
AMERICAN RADIO  
RELAY LEAGUE

\$1 IN CONTINEN-  
TAL U. S. A.



See it at your Dealer's or Order Direct

# THE ONE FOR '41!

---



## *The Radio Amateur's Handbook*

is the all-purpose volume on radio. Text, data book, operating manual — it is all these, and more. A comprehensive text on radio fundamentals and design, it is probably more used in radio schools and colleges than any other volume. An outstanding collection of practical constructional data, it offers a wide variety of tried and proven designs for all the latest equipment. As an operating manual, it provides information on station operation and procedure available from no comparable source.



**I**N the 1941 edition, the basic arrangement and method of presentation initiated in the 1940 edition has been retained. Dozens of new pieces of equipment of all kinds were built for this edition. There are three new receivers, for example — a two-tube beginner's set, a three-tube superhet covering long waves as well as short, and a 7-tube super. New this year also are a converter and a beat oscillator unit. The transmitter construction chapter describes sixteen different units, including several simple and inexpensive transmitters for beginners, as well as band-switching exciters and amplifiers, a new e.c.o., and a number of antenna systems. Modulation, instruments and measurements, u.h.f. — all these sections are generously sprinkled with new gear not hitherto described. The u.h.f. section, in particular, has been considerably expanded, with a whole new chapter dealing with frequency modulation alone. Add these to all the features of earlier editions — and the 1941 HANDBOOK is now more than ever the "greatest dollar's worth in radio."



---

**\$1.00**  
postpaid in  
Continental  
U.S.A.

★  
**\$1.50**  
postpaid  
elsewhere

## **AMERICAN RADIO RELAY LEAGUE**

West Hartford, Connecticut

---



# HAM-ADS

(1) Advertising shall pertain to radio and shall be of nature of interest to radio amateurs or experimenters in their pursuit of the art.

(2) No display of any character will be accepted, nor can any special typographical arrangement, such as all or part capital letters be used which would tend to make one advertisement stand out from the others.

(3) The Ham-Ad rate is 15¢ per word, except as noted in paragraph (6) below.

(4) Remittance in full must accompany copy. No cash or contract discount or agency commission will be allowed.

(5) Closing date for Ham-Ads is the 25th of the second month preceding publication date.

(6) A special rate of 7¢ per word will apply to advertising which, in our judgment, is obviously non-commercial in nature and is placed and signed by a member of the American Radio Relay League. Thus, advertising of bona fide surplus equipment owned, used and for sale by an individual or apparatus offered for exchange or advertising inquiring for special equipment, if by a member of the American Radio Relay League takes the 7¢ rate. An attempt to deal in apparatus in quantity for profit, even if by an individual, is commercial and all advertising by him takes the 15¢ rate.

Provisions of paragraphs (1), (2), (4) and (5) apply to all advertising in this column regardless of which rate may apply.

Having made no investigation of the advertisers in the classified columns, the publishers of QST are unable to vouch for their integrity or for the grade or character of the products advertised

**QUARTZ** — direct importers from Brazil of best quality pure quartz suitable for making piezo-electric crystals. Diamond Drill Carbon Co., 719 World Bldg., New York City.

**QSL'S, Maps, Cartoons.** Free samples. Theodore Porcher, 7708 Navajo, Philadelphia, Pa.

**CRYSTALS, mounted, 80-160, \$1.25, V-cut 40, \$2.25.** R9 Crystals, 338 Murray Ave., Arnold, Pa.

**USED receivers.** Bargains. Cash only. No trades. Price list 3¢. W3DQ, Wilmington, Del.

**QSL'S, W8JOT, Box 101, Rochester, N. Y.**

**TELEPLEXES,** Instructographs bought, sold. Ryan's, Hannibal, Mo.

**CALLBOOKS** — Fall edition now on sale containing complete up-to-date list of radio hams throughout entire world. Also world prefix map, and new time conversion chart. Single copies \$1.25. Canada and foreign \$1.35. Radio Amateur Call Book, 610 S. Dearborn, Chicago.

**MACAUTO code machines:** low monthly rental 50,000 words practice tapes. Write N. C. Ayers, 711 Boylston St., Boston, Mass. GRAnite 7189-W.

**QSL'S** — Brownie, W3CJI, 1725 Frankfield Ave., Allentown, Pa.

**CRYSTALS:** police, marine, aircraft. C-W Mfg. Co., 1170 Esperanza, Los Angeles.

**1000 watt G.E. transformers** 1100-2200-4400 volts each side c.t. Guaranteed. \$13.50. Dawson, 5740 Woodrow, Detroit, Mich.

**GENERAL Electric dynamotors** 24/750 volt 200 mls \$15, Simon 500 watt 500 cycle with exciters \$8. List. Henry Kienzle, 200 Hart Blvd., Staten Island, N. Y.

**QSL'S, all colors, cartoons, snappy service.** Write for free samples today. W1BEF, 78 Warrenton, Springfield, Mass.

**CRYSTALS in plug-in heat dissipating holders.** Guaranteed good oscillators. 160M-80M AT \$1.25; 40X \$1.65. 80M varifrequency (5 kilocycle variance) complete \$2.95. State frequency desired. C.O.D.'s accepted. Pacific Crystals, 1042 S. Hicks, Los Angeles.

**COMMERCIAL radio operators examination questions and answers.** One dollar per element. G. C. Waller, W5ATV, 6540 Washington Blvd., Tulsa, Okla.

**CRYSTALS:** famous P.R., mounted in latest Alsimag 35 holders — 40, 80 meter PR-X, 160 meter PR-Z, \$3; 40, 80 meter PR-Z (low drift), \$3.50; 20-meter PR-20, \$4.50; unconditionally guaranteed. Immediate shipment. Wholesale Radio Labs., Council Bluffs, Iowa, W9GFFQ.

**WANTED HQ120X** and Utah units 2, 3, and 5. Chas. M. Boyd, Tracy City, Tenn.

**SELL:** Gross CB25 phone CW rig. Best offer. W2KZT, 141-28 73rd Terrace, Flushing, L. I.

**QSL'S? — SWL's?** Unbeatable. Made-to-order. Samples? W8DED, Holland, Mich.

**RTL-trscvr-387w** mikes. Write W9AXZ, Chicago.

**SELLING out** — enclosed rack 600 watt phone — 1000 watt CW transmitter, Thordarson preamplifier, Super-Pro, Vibroplex. Make offer. W2JOZ.

**RME-69 and DB-20.** Excellent condition, first check \$99; pair 813's, five hours. \$40. Rex Bassett, Niles, Mich.

**QSL samples, prices for hams.** W2AEY, 338 Elmora, Elizabeth, N. J.

**SELL** — Hammarlund — 100 watt band — switching xmitter, complete with tubes, R.F. only \$30. W2HFM.

**SX-16 receiver** and Utah 400 watt phone, CW transmitter complete with microphone, coils, crystals. \$400. Terms. W9LVU.

**QSL'S.** Free samples. Printer, Corwith, Iowa.

**SELL:** 200 watt transmitter — CW, T55 in final. Best offer gets it. W5HJO, Haynesville, La.

**SKY Buddy** 6 mos. old. Widrevitz, 1249 S. Millard, Chicago, Ill.

**FOR sale or trade:** 1 Skyryder 5 and 10 receiver, table or panel mounting, \$37.50. 1 Ottawa transmitter, table model, 20 watts fone, 60 watts CW, coils for 10, 20, 40, 80, and 160, complete less mike, \$50. 1 Howard 430 model receiver, \$15. Or what? W9KXX.

**QSL'S** — SWL's. Fritz, 455 Mason, Joliet, Ill.

**WRITE Bob, W9ARA,** for best deal on all amateur receivers, transmitters, kits, parts. You get best terms (because I finance them myself); largest trade-in; personal cooperation; lowest prices. Quickest delivery of the new NC-200 and all other receivers. New Howard 400's with crystals \$59.95, SX-23's \$79.50. Write, W9ARA, Butler, Mo.

**RECONDITIONED** guaranteed amateur receivers and transmitters at lowest prices. All makes and models cheap. Ten day free trial. Terms. Write for free list, W9ARA, Butler, Mo.

**QSL'S.** Finest. Lowest prices. Maleco, 1805 St. Johns Place, Brooklyn, N. Y.

**SELLING out:** kw transmitter — whole or parts, receiver, ECO, transmitting tubes. All equipment reasonable. W8OPG.

**CRYSTALS:** three blanks \$1. QSO Crystals, Indiana, Pa.

**60 QSL'S 35¢.** Vachovetz, Glenville, Tarrytown, N. Y.

**WRITE** for big new amateur catalog. More kits and exclusive items than any other catalog on market. Describes new 70 watt rig only \$35. Modulator speech unit to modulate up to 80 watts only \$25 complete. Write Leo, W9GFFQ, today. Wholesale Radio Labs., Council Bluffs, Iowa.

**RECONDITIONED** receivers 90 day guarantee. Free trial lowest terms all makes; complete SX-25 \$79.50. Comet Pro crystal \$39.50, PEB 15, SW3 \$39.50. Write for others. Write Leo, W9GFFQ, for best deal always.

**TRANSMITTING** headquarters; all latest transmitting kits on hand wired lowest prices at lowest terms. Write for special prices on aluminum tubing for beams; large 4 1/2" U. S. map 15¢. Write Leo, W9GFFQ, for everything in radio. Council Bluffs, Iowa.

**QSL'S** — SWL's. Colorful, economical, W9KXL, 819 Wyandotte, Kansas City, Mo.

**SERVICEMEN.** Supreme 89-D tube tester and Universal meter. Like new. \$17.50. W1CLE, Box 92, Rockland, Mass.

**LUMINOUS QSL's** released soon. QSL's, SWL's, artist's designs, brilliant colors. W8LKH — Zip Print, Warren, Ohio.

**CRYSTALS:** 1750-2050, AT cut, within five kilocycles, unmounted, \$1.85. Mounted, \$2.75. Ham Crystals, 1104 Lincoln Place, Brooklyn, N. Y.

**RADIO KITS** — \$3.95 up. Single band; all-wave, 5-10 tubes. Fluorescent lighting. Save 50%. Catalog — free. McGee Radio, P-2035, Kansas City, Mo.

**QSL'S** — SWL's. 100, 3 color, 75¢. Lapco, 344 W. 39th, Indianapolis, Ind.

**CRYSTALS, commercial or amateur:** aircraft, marine, and all types of low drift units for commercial services at attractive prices. Send for catalog. For the amateur: those fully guaranteed, fracture-resisting, T9 crystals, 40, 80, and 160 band to 2050 Hz. \$1.60 postpaid. Spot frequencies only \$2. T9 ceramic holder \$1. C.O.D.'s accepted. Sold by: Frank Anzalone, 375 W. 46th, N. Y. C.; Kerr's Radio Shop, El Paso, Texas; Pembleton Labs., Ft. Wayne, Ind.; Distribuidora Mexicana de Radios, Monterrey, Mexico; Henry Radio Shop, Butler, Mo.; and Eidson's, Temple, Texas.

**SACRIFICE** All Star 40 watt CW transmitter \$30 complete. W9QEC, 2500 Ash, Denver, Colo.

**GENERAL Industries** recording turntable \$27 net. Astatic crystal cutters, matching transformers, pickups, microphones. Recording blanks, stylii, needles, etc., at your amateur net price. Seeli's Radio, Hartford, Conn.

**SURPLUS equipment, single-dial transmitter, power supply, coils, all accessories, described QST, June, 1940, \$275; 101X receiver, S meter, cabinet speaker, \$95. W9YZH, 7011 Corbitt Ave., University City, Mo.**

**SACRIFICE** \$200 new transmitting equipment for \$100 cash. W4AWQ, 7126 3rd Ave., S., Birmingham, Ala.

# OST

## YEARLY BINDERS



### Are We Right?

You should have at least two of them—one for your complete 1940 file of copies, and one for each 1941 issue as published.

With each Binder is furnished a sheet of gold and black gummed labels for years 1922 through 1941. The proper one can be cut from the sheet and pasted in the space provided for it on the back of the binder.

Price **\$1.50** postpaid

Available only in United States and Possessions

**THE AMERICAN RADIO RELAY LEAGUE**  
West Hartford, Conn.

### ★ CHRISTMAS SEALS ★



Help to Protect Your Home from Tuberculosis

### RADIO TECHNOLOGY



RCA Institutes offer an intensive course of high standard embracing all phases of Radio and Television. Practical training with modern equipment at New York and Chicago Schools. Also specialized courses in Aviation Communications, Radio Servicing and Commercial Operating. Illustrated Catalog on request

**RCA INSTITUTES, INC.** Dept. ST-40

A Radio Corporation of America Service

75 Varick St., New York

1154 Merchandise Mart, Chicago

### SICKLES COILS

ALL TYPES OF RF AND IF WINDINGS

Manufactured by

**F. W. SICKLES COMPANY**

300 Main Street

Springfield, Mass.



### ★ TR-112 ★

#### Transmitter - Receiver

The six tube no compromise 2½ meter Transmitter-Receiver with many exclusive features.

Write for literature on this and other properly engineered equipment.

TR-112..... \$39.75  
Amateur Net

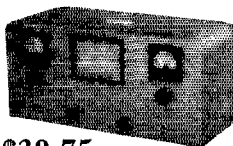

### RADIO TRANSMITTER LABORATORIES

8627 115 STREET

RICHMOND HILL, NEW YORK CITY

CABLE ADDRESS: "RAYRALAB", NEW YORK

# Where to buy it

A directory of suppliers who carry in stock the products of these dependable manufacturers.

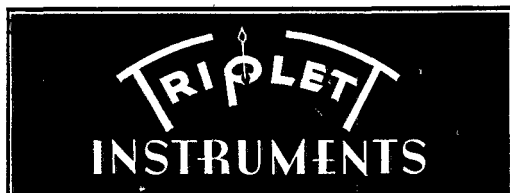
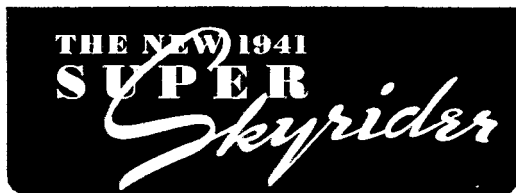

<b>ALBANY, N. Y.</b>	Uncle Dave's Radio Shack	356 Broadway	<b>ALBANY, N. Y.</b>	Uncle Dave's Radio Shack	356 Broadway
<b>ATLANTA, GEORGIA</b>	265 Peachtree Street Radio Wire Television Inc.		<b>ATLANTA, GEORGIA</b>	265 Peachtree Street Radio Wire Television Inc.	
<b>BOSTON, MASS.</b>	Radio Shack	167 Washington Street	<b>BOSTON, MASS.</b>	Radio Shack	167 Washington Street
<b>BOSTON, MASS.</b>	Radio Wire Television Inc.	110 Federal Street	<b>BOSTON, MASS.</b>	Radio Wire Television Inc.	110 Federal Street
<b>BRIDGEPORT, CONN.</b>	Hatry & Young, Inc.	177 Cannon Street	<b>BRIDGEPORT, CONN.</b>	Hatry & Young, Inc.	177 Cannon Street
<b>BRONX, N. Y.</b>	Radio Wire Television Inc.	542 East Fordham Rd.	<b>BRONX, N. Y.</b>	Radio Wire Television Inc.	542 East Fordham Rd.
<b>BUTLER, MISSOURI</b>	Henry Radio Shop	211-215 N. Main Street	<b>BUTLER, MISSOURI</b>	Henry Radio Shop	211-215 N. Main Street
<b>CHICAGO, ILL.</b>	Allied Radio Corp.	833 W. Jackson Blvd.	<b>CHICAGO, ILLINOIS</b>	Allied Radio Corp.	833 W. Jackson Blvd.
<b>CHICAGO, ILL.</b>	Radio Wire Television Inc.	901-911 W. Jackson Blvd.	<b>CHICAGO, ILL.</b>	Radio Wire Television Inc.	901-911 W. Jackson Blvd.
<b>CINCINNATI, OHIO</b>	United Radio, Inc.	1103 Vine Street	<b>CINCINNATI, OHIO</b>	United Radio, Inc.	1103 Vine Street
<b>DETROIT, MICH.</b>	Radio Specialties Co.	325 E. Jefferson Ave.	<b>DETROIT, MICHIGAN</b>	Radio Specialties Co.	11800 Woodward Ave.
<b>HARTFORD, CONNECTICUT</b>	Radio Inspection Service Company	227 Asylum Street	<b>HARTFORD, CONN.</b>	Hatry & Young, Inc.	203 Ann Street
<b>HOUSTON, TEXAS</b>	R. C. & L. F. Hall	1021 Caroline Street	<b>JAMAICA, L. I.</b>	Radio Wire Television Inc.	90-08 166th Street
<b>INDIANAPOLIS, INDIANA</b>	Van Sickle Radio Supply Co.	34 West Ohio Street	<b>LITTLE ROCK, ARKANSAS</b>	Beem Radio Company	409 W. 3rd St.
<b>JAMAICA, L. I.</b>	Radio Wire Television Inc.	90-08 166th Street	<b>MINNEAPOLIS, MINNESOTA</b>	Lew Bonn Company	1124-26 Harmon Place
<b>KANSAS CITY, MO.</b>	Burstein-Applebee Company	1012 McGee Street	<b>NEW HAVEN, CONN.</b>	Hatry & Young, Inc.	1172 Chapel Street
<b>NEW HAVEN, CONN.</b>	Hatry & Young, Inc.	1172 Chapel Street	<b>NEW YORK, N. Y.</b>	Harrison Radio Co.	12 West Broadway
<b>NEW YORK, N. Y.</b>	Radio Wire Television Inc.	100 Sixth Ave.	<b>NEWARK, N. J.</b>	Radio Wire Television Inc.	24 Central Ave.
<b>NEWARK, N. J.</b>	Radio Wire Television Inc.	24 Central Ave.	<b>READING, PENN.</b>	George D. Barbey Company	404 Walnut Street
<b>READING, PENN.</b>	George D. Barbey Company	404 Walnut Street	<b>SCRANTON, PENN.</b>	Scranton Radio & Television Supply Co.	519-21 Mulberry Street
<b>SCRANTON, PENN.</b>	Scranton Radio & Television Supply Co.	519-21 Mulberry Street	<b>WASHINGTON, D. C.</b>	Sun Radio & Service Supply Co.	938 F Street, N. W.
<b>WASHINGTON, D. C.</b>	Sun Radio & Service Supply Co.	938 F Street, N. W.			

Listings on this page do not necessarily imply endorsement by QST of the dealers or of other equipment sold by them.

YOU CAN BE SURE  
WHEN YOU BUY FROM

**QST**

**ADVERTISERS**

“Advertising for *QST* is accepted only from firms who, in the publisher’s opinion, are of established integrity and whose products secure the approval of the technical staff of the American Radio Relay League.”

*Quoted from QST’s advertising rate card.*

*Every conceivable need of a radio amateur can be supplied by the advertisers in QST. And you will know the product has the approval of the League’s technical staff*

*Index to Advertisers*

	PAGE
Aerovox Corporation.....	110
American Radio Institute.....	101
Astatic Microphone Laboratory, Inc.....	107
Barker & Williamson.....	113
Bliley Electric Company.....	78, 97
Brill Company, W. D.....	106, 111
Browning Laboratories, Inc.....	113
Brush Development Company, The.....	81
Candler System Company.....	80
Capitol Radio Engineering Institute.....	116
Cardwell Mfg. Corp., Allen D.....	90
Centralab.....	73
Collins Radio Company.....	Cov. 2
Cornell-Dubilier Electric Corp.....	82
Dodge’s Institute.....	101
Eitel-McCullough, Inc.....	69
Electric Specialty Mfg. Company.....	107
Gardiner-Levering Company.....	113
General Electric Company.....	7, 72
Hallcrafters, Inc., The.....	1, 2, 4, 5
Hammarlund Mfg. Company, Inc.....	74, 75
Harrison Radio Company.....	123
Harvey Radio Company.....	109
Hatry & Young.....	106
Henry Radio Shop.....	105
Hipower Crystal Company.....	116
Instructograph Company, The.....	101
International Resistance Company.....	95
Johnson Company, E. F.....	88
Kenyon Transformer Company, Inc.....	96
Lampkin Laboratories.....	97
LeFebure Corporation.....	92
Mallory & Company, Inc., P. R.....	68
Massachusetts Radio School.....	97
McGraw-Hill Book Company, Inc.....	76
Meissner Mfg. Company.....	89
Millen Mfg. Company, Inc., James.....	84
National Company, Inc.....	Cov. 3, 67, 70, 71
Newark Electric Company.....	87
Nilson Radio School.....	104, 108
Ohmite Mfg. Company, Inc.....	86
Par-Metal Products Corp.....	97
Pioneer Gen-E-Motor Corp.....	112
Port Arthur College.....	104
Precision Apparatus Corp.....	101
RCA Institutes, Inc.....	120
RCA Mfg. Company, Inc.....	Cov. 4, 77
Radio City Products.....	94
Radio Mfg. Engineers, Inc.....	83
Radio Shack, The.....	111
Radio Transceiver Laboratories.....	120
Scientific Radio Service.....	107
Shuler Supply Company.....	106
Shure Brothers.....	113
Sickles Company, F. W.....	120
Simpson Electric Company.....	79
Solar Mfg. Corp.....	120
Speer Carbon Company.....	100
Sun Radio Company.....	95
Taylor Tubes, Inc.....	91
Teleplex Company.....	97
Terminal Radio Corp.....	114
Thordarson Electric Mfg. Company.....	85
Triplet Electrical Instrument Company, Inc.....	112
Turner Company, The.....	113
United Transformer Corp.....	124
Universal Microphone Company, Ltd.....	107
Vibroplex Company, Inc., The.....	110
Wholesale Radio Laboratories.....	93
Yaxley.....	68

# HARRISON • RADIO • COMPANY

• 12 WEST BROADWAY • NEW YORK CITY

Dear Friend:

If you are thinking of buying some radio equipment, every word of this letter is of importance to you. I am an Authorized Distributor of all Amateur apparatus, and can supply you with everything you need. I deal direct with every manufacturer and can give you the latest and best at lowest prices. I have one of the most complete stocks in the country. My prompt delivery service, very liberal trade-in allowances, easiest and simplest time payment terms, and my personal attention to your every wish is sure to please you!

I have all latest model Halliorafters, Hammarlund, National, RME, RCA, Howard, Echophone, etc, receivers in my stock for immediate shipment. (From the factory if you prefer) You need send only a \$5.00 deposit with your order. Try it for ten days and if you don't like the receiver your money will be returned.

Also all National, Hallicrafters, Thordarson, Abbott, RTL, UTC, Stancor, etc, Transmitters and Kits are offered. We wire and test kits in our Shop at reasonable rates.

You can buy everything from me on my easier credit terms for your convenience. Receivers, Transmitters, Kits, etc. Down payment can be as little as 10% of the cash price. The balance in easy monthly payments. Your entire cost for credit is only 6% on the balance. The larger your down payment, the smaller your interest.

I take your old receiver or transmitter in trade. Tell me make, model, age, and condition. Also mention what allowance you feel would be fair to us both.

I also buy modern transmitters, receivers, and complete stations for cash. I always have some good values in reconditioned equipment. It will pay you to communicate with me.

Send to me for prompt delivery of any item you see in any catalog or advertisement at the lowest price shown. I know you'll like doing business with me because I really want every one of my customers to be completely satisfied. Send me your orders; you, too, can depend upon my fullest cooperation and help. I want you to be my customer and friend, and I promise to always give you the very fairest and squarest deal.

Sincerely yours,

73

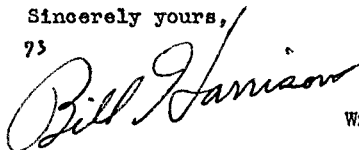

W2AVA

•  
SHORT WAVE  
SPECIALISTS  
SINCE 1928

•  
EVERYTHING  
IN RADIO  
ELECTRICAL AND  
ELECTRONIC  
EQUIPMENT

•  
TELEPHONE  
WORTH 2-  
6 2 7 6

•  
**HARRISON HAS IT!**



## *The Word Is Getting Around...*

"For national defense or private industry... where dependability and adherence to specifications are essential... transformer users turn to UTC."

**THERE IS NO SUBSTITUTE FOR EXPERIENCE**

*Whether STANDARD or SPECIAL  
UTC has a transformer for every purse and purpose*

# UNITED TRANSFORMER CORP

Write: COMMUNICATIONS DIV. ★ 150 VARICK ST. ★ NEW YORK, N. Y.

## Index to Volume XXIV—1940

### AMATEUR RADIO STATIONS

CO2LY, PK4KS, CO2JJ, W2DBQ, VS6AO . . . . .	33, Jan.
W9NLP, W9SZW, SU1AM, ZL1MR . . . . .	64, Feb.
W8STD, W6BXB, W6FGQ, W5VV . . . . .	54, Mar.
W2ELN, W3EIM, W6MQF, W8KSL, W9ZVO .	56, Apr.
W6MYK, W9RQM, HH2MC, W4DRE, W9KJF	61, June
W8UKX . . . . .	41, Oct.
W8AU, W8KNF, CM2WL, W2GVZ, W6KW . .	62, Oct.
K7BUB — Ham Paradise in Alaska . . . . .	28, Sept.

### ANTENNAS

Balloon-Supported Antennas . . . . .	40, Apr.
Building and Tuning a Three-Element Beam (Ulmer) . . . . .	44, Feb.
The Double Vertical Antenna (Riesmeyer) . . . .	21, June
Fixed Position Three-Element Directional Antenna (Exp. Section) . . . . .	59, Mar.
The Fixed "Rotary" Beam Antenna (Lynch) . . . .	28, Aug.
A Flat Line for the Lazy-H Antenna (Exp. Section) . . . . .	60, Feb.
Improved Pi-Section Antenna Coupler (Jeffrey). (Note in Exp. Section) . . . . .	45, Aug.
Improving the Flying Skywire (Griffin) . . . . .	32, Apr.
An Inexpensive 50-Foot Antenna Mast (Exp. Section) . . . . .	58, Apr.
Low-Cost 14-Mc. Vertical (Exp. Section) . . . . .	50, July
More on Balloon-Supported Antennas . . . . .	38, Nov.
More on Homemade Feeder Spreaders (Exp. Section) . . . . .	59, Apr.
A Multi-Band Antenna System (Exp. Section) . . . .	44, Aug.
Portable Kinks (Dreyer) . . . . .	18, July
Preventing Tangling of Open-Wire Feeders with Rotatable Antennas (Exp. Section) . . . . .	59, Mar.
Radio Direction Finding (Bruning) . . . . .	19, Aug.
Raising the Efficiency of Short Vertical Radiators (Hilgedick and Morgan) . . . . .	30, Dec.
Replacing the Antenna Halyards (Exp. Section) . . . .	69, June
Shunt Excited Antennas for Amateur Use (Clark) . . . . .	64, Oct.
Shunt-Fed Mobile Antennas (Exp. Section) . . . . .	49, Nov.
Simple Rotatable Three Element Antenna (Exp. Section) . . . . .	58, May
The Square-Corner Reflector Beam Antenna for Ultra-High Frequencies (Kraus) . . . . .	18, Nov.
A Stationary Reversible Beam (Stiles) . . . . .	56, Mar.
The T-Matched Antenna (Kraus and Sturgeon) . . . .	24, Sept.
A Triangle Antenna (Arnold) . . . . .	20, Jan.

### AWARDS

W5CXH Wins 1939 Maxim Award . . . . .	27, Aug.
---------------------------------------	----------

### BEGINNERS

Audio Oscillator . . . . .	43, Sept.
Code Practice . . . . .	68, Oct.; 62, Sept.
Code Practice Oscillators . . . . .	60, Jan.; 59, Apr.

### BOOK REVIEWS

The Pageant of Electricity, Look and Listen, Television and Short-Wave Handbook, Tele- vision Encyclopaedia, Radio Interference Suppression, Radio Service Trade Kinks, Aeronautic Radio . . . . .	57, Jan.
Audel's New Radioman's Guide . . . . .	57, May
Radio at Ultra-High Frequencies . . . . .	86, July

### CODE PROFICIENCY

Code Proficiency Certificates Issued . . . . .	77, Oct.; 55, Nov.
Code Proficiency Runs from W1AW . . . . .	27, Sept.
Code Proficiency Also Means . . . . .	46, Sept.

Club Members — Code Award . . . . .	46, Aug.
Editorial . . . . .	7, Aug.; 9, Oct.
Got Your Code Proficiency Certificate? . . . . .	38, Sept.
League Announces New C.P. Certificates . . . . .	32, Aug.
Notes on Code Proficiency . . . . .	76, Oct.; 52, Nov.
Roll-Paper Attachment for Typewriter . . . . .	50, Nov.

### COMMUNICATIONS DEPARTMENT

(See also, "Operating Practices," "Contests")

Change in Word-Count . . . . .	64, Apr.
Directory of A.R.R.L. Nets . . . . .	68, Mar.
Expanded Neutrality Code . . . . .	54, July; 48, Aug.
How Emergency Coordinators Work (Corder- man) . . . . .	54, Jan.
Meet the SCM's (W6TI, W8OXO) . . . . .	55, Nov.
The Most Interesting Band (Ledin) 66, Mar.; (Rice) 65, Apr.; (Sakkers) 67, May; (Allen) 72, June; (Burton) 55, July; (May) 49, Aug.; (Mitchell) 54, Sept.; (Brooks) 64, Dec.	
The Regional Radio Club (Holaday) . . . . .	53, Nov.
SCM Elections . . . . .	80, Feb.; 88, Apr.; 90, June; 64, Aug.; 92, Oct.

### CONTESTS

(See also, "U.H.F. — Tests")

A.R.R.L. 1940 QSO Party (Announcement) . . . . .	59, Jan.
(Highlights) . . . . .	67, Mar.
(Results) . . . . .	49, July
A.R.R.L. 1941 QSO Party (Announcement) . . . . .	57, Dec.
Copying Bee (Results, 1939) . . . . .	23, June
DX Contest, 1939 (Analysis) . . . . .	78, Feb.
DX Contest, 1940 (Announcement) . . . . .	38, Feb.
(Highlights) . . . . .	51, Mar.; 28, May
(Results) . . . . .	46, Oct.
Field Day (Announcement) . . . . .	29, June
(Highlights) . . . . .	46, Sept.
(Results) . . . . .	23, Nov.; 44, Dec.
Navy Day — 1939 (Results) . . . . .	58, Feb.
Navy Day Receiving Competition, 1940 (An- nouncement) . . . . .	37, Oct.
ORS-OPS Parties (October, 1939) . . . . .	70, Jan.
(January, 1940) . . . . .	66, Apr.
(April, 1940) . . . . .	56, July
(July, 1940) . . . . .	90, Oct.
Sweepstakes Contest, 1939 (Highlights) . . . . .	71, Jan.
(Results) . . . . .	44, May
(Correction) . . . . .	74, June
Sweepstakes Contest, 1940 (Announcement) . . . . .	30, Nov.
W.A.S. Party, 1.75 Mc. (Announcement) . . . . .	28, Feb.
(Highlights) . . . . .	82, Apr.
(Results) . . . . .	40, Sept.

### CONVENTIONS

Atlantic Division Convention . . . . .	118, Jan.
Arizona State Convention . . . . .	49, Apr.
Central Division Convention . . . . .	119, Jan.; 27, Sept.
Hudson Division Convention . . . . .	8, May
Iowa State Convention . . . . .	27, Oct.
Massachusetts State Convention . . . . .	120, Jan.; 27, Oct.
Midwest Division Convention . . . . .	39, Apr.
New England Division Convention . . . . .	39, Apr.
New Hampshire State Convention . . . . .	29, Sept.
Northwestern Division Convention . . . . .	66, Aug.; 53, Oct.
Oklahoma State Convention . . . . .	116, Jan.; 38, Sept.
Roanoke Division Convention . . . . .	37, July
Rocky Mountain Division Convention . . . . .	78, July
Southwestern-Pacific Division Convention . . . . .	46, Aug.
South Dakota State Convention . . . . .	67, Oct.
Vermont State Convention . . . . .	122, Jan.; 40, Oct.
West Gulf Division Convention . . . . .	117, Jan.; 25, June
Wisconsin State Convention . . . . .	116, Jan.; 22, June; 66, Sept.

## EDITORIALS

Answering CQs.....	7, Apr.
Confidence.....	7, Nov.
Conscription.....	7, Nov.
Code Proficiency.....	7, Aug.; 9, Oct.
Defense Matters.....	8, Nov.
DX Contest.....	7, May
Expanded Neutrality Code.....	11, July
Frequency Modulation.....	9, Feb.; 7, May; 7, Sept.
F.M. on 5.....	7, June
Foreign Communication Prohibited.....	12, July
Insurance.....	7, Apr.
Inter-American Traffic.....	7, Apr.
Jobs.....	7, Sept.
Neutrality.....	8, May
New Exams.....	7, June
Prediction Charts.....	10, Oct.
Review of 1939.....	9, Jan.
QST's Silver Anniversary.....	9, Dec.
Sportsmanship Toward Newcomers.....	7, Mar.

## EMERGENCY AND RELIEF WORK

A.E.C. Members Perform Notable Communication Service in Storm.....	65, Mar.
A.E.C. Emergency Drills.....	66, Apr.
Amateur Radio in Sacramento Valley Flood.....	67, May
Amateurs Aid in Simulated Emergency.....	58, Sept.
Atlantic Coast Amateurs Render Emergency Service (DeSoto).....	28, Oct.
Colorado Sleet Storm.....	70, Nov.
How E.C.'s Work (Corderman).....	54, Jan.
South Dakota Fire Drill.....	62, Sept.
South Texas Flood.....	60, Apr.
Twister Strikes Georgia (Smith).....	15, Apr.
1940 Spring Flood Activities.....	74, June

## EXPEDITIONS

The Yacht Yankee WCFT.....	75, June
----------------------------	----------

## FEATURES AND FICTION

Blonde QRM (Brunn).....	48, Mar.
Dixie Jones' Owl Juice.....	37, Feb.
Personality Over the Air (Kelly).....	42, Jan.
QST Visits General Electric.....	9, Mar.
QST Visits Riverhead and Rokey Point.....	8, Sept.
QST's Silver Anniversary (Editorial).....	9, Dec.
Amateur Radio in 1882 (Allen).....	28, Dec.
A Quarter of a Century with QST.....	12, Dec.
QST's Diary, Volume I (Tuska).....	22, Dec.
Rotten QRM (T.O.M.).....	25, Dec.
The YLs Unite (Bien and Carter).....	22, May

## FREQUENCY CALIBRATION

(See also, "Meters and Measurements")

Calibrated B.F.O. as Aid in Frequency Measurement (Exp. Section).....	61, Feb.
Keying Monitor System (Exp. Section).....	43, Sept.
A Precision Crystal Frequency Standard (Brown).....	13, Aug.

## FREQUENCY MODULATION

A Complete 5-Mc. I.F. System (Goodman).....	16, Apr.
Frequency Modulation (Editorial).....	9, Feb.; 7, May; 7, Sept.
F.M. on 5.....	7, June; 24, June
F.M. Limiter Performance (Browning).....	19, Sept.
Getting on 56-Mc. F.M. (Grammer).....	16, June
Noise Rejection in Frequency Modulation (Hierath).....	47, Dec.
A Practical 112-Mc. F.M. Transmitter (Goodman).....	22, Feb.
Reactance-Tube Frequency Modulation (Crosby).....	46, June
Resonance Indicator for F.M. (Exp. Section).....	74, Oct.
Wide-Band Frequency Modulation in Amateur Communication (Grammer and Goodman).....	11, Jan.

## HINTS AND KINKS

January, page 64	
Another Harmonic Oscillator Circuit (Bush)	
Another Compact Multiple Crystal Mounting	
Getting Results with the Pierce Crystal Oscillator Circuit (Preston)	
Homemade High-Voltage Tank Condenser (Tangen)	

February, page 60	
Novel Second-Detector Circuit (Towle)	
Blocked-Grid Oscillator Keying	
A Flat Line for the Lazy-H Antenna (Groom)	
Calibrated B.F.O. as an Aid in Frequency Measurement (Fund)	
March, page 59	
Fixed-Position Three-Element Directive Antenna (Espey)	
Preventing Tangling of Open-Wire Feeders with Rotatable Antennas	
Rectifier Balancing Connection	
A Plug-In Oscillator Unit (Drumeller)	
A "Light-Beam" Transmitter and Receiver (Floorman)	
April, page 58	
An Inexpensive 50-foot Antenna Mast (Reinhart)	
Notes on Gaseous Tubes as Bias Regulators (Purinton)	
More on Homemade Feeder Spreaders	
Superhet B.F.O. as Code Practice Oscillator (Simmons)	
Meter Switching with Toggle Switches (Gullberg)	
May, page 58	
Series Noise Limiter with Plate Detectors (Rafford)	
Simple Rotatable Three-Element Antenna	
Voltmeter as Sensitive Neutralizing Indicator (Clark)	
Discharging Tool for Safety (Warner)	
Postscript on B.C.L. Elimination	
Simple Bridge for C and R Checking (Long)	
June, page 68	
Soldering Connections to Polystyrene Sockets	
Notes on ECO Drift (King)	
Filter-Discharging Relay or Switch (Olson)	
Replacing the Antenna Halyard	
A Simple Modulation Monitor and Percentage Indicator (Poon)	
A Non-Chattering Overload Relay with Electrical Reset (Drumeller)	
July, page 50	
Starting Tool for Drills (Crayford)	
Low-Cost 14-Mc. Vertical	
Eliminating 'Phone Interference with Line Telephone (Sheffield)	
Neutralizing R.F. Stages with a Modulating Monitor (Jones)	
'Scope Coupling (Brooks)	
Improving the Usefulness of a Globe (Ingraham)	
Note on Tube Keying Systems	
August, page 44	
Three-Band Coil (Sullivan)	
A Multi-Band Antenna System (Snyder)	
Improved Pi-Section Antenna Coupler (Clark)	
September, page 42	
Temperature Compensation to Reduce Receiver Drift	
Replacing an 83 with 866 Jr.'s for Higher Voltages	
Keying-Monitor System (Masterson)	
Sure-Fire Audio Oscillator (Wiley)	
October, page 74	
Workshop Kinks (Hodson)	
Simplifying Television Deflection and Video Chassis (Lawrence)	
Resonance Indicator for F-M (Moody)	
Battery Bias Without Charging Current (Crabill)	
November, page 47	
Composite Oscillator (Dunning and Lindquist)	
Simple Transformerless Duplex Bias Supply	
Modulator as Keying Monitor in Portable Transmitter	
Converting the B.C. Receiver for 160-Meter Work (Lauderdale)	
Shunt-Ped Mobile Antennas (Cruiser)	
Roll Paper Attachment for Underwood Typewriter (Warner)	
I.A.R.U. NEWS	
62, Jan.; 62, Feb.; 57, Mar.; 61, April; 61, May; 66, June; 48, July; 46, November.	
INTERFERENCE	
Eliminating Phone Interference with Line Telephones (Exp. Section).....	50, July
Hints for Eliminating B.C.L. QRM (Turney).....	43, Apr.; 60, May
Notes on Ignition Interference, 40 to 60 Mc....	39, May
KEYING	
Blocked Grid Oscillator Keying.....	60, Feb.
(Correction).....	8, Apr.



Counting W.P.M. Electrically (Larsen).....	30, July	Rectifier Balancing Connection (Exp. Section)...	60, Mar.
Electronic Keying (Beecher).....	9, Apr.	Replacing an 83 with 866 Jrs. for Higher Voltages (Exp. Section).....	42, Sept.
How to Adjust a Bug (Rockey).....	86, Oct.	Simple Transformerless Duplex Bias Supply (Exp. Section).....	48, Nov.
An Inexpensive Electronic Key (Grammer).....	12, May		
Key Adjustment (Rockey).....	69, Jan.		
Keying Monitor System.....	43, Sept.		
Modulator as Keying Monitor (Exp. Section)...	48, Nov.		
Notes on Tube Keying Systems (Exp. Section)...	52, July		

## METERS AND MEASUREMENTS

Bootleg Catcher.....	81, Sept.
Calibrated B.F.O. As Aid in Frequency Measurement (Exp. Section).....	61, Feb.
A Complete Oscilloscope Using the 902 (Greek)..	33, Oct.
Meter Switching with Toggle Switches (Exp. Section).....	60, Apr.
One Meter for Multi-Stage Transmitters (Warner).....	40, Mar.
A Precision Crystal Frequency Standard (Brown)	13, Aug.
Q Measurements (Stafford).....	48, Jan.
Radio Direction Finding (Bruning).....	19, Aug.
Reactance Calculations with the Lightning Calculators (Buss).....	44, Jan.
Simple Bridge for C. and R. Checking (Exp. Section).....	60, May

## MISCELLANEOUS

Application for Transverse Phase Shifts (Bach)...	54, Apr.
Advanced Radio Course Over WRUL.....	62, Mar.
Albany to New York Outboard Motorboat Race. Amateurs Honor H.P.M.....	51, Aug.
B.P.L. or Bust (Thompson).....	45, Aug.
Calls Heard.....	82, Jan.
Checks by Radio (Utterback).....	63, May
Electrical Shock.....	80, Mar.
Improving the Usefulness of a Globe (Exp. Section).....	41, Jan.
Monitors.....	51, July
Oldest and Youngest Hams?.....	60, Jan.
The Radio Absolute Altimeter.....	10, Feb.
Roll Paper Attachment for Typewriter (Exp. Section).....	42, Feb.
Starting Tool for Drills (Exp. Section).....	50, Nov.
Soldering Connections to Polystyrene Sockets (Exp. Section).....	50, July
"Tnx a Meg" (LaMarca).....	68, June
Wired Wireless for Remote Control (Williams)...	82, Mar.
Workshop Kinks (Exp. Section).....	34, Feb.
	74, Oct.

## NAVAL COMMUNICATIONS RESERVE

First Naval District.....	52, Jan.
District of Columbia.....	50, Mar.
Sixth Naval District.....	40, Nov.
Eighth Naval District.....	56, Dec.
Ninth Naval District.....	64, May
Eleventh Naval District.....	49, Feb.
Join the N.C.R. (Lee).....	38, Aug.
The Navy and the Amateur.....	29, Sept.
Navy Day Receiving Competition.....	37, Oct.
Voice and Ears of the Fleet.....	57, Oct.

## OBITUARY

Wm. H. Smith, 9ZF, 9KOA.....	29, Mar.
Silent Keys 48, Feb.; 62, Mar.; 62, Apr.; 22, June.; 29, July.; 82, Aug.; 29, Sept.; 45, Nov.	

## OPERATING PRACTICES

(See also, "Communications Department")

Answering CQs.....	7, Apr.
Change in Word Count.....	64, Apr.
How NOT to Operate (Bien).....	67, Feb.
Key Adjustment (Rockey).....	66, Sept.
Personality Over the Air (Kelly).....	42, Jan.
Say It with Words (Warner).....	56, June

## POWER SUPPLIES

Battery Bias Without Charging Current (Exp. Section).....	75, Oct.
Filter Discharging Relay (Exp. Section).....	68, June
Notes on Gaseous Tubes as Bias Regulators (Exp. Section).....	59, Apr.

Rectifier Balancing Connection (Exp. Section)...	60, Mar.
Replacing an 83 with 866 Jrs. for Higher Voltages (Exp. Section).....	42, Sept.
Simple Transformerless Duplex Bias Supply (Exp. Section).....	48, Nov.

## PROPAGATION

Distance vs. Angle of Radiation (Rockey).....	68, Oct.
The Ionosphere and Radio Transmission.....	32, Mar.
Predictions of Useful Distances for Amateur Communication (Smith and Kirby) . . . . .	26, Sept.; 52, Oct.

## RADIO AND REMOTE CONTROL

New Radio Control Gear for Model Airplanes (Bohnenblust).....	9, Aug.
Winning the National R-C Meet (Good).....	24, Aug.
Wired Wireless for Remote Control (Williams)...	34, Feb.

## RADIOTELEPHONY

(See also, "Frequency Modulation")

Cathode Modulation.....	38, May
The Design of Speech Amplifiers (Millington and Fath).....	50, Apr.
Flasher Type Overmodulation Indicators.....	37, May
Lop-Sided Speech and Modulation (Grammer)...	14, Feb.
A Midget 1.75 and 3.5 Mc. Phone Transmitter (Gordon).....	42, Oct.
Narrow-Band Constant-Level Speech Amplification (Turney and Shimey).....	54, May
Simple Modulation Monitor and Percentage Indicator (Exp. Section).....	69, June

## RECEIVING — GENERAL

Compensating Tube Input Capacitance Variation.....	42, Feb.
A Low-Frequency Converter (Woodward).....	15, Sept.
A Modified Dickert Noise Limiter (Hill).....	22, Feb.
More on the Combined B.O. and I.F. Amplifier (McConnell).....	22, Jan.
Novel Second Detector Circuit (Exp. Section)...	60, Feb.
Regeneration in the Preselector (Browning)...	28, Jan.
A Regenerative Preselector with Output Metering Bridge (Talen).....	32, Feb.
Series Noise Limited with Plate Detectors (Exp. Section).....	58, May
Temperature Compensation to Reduce Receiver Drift (Exp. Section).....	42, Sept.

## RECEIVERS — REGENERATIVE

Compact Battery Receiver for Station or Portable Use (Mix).....	18, Feb.
A Portable Transmitter-Receiver (Hildebrand)...	42, July

## RECEIVERS — SUPERHETERODYNE

Converting the B.C. Receiver for 160-Meter Phone Work (Exp. Section).....	48, Nov.
Improving Crystal Filter Performance (Bacon)...	58, Dec.
A Low-Frequency Converter.....	15, Sept.
Modernizing the Regenerative Superhet (Grammer).....	14, Nov.
A One-Tube Five-Band Converter (Chambers)...	48, Oct.

## REGULATIONS

(See also, "What the League is Doing")

Operating on Class A Frequencies.....	27, Apr.
New Exams (Editorial).....	7, June
Duplex Above 112 Mc.....	24, Jan.
F.C.C. Orders and Interpretations (Warner)...	17, Aug.
F.M. on 5.....	7, June
Foreign Communications Prohibited.....	12, July
New Exams.....	24, June
The Chile Conference (Budlong).....	20, Apr.
Regulations Amended.....	24, June
Who May Operate a Phone Station.....	24, June

## TELEVISION

A Deflection and Video Chassis for Television Reception (Lawrence).....	29, Feb.
---	----------

A Design or Living— with Television (Rosenblatt).....	44, Mar.
An Efficient U.H.F. Unit for the Amateur Television Transmitter (Waller).....	32, July
New Amateur Television Records.....	53, Dec.
A New Electronic Television Transmitting System for the Amateur (Sherman).....	30, May
A New Iconoscope for Amateur Television Cameras (Lamb).....	13, June
A Receiver for the New Amateur Television System (Sherman).....	38, June
Simplifying Television Deflection and Video Chassis (Exp. Section).....	74, Oct.
Television Camera-Modulator Design for Practical Amateur Operation (Lamb).....	11, Oct.
Two-Way Television Communication Inaugurated.....	36, Nov.

### TRANSMITTING — GENERAL

Automatic Tuning for the Amateur Transmitter (Atkins and Read).....	20, Sept.
Discharging Tool for Safety (Exp. Section).....	59, May
Fitting the Chassis to the Layout (Litke).....	36, Mar.
Fool-Proof Screen Feed (Roberts).....	38, Oct.
Home-Made High-Voltage Tank Condenser (Exp. Section).....	66, Jan.
Link Coupling Between Transmitter Stages (Roberts).....	41, Nov.
Magnetic Bandswitching (Bellem).....	54, Oct.
Neutralizing R.F. Stages with a Modulation Monitor (Exp. Section).....	51, July
Neutralizing Economy (Hansen).....	28, Mar.
Neutralization.....	52, Mar.
Overload Relay with Electrical Reset (Exp. Section).....	70, June
Single Dial Frequency Control (Rice).....	30, June
Three-Band Coil (Exp. Section).....	44, Aug.
Voltmeter as Sensitive Neutralizing Indicator (Exp. Section).....	58, May

### TRANSMITTING — CRYSTAL AND E.C.O.

Another Compact Multiple Crystal Mounting (Exp. Section).....	64, Jan.
Another Harmonic Oscillator Circuit (Exp. Section).....	64, Jan.
An Electron-Coupled Oscillator, 1940 Model (Southworth).....	26, Nov.
An E.C.O. Exciter with 20 Watts Output (Mix).....	22, Oct.
Composite Oscillator (Exp. Section).....	47, Nov.
Extended Variable Frequency Crystal Control (Goodman).....	9, May; 7, June
Getting Results with the Pierce Oscillator (Exp. Section).....	65, Jan.
A Heterodyne Exciter (Bliss and Bailey).....	38, July
Notes on E.C.O. Drift (Exp. Section).....	68, June
A Plug-In Oscillator Unit (Exp. Section).....	60, Mar.
Correction.....	8, Apr.
A Simple Two-Tube Exciter (Mix).....	9, Nov.
A Simplified Exciter Circuit (MacGeorge).....	2, Apr.
A Stabilized Variable Frequency Oscillator (Brown).....	13, July
The 6L6 As Crystal Oscillator (Mix).....	54, Dec.

### TRANSMITTERS — PORTABLE AND LOW POWER

A Different Portable-Emergency Transmitter (Austin).....	36, July
A Portable Transmitter-Receiver (Hildebrand).....	42, July
Portable Kinks (Dreyer).....	18, July
The QSL Push-Pull (Sutter).....	26, June
A Sailor's Five Tube Station (Jennings).....	69, Oct.

### TRANSMITTERS — HIGH POWER AND MEDIUM POWER

Another Approach to High Power (McCullough).....	54, Feb.
Compactness with Economy (Monderer).....	34, Jan.
A Hundred Dollars Half Kilowatt (Osborne).....	34, Apr.
Instant Band-Change with Push-Button Control (Linn).....	11, Feb.
Magnetic Bandswitching (Bellem).....	54, Oct.

Single Dial Frequency Control (Rice).....	30, June
A Traffic Transmitter (Baker).....	52, June
160 to 2½ in One Transmitter (Tilton).....	23, Apr.

### TUBES

A New Iconoscope for Amateur Television Cameras (Lamb).....	13, June
New Receiving Tubes 1R4, 1S4, 1S5, 1T4.....	46, Jan.
7B4, 7J7, 7L7.....	21, May
1LB4, 1D8GT, 6AB5, 6AL6G, 7H7, 35Z6G, 50C6G, 70L7GT.....	43, June
1LC5, 1LC6, etc.....	67, July
1T5GT, 117M7GT.....	84, Aug.
New Transmitting Tubes HK257, 811, 812, HY615.....	45, Jan.
HY302.....	58, Mar.
152TL, HY75.....	27, Apr.
829.....	68, July
825.....	78, Sept.
815.....	50, Nov.

### ULTRA-HIGH-FREQUENCIES — APPARATUS

(See also, "Frequency Modulation," "Television")

An Acorn Tube 112 Mc. Converter (Rehm).....	41, July
A Battery Transceiver for 112 Mc. (Chambers).....	23, Apr.
A Compact 112 Mc. Station (Lawrence).....	15, May
A Complete 5-Mc. I.F. System (Goodman).....	16, Apr.
A Double Beam Power U.H.F. Transmitter (Goodman).....	40, Dec.
Designing a Wide-Range U.H.F. Receiver (Schor).....	34, Aug.
Centimeter Waves Coming Up!.....	32, Oct.
A Microwave Superhet (Lewis).....	36, Dec.
A Practical 112 Mc. Converter.....	16, Mar.
A Stabilized 2½ Meter Oscillator (Goodman).....	33, Nov.
A 56-Mc. Crystal Controlled Transceiver (Jacobs).....	46, Apr.
A 56-Mc. Mobile Station (Lynch).....	40, May
160 to 2½ in One Transmitter (Tilton).....	23, Apr.

### ULTRA-HIGH-FREQUENCIES — TESTS

(See also, "On the Ultra-Highs")

New Amateur Television Records.....	53, Dec.
New 112 Mc. Records.....	26, Aug.; 41, Aug.
February Contest and Relay.....	43, Feb.; 44, June
May Contest and Relay.....	20, May; 33, Sept.
September Contest and Relay.....	37, Sept.
December Contest and Relay.....	46, Dec.
Marathon for 1940.....	26, Jan.
Results of U.H.F. Relay Number 2.....	52, Feb.
Who Can Work Most States in 1940?.....	23, Jan.

### WHAT THE LEAGUE IS DOING

(See also, "Regulations")

Amateur Examinations for 1940.....	26, Feb.
Board Meeting, Preview.....	19, May
Minutes.....	22, July
Citizenship Showing.....	23, Sept.
Code Proficiency.....	24, Nov.
Election Notices, Directors.....	24, Jan.; 22, Sept.; 30, Oct.; 34, Dec.
Election Results, Directors.....	26, Feb.; 34, Dec.
Emergency Rigs Under Order 73-A.....	25, Nov.
Executive Committee Actions.....	25, Aug.
Financial Statement.....	26, Apr.; 25, Aug.; 25, Nov.
Growth Statistics.....	25, Nov.
Help Wanted in Monitoring.....	23, Sept.
Jobs.....	30, Oct.; 72, Nov.
The League at Washington.....	24, Aug.
License Issuance.....	24, Nov.; 34, Dec.
New Southwestern Division Director.....	74, Nov.
Poll Postponed.....	25, Aug.
Special Election (West Gulf Division).....	26, Feb.; 19, May
(Southwestern Division).....	22, July; 25, Aug.
Survey of Headquarters.....	33, Sept.
Washington Notes.....	26, Feb.; 19, May
Warning on Schools.....	26, Apr.
1.7 Mc. Band Shifted.....	24, Nov.

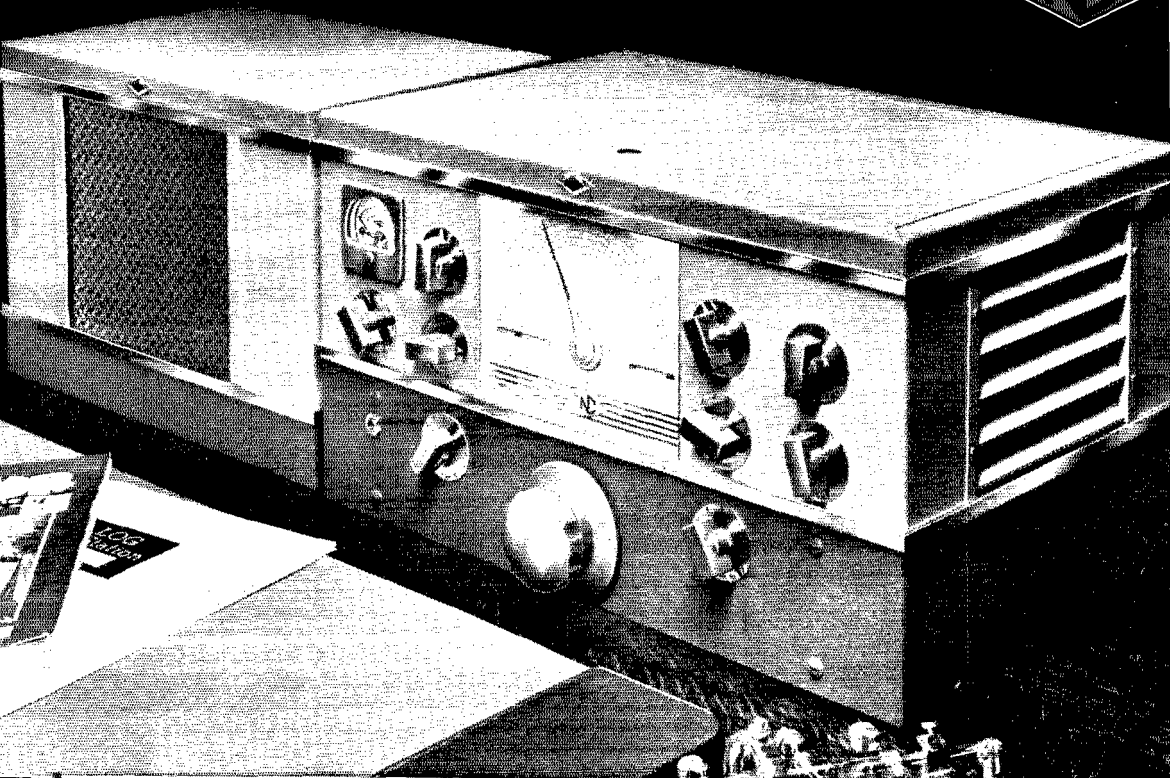

# Silver Anniversary NC-200



Dedicated to amateurs on the twenty-fifth anniversary of their own QST.

A toast to QST, the ARRL, and the Amateur! May the next twenty-five years be as full of achievement as those now past! Good luck and best wishes.



THIS INSIGNIA mounted on each NC-200 Receiver, is National's pledge that this Silver Anniversary Receiver embodies all the skill, all the performance, and all the value born of National's long years of experience.

**NATIONAL COMPANY, INC.**  
**MALDEN, MASS.**

CONTINUOUS POPULARITY IS WON ON RESULTS

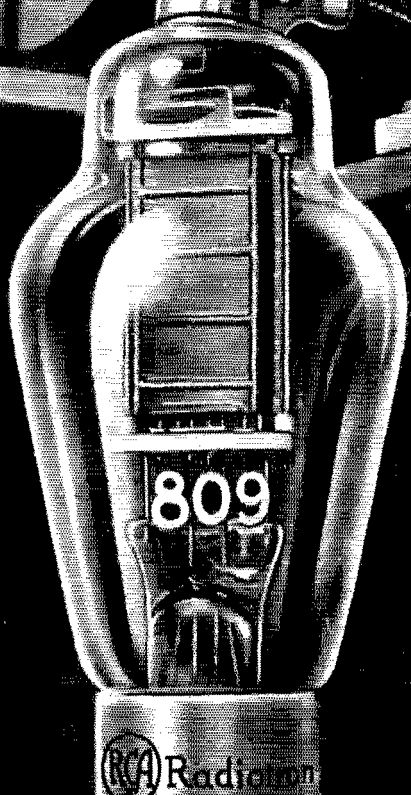

# RCA- 809

## HIGH-MU TRIODE

D-C Plate Voltage  
1000 volts maximum

Plate Input  
100 watts maximum

Grid Driving Power  
3.8 watts (approximate)

(Class C Telegraphy, ICAS Rating)

**\$2.50 amateur net**

**MORE POWER**  
**LESS \$\$**

**= Economy**

Announced 3 years ago to the month—a winner in the 9th ARRL SS Contest—most used transmitting triode by winners of the 10th ARRL SS Contest—RCA-809 continues to ride the tide of fame.

Employed for amateur use under the ICAS Ratings, the RCA-809, priced at only \$2.50 net, provides you with a tube that competes, with ample safety factor, with the "big fellows". For example, one 809 in class C telegraph service will handle 100 watts input. Two 809's in class B modulator service will modulate 100% an r-f stage up to 290 watts input! The tube has a high amplification factor of 50. (It requires, therefore, a bias of only

—10 volts at a d-c plate voltage of 1,000 volts in class B modulator service.) Furthermore, the tube will operate at its maximum rating all the way up to 60 Mc and at reduced ratings up to 120 Mc!

Other features include the new, low-loss Micanol base, the largest anode in its class for real durability under temporary overloads, special ceramic insulation—the same as used in tubes selling for many times the price of the 809—and the famous RCA thoriated-tungsten filament. And don't forget that the filament voltage rating is 6.3 volts—a feature not to be overlooked in emergency work for efficient transmitter operation direct from a storage battery.

**LOW-MU RCA-1623.** *Similar to the 809, the RCA-1623 has an amplification factor of only 20. Like the 809, it is excellent for use as an r-f power amplifier, frequency doubler, class B modulator, or oscillator. Unaffected by ordinary plate-load variations and grid-excitation changes, this tube is an extremely stable oscillator. It performs smoothly at wavelengths as low as 2½ meters!*

**RCA-1623 . . . AMATEUR NET PRICE, \$2.50**

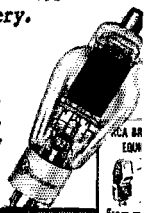

# Transmitting Tubes

PROVED IN COMMUNICATION'S MOST EXACTING APPLICATIONS