

# QST



october, 1940

25 cents

35c in Canada

devoted entirely to

# amateur radio

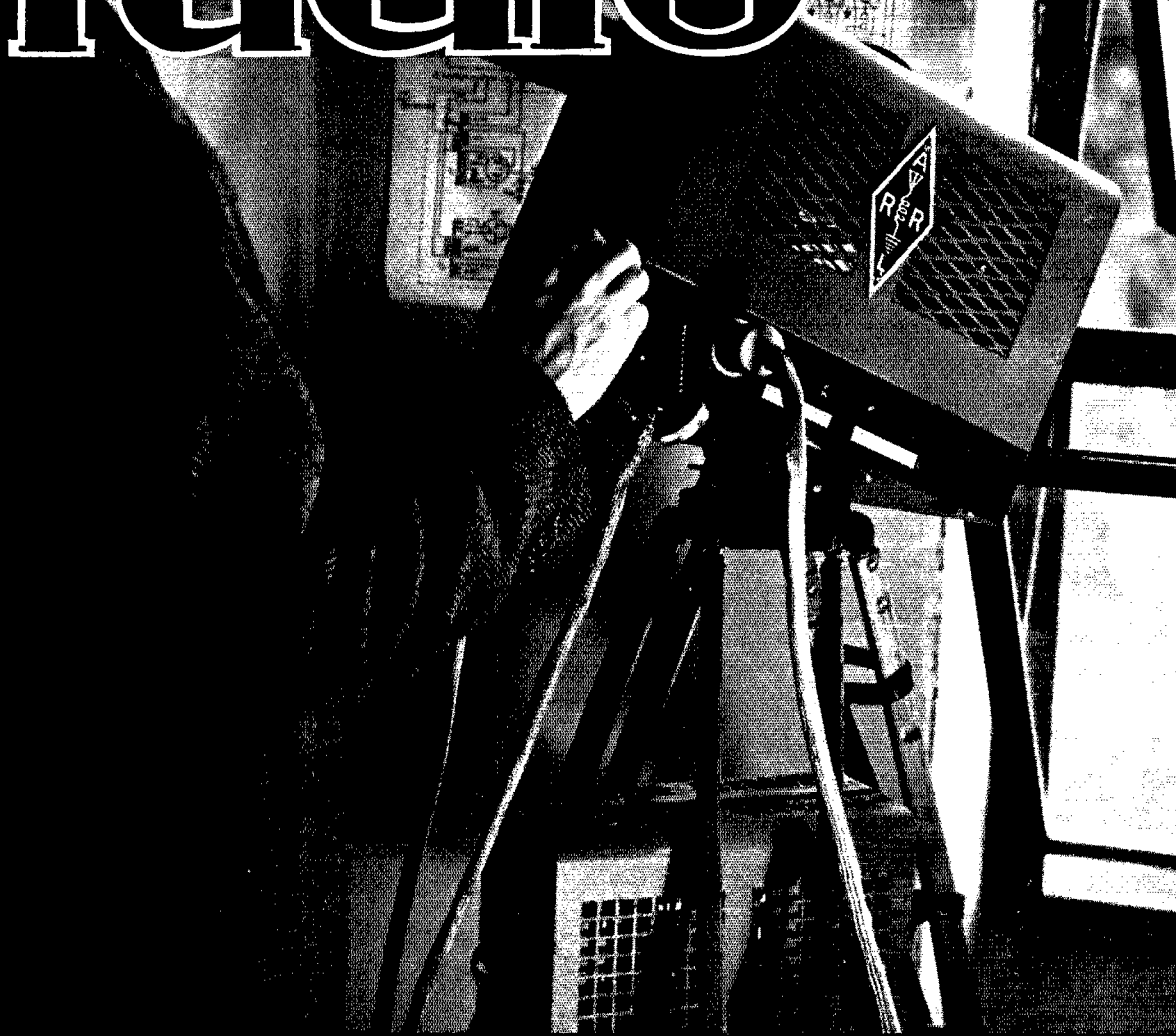

In This Issue—Practical Amateur Television

# 32RA

(A-C)

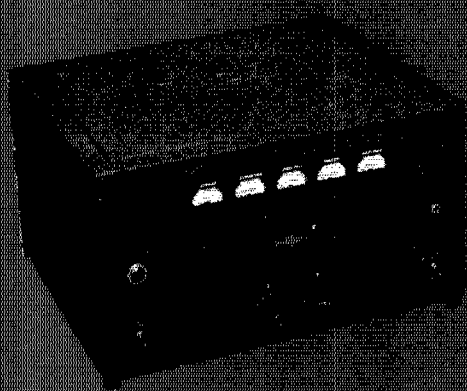

(D-C)

# 32RB

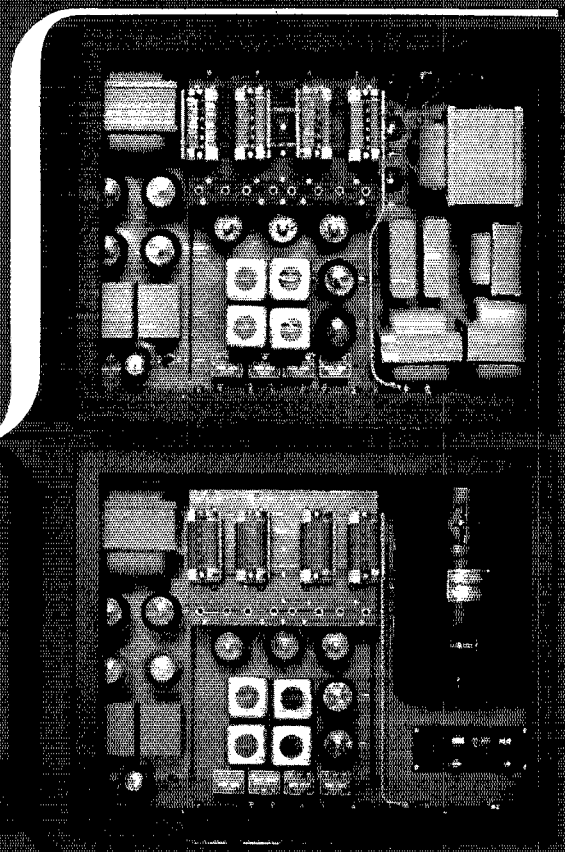

**F**ifty watts radiotelephone, seventy-five watts radiotelegraph with operation from a-c or various d-c voltages is possible with Collins 32RA — 32RB Transmitters.

These two highly developed equipments have identical four channel "quick shift" radio frequency units, audio modulator units, transmitter cabinets and meters. For a-c operation (32RA) a heavy duty power supply chassis operates from a 110 volt 50/60 cycle a-c source. For d-c operation (32RB) a dynamotor having a primary input of 12, 24, 32 or 110 volts replaces the a-c power supply as specified.

Standardization of your a-c—d-c transmitter installations is completely solved with the 32RA—32RB combination.

**Frequency Range:** 1.5 to 15 mc.

**Frequency Change Method:** Panel control instantly selects any of four frequencies.

**A-F Response:** Uniform within  $\pm 2$  db from 200 to 4000 c.p.s.

**A-F Amplitude Distortion:** Less than 5% r.m.s. total harmonics at any modulation level.

**Residual Noise Level:** More than 40 db below 100% modulation.

**R-F Output Impedance:** 30 to 1200 ohms, power factor 70 per cent.

**Cabinet Dimensions:** 12½" high, 22" wide and 18" deep.

**Net Weight:** 32RA 127 pounds, 32RB 100 pounds.

**COLLINS RADIO COMPANY**  
CEDAR RAPIDS, IOWA U.S.A. NEW YORK, N.Y. TEL. BR 4-57



# hallicrafters

VOLUNTEERS FOR NATIONAL DEFENSE

*Doing his share to put the United States in an impregnable international position is the duty of every American.*

*Expert radio operators have far more to contribute in an emergency than the ordinary citizen. We should be very proud of our knowledge and technical training.*

*Let us show our loyalty and willingness to help by deluging the Federal Communications Commission with requests to take the examinations for the next higher rating.*

*We at the Hallicrafters are already serving seven Departments in the Federal Government. The lights in the research laboratory burn every night.*

*Being ready, willing and able to meet any emergency will do a great deal to keep that emergency from arising.*

the hallicrafters inc.

CHICAGO, U. S. A.

USED BY 33 GOVERNMENTS • SOLD IN 89 COUNTRIES

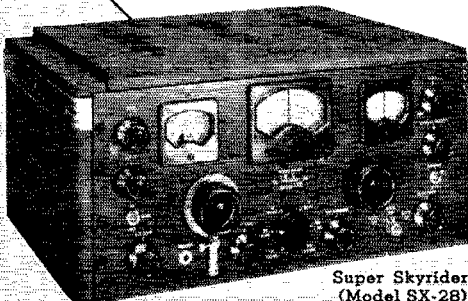

Super Skyrider  
(Model SX-28)

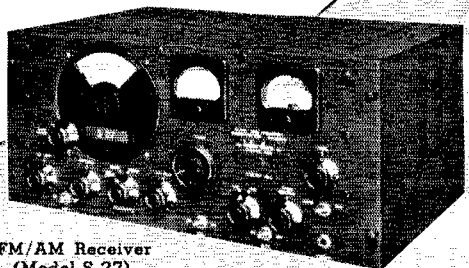

FM/AM Receiver  
(Model S-27)

BUY ON EASY TERMS · MAIL ORDERS PROMPTLY FILLED · WRITE FOR FREE CATALOG

*Proven  
Performance  
and Value*



**MODEL SX24**

One of the more popular amateur receivers. **MORE VALUE — PROVEN PERFORMANCE.** The SX24 compares favorably with the most expensive receivers.

Down payment..... **\$6.90**

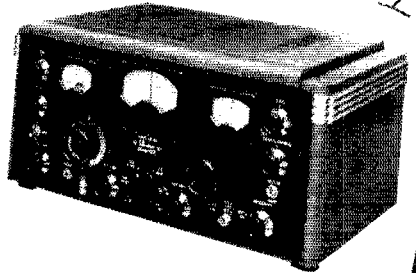

**MODEL SX28**

This finest of all Hallicrafter receivers has already made a great name for itself. Built to rigid government specifications — you are assured of everything that you could desire in a communication receiver.

Down payment..... **\$15.90**

One year to pay the balance  
**IMMEDIATE DELIVERY**

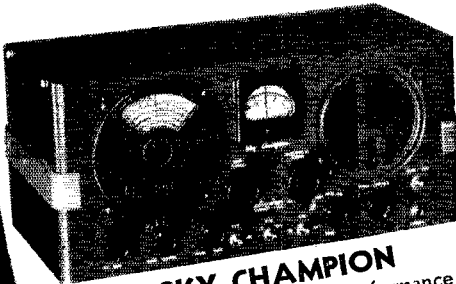

**SKY CHAMPION**

You will be amazed at the performance of the Champion — features found in sets selling for twice as much are embodied in its construction. Real performance at... **\$49.50**

Down payment..... **\$4.90**

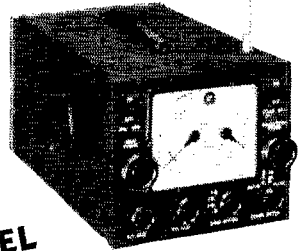

**MODEL S-29**

We can think of no better answer to your portable problem than this truly portable amateur receiver 9 to 500 meters — AC or DC or battery. Complete.... **\$59.50**

Down payment..... **\$5.90**

*Send for our New and Bigger  
Catalog with Exceptional Values*

**The RADIO SHACK**

**167 WASHINGTON ST., BOSTON, MASS., U.S.A.**

OCTOBER 1940

VOLUME XXIV.

NUMBER 10



STAFF

Editorial

KENNETH B. WARNER, W1EH  
Editor and Business Manager

CLARK C. RODIMON, W1SZ  
Managing Editor

GEORGE GRAMMER, W1DF  
Technical Editor

DONALD H. MIX, W1TS  
BYRON GOODMAN, W1JPE  
Assistant Technical Editors

EDW. P. TILTON, W1HDQ  
Contributing Editor, U.H.F.

VERNON CHAMBERS, W1JEQ  
Technical Information Service

JAMES J. LAMB, W1AL  
Research Engineer, A.R.R.L.

Advertising

F. CHEYNEY BEEKLEY, W1GS  
Advertising Manager

CHARLES BRUNELLE  
Asst. Advertising Manager

Circulation

DAVID H. HOUGHTON  
Circulation Manager

RALPH T. BEAUDIN, W1BAW  
Asst. Circulation Manager



OFFICES

38 La Salle Road  
West Hartford, Connecticut

Subscription rate in United States and Possessions, \$2.50 per year, postpaid; all other countries, \$3.00 per year, postpaid. Single copies, 25 cents. Foreign remittances should be by international postal or express money order or bank draft negotiable in the U. S. and for an equivalent amount in U. S. funds.

Entered as second-class matter May 29, 1919, at the post office at Hartford, Connecticut, under the Act of March 3, 1879. Acceptance for mailing at special rate of postage provided for in section 1103, Act of October 3, 1917, authorized September 9, 1922. Additional entry at Concord, N. H., authorized February 21, 1929, under the Act of February 28, 1925. Additional second-class entries to cover sectional editions authorized March 20, 1935.

Copyright 1940 by the American Radio Relay League, Inc. Title registered at United States Patent Office.

# QST

*devoted entirely to*  

# AMATEUR RADIO

PUBLISHED MONTHLY, AS ITS OFFICIAL ORGAN, BY THE AMERICAN RADIO RELAY LEAGUE, INC., AT WEST HARTFORD, CONN., U. S. A.; OFFICIAL ORGAN OF THE INTERNATIONAL AMATEUR RADIO UNION



## CONTENTS

Editorials . . . . .	9
Splatter . . . . .	10
Television Camera-Modulator Design for Practical Amateur Operation . . . . . James J. Lamb, W1AL	11
E.C.O. Exciter with 20 Watts Output . . . . . D. H. Mix, W1TS	22
Massachusetts State Convention . . . . .	27
Iowa State Convention . . . . .	27
Atlantic Coast Emergency . . . . .	28
What the League Is Doing . . . . .	30
Centimeter Waves Coming Up! . . . . .	32
A Complete Oscilloscope Using the 902 . . . . . Donald Greek	33
Navy Day Receiving Competition . . . . .	37
Fool-Proof Screen Feed . . . . . Walter Van B. Roberts, W3CHO	38
Vermont State Convention . . . . .	40
Hamdom . . . . .	41
A Midget 1.75- and 3.5-Mc. Phone Transmitter Herbert W. Gordon, W1IBY	42
Results, 12th A.R.R.L. DX Contest . . . . . F. L. Battey, W1UE	46
A One-Tube Five-Band Converter Vernon Chambers, W1JEQ	48
Predictions of Useful Distances for Amateur Radio Communication in October, November and December, 1940 . . . . .	52
Northwestern Division Convention . . . . .	53
Magnetic Bandswitching . . . . . Lew Bellem, W1BES	54
Naval Communication Reserve Notes . . . . .	57
On the Ultra Highs . . . . . F. P. Tilton, W1HDQ	58
Ham Shacks . . . . . W8AU, W8KNF, W2GVZ, CM2WL, W6KW	62
Shunt-Excited Antennas for Amateur Use C. V. Clarke, Jr., W5FQS	64
South Dakota State Convention . . . . .	67
Distance vs. Angle of Radiation Charles Rockey, Jr., W9CSH	68
A Sailor's Five-Tube Station . . . . . Wilson Jennings, W1MGK	69
Correspondence . . . . .	73
Hints and Kinks Workshop Kinks — Simplifying Television Deflection and Video Chassis — Resonance Indicator for F-M — Battery Bias Without Charging Current . . . . .	74
Operating News . . . . .	76
How's DX? . . . . .	80
WWV Schedules . . . . .	122
Hamads . . . . .	123
QST's Index of Advertisers . . . . .	126

# ATTENTION CW MEN!

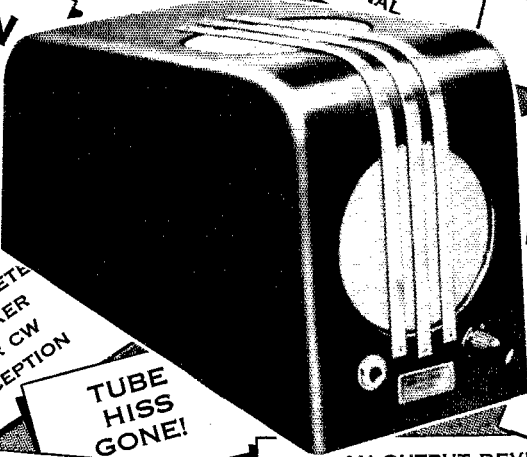

ISOLATES WEAK CW SIGNALS OTHERWISE BLANKETED

25-CYCLE SELECTIVITY  
Signal 12 Times Down  
12½ Cycles off Resonance

ELMINATES THE INTERFERENCE DOES NOT REDUCE SIGNAL

**QRM**  
PRACTICALLY OBSOLETE!

**QRM**  
NO LONGER TROUBLESOME

ROOM FOR MORE HAMS ON THE CW BANDS

TAKES UP WHERE XTAL LEAVES OFF

FOR NOISELESS CW RECEPTION

PEAKED AT 1000 CYCLES

CUT-OVER FOR SWITCH FOR STANDBY SPEAKER

A COMPLETE SPEAKER FOR CW RECEPTION

TUBE HISS GONE!

FOR CW ONLY WILL NOT WORK ON PHONE

CUTS THROUGH THOSE SOUTH AMERICAN PHONES

AN OUTPUT DEVICE FOR ANY RECEIVER

*Uses No Power!*

SUPER SELECTIVITY ON ANY RECEIVER

WIRELESS TELEGRAPHY WAITED 40 YEARS FOR THIS DEVICE

WIDE OPEN SPACES ON THE CW BANDS

A COMBINATION ELECTRICAL MECHANICAL ACOUSTICAL FILTER

## UNI-SIGNAL SELECTOR

ANOTHER MEISSNER PRECISION PRODUCT

Quickly attached to any receiver—only 2 connecting wires!

**NEW—DIFFERENT**

**GET YOURS TODAY!**

Just as soon as this good news gets around every CW Ham will have one. Priced ridiculously low. Only \$13.75 net.

SEE YOUR MEISSNER PARTS JOBBER AT ONCE

Same Results on Headphones! Special Stethoscopic 'Phones plug into receptacle in front of cabinet. Available separately at only \$4.85.

# 1 CONTROL *for YOUR Xmtr!*

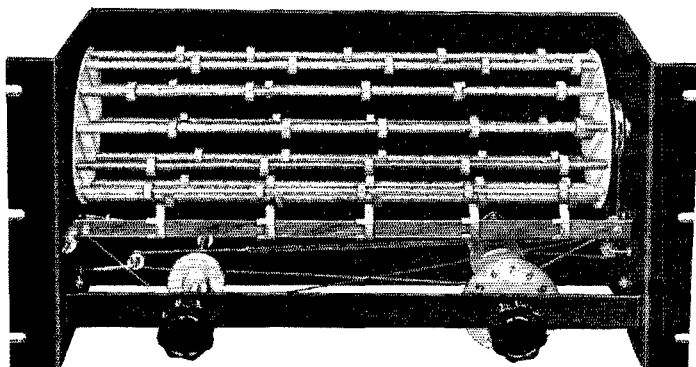

Manufactured under U. S. Letters Patent 2,187,986

*Introducing the most sensational device in Amateur Radio History.*

## *The New Meissner* "SIGNAL RESONATOR"

The Meissner "Signal Resonator," pictured above, may be installed in ANY radio transmitter, regardless of size or type of construction. It automatically tunes as many as FIVE STAGES! Provides 110 distinct and AUTOMATIC tuning functions — manually controlled by a single knob!

Just think of it!! 160, 80, 40, 20, and 10 meters, INSTANTLY AVAILABLE by a twist of the wrist! The entire transmitter tuned "on the nose" — regardless of band or frequency! You don't need roller skates to "tune up" a modern transmitter equipped with the Signal Resonator. One Control does the entire job.

Ask your local Meissner Distributor to tell you more about this amazing device. Once you see it, you'll never be satisfied with any transmitter having more than ONE tuning control.

### DESCRIBED IN SEPTEMBER QST

The Signal Resonator was fully described in an article by Bill Atkins (W9TJ) and Cy Read (W9AA) on page 30 of the September issue of QST. We suggest that you refer to this article for further details.

### EXCLUSIVE FEATURES!

- ★ Automatic, All-Band, Multi-Frequency Transmitter Control.
- ★ Accurate frequency resonance of any transmitter having from one to five stages.
- ★ Only ONE control knob for the ENTIRE transmitter.
- ★ Faster in action than a modern band-switched receiver.
- ★ Precision-built, fool-proof and positive in action.
- ★ Dimensions: 19 inches wide, 8½ inches high, 5 inches deep.

**Net Price, only .....\$29.50**

### FREE AMATEUR CATALOG

Send your name in now for your copy of the new Meissner Ham Catalog, listing amateur equipment and parts exclusively. Contains description and prices on many new and interesting products.

ADDRESS DEPT. Q-10

 **Meissner** MT. CARMEL ILLINOIS

"A FAMOUS NAME FOR TWO DECADES"

## Section Communications Managers of the A.R.R.L. Communications Department

All appointments in the League's field organization are made by the proper S.C.M., elected by members in each Section listed. Mail your S.C.M. (on the 10th of each month) a postal covering your radio activities for the previous 30 days. Tell him your DX, plans for experimenting, results in phone and traffic. He is interested, whether you are an A.R.R.L. member or get your QST at the newsstands; he wants a report from every active ham. If interested and qualified for O.R.S., O.P.S. or other appointments he can tell you about them, too.

ATLANTIC DIVISION				
Eastern Pennsylvania	W3BES	Jerry Mathis	604 1/2 Master St. 9701 Monroe Ave.	Philadelphia
Maryland-Delaware-District of Columbia	W3CIZ	Hermann E. Hobbs	Silver Spring P.O.	Linden, Maryland
Southern New Jersey	W3C30	Lester H. Allen	704 Quinton Ave.	Trenton
Western New York	W8PLA	Fred Chichester		Sonoma
Western Pennsylvania	W8OFO	Kendall Speer, Jr.		Lowber
CENTRAL DIVISION				
Illinois *	W9ILH	Mrs. Carrie Jones	2407 Central Ave.	Alton
Indiana	W9AB	Harry B. Miller	729 E. Lowell Ave.	Mishawaka
Kentucky	W9ARU	Darrell A. Downard	116 N. Longworth Ave.	Louisville
Michigan	W8DPE	Harold C. Bird	R.F.D. 2	Pontiac
Ohio	W8AQ	E. H. Gibbs	405 Broad St.	Padsworth
Wisconsin	W9UIT	Aldrich C. Kronos	2702 So. 40th St.	Milwaukee
DAKOTA DIVISION				
North Dakota	W9WWL	Anton C. Theodos	Box 444	Williston
South Dakota	W9ADJ	E. C. Mohler	Box 149	Rapid City
Northern Minnesota	W9ICZ	Edwin L. Wicklund	R.F.D. 3	Kesington
Southern Minnesota	W9YNQ	Millard L. Bender	608 N. Huron Ave.	Spring Valley
DELTA DIVISION				
Arkansas	WSABI	H. E. Vette	4415 West 12th St.	Little Rock
Louisiana	WSDDW	W. J. Wilkinson, Jr.	1523 Laurel St.	Shreveport
Mississippi	WSEWD	Jewell W. Cole	c/o City of McComb Water Dept.	McComb City
Tennessee	W4DWS	William Harold Walker	1901 Cedar Lane	Nashville
HUDSON DIVISION				
Eastern New York	W2LU	Robert E. Haight	511 South Holmes St.	Scotia
N. Y. C. & Long Island	W2AZV	E. L. Baunach	102 Central Ave.	Massapequa, L. I.
Northern New Jersey	W2GMN	Fred C. Read	1014 North Ave.	Elizabeth
MIDWEST DIVISION				
Iowa	W9PIR	L. B. Vennard	P. O. Box 304	West Burlington
Kansas	W9UEG	Alvin D. Kirby		Arlington
Missouri	W9OUD	Miss Letha Allendorf	1015 W. 3rd St.	Joplin
Nebraska	W9DI	William J. Bamer		Tobias
NEW ENGLAND DIVISION				
Connecticut	W1CTI	Frederick Ellis, Jr.	19 Merrill Rd.	Norwalk
Maine	W1IIE	H. W. Castner	147 Church	Damariscotta
Eastern Massachusetts	W1ALP	Frank L. Baker, Jr.	21 Colby Road	North Quincy
Western Massachusetts	W1IAH	William J. Barrett	239 Columbia St.	Adams
New Hampshire	W1EAF	Clayton W. Evans	163 Second W. Main St.	Concord
Rhode Island	W1HRC	Clayton C. Gordon	70 Columbia Ave., Gaspee	Plateau, Warwick
Vermont	W1KJG	Clifton G. Parker	Box 537	Morrisville
NORTHWESTERN DIVISION				
Alaska	K7GNN	James G. Sherry		Chichagot
Idaho	W7EMT	Carl Eichelberger	Route 2	Kuna
Montana	W7CPY	Rex Roberts	Box 1088	Glenview
Oregon	W7GNI	Carl Austin	1137 Federal	Bend
Washington	W7FCG	W. Beale	R. 4, School Ave.	Walla Walla
PACIFIC DIVISION				
Hawaii	K6ETF	Francis T. Blatt	837 16th Ave.	Honolulu
Nevada	W6BIC	Edward W. Heim	509 Claremont St.	Reno
Santa Clara Valley	W6IUC	Earl F. Sanderson	101 Claremont Ave.	San Jose
East Bay	W6TII	Horace R. Greer	414 Fairmount Ave.	Oakland
San Francisco	W6JBS	Thomas E. Hughes	329-36th Ave.	San Francisco
Sacramento Valley	W6MDI	Vincent N. Feldhausen	113 South Quincy St.	McCloud
Philippines	KAIGR	George L. Rickard	Box 849	Manila
San Joaquin Valley	W6KUT	Edwin A. Andress	2921 North Van Ness Blvd.	Fresno
ROANOKE DIVISION				
North Carolina	W4CYB	W. J. Wortman	P. O. Box 566	Morganton
South Carolina	W4BOE/ANG	Ted Ferguson	1213 College St.	Columbia
Virginia	W3GWO	Frank S. Anderson, Jr.	4703 New Kent Ave.	Richmond
West Virginia	W8XNO	W. D. Babler	238 Watson Ave.	Fairmont
ROCKY MOUNTAIN DIVISION				
Colorado	W9EHC	Carl C. Drumeller	849 East Dale St.	Colorado Springs
Utah-Wyoming	W7CLG	Ernest E. Parshall	Salt Creek Electric Plant	Midwest, Wyoming
SOUTHEASTERN DIVISION				
Alabama	W4DGS	James F. Thompson	12 Clanton Ave.	Montgomery
Eastern Florida	W4PEI	Carl G. Schaal	Waucoma Apts.	Clermont
Western Florida	W4AXP	Oscar Cederstrom	Lakeview Hotel	De Funiak Springs
Georgia	W4AGI	Leland W. Smith	Second St. & Bruce Ave.	Augusta
West Indies (Cuba-Isle-of-Pine-Porto Rico-Virgin Islands)	CM2OP	Mario de la Torre	2010 Pennsylvania Ave.	Havana, Cuba
SOUTHWESTERN DIVISION				
Los Angeles	W6MQM	Ralph S. Click	1038 Milwaukee Ave.	Los Angeles
Arizona	W6KMM	Marion B. Hull	617 North Fourth Ave.	Phoenix
San Diego	W6BKZ	Louis A. Cartwright	370 Nautilus	La Jolla
WEST GULF DIVISION				
Northern Texas	W5DXA	Lee Hughes	125 N. Main St.	Childress
Oklahoma	W5GFT	Russell W. Battern	Box 290	Enid
Southern Texas	W5MNI	Horace E. Bidly	1746 Schley Ave.	San Antonio
New Mexico	W5ENI	Dr. Hilton W. Gillett		Lovington
MARITIME DIVISION				
Maritime	VE1DQ	A. M. Crowell	69 Dublin St.	Halifax, N. S.
ONTARIO DIVISION				
Ontario	VE3SG	F. H. B. Saxon	302 Lee Ave.	Toronto, Ont.
QUEBEC DIVISION				
Quebec	VE2CO	Lindsey G. Morris	Apt. 6, 4510 Girouard Ave., N.D.G.	Montreal, P. Q.
VANALTA DIVISION				
Alberta	VE4GF	C. S. Jamieson	581 W. Riverside Drive	Drumheller, Alta.
British Columbia	VE5DD	C. O. I. Sawyer	2634 West 31st Ave.	Vancouver
PRAIRIE DIVISION				
Manitoba	VE4AAW	A. W. Morley	747 McMillan Ave.	Winnipeg
Saskatchewan	VE4SY	Arthur Chesworth	1071 4th Ave., N. W.	Moose Jaw

\* Officials appointed to act until the membership of the Section choose permanent S.C.M.s by nomination and election.



# Are You Ready for Emergencies

## LIKE THIS?

**F**OR building or rebuilding emergency rigs, the GL-807 has more possibilities than a K-6 on a clear channel.

Long a mainstay in many a shack, the GL-807 presents an unusual array of advantages for emergency work, even up to 125 megacycles. Great stuff for 60-mc FM, by the way.

Ask your dealer to show you the GL-807. And for your other tube needs, too, *try G-E's and measure the difference.* General Electric, Schenectady, N. Y.

## Why GL-807's Meet

## Requirements in Emergency

- |                                |                                   |
|--------------------------------|-----------------------------------|
| Low heater drain               | Full ratings up to 60 mc          |
| Amazingly low driving power    | ICAS ratings                      |
| Excellent frequency-multiplier | High output as crystal oscillator |
| Low plate voltage              | Sturdy construction               |
|                                | High efficiency                   |
|                                | No neutralizing difficulties      |

### RATINGS

Heater Volts.....6.3      Heater Amp.....0.9

	Class C 'Phone	Class C Telegraph	Class AB <sub>2</sub> A-F (2 tubes)
Max. Plate Volts	600	750	750
Max. Plate Milliamp.	100	100	240
Driving Power, Watts	0.1	0.22	0.5
Output Power, Watts	37.5	50	120

**Best of all—GL-807's  
cost ONLY \$3.50 at your G-E dealer's**

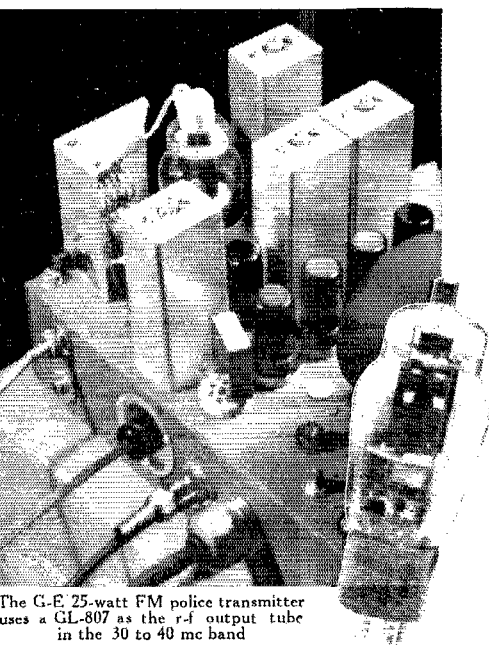

The G-E 25-watt FM police transmitter uses a GL-807 as the r-f output tube in the 30 to 40 mc band

# GENERAL ELECTRIC

### 'Hams' Active Again

As in past storms and floods, station-owning radio amateurs stepped to the fore with their transmitters as an emergency communication link in the current hurricane onslaught on Charleston, S. C., and vicinity. Charleston amateurs were reported to have set up portable equipment using battery power to get out their messages, while other amateurs in various parts of the Eastern seaboard cooperated in handling "traffic."

The amateurs are members of the American Radio Relay League, which long has been active in cooperative efforts of like nature. The amateurs serve without pay, operating their stations for the fun as well as the experience they gain. In the past, quite a number of them have been highly commended for their efforts, and several have received special medals.

# THE AMERICAN RADIO RELAY LEAGUE

## Directors

*President*  
GEORGE W. BAILEY.....W1KH  
74 Webster Road, Weston, Mass.

*Vice-President*  
CHARLES E. BLALACK.....W6GG  
1273 Main St., El Centro, Calif.

*Canadian General Manager*  
ALEX REID.....VE2BE  
169 Logan Ave., St. Lambert, E. C.

*Atlantic Division*  
WALTER BRADLEY MARTIN.....W3QV  
Box 612, Roslyn, Pa.

*Central Division*  
R. H. G. MATHEWS.....ex-W9ZN  
4534 Dover St., Chicago

*Dakota Division*  
FRED W. YOUNG.....W9MZN  
107 Hanover St., Mankato, Minn.

*Delta Division*  
E. RAY ARLEDGE.....W5SI  
P.O. Box 286, Pine Bluff, Ark.

*Hudson Division*  
KENNETH T. HILL.....W2AHC  
115 Willow St., Douglaston, L. I., N. Y.

*Midwest Division*  
FLOYD E. NORWINE, JR.....W9EFC  
7405 Hiawatha Ave., Richmond Heights, Mo.

*New England Division*  
PERCY C. NOBLE.....W1BYR  
37 Broad St., Westfield, Mass.

*Northwestern Division*  
RALPH J. GIBBONS.....W7KY  
c/o United Air Lines, Portland, Ore.

*Pacific Division*  
J. L. McCARGAR.....W6EY  
60 Hamilton Pl., Oakland, Calif.

*Roadside Division*  
H. L. CAVENESS.....W4DW  
State College Station, Raleigh, N. C.

*Rocky Mountain Division*  
GLEN R. GLASSCOCK.....W9FA  
2164 So. Corona St., Denver

*Southeastern Division*  
WILLIAM C. SHELTON.....W4ASR  
Box 652, Daytona Beach, Fla.

*Southwestern Division (Admg)*  
JOHN E. BICKEL.....W6BKY  
801 E. California St., Whittier, Calif.

*West Gulf Division*  
WILLIAM A. GREEN.....W5BRH  
801 Ross St., Adilene, Texas

THE AMERICAN RADIO RELAY LEAGUE, INC., is a non-commercial association of radio amateurs, bonded for the promotion of interest in amateur radio communication and experimentation, for the relaying of messages by radio, for the advancement of the radio art and of the public welfare, for the representation of the radio amateur in legislative matters, and for the maintenance of fraternalism and a high standard of conduct.

It is an incorporated association without capital stock, chartered under the laws of Connecticut. Its affairs are governed by a Board of Directors, elected every two years by the general membership. The officers are elected or appointed by the Directors. The League is non-commercial and no one commercially engaged in the manufacture, sale or rental of radio apparatus is eligible to membership on its board.

"Of, by and for the amateur," it numbers within its ranks practically every worth-while amateur in the nation and has a history of glorious achievement as the standard-bearer in amateur affairs.

Inquiries regarding membership are solicited. A bona fide interest in amateur radio is the only essential qualification; ownership of a transmitting station and knowledge of the code are not prerequisite. Correspondence should be addressed to the Secretary.



## Past Presidents

HIRAM PERCY MAXIM, 1914-1936  
EUGENE C. WOODRUFF, 1936-1940

## Officers

*President*.....GEORGE W. BAILEY, W1KH  
Weston, Mass.

*Vice-President*.....CHARLES E. BLALACK, W6GG  
El Centro, Calif.

*Secretary*.....KENNETH B. WARNER, W1EH  
West Hartford, Connecticut

*Treasurer*.....ARTHUR A. HEBERT, W1ES  
West Hartford, Connecticut

*Communications Mgr.*.....F. EDWARD HANDY, W1BDI  
West Hartford, Connecticut

*General Counsel*.....PAUL M. SEGAL  
1026 Woodward Building, Washington, D. C.

Address all general correspondence to the administrative headquarters at West Hartford, Connecticut.

## “IT SEEMS TO US—”

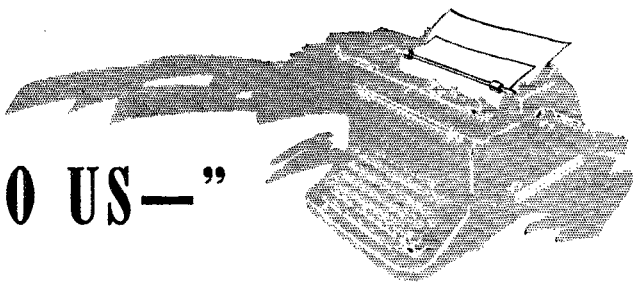

IN the biscuit-eating country we came from, “Butter ’em while they’re hot” had real meaning. Breakfast in those days was a formidable affair starting off with a round or so of fruit and cereal, both swimming in cream and liberally dredged with sugar, and going on to such incidental fare as sausages, scrambled ham and eggs, fried potatoes, fried mush and perhaps a stack of wheats, all held down by several cups of hot cocoa. Somewhere along in the proceedings, however, the cook would kick open the dining-room door and march in with a napkin-covered dish of biscuits. Her entry was invariably accompanied by a clatter of discarded forks on our part as we grabbed for knives and dove for the butter. “Butter ’em while they’re hot . . .”

All of which is apropos of the fact that the League apparently served up a real load of biscuits with the code-proficiency program first announced in the August *QST*: it is our intent to do some editorial buttering while the subject is hot. “Hot” it is, too, as we happen to know from participating in the correcting of the nearly one thousand first test papers; hundreds of amateurs appear to have dropped everything else to get in on it and the resulting enthusiasm is something approached only by such other outstanding successes as the DX Contest and Field Day. Some representative reactions appear in the correspondence section of this issue but they only faintly mirror the acclaim with which the program has been greeted, the joy on the part of hundreds of amateurs that they now have something by which their ability can be measured, and the intense eagerness with which they await future opportunities to demonstrate improvement in that ability. We had expected pretty favorable response from the traffic gang (and got it) but we hardly expected that hordes of u.h.f. experimenters, DX men and ’phone men would also go for it in a way scarcely equalled by any other League activity. After all, when a confirmed DX man says he’s finally found something which adequately fills the gap left by DX, that’s news! — yet we saw it in cold print, with our own eyes.

Many interesting things showed up as a result of this first run. Somewhat unexpectedly,

the largest qualifying group was at the 30-word speed; this was followed by those who made 20, then the gang at 25, then 15 and finally the top-fighters at 35. These refer to actual qualifications; a lot of the boys who qualified at one speed took passes at higher ones but failed to make the grade. Many times the next higher grade was missed by only a single letter — but rules are rules, and in fairness to all were rigidly enforced. Perhaps the saddest example was the fellow who came within a couple of letters of qualifying at 35, 30, 25 and 20 but had perfect copy only for 15. Against this were those who found they had underestimated themselves and discovered through participation in the test that they were capable of 5 to 10 w.p.m. more than they thought. The surprises worked both ways.

Certain words consistently proved stumbling-blocks. Strangely enough, one of these was “procedure” (in the 25-w.p.m. test) which a great many of the gang (obviously because they were copying several words behind) wrote down with two “e’s” as “proceedure.” One chap, in fact, missed out on qualifying at this speed because he went back and deliberately inserted the extra “e” after he’d copied it correctly in the first place. The somewhat dubious moral to this seems to be that if you don’t believe what you hear, at least you should brush up on spelling!

The biggest single reaction was that it is one thing to copy in your head and quite another to reduce that copy to paper. There’s the rub, all right! And speaking of writing it down, the papers show that 30-per is just about the fastest the average person can put it down in longhand; even then, most of it was pretty sloppy, although some of the boys actually qualified in longhand at 35! Most of the gang, however, confessed an inability to keep up with it with a pencil after 25, and the result was scores of expressions of intent to start “mill” practice, for future schedules.

Our own principal reaction is twofold: First, we have experienced few things more stimulating than the prospect of hundreds and hundreds of our U. S. amateurs taking on this program for self-improvement and evidencing

by their every word their eager intent to better their code speed. Second, we believe the principal weakness of the program at the moment is the relatively small participation by the 15-w.p.m. class. The comments of many in this class are revealing; most of them accompanied their copy with half-apologetic remarks indicating they were reluctant to send in any copy at all, until they could make a better showing. For every one who nevertheless did send in copy, there must have been dozens who were similarly-minded and did not. We submit that such sentiments are all wrong, and we urge every amateur in the country to get his certificate for that speed, as a starter. Correcting papers is tedious work, but nothing would please us more than to receive several thousand "15-per" test papers after the next run.

We can take it. The question is, can you!

A. L. B.

**ELSEWHERE** in this issue appears the second group of charts predicting the communications behavior of the various amateur bands. This series, which will be a continuing feature in *QST*, was initiated last month with the publication of similar graphs for August and September, together with explanatory material on their use.

We take pardonable pride in presenting this material, and acknowledge our great appreciation of the cooperation of the National Bureau of Standards in preparing it at the request of our editorial staff. Nothing like it has ever been done before. The Bureau for some time has been publishing predictions of maximum usable frequencies for various transmission distances, but since we amateurs aren't free to pick an optimum frequency when it falls between our bands, we are more interested in knowing which of our own special territories will be good for working that sked 800 miles away, and at what time of the day we'll have the best chance of getting through. So we asked the people at the Bureau whether they could supply that kind of dope, and after looking into the special problems involved they decided it was worth a try. Thus is launched a project which not only will benefit us hams but in which we also have an opportunity to reciprocate by making our own observations to check the Bureau's predictions, thereby possibly aiding in making them increasingly accurate and useful as time goes on.

The path of the prophet is perilous enough without our adding false alarms. Therefore let's remember that these predictions are based on average conditions in the ionosphere: they do not, and cannot, attempt to take into account such unpredictable things as magnetic storms and the like. It is to be expected that exceptions will occur, so don't burn up the

mails telling us we're all wet because one or two night's listening didn't check out to the last mile or minute. Or that you can't send as far as the charts say you ought to be able to! The most uncertain factor, absorption, is the one which controls the higher limit of distance obtainable; we'd expect the skip distances to hit the mark more closely than the upper limits of useful distances.

Finally, the graphs consider only useful communication, not simply the possibility that a signal may be heard. Particularly in the skip zone, scattered reflections may bring in those wavery, watery signals we often hear, but they don't count — it's the good solid sigs that the charts are based on. Use reasonable judgment, jot down your observations of the band conditions as a matter of course during the day's operating — and when you've accumulated data for a month or so let us know how well you check with the predictions. The few minutes so spent will be interesting and fruitful.

G. G.

---

## ★ SPLATTER ★

---

### OUR COVER

Jim Lamb, author of our lead article this month, is caught in the act of focussing on objects out-of-doors from the A.R.R.L. Lab second story window.

### FEEDBACK

In George Brown's article on a Precision Frequency Standard that appeared in August *QST* we omitted the value of  $R_{24}$ . This is a 10-watt 15,000-ohm resistor. The 1000-ke. crystal was a G.E. type G-18A.

---

### Strays

---

A tone signal of variable pitch and intensity for testing 'phone rigs is easily obtainable by tuning in the transmitter oscillator signal on the receiver with the b.f.o. on. The loudspeaker may then be used to feed the microphone. The only case where this might not work out is where the crystal frequency and the output frequency are the same. — *WIGR*.

For some mysterious reason, my superhet receiver experienced a loss in selectivity. After investigating every other possibility, I inspected the i.f. transformers and discovered that the wax holding the top winding in place had loosened up allowing the top coil to slide down close to the bottom coil. I was able to fasten them back in place by melting the wax with a soldering iron.

— *WSIMZ*.

Remember the thrill of your very first QSO? Remember the kick you got from your first real DX contact? And, if you have photography as an allied hobby, remember the excitement you felt when you finished that first print and the picture details began to appear? Put them all together and you have some idea of what is in store when the new ham television camera is fired up for the first time — bring up the Ike bias a hair, a final touch to the focus — and there's the first image beginning to take form on the monitor! There is something new in the old game of ham radio.

# Television Camera-Modulator Design for Practical Amateur Operation

*Combining Economy, Mobility and Reliability in a Compact Tripod-Mounted Assembly*

BY JAMES J. LAMB, W1AL\*

**T**HE new seeing era in amateur communication has been made not only possible but eminently practical by the introduction of the amateur type 1847 Iconoscope, described in June 1940 *QST*, along with the evolution of circuit simplifications which were published for the first time in May 1940 *QST*. The practicability of this combination has been well demonstrated by the experimental equipment described in the latter article; and the fact that the laboratory design lends itself to adaptation in a form even more suitable for practical amateur use has been proved by experience with the set-up which is the subject of the present article.

Although the circuit might seem unduly complex at first glance, a little section-by-section study shows that the whole breaks down into elements that are relatively simple and fully within the scope of amateur understanding. For instance, the video amplifier-modulator chain is nothing more than a straightforward resistance-coupled amplifier of familiar type. Actually, it represents little more complexity than the speech-input end of an amateur 'phone transmitter. The Iconoscope and monitor circuits are found to be no different from what we have already met in the conventional cathode-ray oscilloscope, with the minor exceptions that we find signal voltages as well as d.c. bias applied to

\* Research Engineer, A.R.R.L.

The complete tripod-mounted television assembly is conveniently rolled into operating position on a simple dolly made of three pieces of 1 x 2 wood and three 10-cent casters. Plug in the line cord of the power supply (bottom) and connect the concentric line from the camera (top) to the r.f. transmitter — and you're on the air. The unit immediately below the camera is the pulse generator. The tripod, with "tilt" and "pan" head, is part of an old 16-mm. standard home-movie outfit.

the monitor and "Ike" control grids, and an extra connection from the signal plate at the front end of the Iconoscope tube. While the pulse generator introduces us to something we have

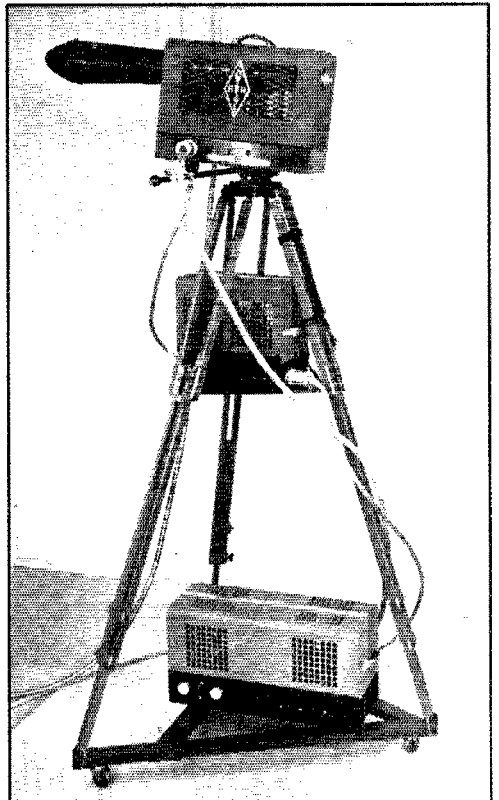

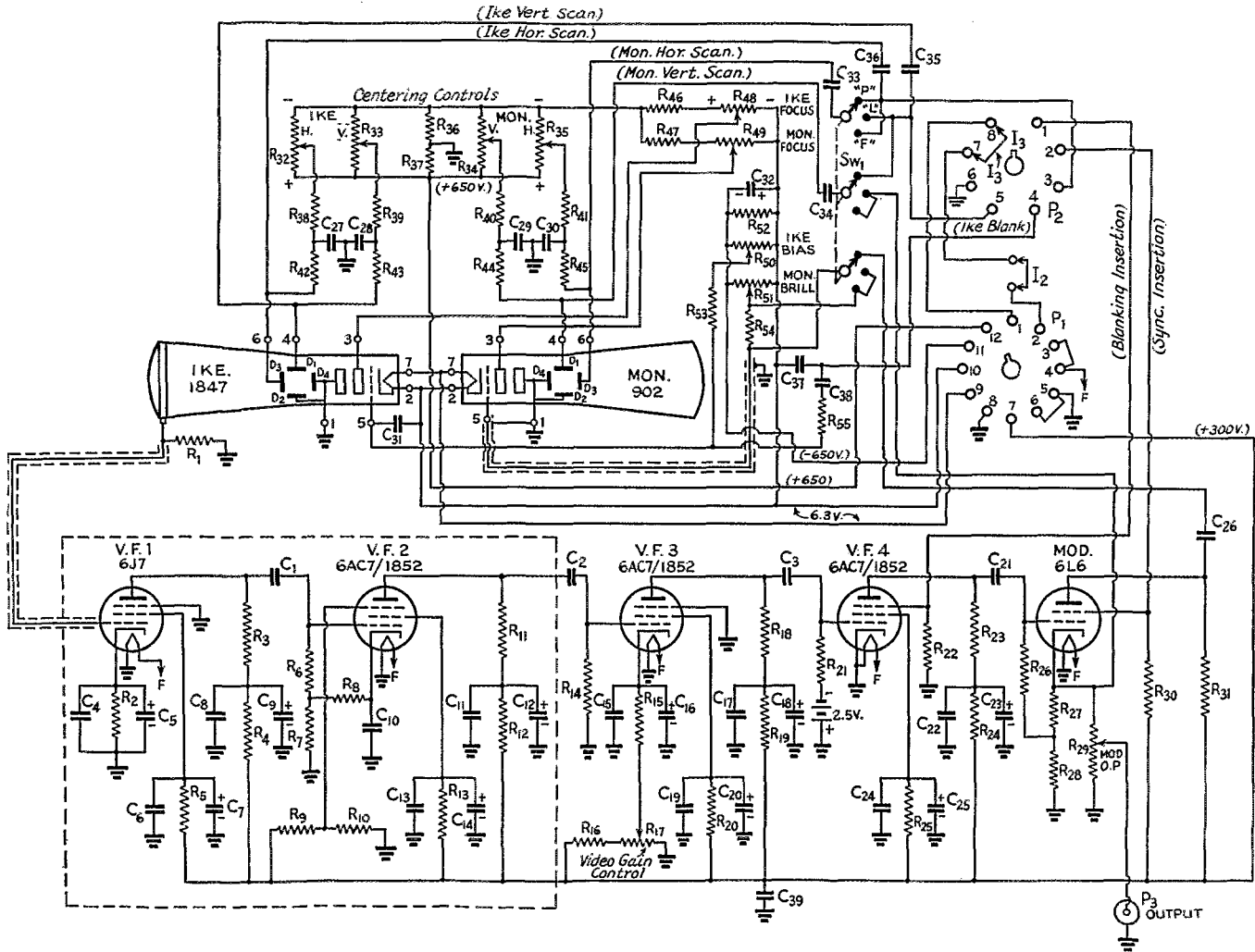

Fig. 1 — The camera-modulator circuit diagram.

- R1 — 0.5 meg.,  $\frac{1}{2}$  w. (Ike coupling).  
 R2 — 300 ohms,  $\frac{1}{2}$  w. (Cathode bias).  
 R3 — 10,000 ohms,  $\frac{1}{2}$  w. (Plate coupling).  
 R4 — 50,000 ohms,  $\frac{1}{2}$  w. (Plate filtering).  
 R5 — 0.25 meg.,  $\frac{1}{2}$  w. (Screen dropping).  
 R6, R4, R31 — 0.1 meg.,  $\frac{1}{2}$  w. (Grid coupling).  
 R7 — 4000 ohms,  $\frac{1}{2}$  watt (Cathode degeneration).  
 R8, R16 — 160 ohms,  $\frac{1}{2}$  w. (Cathode bias).  
 R9 — 50,000 ohms,  $\frac{1}{2}$  w. (Suppressor divider).  
 R10 — 150,000 ohms,  $\frac{1}{2}$  w. (Suppressor divider).  
 R11, R18 — 10,000 ohms,  $\frac{1}{2}$  w. (Plate coupling).  
 R12, R19 — 10,000 ohms, 1 w. (Plate filtering).  
 R13, R20, R25 — 60,400 ohms,  $\frac{1}{2}$  w. (Screen dropping).  
 R14 — 0.1 meg., 1 w. (Gain control divider).  
 R17 — 5000-ohm wire-wound potentiometer (Video gain control).  
 R22 — 20,000 ohms,  $\frac{1}{2}$  w. (Blanking insertion coupling).  
 R23 — 7500 ohms,  $\frac{1}{2}$  w. (Plate coupling).  
 R24 — 50,000 ohms, 1 w. (Plate filtering).  
 R26 — 1 meg.,  $\frac{1}{2}$  w. (Grid coupling).  
 R27 — 1000 ohms, 1 w. (Cathode bias).  
 R28 — 2000 ohms, 2 w. (Cathode loading).  
 R29 — 3000-ohm wire-wound pot. (Mod. output control).  
 R30 — 6000 ohms, 10 w. (Sync. insertion coupling).  
 R31 — 1000 ohms, 10 w. (Mod.-monitor coupling).  
 R32, R33, R34, R35 — 1-meg. potentiometers (Beam centering controls).  
 R36, R37 — 20,000 ohms,  $\frac{1}{2}$  w. (Centering voltage divider).  
 R38, R39, R40, R41 — 1 meg.,  $\frac{1}{2}$  w. (Deflection filtering).  
 R42, R43, R44, R45 — 2 meg.,  $\frac{1}{2}$  w. (Deflection plate coupling).  
 R46, R47 — 0.2 meg.,  $\frac{1}{2}$  w. (Focus voltage dropping).  
 R48, R49 — 0.25-meg. pots. (Focus and brilliance controls).  
 R50, R51 — 0.1-meg. pots. (Bias and brilliance controls).  
 R52 — 0.1 meg.,  $\frac{1}{2}$  w. (Bleeder).  
 R53 — 50,000 ohms,  $\frac{1}{2}$  w. (Ike grid coupling).  
 R54 — 0.5 meg.,  $\frac{1}{2}$  w. (Monitor grid coupling).  
 R55 — 1000 ohms,  $\frac{1}{2}$  w. (Ike blanking feed).  
 C1, C2, C3 — 0.004- $\mu$ fd., 400-v., mica (High-frequency video coupling).  
 C4, C5, C6, C10, C11, C13, C17, C19, C22, C24 — 0.002- $\mu$ fd., 400-v. mica (High-frequency by-pass).  
 C5, C16 — 25- $\mu$ fd., 25-v. electrolytic (Cathode by-pass).  
 C7, C8, C12, C14, C15, C16, C25 — 4- $\mu$ fd., 450-volt electrolytic (Screen and plate filtering).  
 C18 — 0.01- $\mu$ fd., 600-v. paper (Cathode by-pass).  
 C21 — 0.1- $\mu$ fd., 600-v. paper (Low-frequency video coupling).  
 C23 — 16- $\mu$ fd., 450-v. electrolytic (Plate filtering).  
 C27 — 0.05- $\mu$ fd., 1000-v. paper (Monitor coupling).  
 C28, C29, C30, C35 — 0.1- $\mu$ fd., 400-v. (Deflection filtering).  
 C31 — 0.05- $\mu$ fd., 600-v. paper (Ike grid by-pass).  
 C32 — 4- $\mu$ fd., 450-v. electrolytic (Bias filtering).  
 C33, C34, C36 — 0.25- $\mu$ fd., 600-v. paper (Deflection coupling).  
 C38 — 0.05- $\mu$ fd., 600-v. paper (Deflection coupling).  
 C37 — 0.1- $\mu$ fd., 1000-v. paper (Ike blanking stabilizer).  
 C39 — 0.1- $\mu$ fd., 1000-v. paper (Ike blanking coupling).  
 C40 — 0.1- $\mu$ fd., 600-v. paper (Main B-supply by-pass).  
 SW1 — Triple-pole triple-throw non-shorting circuit selector switch (Mallory-Yaxley 3243J, one circuit-section not used).  
 P1 — 12-contact power supply chassis-type connector (Amphenol No. POL2F, used with No. 012 cable connector).  
 P2 — Standard ceramic octal socket (National CIR-8, used with Amphenol PM8-11 octal plug on pulse generator connecting cable).  
 P3 — Co-axial cable chassis connector (Amphenol No. 93-C, with No. 93-M cable connector; or Amphenol No. PCLM, with No. MCLF cable connector).  
 I2 — Interlock, standard plug and receptacle (Amphenol No. 61-F1 receptacle mounted on chassis, No. 61-M1 standard plug on base plate).  
 I3 — Pulse cable interlock (Jumper between pins 7 and 8 in pulse generator cable plug).  
 Bias battery — Two 1 $\frac{1}{2}$ -volt Mallory bias cells. Two 1 $\frac{1}{2}$ -volt flashlight cell may be used instead.  
 Chassis — 7" x 13" x 2" or 2 $\frac{1}{2}$ " deep. Base plate fitted with tapped bushing to take tripod-head screw.  
 Camera cover case, 7" x 13" x 8" high (James Millen Mfg. Co.).

not met in exactly the same form previously, the certainty of obtaining proper results automatically by the simple process of faithfully following the diagrams and specifications eliminates any reason for doubt on this score. The power supply required is entirely conventional, so much so that many amateurs will find that they already have one that may be used with little or no modification.

The complete camera-modulator unit, it is interesting to note, contains about the same number of tubes and circuits as the better type communication receivers now so universally used. But there are no coils to wind, nor are there any tricky tuned-circuit adjustments to be made. The same comparison may be made with regard to cost. The total bill for everything included in the three units shown, not excepting the cables and all tubes, is \$142.42. That's less than the price of the top-flight single-signal superhets now on the market. Of interest to 'phone operators is the additional comparison of the cost of the Iconoscope tube and the cost of a good quality crystal microphone of the type widely used by amateurs. They are practically the same.

A functional description of the amateur television circuit has been given in the May *QST* article describing the first experimental laboratory camera-modulator assembly; therefore, only a general resumé will be necessary here. The camera-modulator proper includes the Iconoscope which picks up the picture focused on its mosaic by a simple lens. The video output of the Iconoscope is amplified through the chain consisting of four 1852's and a 6L6. This last tube is designated the modulator, since its output is at a sufficiently high level to be used to grid-modulate a suitable tube in the u.h.f. final stage of the transmitter. The camera unit also contains the monitor which is nothing more than a 902 cathode-ray tube serving as a miniature television Kinescope, using part of the video output of the modulator. This is an especially unique feature since it permits the operator to see just what he is picking up, right at the camera position, so that he knows exactly what is being put on the air, both as to subject matter and quality.

The pulse generator, which in this design is a separate unit, furnishes vertical and horizontal saw-tooth scanning voltages for both the Iconoscope and the monitor, making scanning in both these tubes automatically synchronous. The

pulse generator also furnishes vertical and horizontal blanking pulses for two purposes. A part of the full output of the blanking amplifier is applied to the control grid of the Ike, biasing its grid negative during the fly-back time of both horizontal and vertical scanning cycles so that

there is no output from the Ike during the line and frame return traces. These combined blanking voltages are also applied at full amplitude to the suppressor grid of the fourth video stage, thus impressing the blanking pulses on the output for conveyance to the receiver on the radio frequency

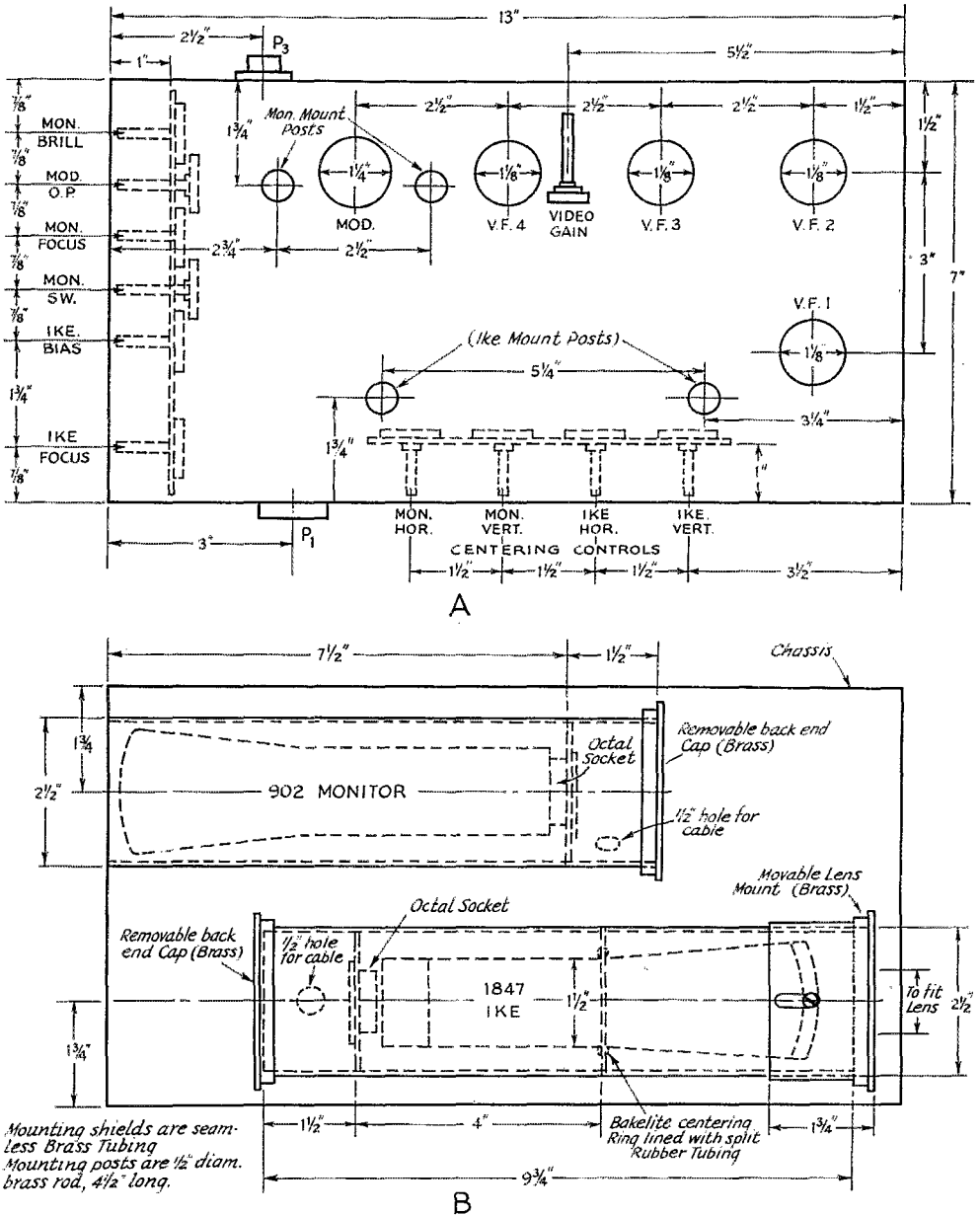
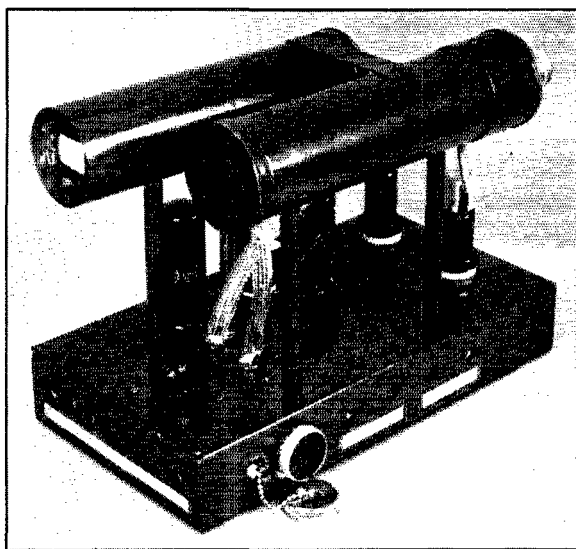

Fig. 2 — Layout plan of the camera-modulator unit. "A" shows the location of tubes and gain control on top of the chassis, with components underneath indicated by dotted lines. "B" gives the dimensions and constructional details of the Iconoscope and monitor mounts.





The compact camera unit, here viewed from the rear, includes the video amplifier and modulator circuits, as well as the Iconoscope (facing forward) and monitor (facing rear) mounted in separate shield assemblies. Constructional details are shown in Fig. 2.

carrier wave. There they are used to cut off the scanning beam of the Kinescope during the return trace intervals between frames and between the lines of each frame. If this were not done, during fly-back the return traces of the scanning beam would show up and spoil the picture reproduction. These blanking pulses are of square-top wave form and are of relatively short duration as compared to the scanning time.

In addition to these blanking pulses which

operate in effect to stop picture pick-up and reproduction between frames and between the lines of each frame, the pulse generator also supplies narrower synchronizing pulses which have no function in the transmission system but which are of prime importance at the receiver. These pulses are sent along with the transmitted signal during the blanking time and are applied to the emitted carrier by modulation of the screen-grid of the 6L6 output tube. The synchronizing pulses are considerably narrower than the blanking pulses and are characteristically sharp-peaked "pips" which show up riding on top of the blanking pulses in an oscillogram of the modulator output.

Although this pulse combination might seem extremely complex and difficult of attainment, both timing and polarity are automatically taken care of in the design of the circuits. Since the vertical and horizontal oscillators each serves as the primary source for the respective vertical and horizontal pulses of the several types, their respective frequencies are taken care of without any special adjustment. The polarity is determined by the sequence of phase reversals in passage through the various amplifying stages. For instance, the blanking pulses are applied with negative polarity to the suppressor of the fourth video stage. Thus they come out with positive polarity in the plate circuit of this tube and in the cathode circuit of the modulator from which the composite signal applied to the carrier is taken. On the other hand, the synchronizing pulses are

Below the camera chassis, with base plate (in foreground) and shielding enclosure of first two stages (right) removed. Note that control shafts do not extend beyond the chassis, but are adjusted by the removable tuning tool shown in another illustration. This eliminates unauthorized knob twiddling and accidental misadjustment.

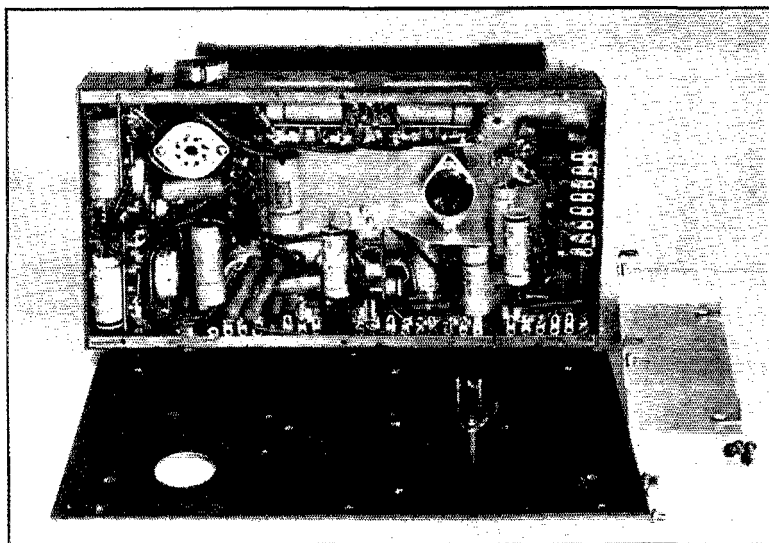

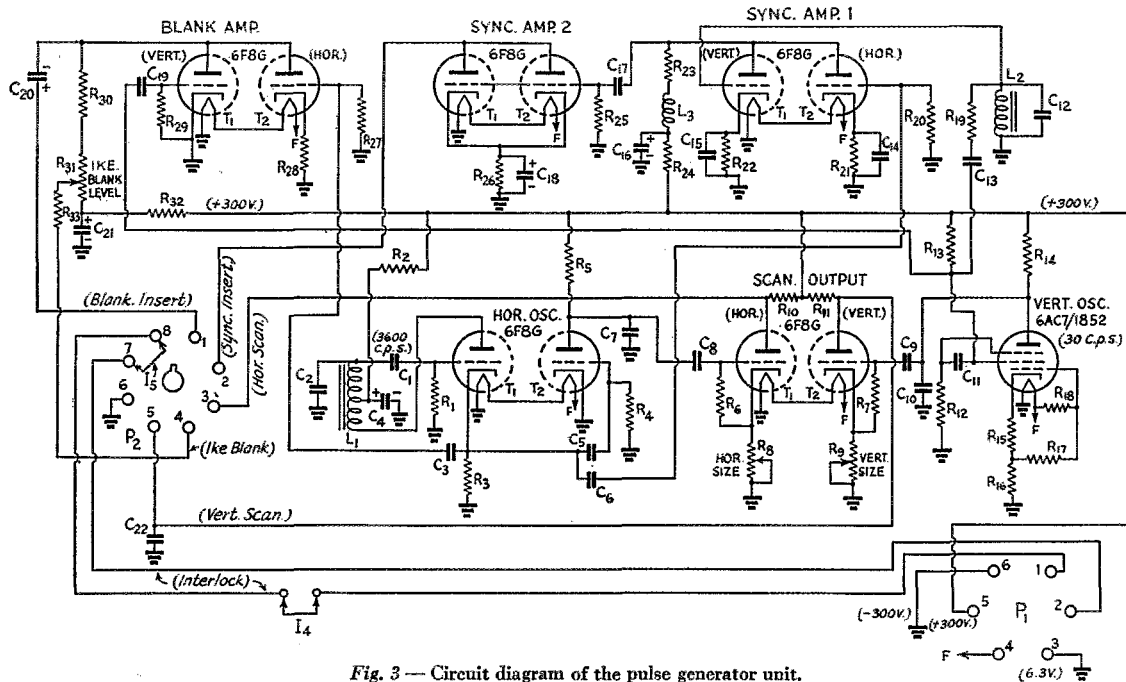
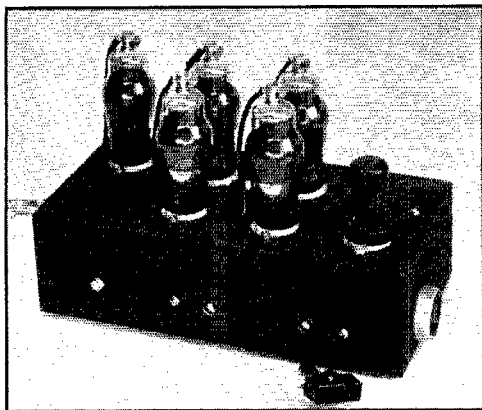

Fig. 3 — Circuit diagram of the pulse generator unit.

- R<sub>1</sub> — 70,000 ohms, ½ w. (Horizontal osc. grid leak).  
 R<sub>2</sub> — 5000 ohms, ½ w. (Horizontal osc. plate filter resistor).  
 R<sub>3</sub> — 1000 ohms, ½ w. (Horizontal osc. cathode resistor).  
 R<sub>4</sub> — 1 meg., ½ w. (Hor. saw-tooth generator grid resistor).  
 R<sub>5</sub> — 1 meg., ½ w. (Hor. saw-tooth generator plate resistor).  
 R<sub>6</sub>, R<sub>7</sub> — 10 meg., ½ w. (Scan. amp. grid resistors).  
 R<sub>8</sub>, R<sub>9</sub> — 50,000-ohm pots. (Scan. amp. cathode-bias (size) controls).  
 R<sub>10</sub> — 0.1 meg., ½ w. (Hor. scan. amp. plate).  
 R<sub>11</sub> — 0.15 meg., ½ w. (Vert. scan. amp. plate).  
 R<sub>12</sub> — 5 meg., ½ w. (Vert. osc. suppressor).  
 R<sub>13</sub> — 0.2 meg., ½ w. (Vert. osc. screen).  
 R<sub>14</sub> — 1 meg., ½ w. (Vert. osc. plate).  
 R<sub>15</sub> — 500 ohms, ½ w. (Vert. osc. grid bias).  
 R<sub>16</sub> — 5000 ohms, ½ w. (Vert. osc. cathode drop).  
 R<sub>17</sub> — 25,000 ohms, ½ w. (Vert. osc. 60-cycle sync. feed).  
 R<sub>18</sub> — 1 meg., ½ w. (Vert. osc. 60-cycle sync. feed).  
 R<sub>19</sub> — 1 meg., ½ w. (Vert. sync. amp. grid feed).  
 R<sub>20</sub> — 1 meg., ½ w. (Hor. sync. amp. grid leak).  
 R<sub>21</sub>, R<sub>22</sub> — 4 meg., ½ w. (Hor. and vert. sync. amp. cathode bias).  
 R<sub>23</sub> — 30,000 ohms, ½ w. (Sync. amp. plate load).

- R<sub>24</sub> — 0.1 meg., ½ w. (Sync. amp. 1-plate filter).  
 R<sub>25</sub> — 2 meg., ½ w. (Sync. amp. 2-grid coupling).  
 R<sub>26</sub> — 250 ohms, ½ w. (Sync. amp. 2-cathode bias).  
 R<sub>27</sub> — 2 meg., ½ w. (Hor. blank. amp. grid coupling).  
 R<sub>28</sub> — 1000 ohms, ½ w. (Hor. blank. amp. cathode bias).  
 R<sub>29</sub> — 5 meg., ½ w. (Vert. blank. amp. grid leak).  
 R<sub>30</sub> — 20,000 ohms, 1 w. (Blank. amp. plate load).  
 R<sub>31</sub> — 1000-ohm pot. (Ike blank. level adjustment).  
 R<sub>32</sub> — 20,000 ohms, 1 w. (Blank. amp. plate filter).  
 R<sub>33</sub> — 1000 ohms, ½ w. (Ike blank. feed).  
 C<sub>1</sub> — 0.002-μfd. mica (Hor. osc. grid blocking).  
 C<sub>2</sub> — 0.006-μfd. mica (Hor. osc. tuning).  
 C<sub>3</sub> — 0.002-μfd. mica (Hor. blank. grid coupling).  
 C<sub>4</sub> — 4-μfd., 450-v. electrolytic (Hor. osc. plate filter).  
 C<sub>5</sub> — 0.01-μfd., 600-v. paper (Hor. saw-tooth amp. grid).  
 C<sub>6</sub> — 0.01-μfd., 600-v. paper (Hor. sync. amp. 1 grid).  
 C<sub>7</sub> — 0.001-μfd. mica (Hor. saw-tooth amp. plate).  
 C<sub>8</sub> — 0.01-μfd., 600-v. paper (Hor. scan. amp. grid).  
 C<sub>9</sub> — 0.1-μfd., 600-v. paper (Vert. scan. amp. grid).  
 C<sub>10</sub> — 0.25-μfd., 600-v. paper (Vert. osc. plate).  
 C<sub>11</sub> — 0.006-μfd., 600-v. mica (Vert. osc. time constant).

- C<sub>12</sub> — 0.001-μfd. mica (Vert. sync. pulse delay).  
 C<sub>13</sub> — 0.01-μfd., 600-v. paper (Vert. pulse coupling).  
 C<sub>14</sub> — 0.01-μfd., 600-v. paper (Hor. sync. amp. cathode by-pass).  
 C<sub>15</sub> — 0.05-μfd., 600-v. paper (Vert. sync. amp. cathode by-pass).  
 C<sub>16</sub> — 4-μfd., 450-v. electrolytic (Sync. amp. plate filter).  
 C<sub>17</sub> — 0.1-μfd., 600-v. paper (Sync. amp. 2-grid).  
 C<sub>18</sub> — 50-μfd., 25-v. electrolytic (Sync. amp. 2-cathode by-pass).  
 C<sub>19</sub> — 0.1-μfd., 600-v. paper (Vert. blank grid coupling).  
 C<sub>20</sub> — 4-μfd., 450-v. electrolytic (Blank. output coupling).  
 C<sub>21</sub> — 20-μfd., 450-v. electrolytic (Blank. amp. plate filter).  
 C<sub>22</sub> — 0.002-μfd. mica (Vert. scan. h.f. by-pass).  
 L<sub>1</sub> — Hor. osc. coil to tune to approx. 3600 c.p.s. Primary of open-mounted type audio output transformer with part or all of core laminations removed — such as RCA No. 7852 with keeper (separate laminations across one end) removed. See text.  
 L<sub>2</sub> — 1080-h., 0.5-ma. audio choke, vert. sync. pulse differentiator (Thordarson T-29C27).  
 L<sub>3</sub> — 60-mh. r.f. choke, peaking h.f. components of hor. sync. pulse.  
 P<sub>1</sub> — 6-contact chassis connector for power supply (Amphenol Type PO6F, used with type O6M cable connector).  
 P<sub>2</sub> — Standard ceramic octal socket for pulse output connection to camera unit (National CIR-8, used with Amphenol PM8-11 octal plug on connecting cable).  
 I<sub>4</sub> — Base-plate interlock (Amphenol No. 61-F1 standard receptacle mounted on chassis, No. 61-M1 standard plug on base plate).  
 I<sub>5</sub> — Pulse cable interlock (Jumper between pins 7 and 8 in pulse generator cable plug).  
 Chassis — 5" x 10" x 3" deep, with cover and base plate (Par-metal No. DF-5510).



Top view of the pulse generator chassis. The tuning tool for adjustment of the various controls is at the right.

applied with positive polarity to the screen of the modulator so that they also come out of this tube's cathode circuit with positive polarity. It is therefore important that no changes should be made in the number of stages, either in the camera-modulator unit or in the pulse generator, without provision for preservation of this proper relationship in polarity of the pulses.

The same requirement applies to the polarity of the video signal from the Ike. Since transmission with *negative* polarity of video modulation is intended in this system, and since the output of the Iconoscope is characteristically negative, there should be an even number of amplifying stages ahead of the modulator when the signal output is taken from the cathode of this last stage. It is understood, of course, that negative video polarity means that black gives maximum output and white gives minimum output. Maximum upward modulation of the carrier by a video component occurs with scanning of a dark part of the picture while minimum modulation occurs with scanning of a bright part of the picture. Of course positive polarity of video modulation could be used (and is used in some foreign television systems) provided both the transmitter and the receiver were designed for it. However, the American commercial practice is to use negative modulation (for technical reasons

which we need not go into here) and accordingly it has been adopted for our amateur system.

The design of this equipment, like that of the amateur experimental television assembly previously described, is for 30 frames (pictures) per second, and approximately 120 lines per picture. It should be made clear that there is no rigorous relationship between the number of lines per picture and the number of pictures per second. Although the frame (picture) frequency is synchronized by the 60-cycle supply, the number of lines (which is determined by the frequency of the horizontal oscillator) need not be exactly 120 per picture. However, since the intention is to use a 3-inch Kinescope for reception, a greater number of lines than 120 or so is not justified in view of the fact that the band width required increases with the number of lines very rapidly — and we haven't any too much channel space, even on the 112-Mc. band. In experimenting with this equipment a wide range of horizontal oscillator frequencies has been tried, giving from less than 100 lines to over 400 lines per picture. At 60 lines (1800-cycle oscillator frequency) the line structure is very coarse and quite unsatisfactory. But above 120 lines the line structure does not show up in the received picture noticeably and no appreciable improvement is evident with a greater number of lines. (The number of lines is readily determined by simply dividing the horizontal oscillator frequency by 30, the number of frames per second, since in this system "straight" scanning is used with no interlacing.) The horizontal oscillator frequency was finally left at 3750 cycles, where it happened to land with the *LC* combination most convenient. This corresponds to 125 lines per picture.

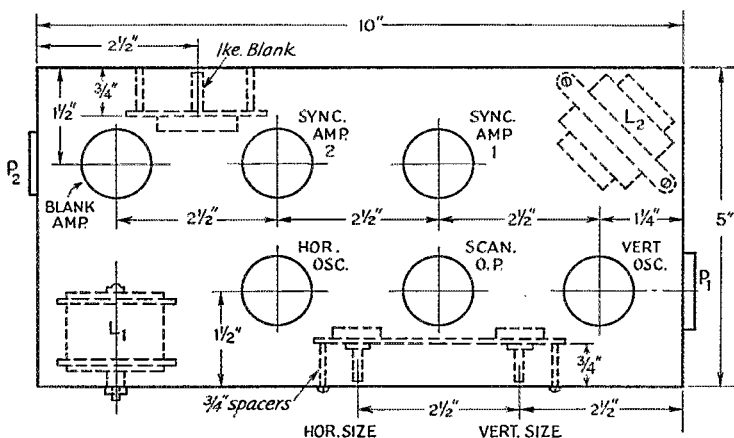

Chassis depth = 3" Socket holes 1 1/8" diam.

Fig. 4 — Location plan of the pulse generator chassis. Components underneath are indicated by dotted lines.

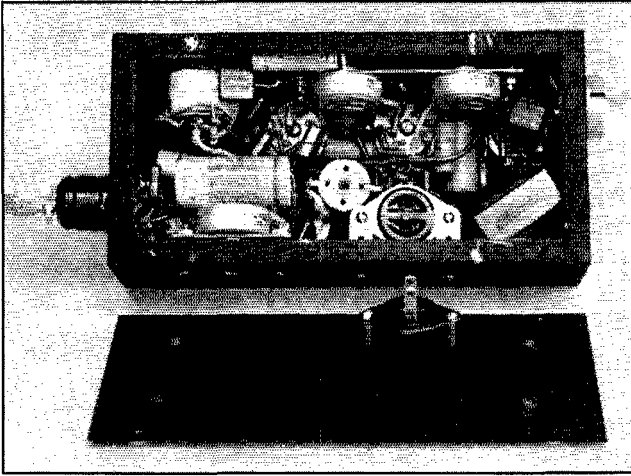

Showing the components inside the pulse generator unit chassis. Details are given in Fig. 4.

### Camera Unit Construction

One of the objectives in the design of the camera-modulator unit was to make it of practical size and proportions for easy handling with tripod mounting. This could not be done with the video and pulse-generator circuit on the same chassis. Accordingly, the pulse generator was made a separate unit with a short cable carrying the pulse voltages to the Iconoscope, monitor and video circuits. This arrangement has the additional advantage of keeping the vertical and horizontal oscillators, with their amplifiers, physically isolated from the sensitive video amplifier circuits and thus minimizes stray coupling of undesired pulse voltages into video circuits where they do not belong.

Although the camera chassis may seem rather crowded underneath, separate shielding of the first two stages and proper attention to the placement of the various components results in good circuit stability with short connections in video circuits, and freedom from hum modulation and cross-talk between deflection circuits, etc. Important dimensions and locations of the principal components are shown in Fig. 2. As a further aid in identification of the parts, the general functional purpose of each item is given in the list accompanying the circuit diagram. In placing the tube sockets of the video stages, the grid and plate terminals (which are opposite each other in the 1852) should be lined up to give the shortest possible coupling connections from one video amplifier to the next. The modulator socket is spaced  $\frac{1}{4}$ -inch below the chassis top. In wiring, the filament connections should be made first, one side of each heater being grounded immediately at the socket. The single wire interconnecting the ungrounded sides should run from stage

to stage in the corner of the chassis, and should be kept well away from grid leads and terminals. The grid coupling condensers should be dressed away from the chassis to minimize capacitance to ground. The screen by-pass condensers should be laid across the sockets between the grid and plate terminals to serve as shields between input and output. Plate and cathode by-pass condensers are tucked in as convenient, usually between the sockets and the adjacent side of the chassis. A line of terminal lug strips near the edge of the chassis makes for convenience in soldering connections and in supporting the resistors and some of the smaller condensers.

When the video amplifier has been completely wired it is a good idea to check the circuit elements for continuity and resistance values by means of an ohmmeter. Caution: Do not connect a voltmeter or other closed-circuit instrument across the grid circuit of V.F.4 if Mallory bias cells are used. If a signal generator is available an operating test also can be made. A good test frequency is 10,000 cycles. Output of approximately 25 volts peak should be shown on a c.r. oscilloscope with an input of 100 microvolts or so to the grid of the first stage, the output being taken off across the cathode circuit of the 6L6.

When the video section has been completed, the next step is to assemble the components and to wire up the Iconoscope and monitor circuits inside the chassis. The two small sub-panels, one carrying the centering controls and the other the bias and focus controls, go in first. The centering control panel, at the bottom in Fig. 2-A, is made of  $\frac{1}{16}$ -inch aluminum sheet, 6 inches by  $2\frac{1}{4}$  inches with  $\frac{3}{8}$  inch bent over for fastening to the chassis with a couple of machine screws. After cutting off the potentiometer shafts and filing them "half-flat" to accommodate the tuning tool (this is a 2-inch length of  $\frac{1}{4}$ -inch diameter copper tubing with solder run in one end along a cut-off piece of aluminum control shafting to make a half-round, after which the shafting is removed; the other end is fitted with a knob). The resistors are assembled on the sub-panel. To make the best use of available space, the four deflection filtering condensers,  $C_{27}$ ,  $C_{28}$ ,  $C_{29}$  and  $C_{30}$ , are located on the front of this sub-panel and are supported on insulated terminal lugs near the edge at the center and near the bottom on the right and left sides. These terminal connections also support the deflection filtering resistors,  $R_{38}$ ,  $R_{39}$ ,  $R_{40}$  and  $R_{41}$ , which connect to the centering controls.

In connecting to the potentiometer terminals, it is recommended that the polarity indications of the schematic diagram be followed so that full right-hand rotation of the control is "plus" in each case. The polarity indications also should be observed in connecting the electrolytic condensers. The video gain control  $R_{17}$  should be connected with its right-hand terminal to ground. This control, which is above the chassis, is mounted on an individual bracket and connected into the cathode circuit of V. F. 3 by insulated flexible leads through holes in the chassis top.

The sub-panel carrying the focus and bias controls is similar, except that it is  $6\frac{7}{8}$  inches wide. In addition to the controls, condensers  $C_{31}$ ,  $C_{32}$ ,  $C_{37}$  and  $C_{38}$  are also carried on this sub-panel, utilizing the space between it and the chassis.

Behind this sub-panel, with shafts projecting between adjacent controls, are next placed the monitor switch,  $Sw_1$ , and  $R_{29}$ , the modulator output control, mounted on individual brackets. Before proceeding further the remaining leads should be soldered to the power-supply connector terminals ( $P_1$ ), leaving lengths sufficient for each to reach its ultimate connection. The pulse-generator connecting octal socket,  $P_2$ , should then be located. This socket is supported on two  $1\frac{1}{2}$ -inch pieces of  $\frac{1}{8}$ -inch tubing tapped for 6-32 screws at the ends. The four deflection-coupling condensers,  $C_{33}$ ,  $C_{34}$ ,  $C_{35}$ , and  $C_{36}$ , are grouped in the space remaining at this end of the chassis. Connections are made to the monitor and Iconoscope leads by means of insulated terminal strips. The monitor coupling condenser,  $C_{26}$ , is also fitted in this area.

### Monitor and Iconoscope Mounts

Dimensioned details of the monitor and Iconoscope mounts are given in Fig. 2-B. The general idea is to place the mountings on the chassis so that the front end of the Ike points forward and the screen end of the monitor faces the rear of the camera. The sockets for these two tubes are centered in thin aluminum discs which

are held in place within the mounting by three 6-32 screws tapped into "ears" 120 degrees apart around the periphery of each disc. Each disc has peripheral slots for the socket-mounting screws to allow rotation of the socket plus and minus 10 degrees for exact alignment of the scanning area or "raster." The monitor socket is mounted with pins Nos. 3 and 7 in a vertical line, with pin 3 above 7. The Iconoscope socket is located so that pins No. 3 and No. 6 are in a horizontal line with the key of the base centering pin upward. Note that the socket terminal numbers are indicated on the schematic diagram of Fig. 1.

The rear covers of the Ike and monitor mounting tubes are removable to give access to the socket mounting screws for rotation adjustment and also to facilitate removal of the 902 and 1847 by pushing against the base centering pin with a small dowel rod or a lead pencil.

Terminal No. 1 of each socket is connected directly to the shielding within the mount. The grid lead (No. 5) of the monitor is separately shielded within the cable which runs down to the chassis. The collection of leads to each of these tubes is run in a braided shield which is grounded at each end and is secured at the chassis by a small cable clamp. The cable leads are flexible wire with rubber and cotton braid insulation. The leads terminate underneath the chassis on insulated terminal strips between the modulator and pulse cable sockets, except for the monitor grid lead which goes to the switch and the Iconoscope grid lead which goes to a terminal on the rear sub-panel.

The top cover for the camera unit is 8 inches high above the chassis and has a 2-inch diameter hole in the front and another in the back for the camera lens and for viewing the monitor. Centered on the monitor port in the back is  $2\frac{1}{4}$ -inch diameter flange over which is slipped a "shadow-box" or visor which is necessary to shield off external light when viewing the monitor. This flange is made from a National type J30 coil shield cut off  $\frac{3}{4}$ -inch from the bottom. It is fixed to the camera case by four self-tapping screws.

The power supply with its top cover off. In the Millen ceramic tube sockets (spaced  $2\frac{1}{4}$ " between centers) are (left) the time delay relay, then the 5Z3 main rectifier, two 2A3 regulator tubes, the 80 rectifier, 6SJ7 regulator control and, finally, the 991 neon tube (right). Behind, in the same order, are  $T_3$ ,  $T_2$  and  $L_1$ . The power switch and extractor end of the fuse mounting are between the pilot light "bull's eyes" at the left, on the front of the chassis; the voltmeter tip jack strip and output voltage adjustment ( $R_8$ ) are at the right.

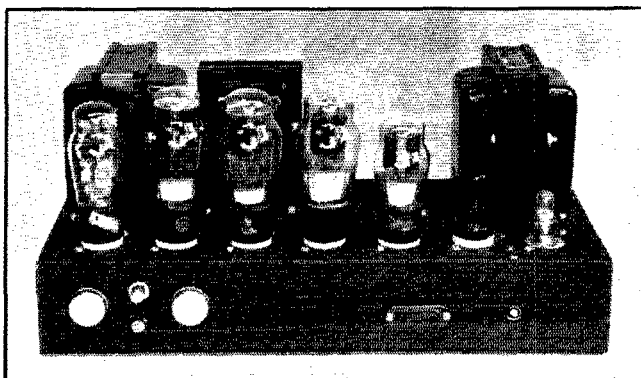

The outside of the chassis, the bottom plate and the Iconoscope and monitor mounts are painted with dark gray Duco lacquer to give a uniform appearance. Before applying the paint, scotch tape was wrapped around the tube sockets extending above the chassis and around the power and output cable connectors for protection during the painting process. The scotch tape was left on until the paint had dried.

### Pulse Generator Construction

The circuit of the pulse generator unit is given in Fig. 3 and the layout plan of its chassis is shown in Fig. 4. The information given in these two diagrams is almost completely self-explanatory, but a few additional suggestions may be helpful. The circuit is essentially the same as that

given in Mr. Sherman's description of the experimental camera-modulator unit in May 1940 *QST*, with two minor exceptions. In the vertical oscillator, the time-constant determining capacitor,  $C_{11}$ , connected between the screen and suppressor grids, is 0.006  $\mu\text{fd.}$  instead of 0.004  $\mu\text{fd.}$  It was found that the lower capacitance gave insufficient time constant with the result that the oscillator attempted to run at an indeterminate frequency between 30 and 60 cycles per second. Although this capacitance is not especially critical, the value of 0.006  $\mu\text{fd.}$  was found to be more satisfactory with condensers of usual commercial tolerance. The other minor modification is in the resistance of  $R_{31}$ , the Iconoscope blanking level adjustment. Here a resistance of 1000 ohms was found to give a somewhat higher maximum out-

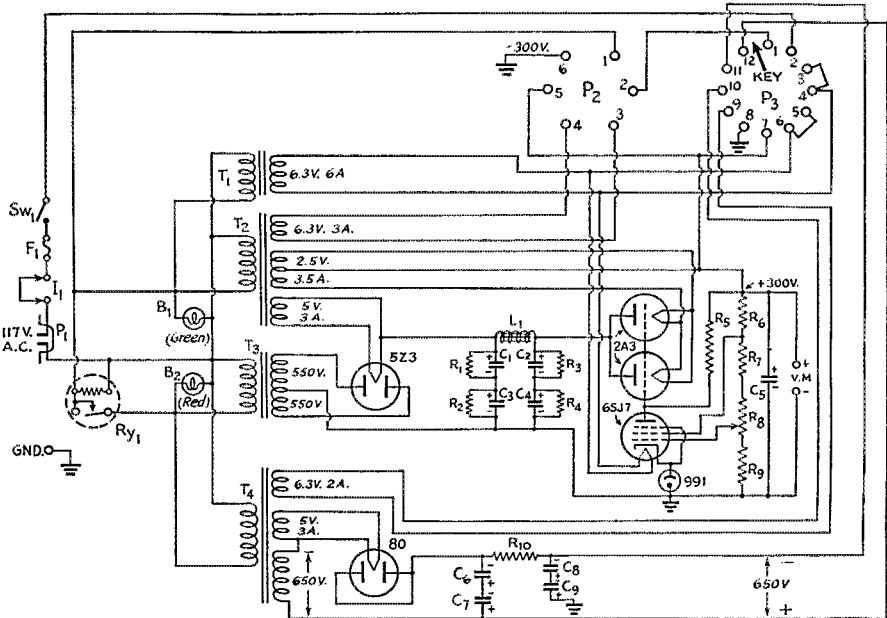

Fig. 5 — Power supply circuit diagram

- T<sub>1</sub> — Camera filament transformer (Thordarson T-19F98).
- T<sub>2</sub> — Pulse rectifier and regulator fil. trans. (Thordarson T-79F84).
- T<sub>3</sub> — 1100-v., 250-ma. plate transformer (Thordarson T-19P55).
- T<sub>4</sub> — Iconoscope- and monitor-supply transformer (Thordarson T-13R11).
- L<sub>1</sub> — 13-h., 250-ma. filter choke (Thordarson T-75C51).
- C<sub>1</sub>, C<sub>2</sub>, C<sub>3</sub>, C<sub>4</sub> — 20- $\mu\text{fd.}$ , 450-v. electrolytic filter cond.
- C<sub>5</sub> — 8- $\mu\text{fd.}$ , 450-v. elec. filter cond.
- C<sub>6</sub>, C<sub>7</sub> — 4- $\mu\text{fd.}$ , 450-v. elec. filter cond.
- C<sub>8</sub>, C<sub>9</sub> — 20- $\mu\text{fd.}$ , 450-v. elec. filter cond.
- R<sub>1</sub>, R<sub>2</sub>, R<sub>3</sub>, R<sub>4</sub> — 100,000 ohms, 2 w. (Condenser Voltage equalizing).
- R<sub>5</sub> — 0.5 meg.,  $\frac{1}{2}$  w. (Regulator-control plate).
- R<sub>6</sub> — 15,000 ohms, 1 w. (Regulator-control divider).
- R<sub>7</sub> — 25,000 ohms, 1 w. (Regulator-control divider).
- R<sub>8</sub> — 10,000-ohm potentiometer (Output voltage adjustment).
- R<sub>9</sub> — 5,000 ohms, 1 w.
- R<sub>10</sub> — 50,000 ohms,  $\frac{1}{2}$  w. (Filter resistor).

- Ry<sub>1</sub> — Thermal time delay relay, circuit-closing type (Millen No. 51006).
- P<sub>1</sub> — Motor-type male connecting plug (Amphenol 61M10, used with No. 61-F11 receptacle on line cond.).
- P<sub>2</sub> — 6-contact chassis-type connector (Amphenol PO6F, used with Type O6M cable connector).
- P<sub>3</sub> — 12-contact chassis-type connector (Amphenol PO12F, used with No. 012-M cable connector).
- I<sub>1</sub> — Interlock, standard plug and receptacle (Amphenol No. 61-F1 receptacle mounted on chassis, No. 61-M1 standard plug mounted on base plate).
- F<sub>1</sub> — Fuse (Littelfuse extractor type fuse mounting with 3-amp. fuse).
- SW<sub>1</sub> — Double-action push switch (Hart & Hegeman Type 80710).
- B<sub>1</sub>, B<sub>2</sub> — 110-v. pilot lights, with jewel colors as indicated (Drake No. 75).
- V.M. — Moulded bakelite twin tip jacks marked "+" and "-" (For d.c. voltmeter connection).
- Chassis — 7" x 17" x 3" deep, with base-plate and cover (Parmetal No. DF-717).

put blanking voltage to take care of critical conditions for which the originally specified 500-ohm value proved to be inadequate.

In this unit individual shields are not provided for the glass tubes because of the metal enclosure which is provided for the top of the chassis. If this enclosure is omitted, individual shielding of the tubes should be used.

### The Power Supply

The power supply illustrated and diagramed in Fig. 5 is designed to give regulated output of 200 ma. at 300 volts d.c. as well as the necessary filament power for the video and pulse generator tubes, and the anode and filament supply for the Ike and monitor.

It includes a thermal time-delay relay which turns on the main B-supply and the supply for the c.r. tubes approximately 25 seconds after the filaments of the video amplifier and pulse generator tubes have been switched on. It is not necessary to use a supply incorporating all of these features, of course, and the simpler type described by Mr. Sherman in May 1940 *QST* could be used. However, the additional features of regulation of the full B-supply output and the time delay are well worth the extra cost. This supply, incidentally, is also well adapted to other purposes. The regulated output may be taken from the volt-meter pin-jack terminals for the operation of a receiver or the low-power stages of a transmitter requiring 250 or 300 volts at times when the equipment is not used with the television camera-modulator. The additional filtering provided by the regulator gives B-supply of exceptionally low hum content. The construction of the power supply is adequately shown by the circuit diagram and photographs, and is entirely conventional.

### Preliminary Testing

Before attempting to put the complete outfit into operation, a few preliminary tests are advisable to determine the approximate adjustment settings of the various controls and to check the operation of the separate sections. Having first determined that the amplifier is in operating condition, as previously suggested, the next check should be made on the pulse generator unit. This will be greatly simplified if a separate cathode-ray oscilloscope is available, particularly the type having a horizontal sweep oscillator that can be externally synchronized. The preliminary checks on this equipment were made with an RCA type 122-B oscilloscope.

Inter-connecting cables all should be plugged in and the base plates of the power supply and camera unit should be on to close the interlock

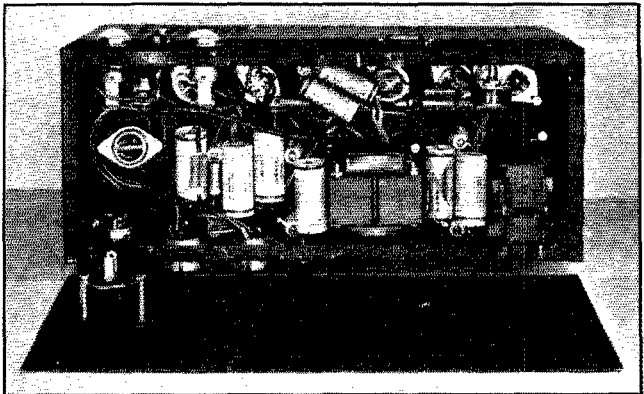

Transformers  $T_4$  and  $T_1$  (right) are mounted underneath the power supply chassis. Note that filter condensers connected in series are supported on stand-off insulators.

circuit. The base-plate of the pulse generator is left off, however, and a shorted dummy plug is inserted in the interlock receptacle. The 80 rectifier in the power supply should be removed to prevent application of anode voltage to the c.r. circuit. The power supply should be switched on and the main B-supply voltage adjusted to exactly 300 volts by means of  $R_8$ .

The ground side of the external oscilloscope should be connected to the pulse-generator chassis. A test lead with a blocking condenser of approximately  $0.1 \mu\text{fd.}$  in series is connected to the high side of the vertical deflection input. If the oscilloscope contains a vertical amplifier, this is switched off. The sweep oscillator of the oscilloscope should be on and, for the time being, 60-cycle internal synchronization may be used.

Operation of the vertical oscillator in the pulse generator is checked by connecting the test lead to the screen of the 1852. With the oscilloscope sweep properly adjusted, the pattern of the square-topped pulse shown in Fig. 2, page 34, May 1940 *QST* should appear. With the test lead connected to the plate of the vertical oscillator tube a saw-tooth wave of relatively small amplitude should result. An enlarged version of this same saw-tooth with reversed polarity is obtained by connecting the test lead to pin No. 5 of the pulse generator output socket. A sharp narrow pulse should be obtained by connecting to the plate of vertical Sync. Amplifier 1 or the grid of Sync. Amp. 2. Much greater amplitude and opposite polarity of the same wave form should obtain with connection of the test lead to pulse cable socket pin No. 2. The horizontal synchronizing pulses will also appear in these oscilloscope patterns of the vertical sync. pulse, although they will be fainter and probably not stationary. Test lead connection to the plate of the blanking amplifier should show a square-top pattern with a

(Continued on page 84)

# An E.C.O. Exciter with 20-Watts Output

*A Stable Unit with Ganged Tuning*

BY DON H. MIX\*

**I**N SPITE of the rapid increase during the past year or so in the number of stations making use of the e.c.o. and other forms of non-crystal-controlled exciters, it is safe to say that there is less cause for complaint against signals of poor quality now than in the earlier days when only a comparative few were in use. Of course, we still have those lazy fellows who don't seem to care what the signal sounds like so long as they are able to flit about the bands as they please. But most of the gang have stuck to the job until the point has now been reached where there are hundreds of transmitters on the air with self-excited oscillators which produce signals with frequency stability every bit as good as that obtainable with crystal control. In cases where the oscillator is keyed for break-in operation, results with the s.e.o. are frequently superior.

\* Asst. Technical Editor, *QST*.

Most of those who have succeeded in obtaining good results have made the unfortunate discovery that an oscillator which appears to be perfect in every respect when operated by itself cannot be depended upon to produce an acceptable signal when coupled to following amplifier stages. The performance of the best oscillator may be ruined easily by instability in a succeeding amplifier stage. Unless unusual care in neutralizing and the tuning of these amplifier stages is to be taken with each appreciable change in frequency, thorough isolation between the frequency-generating circuit and these stages must be provided. Probably one of the most common causes of poor notes these days is an unstable 807 or 6L6 in one of the doubler or amplifier stages. The high power-sensitivity of these tubes makes them prone to self-oscillate, either at the operating frequency or some parasitic frequency—sometimes at both. With crystal control, these oscillations may cause nothing more serious than a bad case of key clicks and a T8 note, but with a s.e.o., their consequences are usually much more serious.

In the unit shown in the photographs the various factors which contribute toward instability have been taken into consideration.

The 6F6 was chosen for the oscillator tube since it is remarkably free from "microphonics" or changes in frequency caused by mechanical jarring. It is followed by a 6L6 frequency doubler to provide isolation between the oscillator and following stages. The 802 is used in the output stage to add further to the isolation and to provide a means of obtaining a power output from the unit of 15 to 20 watts or more at full voltage—a power level comparable to that of a power crystal oscillator. This type was chosen in preference to the 807 as being less susceptible to parasitic oscillations. It is considered preferable to build the isolating and power stages into the e.c.o. unit rather than to feed the oscillator into existing stages of a transmitter which may not be designed for the purpose.

It will be noticed from the circuit diagram of Fig. 1 that the grid circuit of the e.c.o. and the plate circuits of the

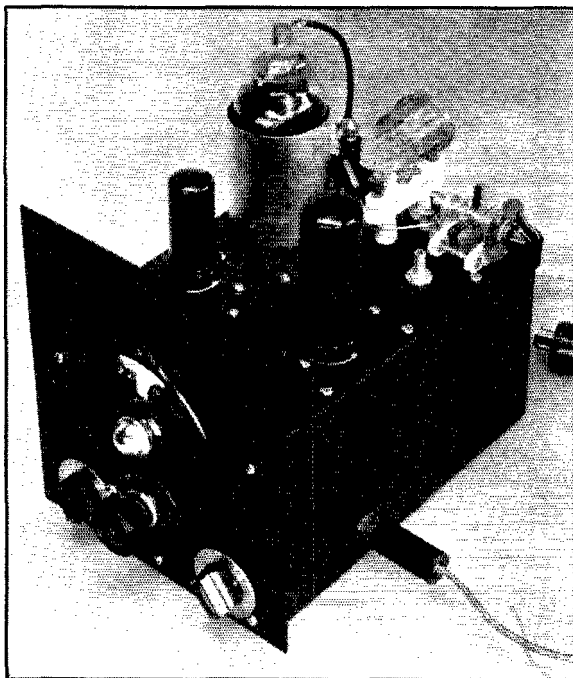

A steel utility box, 5 in. by 6 in. by 9 in., is used as the chassis. A standard 7 by 8 steel panel is fastened on the front. The small knob to the left controls the vernier for small frequency changes, while the one to the right operates the keying switch. The shaft of the 6L6 padder is in front of the 802 plate padder at the rear.



6L6 and the 802 are tuned simultaneously by a gang of three midget condensers. These circuits may be tuned individually by omitting  $C_5$  and  $C_6$  and substituting 100- $\mu$ fd. condensers for  $C_7$  and  $C_8$ . The slight additional cost of the ganging is well worth while, however. Parallel plate feed is used throughout to permit direct grounding of the various tuned-circuit components. The separate cathode winding,  $L_2$ , instead of a tap on  $L_1$  facilitates a convenient keying circuit for the oscillator.

The unit is designed to give output in two bands — either the 1.7-Mc. band and the 3.5-Mc. band or the 3.5-Mc. band and the 7-Mc. band, depending upon the choice of the constructor. The grid-circuit inductance of the oscillator and the plate-circuit inductance of the 6L6 are permanently mounted and only the plate coil of the 802 needs changing for operating as a straight amplifier or as a doubler. For 1.7- and 3.5-Mc. output, the oscillator operates at 875 kc., the 6L6 at 1.7 Mc. and the 802 at either 1.7 or 3.5 Mc. For 1.7- and 3.5-Mc. output the oscillator operates at 1.7 Mc., the 6L6 at 3.5 Mc. and 802 at either 3.5 or 7 Mc. Fixed coils in the first two stages facilitate an arrangement for shielding these stages from the output circuit and following amplifier stages if they are used.

The tuning range is adjusted so that the 1.7- and 3.5-Mc. bands are spread over about 90% of the dial scale. At 7 Mc. only the lower-frequency portion of the range is useful. However, no difficulty should be experienced in setting quickly within audibility of a chosen frequency — even at the 28-Mc. harmonic.  $C_4$  is provided as a handy means of setting the frequency to zero beat or for making small frequency changes.

Although zero temperature-coefficient condensers are specified for the oscillator padding capacity ( $C_1$  and  $C_2$ ), an ordinary 500- $\mu$ fd. mica condenser, or one of the silvered type, may be substituted if maximum reduction in frequency drift is not considered important. Since the tubes are mounted on top of the unit and all voltage-dropping resistor networks are external to the unit, the variation in temperature inside the box is reduced substantially to that of the operating room.

The switch in the keying circuit has three positions. In the first position, the oscillator and 6L6 stages operate through the key to produce a

This article describes an e.c.o. unit which will deliver power comparable with that of a power crystal oscillator. It is designed for output at either 1.7 or 3.5 Mc. or 3.5 and 7 Mc. depending upon the choice of coil dimensions. Change in tuning of the output stage only is required for two-band coverage.

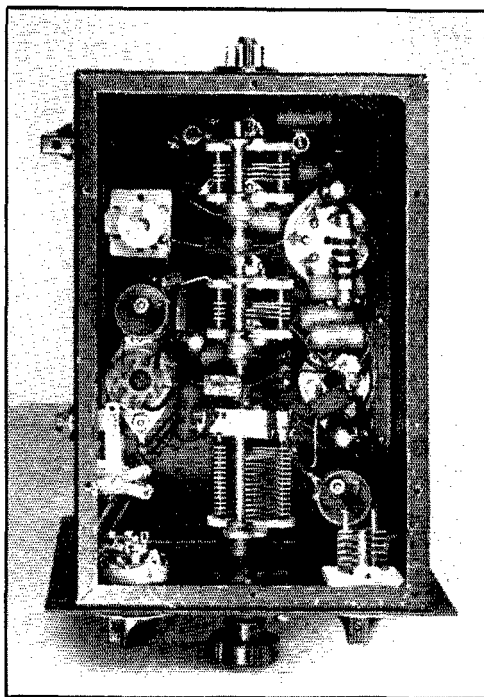

Bottom view with bottom plate removed showing arrangement of components under the chassis. The removable top and bottom plates make the assembly easy. Shielded single conductor is used for the key-circuit leads.

monitoring signal for setting frequency. In the second position, both oscillator and output stages are keyed for break-in operation. For those who prefer buffer keying, the third position switches the oscillator to continuous operation, while the 802 alone is keyed.

It may also be well to mention that the unusually large value of plate blocking capacity for  $C_{13}$  is required in this instance to detune a parasitic circuit set up by the r.f. chokes in the 6L6 grid and plate circuits. The r.f. choke in the cathode circuit of the 802 eliminated a trace of r.f. in the keying leads.

### Construction

The unit is constructed with a steel utility box 5 in. by 6 in. by 9 in. as the chassis. Both top and bottom plates of this box are removable which facilitates construction, since all but a few components are mounted on the top plate. The three condensers of the tuning gang are first coupled together and set in place with the shaft running along the center of the plate and the shaft of the first condenser ( $C_3$ ) protruding far enough in front for the dial. The tube sockets are then placed in the positions shown in the photographs, the sockets for the 6F6 and 802 on one side, and

the 6L6 on the other side opposite the 6F6. The coil forms and the 6L6 padder,  $C_7$ , are then placed, spacing the coil forms a half-inch or so from the plate with spacers. The plate-circuit components for the 802 are then arranged on top of the base so that their mounting screws will not interfere with the components placed below. The plate-circuit r.f. choke and blocking condenser,  $C_{12}$ , are behind the 802 with a National feed-through point for bringing the high-voltage lead up through the base to the bottom end of the choke.

Small components are then placed in the nearest available remaining open spaces. The National R100U r.f. chokes are convenient for mounting in restricted space. The one fastened on one of the mounting screws of the 6F6 socket is the one in the 6F6 cathode lead to the key, while the one to the side of the socket is the plate-circuit choke. The 6L6 plate-circuit choke is next to the 6L6 plate coil and the one fastened to the 802 socket-mounting screw is in the 802 grid circuit. The horizontally-mounted choke is

in the 802 cathode circuit and the end toward the key switch is fastened to a small insulated lug strip, the other end being connected directly to the cathode terminal of the socket.

The two fixed condensers,  $C_1$  and  $C_2$ , which look like resistors, are supported by their leads connected across the terminals of  $C_3$ . They are braced against vibration by binding together at each end with rubber bands. A stiff wire soldered to the lead between the rotor of  $C_3$  and the top of  $L_1$  is fastened to the ends of the condensers with Duco cement to provide further bracing.  $C_9$  is supported by its leads between the stator terminal of  $C_3$  and the 6F6 grid terminal at the socket.  $C_{10}$  is also supported by its leads between the top of the oscillator plate-circuit choke and the grid terminal of the 6L6. Similarly,  $C_{11}$  is suspended between the stator terminal of  $C_7$  and the grid terminal of the 802 socket, passing underneath the condenser shaft but spaced from the chassis. By-pass condensers are tucked in wherever space may be found near the terminal to be by-passed.

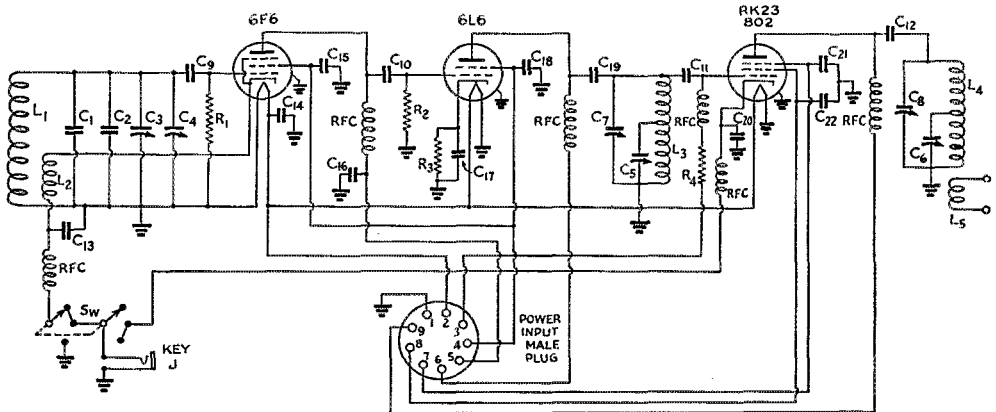

Fig. 1 — Circuit diagram of the e.c.o. exciter.

- $C_1, C_2$  — 250- $\mu$ fd. fixed, zero-temp. Coefficient (Centralab 816Z).
- $C_3$  — 200- $\mu$ fd. midget variable (Hammarlund MC200M).
- $C_4$  — 15- $\mu$ fd. midget variable (Hammarlund HF15X).
- $C_5, C_6$  — 50- $\mu$ fd. midget variable (Hammarlund MC50M).
- $C_7$  — 50- $\mu$ fd. midget variable (Hammarlund HF50).
- $C_8$  — 50- $\mu$ fd. midget variable (Hammarlund MC50S).
- $C_9, C_{10}$  — 100- $\mu$ fd. mica.
- $C_{11}$  — 250- $\mu$ fd. mica.
- $C_{12}$  — 0.001- $\mu$ fd. mica.
- $C_{13}, C_{14}, C_{15}, C_{16}, C_{17}, C_{18}, C_{19}, C_{20}$  — 0.01- $\mu$ fd. paper.
- J — Single open-circuit jack.
- $R_1$  — 1 meg.,  $\frac{1}{2}$ -watt.
- $R_2$  — 0.1 meg.,  $\frac{1}{2}$ -watt.
- $R_3$  — 400 ohms, 1-watt.
- $R_4$  — 50,000 ohms, 1-watt.
- R.f.c. — 2.5-mh. r.f. choke.
- Sw — 2-circuit, 3-position switch (Mallory 3223J).
- $L_1$  — 0.875 Mc. — 60 turns No. 24 enam., close-wound.
- 1.7 Mc. — 26 turns No. 22 d.s.c.,  $\frac{3}{8}$ -in. long.
- $L_2$  — 0.85 Mc. — 20 turns No. 24 enam., wound turn for turn over ground end of  $L_1$ , same direction.

- 1.7 Mc. — 9 turns No. 22 d.s.c., wound turn for turn over ground end of  $L_1$ , same direction.
- $L_3$  — 1.7 Mc. — 85 turns No. 30 d.s.c., tapped at 22 turns from plate end.
- 3.5 Mc. — 37 turns No. 24 d.s.c., close-wound, tapped at 10 turns from plate end.
- $L_4$  — 1.7 Mc. — 60 turns,  $1\frac{1}{2}$ -in. diam.,  $1\frac{15}{16}$ -in. long. (National AR160E coil with 12 turns removed, tapped at 12 turns from plate end) (105  $\mu$ hs. tapped at  $\frac{1}{3}$  of total number of turns from plate end).
- 3.5 Mc. — 32 turns,  $1\frac{1}{2}$ -in. diam.,  $1\frac{5}{16}$ -in. long, tapped at 11 turns from plate end (National AR80E coil with 24 turns removed, tapped at 11 turns from plate end) (26  $\mu$ hs. tapped at  $\frac{1}{2}$  of total number of turns from plate end).
- 7 Mc. — 19 turns,  $1\frac{1}{2}$ -in. diam., 1-in. long, tapped at 8 turns from plate end (National AR40E with 9 turns removed, tapped at 8 turns from plate end) (8.8  $\mu$ hs. tapped at  $\frac{2}{3}$  of total number of turns from plate end).

Note:  $L_1, L_2$  and  $L_3$  wound on Millen 1-in. diam. forms, no pins.

The high-potential r.f. wiring may be done with a few short lengths of No. 14 wire. All power wiring is done with push-back wire laid close to the chassis and cabled along one side to the nine-pin male power-input plug mounted on the rear wall of the box. Power leads for the 802 suppressor, screen and plate may be brought up to the power-input plug but should not be soldered to the plug until preceding stages have been tested.

A standard steel panel, 7 in. by 8 in. is fastened to the front end of the box.  $C_4$  and the key-circuit switch are mounted in the lower corners. The key jack is mounted on the side of the box. Shielded single-conductor wire should be used for all key-circuit wiring from the r.f. chokes to the key jack and should also be used for the external wiring from the plug to the key to prevent r.f. pickup. The outside shield is used for the grounded side of the circuit. Wiring to the key switch and jack and to the power-input plug may be done before the unit is placed in the box, so that only the single connection between the stator of the vernier,  $C_4$ , and the top of  $L_1$  need be made after the top is fastened in place. After the top has been screwed down, an inspection of the edges should be made to make sure that it is secure at all points. Any gaps between the top and the box should be closed up with extra screws at the proper points.

A small metal scale is fastened to the mounting collar of  $C_8$  and a small pointer knob provided so that this condenser may be returned immediately to the proper setting for each of the two output bands. The shaft of  $C_7$  is turned with a small screwdriver and, once adjusted, needs no further attention for operation in either band. Output is taken directly from the link terminals on the plug-in base of  $L_4$ .

### Tuning

If dimensions have been followed closely, no adjustment of the tracking taps on  $L_3$  and  $L_4$  should be required. The procedure for adjusting for 3.5- and 7-Mc. output will be described in detail. Adjustment for 1.7- and 3.5-Mc. output with the coils for these bands is carried out in a similar manner. With the key switch thrown in the last position, placing the 6F6 and the 6L6 only in operation, the plate voltage may be applied with the key open. This should produce a continuous signal from the first two stages by which the tuning range of the oscillator may be checked with a receiver. Care should be exercised in distinguishing the signal from its image on a superhet or from blocking on any type receiver with a large receiving antenna. If the

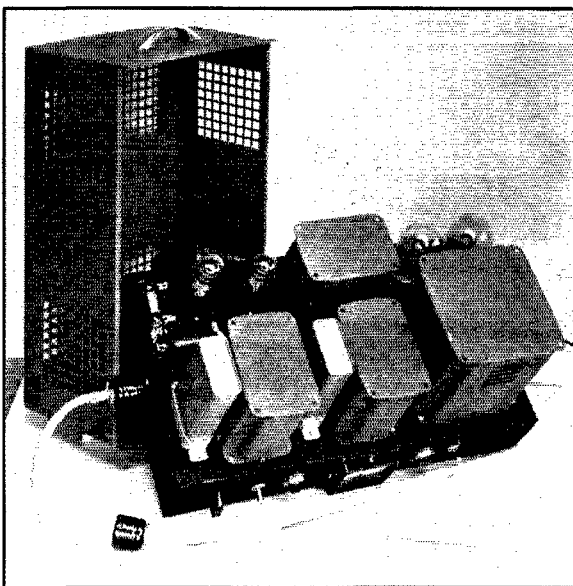

Top view of power supply with cover removed. All high-voltage points are unexposed. The VR150's are to the left in back of the voltage-divider resistances which are mounted on top for ventilation.

range of 3500 to 4000 kc. is not covered, it will be necessary to remove a turn from  $L_1$  if 4000 kc. is not reached, or to add a turn if 3500 kc. is not reached. Plate current to the 6F6 should run at approximately 9 ma. with a plate voltage of 300 and screen voltage of 150.

The next step is that of trimming up the plate circuit of the 6L6. This is done with all voltages (except heater) removed from the 802 and with a low-range milliammeter in the external grid return lead to ground. With the oscillator set at or about 4000 kc., the key switch is set at the third position and the key closed. Adjusting the 6L6 plate circuit to resonance by turning  $C_7$  with a screwdriver should produce a reading of about 4 ma. on the grid-current meter. The oscillator should then be tuned to 3500 kc. and, after noting carefully the setting of  $C_7$ , it should again be adjusted for maximum grid current. If readjustment of  $C_7$  at 3500 kc. produces an increase of grid current of more than 1 ma., the tap on  $L_3$  will have to be readjusted. It should be moved a turn toward the plate end of the coil, if an increase in the capacity of  $C_7$  is necessary to restore resonance; or a turn in the opposite direction if a decrease in the capacity of  $C_7$  is required. At resonance, plate current to the 6L6 will run approximately 20 ma. at plate and screen voltages of 300 and 150 respectively. This stage is not keyed and runs continuously, there being but slight difference in the plate current whether the key is closed or open.

Lining up of the 802 stage is done in a similar

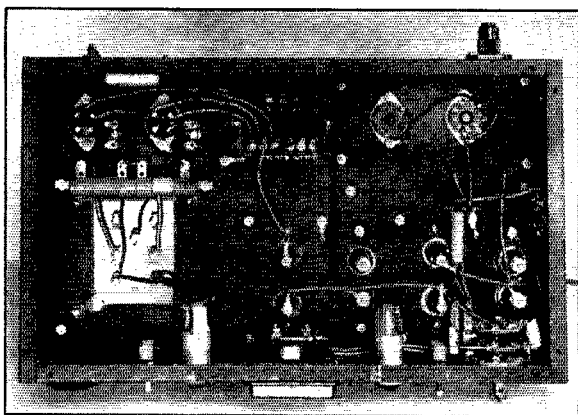

Bottom view of power supply showing line-filter and hash-filter chokes and the meter switching. The terminal at the rear of the chassis is for external connection to the 600-volt line.

manner with all voltages applied to the 802 and a load of some sort coupled to the output link. Resonance here is indicated by the customary dip in plate current. When the circuit is tracking, there should be but very slight difference in the setting of  $C_3$  for resonance over the entire band. After the tracking for 3.5 Mc. has been adjusted, the 7-Mc. coil may be plugged in the output

circuit. In this case, the circuit need track only between 7300 and 7000 kc., of course. With proper coupling, the plate current at resonance may be run up to the rated 60 ma.

### Power Supply

A proper power supply is of utmost importance if chirpy keying and changes in frequency with changes in line voltage are to be avoided.

Experience has shown that the problem of chirpy keying is most satisfactorily solved by the maintenance of steady voltages on the oscillator plate and screen. This is sometimes accomplished by the use of an independent supply for the oscillator. In case other stages are to be operated from the same supply, some system of voltage regulation will be found necessary in most

cases. In this case, where the 6F6 and 802 are keyed simultaneously, regulation of the voltages for the 6L6 plate and screen as well was found desirable.

The power-supply unit has been designed particularly for use with the e.c.o. exciter. Referring to the circuit diagram of Fig. 2, the VR150 regulator tubes provide constant voltages

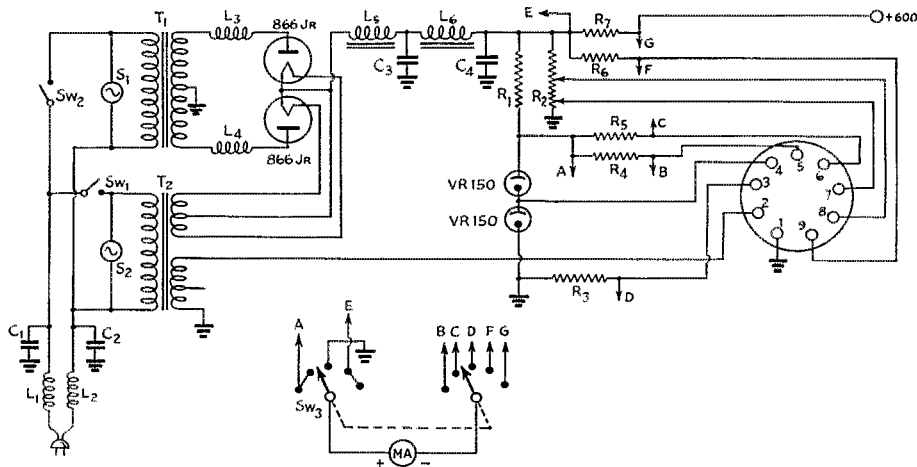

Fig. 2 — Circuit diagram of the power supply for the e.c.o. unit.

- $C_1, C_2$  — 0.1- $\mu$ fd.-double-unit, 400-volt paper condenser.
- $C_3, C_4$  — 4- $\mu$ fd., 1000-volt filter condensers.
- $L_1, L_2$  — Line filter chokes (Ohmite Z-20, double unit).
- $L_3, L_4$  — Hash filter chokes (Millen 77866).
- $L_5$  — 5/25 hys., 225-ma. swinging filter choke (UTC-S32).
- $L_6$  — 20 hys., 225-ma. smoothing filter choke (UTC-S31).
- MA — D.C. milliammeter, scale 0-30 ma. (Triplett type 326).
- $R_1$  — 7500 ohms, 25-watt.
- $R_2$  — 20,000 ohms, 100-watt, 2 sliders. One slider set at 6000 ohms between suppressor tap and ground, other set at 12,000 ohms between screen tap and ground.

- $R_3$  — 50 ohms,  $\frac{1}{2}$ -watt.
- $R_4, R_5$  — 50 ohms, 1-watt.
- $R_6$  — Multiplying resistor wound with No. 28 copper wire to give scale multiplication of 3.
- $R_7$  — Multiplying resistor wound with No. 26 copper wire to give scale multiplication of 8.
- $S_1, S_2$  — 110-volt signal lamps.
- SW<sub>1</sub>, SW<sub>2</sub> — S.p.d.t. toggle switches.
- SW<sub>3</sub> — Two-gang, 5-contact switch (Mallory 1326L).
- T<sub>1</sub> — Plate transformer, 600 volts d.c., 250 ma. (UTC-S45).
- T<sub>2</sub> — Filament transformer, 6.3 volts, 5 amp., 5 volts, 6 amp. (UTC-S67).

---

### E.C.O. JOHNNY

Johnny was an amateur  
Who used an e.c.o.  
He didn't like those crystals —  
"T was "too hard to make them go."

"My e.c.o. is not so bad,  
I shift it with a touch.  
Why use those things called crystals?  
'They cost too doggone much."

He put the rig on forty  
And tuned the e.c.o.  
He'd work himself an islander,  
If his bug would just go slow.

The e.c.o. was steady  
(At least not wobbling bad.)  
He called himself a KA1 —  
AND SUCCESS came to our lad.

Johnny watched the mail box  
And impatience tried to hide.  
Came finally an envelope —  
Did Johnny beam with pride!

He removed a piece of paper,  
But no QSL did fall;  
Johnny had reached the Island —  
The Grand-est one of all!

— W9CEY

---

of 300 for the plates of the 6F6 and 6L6 and 150 for the screens of these two tubes. Close regulation of the voltages applied to the 802 is not required. Screen and suppressor voltages of approximately 250 and 100 respectively are obtained from the voltage-divider resistance  $R_2$ . Precaution against the pickup of r.f. through the supply line or power supply itself or leads to the r.f. unit has been taken by the use of an r.f. filter in the input line, a shielding cover and shielded 8-wire cable between power-supply and r.f. units. A milliammeter and switch are provided for checking the various currents and signal lamps and switches for the filament- and plate-supply circuits. The shield of the cable, connected to pin No. 1, is used for the ground, negative high-voltage and one side of the filament circuit. The cable plugs into a 9-prong Amphenol female outlet set in one end of the chassis. Since the power-supply has a rating of 250 ma. and the total current drawn by the e.c.o. unit will be somewhere between 100 and 125 ma. at full load, another stage requiring 100 to 150 ma. at 600 volts may be operated from this supply, and an external terminal for this purpose has been provided at the rear of the chassis.

The resistors,  $R_3$ ,  $R_4$ ,  $R_5$ ,  $R_6$  and  $R_7$  are shunts for the 30-ma. meter.  $R_6$  and  $R_7$  are multiplying resistors to increase the range of the meter to 90 ma. for measuring the 802 plate current and to 240 ma. for measuring the current in the lead to the external circuit. These two shunts are wound on a short length of fibre rod  $\frac{1}{4}$ -in. in diameter.

At some sacrifice in voltage regulation of the

supply to the 802 and loss of independent control of filament and plate voltages, a suitable supply may be built at a lower cost.  $T_1$  and  $T_2$  may be replaced by a single combination transformer delivering 600 volts a.c. each side of center, 200 ma. for the high-voltage winding and having 6.3-volt, 3-amp. and 5-volt, 3-amp. windings for the filaments. A suitable transformer is the UTC-S41. The filter chokes may be replaced by a pair rated at 120 ma., such as the Thordarson T53C19, and the 866 Jr. half-wave rectifiers by a single type 83 full-wave rectifier. Condenser input will be required and a double-unit 8- $\mu$ fd. 450-volt electrolytic condenser with the sections connected in series may be used.  $C_3$  and  $C_4$  may be replaced with 600-volt 8- $\mu$ fd. electrolytics. The chassis cover may in many cases be eliminated if the power supply is kept well removed from r.f. fields. The hash-filter chokes may be dispensed with if no interference from rectifier hash is experienced, although they are good insurance against roughening of the oscillator signal from this source.

Should the full output from the 802 not be required, a power supply of considerably lower voltage might be used. If a voltage lower than 300 is used, the voltage regulator tube between the screen tap and ground should be changed to a VR75.

---

## Massachusetts State Convention

(New England Division)

**Boston, Mass., October 5th**

THE Massachusetts State Convention will be held at the Hotel Bradford, Boston, on Saturday, October 5th, under the auspices of the Eastern Massachusetts and South Shore Radio Clubs. A fine array of speakers, lots of prizes, contest, meetings and a real turkey supper with all the fixings make up the program. Among the demonstrations will be featured the latest in television and frequency modulation and it is worth making the trip just to see the exhibits. Registration fee is \$1.00. Combined banquet and registration is \$2.50. For tickets and information write Robert Williams, W1JQX, 105 Harvard St., Newtonville.

---

## Iowa State Convention

(Midwest Division)

**Council Bluffs, Iowa, October 5th-6th**

THE two-day convention program of the Iowa State Convention, scheduled for the Hotel Chieftain, Council Bluffs, October 5th and 6th, is filled up completely with excellent speakers on

(Continued on page 40)

# Atlantic Coast Amateurs Render Emergency Service

## **South Carolina-Georgia Hurricane and Virginia Flood Disrupt Wire Services**

ON AUGUST 11TH the South Atlantic Coast was struck by the worst tropical hurricane in several years, leaving in its path death, wrecked property, flooded highways and crippled communications.

During the period August 14th to 17th, incessant rains overloaded the rivers of Virginia and their tributaries with muddy water that crested at record or near-record peaks and flooded communities in various sections of the state.

In both cases amateur radio, although handicapped by initial unpreparedness and lack of organization in some cases and without facilities near critical points in others, provided valuable communications links while wire lines were down or badly overloaded.

The whole section of the South Atlantic coast from Norfolk, Va., to Jacksonville, Fla., felt the force of the hurricane. Communications facilities generally were disrupted, numerous towns in Georgia and South Carolina being cut off.

Amateurs of Charleston, S. C., received the hurricane warning early Sunday morning, August 11th. The Charleston Amateur Radio Club was mobilized and functioned as a unit, led by its president, E. Linwood Sykes, W4AFQ.

Lacking emergency-powered equipment, their first thought was to find a location where power might be made available. Through James Gantt, W4DFC, a South Georgia Power Co. employee, a location adjoining the steam plant was provided, with the promise that a special temporary power line would be run to it.

These arrangements completed, the ham crew proceeded to wade through two blocks of waist-deep water carrying receivers and the transmitters of W4DFC and W4CYS. After getting the transmitters set up and antennas erected, they learned that the power company was unable to run the promised temporary line because of high winds—the velocity at this time being in the vicinity of 75 m.p.h.!

A quick check disclosed another nearby building containing a sub-station, with power already available. The equipment was moved again, and set up on the second floor of this building. The wind was blowing water from the river in sheets, but Joe Allikas, W4EOR, succeeded in getting antennas up in short order.

### **Charleston On the Air**

It was 4:20 P.M. when the 7-Mc. transmitter finally got on the air and an attempt was made to

keep pre-arranged schedules with W4FEC and NAO. But by this time power was off in Savannah as well, and no contact was made. W4GU aided in the unsuccessful attempt to raise W4FEC. Finally NAO was worked, but the QRM was too bad on 7 Mc. so the transmitter was shifted to 3505 and traffic began to move. This was at 5:30 P.M.

Shortly thereafter, W4CUS was placed in operation on 160-meter 'phone, working into the South Carolina Emergency Net. Dr. T. W. Zeigler, W4PG-W4CUS, had brought this transmitter and his receiver in from his summer home at Folly Beach early Sunday morning. The first contacts were made on 1960 kc. with W4EZF and W4BPD, transmitting a message to Charlotte, requesting three line crews for the Power Company.

Telephone service all around was out of order, lines and poles having been blown down in the high winds, and to deliver messages it was necessary to wade through wind-whipped tidewater filled with rushing debris that tore clothing and bruised bodies. Cars parked two blocks away then took messages to their destinations.

Later a delivery channel was arranged by scheduling the police emergency station over W4CUS on 1.7 Mc. The regular police transmitter, WCPD, was off the air, but Alexander McGilliard, W4GOQ, and W4PG-W4CUS had rigged a low-power battery-operated transmitter that enabled the police to keep in touch with their cruisers.

By the next morning some telephone and telegraph wires were back in commission, and power had been restored in the center of the city. That night operation at home stations was resumed.

Approximately 500 messages were handled, including Red Cross, press, power and telephone company traffic, and personals. W4CUS had a total of 300.

### **24 Hours Without Food**

In addition to those mentioned, the Charleston crew included Carlton Claussen and Henry Couch of the N.C.R., and P. M. Clements, Jr., and William Peecksen, who assisted W4CUS. Other than one sandwich and a cup of coffee, the whole gang was without food or rest from 9 A.M., Sunday, until Monday morning.

Following the restoration of power and telephone service, W4EDO/WUIA and W4DXF offered service to Western Union and others.

Stations who assisted in one way or another include W4EZF, W4BPD, W4FVE, W4EOZ, W4FNC, W4EJK, W4EGH, W4CSP, W4GLX, W4KZ, W4ANU, W4MY, W4FHE, W4ERG, W4EXX, W4GCJ, W4BJU, W4DQV, W4EXJ, W4GFP, W4GKD, W4EXH, W4FNS, W4FWV, W4DVK, W4AZT, W4FMZ, W4DLX, W4AGI, W4ACZ, W4ASR, W4GGD, W4EHF, W4FWO, W3GTS, W1FOF, W9SXP. Most of the traffic from W4CUS went through W4EZF, who turned it over to W4BPD. Red Cross traffic for Washington was relayed cross-band to W4AZT on 75 meters, who made delivery to W3ZD in Washington.

Generally speaking, the amateurs performing this work received adequate official credit and praise. In one case, however, they received "credit" that was undeserved. The Governor of South Carolina, in a radio broadcast (which fortunately went unreported by the press), referred to "unfounded lies" transmitted by amateur radio. The particular rumor referred to was not transmitted by amateur radio but over one of the local b.c. stations, operating on its mobile frequency of 1670 kc. If nothing else, the incident serves to emphasize that in an emergency only reports signed by an authorized official should be released, and that estimates of death, damage, etc., should be avoided.

#### *By Truck to Savannah*

At Savannah, W4FEC and W4EWY were apparently forced off the air by power failure. W. F. Morehead, W4GDY, and Howard Patterson, a prospective ham, were dispatched to that city with a portable station under the call WUGU from the C.C.C. Radio School at Fort McPherson by the Corps Area Signal Officer. The station, which utilized an Army truck for transportation, included two RME 69 receivers, a T21-T55 transmitter, two 1-kw. d.c. generators and two rotary converters.

Heavy rains and high winds which blew trees across the roads impeded their progress, but with the assistance of Highway Patrolmen they eventually arrived in Savannah—where the truck broke down within twenty feet of W4GDY's home! After being towed to Fort Screven, they were in operation within 45 minutes after arrival. A considerable quantity of official and personal traffic was handled during the next three days, and W4GDY was commended by Army officials for setting up and maintaining communications under such adverse conditions.

The base station for WUGU at Fort McPherson, W4GSO-WUGA, was operated by W4BRF, W4GSO and W4GFP.

#### *Virginia Flood Threat*

The flood in Virginia resulted from unprecedented heavy rains that drained from the steep

hillsides of the mountainous interior and choked narrow canyons with yellow water.

The first community to experience a communications emergency was the little town of Galax, at the foot of the Iron Mountains, where rushing torrents left 800 of the town's 2500 population homeless. All wires were down except some power lines between Galax and Pulaski. Vernon W. Hinton, W3AAF, in Pulaski, although inactive for several years, got his station on the air. Telephones were connected to the power line, and Galax was again in contact with the outside world. W4DWB and W3EHZ did an efficient job, serving as outlets to Richmond and Washington. The circuit operated on August 14th and 15th.

Richmond and other large cities in Virginia had a bad scare, but that was about all. On the afternoon of August 15th, the Associated Press called S. C. M. Frank S. Anderson, Jr., W3GWQ, and requested that he arrange for the handling of their traffic if it became necessary. W3ALP, W3CLD, W3ICL and W3GRU were lined up, and all stood by for the entire period, but fortunately all lines to the major cities remained intact.

Up the James River, however, it was another story. The town of Columbia, 50 miles up the river, was hard hit. Since the river level at this point is used as an indicator of the flood stage at Richmond, communications between the two points was considered especially vital. On the afternoon of the 16th it was apparent that the lines would not hold out much longer.

#### *Amateurs Serve Weather Bureau*

At the request of the U. S. Weather Bureau, Rudolph W. Raabe, W3ZU, and Leo W. Huckstep, W3BSM, went to Columbia with portable equipment in a station wagon provided by the City of Richmond. They took with them a 1-kw. gas-driven generator loaned by WRVA for use in event of power failure.

On their arrival the Town of Columbia gave them the use of the Community Hall, where they set up the stations. W3ZU came on the air at 10:18 P.M. on the 16th, on 75-meter 'phone, and W3BSM at 6:10 A.M. on the 17th, operating WAHM (WRNL's portable) on 2022 kc.

Sanford Terry, Jr., W3AGH, on 80-meter c.w. served as Richmond contact for W3ZU, while W3GWQ was W3BSM's outlet. At one time Richmond lost contact with W3ZU and for about three hours W3BSY relayed the traffic. Schedules were maintained at regular times, transmitting water level readings and other traffic.

W3AMB served as relief operator at W3GWQ. W3AJK went to Columbia the night of the 17th as relief for W3ZU and W3BSM.

During the period a variety of favorable publicity was obtained for amateur radio. The Richmond papers carried stories mentioning amateur work each day of the crisis. WRVA carried plugs

*(Continued on page 78)*

# ★ WHAT THE LEAGUE IS DOING ★

## SUNDRY NOTES

THE schooner "Morrissey," WHFZ and W10XDA, is authorized to communicate only with those amateurs who are specifically so authorized. F.C.C. has issued amendments to its Order No. 72 to give this authority to W2USA, W2AVO, W2APT, W3HZH, W8HP and W1AW. . . . We suppose you read in the papers that F.C.C. extended the date for complying with the order about citizenship and fingerprints to September 15th. . . . If you know any would-be hams who took their examinations in June or July without filing proof of citizenship, and who haven't heard anything about the latter requirement tell them about it and suggest that they get the necessary forms from nearest F.C.C. office and send them to Washington with an explanation of the circumstances, asking that the showing be attached to their application for license. . . . It is unofficially reported that the Italian government has announced the postponement of the International Telecommunications Conference scheduled for 1942. . . . On June 10th the Philippine Department of National Defense prohibited foreign communication by KA amateurs except with W and K hams. F.C.C. Order No. 72 permits us to communicate only with those KA's who are U. S. citizens. (A Filipino is a "national" of the United States, but not necessarily a citizen.) Thus the unhappy condition exists that a KA amateur who is not a U. S. citizen may communicate only with other KA stations. . . . F.C.C. has prepared a proposed amendment to the Communications Act providing for the "registration" of radio transmitters. The purpose is to facilitate checking upon the transfer of transmitters from one owner to another, particularly to owners who have no business possessing the equipment. More later.

## JOBS AVAILABLE

IN ADDITION to enlistments in the Army and Navy as radio operator or mechanic, several branches of the government have needs for radio personnel that will interest amateurs. The most interesting and important of these continues to be the F.C.C. monitoring jobs.\* Many scores of amateurs have applied and are being taken into the service. See page 23 of September *QST* for the general outline and consult your director or SCM for further particulars. There are two pay grades at \$1620 and \$1800 per year. Don't be scared off by the questions in the application form about commercial experience. That is just

\* Flash! F.C.C. just advised us that the operator jobs are all filled; no more applications wanted. Amateur response was great; they are very pleased.

an old form they had on hand; the F.C.C. really wants amateurs.

Transfer of F.C.C. field personnel into the new monitoring organization is leaving vacancies as inspector in the regular establishment. They will need perhaps a hundred each of what they call radio monitoring officers at \$3200 a year and assistants at \$2600. Amateur experience does not count in these jobs; considerable technical education and experience are required, as well as 25 w.p.m. Civil Service Announcement No. 91 contains the dope. Interested amateurs who may possess the qualifications should write for a copy of the announcement.

The National Youth Administration wants a hundred radio instructors. The requirements are the possession of a first-class radiotelegraph or radiotelephone license and some experience in building and operating equipment, plus a Class-A amateur ticket. Pay will vary in different states between \$1500 and \$1800. Service generally will be at a resident camp, where board and lodging will be available cheap, but may be at a state administrative office. The duty is to train youths in code and theory to qualify as Class A amateurs and as third-class-or-better commercials; also to supervise the building of gear for public agencies such as state police, state universities, etc. Applications should be made to your State N.Y.A. Administrator or to R. R. Burton, N.Y.A. Radio Engineer at Washington.

We have incomplete information that the Civilian Conservation Corps desires a thousand instructors in radio operation and maintenance, one to each camp. It is proposed that these instructors make their permanent living quarters in or near the camp, have a teaching schedule of 44 hours per week, and be subject to call throughout the day and night. The contemplated salary is \$2000. At this writing we have not received the specifications of eligibility or procedure, but we'll spread the word by broadcasts and bulletins as soon as it is known.

## ELECTION NOTICE

**To all members of the American Radio Relay League residing in the Central, Hudson, New England, Northwestern, Roanoke, Rocky Mountain, Southwestern and West Gulf Divisions:**

You are hereby notified that, in accordance with the constitution, an election is about to be held in each of the above-mentioned divisions to elect both a member of the A.R.R.L. Board of Directors and an alternate thereto for the 1941-1942 term, except that in the case of the



Southwestern Division the election will be for an alternate only and in the case of the West Gulf Division will be for director only. Your attention is invited to Sec. 1 of Article IV of the constitution, providing for the government of A.R.R.L. by a board of directors; Sec. 2 of Article IV, and By-Law 12, defining their eligibility; and By-Laws 13 to 24, providing for the nomination and election of division directors and their alternates. Copy of the Constitution & By-Laws will be mailed any member upon request.

Voting will take place between November 1 and December 20, 1940, on ballots that will be mailed from the headquarters office in the first week of November. The ballots for each election will list, in one column, the names of all eligible candidates nominated for the office of director by A.R.R.L. members residing in that division; and, in another column, all those similarly named for the office of alternate. Each member will indicate his choice for each office.

Nomination is by petition. Nominating petitions are hereby solicited. Ten or more A.R.R.L. members residing in any one of the above-named divisions may join in nominating any eligible member of the League residing in that division as a candidate for director therefrom, or as a candidate for alternate director therefrom. No person may simultaneously be a candidate for the offices of both director and alternate. Inasmuch as the by-laws were recently amended to transfer all the powers of the director to the alternate in the event of the director's death or inability to perform his duties, *it is of as great importance to name a candidate for alternate as it is for director.* The following form for nomination is suggested:

**Executive Committee**

**The American Radio Relay League  
West Hartford, Conn.**

**We, the undersigned members of the A.R.R.L. residing in the . . . . . Division, hereby nominate . . . . . of . . . . . as a candidate for DIRECTOR; and we also nominate . . . . . of . . . . . as a candidate for ALTERNATE DIRECTOR; from this division for the 1941-1942 term.**

**(Signatures and addresses)**

The signers must be League members in good standing. The nominee must have been both a member of the League and a licensed radio amateur operator for a continuous term of at least four years immediately preceding receipt by the Secretary of his petition of nomination, except that a lapse of not to exceed ninety days in the renewal of the operator's license and a lapse of not to exceed thirty days in the renewal of membership in the League, at any expiration of either during the four-year period, will not disqualify the candidate. He must be without commercial radio connections: he may not be commercially

engaged in the manufacture, selling or renting of radio apparatus normally capable of being used in radio communication or experimentation, nor commercially engaged in the publication of radio literature intended, in whole or part, for consumption by licensed radio amateurs. Further details concerning eligibility are given in By-Law 12. His complete name and address should be stated. The same requirements obtain for alternate as for director. All such petitions must be filed at the headquarters office of the League in West Hartford, Conn., by noon E.S.T. of the 20th day of October, 1940. There is no limit to the number of petitions that may be filed on behalf of a given candidate but no member shall append his signature to more than one petition for the office of director and one petition for the office of alternate. To be valid, a petition must have the signatures of at least ten members in good standing; that is to say, ten or more members must join in executing a single document; a candidate is not nominated by one petition bearing six signatures and another bearing four. Petitioners are urged to have an ample number of signatures, since nominators are frequently found not to be members in good standing. It is not necessary that a petition name candidates both for director and for alternate but members are urged to interest themselves equally in the two offices.

Present directors and alternates for these divisions are as follows: Central Division: director, R. H. G. Mathews, Chicago; alternate, E. W. Kreis, W9HRM. Hudson Division: director, Kenneth T. Hill, W2AHC; alternate, Robert M. Morris, W2LV. New England Division: director, Percy C. Noble, W1BVR; alternate, Russell Bennett, W1GTN. Northwestern Division: director, Ralph J. Gibbons, W7KV; alternate, W. N. Wintler, W7KL. Roanoke Division: director, H. L. Caveness, W4DW; alternate, J. Frank Key, W3ZA. Rocky Mountain Division: Glen R. Glasscock, W9FA; alternate, C. W. Duree, W9EII. Southwestern Division: alternate and acting director, John E. Bickel, W6BKY. West Gulf Division: director, William A. Green, W5BKH. A special election is already in process to choose a Southwestern Division director. A West Gulf Division alternate having been elected earlier this year to serve also the 1941-42 term, there is no election this autumn for that office.

These elections constitute an important part of the machinery of self-government in A.R.R.L. They provide the constitutional opportunity for members to put the direction of their association in the hands of representatives of their own choosing. Members are urged to take the initiative and to file nominating petitions immediately.

For the Board of Directors:

K. B. WARNER,  
Secretary

August 1, 1940

"I have myself seen further developments of the subject-matter of this article which are simply amazing. The adaptation of these methods and gear to ham radio would open a field of tremendous interest. I advise every ham to follow these developments carefully in the articles which will run in future issues." — *George W. Bailey, W1KH, President, A.R.R.L.*

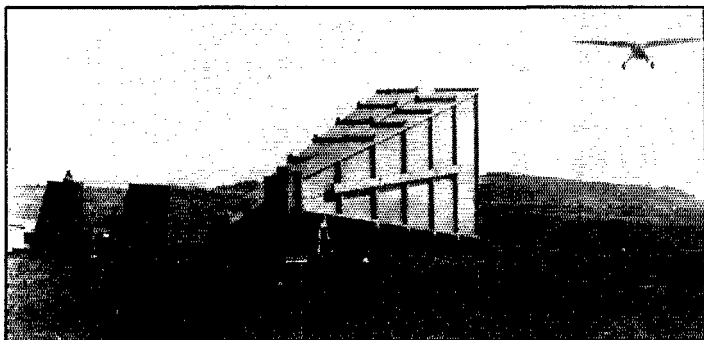

## Centimeter Waves Coming Up!

### *M.I.T. Research Produces 700-Mc. Gear*

**H**ow would you like to have a signal squirter with a beam only  $20^\circ$  wide and no secondary lobes? Or an antenna with a power gain of 50 over a dipole? Sounds pretty good, doesn't it? Such things may be in the offing for amateurs in the near future, it appears from the results of research being carried on at the Massachusetts Institute of Technology at Cambridge, Mass. Over the past three years, the Instrument Landing Research at M.I.T. sponsored by the Civil Aeronautics Authority has been carried on to uncover better ways and means of landing aircraft in foggy weather. The equipment developed makes use of a frequency of approximately 700 megacycles ( $\lambda = 42$  cm.).

The idea underlying the project is the provision of a straight-line landing path, for airplanes to follow, by sending up two overlapping beams, one above and one below the path, and two more beams, one to the right and one to the left of the path, modulated at different frequencies so that they may be distinguished at the receiver. The region in the intersection of the four beams where they are all the same intensity provides an "on-course" indication at the receiver in the airplane. Since one of the beams has to lie below the glide path, which is  $3^\circ$  to  $10^\circ$  above the horizon (usually the former), it is necessary to produce very sharp beams. It is desirable to use ultra-short wavelengths in order to get the necessary sharp beams with reasonable antenna size.

With the 42-cm. wavelength, it was found possible to use horn antennas only 10 feet high,  $2\frac{1}{2}$  feet wide and 25 feet long to obtain sharp enough beams. The illustration shows these horns with an airplane making a test approach on the glide path. The ground equipment consisted of two

"standpipe" oscillators using concentric-line tuning elements with Western Electric 316-A tubes and associated power supply and modulation equipment. The set-up in the airplane was a sensitive, stable superheterodyne receiver using an acorn tube oscillator and a diode as a mixer tube.

Of course the whole trick is the use of ultra-super-short wavelengths to get the required directivity. We thought you would be interested in hearing about some real use being made of the "useless" ultra-short waves. Incidentally, work is proceeding on adaptations of some of the apparatus to ham construction — and pocket-books — and it will appear in an early issue of *QST*.

The Blind-Landing gang directed by Professor Bowles, who is in charge of the Electrical Communications Division, has been under the supervision of Professors W. L. Barrow and W. M. Hall, both ex-hams, and includes Lewis, W1LKV (ex-W9AOG); Kerr, W9HRX; Mieher; Weiss, W2INQ and Zimmermann, W9FZJ.

More dope to come! One-and-a-quarter meters will soon be long-wave stuff!

— F. D. L.

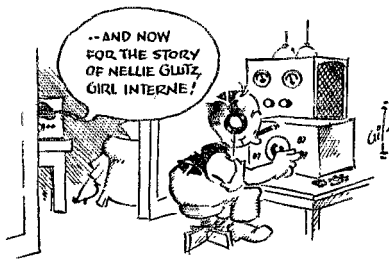

EARPHONES STILL HAVE THEIR ADVANTAGES —

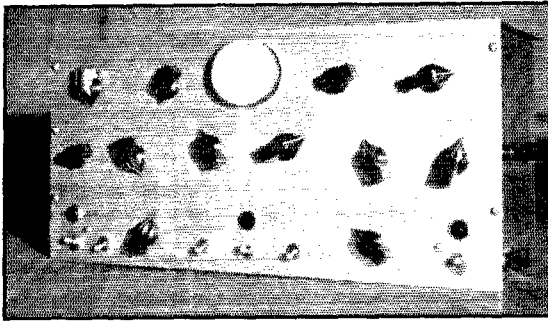

Here is a description of an oscilloscope with all the trimmings that will allow you to make practically any kind of measurement these handy gadgets can make.

A view of the front panel shows the simplicity of the layout. A description of the controls will be found in the text.

## A Complete Oscilloscope Using the 902

*Including Auxiliary Amplifiers and Provision for Magnetic Deflection*

BY DONALD GREEK\*

**T**HE usefulness and flexibility of the cathode-ray oscilloscope as a laboratory and test instrument is sufficiently well known and requires no elaboration here. The advent of the low-priced and low-voltage oscilloscope tubes such as the one-inch 913 has added other advantages which have greatly extended oscilloscope use. The pages of *QST* in the past have carried many descriptions of such instruments.

The greatest advantage of tubes of the 913 type is the low voltages required which makes possible the use of ordinary receiver transformers and other components. However, although entirely suitable for many applications, the small screen of the 913 is a disadvantage that makes the construction of an elaborate and complete oscilloscope with this tube hardly worth while. On the other hand, the 902 two-inch oscilloscope tube combines the advantages of low-voltage operation and larger screen size, together with several other advantages. In addition to the screen area being four times that of the 913, the deflection sensitivity of the 902, for the same anode voltage, is more than twice as great. Also, the all-glass construction of the tube permits magnetic deflection which is not possible with the 913. Thus with the 902 it becomes possible to design a complete oscilloscope capable of doing practically anything the more larger tubes will do. The purpose of this article is to describe such an instrument.

In order to provide for as complete an instrument as possible, the following requirements have been considered as essential:

- (1) Linear sweep circuit.
- (2) Horizontal amplifier.
- (3) Vertical amplifier.

- (4) Spot positioning.
- (5) Provision for magnetic deflection.
- (6) Grid amplifier and provision for grid modulation.
- (7) Suitable switching and control arrangement.

With spot positioning it becomes possible to use a small screen almost to the same advantage as a larger one, since any particular portion of the trace being studied can be made to fill the entire screen.

In addition to electrical requirements, compactness and reasonable costs are essential.

### The Circuit

Seven tubes, including the 902, are used in the scope to be described. The sweep circuit utilizes a 6J7 and 884, the amplifiers used 6J7's, and type 80's are used as rectifiers.

The positive side of the high voltage for the 902 is at ground potential, as is conventional, and the various voltages for the tube are obtained from the bleeder resistor made up of  $R_2$ ,  $R_3$ ,  $R_4$ ,  $R_5$ ,  $R_6$ .

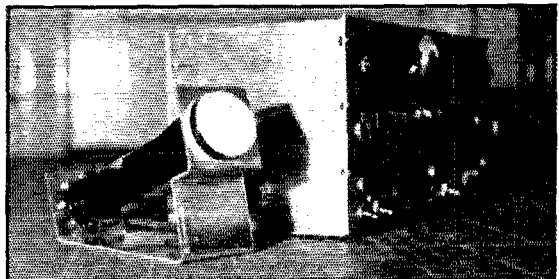

The tube can be removed from the cabinet for special applications where complete freedom from stray magnetic fields is required, or where magnetic deflection is to be used.

\*2201 Walton Ave., New York City.

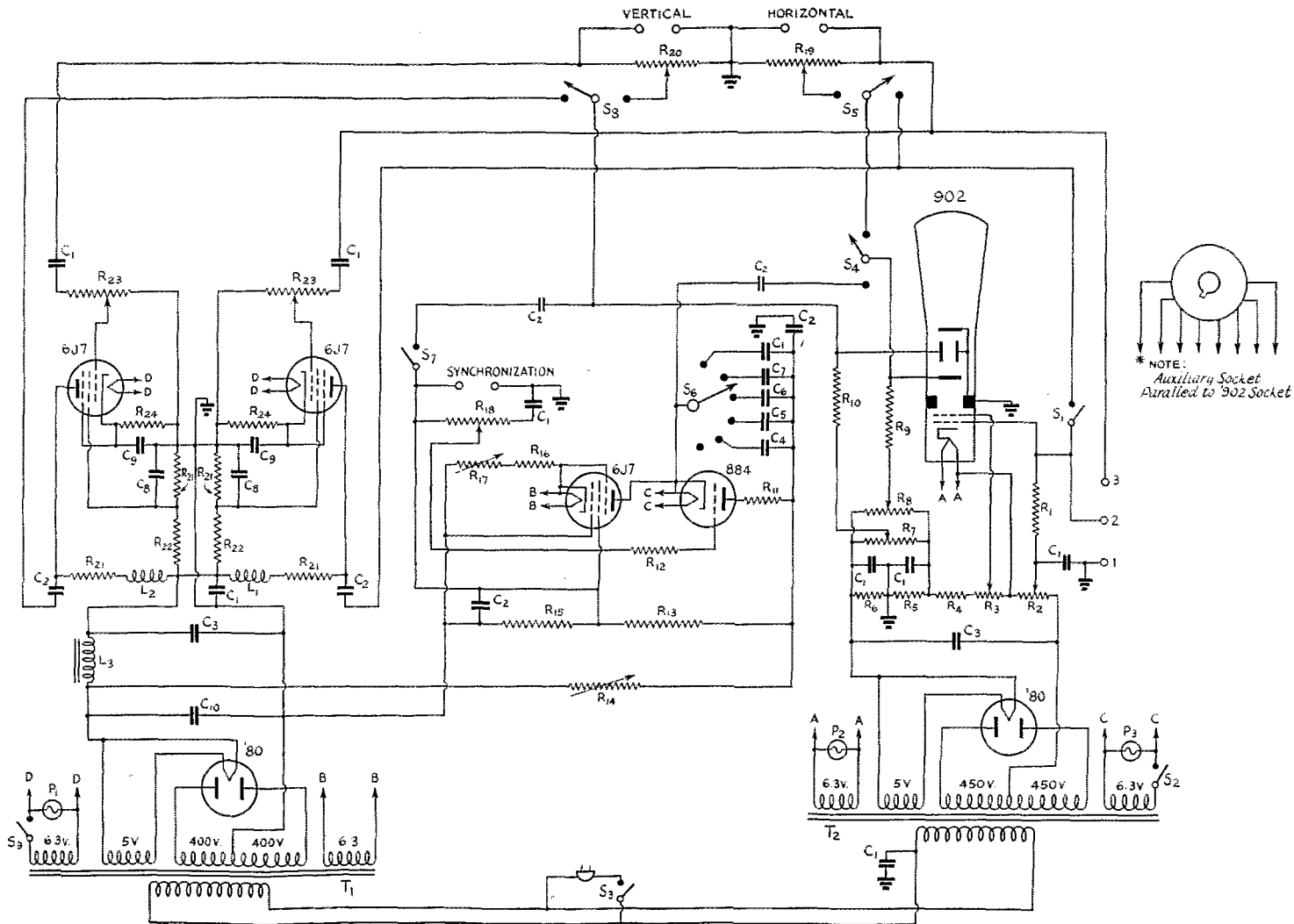

Fig. 1 — complete circuit diagram of the oscilloscope.

- C<sub>1</sub> — 0.1- $\mu$ fd. 600-volt paper.
- C<sub>2</sub> — 0.25- $\mu$ fd. 600-volt paper.
- C<sub>3</sub> — 8- $\mu$ fd. 500-volt electrolytic.
- C<sub>4</sub> — 0.0001- $\mu$ fd. 400-volt paper.
- C<sub>5</sub> — 0.001- $\mu$ fd. 400-volt paper.
- C<sub>6</sub> — 0.005- $\mu$ fd. 400-volt paper.
- C<sub>7</sub> — 0.025- $\mu$ fd. 400-volt paper.
- C<sub>8</sub> — 0.01- $\mu$ fd. 400-volt paper.
- C<sub>9</sub> — 5- $\mu$ fd. 25-volt (electrolytic).
- C<sub>10</sub> — 16- $\mu$ fd. (8-8 parallel) 500-volt electrolytic.
- R<sub>1</sub> — 300,000 ohms,  $\frac{1}{2}$ -watt.
- R<sub>2</sub> — 25,000 ohms, 1-watt.
- R<sub>3</sub> — 50,000 ohms, 1-watt.
- R<sub>4</sub> — 75,000 ohms, 1-watt.
- R<sub>5</sub> — 30,000 ohms, 1-watt.
- R<sub>6</sub> — 30,000 ohms, 1-watt.
- R<sub>7</sub>, R<sub>8</sub> — 1-meg. potentiometer.
- R<sub>9</sub>, R<sub>10</sub> — 5-meg.  $\frac{1}{2}$ -watt.
- R<sub>11</sub> — 1000 ohms, 1-watt.
- R<sub>12</sub> — 300,000 ohms, 1-watt.
- R<sub>13</sub> — 40,000 ohms, 1-watt.
- R<sub>14</sub> — 50,000-ohm wirewound rheostat.
- R<sub>15</sub> — 6000 ohms, 2-watt.
- R<sub>16</sub> — 1500 ohms, 1-watt.
- R<sub>17</sub> — 50,000-ohm rheostat.
- R<sub>18</sub> — 500,000-ohm potentiometer.
- R<sub>19</sub>, R<sub>20</sub> — 5-megohm potentiometer.
- R<sub>21</sub> — 100,000 ohms, 1-watt.
- R<sub>22</sub> — 150,000 ohms, 1-watt.
- R<sub>23</sub> — 500,000-ohm potentiometer.
- R<sub>24</sub> — 1000 ohms,  $\frac{1}{2}$ -watt.
- S<sub>1</sub>, S<sub>2</sub>, S<sub>3</sub>, S<sub>6</sub> — S.p.s.t. toggle.
- S<sub>4</sub>, S<sub>5</sub>, S<sub>8</sub> — S.p.d.t. toggle.
- S<sub>7</sub> — 6-contact selector switch.
- S<sub>9</sub> — Snap switch mounted on R13.
- L<sub>1</sub>, L<sub>2</sub> — 25-mh. choke.
- L<sub>3</sub> — 30-henry 15 ma. choke.
- P<sub>1</sub>, P<sub>2</sub>, P<sub>3</sub> — Jeweled pilot lamps.
- T<sub>1</sub>, T<sub>2</sub> — Broadcast replacement transformers.

In order to move the spot completely across the tube, which is the function of the spot-positioning controls  $R_7$  and  $R_8$ , both positive and negative bias voltages must be applied to the horizontal and vertical plates. For this reason the connection between  $R_5$  and  $R_6$  is placed at ground potential. Thus points along  $R_7$  and  $R_8$  can show either positive or negative potentials with respect to ground, depending upon their settings. High resistances  $R_9$  and  $R_{10}$ , connected in series with the plates, are necessary to maintain the input impedance of the oscilloscope high and relatively constant regardless of the settings of the spot-positioning controls.

In order to allow for grid modulation,  $R_1$  is placed in series with the grid lead and an 0.1- $\mu$ fd. condenser serves for grid coupling and also bypasses any line-frequency voltage which might find its way into the grid circuit.

The sweep circuit is conventional, with the exception of resistance synchronization control being used instead of the customary transformer. The 884 generates the saw-tooth sweep voltages while the 6J7 acts as a current-limiting pentode to insure linearity.

The loads of the horizontal and vertical amplifiers are combined resistance and inductance, to

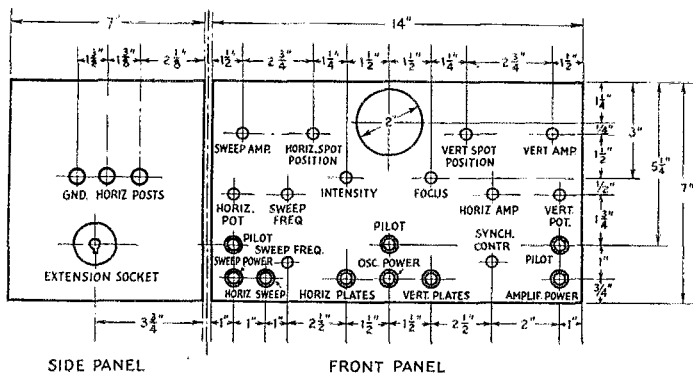

Fig. 2 — Detail of the panel arrangement and the necessary dimensions.

increase the high frequency response. Separate bleeder resistances are used in the amplifiers to reduce interaction.

In place of the usual fixed deflection-plate shunting resistances, potentiometers  $R_{19}$  and  $R_{20}$  are used. These controls allow strong signals to be fed directly to the deflection plates and eliminate the possibility of distortion through the amplifiers. In addition, the potentiometers allow the control of d.c. signal values.

### Construction

The whole unit is built upon a 7- by 13- by 2-inch Electricalloy chassis. The cabinet is formed by a separate 7- by 14- by  $\frac{1}{16}$ -inch aluminum front panel fastened to the chassis, and the sides and rear of the cabinet are made from a single 7- by 27 $\frac{3}{4}$ - by  $\frac{1}{16}$ -inch sheet of aluminum bent into shape to fit the chassis. The ends are flanged  $\frac{1}{4}$  inch to permit fastening to the front panel. The top and bottom covers are 7 $\frac{1}{4}$ - by 13 $\frac{1}{4}$ - by  $\frac{1}{16}$ -inch aluminum held in place by quarter-inch wide strips of spring bronze at the corners of the covers. The cathode-ray mount is  $\frac{1}{16}$ -inch aluminum cut and bent to shape as shown in Fig. 4. The pressure of the sides of the cabinet is sufficient to hold it in place, and this mounting makes it possible to tilt the tube when desired. In addition, the mount serves as an external mounting when used in conjunction with the extension socket. This socket is paralleled to the oscilloscope socket and, to simplify magnetic observations, is mounted on the side of the cabinet.

The layout of the components of the oscilloscope is shown in Fig. 3. Since the 902 is extremely sensitive, it becomes important to place the tube out of the fields of the power transformers. In cases where there is field interaction, it is worth while to rotate the transformers one at a time, while connected, until a clean and even sweep line is obtained. In this respect, the extension socket is valuable in cases where complete freedom from interaction is necessary, since the tube can be placed far from the transformer fields.

All the terminal connections are brought out to the side and rear panels, leaving the front panel clear. The right side panel contains the vertical and synchronization terminals, the left panel the horizontal terminals and the extension socket. The grid terminals, together with the grid amplifier switch  $S_1$ , are mounted at the rear of the chassis.

In wiring, signal and ground leads should be made as short as possible. As a precaution against stray pick-up, all power and filament leads should be twisted together up to the point of connection.

In general the construction should not present any difficulties, with a possible slight exception in the case of the amplifiers. Since the response of the resistance-coupled amplifiers is a function of the capacity shunting the load resistance, and this capacity is made up in part by the varying wiring capacity to the deflection plates, for extended linear response it might be necessary to add turns or subtract turns from the load choke coils  $L_1$  and  $L_2$ . However, if the construction has been followed closely the value given, which was found by trial, should be about right for good response.

### Controls

The various controls are shown in the view of the front panel and more clearly in the sketch of Fig. 2. Taking the controls from left to right: top view — sweep amplitude control  $R_{14}$ , horizontal spot positioning  $R_7$ , vertical spot positioning  $R_8$ , vertical amplifier control  $R_{23}$ ; center row — horizontal potentiometer  $R_{19}$ , sweep frequency vernier  $R_{17}$ , intensity control  $R_2$ , focusing control  $R_3$ , horizontal amplifier control  $R_{23}$ , vertical potentiometer  $R_{20}$ ; bottom row — sweep power toggle  $S_2$ , horizontal and sweep toggle  $S_4$ , sweep frequency  $S_6$ , horizontal toggle  $S_5$ , vertical-plate toggle  $S_7$ , synchronization control  $R_{18}$ , and amplifier power switch  $S_9$ .

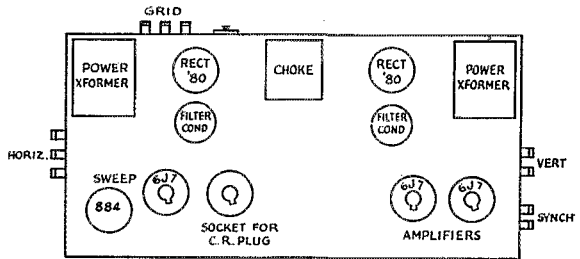

Fig. 3 — A plan sketch of the oscilloscope, showing the arrangement of parts on the chassis.

Referring to the schematic diagram of Fig. 1, the controls can be seen to operate in the following manner: The switch  $S_3$  is the on-off switch for the instrument. By switch  $S_2$ , located in series with the filament of the 884, and switch  $S_9$  likewise in series with the heaters of the amplifiers, the power to the sweep and amplifier circuits can be controlled independently.

The connection to the vertical plates is made through  $S_8$ . Throwing this switch to the left connects the plates to the vertical amplifier, while to the right direct connection is made through the potentiometer  $R_{20}$ .

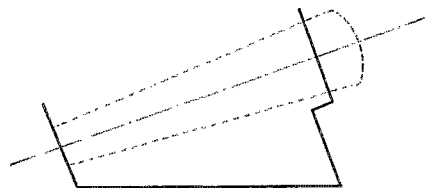
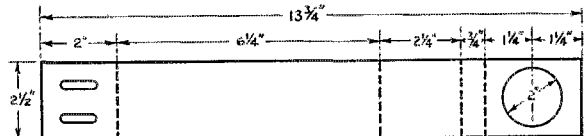
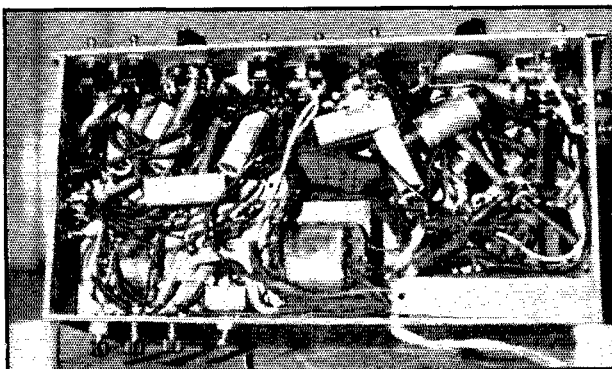

Fig. 4 — Detail of the 902 mounting strip. The material is 1/16-inch aluminum.



A bottom view of the chassis shows most of the resistors and by-pass condensers. Note how the ends of the cabinet sides are bent to help support the panel.

In the case of the horizontal plates, no outside voltage can be applied while the sweep voltage is connected. This is accomplished by means of the interlocking arrangement of switches  $S_4$  and  $S_5$  which operates in the same manner as the vertical plates selector switch  $S_8$ .

Synchronization of the sweep circuit is controlled through snap-switch  $S_7$  mounted on the synchronization control  $R_{18}$ . When this switch is closed synchronization is internal; however, the switch  $S_7$  is so mounted that it is opened as  $R_{18}$  is turned up, transferring the sweep to external synchronization.

Connection to the grid of the oscilloscope tube is made through the terminals 1, 2 and 3. Direct connection is obtained through terminals 1 and 2, with grid toggle  $S_1$  open. Connection through the amplifier is made with grid terminals 1 and 3, with the grid toggle switch  $S_1$  closed.

#### Conclusion

The operation and use of oscilloscopes have been described extensively in the literature and

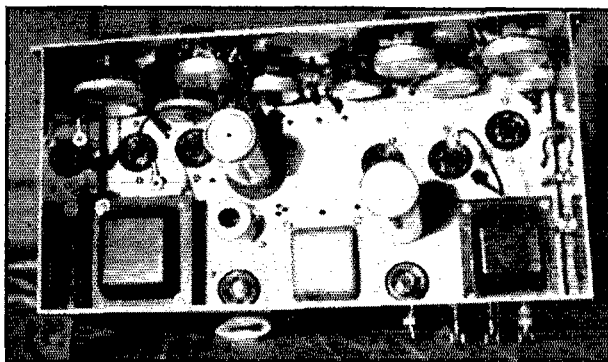

A top view of the chassis (with the 'scope mounting removed) shows the placement of components.

so will not be gone into here. With the oscilloscope described it has been possible to duplicate all of the usual measurements, and with appropriate auxiliary apparatus such applications as resonance curve tracing, magnetic phenomena tracing, and transient observations have been made. The high sensitivity of the 902, together with the versatile arrangement of controls and terminals, makes this a versatile instrument capable of many unusual applications.

## Navy Day Receiving Competition

To Be Held on October 27th

**A** MESSAGE to radio amateurs from the Secretary of the Navy will be transmitted on Navy Day, October 27th. In connection with this message A.R.R.L. will conduct the Sixteenth Annual Navy Day Receiving Competition. All amateurs are invited to take part in this activity, which constitutes amateur radio's participation in the celebration of Navy Day.

Two messages will be transmitted, one from Radio Washington (NAA), the other from Radio San Francisco (NPG). These messages will be substantially the same in thought but will vary slightly in wording. A letter of appreciation from the Navy Department will be sent to *every amateur* who makes perfect copy of the text of one message. Both messages may be copied, but only the best copy should be submitted in the competition. It is not necessary to copy both stations, and no extra credit is given for so doing. However, if both stations should be copied, please mention the fact when submitting your *best* copy so that the number of operators copying each station may be ascertained. Only the *text* (including any punctuation therein) of each message will count (not the preamble, break signs, and the like). Copy what you hear. Do not guess! Credit will of course be deducted for logging anything that was not actually transmitted!!

Mail copies for grading to the A.R.R.L. Communications Department, West Hartford, Conn. Send your original copies — recopying invites errors. An Honor Roll of letter winners and all other participants will appear in *QST*. The relative standings of the various Naval Districts will be determined by comparing the number of letters awarded with the number of copies submitted from each District. In submitting copy please mention it if you are a member of the Naval Communication Reserve.

Transmissions will be at approximately 25 words per minute and will be preceded by a five-minute CQ call on the following schedule: From Washington: NAA, 9:00 p.m., E.S.T., simultaneously on 4045 and 8090 kcs. From San Francisco: NPG, 7:30 p.m., P.S.T., simultaneously on 4045 and 9090 kcs.

# Fool-Proof Screen Feed

## Voltage Divider Design for Preventing Screen Overloads

BY WALTER VAN B. ROBERTS,\* W3CHO

WHEN a screen grid power tube is working normally its screen may equally well be fed from a separate source of fixed voltage or through a dropping resistor from the plate supply. However, in either of these cases trouble may occur when conditions depart from normal. Where fixed voltage is used, for example, we are warned against too light loading of the plate circuit since this tends to cause the screen current to rise above permissible values. Even worse, of course, is the result of removing the plate voltage while the screen voltage is on. On the other hand, if a dropping resistor is used the screen voltage may rise to dangerous values in case the screen current is interrupted, as it might be by failure of excitation when there is a large amount of fixed bias.

The screen circuit of the tube acts like a resistance whose value varies with operating conditions from practically infinity, when there is no screen current, down to abnormally low values when there is no plate current but full screen voltage

current of 20 ma. and a screen voltage of 250 when operating normally. Hence, the apparent screen resistance is 12,500 ohms. Suppose that the screen is fed from the 1250-volt plate supply through a 50,000-ohm dropping resistor as recommended. What happens when due to some misadjustment of the transmitter the screen resistance rises to a value of say 50,000 ohms? Obviously the screen voltage rises to 625 and the current drops to 12.5 ma., but the screen dissipation which was normally 0.02 amperes times 250 volts, or 5 watts, now rises to .0125 amperes times 625 volts, or 7.8 watts. Thus, if the normal dissipation had been close to the maximum allowable, it is evident that the maximum allowable would have been exceeded during the assumed misadjustment of the circuit. As a matter of fact, the ratings of most screen grid transmitting tubes appear to include a sufficient factor of safety to permit the use of the screen dropping resistor without danger of the screen dissipation exceeding the maximum rating, but there is always the danger of the screen voltage rising excessively, and the poor regulation of the screen voltage resulting from this method is often objectionable.

There is also a third method of screen supply, namely, a potentiometer across the plate supply, but usually very little is said about the resistance of this potentiometer. If its resistance is very low it will act like a fixed voltage supply and be subject to the objections previously mentioned. On the other hand, if its resistance is sufficiently high it will act substantially like the simple dropping resistor. If properly designed, however, it can provide a completely fool-proof screen supply having very much better regulation than the simple dropping resistor, together with a complete safeguarding of the screen from excessive dissipation under any condition of adjustment. It is the purpose of the present article to simplify such a design.

Fig. 1 shows the combination of a dropping resistor  $a$  with a shunt resistor  $b$ . There is an infinite number of combinations of these two resistors which will supply normal screen voltage  $e$  together with normal screen current  $i$  when the amplifier stage is adjusted for normal operation, but if either  $a$  or  $b$  is given a definite value, the other must have a certain value in order to supply the desired normal screen current and voltage. Thus, if it is assumed that  $b$  is always adjusted to give normal screen current and voltage when the screen resistance is of normal value, it can be

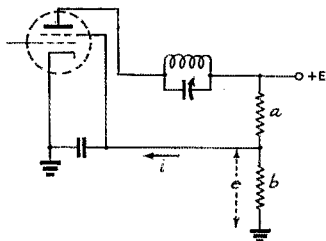

Fig. 1 — Screen supply by means of a voltage divider, the design of which is discussed in the text.

together with plenty of excitation. Thus, if the screen is supplied with constant voltage there will be an excessive amount of power dissipated in the screen when the screen resistance falls to abnormally low values, while if the dropping resistor method of feed is used, increased screen dissipation will occur when the screen resistance rises above its normal value. While it is obvious that the dissipation will increase when a fixed voltage is applied to a decreasing resistance, it is perhaps not so obvious that, in the case of the dropping resistance method of feed, the dissipation will increase when the screen resistance increases, so an example will be given. According to the ICAS rating, a plate-modulated 804 has a screen

\* Patent Department, Radio Corp. of America, New York City.



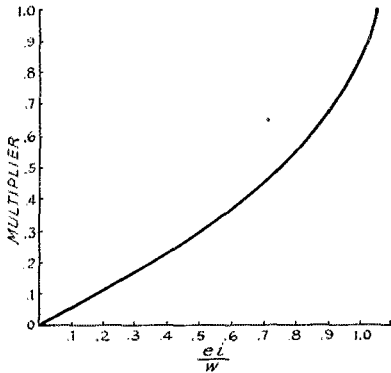

Fig. 2

shown that for any given value of  $a$  the screen dissipation cannot be made to exceed

$$\frac{E^2}{4a} \cdot \frac{e}{E - ai} \dots \dots \dots (1)$$

watts by any misadjustment of the circuit, even including such mistakes as removing plate voltage entirely. (In this, and in all other formulas to follow, currents must be expressed in amperes, voltages in volts, and resistances in ohms.) From expression (1) it turns out that for most tubes,  $a$  may be chosen anywhere within a considerable range of values without the maximum possible screen dissipation exceeding the allowable value. One thing of interest is to find out how small  $a$  can be made without danger of exceeding the allowable screen dissipation, because the smaller  $a$  can be made the better the screen voltage regulation. This can be found as follows: Let  $W$  be the allowable watts screen dissipation while  $ei$  is of course the normal screen dissipation. (To play extra safe  $W$  can be taken somewhat smaller than the maximum rating if desired.) Then the smallest safe value for  $a$  is obtained by multiplying the quantity  $E/2i$  by the multiplier given by Fig. 2. Once the value of  $a$  is decided upon,  $b$  may be obtained from the formula

$$b = ae/(E - e - ai) \dots \dots \dots (2)$$

That is all there is to it. To show how the calculation is made in a particular case, consider the 813 tube acting as a grid-modulated amplifier. From the tube instruction sheet we find  $E = 2000$ ,  $e = 400$ ,  $i = 0.003$ , and  $W = 15$ . Let us decide to play extra safe and take  $W$  as 10 watts. Then  $ei/W = 0.12$  and from Fig. 2 the multiplier is

Screen grids aren't intended to run red hot, but they frequently do. Here's an easily-applied method for determining the proper constants in the screen-supply circuit to prevent excessive screen dissipation under any conditions of plate tuning or excitation.

seen to be about 0.06. Multiplying  $E/2i$  by .06 we have  $a = 20,000$  ohms. Then from formula (2),  $b$  should be 5190. This is not a convenient figure, but as mentioned before, only one of the resistors can be chosen at all at will, so in order to obtain the desired normal values of  $e$  and  $i$  it will be necessary to do one of three things: Make up the proper resistance for  $b$  by using several resistors that add up to 5190, use an adjustable resistor, or use a potentiometer whose total resistance is about equal to the sum of  $a$  and  $b$  and adjust the slider to get the normal values of  $e$  and  $i$  under normal operation. Thus, the method of design illustrated here may be looked upon either as a way to pre-calculate fixed resistors  $a$  and  $b$  which will safeguard the screen from the possibility of any more than a predetermined input  $W$ , or as a way to determine the approximate total resistance of a potentiometer which can supply the desired operating current and voltage together with the above-mentioned limitation of possible screen dissipation.

Having now obtained some values for  $a$  and  $b$  that will make the screen safe under any and all conditions, let us see what sort of voltage regulation there will be. Under normal conditions, of course, the screen voltage will be 400. Now suppose that screen current is stopped completely, as by lack of excitation in the presence of cut-off bias. Then the voltage will become 2000 multiplied by the ratio  $b/(a + b)$ , or 412 volts. This is not much of a rise. In fact, it is so little that we had better start all over again and assume a much smaller value of  $W$  so as to come out with much higher values of  $a$  and  $b$  and thus not waste so much power in them, a thing especially to be avoided in case the voltage applied to  $a$  and  $b$  is modulated. So let us jump to the extreme case of setting  $W$  equal to the normal screen input. Then the screen input is always lessened when the adjustments of the transmitter depart in any way from normal. Taking  $ei/W$  as unity, Fig. 2 gives a multiplier of unity and  $a$  is found to be a third of a megohm. As a result,  $b$  must be two-ninths of a megohm. These resistances are now so great that there is not much power wasted in them, but the regulation is not as good as before. In fact, the screen voltage will be found to rise to twice its normal voltage in the absence of screen current whenever we take  $W$  as equal to the normal screen input in calculating  $a$  and  $b$ .

The foregoing calculations have been made rather lengthily in order to illustrate how easily resistances  $a$  and  $b$  can be determined to meet the individual requirements of the designer, which may fall anywhere between the extremes of requiring the best possible regulation of screen voltage consistent with safety on the one hand, or requiring minimum screen dissipation together with a safe limitation on the screen voltage on the other hand.

The latter extreme, or a condition near to it,

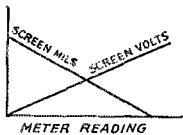

Fig. 3 — Typical behavior of screen voltage and current with a voltage divider designed for maximum rated screen dissipation.

will probably appeal to the amateur since the power wasted in  $a$  and  $b$  and the cost of these resistors is least for this condition. Furthermore, the calculations are particularly simple in this case. Just make  $a$  approximately equal to  $E/2i$  and then calculate  $b$  from equation (2).

It is very convenient to insert a milliammeter of suitable range between ground and the lower end of resistor  $b$  in Fig. 1. The current in this meter is proportional to screen voltage so the meter may be calibrated to act as a screen voltmeter. Not only that, but the screen current may also be determined from the meter reading by subtracting from the quantity  $E/a$  the product of the quantity  $(1 + b/a)$  and the meter current measured in amperes. For any fixed values of  $a$ ,  $b$ , and  $E$ , a chart may readily be made up and mounted near the meter giving curves of screen voltage and current plotted against meter reading. This chart will look like Fig. 3. Incidentally, the "dip" of this meter is sometimes a better plate tuning indicator than the plate current meter itself!

In selecting power ratings for resistors  $a$  and  $b$ , either the normal dissipation or the greatest possible may be used. In the former case  $a$  should

be rated to dissipate  $\frac{(E - e)^2}{a}$  watts while  $b$

would be required to dissipate  $\frac{e^2}{b}$  watts. If we

wish to play safe by making the ratings sufficient to handle any possible condition, the rating for  $a$

would be  $\frac{E^2}{a}$  watts and for  $b$  the rating should be

$\frac{(Eb)^2}{(a + b)^2}$  watts.

Of course, if a portion only of an adjustable resistor is used, only the corresponding fraction of its total rating should be figured.

#### Appendix

To justify the foregoing equations and expressions, their derivation will be indicated briefly. Consider the screen resistance in Fig. 1 as a variable resistance of  $x$  ohms. The heating of this resistance is  $\frac{E^2 b^2 x}{[(a + b)x + ab]^2}$  watts. This is a maximum when  $x$  is made equal to the resistance of  $a$  and  $b$  considered in parallel; that is, when  $x = ab/(a + b)$ . This maximum value is  $\frac{E^2}{4} \cdot \frac{b}{a(a + b)}$  and represents the greatest possible dissipation in  $x$  for any value of  $x$  from zero to infinity.

Next find the relation required between  $a$  and  $b$  in order that the screen may receive the correct current at the proper voltage when normally adjusted. If conditions are correct the current through  $b$  will be  $e/b$  while the screen current is  $i$ . Hence, the current through  $a$  must be  $e/b + i$ . Now this current flowing through  $a$  must produce a voltage drop

$(E - e)$ . Hence, we have the equation  $a(e/b + i) = (E - e)$  from which equation (2) is readily obtained.

Putting the value of  $b$  given by equation (2) into the expression derived above for maximum possible dissipation, we get expression (1).

Equate expression (1) to a desired maximum possible dissipation  $W$  and solve for  $a$  and we find  $a = \frac{E}{2i} \left[ 1 - \sqrt{1 - \frac{e^2}{W}} \right]$ . The bracketed term of this is what has been plotted in Fig. 2.

This completes the derivation of the expressions used hitherto, but for convenience a few more relations will be added without derivation as they can be easily derived and may be handy in some cases:

In case  $b$  is chosen arbitrarily then  $a$  must be equal to  $\frac{b(E - e)}{i(b + e)}$ .

In case the total resistance  $(a + b)$  is chosen arbitrarily to have the value  $R$ , then the screen tap must be connected at a fraction of the total resistance, measured from the grounded end, which satisfies the equation  $\frac{E - e}{i - f} - \frac{e}{f} = Ri$

If the screen tap has been located in accordance with the preceding equation so as to assure the desired normal screen current and voltage, then the maximum possible screen dissipation is  $\frac{E^2}{4} \cdot \frac{if^2}{Ef - e}$  watts.

In concluding, the writer wishes to express his thanks to the Clarostat Mfg. Co. for supplying adjustable resistors for experimentation in an 813 amplifier employing screen-feed designed in accordance with the present article.

## Vermont State Convention

(New England Division)

**Rutland, Vt., October 12th**

THE Green Mountain Radio Club promises that plenty of fun will be had at the Vermont State Convention to be held at the Mead Community House in Rutland on Saturday, October 12th. It will be an old-fashioned "ham jamboree," with prizes, speakers, special meetings, entertainment, dancing and tops in a New England turkey dinner. Registration begins at twelve o'clock noon, and the fee is \$1.50 per person. Write R. C. Teachout, W1FSV, 42 Pine St., Rutland, for further details.

## Iowa State Convention

(Continued from page 27)

subjects such as frequency modulation, audio systems, u.h.f. antenna beam patterns and others. The A.R.R.S. will have important demonstrations as will the N.C.R. Entertainment Saturday night will consist of a dance with an NBC eleven-piece band playing. Sunday afternoon at three o'clock will be the climax with the big banquet and the giving away of the major prizes, consisting of a transmitter and several receivers. The committee is working very hard to secure Dr. Lee DeForest as a visitor. Ladies not participating in the technical portion of the program will be entertained at a special luncheon and style show Saturday afternoon. Registration fee is \$2.50 (\$2.00 for ladies). Write Chairman C. C. Cummings, W9QAQ, Hotel Chieftain, Council Bluffs, Iowa.



# H A M D O M



**T**IME was when a licensed amateur of ten was practically a veteran. That was in the days when we had boys and girls of eight or nine going down and getting their licenses along with the oldsters. But then the code speed was raised, the examination was greatly stiffened, and the average age of amateurs rose from 24 or 25 to about 30. There came a time when we knew of no licensed amateur younger than 12, a period even when we couldn't point to any as young as that.

But now youth is once more in the limelight. First, there was 11-year-old Ralph Taylor, W9FTV, pictured in our February issue. Now comes William Fullerton, of Freeport, Pa., licensed since the first of the year as W8UKX and diligently active on 40-meter c.w. Bill is just 10 years old.

Bill Fullerton, Amateur, is a product of a social system that causes juveniles to scorn the arts and adhere to more masculine practices, such as tearing the insides out of electric trains to see what makes them tick. At the age of five he showed a marked ability for music. In fact, he still has what amounts to a perfect sense of pitch. He was given lessons in music and got along fine

—until someone told him that only sissies played music. Then it was all off.

There was little doubt of his interest in things mechanical and electrical, however. All his toys had been taken apart to see what made the wheels go 'round. He devoured all the electrical magazines he could get his hands on. From these he learned the fundamentals of radio and assembled two or three small broadcast sets — which worked!

When Bill was nine years old he contracted inflammatory rheumatism and was confined to bed for three months. It was during this time that his amateur career actually began. Using a small key which he made from a piece of tin can he started to practice the International Morse Code as he found it in a Boy Scout Handbook. It wasn't long before he wanted a short-wave receiver. His father, Clyde H. Fullerton, bought him a Comet Pro.

The speed with which Bill picked up code was uncanny. It wasn't long before he determined in earnest to be a ham. Learning that examinations were being given in Pittsburgh, his mother took him down in September of last year. He passed the receiving and sending examinations 100%, but flunked the theory. Perhaps it was that post-office pen! Anyway, in December he tried again — this time fortified with a fountain pen. He passed with flying colors and was assigned W8UKX.

Meanwhile the rig — built with the aid of W8EQZ, using a 6L6 driving an 814 with 180 watts input — was ready and waiting. During the first week every district was worked. Since then a lot of brass has been pounded on 7096 kc. The station is coming steadily along: an HQ-120-X has taken the place of the Comet Pro, a speech amplifier and modulator is under construction, and just the other day Bill handed his dad a list of parts for a little 12-watt 160-meter rig he plans to build. "I don't see why my kids pick such expensive hobbies," sighed Fullerton, Sr. You see, Bill's brother Bob, aged 14, is a bug about photography. . . .

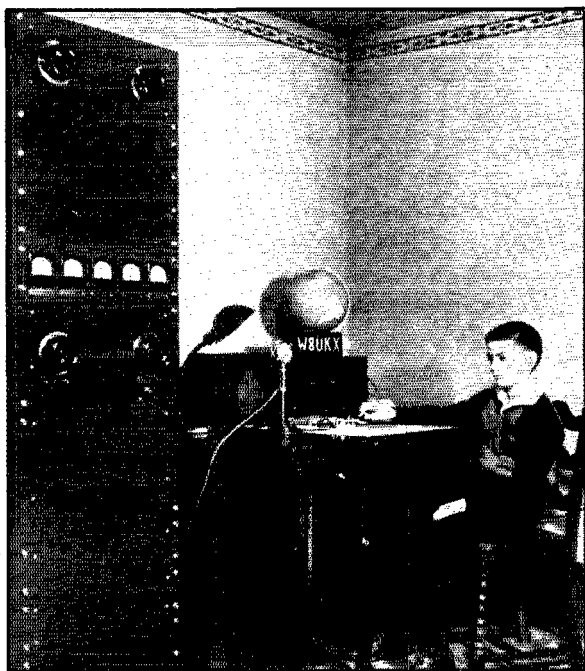

# A Midget 1.75- and 3.5-Mc. 'Phone Transmitter

*A 10-Watt Rig with E.C.O. for Dodging QRM*

BY HERBERT W. GORDON,\* W1BY

FOR reasons of necessity or convenience, a far greater number of low-power stations exists than is generally realized. In the lower frequency 'phone bands, 75 and 160 meters, many of these brave souls are attempting to navigate QRM with but few of the possible advantages in their favor. In particular, their signals usually are controlled by one crystal, and when a high-power station opens up on the same frequency it is just too bad.

The compact, two-band transmitter described here has as its chief feature a stable electron-coupled oscillator to provide operating flexibility. In its simplest form the outfit need not cost more than \$20, although when dressed up as pictured the cost may run closer to \$40.

## The Circuit

For best stability we chose a tube that would, first of all, deliver sufficient power lightly loaded. The 6F6 meets this specification and is, in addition, mechanically solid. The oscillator frequency, both grid and plate circuits, is in the middle of the broadcast band. A high-C grid circuit, stabilized

\* 167 Washington St., Boston, Mass.

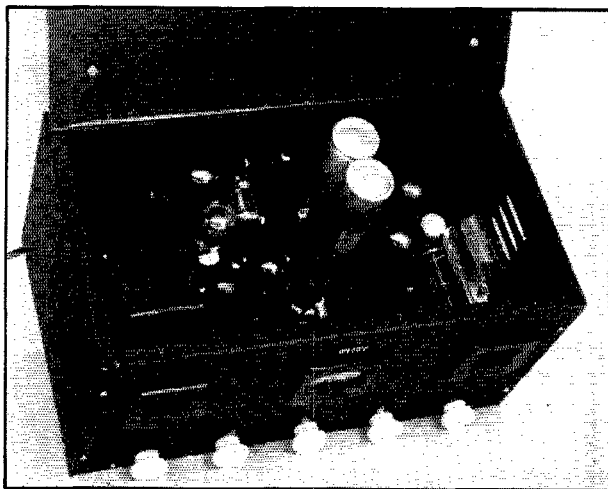

Although small enough to be carried around easily, this low-power 1.75- and 3.5-Mc. 'phone outfit has three r.f. stages, modulator and high-gain audio, and power supply. The r.f. output is about 10 watts.

screen voltage, adequate shielding, solid anchoring of parts, and the use of No. 14 wire for connections, further contribute to stability.

To cover both the 160- and 80-meter bands it was necessary to have the correct ratio of variable to fixed capacitance in the grid circuit. After many trials, a range of 475  $\mu\text{mfd.}$  to 615  $\mu\text{mfd.}$ , using a 140- $\mu\text{mfd.}$  variable, proved to be optimum. The 475- $\mu\text{mfd.}$  fixed capacitance is made up of three silvered-mica condensers, as shown in Fig. 1. The 160-meter range is from 1700 to 2,060 kc. with the coil used; the coil must be exactly as described for the same range. The cathode tap should be about 6 turns from ground for the best note.

The output of the shunt-fed plate circuit to the oscillator is capacitively coupled to the 6N7 buffer-doubler, which has its grids and plates tied together in parallel. Its plate circuit is shunt fed and is capacitively coupled to the 6L6 final amplifier.

The 6L6 amplifier uses a conventional balanced plate tank for neutralizing. The tank condenser,  $C_{19}$ , is shunted by a 50- $\mu\text{mfd.}$  midget to provide additional capacity so that tank coils of reasonable size can be used. The 6L6 loads the buffer quite heavily, which is convenient since it makes the buffer tank tuning non-critical. There is ample excitation for 'phone operation on either 2 or 4 Mc.

The r.f. line-up and power supply considerations dictated an input of approximately 50 ma. at 300 volts, or 15 watts, to the modulated stage. This represented an impedance of 6000 ohms. We needed a modulator that could deliver about 7½ watts of audio, Class-A operated so that no driving power would be necessary. A single 6L6 is about the only tube to qualify from this standpoint.

In planning the transmitter it was realized that only an extremely small speech amplifier unit could be accommodated in the small cabinet. The new glass-base midget tubes proved to be the answer to size so far as tubes themselves were concerned. An examination of the characteristics

of the five tubes in this series resulted in the choice of a 1T4 pentode as the first speech amplifier, and a 1S5 diode-pentode as the second stage. Theoretically the overall gain of such an amplifier would be ample, and practically we had more gain than was ever needed.

The filaments in these tubes are designed to operate on 1.4 volts at 50 ma. d.c. Rather than install flash-light cells, the thought occurred to us to use d.c. from the plate supply as a means of heating them. Since the 6L6 modulator operates Class-A its plate current is practically steady, and is furthermore about the right value for the filaments. As shown by the circuit diagram, the filaments are in series with a 500-ohm resistor and the cathode of the modulator. No ill effects are experienced in operation. The tubes take about two seconds to warm up when the plate supply is switched on for transmission.

An advantage of using the battery tubes is the almost complete absence of hum, since no a.c. is brought into the amplifier. The plate current is so small that filtering is easy. *RC* filters, using  $\frac{1}{2}$ -watt resistors, are more than sufficient.

One transformer takes care of all power-supply requirements. Condenser input was considered desirable in order to get the maximum d.c. voltage. In practice, however, we ran into some trouble with condenser input. Referring to the circuit diagram, the pilot bulb,  $P_1$ , which illuminates the meter, also acts as a tuning indicator and fuse by virtue of the fact that it is in series with the center tap of the high-voltage winding of the power transformer and ground. When using an electrolytic input condenser the current surge on closing the circuit was so great that it almost invariably blew out the pilot bulb, rated at 150 ma. The answer was to install an oil-filled 4- $\mu$ fd. paper condenser; which reduced the surge to negligible proportions.

Additional filtering for the speech amplifier is provided by a second choke and a 75,000-ohm resistor, with condensers on each side of the choke and resistor.

Meter switching using an inexpensive, easily-obtained switch is included. The meter reads

Low-power fans will find some interesting circuit features in this compact transmitter. Self-contained except for microphone and antenna, it is easily adapted to portable work from a.c. mains.

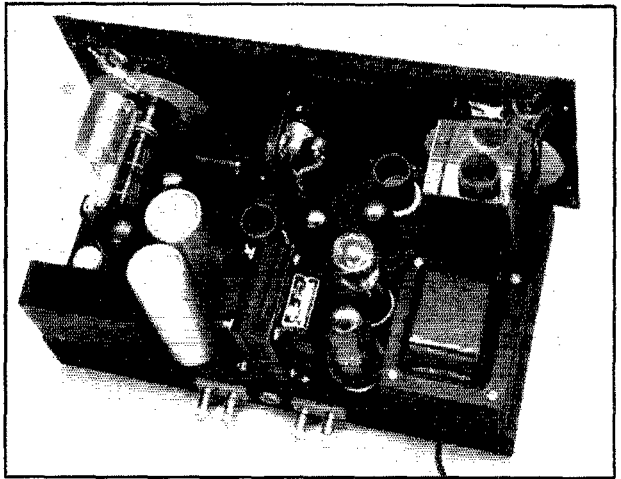

Looking at the top of the chassis, from the rear. The top of the shield containing the e.c.o. grid circuit is removed to show the grid coil in place.

modulator, Class-C amplifier, buffer and oscillator plate currents.

#### Mechanical Details

The transmitter is housed in a metal cabinet measuring 14 inches long, 8 inches wide and 7 inches high. The chassis is 2 inches high, 13 inches long and 7 inches wide. In the rear view, from right to left along the near edge, are the power transformer, rectifier and voltage regulator, first filter choke, filter condensers ( $C_{27}$ ,  $C_{28}$  and  $C_{24}$  are in one can) and finally the speech amplifier in its shield. Next to the speech amplifier, toward the panel, are the modulator tube and gain control knob. The gain control is mounted on the chassis rather than the panel because it is seldom necessary to change its setting in operation. The shield can housing the grid circuit of the electron-coupled oscillator is at the extreme right next to the panel. Beside it are the 6F6 and the oscillator plate coil. Next comes the 6N7 buffer-doubler and its coil, followed by the 6L6 final amplifier. The final tank coil socket is mounted by two homemade brackets on the tank condenser. This condenser is mounted on its side by two additional brackets to bring the shaft to the correct height for the tuning dial.

The chassis is spaced just a hair higher than normal on the front panel because in the cabinet used the panel goes all the way to the bottom while the chassis rests on the inner surface of the cabinet. The chassis is also spaced from the front panel by four sleeves,  $\frac{1}{2}$  inch in length, to make room for the lip at the bottom of the cabinet. The rigidity of the panel-chassis assembly is improved by the addition of a piece of bent  $\frac{1}{4}$ -inch brass stock mounted between the top center of the panel and approximately the center of the chassis.



mitter chassis by means of 4 spade bolts. A half-inch hole is drilled in the main chassis to permit viewing the condenser plates so the dials may be set properly.

For the sake of appearance meter-type dials (Millen) are used to match the Triplett  $2\frac{3}{8}$ -inch meter. There are no a.c. and standby switches on this unit because in the author's particular instance all such controls are on an external panel on the operating desk.

The r.f. output terminals and standby switch binding posts are standard units mounted on the rear chassis edge. The microphone jack is between them. A window is cut in the back of the cabinet to allow easy accessibility to the binding posts and jacks.

Before actually starting any mechanical work on the chassis, it would be wise to leave on the paper in which it is wrapped. After the layout has been planned, outline on this paper the positions of the holes to be drilled. Then prick-punch into the metal and drill without removing the paper. This protects the chassis from scratches and provides a convenient drilling template.

The bottom half of the shell-type power transformer is disassembled and mounted after the transformer is put into its opening hole. This method of mounting makes a better appearance than would otherwise be obtained.

All the parts should be assembled on the chassis before attempting to fit the panel to the chassis. The mechanical construction is pretty straightforward and the wiring is not difficult. Do not stint in the use of tie-ins and soldering lugs. Spare terminals on the coil and tube sockets may be employed to anchor some of the parts, as shown in the photographs.

### Operating Notes

It is advisable to follow the specifications for  $L_1$  as closely as possible to ensure operation over the desired frequency range. The actual range can be checked by finding the frequency limits on a calibrated receiver with  $C_1$  set at the extremes of its scale. Slight adjustments to  $L_1$  will center the band on the dial scale. The oscillator plate current, with  $L_2C_{10}$  tuned for minimum plate current, should be about 20 ma. The plate current of the 6N7 buffer-doubler will be in the vicinity of 25 ma.

With the first two stages tuned, the next step is to neutralize the 6L6 final amplifier. To do this, set  $S_1$  in the position to read the final plate current, then disconnect the positive terminal of the

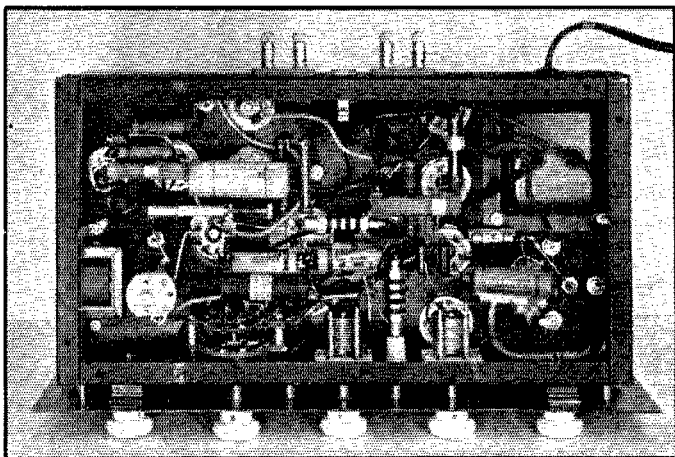

A bottom view, showing the wiring. Oscillator and buffer plate tuning condensers are mounted below chassis, as is also the air padder for the final plate tank.

milliammeter from the plate supply and temporarily ground this terminal of the meter. (Do not change the setting of  $S_1$  while the meter is grounded because the plate supply will be short-circuited through the meter.) As  $C_{19}$  is tuned through resonance the meter will give a current indication because of rectified r.f. in the plate circuit. Adjust the neutralizing condenser,  $C_{18}$ , for minimum meter reading; with perfect neutralization the meter will read zero regardless of the setting of  $C_{19}$ . After the amplifier is neutralized the meter may be reconnected to the plate supply for normal operation. The same setting of the neutralizing condenser will serve for both 1.75 and 3.5 Mc.

Loading on the final amplifier should be adjusted so that the plate current, at resonance, is 50 to 60 ma. The plate voltage, measured from plate to cathode, should be 275 volts. The modulator will draw about 37 ma., which, although slightly low for full emission from the speech-tube filaments, is sufficient for good operation.

For operation on 80 meters, the 160-meter buffer plate coil is plugged in the oscillator plate coil socket and a new coil is used for the buffer doubler. The final plate coils also are changed. Since the capacity of  $C_{19}$  is small,  $C_{17}$  provides additional capacity to bring the circuit to resonance on 1.75 Mc. In initial adjustments,  $C_{19}$  should be set at maximum capacity, with the 1.75-Mc. plate coil in place, and  $C_{17}$  adjusted to bring the circuit to resonance. Then when the 3.5-Mc. coil is plugged in resonance will be found on  $C_{19}$  near its minimum capacity, but it will not be necessary to readjust  $C_{17}$ .

The plate spacing of the tank condensers is quite small, so there is danger of arcing if the amplifier is operated without a load. It is a good

(Continued on page 108)

# Results, 12th A.R.R.L. DX Competition

BY E. L. BATTEY,\* W1UE

**DX** is what you make it! With world-DX, as we have learned to know it, at an all-time low in March, 1940, there were the skeptics who said, "A DX Contest now? Impossible!" But the real enthusiasts insisted, "Give us a Contest based on what DX there is and we'll show you!" And they did! It was a grand contest, and a good time was had by all, in spite of the scarcity of DX. The added feature of contacts with other W's filled in the slow spots. "DX is what you make it," we always say, and the boys made a definite go of this year's contest, handicaps or no!

From the standpoint of logs submitted, the contest held its own with the best: 919 United States amateurs reported their results; 632 were in the c.w. doings, while 311 hit the 'phone section. Outside the U. S. there were logs submitted by 138 operators, 80 participating on c.w., 62 on 'phone. Some operators took part on both code and voice.

The winners are those first-listed in each A.R.R.L. Section and outside territory in the tally of scores. Competition was keen and all winners rate a hearty "congratulations" from all concerned.

## Highest Scorers

The W6's really showed the rest of the gang how in this year's fray. The highest scorer in both the c.w. and 'phone section was a W6!! In fact, the five highest c.w. scores came from W6-land. It may have been the absence of Europe that brought this about, but you may be sure that good operating by experienced men also played a big part! Nice going, West Coasters!

### C.W. Highs (W's)

W6GRL.....	2,562,310	W6MSM.....	778,335
W6QD.....	1,835,960	W9TH.....	769,600
W6VB.....	1,656,192	W1IOZ.....	765,300
W6HJT.....	1,640,080	W6RMT.....	743,690
W6OEG.....	1,536,610	W8QFP.....	738,100
W3EMM.....	1,382,760	W3FQP.....	719,210
W2UK.....	1,303,560	W6EPM.....	713,273
W4ECI.....	1,225,305	W8ERA.....	676,590
W4BZ.....	1,173,260	W9FFY.....	675,845
W6ITY <sup>1</sup> .....	1,111,383	W5BRR.....	675,220
W8LEC.....	1,094,800	W3FRY.....	674,355
W5KC.....	1,015,700	W5GRH.....	670,840
W6KEV.....	1,007,005	W2ZA.....	663,680
W8BTI.....	907,850	W6MVQ.....	654,133
W3BES.....	897,005	W6EAK.....	653,125
W9IU.....	894,915	W3EDP.....	638,290
W9DIR.....	884,380	W4FIJ.....	635,550
W2LXK.....	836,928	W1CBZ.....	605,425
W6QL.....	790,200	W8HGW.....	600,780

<sup>1</sup> W6BRR, opr.

\* Asst. Communications Manager.

## 'Phone Highs (W's)

W6OCH.....	1,287,660	W5VU.....	602,310
W4BMR.....	1,110,525	W5AKZ.....	599,500
W6CQS.....	903,960	W5VV.....	563,490
W6ITH.....	899,520	W1IED.....	471,015
W6NNR.....	847,045	W9MCD.....	446,250
W4EEE.....	822,740	W9NDA.....	403,065
W8CKY.....	790,650	W5YF <sup>2</sup> .....	397,760
W6AM.....	750,870	W6MEP.....	374,400
W2JT.....	743,900	W8NV.....	364,061
W6EJC.....	731,895	W8LFE.....	313,425
W1ADM.....	702,100	W1AKY.....	312,375
W1AXA.....	671,930	W6PDB.....	308,220
W6NHK.....	654,815		

## Highest in Each W District

C.W.	'Phone		
W1IOZ.....	765,300	W1ADM.....	702,100
W2UK.....	1,303,560	W2JT.....	743,900
W3EMM.....	1,382,760	W3GKM.....	204,575
W4ECI.....	1,225,305	W4BMR.....	1,110,525
W5KC.....	1,015,700	W5VU.....	602,310
W6GRL.....	2,562,310	W6OCH.....	1,287,660
W7VY.....	504,000	W7EOI.....	280,000
W8LEC.....	1,094,800	W8CKY.....	790,650
W9IU.....	894,915	W9MCD.....	446,250

## W Leaders in Contacts

W6GRL is 'way out in front in number of c.w. contacts with 368, followed by W6QD with 307, W6VB 293 and W6HJT 290. (Those W6's again!) Other highs were W3EMM 269, W6OEG 268, W2UK 259, W4ECI 241, W4BZ 234, W6ITY 230, W8LEC 229, W3BES 224, W5KC 214, W9IU 210, W5BRR 203, W8BTI 202, W3FQP 199, W6MSM 197 and W6RMT 195.

In the 'phone group, it's W6 again with W6OCH leading in contacts — 248. Next in line come W4BMR and W6CQS 203, W6NNR 192, W6ITH 189, W6AM 187, W4EEE 174, W6EJC 173, W6NHK 172, W2JT 168, W1AXA 162, W5VU 158, W1ADM 157, W5AKZ 156, W8CKY 150, W5VV 148 and W1IED 137.

## W Leaders in Countries/Districts

Those having the highest multipliers (total of countries and W districts worked on each band used): C.W. — W6GRL 89, W6QD 79, W6HJT and W6VB 76, W4BZ and W6OEG 74, W4ECI 73, W2UK and W3EMM 72, W5KC 70, W6ITY and W6KEV 69, W8LEC 68, W8BTI 67, and W2LXK and W9TH 64. 'Phone — W8CKY 70, W4BMR 67, W6OCH 66, W6ITH 64, W4EEE and W6CQS 62, W1ADM, W2JT and W6EJC 59, W1AXA 58, W6NNR 57, W5VV and W6AM 54, W6NHK 53, W5VU 51, and W5AKZ and W9MCD 50.

<sup>2</sup> J. S. Stover, ex-W9PEV, opr.



### Club Scores

The South Bay Amateurs Association of Los Angeles is winner for the third consecutive year of the gavel offered to the amateur radio club whose members, operating individual stations, submitted the highest collective score. This group made a total of 6,101,262 points! Not bad!! W6GRL wins the individual club certificate for S.B.A.A.

Second high for the third year in a row is the Frankford Radio Club of Philadelphia — 3,900,831 total points. Individual winner in this club is W3BES. In third place is the Birmingham (Ala.) Amateur Radio Club with 1,915,294 points, and W4ECI the individual high.

Other competing clubs, having three or more reporting participants, are listed in order of scores. The calls given in parenthesis are winners of the club certificates. Unless otherwise stated, certificate was won in the C.W. Section: Maui Amateur Radio Club, 1,868,352 (K6CGK); Greater Cincinnati Amateur Radio Association, 1,542,345 (W8BTI c.w.; W8NK 'phone); York Radio Club (Elmhurst, Ill.), 1,247,935 (W9TH); Austin Radio Club (Chicago), 842,357 (W9NRB); Dayton Amateur Radio Association, 547,699 (W8CED); Columbia University Radio Club, 532,175 (W2HHF); Ozark Empire Radio Club, 363,115 (W9QMD c.w.; W9IMZ 'phone); New Haven Amateur Radio Association, 362,265 (W1FMV); University of N. C. Radio Club, 214,025 (W4DWB); Medina County (Ohio) Radio Club, 149,433 (W8JJY); Tu-Boro Radio Club (L. I., N. Y.), 147,835 (W2KIK). Individual club awards are made only in cases where three c.w. entries or three 'phone entries were received from club members or local hams invited by the club to participate.

### Disqualifications

The following are deemed ineligible for DX-score listings, or awards, in the March 1940 competition. In each case disqualification is for off-frequency operation. This is in accordance with Rule 11 as announced in February 1940 QST.

C.W.: W2APT, W5BGP, W6MRB, W6MUS, W6TT, W9YCR, CM2SW, CX2AJ, HC1VT, HH2MC, HK2BD, PY1AJ, PY2AG, PY5QG. 'Phone: W3BET.

### High Scores Outside U. S. A.

	C.W.	'Phone	
XF1A	839,851	K4FKC	388,376
XE1CM	768,750	K6PLZ	278,376
K4DTH	643,428	K6PTW	267,432
LU7AZ	515,032	LU5AN	207,624
PY2AC	464,100	CE2BX	188,588
K6SCB <sup>1</sup>	435,464	CO2AM	167,325
K6PAH	376,625	HC2CC	164,472
K6CGK	334,917	NY4AD	115,264
K6PAL	325,910	OA4R	109,140
K6PIN	324,280	YV4AE	105,257
K6PHD	304,806		

<sup>1</sup> K6KQK, opr.

Leader in number of c.w. contacts was our old friend XE2N, who tried to fool the boys this year by using the trick call of XF1A. He made 1338 QSO's! A strong second was XE1CM, 1230. Other highs: K4DTH 1056, LU7AZ 868, PY2AC 780, K6SCB 755, K6CGK 681, K6PIN 669, K6PAH 662, K6PAL 616, K6FAZ 581, K6PHD 554, and K6AYD 522. Those K6's sure knocked 'em off!

Leader in 'phone contacts was K4FKC, who exercised his tonsils to the tune of 918 QSO's! Other fast talkers: K6PLZ 716, K6PTW 612, LU5AN 507, CO2AM 485, CE2BX 430, HC2CC 429, NY4AD 365, YV4AE 325, and OA4R 321.

Those making the highest multipliers (total of U. S. A. states worked on each band used): C.W. — XF1A 127, XE1CM 125, K4DTH 122, LU7AZ and PY2AC 119, K6SCB 116, K6PAH and K6PAL 115, K6AYD 113, K6PHD 111, K6PIN 110, and LU9AX 100. 'Phone — K6PTW 88, K4FKC 86, K6PLZ and CE2BX 84, LU5AN 82. HC2CC 77, and K6LKN 72.

— — — —

The list of scores which follows gives a "bird's-eye view" of the accomplishments of all. Since competition is actually between the operators of any given Section or Country, we know you will be interested in seeing what the gang in your area did. Since there was no time limit (two complete week-ends being specified), the hours operated by each man are not indicated.

And now 12 A.R.R.L. DX Competitions have gone down the pike. According to schedule the next will be number "13," and that's a good number for it, judging by the present prospects! Hi.

### SCORES

#### 12th A.R.R.L. DX Competition

(Operator of the station first-listed in each Section and Country is winner for that territory. . . . Asterisks denote stations not entered in contest, reporting to assure credit for stations worked. . . . The multiplier used by each station in determining score is given. In the case of W participants this is the total of counties and W districts worked on all frequency bands used. In the case of non-W participants it is the total of U.S.A. states worked on all bands. . . . The number of contacts established is next listed. . . . The letters A, B and C approximate the power input to the final stage at each station; A indicates power up to and including 100 watts; B indicates over 100 watts, up to and including 500 watts; C indicates over 500 watts. . . . Example of listings: W3BES 897005-61-224-B, or, Final Score, 897005; multiplier 61; 224 contacts; power over 100 watts. . . .)

ATLANTIC DIVISION		W3GRF	197370-43-100-B
E. Pennsylvania		W3CPV	194231-43-89-B
		W3FLH	131775-35-70-C
W3BES	897005-61-224-B	W3GHD	127720-36-84-B
W3FRY	674355-61-178-B	W3BIP	115770-34-73-B
W3GHS	532225-61-151-B	W3ASW	97606-37-72-B
W3FGB*	336030-46-117-B	W3BXE	95250-30-84-A
W3AGV	311520-48-120-B	W3HTF	79785-27-50-B
W3KT	301782-53-114-B	W3ATR	65835-21-57-A
W3DGM	262430-46-115-B	W3IKW	63180-27-72-B
W3GHM	260040-44-120-B	W8FDA	55500-30-66-B
W8OKC	238080-48-119-B	W3HJE	43605-27-58-B

(Continued on page 110)

# A One-Tube Five-Band Converter

*1.75- to 28-Mc. Reception With the Least Expense*

BY VERNON CHAMBERS,\* WIJEQ

A 1400- to 1600-kc. i.f. allows the converter to be used with any b.c. or ham receiver capable of covering that range. This deserves the beginners' consideration.

EVERY now and then we run through the Technical Information Service File looking for ideas on what the fellows need and want in the way of gear. The last survey showed a decided interest in the type of converter to be described; something simple, inexpensive and adaptable for use with any standard broadcast receiver. The many uses for such a unit are apparent: It can serve the ham who wants a spare set around the shack or house, or the beginner who does not want

## Construction

The chassis and panel plans are shown in Fig. 2. Nearly all of the parts are mounted on an  $8\frac{1}{2}$  by  $4\frac{3}{4}$  by  $1\frac{1}{2}$ -inch chassis. Those remaining,  $C_1$ ,  $C_2$  and the dial assembly, mount on the panel of a 9 by 5 by 6 inch cabinet. The top view shows the positions of the components when mounted.  $C_3$  is elevated above the chassis by metal pillars which allow the condenser shaft and assembly to be properly aligned. To insure short r.f. leads the tube and coil sockets are supported on pillars also. The heater prongs of the tube socket face the rear of the chassis. Holes  $1\frac{1}{4}$  inches in diameter are drilled below the sockets to make access to the prongs for a soldering iron.

The by-pass condensers, resistors and switches are below the base as shown in bottom view. Output and power leads are soldered to lug strips

Fig. 1 — Wiring diagram of the single-tube converter.

$C_1$ ,  $C_2$  — 100- $\mu$ fd. midget variable (Hammarlund HF-100).

$C_3$  — 35- $\mu$ fd. midget variable (National UM-35).

$C_4$ ,  $C_5$  — 0.1- $\mu$ fd., 400-volt.

$C_6$  — 0.01- $\mu$ fd., 400-volt.

$R_1$  — 300 ohms,  $\frac{1}{2}$ -watt.

$R_2$  — 50,000 ohms,  $\frac{1}{2}$ -watt.

$R_3$  — 20,000 ohms, 10-watt.

$Sw_1$  — S.p.s.t. switch.

$Sw_2$  — 4-pole double-throw switch (Yaxley 3242J).

$T_1$  — Output transformer (Millen 512 WT).

Dial assembly (Millen 10011).

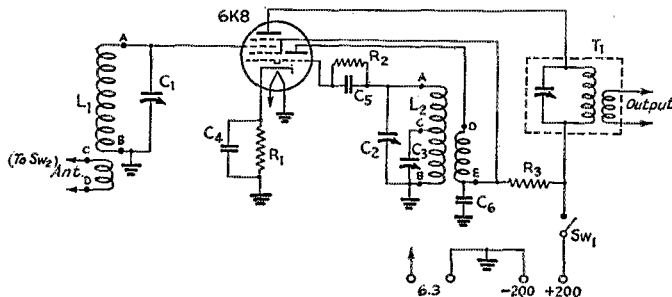

to invest in a regular receiver at the start. Then, of course, there is portable and emergency operation with the auto and battery-powered b.c. sets.

Fig. 1 shows the circuit diagram of the converter. It is readily recognized as the straightforward arrangement used in several of the *Handbook* and *QST* receivers. A 6K8 functions as the mixer-oscillator tube.  $L_1$  and  $C_1$  form the mixer tuned circuit and  $L_2C_2C_3$ , the oscillator portion of the 6K8.  $C_3$  may be tapped across the coil for band-spread to suit the individual's choice; the taps suggested in the coil chart give approximately 90-divisions spread with the dial used.

A separate tickler winding provides feed-back for the oscillator. The output transformer,  $T_1$ , is a commercial component which may be purchased for little more than the cost of parts for a home-made affair.

\*Technical Information Service.



A front view shows the band-set knob at the center with the band-set and detector tuning condensers to the right and left, respectively. The antenna and on-off switches are to the left and right at the bottom of the panel.

This top view shows  $L_1$  and  $L_2$  to the right and left of the 6K8. The output transformer stands at the left. The power-cable-output leads and antenna terminals may be seen along the rear wall of the chassis.

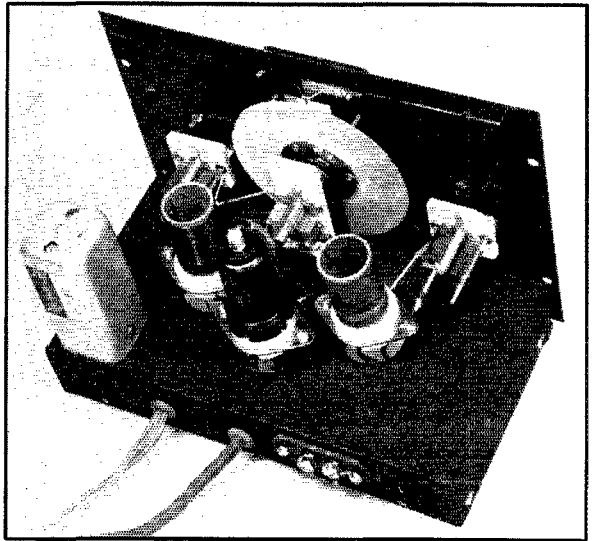

fastened in place by the socket and output transformer screws and nuts.

The two switches on the front wall of the chassis should be mounted before the panel is attached. Each switch should have an extra nut screwed to the shaft; this provides a small space between the chassis and panel when the two are fastened together, and the front edge of the bottom plate slips into this space when the cabinet is assembled. The panel and chassis are held firmly together by a third nut on each switch shaft.

$Sw_1$  has a rotary shaft rather than the usual lever. It is manufactured by the Arrow-Hart & Hegeman Electric Co. and was used to give a symmetrical appearance to the panel.

Fig. 3 shows how  $Sw_2$  is wired. This switch shifts the antenna from the converter to the receiver rapidly and conveniently.

Wiring of the converter needs no special care. However, it is well to keep the r.f. leads short.

### Coils

Coils  $L_1$  and  $L_2$  are wound on 1-inch diameter forms with the associated antenna and tickler coils wound approximately  $\frac{1}{8}$  inch below the main windings. Fig. 4 shows the construction. The actual spacing between windings is not too important and will have to be slightly less than suggested so far as the 1.7-Mc. mixer coil is con-

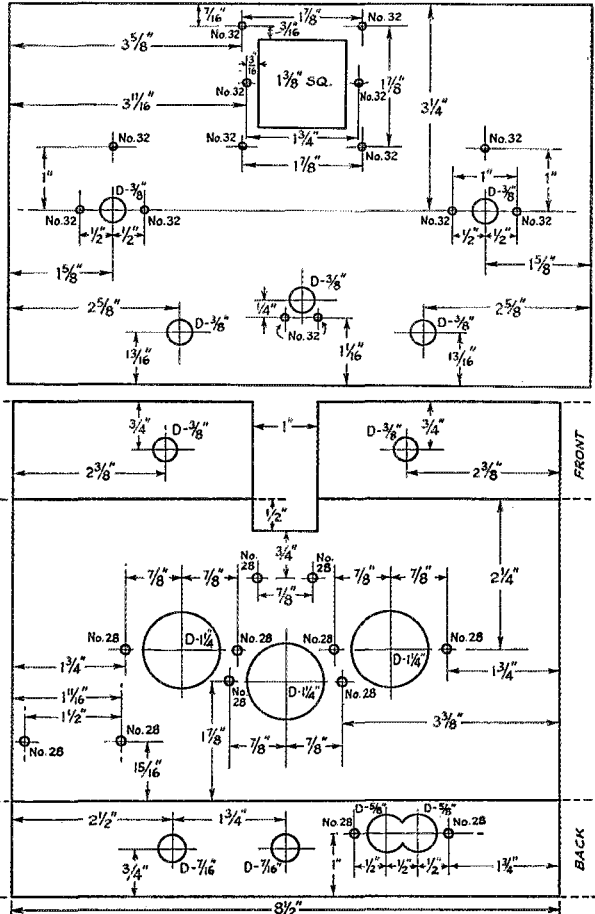

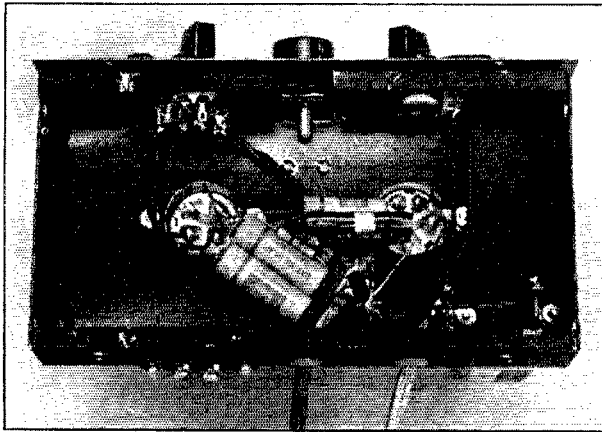

Very few components mount below the chassis and the wiring of these needs no special attention.

cerned; the form will not handle all of the turns otherwise. We recommend that the main winding for this coil be started at the top of the form and wound down toward the bottom. The tickler coil should then be started at the bottom of the form and wound up toward  $L_2$ ; if this is done the spacing will take care of itself. The spacing between windings of the other coils may be decided experimentally if the constructor is interested in pruning his particular set of coils for best results.

### Power Supplies

A standard 200–250-volt receiver power supply may be used with the converter. The heater re-

quirements are 6.3 volts at 0.3 amperes. It is also possible to tie into the b.c. or communication receiver supply if it is capable of standing the extra 10 or 12 ma. "B" drain that the 6K8 will impose upon it. A portable supply consists of a 6-volt storage battery and two or three 45-volt "B" blocks. For automobile operation it is assumed that the car battery and b.c. receiver supply will be employed.

### Adjustment and Operation

The unit may be tested after the chosen power supply has been connected. The antenna and converter output leads are connected in place first. Power is then applied and the receiver

**6K8 CONVERTER COIL CHART**

Band	Coil	Turns	Wire	Length	Antenna Coil	Tickler	Band-Spread Tap *
1.75 Mc.	$L_1$	65	28 d.s.c.	Close-wound	14 turns No. 28 d.s.c.	15 turns No. 28 d.s.c.	26
	$L_2$	45	22 enam.	Close-wound			
3.5 Mc.	$L_1$	38	22 enam.	Close-wound	7 turns No. 22 enam.	15 turns No. 28 d.s.c.	**
	$L_2$	60	28 d.s.c.	Close-wound			
7 Mc.	$L_1$	21	22 enam.	$\frac{7}{8}$ in.	5 turns No. 22 enam.	5 turns No. 22 enam.	$11\frac{1}{4}$
	$L_2$	23	22 enam.	Close-wound			
14 Mc.	$L_1$	8	22 enam.	$\frac{3}{4}$ in.	3 turns No. 22 enam.	4 turns No. 22 enam.	$2\frac{3}{4}$
	$L_2$	7	22 enam.	$\frac{3}{4}$ in.			
28 Mc.	$L_1$	3	22 enam.	$\frac{1}{2}$ in.	2 turns No. 22 enam.	2 turns No. 22 enam.	$1\frac{3}{4}$
	$L_2$	3	22 enam.	$\frac{1}{2}$ in.			

All coils wound on 1-inch forms (Millen 45004 for  $L_1$ , 45005 for  $L_2$ ).

Antenna and tickler coils are close-wound approximately  $\frac{1}{8}$  inch below  $L_1$ ,  $L_2$ .

\* Turns counted off from ground end of coil.

\*\* No band-spread tap; jumper placed between prongs of coil form.

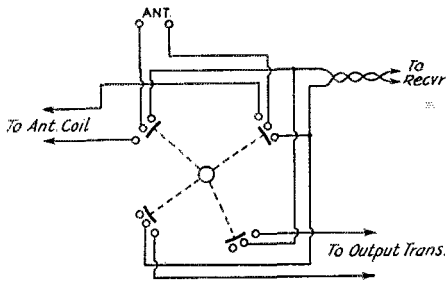

Fig. 3 — The antenna switch wiring diagram.

turned on. The band-setting condenser,  $C_2$ , is set at half scale and the receiver is tuned to a frequency between 1400-1600 kc. The noise level as heard in the receiver output may be used as a tuning indicator with which to peak up the converter output circuit. The transformer is tuned with an insulated screwdriver and proper peaking will be indicated by an increase in noise.

The oscillator band-spread condenser is used to tune in signals after a band has once been located on the band set condenser. The mixer circuit is quite broad and, as a result, it is not necessary to reset  $C_1$  each time the oscillator circuit is tuned. During the preliminary adjustments the condenser may be left at half scale unless the noise level is sufficiently low to warrant peaking to the highest point attainable. For regular work the circuit need be retuned not more than three or four times across each band. Of course, it will be advisable to tune weak signals carefully.

A signal generator or amateur signals of known frequency may be used to line up the converter. In all cases it will be found that the low end of a band is hit with  $C_2$  adjusted to approximately half scale. The band-spread

condenser,  $C_3$ , should be at nearly maximum capacity during the lining up procedure. Because only part of the band-set condenser capacity is required to tune to the amateur bands it is possible to use the converter as a general coverage affair by setting this condenser to higher or lower capacity values.

Some provision to attain the effect of a beat oscillator must be made for c.w. reception. This may be done by setting the receiver or i.f. system to the frequency of a weak broadcast station carrier. Of course, this is done before the converter is lined up.

A standard beat oscillator assembly probably will be more desirable. Beat oscillator circuits are given in the *Handbook* and in many *QST* articles on receiver construction. Coupling between the oscillator and receiver is quite simple

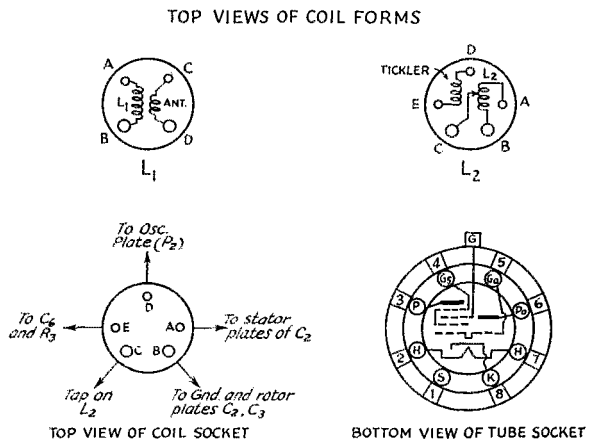

Fig. 1 — Wiring diagrams of the coils and sockets.

and only requires that the oscillator output lead be placed in the vicinity of the receiver second (Continued on page 53)

Get Your Code Proficiency Certificate!

One of these Proficiency Certificates may be awarded to you. Try for it, by copying WIAW at 10:15 P.M. EDST, September 21st, or 10:15 P.M. EST October 17th. (Official text starts at 10:30.) If you can take 15 w.p.m. by ear and prove it, this handsome lithographed certificate is yours! If you can do 20, 25, 30, or 35 w.p.m., your certificate will so state! Every F.C.C. amateur operator licensee is eligible.



# Predictions of Useful Distances for Amateur Radio Communication in October, November and December, 1940

NATIONAL BUREAU OF STANDARDS, WASHINGTON, D. C.\*

**T**HIS paper gives predictions of maximum and minimum useful distance ranges in the five amateur frequency bands regularly usable for long-distance sky-wave transmission in the three months indicated. For a discussion of sky-wave transmission see Letter Circular 575 of the

\* Report prepared by N. Smith, S. S. Kirby, and F. R. Grately.

National Bureau of Standards, "The ionosphere and radio transmission conditions," obtainable on request from the Bureau. This letter circular was published in part in March, 1940, *QST*, page 32. The use of the charts given here is explained in the article in September, 1940, *QST*, "Predictions of useful distances for amateur communication."

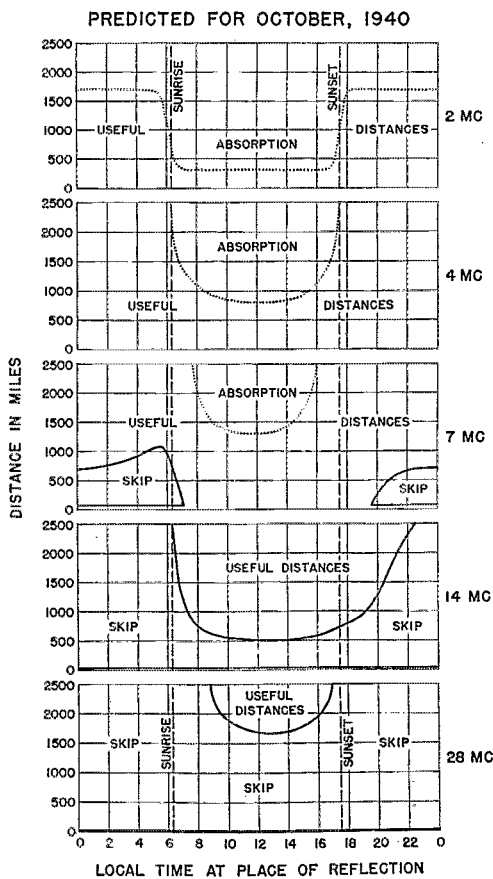

Fig. 1. Useful distances for radio wave propagation via the regular layers of the ionosphere, predicted for October, 1940. The 56-Mc. band will be useful only for local transmission (optical and quasi-optical paths).

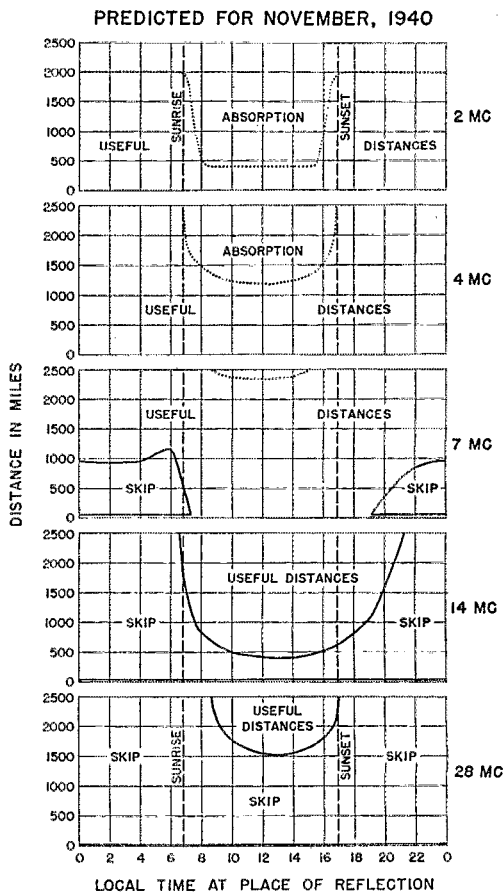

Fig. 2. Useful distances for radio wave propagation via the regular layers of the ionosphere, predicted for November, 1940. The 56-Mc. band will be useful only for local transmission (optical and quasi-optical paths).

As winter approaches the following important differences in sky-wave propagation will occur: (1) decreased day skip distances and increased night skip distances, for transmission via the regular layers; (2) decreased absorption and static, and consequently greater useful distance ranges where these are limited by absorption as on the lower frequencies, and during the day; (3) almost complete disappearance of sporadic-E transmission and therefore cessation of irregular transmissions at 56 Mc. and 28 Mc. over distance ranges of 500 to 1000 miles; (4) regular day transmission at 28 Mc.

It should be emphasized that the graphs represent average conditions for magnetically undisturbed days. There will be some day-to-day variations around the average.

It is again pointed out that skip distances are increasing from year to year with the waning sunspot cycle and that this trend will continue for several years. As an example of the effect this

PREDICTED FOR DECEMBER, 1940

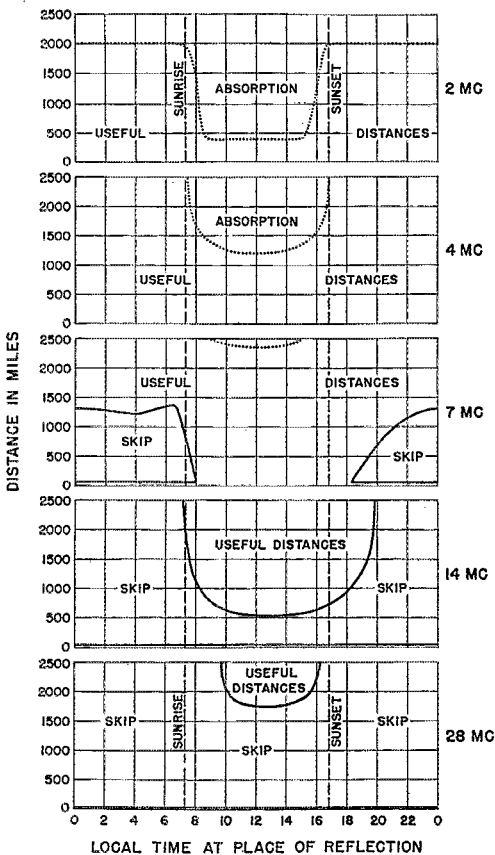

Fig. 3. Useful distances for radio wave propagation via the regular layers of the ionosphere, predicted for December, 1940. The 56-Mc. band will be useful only for local transmission (optical and quasi-optical paths).

will be the last winter, for five or six years, for regular long-distance transmission on 28 Mc.

## The Northwestern Division Convention

ALL agreed that the Walla Walla Amateur Radio Club arranged a fine program for the fifteenth annual A.R.R.L. convention held August 24th and 25th. Close to 100 amateurs were in attendance.

Following Saturday morning registration, Director Ralph Gibbons, W7KV, opened the business meeting by outlining the problems before the assembly. After luncheon Frank A. Dunningan started the technical meetings with an interesting résumé on frequency modulation. Don Wallace of W6AM discussed top loading of antennas as developed in the national park service. League past president Dr. E. C. Woodruff, W8CMP, provided the feature of the afternoon with an interesting equipment demonstration from the ever-ready bag of tricks. The development of practical, economical and fool-proof grid bias supply circuits was diagrammed and illustrated.

The banquet was a gala affair, with plenty of prizes. A resolution was adopted on report of Mr. Dunkle of a resolutions committee, pledging the support and availability of amateur radio facilities in the division to the government for the emergency period. Communications Manager F. E. Handy outlined the A.R.R.L. program of proficiency, progress and the League steps taken for security of amateur radio. The conventioners were then entertained by a varied program of movies and dancing. Group breakfast meetings were the first order of the second convention day, and last on the schedule was a picnic in Pioneer Park, highlighted by u.h.f. operating, gabfesting, sports and a not-to-be-forgotten lunch.

Olympia invites the next A.R.R.L. convention, and a director's committee appointed on the first day of the sessions has the invitation and plans in process for further announcement.

— F. E. H.

## A One-Tube Converter

(Continued from page 51)

detector grid. The correct degree of coupling can best be found experimentally. The beat oscillator frequency may be either of the converter output frequency (1600 kc.) or, if the b.c. receiver is a superhet, the same as its intermediate frequency. If more or less band-spread than the specified coils give is desired, it is only necessary that the band spread tap be moved toward the grid end of the coil for less spread, or toward the ground end for more.

# Magnetic Bandswitching

*A Five-Band Exciter with Push-Button Control*

BY LEW BELLEM, WIBES\*

Carrying the pre-tuned type of exciter to the ultimate of convenience, the magnetically-switched unit described here is ideal for remote-control band-switching. Push the button and you're on a different band, all tuned up and ready to go!

**T**HE advent of crystal control back in the early 20's spelled the doom of the simple single stage transmitter and brought into existence cascade buffers. Since that time the ingenuity of hams has been constantly devoted to the problem of simplifying the job of changing such a multi-stage transmitter from band to band. The kaleidoscope of exciters which has appeared during this period is as a whole a real tribute to their efforts. Just as certainly, however, many have fallen short of their goal in some major respect.

A frank review of the outstanding require-

\*143 Eastwood Ave., Providence, R. I.

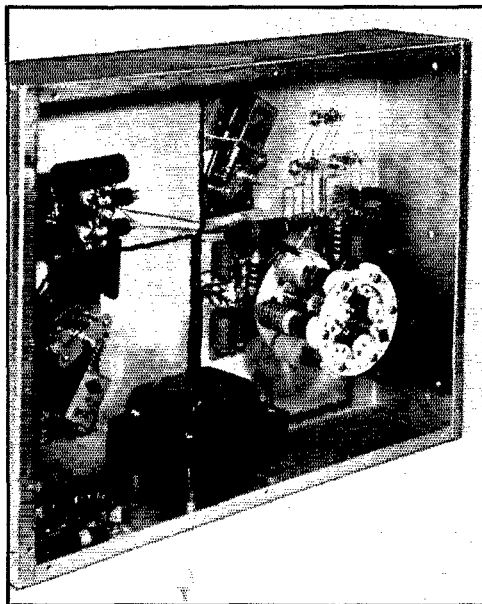

Simplicity is apparent in the chassis appearance of the magnetic band-switching exciter. There are no panel controls because every thing is arranged for remote operation.

ments for the ideal band-switching system brings out the following general facts:

1st — It must be compact and conventional from an electrical standpoint for efficiency, appearance and ease of assembly.

2nd — It must be adaptable to present exciters with a minimum of trouble and alteration.

3rd — It must permit choice of any band, remotely, without necessity for retuning.

4th — It must be simple and foolproof mechanically.

5th — It must represent no substantial outlay in excess of a conventional plug-in coil system.

This is not so pretentious a list of "musts," but nevertheless has defied complete solution. It is believed that the exciter to be described really represents the complete answer to this problem. There is no doubt that the widespread use of such a system would go a long way toward uniting the interests of one band with those of another.

The unit is actually a complete 5-band c.w. transmitter capable of 130 watts output. As an exciter, it is of course suitable for driving any final stage to a kilowatt-plus input. The oscillator is the usual 6V6G and uses five "fundamental" Biley crystals from 160 down to 10 meters. The two succeeding stages use G.E. beam pentodes GL-807 and GL-814 as buffer and amplifier respectively. Due to the excellent internal shielding of these tubes, all stages work straight through without the necessity for neutralizing. While it would be perfectly possible to eliminate the 807 stage by working the oscillator harder, it was preferred to keep the crystal stage in the rôle it was meant to play — a frequency source and not a power plant.

So far we have a conventional three-stage r.f. unit which just about satisfies conditions 1 and 2. Conditions 3 and 4 are fully met by using three magnetically-operated "Inductocap Turrets" recently introduced by Coto-Coil. The cost of such an arrangement is practically equal to that of a similar exciter with a full complement of plug-in inductors. These turrets carry complete and separate LC circuits for all five bands. The inductors are wound on polystyrene forms with midget variable air condensers for padding each band. The oscillator and buffer turrets are the 50-watt style with single- and double-spaced condensers; both types are equipped with an extra condenser for coupling to the grid of the next tube. The GL-814 stage uses the 200-watt



turret, which has larger inductors equipped with links. The sectional switches of all three turrets are indexed from band to band by a push-button which pulses the small solenoid motor attached to each. The button may of course be located at any distance from the transmitter, giving positive remote control over band selection.

### General Construction

The entire exciter is assembled on a 13 by 17 by 4-inch chassis. A smaller chassis could have been used if it had been available in the desired depth. The four-inch skirt allows the oscillator turret to be mounted "head-first" through the deck with  $\frac{1}{4}$  inch to spare and provides excellent shielding as well. No dimensions for the layout are given for there is no necessity for exact duplication. It is only recommended that the five crystal sockets be mounted as closely as possible to the grid of the 6V6G socket. The oscillator turret includes a switch section directly behind the coil support for cutting in the proper crystal for the band in use. Hence, the turret too should be placed near the tube socket to keep the crystal leads as short as possible. The crystal sockets are the new Amphenol polystyrene type and make a much neater job than the 5-prong socket mount. The black "pill-box" to the right of the oscillator turret is a keying relay in the cathode of the oscillator and has been rebuilt from an old Yaxley A-B eliminator relay. The small toggle switch showing alongside the oscillator tube shorts out the keying contacts and obviates the need for keeping the relay energized during 'phone operation.

The buffer stage is equally simple to assemble. The turret is inverted, however, with the motor drive below deck. With a little alteration a Crisco tin (three-pound size) makes a dandy shield for the whole coil-condenser assembly. A disc is cut out of the bottom, sufficiently large to allow the can to be dropped down over the turret. Three holes in the remaining flange permit fastening the can to the chassis. The cover is removable to give access to the padding condensers. The 500 volts and excitation lead to the GL-814 grid are brought through the deck with ceramic buttons while the plate lead emerges from the side of the shield through a rubber grommet directly on a line with the 807 plate cap. The shield around the bottom of the GL-807 is from an old 2-inch i.f. transformer can with the head cut off to the proper height to meet the internal tube shield.

The GL-814 stage is essentially a duplicate of the buffer except that the coil shield is dispensed with and the tube socket is dropped down on  $1\frac{1}{2}$  inch studs to reduce the height of the tube above the chassis deck. Amphenol ceramic sockets are used throughout. The oscillator and buffer sockets are mounted in  $1\frac{1}{8}$ -inch punched holes by means of the springs supplied. The oval

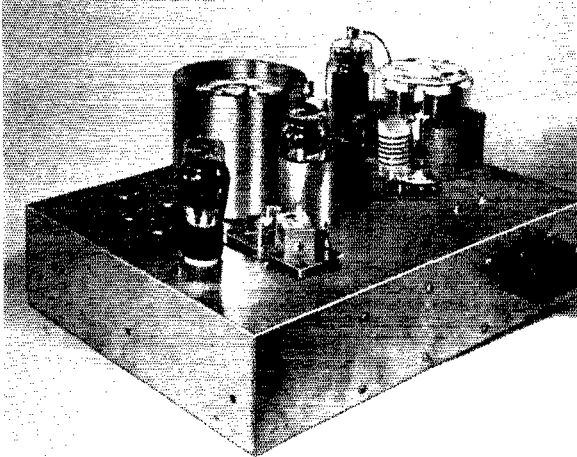

The magnetically-switched turret for the oscillator is mounted on the under side of the chassis. The magnetic steppers for the buffer and amplifier turrets also are visible in this view.

metal mounting plate is left on the amplifier socket for fastening to the studs and the chassis is punched for  $1\frac{3}{8}$  inch to allow the base of the GL-814 to pass through.

A few constructional kinks are worthy of special note. The Inductoap Turrets chosen for this job have 110-volt motor coils all connected in parallel and energized simultaneously by a single push-button. The clap resulting from the three solenoids operating together when bolted down to a steel chassis might scare the uninitiated so it was decided to try to ease the effect of the impact. Stealing an idea from the auto industry brought to mind the "floating power" principle so twelve rubber grommets to fit  $\frac{1}{4}$ " holes were procured (these just pass a 6-32 screw nicely). The four corner holes in the turret motor plates were enlarged to this size and remounted with the grommets isolating the entire assemblies from both the chassis and mounting screws, resulting in a remarkable reduction in noise. A word of warning — bond the motor plates to the chassis with short lengths of flexible wire, since the rubber leaves the entire metal structure of the turrets floating electrically.

It is readily apparent that a unit as flexible as this must provide some means for identification of the band in use. This is easily done with pilot lamps on the panel controlled by one of the spare switch sections on the turrets. Fig. 1 shows clearly how this may be accomplished. No panel is shown in the photograph for it is completely devoid of ornaments anyway. In this particular case the pilot lamps are located in a desk control console at the receiving position. Meters likewise are remote from the exciter in a separate illuminated meter panel. Every external circuit except the r.f. output enters the chassis through a Jones 30-contact plug and receptacle.

The actual r.f. circuit is quite conventional and needs little explanation. It is well recognized that certain crystal "cuts" are sometimes

stubborn in oscillators that function perfectly with others. Since this exciter uses three different cuts (LD for 160 and 80, BC for 40, HF for 20 and 10) a compromise circuit was necessary. No trouble will be experienced if the constants given are observed. Note that both cathode and grid resistor bias are used. The buffer and amplifier are supplied with fixed bias from an external pack, and fixed screen voltages are taken from a tapped resistor. Both these features are essential if the oscillator is to be keyed as shown.

### Adjustment

The first step in aligning the various stages is to index each turret by hand to the 160-meter band. Once all stages are in step they may be indexed electrically thereafter by means of the control button. Plug all of the crystals into their proper sockets, turn on the oscillator plate voltage and adjust the 160-meter padding condenser for resonance. The coupling condenser on the oscillator turret should be be set for about 5 per cent capacity in the initial tune-up. It may be increased later if more excitation is required. The four higher-frequency bands are next resonated before high voltage is applied to the 807. With this operation completed, the buffer turret is similarly tuned from 160 to 10. Here again adjust the excitation condenser to the grid

of the 814 for optimum coupling. It is easily possible to run the grid current up to 25-30 ma., so care must be used to see that the manufacturer's specifications are not disregarded in this respect. When properly lined up, on all five bands the 814 will be driven to essentially equal grid currents — between 9 and 12 ma. A final check of all adjustments should now be made to peak all circuits on the nose. Be certain that the oscillator tanks are not tuned to the steep side of resonance. A rapid indexing through the five bands several times will show if the crystals are cutting in promptly. The last step simply requires that each final tank be tuned to resonance and a load applied. The resonance curve of the LC circuits in the turrets is broad enough to allow frequency changes without retuning, over wide limits and without appreciable loss of excitation. For instance, a QSY from 14,150 to 14,250 can be made with no apparent change in meter readings.

### Applications

As stated before, this r.f. unit may be used as a c.w. transmitter on all bands without additional equipment. The 200-watt turret carries three extra switch sections, two of which are ceramic and may be used for antenna switching.

(Continued on page 72)

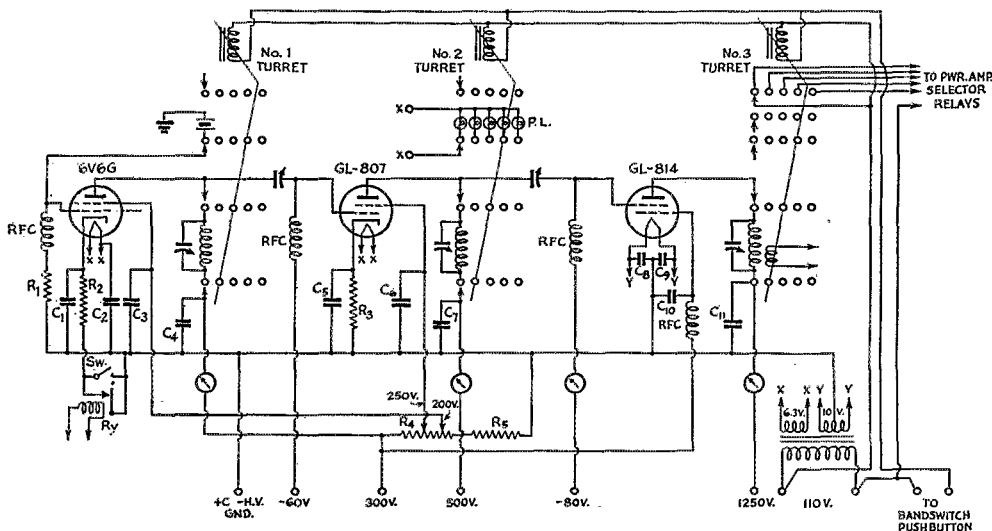
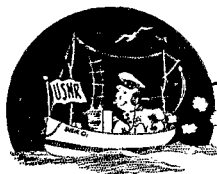

Fig. 1 — Circuit of the exciter with magnetic bandswitching. For simplicity, only one band is shown; circuits for the other four bands connect to the appropriate switch points.

- R<sub>1</sub> — 30,000 ohms, 1-watt.
- R<sub>2</sub>, R<sub>3</sub> — 300 ohms, 1-watt.
- R<sub>4</sub> — 5000 ohms, 50-watt, adjustable.
- R<sub>5</sub> — 10,000 ohms, 10-watt.
- C<sub>1</sub>, C<sub>4</sub>, C<sub>7</sub> — 0.01- $\mu$ fd. mica, 1000-volt.
- C<sub>2</sub>, C<sub>3</sub>, C<sub>6</sub>, C<sub>10</sub> — 0.1- $\mu$ fd. paper, 600 volt.
- C<sub>5</sub> — 0.05- $\mu$ fd. paper, 600-volt.
- C<sub>8</sub>, C<sub>9</sub> — 0.006- $\mu$ fd. mica.
- C<sub>11</sub> — 0.002- $\mu$ fd. mica, 5000-volt.

- R<sub>y</sub> — Keying relay.
- Sw — S.p.s.t. toggle switch.
- P.L. — 6.3-volt pilot lamp.
- Turrets — No. 1: Oscillator bandswitching assembly (Coto Inductocap type 810-45CS).
- No. 2: Buffer bandswitching assembly (Coto Inductocap type 810-45CD).
- No. 3: Amplifier bandswitching assembly (Coto Inductocap type 810-145CD).



## NAVAL COMMUNICATION RESERVE NOTES

### Voice and Ears of the Fleet

BY LIEUTENANT C. F. CLARK,  
C-V (S), U.S.N.R. (W4EZ)

**COMMUNICATIONS:** The voice and ears of the Navy. In case of mobilization, the Fleet would be augmented tremendously but who would think of sending thousands of additional men to sea without their tongues and ears? But where to get them? Can we reach in the hat and pull out six thousand of them at one stroke? At the beginning of the last war, no, but hereafter, the answer should be yes. Old Doc NCR, the Naval Communication Reserve, should have them right on tap — radiomen, signalmen, and communication officers, who do their jobs well, and know a thing or two about their general military duties, as well.

How safe would we be, entrusted to these men in time of emergency? we are asked. The answer is found in the frequent assertion emanating from the Office of the Chief of Naval Operations, that the tactical training circuits of the Naval Communication Reserve are highly efficient.

But how do we get that way — by just sending messages back and forth to each other for practice? Again, no. The tactical network of the eastern half of the United States is controlled by NAA, Navy Radio, Washington; and the Western Network, comprising the western half of the country, is controlled by NPG, Navy Radio, San Francisco. Each Naval District has a master and an alternate control station, equipped completely with navy equipment. NIB, Miami, is the master control station for the Seventh Naval District, and NDU, Jacksonville, is the alternate control station. But let us see what happens:

It is Thursday, 7:44 P.M. E.S.T. or 0044 G.C.T., Friday; to the radioman, the zero hour. Twenty-two stations, silent and tense, awaiting the signal that starts the battle. 0045: Flagship NAA calls the roll of all ships present, making two-way contact with twenty-two ships (stations) in only six minutes. Now the high command takes over. Ships are divided into tactical units. Each station represents a ship, the first-named station in each tactical unit acting as commander of that unit. Signal: Enemy sighted! He is pursued! Is he overtaken — captured — destroyed? Not unless we have correctly received and interpreted the lightning-fast commands, flashed in rapid succession to all tactical units by radio; and not unless we have correctly solved the maneuvering

board problems, and swung our ships correctly in obedience to tactical commands. Around this the battle centers.

These tactical exercises take various forms, for there is no cut-and-dried method of winning a battle. Sometimes we literally search for an "enemy" radio station, by means of direction finders and signal volume; and we have tracked down the culprits to their very address, and placed them under arrest, without having known, at the beginning, what part of the United States they were in! Excitement runs high. Not the excitement of disorder and confusion, but the excitement of eagerness and tenseness.

But with the battle won, who profits thereby — just the personnel of the twenty-two control stations? No. The two control stations of each district in turn conduct similar battle problems within their respective districts, until every station within the district has participated. While the radiomen are thus engaged, the strikers are doing the very same thing over classroom circuits, in which actual operating conditions are simulated.

Then there are the signalmen, too. While their activities may not seem so dramatic, their relative importance is greatly augmented in times of emergency, when radio silence is imposed.

And to round out a good military man, they have their general quarters, abandon-ship and fire drills, and manual of arms; and they even learn to use the rifle for the purpose for which it is primarily intended. Bi-monthly range parties are just as much a part of our curriculum as signaling; it all goes toward rounding out a good man-o'-warsman.

### Washington Vocational School Offers Free Radio Courses

**OF INTEREST** to residents of Washington, D. C., and vicinity are the free radio courses offered at the John A. Chamberlain Vocational School, 14th and Potomac Ave., S. E. One course covers Radio Servicing while another covers Radio Operating.

Applicants must be not less than 16 years of age and must intend to enter the field of radio as a means of livelihood. The first semester of the school year starts September 20, while the second semester starts in February, 1941. Acceptable applicants will be received at any time during the school year.

Those interested should communicate with the Principal, Mr. Edward D. Reed.



# ON THE ULTRA HIGHS



CONDUCTED BY E. P. TILTON,\* W1HDQ

How is activity holding up in Five in your neighborhood, now that the summer DX season is past? Though daily work on 56 Mc. continues the year 'round in the populous centers of the East, the boys in other sections of the country have usually deserted Five in early September if not before, finding the DX on Ten and Twenty, or the abundance of activity on the lower frequencies, too much of a temptation.

We hope that it may be different this year. Ten has been losing some of its attractiveness, with the passing of the sunspot-cycle peak some seasons back; and now, with DX practically non-existent on any band, the time is ripe for concentrated effort throughout the fall and winter season on the ultra-highs. In years past, operation in many areas has been confined almost entirely to the working of skip DX, with little thought given to the extension of the daily working range. The considerable growth of interest in working over distances up to 250 miles and more, particularly in the Middle West, is a healthy sign.

If you are having trouble in getting contacts on Five, get the other fellows within a radius of 100 miles or so who are interested in u.h.f. work together and work out some sort of definite program of operation. There may not be enough activity to keep things going every night, so why not set aside a night or two each week when all will agree to get on Five and stay there throughout the evening? "The Horsetraders" with their Tuesday-night sessions have kept Five alive in Western New England through thick and thin. The "Minute-Men" have done a splendid job in the Boston area, continuing their Sunday-morning meetings for several years; while in Illinois, "net" operation pioneered by W9ARN, W9ZHB, and others, has made Five a year-round band.

The most recent group to attain prominence is the Ozark Net, an ambitious group which is rapidly putting St. Louis and vicinity on the five-meter map. There are no "weak sisters" in this Ozark group. Each member has a husky rig, a multi-element rotary beam, and a first-class receiver. To be eligible for membership, an applicant must be in a position to work all members of the net consistently — no mean task when it is considered that W9EET is located in Sullivan, Mo., some 60 miles from St. Louis.

The net goes into action nightly at 7:30, C.S.T., and several members are active each evening. Main objective, during evenings when Five is open, is the working of W7, an aim which is yet to be realized. Some splendid work is being done

\*329 Central St., Springfield, Mass.

with the boys in Illinois, Iowa, and Indiana, distances up to 250 miles being covered quite regularly. At present the net includes W9's EET, Sullivan; NYV, Beek; GHW, Kirkwood; OWD, Overland; WAL, St. Louis; NKW, Wellston; and VAV, St. Louis; all of Missouri.

Several of the boys are using close-spaced 4-element beams employing a somewhat novel method of feed. A piece of half-inch pipe 100 inches long is used for the radiator, with two pieces of No. 12 wire coming back from the ends of the pipe, and three inches below it, in the manner of the Kraus folded doublet. Directors are spaced 0.15 wavelength and are split in the center in order to permit tuning with a series condenser. The reflector is one piece and is spaced one-tenth wavelength. The array is fed with a two-inch spaced line. The boys claim that the folded doublet acts just like a simple dipole having no parasitic elements, and that the whole array is very simple to adjust. They would be pleased to hear from anyone who tries out this type of array.

The big opening of July 23rd was apparently the beginning of the end of the summer DX season. Many openings occurred after this, of course, but for the most part conditions were spotty and signals unreliable after the first week in August. The band sprung a surprise on July 30th by opening up at about 10:15, remaining so for excellent contacts until after midnight. Skip in the East is usually all over for the evening by the time that this session was just getting under way. After a fine evening for extended-local work on Aug. 3rd, most of the boys had given up and gone to bed when, shortly after midnight, the boys from Missouri began popping into W1, 2, and 3. This early-morning session was featured by a four-way QSO involving W1KLJ, Bristol, Conn.; W3BYF, Allentown, Pa.; and W9ZJB and W9AHZ of Kansas City, Mo. In Hartford, W1LLL was on the band until 3 A.M., at which time W9ZJB could still be heard, calling "CQ-DX" on c.w.

Featured during August was an almost continuous period of more than two weeks of nightly temperature inversions up and down the Atlantic Seaboard. During the evening of Aug. 3rd, W3GGR/3, Pleasant Hill, Md., contacted W2's TP and AMJ, 150 miles; W1's CLH, 180 miles; KLJ, 240 miles; HDQ, 260 miles; BJE and GJZ, 300 miles; and DEI, 315 miles; all with 30 watts input to an 807! During this same evening, W2MEU and W2COT were busy preparing for a combination radio and fishing trip and were operating portable-marine while lying at anchor at Staten Island, N. Y. Using an RK-34 oscillator-

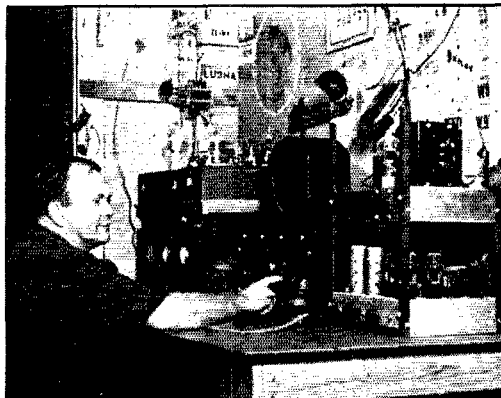

Top, left: W9EET; right, W9OWD.

Center, left: W9NYV



**THE  
OZARK  
NET MAKES  
5-METER  
HISTORY**



Center, right: W9GHW. Bottom, left: W9NKW; right, W9WAL.



W9EET, Edwin A. "Lightnin'" Banta, Sullivan, Mo. 100TH, 200 watts; Ultra-Skyrider with 1851 r.f. stage; 4-element rotary. W9OWD, Owen H. "Griff" Griffiths, St. Louis, Mo. 35T, 150 watts; HRO with DM-36; 3-element rotary. W9NYV, Rex D. Louden, Beck, Mo. TZ-40's, 200 watts; SX-25 with DM-36; 3-element rotary and Vec. W9GHW, Ben C. Comfort, Kirkwood, Mo. 75T's, 250 watts and up; SX-27; 3-element rotary and ground-plane vertical. W9NKW, Forrest G. "Stub" Stubblefield, Wellston, Mo. TZ-40's, 200 watts; 101-X with Meissner converter; 4-element rotary. W9WAL, G. S. "Jerry" Scott, St. Louis, Mo. T-40's, 250 watts; SX-17 with DM-36; 4-element rotary and 2 half-waves in phase, vertical. Latest to qualify, no picture available: W9FVAV, Roy A. Hutson, St. Louis, Mo. T-55, 150 watts; Bretting with converter, 3-element rotary.

doubler, running 4 watts input, W2MEU/marine put a solid signal up to Wilbraham, some 130 miles distant. Starting out before dawn the next morning, the boys worked W2ILK at 5:30 A.M.! From a point some 30 miles off Manasquan, N. J., W1HDF, Elmwood, Conn., 150 miles distant, was contacted at 8:00 A.M. Not bad for 4 watts input and an antenna (concentric) 11 feet above the water line!

During August, signals seemed to hit tremendous peaks for a short time around sunset. On the evening of the 16th, this phenomena was most pronounced. At W1HDC, our reliable indicator of band conditions, the third harmonic of WDS, Rocky Point, L. I., (56.7 Mc.) was S-9 at 7 P.M. With no bending this signal is practically inaudible. During the course of this evening, what we believe to be an all-time record for u.h.f. "miles-per-watt" was set by our fire-warden friend, W1MEP. Chet connected with W1KTF, Darien, Conn., 145 miles. Dave then stood by to attempt to line up W2's or 3's. W3BZJ was on the job, and a 235-mile contact was completed when W1MEP went on c.w. — Glastonbury Mt., Vermont, to Glenside, Pa., with 2½ watts input! W1HXP, 110 miles, and W1GJZ, 135 miles, and several others close to the 100-mile mark rounded out the most exciting evening in Chet's experience on Five.

#### HERE AND THERE:

THOUGH Mt. Washington, N. H., was once the scene of operation of a 56-Mc. station, W1BPI-W1XR, in recent years little has been done on Five from this, the highest spot in Northeastern United States. To explore its possibilities under modern conditions, W8CIR traveled all the way from Aliquippa, Pa., arriving at the summit of this 6288-foot in the midst of a snowstorm — on August 24th! Though conditions on Five were very poor during his entire two-day stay on the summit, Ed managed to contact 15 W1's, the most distant being W1KLJ, Bristol, Conn., 205 miles. This takes on the aspect of a real accomplishment when one looks over the nature of the country in between these two points. The shortest distance covered in any of the contacts was about 90 miles.

During the following week, Ed operated from a 600-foot elevation near York, Maine, providing the difficult Maine contact for 20 stations in all parts of W1. Here again, W1KLJ was the DX, 160 miles, though Bob didn't need this one for Maine, having knocked off this coveted state during the May Relay, in contacting W1IUI/1 at Sanford, Me. Rounding out a week of this sort of thing, W8CIR/1 finished up on Friday, Aug. 30th, at Hogback Mountain, 2250-foot elevation, near Marlboro, Vt. From this point, W1COO, Brentwood, N. H., W1EKT and W1MJ in Wakefield, Mass., and all the gang in Western New England were worked in rapid succession. Thus, by courtesy of a ham from Western Pennsylvania, that famous pair, "Maine and Vermont," were written into the 56-Mc. logs of many New England stations for the first time. We should be hearing from Maine again, too, for we have word that W1MFK is now operating regularly in Portland.

W3BZJ reports that W3HWN, now at Mechanicsburg, Pa., is putting a consistent signal into the Philadelphia area, and W8CIR at the other end of the state works him quite regularly, so that Pennsylvania gap should now be taken care of in future relays.

From Macon, Georgia, W4AUU reports that he and W4EQM, Langdale, Alabama, are working each other on schedule. This is the first "local" contact for both, and it all started when Jim put up a 3-element close-spaced horizontal

beam. Jim is bearing down on the boys in the Atlanta area, in the hope that they will provide further contacts to keep things hot through the winter months.

We may have a fire-warden station on Five in Arizona soon, too. W6OMH, stationed at Hyde Mountain Lookout, 7000-foot elevation, sent word to W6OVK and W6QLZ that he is hearing them. The distances to Phoenix and Tucson are about 100 and 200 miles, respectively. W6OVK reports that Five is turning out to be a swell band for renewing old acquaintances. Jim was surprised to find that W5EHM is an old friend, dating back to the early 20's when they were 50K and 5VU, in Mineral Wells, Texas. Another oldtimer with whom Jim was able to swap happy memories was W5VV who, as 5TC of spark days, was contacted back in '19 to '22. The five-meter gang in Tucson now includes W6's SGG, PGO, OWX, OJK, SNU, SNT, MWJ, and SLO, with more coming.

Last month we listed Idaho as one of the few remaining states from which no 56-Mc. contacts had been made this year. W7ACD at Shelley says he is going to change all that. He has worked W9's ZJB, ZQC, and USH, and W5's AFX and FYF cross-band, 28-56 Mc., and will be transmitting on Five soon. Louie uses an RME DM-36-69 combination for receiving and has a 100TH final and several V beams. Shelley is within normal skip range of most of the Middle West and parts of W5 and W6, so that W7, for which so many have looked in vain, should be forthcoming soon.

From Detroit, W8QDU reports things picking up, with a concentration of activity in Toledo, Ohio, and in Saginaw, Grand Rapids, and Kalamazoo, Mich. Fred has been hearing W9CLH, Roselle, Ill., some 250 miles distant; and W8CIR, 200 miles away in the opposite direction, is a consistent contact.

How are you on pulling through those weak ones the other boys talk about? W9ANH says that the substitution of a spaced line from his antenna relay to his receiver in place of the twisted pair formerly used made the difference between hearing and not hearing many of the weaker sigs. And while we're on the subject, how many of you tune the feeders for receiving? We spend hours trying to coax another watt or two out of our finals — and then just hang a couple of nondescript wires on the antenna terminals of the receiver. Try a parallel-tuned circuit, link-coupled to the receiver input, or even just a variable condenser across the antenna coupling coil. You might be surprised to hear a lot of stuff that you've been missing.

W9ANH reports that ZHB, Zearing, Ill., is now heard consistently. Ed has sold all the gang on the horizontal beam idea, and they are doing right well as a result. Since ZHL got up his 3-element "Q" beam he has been working HAQ in Davenport, Iowa, close to 200 miles, and the Illinois gang frequently. ZHL and ZHB check conditions over the 160-mile path between Zearing and Terre Haute, with daily skeds.

Our Editor asks why no one is on with f.m. The answer is that f.m. on Five is taking hold; slowly, to be sure, but inevitably, as more receivers capable of doing it justice are getting into circulation. W9WOQ, Peoria, Ill., is on with a pair of 250TH's with a full kilowatt, f.m. or a.m. At the recent Central Illinois Hamfest held near Peoria, WOQ and RGH put on a very effective demonstration of the advantages of f.m. Quite a number of converts were made, and more f.m. will be forthcoming in that area shortly.

A three-state roundtable QSO on Five in the Middle West is something worthy of note. W9ZHB reports such an event involving NFM, Solon, Iowa; EET, Sullivan, Mo.; and ZHB, Zearing, Ill.; on the three points of a triangle whose shortest side is approximately 240 miles! Contacts like this, and many others over similar distances by BDL, Marshall; ARN, Bartonville; RGH, DQH, Peoria; DQU, Tuscola (all Illinois); HAQ, Davenport, Iowa; and ZHL, ANH, and UNS, Terre Haute, Ind.; all of whom use horizontal antennas, give the advocates of vertical polarization some food for thought. The extended-local record is 400 miles, and this was made with vertical antennas at each end. Having had excellent results with both types, we're still "on the fence."

Milwaukee-to-Chicago, long considered impossible on Five, is now being covered regularly. W9IZQ, Wauwatosa, Wis., reports frequent contacts with CLH, VHG, ZUL, MXK, and others in the area around the Windy City.

## U. I. F. MARATHON

JULY WINNER: W6QLZ, PHOENIX, ARIZ.; 730 POINTS!

Call	Contacts Through			Cumulative Score	States in 1940
	56	118	224		
W1AIY	19		3	63	2
W1BCT		8		16	2
W1CGY	15			33	3
W1CLR	72			264	13
W1CUG	6			53	4
W1EET	52			74	3
W1EKT	85			227	9
W1ELP <sup>1</sup>	66	51		257	9
W1GJZ	118			485	12
W1HDF					
W1HDQ <sup>2</sup>	172	38		1177	22
W1HXP					16
W1JJR	39	4	3	501	14
W1JLK	27			176	6
W1JPF	25			52	2
W1KJL	214	7	5	1176	23
W1KVK		63		146	1
W1LLL	120			729	20
W1LFF	54			112	6
W1LZV		54		176	2
W1MBS		96		198	3
W2ADW	13	15		108	3
W2AMJ	173			806	24
W2BYM	37	3		213	15
W2COT	103	9		222	7
W2DZA		62		148	4
W2GIV	114			576	21
W2LAL	73			177	7
W2LXO		119		276	4
W3AC	53			142	5
W3BYF	58			314	18
W3BZJ	198	40		1210	34
W3DI	22			464	15
W3EIS	92	2		75	5
W3FJ	15			103	7
W3FSM	37	29		89	2
W3FX	197	28		107	3
W3HOH	69	1		587	15
W3RL				562	21
W4ELZ	31			280	12
W4FBB	82			738	18
W5AJG	162			1683	25
W5FY <sup>2</sup>	11			101	5
W5VY	59			662	18
W6IOJ	17	36		276	3
W6OVK				174	7
W6PCO	7			51	6
W6QG	20			57	4
W6QLZ	58	2		1051	17
W6QNU		56		153	1
W6RVL	1	180		493	1
W8MHM	30	10	1	96	7
W8NKJ	51	21		382	10
W8QDU	92	34		742	20
W8QSS	59			518	15
W8RKE	72			591	19
W8RUE	65	15		306	15
W8SNN		31		42	1
W8TU	25			181	8
W9ARN	76			680	20
W9DQH	41			292	17
W9VWU	43			405	14
W9ZVB	134			1321	26

<sup>1</sup> Frequency modulation used exclusively at W1ELP.  
<sup>2</sup> Not eligible for award.

In order to conserve space, stations not reporting for two consecutive months have been deleted. These will be re-listed upon receipt of further reports.

### 112 MC.:

FIVE has nothing on 112 Mc. when it comes to multi-state "roundtables." Four states were represented recently when W1LAS, East Portchester, Conn.; W2MCG, New York City; W2DZA, Teaneck, N. J.; and W3BZJ, Glenside, Pa., got together on 2½. W2MCG reports that he has worked 285 different stations on 112 Mc. since the first of the year. His best DX is W3CWU, Chester, Pa., about 105 miles.

W3BZJ lists the following DX contacts on 112 Mc.: W1MRF, Bridgeport, Conn., 140 miles; W1LAS, 110 miles; and W2's MCG, AES, DZA, HYJ, JYC, KTW, KYT, LBK, MJL and MO, 70-100 miles. Bob voices the old ap-

peal: "Sign your calls slowly and carefully. I hear lots of sigs that cannot be identified." During a Sunday-morning contact with your conductor on August 4th, we were able to get through to W3BZJ, some 200 miles, on 112 Mc. When Bob came down from Five, we were unable to pull him through, so the Massachusetts-Pennsylvania hop awaits better receiving facilities at W1HDQ, it appears.

W6RVL relates that 112-Mc. rigs, both mobile and fixed, were used very successfully in emergency rôles in connection with the severe forest fires in California in late July. W6's VJ, IOJ, CPY, LSC, MAK, RUS, EJJ, OEG, QLL, and CUR were all in active service during the 48-hour emergency period. Some nice long-haul work was turned in by RVL on July 22nd (report received too late for last issue) while operating from Mt. Frazier, 8026-foot elevation. W6LFN/6 mobile, in motion, in Sequoia National Park, 130 miles, and W6OIN at San Diego, 170 miles, represent nice going with a pair of HY-615's!

From Chicago, W9NIL writes that he and W9AVE are interested in the possibility of working across Lake Michigan on 112 Mc. With the favorable over-water path in mind, it seems that contacts with Michigan City, Kalamazoo, or even Grand Rapids, should be within the realm of possibility. If any of the boys on 2½ on the eastern side of the lake are interested, W9NIL would be pleased to keep schedules.

From San Diego, K6QPG/6 writes that he will be in the New York area during October and November, and is looking forward to working the host of W2's he's been hearing about.

This department has been taken to task for slighting the 112-Mc. Band in favor of Five. To which we reply that we cannot report what is not reported to us. We know that much interesting work is going on in many places, but unless you tell us about it we cannot present the story in QST. What is going on in your neighborhood?

### 224 MC.:

OUR 90-mile record for 224-Mc. work (which we thought so secure) was broken even before the story of it appeared in print! The W6's accepted our challenge in advance and proceeded to put 224-Mc. signals across that San Diego-Los Angeles path which figured in new records on 112 Mc. earlier this season.

Several W6's are now active on 1¼, including MYJ, North Hollywood, using a 316-A "doorknob" and a 955 super-regen; W6QG, Santa Ana, 35T's and 7A4; and LFN and IOJ, both operating mobile with HY-615 transceivers. The first contacts made were of the cross-town variety, but results were so favorable that greater distances were attempted, culminating in the San Diego-to-Los Angeles attempt. With LFN at San Diego and IOJ in the Hollywood Hills, contact was made with S-9 signals each way. At this point they could even hear the radiation from each other's receivers! Determined to lengthen this path, LFN moved south and IOJ traveled north, contact being made with IOJ at the Ventura-Los Angeles county line near Chatsworth, a distance of 135 miles!

While the rugged hills of Connecticut present no possibilities for DX on 224 Mc., W1HDF and W1AIY are having a lot of fun trying to break down the path between Elmwood and Wolcot, some 18 miles. AIY has heard HDF with his receiver in his car at a point less than a mile from the home location, but through many different types of beams have  
(Continued on page 67)

## U. I. F. DX RECORDS

### Two-Way Work

56 Mc.: W1EYM — W6DNS, July 22, 1938.  
2500 miles.

112 Mc.: W6BJI/6 — W6KIN/6, July 4, 1940.  
255 miles.

224 Mc.: W6IOJ/6 — W6LFN/6, 135 miles,  
August 18, 1940.

HAM



SHACKS

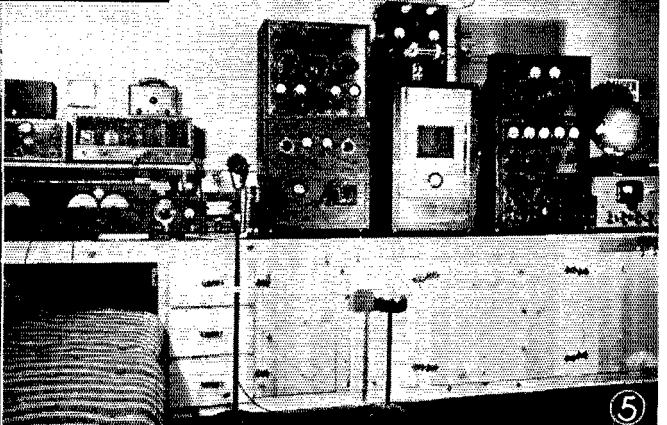
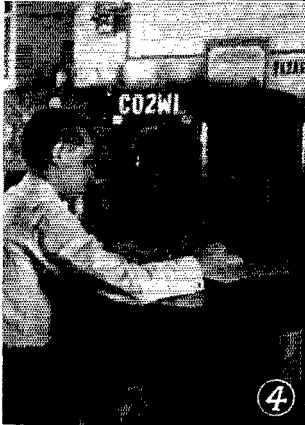
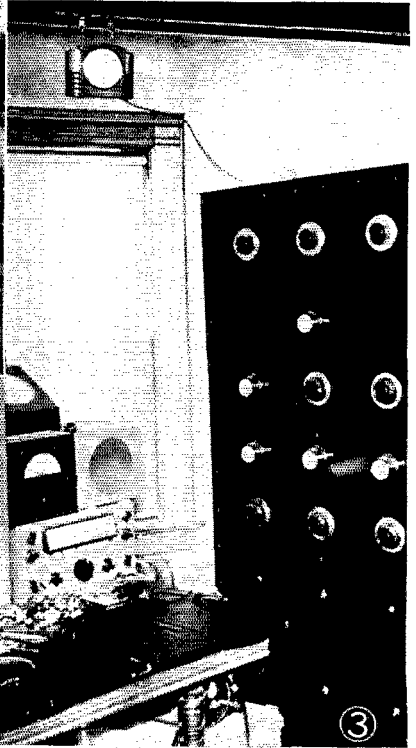
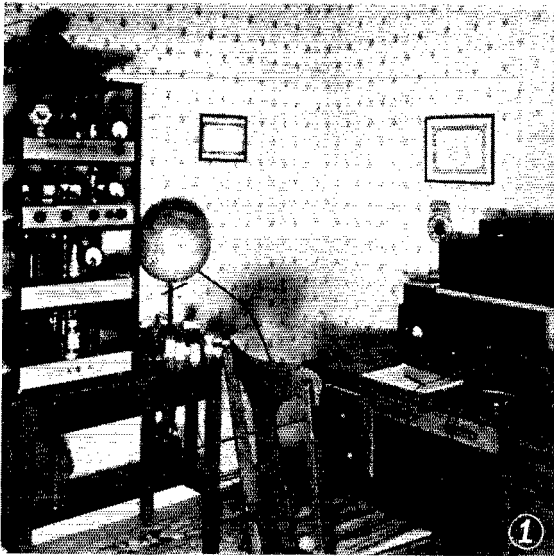

1—W8AU; 2—W8KNF; 3—W2GVZ; 4—CM2WI; 5—W6KW



## WBAU

**LOU DE LA FLEUR** is one of Western New York's leading DX men. He's a DXCC member and has led his section in the DX Contest in two out of the last four times, placing second in '38 and fourth in '36.

The transmitter is built up in an open angle-iron frame. The two lower shelves contain the high- and low-voltage plate supplies. On the third shelf is the exciter for the final amplifier. A 6L6G crystal oscillator is followed by an 809 which drives a 35T. The latter is link-coupled to the grid circuit of the 810 final amplifier on the fourth shelf. The antenna-tuning equipment is mounted on top.

The receiver will be recognized as the 101X. To the left of the speaker is the microphone and grid-bias modulator for 'phone work. For band-edge locating, a 100-kc. oscillator is mounted to the left of the receiver.

Lou is engaged in police radio work in Utica.

## W8KNF

**KARL RAU's** comfortable-looking shack is established in a corner of his basement. An area 8 by 9 feet has been partitioned off and lined with Celotex. A wood floor, 3 inches above the basement concrete, has been built up. In one corner of the room the water heater is set in an alcove and this keeps the shack warm and dry.

All of the equipment is homemade. The receiver is a 11-tube superhet with noise silencer. On the front panel is a switch which cuts the receiver power supply and actuates the transmitter control relay. The unit to the right of the receiver is a frequency meter with calibrating crystal.

The transmitter is designed to operate at 300 to 400 watts input on 4, 14 or 28 Mc. In the e.c.o. at the right-hand end of the operating table, a pair of 59's in push-push is used. This unit is link-coupled to a pair of 807's in the rack. An additional 6L6 doubler is provided for 28-Mc. operation. The final makes use of a pair of HK54's which are modulated by Class-B TZ40's. The speech amplifier is fitted with automatic modulation control.

A 119-ft. doublet with an EO1-cable transmission line is the antenna used for 75. A 2-element rotary is used for 20, while a second doublet is used on 10. An antenna relay makes it possible to receive on the transmitting antenna in use.

W8KNF is well prepared for emergencies. There is a transmitter for 80 and 160, 'phone or c.w., with a 6F6 Pierce oscillator driving an 807 final. The modulator works from a crystal mike with a 6J7-6C5 speech amplifier. A Dodge generator has been rewound to supply 60-cycle power. It is driven by friction of the pulley against the rear wheel of any car. By running the engine at a speed equivalent to 7 m.p.h., correct voltage is maintained. Both receiver and transmitter operate from a voltage-regulated supply.

Karl is 40 years of age and is occupied in research work in wax and candles. He received his ticket in 1933 and has been active ever since. He has been a member of A.R.R.L. for 6 years, O.P.S. for 4 years and a member of the Medina County Radio Club for 8 years. He operates almost exclusively 20 and 75 'phone with traffic and contests as they come. We notice from the cards on the wall that he's worked his share of DX too. He enjoys most of all the O.P.S. parties, in which he usually places well.

## CM2WL

**TO THOSE** who think DX can't be worked with low power, the performance of CM2WL should be an inspiration. With 30 watts input he has made both WAS and WAC on 'phone.

The r.f. section of the transmitter consists merely of a 6F6 crystal oscillator and 6L6G final. This unit operates from a 400-volt 150-ma. supply. The final is modulated by a Class-A 6L6G with a 6F5-6C5 speech amplifier. This unit operates from a separate 450-volt pack. The mike is an Astatic crystal. The receiver is an all-wave b.c. job.

Eduardo Oliva Radelat is editor of *Radio Amateur*, the official organ of the Radio Club of Cuba. He is a member of A.R.R.L. and holds an O.P.S. appointment. His activity is confined almost exclusively to 14 Mc.

## W2GVZ

**IT'S ALMOST** impossible to spend any amount of time on 3.5-Mc. c.w. without running across W2GVZ, for in addition to his other varied ham activities, Pat Jessup, S.C.M. of the Northern N. J. Section, is one of the busiest traffic handlers on the air. Besides maintaining several individual skeds, he is active in the A.R.R.L. and A.A.R.S. traffic nets in his section. He is also a member of TLA.

Unfortunately, it was impossible to obtain a single shot of the complete station. There are three complete transmitters. The rig for 14 and 28 Mc. is shown in the photograph. A pair of 860's in parallel, operated at 750 watts input, is used in the final. The exciter consists of a 47 oscillator, 841 doubler and RK20 driver. The e.c.o. under the operating table is used for contests and DX chasing. All stages, excepting the e.c.o. when used, are primary-keyed. To operate in the 28-Mc band, the final amplifier is used as a doubler.

The 7-Mc. transmitter is a three-stage affair. A 6L6 oscillator and 860 buffer drive the 860 p.p. final which also runs at 750 watts input. The oscillator stage is keyed with one relay, while the other two stages are primary-keyed simultaneously with a second relay for break-in operation.

The 3.5-Mc. transmitter has a 300T in the output stage which normally runs at 900 watts

(Continued on page 106)

# Shunt-Excited Antennas for Amateur Use

## Another Method for Feeding Grounded Vertical Radiators

BY C. V. CLARKE, JR., W5FQS\*

**E**XCEPT for a few scattered examples, one of which is the delta-matched doublet, the shunt-excited antenna is almost unknown among amateur circles. Series excitation is usually more suitable for such antennas as the Hertz and its many variations, the long-wire family (including that dream of every amateur, the rhombic), and the horizontal Marconi. The vertical Marconi, however, is very well suited to shunt excitation and, if the amateur is planning the installation of such a unit, it would be well to consider the merits of this system.

Every amateur is familiar with the series-excited, or base-insulated, antenna, with the coupling device in series with the antenna and ground connections, but some of the fraternity may not be so familiar with the shunt-excitation principle. The radiator proper is a vertical metal structure with its base grounded. The feed system consists of a wire connected to a point part of the way up the vertical structure and sloping down and out from the base. The output of the transmitter is applied between the free end of this wire and the ground. The portions of the vertical structure above and below the connecting point are effectively in parallel or shunt; hence the name "shunt-excited" radiator.

Two of the advantages of the shunt-excited radiator as compared with its series-excited counterpart are that no base insulators are required and that a stroke of lightning will be more likely to go directly to ground rather than traveling over the feeders and into the shack.

Still another advantage from the amateur point of view, or rather a sub-advantage to the aforementioned advantage that no base insulators are required, is that there are a number of metal structures such as flag poles, windmill towers, water tanks, or even tall metal smokestacks which can often be pressed into service as vertical radiators. In the author's opinion this is the most attractive feature of the scheme — if there is a suitable metal structure available, the amateur can have a vertical antenna "to tell the boys about" that otherwise would go on serving its present utilitarian purpose and never feel the pulse of electrons zipping along its surface spouting out CQ's in all directions!

If a quarter-wave structure is available, so much the better. But if the structure happens to be either taller or shorter than a quarter wave, do not give up the idea of shunt excitation, because

lengths other than a quarter wavelength can be made to work. Of course, if the structure is much over  $\frac{3}{8}$  wavelengths high, it should not be grounded except through an impedance or it will be very difficult to feed. And if the antenna is very short, the radiation efficiency will be rather low. However, short radiators can be lengthened either physically or electrically, for better radiating properties. Some improvement in physical length can be obtained by putting a 15- to 20-foot piece of pipe, dural angle or something similar at the top of the existing structure and by providing a good connection between the two. The antenna can be lengthened electrically by using a capacity crown at the top of the structure, or by the use of a crown insulated from the tower with an inductance connected between the crown and the tower proper.<sup>1</sup> This scheme shifts the current distribution on the tower and is comparable to folding the ends of a half-wave doublet. One should use as large a crown as is convenient. Each individual case will vary — antenna heights will be different, antenna diameters and cross sections will be different, ground conductivity will vary, etc., so it is impossible to lay down any hard and fast conditions for top loading. If the amateur decides to try top loading, he had best resign himself to go about it on a "cut and try" basis.

As in the case of all Marconi antennas, the ground should be as good as it is economically feasible to make it. If the base of the structure is mounted in concrete, a ground rod should be put down and connected to the metal structure. If the structure has more than one leg, a ground rod should be put down for each leg and the rods should be bonded together as well as to the tower. If the soil is poor, it would be well to extend radially from the base of the tower four or more wires at least 25 feet long, buried two or three

<sup>1</sup> Ferrill, "Simple Vertical Antennas," *QST*, Feb., 1939.

Shunt-excited vertical radiators are used by a number of broadcast and police stations, but very little has been said about their application to amateur work. This story tells how you can shunt-feed almost any vertical metal structure, and the fact that the structure can be grounded makes it ideal from a lightning-protection standpoint.

\* Box 407, Pasadena, Texas.

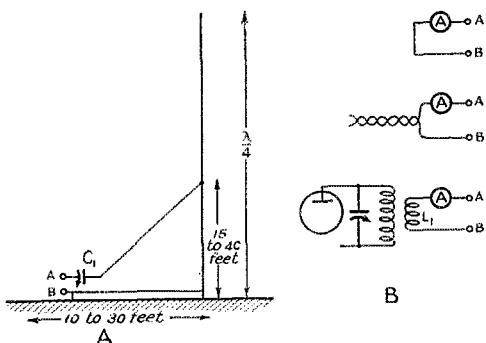

Fig. 1 — The general plan for a shunt-excited vertical radiator is shown at A. The series condenser should be about 350  $\mu\text{fd.}$  for a 160-meter antenna.

Several connections for A-B are shown at B. That at the top is the direct short for tuning the antenna, the next one is for twisted-pair feed, and the bottom one is for direct coupling. A lamp can be substituted for the meter.

inches below the surface of the ground. Of course, this is out of the question in some cases. Broadcast practice is to use 120 such wires, spaced every 3 degrees, extending out for several hundred feet from the base of the tower. This is nice, but the average amateur will have to make a compromise.

### Feeding the Radiator

Practical shunt-excited radiators can be divided into two classes — those located very close to the shack, and those located some distance from the shack. These latter require a feed line to the antenna.

If the antenna is close to the shack, say with its base from about 10 to 30 feet away (for 160-meter operation), less than two or three hours' work will result in a shunt-excited antenna. The feeder should be tapped on the tower about 15 to 40 feet above ground (for 160-meter operation), and the feeder sloped down into the shack. (See Fig. 1.) For other bands, the distances can be proportionately smaller. The inclined wire should be No. 14 or larger. It should be noted that, although the base of the antenna is grounded and terminal B is grounded, there is a wire connection between the two. This helps to cut down losses due to resistance of the ground connections in the return path of the feed system.

If we were to make an impedance measurement between A and B (Fig. 1), we would find the impedance has a resistive and a reactive (inductive) component. In order to feed the system it is necessary to tune out the reactive component, and so the series condenser  $C_1$  must be included. Resistance and reactance measurements made on the author's tower indicate that when the tap of the inclined feeder is moved up the tower the resistance and reactance at A-B increase. When the distance between the base of the tower and the measuring set was increased the resistance

and reactance at A-B also increased, but much faster than when the tap point was changed. Part of this greater variation was probably due to the fact that the tower was not of uniform cross section, but this greater variation is in accordance with the theory of this type of antenna operation.

Since a variation in the distance from the base of the tower to the termination of the inclined conductor drastically affects the impedance at A-B, it would be well for the amateur to give some thought to mechanical considerations of the termination, to insure that it is solid. Lack of any haywire construction here may make the difference between an efficient system and one that is not delivering peak performance.

### Tuning the System

If no feed line is used from points A-B (Fig. 1) to the transmitter, it is a simple matter to adjust the system. A lamp or 0-1 ammeter is connected between points A and B, and the antenna is excited from a temporary antenna nearby. The temporary antenna can be simply a wire supported 5 or 10 feet off the ground in the vicinity of the antenna to be adjusted. Power from the transmitter is fed into the temporary antenna, and the condenser  $C_1$  is adjusted until maximum current, as indicated by the lamp or meter, is obtained. A coupling coil of several turns can then be substituted for the lamp or meter, and this coil used to couple directly into the transmitter final tank circuit. The setting of the condenser  $C_1$  should not be changed — all coupling adjustments are made by varying the spacing between the coupling coil and the final tank, until the final amplifier draws the proper amount of current when tuned to resonance.

The system as adjusted in this manner will be fairly efficient, but for every installation there will probably be an optimum point for the tap of the inclined wire on the antenna. If a field-strength meter is available, or if a friend having a receiver with an "S" meter lives within a mile or so, the tap could be moved up and down on the antenna while maintaining a constant input to the final stage of the transmitter (by varying the coupling). As the tap is moved, the signal-strength variation is noted, and then the feed wire is permanently attached to the antenna where the best results are obtained in the test. It will be found that the tap can be varied for quite a distance before the performance is seriously affected.

Another method of adjusting the line is to couple the line to the transmitter by means of a small pick-up coil at A-B, with the meter or lamp also in series and, keeping the input to the transmitter constant by varying the coupling, adjusting the condenser  $C_1$  for maximum current as indicated by the lamp or meter.

If a top-loading system were employed using a capacity crown and a series inductor, this latter

system can be used to find the optimum value for the inductor. If the antenna is remote from the shack, the amateur can use a portable low-powered transmitter located at the foot of the inclined conductor during the adjustment. A 6L6 oscillator will give enough power. The adjusting procedure is essentially the same as in the preceding case — a trial point for the tap of the inclined feeder is selected on the tower, the feeder is connected to a condenser and a coupling coil, coupled to the oscillator and adjusted to resonance. Then the "S" meter reading is recorded. Then a change is made in the series inductor of the top loading system, the tuning condenser at the base of the inclined feeder is re-resonated, and the coupling between the oscillator and the pick-up coil is varied to keep the plate current to the oscillator constant. The S-meter reading is then recorded, and the two readings compared. This process is repeated until a maximum is obtained on the "S" meter. If the amateur can get a couple of fellows to help him — one to run the oscillator, one on the tower to vary the inductance, and one reading the field strength, the process will be speeded up considerably.

If the antenna is not just outside the shack, one could build a "dog house" for the transmitter and use remote control. But if the transmitter is located some distance from the antenna it becomes necessary to give some thought to transmission lines. Either a low impedance line, such as a concentric line or a twisted-pair line, or a high impedance line, such as a two wire balanced non-resonant line, can be used. The low impedance line is more easily adapted to this system.

If a low-impedance line is used, the series condenser, the tap point on the antenna, and the distance from the base of the antenna to the termination of the low impedance line must be adjusted so that two conditions are fulfilled — the system is tuned to resonance, and there appears across *A* and *B* (Fig. 1) a resistance equal to the characteristic impedance of the transmission line. The transmission line is connected to the series condenser and ground, and under these conditions there will be no standing waves on the transmission line, and the system will be ready for operation.

If r.f. measuring equipment is available, one can actually measure the reactance and resistance

at the foot of the inclined wire and vary the two distances until the desired resistance is obtained. However, since in the vast majority of cases such equipment is not available, we should consider the more practical case of the ham who has a grounded tower, a transmission line, and some means of getting r.f. readings along the line in order to determine whether or not standing waves are present.

A trial point for the inclined feeder is selected on the antenna, the transmission line is coupled to the transmitter, and the series condenser is tuned for maximum current in the inclined wire. Then the line current in the transmission line should be read at several points along the line, care being taken not to take the measurements an exact half wavelength apart. If the currents at the points along the line are not very nearly the same, the tap is moved and a new set of readings is taken. This procedure is repeated until a point on the antenna is found that eliminates standing waves on the transmission line. The adjusting procedure is then complete. It may be found that the distance from the base of the tower to the transmission line termination has to be varied in order to secure the proper termination for the transmission line.

A two-wire non-resonant line can be used to feed the antenna, as in Fig. 2.  $L_1$  and  $C_1$  will be approximately the same as in the case of the antenna fed directly by the transmitter.  $L_2$  and  $C_2-C_3$  should also resonate at or very near to the operating frequency, and the coupling between  $L_1$  and  $L_2$  should be adjusted so that standing waves disappear along the transmission line.

A Faraday shield between  $L_1$  and  $L_2$  will help in the reduction of harmonics but is not absolutely essential. Grounding the common of  $C_2$  and  $C_3$  is also helpful in the elimination of harmonic radiation.

As there is an optimum value for the size of the tank condenser in the final amplifier, so is there an optimum value for the condensers  $C_2$ ,  $C_3$  in the line termination, depending upon the operating frequency and the surge impedance of the line. An approximate formula for the calculation is:

$$X_c = \frac{Z_c}{2Q} \quad C = \frac{1}{6.28 f X_c}$$

$Z_c$  is the surge impedance of the transmission line in ohms,  $X_c$  is the capacitive reactance of each section of the combination  $C_2$  and  $C_3$  in ohms,  $f$  is the frequency in Mc.,  $C$  is the capacity in microfarads of  $C_2$  and  $C_3$  each, and  $Q$  is a factor which can be from around 8 to 16, though the use of lower values of  $Q$  is permissible. Using a frequency of 2 Mc. and a  $Q$  of 10, each section of the condenser should be around 0.003  $\mu$ fds. for a 500-ohm line, and around 0.0025  $\mu$ fds. for a 600-ohm line. It is probably better to use fixed condensers here, and to tune the circuit to resonance by varying  $L_2$ . A small auxiliary variable con-

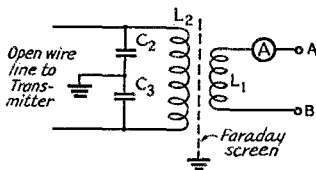

Fig. 2 — Coupling an open-wire line to the shunt-excited antenna. The open-wire line is coupled in the usual fashion at the transmitter. The Faraday screen is not necessary but will help in the reduction of harmonic radiation. Points A and B are the same as in Fig. 1-A.

denser, or a flipper mounted in  $L_2$ , can be used for fine adjustment. As the circulating current is rather high,  $L_2$  should be of copper tubing, except in the case of low-powered transmitters, where No. 12 or No. 10 wire can be used.

The value of  $L_2$  can be calculated by setting  $X_L = X_c$ . Then,

$$L = \frac{X_L}{6.28 f}$$

where  $L$  is the inductance in microhenries and  $f$  is the frequency in Mc. Having found  $L$  in microhenries, an approximate solution for the actual coil can be had from the Lightning Calculator or from

$$L = \frac{0.2 A^2 N^2}{3A + 9B}$$

where  $L$  is in microhenries,  $A$  is the coil diameter in inches,  $B$  is the coil length in inches, and  $N$  is the number of turns.

$L_2$  and  $C_2$  and  $C_3$  should be tuned before the adjusting procedure is started, and then, once tuned, let alone. The circuit is loosely coupled to the final tank and tuned just a hair on the high frequency side of resonance with the operating frequency. This is done because, when a load is coupled to a parallel circuit, the reflected resistance changes the susceptance of the inductive branch of the circuit, and the circuit becomes slightly reactive. So this reactance is compensated for in the initial tuning procedure by tuning the parallel circuit to a frequency slightly *higher* than the operating frequency. Do not overdo it, though. With a  $Q$  of 10, the parallel circuit is tuned something less than 10 kc. higher than resonance on the operating frequency in the 160-meter band.

There are a number of feed systems which it is possible to use, but the ones outlined do not require actual measurements at the base of the inclined wire. Zepp feeders are not recommended for this class of service. The feeders are not balanced to ground and feeder radiation will occur.

At present the author is using such a tower for 160-meter 'phone. The tower is a four-legged structure, 14 feet 6 inches wide at the base, tapering to 2 feet wide at the top. It is 125 feet tall and 92-ohm twisted pair is used. The inclined feeder is of No. 14 wire, tapped on the tower 35 feet 8 inches above the ground, running to a point 25 feet from the base. A series condenser of around 210  $\mu\text{mfd.}$  is used at this termination.

In conclusion, the author wishes to say that, due to the many variable factors which will be encountered in each particular case, it is impossible to lay down empirical formulas for the calculation of the tap point on the antenna and the distance from the base of the tower to the termination of the transmission line which would be of much use to the amateur. Quite a bit of work is involved in the experimental determination of these two distances, but outside of this the ama-

teur should not run into any problem that gives him much trouble. Enlist two or three of the local boys to help you, and your antenna will be finished in a short time.

The amateur should also realize that top loading of moderately-short shunt-excited antennas is no more essential than in the case of the more commonly encountered series-excited radiator. In the author's opinion, lengths as short as  $\frac{1}{8}$  wave can be successfully used without top loading, though an improvement would result from the use of such a system. If one considers the cost of materials, and the time and labor involved in the installation and adjustment of such a system, one can readily see that there are cases where top loading would not be justified, and that there are cases where top loading would pay big dividends.

Do not climb up the tower with a neon bulb and expect it to light, as the author did the first time he tried a shunt-excited antenna several years ago. While you are on the tower, your body assumes a like charge to that of the tower, and there is no potential difference existing to ignite the bulb!

## South Dakota State Convention

(Dakota Division)

**Aberdeen, S. D., October 19th-20th**

To show their fellow hams a good time and give them something to take home in the line of new developments in radio are the objects of the Aberdeen Amateur Radio Association in sponsoring the South Dakota State Convention in their city on October 19th and 20th. Headquarters will be at the Y.M.C.A., and Saturday morning will start out with amateur examinations conducted by the radio inspector. From this point until the banquet and awarding of prizes Sunday evening, the club is planning an interesting program including a code speed contest, visits to local amateur shacks, an address by the division director, and visits to local broadcasting stations. The registration fee is \$1.50. Write Mrs. Martha J. Shirley, W9ZWL, 502 11th Ave., S.E., Aberdeen, for further information.

## On the U.H.F.

(Continued from page 61)

been tried and scores of tests run off, neither has been able to hear the other from the home locations. A hint as to what may in the end provide a signal across this path was afforded when AIY found it necessary to point his 3-element portable beam far off the line to Elmwood in order to receive HDF's test signals with good strength.

And a note to all: This U.H.F. Department has been functioning now for nearly a year. Plans for 1941 are being considered. Have you enjoyed our Marathon? Do you want another next year? What sort of material would you like to see presented in this section of *QST*? Up to now, we have followed no fixed form. "On The Ultra-Highs" will contain whatever you, the customers, want it to contain. Your suggestions are in order.

# Distance vs. Angle of Radiation

*Relation of Radiation Angle and Layer Height to Transmission Range*

BY CHARLES ROCKEY, JR.,\* W0SCH

WHILE one may go to any of the current Handbooks for data on which vertical angles the radiation from any common type of antenna will include, the writer has yet to see available to the average amateur any information on just how far away a wave radiated at a given angle will return to earth.

Of course, it is quite impossible to obtain general data on this that is infallible under all conditions, but it was felt that some material based on approximately average conditions should be helpful to the amateur who is interested in securing maximum effectiveness from his antenna

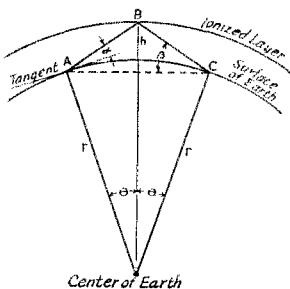

Fig. 1 — A radio signal from point A leaving at an angle  $\alpha$  can be considered to be reflected from the ionosphere at point B back to the earth at C. The virtual height of the ionized layer is designated by  $h$ , and the radius of the earth is shown by  $r$ .

system. It is the purpose of this article to present some information along these lines, in a form that the average amateur can find useful.

A recent article in *QST*<sup>1</sup> gave the average virtual layer heights, and these values were used in calculating the curves shown in Fig. 2. The heights vary over wide limits in some cases, but it is felt that the values selected represent the average. The *E* layer virtual height is fairly consistent around 110 km. (68.4 miles), and 200 km. (124 miles) was used for the summer *F*<sub>1</sub> layer, 300 km. (186 miles) for the night *F*<sub>2</sub> and winter *F*<sub>2</sub> layers, and 400 km. (248 miles) for the summer *F*<sub>2</sub> layer.

The data given in Fig. 2 was obtained by graphical means. A graphical solution of Fig. 1 required more room than was available on any sheet of paper that could be found, and the drawing was made with fine chalk on the pavement

of the back alley. (The making of this drawing drew quite a bit of local attention — we were accused of doing everything from fomenting an anarchist plot to publicly indulging in "Birmingham Chess," and upbraided accordingly.) The accuracy of the method used may be questioned by some, but accurate results to two significant figures were obtained. Those with the necessary qualifications would doubtless have used trigonometry from the start, but our high school math wasn't quite up to it, and we went at the solution the hard way.<sup>2</sup>

In Fig. 2, the distance along the earth where a reflected wave comes down again, for various layer heights, is plotted against the vertical angle of radiation of the wave. Actually, it is practically

(Continued on page 108)

<sup>2</sup> Mr. Rockey's results from his graphical solution were quite good, and needed no modification. The trigonometrical solution to Fig. 1, for any distance *AC* and layer height *h*, can be obtained as follows:

$$\text{In radians } \theta = \frac{AC}{2r}$$

where  $r$  = mean radius of the earth (3960 miles).

The vertical angle of radiation  $\alpha = \beta - \theta$

$$\text{where } \beta = \tan^{-1} \frac{h + r \cos \theta}{r \sin \theta}$$

However, if *AC* is made too great for any particular layer height, the solution for  $\alpha$  will be in error. The above holds only for real cases where  $\beta$  is equal to or greater than  $\theta$ .

The maximum distance is obtained when  $\beta = \theta = \cos^{-1} \frac{r}{h+r}$  — Ed.

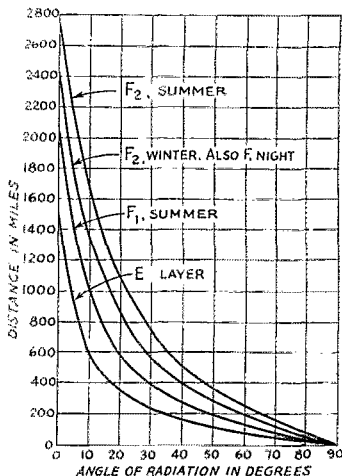

Fig. 2 — A chart of distance along the earth (*AC* in Fig. 1) plotted against various vertical angles of radiation ( $\alpha$  in Fig. 1).

\* 233 Franklin Ave., River Forest, Ill.  
<sup>1</sup> "The Ionosphere and Radio Transmission," *QST*, March, 1940.

# A Sailor's Five-Tube Station



## Designing the Rig for Real Portability

BY WILSON JENNINGS,\* RM2c, WIMGK, EX-W4AJ0

THERE is an old saying that no person moving around as much as a sailor and, as a radioman in the U. S. Coast Guard, I am subject to a transfer at any time. With only a little time to complete transfer arrangements when an order comes through, I had to have an amateur station, if any, that could be tucked away in a corner of the bag at a moment's notice.

From time to time the various radio magazines have carried constructional articles on portable transmitters and receivers, and even complete stations, but I was never able to find anything that exactly suited my particular needs, although the many descriptions showed a great deal of ingenuity. There is considerable difference between a transmitter or station that is movable and one that is strictly portable and, with this in mind, I set out to design a station that would suit my particular needs. Needless to say, the expense had to be kept at a minimum, which means very close to the ten-dollar level. Cutting the expense was effected by using standard circuits and modi-

A complete 3.5-Mc. station (minus power supply) that weighs less than 7 lbs., the above unit measures only 6¾ by 7¾ by 4¾ inches. The tuning dial on the left is for the transmitter, the one on the right tunes the receiver. The jacks are for headphones and key, and the knobs control receiver band-set and regeneration. The switch throws the antenna from the receiver to the transmitter.

### The Circuit

As can be seen from Fig. 1, the transmitter is a two-tube affair using a 6C5 Pierce oscillator to drive a 6L6 amplifier, and is quite similar to a number of rigs that have been described previously. The main difference lies in substituting a resistor for the r.f. choke in the plate circuit of the oscillator, since the difference in price between a resistor and an r.f. choke is enough for a package of cigarettes and a stamp for a letter. If the 6L6 is run at any voltage over 250, the oscillator would require a plate dropping resistor anyway, so money and space were saved. A choke can be used, of course. The cathode circuits of both tubes are keyed for break-in operation.

The receiver diagram is shown in Fig. 2 and will be recognized as the standard cathode-tap regenerative circuit with a two-stage resistance-coupled audio amplifier. An old output transformer is used as a coupling choke to the headphones, since the plate current of the 6F6 audio

\* U. S. Coast Guard Station NOU, Base Four, New London, Conn.

Fig. 1 — Wiring diagram of the transmitter.

- C<sub>1</sub> — 50- $\mu$ fd. mica.
- C<sub>2</sub> — 250- $\mu$ fd. mica.
- C<sub>3</sub> — 100- $\mu$ fd. mica.
- C<sub>4</sub>, C<sub>6</sub> — 0.1- $\mu$ fd. 600-volt paper.
- C<sub>5</sub> — 140- $\mu$ fd. (National Experimenter type).
- C<sub>7</sub> — 0.002- $\mu$ fd. mica.
- R<sub>1</sub>, R<sub>3</sub> — 50,000 ohms, 1-watt.
- R<sub>2</sub> — 25,000 ohms, 1-watt.
- S<sub>1</sub> — Toggle switch for antenna switching.
- L<sub>1</sub> — 3.5 Mc.: 22 turns No. 18 enam. closewound on 1¼-inch diam. form, center-tapped.
- A — 0-200 milliammeter.

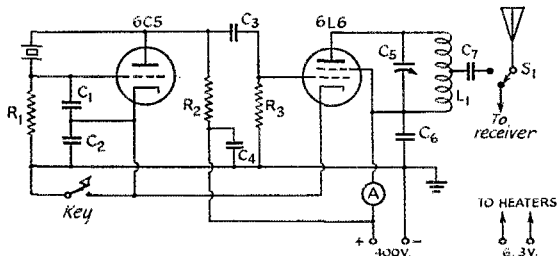

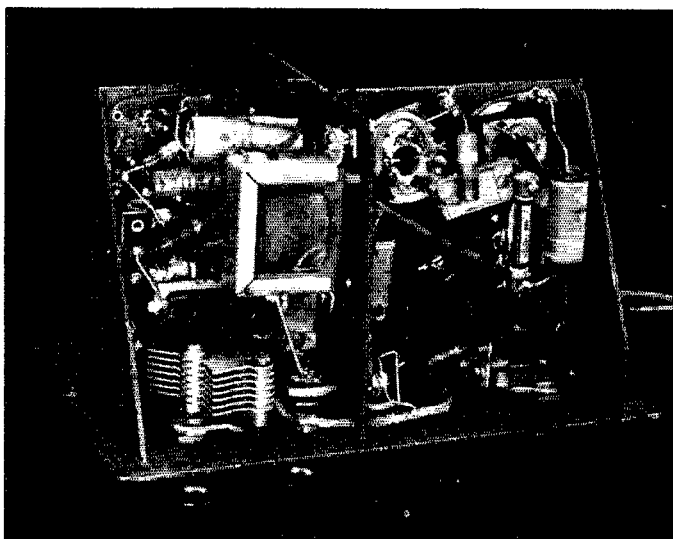

A shot of the underside of the chassis shows that most of the available room is used. What appears to be a transformer in the receiving section (left) is an output transformer used as an output coupling choke.

output stage is too high for a normal pair of headphones.

The transmitter and receiver are housed together in a small wooden cabinet which measures  $6\frac{3}{4}$  inches high by  $7\frac{3}{4}$  inches long by  $4\frac{3}{4}$  inches deep. The cabinet merely serves as a housing, and

all of the radio gear is mounted on a home-made chassis which is soldered to the panel. The chassis was made of 18-gauge galvanized stock which is available at any tinsmith's at very little cost — I was lucky enough to get mine free from the scrap heap of the tinner.

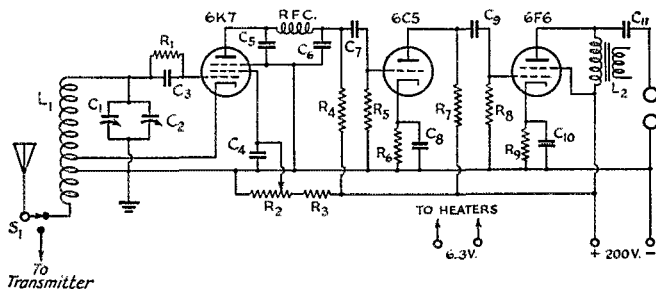

Fig. 2 — Circuit diagram of the receiver.

- C<sub>1</sub> — 140- $\mu$ fd. band-set variable (National Experimenter type).
- C<sub>2</sub> — 35- $\mu$ fd. band-spread variable (National Experimenter type).
- C<sub>3</sub>, C<sub>5</sub>, C<sub>6</sub> — 100- $\mu$ fd. mica.
- C<sub>4</sub> — 4- $\mu$ fd. electrolytic.
- C<sub>7</sub>, C<sub>9</sub> — 0.01- $\mu$ fd. paper.
- C<sub>8</sub>, C<sub>10</sub> — 10- $\mu$ fd. 25-volt electrolytic.
- C<sub>11</sub> — 0.1- $\mu$ fd. paper.
- R<sub>1</sub> — 5 megohms,  $\frac{1}{2}$ -watt.
- R<sub>2</sub> — 50,000-ohm potentiometer.
- R<sub>3</sub> — 25,000 ohms, 1-watt.
- R<sub>4</sub>, R<sub>7</sub>, R<sub>8</sub> — 50,000 ohms, 1-watt.
- R<sub>5</sub> — 0.25 megohms,  $\frac{1}{2}$ -watt.
- R<sub>6</sub> — 1000 ohms,  $\frac{1}{2}$ -watt.
- R<sub>9</sub> — 500 ohms,  $\frac{1}{2}$ -watt.
- RFC — 2.5-mh. r.f. choke.
- L<sub>1</sub> — 3.5 Mc.: 31 turns No. 26 d.c.c. closewound on tube base. Bottom end connects to antenna, tap  $3\frac{1}{2}$  turns up for ground and 5 turns up from bottom for cathode tap.
- L<sub>2</sub> — Small 6F6 output transformer, voice coil winding not used.
- S<sub>1</sub> — Same as in Fig. 1.

### Construction

The dimensions of the chassis are given in Fig. 3, and a study of this and the photographs will show how the chassis is assembled. The front panel should be cut first and fitted to the cabinet so that the edges will come flush. The holes in the front panel can then be drilled according to Fig. 3. The two tuning dials can be placed in their proper positions

and circles drawn about them. Inside these circles, so that they will be covered by the dials, at least four  $\frac{1}{4}$ -inch holes should be drilled. Then, by mounting the dials at least one-quarter inch from the panel and by having a ventilation louvre in the top of the cabinet, it will be possible to get some air circulation and help to keep the transmitter and receiver at a reasonable temperature. The holes on the panel are covered by the dials and are

When the author of this story brought his gadget into the lab we knew at once that there was a story in it. It represents about the minimum in space for a complete transmitter and receiver and, further, the cost has been held down to the point where it will match the purse of anyone.



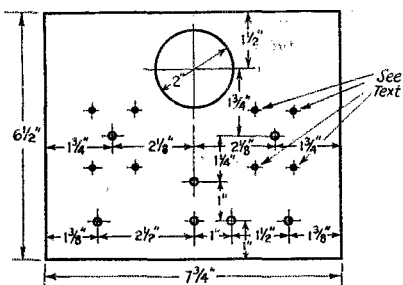
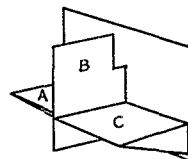
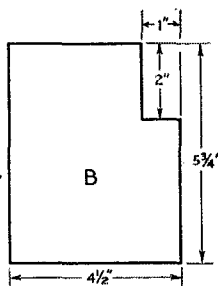
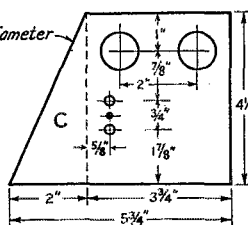
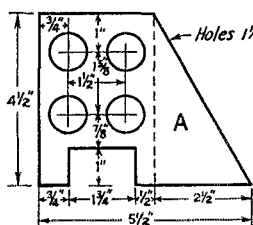

Fig. 3 — Plans and detail of the chassis. The separate pieces are assembled as shown in the lower right-hand corner. The material is 18-gauge galvanized stock.



in no way objectionable from an appearance standpoint. In case it is impossible to secure a screen louvre like I used, I would suggest marking one's call letters on the top of the cabinet and drilling out the letters with a small drill, for cooling and for rather fancy identification.

It will probably be better to plan where the parts should go and get this all "doped out" before any cutting of the decks is done, particularly if slightly different parts are used. A good idea is to take a piece of paper or cardboard and cut it to the exact size of the decks, as shown in Fig. 3. The parts can then be laid down and juggled around until they fit the constructor's thoughts on where they should go. When this has been determined, the parts can be placed on the metal counterparts and the holes marked with a pencil or scribe. The decks can then be cut out and the

sides bent down. The sides give support to the decks when they are soldered to the front panel. Use plenty of solder and make sure the metal is clean before soldering. The main thing to a good soldering job is to have the material clean and bright. I used a small alcohol lamp to pre-heat the metal, and then plenty of paste and a 100-watt iron to flow the solder along the joints. If acid flux is used, it must be removed before the chassis is painted.

After the soldering has been completed, the excess solder can be dressed down by using a three-cornered file as a gouge. When the soldered joints have been cleaned up, the chassis holes can be drilled. If they are drilled before the metal is bent, it is difficult to get a straight bend.

When all of the holes have been drilled on the chassis, and no more metal work is to be done,

A top view of the station shows the transmitter on the left and the receiver on the right. The crystal can be seen at the extreme left of the transmitter section.

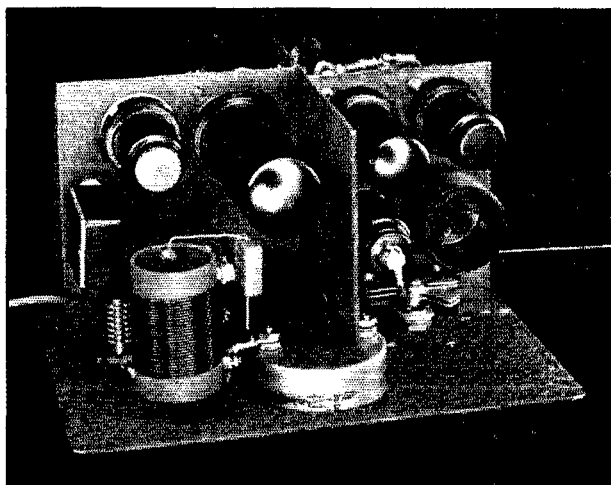

the chassis is cleaned by scrubbing it thoroughly with a stiff brush under gasoline. This should be followed by a bath in hot soapy water and a rinse in warm water. After the chassis is clean and dry, it can be crackle-finished or, if that sounds like too much expense, ordinary four-hour-drying enamel such as is sold in the five-and-ten will be satisfactory. It can best be applied with a spraygun such as is used for insects. It should be sprayed on evenly and completely, with about ten hours between each coat for adequate drying. Four coats will make it look like a factory job provided no dust is allowed to settle on it while drying. If only one or two coats are applied, it will be found that the enamel scratches off easily, but three or more coats really do the trick.

The wiring and tuning of the set is conventional and need not be described at any length. There isn't too much room for the various condensers and resistors, so a little thought must be given to the arrangement of the various components before they are wired in place.

My power supply has two filament supplies of 6.3 volts each, for the transmitter and the receiver, and the d.c. output is capable of furnishing 500 volts at 300 ma. However, this much power is not required, and a 400-volt 125-ma. supply would be quite adequate. The bleeder resistor is tapped for the receiver, since the full voltage is too much for the receiver.

As for results with this little set, I have used screen wire on my window, the bed springs, and various wires of random lengths for an antenna system, using a simple Collins coupler made of receiving condensers. The set seems to load up nicely on almost anything, and I have worked all of the New England states, South Carolina, Missouri, Illinois and Indiana on 3.5 Mc., the band for which the rig is designed. The receiver works well, and stations in Europe, Africa, South America and all U. S. districts have been heard with good volume.

This story was not intended to describe the smallest possible station but more to point out how, by departing slightly from conventional design, it is possible to put a lot of gear in a small space. If any reader does not see from the photographs how some of the parts fit into the space, I will be glad to answer all questions, provided a stamp is enclosed with the inquiry.

## Magnetic Bandswitching

(Continued from page 56)

A single-wire antenna cut to a half wave for 160 may be used for all bands and switched from tank to tank by one of the ceramic sections. The tank may be used to feed non-resonant lines to individual doublets or the links may be picked up by the two switch sections and fed to a tuned Zepp system. The latter method would of course require retuning for each band.

This particular exciter was, however, built for the purpose of driving five separate 1 kw. final amplifiers using a common power supply and modulator for all. Since several types of tubes with kilowatt capabilities are available today, this is not such an expensive proposition as first consideration might indicate. The actual association of the exciter with the final stages is quite simple. Twisted pairs from each tank link of the 6L-814 turret are run to the grid tank links of their respective finals. The plate circuits of all finals are of course tuned and coupled permanently to their respective antennas. The method used to bring the proper final into service requires five d.p.s.t. relays with one pole suitably insulated for handling the power amplifier plate voltage. The other pole on each relay controls the 110-volt circuit to separate filament transformers in each final. One of the idle switch sections on any turret may be used to control these relays. In this way the final stages are interlocked with the corresponding bands of the exciter. It might be pointed out that the relays are not absolutely essential to this scheme. The filament circuits could be controlled directly by the turret switch section but this leaves the high voltage on the four "dead" finals as well as the stage in service. In the interests of safety—*use the relays.*

While this exciter has been designed for all five bands and uses "fundamental" crystals for each, this does not preclude other arrangements. For example, an exciter may be built to shuttle between two bands if desired. Turrets are also available for any three or four bands that may appeal to the individual. Doubling is also possible with special turret assemblies where one crystal and oscillator inductor remains in service through two or three index positions and drives the 807 as a doubler instead of as a buffer. A 40-meter crystal with the 807 acting as a doubler will drive the 814 to the same grid current on 20 as will a straight-through combination.

## Amateurs Render Service

(Continued from page 89)

for amateur radio during broadcasts of flood bulletins and two 15-minute descriptions of the flood were given over the station by W3ZU.

As in each similar emergency experience in recent years, the participants all have but one refrain: Next time we'll be prepared! The lack of emergency-powered equipment at the critical points was a glaring weakness. But preparations are now being made to remedy this defect, and the results will soon be apparent. Amateur radio did a good job in this emergency, but it could have been better, and the amateurs of Georgia, the Carolinas and Virginia are determined that next time it *will* be better.

—C. B. D.



# CORRESPONDENCE FROM MEMBERS

The publishers of *QST* assume no responsibility for statements made herein by correspondents.

## CODE PROFICIENCY CAMPAIGN

180 Varick St., New York City

Editor, *QST*:

. . . The most useful activity A.R.R.L. has dug up for the hams in many years. I hope the fraternity joins in enthusiastic support of this program. We owe it to Uncle Sam. . . .

— *T. A. McCann, W3FRE*

2110 Scott St., Lafayette, Ind.

Editor, *QST*:

. . . In my opinion this code proficiency program is the finest activity you have ever sponsored. . . .

— *John C. Eckhart, W9CTG*

319 W. Washington, Greenville, Mich.

Editor, *QST*:

We appreciate the fact that no amateur has a "hands off" right to any particular frequency in the spectrum. However, wouldn't it be common courtesy to give W1AW right-of-way during proficiency runs? During the August 5th tests the three highest speed runs were so badly QRMed on 40 meters that it greatly handicapped an operator trying to receive these speeds. Yes, I know it's good experience to learn to copy through QRM — but not under the strain of a speed test! Why not familiarize yourself with the dates of the tests, and if you are on the same frequency and have no other crystal forego yourself the pleasure of fifteen minutes of operating time for the benefit of thousands of men who are trying to receive evidence of increased skill? Better still, why not take part in the tests? You may be good, but it might surprise you to find how much concentration it takes to copy an honest 25 or 30 w.p.m.

— *A. R. Richards*

70 Columbia Ave., Warwick, R. I.

Editor, *QST*:

. . . It's a lot easier to copy at high speed in your head than it is to put it down on paper, especially if you are out of practice. This is quite adequately proven by the fact that, after a certain speed is reached, errors in the copy commence to present themselves for the reason that at higher speeds time is not available to correct the spelling, if the ear recognizes the word but fails to note the spelling. . . . I have nearly as much correct copy in each of the 25, 30 and 35 w.p.m. groups, and if I had not been putting it down the blank spaces would have been filled in my mind and the copy for "conversation purposes" would have been solid. Betcha lots of the gang got a surprise when they tried to put it down!

— *Clayton C. Gordon, W1HRC*

1240 Sixth Ave., San Francisco, Calif.

Editor, *QST*:

Congratulations on a swell step in the right direction! All my 'phone pals are practically up for an A.R.R.L. Code Proficiency Certificate. May I suggest a later schedule for the West Coast?

— *Lee H. Owens, W6IFW*

R.F.D. 2, Nunica, Mich.

Editor, *QST*:

. . . I think the W1AW practice transmissions are the best I have ever heard. . . . I also think that the transmissions are put on at a very suitable time — 10:15 P.M. E.D.S.T. Certainly most amateurs should find it a convenient time. . . .

— *Lester D. Timmerman, W8TKW*

305 S. Madden St., Shamrock, Tex.

Editor, *QST*:

. . . The best idea ever staged by A.R.R.L. . . . I am one of the thousands that can ragchew at 35 w.p.m. but have a lot of trouble getting written copy at 20 w.p.m. and nothing but continued nightly practice from W1AW will help. . . .

— *Esca Forgy, W5GKB*

5030 N. Mango Ave., Chicago, Ill.

Editor, *QST*:

. . . A great deal more sport than I imagined it would be. . . .

— *E. J. Schaachte, W9GBS*

1227 Windsor Ave., Richmond, Va.

Editor, *QST*:

. . . I predict that soon . . . hams will not be saying, "My code speed is 25 w.p.m.," but, "I hold an A.R.R.L. 25 w.p.m. certificate."

— *R. N. Eubank, W3WS-W3AAJ*

140 S. Eighth St., El Centro, Calif.

Editor, *QST*:

. . . Only wish the periods came more often. . . .

— *F. T. A. lerson*

Framingham, Mass.

Editor, *QST*:

. . . May I say that, in my opinion and in the opinion of the members of this Club, the Code Proficiency Award program of the A.R.R.L. is one of the most worthwhile projects ever undertaken by the League. We extend to you our appreciation, and we hope to make a 100 per cent club score before the completion of the test runs.

— *William W. Fairbanks, President Framingham Radio Club*

34 Orleans Road, Valley Stream, N. Y.

Editor, *QST*:

. . . I work 'phone mostly but still try to keep up the c.w. speed. I believe that your code tests will prove very beneficial and will cause a lot of interest. . . . I would like to have the speed increased on up to 50 or 55 w.p.m. in 5 w.p.m. increments. . . .

— *F. S. Fritts, W2MYK*

West Middletown, Ohio

Editor, *QST*:

. . . Although I work some 'phone, I have always been partial to c.w. and my advice to all new amateurs has been never to stop working c.w. It is something that everybody cannot do, but anyone can talk on 'phone. . . .

— *John G. Hunt, W3QIE*

7126 Pershing, St. Louis, Mo.

Editor, *QST*:

. . . Congratulations to A.R.R.L. for finally inaugurating a code proficiency drive. It is only because amateurs are proficient and valuable in such arts that we are permitted to continue operating. F.C.C. does not wish to close us down largely because of fear we would lose our fine code proficiency. Amateurs should take advantage of our position and cooperate with A.R.R.L. in its campaign for more and better operators. . . .

— *Wm. G. Skinker, W9AEJ*

4915 N. Sawyer Ave., Chicago, Ill.

Editor, *QST*:

. . . Code proficiency is extremely important. You've

(Continued on page 103)



# HINTS AND KINKS FOR THE EXPERIMENTER



## WORKSHOP KINKS

IN PREPARING a metal chassis for drilling it has been suggested that a piece of wrapping paper be fastened about the chassis with adhesive tape. A better method, I have found, is to use a piece of very heavy brown paper cut about a half inch shorter than the length of the chassis. It should be flooded with a rather watery paste (flour and water will do) and then placed in position on the chassis. By smoothing with both hands from the center outward all air bubbles and lumps may be removed and it will be found that the water has expanded the paper to such an extent that the edges will meet the edges of the chassis.

After drying, the paper will be perfectly smooth due to the tightening effect even though a wrinkled sheet was used. To remove the paper after the work is finished, simply get permission from the XYL to soak it in the bathtub for a half hour and the paper will drop (possibly from surprise).

An added advantage of this method is that it becomes unnecessary to center punch to prevent the drill from walking. The drill will penetrate the paper instantly, of course, and the paper provides a "socket" for the drill.

When drilling socket holes of an inch or more in diameter with a fly-cutter, it is much more satisfactory to cut a little way in from both sides

(the deeper you go the more metal in proportion to depth must be removed), and then strike it several times from both sides with a flat-headed hammer. In this way the time consumed in cutting is reduced by about three fourths and in addition there are no burrs to be removed later. A good clean hole results and since the drill has not been worked too much in the center hole there is much less likelihood of error in the size of finished hole.

— W. T. Hodson, W2FJE

## SIMPLIFYING TELEVISION DEFLECTION AND VIDEO CHASSIS

THOSE experimenters who have built, or intend to build, the television deflection and video chassis described in the February, 1940, issue of *QST* may be interested in a few changes in the circuit that eliminate one tube and a few parts.

A type 6F8G tube may be substituted for the 6H6 and 6SJ7 tube shown in the original circuit. One half of the 6F8G is used as the diode "sync" separator, the grid functioning as the plate of the diode. The plate of this triode is grounded to form a shield for the diode. The second half of the 6F8G is used as a triode amplifier to replace the 6SJ7. The grid resistor has been increased over the original value to allow the use of grid leak bias, thus eliminating the cathode resistor and by-pass shown in the original circuit. Increasing the size of the grid leak also makes possible the use of a smaller coupling capacitor  $C_{21}$  to the grid of this tube.

The circuit constant designations shown in Fig. 1 are the same as the corresponding ones in the circuit as originally published. It will be noted that the value of  $C_5$  has been increased from 0.01  $\mu$ d. to 0.1  $\mu$ d. This gives better sync at the top of the picture, in the original circuit as well as in the modification.

— H. C. Lawrence, Jr., W2IUP

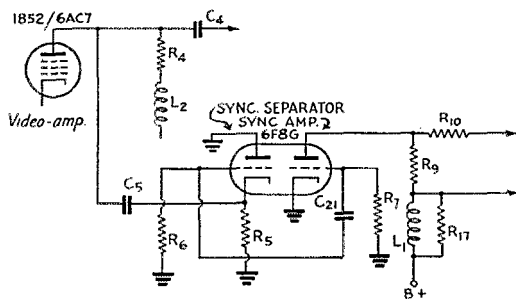

Fig. 1— Circuit for the elimination of one tube in deflection and video chassis of television reception described in February, 1940, *QST*. Circuit constant designations are the same as those used for corresponding parts in the original circuit.

$R_5$  — 200,000 ohms.

$R_6$  — 10,000 ohms.

$R_7$  — 5 megohms.

$C_5$  — 0.1  $\mu$ d. paper, 400 volt.

$C_{21}$  — 0.01  $\mu$ d. paper, low voltage.

Resistors are all  $\frac{1}{2}$  watt IRC, Type BT.

## RESONANCE INDICATOR FOR F-M

A CIRCUIT which has been developed commercially is shown in Fig. 2. At resonance, the shadow angle is zero, since the 6E5 is biased to cut-off and no voltage is delivered by the 6H6. A voltage regulator tube insures stable operation and accuracy is practically equivalent to that obtainable with the more costly zero-center galvanometer method.

— Willard Moody

Fig. 2 — Circuit diagram of inexpensive resonance indicator for FM.

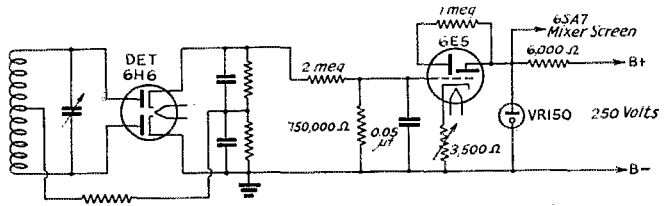

**BATTERY BIAS WITHOUT CHARGING CURRENT**

**KEYING** the oscillator or buffer in a multi-stage transmitter offers a number of advantages, but usually a bias supply of some sort is required to cut off plate current when there is no excitation. Generally, battery bias is the simplest solution, but the grid current flow through the battery shortens its life and causes trouble. I believe I have a circuit here which will be found more satisfactory than the usual combination of grid-leak and battery bias. In my arrangement, the battery is used solely to bias the tube when there is no excitation, and a neon bulb is used as a grid leak to give bias with excitation. In this way, only a very small part of the grid current flows through the battery; in my case, about five *micro-amperes*. Thus, the charging current is so low that the service life of the battery will be essentially the same as the shelf life. The additional parts required to change from conventional resistor-battery bias to this system in my rig, where a single 809 is used in the final amplifier, were a 3-watt neon bulb, an Edison base socket and a 10-megohm resistor. Fig. 3A shows the conventional circuit, while the revised circuit is shown at B.

In my case, the grid leak was omitted in the

revised circuit, because the voltage drop across the neon bulb, which has a resistor in the base, was 80 volts with 25 ma. grid current which is about right for the 809. Without the resistor, it would be about 60 volts, but it was not deemed worth while to remove it. With the 809, a 45-volt B battery is more than enough to cut the plate current.

If this scheme is used with different tubes, there are several points to be observed. Do not by-pass the lower end of the r.f. choke to ground, since the neon bulb might oscillate, modulating the signal. For low- $\mu$  tubes requiring higher bias, two or more bulbs may be connected in series, and a higher battery voltage used. However, the battery voltage should not be much more than necessary to cut off plate current. For proper operations, it is important that the neon bulb draw no current from the battery, so the number of neon bulbs and the battery voltage should be so related that the total extinction voltage for all the bulbs in series is less than the total battery voltage. Figuring at 55 volts per bulb for the extinction voltage, it will be seen that there should be at least one bulb per 45-volt battery, although more bulbs may be used if found necessary. If enough batteries are used to cut off plate current with no excitation, and then enough neon bulbs to give at least twice cut-off bias with excitation, no trouble should be experienced. Should a higher operating bias be required, an additional amount of grid leak resistance may be inserted at X in Fig. 3B. A single 45-volt B battery should suffice for the 809, T20, TZ20, TZ40, 811, and most high mu tubes, while the 812, T40, and T55 will require 67.5 or 90 volts. A single 3-watt bulb can be expected to handle up to 30 ma. grid current, so when grid current exceeds this value, two or more bulbs must be connected in parallel, one for every 30 ma. or fraction thereof. With the first stage keyed, it will probably be more economical to use a bias-supply if low- $\mu$  tubes are used in the final. Other tubes which may be used are the VR75, VR105, VR150 and OA4G.

If tubes are connected in parallel, resistors of about 100 ohms should be used in series with each tube or branch. Fig. 3C shows a typical arrangement for three stages following a keyed oscillator.

—Percy F. Crabill, Jr., W3HQX

Fig. 3 — Circuit for eliminating charging current through biasing batteries. A — Conventional leak and battery biasing circuit. B — Revised circuit for single stage. C — Typical arrangement for three amplifier stages following a keyed oscillator.

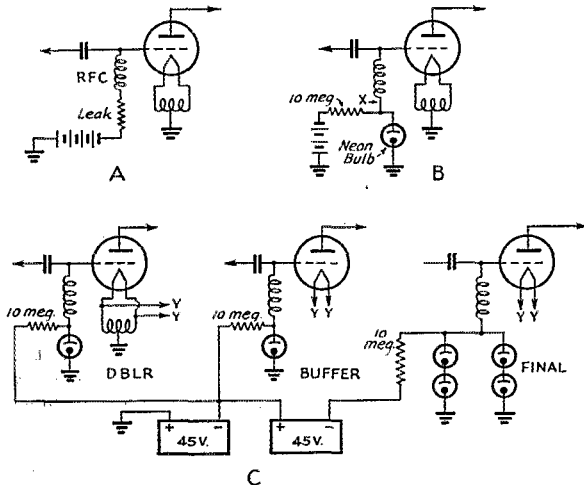



# OPERATING NEWS

F. E. HANDY, WIBDI, Communications Mgr.

E. L. BATTEY, WIUE, Asst. Communications Mgr.

**Some Notes about the A.R.R.L. Code Proficiency Award.** The interest in the new League Award has been phenomenal. Proficiency in operating technique certainly is a matter of universal amateur interest and pride. Perhaps it is no wonder then that our desks have been flooded with applications for the new award, and our outgoing mails have been heavy with the burden of certificates, even in midsummer.

This is an award for which every F.C.C. amateur operator licensee may apply—a token of advanced proficiency and personal skill. The qualifying runs come about once a month. We freely confess that we could not keep up with the deluge of applications if they came oftener! Different days of the week have been selected for each qualifying run from WIAW, to take care of the cases of those who have unusual work schedules. The League station continues its daily-except-Friday schedules of practice material which start at 10:15 P.M., E.S.T. Elsewhere in this issue we are pleased to list a carefully compiled tabulation of commercial and government stations that send press and weather at around certain desirable speed ranges just to help every operator improve code speeds. Many, many operators write us that getting these transmissions is more real sport than they had ever imagined.

There is no limit to the number of endorsements that an amateur operator may earn, once he has his certificate, up to and including the 35 w.p.m. endorsement. Beyond that point we do not intend to go for the present. The purpose of the program is to prove to the world that a large number of us can secure this recognition, and that we are many of us able to copy successfully plain language text at speeds faster than the license qualification requirement!

The three next WIAW qualifying runs will be on

October 17th, Thursday  
November 20th, Wednesday  
December 17th, Tuesday

All WIAW practice transmissions cannot be used to qualify, but only those sent starting (after ample explanatory information has been sent) at 10:30 P.M., E.S.T. on those dates. Each speed is maintained for four minutes or more before the operator changes to a progressively higher speed. Since one minute of perfectly solid copy only is needed to qualify, this amounts to giving more than one chance to the listener to get the test text down in black and white. A few fellows sent

in just the preamble explaining that a qualifying run was coming, and a few sent only fragmentary copies of speeds that were above their ability, resulting in about 5.5% failing to rate the award applied for. All these will undoubtedly make the grade on the next try. It gives us great pride to present in this *QST* a list of all who received awards on Run No. 1 who are not in any way connected with our staff. They are to be commended on their enterprise, copying on make-shift vacation receivers in some cases, with split headphone arrangements to defeat interference and summer QRN in other cases, and in sweltering temperatures too.

**Marking Copy Submitted.** One or two fellows forgot to put names on the papers. We therefore urge everyone applying for his Code Certificate Award to put his name, F.C.C. call, and full address at the top of each sheet of copy submitted so the paper can be identified positively.

*Mark the particular one minute of perfect copy that qualifies you and which you desire to have checked for the initial certificate or for later endorsements.* You may of course have left out a letter or miscopied something, but in most cases we feel that you can be fairly sure about your copy, and there is no point in sending in copy that you *know* contains "busts" at less than one minute intervals! If you have doubts, you can examine carefully. To make 15-, 20-, 25-, 30-, or 35-w.p.m. speeds requires that you have 89, 119, 149, 179 or 209 consecutive, correct, characters-and-spaces. The *rate* is determined of course by the number of 5-character words and the necessary number of spaces to make them words, irrespective of the exact number of dictionary words used.

**How to Progress.** Making progress in code proficiency is simply a matter of getting frequent practice, after the initial memorizing of code, which by the way should be carried through from the start by *writing down* a letter to correspond to a *sound* combination. One should not practice for such long periods if he becomes too tired, but should aim rather at having definite days and times for practice on the favorite press or amateur station, and putting in an hour more or less (as much as one enjoys) each time.

Another hint: It is stated by those who should know, who instruct large groups of men in the minimum time possible, that for the accomplishment of higher receiving attainment, correct *sending* ability is also important and should be developed along with receiving practice. In fact

as much as a third of one's operating time (in aiming at higher receiving proficiency) should be spent in sending practice. Amateur operating will give all of our thousands eligible for these awards the needed sending practice. It will be well to check the way the key is held, see that the fingers and wrist are loose or flexible, muscles relaxed, and the forearm moving vertically for best straight key work. One should emulate tape transmission, and aim particularly at smooth even spacing between characters and words, to improve his sending. If it is found that certain letters are habitually distorted or slurred, special practice on these may help to overcome the difficulty; there is nothing like starting right, to cultivate just the right habits at the start of course, to speed up in perfect form. Regardless of the type of key the dot rate must be right (relative) to the actual sending speed. 10 w.p.m. sending with dots set for 30 w.p.m. is all wrong!

But one ham in four copied "on a mill." Quite a few said they had followed code in their head for years, and admitted the need for self-training to be able to put it down for accurate useful communications. A multitude of typewriters (verily) are being oiled up on the nightly practice transmissions. The new determination of many is now to master a typewriter (and coordination in copying on it). A high degree of enthusiasm for increasing Code Proficiency is evident. In conclusion—your interest in the new program is highly gratifying. Keep the copies of qualifying runs coming at us, and we'll try to keep up and do our part. It's a heap of fun to try, and your achievement will be recognized in QST as well as by certificate.

— F. E. H.

## Code Proficiency Certificates Issued

THE A. R. R. L. Code Proficiency program got off to a fine start on August 5th with the first official test run from W1AW. Listed below are the operators who qualified for certificates on that date. When it is known that original copy was made on a typewriter, this fact is indicated by an asterisk on the operator's call or name.

Certificates are awarded by the League on initial qualification in a particular speed, requiring only 100 per cent accurate reception for at least one minute of a run at a particular speed. Progress in proficiency in code reception will be shown after the initial test and certificate award, by a separate dated and initialed Silver Endorsement Sticker (a distinctive design for each speed).

In addition to the qualifying runs, W1AW transmits code practice each night except Friday. Some of the fellows are sending us copy of the practice as material to qualify them for certificates. It should be remembered that certificates are issued only for the official qualifying runs, once each month. The next dates on which you may try for your certificate or endorsement sticker are September 21st, October 17th, November 20th and December 17th. In sending in copy please state whether you are applying for a certificate or endorsement. If the latter, please indicate the last speed for which you have certification. Also, in sending copy kindly mark the particular one minute of solid copy that you believe qualifies you for endorsement. Taking into account the rate of speed (5-character words and spaces between them) this requires 89, 119, 149, 179, or 209 consec-

tive correct characters-and-spaces to make the 15-, 20-, 25-, 30- or 35-w.p.m. speeds, respectively.

Listen for W1AW on 1761, 3825, 7280, 14,254 or 28,600 kes. on the official dates and try your hand. The time is 10:15 p.m. (E.D.S.T. on September 21st, E.S.T. thereafter). Official text starts at 10:30 p.m.

35 w.p.m.:

W9QIL\*, W9GJB, W9YOP\*, W2KHY, W9QUY\*, W5DLZ\*, E3E2\*, W9NFL\*, W9GMV\*, W1KIE, W4FDT\*, W2LEI\*, W1LWH\*, W9YCR\*, W8AU\*, W8UXT\*, W1AOT, W3ADE\*, W1CTI, W3FED, W8DAE, W1BFT\*, W4GQM\*, W2MYK, W5CDZ\*, W9FA\*, W1VB\*, W9WIN\*, W8DOD\*, W2BZJ\*, W5NW\*, W6IOX\*, W2CJI, W9HLB\*, W1HY\*, W4BYW\*, W9VEE, W5HQX\*, W9VNB, W3ARK\*, W8RZF\*, K6EKE, W8BEN\*, W2CKK\*, W3IKW\*, W2DUP, W2EGT\*, W7DJP\*, W2MXP\*, W2LNG\*, W5HOB\*, W3AKB\*, W7EBQ\*, W4GCR\*, W6RNL\*, W9IHY\*, W2KBM\*, W8SLH\*, W9UUM, W9QPQ\*, W9CAA\*, W8SOY\*, W1KB\*, W9STG\*, W9ZQW\*, W3ECP\*, W6AM, W9EYH, W2ITX, W2ENZ\*, W6BMC\*, W7DES\*, W5DWW\*, W9RLB\*, W9CRK, W8JQE\*, W2JUJ, W3FBM, W9PNE, Edward Tong\*, A. R. Wisler, W1BDI\*, W1LVQ\*, W1TS\*.

30 w.p.m.:

W4EV, W2LPG, W4FNS, W9GJB\*, W3DVO, W1IKE, W8TW, W1JAH\*, W3DBG, W8HUX\*, W2MJV, W1MAN, W8SUW\*, W4DWU, W1ANA, N3ITW\*, W5EOA/8, W1BFA, W5GRN\*, W8TWS, W1MBS, W5HAC\*, W9MBG, W1LZ, W4GLL, W5EKK\*, W2JDC, W2HXI, W9NJP, W3FO\*, W8BYA, W1BDU, W3GRF, W4DVO, W6RYA, W8LEC\*, W8FPK, W8KZO\*, W8UEY, W3BWT, W4FCU\*, W1MPZ, W2BZB, W1GRK, W2JHB\*, W9YEX\*, W3BXE, W9KSM, W2CLC\*, W9CTG, W6RUU, W4EPT, W6PFK\*, W2BHW, W1FTJ, W. R. Faries, W5IGO, W4FMW, W2BWC\*, W. R. Foley\*, W5ETZ, H. W. Frank\*, W2GRG\*, W1KQY\*, W9KAQ, W5GZU\*, W2KPU, W8AQ, W2HCD\*, W9ZOO, W3DJ, W1AHC, W8BMA, W5BKH, W3FFE, W6QLU, W9GLI\*, W1KSJ, W2III, W3NF\*, W4ZU\*, W2SQ/2\*, W2KFB, W9OWU, W3HRS, W1EKU, W2KVL, F. E. Horner, W8KXS\*, W1LWA, W1P, W3DRO, W3CTX, W2GIC, W8EIU, W1BTG, W8DAQ, W9STW, W3FSP\*, W9GTR, W3RT, W9UJM, W9YZN, W9TH, W1AJK, W2ALK, W4FJR, W5HAJ\*, W3HTF, W2MT, W9HQZ, W9RQZ\*, W8EU, W1KFN\*, W1BJB\*, W2LHZ, W3BES, K4KD, W2LYH, W1MOG, W9FFV, W6AK\*, W2LYI, W8CED, W9ZYK, W9AOB\*, W8JSU\*, W8DZC, W7BGM\*, W9VKF, W1CFG, W8HS\*, W6CAE, W1BGZ, W9BRY, W9RYZ\*, W2FAQ, W6JJI, W9YXO, J. J. Orsyk, W6QQL\*, W5WG, W1FGN, W2LFR, W9WJO\*, W1BGP, W1MJG, W8ESR, W1EZ, W1ATU, W2MNT, W2LRW-W2MXR, W2HUG, W3IGK\*, W6OXM\*, W3QE\*, W4CBA\*, W5BUK\*, W8NCJ, W1ZR\*, W9DOU\*, W5GND\*, W3ARN, R. A. St. Onge, W8AJV, W6ONG\*, W8ROX, W9VDY, W9UZ\*, W1IGN, W8ITK, W9QYI, W1IN, W3AOC, W1AKS\*, W6ETJ\*, W8KPL, W9AEJ, W4BBZ, W9HXW\*, W6MUO, W1LVA, W1LNN, W7CKG\*, W6ESA\*, W5BEH, W1EVL, W9VID, W1CCF\*, W3PTJ\*, W9AYH\*, W4HRB, W1EFM, W1KDW, W9KUI, W1DOV, W5BOR, W1IMY, W8SIX, W8TWI, W2BMX, W8LIY, W1KXU, W3DGM, W3LIJ\*, W6FYR, W6FNG\*, R. C. Weise, W2GE, W3FIG, W8KWA, W9FGN, W6DTY, W2IYH, W2LXC, W8SNW, J. C. Wrennick\*, W2AJL\*, W2LAB, W8CVB, W8DNU\*, W6GTM\*, L. M. Converse, W8BJO, W9QMD\*, W5RH\*, W6BYQ, W9MUX, W1JPE.

25 w.p.m.:

W4EOX, W4FZO, W9DB, W8SAY, W8NPL\*, W8IOY, W8REC, W2NDQ, W3IWF, W2IR\*, W3EEW\*, W9ONI, W3HUS, W2MLW, W8PCW, W6HKN, W1MND, W9NBX, W1LHY, W1HWE, W9FWS, W1CBU, W8TFS, W9BZG, W9KPA\*, W5LLR, W9CSJ, W8UUD, W9NSU, W8LVH, W1KJF, W9JMG, W9IMI, W6PU, W9MBL, W2JY, W1LPM, W5AHT, W8FWU, W8EBR, W9DUX, W9GFF, R. Gabrielson\*, W8TUQ, W1BKG, W4DIN\*, W5GST, W8MJA, W9RQM, W2IEK, W1HRC\*, W3GOW, W2LU\*, W8ORD\*, W4AOB, W9RMI, W6MYT, W9NYU, W5INQ\*, W4GEE, W2AER, W3BAK\*, W4TZ, W9GRA, W4DBM, W1MBN, W3ICK, W1MJD\*, W8EUQ.

W8AVH, W7EQC\*, W9SEB\*, W9DBO, W2LWE, W2IYQ\*, W9NZE, W5GWL, W9MGN, W8OE, W6PBV\*, W1KWB, W1LIC, W8RN, W9WIS, W2HTH, W2AOJ, W5FMP, W2BOT\*, W9FCE, W9NCS\*, W8UHL\*, W9K01, W1ICA, W8CAT, W3FTG\*, W4FQR, W3FFN, W9KBL, W3LAY, W1BAV, W1MMU, W5GDH\*, W6PCP\*, W9NIU, W8SEI, W4DAH, W5HYW, W3ADZ, J. H. Pitman, W8PCI\*, W8SFI, W2MYI, W9BGH, W2CIZ, W1HXJ, W9YQE, W5HTI\*, G. R. Rochelle\*, W2MZZ, W9EYT, W1CPV\*, W2IVU, W8SQT, W2JKP\*, W8QJJ, W9QIX, W8AYS, W4GKL, W2NDG, W1KMH, W8QFN, W1JCK\*, W4CNZ\*, W2DXO, W6QXK, W9QOA, W8SS\*, W1JLT, W2JRG, W6PHZ, W3EPJ, W2BMG, W9BSX, W9EHO, W9OGZ\*, W5ITK, W3HC, W9IYA, W9HTU, W8TKW, W8RFR, W2MDI, W5DHT, W6MDB, W8SQW, W8TOJ, W7HXX, W9ACU, W6RNO, W1WS, W9QAU, W9BNI, W4ERG, W1AUN\*, W4FSA\*, W2LXN, W9CCE, W8TQH, W1MNG, W7AJ, W5HOC.

20 w.p.m.:

W4DIZ, W9FIC, W9DTE, W3ATJ, W8TMA, W1MLJ, W1HYF\*, W2ETS, E4GKO, W6HBR, W2GDK, W9PGP, Jonas Asplund, W9KYZ, W9NN, W1LKK, W1MLO, W8MTK, W3EXQ, W1GJ, W6BKY, W9QVA, W7ZN, W9CVU, W8JIW, W1FWH, W3IDQ, W6LPX, W9UWE, W2IBK, W8QCU, W2NCB, W8MHL, W1DFY\*, W3GUS/2, W8BSS, W3IEM, W5BB, W9DTK\*, W9ERN, T. K. Clifton\*, W2MLO, W8OJI, C. W. Cox, W5FGL, W2MDP, W1KZS, W1MTR, W9HKA, W8EOY\*, W1KLV, W4GFO, W1ZAC, J. H. Deady, W9VWL, W6LLH, W8UVF, W9GDQ, E. G. Dumas, W9FYB, W1MUP, W9QIP, W8SWB, W2MRJ, K6LKN, W9FVD, W3DAJ, W2MLL, W1FPS, W5GKB, W9JU, W1MAG, W1LOP, W1EHT, W8UVL, W5FAL, W8THN, W1KWU, W9QPZ\*, W8NXT, W1BQU, W8PVY, W9ACC, W4CXO, W9OWQ, W8BHK, W9RBI, W4MA, W1RH, W9ETZ, W4GHD, W1MJP, W3GRD, W1LVZ, W4EFE, W3INV, W4DDJ, W4BUC, W8AZU, W2KWR, W9PNX, W3ALF, W9WUU, W2MCO, W7FHW, W9TBB, W6SUD, W9QLZ, W2HBO, W9FAQ, David Kennedy, W8SVC, W8SVD, W8MTO, W2LSG, W3GXQ, W2LGK, W8LCO, W6MUF, W8QCW, W1PV, W9BQJ, W6DEP, W1LXE, W2MQV, W8BOT, W3ILN, W4GSE, W9TMM, W8SFV, W3FRE, W9OQP, W8NY, W8RSD, W4GTQ, W6RMT, W7GXD\*, W8OML, W4FQC, W3FQB, W3INT, W4EDR, W3HVQ, W4GOX, W4FVN, W5GWQ, W9YDQ, W1LWZ, W8UCZ, F. J. Orcutt, W8UKB, W3GNO, W9QKB, W2DQP, W9BIN, W4BDY, W8IFQ, W3HAZ, W8OMH, W2KEG, W4FXG, W1GXY, W2BYO, W1KVP, W4FVI, W8TZW, W1LKT, W8NFM, W8SPT, W1MVD, W3CBN, W9ARN, W6MHL, W5COP, W. K. Rowe, W1EFR, W9EUT, W9RNK, W9CBS, W2KMK, W9BKK\*, W3ATR, W9ANB, W2CGG\*, W1KTT, W9MFD, W9K1K, W9QNP, W1BWA, W3HRD, W8RUI, W3FUM, W5DNN, W9EWT, W2INF, W9ZAW, W2MDW, W1DOV\*, W9FTV, W9NYH, W2LYC, W7EDJ, W2LSQ, W4BFM, W8HKS, W2JEB, W4GHB, W3IHH, W2LRO, W. V. Warner, W2DOG\*, W4FRJ, W3HRT, W1APA, W1JOX, W2DQA, W3AIZ\*, W5EIJ, W2DKF, W2LBA, W2LJY, W6SGQ, W9NGG, W8TGH.

15 w.p.m.:

W8RVM, W6IYH, W2MCF, W6RXW, W4CJM, W1ALP, W9JQI, W6BDZ, W9AHG, W5FWD, W5HQR, W5IDN\*, W1GJJ, W8TMC, W1AGT, W3ARM, W4EPE, W4DPQ, W8NYW, W9GLG, W8IEH, R. L. Carey, W4AXP, W9UKB\*, W3IHN, W8IKM, W8UCY, W3BQP, W9KNT, W5HEE, W6SBO, W8UKH, W9GXQ, W2GDL, W8BWK, W9ODX, W9DFW, H. F. Down, W5DYS, W9MXT, W9NDA, W2MAS, W9MWR, W6NHW, L. J. Frenkel, W8UUA, W5CPC, W8SWA, W3GGT, W1AB, W5HA, W1MNM, W5AUT\*, W5HJF, W8TGH, W9SVZ, W9VMG, L. E. Hellman, W8UHV, W6BUJ, W1GZL, W1BAX, W8DFC, W9LHD, W2NED, J. W. R. Johnson\*, W9CVL, W3IGS, W9CJS, W2LCD, W3IOK, W1IDX, W3EEI, W3IDH, A. D. Krebel, W9ONS, W8AXH, W4AJE, W5TN, W3HBT, W8LCY\*, W1FWS, W8SJD, W9NVA, W1MIM, W5IMN, W3IOB, W1BPI, W1JWJ, W3EQF, W3EKV, W5HERX, W9BZN, W5IIB, E. F. Moorman, W4FDJ, W9CEY, W2DLO, W9FZM, W1HXE, W9LKW, W2GTA, W9VRN, W2KVE, W5HHC, H. L. Passenger

W4PGJ, W3HNQ, W9LAF, W1MPP, W8UQM, W9FRK, W3DLU, W1MCH, W2JSF\*, W2LXI, W2KJP, W3BYF, W6KRI, W7GCQ, W9ZWL, W8RMR, W5HWG, W4GBV, W3HXB, A. W. Speyers, III, L. A. Stapp\*, W1KR, W1JKH, W5IVC, W6NGC\*, W9SPO, W5HJO, W8UBW, W8LZY, W6SKJ, W9PRM, W8NVC, W9QMH, W2MXX, W8SNO\*, W6OMY, W9CPX, W3GWM, W1EAO, W3HWO, W3PWF, W8JHP, Geo. Zeppenfeldt, W3IWM, W5ITA, W8ENH.

## ARTICLE CONTEST

The article by Dick Nebel, W2DBQ, wins the C.D. article contest prize this month. We invite entries for this monthly contest. Regarding subject matter, we suggest that you tell about what activity you find most interesting in amateur radio. Here you will find an almost limitless variety of subjects. Perhaps you would like to write on working for code proficiency, participating in League contests, keeping schedules for traffic work, working in Section Nets, holding a League appointment, working on radio club committees, organizing or running a radio club, or some other subject nearer to your heart.

Each month we will print the most interesting and valuable article received. Please mark your contribution "for the C.D. contest." Prize winners may select a bound *Handbook*, *QST* Binder and League Emblem, six logs, eight pads radiogram blanks, DX Map and three pads, or any other combination of A.R.R.L. supplies of equivalent value. Try your luck!

## What Do You Do "In the Public Interest" to Justify Your F.C.C. License?

BY DICK NEBEL, W2DBQ\*

Too often we run across the ham who scoffs at operation of amateur networks. In idle moments we often rue the fact that these individuals became radio operators without first being educated as to the intricacies of the art and of the responsibilities that are theirs upon receiving their license from the Federal Communications Commission.

Amateur radio is referred to as a hobby, but we are decisively convinced that its present category is far beyond the familiar conception of the word "hobby." True, one of its functions is to provide pleasure and pastime to those connected with it without pecuniary interest. We who look upon it from the other side know that the United States Government is not spending time and money on a selected group of individuals without expecting some form of return that will be of mutual benefit to our several governmental services and the general public.

The scoffers previously referred to are usually a group of persons who have had a poor introduction to amateur radio and have thus started out on the wrong foot. The cause of this discrepancy lies squarely upon the shoulders of each of us as licensed radio amateurs. It is within our province to do something about this unfortunate situation which permits people to enter our ranks lacking serious intentions and who regard amateur radio only as a plaything with which to further their own selfish interests or to project their personalities via radio to a listening world (!), particularly since the advent of hundreds of thousands of all-wave receiving sets. We could use this medium of all-wave receivers to build up

\* A.R.R.L. Emergency Coördinator, RM, ORS, 1104 Lincoln Pl., Brooklyn, N. Y.



our prestige in the eyes of the public by conducting our transmissions in a dignified manner which would tend to bring respect from the listening public instead of the prevalent attitude of mild humorous interest.

Short-wave listeners hear a local amateur carrying on one of those contacts in a lighter vein and think, "What fun to be able to broadcast." The party arranges to visit the amateur, and it is at this first meeting that impressions are formed that are, in the future, the making of an amateur who will prove an asset to our personnel or a detriment to all concerned.

It cannot be too gravely emphasized that we should take pains to convince outsiders of the seriousness of our work and of the definite responsibilities we assume when becoming a licensed amateur. Explain that there are high standards to be maintained and definite services to be rendered in order to justify our existence as an organized group.

Message handling provides a readily accessible means of rendering service. Every time we deliver a message to a third party we make another friend for amateur radio. With the adverse conditions existing in the world today we cannot have too many friends. We can be very proud that our United States Government stands solidly in back of us as evidenced by our affiliation with the War and Navy Departments and representation at international radio conferences. We can hold this confidence by getting on the air and *doing something* to justify the use of frequencies that could well be used by commercial interests which, in this case, would provide the Government with a source of revenue instead of, as in our case, an expense to maintain.

There are a great many in our ranks who derive a large part of their operating pleasure from participating in A.R.R.L. networks, trunk lines, the A.A.R.S., N.C.R. and similar organized groups. These men comprise our "consistent traffic handlers." It is through their efforts that these organizations continue to function. They are thrilled by an evening of snappy traffic handling as much as a DX fan on his first Asian contact. This group of operators put all they have into rendering a valuable service to the public and the various agencies. However, there are many branches of interest in amateur radio, and every man certainly is privileged to pursue the type of work which most interests him and affords the greatest amount of pleasure to his way of thinking.

There will always be stations operating exclusively on c.w., on 'phone, on the higher frequency bands looking for DX, on the ultra-high frequencies, interested in experimental work, etc. This is as it should be. We do say, though, that every person who calls himself a radio amateur should be perfectly familiar with message handling, should know the proper form of setting up a message, how to count check, how to ask for fills, etc. We by no means say that every man should at all times remain one of our topmost traffic handlers, but he certainly should aim at experience to familiarize himself with operating procedure worthy of his title as an Amateur Radio Operator. As such, he should be able to fill the shoes of an operator when called upon in time of emergency.

Every branch of amateur radio of course offers some opportunity to contribute something toward the cause and to

#### Picnickers

The Seventh Annual Ham-fest and Picnic of the Ham-festers Radio Club of Chicago was a really big affair with approximately 2500 present (Aug. 4). The YL's at the doings got together for a group picture. Left to right are "Lucille" W9HTR; "Carrie" W9ILH; "Ethel" W9QV; "Esther" W9EFW; "Ella" W9UPF; "Elvera" W9TLJ; "Julia" W9LRT; "Carol" W9WWP; and "Edna" W9IKS.



## Brass Pounders' League

(July 16th-August 15th)

Call	Orig.	Del.	Rel.	Extra Del.	
				Credit	Total
W8GZ	23	78	1024	75	1200
W6FWJ	100	40	964	40	1144
W7EBQ			1120		1120
W9QIL	66	118	776	115	1075
W7EBQ			1044		1044
W9KG	32	44	872	44	992
W4PL	10	23	886	21	940
W3GKO	14	61	775	57	907
W60BJ	0	434	0	434	868
W9ZTU	484	47	280	17	828
W4DWB	25	61	686	38	810
W6PGB	47	102	543	92	784
W2SC	32	145	314	143	634
W8SJF	11	44	536	37	628
W5VQ	24	50	516	0	590
W6ROZ	22	24	520	18	584
W2ISQ	58	51	350	48	507
W3BWT	67	63	316	58	504

#### MORE-THAN-ONE-OPERATOR STATIONS

Call	Orig.	Del.	Rel.	Extra Del.	
				Credit	Total
KAIHR	750	514	30	482	1776
KAIHQ	332	230	516		1078
W50W	87	99	564	87	837
W2USA	533	52	34	43	662
W4FCU	5	9	478	8	500

These stations "make" the B.P.L. with total of 500 or over. One hundred deliveries+Ex. Del. Credits also rate B.P.L. standing. The following one-operator stations make the B.P.L. on deliveries. Deliveries count.

W9TKX 284	W6GFQ 197	W1BDU 109
W3QP 282	W4CUS 196	W3HRS 107
W6LUJ 278	W9OMC 150	W9NCS 104
W2LZR 228	W4AOB 127	

#### A.R.R.S.

Call	Orig.	Del.	Rel.	Extra Del.	
				Credit	Total
WLTW (W9QIL)	58	79	305	76	518

#### MORE-THAN-ONE-OPERATOR STATION

Call	Orig.	Del.	Rel.	Extra Del.	
				Credit	Total
WLM (W3CXI)	151	87	1862	48	2148

A total of 500 or more or 100 deliveries+Ex. D. Cr. will put you in line for a place in the B.P.L.

1 June-July.

render service to the public. We find that there is one type of radio amateur who contributes nothing, and he is the one against whom real amateurs may well be incensed.

This type of operator is the one who uses his station solely for his own benefit without thought for the interests and rights of others. He is the individual we referred to as scoffing at the attempts of others to do something worthwhile, the

(Continued on page 88)



# How's DX?



## HOW:

**T**HERE is just a touch of irony in that title as the old mill bats it out for the umpteenth time, and perhaps the name of this pillar should be changed to "What DX?" or "Remember When?", but it does no particular good to moan at this stage of the game, so let's take a look at what there is this month.

It's a little disappointing to look over the list of fellows who qualified in the first Code Proficiency tests and find so few of the DX gang listed. Most of the old reliables show up, the kind that can always be depended upon for everything, but an awful lot are conspicuous by their absence. Anyone who has haunted the high end for any length of time knows that there are plenty of the gang who can handle code with no difficulty at all. Of course, as Jeeves suggests, it could be that they can just whip up a bug into a terrific frenzy without being able to copy anything, but we like to think differently. Our hopes were high for a large showing by the DX gang in the Proficiency tests — we'd hate to think that they're all such big men that they can't fool around with anything so close to home. So, come on, youse guys — show what you can do.

The latest ex-almost-member of the DXCC got awfully mad when told of receiving the bounce and, confidentially, threatened to sue the League for something-or-other. Our not-so-much-of-a-hero, Mr. X, was alleged to have said, by no less an authority than Mr. X (and we quote), "Get me a lawyer. You can't do this to me." (End of quote.) At this point we would have liked to have said (censored by the editor), "Listen, Mr. X. Suppose we told the gang that the cards you submitted had been turned over to you by a foreign amateur for forwarding to us for credit for this foreign amateur, and you took the liberty of modifying the cards so that the call on them looked more like yours than his? Then suppose we mentioned your call — where could you get enough protection?" (End of censored portion.) But, having a very nice disposition (except when something like this comes up), we won't dwell on the subject any more except to mention that anyone interested in knowing the call of this latest culprit can obtain the information by sending two box tops from any box of bullets and a cancelled one-cent stamp, to cover the cost of mailing. Special rates for lynching parties.

## WHERE:

**A** LOT of fellows have asked us to give a list of the confirmations credited to the top DXCC members, and now is as good a time as any to comply. Unfortunately, when the DXCC was first started, no record was made of the station credited but just the country, so some of the lists won't show all of the stations that kicked through with a QSL. The first one we'd like to present is that old standby whose activities have been curtailed slightly this past year, not through lack of interest but because other work kept him busy, "Ham" Whyte, G6WY. We'll list the more juicy ones: Anglo-Sudan, CR6AF, Ascension Islands, Bahrain, Balearic Islands, Baluchistan, British Honduras, Bulgaria, Burma, Cape Verde Islands, Ceylon, J8CD, SV6SP (Crete), I7AA (Ethiopia), Faeroes Islands, VP8AD (Falkland Islands), Fed. Malay States, French Equatorial Africa, FISAC, ZB2A, Guam, Iceland, Iran, Kenya, EL2A, HB1CE, Luxembourg, Macau, Malta, Chagos, FP8PX, Spanish Morocco, Non-Fed. Malay States, Palestine, Paraguay, Northern Rhodesia, Southern Rhodesia, YS2LR, Siam, VPU2 (Sierra Leone), Tanganyika, Tunisia, Syria, Strait Settlements, Sumatra, French India, Z8SF, five countries in U.S.S.R., Tangier Zone, Tibet, Transjordan and Uganda. The rest are more or less common and include those that have had several stations active. (Jeeves, stop drooling!)

## WHEN:

**KH6SHS** doesn't seem to have put in an appearance this month — we'd appreciate any dope on the guy. (For personal reasons? — Jeeves.) There are still a lot of fellows who would like to work him. (You wouldn't be one, would you? — Jeeves.) It certainly is a problem these days to get any help that shows the proper respect, and vice versa . . . . Speaking of KH6SHS, W9YFV thinks we slipped up on that picture of Jeeves and the orchids in the August issue, since KH6SHS shouldn't come through in the East until about 1 A.M., and that's too late for any respectable date. What Eddie doesn't know is that we have a very peachy antenna called the "Signal Sucker" that drags them in regardless of whether they're on the air or not. (Wake up, boss. You have a column to finish. — Jeeves.) . . . . **KF6SJJ** (14,330 T9) is still quite active on Howland, according to W9YFV, W3OP and W6BIL. Another active KF6 is **W7DBR/KF6** on Canton, reported by W6PBV . . . . **KF6JEG** has moved to Jarvis and is signing **KF6JEG/KG6** (14,360 T9) . . . . W3OP also reports **KA1HR** (14,260 T9).

W2LZR has been busy on 7 Mc. with **K7GJW** (7050 T9x) and **K7ENA** (7100 T9), who come through around 1:30 A.M., EST . . . . W6PMA takes a crack at the same band and pulls out **K7LEB** (7025 T9), **K7HXS** (7060), **K7IGJ** (7070), **K7EFW** (7010, 7095), **K6NJZ** (7080) and **KC4USB** (7070). **K7HKB** (7060), **K7HGM** (7010), **K7QI** (7030) and **W6JZS/K7** (7005) were heard. The K7's come through from about 10 P.M.

On 'phone, W8ITH scrapes up what there is, including **KC4USA** (14,250), **KA1ME** (14,135), **KA1FH** (14,135), **KA1CM** (14,060), **KA1GB** (14,130), **KA7FS** (14,155), **KA1JH** (14,135), **KA1AK** (14,100), **KA1CD** (14,110), and **K7GNN** (14,175). Reg gives the address of KA1GM as W. C. Mitchell, 15 Don Jacinto, Caridad, Cavite, P. I.

## WHO:

**T**OM ARNOLD, who signs VU2AN in Baluchistan when ham radio is allowed, listens a bit every now and then, and says W signals didn't come through as well this winter as previously. But it's nice to know he's still there and interested . . . . K6SBM is the brother of KF6JEG . . . . XU3OF/XU8OF mentions that before certain laws went into effect they used to have a nice round table every Friday night, over in the East, on 20 'phone. Among those present were XU2MC (Marine) Peking, XU3OF (Navy) Chefoo, XU6MJ (Navy) Swatow, XU7HV (Navy) Poochow, KA1LB (retired Navy) Rizal, and KA1MN (Navy) Cavite. It looks like the Navy was ganging up on the Marines! . . . . W9FS is in line for congratulations on his recently-acquired better half. In the shuffle, Bert moved to a new hand-picked location where there is no noise and signals come in hours earlier than before only — there ain't no DX! Bert keeps his hand in, however, by a traffic sked with KA1HQ . . . . KE6SRA is slated to go to Wake Island, and will probably be there by the time this gets around to you . . . . K4KD is stymied in his three-band WAS by a W5 and a W9 who haven't QSL-ed. We understand medical men are still working on a cure for that affliction . . . . W7HOJ is proud again, this time that his 15 watts knocked off KF6SJJ and KA1HR . . . . W8OSL, when last heard from, had joined the service and was learning to be a meteorologist or something at Langley Field, Va. If we were in the mood for coming a pun, we could ask Jules, now that he's a meteorologist, weather or not there ever will be any more DX to work. (I quit after that. — Jeeves.) (We can do without that sort of thing. — Editor.) (I guess I'm not in the mood. — W1JPE.) . . . . With the recent trade of destroyers for island bases, the coming election may be determined by the DX gang and a

(Continued on page 82)

**MORE  
ON THE  
NC-200**

LAST MONTH we were discussing the new NC-200 receiver when we were interrupted through lack of space. If we recall correctly, we had described the coil system, RF performance and frequency drift, and were just getting around to the high frequency oscillator.

The twelve tubes of the NC-200 include a 6K8 which serves as first detector, and a 6J5 as oscillator. The 6K8 is not used in a conventional converter circuit, of course. It is simply a detector and mixer. By using a separate tube for the HF oscillator much higher stability can be achieved, not only because of the circuit isolation but also because of the greater freedom in designing the oscillator. An advanced form of the tuned-plate oscillator which we described on this page a few months ago is used. There is no detuning effect from the RF gain control, and the motor-boating or fluttering which occurs in most receivers when tuning in strong high frequency signals is absent. As an indication of the exceptional stability of this circuit, we might give some figures for the ten meter band, where a line voltage shift from 90 to 125 volts produces less than 1000 cycles change in tuning. This is a variation of less than .003 per cent!

A new crystal filter is used. Its selectivity range has been increased to make the filter equally useful on phone and CW. The phasing circuit has also been improved, with the result that rejection ratios as high as 10,000 to 1 are available when an interfering signal is only a few hundred cycles from the desired signal.

Additional aids to operating under adverse conditions are the series-valve noise limiter with wide range adjustable threshold and the tone control which will attenuate either high or low audio frequencies. All of which provide such flexibility of control that the operator can get the best receiver performance under all sorts of conditions, in all sorts of locations.

There has been much refinement of detail in the NC-200. The AVC, for instance, holds audio output constant within 2 db for input signals ranging from 10 to 100,000 microvolts. Standard AC models may be operated on batteries for emergency or portable use. All that is necessary is to plug in a battery cable in place of a dummy plug. This makes all necessary connections, and leaves the standby switch and speaker in operation. The B-supply filter is left in circuit to assist in filtering vibrator or dynamotor B-power units. Removal of the speaker plug disconnects the screen as well as plate circuits of the audio tubes, thus protecting the tubes and providing maximum current economy when using B-batteries.

We have taken two months to tell about the NC-200, which would seem like time enough to describe anything. However, when you look over a NC-200 as we hope you will, you will find that we did not exhaust our subject. It is quite some receiver!

WILLIAM A. READY



# "HEY... DON'T FORGET THE VIBRAPACK!"

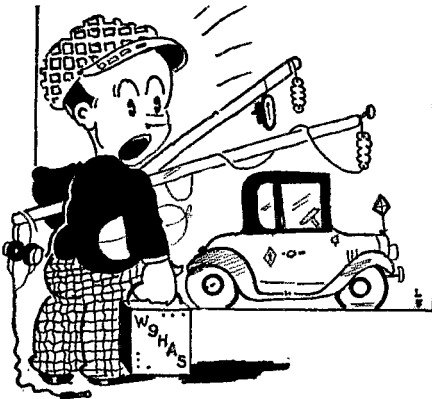

That's right, Charlie! You mustn't forget the Vibrapack,\* because it provides Perfect Portable Power for radio transmitters, receivers, and P. A. systems.

Vibrapacks have all the desirable characteristics necessary for an ideal portable or mobile power supply—

## 1. Dependability—

Proved by the thousands of police radio installations where Vibrapacks operate on a 24-hour-a-day schedule to give unflinching service.

## 2. Efficiency—

Which means noticeably less current drain from the storage battery.

## 3. Compact—light in weight—

Important where space is limited, or where weight is important as in airplane installations.

## 4. Low first cost—

A big investment is unnecessary—you will save by using a genuine Mallory Vibrapack.

## 5. Low maintenance cost—less time required for servicing—

The only part of a Vibrapack which normally ever wears and requires replacement is the long-life vibrator. It requires but an instant to install a new vibrator—compare this with the elaborate overhaul required by other forms of power conversion equipment.

Ask your distributor for technical data on Vibrapacks, or write for Form E-555C.

**P. R. MALLORY & CO., Inc.**  
INDIANAPOLIS INDIANA

Cable Address—Pelmallo

\*TRADE MARK REG. U. S. PAT. OFF.

Use

**P. R. MALLORY & CO. Inc.**  
**MALLORY**  
APPROVED  
PRECISION PRODUCTS

candidate's positive stand on whether or not those island bases will be allowed ham radio and count as new countries. Can't you just visualize campaign slogans like "Run Up Your Total With Roosevelt" or "Work More DX With Willie"?

—WJPE



(Continued from page 79)

so-called "radical of the air waves." His attitude toward delivering or handling a message is, "Why should I spend money, time and effort on something in which there is no return?" Such a person apparently places small value on the appreciation or understanding of others, of our real values. To such a query our usual rejoinder is "What in particular are you doing to justify the U. S. Government's issuing you a license?" This is a difficult question, but if every amateur had a legitimate answer to it we should never have to be concerned over the future of amateur radio.

To avoid the need to combat this radical we should see to it that none of this type is developed in our ranks. In a majority of cases a licensed amateur has a hand in getting another fellow started. As pointed out previously, we can make worthwhile amateurs who will be a credit to the art if we only will take the trouble to get them started on the right track. This should be considered the duty of each and every one of us.

## Hamfest Schedule

**October 5th, at Schenectady, N. Y.:** The Schenectady Amateur Radio Association Hamfest will be held Saturday, October 5th, at the Hotel Mohawk. Registrations made before October 1st, \$1.85; after that date, \$2.20. Send reservations to L. R. Hanrahan, 627 Charles St., Scotia, N. Y. Tentative program: Registration in the morning; technical talks and code contest in the afternoon (movies for the ladies); dinner at Club Petite, 6 P.M.; entertainment; prizes.

## BRIEFS

The list in June *QST* of holders of specially endorsed W.A.S. certificates should have included W7AFZ, whose certificate is endorsed for working all states on 14-Mc. c.w. An example of speed in working all states is given by W2MXP—he went on the air May 1, 1940, and on May 24th he had completed W.A.S. On June 24th he had received all cards and mailed them in for his certificate! W5IVG set for himself a 60-day limit to work all states. In 40 days he had worked 47 of them, Delaware being missing. On the morning of the 60th day he worked W3HC in Wilmington, so he made his goal . . . W.A.S. in 60 days after getting his ticket.

W8SES, Dunbar, W. Va., will transmit code practice for beginning amateurs on Tuesday, Wednesday, Thursday and Saturday nights at 9:00 P.M. EST, 1878 kcs. This schedule will start October 1st.

# "CONTROLLED" *Selectivity*

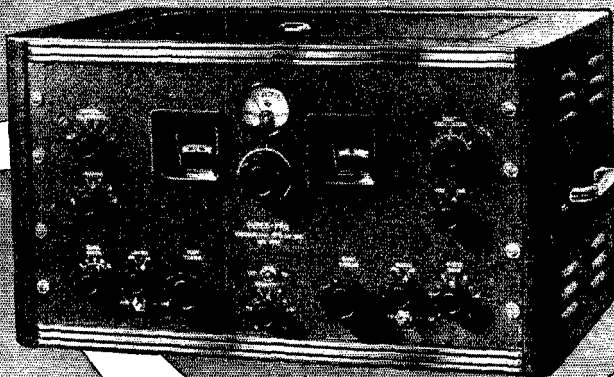
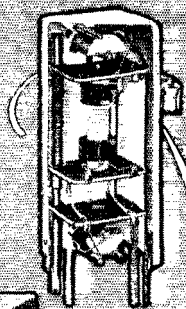

VARIABLE XTAL

VARIABLE IF UNIT

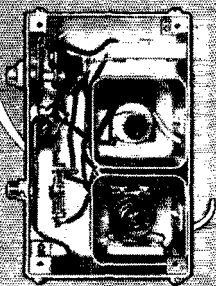

## SUPER-PRO *Series - 200*

THE owner of a "Super-Pro" never faces the problem of too much or too little selectivity. For high fidelity musical reproduction, there are available band widths up to 16 kc. with other degrees of selectivity all the way down to better than 1 kc. for single signal code reception. This smooth variable selectivity is your assurance of the best possible reception under practically all conditions. Besides having "controlled selectivity," the "Super-Pro" has two stages of T.R.F., three stages of I.F., noise limiter, and every other feature necessary for

top performance. Mechanically, every part in the "Super-Pro" is designed to give years of efficient service. The fact that "Super-Pro" receivers are used extensively by the U. S. Signal Corps and many other governmental departments, speaks for itself. Use the set the experts use!

### MAIL COUPON TODAY!

-----  
 HAMMARLUND MFG. CO., INC. Q-10  
 424 W. 33 Street, New York City  
 Please send "Super-Pro" booklet  
 Name.....  
 Address.....  
 City..... State.....



Canadian Office:  
41 West Ave. No., Hamilton

# HAMMARLUND

EXPORT DEPARTMENT, 100 VARICK ST., NEW YORK CITY

# YEARS AHEAD

TRIPLET

## 1941 Model 1696-A MODULATION MONITOR

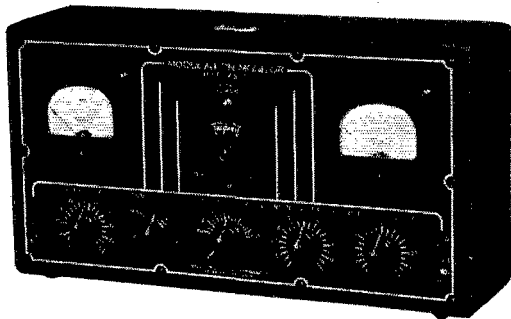

**YOU'VE** solved your problem of getting maximum efficiency from your transmitter when you invest in a Model 1696-A Modulation Monitor.

And . . . better yet . . . it saves you money by increasing your range without the added expense of remodeling your transmitter. (Amateur experience has shown that a properly modulated 10-watt rig can be as efficient as a 50% modulated 40-watt transmitter.) The Model 1696-A is easy to use. Plug it into your A.C. line — make simple coupling to the transmitter output and the monitor shows:

- **CARRIER REFERENCE LEVEL**
- **PER CENT OF MODULATION**
- **INSTANTANEOUS NEON FLASHER** (no inertia) indicates when per cent of modulation has exceeded your predetermined setting. Setting can be from 40 to 120 per cent.

Use of the monitor permits compliance with FCC regulations. Two **RED DOT Lifetime Guaranteed Triplet instruments**. . . Modernistic metal case, 14½" x 7½" x 4½", with black suede electro enamel finish. Black and white panel.

Modulation Monitor Booklet — regular purchase price \$1.00 — Furnished **FREE** with each Model 1696-A. Tells you what you want to know about this monitor, and includes details, including diagrams, for operation of Model 1696-A.

**Model 1696-A.** Amateur Net Price (U.S.A.) **\$34.84**

### Model 327-A . . .

One of Triplet's 25 case styles — Precision Electrical Measuring Instruments . . . Round, Square, Fan, Twin Cases, 2", 3", 4", 5" and 7".



For More Information — Write Section 2510, Harmon Drive

THE TRIPLET ELECTRICAL INSTRUMENT CO.  
Bluffton, Ohio

## Code Practice

**A** NUMBER of amateurs whose stations are equipped with automatic transmitting gear have volunteered schedules for the transmission of code practice at varying speeds. These schedules are presented below for the benefit of those operators who are trying to increase their speed. In addition, the schedules of a number of commercial stations which send press, weather and other information are listed. These have been reported to us by amateurs as providing excellent practice material. It should be noted well that press and other data specifically addressed *may not be divulged* except to the addressee. Amateurs are cautioned against using such material except for practice.

### Amateur-Band Code Practice

- W1AW — 10:15 P.M. EST,<sup>1</sup> except Fri. (15–35 wpm); 1761–3825–7280–14254–28510 kcs.  
W2KEZ — 6:00–7:15 P.M. EST, Fri. (20 wpm), Sat. (45 wpm); 3540.5 kcs.  
W2KYF — 9:00–10:00 P.M. EST, Wed. & Fri. (25 wpm); 3545 kcs.  
W6AM — 8:00 P.M. PST, Mondays (15–35 wpm); 14306 kcs.  
W7YG — 7:30–8:30 P.M. PST, Mon. (15 wpm), Tues. (20 wpm), Wed. (25 wpm), Thurs. (30 wpm), Fri. (35 wpm); 7022 kcs.  
W9IBC — 7:00–7:30 P.M. CST, Mon., Tues. & Wed. (15–25 wpm); 7004 kcs.

<sup>1</sup> EDST until Sept. 29th.

### Press and Weather Transmissions

(All Times Given are E.S.T.)

22 W.P.M.	1:50 P.M.	Mon. thru Sat.	WBE/WCB
	6:30 P.M.	Mon. thru Sat.	WBE/WJP
	9:00 P.M.	Sun. thru Fri.	WCR/WBG2
30 W.P.M.	Midnight	Mon. thru Fri.	WJP/WBG2
	5:00 A.M.	Mon. thru Sat.	WDH/WHL
	8:00 A.M.	Sun. only	WDH/WRK
	9:00 A.M.	Mon. thru Sat.	WDH/WRK
	2:00 P.M.	Daily	WDH/WRK
	6:15 P.M.	Daily	WRK
37 W.P.M.	7:00 P.M.	Daily	WRK/WHL
	7:00 A.M.	Mon. thru Sat.	WCX/WJS
	8:00 A.M.	Mon. thru Sat.	WCX/WJS
	10:00 A.M.	Sun. only	WJS
	11:00 A.M.	Mon. thru Sat.	WCX/WJS
	Noon	Mon. thru Sat.	WCX/WJS
	Noon	Sun. only	WCX/WJS
	1:15 P.M.	Mon. thru Sat.	WJS
	2:15 P.M.	Mon. thru Sat.	WJS
	4:30 P.M.	Daily	WCX/WJS
	5:15 P.M.	Daily	WCX/WJS
	6:00 P.M.	Mon. thru Sat.	WCX/WJS
8:05 P.M.	Daily	WCX/WJS	
8:50 P.M.	Daily	WCX/WJS	
10:05 P.M.	Daily	WCX	
50 W.P.M.	6:00 A.M.	Mon. thru Sat.	WPU
	6:30 A.M.	Mon. thru Sat.	WRM
	8:00 A.M.	Mon. thru Sat.	WRM
	10:00 A.M.	Mon. thru Sat.	WRM
	Noon	Mon. thru Sat.	WRM
	1:50 P.M.	Mon. thru Sat.	WRM
	2:50 P.M.	Mon. thru Sat.	WRM
	6:30 P.M.	Mon. thru Sat.	WPU
	8:45 P.M.	Mon. thru Sat.	WPJ
	9:15 P.M.	Mon. thru Sat.	WPK2

Frequencies: WBE 19850; WBG2 7615; WCB 15580; WCX 7850; WDH 19470; WHL 10750; WJP 8810; WJS 15700; WPJ 11640; WPK2 13185; WPU 14635; WRK 15910; WRM 18560.

### Miscellaneous:

- 3:30–4:30 P.M. IAC 12865 (Appx. 40 W.P.M.)  
5:00–8:00 P.M. GIC 8640; GID 13555; GIH 10650 (20 W.P.M.)  
6:00–8:00 P.M. DLE 10130 (Appx. 20 W.P.M.)  
6:30–8:00 P.M. DON 10128 (Appx. 35 W.P.M.)  
7:00 P.M. LOL 8690; PPR 8310; WFC 6785  
8:00 P.M. WAC 10470; WFD 4985

(Continued on next left-hand page)

# Your BEST BET!

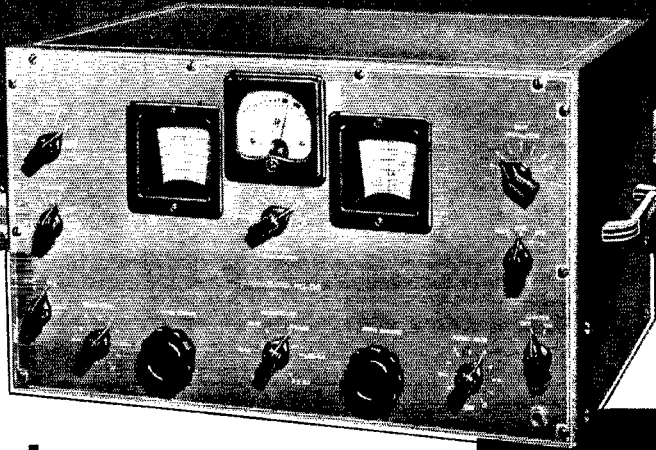

## for the coming SEASON! HQ-120-X

If you want to be up-to-date during the coming season, the "HQ-120-X" is your best bet. Not only does the "HQ" have all "modern improvements," but it has had them for over a year. Therefore, these new features have been tried and proved, which doubly assures you of complete satisfaction. Those who already have "HQ-120-X" receivers are now reaping the benefit of Hammarlund's advanced engineering. They do not have to buy new receivers in order to obtain calibrated band spread, variable crystal filter, antenna compensator, and the many other outstanding features which go to make up the "HQ." Join the thousands who have already

proved that the "HQ-120-X" is an outstanding amateur receiver.

See and hear the "HQ" at your jobber's and ask about the easy time-payment plan.

### MAIL COUPON TODAY!

HAMMARLUND MFG. CO., INC.  
424-438 W. 33 Street, New York City  
Please send 16-page "HQ" booklet.

Q-10

Name .....

Address .....

City ..... State .....



Canadian Office:  
41 West Avenue No.,  
Hamilton, Ontario

# HAMMARLUND

# ...of Growing Importance

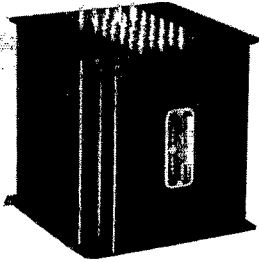

**T**HIS black, metal case — familiar alike to radio amateurs and manufacturers of quality radio equipment — grows in importance with time.

For years Kenyon Transformers have been specified in radio equipment where dependability was of importance. In the ordinary course of events their superior characteristics were taken for granted.

Today, however, when manufacturers of vital aeronautical, naval and military equipment must leave nothing to chance — must assure absolute reliability under every circumstance — Kenyon has proved the bulwark of 'total reliability'.

Thus, day by day, the *Kenyon* policy, "No compromise with quality," gains added significance and is of *growing importance* to the production of reliable equipment whether for Amateur, Commercial or Governmental use.

**KENYON TRANSFORMER CO.**  
INC.

840 Barry St.

New York, N. Y.

8:30 P.M. WPN 6410  
9:00 P.M. NSS 5965 (50 W.P.M.)  
10:00 P.M. KUP 6440; NAA 9250; NPG 12885; NSS 4525;  
XDP 4800; XDD 13043  
11:15 P.M. WSC 8430; WSL 5555  
Midnight KPH 8440, 12735; KTK 6400, 8680; NSS 4525;  
VAI 8330

## How to Adjust a Bug Key

WE ARE indebted to Robert R. Hall, W9CRO, O.R.S., Route Manager (Minnesota Net), who sends these excellent tips on how to adjust a bug. These points were compiled by W9CRO and W9HFF.

1. Adjust the pivot bearings (top and the bottom of the bug) so the armature is the correct height . . . contacts all on the same level. The bearings should be *just tight enough* so side play is *barely* perceptible.

2. Adjust the right hand armature stop adjusting screw so the armature *just touches* the damper wheel when the armature is held against this stop. (Damper wheel is to stop the armature swing and should not contact the armature more than *just enough* for this.)

3. Set the left hand armature stop adjusting screw so the end of the armature will oscillate, when the armature is moved against this stop with just a brisk movement, over an over all distance of about  $\frac{1}{4}$  inch (if dia. of tip of the armature  $\frac{3}{8}$  inch) or so end of the armature moves in an arc  $\frac{1}{2}$  inch long. Slight variation may be permitted.

4. Set the armature return spring so it just returns the armature against the right hand stop screw with enough tension to just prevent possible bounce when it strikes the stop. Armature should have no tendency to bounce from damper wheel. Tension on this spring should be *just enough to return it but should not be heavy*.

5. Set armature weights about  $\frac{3}{4}$  the way for slowest action. (After making adjustments of par. 6, place for weights can be accurately told if key is used on a transmitter with a plate milliammeter. With a straight key make dots at normal sending speed and note the milliammeter average peak reading. Return to bug. Set weights so ma. gives same reading on a series of dots.)

6. The dot contact screw should be set with great care. Push armature to the dot position and hold it there until the armature stops oscillating. Hold it there while adjusting contact. Contact screw should be set up until contacts make a *firm contact*. Contact should not be so light it arcs or misses. It should not be heavier than to just make a firm contact. Previous adjustments should be rechecked since some adjustments are interdependent. The bug should make dots for about five seconds with one stroke on the armature before they stop. Movement at the end of the handle should be about  $\frac{1}{8}$ th inch, when moved from a dead position to the dot position.

7. The dash contact adjusting screw which is also the stop should be adjusted so that the end of the handle has the same distance to move in making a dash as the handle has to move from the dead position in making a dot. About  $\frac{1}{8}$ th inch at the end of the handle.

8. The dash tension spring should be adjusted to require the same tension to make a dash as is exerted on the handle to make a dot which would be just slightly more than the tension on the armature return spring to equalize the added inertia in the armature when making a dot. These adjustments are average but suited to most occasions and close to the ideal.

A word or two on *how to key*:

Do NOT "bat" out the dots and dashes with the thumb and forefinger widely separated and power enough to push the bug around. Keying should be a smooth easy process of unbroken rhythm with a minimum of effort. Assume a comfortable position with the arm resting on the table. Grasp the handle lightly between thumb and forefinger. Control the action of the bug without much motion of the hand or fingers. Let the bug do the work, you just control it. A slight twist or roll of the wrist will change from dot to dash side. Relax and enjoy the bug.

### BRIEF

W9COR tells of a gang of 3.9-Mc. 'phone operators meeting each morning at 7:00. Known as the "89 gang," all reside in the eighth and ninth districts. Present membership is about 18. The group holds a reunion each year at some resort easily accessible to all members.



Choose YOUR FREQUENCY

THEN... select a **BLILEY CRYSTAL UNIT**

There's a dependable **BLILEY CRYSTAL UNIT**  
made for accurate frequency control  
in all popular amateur bands

Priced from \$3.35 up

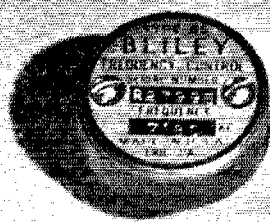

40 METERS  
TYPE B5

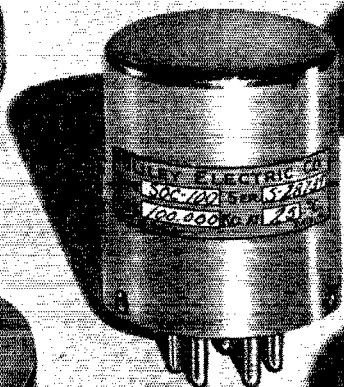

STANDARD FREQUENCY  
100KC. CRYSTAL UNIT  
TYPE SOC100

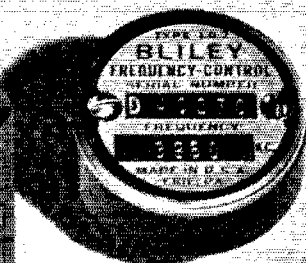

80-160 METERS  
TYPE LD2

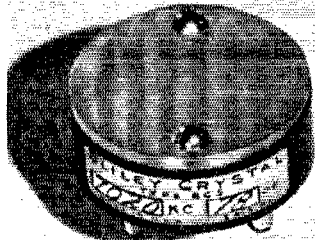

40-80-160 METERS  
TYPE BC3



10-20 METERS  
TYPE HF2

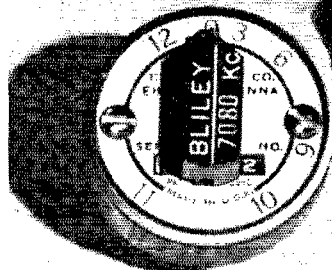

40-80 METERS  
VARIABLE FREQUENCY  
TYPE VF1

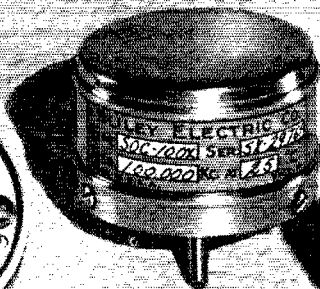

STANDARD FREQUENCY  
100KC. CRYSTAL UNIT  
TYPE SOC100X

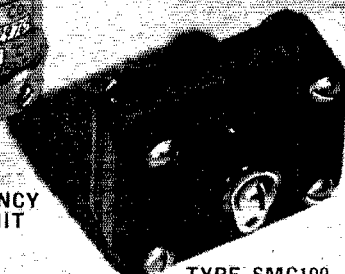

TYPE SMC100  
CALIBRATOR CRYSTAL UNIT  
100KC.—1000KC.

BLILEY ELECTRIC COMPANY, UNION STATION BUILDING, ERIE, PA.

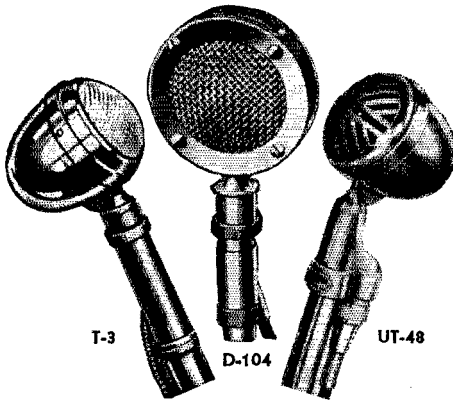

## A Trio of Dependable Crystal Microphones for Amateurs

These three models from Astatic's complete line of crystal microphones are favorites with amateurs because they provide dependable, high type performance with price moderation.

★ ★ ★

**MODEL T-3**—Tilting head model especially desirable for studio set-ups, amateur rigs, intercommunicating systems and high class recording. All chrome. List Price \$25.00.

**MODEL D-104**—Time tested and proven crystal microphone. Oldest in Astatic line. Modernized. Used by amateurs the world over. Sturdy and dependable. List Price \$22.50.

**MODEL UT-48**—Known as Astatic's "Amateur Special." A moderately priced speech-range microphone incorporating modern features. Tilting head. Satin chrome finish. List Price \$16.50.

See Your Astatic Jobber or  
Write for Catalog

# ASTATIC

**ASTATIC MICROPHONE LABORATORY, INC.**  
YOUNGSTOWN, OHIO

In Canada: Canadian Astatic Ltd., Toronto, Ontario

Astatic Crystal Products Licensed Under Brush  
Development Co. Patents

## W1AW Operating Schedule

Effective October 1, 1940

### OPERATING-VISITING HOURS:

3:00 P.M.—3:00 A.M. E.S.T. daily, except Saturday-Sunday.

Saturday — 8:30 P.M.—2:30 A.M. E.S.T.

Sunday — 7:00 P.M.—1:00 A.M. E.S.T.

**OFFICIAL BROADCAST SCHEDULE** (for sending addressed information to all radio amateurs).

### Frequencies

C.W.: 1761-3825-7280-14,254-28,510 kcs. (simultaneously)

Starting Times (P.M.)				Speeds (W.P.M.)						
E.S.T.	C.S.T.	M.S.T.	P.S.T.	M	T	W	Th	F	Sat	Sun
8:30	7:30	6:30	5:30	20	15	25	15	20	—	20
Midnight	11:00	10:00	9:00	15	25	15	20	15	15	—

PHONE: 1806, 3950.5, 14,237, 28,510 kcs.

Each code transmission will be followed in turn by voice transmission on each of the above frequencies.

### CODE PRACTICE:

Besides the O.B.S. times and word speeds given above, W1AW will adhere to a schedule for sending code practice transmissions at progressively increasing speeds (15 to 35 w.p.m. in 5 w.p.m. steps) *daily except Friday*, starting at 10:15 P.M. E.S.T. Proficiency Certificate Award qualifying runs start 15 minutes later than practice schedules on a date announced for each month. (Sept. 21st; Oct. 17th; Nov. 20th.)

### GENERAL OPERATION:

Besides specific schedules in different bands, W1AW devotes the following periods, except Saturdays and Sundays, to GENERAL work in the following bands:

Time, E.S.T.	Frequency
4:30 P.M.—5:00 P.M.	28,510-kc. 'phone/c.w.
6:00 P.M.—6:30 P.M.	14,237-kc. 'phone
6:30 P.M.—7:00 P.M.	14,254-kc. c.w.
8:00 P.M.—8:30 P.M.	14,254-kc. c.w.
9:15 P.M.—9:45 P.M.	3950-kc. 'phone
9:45 P.M.—10:15 P.M.	14,237-kc. 'phone
12:45 A.M.—1:15 A.M.	1806/1760-kc. 'phone/c.w.
1:15 A.M.—2:00 A.M.	3825-kc. c.w.
2:00 A.M.—3:00 A.M.	7280-kc. c.w.

7:00 P.M.—8:00 P.M.: Schedules on 3500-kc. band

10:15 P.M.—11:00 P.M.: Code Practice, all c.w. freqs.

11:00 P.M.—Midnight: National Trunk Line Net N.C.S.

At other times, and on Saturdays and Sundays, operation is devoted to the most profitable use of bands for general contacts and to participation in special week-end operating activities. The station is not operated on legal national holidays.

— — — —

## O.R.S./O.P.S. Activities

If you have a good 'phone, why not drop a line to your S.C.M. (address in each QST) for application blanks for O.P.S. appointment? A.R.R.L. Headquarters will also be glad to send information regarding O.P.S. work to any amateur who inquires, including sample copies of bulletin material as long as extra copies last. Every high quality 'phone station which is operated in line with correct practices should be included in the Official 'Phone Station roster.

The Official Relay Station appointment is primarily a traffic appointment, for amateurs interested in regular traffic work, schedules, etc. Opportunity is given all O.R.S. appointees to test station performance during quarterly QSO parties. The pleasure derived from these get-togethers can be fully appreciated only by participation. If sincerely interested in traffic handling, take steps now to obtain O.R.S. appointment! Drop a line to A.R.R.L. Headquarters or direct to your S.C.M. for complete details on how to become O.R.S. Act now and get ready for the big fall/winter season.

(Continued on next left-hand page)

for Every Application

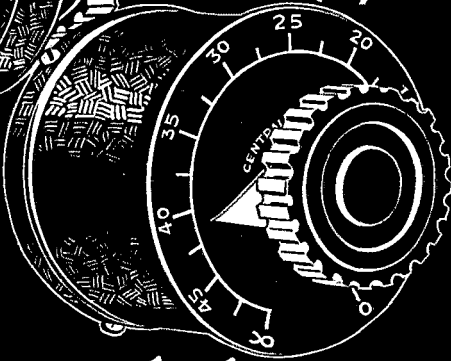
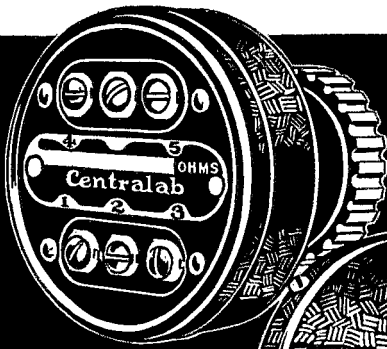

Series II

# Centralab SOUND PROJECTION CONTROLS

## CENTRALAB SERIES II

Controls are the finest for input circuits in broadcast stations, public address systems, and recording apparatus of new or old design. Will prove faultless in the most critical service.

The curve chart above shows the change in impedance and attenuation plotted against clockwise rotation for a "T" pad attenuator. The impedance characteristic (dotted line) is substantially the same at any setting. The attenuation curve (solid line) varies from infinity at zero rotation to zero Db. at full rotation. No insertion loss.

Electrostatic and electromagnetic shielding provided by a black finished steel case. Bakelite screw type terminal strip on back of case. All resistance elements insulated from shaft and bushing. Single hole mounting. Mounting bushing  $\frac{3}{4}$ " long with 2 locknuts and lockwashers. Case diameter  $2\frac{3}{4}$ ". Depth back of panel "T" Pad -  $2\frac{3}{4}$ "; Gain Control -  $1\frac{3}{4}$ ". Maximum load dissipation 1 watt.

For detailed information, write for technical booklet.

**CENTRALAB: Division of Globe-Union Inc.**  
MILWAUKEE, WISCONSIN

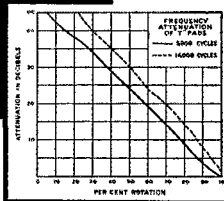
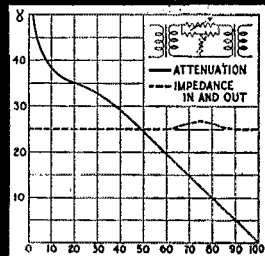

## ECONOMY P/A CONTROLS

These controls are intermediate to the series II line and the older series I types. As their name implies, they are economy controls designed primarily for inexpensive sound equipment where original cost is a limiting factor. They are designed for all types of fading and mixing systems. All units have soft aluminum shaft  $2\frac{1}{4}$ " from end of  $\frac{3}{8}$ " brass bushing. Small diameter bakelite case same dimension as Standard Radiohm. Non-rubbing contact for smooth, quiet operation. Limited to input applications. Maximum power rating for all units one watt.

Actual Size  
4 1/2" by 9 1/8"  
— 272 fact-  
filled pages



# GET YOUR COPY OF THE BIG SYLVANIA Tube Fact Book

272 Pages of Vital  
Tube Information  
Including  
Operating Conditions  
Tube Characteristics and  
Circuit Applications on  
374 Tube Types

USE THIS COUPON TODAY

## SYLVANIA

Set-Tested Radio Tubes

HYGRADE SYLVANIA CORPORATION  
Emporium, Pa. Q100

Enclosed is 35c. Please send me a copy of the latest  
edition of the Sylvania Technical Manual.

Name .....

Address .....

City ..... State .....

Serviceman  Experimenter  Dealer  Amateur

The mid-summer O.R.S. and O.P.S. QSO Parties went off very well in spite of the extremely hot weather. Scores ran higher than in previous summer get-togethers. There was quite a shuffle in the O.R.S. ranks and several new calls are noted among the "high ten." W4DWB, an old reliable O.R.S. Party man, topped the field, edging out old master W3BES. And in third place is W3EDP, who is a comparatively newcomer, having received his appointment in June. It appears that we will have an interesting season with much new blood. The old timers must look to their laurels!

W4DCQ was top man in the O.P.S. Party with a dandy summer score. W2JME makes second place for the second consecutive time. The others in the "high ten" are well known to the O.P.S. group. W2LXI, appointed in April, is coming right ahead in the parties!

The next quarterly get-togethers for O.R.S., O.P.S. and all League Officials are scheduled for October 26th and 27th.

### Official Relay Station Scores (July)

Station	Score	Stns.	Secs.	Diff. Stns.	Diff. Secs.	Heard	Power (Watts Input)	Operating Time
W4DWB	15,000,876	198	55	17	—	200	18 h. 15 m.	
W3BES	14,833,012	207	50	6	—	—	19 h. 20 m.	
W3EDP	12,167,820	201	51	1	—	600	14 h. 30 m.	
W1TS	11,729,250	182	52	—	—	350	14 h. 15 m.	
W0BRD	11,207,947	179	50	—	—	50-95	19 h. 50 m.	
W0RCQ	10,365,274	178	49	17	70/900	70/900	19 h. 10 m.	
W3DGM	10,353,420	182	49	15	—	30	20 h.	
W1BFT	9,322,500	181	45	20	—	—	13 h. 38 m.	
W0VES	9,218,700	171	46	32	—	—	20 h.	
W0TKX	9,053,322	168	49	9	—	225	18 h. 23 m.	

Station	Score	Stns.	Secs.	Station	Score	Stns.	Secs.
W9QPG	8,566,721	171	47	W5FZD	4,028,265	119	40
W6RBQ	7,980,687	116	43	W2AYJ	3,919,491	122	39
W2HXI	7,698,960	156	48	W3EML	3,937,200	132	38
W1MVH (1 KQY, opr.)	7,366,297	141	50	W9VOQ	3,876,955	127	36
W3HXA	7,254,224	154	48	W9QMD	3,817,298	114	43
W8ROX	6,625,000	155	45	W3BXE	3,804,696	134	34
W6PCE	5,984,084	109	38	W3IAY	3,778,666	130	33
W9YCR	5,929,200	134	46	W8DAE	3,587,328	124	38
W8FFK	5,521,110	140	43	W9AEJ	3,484,960	120	40
W6LMZ	5,295,205	98	41	W2KYV	3,351,537	121	40
W6PBV	5,065,728	96	40	W9YZN	3,186,225	116	37
W9CBJ	5,052,454	134	45	W8IVC	2,859,976	113	35
W6BAM	4,734,401	95	38	W4GIQ	2,816,410	112	34
W8SFV	4,645,520	133	43	W5DBR	2,701,895	94	39
W5KC	4,475,165	120	43	W7GPP	2,680,360	79	34
W3NF	4,436,640	118	40	W9NCS	2,531,349	100	37
W9BQJ	4,431,178	125	42	W1AW (Geo.)	2,507,648	103	34
W3IVJ (1M JY, opr.)	4,315,614	126	41	W4GNQ	2,329,408	98	38
W3GYQ	4,038,728	127	40	W2LMN	2,288,496	102	37
				W4NC			
				(4 oprs.)	2,148,300	115	40
				W4FDT	2,005,375	89	36

### Official Phone Station Scores (July)

Station	Score	QSO's	Secs.	Heard	Power (Watts Input)	Operating Time
W4DCQ	8,845	55	29	15	900	8 h. 18 m.
W2JME	6,175	45	25	11	300/500	5 h. 30 m.
W3HDJ	4,431	39	21	8	300-400	6 h. 50 m.
W9WXL	4,070	33	22	10	250	6 h. 35 m.
W2LXI	4,000	44	16	7	300	5 h.
W8VZ	3,781	37	19	7	600	6 h.
W4QJ	3,344	30	19	13	250	5 h. 30 m.
W8KBJ	2,869	29	19	3	200	4 h. 50 m.
W3DRQ	2,595	31	15	9	150	7 h. 20 m.
W6CHV	2,295	23	17	10	90	8 h. 20 m.

Station	Score	QSO's	Secs.	Station	Score	QSO's	Secs.
W1DWP	1,848	24	14	W9MWR	1,199	21	11
W8BFB	1,820	24	14	W5HXI	1,170	18	13
W1KTE	1,595	23	11	W8KSJ	900	20	9
W8QFN	1,536	22	12	W5EPB	880	16	11
W2HNA	1,508	22	13	W3EQK	847	15	11
W4EPA	1,476	17	12				

# THE RECEIVER BUY OF THE SEASON!

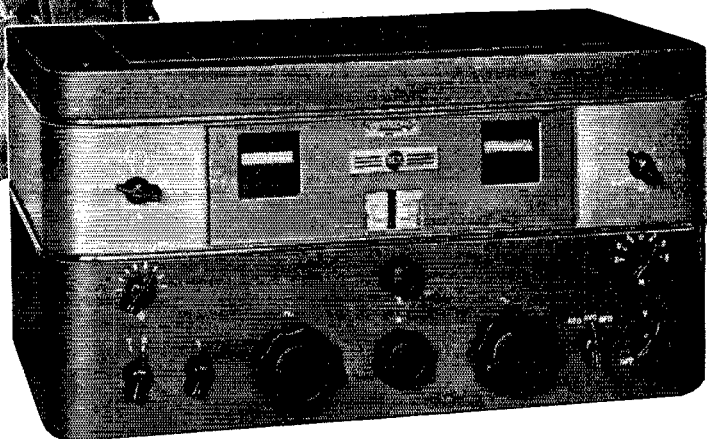
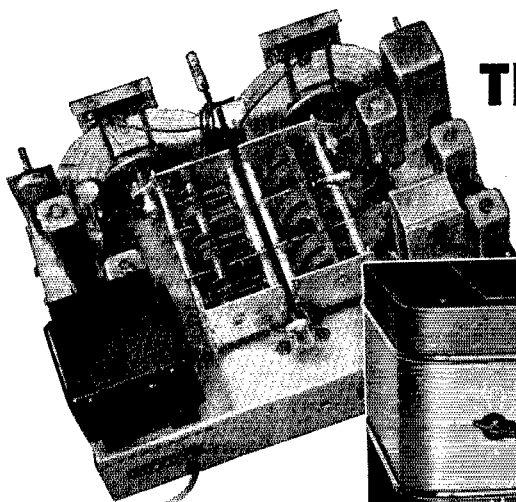

## AR-77 COMMUNICATION RECEIVER

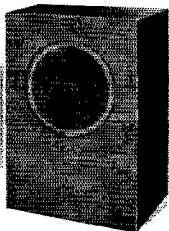

### Double-Purpose Value

During off periods of "QSO-ing", when you are busy experimenting or just relaxing, you will want some good entertainment programs. To meet this extra requirement, we offer a new Extended Range Loudspeaker MI-8314-A for the AR-77. A combination hard to beat for faithful reproduction of all modulated signals. Dimensions of the MI-8314-A Speaker are: 28" high, 18 3/4" wide, 13" deep.

Amateurs' Net Price for both AR-77 Receiver and MI-8314-A Speaker \$154.50

#### "STAY-PUT" TUNING

Tests under average conditions show maximum drift at 30 Mc to be only 3.0 Kc on one hour run, thereby keeping signal audible.

#### ADJUSTABLE NOISE LIMITER

Can easily be regulated to meet local conditions. Easily understood signals obtained through noise peaks hundreds of times higher than signal level.

#### "BREAK-IN" OPERATION

Used on a separate antenna, receiver recovers instantly when transmitter key is up. Ideal for "traffic hounds" to move a hook full of messages promptly. (Receiving antenna should resonate in higher frequency band than transmitter frequency to prevent excessive voltage pick-up from transmitter.)

#### HIGHEST SIGNAL-TO-NOISE RATIO

A 2-to-1 ratio of signal-to-noise is obtained at an average sensitivity of 2 microvolts throughout range.

#### UNIFORM SENSITIVITY

Each r-f circuit has dual alignment with air-dielectric trimmers for high-frequency end and inductance adjustment of coils for low end.

#### BANDSPREAD TUNING

Calibrated bandspread for 10, 20, 40, and 80-meter bands extends to nearly full rotation of dial for "split-kilocycle" readings. Carrier level meter serves for both peak tuning and to measure signal strength in popular "S" scale.

#### 6-STEP SELECTIVITY

Wide choice of selectivity assures operator control of signal interference.

#### IMPROVED IMAGE REJECTION

Image ratio of approximately 40-1 at 30 Mc is obtainable.

#### NEGATIVE FEEDBACK

Smooths out and extends the audio response curve.

**Give it a Whirl!** Other AR-77 features include Uniview dials; accurate signal reset; standby switch with relay terminals; temperature and voltage compensated oscillator; high-gain pre-selector stage and a popular tuning range of 540 to 31,000 Kc. Write for Bulletin. Amateurs' Net Price \$139.50. MI-8303 Table Speaker in matched cabinet \$8.00 extra. All prices f. o. b. factory.



# for Performance Plus

RCA MANUFACTURING COMPANY, INC., Amateur Division, CAMDEN, N. J. • A Service of the Radio Corporation of America

# HYTRON H. F. BANTAMS\* WITH CERAMIC BASE MAKE A GOOD RECEIVER BETTER!

More recently, W9HLF replaced the metal tubes in the h.f. circuits with a set of three of the Hytron GTX series. Some slight changes were necessary to suspend the compensating condensers over the glass tubes which are taller than the metal envelopes. This change resulted in an improvement in receiver sensitivity. WIKHE, following suit, experienced a similar improvement.

Take Full  
Advantage of  
Those Expensive  
Low-Loss Sockets  
in your  
Communications  
Receiver!



The above paragraph is part of an article which appeared under "Hints and Kinks for the Experimenter" in the September issue of QST. It merely bears out what Hytron has been saying all along — that by replacing those black-base tubes in your high frequency stages with low-loss Hytron ceramic-base types, your ceramic polystyrene sockets become useful instead of ornamental. Note especially the improvement at 7 to 60 megacycles.

Hytron GTX Bantams\* are laboratory-selected tubes tested for use in high-frequency communication receivers where maximum signal gain and circuit stability are essential.

6A8GTX	\$0.95 Net	6K8GTX	\$1.30 Net
6J5GTX	\$0.95 Net	6SA7GTX	\$1.05 Net
6J7GTX	\$0.95 Net	6SJ7GTX	\$1.05 Net
6K7GTX	\$0.95 Net	6SK7GTX	\$1.05 Net

All of the above are interchangeable with both metal and "G" types. Metal base ring grounded to No. 1 pin. Special Shield supplied.

\*TRADE-MARK REGISTERED



A DIVISION OF THE  
HYTRON CORP.

23 DERBY ST.  
SALEM, MASS.

HYTRON  
LABORATORIES

MANUFACTURERS OF RADIO TUBES SINCE 1921

## ELECTION NOTICES

To all A.R.R.L. Members residing in the Sections listed below:  
(The list gives the Sections, closing date for receipt of nominating petitions for Section Manager, the name of the present incumbent and the date of expiration of his term of office.) This notice supersedes previous notices.

In cases where no valid nominating petitions have been received from A.R.R.L. members residing in the different Sections in response to our previous notices, the closing dates for receipt of nominating petitions are set ahead to the dates given herewith. In the absence of nominating petitions from Members of a Section, the incumbent continues to hold his official position and carry on the work of the Section subject, of course, to the filing of proper nominating petitions and the holding of an election by ballot or as may be necessary. Petitions must be in West Hartford on or before the date specified.

Due to resignations in the Northern New Jersey and Oregon Sections, nominating petitions are hereby solicited for the office of Section Communications Manager in these Sections, and the closing date for receipt of nominations at A.R.R.L. Headquarters is herewith specified as noon, Tuesday, October 15, 1940.

Section	Closing Date	Present SCM	Present Term of Office Ends
Philippines	Oct. 1, 1940	George L. Rickard	Oct. 15, 1939
Idaho	Oct. 1, 1940	Carl Eichelberger	June 15, 1939
Alberta *	Oct. 1, 1940	C. S. Jamieson	Feb. 15, 1940
Kentucky	Oct. 1, 1940	Darrell A. Downard	April 15, 1940
Maritime *	Oct. 1, 1940	Arthur M. Crowell	June 15, 1940
Utah-Wyo.	Oct. 1, 1940	Ernest F. Parshall	Aug. 22, 1940
Tennessee	Oct. 1, 1940	Wladimir Harold Walker	Oct. 14, 1940
Michigan	Oct. 1, 1940	Harold C. Bird	Oct. 15, 1940
Ontario *	Oct. 1, 1940	Fred H. B. Saxon	Oct. 15, 1940
West Indies	Oct. 15, 1940	Mario de la Torre	Oct. 23, 1940
Kansas	Oct. 15, 1940	Meivin F. Kirby	Oct. 29, 1940
No. N. J.	Oct. 15, 1940	Joseph Jessup (resigned)	.....
Oregon	Oct. 15, 1940	Harold W. Johnstone (resigned)	.....
Georgia	Nov. 15, 1940	Leland W. Smith	Nov. 29, 1940
Quebec *	Dec. 2, 1940	Lindsay G. Morris	Dec. 14, 1940
Colorado	Dec. 2, 1940	Carl C. Drumeller	Dec. 17, 1940

\* In Canadian sections nominating petitions for Section Managers must be addressed to Canadian General Manager Alex Reid, 169 Logan Ave., St. Lambert, Quebec. To be valid such petitions must be filed with him on or before the closing dates named.

1. You are hereby notified that an election for an A.R.R.L. Section Communications Manager for the next two-year term of office is about to be held in each of these Sections in accordance with the provisions of the By-Laws.

2. The elections will take place in the different Sections immediately after the closing date for receipt of nominating petitions as given opposite the different Sections. The Ballots mailed from Headquarters will list in alphabetical sequence the names of all eligible candidates nominated for the position by A.R.R.L. members residing in the Sections concerned. Ballots will be mailed to members as of the closing dates specified above, for receipt of nominating petitions.

3. Nominating petitions from the Sections named are hereby solicited. Five or more A.R.R.L. members residing in any Section have the privilege of nominating any member of the League as candidate for Section Manager. The following form for nomination is suggested:

Communications Manager, A.R.R.L.  
38 La Salle Road, West Hartford, Conn.

We, the undersigned members of the A.R.R.L. residing in the ..... Section of the ..... Division hereby nominate ..... as candidate for Section Communications Manager for this Section for the next two-year term of office.

(Five or more signatures of A.R.R.L. members are required.)

The candidates and five or more signers must be League members in good standing or the petition will be thrown out as invalid. Each candidate must have been a licensed amateur operator for at least two years and similarly, a member of the League for at least one continuous year, immediately prior to his nomination or the petition will likewise be invalidated. The complete name, address, and station call of the candidate should be included. All such petitions must be filed at the headquarters office of the League in West Hartford, Conn., by noon of the closing date given for receipt of nominating petitions. There is no limit to the number of petitions that may be filed, but no member shall sign more than one.

4. Members are urged to take initiative immediately, filing petitions for the officials for each Section listed above. This is your opportunity to put the man of your choice in office to carry on the work of the organization in your Section.

— F. E. Handy, Communications Manager

## ELECTION RESULTS

Valid petitions nominating a single candidate as Section Manager were filed in a number of Sections, as provided in our Constitution and By-Laws, electing the following officials, the term of office starting on the date given.

Alaska	James G. Sherry, K7GNN	June 14, 1940
Santa Clara Valley	Earl F. Sanderson, W6FUZ	Aug. 15, 1940
Western Mass.	William J. Barrett, W1JAH	Aug. 17, 1940
Ohio	E. H. Gibbs, W8AQ	Aug. 17, 1940
Southern Minnesota	Millard L. Bender, W9YNQJ	Aug. 22, 1940
New Hampshire	Mrs. Dorothy W. Evans, W1FTJ	Sept. 1, 1940

In the Illinois Section of the Central Division, Mrs. Carrie Jones, W9LLE, and Mr. Dayton L. Warner, W9LPC, were elected and Mrs. Jones, electing the votes of 221, received 202 votes. Mrs. Jones' term of office began July 11, 1940.

# UNSUNG HEROES

OF AMERICAN SCIENCE AND INDUSTRY  
 - CHAPTER ONE -  
 "THE RADIOMETEOROGRAPH"

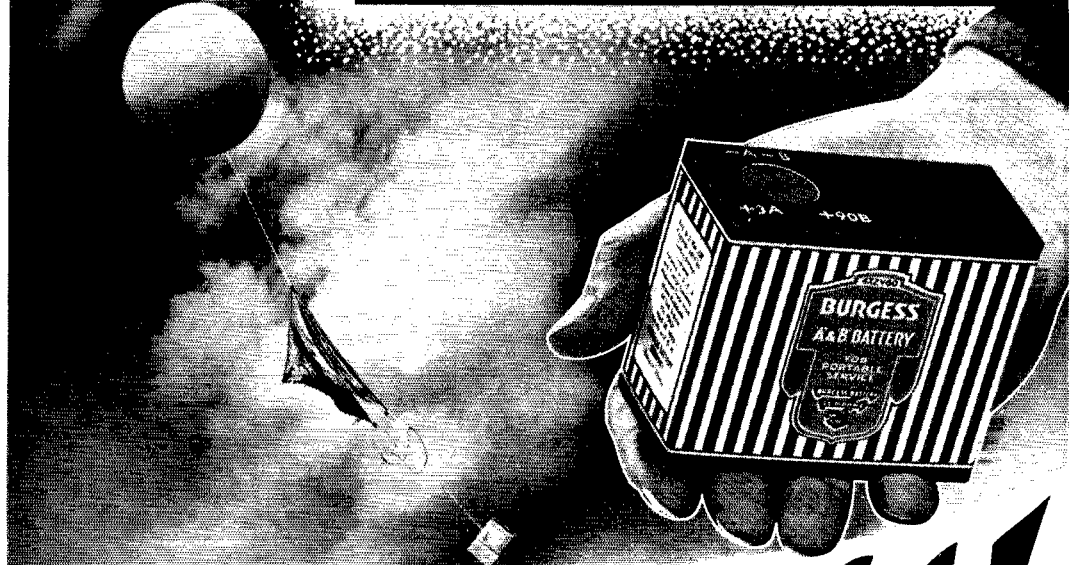

*Going Up!*



THE  
RADIOMETEOROGRAPH

The Radiometeorograph is in reality a special radio transmitter. When carried aloft by the balloon, it emits signals that are interpreted by the "ground crew", giving readings on the temperature, humidity, and air pressure encountered at various altitudes. A parachute is provided to return it safely to earth after its balloon has burst in the extremely thin air.

perhaps fifteen miles into the stratosphere. That's a long trip, straight up, even on business, and the radiometeorograph *is* on business. On its important errand any chance of power failure must be minimized. Burgess Engineers were consulted and the Burgess No. 4X2V60 was designed for this specific application and is the only battery used on these instruments.

It's really hard to believe—a combination 90-volt "B" and 3-volt "A" battery, with plug-in socket, all weighing less than 12 ounces—yet efficient and dependable.

You, too, can depend on Burgess Quality.

**BURGESS**

# HERE'S BIG VALUE

**RCP**  
dependable  
**TEST**  
instruments

## AC-DC "25-in-1" RCP MULTI-RANGE TESTER

### MODEL 446

3-inch square D'Arsenval Meter accurate within 2%.

DC voltmeter 0/5/50/250/500/2500

DC milliammeter 0/1/10/100/1000

SC ammeter 0/10

AC voltmeter 0/10/100/500/1000

3 range ohmmeter 0/500/100,000/1 Meg

Meter sensitivity 1 Milliampere or 1000 ohms per volt

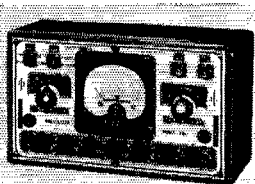

The equivalent of twenty-five complete instruments, this multi-range tester is in a class with testers selling for twice the price. Selector-switch operated, complete with batteries. Net. . . . . **\$9.95**

## AC-DC UNIVERSAL DE LUXE RCP MULTITESTER

### MODEL 414

DIRECT READING capacity measurements in 5 individual ranges reading from 0.0001 to 300.00 microfarads. 4½ inch Meter FUSED. 2000 ohms per volt sensitivity; accurate within 2%. Ultra sensitive low ohm range only 2 ohms center of scale.



DC volts 0/5/50/250/2500/5000

AC volts 0/10/100/500/1000/5000

DC mils 0/10/50/250/1000

DC amps 0/1/5/25

Capacity Mfd. 0/.03/.3/3/30/300

Megohms 0-1.5/15

Ohms 0-100/0-15,000/150,000

Open face bench type, hard wood case. Net. **\$21.95**

Send for the new RCP Dependable Test Equipment Catalog No. 124 describing this entire line of test instrument values. Prices as low as \$5.95.

RADIO CITY PRODUCTS CO., INC.  
88 PARK PLACE, NEW YORK, N. Y.

**RCP**

## Amateur Television

(Continued from page 21)

straight base instead of the 60-cycle ripple base obtained with connection to the screen of the vertical oscillator.

To check the frequency of the horizontal oscillator, the output of a variable frequency audio beat-frequency oscillator should be connected to the horizontal deflection-plate terminals of the oscilloscope. The test leads for the vertical deflection plates should be connected across the cathode of the first section ( $T_1$ ) on the horizontal oscillator. The beat-frequency oscillator frequency should be varied until it is the same as that of the horizontal oscillator as indicated by a single cycle on the oscilloscope. If no audio signal generator is available, the frequency tone may be heard by connecting a headset across the horizontal oscillator cathode resistor,  $R_3$ , through a small coupling condenser of approximately 100- $\mu$ fd. capacitance. The pitch of the audio tone should be approximately the same as that of the top black note on a piano.

To examine the wave-form of the various horizontal oscillator pulses, the external synchronization terminals of the oscilloscope should be connected across the horizontal oscillator cathode resistor through a small-capacitance coupling condenser. With the vertical deflection test lead connected across the same resistor, a narrow vertical pulse pattern like that shown in Fig. 4, page 34, May 1940 *QST*, should appear. A saw-tooth wave form should be obtained with the test lead connected to the plate of  $T_2$  of the horizontal oscillator, or the grid of  $T_1$  of the scanning output amplifier. A saw-tooth of the same pattern but of enlarged amplitude and opposite polarity should be obtainable at the plate of the scanning output amplifier.

A narrow peaked pulse should result with connection to the plate of Sync. Amplifier 1, and a similar pulse of greater amplitude and opposite polarity should result with connection of the test lead to the plate of Sync. Amp. 2. A square-topped pulse should appear with connection to the plate of the blanking amplifier. A similar pulse but of much smaller amplitude should appear with connection to pin No. 4 of the pulse generator output socket when the Iconoscope blanking level control,  $R_{31}$ , is fully advanced.

With external synchronization obtained by a connection of the oscilloscope's horizontal input to the Ike blanking terminal of this socket, and the oscilloscope sweep amplifier synchronized with the vertical (30-cycle) pulse, connection of the vertical deflection test lead to the modulator output terminal of the camera should give a pattern like that shown in Fig. 3, page 34, May 1940 *QST*. This shows the vertical blanking pulse with the synchronizing pulse superimposed. A similar picture of the horizontal blanking and synchronizing pulses should result with the horizontal sweep oscillator of the oscilloscope synchronized with the horizontal oscillator frequency.

It should hardly be necessary to mention that

(Continued on next left-hand page)



**150 WATTS OUTPUT  
WITH A SINGLE 35T**

**WINS DX CENTURY CLUB  
MEMBERSHIP FOR**

**ED HOPPER  
AMATEUR STATION**

**W2GT**

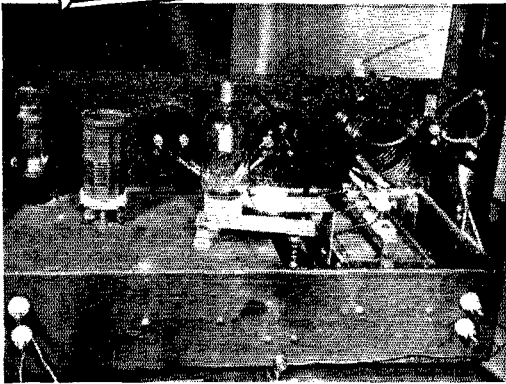

*Above is shown the complete station W2GT. At left is a close up of the lone Eimac 35T that was responsible for 150 Countries contacted and confirmed.*

Ed's success should be an inspiration to the amateur who operates a low power station—certainly it's a definite indication of what you can expect with an Eimac tube in your "rig." Ed says: "Choosing Eimac tubes was not accidental but, based upon the experiences of many friends who found, as I have found, that Eimac tubes give long life, dependability, stability, are easy to neutralize and easy to drive."

**EIMAC REPRESENTATIVES**

California, Nevada  
HERB BECKER, 1530 W.  
104th St., Los Angeles, Cal.  
Wash., Ore., Idaho, Mont.  
GENERAL SALES CO.,  
Verner O. Jensen, 2605-07  
Second Ave., Seattle, Wash.  
Colo., Wyo., New Mexico,  
Arizona, Utah  
RICHARD A. HYDE,  
4253 Quitman St., Denver,  
Colo.

N. Caro., S. Caro., Georgia,  
Tenn., Flor., Ala., Miss.  
JAMES MILLAR, 316  
Ninth St. N. E., Atlanta,  
Georgia  
N. Y., N. J., Penn., Md., Del.,  
Dist. of Col., Maine, N. H.,  
R. I., Conn., Mass.  
ADOLPH SCHWARTZ,  
14726 Elm Ave., Flushing,  
New York

Texas, La., Okla., Ark.  
J. EARL SMITH, 2821  
Live Oak St., Dallas, Texas  
Chicago, Illinois, Wisconsin  
G. G. RYAN, 549 W.  
Washington Blvd., Chicago,  
Ill.  
Ohio, Mich., Ky., Ind., Minn.  
Mo., Kan., Neb., Iowa  
PEEL SALES ENGINEERING CO., E. R. Peel  
154 E. Erie St., Chicago, Ill.



**35T**

**Eimac  
TUBES**

Eitel-McCullough, Inc.  
San Bruno, California

# ABBOTT—MRT-3

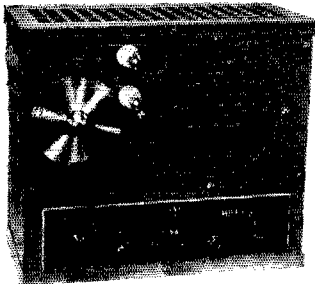

**2½ Meter  
Hi-Power  
Mobile  
Transceiver**  
20 Watts Input

Price  
**\$47.00 List**  
Less — 40%  
to Amateurs

The unit you need for your car operates from car battery and vibrator power supply.

Real transmitting tube Hytron HY-75 used in the R.F.

**EXTREMELY COMPACT**

Size 9" long — 8" high — 4" deep. Self contained PM dynamic speaker.

### FIXED STATION OPERATION

AC power supply is available for fixed station operation from 110 volts A.C.

**NOTE:** Portable and mobile operation on 2½ meters is permitted by the F. C. C.

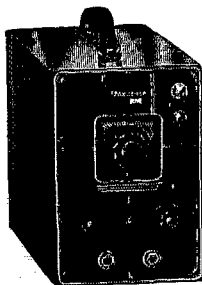

## DK-2

2½ METER  
BATTERY TRANSCEIVER

Ideal for summer portable operation — simple and convenient.

**List Price \$27.50**  
LESS TUBES AND BATTERIES  
40% Discount to Amateurs

**GENERAL:** The DK-2 is a completely self-contained 112 mc. radio-telephone transmitter and receiver, for use in your car, plane, boat, or while being carried, for portable work. It is very simple to operate. The working

range is between 2 to 30 miles depending on the location. Astonishing results have been obtained.

**BATTERY REQUIREMENTS:** Three 45 volt B batteries like Burgess 5308; and four No. 6 dry cells, or two Burgess 2F2H batteries.

SEE IT AT YOUR FAVORITE DEALER

Write for bulletin

## ABBOTT INSTRUMENT, INC.

51 Vesey Street

New York City

## EASY TO LEARN CODE

It is easy and pleasant to learn the modern way — with an Instructograph Code Teacher. Ideal for the beginner or advanced student. Many tapes available ranging from alphabet for beginners to typical messages on all subjects. Speed range 5 to 40 WPM. Always ready, no QRM, beats having someone send to you.

### FOR SALE OR RENT

**STANDARD** with 10 tapes and book of instructions, A.C. motor, . . . . . \$24.50  
With spring-wound motor, . . . . . \$18.50  
**JUNIOR** with 5 tapes and book of instructions (not rented), . . . . . \$12.00

**RENTAL** Standard with 10 tapes and book of instructions \$3.00 first month, \$2.25 each additional month. References or \$10 deposit required. All rental payments may be applied on the purchase price should you decide to buy the equipment.

Write for details today



## INSTRUCTOGRAPH COMPANY

Dept. O, 4701 Sheridan Road, Chicago, Illinois

Representative for Canada:

Radio College of Canada, 54 Bloor St. West, Toronto

additional capacitance should be connected across  $L_1$  of the horizontal oscillator if its frequency is too high. If the frequency is too low, less capacitance may be used for  $C_2$ , or more iron should be removed from the core of the transformer coil if there is any left. As has been stated previously, it is not necessary that the frequency of this oscillator be exactly 3600 cycles per second. Any frequency between 3600 and 3800 or even 3900 will do.

Even without a separate oscilloscope to make the foregoing tests, the over-all performance of the pulse generator may be checked on the monitor of the camera unit. With switch  $Sw_1$  of Fig. 1 in the "Frame" position (designated "F" in the circuit diagram) a picture like that of Fig. 5, page 35, May 1940 *QST*, but with a straight base line and no video "haze," should appear. With this switch in the "Picture" (P) position, and with the monitor bias properly adjusted, a rectangular illuminated area should appear on the screen. The width and height of this area are adjusted to occupy a desired part of the total screen surface by manipulation of the vertical and horizontal size controls of the pulse generator unit. This scanning area (raster) should be centered on the screen by adjustment of the monitor horizontal and vertical centering controls on the side of the camera unit. This rectangle should have straight sides with fairly sharply defined edges when the monitor focusing adjustment is properly set. If the top and bottom edges do not line up horizontally, the monitor tube socket should be slightly rotated by loosening the socket mounting screws and moving the socket one way or the other, from the back.

When the monitor operation has been checked as just described, the monitor tube should be removed and placed in the Iconoscope socket. A scanning area of the same size should appear with adjustment of the Iconoscope bias control. The approximate setting of the focus control also should be checked for adjustment for sharpest definition of the edges of the scanning area. In this case the scanning area will be rotated 90 degrees because of the differences in socket connections characteristic of the Iconoscope.

When these preliminary tests have been made and the approximate control settings have been noted, the monitor tube should be replaced in its own socket and the Iconoscope should be placed in its socket. The Iconoscope output connection to the grid of the first video amplifier is made through a small ceramic bushing (Millen No. 32150) pushed through a ¼-inch diameter hole in the bottom of the Ike mount immediately below the signal tab and held in place by softening the lead collar on the inside. Braided shield over the grid lead is carefully soldered to the lead flange on the outside and grounded to the grid shield of the first video amplifier tube. The tinned flexible lead extending through the bushing is bent over and carefully soldered to the signal tab of the Iconoscope. Prior to this, of course, the Ike coupling resistor,  $R_1$ , will have been soldered to the exten-

(Continued on next left-hand page)

# 35 WATTS

## Build It Yourself!

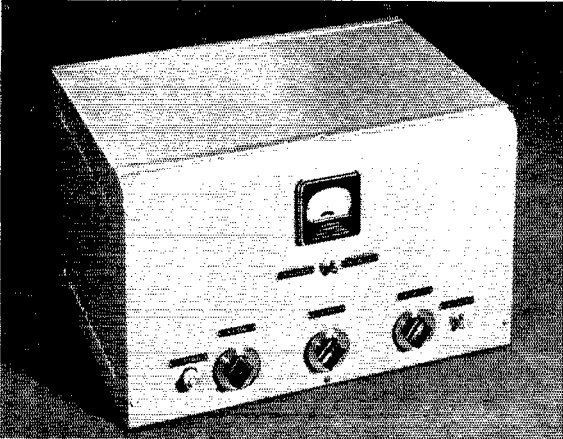

35 Watt Phone-CW Transmitter

**T**HIS new Thordarson kit makes a flexible, easy to build, single-unit phone & CW transmitter. It covers the 160, 80, 40, 20 and 10 meter bands by means of stock plug-in coils. The power supply and Class B audio amplifier are included on the same chassis as the RF section.

A 6V6-G harmonic crystal oscillator circuit easily provides enough driving power for the 6L6-G final modulated amplifier. Harmonic operation of the crystal oscillator may be obtained when using 160, 80, and 40 meter crystals.

When properly loaded for phone operation the power input to the final amplifier stage is 35 watts. The modulator consists of a 6A6 operating in Class B.

This stage is driven by another 6A6 triode with its two sections in parallel. Sufficient gain is realized in this stage to obtain 100% modulation when using a high quality carbon microphone. A low impedance variable link is provided to couple the transmit-

ter to double antenna or to an antenna matching network.

Available in complete Kit form at your local Thordarson Distributors. Ask for free Bulletin SD464.



Amateur's net price, less coils, crystal, meter and tubes:

\$43.50

### NEW TRANSMITTER GUIDE

14 designs— from a 20 w. CW to a 1000 w. model, including 2 mobile types— pictured and described in fine detail in the new Thordarson Transmitter Guide. Just off the press! Obtain your copy now from your Thordarson Distributor. Or write the factory. Ask for Guide No. 344-E, 15c Postpaid.

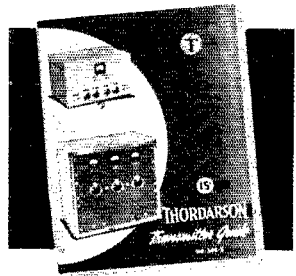

*Transformer Specialists*

# THORDARSON

Since 1895

500 W. HURON ST., CHICAGO

# RADIO TRAINING



**P**ORT ARTHUR COLLEGE — not privately owned, not operated for profit, a college built and endowed by the late capitalist-philanthropist, John W. Gates — offers the most thorough practical Radio training in America. P. A. C. owns Radio Station KPAC, which is equipped with the very latest type 1000-Watt high fidelity RCA transmitter, operating on 1220 kc. with directional antenna system. The college is authorized to teach RCA texts. Additional equipment consists of the latest type Marine and Airways Transmitter installation complete; SOS Automatic Alarm; Marine Direction Finder, two-way Television Transmitter and Receiver; Trans-radio Press Receiving Equipment; laboratory facilities where every phase of practical radio assembly technique is taught. Students assemble composite transmitters, audio amplifiers, RF amplifiers, etc. The Radio training covers thoroughly Airways, Press, Announcing, Teletype, Typewriting, Laboratory and practical experience at KPAC transmitter, control room and studios. Announcing is an optional part of this training; nevertheless a number of students annually make successful announcers.

Port Arthur College pioneered the teaching of radio with its first classes in 1909, and for thirty-one years has maintained an active Employment Bureau that is successful in placing graduates in airways, broadcast and marine radio industries.

*If interested in details about the Radio Course, write for Bulletin R*

**PORT ARTHUR COLLEGE**  
**PORT ARTHUR (World-Known Port)**  
**TEXAS**

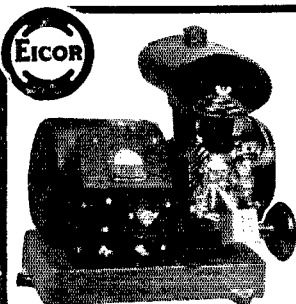

**EICOR INC.**  
 Export: Ad Aur Iema, Inc., 118 Broad Street, New York

## UTILITE Power Plants

Plenty of power at low cost! Matchless Dependability. Complete line from 200 to 2000 Warts AC and DC. Write T day for Dat .

513 SO. LAFLIN STREET  
 CHICAGO, U.S.A.

sion of this lead through the bushing and to the head of the front Ike mount support screw, as indicated in the schematic of Fig. 1.

Before putting the complete outfit into operation with the lens in place, the Iconoscope bias control should be turned all the way negative (to the left). With the lens in the approximately correct position as previously determined from knowledge of its focal length, the camera should be aimed at a suitable test pattern illuminated with one or two No. 2 Photoflood lamps. For this test pattern, a large "X" made of strips of black paper about 1 foot long and 1 inch wide pasted on white cardboard is suggested. This should be placed 3 or 4 feet in front of the camera with the photoflood lamps, say one on either side, about 1 foot away. In the present rig, a simple f3.5-2-inch focal-length camera lens has been used successfully. This lens was picked up second-hand for \$3. Focusing adjustment as well as a diaphragm are included in the lens mounting, so additional provision for these is not required.

It is absolutely essential that adjustment of the Iconoscope controls be made very slowly and carefully. The grid bias adjustment is especially critical and the focusing is almost as critical. It either is slightly off the correct setting, nothing resembling a picture of the object being televised will appear on the monitor. There is some interlocking between the monitor brilliance and the Iconoscope bias adjustment, so each should be reset when the other has been changed. However, a little practice will make the operator familiar with these minor peculiarities and ultimately bring realization of the full capabilities of the equipment.

One peculiarity that will be noticed when a pattern containing a black object extending horizontally over about half the picture width (against a light background) is the appearance of white "shadows" at either end. The converse occurs with white against a dark background. This is the result of the restricted low frequency response and is the only major point on which this television system merits adverse criticism. However, in practice actual scenes which contain subject matter of this type are seldom encountered, especially in close-up views, so it is not a particularly important deficiency.

In closing this story, the prospective constructor is warned that he is in for many hours of absorbing activity in exploring the many facets of amateur television, using just the equipment described in this story and without putting a signal on the air at all. The many seeming complexities of television theory rapidly become familiar elements of relative simplicity, and more is learned in a few hours of practice than all one's previous reading and theorizing ever promised.

And it's fun.

**SWITCH  
 TO SAFETY!**





# Station Activities



## ATLANTIC DIVISION

**EASTERN PENNSYLVANIA** — SCM, Jerry Mathis, W3BES — The Harrisburg Amateur Radio Club plans a Hamfest at Picketown in September. — W3ADE. Passed all the necessary examinations for one of the new F.C.C. monitoring jobs. — W3ADZ. By working 3APT on 14 Mc. have now completed a three-band W.A.S. — 3AGV. Was appointed alternate N.C.S. in the Army net and sign WLMB. — 3AOC. By October first the Eastern Penna. Net will be in full swing. Any O.R.S. wishing to join please write. — 3AQN. Taking the fatal plunge September 14th. — 3BLL. Spent most of my time building new 56 Mc. equipment. — 3BRZ. Received my 30 w.p.m. code proficiency certificate. — 3BXE. Received my code proficiency award for 30 w.p.m. — 3DRO. Having a lot of fun on 3.5 Mc. after a lifetime on good old 7 Mc. — 3FEW. Renew O.O. and O.B.S. work Sept. 1st. — 3FJU. Trying 7 Mc. with about 60 watts at present. — P.A.M.L. 3FPC. Took points. — 3FXZ. Went sissy and built a phone. — 3GDI. Busy rebuilding after a hectic O.R.S. Party. — 3GHI. Made my first million in O.R.S. party. — 3GOW. 3GUV and myself will be operating with the 108th F.A. P.N.G. — 3GYK. 3HFD has added a baby YL to his family. Congrats, Frank. Built a Perrine e.c.o. for 3EHC-3HFE. 3IAY used a lot of sales talk trying to get us to the Harrisburg Hamfest. Will be back in W. Va. within three weeks so will see you fellows next summer. Will sign 8UNH. — 3IWC. July 30th storm laid my Vee beam on the ground so only got S8 from KA1HR. — 3QP. Helped to keep the 3910 kc. channel clear during the S. Car. hurricane. — 8EU. Enjoying the A.R.R.L. code practice. — 8OML. Back on c.w. for short while; certainly feels great to get back to the swing of the bug. — 8QGG. Am staying with cousin 3GYI in Philly. — 8TAH. Operated on 7136 and 7153 kc. all month. — 8UQM. The A.R.R.L. code proficiency campaign is meeting enthusiastic acceptance in this area. In addition to those mentioned above 3GRF, AGV, BES and HTF received 30 w.p.m. and 3IKW is flaunting his 35 w.p.m. ticket.

Traffic: W8ADE 12 AGV 2 AKB 14 AOC 28 (WLMB 259) AQN 1 BES 35 BXE 19 DRO 7 HEE 12 GDI 2 GKO 907 GOW 7 GYK 6 HFD 5 HFE 6 HWS 291 HZK 67 IAY 4 IWC 16 QP 408 SASW 26 8EU 16 8UQM 1.

**MARYLAND-DELAWARE-DISTRICT OF COLUMBIA** — SCM, Hermann E. Hobbs, W3CIZ — Ass't SCM, Ep Darne, W3BWT, Chief R.M.'s: 3BWT, R.M.'s: 3CDQ, 3CXL. Regional Coördinator: 3ZD. DRD was in Northern New York along with GYQ for Army maneuvers, as was EZN. BAK is keeping schedules with his son in Chicago area and his daughter in New Hampshire on 7 Mc. EKZ, GXO, FAM, CVA and E. J. Nichols were the delegation representing Baltimore, Md., at the Roanoke Division Convention. Rock reports 22 from Baltimore attended D.V.R.A. hamfest at Trenton, N. J. ZD vacationed in Florida with his family and excellent portable station. CDQ worked in F.T.S. Y.L.R.L. two weekend parties. Eighteen members of Washington Radio Club attended Roanoke Division Convention. Won prize gavel for Club having largest number present. Present were: AWS, BWT, CDQ, CZE, DAP, DK, DXJ, ESO, FGD, FQB, HTK, HTW, IBS and WU, plus YL's and XYL's. The Washington Radio Club held its second summer picnic near Miller's Cabin, Military Road, August 24th. Games and "wienie" roasts, were enjoyed by all present. HN, ZD, FZ and BWT were on the air during recent southern hurricane to help if needed and keep clear channels into Washington to the affected area. Well, gang, the "Boom Season" for our hobby is on. Don't forget your reports to the S.C.M. He wants to know all about your Club and individual activities. Write him, so he may let the rest of Hamdom know what an active, smooth running Section we have here. 73 to all. Ep Darne, Ass't SCM.

Traffic: W3BWT 504 HIZ 22 WU 3 EKZ 1 CXL 84.

**SOUTHERN NEW JERSEY** — SCM, Lester H. Allen, W3CCO — Ass't SCM and A.A.R.S. Liaison R.M., Ed G. Raser, W3ZI — N.C.R. Liaison R.M., Ed B. Kerr, W3CCO — Regional Coördinator in charge of Emergency Coördination, Ted Toretti, W3BAQ — R.M.'s: 3BEI, 3BYR, 3EUI — P.A.M.: 3GNU — Section Net Frequencies: O.R.S. — 3700 kc. O.P.S. — 1980 kc. Your SCM requests that all

Club secretaries (affiliated and non-affiliated), appointees, brother amateurs send in a report each month immediately on the 10th as my report to Headquarters is due on the 20th. The most outstanding chatter around the Section this month has been on the Delaware Valley Radio Association's Outing and Hamfest. The attendance was a little over 400 with 26 States represented. 3FDY, 3FMF, and two other unidentified amateurs flew to the Hamfest in their Taylor Cub plane, the Baltimore Amateur Radio Association chartered a bus, two amateurs came on a bicycle from Philadelphia, one fellow hitch hiked from Asbury Park. 3QV, our Honorable Director, made his yearly appearance and gave the boys first information on the available jobs as Radio Operators that the F.C.C. is offering. 3BAQ had a portable emergency set-up and aroused quite a little interest in Coördinator and A.E.C. work. 3KW, Coördinator in the Camden area, also had his portable-mobile equipment on display and through these efforts 12 boys in the South Jersey Section signed up in the A.E.C. Supporting Division and a few applications were received for L. I. and Eastern Pa. sections. A Phone vs. C.W. baseball game was played and the C.W. boys took over the Phones by the score of 11 to 8. The big game between the 2nd and 3rd Dist. was won for the first time by the 2nd Dist. by the big score 11 to 0. The South Jersey Radio Association is planning a big banquet to celebrate its 25th anniversary and the Delaware Valley Radio Association is planning a celebration for its 10th birthday. GLY lost his antenna tower in the last wind storm. VX has a new 60-ft. lattice tower in the backyard (with lights and all). BAY, CGV, 2IUP and 3VX installed a 112- and 56-Mc. hookup for the Sailboat races at Sea Side which worked out very fine. IOK of the D.V.R.A. won the kitty prize (811 tube) at the August meeting of the S.J.R.A. VX has been experimenting with kite antennas on 56 Mc. at a height of 300 ft. and claims it raises the signal strength about 7 or 8 S's. BMC has been transferred and will have a new QTH at Springfield. HKM has a classy 56-Mc. portable rig in his car and usually rides up to Atlantic Highlands to get contact. Speaking of 56 Mc., CUD is looking for a few DX contacts. FBZ is building a lattice tower. ZX has worked 107 countries and is more or less taking it easy while the DX of foreign countries is banned. IVO is a prospective O.R.S. man. HAZ and IOK just received their Code Proficiency Certificates. CCO was admitted to the A-1 Operator Club and has the certificate on the wall. HTG, HBV and DNU are interested in lining up as F.C.C. special radio operators. MI is feeling better and wishes to announce the Somerset Hills Radio Club meets once monthly at its various members' homes. Anyone in or around Bernardsville interested in joining or visiting contact him at his home. CCC left on a Naval Reserve cruise which will take him down in the Caribbean Sea. ZI reports hearing a lot of the S.J. gang up at Watertown, N. Y. DAJ is active on 14 Mc. and has 100 countries to his credit. 6BUK toured the S.J. Section and attended one of the S.J.R.A. meetings; he was escorted on his tour by GPU. EIE has gone in for building Radio Control airplane models. EHU is building a radio controlled airplane model. BO, one of S.J.'s old O.R.S. men, is working in Baltimore with the Western Electric Co. CCO gave interesting talk on League affairs and Club promotions at the August meeting of the S.J.R.A. HAZ, IOK, ITU, Chick Anderson and Andy Jamieson, all of the D.V.R.A. accompanied Les on this trip. Section Field Day is being arranged by BAQ. All groups interested in participating advise Ted immediately. The Delaware Valley Radio Ass'n will show its feature motion picture and Field Day slides in color at the October meeting of the South Jersey Radio Ass'n. Anyone wishing further information on this meeting contact the Secretary, Chris J. Davis, 403 Thomas Ave., Riverton, N. J. The meeting will be open to visitors. ABS installed a double zepp (vertical) and is rebuilding the 6-element beam for 28 and 14 Mc. OQ is working with the American Philosophical Society on Ionosphere Study. GHR of Woodbury is active on 3.5 Mc. and is a prospective O.R.S. GUS moved to new QTH. Sorry to lose you. Gus. IWA and IUS are new hams in Morristown. The Somerset Hills Radio Ass'n has applied for affiliation with the A.R.R.L. IVO, INS, FXV, HRJ, FBC, HHZ, HEO, IAS, DAJ, EWF, VX and HHZ are new A.E.C. members. Until next month, 73 and don't forget the reports.

Traffic: W3IFT 130 EUH 55 OQ 53 GCU 51 CCW 40 ASQ 38 ZI 34 ATF 29 ITU 25 CCO 20 HAZ 14 GRW 12 ABS 2.

**WESTERN NEW YORK** — SCM, Fred Chichester, W8PLA — R.M.'s: BJO, CSE, DSS, FCG, PCN. P.A.M.'s:

CGU, RVM, UNY, E.C.'s: FNT, GWY, RVM, SBV, SMH, THC. Net frequency: 3720 kc. DLA is changing QTH but expects to be back on 14 Mc. soon. DNW and PQI operated portable at Boy Scout Camp on Lake Chautauque. EET returned to college at Cleveland. LJA graduated from Antioch College with an accountant degree. Hal Bubb, Chief Operator at WIAW, visited his family in Jamestown. GPS has been appointed Chief Operator at the new police radio station. WJNY, at Jamestown. MQX is back on 7 Mc. NWH is on 1.8 Mc. DHU is still on the road but gets home for an occasional QSO. ETH has been asked to report to the F.C.C. for a job. SGX surprised the gang and got married August 10th. The W.N.Y. 'phone gang had a swell picnic and swim at Holland's Cove, where QBP and PPR have cottages, on July 28th. QBP is the 1.75-Mc.'s laziest ham. He lies in bed when on the air and turns the rig on and off with a foot switch. BJW marched to the altar this month. TUQ celebrated her first anniversary as a ham on Aug. 11th. Several of the Rochester gang took a cruise to Coburg, Ont., Aug. 11th. NWH visited WIAW while on vacation. SJZ joined the U.S.N.R. "Charlie" Floring, EBR, is back home in Syracuse after wandering all over the U. S. A. for the past three years and is active on 3.9-Mc. 'phone. Stan Kenyon, SVC, will attend Tri-State College in Indiana, taking up radio engineering, starting in September. UJM is a new Groton ham. BHK is busy clearing up key clicks. NYA is rebuilding. RMR continues to work K8's on 7 Mc. with his T20 final. ROU has enlisted in the U. S. Army and is stationed at Ft. Monmouth, N. J., in the Radio Intelligence Service. 31EM of Baltimore, visited relatives on the staff of Mt. Morris Hospital. Ex-7HHP is now UYZ at Hornell. The Elmira gang has one club that has been able to keep interest alive during the hot summer months. DZC says the first official A.R.R.L. code test removed any doubt he had that plenty of practice is necessary before copying good code above 20 w.p.m. HQY, TOE, TZP, TOG and TXB handled the radio end of the sailboat races at Watkins Glen. The 56-Mc. band was used. 4FPK attended a meeting of the Club recently. Before going to Atlanta, Ga., Bob was DCX. Attendance at the N.Y.A. radio school averaged 20 for the first three nights. One night seven YL's were on hand when the class opened. The summer picnic of the Club was held at Sullivan's Monument Aug. 21st. TNP is rebuilding his final to a pair of 6L6's. 1JZJ, with a 112-Mc. station in his car, visited some of the gang. SBV is spending most of his time practicing on the mill in order to get up his copying speed. KYR will take over the Emergency Coordinator's job for Erie county (we hope). THC is the new coordinator in Onondaga county. JIW is going to town as a new O.R.S. PCN has been appointed Route Manager in the Section and monitors net frequency regularly. GBM, Malone, is now on 1.75-Mc. 'phone. 2JEA, who operated portable at Batavia several years ago, is now 8SOW at that place.

Traffic: W2FCG 73 JIW 106 PCN 167 AQE 21 RKM 10 SOW 20.

#### HUDSON DIVISION

**E**ASTERN NEW YORK — SCM, Robert E. Haight, W2LU — ISQ is king of the traffic boys for E.N.Y.; he sports new e.c.o. MIY enjoyed 10 hours in O.R.S. party and attended Delaware Valley Radio Ass'n hamfest. LLU schedules 1MBN and desires O.R.S. appointment. JJC reports from Washington where he is studying chemistry. HNH was at Norfolk, Va., on active duty as RM3c V3, U.S.N.R. MHW was appointed O.B.B.; he can be heard on 3625, 3720, 3832 and 7111 kcs. MZR was visited by 8BR. BJX reports Mid Hudson Club enjoyed a number of outings during the summer, with successful results during F.D. IYH received 30 w.p.m. certificate for A.R.R.L. Code Proficiency Test. CGT is active on 14 and 7 Mc. KGU holds forth nightly on 1.75 Mc. EDT is heard on 7 and 3.5 Mc. VP moved to Kingston and will be on 3550 and 1943 kcs., using RK20 final. JRG is getting brother Larry ready for ham ticket; also working on radio controlled model speedboat driven by a 1/5 h.p. gas motor. KW is erecting 130-foot steel towers. MXF, new licensee, is the father of 6JUI, Santa Monica, Calif.

Traffic: W2ISQ 507 MIY 139 LU 36 LLU 2 JRG 11 MHW 126.

**NORTHERN NEW JERSEY** — Acting SCM, Fred Read, W2GMN — Ass't SCM in charge of Emergency Coordination, Les Baglee, W2JMX — R.M.'s: BZJ, CGG, LMN, P.A.M.: HNP. Section net frequency: 3630 kc. New appointments: R.M., LMN; E.C., DLF Verona, DUJ

Livingston, LXI Nutley, O.P.S.: CQD, O.R.S.: JIY, MNT, New A.E.C. registrations: AGH, CGG, DLF, FOP, ICA, JFZ, JQE, KVE, LQN, LZW, MFF, MYP, MWN. Owing to pressure of business and personal affairs, GVZ has been forced to curtail time spent on radio and has resigned as S.C.M., R.M. and E.C., and is only retaining O.R.S. Fred Read, W2GMN, former S.C.M., has been appointed Acting S.C.M. until an election can be held. All correspondence and reports should now be sent to him at 1014 North Ave., Elizabeth, N. J. GVZ wishes to express his appreciation to all for the very excellent cooperation received during the past year and urges that equal assistance be given to both GMN and the new S.C.M. when elected. LMN has been appointed R.M. in charge of the Section Net. JT lost his tower, mast and three-element during a thunderstorm. That is really tough. HUK is getting hitched in Sept. MAX has been helping with code practice and receiver construction in the Boy Scouts. The apartment landlord made LAG take down his 1/2 wave 3.5-Mc. vertical. Woe is him. CGG won prize in RM-nite guessing contest. JKG is active as O.B.S. and has been in traffic work during the summer. The Livingston Amateur Radio Club has applied for A.R.R.L. affiliation with a membership of 12. The Clifton Radio Club held annual summer outing at High Point Park with a large turnout. KTM, LIO, MFF and MNG were on hand with 112-Mc. jobs. FWT is back on 1.75-Mc. 'phone. KEG conducts code class Tuesday and Friday nights at Clifton Radio Club. HRO is going on 112 Mc. NCN will be on 7 Mc. soon. MRK is interested in traffic. MRX runs 60 watts to an 807 on 7 Mc. in Dumont. 3GUS has moved to Plainfield and is awaiting a W2 call. NDN uses a 6L6 on 7 Mc. HMJ, the Staten Island speed demon, moved to Newark and becomes a very welcome addition to the traffic and A.A.R.S. gang in this Section. KWK uses QSL 60 on 7 Mc. HXI joined F.T.S. JME is planning a rotary beam and a ganged exciter with e.c.o. and crystal. KXT has a pair of 56's on 112 Mc. with 15 watts. CMC is applying again for O.R.S. EKU is back on 1.75 Mc. with 140 watts. JDC and ANW are interested in O.R.S. MBO has received satisfactory rating for the F.C.C. jobs. 3DBW is on at Rahway on 1.75-Mc. 'phone. En route to Trenton hamfest, 1KZR met MAJ, who is a cop at Linden. IQQ has 50 watts for either 112 or 224 Mc. FAW, who never ran more than 60 watts, is W.A.C. seven times over. LIP is now in Coast Guard, operating aboard U.S.S. Spencer. BPK has new 1.75-Mc. antenna; FB moved to new QTH. JIY is on 3.5 Mc. with 807 and 30 watts.

Traffic: W2HXI 122 CGG 105 LMN 72 (WLNX 72) MNT 49 KHA 48 IYQ 30 MKW 19 CJX 6 MRJ 5 JIY-LXI 1.

**NEW YORK CITY & LONG ISLAND** — SCM, Ed. L. Baunach, W2AZV — Great fall activity is anticipated in the Section with a number of new appointments. The Section Net will have over twenty active stations. The Net meets at 8:30 p.m. on 3710 kc. LR is the control station and ITX the alternate control. MT is R.M. for Queens County, ITX is R.M. for Suffolk County. IXQ is P.A.M. for Kings County. JAU, IYX and MIO have been appointed O.R.S., O.P.S. and O.B.S. respectively. LZR will be the N.Y.C. outlet for Trunk Line "C" and MT the alternate. ITX will be the N.Y.C. station for Trunk Line "L" and LR the alternate. Although activity is growing in the A.E.C. more operators are needed to register and be on the Section Net to learn how to handle traffic in time of need. DO YOU THINK THAT YOU CAN HANDLE A MESSAGE DURING AN EMERGENCY WITHOUT ANY REPEATS OR DELAYS? TRY YOURSELF OUT SOME NIGHT ON 3710 Kc. DBQ or LR will be very glad to give you pointers that you don't know. ETS and NAZ are out for O.R.S. With the vast government military expansion program more operators and active stations are wanted for the A.A.R.S. and the N.C.R. Give your full support by joining either one. You will learn something different from regular operating. LGK operated low power portable for O.R.S. party and got FB results. LOQ started his four-times-weekly schedule with 4PL. The Fishermans Net had a get-together at ADW's for a mast raising and a picnic. The Queens Radio Amateurs held their third annual dinner Sept. 7th. MPJ sends in his first report from 2207-19th Astoria. FAQ QSOed 38 states with 35 watts input. JAU is looking for Idaho and Utah for W.A.S. on 7 Mc. JBL operates on 7006 and 14,250 kc. LZR operated 14 hours in the O.R.S. party and worked his first K7. LHP is working for R.C.A. at Harrison, N. J. FNJ is back on 1.75 Mc. with new rig. KTA has a new all-band antenna. IXQ passed

(Continued on page 104)

# FULLILL YOUR AMBITION IN RADIO COMMUNICATION

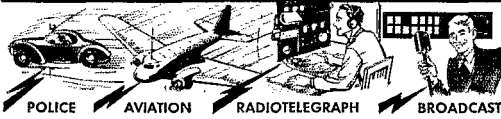

Train yourself at home for that radio job or promotion you want. Study under the personal direction of Arthur R. Nilson, co-author of the popular Nilson and Hornung radio textbooks. Up-to-the-minute low-cost, home-study courses will help fit you for radio license examinations. As your next step toward success, send for descriptive literature on these courses.

## THREE NILSON COURSES TO COVER ALL PHASES OF RADIO COMMUNICATION

### 1. Essentials of Radio Communication

Includes all essentials of the written examination for 2nd class radiotelephone license and restricted radio telegraph permit. More than 200 drawings and diagrams.

### 2. Radiotelegraphy

Covers the scope of element 6 when combined with course Essentials of Radio Communication. A series of 12 supplementary lessons covering advanced radiotelegraphy and radio mathematics as required for 1st and 2nd class licenses.

### 3. Broadcast Operating

Covers the scope of element 4. Mathematics, circuits and equipment and rules and regulations for those who want to specialize in broadcast operating.

Free Booklet "What The Modern Radioman Must Know" gives in more complete detail the wide scope of Nilson's home-study courses. Send for your copy now!

**NILSON RADIO SCHOOL**  
51 East 42nd St., New York, N. Y.



## FASTEST WAY TO LEARN CODE

Easy, Fascinating—LEARN BY EAR to be a GOOD OP.

The New All Electric Master Teleplex Code Teaching Machine is exactly what thousands are looking for. No experience needed. Excellent for beginners — steps up WPM for ALL Ops. There is no guesswork with Master Teleplex, because it records your sending in visible dots and dashes. You SEE and HEAR exactly how you are making your signals. You learn code the way you'll be using it — by SOUND. That's why schools teaching code use TELEPLEX. Complete course included at no extra charge. Used by many schools and several governments for teaching code. Low cost, easy terms. MONEY BACK GUARANTEE. Send now for booklet Q-10, no obligation. Post card will do.



The "Ham" Special  
**TELEPLEX CO.** 67-69 PARK PLACE  
NEW YORK, N. Y.

In Canada write  
**CANADIAN ELECTRONIC INSTITUTE, TORONTO, ONT.**

## Correspondence Department

(Continued from page 78)

seen the figures on requirements for the Naval Reserve; no telling how many the Army needs. The question often comes up as to why code operators are so important and not 'phone operators. Many operators of 'phone stations are not acquainted with the fact that nearly anybody who can talk can be taught to say something of intelligence, but all the talk in the world wouldn't make it possible to handle stuff like this: QUAXK ZOQAZ etc., on 'phone. Such code groups would have to be spelled out with the use of a word list, and in that case they could be handled faster by telegraph than telephone. . . .

An operator should be able to handle a straight key as well as a bug. In Navy service, an operator must have a certificate of proficiency before he is permitted to use a speed key on a circuit. The prime requisite is accurate copy and then speed. . . .

— F. H. Schnell, W9UZ

## Distance Vs. Angle of Radiation

(Continued from page 68)

impossible to obtain any radiation at an angle of less than 3°, and the curves need not have been carried as far as they were. If one is situated in the country, away from building congestion and the like, it is possible to obtain fairly low angles of radiation from the proper antenna system, but the fellow living in the city or suburbs had best count on 10° as his lower limit. The A. R. R. L. *Antenna Book* gives the theoretical vertical patterns for the more common antenna systems. The chart shows only the first reflection (actually a *refraction*), of course, and DX transmissions are made possible by several of these reflections.

The chart in Fig. 2 can be used in several ways to explain effects encountered in our everyday communication. By referring to the article previously mentioned,<sup>1</sup> it is possible to judge fairly well what layer is reflecting your signals at any particular time. By then referring to Fig. 2 one can determine the approximate angle of vertical radiation necessary for the signal to get through, remembering, of course, that this applies only to the first reflection. The chart is based on "virtual height" of the layer and, for low angles of radiation the height will be effectively a little less than for the higher angles.

The chart will also show why you may work stations several thousand miles away with louder signals than your friend down the street, although he always gets much louder reports from stations less than a thousand miles away. The louder nearby signals show that that particular antenna is radiating at a higher angle, while the better DX antenna, which is concentrating most of its energy at low angles, is incapable of a strong nearby signal because little or no energy is radiated at the necessary angle. Many of the 14- and 28-Mc. DX gang worry about their antennas only when they start to get loud nearby signals, and the chart shows the correctness of their views.

The writer wishes to acknowledge the efforts of Mr. Warren Jackson, Jr., W9CYS, for his invaluable assistance in collecting the tabulated material.



# Taylor's Honorary Salesman —

The  
**A M A T E U R**

**SOLD OVER 23,000  
TAYLOR WONDER TUBES**



You have heard him on the air, day or night, operating phone and CW on all bands. He has won DX contests—he has worked the ones that are hard to get—he's a member of the DX Century Club—he belongs to both the Army and Navy Amateur Nets—he's an all round ham.

On the strength of his recommendation (he appreciates greater Safety Factor) we have sold over 23,000 T-40's and TZ-40's alone.

## WHO IS HE —

We're proud to say that he is any one of the thousands of satisfied Taylor Tubes users. For it is without doubt these same thousands of amateurs *who by their constant praise of Taylor Tubes over the air* have made it possible for Taylor Tubes to give you

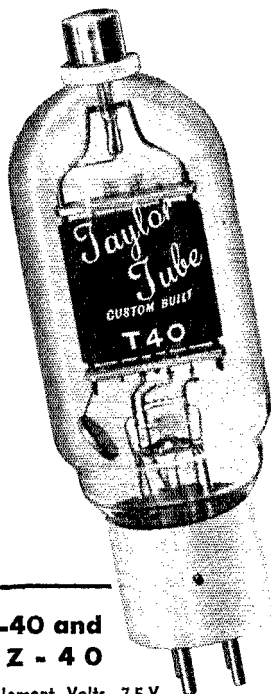

**T-40 and  
TZ - 40**

Filament Volts... 7.5 V.  
Plate Voltage... 1500 V.  
Plate Current 150 MA.  
Plate  
Dissipation... 40 W.

**\$3.50**

*"More Watts Per Dollar"*

**Taylor** HEAVY **CUSTOM BUILT** DUTY **Tubes**

**TAYLOR TUBES, INC., 2341 WABANSIA AVE., CHICAGO, ILLINOIS**

(Continued from page 101)

test for opr. at WNYC. JGC is going to work in Porto Rico. 1LRS will be located at 309 Hinsdale St., Brooklyn, for the next two years. With the arrival of VG's Class A ticket he is going on 14-Mc. 'phone. LYC is trying for Class A. ELK's new QTH is on top of a hill and FB for DX. DOG is all set for fall operations with a new mike. KWW is deeply interested in traffic work. AZV is still trying to dope out the best antenna system. ITX and LWE took a portable in LWE's truck around I. I. for some very successful tests on Sunday. LKN is now a member of the N.C.R.

Traffic: W2USA 662 SC 634 LZR 402 LPJ 343 AZV 83 NAZ 63 KI 54 LOQ 29 LR 27 ITX 26 MT 21 CBT 15 BYL 14 CHK 11 DBQ-CIT 9 AA 8 IRC 7 FAH-HGO 6 AEU 10 MPJ 5 AZM-LGK-AJY 4 BGO-LYC 3 AVS-JBL 2 VG 1.

#### NEW ENGLAND DIVISION

CONNECTICUT—SCM, Fred Ells, W1CTI—AW leads off with a fine total for the hot summer weather. BDI has been keeping in touch with his folks in Maine by amateur radio. The New Haven Amateur Radio Association, W1GB, held a code contest and many of the gang passed their 20 w.p.m. mark. GB, 3535 kc., wishes to contact other club stations and discuss club matters. Clerks, here is your chance to contact one of the oldest affiliated clubs in the country. KFN received A.R.R.L. Code Proficiency certificate, 30 w.p.m. KSJ says, "Very much in favor of new code practice schedule on AW. Working hard to learn mill so I can get 35 w.p.m. sticker." HYF received 20 w.p.m. certificate, and is taking an F.C.C. job. APA snared a certificate for 20 w.p.m. but had to leave before he could try the higher speeds. IYB is stationed at Miami, Fla. with Pan-American Airways doing point-to-point work. CCF has been appointed examiner for code speed work at B.A.R.A. Code classes at C.B.A. end up with all hands trying to copy AW on the 10:15 pencil copy. 3640 kc. is the spot. See you all there on Nutmeg Net or any other time.

Traffic: W1AW 446 (WLMK 61) MEC 60 BDI 53 TD 29 GB 17 KSJ 6 APA 5 CTT-HYF 1.

MAINE—SCM, H. W. Castner, W1HIE—LMM reports continued interest in the Waterville Amateur Radio Club; they have 23 members to date. LYK paid us a visit and reports a lot of interest and activity around Lewiston and Auburn. IKE will be at Bates College this year and will transfer his activities from the Nutmeg Net in Connecticut to the Pine Tree Net. We are sure glad to have a live wire like Dick with us this year. HYH is planning to take part in the organized nets this coming season. GQ has been on 3.5 Mc. this summer. FJP has plenty of emergency power available. LDC is part time announcer at WCOU. VF writes me details of a recent cruise for training purposes which he made and sure had a grand time. He says they had a fine "Skipper." Sure! Why not? Your old S.C.M. being an ex-Navy man arises to say they're all fine skippers and any of you boys who don't know it had better find out that the N.C.R. and the U.S.N.R.F. is one ding busted fine outfit. MKB is on 7 Mc. and still pounding brass for the R.R. LKP has been on 3.5 and 3.9 Mc. and has a Sunday schedule with 8AQ. MGP at North Haven has four crystals on 3.5 Mc. and two on 1.7 Mc. and is heard often. LWX is sure a live wire around Hal-lowell. All you boys and girls will be reading this report about the last of September. Many of you have remodelled and renewed the old rigs and you are faced with the possibilities of pleasure and service during the coming winter season. Already we note a definite increase in interest in the organized activities of A.R.R.L. Most of you have learned by this time that the A.R.R.L. is emphasizing the need of better operating. Many who have been licensed for years have given little attention to actual operating and have found it of little use. It is hoped that everyone will give this condition serious consideration. A cordial welcome is extended to anyone to participate in the Pine Tree Net, the Army Net or the Naval Communications Reserve. There are a fine bunch in all these activities and no one need fear being "burned up" or "put under the table." There is also a great need of more interest in the Emergency Corps. We need many more Emergency Coordinators in many cities and towns. A letter to the S.C.M. will bring full particulars concerning any of these worthy activities.

Traffic: W1LWX 4 LKP 5 MKB 2 LYK 15 MAP 6.

EASTERN MASS.—SCM, Frank L. Baker, Jr., W1ALP—Don't forget, gang, hope to see you all at the Boston Hamfest on October 5th at the Hotel Bradford. LRO is new E.C. for Provincetown. KXU is now on 112 Mc. JNU will

be on with new 400 watt job. EU changed his YI. to XYL. Congrats. KCQ is trying to copy c.w. on the mill. KH had a grand time at the Roanoke Division Convention. BDU made B.P.L. HWE has his 25 w.p.m. proficiency certificate. LNN has new QSL-40 rig on 3.5 and 7 Mc. AAR says there is new A.A.R.S. net on 1.75 Mc. to help the 'phone men get c.w. practice. How about some of you 1.75-Mc. 'phone hams signing up for O.P.S.? There seems to be a lot of demand for some on this band. IN lost his antenna in storm. HUP hopes to have new beam, and 7-Mc. antenna. WI is working on new final; got Utah for W.A.S.; needs only Vt. HOB has new antenna; reports club had Annual Outing at Bow Lake. AAL is putting up new mast. GAG is working on his rigs. IBF has new house in Danvers, and will be active again as O.O. The M.A.K. Radio Club had 5 cars on 112 Mc. working on trip up to and back from N.H. on their annual outing. 100% QSO's resulted and movies in color were taken. SS claims to be first to send in finger prints and photo. BAQ lost the antenna on his 112-Mc. portable marine in the lake. Welcome to new ham in North Easton. MSM. JOW is new A.A.R.S. member. EPE is still keeping daily A.A.R.S. schedules. ALP is on 7 Mc. for a change. KCT and his fine net open up soon, with drills 3 nights a week on 3.5 Mc.

Traffic: W1BDU 187 AAR 36 AAL 34 KH 15 KTE 14 HWE 11 KXU-EHT-LNN 6 WI 2 EPE 58 (WLGS 24) June-July AKS 78).

WESTERN MASSACHUSETTS—SCM, William J. Barrett, W1JAH—AZW heads what there is of the traffic parade this month. With this report JAH starts his third term as your S.C.M. My thanks for the renomination, fellows. One thing that would be greatly appreciated here would be early mailing of monthly report cards. JAH managed to get 30 per on a mill on his third attempt at mill copying, so there's hope. AJ is resuming his NY1AA schedule after a long layoff; Ralph gave his battery powered emergency rig a workout and everything perks FB. DCH took a short trip to Washington where he had chance to meet some of the boys he has worked. GZL says the 'phone boys are dusting off their keys and practising for the code proficiency award. Les started at 15 and intends to gain five words per month—that's a worthy ambition Les; hope you make it. Congrats to KER on new Junior op. and to KUW for a second Jr. op. KRZ and KTX visited KOO, KTB, DQK, JZF and LII while staying with BJP in Newport, Vt. KRX has 100 watt modulator as result of the visit. BVV met FX and JKH while vacationing in New Hampshire. IOR has had the YL's all to himself since the Nat. Guard called out IZW, LTA, FJC, LOD and KUX and the N.C.R. had LLY, ICP, JWA, LQD and JVI. Chet reports that the gang at BKQ were guests at Worcester Women's Radio Club weenie roast. LEJ is building a compact five-band 150-watt rig, getting all set for the traffic season. BNL is spending most of his spare time making card index for 20 years of QST and other radio journals. EOB took training cruise with N.C.R. How about a revival of hand key sending to limber up our glass arm? Hope you are all taking a shot at the code practice from AW nightly.

Traffic: W1AZW 22 JAH 20 (WLGH 6) BVR 18 (WLG 156) AJ 16 DCH 9 GZL 8 KRX 2 WLGN 11.

NEW HAMPSHIRE—SCM, Carl B. Evans, W1BFT—This report is my last as S.C.M., my appointment expiring the first of September. At this time, I wish to thank you one and all for your fine cooperation during my past four years of office. Due to business pressure and U.S.N.R. activities, I felt it necessary to pass the job on to someone with more time to take care of this work. Your newly nominated S.C.M., FTJ, is well known around this Section and should be readily capable of handling the work. I will appreciate your continued cooperation with FTJ, as your new S.C.M. Send your reports to her, same address as in the past. Hi. The Nashua Mike & Key Club held its annual outing at Silver Lake, Hollis, New Hampshire on Sunday, August 18th. Have YOU got your A.R.R.L. proficiency certificate from copying AW yet? If not, go to it, as we want N.H. well represented. HXJ and KMH report getting theirs for 25 w.p.m. HJI is active on 14-Mc. 'phone using a home-made 3-element rotary beam and has contacted KC4USA, FB, Herb. JKH schedules 8UNY (ex-1CPR) on 7 Mc. AXL is back on 3.9- and 2-Mc. 'phone after lay-off. AEF is active on 1840 kc. but expects to be back handling traffic this fall. The N.H. State Traffic Net (NHN) will resume operation on or before September 23d, same frequency 3840, same time 6:30 p.m. daily except Sundays. BFT will continue to act as control with GMM as first alternate. Let's have a good, snappy net this year, and all N.H. hams should check in

occasionally to see how things are run, as a form of emergency preparedness.

Traffic: WIKIN 80 HXJ 19 IDY 12 JKH 2 BFT 1.

RHODE ISLAND — SCM, Clayton C. Gordon, WIHRC — JP is still on 112 Mc. DDY reports the Jr. op now recognizes "HL." FUB is struggling to get on 112 Mc. Charles Fraits is now MUH and is working his code speed up to 20 w.p.m. LCS is on 3.5 and 7 Mc. IZO, who was just presented with a Jr. op prior to leaving, is now at Annapolis in the Math. Dept. Swell. LDL is holding weekly rag-chew schedules with MMG in Milford. N. H. JEZ is building emergency equipment. MEK is still working on that new superhet. LCH is still on 1.75-Mc. 'phone. HJB is settled in the new QTH and has an SX17 receiver. IMY is on 3505 kc. and 112 Mc. after taking a 2-year rest from Ham Radio and asks when the deadline for reports is. (For information of all — report period is from the 16th of one month to the 15th of next month, and reports are written here on the night of the 19th and mailed on the morning of the 20th, which makes your dead-line — in the mail — not later than the morning of the 18th.) KYK is getting back on his feet slowly but surely. KOG has started work on a new Sweepstakes rig. MJL has gone e.c.o., 6K7-807. LWA has 28-Mc. Johnson Q. The Narragansett Ass'n of Amateur Radio Operators competed in the Field Day, working 133 stations (114 being portable). EOF has built a new antenna coupler. MAE is active in Westerly. INN is on 3.9-Mc. 'phone. MOK succeeded in getting the 35T working FB. IEJ is building 1000-watt 110-volt a.c. generator for the Westerly Radio Club station MTE. MVL is active on 3.5 Mc. KRQ is practicing on the mill and working for the proficiency award.

VERMONT — SCM, Clifton G. Parker, WIKJG — Several amateurs report efforts to copy code direct on the mill. Has any Vermont amateur a code practice machine which he will donate for use in code practice transmissions for a few weeks? A tape or dial mechanism is a great help. AYP with GAN as bodyguard are busy with AVP's new 28-14-Mc. rig and are installing a Sig Squitter atop Bill's garage. GAE is busy setting up rig at his home in Benson. GNF reports FB vacation trip including visits to R.C.A. and Tropical stations on Cape Cod and a tour of the National plant at Malden. KUY and JRU have been swapping receivers again. KXY with his family visited your S.C.M. KUY combines business and pleasure by living with MLJ at South Barre during the week. AEA has been working with inverted r.f. amplifiers. MCQ has returned from the Veterans' Hospital to his home in Stowe and plans to return to the air soon. JRU attended demonstration of f.m. broadcast reception by Major Armstrong atop Mt. Mansfield. KXL has taken a position at WDEV in Waterbury, Vt. MLJ is industriously at the DX and had a W3 guest for week-end. A new YL operator arrived at KJG's on August 4th. All FB.

Traffic: WIKJG 9.

#### DELTA DIVISION

LOUISIANA — SCM, W. J. Wilkinson, Jr., W5DWW — W5FVD is active on 7 Mc. ENHJ has 812 in final working FB. ERV is active on 7 and 28 Mc. HSH and HUZ are rag chewing on 1.75-Mc. 'phone. WG is having nice time with 'phone rig. AGM is trying new rig. KC is still winning contests for La. DKR is rebuilding to operate 1.75-Mc. 'phone. IWO can usually be found on 28-Mc. 'phone. UY has been transferred to Miss. HGJ is operating 14-Mc. 'phone. IXE is building new 40-watt rig. IOO finds 7 Mc. the only band. Ex-EMF moved back to Alexandria. DXL knows all about grinding crystals. 80RY applied for Fifth District call. EGK is back after long silence. NI after having allowed his license to lapse 12 years ago received his original call when he applied for new license recently. ITH walked off with fried chicken eating honors at Lake Providence hamfest. DRF is building F.C.O.'s. HEJ operates on 1.75-28-Mc. 'phone and 14-7-Mc. c.w. IXW is at present at Camp Beauregard. CNG is his big brother. AKT can always be depended on for a lecture on "Safety." IHT is working 28-Mc. 'phone. IVF has new super Defiant receiver. IXE and HUZ can furnish that rag-chew you have been looking for. IYR has a mighty fine signal on high end of 7 Mc. GPE is renewing acquaintances with Monroe gang after spending some time at L.S.U. IPX has been converted to 7 Mc. IOP is losing sleep for late hour QSO's. EEL is trying several 'phone bands. IOP, ASH and GYO are all on forty. DWW can be found on 7032 kc. nearly every evening. Several clubs are functioning in swell style now and others

are contemplated. Club activities are interesting to other clubs so let's have more dope from those now organized. The O.V.A.R.C. is operating nicely and many FB meetings are being held. Plenty of technical as well as entertaining and educational substance can be expected when attending their meetings. Although not much information is available, the Alexandria and Shreveport clubs are active. BSR has been a frequent visitor among the New Orleans Hams. HHV of Lake Charles has new vertical antenna. BPL is working c.w. on 7 Mc. with 150 watts. AZO is shouting over 1.75-Mc. 'phone. GXI is the new Sec'y of New Orleans Radio Club, vice IHM, who moved to New York. HOU has built a heterodyne exciter. IMT has worked 44 states with a 6L6 osc. on 7 Mc. New Orleans Radio Club entertained WICBD, Asst. Sec'y, A.R.R.I., with a dinner at Arnauds on June 22nd. An FB meeting was held after the dinner. Still have plenty of room in this report for more of your station activities reports. Drop a line to your S.C.M. on or about the sixteenth of each month and it will be appreciated. All appointees are reminded to send O.P.S., O.R.S. and other certificates to the S.C.M. for endorsement so that they will not lapse.

Traffic: W5DWW 6 FVD 8 HEJ 9.

TENNESSEE — SCM, W. H. Walker, W4DWS — R.M.'s: 4PL and 4CXY. AGW has applied for emergency service. FDT, always on the job, did a nice piece of work in collaboration with Western Union and 5DIG. Those boys were standing by ready to do their stuff, had the storm at Galveston not subsided. FJR has taken over BDB's traffic net while he is rebuilding. FYK in Morristown is trying for W.A.S. on 7 Mc. ANN was in the midst of the recent flood in East Tennessee where he operated the mobile unit WAIX (B.C.). When you guys read this, congratulations will be in order for your S.C.M. — the girl friend finally said, "Yes!" AYE is leaving shortly for his job as government operator on one of the islands. FRU has been working stations in the flood zone; he has a new Sky Champion. FCU/GFO have cooperated in traffic handling — the result is at the foot of the report. Don't forget, fellows, you have an election for S.C.M. coming up. Who do you want for the office? 73.

Traffic: W4PL 940 FCU 500 FRU 71 BDB 101 FDT 56.

#### ROANOKE DIVISION

NORTH CAROLINA — SCM, W. J. Wortman, W4CYB — Congratulations to DWB on making the B.P.L. with a total of 810. Second place goes to GIQ with total of 329. Thanks, fellows, and very FB. The University of North Carolina Station, WE, is also very active under the operating of FXU. ANU reports working two entire nights with emergency traffic from the Charleston hurricane, handling over a hundred messages. AKC is busy on 7 Mc. GIV schedules DWB for traffic purposes. CCO returned to the air on 3.5 and 7 Mc. DLX has been chewing the fat mostly. QI is consistent on 3.9-Mc. 'phone with Official Broadcast. DGU chews fat on 3.9-Mc. 'phone; now operating with new e.c.o. FLC has new rig with 100 watts on 7 Mc. AAK is out again after a long hospital trip. We are glad to see you about once more, Marty. ERG is active on 3.5 and 7 Mc. ENH reports hearing 9PZ1 and 9BJV in South Dakota, also 8QTU, all on 56 Mc. Reported work in the Charleston hurricane comes from BXF, CXG, DST, FXV, EYF and DLX in addition to ANU. Our thanks and congratulations to all that helped. GXB visited in Charlotte with some of the gang. AYP is attempting to find 3.9 Mc. with his 28 Mc. rig. AH has FB new portable in a suitcase with 9 watts. CSO, the Naval Reserve Station in Charlotte, did some nice work clearing QRR traffic from Charleston. The Greensboro Club has new location, the Old Eastern Airways station on the Greensboro-Winston Salem highway. All equipment was moved in a couple of trucks. New hams are GXA and GXB. ZH is ready to go, after recuperating from the lightning stroke on equipment. MR is touching up the 100th's for Fall. AJT is working on 3.9-Mc. 'phone and 7 Mc. Gobs of fellows in the State are taking in the code practice from WIAW. Let's try it, gang. Even if you can copy but 15 words a minute, send it in. Some 25 of the fellows and their YL's or XYL's attended the Division Convention at Old Point Comfort. DW was off playing war and couldn't make it, for which we are sorry, but the rest had a good time. Thanks to the Va. gang.

*Operating Pleasure*

**FREQUENCY FLEXIBILITY  
with CRYSTAL STABILITY**

The Bliley Vari-X, with VF2 wide range variable crystal units, provides V.F.O. flexibility with full crystal stability. Circular D2, obtainable from your Bliley Distributor, gives complete information.

**BLILEY Vari-X**  
VARIABLE CRYSTAL OSCILLATOR

## A Midget 1.75- and 3.5-Mc. Phone Transmitter

(Continued from page 45)

plan, therefore, to keep the antenna load on the transmitter at all times.

It may be found, when listening to the carrier in the receiver with the beat oscillator on, that tuning of  $C_{10}$ , and to a lesser extent  $C_{14}$ , will affect the quality of the note. Care should be used in tuning up to ensure that proper adjustments for maximum stability are made. From the mechanical standpoint, the entire transmitter could be pounded vigorously, or the oscillator tube itself hit by a screwdriver, or the entire unit in operation picked up and dropped several inches without a frequency changed of more than a few hundred cycles.

Although no connection is shown, there should be no reason why any of the normal keying methods could not be used. The screen of the oscillator might be keyed, for instance, or a small normally-closed relay might be connected across the grid coil to short it out when the key is open.

In actual operation, the input varied from 15 to 20 watts and we had no trouble in contacting almost all stations called. The flexibility of the unit because of the e.c.o. feature allows its successful use where in normal circumstances a fixed-frequency low-power rig would be severely limited. When finished and operating satisfactorily, it will give the builder a first-rate low-power rig which will cause much favorable comment.

## Ham Shacks

(Continued from page 63)

input. A 6L6 oscillator and RK20 buffer are used as the exciter. The keying system used in this transmitter is similar to that used in the 7-Mc. job.

A DB20 preselector is used in conjunction with the HRO receiver which is equipped with a QST Hetrofil. An 81-X serves as a stand-by receiver and monitor. There are two "bugs" and a straight key on the operating table. One "bug" is set for high speed, the second for medium speed, while the straight key is used for slow speed.

Since Pat is an E.C., he is well equipped with emergency gear. There is a 300-watt gas-engine-driven a.c. generator which will operate a Harvey UHX10 transmitter as well as the HRO receiver. For portable work, he has a simple 42 crystal oscillator and a battery regenerative receiver. There is also an RME ME14 six-tube battery receiver and dynamotor and vibrator-pack power supplies to operate from storage batteries.

A Mims deluxe 10-20 three-element rotary is used for DX work. The direction indicator may be seen to the right of the loud-speaker. A centered 3.5-Mc. half-wave antenna with 16-ft. feeders is used at 7 and 3.5 Mc. The feeders are coupled to the transmitter in use through a pi-section network which is inductively coupled to the output tank circuit with Faraday screening.

Pat holds R.M. and O.R.S. appointments and holds certificates for DXCC, A-1 Operator,



E. H. Rietzke  
Pres. CREI

## Put Your Radio Experience to Profitable Use!

Your Experience PLUS Technical Training Prepares You for a Good Engineering Job!

Wake up — to the opportunities that Radio has to offer men who are equipped to competently qualify for important engineering jobs! You have "a jump" on the other fellow, because your present experience is a valuable asset, if supplemented by CREI training in Practical Radio and Television Engineering.

Our training brings results! CREI graduates are recognized for their high calibre throughout the industry. That is why so many of our men are holding important jobs in aviation radio, manufacturing, operating — and why there are CREI men in more than 350 broadcasting stations. Our job is to train ambitious men for these good-paying positions — your job is to do something about it!

### Write for Facts Today!

Our free booklet and personal recommendations may hold the answer to your future success. In your inquiry, please state briefly your background, education, present position — and whether you are interested in Home Study or Residence training.



**Capitol Radio Engineering Institute**

Dept. Q-10, 3224 16th St. N.W., Washington, D.C.

106

# Get Better Performance use OHMITE Parts

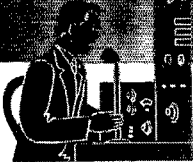

... then you know you're on the air with the pep, efficiency and dependability you want! Thousands of amateurs as well as designers and manufacturers of radio equipment specify these same Ohmite Parts every time! Make every unit count in your rig — Ask Your Jobber for Ohmite Parts.

**Dummy Antenna** — Used in checking R.F. power, impedance match, line losses, etc.; helps you tune up to peak efficiency.

**Adjustable Dividohms** — Easily adjusted to resistance you want or tapped where needed. 10 to 200 watts.

**Band Switch** — Quick, easy band change with really low-loss efficiency. For rigs up to 1 K.W.

**Brown Devils** — 10 and 20 watt vitreous-enameled resistors for voltage dropping, bias units, bleeders, etc.

**Parasitic Suppressors** — Small, compact resistor and choke, prevents u.h.f. parasitic oscillations.

**Center-Tapped Resistors** — Used across transmitter tube filaments to provide an electrical center for the grid and plate returns.

**R. F. Plate Chokes** — Designed to avoid fundamental or harmonic resonance in the amateur bands. 1000 M.A. rating.

**Close-Control Rheostats** — Keep power tube filaments at rated value for best efficiency and long life. 25 to 1000 watts.

Write for Free Catalog 17

OHMITE MANUFACTURING CO.  
4863 Flournoy St., Chicago, U.S.A.

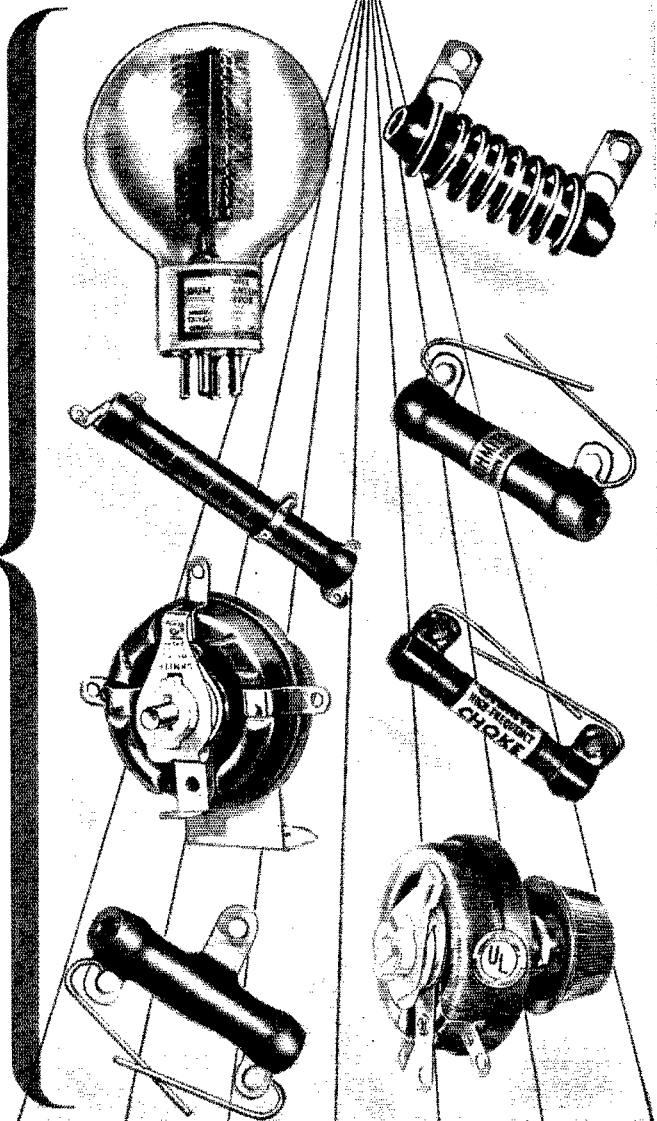

Be Right with OHMITE  
RHEOSTATS \* RESISTORS \* TAP SWITCHES

# TERMINAL'S CUSTOMERS REAP DIVIDENDS!

The phenomenal growth of the Terminal Radio Corporation has resulted in *increased services and lower costs* to its customers. Terminal is New York City's largest radio supply house dealing *exclusively* in radio equipment.

- ✓ **COMPLETE STOCKS** — At Terminal you will always find a complete, up-to-the-minute selection of everything in radio for every requirement.
- ✓ **HELPFUL SALESMEN** — Terminal salesmen are trained and experienced radiomen; most of them are active "hams." They know your problems and their answers.
- ✓ **LOWEST PRICES** — Great savings are reflected in many instances by Terminal's tremendous purchasing power. You always save time and money at Terminal.
- ✓ **PROMPT DELIVERIES** — Complete messenger and trucking facilities aid our shipping department in dispatching orders efficiently and speedily.

## EVERYTHING in RADIO for Amateurs and Engineers

Dealing *solely* in radio equipment, and as radio specialists, Terminal can *properly* handle your requirements.

### MIDTOWN

68 West 45th St.  
Radio Receivers  
Records  
Recorders  
Ham Receivers  
Test Equipment  
Quality Parts  
Amplifiers  
P.A. Systems  
Transmitting Tubes  
Receiving Tubes

### DOWNTOWN

80 Cortlandt St.  
Ham Receivers  
Quality Parts  
Test Equipment  
Transmitting Tubes  
Amplifiers  
P.A. Systems  
Record Players  
Recording Equip't  
FM Tuners  
Receiving Tubes

You need go no further than *either* of Terminal's two conveniently located stores in New York

# TERMINAL Radio Corp.

68 West 45th St. • 80 Cortlandt St.  
2 stores in NEW YORK CITY  
Vanderbilt 6-5050 • Cable: TERMRADIO

W.A.S., W.A.C. and R.C.C. He has worked 133 countries, with 120 confirmed. W2GVZ will be found listed regularly in the B.P.L. and is a regular participant in most contests. Other hobbies? "Heaven forbid!", says Pat.

### W6KW

**JOHNNIE GRIGGS'** station, W6KW, is located in a shack especially built for the purpose at the rear of his home.

While each of the three transmitters is fitted with plug-in coils so that any one may be operated at any of the lower ham frequencies, each is usually left tuned and ready to operate in one of the bands in which most operation takes place. The large cabinet to the right of the receiver houses the 75-meter 'phone transmitter. In this rig the 47 oscillator is followed by first and second buffer stages using a 10 and 860 respectively. The final is a 250TH running at 400 watts input.

The unit to the right of the antenna-tuning equipment is the 20-meter 'phone transmitter in which an 807 oscillator drives a 35T followed by a 75T which drives the push-pull HK354F final at 1-kw. input.

The 805 modulator in the cabinet between the two transmitters is used for both transmitters by means of a switching system. The tube line-up in the speech-amplifier section on the shelf over the receiver is as follows: 6F5 for crystal mike input, 6C5, p.p. 6C5's, and p.p.-parallel 2A3's Class AB which drive the modulator through a 500-ohm line. Push-to-talk switching is accomplished through a system of relays operated by a switch at the operating position.

The 40-meter c.w. transmitter is not shown in the photograph. It is built in a 6-ft. cabinet rack and consists of a 6L6GX oscillator followed by two buffer stages employing an HY61 and a 35T. A push-pull stage of 100TH's drives the push-pull 450TH final. This transmitter, which was designed particularly for keeping skeds with the Byrd Expedition stations, is keyed by means of grid-controlled rectifiers.

A switching arrangement is used for the 14-Mc. 8JK and collinear antennas. The latter is also used for 75-meter work. A half-wave doublet is used on 40.

Receivers now in use are the PR-15 and SX-25. An i.f. amplifier and oscilloscope are provided for checking percentage of modulation on received 'phone signals. A Triplett modulation monitor is used for checking transmissions and a frequency-meter monitor for frequency checks and c.w. monitoring.

Johnnie is 33 years old and is continuity editor at XEMO. He started in the ham game back in 1922 and has been at it practically continuously ever since. He was active during the 1938 flood in Southern California and is always prominent in San Diego hamfest activities. He assisted in the design of much of the equipment now in use by Byrd Expedition stations.

# STATION OPERATING SUPPLIES

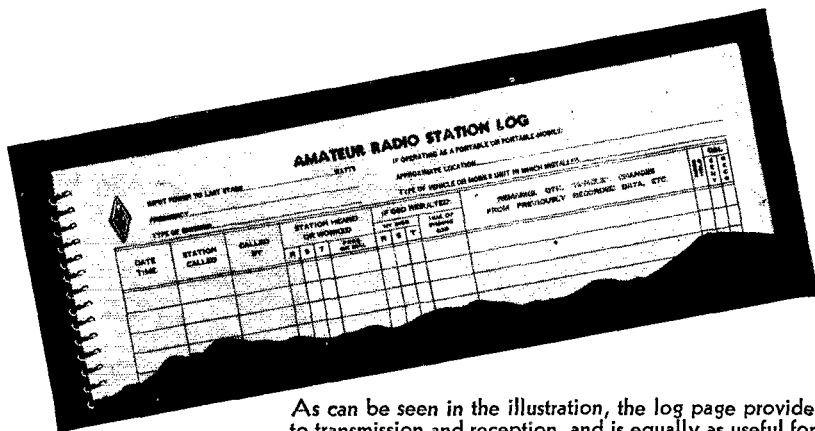

## LOG BOOK

As can be seen in the illustration, the log page provides space for all facts pertaining to transmission and reception, and is equally as useful for portable or mobile operation as it is for fixed. The 38 log pages with an equal number of blank pages for notes, six pages of general log information (prefixes, etc.) and a sheet of graph paper are spiral bound, permitting the book to be folded back flat at any page, requiring only the page size of  $8\frac{1}{2} \times 11$  on the operating table. In addition, a number sheet, with A.R.R.L. Numbered Texts printed on back, for traffic handlers, is included with each book. **35c** per book or 3 books for **\$1**

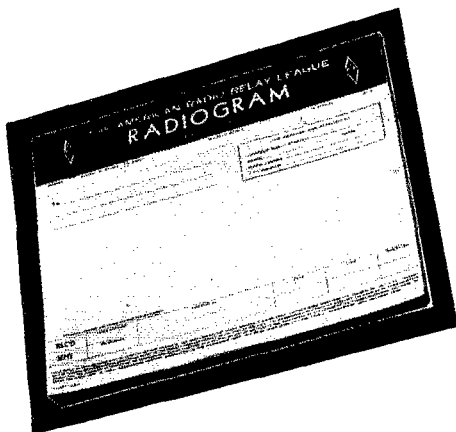

## OFFICIAL RADIOGRAM FORMS

The radiogram blank is designed to comply with the proper order of transmission. All blocks for fill-in are properly spaced for use in typewriter. It has a strikingly-new heading that you will like. Radiogram blanks,  $8\frac{1}{2} \times 7\frac{1}{4}$ , lithographed in green ink, and padded 100 blanks to the pad, 25c per pad, postpaid.

## MESSAGE DELIVERY CARDS

Radiogram delivery cards embody the same design as the radiogram blank and are available in two styles — on stamped government postcard, 2c each; unstamped, 1c each.

The operating supplies shown on this page have been designed by the A.R.R.L. Communications Department.

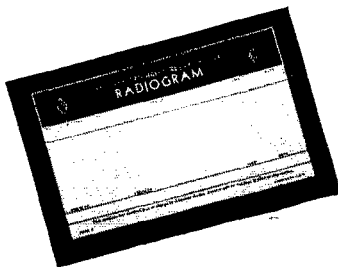

American Radio Relay League, Inc.

West Hartford, Conn.

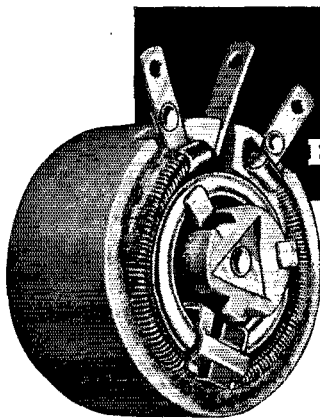

## A Better POWER RHEOSTAT

Selected resistance wire on insulated aluminum core. ★ Heat-resistant ceramic body, cold-setting cement, and ceramic rotor insulator. ★ Unique tripod-type rotor. ★ Graphited-copper contact shoe rides third-rail ring and winding. ★ 25-watt rating even at one-third resistance setting. A brute for punishment.

For years Clarostat engineers have sought a better power rheostat. They examined, tested, compared all types. Hundreds of models were built. The end result is the entirely different Clarostat Power Rheostat now available to you. ★ Try one in your "rig." ★ Ask local supplier to show you this job. Ask for data. ★ Or write direct to Clarostat Mfg. Co., Inc., 285-7 N. 6th St., Brooklyn, N. Y.



## Scores 1940 DX Contest

(Continued from page 47)

W8RZK	35847-28	73-B	W8QCK	22112-24	41-B
W3HXA	35280-24	47-B	W8KXP	16080-16	30-B
W3FIL*	33400-20	21-B	W8ADY	18235-17	37-B
W3JN	21850-23	38-B	W8TNG	6604-13	27-A
W3HRS	20230-17	29-B	W8TOJ	4875-13	18-A
W3CHH	19467-21	35-C	W8MIZ	2275-13	28-A
W3FUF	16172-13	22-B	W8TUD	760-8	19-A
W3ARK*	16020-19	26--	W8LYI*	675-5	8--
W3GGW	12380-20	36-B	W8DLI	300-5	12-A
W3OP	9600-8	12-B	W8RWJ	100-1	1--
W3ENH	9240-12	21-B	Phone		
W8RFR	8640-9	12-B	W8ROP	287525-35	104-C
W8GV	4147-13	27-B	W8FCO*	12402-13	21-B
W3IMH	1035-9	23-A	W8BWP	5160-8	15-A
W3EAN	810-4	4--	W8RED*	2025-5	5--

### CENTRAL DIVISION

W3QLW	840-4	4--	Illinois		
W8QLW	500-4	8-B	W9PTH	769600-64	182-C
W8ALW	490-7	13-A	W9NBR	548185-55	131-AC
W3DZR*	50-2	5-A	W9PKW	517600-52	129-C
W3BFL	20-2	2-A	W9GRV	511005-57	140-B
Phone			W9UTB	420140-46	128-B
W3GKM	204575-35	86-C	W9AEB	285360-48	106-B
W3FJU	122920-28	63-C	W9MDK	162080-32	83-B
W3FFG	50900-20	34-B	W9VDX	156750-38	93-B
W3FTL*	4900-7	7-B	W9GY	135600-40	50-B
W8TDE	3955-7	18--	W9WY	124832-32	61-B
W3GWY	210-2	3--	W9WV	103150-30	74-B
Md.-Del.-D. C.			W9DSO	102600-27	76-C
W3BEN	83864-52	29-C	W9DUX	95725-35	72-B
W3AOO	91070-31	42-B	W9FXZ	85480-28	81-BC
W3FRP	74118-33	68-B	W9QJR	77760-32	48-B
W3DRD	55390-29	40-B	W9ZFP	73800-30	55--
W3EKZ	49197-31	62-B	W9VOQ*	73600-32	61-B
W3GYQ	56335-23	39-B	W9WC	69490-30	65-B
W3CDG	18105-17	23-C	W9ZMG	65700-30	39-B
W3RIJ	17920-14	23-B	W9TCN	54250-31	65--
W3HHZ	12340-16	20-BC	W9QLD	50575-35	66-B
W3WU	490-12	25-B	W9LAE	39345-19	28--
W3HDV	2970-9	19-B	W9BPU	3000-12	25--
W3BVO	828-9	19-A	W9BTR	28978-19	37-C
W3ILD	5-1	1-B	W9QOE	20400-24	37-AB
Phone			W9MZP	18210-15	36-B
W3BNC	141750-30	75-C	W9EFQ*	13200-18	24--
W3BOY*	5-1	1--	W9NDI	9180-18	26-A

### So. New Jersey

W3EDP	638290-62	178-C	W9GVD	8500-17	42-A
W3PC	333055-59	122-C	W9CKG	5080-8	13-B
W3HTG	249713-37	105-C	W7BVS/9	4730-11	30-A
W3BVE	95438-31	60-B	W9RTU	4023-9	14-A
W3IOL*	7700-10	21-B	W9GGI*	3685-11	59-A
W3HAZ	5335-11	21-B	W9SGL	3600-10	15-A
W3PHY*	4120-8	8-B	W9TUE	3490-14	31-A
W3ZI	1620-9	17-A	W9NMY	1360-8	11-A
Phone			W8ADA	1780-10	17-A
W3DOK	156090-33	72-B	W9IMA	1645-7	9-B
W3PC	17290-14	19-C	W9OJB	1190-7	15-A
W3CEU	15650-10	16-B	W9KOD	640-4	4-BC
W3PHY	4920-8	9-B	W9TMS*	606-3	3-B
W3ACC	2020-4	6-B	W9ZEM*	200-1	2--

### W. New York

W8IOT	402875-55	135-B	W9UWZ*	100-1	1-C
W8DZC	152865-23	84-C	W9HWV*	30-2	3--
W8IIV	33824-28	64-A	Phone		
W8CUIY	32315-23	34-B	W9NDA	403065-39	120-C
W8QZP	31483-19	28-B	W9PEP	131370-29	71-C
W8BWN	25095-21	40-B	W9VND	110754-27	63-B
W8BHK*	12380-14	25--	W9NLP	100920-29	50--
W8OMA	8925-17	29-A	W9CIU	73710-27	52--
W8RKM	5600-14	22-A	W9ROQ	69055-23	42-C
W8TXL	1800-9	21-A	W9ZYL	58075-23	49-B
W8DTV*	1560-8	20-A	W9QWM	50270-22	39-B
W8DLA	1500-8	12--	W9OAW	31770-18	30-B
W8DHU	1300-10	26-A	W8BDL*	8145-9	10-B
W8KEL	1300-4	8-B	W9IBC*	4900-7	7--
W8SEI*	870-6	10--	W9UMG*	3000-5	6--
W8HQV*	180-4	9--	W9UAZ*	2100-5	8-ABC
Phone			W9MWH	750-3	3--

### W. Pennsylvania

W8DWW	516320-56	143-BC	Indiana		
W8SFV	230660-38	100-A	W9IU	894915-63	210-C
W8JMP	140980-39	88-B	W9VW	435540-42	155-B
W8GMH	57040-23	40-B	W9NOD	207900-45	69-B
W8JSU	47600-28	36-B	W9AMM	78778-34	65-B
W8IAT	38880-24	49-B	W9EGQ	76705-29	74-B
W8OJS	37500-25	54-B	W9AB	49361-28	40-A
W8NCJ	24360-22	24-A	W9AEA	31570-22	32-B
			W8OYY/9	19470-22	43-B
			W9ZYK	11505-15	31-B
			W9CWO	7670-13	14-B
			W9GWH	224-17	27-B
			W9ZVQ	810-6	8--
			Phone		
			W9MM	279360-36	108-C

(Continued on next left-hand page)

## CRYSTAL TALK

By **HIPOWER**

The Hipower Crystal Company, one of America's oldest and largest manufacturers of precision crystal units, is able to offer the amateur and manufacturer attractive prices because of their large production and the exclusive Hipower grinding process. Numbered among Hipower's customers are:

U. S. Army and U. S. Navy  
National Broadcasting Co.  
Columbia Broadcasting System  
Mutual Broadcasting System  
United States Airlines

Such satisfied customers provide assurance that whatever the need may be, Hipower can supply it. For the amateur, we offer the following world famous crystals.



"EMERALDS" Guaranteed to have a drift with temperature change of less than 10 CV. per °C. per MC. With holder. 160-80-40 meters. . . . \$3.35 Special 20 meter unit. . . . \$5.50

"RUBIES" One of the finest amateur crystal units available. Guaranteed drift of less than 4 CV. per °C. per MC. With holder. 160-80-40 meters. . . . \$4.50 Special 20 meter unit. . . . \$7.25

AVAILABLE AT YOUR PARTS DISTRIBUTOR  
Manufacturers Write for Prices

## HIPOWER CRYSTAL COMPANY

2035 CHARLESTON ST.

CHICAGO, ILL.



# **A BANDSWITCHING COMMERCIAL TRANSMITTER**

*designed and built by*

COMMUNICATIONS CO. INC., Coral Gables, Florida  
for one of the large Airlines in the East.

## **JOHNSON**

**CONDENSERS and  
INDUCTORS**

A 150 watt, four channel, band-switching transmitter using four Johnson 250E30 condensers, four 500E20 condensers, and four 622 Hi-Q Inductors. Airlines can't afford to take chances when human lives are at stake so this manufacturer chose, and the Airline approved, Johnson Condensers and Inductors. You can buy the same identical numbers for your own rig from your parts jobber. See or write him today for more information or if you prefer you may write us direct.

**Do you have a copy of the new Johnson-Bassett Catalog?  
Ask for Catalog 966J.**

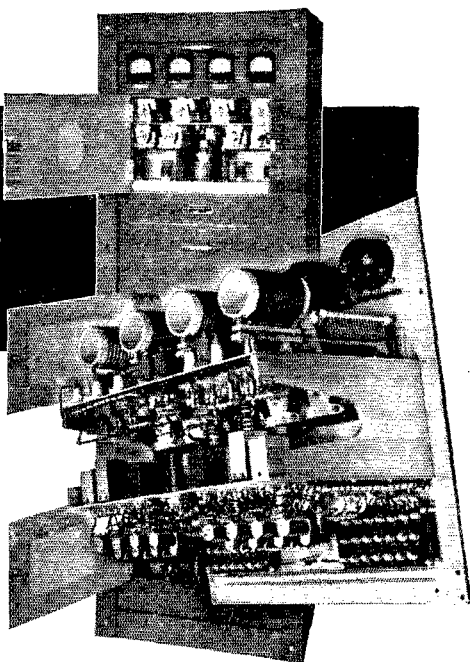

### **E. F. JOHNSON CO**

**WASECA, MINNESOTA**

**EXPORT: 25 WARREN ST., NEW YORK, N. Y.**

**"MANUFACTURERS OF RADIO TRANSMITTING EQUIPMENT"**



**VOILA!**

Nope, nobody's really kissed us on both cheeks or pinned any medals on our chest (as yet) but you ought to see some of the letters pouring in on us from all corners of the world heaping praise upon praise for our unstinted efforts in providing exemplary SERVICE. No wonder we've a right to crow, for where else but at SUN can you obtain such fine, individual treatment? Just try us ONCE and we bet you, too, will remain a satisfied customer. You'll find "it's SUN SERVICE that pleases."

**JUST A FEW LEFT!**

**BEEDE MILLIAMMETERS**

3" square bakelite case. Moving coil arrangement. 0-5, 10, 25, 50, 100, 200, 250, 300 or 500 MA. **\$2.39**  
YOUR CHOICE, any type.....

**★ HIGHLIGHT of the MONTH ★**

**The New HALLICRAFTERS SX-28**

The communications receiver that has taken the Ham World by storm. Built to the most rigid government specifications. Features 0 bands, 540 Kc. to 43 Mc. coverage, 2 R.F. stages, hi-fidelity push-pull audio output, band pass audio filter, "S" meter, new and improved noise limiter. Complete with 14 tubes and crystal, **\$159.50** less only speaker. PRICE.....

**NEW! MEISSNER F-M RECEIVER**

A complete home F-M receiver with built-in speaker. Includes 12 tubes, 3-stage I.F. amplifier, high gain R.F. amplifier, limiter, detector systems. Range 42-50 Mc. Polished walnut cabinet, sliding rule dial. **\$59.50**  
YOUR COST — complete.....

**FREE STANCOR PUBLICATIONS**

Just out! Three important publications of interest to every ham. Sent free on request.

**HAMANUAL** — 5th Edition. New, revised. Valuable information on transmitter design — circuits, parts lists, formulas, etc.

**SERVICE GUIDE**. Lists transformer replacements, circuit charts, tube complements for over 4300 radio receivers.

**PACK CATALOG**. Standard power packs for portable radios, auto radio demonstrations, pin games, time clocks, telephones, model railways, etc. DC and AC models.

**WANT TO SAVE?**

Send for SUN'S SPECIAL BARGAIN BULLETIN. New and used receivers, demonstrators, trade-ins, etc. Bargains and values galore! Write for latest list.

**FREE BOOKLET—"SUN SOUND SYSTEMS"**

Check-full of P.A. values. Lavishly illustrated.

*New York's Oldest "Ham" House*

W2JEH ■ W2DXC ■ W2LFV ■ W2CLH

**SUN RADIO CO.**  
212 Fulton Street, Dept. MT New York  
Cable Address: SUNRADIO NEW YORK

W0NYX 62160-21- 41-B  
W0GVT 23595-13- 21-A  
W0LQ 4960- 8- 10-  
W0QEI 4280- 8- 12--

*Kentucky*  
W0MOW 6450-15- 30-A  
W0UTO 650- 5- 7-A  
*Phone*  
W0WMI 214200-36- 88-C  
W0ELL 43430-17- 36-B  
W0BUR 12090-13- 15-B  
W0HRP 3010- 7- 10-B

*Michigan*  
W8LEC 1094800-68-229-C  
W8QOF 738100-61-185-  
W8JDG 365040-48- 06-C  
W8JAH 337875-51-128-B  
W8QJZ 208550-43-108-BC  
W8BWC 32956- 31- 59-C  
W8CVU 77562- 31- 74-B  
W8KPL 74060-28- 74-A  
W8AAO 38610-27- 68-B  
W8EXW 27370-23- 48-B  
W8MCC 19690-16- 36-A  
W8SCU 11298-14- 29-B  
W8SDR\* 3025- 5- 7-  
W8SCW\* 1645- 7- 9-B  
W8CE\* 880- 8- 22-B  
W8QHA 630- 6- 11-  
W8JCY 128- 4- 7-A  
*Phone*  
W8CTQ 113760-32- 65-C  
W8EXT 83545-31- 46-  
W8AKY 33900-25- 37-B  
W8MQT 50820-21- 47-B  
W8QON 45200-20- 35-B  
W8PY\* 43510-19- 40-B  
W8JH\* 33820-20- 29-C  
W8NML 2740-20- 36-B  
W8SW\* 14400- 9- 16-B  
W8SRC 13000-10- 18-  
W8QBR 4240- 7- 10-  
W8SDR\* 4050- 5- 10-  
W8SCA\* 1100- 5- 6--  
W8DED 600- 5- 9-A  
W8RLJ 330- 6- 11-B

*Ohio*  
W8BTT 907850-67-202-C  
W8ERI 678590-57-180-C  
W8HGW 600780-57-170-A  
W8JUN 400675-55-127-C  
W8CED 317184-37-137-AB  
W8KGG 225225-45- 88-C  
W8PUD 156910-26- 87-C  
W8LCO 142625-35- 93-B  
W8OXG 141180-39- 97-B  
W8ENA 134786-38- 84-A  
W8KO 133000-40- 76-B  
W8YX1 128760-37- 75-BC  
W8DAE 121175-37- 76-AB  
W8FGX 116620-24- 58-C  
W8MOA\* 106370-22- 74-C  
W8BXM 92925-35- 75-B  
W8ENH 76800-30- 75-B  
W8JYJ 62850-30- 39-B  
W8LOF 62720-32- 59-A  
W8SQE 54900-30- 62-B  
W8LCY 48375-25- 45-A  
W8RFA 48300-14- 35-A  
W8TQN 47520-27- 48-B  
W8AQ 38208-24- 57-B  
W8PXP 36216-18- 43-B  
W8SYC 21069-18- 25-B  
W8CGN 20500-20- 34-B  
W8BZB 19665-19- 36-A  
W8ROX 19040-24- 55-A  
W8ISK\* 18410-14- 35--  
W8OPT 16107-21- 41-B  
W8PCS 13600-17- 27-B  
W8TPS 10880-16- 22-A  
W8GER 8750-14- 30-B  
W8BSR 6075-15- 24-B  
W8ORX 4345-11- 23-A  
W8QHV 4180-11- 19-C  
W8QKQ 3640-26- 28-A  
W8GVL 3050-10- 23-A  
W8QOG 3030- 6- 6-A  
W8SXT 1550- 5- 5-A  
W8TSE 1012-11- 19-A  
W8GCG 810- 6- 8-A  
W8MAE\* 200- 5- 8-  
W8HFR\* 136- 4- 8-  
W8TRV 87- 3- 7-  
*Phone*  
W8NV 364061-49-111-C

W8LFE 313425-45-101-C  
W8BF 256725-45- 76-C  
W8AAJ 148925-35- 73-B  
W8QOJ 43415-10- 30-A  
W8NK 38250-18- 26-B  
W8QAD 34860-21- 28-B  
W8CBI\* 21900-15- 28-  
W8PNJ 20100-15- 21-A  
W8PVM 17420-13- 21-B  
W8ODF 11800- 7- 17-  
W8TEF 645- 3- 5-B  
W8UAM 615- 3- 3-A

*Wisconsin*  
W8DIE 884390-57-194-C  
W8VDY 513040-53-150-B  
W8RPF 137280-33- 63-BC  
W8ITH\* 28060-23- 54-B  
W8KXK 20814-22- 36-B  
W8IQZ 16720-13- 22-A  
W8NKT 17850-14- 27-A  
W8BQZ 13140-12- 20-B  
W8VXF 7735-17- 34-B  
W8CFF 4940-10- 32-B  
W8WXD 2910- 5- 17-B  
W8RHH 2300- 8- 17-C  
W8DMO 928- 8- 25-A  
W8IDV\* 360- 6- 12-A  
W8EGZ 100- 4- 5--  
*Phone*  
W8EY 106400-35- 58-C  
W8CCI 95200-28- 53-B  
W8KDF 34230-21- 41-B  
W8ESJ\* 3000- 5- 6-C  
W8FIE 1820- 4- 5-  
W8ESM 116- 4- 7-A

**DAKOTA DIVISION**

*No. Dakota*  
W8PQV 163825-35-102-C  
W8ZLP 125884-31- 04-B  
W8ZLL 89100-33- 85-A

*Phone*  
W8VSK 49300-20- 37-B  
W8RPI 15960-14- 19--  
W8NYF 12400-10- 20-A  
W8ANL 7560- 9- 16-B  
W8WFO\* 7240- 8- 10--  
W8RGT 6560- 8- 12--  
W8ZPL 4185- 9- 17-A  
W8IOY\* 10- 1- 2--

**So. Dakota**

W8PZI 223514-31- 79-C  
W8WUU 24297-21- 42-A  
W8ZQC 8288-14- 24-B  
W8YOB\* 1225- 7- 16--  
*Phone*  
W8USH 125430-37- 66-B

**No. Minnesota**

W8RXL 178155-37- 90-B  
W8NIM 107100-35- 81-B  
W8ZYM 23200-20- 43-A  
W8QCP 5600-16- 32-AB  
W8PFR 2632-14- 19-AB  
*Phone*  
W8PFR 57375-25- 44-B  
W8RLL 17925-15- 30-C  
W8FEW\* 100- 1- 1-  
W8QIG\* 100- 1- 1--

**So. Minnesota**

W8DGH 172093-39- 99-B  
W8NUJ 78416-29- 67-A  
W8BQJ 26760-24- 52-A  
W8CYA 11790-18- 36-B  
W8NZE\* 20- 2- 2-B

**Phone**

W8QXC 34650-19- 34-B

**DELTA DIVISION**

*Arkansas*  
W8EGY 7875-25- 87-B  
*Phone*  
W8AKZ 599500-50-156-C  
W8FWD 27405-15- 24-B  
W8FPD 22750-14- 21--

**Louisiana**

W8KC 1015700-70-214-C  
W8BR 675220-52-203-C  
W8BZT 351750-50-125--  
W8IHM 198720-36-109-B  
W8HQZ 140250-33- 90-BC  
W8BEZ 33360-16- 47-B  
W8EUK 21390-21- 53-A  
W8HEZ 11305-17- 29-A

(Continued on next left-hand page)

# Approval of Amateurs Everywhere!

## HOWARD

### Progressive Series Plan



HOWARD'S revolutionary direct factory conversion set-up enables you to own at all times the latest receiving equipment — without risk of obsolescence loss or unfavorable trade-in deals. It is the most flexible and all-in-your-favor purchase plan in existence. If you want fine receiving equipment — with the advantages of adding to your investment at any time you desire — the HOWARD Progressive Series Plan provides the answer.

You can start the HOWARD Progressive Series Plan with basic Model 435 for a protected investment of only \$29.95. Model 436 . . . \$39.95. Model 437 . . . \$54.50. The total cost for the entire *Ideal Receiving Layout* pictured above . . . \$138.35. For complete details see your local amateur distributor or write the factory direct.

(Export and Pacific Coast Prices Slightly Higher)

**See the Howard Progressive  
Series Models at Your Distributors!**

**HOWARD RADIO CO.**

1731-35 Belmont Ave., Chicago, Illinois

### A Fine Receiver

For those desiring a single unit communication receiver that establishes new standards of performance, the new 14 tube HOWARD 490 is outstanding in every respect. Built to the most exacting electrical and mechanical specifications, the 490 has sensitivity that never knows "crowding" and selectivity that may be varied at will from the hairline sharp position required for CW signals to the wide band requirements of high fidelity reproduction.

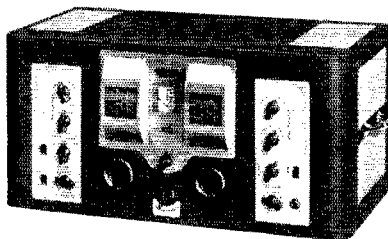

**MODEL "490"**  
With Crystal Filter and  
Separate 10" Speaker **\$149<sup>50</sup>**

Cable Address  
**HOWARDCO, U.S.A.**

# B & W JUNIORS

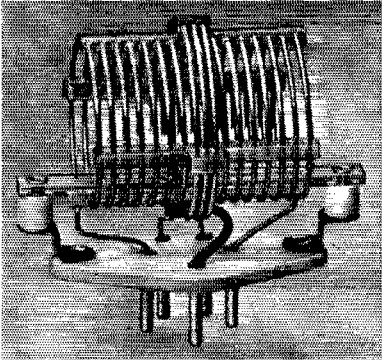

Amateur  
Net  
**\$1.00**  
Each

## NEW! HUSKIER! "TOPS" FOR MOST LIMITED-SPACE APPLICATIONS!

These new B & W JUNIORS far surpass, in ruggedness and efficiency, most of the larger, more bulky coils of comparable rating. Designed for optimum performance in many types of applications at input powers up to 75 watts and plate voltage to 850 volts, JUNIORS are available end linked, center linked and variable center linked. Get the whole story — at your jobber's or write direct.

Price Reductions Effective Oct. 1st

All Types B & W "BABIES"..... 75c net  
"Baby" Coil Turrets..... \$5.25 net

## BARKER & WILLIAMSON

Radio Manufacturing Engineers • ARDMORE, PENNSYLVANIA

# RADIO

**ENGINEERING,** broadcasting, aviation and police radio, servicing, marine radio telegraphy and telephony, Morse telegraphy and railway accounting taught thoroughly. 48 weeks' engineering course, equivalent to three years of college radio work. School established 1874. All expenses low. Catalog free.

DODGE'S INSTITUTE, Day Street, Valparaiso, Indiana



## Just Published!!

SEVENTH (1940) EDITION

Nilson & Hornung's

## RADIO OPERATING QUESTIONS AND ANSWERS

Covers all elements, 1 to 6, of the sample questions published by the F.C.C. in their Study Guide for Commercial Operators. Ideal handbook. Pocket size, flexible. Price \$2.50, postpaid. Money back if not satisfied and book is returned in 10 days. Send check or money order... not cash. C.O.D. charges extra. Free circular on request.



## NILSON RADIO SCHOOL

51 East 42nd St., New York, N. Y.

W5BUK\* 342- 6- 12-B  
Phone  
W5CXQ 196320-28- 77-B  
W5ACY 154980-27- 84-B  
W5AXS\* 17080-14- 16-B  
W5BUK\* 5670- 9- 12-B  
W5HOU\* 1200- 3- 4--  
W5AKJ 100- 1- 1--

Mississippi  
W5AUB 145080-36- 77-B  
W5HKT 13080-12- 28-A  
W5IEZ\* 4981-17- 42--

Tennessee  
W4DQH 198170-38-103-B  
W4GIX 77860-24- 77-B  
W4FLW 16640-20- 35-B  
W4ESZ 216- 4- 12-B  
Phone  
W4GGR 93600-26- 55-C  
W4AYU 76494-22- 51-B  
W4DQH 55770-22- 42-A

### Hudson Division

#### E. New York

W9CJM 303195-51-125-C  
W9AUF 77860-24- 58-BC  
W9IZO 19955-13- 29-C  
W9HCZ 13005-17- 41-B  
W9JFA 9324-19- 29-B  
W9KPH\* 3420- 9- 19-A  
W9MOZ\* 5- 1- 1--  
Phone  
W9MBC 7515- 9- 15-B  
W9MFS\* 7000- 7- 10--  
W9MSW\* 840- 4- 4--  
W9FCQ/2 20- 2- 2-A

#### N. Y. C. & L. I.

W9UK 1303560-72-259-C  
W9LXK 836928-64-194-C  
W9HHF 492420-60-135--  
W9AYJ 159390-42- 93-B  
W9KIK 121275-45- 88-B  
W9AHC 116985-33- 82-B  
W9FCQ 69107-29- 71-BC  
W9KMS 63560-28- 74-A  
W9B0 56700-28- 63-AB  
W9AXZ 52762-23- 65-B  
W9JB 51865-23- 57-B  
W9DKF 42255-27- 46-B  
W9BZS 81174-28- 42-B  
W9KYV 26000-20- 50-AB  
W9BUX 21945-19- 41-B  
W9LXD 18200-20- 40-A  
W9ITN 16925-25- 51-B  
W9HNJ 10950-15- 32-A  
W9ANX 10800-18- 44-B  
W9MGU 9555-13- 28-B  
W9EYS 4180-11- 38-A  
W9GP 3850-10- 20--  
W9BPD 2655- 9- 21-B  
W9KZX\* 2520- 9- 18--  
W9KEZ\* 2460- 6- 6-C  
W9HBJ\* 2120- 8- 15-B  
W9KLC\* 1225- 7- 16-A  
W9HBO 560- 8- 14-A  
W9LLE\* 390- 6- 13-A  
W9SQ\* 160- 8- 4-A  
W9A\* 100- 1- 1-C  
W9MFC\* 90- 3- 6-A  
W9KVL\* 5- 1- 1--  
Phone

W9LXY 25840-16- 29--  
W9LKP 7280- 8- 11-B  
W9A\* 1200- 3- 4-B  
W9KSG\* 900- 3- 3--  
W9BT\* 860- 4- 5--  
W9IOK 500- 4- 6-B  
W9MJU\* 410- 2- 3--  
W9EFL\* 400- 2- 3--  
W9KBO\* 400- 2- 3--  
W9KBG\* 100- 1- 1--

#### No. New Jersey

W9ZA 663680-61-172-C  
W9WC 295000-52-123-B  
W9DZA 178227-41- 93-B  
W9ARB 149280-32- 78-C  
W9JCA 104440-32-104-C  
92752-31- 77--  
W9BQS 81760-28- 52-B  
W9HXI 65070-27- 64-B  
W9HZN 51165-27- 57-B  
W9MLV 42770-26- 63-B  
W9LXI\* 40920-24- 37-B  
W9KHA 19800-18- 32-B

W9GVZ 18675-15- 21-C  
W9GME 16700-20- 36-B  
W9LKN 4455-11- 24-A  
W9LMN 4140- 9- 16-A  
3410-11- 24--  
W9MLW\* 3080-11- 28-A  
W9MDP 2072- 8- 15-B  
W9JLY 2000- 4- 5--  
W9EYZ\* 1840-10- 21-A  
W9MFF 1260- 4- 6--  
W9FMP\* 870- 6- 10-A  
W9BIV 725- 5- 10-A  
W9CPI 630- 3- 4-A  
W9HMF\* 5- 1- 1--  
W9MAX\* 5- 1- 1--

Phone  
W9JTT 743900-50-168-C  
W9TUV 121800-35- 50-B  
W9DYR 28390-17- 30-B  
W9JJI 27873-19- 28-A  
W9HTL 25508-14- 24-B  
W9BYM 19800-15- 17-B  
W9BYD 16050-15- 23-B  
W9FPM\* 1240- 4- 5-B  
W9MJC\* 860- 4- 5--  
W9KZD 460- 4- 4-A  
W9FMP\* 400- 2- 2--  
W9EYZ\* 200- 1- 2--

### Midwest Division

Iowa  
W9GKS 448730-46-146-B  
W9QLX 448500-50-142-B  
W9LHD 124780-34- 87-B  
W9FDL 119955-33- 62-B  
W9NTA 82470-30- 96-B  
W9WMP 47580-26- 62-A  
W9QUP 39393-27- 85-B  
W9DIB 11200-20- 36-B  
W9REY/9 10020-13- 34-B  
W9YOQ 4940-11- 12-B  
W9VFM 2050-10- 22-B  
W9IYH\* 200- 5- 8--  
W9DOC\* 20- 2- 2--

#### Phone

W9MCD 446250-50-113-C  
W9JOL 41780-16- 46-B  
W9JIS 35720-19- 34-B  
W9ZYS 8360-11- 18-A  
W9TJA 6540-12- 14-A  
W9BGK\* 210- 2- 2--

#### Kansas

W9CWW 546360-58-156-C  
Phone  
W9VGS 460- 4- 4--

#### Missouri

W9DAE 293850-46- 97-C  
W9QMD 210330-41- 76-B  
W9GBJ 142740-39- 86-B  
W9YRX\* 89895-21- 69-C  
W9PGI 53190-27- 71-B  
W9PXE 51590-22- 32-B  
W90MG 42480-18- 36-B  
W9AEJ 16216-21- 45-A  
W9HDM 6525- 9- 12-A  
W9GHD 2490-15- 34-A

#### Phone

W9OTB 72000-25- 44-B  
W9KOH 41760-18- 27-B  
W9VAV 37000-20- 23-B  
W9KFL 11100-12- 14-B  
W9CXB 9135- 9- 13-A  
W9IMZ 1890- 7- 16-C  
W9JAO 1410- 6- 9-A  
W9EIT\* 400- 2- 2--  
W9HPN 220- 2- 3-B

#### Nebraska

W9WGL 488000-50-157-B  
W9BBS 351450-40-124-C  
W9ARE 258808-44-115-B  
W9BZG 6878-19- 36-B  
W9EWO 1968-16- 25-B  
W9CDL 520- 4- 7-A

#### Phone

W9ZXA 18886-19- 43-B  
W9MTI 3222- 6- 13-B  
W9KQC 100- 1- 1--

### NEW ENGLAND DIVISION

#### Connecticut

W9GCX 377440-56-141-B  
W9INI 325450-46-123-B  
W9IAB 319365-47-105-C  
W9IFV 215344-43- 92-B  
W9IPL 145160-38- 80-B  
W9IFMV 129525-33- 82-B

# Question

Dear DM:  
 Kindly inform me of the best low-powered phone hook-up that will radiate 2.5 amps or more.  
 Sincerely,  
 George J. Speakman  
 3741-12th Ave.,  
 Intervale, Pa.  
 April 18, 1940

ROBERT L. WOODRUFF, ASSIST. PRESIDENT  
 100-110 W. BALTIMORE AVE., BALTIMORE, MD.

FRANKLIN B. BRANSON, VICE PRESIDENT & GENERAL MANAGER

**THE AMERICAN RADIO RELAY LEAGUE**

ADMINISTRATIVE HEADQUARTERS  
 WEST HARTFORD, CONNECTICUT, U.S.A.  
 April 19, 1940

ARTHUR B. HERBERT, VICE PRESIDENT  
 P. O. BOX 21, WEST HARTFORD, CONNECTICUT

GEO. L. MOORE  
 1001 W. HARTFORD  
 OFFICIAL ORGAN GET  
 MEMBERSHIP SERVICE

Mr. George J. Speakman,  
 3741 Twelfth Ave.,  
 Intervale, Pa.

Dear Sir:

It is quite unusual to classify amateur transmitters in the manner referred to on your post card. It is customary to think in terms of watts output. The output can be very closely approximated by assuming that the amplifiers will work at an efficiency value of 80 to 75 percent. Therefore, the required input necessary to furnish a given output can be readily calculated. Antenna current is not a true indication of power output inasmuch as the reading will depend upon several factors, such as the type of antenna, location of the meters, etc.

It is suggested that you turn to the transmitter construction chapter of the 1940 Handbook after you have decided upon the power which you wish to employ. You will find a large variety of transmitters described in this section of the Handbook, and it will be a simple matter to choose one which meets your demands. The modulation-equipment chapter will supply the circuit and construction details of the audio equipment which may be used in conjunction with any r.f. layout you select. A third chapter devoted to power supplies will explain the design of the necessary power equipment.

Incidentally, Sir, you are bound to be interested in the Complete Transmitter Chapter which explains how several units shown in the Handbook can be combined to furnish complete 'phone-c.w. transmitters. Fortunately, the connections between units are clearly explained. After the construction has been finished, the Handbook adjustment, operation and antenna chapters will be invaluable.

Best of luck - and please write to us whenever we can be of help to you.

75,  
 Vernon Chambers,  
 Technical Information Service

# Answer

The files of the A.R.R.L. Technical Information Service provide our best "sales talk" for the Handbook. The answers to most questions are to be found in the Handbook. You should have this "information service" right at your fingertips.

The Radio Amateur's Handbook is priced at \$1, postpaid in Continental U.S.A.; \$1.25, postpaid, elsewhere. Buckram Bound Edition, \$2.50, postpaid, anywhere.

**AMERICAN RADIO RELAY LEAGUE, Inc.**  
 West Hartford, Connecticut

# Now In Stock



## LINEAR TANK

2½ meter oscillator using a 6E6 tube. Completely wired. Measures 18½" x 3¾". **\$3.50 net, less tube**

## AUTOMATIC SENDERS

Increase your code speed. For beginners or experienced operators. Sends from 6-60 words per minute. Make your own special tapes with built-in tape perforator; with 5 rolls blank tape. . . . . **\$12.50 net**

Nationally known crystal microphone with combination hand and table stand. Substantially smooth from 30-5000 cycles. Output level—52. **Special at \$4.29 net**



## ECHOPHONE Commercial

New 6 tube AC-DC communications receiver. 3 bands (545 kc.-30.5 mc.) Electrical bandspread. Beat frequency oscillator. Automatic volume control. Self-contained speaker. Headphone jack. Calibrated dial with various channel services marked. Complete only. Excellent value at. . . . . **\$19.95 net**

**W2IIL ■ ■ W2LJA ■ ■ W2KWY**

OUR *Best* VALUE IS OUR RECORD OF LOYAL SERVICE

# HARVEY

*Radio Company of New York*

103 WEST 43rd STREET • NEW YORK, N. Y.

CABLE ADDRESS "HARADIO"

WIKQY	115520-31- 90-B	WIFKS	4960- 8- 10-B
WICSY	112500-30- 85-B	WIKMY	3480-12- 20--
WIBIH	36395-29- 42-B	WILVR*	1740-12- 29--
WIFUY*	31680-18- 29-B	WIBQA*	1400- 8- 16-A
WIBYW	4720-16- 21-B	WIDGA	420- 7- 12-A
WIIS	3341-13- 33-B	WILVS*	250- 5- 10--
WILIG	1729- 7- 12-A	WIMBE	160- 4- 8--
WIKDQ*	380- 8- 22-A	Phone	
WILQK	720- 9- 16-B	WIADM	702100-59-187-B
W8ANTU/1	462- 6- 18-A	WIAKA	671930-58-162-B
WIAVB*	100- 1- 1--	WIAKY	312975-44-110-C
WIACV	10- 1- 2-B	WIKQN	160560-36- 75-B
Phone		WIZI*	101850-21- 49--
WIBED	471015-45-137-C	WIJNX	84420-28- 52-B
WILFL	58695-21- 46-B	WIXM	62445-28- 49-B
WIJOS	15795-13- 15-B	WIFJN	48067-23- 47-B
WION*	10- 2- 2--	WIHSB	13065-13- 21-B
WILPN*	5- 1- 1--	WILMB	11800-10- 18-B
Maine		WILWQ	6300- 7- 9-B
WIBFA	191880-39-101-B	WIZR*	1715- 7- 11-A
WILSK	60200-20- 51-B	WILKM	1225- 5- 11-B
WIDFQ	49270-26- 67-B	WIKMY	645- 3- 5--
WIDLK	46340-28- 66-A	W. Massachusetts	
WICOM	35495-31- 58-B	WIIOZ	765390-62-180-C
WICRU	23000-23- 48-A	WIIJT	273015-45- 92-B
WICBU	6700-20- 48-A	WIBPN	270555-51-111-B
WIMDF	1349- 9- 12-A	WIBGY	98760-41- 73-B
Phone		WIKJO	8415-17- 42-B
WIKJJ	119625-29- 65-C	WIJXH	7750-10- 22-B
WIACW	22725-15- 36-A	WIKOS	1560- 8- 20-A
WIMCW	19600-14- 33-B	WIFRV	1170-13- 18-B
WIBXE	19440-16- 35-B	WIFAA	840- 8- 21-A
WIFDL	8775-13- 21-C	WIKZS*	80- 4- 4--
WIGKJ	220- 2- 3--	WIAJ*	5- 1- 1--
WICBU	10- 1- 2--	Phone	
E. Massachusetts		WICOI	158565-33- 68-B
WICBZ	605425-61-181-B	WIKLN*	100- 1- 1--
WIGLF	354430-46-135-B	WILDE*	99- 3- 7-B
WIRY	350065-53-124-B	New Hampshire	
WICCA	295692-51- 96-AB	WIBPT	249780-46-117-B
WIWV	151905-39- 76-B	WIDUK	114555-35- 77-AB
WIJEA	133190-38- 93-B	WIKLV	30305-29- 57-B
WIMIW	117200-40- 55-B	WIFPT	13205-19- 44-A
WIAQT	66600-25- 58-B	WILTD	5680- 8- 9-B
WICPB	25600-20- 30-B	WIKKT	580- 4- 10-A
WIKHE*	12375-11- 16--	WIGKY	490- 7- 14-A
WIPH	10680-12- 26--	WIMDL	125- 5- 5--
WIKTG*	9230-13- 28-B		

# How to Become A RADIO AMATEUR

*Universally recognized as the standard elementary guide for the prospective amateur*

It describes the construction of a simple and inexpensive transmitter and receiver that you can build yourself, and how to get up your antenna and get your station going. It also deals with the interpretation of what you hear and gives you a general understanding of the ropes in ham radio. It will also be found particularly helpful to the beginner because it tells about learning the code, how to get up code speed for the examination, and so on.

Price 25c postpaid (no stamps, please)

AMERICAN RADIO RELAY LEAGUE  
West Hartford, Connecticut

Phone  
WIATE 265230-42-95-C

**Rhode Island**  
WILFB 725-5-10-B  
Phone  
WJFG 237960-36-87-C  
WIFOV 235970-35-86-C  
WICJH 111600-30-60--  
WIBBN 16185-13-21-B

**Vermont**  
WJVS 112320-39-82-B  
WIKTB\* 18370-22-34--  
Phone  
WIDQK 12540-11-19-B

#### NORTHWESTERN DIVISION

**Idaho**  
WUQJ 316440-54-127-A  
WAVR 83520-24-70-B  
W7FBD 7248-12-28-A  
Phone  
WACD 184200-40-95-B  
W7CRL 18630-18-27-B  
W7HPH\* 100-1-1--

**Montana**  
W7FRS 255600-50-124-A  
W7JC 115950-30-89-B  
W7HCY 35695-23-65-B  
W7HIB 23825-21-54-A  
W7DHW\* 5-1-1--  
Phone  
W7EOI 280000-40-108-C

**Oregon**  
W7GBW 400500-50-141-A  
W7ENW 306275-37-108-BC  
W7EZX 153499-41-81-B  
W7FH 91200-24-38-A  
W7BOH 16160-16-31-A  
W7GUP 12245-11-31-A  
W7CQE 12225-15-24-B  
W7HXG 4400-8-15-A  
W7HJU\* 3010-7-10-A  
W7HVF\* 2850-10-23-A  
W7HJJ\* 330-3-3-A  
Phone  
W7GAE 256752-36-108-C  
W7QP 246800-40-93-B  
W7AMQ 129775-29-69-C  
W7GFU 121923-31-54-A  
W7DXT 34390-19-38-B  
W7GUR 2520-9-18-C  
W7FFJ 240-6-8-B  
W7GVD\* 210-2-2--

**Washington**  
W7VY 504000-56-168-C  
W7ESN 307152-48-132-B  
W7DYQ 264040-46-94-C  
W7LD 158800-40-91--  
W7HBL 104960-32-68-C  
W7JB 46275-15-57-C  
W7KD 7440-8-15-C  
W7HIF 6526-13-25-B  
W7CKH 5445-9-26-A  
W7HOJ 2568-6-10-A  
W7HHV 2520-4-12-A  
W7GQZ 2056-8-14-A  
W7GVH\* 500-4-6--  
Phone  
W7EOP 22520-20-37-B  
W7BBY 17710-11-18-B  
W7BQW 2370-6-13-A  
W7FLG\* 1545-5-6--  
W7DDI 640-4-4--  
W7HXU\* 630-3-4--  
W7AVM\* 100-1-1-A  
W7GOP\* 5-1-1--

#### PACIFIC DIVISION

**Nevada**  
W6QQL 790200-60-192-B  
W6PDV 81272-28-65-B  
W6RJI 845-18-32-A  
Phone  
W6GSB 100170-27-68-BC  
W6HCE 56070-21-40-A  
W6FUO\* 4025-5-9--

**Santa Clara Valley**  
W6HJT 164000-76-290-C  
W6PBV 218960-34-110-B  
W6DZE 84240-27-73-B  
W6QLO 12030-15-26-A  
W6PTX 100-1-1--

Phone  
W6BJB 32385-17-30-B

**East Bay**  
W6MVQ 654133-59-165-B  
W6LDD 259560-42-106-B  
W6CSJ 179350-34-105-A  
W6JOH 112455-27-73-AC  
W6LMZ 78850-29-50-AB  
W6EJA 9870-7-16-B  
W6PFK 3616-8-18-A  
W6DHS 4200-8-10-B  
W6RRH 1260-4-6--  
Phone  
W6OCH 1287660-66-248-C  
W6CQS 903960-62-203--  
W6ITH 899520-64-189-B

**San Francisco**  
W6CIS 595560-56-170-B  
W6MCQ 400800-52-159-B  
W6ZS 465120-51-173-C  
W6WN 282423-47-120-A  
W6MUF 64350-30-59-A  
W6RFF 6160-8-21-A  
W6OBK 4800-6-8-B  
W6QL\* 4550-5-11-C  
W6DLX\* 225-5-9--  
W6PKN 30-2-3-B  
Phone  
W6MWK 264250-43-82-C  
W6SG 9000-8-16-B

**Sacramento Valley**  
W6RMT 743600-62-195-B  
W6EFM 713273-61-172-B  
W6NHA 222490-38-109-B  
W6LGD 30560-19-37-B  
W6DBP 12320-14-24-B  
W6HPB 4320-8-13-A  
W6PAR\* 1245-3-7--  
Phone  
W6EJC 731895-59-173-C  
W6IMV 103625-25-60-B  
W6DEL 1230-3-6-B  
W6PAM\* 300-1-3-B

**San Joaquin Valley**  
W6KEV 1007005-69-194-C  
W6MSM 776335-57-197-C  
W6BVM 278267-41-105-B  
W6PYG 186200-35-76-A  
W6QXF 118513-31-62-B  
W6CLZ 9230-13-28-B  
W6DQV 8460-12-27-A  
Phone  
W6IWU 20891-13-28-B

#### ROANOKE DIVISION

**No. Carolina**  
W4GLQ 388700-52-137-B  
W4MR 263616-48-111-B  
W4TO 135340-32-70-B  
W4GNF\* 121600-32-86-B  
W4ACA 109461-33-75--  
W4DWB 100480-32-76-B  
W4WE\* 100470-34-79-B  
W4EFL 12855-15-20-B  
W4DW\* 3150-9-13--  
W4FXU 220-4-11-A  
Phone  
W4BMR 1110525-67-203-C  
W4TO 113305-31-47-B  
W4TW 10150-10-13-B  
W4OC 5800-7-8-C  
W4GNF\* 4305-7-9-B

**So. Carolina**  
W4AUW 176528-44-81-B  
Phone  
W4BQE 48510-21-44-B

**Virginia**  
W3EMM 1382760-72-269-C  
W3FQP 719210-59-199-C  
W3AG 155040-38-56-B  
W3DHz 27810-18-24-B  
W3ALF 10400-16-35-A  
Phone  
W3GWQ 25585-17-35-B

**West Virginia**  
W8TGH 61240-20-54-B  
W8SPR 21850-23-57-A  
W8JM 11390-17-39--  
Phone  
W8RJG 6400-8-8--  
W8JM 100-1-1--  
W8RZJ 5-1-1--



## FOUR-LEAD

## Dual DANDEES

Entirely separate sections. Two positive and two negative leads.

Identified as PRS-B series, as distinguished from PRS-A duals with concentrically-wound sections and three leads.

With these latest Four-Lead Dual Dandees, still more uses are found for ultra-compact electrolytics. Two entirely separate sections permit use in two entirely isolated circuits, or in common negative or common positive circuits.

### Ask for CATALOG...

Can be used in separate circuits, or in common negative or common positive circuits.

Latest Aerovox Catalog contains more pages, more listings, more choice. Ask jobber for copy — or write us direct.



Popular capacities and working voltages, for further flexibility.

## RADIO OPS WANTED!

In recent months the newspapers have run many articles about the Navy, Coast Guard and the Army looking for trained radio operators. It is a very interesting career for the expert radioman!

You can qualify for your Amateur or Commercial License and a good rating by taking CANDLER TRAINING in your own home as thousands of Amateur and Commercial Radiotelegraph Operators have done in the last twenty-five years. You will get the same instructions as McElroy and McDonald, the WORLD'S CHAMPIONS, received.

The New BOOK OF FACTS gives you the story of the champions and many inside tips that will help you. It is FREE, a postal will bring it to you. No obligation.



## CANDLER SYSTEM CO.

Dept. Q-10

ASHEVILLE, NORTH CAROLINA

# Your Inquiries Invited

IT PAYS YOU TO DEAL  
with **W9ARA**

We have the world's largest stock of National, Hammarlund, Hallicrafters, RME, Howard, RCA and other amateur receivers of all makes and models. We stock large quantities of the newest models such as the SX-28, NC200, S29, etc. so that we can fill orders promptly.

You get best trade-in for your receiver. Get my offer. You can pay the balance on terms.

I finance all terms myself so I can give you better terms with less cost to you — no red tape — quicker delivery. Write me for terms.

You get ten day free trial of any receiver. Prompt shipment from our stock or from factory whichever you prefer.

You get personal attention you can't get elsewhere. I will help you get the best apparatus for your use and cooperate with you to see you are 100% satisfied.

So write to me for any amateur equipment in any catalog or ad. I guarantee you can't buy for less or on better terms elsewhere. Write me about your needs and wishes.

*Bob Henry*  
W9ARA  
**BUTLER, MISSOURI**

*★ Performance ★ Accuracy ★ Value*

## All in the NEW PRECISION No. 872

Automatic Push Button AC-DC Multi-Range Tester  
**29 RANGES** including 3000 Volts AC & DC

★ LARGEST METER (3 1/2 inches wide) ever provided in a compact instrument, 7" x 4 1/2" x 3" overall.

★ Simplified push-button selection: ALL measurements made from ONLY TWO tip jacks (except 3000 volts).

★ RANGES: ● 6 DC voltage ranges at 1000 ohms/volt; 0-6/30/300/600/1200/3000 volts ● 5 AC voltage ranges at 500 ohms/volt; 0-12/60/600/1200/3000 volts ● 5 DC current ranges to 1200MA. ● 3 OHM METER ranges to 5 MEGS; up to 500M ohms on internal battery ● 6 DECIBEL ranges (-10 to +64 DB) ● 5 OUTPUT ranges to 3000 volts.

★ IT'S "PRECISION" BUILT! — 1% wire wound bobbins — 1% matched metalized multipliers — individually sealed calibrating controls — telephone cabled wiring, etc.

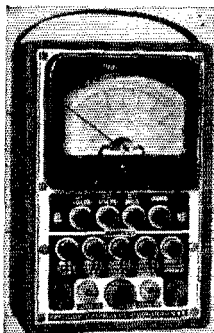

COMPARE THIS "PRECISION" VALUE at only \$17.95 net  
This is only one of the more than 40 models comprising the complete "Precision" line of dynamic mutual conductance tube testers, combination set testers, multi-range testers, signal generators, etc. Prices start as low as \$14.95.

Ask for the PRECISION TEST EQUIPMENT 1941 CATALOG

**PRECISION TEST EQUIPMENT**  
Standard of Accuracy SEE THEM AT YOUR JOBBER

**PRECISION APPARATUS COMPANY**

647 Kent Avenue Brooklyn, New York  
Export Div.: 458 Broadway, New York, U. S. A. — Cables: Morhanex

### ROCKY MOUNTAIN DIVISION

*Colorado*  
W9FFY 675845-59-163-AC  
W9WTW 592470-58-162-B  
W9RTQ 133155-33-85-B  
W9GKW 2430-9-16-B  
*Phone*  
W9GBQ 91930-29-74-A  
W9YXS 86550-30-64-BC  
W9UXI 15015-13-21-A  
W9VIY 6610-10-19-B  
W9HIF\* 6300-10-12-B  
W9IVT\* 3025-5-7--  
W9QIS 615-3-3--  
W9FRQ\* 400-1-4--  
W9QKW\* 300-1-3-A

### Utah-Wyoming

W7HRM 82098-29-94-B  
W6QVY 3720-8-17-A  
W7ABO 3550-10-24-A  
W7GZG 270-6-9--  
*Phone*  
W7GBY 44700-20-48-B  
W6DZX 35190-17-35-B  
W6PGH 100-1-1--  
W6BLE\* 100-1-1--

### SOUTHEASTERN DIVISION

*Alabama*  
W4ECI 1225305-73-241-C  
W4EV 348390-48-131-B  
W4EHH 331820-47-130-B  
W4FZG 9779-11-27-B  
*Phone*  
W4ECF 209024-32-91-C  
W4FUM 141300-30-68-C  
W4FYB\* 8400-10-16-B

### E. Florida

W4QN 434017-53-147-B  
W4FZW 49035-21-49-A  
W8EDD/4 39840-24-47-A  
W4FAN 17644-22-47-B  
W4AKH 15030-18-34-A  
W4EQQ 7497-17-33-B  
W4DBF 6030-9-20-B  
W4DZ 3141-9-14-A  
W4FET 2770-10-18-A  
W4EEO 780-6-7-B  
W8HSP/4\*10 225-5-9-A  
W4DRK\* 80-4-4-A  
W4TR\* 40-2-4--  
W4DVT\* 14-2-2--  
*Phone*  
W4DDB 41538-21-47-A  
W4EUN 1220-4-4-B  
W4DRK\* 100-1-1-A

### W. Florida

W4CDE 285055-47-125-B  
W4FRQ 5-1-1--  
*Phone*  
W4FWY 27965-17-25-B  
W4GAA\* 100-1-1--

### Georgia

W4BZ 1173260-74-234-C  
W4FLJ 635550-57-178--  
W4BXX 519390-58-138-B  
W4GCO 11088-16-37-A  
W2MEX/4 2160-8-16-B  
W4FTN 1755-9-20-B  
W4EGX\* 225-5-9--  
*Phone*  
W4EEE 892740-62-174-B  
W4DYK 133840-32-73-C  
W4FLJ\* 1500-3-5-B  
W4ELO 40-2-4--

### SOUTHWESTERN DIVISION

#### Los Angeles

W6GRL 5622310-89-368-C  
W6QD 1835960-79-397-C  
W6VB 1656192-76-292-C  
W6GEG 1536610-74-268-C  
W6EAK 653125-55-193-B  
W6NLI 624030-58-135-B  
W6NPY 466884-51-136-B  
W6IOJ 432425-49-124-A  
W6ONG 313445-41-123-B  
W6LRU 227480-44-98-A  
W6QKB 150360-32-100-A  
W6REH 150974-38-84-C  
W6NNV 118050-30-86-B  
W6OSU 112530-33-55-C  
W6DBT 98720-31-75-B  
W6RTB 85050-27-47-B

W6ACL 45300-20-35-B  
W6PQL 26025-15-44-A  
W6PCB\* 25500-15-36-B  
W6RGE 21755-19-30-A  
W6LUR 14320-16-29-B  
W6PDF 13650-15-30-B  
W6CID 8472-12-28-A  
W6SFS 6391-11-22-B  
W6EA 3600-8-14-A  
W6RIU\* 2400-4-6--  
W6VLQ 2190-6-16-A  
W6KNF 1620-4-5-B  
W6DHO 1500-3-5-B  
W6RUD 1135-5-8-A  
W6IOX\* 900-3-3--  
W6JBP 600-6-5-A

### Phone

W6NNR 847015-57-192-C  
W6AM 750870-54-187-C  
W6NKH 654815-53-172-C  
W6MEP 374400-45-97-B  
W6PDB 308220-44-120-B  
W6CGY 111755-31-56-B  
W6QOZ 86625-25-58-C  
W6QZA 57015-21-30--  
W6QMI 50635-19-50--  
W6KNF 20175-15-22-B  
W6QGT\* 19110-14-17--  
W6PEN 16505-11-15--  
W6NWQ 13715-13-21-B  
W6OQK 8470-7-14-A  
W6KTS 5810-6-17-A  
W6QXA 530-8-19-B  
W6BUK 2400-4-6-B  
W6QKS 930-3-5-A  
W6SIO 930-3-5-A  
W6RKI\* 780-5-6--  
W6RJV 400-1-4--  
W6RCH 100-1-1--  
W6REG\* 100-1-1-A  
W6LEF 5-1-1--

### Arizona

W6KMM 418000-50-134-A  
W6RAM 155400-40-92-B  
W6OVK 110360-31-70-B  
W6PJP 5544-12-17-A  
W6OMR\* 3420-9-19-A  
*Phone*  
W6OJK<sup>16</sup> 252195-43-90-C  
W6PCB 62330-23-48-B  
W6PQQ 42585-17-26-B  
W6OWX 28900-17-36-B  
W6OIF 13538-14-23-B

### San Diego

W6ITY<sup>11</sup> 1111383-69-230-B  
W6BAM 583632-56-160-C  
W6BEK 562100-56-135-B  
W6BYZ 76020-28-49-B  
W6FZH 31365-17-36--  
W6FTM 23735-27-48-B  
W6GAP 12805-13-26-A  
W6OLU\* 12600-6-21-C

### Phone

W6GCT 256035-39-96-C  
W6GHV 204750-35-87-A  
W6MHL 82560-22-53-B  
W6NAV 62440-20-55-B

### WEST GULF DIVISION

#### No. Texas

W670840-62-169-B  
W5RCH 303120-45-123-AC  
W5DXA 138390-34-76-B  
W5AWT 122385-41-93-AB  
W5GJG 101115-33-80-A  
W5DWO 59405-29-66-AB  
W5DAA 29949-23-38-B  
W5HMP 27260-22-58-A  
W5GDH 6630-13-26-A  
W5LLY 1100-5-6-A

### Phone

W5WU 602310-51-158-C  
W5YF<sup>12</sup> 397760-44-117-C  
W5AAN 41310-18-41-B  
W5HJU 30720-12-47-B  
W5FZN 4905-9-14-A

### Oklahoma

W5RGA 501075-51-160-B  
W5HLD 185940-36-105-B  
W5AQE 101340-36-88-A  
W5GJJ 19620-18-47-A  
W5FCW 15885-19-44-B  
W5WFG 964-7-15-A  
*Phone*  
W5GZK 238320-48-81-B



## *New Exams* New License Manual

The new examinations are based on the multiple-choice type of questions. This of course requires an entirely different approach on the part of the applicant studying to take the examination for license. The NEW "License Manual" has been written to make it as easy as possible for the individual to acquire the necessary knowledge to pass the examination with flying colors. Whether you are going up for your Class C, B or your Class A ticket, "The License Manual" will provide the most direct path to getting that ticket. If you are one of the thousands who always wants a "License Manual" around the shack for ready reference for amateur regulations, it will please you to know that the regulations are very thoroughly indexed.

*Price 25c postpaid (no stamps, please)*

**American Radio Relay League**  
West Hartford, Connecticut

## LEARN RADIO • TELEVISION

60-page catalog on request. Oldest, largest and best equipped in New England. Fall term, Sept. 9. Write for new catalog.

**MASS. RADIO SCHOOL**

18 Boylston Street Boston, Massachusetts

## SICKLES COILS

ALL TYPES OF RF AND IF WINDINGS

*Manufactured by*

**F. W. SICKLES COMPANY**

300 Main Street Springfield, Mass.

## AMATEUR RADIO LICENSES

Day and Evening Classes in Code and Theory

HOME STUDY COURSES

*Reasonable, Efficient and Thorough, Hundreds of Licensed Students Now on the Air*

American Radio Institute, 1123 Broadway, New York, N. Y.

## Piezo-Electric Crystals Exclusively

- Quality crystals of all practical frequencies supplied SINCE 1925. Prices quoted upon receipt of your specifications.

Our Pledge: **QUALITY FIRST**

**SCIENTIFIC RADIO SERVICE**

*"The Crystal Specialists Since 1925"* University Park, Hyattsville, Md.

# AUTOMATIC SENDERS

- TEACH YOU CODE
- SPEED UP YOUR RECEIVING
- SEND YOUR MESSAGES

LEARN CODE the way you'll use it—by hearing it.  
Adjustable speed. Silent induction-type motor.

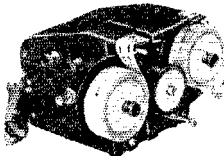

**Type S - \$17.50**

Sends from 4 to 60 words per minute. Higher speeds if desired. Complete with 10 rolls of double-perforated lesson tape of carefully selected and arranged matter for speediest results in learning code. Most compact and practical code teacher on market.

**Type J - \$12.50**

Sends from 6 to 70 words per minute. Built-in tape perforator. Cut your own code-practise tapes and message tapes. Complete with already-cut practise tape and 5 rolls of blank tape. Repeats calls and messages indefinitely. Length of messages practically unlimited.

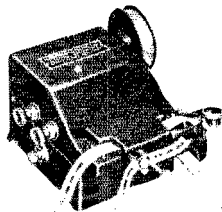

*If your dealer can't supply you, write us*

**FULLY GUARANTEED**

**GARDINER-LEVERING CO.** Haddon Heights  
New Jersey, U. S. A.

## PINCOR ROTARY CONVERTERS

Engineered right . . . built right. That is why this complete line of Pincor Rotary Converters can always be depended upon to give thousands of hours of trouble-free service for operation of public address systems, gasous signs, power amplifiers, radios, A. C. motors, musical instruments and other electrical apparatus, even under the most adverse conditions. Available with or without filter for converting 6, 12, 32, 110, 220 or special voltages D. C. to 110 or 220 volts A. C. Capacities: 40 to 5000 watts. Quiet, smooth, lightweight and compact. Send for NEW complete catalog today. Use coupon below.

**PIONEER  
GEN-E-MOTOR CORP.  
CHICAGO, ILL.**

Export Address:  
25 Warren Street, New York, N. Y.  
Cable: Simontrice, New York

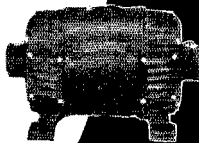

PIONEER GEN-E-MOTOR CORP., Dept. R-61, 466 W. Superior St., Chicago, Ill. Please send me NEW complete catalog on Pincor Rotary Converters.

Name.....  
Address.....  
City.....State.....

# "HARRISON FOR RECEIVERS"

That's what all the boys are saying!  
Harrison gives you Lowest Prices — Latest  
Models — Easy Payment Terms — Best  
Trade-in Allowances — 100% Satisfaction —  
*The best deal all around!*

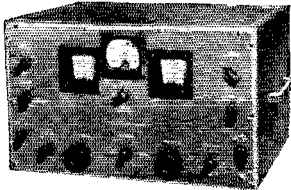

## THE NEW HQ-120 X IS GOOD!

The improved version of this famous Hammarlund receiver is certainly FB! You'll

be sure to like it. Complete — Cash price \$138.00. Buy it on the "Harrison Easy Payment Plan" with terms to your convenience. For example — \$21.25 down and 12 monthly payments of \$10.35. Or — you tell us!

Of course — you get the best Trade-in Allowance at Harrison!



## THE NEW SUPER- PRO IS BETTER!

They're tops! Ask the Ham

who owns one. Not at all expensive when you consider performance. Complete — \$279.00.

Harrison's Easy Terms are arranged to your convenience. Ask for details.

Also Transmitters, Kits, Tubes, Parts, etc.  
No matter what you need —

## "HARRISON HAS IT!"

(Send for latest list of Receivers)

12 WEST BROADWAY NEW YORK CITY  
Telephone WOrth 2-6276

# • HARRISON •

RADIO COMPANY

W5GVP\* 122715-27- 63-B  
W5HXB 5- 1- 1--

*So. Texas*  
W5CQWW 141050-35- 84-B  
W5CTW 99240-24- 67-C  
W5NU 41760-32- 71-A  
W5FNX 18585-21- 44-B  
W5EWZ 10790-13- 33-A  
W5HZT 5490-10- 16-A  
W5HBI 2072- 4- 9-B  
W5HLK\* 900- 3- 3--  
W5GXA 540- 6- 18--  
W5HME 224- 2- 4-A  
W5GWL 45- 3- 3-A  
*Phone*  
W5VV 563490-54-148-C  
W5EDX 261675-45- 39-B  
W5FGQ 151710-26- 65-C  
W5BCU 35640-24- 49-A  
W5BZP\* 1920- 6- 7--  
W5GWL 810- 6- 8-A  
W5HDK 100- 1- 1--  
W5FNX\* 100- 1- 1--  
W5GGS\* 30- 2- 3--  
W5HBT 20- 2- 2--  
W5CX8\* 14- 2- 2-A

*New Mexico*  
W5IOA 8911-13- 43-A  
W5HOY 252- 6- 9-A  
*Phone*  
W5DWP 237510-39- 97-B  
W5GGX 179248-34- 87-C  
W5GYM 147200-40- 72-B  
W5HPZ 16590-14- 38-A

*AFRICA*  
*Belgian Congo — OQ*  
*Phone*  
OQ5AB 38505-51-151-A  
OQ5IM 8550-25- 69-A

*ASIA*  
*China — XU*  
XU8WS 4200-15- 56-B  
XU5MK 2628-18- 31-A  
XU8MA 276- 6- 11--  
*Phone*  
XU8AM 24480-32-153-B

*Chosen (Korea) — J8*  
J8CL 4110- 7-126-A

*Japan — J*  
J2OV 28424-38-148--  
J2KN 23715-31-153-B  
J2LL 19413-27-154-B  
J3CG 8531-19- 91-A  
J2LX 4370-10- 88-B  
J2KI 600- 5- 24-A  
J7CJ 244- 2- 25-A  
J2KD 228- 3- 17-A  
J2OM 57- 1- 12-A  
*Phone*  
J2NF 17312-32-113--  
J2KI 268- 4- 14-A  
J2NT 60- 3- 4-A

*Manchukuo — MX*  
MX3H 130- 2- 13-B

*NORTH AMERICA*  
*Alaska — K7*  
K7GOM 55608-56-199-A  
K7BUB 53250-50-216-C  
K7HNG 23954-37-131-A  
K7HKB 21952-32-147-B  
K7FOS 15600-40- 78-A  
K7HJL 423- 9- 10--  
*Phone*  
K7GSC 24336-39-129-B  
K7ATD 120- 4- 6-A

*Canal Zone — K5*  
*Phone*  
K5AT 53680-40-269-A

*Costa Rica — TI*  
TI2FG 3200-20- 32-B  
*Phone*  
TI2FG 540- 9- 12-B

*Cuba — CM/CO*  
CM2AD 190570-85-455-A  
CM2AO 53340-35-314-B

CM2OP 25410-42-121-B  
CM2AP 3456-16- 48-A  
*Phone*  
CO2AM 167325-69- 485-B  
NY4AD 115264-64-365-B  
CO2JM 58882-61-196--  
CO2BA 35360-40-187-B  
CO2JK 30320-40-154-B  
CO2MG 13615-35- 83-A  
CO2UF 32- 1- 7--

*Mexico — XE/XF*  
XF1A 839851-127-1338-B  
XE1CM 768750-125-1230-B  
XE1AM 100750- 65- 310-B  
XE1AX 94392- 76- 250-B  
XE2CN 46171- 43- 226-A  
*Phone*  
XE2HD 80145- 65- 249-A  
XE2IK 16185- 39- 83-C  
XE2CN 2610- 18- 29-A  
XE1MF 80- 4- 4--

*Nicaragua — YN*  
*Phone*  
YN1P 28700-35-164-A

*Puerto Rico — K4*  
K4DTH 643428-122-1056-BC  
K4KD 155936- 88- 355-B  
*Phone*  
K4FKC 388376-86-918-C

*Rep. of Honduras — HR*  
*Phone*  
HR5C 13475-35- 77-B

*Rep. of Panama — HP*  
*Phone*  
HP1A 26680-46-116-B

*Virgin Islands — KB4*  
K4AAN 4266-18- 48--

*OCEANIA*  
*Guam — KB6*  
KB6RVN 228- 4- 13-B

*Hawaii — K6*  
K6SGB<sup>13</sup> 435464-116-755-B  
K6PAH 376625-115-662-B  
K6CGK 334917- 99-681-BC  
K6PAL 325910-115-616-A  
K6PIN 324280-110-669-B  
K6PHD 304806-111-554-B  
K6AYD 290523-113-522-BC  
K6FAZ 257744- 89-581-B  
K6PGQ 164889- 93-361-B  
K6QYI 132880- 88-302-A  
K6QUJ 72820- 44-334-B  
K6DTR\* 39364- 52-155-C  
K6SAJ\* 29620- 36-162-C  
K6SDY 16095- 87- 87-A  
K6ROC 12420- 27- 97-A  
K6QZW\* 9394- 22- 87-A  
K6BDZ 4640- 20- 50-A  
K6SBM\* 3096- 18- 35--  
*Phone*  
K6PLZ 278376- 84-716-B  
K6PTW 267432- 88-612-B  
K6LKN 88200- 72-252-B  
K6BNR 10230- 33- 62-C  
K6PCF 9044- 34- 61-B  
K6RCB 2240- 16- 28-A  
K6OTH\* 560- 7- 16-B

*Java — PK*  
*Phone*  
PK1OG 20650-35-121-A  
PK3JK 6552-21- 63-A  
PK1JR 4464-18- 49--  
PK2LZ 1164-12- 20-A  
PK1SM 220- 4- 11-A

*Philippine Islands — KA*  
KA1MN 12680-20- 84-B  
KA1SP 5814-17- 69-AB  
KA1EL 1728-12- 31--  
*Phone*  
KA1LB 31348-34-188--  
KA1JH 3008-16- 38-B  
KA3BW\* 45- 1- 9--

*Sumatra — PK4*  
*Phone*  
PK4DA 5250-21- 50-B  
PK4JD 3962-16- 50-A  
PK4KS 2960-16- 37-B

# Where to buy it

A directory of suppliers who carry in stock the products of these dependable manufacturers.



**ALBANY, N. Y.** Uncle Dave's Radio Shack 356 Broadway  
**ATLANTA, GEORGIA** 265 Peachtree Street  
 Radio Wire Television Inc.  
**BOSTON, MASS.** Radio Shack 167 Washington Street  
**BOSTON, MASS.** 110 Federal Street  
 Radio Wire Television Inc.  
**BRIDGEPORT, CONN.** 177 Cannon Street  
 Hatry & Young, Inc.  
**BRONX, N. Y.** 542 East Fordham Rd.  
 Radio Wire Television Inc.  
**BUTLER, MISSOURI** 211-215 N. Main Street  
 Henry Radio Shop  
**CHICAGO, ILL.** 833 W. Jackson Blvd.  
 Allied Radio Corp.  
**CHICAGO, ILL.** 901-911 W. Jackson Blvd.  
 Radio Wire Television Inc.  
**CINCINNATI, OHIO** 1103 Vine Street  
 United Radio, Inc.  
**DETROIT, MICH.** 325 E. Jefferson Ave.  
 Radio Specialties Co.  
**DETROIT, MICHIGAN** 11800 Woodward Ave.  
 Radio Specialties Co.  
**HARTFORD, CONNECTICUT** 227 Asylum Street  
 Radio Inspection Service Company  
**HOUSTON, TEXAS** 1021 Caroline Street  
 R. C. & L. F. Hall  
**INDIANAPOLIS, INDIANA** 34 West Ohio Street  
 Van Sickle Radio Supply Co.  
**JAMAICA, L. I.** 90-08 166th Street  
 Radio Wire Television Inc.  
**KANSAS CITY, MO.** 1012 McGee Street  
 Burstein-Applebee Company  
**NEW HAVEN, CONN.** 1172 Chapel Street  
 Hatry & Young, Inc.  
**NEW YORK, N. Y.** Harrison Radio Co. 12 West Broadway  
**NEW YORK, N. Y.** 100 Sixth Ave.  
 Radio Wire Television Inc.  
**NEWARK, N. J.** 24 Central Ave.  
 Radio Wire Television Inc.  
**READING, PENN.** 404 Walnut Street  
 George D. Barbey Company  
**SCRANTON, PENN.** 519-21 Mulberry Street  
 Scranton Radio & Television Supply Co.  
**WASHINGTON, D. C.** 938 F Street, N. W.  
 Sun Radio & Service Supply Co.



**ALBANY, N. Y.** Uncle Dave's Radio Shack 356 Broadway  
**ATLANTA, GEORGIA** 265 Peachtree Street  
 Radio Wire Television Inc.  
**BOSTON, MASS.** Radio Shack 167 Washington Street  
**BOSTON, MASS.** 110 Federal Street  
 Radio Wire Television Inc.  
**BRIDGEPORT, CONN.** 177 Cannon Street  
 Hatry & Young, Inc.  
**BRONX, N. Y.** 542 East Fordham Rd.  
 Radio Wire Television Inc.  
**BUTLER, MISSOURI** 211-215 N. Main Street  
 Henry Radio Shop  
**CHICAGO, ILLINOIS** 833 W. Jackson Blvd.  
 Allied Radio Corp.  
**CHICAGO, ILL.** 901-911 W. Jackson Blvd.  
 Radio Wire Television Inc.  
**CINCINNATI, OHIO** 1103 Vine Street  
 United Radio, Inc.  
**HARTFORD, CONN.** 203 Ann Street  
 Hatry & Young, Inc.  
**JAMAICA, L. I.** 90-08 166th Street  
 Radio Wire Television Inc.  
**LITTLE ROCK, ARKANSAS** 409 W. 3rd St.  
 Beem Radio Company  
**MINNEAPOLIS, MINNESOTA** 1124-26 Harmon Place  
 Lew Bonn Company  
**NEW HAVEN, CONN.** 1172 Chapel Street  
 Hatry & Young, Inc.  
**NEW YORK, N. Y.** 100 Sixth Avenue  
 Radio Wire Television Inc.  
**NEWARK, N. J.** 24 Central Ave.  
 Radio Wire Television Inc.  
**READING, PENN.** 404 Walnut Street  
 George D. Barbey Company  
**SCRANTON, PENN.** 519-21 Mulberry Street  
 Scranton Radio & Television Supply Co.  
**WASHINGTON, D. C.** 938 F Street, N. W.  
 Sun Radio & Service Supply Co.

Listings on this page do not necessarily imply endorsement by QST of the dealers or of other equipment sold by them.

# Talk Thru the New SHURE "STRATOLINER" and Go Over Big!



Go on the air and get there — with this beautiful new Shure Stratoliner! Shure-Engineered high-efficiency speech characteristic and high output level (29.7 db below 1 volt for 10 bar speech signal) insures clear crisp signals — cuts thru noise and static. Excellent for amateur and commercial 'phone communications. Swivel head. Satin Chrome finish. Bimorph Crystal. Built-in cable connector. 7 ft. cable.

Model 708SH — Crystal Microphone without desk mount. List Price. . . . . **\$17.50**

Model 708S — Same, complete with Model S36A Iridescent Gray Desk Mount. List Price. . . . . **\$20.50**

*Shure Patents Pending. Licensed under patents of the Brush Development Company*



## YOUR NEEDS DESIGNED

*the one and only*  
**"HAMMETER"**  
Model 240

● In its compact case, the Hammeter holds the answer to all of your problems of checking steps in building, or running down trouble. Test cables, clips and case are heavily insulated—shock-proof. Voltage ranges have resistance of 1,000 ohms per volt. Simpson quality and beauty throughout. Note ranges, opposite, and remarkably low price. Don't overlook the plus value of Simpson Panel Instruments—the meters that give you the expensive bridge type construction with soft iron pole pieces at prices no higher than you pay for the ordinary kind.

A.C. volts: 0-15-150 - 750 - 3000;  
D.C. volts: 0-15-75-300-750-3000;  
D.C. milliamperes: 0 - 15 - 150 - 750;  
ohms: 0-3000 (center scale 30) and 0 - 300,000 (center scale 3,000).

Your Net Price. **\$14.75**

SIMPSON ELECTRIC CO.  
5210 Kinzie Street, Chicago

# SIMPSON

*Instruments that STAY accurate*

<b>SOUTH AMERICA</b>		<b>Chile — CE</b>	21917-31-142-A
<b>Argentina — LU</b>		<b>CE4AD</b>	
LU7AZ	515032-119-868-C	<b>Phone</b>	
LU9AX	235900-100-473-BC	<b>CE2BX</b>	188588-84-430-B
LU2FC	165636-86-417-B	<b>CEIAR</b>	11129-31-73-C
LU3DH	45640-56-163-A	<b>CE2AR*</b>	6877-23-61-C
LU5FB	2800-14-43-A		
<b>Phone</b>		<b>Colombia — HK</b>	
LU5AN	207624-82-507-BC	<b>HK4DA</b>	12702-29-90-A
LU7BK	28035-45-127-B	<b>HK5ED</b>	3360-16-42--
LU5DD*	450-9-10-B		
LU3HA	240-6-8-A	<b>Ecuador — HC</b>	
LU8EC	45-3-3--	<b>Phone</b>	
		<b>HC2CC<sup>14</sup></b>	164472-77-429-B
<b>Brazil — PY</b>		<b>Peru — OA</b>	
PY2AC	461100-119-780-C	<b>OA4U<sup>15</sup></b>	86870-73-238-B
PY2DV	113550-75-312-C	<b>Phone</b>	
PY1DS	101248-56-367-B	<b>OA4R</b>	109140-69-321-B
PY1HQ	71940-44-327-B		
PY1GJ	82640-60-213--	<b>Uruguay — CX</b>	
PY2GS	51525-45-229-A	<b>CX1FB</b>	64350-66-204--
PY5AG	41718-51-166-A	<b>Phone</b>	
PY2NO	30414-37-173-B	<b>CX2CO</b>	78195-60-265-A
PY2AL	22308-33-140-B		
PY2KT	10992-24-95-A	<b>Venezuela — YV</b>	
PY2BJ	5947-19-65-B	<b>YV4AE</b>	100-4-5-A
PY1FM	1053-13-18-A	<b>Phone</b>	
PY2IH	440-8-11-A	<b>YV4AE</b>	105257-67-325-A
PY2AJ	56-4-4--	<b>YV1AQ</b>	29045-37-157-A
<b>Phone</b>		<b>YV1AV</b>	5607-21-54--
PY5AQ	60387-53-235-B	<b>YV1AP</b>	4002-29-69-A
PY1HM	18546-33-119-B		
PY2LN	17600-32-110-R		
PY2DA	9464-26-74-B		

<sup>1</sup> Univ. of Cincinnati; W8SUN, opr. <sup>2</sup> W8TMT, opr. <sup>3</sup> W2CJF, opr. <sup>4</sup> Bloomfield Radio Club; G. W. Schober, chief opr. <sup>5</sup> W9AFE, opr. <sup>6</sup> Progressive Amateur Radio Assn.; WIKMS, chief opr. <sup>7</sup> W7HYL, opr. <sup>8</sup> Greensboro Radio Club. <sup>9</sup> Univ. of N. C. Radio Club; W4GRK, opr. <sup>10</sup> W6NTC, opr. <sup>11</sup> W6BBR, opr. <sup>12</sup> So. Methodist Univ.; J. S. Stover, ex-W9PEV, opr. is K6KQK, opr. <sup>14</sup> Mrs. W. B. Grosskreuz, opr. <sup>15</sup> Score of Opr. Russ Cole given; Opr. W. Culmsee, 32860, is the Arizona phone award has not yet been made, pending completion of an investigation of the charge by another participant that the W6QJK score given here is the result of the work of two operators.

## WWV Schedules

**E**XCEPT for the special broadcasts of WWV using 20 kw. as described below, WWV is now running a continuous schedule (day and night) on 5000 kc. with a power output of 1 kw. This continuous transmission is modulated with the standard pitch in music, 440 cycles per second.

Each Tuesday, Wednesday and Friday (except legal holidays), the National Bureau of Standards station, WWV, transmits with a power of 20 kw. on three carrier frequencies as follows: 10:00 to 11:30 A.M., E.S.T., on 5000 kc.; noon to 1:30 P.M., E.S.T., on 10,000 kc.; 2:00 to 3:30 P.M., E.S.T., on 15,000 kc. The Tuesday and Friday transmissions are unmodulated c.w. except for 1-second standard-time intervals consisting of short pulses with 1000-cycle modulation. On the Wednesday transmissions, the carrier is modulated 30% with a standard audio frequency of 1000 c.p.s. The accuracy of the frequencies of the WWV transmissions is better than 1 part in 10,000,000.

## TURNER

*Microphones*

Write for free new literature to  
**The TURNER CO. Cedar Rapids, Iowa**

Crystals licensed under patents Brush Development Co.

# HAM-ADS

(1) Advertising shall pertain to radio and shall be of nature of interest to radio amateurs or experimenters in their pursuit of the art.

(2) No display of any character will be accepted, nor can any special typographical arrangement, such as all or part capital letters be used which would tend to make one advertisement stand out from the others.

(3) The Ham-Ad rate is 15¢ per word, except as noted in paragraph (6) below.

(4) Remittance in full must accompany copy. No cash or contract discount or agency commission will be allowed.

(5) Closing date for Ham-Ads is the 25th of the second month preceding publication date.

(6) A special rate of 7¢ per word will apply to advertising which, in our judgment, is obviously non-commercial in nature and is placed and signed by a member of the American Radio Relay League. Thus, advertising of bona fide surplus equipment owned, used and for sale by an individual or apparatus offered for exchange or advertising inquiring for special equipment, if by a member of the American Radio Relay League takes the 7¢ rate. An attempt to deal in apparatus in quantity for profit, even if by an individual, is commercial and all advertising by him takes the 15¢ rate. Provisions of paragraphs (1), (2), (4) and (5) apply to all advertising in this column regardless of which rate may apply.

**Having made no investigation of the advertisers in the classified columns, the publishers of QST are unable to vouch for their integrity or for the grade or character of the products advertised**

**QUARTZ**—direct importers from Brazil of best quality pure quartz suitable for making piezo-electric crystals. Diamond Drill Carbon Co., 719 World Bldg., New York City.

**QSL'S. Maps. Cartoons. Free samples.** Theodore Porcher, 7708 Navajo, Philadelphia, Pa.

**CRYSTALS**, mounted, 80-160, \$1.25, V-cut 40, \$2.25. R9 Crystals, 338 Murray Ave., Arnold, Pa.

**USED receivers. Bargains. Cash only. No trades. Price list 3¢.** W3DQ, Wilmington, Del.

**CALLBOOKS**—Fall edition now on sale containing complete up-to-date list of radio hams throughout entire world. Also world prefix map, and new time conversion chart. Single copies \$1.25. Canada and foreign \$1.35. Radio Amateur Call Book, 610 S. Dearborn, Chicago.

**CRYSTALS:** famous P.R., mounted in latest Alsimag 35 holders—40, 80 meter PR-X, 160 meter PR-Z, \$3; 40, 80 meter PR-Z (low drift), \$3.50; 20-meter PR-20, \$4.50; unconditionally guaranteed. Immediate shipment. Wholesale Radio Labs., Council Bluffs, Iowa. W9GFQ.

**QSL'S. WSJOT, Box 101, Rochester, N. Y.**

**TELEPLEXES, Instructographs bought, sold.** Ryan's, Hannibal, Mo.

**MACAUTO code machines:** low monthly rental 50,000 words practice tapes. Write N. C. Ayers, 711 Boylston St., Boston, Mass. GRANITE 7189-W.

**1000 watt G.E. transformers 1100-2200-4400 volts each side c.t. Guaranteed. \$13.50.** Dawson, 5740 Woodrow, Detroit, Mich.

**QSL'S, SWL'S. 100—3 color—75¢.** Lapco, 344 W. 39th, Indianapolis, Ind.

**WANTED: micrometer .0001 accuracy.** W9VQC.

**SELL: RME-59 receiver, perfect condition.** \$70. Alvin Draper, 2214 Alger, Lakewood, Ohio.

**NEW personalized mail order service on all amateur parts and equipment. New and used.** QSL W2IOP, Harvey Radio, N. Y.

**COMMERCIAL radio operators examination questions and answers. Two dollars per element.** G. C. Waller, W5ATV, 6540 Washington Blvd., Tulsa, Okla.

**QSL'S of distinction. W2ABY, 338 Elmora, Elizabeth, N. J.**

**TRADE for radio equipment or camera good used Wollensak 425X microscope.** W4DPJ.

**BOSTON Hamfest, Massachusetts A.R.R.L. State Convention, Hotel Bradford, Boston, October 5.**

**FOR sale: NC-100-X receiver—250 watt transmitter with speech equipment in 2 relay racks. All power supplies, microphone, calibrated frequency, extra assorted equipment, all for \$150.** W1KFX, 3028 W. Hunting Pk., Philadelphia, Pa.

**QSL'S—Fritz, 455 Mason, Joliet, Ill.**

**GENERAL Electric dynamotors 24/750 volt 200 mills 15, Simon 500 watt 500 cycle with exciters \$8. List. Henry Kienzle, 200 Hart Blvd., Staten Island, N. Y.**

**TWO 954's \$3.50 ea., 955 \$2, two 35T's \$4 ea., pr new 809's \$3.75, 1250 volt 400 ma. power supply \$25. Triplett meters, mod. xformers, other items. E. R. Arenius, Longmeadow, Mass. QSL'S?—SWL'S? Unbeatable. Free samples. W8DED, Holland, Mich.**

**RADIO repair business. Established six years. Ham station, tools, equipment—everything. Sickness. Must leave city. Hayes Radio, 47-16 48th Ave., Woodside, L. I., N. Y. C.**

**WANTED: ham receiver, ten meters up. Otto L. Lühring, Alton, Iowa.**

**MAKE offer 187 back issues QST 1919 to 1935; also 49 copies Radio News 1919 to 1924. List for stamp. Lester, 1927 Hawthorne, Houston, Texas.**

**MUST sell first class 250 watt transmitter complete with coils, meters, mike, and tubes. Very reasonable, relay rack construction. Write for details and photo. W9PFI.**

**QSL'S. Unbeatable by Maleco, 1805 St. Johns Place, Brooklyn, N. Y.**

**BOSTON Hamfest, Massachusetts A.R.R.L. State Convention, Hotel Bradford, Boston, October 5.**

**SALE: kw amplifier PP 100-TH's, B & W 10 meter coils, Johnson 11000 volt condenser. On 12 x 18 metal chassis, \$35 cash. No trades. W4DID.**

**HOUR meters: register hours, minutes servicing of equipment. See advertisement last month. \$2.75. Outstanding value. Allan Schumacker, Ampere, N. J.**

**SELL: HQ-120X new. Any reasonable offer. W3FYW.**

**WRITE Bob, W9ARA, for best deal on all amateur receivers, transmitters, kits, parts. You get best terms (financed by myself), largest trade-in, fairest treatment, lowest prices. Brand new Howard 460's with crystals \$59.95, SX-23's \$79.50. Write. W9ARA, Butler, Mo.**

**DO you realize how much W9ARA will allow you for your present receiver on any new receiver? Typical allowances: 191R's \$22.50, Howard 430's \$20, S20's \$32.50, NC44's \$35, SX-24's \$50, SX-25's \$70. Tell me what receiver you want and what you have to trade. I ship all receivers on ten-day trial. I will cooperate with you to see you are satisfied. Bob Henry, W9ARA.**

**RECONDITIONED guaranteed amateur receivers at lowest prices. All makes and models cheap. Ten-day free trial. Terms. Write for free list. W9ARA.**

**CRYSTALS—80-160, \$1; three blanks, \$1. QSO Crystals, Indiana, Pa.**

**SELL—National 81-X amateur communications receiver, excellent condition, speaker in grey wrinkle cabinet to match. First \$60 takes. W4CWB.**

**SWAP modulator, other equipment for Comet or Super-Pro. W3AOC.**

**BARGAINS: transmitting equipment; entire station surplus, cash or trade for foto equipment, etc. W2CE.**

**CRYSTALS: amateur, marine, police, aircraft, experimental. Request quotations or catalog. Ham Crystals, 1104 Lincoln Place, Brooklyn, New York.**

**250 watt CW transmitter \$65, Bug \$2, FB7A complete \$18. W8SMH, 47 Haendel, Binghamton, N. Y.**

**BARGAIN—new efficient 170 watt five band transmitter complete except speech amp. Best components. \$150. Write W9ADP.**

**QSL'S—SWL'S. Colorful, economical. W9KXL, 819 Wyandotte, Kansas City, Mo.**

**BOSTON Hamfest, Massachusetts A.R.R.L. State Convention, Hotel Bradford, Boston, October 5.**

**150 watt phone, CW 10 to 160 transmitter with all accessories. Used about ten hours. Parts alone worth twice the \$65 asked. W1MBF.**

**CRYSTALS, commercial or amateur: police, aircraft, marine and all types of low drift units for commercial services at attractive prices. Send for catalog. For the amateur: those PB, fully guaranteed 79 crystals—the choice of thousands of hams everywhere. You will like them too, 40, 80 and 160 meter bands \$1.60 postpaid, close frequency choice. 79 ceramic holders \$1. C.O.D.'s accepted. Sold by: Henry Radio Shop, Butler, Mo.; Kerr's Radio Shop, El Paso, Texas; Pemberton Labs., Ft. Wayne, Ind.; Valley Radio Distributors, Appleton, Wis.; and Eidsen's, Temple, Texas. Jobber territory open, inquire.**

**TRANSMITTERS low priced: 70 watt rigs \$35; modulators for same complete \$25; Utah Jr's \$15. Write for list on frequency meters, preselectors, etc. Easy terms for best deal. Write Leo, W9GFQ.**

**RECEIVERS all makes guaranteed and reconditioned, lowest terms. Write for big list as well as other bargains. Get acquainted with Leo, W9GFQ today. Wholesale Radio Labs., Council Bluffs, Iowa.**

**DOUGLAS Universal modulation transformers. 50 watts audio \$4.50 pair; 100 watts audio \$7.75 pair. Postpaid. One year guarantee. W9YR, Box 349, Rice Lake, Wis.**

**ONE RCA UV851 tube slightly used— for sale due to change in xmitter type. Reasonable. KGDM, Stockton, Calif.**

CRYSTALS: police, marine, aircraft. C-W Mfg. Co., 1170 Esperanza, Los Angeles.

TRANSMITTER — 6L6X — 807 — pair HK24's — 6L6 modulators metal cabinet. Make offer — ask details. W8RFP.

NEW RCA-814, guaranteed 100% perfect, \$12.50. New Acme-Delta swinging choke, 8-40 at 400 ma., \$4.50. W2EXR.

SELL: transmitter. Want: gas driven hundred ten a.c. generator. W8BJO.

CRYSTALS in plug-in heat dissipating holders. Guaranteed good oscillators. 160M-80M AT \$1.25; 40X \$1.65. 80M variable frequency (5 kilocycle variance) complete \$2.95. State frequency desired. C.O.D.'s accepted. Pacific Crystals, 1042 S. Hicks, Los Angeles.

BOSTON Hamfest, Massachusetts A.R.R.L. State Convention, Hotel Bradford, Boston, October 5.

BIGGEST buy in beams. Storm proof, all-steel, hi-torque rotators, Selsynchronous indicators, aluminolloy elements. Rotary Array Service, W8ML.

TRANSMITTING tubes: brand new GE PR-211's \$3, RCA-217C rectifier \$2, 203A and 211 sanded plates \$4, slightly used RCA-849 \$15, 210's sanded plates \$1, 203A \$3, 852's \$4. Consider trades. W2CUZ, Briggs Ave., Yonkers, N. Y.

HRO Sr. bought new last year. Excellent condition, used very little. Guaranteed. \$125. H. E. Hightower, Damascus, Ga.

SACRIFICE Utah kit 1 and 2 complete with all tubes including 866 Jr's and 807's, four Triplett meters, 160, 40 and 20 coil sets and RME-69 receiver. Like new. Make offer. Dr. K. F. Oerlein, California, Pa.

FOR sale: QST's December 1915 to December 1920 inc. All perfect copies bound in three volumes complete with covers. Best offer. W9ZT, 1623 Irving Ave., N., Minneapolis, Minn.

MOVING to 4th district so will sell all my transmitting equipment: relay rack 10 — 20 meter fone and CW transmitter, 802, 807, PP HF100's, Eimac 300T final. All power supplies, xtal tubes, relays, etc., including 5 kw. pole transformer in final supply; also matching relay rack modulator 242A's Class B; and power supplies, mike, etc. Lots of other surplus equipment including pair 852's, pair 50T's, pair 203B, 500 volt 300 mls MG, meters, parts, etc. Prefer to sell transmitter as unit. All letters answered. What am I offered? W3CKT, 104 S. Franklin Ave., Margate, Atlantic City, N. J.

QSL'S — Brownie, W3CJL, 1725 Frankfield Ave., Allentown, Pa.

ATTRACTIVE patriotic wall ur call emblem, trimmed national colors, \$1.15. W9FDE.

SELL Sky Challenger II speaker, xtal practically new — sacrifice at \$51.50 cash. Must sell complete station. Bargains galore. Send for complete list of parts including 2 100-TB's, T-55, T-20, 1800 volt pwr supply, xtals, etc. W8UIS, Box 263, Royal Oak, Mich.

BOSTON Hamfest, Massachusetts A.R.R.L. State Convention, Hotel Bradford, Boston, October 5.

HALLICRAFTERS 2-29 Sky Traveler operates on a.c.-d.c. or batteries. 542 kc. to 30 Mc. Telescopic antenna, noise limiter, electrical bandspread, built-in speaker, 9 tubes. Easy terms. Seeli's Radio, Hartford, Conn.

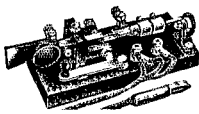

### TELEGRAPH SPEED KEYS

Radio Type in Kits — \$2.89

Send Card for Complete Information

ELECTRIC SPECIALTY MFG. COMPANY

Box 645, Cedar Rapids, Iowa

### RADIO COURSES

Classes Start October

RADIO OPERATING • BROADCASTING • CODE

RADIO SERVICING • TELEVISION

• ELECTRONICS — 1 year day course; 2 years eve.

Day and Evening Classes — Booklet upon request

NEW YORK YMCA SCHOOLS

4 West 63rd Street, New York City



... so are we known... We are proud to have fourteen CARDWELLS chosen for the model transmitters described in this authoritative amateur transmitter guide. Hundreds of other quality condensers available for all purposes. SEE THEM AT YOUR DEALER

THE ALLEN D. CARDWELL  
MANUFACTURING CORPORATION  
83 PROSPECT STREET, BROOKLYN, NEW YORK

## RADIO TECHNOLOGY



RCA Institutes offer an intensive course of high standard embracing all phases of Radio and Television. Practical training with modern equipment at New York and Chicago Schools. Also specialized courses in Aviation Communications, Radio Servicing and Commercial Operating. Illustrated Catalog on request

RCA INSTITUTES, INC. Dept. ST-40

A Radio Corporation of America Service

75 Varick St., New York 1154 Merchandise Mart, Chicago

## RADIO OPERATORS' LICENSE GUIDE

Here's a new Guide Book that contains over 1200 questions and answers which will help you pass the new six element examinations for a commercial radio operator's license. It correctly answers all questions contained in the study guide that was recently released by the Federal Communications Commission for the use of those proposing to take its examination. It will not only see you through your examination, but will also serve as a valuable future reference book. \$3.00 postpaid. Refunded if not satisfactory. Send check or money order.



ONLY \$3.00 Postpaid

WAYNE MILLER  
Engineering Bldg. • Chicago, Illinois

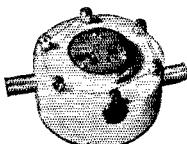
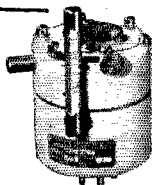

## GENERAL COMMUNICATIONS CRYSTALS HOLDERS AND OVENS

Precision Made by *Bliley*

WRITE FOR CATALOG G-11

BLILEY ELECTRIC CO., ERIE, PA.



# Your Nearby Dealer Is Your Best Friend

Your nearby dealer is entitled to your patronage. He is equipped with a knowledge and understanding of amateur radio. He is your logical source of advice and counsel on what equipment you should buy. His stock is complete. He can supply your needs without delay. His prices are fair and consistent with the high quality of the goods he carries. He is responsible to you and interested in you.

One of these dealers is probably in your city — Patronize him!

## ATLANTA, GEORGIA

Radio Wire Television Inc.  
265 Peachtree Street  
"The World's Largest Radio Supply House"

## BALTIMORE, MARYLAND

Radio Electric Service Co.  
3 N. Howard St.  
Everything for the Amateur

## BOSTON, MASS.

Radio Wire Television Inc.  
110 Federal Street  
"The World's Largest Radio Supply House"

## BRONX, NEW YORK

Radio Wire Television Inc.  
542 East Fordham Road  
"The World's Largest Radio Supply House"

## BUFFALO, NEW YORK

Radio Equipment Corp.  
326 Elm Street  
W8PMC and W8NEL — Ham, service and sound equipment

## BUFFALO, NEW YORK

Dymac Radio  
1531 Main Street — Cor. Ferry  
Open Evenings GA. 0252

## HARTFORD, CONNECTICUT

Radio Inspection Service Company  
227 Asylum Street  
What do you want? We have it. Radio exclusively

## HARTFORD, CONNECTICUT

Hatry & Young, Inc.  
203 Ann Street  
Stores also in Bridgeport and New Haven

## HOUSTON, TEXAS

R. C. & L. F. Hall  
1021 Caroline Street (C 0721)  
"Specialists in Amateur Supplies"

## JAMAICA, L. I., NEW YORK

Radio Wire Television Inc.  
90-08 166th Street (Merrick Road)  
"The World's Largest Radio Supply House"

## NEWARK, N. J.

Radio Wire Television Inc.  
24 Central Avenue  
"The World's Largest Radio Supply House"

## NEW YORK, N. Y.

Radio Wire Television Inc.  
100 Sixth Avenue  
"The World's Largest Radio Supply House"

## NEW YORK, N. Y.

Harrison Radio Company  
12 West Broadway  
Harrison Has It! Phone WOrth 2-6276 for information or rush service

## PHILADELPHIA, PENNSYLVANIA

Eugene G. Wile  
10 S. Tenth Street  
Complete Stock of Quality Merchandise

## PROVIDENCE, RHODE ISLAND

W. H. Edwards Company  
85 Broadway  
National, Hammarlund, Hallicrafter, Thordarson, Taylor, RCA

## RICHMOND, VIRGINIA

The Arnold Company  
Broad at Harrison St.  
W3EQQ — "The Virginia Ham Headquarters" — W3FBL

## SCRANTON, PENNSYLVANIA

Scranton Radio & Television Supply Co.  
519-521 Mulberry Street  
Complete Stock of Quality Amateur Supplies

YOU CAN BE SURE  
WHEN YOU BUY FROM

**QST**

ADVERTISERS

“Advertising for QST is accepted only from firms who, in the publisher’s opinion, are of established integrity and whose products secure the approval of the technical staff of the American Radio Relay League.”

*Quoted from QST’s advertising rate card.*

*Every conceivable need of a radio amateur can be supplied by the advertisers in QST. And you will know the product has the approval of the League’s technical staff*

*Index to Advertisers*

Abbott Instrument, Inc.	96
Aerovox Corporation	117
American Radio Institute	119
Astatic Microphone Laboratory, Inc.	88
Barker & Williamson	114
Billie Electric Company	87, 106, 124
Burgess Battery Company	93
Candler System Company	117
Capitol Radio Engineering Institute	106
Cardwell Mfg. Corp., Allen D.	124
Centralab	89
Claroat Mfg. Company, Inc.	110
Collins Radio Company	Cov. II
Dodge’s Institute	114
Ecor, Inc.	98
Eitel-McCullough, Inc.	95
Electric Specialty Mfg. Company	124
Gardiner-Levering Company	119
General Electric Company	7
Hallcrafters, Inc., The	1
Hammarlund Mfg. Company, Inc.	83, 85
Harrison Radio Company	120
Harvey Radio Company	116
Henry Radio Shop	118
Hipower Crystal Company	110
Howard Radio Company	113
Hygrade Sylvania Corp.	90
Hytronic Laboratories	92
Instructograph Company	96
Johnson Company, E. F.	111
Kenyon Transformer Company, Inc.	86
Mallory & Company, Inc., P. R.	82
Massachusetts Radio School	119
Meissner Mfg. Company	4, 5
Millen Mfg. Company, Inc., James	Insert
Miller, Wayne	124
National Company, Inc.	Cov. III, 57
New York YMCA Schools	124
Newark Electric Company	90
Nilson Radio School	102, 114
Ohmite Mfg. Company	107
Pioneer Gen-E-Motor Corp.	119
Port Arthur College	98
Precision Apparatus Corp.	118
RCA Institutes, Inc.	124
RCA Mfg. Company, Inc.	Cov. IV, 91
Radio City Products	94
Radio Mfg. Engineers, Inc.	127
Radio Shack, The	2
Scientific Radio Service	119
Shuler Supply Company	112
Shure Brothers	122
Sickles Company, F. W.	119
Simpson Electric Company	122
Solar Mfg. Corp.	114
Sun Radio Company	112
Taylor Tubes, Inc.	103
Teleplex Company	102
Terminal Radio Corp.	108
Thordarson Electric Mfg. Company	97
Triplett Electrical Instrument Company, Inc.	84
Turner Company, The	122
United Transformer Corp.	128
Van Sickle Radio Supply Company	120
Wholesale Radio Laboratories	109
Yaxley	82



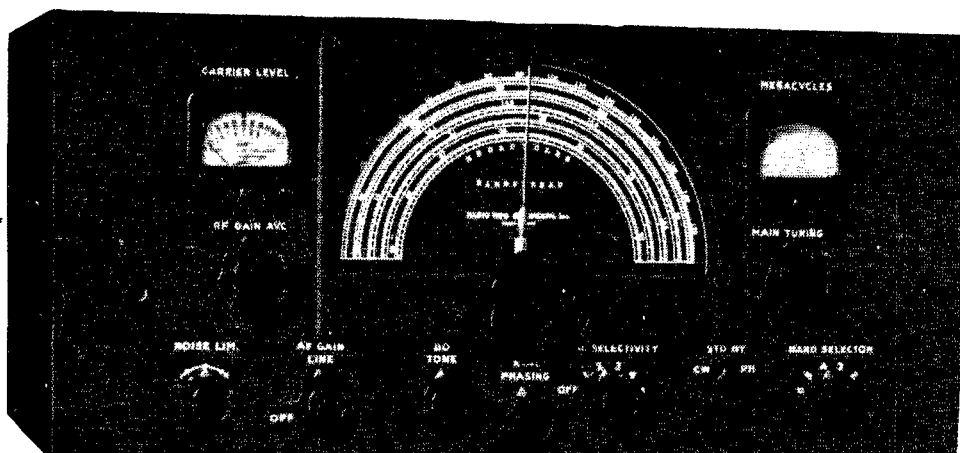

## Now You See It • Now You Don't!

No, we're not playing the old shell game so popular when our fathers were boys . . . we're referring to the new RME-99 communications receiver as pictured above.

It's a great communications receiver with all the features so desired by the amateur operator. In fact, you may bet a thousand-to-one that the ham who owns one of these receivers has, without a doubt, the last word in high-quality performance.

But—just as in the old shell game, things are not always what they seem. In the case of the new "99", for example, its extreme versatility in design, makes it much more than a mere "one service" receiver. One moment you see a top notch amateur band model . . . the next moment, "faster than the eye can follow" it does duty as a dependable commercial unit of outstanding characteristics.

Not only that . . . this same chassis, with a few minor changes, is being ordered by high frequency commercials . . . forest stations, foreign governments, aircraft interests, and the like . . . to be used in radio communication services where absolute reliability and accuracy **MUST BE ADHERED TO, DAY IN AND DAY OUT, WITHOUT FAIL!**

Why do you suppose these services choose RME? Why do you suppose "when all the chips are down" RME equipment is chosen?

The secret of this almost universal choice, by professionals, as well as amateurs, lies to a great extent in the high-g geared make-up of the RME organization . . . an organization of:

- SOUND ENGINEERING PLUS WIDE EXPERIENCE IN THE DESIGN OF PRECISION RADIO APPARATUS.
- CAREFUL CONSTRUCTION BY SEASONED EMPLOYEES.
- RELIABILITY GAINED BY ALWAYS INCORPORATING PARTS OF HIGHEST QUALITY.
- ADEQUATE FACILITIES FOR COMPLETE LABORATORY ANALYSIS.
- AND A REPUTATION FOR FAIR DEALINGS COVERING YEARS OF ACTIVITY.

For nearly a decade, amateur and professional operators have turned to RME for the fulfillment of their communication reception needs. Perhaps *your own* problems can be solved quickly and accurately, at a great savings, by our engineering laboratory. Why not make it a habit of consulting us first? Eliminate needless, blind searching for that next receiver for that special purpose!

*Our Literature Describing a Multitude of Special Equipment is Available for the Asking*



**RME**  
TIME WILL TELL  
**RME**

*Fine Communications Equipment*

**RADIO MFG. ENGINEERS, Inc.**

**111 HARRISON ST.**

**PEORIA, ILLINOIS**

# UTC Varitrans Control Units

For controlling: Rectifier output - motors - heaters - lights  
line voltage

## FEATURES

- PRECISE OUTPUT VOLTAGE ADJUSTMENT
- VOLTAGE INDEPENDENT OF LOAD
- HIGH EFFICIENCY
- LOW TEMPERATURE RISE
- ROLLER TYPE NON-FUSING CONTACT
- COVER SIZE HEAT RADIATING DISC
- GLASS INSULATED WIRE
- RECTANGULAR LAMINATION AND CASE STRUCTURE
- PANEL OR BENCH MOUNTING

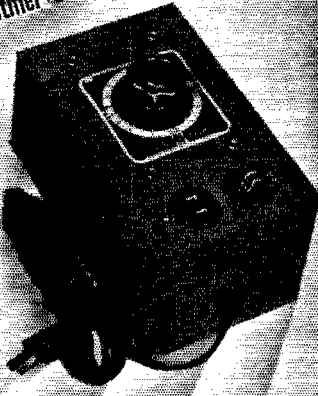

Standard VARITRANS are for 115 or 230 Volt service. The respective smoothly adjustable output voltages are 0-130 and 0-240 volts. Universal VARITRANS have a 0-30 volt variable secondary ideal for line voltage correction and low voltage equipment. 115 Volt VARITRANS are available in 2, 5, 7.5, 11, 17, 30, and 44 amp. stock sizes. Write for Bulletin PS-404.

# UTC Automatic Voltage Regulators

95-130 Volts Input-110, 115, 120 Volts output; 1% accuracy

## FEATURES

- CONSTANT OUTPUT VOLTAGE independent of transients or continuous variations in line voltage.
- ACCURACY 1% in output voltage for an input range of 95 to 130 volts.
- INDEPENDENT OF LOAD negligible variation in output voltage from no load to full load.
- NO MOVING PARTS this new UTC design (patent pending) requires no maintenance... assures permanent dependability.
- 110, 115, 120 VOLT OUTPUT available at the triple outlet receptacle.
- HIGH EFFICIENCY comparable to a standard non-regulating transformer.
- HIGH POWER FACTOR better than 10% on typical unit.
- LOW DISTORTION Distortion is usually low in these units... less than 20% for all harmonics in typical unit.
- NEGLIGIBLE TIME CONSTANT/LOW TEMPERATURE RISE 55° C. on typical unit.

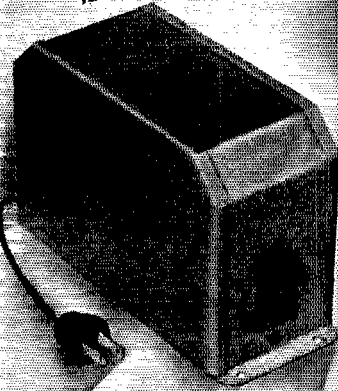

The UTC Automatic Voltage Regulator is new. It involves no moving parts and effects instantaneous correction for either transient or chronic line voltage fluctuations. This unit has innumerable applications in broadcast apparatus, laboratory equipment, etc. Available in 15, 30, 60, 120, 250, 500, 1000 and 2000 VA stock sizes. Write for Bulletin PS-404.

# A TRANSFORMER SOURCE... For LEADERS OF INDUSTRY!



A list of UTC users reads like the blue book of industry. Chosen for quality, dependability and unusual designs, UTC has solved many transformer application problems. May we cooperate with you on your application?

# UNITED TRANSFORMER CORP.

Write: COMMUNICATIONS DIV. ★ 150 VARICK ST. ★ NEW YORK, N. Y.

EXPORT DIVISION: 100 VARICK STREET NEW YORK, N. Y. CABLES: 'ARLAB'

QST for October, 1940 EASTERN Edition

PRINTED IN U.S.A.  
RUMFORD PRESS  
CONCORD, N. H.

# *There is a new* **NATIONAL CATALOGUE**

YOUR DEALER has a copy of the new National Catalogue for you. In it you will find your old favorites listed as before, as well as favorites-to-be that are listed for the first time. Some of the old products are revised, like the little SW-3 (still going strong!) which has been improved again. Some of the new products are already well known, like the new Transmitting Condensers, and the new RF Transmitting Choke. Some of the new products make their debut for the first time, like the new line of inexpensive dials, the new precision dial, new bushings, sockets and what not.

Of course, the big news is the new NC-200 receiver, which we shall not say much about here, because it is not to be officially released until next month. You will hear plenty about it then, for even with half its features it would still be big news.

Drop in and get a copy at your dealer's. He will enjoy seeing you, and you will enjoy seeing the catalogue.

**AT YOUR DEALERS**  
*National Company*

# 5 KW

## *Air-cooled!*



Hundreds of giant 891-R's and 892-R's in daily service in leading broadcast stations testify to the sound economy resulting from RCA's development of these popular Air-Cooled Transmitting Triodes. First costs are lower. Installation has been greatly simplified. Gone are all water-cooling problems. High output and long life make these tubes favorites for broadcast service.

All of which is interesting, but what, specifically, does it all mean to you as an amateur?

The answer is that it would be impossible to give you the amazing performance values inherent in the smaller RCA amateur tube types were it not for lessons learned in developing tubes of larger size or higher power for the world's most exacting commercial applications.

From anode to filament, from tube envelope evacuation to the avoidance of gas, the development of amateur tube types goes hand in hand with RCA commercial tube engineering. In every component part; in every phase of engineering and design; in every characteristic, your RCA Amateur Tube is a direct reflection of RCA's far-reaching participation in the most important commercial broadcast developments.

### Typical RCA Values

In no amateur tubes is RCA supremacy better illustrated than in the RCA-811 and 812—introduced only a few months ago, but already breaking all sales records. Thanks to the exclusive anode coating and other RCA features, these tubes set a new record for high-perveance, high-power tubes at unheard of low cost. 225 watts\* input, only 6.5 to 8 watts driving power at \$3.50 amateur net! Write for bulletin.

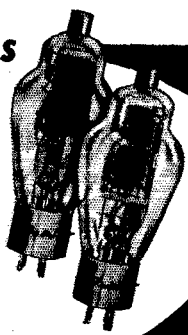

\*ICAS (Intermittent Commercial and Amateur Service) class "C" telegraphy ratings.

*Invest in Experience  
not Experiments...  
Buy RCA!*



# Radio Tubes

PROVED IN COMMUNICATION'S MOST EXACTING APPLICATIONS

TRULY-FLEXIBLE ISOLANITE COUPLINGS

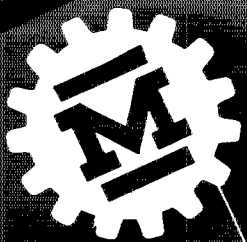

# JAMES MILLEN

MANUFACTURING COMPANY, INC.

*Radio Engineers and Manufacturers*  
6 PLEASANT STREET • MALDEN, MASS.

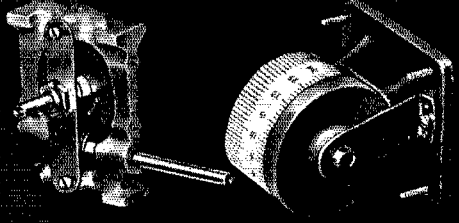

DIALS TO MATCH METERS

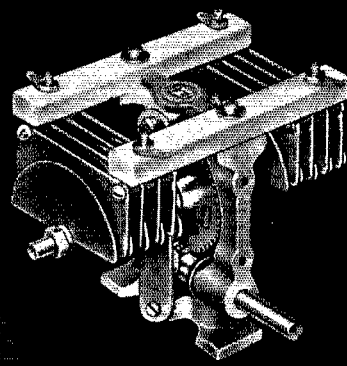

NEW DEVELOPMENTS  
IN TRANSMITTING  
CONDENSERS

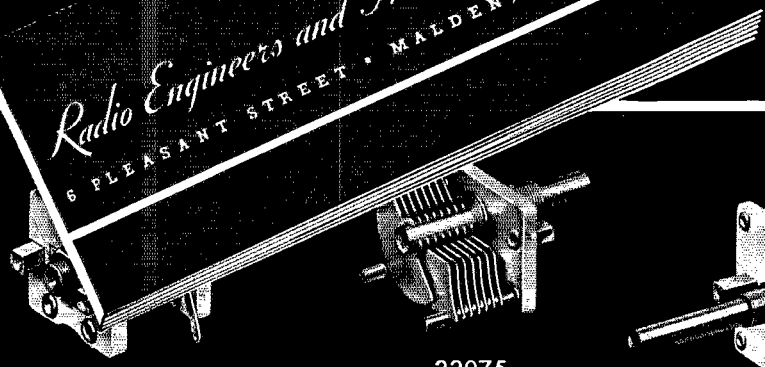

21935

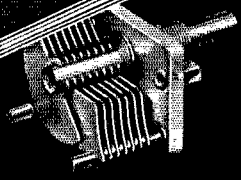

22075

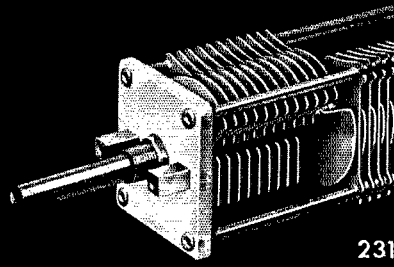

23100

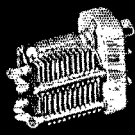

25100

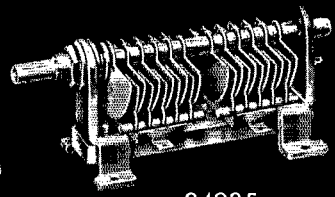

24935

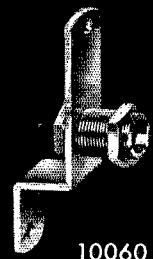

10060

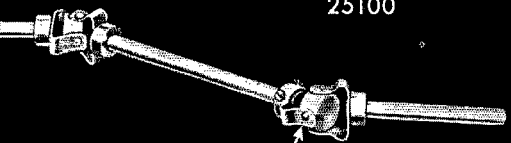

39001



39006



39002



39003

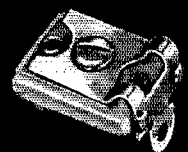

28030



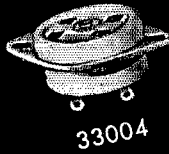

33004



33002



33004

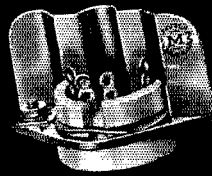

33888



32150



3

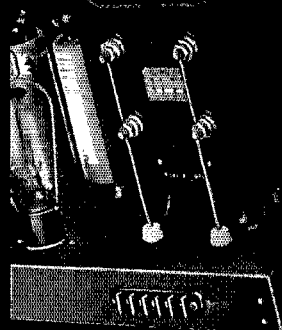

38001



32103



32101



32100



32102



37



36001



37001

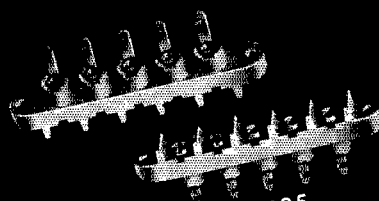

37105



37104

*Designed for Application*