

QST

June, 1940

25 cents

30c in Canada

devoted entirely to

amateur

radio



In this issue — More on Automatic Frequency Control!

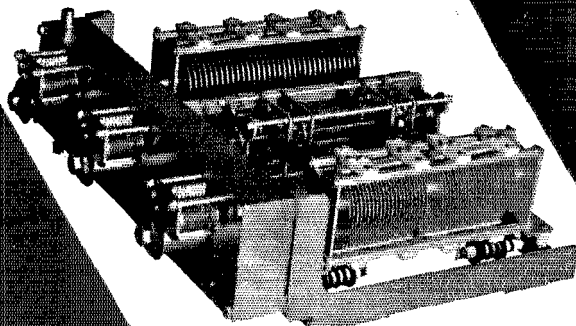

Single-Ended To Push-Pull

The 231C grid network couples a single-ended intermediate amplifier to a balanced power amplifier. It maintains voltage and phase balance within close limits and supplies constant excitation voltage over a wide continuous frequency range (2.5-20 mc). Perfect, fixed neutralization is thereby achieved and the output tubes operate at high efficiency regardless of the transmitting frequency.

The circuit employed in the 231C grid network is another exclusive Collins development. It accomplishes its purpose in a simpler, more effective way than any of the various circuits ordinarily used.

The 231C is more than a conventional transmitter with the Autotune frequency changing device added. Besides the Autotune, special, highly developed features are employed in every section to accomplish superior performance and greatest reliability.

This is the third advertisement calling attention to unusual developments embodied in the 231C. A 12 page booklet describing the equipment in detail is available.

COLLINS RADIO COMPANY

CEDAR RAPIDS, IOWA U. S. A. NEW YORK, N. Y. 11 WEST 43 STREET



Skyrider Defiant

One stage of preselection. New, highly efficient noise limiter circuit. Four bands cover from 545 kc to 43.5 mc. Accurately calibrated bandspread dial. Frequency stability throughout a wide range of line voltage, humidity and temperature variations. Six point variable selectivity. Meter calibrated in both S and DB units. Single-signal crystal filter. Complete with 9 tubes and crystal (no speaker) \$69.50.

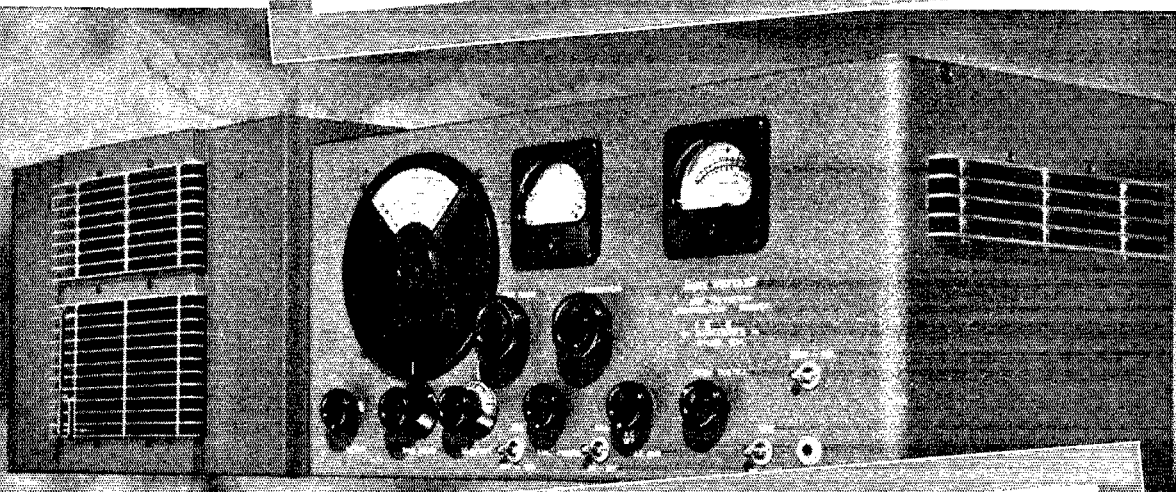

Super Defiant

Two stages of preselection. Automatic noise limiter. 540 kc to 42 mc coverage in four bands. Better signal-to-noise ratio. Calibrated bandspread dial. Compensation in oscillator circuit for frequency stability. Six-step variable selectivity. Meter calibrated in S and DB units. Push-pull output delivering 8 watts. Ten-inch PM speaker in metal cabinet. Complete with 12 tubes, crystal and speaker, \$99.50.

the hallicrafters inc.
CHICAGO, U. S. A.

WORLD'S LARGEST BUILDERS OF AMATEUR COMMUNICATIONS EQUIPMENT

A RADIOPHONE FOR EVERY PURPOSE



In addition to the popular HT-8, 25 watt model, the Hallicrafters have developed 50 watt and 12 watt radiophones—making available a unit for every use.

Now!

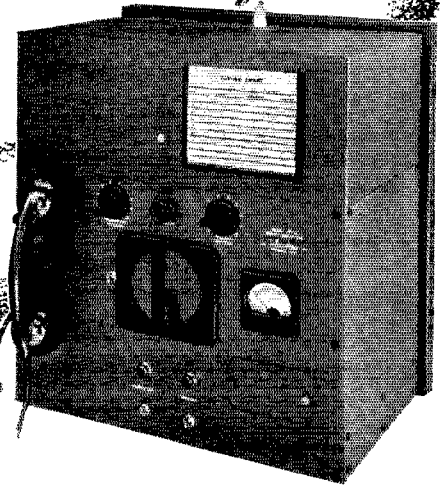
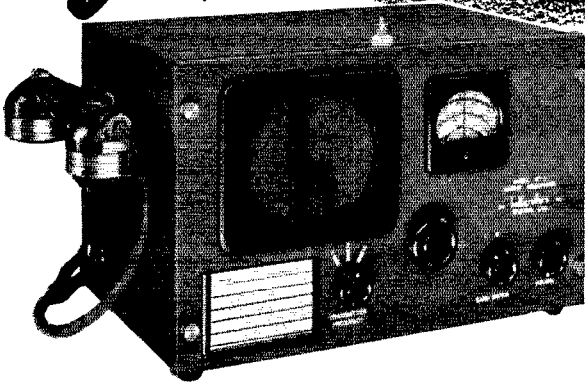

HT-12 is a combination 10 frequency 50 watt transmitter and 10 frequency receiver. Both crystal controlled. Separate power supply for 110, 32 or 12 volts. Dimensions: $20\frac{1}{2} \times 19\frac{1}{4} \times 12$.

HT-11 is a combination 3 frequency 12 watt transmitter and a 2 band receiver (marine, broadcast). Separate power supply, 6 or 12 volts. 32 or 110 volts special. Dimensions: $13 \times 8\frac{1}{2} \times 9$.

the hallicrafters inc.
CHICAGO, U. S. A.

WORLD'S LARGEST BUILDERS OF AMATEUR COMMUNICATIONS EQUIPMENT

JUNE 1940

VOLUME XXIV

NUMBER 6



STAFF

Editorial

KENNETH B. WARNER, W1EH
Editor and Business Manager

CLARK C. RODIMON, W1SZ
Managing Editor

GEORGE GRAMMER, W1DF
Technical Editor

DONALD H. MIX, W1TH
BYRON GOODMAN, W1JPE
Assistant Technical Editors

EDW. P. TILTON, W1HDQ
Contributing Editor, U.H.F.

VERNON CHAMBERS, W1JQJ
Technical Information Service

JAMES J. LAMB, W1AL
Research Engineer, A.R.R.L.

Advertising

F. CHEYNEY BEEKLEY, W1GS
Advertising Manager

CHARLES BRUNELLE
Asst. Advertising Manager

Circulation

DAVID H. HOUGHTON
Circulation Manager

RALPH T. BRAUDIN, W1BAW
Asst. Circulation Manager



OFFICES

38 La Salle Road

West Hartford, Connecticut

Subscription rate in United States and Possessions, \$2.50 per year, postpaid; all other countries, \$3.00 per year, postpaid. Single copies, 25 cents. Foreign remittances should be by international postal or express money order or bank draft negotiable in the U. S. and for an equivalent amount in U. S. funds.

Entered as second-class matter May 29, 1919, at the post office at Hartford, Connecticut, under the Act of March 3, 1879. Acceptance for mailing at special rate of postage provided for in section 1103, Act of October 3, 1917, authorized September 9, 1922. Additional entry at Concord, N. H., authorized February 21, 1929, under the Act of February 28, 1925. Additional second-class entries to cover sectional editions authorized March 20, 1935.

Copyright 1940 by the American Radio Relay League, Inc. Title registered at United States Patent Office.

QST

devoted entirely to

AMATEUR RADIO

PUBLISHED, MONTHLY, AS ITS OFFICIAL ORGAN, BY THE AMERICAN RADIO RELAY LEAGUE, INC., AT WEST HARTFORD, CONN., U. S. A.; OFFICIAL ORGAN OF THE INTERNATIONAL AMATEUR RADIO UNION



CONTENTS

Editorials	7
Splatter	8
More on the Extended Variable Crystal Control	
Byron Goodman, W1JPE	9
A New Iconoscope for Amateur Television Cameras	
James J. Lamb, W1AL	13
Getting on 56-Mc. F. M.	16
George Grammer, W1DF	16
The Double Vertical Antenna	21
A. Henry Riesmeyer, exW8CHT	21
Wisconsin State Convention	22
Silent Keys	22
Results, Sixth A.R.R.L. Copying Bee	23
What the League Is Doing	24
West Gulf Division Convention	25
A.R.R.L. Affiliated Club Honor Roll	25
The "QSL Push-Pull"	26
Fred Sutter, W8QBW-QDK	26
Eighth A.R.R.L. Field Day Contest	29
Single-Dial Frequency Control	30
Henry E. Rice, Jr., W9YZH	30
Circulation Statement	37
A Receiver for the New Amateur Television System	
J. B. Sherman	38
Bibliography of QST Articles on Television Reception	43
New Receiving Tubes	
11B4, 1D8GT, 6AL6G, 7H7, 35Z6G, 50C6G, 70L7GT	43
Third U. H. F. Contest and Relay Results	
J. A. Moskey, W1JMY	44
Reactance-Tube Frequency Modulators	
Murray G. Crosby, W2CSY	46
A.R.R.L. QSL Bureau	50
Correspondence Department	51
A Traffic Transmitter	52
Harold M. Baker, W9MDJ-EZ	52
Say It With Words	56
Kenneth B. Warner, W1EH	56
Ham Shacks	60
W6MVK, W9RQM, HH2MC, W4DRE, W9KJF	60
On the Ultra Highs	62
E. P. Tilton, W1HDQ	62
I.A.R.U. News	66
Hints and Kinks	
Soldering Connections to Polystyrene Sockets — Notes on ECO	
Drift — Filter-Discharging Relay or Switch — Replacing the	
Antenna Halyard — A Simple Modulation Monitor and Per-	
centage Indicator — A Non-Chattering Overload Relay With	
Electrical Reset	68
Operating News	71
How's DX?	76
Hamads	123
QST's Index of Advertisers	126

Section Communications Managers of the A.R.R.L. Communications Department

All appointments in the League's field organization are made by the proper S.C.M., elected by members in each Section listed. Mail your S.C.M. (on the 16th of each month) a postal covering your radio activities for the previous 30 days. Tell him your DX, plans for experimenting, results in 'phone and traffic. He is interested, whether you are an A.R.R.L. member or get your QST at the newsstands; he wants a report from every active ham. If interested and qualified for O.R.S., O.P.S. or other appointments he can tell you about them, too.

ATLANTIC DIVISION				
Eastern Pennsylvania	W3BES	Jerry Mathis	5132 Haverford Ave.	Philadelphia
Maryland-Delaware-District of Columbia	W3CIZ	Hermann E. Hobbs	9701 Monroe St.	Linden, Maryland
Southern New Jersey	W3CCO	Lester H. Allen	Silver Spring P.O.	Trenton
Western New York	W8PLA	Fred Chichester	704 Quinton Ave.	Sonyea
Western Pennsylvania	W8OFO	Kendall Speer, Jr.		Lowber
CENTRAL DIVISION				
Illinois*	W9ILH	Mrs. Carrie Jones	2407 Central Ave.	Alton
Indiana	W9AB	Harry B. Miller	729 E. Lowell Ave.	Mishawaka
Kentucky	W9ARU	Darrell A. Downard	116 N. Longworth Ave.	Louisville
Michigan	W8DPE	Harold C. Bird	R.F.D. 2	Pontiac
Ohio	W8AQ	E. H. Gibbs	405 Broad St.	Wadsworth
Wisconsin	W9UIT	Aldrich C. Krones	3702 So. 46th St.	Milwaukee
DAKOTA DIVISION				
North Dakota	W9VWL	Anton C. Theodos	Box 444	Williston
South Dakota	W9ADJ	E. C. Mohler	Box 149	Rapid City
Northern Minnesota	W9IGZ	Edwin L. Wicklund	R.F.D. 3	Jensington
Southern Minnesota	W9YNQ	Millard L. Bender	608 N. Huron Ave.	Spring Valley
DELTA DIVISION				
Arkansas	W5ABI	H. E. Veltz	4415 West 12th St.	Little Rock
Louisiana	W5DWW	W. J. Wilkinson, Jr.	1523 Laurel St.	Shreveport
Mississippi	W5EWD	Jewell W. Cole	c/o City of McComb Water Dept.	McComb City
Tennessee	W4DWS	William Harold Walker	1901 Cedar Lane	Nashville
HUDSON DIVISION				
Eastern New York	W2LU	Robert E. Haight	511 South Holmes St.	Scotia
N. Y. C. & Long Island	W2AZV	E. L. Baunach	102 Central Ave.	Massapequa, L. I.
Northern New Jersey	W2GVZ	Joseph P. Jessup	131 California St.	Ridgewood
MIDWEST DIVISION				
Iowa	W9PIR	L. B. Vennard	P. O. Box 304	West Burlington
Kansas	W9UEG	Melvin D. Kirby		Arlington
Missouri	W9OJD	Miss Letha Allendorf	1015 W. 3rd St.	Joplin
Nebraska	W9DI	Willis I. Bamer		Tobias
NEW ENGLAND DIVISION				
Connecticut	W1CTI	Frederick Ells, Jr.	19 Merrill Rd.	Norwalk
Maine	W1IIE	H. W. Castner	147 Church	Damariscotta
Eastern Massachusetts	W1ALP	Frank L. Baker, Jr.	21 Colby Road	North Quincy
Western Massachusetts	W1IAH	William J. Barrett	239 Columbia St.	Adams
New Hampshire	W1BFT	Carl B. Evans	163 South Main St.	Concord
Rhode Island	W1HRC	Clayton C. Gordon	70 Columbia Ave., Gaspee	Proseau, Warwick
Vermont	W1KJG	Clifton G. Parker	Box 537	Morrisville
NORTHWESTERN DIVISION				
Alaska*	K7GNN	James G. Sherry		Chichagoi
Idaho	W7EMT	Carl Eichelberger	Route 2	Kuna
Montana	W7CPV	Rex Roberts	Box 1088	Glendive
Oregon	W7DXF	Harold W. Johnston	902 N. W. DeSpain	Pendleton
Washington	W7FCG	W. Beale	R. 4, School Ave.	Walla Walla
PACIFIC DIVISION				
Hawaii	K6ETF	Francis T. Blatt	837 16th Ave.	Honolulu
Nevada	W6BIC	Edward W. Heim	509 Claremont St.	Reno
Santa Clara Valley	W6FBW	Elbert Amarantes	454 Washington St.	San Jose
East Bay	W6TI	Horace R. Greer	414 Fairmount Ave.	Oakland
San Francisco	W6CIS	Kenneth E. Hughes	622-36th Ave.	San Francisco
Sacramento Valley	W6MDI	Vincent N. Feldhausen	113 South Quincy St.	McCleod
Philippines	KA1GR	George L. Rickard	Box 849	Manila
San Joaquin Valley	W6KUT	Edwin A. Andress	2921 North Van Ness Blvd.	Fresno
ROANOKE DIVISION				
North Carolina	W4CYB	W. J. Wortman	P. O. Box 566	Morganton
South Carolina	W4BOE/ANG	Ted Ferguson	1213 College St.	Columbia
Virginia*	W3GWO	Frank S. Anderson, Jr.	4703 New Kent Ave.	Richmond
West Virginia	W8OXO	W. D. Tabler	238 Watson Ave.	Fairmont
ROCKY MOUNTAIN DIVISION				
Colorado	W9EHC	Carl C. Drumeller	819 East Dale St.	Colorado Springs
Utah-Wyoming	W7CLG	Ernest E. Parshall	Salt Creek Electric Plant	Midwest, Wyoming
SOUTHEASTERN DIVISION				
Alabama	W4DGS	James F. Thompson	12 Clanton Ave.	Montgomery
Eastern Florida	W4PET	Carl G. Schaal	Waucoma Apts.	Clermont
Western Florida	W4AXP	Oscar Cederstrom	Lakeview Hotel	De Funiak Springs
Georgia	W4AGI	Leland W. Smith	Second St. & Bruce Ave.	Augusta
West Indies (Cuba-Isle-of-Pines-Porto Rico-Virgin Islands)	CM2OP	Mario de la Torre	Escobar 110 (Altos)	Habana, Cuba
SOUTHWESTERN DIVISION				
Los Angeles	W6MQM	Ralph S. Click	1038 Milwaukee Ave.	Los Angeles
Arizona	W6KMM	Marson B. Hull	617 North Fourth Ave.	Phoenix
San Diego	W6BKZ	Louis A. Cartwright	370 Nautilus	La Jolla
WEST GULF DIVISION				
Northern Texas	W5DXA	Lee Hughes	125 N. Main St.	Childress
Oklahoma	W5GPT	Russell W. Battern	431 South Buchanan	Enid
Southern Texas	W5MN	Horace E. Biddy	1746 Schley Ave.	San Antonio
New Mexico	W5ENI	Dr. Hilton W. Gillett		Lovington
MARITIME DIVISION				
Maritime	VE1DQ	A. M. Crowell	69 Dublin St.	Halifax, N. S.
ONTARIO DIVISION				
Ontario	VE3SG	F. H. B. Saxon	302 Lee Ave.	Toronto, Ont.
QUEBEC DIVISION				
Quebec	VE2CO	Lindsay G. Morris	Apt. 6, 4510 Girouard Ave., N.D.G.	Montreal, P. Q.
VANALTA DIVISION				
Alberta	VE4GE	C. S. Jamieson	581 W. Riverside Drive	Drumheller, Alta.
British Columbia	VE5DD	C. O. I. Sawyer	2634 West 31st Ave.	Vancouver
PRAIRIE DIVISION				
Manitoba	VE4AAW	A. W. Morley	747 McMillan Ave.	Winnipeg
Saskatchewan	VE4SY	Arthur Chesworth	1071 4th Ave., N. W.	Moose Jaw

* Officials appointed to act until the membership of the Section choose permanent S.C.M.s by nomination and election.

LOW Driving Power—

QUICK Band Change—

... MORE POWER in the antenna with less equipment! Important advantages to many an amateur today. That's why we say "Turn to the new G-E beam power tubes." They cut out intermediate stages, eliminate neutralization difficulties, give your rig more flexibility.

GL-813

... The G-E beam tube for high power. It will produce 150 watts cw as a crystal oscillator, 260 watts cw with only 1 watt driving power. An excellent frequency multiplier. Makes quick band change at high power easy. At your G-E dealer's.

NOW
\$22.00

GL-807

... The G-E beam tube for your low-power requirements. Oscillator, amplifier, frequency multiplier or modulator—you can't buy a more versatile performer for \$3.50! Less than half a watt drives two 807's; ICAS cw output: 100 watts!

GL-814

... The G-E beam power tube for any medium-power r-f application up to 30 mc. 160 watts cw, 130 watts plate-modulated phone (ICAS) with 1.5 or 3.2 watts driving power respectively. A fb frequency multiplier, too. \$17.50 puts one in your rig.

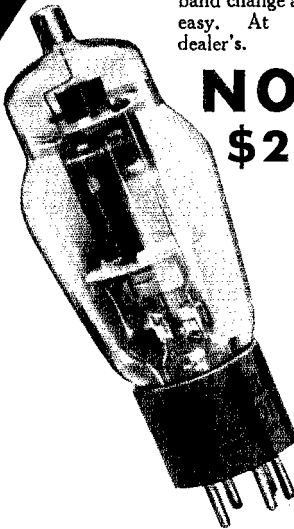
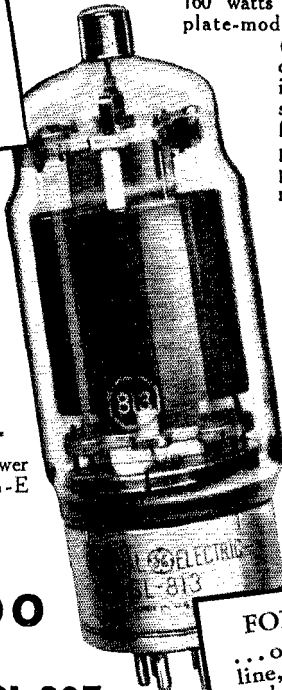
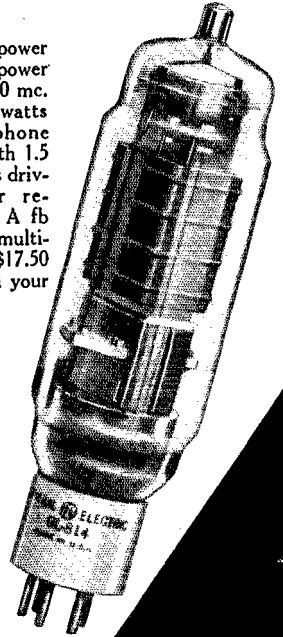

FOR COMPLETE DOPE
... on the G-E transmitting tube line, and for complete ratings and operating instructions for the GL-813—send the coupon.

General Electric, Sec. 161-12
Schenectady, N. Y.

Please send me:

- Ratings and operating instructions on the GL-813—now priced at \$22.00
- Bulletin GEA-3315A listing the complete G-E transmitting tube line

Name.....

Street.....

City.....

GENERAL  **ELECTRIC**

161-12

THE AMERICAN RADIO RELAY LEAGUE

Directors

President

EUGENE C. WOODRUFF W8CMP
234 W. Fairmount Ave., State College, Pa.

Vice-President

GEORGE W. BAILEY W1KH
74 Webster Road, Weston, Mass.

Canadian General Manager

ALEX REID VE2BE
169 Logan Ave., St. Lambert, P. Q.

Atlantic Division

WALTER BRADLEY MARTIN W3QV
Box 612, Roslyn, Pa.

Central Division

R. H. G. MATHEWS ex-W9ZN
4534 Dover St., Chicago

Dakota Division

FRED W. YOUNG W9MZN
107 Hanover St., Mankato, Minn.

Delta Division

E. RAY ARLEDGE W58I
P.O. Box 236, Pine Bluff, Ark.

Hudson Division

KENNETH T. HILL W2AHC
115 Willow St., Douglaston, L. I., N. Y.

Midwest Division

FLOYD E. NORWINE, JR. W9EFC
7405 Hawatha Ave., Richmond Heights, Mo.

New England Division

PERCY C. NOBLE W1BVR
37 Broad St., Westfield, Mass.

Northwestern Division

RALPH J. GIBBONS W7KV
c/o United Air Lines, Portland, Ore.

Pacific Division

J. L. McCARGAR W6EY
66 Hamilton Pl., Oakland, Calif.

Roanoke Division

H. L. CAVENESS W4DW
State College Station, Raleigh, N. C.

Rocky Mountain Division

GLEN R. GLASSCOCK W9FA
2164 So. Corona St., Denver

Southeastern Division

WILLIAM C. SHELTON W4ASR
Box 652, Daytona Beach, Fla.

Southwestern Division

CHARLES E. BLALACK W6GG
1273 Main St., El Centro, Calif.

West Gulf Division

WILLIAM A. GREEN W6BKH
801 Ross St., Abilene, Texas

THE AMERICAN RADIO RELAY LEAGUE, INC., is a non-commercial association of radio amateurs, bonded for the promotion of interest in amateur radio communication and experimentation, for the relaying of messages by radio, for the advancement of the radio art and of the public welfare, for the representation of the radio amateur in legislative matters, and for the maintenance of fraternalism and a high standard of conduct.

It is an incorporated association without capital stock, chartered under the laws of Connecticut. Its affairs are governed by a Board of Directors, elected every two years by the general membership. The officers are elected or appointed by the Directors. The League is non-commercial and no one commercially engaged in the manufacture, sale or rental of radio apparatus is eligible to membership on its board.

"Of, by and for the amateur," it numbers within its ranks practically every worth-while amateur in the nation and has a history of glorious achievement as the standard-bearer in amateur affairs.

Inquiries regarding membership are solicited. A bona fide interest in amateur radio is the only essential qualification; ownership of a transmitting station and knowledge of the code are not prerequisite. Correspondence should be addressed to the Secretary.



HIRAM PERCY MAXIM, FIRST PRESIDENT

Officers

President EUGENE C. WOODRUFF, W8CMP
State College, Pa.

Vice-President GEORGE W. BAILEY, W1KH
Weston, Mass.

Secretary KENNETH B. WARNER, W1EH
West Hartford, Connecticut

Treasurer ARTHUR A. HEBERT, W1ES
West Hartford, Connecticut

Communications Mgr. F. EDWARD HANDY, W1BDI
West Hartford, Connecticut

General Counsel PAUL M. SEGAL
1026 Woodward Building, Washington, D. C.

Address all general correspondence to the administrative headquarters at West Hartford, Connecticut.

"IT SEEMS TO US—"

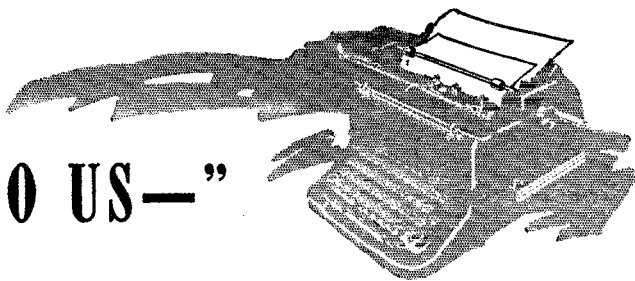

EFFECTIVE July 1st we have brand new examinations for all classes of amateur operator licenses! For many years we have been familiar with the old ten-question type of examination, which required an amateur to write more or less of a book in reply. Now we have an utterly new system which is very interesting in many of its implications.

The new examinations will continue to require the drawing of some circuit diagrams, and there will be a few questions involving simple radio arithmetic. But most of the questions will be of the type that we have seen so often in recent years in quizzes of various sorts, wherein a question is asked and five answers suggested, only one of which is right. The technical name for this animal is the "multiple-choice question," and educators and psychologists say that it works out very satisfactorily. The Commission, in fact, has used it for the past year or so in the commercial examinations. Although the candidate only checks off the right answers, giving the impression to a man who knows his stuff that the exam is much too easy, people experienced with this kind of quizzing say that if a candidate does not know and is reduced to guessing, it is quickly apparent in a deplorable score. There are, of course, a great many more questions in this type of examination, the new B-C one to contain fifty questions and the new Class A one to run forty. Despite this, it is figured that the amount of time consumed in taking the examination will be greatly reduced, while at the same time the new system will provide a much better sampling of the applicant's knowledge by virtue of the larger number of questions, without making the examination more difficult.

It sounds all to the good for us, then. It is time that we had a change in the questions, and it is time that the system was modernized so as to provide a truer test of whether the applicant has that minimum knowledge which ought to be required of him before going on the air. But there are other advantages to us that are possibly of equal importance:

There is scarcely any disputing the fact that the grading of essay-type answers is always

unsatisfactory. Great skill is necessary, in work that is appalling drudgery, if there is to be any uniformity between graders, and such work is both expensive and slow. Under the new system an applicant's answers can be quickly checked because they are either entirely right or entirely wrong. Thus the interests of both speed and uniformity are aided. In fact, the Commission is contemplating transferring the grading of amateur papers to the field offices where the examinations are given. Thereby, although the licenses will still have to come from Washington, their issuance should be materially speeded up through the elimination of grading delays.

You fellows who are about to go up for your tickets should take note that if you appear during June you will be examined by the old system, but that you will get the new examination if you go up July 1st or later. As far as can be foreseen, the difference is purely in method and not in the scope or difficulty in the exam, and the same passing mark is required; so let yourselves be guided purely by the date when you expect to be prepared. Yes, we are, of course, getting out a new edition of our famous License Manual as a study guide for the new exam.

AS ANNOUNCED elsewhere in this issue, the glad tidings came on April 13th that part of our five-meter band is now open to frequency-modulated voice transmission. This is an opportunity that many of us have been awaiting because, truth to tell, it is sometimes very difficult to find enough noise on the 112-Mc. band to obtain a full realization of the superiority of f.m. Heaven knows that that is not the case on Five, and there is every reason to expect that the use of this method there will bring us markedly superior results.

The Commission did not specify any deviation ratio for us, thus leaving us free to experiment with different swings. We may try narrow-band and wide-band and experiment to our hearts' content in varying the deviation to fit a particular correspondent's receiver. Nor are buffer bands specified: We may swing right out to the limits of the f.m. allocation at either

58.5 or 60 Mc. However, we must comply with the standing rule that, in any such allocations, the center frequency must be chosen sufficiently distant from the edges of the allocations so that the whole effect stays within authorized territory.

Much of the radio world is ga-ga about f.m. We continue in the belief that it has some great merits for amateur work but that we cannot come to any final opinion about it

until we have more experience with its interference pattern. The opening of part of Five now gives an opportunity to the numerous splendid stations and experienced amateur operators in this band to see just what it will do for us, and in a band where escape from ignition interference is more difficult than on higher frequencies.

To work, then, five-meter gang, and swing it!
K. B. W.

★ SPLATTER ★

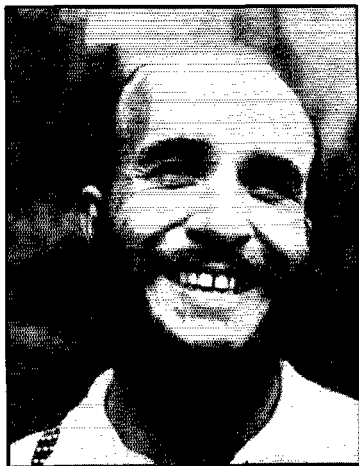

The smile you see here adorns the face of Henry Rice, W9YZH, in celebration of the completion of the single-dial transmitter described in this issue. The other adornment is the result of a mighty oath not to touch a razor until the blanked thing was finished! Incidentally, W9YZH insists on calling the story a "report on an experiment," but we (and others who have seen the job) think it has gone far beyond the experimental stage.

With the opening of a portion of the 56-Mc. band for frequency modulation occupancy there should be added impetus to work on the ultra highs. F.m. is just in swaddling clothes in the ham ranks, but we hope for big things from it.

George Grammer explains how simple it is to convert the present 56-Mc. transmitter for f.m.

Murray Crosby, W2CSY, who describes his push-pull frequency-modulator in this issue, is an early worker in the f.m. field and has published several papers on various aspects of the subject in the engineering journals. He is also an enthusiastic ham, active on 20-meter 'phone. We ran a description of his station in *QST* a couple of years ago.

Ham work with television has been pretty spotty, what with Iconoscopes at \$650 a throw! We told the manufacturers that this condition would exist until we had a picture pick-up tube for a comparatively few dollars—and what would they do about it? One of the manufacturers has replied with a tube that will do a nice job—and sells for less than \$25! Mr. Sherman used such a tube in the camera he described last month and Jim Lamb tells more of its technical features and use in this issue.

OUR COVER

Before final results can be reported on any idea its possibilities have to be explored thoroughly. There wasn't time last month, but By Goodman has really delved into this business of stretching more kilocycles out of crystals. The pictured result of the idea represents where work now starts toward simplification.

We were sorely tempted to have the gadget shown bottomsides up, featuring the doghouses for shielding, all laid out spic and span. Had we had another cover available you would have been treated to both!

FIELD DAY, JUNE 22-23

Those who like to do it out of doors will certainly be present on the above dates. See page 29 for all the dope.

More on Extended Variable Crystal Control

A Report of Results With a Practical Unit

BY BYRON GOODMAN,* WIJPE

THE story last month on the system suggested by W9ZGD for extending the variation range of variable-frequency crystals¹ aroused considerable interest in the ranks, if the letters received at Headquarters are any indication. At first glance, the system looks like a natural cure-all for the various shortcomings of our present methods of variable frequency control, but many a discerning amateur saw the possibility for trouble through drift caused by temperature changes. This possibility was not overlooked by W9ZGD and the Headquarters staff, but lack of time prevented a thorough investigation at the time the story was written, so the subject was only mentioned casually in the first article. Further, there was certain information to be obtained from the crystal manufacturers that lack of time prevented being included in the first story. It is the purpose of this article to present the additional information and to describe a practical unit. The unit to be described is not intended to be the final solution since, of necessity, it was made as elaborate as was felt necessary to find all the answers we wanted. However, we feel that it is a good starting point for future design.

Reference to the previous story¹ will recall to the reader the principle of extended variable crystal control. As an example, two 80-meter crystals differing by 200 kc. at their fundamental frequencies are used to control cascaded tripler stages to obtain energy at the 9th harmonics of the two crystals. At this point, the two 9th harmonics have a frequency difference of 1800 kc., and beating the two energies in a mixer stage will give an 1800-kc. signal in the output of the mixer. Doubling again will give a 3600-kc. signal. If now one or the other crystal frequencies is varied so that the frequency difference is no longer 200 kc. but 206 kc., the difference at the 9th harmonic will be 1854 kc. and the output from the mixer will be 1854 kc., which doubled gives a 3708-kc. signal. Thus, varying one crystal by 6 kc. gives an effective variation in the same amateur band of 108 kc. when using this system (with the 9th harmonics of the crystals and a single frequency-doubling after beating. Other combinations would give more or less variation, depending on the order of the frequency multiplication).

* Assistant Technical Editor.

¹ Goodman, "Extended Variable Frequency Crystal Control," *QST*, May, 1940.

If the two crystals have the *same* temperature coefficient, the resultant drift on the output frequency will be very nearly the same as that of one crystal working directly on that frequency. For example, if the two crystals are cut for 3800 kc. and 4000 kc. respectively, and have a coefficient of 10 cycles/Mc./°C., a 1°C. temperature change will shift the 200-kc. frequency difference to 200.002 kc. or 199.998 kc., depending on the direction of the temperature change and whether the coefficient is plus or minus. At this new temperature, the output from the doubler following the mixer will be 3600.036 kc. or 3599.064 kc., depending on the direction of drift. It is apparent that this is the same drift that would be obtained from a 3600-kc. crystal with the same coefficient and temperature change. Less extension of the variable range would result in a drift *less* than that of a single crystal, if both crystals had exactly the same coefficient.

However, in the case of crystals with *different* temperature coefficients (and practically any two crystals will fall in this class) a different condition exists. Let us assume that the 3800-kc. crystal has a coefficient of + 2 cycles/Mc./°C., the 4000-kc. crystal has a coefficient of - 2 cycles/Mc./°C., and that the temperature changes 1°C. The frequency difference at the fundamental now becomes 199.9844 kc. or 200.0156 kc., depending on the direction of the temperature change. Multiplied, mixed and doubled, the original 3600-kc. output has now drifted to either 3599.7192 kc. or 3600.2808 kc. The drift of a 3600-kc. crystal with the same coefficient would be only 7.2 cycles, compared to this drift of 280.8 cycles. If the 3800-kc. crystal had a negative coefficient of 2 cycles and the 4000-kc. one had a positive coefficient of 2 cycles, the drift would be the same but in the opposite direction.

If the story on extended variable frequency crystal control interested you at all last month, you will want to learn the results of further experimentation as set forth in this story. If you overlooked last month's story and had planned skipping this one too, you're making a mistake unless, of course, your present method of frequency control satisfies you completely.

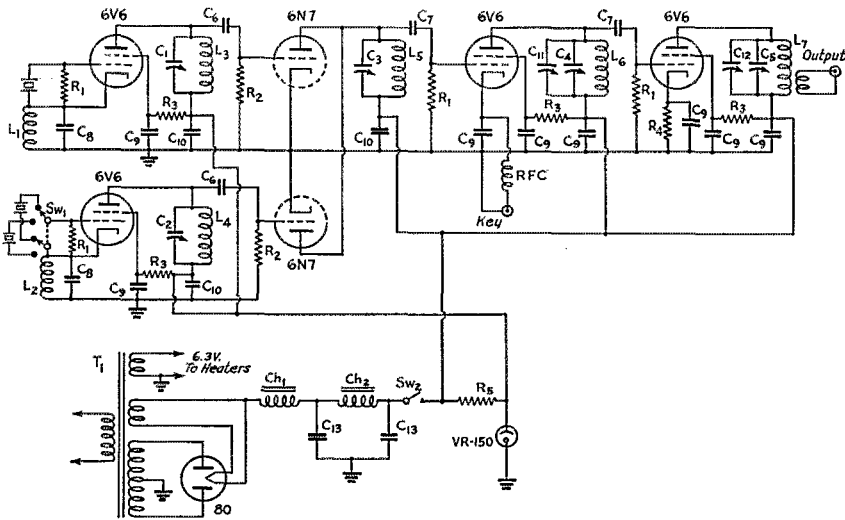

Fig. 1 — Circuit of the extended variable control exciter.

- C₁, C₂ — 100- μ fd. midget variable (Hammarlund HF-100).
- C₃ — 35- μ fd. midget variable (National UM-35).
- C₄, C₅ — 35- μ fd. midget variables, ganged (National UM-35).
- C₆ — 100- μ fd. midget mica.
- C₇ — 250- μ fd. midget mica.
- C₈ — 200- μ fd. midget mica.
- C₉ — 0.01- μ fd. 600-volt paper.
- C₁₀ — 0.002- μ fd. midget mica.
- C₁₁, C₁₂ — 60-250- μ fd. adjustable mica trimmer (Mallory CTX955).
- C₁₃ — 8- μ fd. 450-volt electrolytic.
- R₁ — 75,000 ohms.

- R₂ — 50,000 ohms.
 - R₃ — 2000 ohms.
 - R₄ — 300 ohms.
 - R₅ — 1000 ohms, 10-watt wire-wound.
- All resistors are 1-watt unless otherwise mentioned.
- Sw₁ — Two-circuit two-position rotary.
 - Sw₂ — S.p.s.t. toggle.
 - Ch₁, Ch₂ — 8 henrys, 150-ma. (Thordarson T-13C30).
 - T₁ — 750 volts c.t., 150-ma., with 5- and 6.3-volt windings (Thordarson T-13R15).
 - L₁, L₂ — 20 turns No. 24 d.s.c.,

- closewound on $\frac{5}{8}$ -inch diam form.
 - L₃, L₄ — 12 turns No. 18 enam., self-supporting, $\frac{3}{4}$ -inch long, $\frac{3}{4}$ -inch diam.
 - L₅ — 4 turns No. 18 enam., self-supporting, $\frac{3}{4}$ -inch diam., $\frac{3}{8}$ -inch long.
 - L₆ — 70 turns No. 32 d.s.c., closewound on $\frac{3}{4}$ -inch diam. form.
 - L₇ — 28 turns No. 32 d.s.c., closewound on $\frac{3}{4}$ -inch diam. form.
- Link is 6 turns No. 24 enam. closewound at ground end.

The other possibility is that of crystals with coefficients of the same sign but of different values. If, for example, the 3800-kc. crystal had a coefficient of 2 cycles and the 4000-kc. crystal had one of 4 cycles, a 1°C. change would result in a change at the output frequency (3600 kc.) of 151.2 cycles, compared to a change of 14.4 cycles

for a 3.6-Mc. crystal with a coefficient of 4 cycles. If the 3800-kc. crystal had a coefficient of 4 cycles and the 4000-kc. crystal had the 2-cycle coefficient, effective drift for a 1°C. change would be 129.6 cycles.

However, it is well to note that if the 3800-kc. crystal has a coefficient 40/38 of that of the

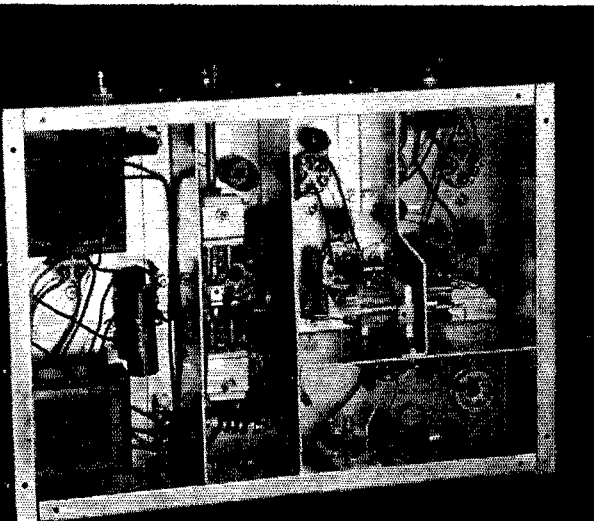

A view under the chassis shows the arrangement of the shield compartments and the various components. The two oscillator plate condensers are tuned through holes in the side of the chassis, and the tripler plate condenser is tuned from the rear of the chassis. The mixer tuning condenser is the one on the gang towards the rear of the set.

QST for

The complete unit viewed from the top shows nothing unconventional except the shield cans around the crystal holders. The two tubes directly behind the crystal holders are the 6V6 oscillators. The 6N7 tripler is directly behind the two oscillator tubes, with the VR-150 voltage regulator sitting on the rear right-hand corner. The switch on the front at the right selects one of two crystals — the knob controls the tuning of the mixer and output stages. The chassis measures 10 by 14 by 3 inches.

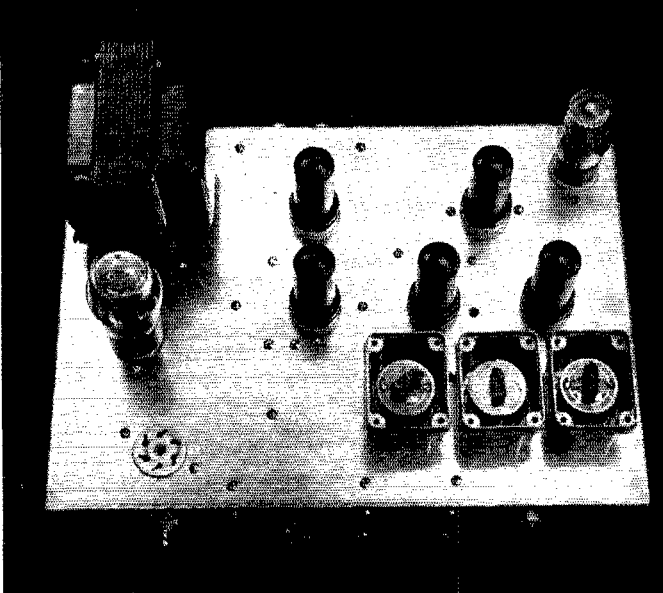

4000-kc. one and of the same sign, temperature changes would have no effect whatsoever on the output frequency! Thus, even though the actual coefficients were on the order of 100 cycles/Mc./°C., there would be no change in output frequency with temperature changes, providing the two crystals were maintained at equal temperatures at all times.

We are therefore faced with a fundamental disadvantage of the system — the fact that temperature effects are greatly accentuated unless crystals are used that have very nearly the same temperature coefficients. Two obvious solutions are immediately apparent: either use crystals with the same coefficients, or control the temperature of the crystals. The first solution runs into a snag when it is learned that, at the present, the crystal manufacturers cannot economically furnish two crystals with the necessary definite integral frequency difference and with the same temperature coefficient. The second solution is possible but not likely to appeal to many constructors at first glance.

Having painted a solid black picture thus far, now is a good time to introduce some rays of light. First off, the crystals are running steadily even during receiving periods (the mixer is keyed in the cathode, and no signal appears on the signal frequency with the key up) so the temperature of the crystals doesn't take too long to settle down to a steady value. Also, the Biley Company, the maker of the variable-frequency crystals, tells us that, on the average the VF-1 units have a coefficient of ± 2 cycles/Mc./°C., although they are only rated at not exceeding ± 4 cycles. The new VF-2 units, which are capable of a 12-kc. variation on 80 meters, have a temperature coefficient not exceeding 55 cycles, but we are told that it averages fairly close to 45 cycles. Thus it might be possible to use two of the higher-drift crystals and, by virtue of their closer

agreement in temperature coefficient, end up with a system having no more drift than with the low-drift crystals and much greater range of frequency variation.

A Practical Model

In order to learn the answers to the above questions and to find out how serious the temperature drifts might be under normal operating conditions, a practical model was constructed. No particular attempt was made to simplify the thing, since it was decided that it would be better to work with a unit which had everything in it designed for best operating conditions. If the system was impractical in this version, it would be useless to try to simplify it.

A glance at the wiring diagram in Fig. 1 shows that two 6V6 tubes were used in the Tri-tet circuit as crystal oscillators. The plate circuits of these oscillators, which use crystals in the high-frequency end of the 80-meter band, are tuned to the third harmonics, which fall between 11 Mc. and 12 Mc. Energy from these plate circuits is coupled into the triode sections of a 6N7, and the frequencies are tripled again by using high-resistance grid leaks and tuning the plate circuits to the third harmonics, which fall around 35-36 Mc. A single plate circuit does for both sections of the tube. Energy from this tank circuit is fed into a 6V6 mixer which is keyed in the cathode circuit, and doubling to the 80-meter band is done in another 6V6. For ease in operation, the plate-circuit tuning condensers of the mixer and doubler are ganged. A VR-150 voltage regulator tube keeps the voltage on the crystal oscillators constant at 150 volts, to eliminate any chirp that might be caused by voltage fluctuations.

The photograph of the top of the unit shows the arrangement of the tubes and crystals. Provision was made for three crystals, in case the VF-2 units could not be used. The crystals are plugged

in to 5-prong tube sockets. The bottom parts of the new Millen shield cans were used as shields around the crystals, so that the upper part of the shield cans could be slipped over to furnish more complete shielding and a support for the flexible shafts necessary to adjust the crystals from the front panel when a cabinet is used. A switch on the front of the chassis selects one of two crystals for one of the oscillators, and a toggle switch cuts off the plate power until the tubes have warmed up. If this toggle switch isn't included, the VR-150 will draw too much current when the set is first turned on. The large knob controls the two ganged condensers which tune the mixer and doubler tank circuits.

Many more of the details of construction can be seen in the photograph of the underside of the chassis. It will be seen that sheet aluminum was used to form shield partitions between the various sections of the unit. The shielding was formed to divide the chassis into sections housing each oscillator, the tripler stage, and the mixer-doubler gang. The bottom plate to the chassis completes the shielding when it is fastened in place.

The two small variable condensers used to tune the plate circuits of the crystal oscillator are mounted, with insulating washers, on the shield separating the two compartments. They are adjusted by an insulated screwdriver through small holes in the side of the chassis. Their respective coils are self-supporting and are mounted directly on the terminals of the condensers. The cathode coils are wound on small bakelite forms (National XR-3) which are supported by a couple of the bolts used to fasten the tube sockets.

The plate condenser for the tripler stages is mounted on the back of the chassis with the small pillars furnished with the condenser. The shaft was sawed off and slotted so that it could be adjusted from outside the chassis with an insulated screwdriver or aligning tool.

The two condensers used to tune the mixer and output stage are mounted on the underside of the chassis and supported by the small angles furnished with the condensers. A flexible coupling is used to gang them and another is used to connect to the brass rod projecting through the front of the chassis. Two small brackets of aluminum were made to mount on the other ends of the condensers, and these brackets support the padding condensers, C_{11} and C_{12} . Padding condensers are necessary to bring up the circuit Q and to help in tracking. The coils in the mixer and output stage, unlike the other stages, are wound on $\frac{3}{4}$ -inch diameter polystyrene forms (National PRF-2) fastened to the chassis at convenient points with polystyrene cement or regular coil dope. Amphenol microphone connectors at the rear of the chassis serve as convenient connections for the output and the key. Wires carrying r.f. between stages were fed through the new small

ceramic tubes (32150) made by Millen which can be sweated in place with a soldering iron.

The extra socket on the chassis was provided to take a 6E5 "magic eye" tube, to be used as an indication of resonance in the output circuit. It was connected as a grid-leak detector to the ungrounded side of the output link, but the voltage developed wasn't high enough to give the kind of indication we wanted, and the 6E5 is not shown in the wiring diagram.

There is, of course, nothing more to lining up the unit than there is to tuning a simple exciter unit. The only precaution necessary is to see that the circuits are not tuned to the wrong harmonics. Also, it is advisable to do the original tuning with the VR-150 out of the circuit and with the resistor R_5 shorted, so that a neon bulb can be used as a resonance indicator. The plate tanks of the oscillators will tune with their condensers practically fully meshed and the tripler tank should tune with the condenser set about half meshed. When the oscillators and tripler have been tuned, and r.f. shows on the grid of the mixer stage, the key can be closed and the mixer padder C_{11} adjusted until r.f. shows on the grid of the doubler 6V6. The pad C_{12} is then adjusted until r.f. shows on the plate of the doubler tube.

The next step is to check the performance of the VR-150, which is done by cutting in a 0-50 or 0-100 milliammeter between the VR-150 and ground. The current to ground should be between 20 and 30 ma. — any wide deviation from this will result in less effective regulation by the tube. If the current is too low, decrease the value of R_5 , and if the current runs over 30 ma., increase the value of R_5 .

The tracking of the ganged condensers can be checked by turning the tuning condensers C_4 - C_5 nearly full in, adjusting the variable crystals until a signal on 3500 kc. is obtained, and then adjusting the trimmers C_{11} and C_{12} for maximum output. Then adjust the crystals for a signal at 3900 kc. and tune the tuning condensers C_4 - C_5 for maximum output. If it is possible to further increase the output by adjusting the padding condensers, it indicates that the two circuits are not tracking. However, the values are not too critical and, if the coil dimensions are followed closely, no trouble should be experienced. The other condensers (C_1 , C_2 and C_3) can be trimmed up in the middle of the range, and practically no loss in output will result from their slight mistuning at the edges of the range. The output from this unit, with 275 volts being delivered by the power supply, is about 4 watts, plenty to drive the average beam-power tube.

Keying should be chirpless and click-free. Any chirp indicates that the voltage regulation on the oscillators is not right, and it should be checked again. Slight clicks caused by the breaking of the

(Continued on page 98)

A New Iconoscope for Amateur Television Cameras

An Economical 2-Inch Electrostatic-Deflection Type Tube

BY JAMES J. LAMB,* WIAL

THE heart of the experimental camera-modulator unit described in the May issue of *QST* is a developmental Iconoscope tube designed especially for use in amateur television transmitters. Although much smaller than the standard commercial types, the amateur model is a true Iconoscope operating on the storage principle and, despite a small-size mosaic, it is suitable for generating a clear picture of at least 120 lines for transmission in the 112-116-Mc. amateur band, or in a higher-frequency band available for amateur television transmission. In addition, the tube is also admirably adapted to use in experimental demonstration systems for teaching television principles and in simple television systems using wire-line transmission to points remote from the scene of action.

In addition to its low-cost design features, the new "Ike" permits further economies in practical application in that it requires much less elaborate auxiliary equipment than its commercial predecessors. Since the tube operates on a second anode voltage of only 600 volts, the cost of the high-voltage supply is small. Because electrostatic rather than magnetic deflection is used, a separate deflecting yoke is not required. The mosaic is perpendicular to the axis of the electron gun so that keystoneing circuits are unnecessary. Since the mosaic is less than 2 inches in diameter, a relatively inexpensive short focal-length lens satisfies the requirements for good picture pickup.

A convenient feature of the design of the Icono-

* Research Engineer, A.R.R.L.

scope is that its electrostatic deflection system is similar to that of the 902 miniature cathode-ray tube so that the latter can be readily used in conjunction as a monitor and electronic view-finder. The same anode and filament supply may be used for both tubes and the corresponding deflection plates may be operated effectively in parallel from the same sweep generators, vertical and horizontal. In addition to being something of an innovation in television practice, this feature is also a great convenience.

The picture viewed on the 902 monitor screen is the same, in both size and shape, as the image focused on the mosaic of the Iconoscope. However, this does not mean that the picture is restricted to this size in reproduction on the receiving Kinescope. At the other end of the transmission circuit, whether it be wire or radio, the picture may be "blown up" on the screen of a 3-inch cathode-ray tube, or to even greater dimensions with a larger tube.

How It Operates

The principal parts of the Iconoscope are the mosaic, signal electrode, collector, and electron gun with horizontal and vertical electrostatic deflection plates. The position of these parts in the developmental amateur Iconoscope is illustrated in the functional diagram of Fig. 1. The mosaic consists of a large number of small photosensitive particles deposited on one face of a transparent sheet of insulation. The particles are spaced a very small distance apart on the sheet

◆

The developmental amateur Iconoscope (left) as it appears alongside the standard commercial type (right) used in television broadcasting. Both tubes are produced by RCA Mfg. Co., Inc., Harrison, N. J.

◆

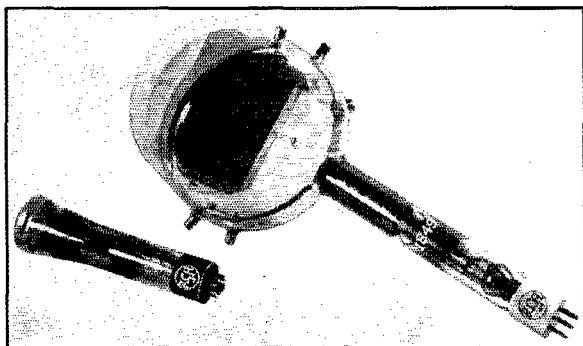

so as to be insulated from each other. On the opposite face of the insulating sheet is a transparent conductive film, the signal electrode. This electrode is in contact with a band of conductive material on the inner surface of the bulb. Another band of conductive material is mounted on the external surface of the bulb, directly over the internal band. The capacitance between the two bands, in series with the capacitance between the signal electrode and mosaic, provides coupling between the mosaic and the signal-electrode terminal.

In operation of the Iconoscope, an image of a scene is focused on the mosaic, and the beam of electrons provided by the gun is made to scan the image. As the beam moves over the image, there is generated across the load resistor a voltage whose magnitude at any instant depends on the image brightness at the point where the beam is at that instant. This voltage is used as the video signal for television transmission of the scene viewed by the Iconoscope. The process by which the Iconoscope generates this voltage can be described briefly as follows:

Consider first the action of the tube when the mosaic is scanned by the beam with no illumination on the mosaic. When the electron beam strikes a mosaic particle, the particle emits secondary electrons, the number of secondaries being several times the number of beam electrons striking the particle. Some of these secondaries return almost immediately to the particle; the rest escape and go either to the collector or to other parts of the mosaic. During the first part of the time of contact between the electron beam and mosaic particle, most of the secondaries emitted from the particle escape from it. Because the particle is insulated, its potential changes in the *positive* direction as long as the number of electrons escaping from it is greater than the number of electrons flowing to it. The number of electrons which escape depends on the potential of the particle, the number becoming less, of

course, the more positive the particle becomes. Hence, if the beam is on the particle a sufficiently long time, the particle will be driven to a *positive* potential at which the number of electrons escaping is equal to the number of electrons arriving. In usual operation, the time required for the beam to pass over a particle is long enough for the particle to attain this positive potential. The value of this potential for typical operating conditions is a few volts positive with respect to the collector; this is the maximum positive potential attained by a photosensitive particle.

After the beam passes the particle, some of the secondary electrons emitted from the rest of the mosaic fall on the particle. The arrival of these electrons changes the particle potential in the *negative* direction to a new value. In a typical operating condition, this value is a few volts *negative* with respect to the collector. With no light on the particle, the particle stays at this negative potential until the next time the beam strikes, when the particle again releases electrons and rises to its maximum positive potential.

Consider now the action of the tube when the mosaic is scanned with part of it illuminated. *Both an illuminated particle and an unilluminated one, when struck by the beam, rise to the same maximum positive potential of a few volts with respect to the collector.* During the time between contacts with the beam, both the illuminated particle and the unilluminated particle receive electrons from the rest of the mosaic, and, therefore, charge in the *negative* direction during this time. The illuminated particle, however, at the same time emits electrons, the emission being caused by the light on this particle. The illuminated particle, therefore, does not fall to as negative a potential as the unilluminated one does. Hence, the next time the beam strikes, the illuminated particle does not have as far to rise to reach maximum positive potential. As a result, *less charge is released to the collector when the beam strikes the illuminated particle than when the*

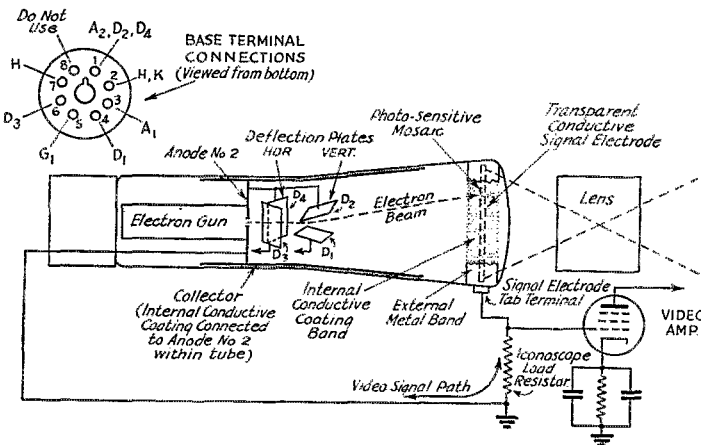
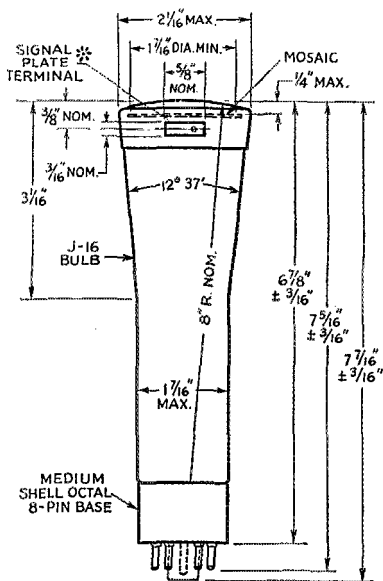

Fig. 1—Functional diagram illustrating the operation of the amateur Iconoscope.



* Located on same side of bulb as pins 4 & 5

Fig. 2 — Dimension drawing of the Iconoscope.

beam strikes the unilluminated one. The difference in charge is approximately proportional to the difference in illumination.

Now consider the action of the tube when an image is focused on the mosaic and scanned by the electron beam. As the beam moves over the mosaic, varying amounts of charge flow from the mosaic to the collector, the amount of charge flowing at any instant being a measure of the light on the particle where the beam is at that instant. In other words, a video signal current flows between the mosaic and collector. It can be seen that, since the beam current to the mosaic is constant, the video signal current must complete its circuit path through the load resistor, the capacitance between the external and internal bands and the capacitance between the signal electrode and mosaic, as shown in Fig. 1. The voltage developed across the load resistor by this signal current is the video signal output of the Iconoscope.

It also can be seen that when the beam moves from a dark portion of the image to a brighter portion, the electron current from the mosaic to the collector *decreases*. The output voltage, therefore, changes in the negative direction. Hence, the signal output of the Iconoscope is of negative polarity; that is, a highlight in the image is represented by a relatively negative value of signal voltage; a shadow in the image is represented by a positive value.

This peculiarity in polarity of output requires an *odd* number (1, 3, 5, etc.) of conventionally coupled video amplifying stages between the

Iconoscope signal output and Kinescope (or monitor) grid to give the correct polarity for positive reproduction of the picture. For modulation with *negative* polarity (in accordance with usual American practice) an *even* number of conventionally coupled amplifying stages should be used—including the modulator when the output is taken from its plate circuit. It must be remembered that there is no reversal of polarity in a cathode-follower coupling stage (that is, one in which the cathode resistor is the output coupling load); therefore such stages are not to be counted in determining whether the total number is odd or even.

Tentative Characteristics and Ratings

Heater voltage (a.c. or d.c.)	6.3 volts
Heater current	0.6 ampere
Direct interelectrode capacitances:	
Control electrode G_1 to all other electrodes	7 μ fd.
Deflecting plate D_1 to all other electrodes	6 μ fd.
Deflecting plate D_2 to all other electrodes	5 μ fd.
Signal-electrode terminal to all other electrodes (with external shielding)	11 μ fd.
Signal electrode to signal-electrode terminal	50 μ fd.
Bulb	J-16
Base	Medium Shell Octal 8-Pin

Maximum Ratings and Typical Operating Conditions

(Voltages are specified with respect to cathode)

Anode No. 2 and collector voltage *	600 max. volts
Focusing electrode (Anode No. 1) voltage *	200 max. volts
Control electrode (Grid G_1) voltage	Never positive
Negative grid bias for current cut-off	Not more than 15% of Anode No. 2 voltage
D.c. resistance between grid and cathode	1 max. megohm
Peak voltage between anode No. 2 and any deflecting plate	350 max. volts

Typical Operation:

Heater Voltage	6.3 volts
Anode No. 2 and collector voltage	800 volts
Anode No. 1 voltage	150 approx. volts
Grid voltage	Adjust for best picture
Horizontal deflecting voltage (D_2 - D_4)†	200 volts
Vertical deflecting voltage (D_1 - D_2)†	225 volts

* Design maximum for 117-volt line.

† Peak-to-peak value required for scanning full mosaic diameter.

Base Connections

The base connections (also shown in a bottom-view diagram) are as follows:

- Pin 1 — Anode No. 2 and Deflection Plates (D_2 , D_4)
- Pin 2 — Cathode and Heater (K, H)
- Pin 3 — Anode No. 1 (A_1)
- Pin 4 — Free Vertical Deflection Plate (D_1)
- Pin 5 — Grid (G_1)
- Pin 6 — Free Horizontal Deflection Plate (D_3)
- Pin 7 — Heater (H)
- Pin 8 — No connection (actually connected within tube to Pin No. 1)

The tab on the metal band at the front of the tube is the signal plate connection. The pin num-

(Continued on page 96)

Getting on 56-Megacycle F.M.

Transmitting Methods; Checking Linearity and Deviation

BY GEORGE GRAMMER,* W1DF

OPENING of the 58.5-60 Mc. region to amateur frequency modulation gives us a real opportunity to test the merits of the system on an equal footing with amplitude modulation. This summer, we hope, will find enough operation to show whether a large number of stations can work comfortably at the same time in a given band of frequencies. Of the noise suppression, especially on the ignition ever present at most locations, there can be no doubt. The question mark is our old friend, interference.

The new rule makes only two technical specifications: that the total frequency band emitted be confined between the specified limits, and that the frequency-modulated signal be free from amplitude modulation. The latter requirement is relatively easy to meet and the transmitter's performance in this respect can be checked quite simply. The first is permissive in at least one sense — it leaves us free to select our own standards as to the amount of frequency deviation to be used. On the other hand, it imposes the obligation on the amateur to know the width of the channel his transmitter occupies, and to place his carrier far enough inside the band limits so that none of the effects extend outside.

The troublesome question is that of the amount of deviation to use — troublesome not particularly from the standpoint of transmitting

but because receivers have to be designed and built for a specific band width. No doubt most of those who build f.m. receivers right now are doing so partly for broadcast reception — a reasonable enough state of affairs since relatively few amateur stations are yet on the air with f.m. A receiver with sufficient band width for b.c. reception is considerably wider than is necessary for amateur work, so that the selectivity is not all that could be desired. Fortunately, the interference question is not acute at present, so perhaps it is not too bad an idea to make the receiver take in broadcasts as well as ham communication. The chief effect of narrow-band ("narrow" in a relative sense) transmission received on a wide-band receiver is that the audio output is not as great, but since the noise is also lower the signal-to-noise ratio is not affected to any appreciable extent. The receiver described by Byron Goodman in recent issues¹ was designed with 5-meter f.m. in mind, and also is suitable for broadcasting.

On the other hand, we should not let such receiver considerations too greatly influence the choice of a figure for frequency deviation at the transmitter. Setting standards is perhaps not desirable until we have enough experience with the system to know what we need, but it is desirable

¹ Goodman, "A Practical 112-Mc. Converter," *QST*, March, 1940; "A Complete 5-Mc. I.F. System," *QST*, April, 1940.

* Technical Editor, *QST*.

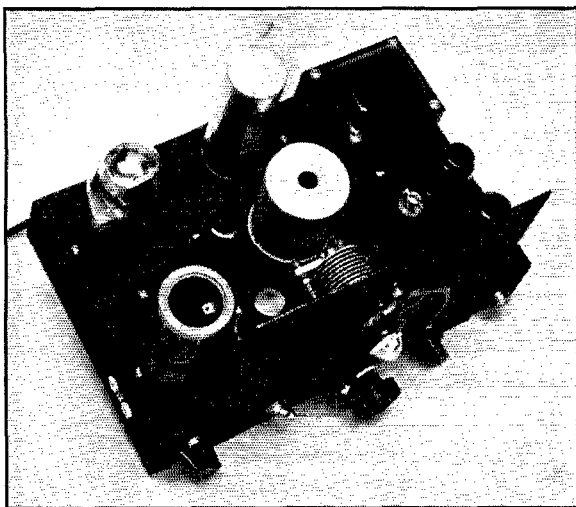

◆

This modulator-oscillator unit, originally described in January *QST*, can work into practically any crystal-controlled 56-Mc. transmitter for frequency-modulated output. It contains a speech amplifier and power supply, so that no additional equipment is needed. A detailed description will be found in the January issue, to supplement the information given in this article.

◆

Now for a real tryout of frequency modulation in ham communication — on a band where its possibilities can be explored to the full! Any 5-meter rig that meets the present a.m. regulations can be converted to f.m. in 58.5–60 with little trouble or expense. Here's how — with some new dope on measuring deviation and checking linearity.

to permit those who want to build more selective receivers to do so and get the benefit of them. It is true that the deviation is easily controlled at the transmitter and therefore can readily be adjusted to fit any given receiver, but a wider swing than is necessary to obtain the benefits of the system is not the way to make economical use of the frequencies available.

For voice communication the standards adopted for f.m. police work seem reasonable. These call for a maximum deviation of 15 kc., or a channel width of 30 kc., and are based on a deviation ratio of 5 (about the same as in broadcasting) for an upper audio-frequency limit of 3000 cycles. Such an a.f. range is adequate for good intelligibility, although it does not meet "high-fidelity" standards. Nevertheless the same channel width for 5-meter f.m. is probably a good idea. Audio frequencies above 3000 cycles could still be transmitted in such a channel — frequencies up to 5000 cycles would not cause sidebands of appreciable strength outside the 30 kc. — at the expense of the deviation ratio.

A receiver designed for such a channel could be built along the same lines as the receiver in the March and April issues.¹ The only change would be to substitute "straight" 5-Mc. i.f. transformers, without resistance loading, for the f.m. units labelled T_1 , T_2 , and T_3 (Fig. 1, page 18, April *QST*), a diode transformer being used at T_3 . The discriminator transformer, T_4 , would remain as specified. The regular 5-Mc. units give a band width of just about 30 kc., and thus are quite suitable for 30 kc. f.m. and not too bad for a.m. reception.

Transmitting

The man who already has a crystal-controlled 56-Mc. transmitter, will find the business of adapting it to f.m. rather easy. Quite the simplest arrangement is the reactance modulator, already described in January *QST*.² The circuit is reproduced here as Fig. 1. If the transmitter incorporates an e.c.o., this modulator circuit is all that need be installed to go on f.m. at once. The modulator is simply connected across the oscillator tank as shown, and an audio signal from the

speech amplifier fed between ground and the terminal marked "Audio input." A maximum of about 2 volts of audio is required; it may be taken from any suitable point in the speech amplifier behind the gain control.

A complete unit suitable for working into the crystal oscillator tube in a crystal-controlled transmitter is shown in Fig. 2. This is the same outfit that was described in January *QST*, but with the wiring diagram all in one piece for convenience. It needs no further detailed description here. Additional coil data have been provided to make the unit applicable to transmitters starting out with crystals of various frequencies.

The r.f. output of the unit shown is intended to be fed through a link to a tuned circuit which substitutes for the crystal in the crystal oscillator. This tuned circuit is resonant at the same frequency as the output tank of the control unit, L_2C_3 in Fig. 2, and is in fact identical with it in construction. In transmitters using triode or pentode crystal oscillators in which the tubes are not well screened, it is advisable to use the crystal oscillator tube as a doubler rather than as a straight amplifier. If the transmitter uses a 7-Mc. crystal oscillator, for instance, the output of the unit of Fig. 2 can be on 3.5 Mc. and the grid circuit of the ex-crystal tube tuned also to 3.5 Mc. This will avoid difficulty with self-oscillation in the ex-crystal tube. With a pentode oscillator it is possible to work straight through provided the grid tank substituted for the crystal is tuned well on the high-frequency side of resonance, but this procedure is not advisable since it may make the modulation non-linear. It is rather important that all circuits in the transmitter be tuned "on the nose" for best performance. Of course, if the crystal tube is a well-screened transmitting type it can be used as a straight amplifier.

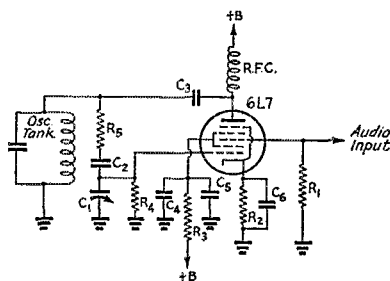

Fig. 1 — The simple reactance modulator circuit. C_1 — 3–30- μ fd. compression trimmer (set full open). C_2 , C_3 — 250- μ fd. mica. (C_2 not needed when there is no d.c. voltage on oscillator tank.)

- C_4 — 0.01- μ fd. paper.
- C_5 — 8 μ fd. electrolytic, 450-volt.
- C_6 — 0.01- μ fd. paper.
- R_1 — 0.5 megohm, $\frac{1}{2}$ -watt.
- R_2 — 300 ohms, $\frac{1}{2}$ -watt.
- R_3 — 30,000 ohms, 1-watt.
- R_4 — 0.5 megohm, $\frac{1}{2}$ -watt.
- R_5 — 50,000 ohms, 1-watt.
- RFC — 2.5-mh. r.f. choke.

² Grammer and Goodman, "Wide-Band Frequency Modulation in Amateur Communication," *QST*, January, 1940.

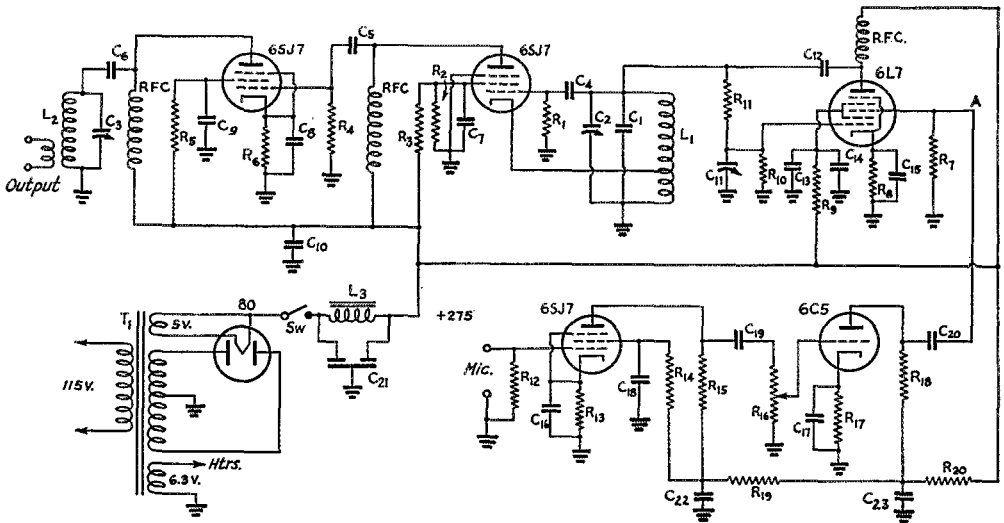

Fig. 2 — Circuit diagram of the control unit for use with normally crystal-controlled transmitters.

- | | | |
|---|---|---|
| C ₁ — 150- μ fd. silvered mica for 7 Mc., 650 μ fd. for 3.5 Mc.; 1150 μ fd. for 1.75 Mc. | R ₁ — 0.1 megohm, 1-watt. | 3.5 Mc.: 11 turns No. 24 enam., length $\frac{3}{4}$ inch, diameter 1 inch, tapped 4th turn from ground. |
| C ₂ — 100- μ fd. variable (National SE-100). | R ₂ — 25,000 ohms, 1-watt. | 1.75 Mc.: 21 turns No. 24 enam., length 1 inch, diameter 1 inch, tapped 6th turn from ground. |
| C ₃ — 50- μ fd. variable (Hammarlund HF-50). | R ₃ , R ₄ , R ₅ — 50,000 ohms, 1-watt. | L ₂ — 14 Mc.: 10 turns No. 18 7 Mc.: 7 turns No. 18 3.5 Mc.: 40 turns No. 24 1.75 Mc.: 75 turns No. 26 |
| C ₄ — 100- μ fd. mica. | R ₆ — 300 ohms, $\frac{1}{2}$ -watt. | All coils wound with enamelled wire on $1\frac{1}{2}$ -inch diameter forms (Hammarlund SWF-4). 1.75-Mc. coil close-wound; others spaced to a length of $1\frac{1}{2}$ inches. |
| C ₅ — 250- μ fd. mica. | R ₇ — 0.5 megohm, $\frac{1}{2}$ -watt. | Link 3 to 5 turns, not critical. |
| C ₆ — 0.001- μ fd. mica. | R ₈ — 300 ohms, $\frac{1}{2}$ -watt. | L ₃ — 10 henrys, 40 ma. |
| C ₇ , C ₈ , C ₉ , C ₁₀ — 0.01- μ fd. paper. | R ₉ — 30,000 ohms, 1-watt. | T ₁ — 250 volts at 40 ma.; 6.3 volts at 2 amp.; 5 volts at 2 amp. (Thordarson T13R11). |
| C ₁₁ — 3-30- μ fd. compression trimmer (set full open). | R ₁₀ — 0.5 megohm, $\frac{1}{2}$ -watt. | Sw — S.p.s.t. toggle switch. |
| C ₁₂ — 250- μ fd. mica. | R ₁₁ — 50,000 ohms, 1-watt. | |
| C ₁₃ — 0.01- μ fd. paper. | R ₁₂ — 5 megohms, $\frac{1}{2}$ -watt. | |
| C ₁₄ — 8- μ fd. electrolytic, 450-volt. | R ₁₃ — 900 ohms, $\frac{1}{2}$ -watt. | |
| C ₁₅ — 0.01- μ fd. paper. | R ₁₄ — 1 megohm, $\frac{1}{2}$ -watt. | |
| C ₁₆ , C ₁₇ — 10- μ fd. 25-volt electrolytic. | R ₁₅ — 0.25 megohm, $\frac{1}{2}$ -watt. | |
| C ₁₈ — 0.1- μ fd. paper. | R ₁₆ — 0.5-megohm volume control. | |
| C ₁₉ , C ₂₀ — 0.01- μ fd. paper. | R ₁₇ — 2000 ohms, $\frac{1}{2}$ -watt. | |
| C ₂₁ — Dual 8- μ fd. electrolytic, 450-volt. | R ₁₈ — 50,000 ohms, $\frac{1}{2}$ -watt. | |
| C ₂₂ , C ₂₃ — 8- μ fd. electrolytic, 450-volt. | R ₁₉ — 0.25 megohm, $\frac{1}{2}$ -watt. | |
| | R ₂₀ — 0.15 megohm, 1-watt. | |
| | RFC — 2.5-mh. r.f. choke. | |
| | L ₁ — 7 Mc.: 10 turns No. 18 enamelled, length $\frac{3}{4}$ inch, diameter 1 inch, tapped 3rd turn from ground. | |

Note: Data for L₁ subject to individual trimming for proper frequency coverage. Adjust inductance by changing turn spacing to bring low frequency end of band near maximum capacity on C₂. Coil specifications given apply to coil centered in round shield 2 inches in diameter and 2 $\frac{1}{2}$ inches high. The 3.5- and 7-Mc. coils will give full coverage of the 56-60-Mc. band with C₂ 100 μ fd.; the 1.75-Mc. coil will cover approximately 57-60 Mc. with the same variable condenser.

With harmonic-type oscillators the input frequency can be the same as that of the crystal, since the output frequency of the crystal tube is already a harmonic. In the Tri-tet the cathode tank should be short-circuited; in the types using a cathode impedance to provide feedback this impedance also should be shorted. Care should be taken to avoid short-circuiting the grid bias, whether from a cathode resistor or grid leak. In the latter case this usually will mean that a blocking condenser (500 μ fd. or larger) should be connected between the "hot" end of the grid tank and the grid of the ex-crystal tube, with the grid leak (and choke) connected on the

grid side of the condenser. Such a blocking condenser can be incorporated in the plug-in tank. The grid tank tuning condenser can be a small air padder mounted in the coil form.

Those who already have a suitable power supply and speech amplifier can omit the lower part of Fig. 2 and build simply the oscillator, buffer and modulator. Transformer input to the modulator, Fig. 3, can be used in case the available speech amplifier happens to have a low-impedance output circuit. The transformer and gain control connect between ground and point "A" of Fig. 2, R₇ being omitted. Any of the conventional methods may be used, in fact, to

couple the modulator to an available speech amplifier, with one precaution — if a high-impedance connection is used the "hot" lead should be shielded to prevent hum pickup.

Checking Linearity

The principles upon which the transmitting system operates have already been covered in some detail,² and for the most part do not need to be repeated. It is essential to be able to check the linearity of the modulator and the extent of frequency deviation; linearity because unequal frequency deviations on either side of the carrier for a given symmetrical grid voltage mean a.f. distortion, and deviation because it is necessary to know that the signal is within the predetermined channel limits. These are comparable to checks of waveform distortion and percentage of modulation in the amplitude system.

The frequency shift in a simple oscillator-modulator system depends upon the initial tank current without modulation, and the amplitude of the r.f. current which the modulator can draw through the tank. Assuming a given oscillator tube and fixed plate voltage, the tank current is determined primarily by the L/C ratio of the tank, being higher for a high- C tank circuit. The modulator current is, of course, determined by the characteristics of the modulator tube and the r.f. load in its plate circuit. The higher the L/C ratio of the oscillator tank circuit, the smaller is the effect of the modulator current on the circulating current flowing through the tank inductance. Consequently the system will be less sensitive to a given audio modulating voltage as the oscillator is made more high- C .

For highest carrier stability it is desirable to make the oscillator tank high- C , in accordance with usual practice. If we assume a figure for deviation, then the problem becomes one of determining the highest amount of C that can be used in the tank without running into the limits of modulator capability before the desired deviation is reached. Taking 15 kc. as a desirable maximum deviation on 56 Mc., then the deviation necessary at the modulated oscillator is equal to 15 divided by the ratio of the oscillator frequency to 56 Mc. For example, if the oscillator is operating on 7 Mc., the oscillator deviation will be 15/8, or 1875 cycles; if the initial frequency

is 3.5 Mc., the oscillator deviation will be 15/16, or 937 cycles.

When the frequency shift is small in comparison to the initial frequency, which is the case even with wide-band modulation, the frequency deviation is practically proportional to the r.f. current drawn by the reactance modulator. For linearity, the modulator r.f. plate current must be directly proportional to the instantaneous voltage between modulating grid and cathode. The audio voltage simply operates as a rapidly-varying gain-control bias which determines the amplitude of the r.f. current flowing in the modulator plate circuit as a result of the r.f. voltage which appears at its control grid. The operation of the modulator is essentially Class-A; in fact, it resembles in many respects the van der Bijl type of modulator.

The fact that the modulator is a Class-A type device makes possible a rather simple method of checking linearity. A distinguishing feature of single-tube Class-A operation is steady d.c. plate current for any signal amplitude which does not exceed the limits of linearity. A change in d.c. plate current indicates distortion, and hence a shift in the reading of a meter connected in the plate circuit shows that the operation is no longer linear. This method applied to the modulator of Fig. 2 showed excellent agreement with data obtained by the rather laborious point-by-point method of measuring frequency change for small changes of modulating-grid bias. The plate-current shift with acceptable distortion is of the order of 0.1 milliampere in a steady plate current of about 4.5 ma. There is a rather sudden shift in plate current as the audio signal is increased beyond the maximum point, with the result that the meter makes a rather good linearity indicator under voice operation — and, if the limit of desired deviation and the limit of linearity are reached at the same time, a good maximum-deviation indicator as well.

Checking linearity by plate-current shift would not necessarily work with all types of modulators — the push-pull type, described elsewhere in this issue,³ might not show the same effect — and it is conceivable that the single-tube reactance modulator under some conditions might show no plate-current shift even when the distortion is appreciable. A comparable condition would be that which occurs with ordinary grid-bias modulation when the output is flattened both at the top and bottom of the modulated wave. However, it is a useful method, and it can be double-checked by applying a tone signal to the modulator, listening to the signal on an f.m. receiver, and increasing the modulating signal until the receiver output shows distortion. This is easily recognized by ear when a pure tone is used, as the sound takes on a different

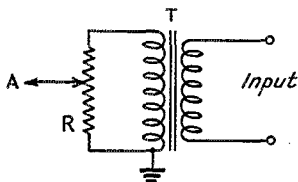

Fig. 3 — Input circuit from line to modulator. Transformer T is a line-to-grid audio. R is a 0.5-megohm volume control. The input circuit connects to point A in Fig. 2 when an external speech amplifier is to be used.

³ Crosby, "Reactance Tube Frequency Modulators," *QST*, June, 1940.

character. Those musically inclined will recognize it as the presence of two tones an octave apart rather than a single tone. If an oscilloscope is available it can be used for a visual check of the wave form to see if any change occurs as the modulation is increased.

Distortion or non-linearity in the operation of the modulator also means a shift in the mean output current of the modulator, and this in turn naturally causes a shift in the mean or carrier frequency of the oscillator. The effect of carrier shift is to increase the noise when the carrier is modulated, so it is necessary to make sure that the operation is linear over the deviation range. Increasing the L/C ratio will widen the linear range of deviation. The constants given in Fig. 2 are quite satisfactory, and in the absence of unusual factors should give good performance with more than the 15-kc. deviation (at 56 Mc.) already mentioned.

Measuring Deviation

A rather simple method of measuring deviation has recently been devised by Crosby,⁴ and from the amateur standpoint it has the desirable feature of requiring very little in the way of extra equipment. An ordinary receiver, preferably one with a crystal filter, is the chief item. The only other is a source of audio frequency of fairly good wave-form, such as an audio oscillator of the double-triode type described in the *Handbook*.⁵ The method is based on the mathematics of frequency modulation, which show that at certain deviation ratios the carrier amplitude becomes zero. There is a series of such zero points, but for our purposes the one of chief interest is the first, which occurs when the deviation ratio is 2.405, or 2.4 approximately.

The measurement procedure is quite simple. The unmodulated carrier is tuned in on the receiver, with the receiver's beat oscillator turned on and adjusted to give a suitable beat note. The crystal filter should be set in the sharp position and the carrier carefully peaked. The tone modulation is then applied, starting with the gain at zero, and the amplitude increased slowly while the beat note is carefully monitored. As the modulation increases, the beat note will become weaker, finally disappearing altogether and then coming in again as the modulation is increased still further. At the zero point the frequency deviation of the modulated carrier is equal to 2.4 times the frequency of the modulating tone. Thus it simply becomes necessary to select an audio frequency which is $1/2.4$ times the desired frequency deviation, adjust the modulating signal to give the zero point in the receiver, and any modulating signal of the same peak amplitude will give the same total deviation. If the carrier

is monitored on 7 Mc., a convenient audio frequency to choose is 800 cycles, since 2.4 times 800 is 1920 cycles, approximately the right figure to produce 15-kc. deviation at 56 Mc. On the piano scale this frequency falls between G and G-sharp in the octave starting with the first C above middle C, and the audio oscillator can be adjusted to the right tone if there is a piano in the vicinity. Alternatively, 880 cycles could be used; this frequency is easy to get since it is just twice the 440-cycle tone on the WWV broadcasts, hence the oscillator is simply adjusted to give a note an octave higher. This tone will give somewhat greater deviation (about 17 kc. at 56 Mc.) but represents a good "100% modulation" mark. A 440-cycle tone can be used if the oscillator operates on 3.5 Mc. and is monitored on that frequency.

There are a few precautions to be observed in using this method of checking deviation. The modulation on the carrier is likely to be confusing, since it rides on top of the beat note and goes through various rises and falls in apparent tone. The listener must therefore concentrate on the carrier beat and pay no attention to the others. The crystal filter is a big help because it provides selectivity, making the beat stand out and subordinating the various other tones. A beat note widely different in pitch from the modulating tone will help in discriminating between the two; the carrier beat may be either higher or lower than the modulating tone just so long as it is different. If there is a definite peak in the speaker or headset used for monitoring, it is helpful to set the beat note on that peak, as the additional audio selectivity will increase the discrimination against the unwanted tones.

If there is no crystal filter in the receiver, or if a regenerative receiver is used, the beat note is likely to be masked by the modulation unless some form of audio filter is used. A tuned audio circuit shunted across audio amplifier grid circuit should be sufficient, the beat note being set at the frequency to which the tuned circuit is resonant. A 10- or 20-henry choke shunted by a capacity of 100 to 200 μfd . will give a peak in the vicinity of 2000 to 3000 cycles and will be suitable for use with a high-impedance circuit such as the grid circuit of an audio stage. We found a rather high beat note preferable because it is relatively easy to concentrate on it and to exclude, mentally, the lower modulation frequency.

As the modulation is increased there may be a shift in the carrier frequency for the reasons already discussed. It is important to follow the carrier when this occurs, keeping it tuned in exactly on the beat, and to facilitate such following the modulation must be increased slowly. The beat note, of course, gets quite weak as the null is approached, and close observation is necessary to determine when it reappears on the other side.

(Continued on page 108)

⁴ Crosby, "A Method of Measuring Frequency Deviation," *RCA Review*, April, 1940.

⁵ Audio test oscillator, page 271, 1940 edition.

The Double Vertical Antenna

Element-Switching for Two-Band Operation

BY A. HENRY RIESMEYER,* EX-W8CJT

MANY amateurs, because of restricted economical and local conditions, have installed vertical antennas, particularly for the high and ultra-high frequencies. Their choice hasn't been bad, either, since under many conditions the vertical antenna will give good low-angle radiation. As a consequence, the vertical antenna has met with practically universal use on 56 Mc., quite wide-spread application on 28 Mc. and some interest on 14 Mc. Normally, however, its use is confined to one band unless the antenna is fed

such that DX transmission is lost to a great extent. However, if the vertical antenna is operated on its harmonic *with* the two halves excited in phase, the angle of radiation is lowered and a substantial gain results. Such operation can be obtained by using either a matching stub or a phasing coil located at the center of the antenna. The use of a stub is normally out of the question because of mechanical difficulties—can you imagine trying to balance a matching stub out in mid-air? However, the conversion can be easily

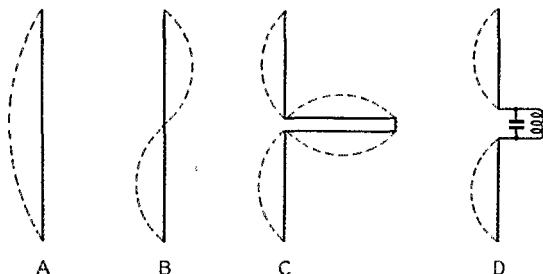

Fig. 1—The current distribution of a half-wave antenna (A) and when operated on the second harmonic (B). This latter condition results in high-angle radiation which can be corrected by phasing with either a quarter-wave stub (C) or a tuned circuit (D).

in the center with a tuned line and, since it is often awkward and inconvenient to use center feed, it is the purpose of this article to present a method for using the antenna on two bands while still retaining the more convenient feed to the base of the antenna. Tuned feed will be necessary, of course, unless some method of stub-switching is used.

Ordinarily, a vertical antenna is designed to function on one band, since when it is operated on the harmonic frequency the vertical angle of radiation is increased considerably, with the re-

accomplished by the use of a phasing coil. By incorporating a switching arrangement, such an antenna could be used on two bands.

Design

Fig. 1 shows a schematic diagram of the antenna system. The antenna length is easily calculated from the following formula:

$$\text{Length} = \frac{492 \times 0.95}{\text{Freq. in Mc.}}$$

and

*1620 Orchard Street, Arnold, Pa.

◆
A close-up of the band-change system shows how the Lucite rod is machined to fit snugly into the tubing used for antenna elements. A strip of Lucite sheet supports the coil, switch and condenser.
◆

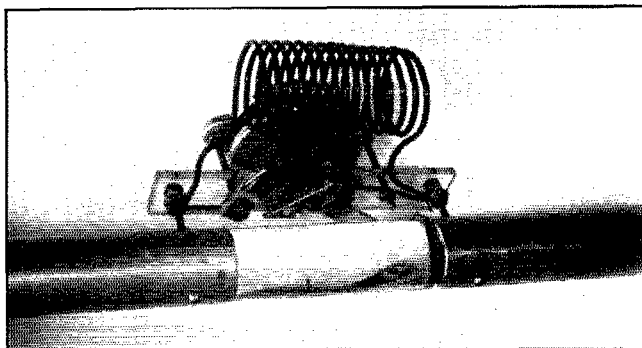

The amateur with a desire to work his vertical antenna on two bands with good radiation characteristics on both frequencies will find this story right down his alley. The principle can be extended to multi-element systems as well.

Length = $\frac{492 \times 0.97}{\text{Freq. in Mc.}}$ for second harmonic operation.

Thus an antenna 33.9 feet long will have a fundamental frequency of 14.2 kc., and when operated on its harmonic it will be resonant at a frequency of 29.0 kc. This then would serve very well for 20- and 10-meter 'phone operation.

An antenna only 16.4 feet will have a fundamental frequency of 23.5 kc. and a harmonic frequency of 58.0 kc. which will work out well for 10- and 5-meter operation.

In both cases, when the antenna is operated on its harmonic it is necessary to insert a phasing coil in the center of the antenna. Ordinarily, to do this it would be necessary to lower the antenna every time a change-over was desired. This looked to be too much like work, so an arrangement was designed by which the change-over can be accomplished from the ground.

A rod of Lucite (Lucite¹ is a synthetic resin having very good electrical properties) is machined at both ends to fit into the fourth section (from the bottom) of a six section 20-meter verti-

¹ Many duPont dealers throughout the country handle Lucite but, if it isn't available locally, it can be obtained direct from E. I. duPont de Nemours & Co., Plastics Department, 626 Schuyler Ave., Arlington, N. J. Lucite has excellent mechanical and weathering properties, and the antenna described by ex-W8CHT was designed to withstand a 40 m.p.h. wind. Using a two-inch diameter rod of Lucite (and drilling out the rod to take the antenna tubing), the system should stand a wind of well over 60 m.p.h.—Ed.

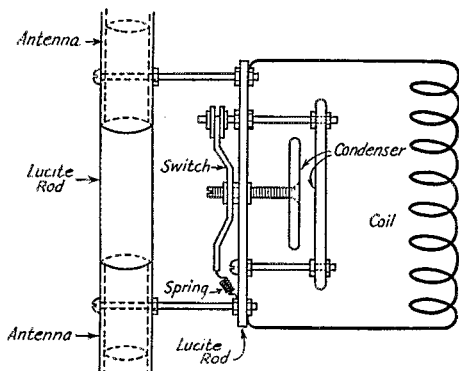

Fig. 2—A sketch showing the mechanical construction of the phasing section. The bolts that fasten the Lucite rod in the tubing also serve to hold the strip that supports the coil and condenser.

cal or the middle of the center section of a three section mast. In the case of the first-mentioned mast, the Lucite was machined to fit the inside half of the half-inch pipe that was used. The section of mast was then cut in two about three inches from the joint (as shown in Fig. 2) and the Lucite rod inserted between the two sections and fastened with small machine bolts. The phasing coil and condenser (which can be an old neutralizing condenser), after being adjusted to the harmonic frequency, is mounted on the machine bolts. The small switch mounted on the condenser support is simply a short-circuiting knife switch which, by means of a string running down to the ground, can be opened for harmonic operation, and when released the spring automatically closes the switch for fundamental operation. The whole arrangement is shown in the photograph. After the coil is in place the lengths of the sections are adjusted for the correct frequency, and the antenna is raised in place. The method is not new but the application will bring new results to those who try it out.

Wisconsin State Convention Schroeder Hotel, Milwaukee, June 15th-16th

THE Milwaukee Amateur Radio Club is sponsoring this year's Wisconsin State Convention, to be held at the Schroeder Hotel, June 15th and 16th, under the chairmanship of E. W. Kreis, W9HRM. With W9ANA in charge of the program and W9VD handling prize matters, a successful affair is assured. Write Ray Peschek, W9LUJ, 2728 N. 24th St., Milwaukee, for advance registrations. The price is \$3.00.

Silent Keys

IT is with deep regret that we record the passing of these amateurs:

Edward T. Blackmon, W4FQX, Decatur, Ga.
 Leslie M. Dickson, W9RMN, Waukegan, Ill.
 Ralph E. Dowdy, W9FPQ, ex-W5GLY, Owensboro, Ky.
 Herbert H. Eyers, Jr., W1HTK, Gloucester, Mass.
 Wayne A. Graham, W9KLJ, Gallatin, Mo.
 James A. Marshall, W9UJI, Clinton, Ind.
 George H. McCormack, W6BOW, San Diego, Calif.
 Charles J. Mehring, W8GOR, Mercer, Pa.
 Frederick W. Royal, Jr., W3HGK, Newport News, Va.
 William D. Simpkin, W1JIH, Malden, Mass.

Results, Sixth A.R.R.L. Copying Bee

FIVE operators made 100% copy in the Sixth A.R.R.L. Copying Bee (December, 1939). Their achievement merits the respect of all who have ever participated in the art of deciphering dots and dashes. They have reached the aerie of Copying Bee enthusiasts!

All Hail!—The Winners

James V. Gartland, W2BWR
Walter J. Hicks, Jr., W2HQG
Francis Enge, W2HSZ
J. H. Nicholson, W3EEN
Milburne O. Sharpe, W5IAC

It was a repeat performance in the case of W3EEN. He was a winner also in '38, and is the first operator to twice make 100 per cent copy in the "Bees." W2BWR made his copy from W1AW's 12:15 A.M. transmission on 1762-kc. W2HQG and W2HSZ copied theirs from W2KEZ on 3510-kc. at 10:15 P.M. W3EEN got the 9:15 P.M. transmission from W1AW on 3825-kc. W5IAC's copy was from W2KEZ's 9:15 P.M. transmission on 7003-kc.

A special word of thanks is due the operators of the stations transmitting the Copying Bee texts. Without their cooperation there would be no Bee! These six stations made fifteen transmissions, all by "automatic," at a speed of 25 words per minute: W1AW, W2KEZ, W6AM, W6CIS, W9BAZ and W9UZ. The text transmitted by each station consisted of 60 words or groups, including many brain-twisting combinations.

Contestants have been sent their corrected papers, together with copies of all texts transmitted. Of the 253 operators submitting entries, 80 made their best copy from W1AW (two transmissions, five frequencies), 54 made best copy from W6AM (five transmissions, five frequencies), 50 from W2KEZ (two transmissions, two frequencies), 47 from W9BAZ (two transmissions, two frequencies), 12 from W6CIS (two transmissions, two frequencies), and 10 from W9UZ (two transmissions, two frequencies). W1AW was also copied or logged by 61 additional operators, W2KEZ by 28 additional, W6AM by 30, W6CIS by 26, W9BAZ by 16 and W9UZ by 26. Only 2 per cent (approx.) of all participants made perfect copy.

One chap remarked that whoever made up the Copying Bee texts must have had a bad case of delirium tremens. You mean *dilerium trimins* don't you, OM?! Twenty Three.

E. L. B.

Copying Bee Ratings

100%: W2BWR W2HQG W2HSZ W3EEN W5IAC.
98%: W3EFH, 97%: W2LOQ W9RNMN W8BKM W2ICX
W2EYV W8NAU W9ZQW. 95%: W9ERU W9ASV
W4EV W4BBZ W8DOD W6MXC W9YPO W9YXH
W2LEI CM2OP. 93%: W9NYW W6HJT W6IOX W9RLB
W6GVU. 92%: W8KKW W8QZK W9AKT W2KTR
W2LID W6AK W9AHR W5HHP W6LVN. 90%: W9QUY
W9QMD W6PFK W6QAC W1ISH W8PP W1BVR
W3FPG W7AJ W8JQE. 89%: W1BFT. 88%: W8AQ
W4EPT W3FSP W2JDC W6FJK W3AKB W9TH W6PBV
W2KFB W2DBQ VE3EF. 87%: W8QLE W2BZJ W1LHD
W4VK W8SSL W8HS VE2AY W2MEM W3HLQ
W5CWW. 86%: W2OQ. 85%: W8FTW W9AZT W5GRW
W7LD W7WY W9MFB W9VYV W6RWS. Below 85%, in
order, those with same rating grouped together: W9KSM-
W3DGM-W7GUU VE3AAG-W2GUM-W2GBJ-W9KZV-
W6AFH-W9HSM-W6GBN-W9OTR-W3NF-W8PZL-
W8QQB-W1KIN W9YCV-W2LZR-W8PGI-W2ISJ-
W6DSY-W4EPV-W9NZE-W6OGJ-VE1EP-W1KIE-
W2MLE-VE4BU-W2KUW W6TN W8SLH-W8SPB-
W5GWO-W6RZL-W9EUO-W2LNU-W3FFE-W6PJR-
W2MIQ-W8RMH W5CEZ VE2CR-W3GHW-W6NIF-
W6BBR-VE4UN-VE4JR-W9LJL VE4AJC-W1MES-
W9DMR-W9RRS-W2LOZ-W8NLQ-W9FOQ W5GSD-
W1LNN W8ROX-W9QYI-W3HAE-K6LKN W7CQJ-
W2LIP-W6EY-W2IDY-W7AOS-W9QAU-W9CCM
W2BTW-W7GYO-W6KSX-W3HZK-W4DW-W8AFE-
W1BZS W1CBW-W2KXB-W8SIX W1ZR-W6OQH-
VE4AT-W2PF-W8PCW-W2KSR-W6RUE W9KBL-
W6QYQ-VE3OD W2GTA-W8TQT-W9LDV-W3GXQ-
W3GC-W9ITH W1KNU-W9IC0-W9UOD-W6OVG-
VE3ATR-W8EU-VE4TA-W8JM W9ZOO W8DM-
W8SBV-W1AZW-W1EHJ-W1FXB-W9ZFC W3FQS-
VE5AGA-W7AYQ-W1KSI-VE3AN-W3DQU W2HBO-
W2LQH-VE2JG-W2APM-W2KWR-W6DLL-W8OSE-
W9GLI W7AMU-W7BYX W9QOA W8STE-W5ANR-
W7CQE W8SQW W9OYY-W9QDC-W6MYT-W3FE
W2KES W9WJX-VE3AUW-W5HJL-W2FBA W1KVK-
W4FMZ-W2LAZ-W8UFD W2BIQ-C. D. Harris W9KIK
W6OYL-W1MDV-W2GK K. C. Ammerman-W3GCU-
VE4AKK-W2MLV-W8LVG W2MGI-W8ORM W2LKG-
W6QYD W. S. Kalisty W9FCE VE3AMI F. Wessely-
W8RPT W. R. Sutton-W3HQZ-CM2AG-W1MGL
W7DXL-CM2AX W2KTD-J. V. Sutton W9YFJ W7GPK-
W9VFM W3ILP.

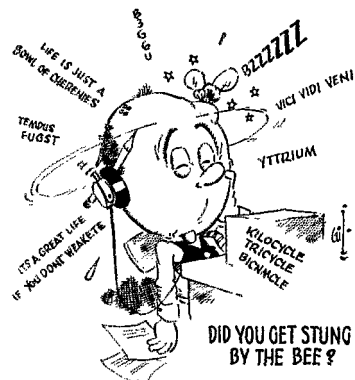

★ WHAT THE LEAGUE IS DOING ★

60-MC. FREQUENCY MODULATION

THE upper megacycle and a half of the 5-meter band has been opened to frequency-modulated voice transmission! On April 13th, F.C.C. amended our rules to permit f.m. on 58.5 to 60 Mc., effective immediately. No buffer bands are specified nor is any deviation ratio. The only stipulation is that, when using f.m., no simultaneous amplitude modulation is permitted.

F.m., of course, is still permitted on the higher-frequency bands. Please note that the stipulation that no simultaneous a.m. is permitted when using f.m. does *not* prevent an unstable a.m. signal above 112 Mc. from having incidental f.m. There is *no* intention of extending the compulsory d.c. and stability requirements to the 112 band.

So there you are, 5-meter gang. We expect some real f.m. results from you now!

REGULATIONS AMENDED

THE new f.m. authorization was accomplished by an amendment of our regulations. Before giving you the new wording, we should like to tell you that the Commission last July changed the numbering system for all its regulations, but has not given the subject much publicity in the case of the amateur rules because the only copies that have been distributed bear the old numbers. We understand that a new print is on the verge of coming out with a new numbering system. Consequently, it will be A.R.R.L. practice henceforth to refer to the amateur regs by their new numbers, showing the old numbers in parentheses or other reference, until we are all thoroughly familiar with the change.

Now when the Commission wrote a new rule to open 58.5-60 to f.m., it took the occasion to rearrange some of our other rules which specify allocations for types of emission, just in the interests of clarity and without changing the purport in any way. The six rules involved in this amendment are those which bear the old numbers 152.27 to 152.32, inclusive, which since last July have been known as 12.113 to 12.118. These have now been repealed and in their stead are five new rules numbered from 12.113 to 12.117. The section which assigns our bands exclusively to amateurs has not been changed. Following that comes the rephrased text, reading as follows:

12.113. *Individual frequency not specified.* Transmissions by an amateur station may be on any frequency within the bands assigned. Sideband frequencies resulting from keying or modulating a transmitter shall be confined within the frequency band used.

12.114. *Types of emission.* All bands of frequencies allocated to the amateur service may be used without modulation (Type A-1 emission).

12.115. *Additional bands for types of emission using amplitude modulation.* The following bands of frequencies are allocated for use by amateur stations using additional types of emission as shown:

1,715 to 2,000 kc. ²	---	---	A-4	---
1,800 to 2,000 kc.	---	A-3	---	---
28,500 to 30,000 kc.	---	A-3	---	---
56,000 to 60,000 kc.	A-2	A-3	A-4	---
112,000 to 116,000 kc.	A-2	A-3	A-4	A-5
224,000 to 230,000 kc.	A-2	A-3	A-4	A-5
400,000 to 401,000 kc.	A-2	A-3	A-4	A-5

12.116. *Additional bands for radiotelephony.* Amateur stations may use radiotelephony with amplitude modulation (Type A-3 emission) in the frequency bands 3900 to 4000 kc. and 14,150 to 14,250 kc. provided the station is licensed to a person who holds an amateur operator license endorsed with Class A privileges, and actually is operated by an amateur operator holding Class A privileges.

12.117. *Frequency modulation.* The following bands of frequencies are allocated for use by amateur stations for radiotelephone frequency modulation transmission:³

58,500 to 60,000 kc.
112,000 to 116,000 kc.
224,000 to 230,000 kc.
400,000 to 401,000 kc.

Type A-1 emission, for which all the bands are open, is pure c.w. telegraphy. A-2 is tone-modulated telegraphy. A-3 is *amplitude*-modulated telephony; it does *not* include frequency modulation. A-4 is facsimile and A-5 is television. There is no such type number for f.m. and that is why it is mentioned by name in Sec. 12.117.

WHO MAY CONTROL A 'PHONE STATION

WE WROTE a squib in this department in April about who may operate the controls in a 'phone station working on Class-A frequencies. The article was accurate but has caused numerous inquiries. Let's start all over again:

The amateur operator license authorizes the holder to operate not only his own station but any other amateur station, within the privileges granted by the class of endorsement on the license. In c.w. operation, only a licensed person may operate the key or the controls. However, our regulations permit unlicensed persons to speak over the microphone of a 'phone station provided that the station is under the control of a licensed operator, with the proper class of endorsement. Only such a licensed operator may throw the switches or make calls or sign off the station. Now let's get down to cases:

² Subject to change to "1750 to 2050" kilocycles in accordance with the "Inter-American Arrangement Covering Radiocommunication," Habana, 1937.

³ When using frequency modulation no simultaneous amplitude modulation is permitted.

Except on the 3900-4000 and 14,150-14,250 bands, any licensed amateur operator of any class (A, B or C) may operate the 'phone station. He may permit an unlicensed person to speak over the mike, but only a person holding some class of amateur operator license may do the calling and the signing off and the actual throwing of switches. The unlicensed persons, such as wife, children or visitors, may not do this; they may speak only after the transmission has been started by the licensed operator, and they have to let the latter do the signing over. All persons who speak over the mike, licensed or not, must be indicated in the station log. Generally the amateur arranges his log to specify that all operation is by himself unless otherwise specified — so he will not have to sign his name for every QSO. Under those conditions, all such persons other than himself, licensed or not, must sign the log for each QSO.

Now it used to be that a ham who had Class-A privileges could go into the 'phone shack of a fellow who did not have a Class-A endorsement and put his transmitter in the 3900-4000 or 14,150-14,250 band, and act as the operator in charge for him. But for about a year and a half this has been forbidden by our regulations. These Class-A frequencies may be used only in a station that is licensed to a person who, himself, possesses a Class-A license. And such a station may be operated (i.e., controlled) only by persons who hold Class-A licenses. A person with a Class-B or a Class-C license may not operate the controls of a 'phone station operating in these two Class-A bands nor may he make calls or sign off the station — any more than an unlicensed person may do these things, because he is not licensed for them either. Only a Class-A man may do these things. In other words, when a station is working on Class-A frequencies, the only thing that may be done by a person not also holding Class-A operator privileges is to speak over the mike in between the manipulations and pronouncements of the Class-A man in charge. And of course the usual rules about log-signing apply.

NEW EXAMINATIONS

EFFECTIVE July 1st there are complete new examinations for amateur operator license for all classes, based on the system employed in the commercial exams: many more questions, but of the "multiple-choice" type that actually can be answered in much less time. See this month's editorial for a fuller discussion of the subject.

The A.R.R.L.'s study guide for the examinations, *The Radio Amateur's License Manual*, is being revised for the new exams as this is written. The new edition should reach your radio store by the time this issue of *QST* does. For some weeks we shall have both editions on sale. Thus if you plan to go up for examination any time before the end of June, the old *License Manual*

will continue to be your mentor; but if it will be July 1st or later before you are prepared, you will want to base your study on the new edition.

West Gulf Division Convention

**Blackstone Hotel, Fort Worth,
June 28th-29th**

THE latest issue of "Convention News," fast-talking tabloid published by the Kilocycle Club on behalf of the 14th Annual West Gulf Division Convention to be held at The Blackstone in Fort Worth the last weekend in June, discloses that a program so varied and complete is planned that it cannot even be summarized in the brief space available here. One fact worth mentioning is that the largest display of amateur gear ever seen at a W.G. convention is assured. Pre-registration tickets (ladies, \$2.50; men, \$3.00) not only save 50¢ but are eligible for a cash prize. Send for yours *now* to the Kilocycle Club, 5732 Pershing, Fort Worth, Texas.

A.R.R.L. AFFILIATED CLUB HONOR ROLL

All members of these are A.R.R.L. members

Associated Amateur Radio Operators of Denver, Colo.
Bridgeport Amateur Radio Association, Bridgeport, Conn.
Chester Radio Club, Chester, Pa.
Detroit Amateur Radio Association, Detroit, Mich.
Hi-Q Radio Club, Lynn, Mass.
Intercity Radio Club, Galion, Ohio
Iowa-Illinois Amateur Radio Club, Burlington, Iowa
Baton Rouge Amateur Radio Club, Baton Rouge, La.
M.A.K. Amateur Radio Association, Mass.
Mike & Key Club of Ithaca, New York
O.B.P., Chapter No. 1, St. Louis, Mo.
Radio Club of Tacoma, Inc., Tacoma, Wash.
Short Wave Amateur Club of America, New Orleans, La.
The L/C Club of New Jersey, Jersey City, N. J.
The T9 Club, Beverly, Mass.
Trenton Radio Society, Trenton, N. J.
Valley Radio Club, Eugene, Oregon
Winston-Salem Amateur Radio Club, Inc., Winston-Salem, N. C.
York Radio Club, Elmhurst, Ill.
York Road Radio Club, Glenside, Pa.
The 56-Mc. Minutemen, Winchester, Mass.

The "QSL Push-Pull"

A Two-Tube 100-Watt C. W. Transmitter

BY FRED SUTTER,* W8QBW-QDK

AFTER the gang had recovered from the shock of a single 6L6G with outputs of 40 to 60 watts,¹ the question naturally suggested itself: "Why not put two of 'em in push-pull and put out 100 watts?" Well, the idea of two 95-cent tubes with an output of 100 watts or so is rather intriguing, so the "QSL Push-Pull" job was put on the fire. After a good bit of tinkering the following was found to be a satisfactory 80-, 40- and 20-meter rig, and the cost is comfortably low.

This transmitter, like all the QSL jobs, is on a chassis 3½ by 5½ inches. It weighs one pound, 14 ounces, and will light a 100-watt Mazda dummy to full brilliancy or a trifle better. It looks ridiculously small and simple and lacking in parts, but after all it is the tubes that do the work and parts and gadgets are but necessary evils — the fewer the better. The cost of the power supply, complete, is \$8.29 and the transmitter costs \$5.21, not including the crystal and 6L6G tubes which most everybody already owns.

Close heed should be given to a few suggestions which follow. The power supply should be able to deliver not less than 600 volts d.c. at 300 milliamperes. The excellent transformers hitherto

* 1000 Kensington Road, Grosse Pointe Park, Mich.

¹ The other "QSL" transmitters were described in February, 1938, and September, 1939, *QST*. Additional information on the "QSL Forty" appeared in *QST* for March and July, 1938.

Exploring further the possibilities of the 6L6G tube for economical transmission, W8QBW turns up with the "QSL Push-Pull." One hundred watts c.w. output from a transmitter costing, complete, less than twenty dollars is something to think about.

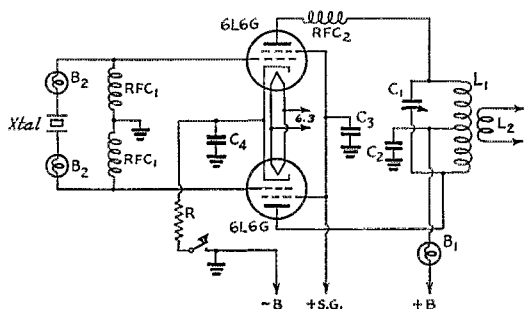

Fig. 1 — Wiring diagram of the QSL Push-Pull transmitter.

C₁ — 50-μfd. variable, double-spaced (Hammarlund MC-50-SX).

C₂ — 0.005-μfd. mica.

C₃, C₄ — 0.01-μfd. paper, 1000-volt.

R — 200 ohms, 10-watt.

RFC₁ — 2.5-mh. choke.

RFC₂ — Parasitic choke, 8 turns wound on pencil, slight spacing between turns.

L₁, L₂ — See coil Table.

B₁ — 500-ma. pilot bulb (No. 41, white bead).

B₂ — 150-ma. pilot bulb (No. 40, brown bead).

specified for our various QSL transmitters are not quite husky enough for this work. The U.T.C. S-42 is ideal for this, or indeed for any of the QSL jobs, and so far as I am aware is the only thing on the market which so exactly meets our requirements. The antenna and feeders should be cut to the proper length, because this will at the outset eliminate one source of trouble. (The antenna here at W8QBW is now an 80-meter half-wave end-fed Zepp with feeders one-quarter wave long.)

The coils specified may be just what you need, or they may not. However, it is very easy to wind or to alter or to try various values of L_2 , and this should be done for maximum performance. To demonstrate a 100-watt dummy fully lit it will be necessary to use proper values of inductance for L_1 and L_2 , otherwise the lamp won't light at all or will give only a feeble glow. When things are just right it will blaze up more brightly than a similar lamp on your house circuit. For example, on 80 meters (for such a dummy load) L_1 should be about 25 to 30 μh. and L_2 about 4 or 5 turns

This below-chassis view shows the simplicity of arrangement. The tuning condenser is mounted on a small piece of bakelite to insulate it from the chassis. Use a tuning knob with a recessed set-screw to prevent accidental finger contact.

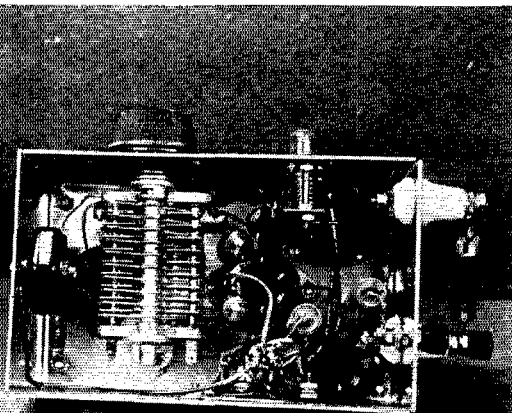

QST for

The "QSL Push-Pull" bears a family resemblance to its predecessors. Despite the power output, the post-card-size chassis is not crowded.

with 100 μ fd. across the lamp. On 40 meters you can use the 40-meter coil specified, but use only 3 turns on L_2 and very little capacity across the lamp. Your own arrangement may require slightly different values, but from what has been said you will appreciate the importance of getting your inductances right for either a dummy or for an actual antenna. Some folks just let all the variables happen at random and then stick in an antenna "tuner" hoping that by some prestochango this will iron out the misfits. Better strike at the root of the fly in the ointment and nip the misfits in the bud, as the fellow said.

General

Although the chassis is only the size of a QSL card and the output is 100 watts there is ample room for the parts, with plenty of clearance for ease of assembly. The photograph shows, in front, the knob for the plate condenser and the pilot bulb for indicating plate current. On the right is the cathode resistor, R_1 , mounted on two feed-throughs. This is placed outside as it develops considerable heat with keying. There is also a ground screw shown. One keying lead goes to this ground screw and the other to the upper end of the resistor. On top, at the right, are the two 6L6G tubes. Next to them is the crystal, flanked fore and aft by the two pilot bulbs for indicating crystal current. At the left is the coil. On the rear apron, shown in the other photograph, is the five-point power socket. The plate condenser, C_1 , is insulated from the chassis, being mounted on a bit of bakelite.

The pilot sockets and bulbs must be kept clear of the chassis also. B_1 is mounted with a single screw and the hole in the apron is large enough to provide clearance. Mount the socket far enough

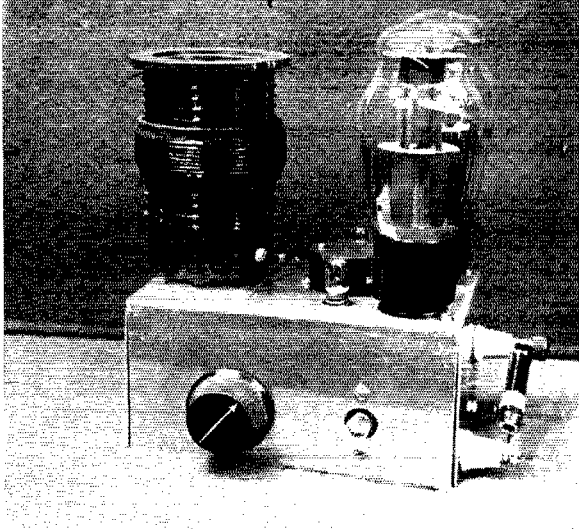

behind the apron so that only glass projects. The "B" plus connects to the socket terminal which goes to the center contact of the bulb, so that no voltage can appear on the shell of the socket or the bulb until the latter is screwed all the way in. Thus you can't get bitten at this point. For B_2 use Yaxley socket 317-H or ARHCO No. 38. For B_1 use a Yaxley 304CH with the bracket bent down, drilled for the mounting screw and the surplus cut off, or the ARHCO No. 40 may be used. Sometimes soft rubber grommets are used to mount such sockets, but here we have held B_2 in place only by the short stiff leads, which seems to be satisfactory.

Run one plate lead to one of the stator lugs of C_1 and from the opposite stator lug run a lead to the coil socket. Now take a strip of brass about $\frac{1}{4}$ inch wide and 2 inches long, drill a No. 28 hole at the center and fasten to the front bearing foot of C_1 with a 6-32 screw and lock washer. Run the other plate lead (put RFC_2 in this lead) to one end of this strip and from the other end run a lead to the coil socket. This takes care of the plate-to-condenser-to-coil connections. Pay no attention to the upper screw just over the plate bulb, or to the covering plate under the coil. These have no structural significance. Be sure to use MIP sockets.

Coils

The plate coil, L_1 , is wound on a Hammarlund giant coil form TCF-4. The antenna coil, L_2 , is

COIL TABLE

3.5 Mc.:	L_1 — 22 turns No. 18, 3/32 inch spacing (center to center), 2 inches long.
	L_2 — 9 turns No. 14, close-wound.
7 Mc.:	L_1 — 14 turns No. 18, 3/16 inch spacing, 2 $\frac{1}{2}$ inches long.
	L_2 — 8 turns No. 14, close-wound.
14 Mc.:	L_1 — 8 turns No. 16, $\frac{1}{4}$ inch spacing, 2 inches long.
	L_2 — 1 $\frac{3}{4}$ turns No. 14, close-wound.
	L_1 — 2 $\frac{1}{4}$ inches in diameter. See text for data on L_2 .

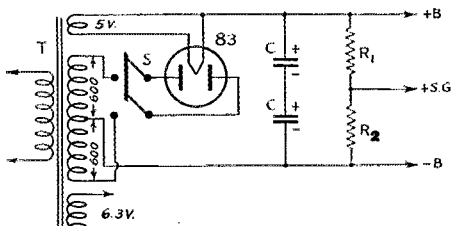

Fig. 2 — Power-supply wiring diagram.

C — 20- μ fd. electrolytic, 450-volt (Solar Mimicap).

R_1 — 5000 ohms, 20-watt.

R_2 — 30,000 ohms, 20-watt.

S — D.p.s.t. porcelain base, to permit 83 filament to warm up before plate voltage is applied.

T — 600 volts each side c.t., 300 ma.; with 5- and 6.3-volt windings (UTC S-42).

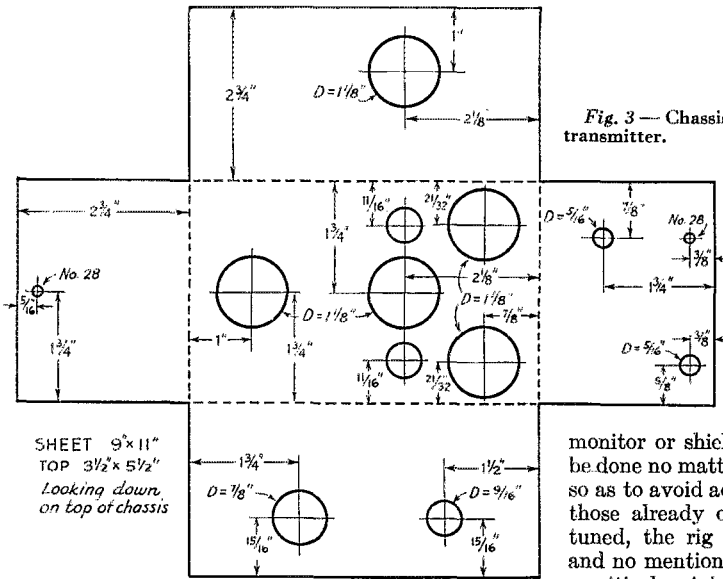

Fig. 3 — Chassis layout for the QSL Push-Pull transmitter.

Push-Pull is not quite as satisfactory as on 40 and 80. The output is lower and there is a slight tendency to chirp. This can be minimized by careful tuning while listening to the note in a

monitor or shielded receiver, which should be done no matter what transmitter you use so as to avoid adding one more sour note to those already on the air. When properly tuned, the rig will bring you 9X reports and no mention of chirp unless you ask for a critical opinion. In any event the note is easy to copy, so that 20-meter operation is

satisfactory enough on the whole. I am inclined to think that this tendency to chirp on 20 meters is inherent in the crystal or the circuit and if anyone can suggest a possible remedy I will be glad to hear of it.

This just about finishes the tale of the 6L6G, so now we'll let our little hero take a bow and hop back into his socket.

Strays

The chief engineer of Thordarson and two of his co-workers in the engineering department all have W9 calls starting with UV. Joining the staff about three years apart, they are W9UVC, W9UVP and W9UVV — Douglas Fortune, Wilfred C. Howe and Roger Zaun, respectively.

Why so much talk about fancy antennas? I worked W1AW on 7 Mc. with an antenna 22 inches long and received a report of 459. The regular antenna feeders were grounded and did not come closer than 10 feet from the wire. — W5FMF, Goltry, Okla.

When building coils for the 112-Mc. converter described in March *QST*, the coils can be adjusted conveniently if the coil form is first sawed off smoothly about $\frac{1}{16}$ inch above the base that supports the prongs. Then, after the coils have been adjusted to cover the range properly, the sawed-off portion of the form can be cemented back to the base by a few drops of polystyrene cement or Duco lacquer, leaving the coil completely protected as described in the article. — W1KH.

on a bakelite tube $2\frac{1}{2}$ inches in diameter. This slips over L_1 with only slight clearance or play. It may be fixed in place with a few drops of cement. The photograph shows L_2 propped in place with a strip of bakelite, the reason for this being that it was desirable to have L_2 removable so as to try various values of inductance. Better not do any cementing until you are sure no changing is needed. Prepare L_2 as follows; cut a short piece of tubing, say an inch or so long, and scrape off the glossy finish so that the cement can take hold (cement on glossy bakelite will peel like July sunburn!). Now wind L_2 on a can of such size that when it is sprung out to shape it will be a trifle smaller than the tube. Work the coil, turn by turn, on to the tube which, you will find, it hugs closely. A few drops of cement will finish the job.

The coils shown in the table work nicely here and will serve as a guide. On 80 meters we tune series and so have considerable antenna current, this running well over 2 amperes. On 40 and 20 meters we tune parallel and the current is very low, but is sufficient to light up a blue-bead No. 46 pilot bulb antenna-current indicator, so that this will do nicely to show when you are putting maximum current into the feeders. For 80 meters we use four No. 41 white-bead pilot bulbs in parallel to indicate antenna current.

On 80 and 40 meters the plate current is 300 to 325 ma., but it is less on 20 meters. The crystal current on 80 meters is so low that it will not light the No. 40 brown-bead pilot bulbs. On 40 meters the bulbs show yellow and on 20 meters they burn white but not full brilliancy. The rig is very satisfactory as to crystal currents.

I regret to say that on 20 meters the QSL

Eighth A.R.R.L. Field Day Contest

June 22nd-23rd, Dates for Self-Powered Emergency Rig Tests

The Contest Period: Operating time for the F.D. shown in logs must be between Saturday, June 22nd (4 P.M. local time), and Sunday, June 23rd (6 P.M. local time).

Object: The annual F.D. is dedicated to testing in actual operation, independently powered station equipment. *To be prepared for communications emergencies* requires advance readiness on the part of every amateur. The operator must have the equipment, know how to set up quickly for efficient operation, know how to formulate and handle messages (proper order of parts, check, receipting for responsibility, recording of handling data), know how to tune up workable ready-cut antennas in new locations, how to make the most of low power, and many other things. Operator experience is as essential as the equipment.

Operation: The aim for each field-portable is to work as many other amateur stations as possible (either home or afield) in the time allotted, reporting location and circumstances by radio message, to A.R.R.L. Advance entry is not required. All participating will use the call (c.w.) CQ FD or ('phone) CALLING ANY FIELD DAY STATION. Mobile work does not count. It is a test of portables. Manufactured contacts between stations of the same club field group in the contest do not count. Any or all amateur frequency bands may be used.

Portable stations operated in the field (away from "home" address) are eligible to submit field scores. Only portable set-ups may be listed with F.D. classification. Individuals or groups under

one call must be "in the same locality," "in one group or building or field" constituting a single FCC-notified¹ location. To have points count, station control points at a F.D. station must be within 500 feet of some given spot (vertical distances not considered).

F.D. Scoring: Each non-portable amateur station worked counts *one point* toward the score. Portable-to-portable contacts will count *two points*. The same station contacted again counts again *only* if the F.D. transmitter credit reported was on a different amateur frequency band. An extra credit of 25 points² before multiplier may be claimed for radio origination of not more than one message addressed to A.R.R.L. Hq., *provided only* message copy is submitted with claimed score. F.D. Messages to Hq. all will include the following data: Number of operators, location, conditions, power. One additional point (also before multiplier) may be claimed for radio handling of each F.D. message of another group if copy showing full handling data is submitted with station list and claimed score ($\frac{1}{2}$ point for receiving and $\frac{1}{2}$ point for radio relay transmission).

Multipliers: Score may be multiplied by 2 if *either* the receiver or transmitter is independent of mains or commercial power source, by 3 if *both* transmitter and receiver are supplied from an independent local source or sources. The following additional score multiplier is determined by the power input to the final stage (plate voltage times plate current):

- (a) Up to and including 30 watts — multiply score by 3.
- (b) Over 30, and up to 100 watts — multiply score by 2.
- (c) Over 100 watts — multiply score by 1.

Reporting: Score claims must be shown as the sum of points for each set-up. A station-worked list for *each band* must show contact times for each contact. A statement covering on-off times

HOME STATIONS

Home stations with commercial power are invited to list all their contacts with F.D. stations in the above period, sending these in for a separate score listing — to show what they can do — and to encourage the cause of amateur preparedness even if they are personally unable to join a F.D. group as yet. Home station scores will be THE NUMBER OF FD PORTABLES WORKED plus POINTS FOR FD MSGS HANDLED (1 ea. rec'd if copy mailed Hq.) (2 for relays; 1 when rec'd, 1 when sent forward). All stations claimed must be listed with the time worked, and message credits must be substantiated by copies of the messages, with full handling data.

¹ To comply with F.C.C. regulations for portable station operation, licensees must make advance notification of the location in which the portable will be operated, to the Inspector-In-Charge of the district, and use proper station identification (DN 1-2, etc.) unless work is confined to 28-Mc., 56-Mc. and higher frequency amateur bands.

² 10 points will be deducted from the possible 25 for incorrect check, failure to show full handling data, improper order of sending preambles, or other defects or variance from standard A.R.R.L. procedure. Word count for correct checking is explained in *The Radio Amateur's Handbook*, Chapter 31, page 432, except that present practice (p. 64, Apr. '40 QST) now makes count for radio calls and 5-figure groups *one* only.

(Continued on page 108)

Single-Dial Frequency Control

Gang-Tuned Transmitter Aligned with Receiver Calibration

BY HENRY E. RICE, JR.,* WØYZH

A RADIO amateur, being by definition a person interested in the technique of radio communication, seldom is satisfied with every detail of that which he has in the way of station equipment and operating convenience. His fellow amateurs provide a liberal source of ideas. The manufacturers supply an unending stream of new tubes, parts, and suggestions for their use and ap-

*7004 Plymouth Ave., University City, Mo.

plication. It is small wonder that this feeling of dissatisfaction prevails.

All this by way of saying that one amateur is in no way misled by the fact that he is, for the present, fairly well satisfied with his current best effort. To be sure, it has survived four issues of *QST* without a decision that the parts are of greater value than the finished product, but be that as it may, sooner or later must come the inevitable urge to rebuild. The meantime must serve to explain the problem and to describe the result.

The line of reasoning ran somewhat as follows: We think in terms of two-way communication, so why should we be willing to purchase a communications receiver on the basis that we can have listening privileges, only, over a considerable part of its tuning range? Single-dial tuning was incorporated in receiver design a number of years ago, and a similar method of gang-tuning for transmitters has been shown to be practicable.¹ Any two circuits composed of L , C and R can be tracked with sufficient accuracy for all practical purposes. Therefore, it should be entirely practical to track a master oscillator with a receiver.

It is practical, but by the same token it's quite a chore, and when once accomplished in the form of a tracked oscillator, it seemed logical to complete a transmitter of moderate power expressly designed to give the idea a real workout.

The Exciter

The oscillator circuit, as well as that of the Class A amplifier which follows it, is essentially as previously described.¹ A variable resistor was substituted in the cathode circuit of the 6SJ7 stage to allow accurate bias control with different values of plate voltage, and a switch was added for convenience in servicing the transmitter.

An aluminum shield box, with a partition separating the grid and output circuits, is built around the oscillator stage. This box is mounted on live

¹ Mix, "Gang Tuning for the Multi-Stage Transmitter," *QST*, June, 1938.

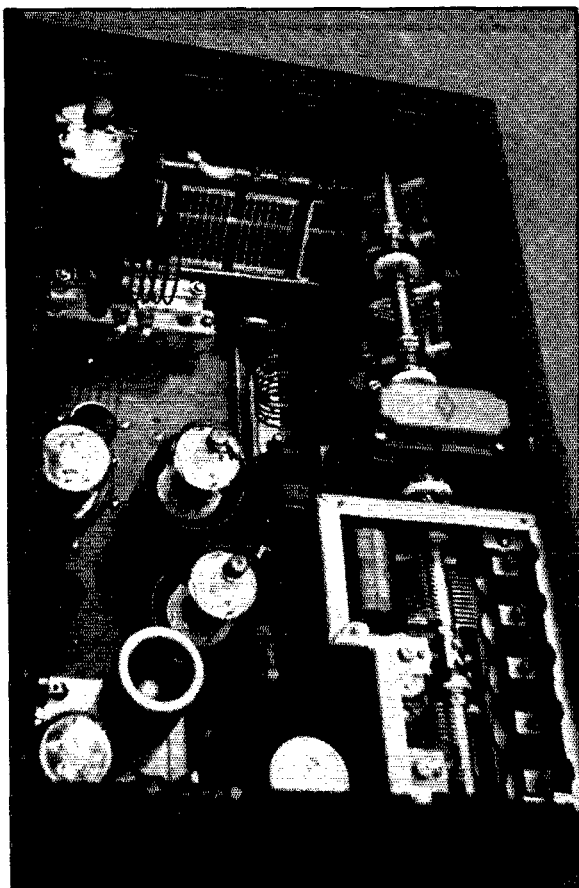

Inside the cabinet, looking from the side. Final amplifier at top, with ganged tuning condensers for the final and driver along the front at the right. The oscillator occupies the aluminum compartment in the lower right corner. The disc-type condensers in the oscillator section were found to be unnecessary and are no longer in the circuit. The two variables ganged together are connected in parallel to form C_1 , the oscillator tuning condenser.

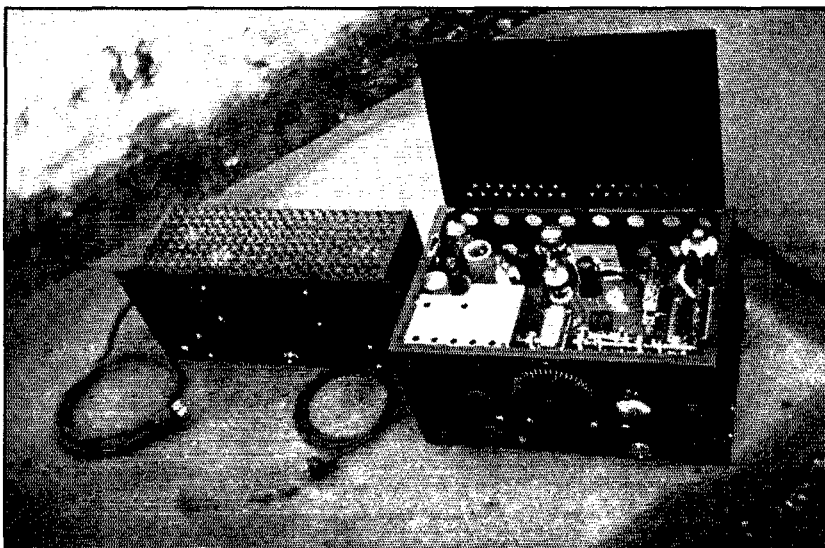

Built to match a receiver in size and appearance, this variable-frequency transmitter also has its frequency-calibration curve adjusted to coincide with the receiver dial settings. Controls are as follows: Top row, S_1 and S_2 (ganged), trimmer condenser, main tuning dial, meter and switch, final amplifier bandset condenser; bottom row, power switch, excitation control, key jack, band-switch, crystal socket, crystal-e.c.o. switch.

rubber grommets and is electrically insulated from, and keyed to, the main chassis. The advantage in the mechanics of this method of keying lies in the fact that all grid padding and tuning condensers can be mounted directly on the shield box, thereby reducing the number of lead wires and in turn reducing the chance of mechanical instability with its attendant frequency instability. A cable, plug and socket serve to supply all voltages and the keying lead connection and also provide convenience in servicing. The output is taken from a small feed-through insulator.

With that, we can forget all else and become frequency conscious for the moment. "The frequency of the oscillations is determined chiefly by the constants of L_1 and C_1 ," quoting from an unquestionably elementary, though often useful, source, the *License Manual*. Yes, and in this case the oscillation frequency must be precisely what we want it to be at any given setting of our C_1 . In other words, assuming the bandswitches on the receiver and transmitter to be set for the same amateur band of frequencies we should be able to note the receiver dial setting at which a signal is heard and, by adjusting the dial which controls C_1 (the main tuning dial) to the same setting, be ready to transmit on very nearly the same frequency. To make this procedure possible, it is imperative that the same type of dial be used on receiver and transmitter, and that the frequency curves of the two units be very nearly alike. The problem is simplified to some extent by the use of a receiver with considerable band-spread, and

one which covers only the frequency bands on which we intend to transmit. However, although desirable from the standpoint of ease of preliminary adjustment and reasonably carefree operation on the air, these conditions do not add up to a requirement by any means.

This oscillator allows coverage of the five lowest frequency amateur bands, using the old band limits in the 160-meter range. Thus, keeping in mind the principle of an initial doubling of frequency in electron-coupled circuits, the tuned circuit at the grid of the oscillator must cover five distinct ranges. If the functions of S_{2-1} and S_{2-2} and of the condensers C_1 , C_2 , etc., which they control are to make sense, these frequency ranges must be kept in mind constantly. They

Some day, we imagine, some amateur will build a station with a control panel having one switch to select the band he wants and one dial to tune that band — for both transmitter and receiver. The circuit described here does not go quite that far, but it does provide a transmitter which can be tuned as quickly and easily as the receiver — and furthermore makes the dial settings of the two coincide for the same frequency. The author discusses the considerations involved, for the benefit of those seekers after convenient operating whose thoughts may be turning in the same direction.

are obtained by dividing the upper and lower band edges, the figures being in kilocycles, by 32, 16, 8, 4 and 2 respectively, starting with the 28-Mc. band. The actual ranges which must be covered by the grid circuit are as follows: 875-937.5 kc. for ten, 875-900 kc. for twenty, 875-912.5 for forty, 875-1000 for eighty and 857.5-1000 (875-100 kc. should be used here also, if permissible, to avoid additional complication in padder switching) for one-sixty. It is suggested that these figures be written in column form and compared with the circuit diagram as it covers the arrangement of band-spread taps and the like for a complete understanding of the problem. So much for the general arrangement of the padders and for the band-spread requirements.

The oscillator coil, L_1 , is a National Type AR16-80 bare copper air-wound, which has been removed from its regular base and mounted on an octal tube base, all eight prongs being in use. While on the subject, the inductance of all makes of small air-wound coils on the market seems to be of a suitable value to fit them for use as grid coils in any self-controlled oscillator circuit which uses a comparatively low-interelectrode capacity tube. It is only necessary to purchase one ordinarily intended for use in a tuned circuit two bands higher in frequency. Naturally, this is only a rule-of-thumb method, but it is a real convenience in that these coils are unquestionably superior to the form-wound variety in the matter of locating taps. All such connections require careful soldering and, in the case of the very close-spaced 80-meter coil, it is advisable to bend the particular turn of wire in toward the center where the connection can be made in the clear. The turn may then be pushed back into place and the joint insulated with a small tab of transformer paper folded and pushed down against the adjacent turns on either side. All band-spread taps on the grid coil in this transmitter were adjusted to a degree of accuracy which can be expressed as to within $\frac{1}{8}$ " plus or minus on the circumference of the proper turn, or in frequency as to within 200 cycles. In other words, assuming the transmitter and the receiver to be thoroughly warm, and with identical dial readings for both at one end of a given band with C_3 adjusted for zero beat, the two units can be tuned across the band with a maximum deviation from zero beat of 200 cycles at the opposite end, again with identical dial readings. This degree of accuracy in matching the bandspread is hardly necessary, as will be brought out later, but it is rather satisfying to approach perfection.

Condenser C_1 would seem to be the real problem, although the fact remains that the determination of the frequency characteristic by this condenser and the adjustment of the coil taps must be carried toward whatever degree of accuracy has been decided upon more or less together. Yes, it seems best to decide on the greatest er-

ror in tracking which can be tolerated because perfect alignment in this instance is practically out of the question, and surely we don't want to deny ourselves the thrill of tuning the length of the bands successfully by some standard. Let's not make it too tough because, before being long on the air, we are certain to give some fellow a call and find that his b.f.o. is tuned to the opposite side of zero beat from our own. It is suggested that a maximum error of 5000 cycles is o.k. when tuning the entire 20-meter band. Our tracking problem involves one all-important factor in addition to those which are encountered in superheterodyne or t.r.f. receiver design, and that is the matter of tuning beyond the band edges. In spite of the fact that it may be practical to establish points of perfect alignment at some distance from the extremities of the tuning range in order to secure the best possible average alignment, our purpose will be best served by a high degree of accuracy near the ends. Once safely inside the band, an error of a few kilocycles doesn't matter very much, and when shifts of more than fifteen or twenty kilocycles are made it takes only a moment to readjust C_3 for zero beat or a monitor note as desired. Most operators are quite particular about pitch of the note when monitoring keying, and for that reason a slight resetting of the trimmer is usually worth-while.

The proper approach to the construction of the bandspread condenser, C_1 , will depend on the frequency curve of the receiver in question. In all cases where the tuning characteristic is anywhere near straight-line-frequency, it is believed that the method given herewith and pictured in Fig. 2 is just about the simplest solution. It is safe to say that the number of degrees of rotation of the SE type plates would never be precisely the same in any two circuits, so the figure is not given. The semi-circular plates will outnumber the SE type by two to one for straight line tuning. Naturally, only condensers which can be taken apart will serve our purpose, and they have to be completely dismantled to arrange the ST and SE type stators opposite their corresponding rotor groups. There seems to be very little more which need be said on the subject of tracking at this point except for one last word of caution. When the tracking is nearing what we are after, care must be taken to ensure that all set-screws in shaft couplings and the like are set up firmly each time an adjustment is made. Once upon a time, this circuit followed the receiver across the 20-meter band with less than one dial division error at any point, and there are about 400 divisions in the full bandspread. One final twist with a screw driver must have caused a hollow-point set-screw to creep on the shaft. Now, the maximum error is about 4000 cycles, but the alignment is good to within better than 1000 cycles for the first 15 kc. in from both ends. By the way, 20 meters is probably the best band on which to

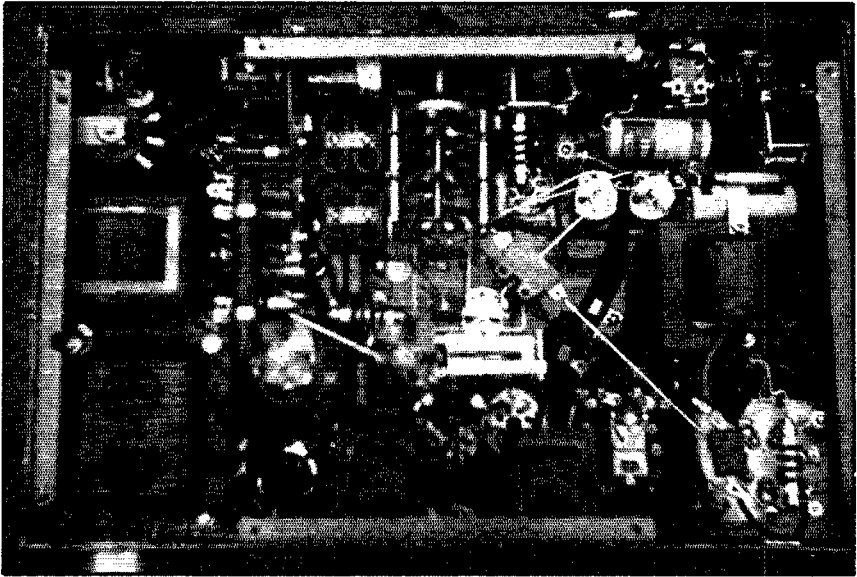

This bottom view shows the general arrangement of parts under the chassis. Compact construction leaves very little room to spare in this part of the unit.

adjust the frequency curve. The lower-frequency bands will be correspondingly better, and the degree of accuracy is not quite as much of a factor in 10-meter operation.

The 6F6 stage serves as a booster amplifier. It operates on 160 meters at all times, and it can be used to excite the final amplifier directly on that band if desired. Impedance-capacity coupling is used for both input and output circuits of this stage, and it is keyed with the oscillator. The screen voltage is kept down to a very low value, 40 volts to be exact. Thus, this stage loads very lightly, as do all other stages throughout the entire r.f. section. An r.f. choke in the keying lead might be necessary in some cases, but was not needed in this job. The same holds true for a by-pass condenser here and there.

Frequency Multiplication and the Final Amplifier

The bandsread condensers used for the driver and final, C_8 and C_{13} , are of about 35 and 50 $\mu\text{fd.}$, respectively, maximum capacity and are made up of a combination of plate shapes as described for the oscillator grid tank. Bandsread adjustment is not at all critical in the case of amplifier stages which use the conventional values of C in the loaded plate circuits. Fixed voltage is used at the control grids of both 807's and the final amplifier, and all are biased to well beyond cut-off. The values of the grid resistors used in the frequency multipliers may seem rather high, but are actually very satisfactory in practice. Low grid drive, coupled with low plate

voltage, ensures that the 807's are loading and not likely to develop troublesome instability at any frequency. Small parasitic chokes, made by winding ten turns of enameled wire on a test prod, were inserted in the plate leads of the 813 and the 807's as a precautionary measure. Their use may not be necessary in properly shielded stages operating at reasonable values of plate and screen voltage, but it is necessary to increase the voltage on both of the 807 stages if ten meter output is wanted without doubling in the final, in which case the chokes may prove worthwhile. The main band-switch, S_3 , is mounted on small ceramic stand-offs with its frame by-passed to the chassis. Greater stability in operation and a slight increase in driving power resulted from this treatment. Two sections of the switch are not in use in the circuit as drawn. One of these might serve to carry the capacity coupling lead from the 6F6 straight through to the final for 160-meter operation, and the other to change over to higher plate voltage on the driver for ten meters. At any rate, it is safe to say that very few amateurs are equally interested in all five bands, so here is a chance to arrange the circuit for most efficient operation on our favorites — 80, 40 and 20 in this instance.

C_7 serves as an excitation control. A low- C tuned circuit is an advantage over a coil cut to resonance in similar cases because an occasional casual readjustment will ensure that no amplifier stage will be far off resonance at any time. Resonant coils are more or less of a nuisance to cut in the first place, and are completely satis-

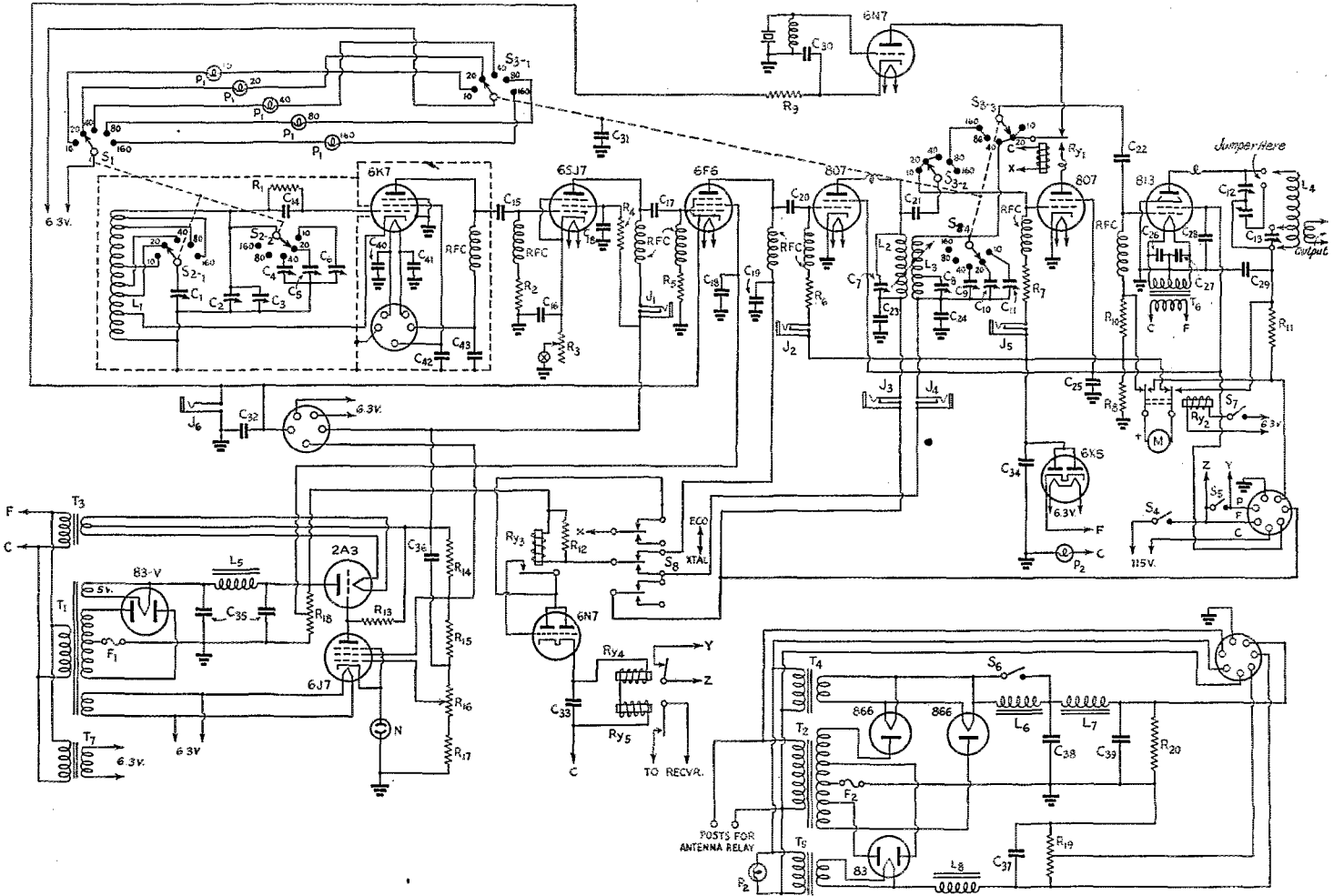

Fig. 1—Circuit diagram of the single dial transmitter. The 110-volt pilot bulb in the bias supply is a "tell-tale" to make certain that the power plug is properly poled in the outlet. With a ground on the transmitter the bulb will light when the plug is inserted the wrong way, will be dark with proper connections.

- C₁, C₈, C₁₈ — See text.
- C₂ — 365- μ fd. variable (Cardwell MR-365-BS).
- C₃ — 10- μ fd. midget (Cardwell ZR-10-AS).
- C₄, C₅ — 140- μ fd. air padder (Hammarlund APC-140).
- C₆ — 100- μ fd. air padder (Hammarlund APC-100).
- C₇ — 35- μ fd. variable (National EX-35).
- C₉ — 50- μ fd. air padder (Hammarlund APC-50).
- C₁₀, C₁₁ — 25- μ fd. air padder (Hammarlund APC-25).
- C₁₂ — Split-stator, 70- μ fd. per section, 0.07" spacing (Cardwell MT-70-GD).
- C₁₄, C₁₅ — 250- μ fd. mica.
- C₁₆, C₁₈, C₁₉, C₂₈, C₃₀, C₃₁ — 0.01- μ fd. paper.
- C₁₇ — 25- μ fd. mica.
- C₂₀ — 50- μ fd. mica.
- C₂₁, C₂₂ — 50- μ fd. mica, 2500-volt.
- C₂₃, C₂₄, C₂₆, C₂₇, C₂₈, C₄₀, C₄₁, C₄₂, C₄₃ — 0.01 mica.
- C₂₉ — 0.002- μ fd. mica, 2500-volt.
- C₃₂ — 0.02- μ fd. paper.
- C₃₃, C₃₄ — 40- μ fd. electrolytic, 150-volt.
- C₃₅ — 8-8 μ fd., 600-volt paper.
- C₃₆ — 0.05- μ fd. paper.
- C₃₇ — 8- μ fd. paper, 600-volt.
- C₃₈ — 2- μ fd. paper, 1500-volt.
- C₃₉ — 2- μ fd. paper, 1000-volt.
- R₁ — 0.1 megohm, $\frac{1}{2}$ -watt.
- R₂ — 50,000 ohms, $\frac{1}{2}$ -watt.
- R₃ — 1000-ohm variable, with switch.
- R₄ — 40,000 ohms, 1-watt.
- R₅ — 5000 ohms, 1-watt.
- R₆ — 0.1 meg., 1-watt.
- R₇ — 0.2 meg., 1-watt.
- R₈ — 6000 ohms, 10-watt.
- R₉ — 300 ohms, 10-watt.
- R₁₀, R₁₁ — Meter shunts.
- R₁₂ — 1000 ohms, 10-watt.
- R₁₃ — 0.5 meg., 1-watt.
- R₁₄ — 10,000 ohms, 10-watt.
- R₁₅ — 25,000 ohms, 1-watt.
- R₁₆ — 10,000-ohm potentiometer (Yaxley Y10MP).
- R₁₇ — 5000 ohms, 1-watt.
- R₁₈ — 20,000 ohms, 25-watt, with adjustable tap.
- R₁₉ — 50,000 ohms, 100-watt, with adjustable tap.
- R₂₀ — 75,000 ohms, 100-watt.
- T₁ — Power transformer, 400 v. each side c.t. at 200 ma., with 5 volt and 6.3 volt filament windings (Thordarson T-13R16).
- T₂ — Power transformer, 1075-0-1075/507-0-507 at 125/150 ma. (Thordarson T-19F57).

- T₃ — Filament transformer, 2.5 v.c.t. at 5.25 amps. (Thordarson T-19F88).
- T₄ — Filament transformer, 2.5 v.c.t. at 10 amps. (Thordarson T-19F89).
- T₅ — Filament transformer, 5 v.c.t. at 5 amps. (Thordarson T-19F83).
- T₆ — Filament transformer, 10 v.c.t. at 8 amps. (Thordarson T-19F96).
- T₇ — Filament transformer, 6.3 v.c.t. at 3 amps. (Thordarson T-19F97).
- L₆, L₆, L₇, L₈ — 8 henrys, 150-ma. (Thordarson T-13C30).
- S₁ — Bakelite-insulated single circuit selector switch (Yaxley 3215J).
- S₂ — Bakelite-insulated multi-circuit selector switch (Yaxley 1315L).
- S₃ — Bakelite-insulated multi-circuit selector switch (Yaxley 1335L (see text)).
- S₄, S₅, S₆, S₇ — S.p.s.t. toggles (S₄ and S₅ are mounted in a National rotary switch frame).
- S₈ — 3 p.d.t. three-position rotary jack switch (Yaxley No. 763).
- Ry₁ — S.p.d.t. 115-volt a.c. coil (Guardian A-100-C).
- Ry₂ — D.p.d.t., 6.3-volt a.c. coil (see text).
- Ry₃, Ry₄, Ry₅ — S.p.d.t. 2500-ohm coils (Allied Control Company Type PC 1).
- F₁ — $\frac{1}{2}$ -amp. high-voltage fuse.
- F₂ — $\frac{1}{8}$ -amp. high-voltage fuse.
- J₁-J₅, inc. — Closed-circuit jack.
- J₆ — Open-circuit jack.
- P₁ — 6.3-volt dial light.
- P₂ — 2-c.p. 115-volt lamp.
- N — Neon bulb without resistor.
- M — 1.5-ma. d.c. milliammeter.

Coil Data

- L₁ — National Type AR16-80 (see text).
- L₂ — 25 turns of No. 22 enameled wire on a 1 $\frac{1}{2}$ " diameter form (see text).
- L₃ — 7 Mc.: National AR16-20 with bandsread-tap at exact center.
14 Mc.: 3 turns of No. 14 enameled wire, 1 $\frac{1}{2}$ " long and 1 $\frac{1}{4}$ " diameter with bandsread tap at 3rd turn from cold end (self-supporting and mounted on a National PB-16 plug-in base).
- L₄ — 3.5 Mc.: Barker & Williamson Type 80 B with bandsread tap at 11th turn from hot end, 4-turn link.
7 Mc.: Type 40 B (4 turns removed) with bandsread tap at 5th turn from cold end, 3-turn link.
14 Mc.: Type 20 B (2 turns removed) with bandsread tap at 2nd turn from cold end, 2-turn link.

factory only on the narrow 300-ke. 7-Mc. band. It is not good practice to run a stage more than 150-ke off plate current dip because, even though the plate current of that stage and the grid current of the succeeding one may remain within reasonable limits, the quality of a c.w. note is almost certain to be impaired. I₂ is mounted permanently and in a horizontal plane. Coil L₃ is plug-in and must be changed when switching from 40 to 20 to 10 meters. Its socket is mounted on sliders like the secondary of a "loose coupler." Two $\frac{1}{8}$ " round brass rods are supported between small blocks of Micalox and two No. 41 Palmec stock clips serve as supports and sliding contacts, one for the plate lead and one for the bandsread connection. The plate voltage lead is a length of flexible wire connected directly to the coil base. The spacing between L₂ and L₃ is not at all critical and can be left at about two inches for either 7- or 14-Mc. operation. It can be varied between

$\frac{1}{2}$ " and 3". All in all, the "harmonic generator" seems to be very satisfactory as applied in this circuit.

The Final Amplifier

The choice of a final tube was dictated by the available cabinet height. However, assuming that physical size had not been a factor, the 813 would continue to be the logical choice. If a tube requiring more drive had been used, it is quite probable that a much more expensive bandsread switch would have been found necessary to prevent losses at the higher frequencies. Also, the circulation of air is restricted to such an extent that plate dissipation must be reckoned with, and there is an ever-present possibility of inadvertent off-resonance operation since C₁₂ has to be redipped when changing bands. A 100-watt tube

² Reinartz, "A Fundamental-Reinforced Harmonic-Generating Circuit," QST, July, 1937.

operating at the low value of plate voltage specified will stand this condition for a longer period of time than it would be likely to persist without being noticed and corrected. Therefore, no protective device is necessary. Thus, we have justified the use of a husky beam-power tube; or have we?

A jumper between the stator sections of C_{12} , or a switch if frequent use of the 160-meter band is made, will produce enough capacity, and one section will allow for a minimum of about 12 μfd . C_{13} will add a little to the figure specified by the manufacturer for C_{12} alone. The meter is a 1.5-ma. instrument connected across shunts which raise the full-scale deflection to 15 and 150 ma. for grid and plate readings. A relay is used to make the changeover simply because it was de-

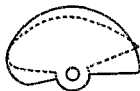

Fig. 2 — The band-spread condensers consist of combinations of s.l.c. and s.l.w. plates in one condenser, the number of plates of each type being determined experimentally to give a suitable calibration curve. The total capacity of C_1 , the oscillator condenser, is in the vicinity of 225 μfd . in the author's circuit.

sirable to use the same type switch on the front panel as the one which serves to cut in the S-meter on this particular receiver.

The Crystal Oscillator

It will be noted that a separate tube is used for the crystal oscillator, but that a common plate tank serves for it and the regular driver stage. Only 40-meter crystals can be used in this set-up. When the crystal-e.c.o. switch, S_8 , is thrown to e.c.o. position the 6N7 plate is floating, and thus the keying leads to both oscillators may be left connected at all times. This is a convenience because it is possible to heterodyne the two signals, and instantaneous change-over from crystal to self-control can be made without jumping frequency. In general, this crystal oscillator is a very good one but, up to now, it has been about as useful as a buggy-whip socket on an automobile.

Power Supplies

The voltage-regulated supply used for the oscillators and other low-power stages is described in the *Handbook*. C_{36} and a tube shield placed over the neon bulb were found necessary to clear up the e.c.o. note. Without passing an opinion on the relative merits of this method of voltage regulation, it may be well to note that G.E. now makes a line of neon bulbs without resistors. They have a bayonet type base and small metal-shell sockets are available from some supply houses.

The main supply is assembled on a separate 6

by 17 inch chassis. It is protected by a screen cover and is connected to the transmitter through a seven-wire cable. No additional a.c. connection or power switch is needed for this extra unit. S_6 is used to cut in the input choke when a reduction of power to 100 watts is wanted, as for contest or 'phone operation. This supply is making excellent use of the power transformer capabilities, and it is felt that its power ratings would be exceeded unreasonably by operating the final amplifier at 150 watts input except on c.w. Fuses are inserted in the transformer center tap leads of both supplies. The bias supply seems to be entirely satisfactory, thanks to a suggestion made by W4FPD for the substitution of a 110 volt 7-watt lamp for the fuse used previously, and to W4DAN for recommending the use of the huskier 6X5 tube as a rectifier.

Automatic Switching

"Brief calls with frequent short pauses for reply can approach (but not equal) break-in efficiency." This sentence is quoting a statement from *The Radio Amateur's Handbook*, and it is undeniably true. It is equally true that break-in, in the commonly-accepted sense of the word, is hard on the ears and nerves of the operator and, unless rather elaborate precautions are taken, it means rough treatment for the receiver as well.

The desirability of some form of key-control switching can be appreciated readily at this point in our discussion. The only stumbling block lay in the fact that the set-up was becoming a bit complicated by that time; there was no more above-chassis space, and there was very little left down in the hold. At any rate, I wanted the feature, and every effort was made to design a simple and trouble-free circuit. The parts cost of the arrangement shown is about \$4.50, and the circuit can be applied to practically any transmitter, and this means 'phone as well as c.w. For instance, probably the most common installation would consist of a parallel connection of the holding coil of Ry_3 across the regular cathode bias resistor in a crystal oscillator stage. In most cases, the effective value of the bias resistor will not be decreased enough to warrant a change.

The operation of the circuit is quite readily explained by the fact that a triode tube of any reasonable power sensitivity will not pass current with its control grid floating. The grid collects negatively charged electrons on its own hook, so to speak, and the resultant bias potential holds down the plate current effectively for our purpose. Then, as the jumper between the control grid and anode is closed intermittently by indirect keying, power is "pumped" into C_{33} and a voltage appears across the "bleeder" which is made up of the holding coils of Ry_4 and Ry_5 . The resultant current flow causes these relays to close. One serves to make the 110-volt connection to the high-voltage transformer primary,

and the other automatically cuts the r.f. gain on the receiver to a low value for monitoring purposes (the receiver "B" plus would be opened for 'phone operation). The delay action, with the value of condenser specified, will vary considerably with different makes. The one used is about correct for regular use by a reasonably fast operator, or by any operator for calling purposes. S_5 can be closed for long transmissions if desired.

General

The cabinet matches the receiver case and is equipped with a safety switch. A plate potential of 1150 volts or thereabouts is not to be trifled with, and in a small receiver-type case the danger is greater than usual because of the comparatively harmless appearance of the unit. The plate voltages are normally as follows: 180 on the e.c.o. and Class-A buffer plates, 300 on the 6F6 and 6N7 plates, 400 on the plates of the 807's and 1150 for the 813. The screen voltages are 40 for the 6F6 and 275 each for the frequency multipliers and the final. The plate currents are roughly as follows: 5 ma., with or without excitation, to the 6SJ7, 30 ma. to the 6F6, 40/50 to the 807's and 130/150 to the 813. Grid currents are $\frac{1}{2}$ ma. each for the 807's and 10/15 for the final. J_1 to J_5 , inclusive, are mounted below the chassis and are for plugging in a test meter. The five (green) pilot lights, P_1 , serve to indicate the bands and are arranged in a line on the front panel to simulate the band indicator used on the receiver. It was definitely impractical to use only one bandswitch in this layout, and these lights are wired in such a manner that both switches must be thrown to the same band position before any bulb will light. A 110-volt receptacle is mounted at the rear of the transmitter chassis to supply the receiver when the filament switch is closed. Thus, only one single wall or floor outlet is needed to supply this complete station, and only one switch has to be thrown to turn on all filaments. Because of the very close electrical relationship which has developed between this transmitter and the station receiver, it was perfectly natural that they should be made to look alike.

This rig has been on the air for several months and approximately five hundred contacts have

been made. It was tried out by three good operators in the last Sweepstakes (I tried it too) and everyone was much pleased with the results. It is a bit tough on the nervous system at first, but a few minutes usually suffice to familiarize any operator with its best use. I have enjoyed sitting back and watching others in the familiarizing process. A sour note has cropped up once or twice. This condition, although a trifle embarrassing, could have been nothing more serious than a few loose filings. The ever-effective amateur cure-all, in the form of a sound thump on the case, was applied and said sour note disappeared promptly. The receiver and transmitter can be stacked one above the other and a small rawhide belt slipped over the two dials. It works, but is not mechanically practical due to the very heavy drag on the dial mechanism. Stacked doublet antennas fed by a common twisted pair² should be an interesting possibility for use with this transmitter.

Granting that the method of track tuning as discussed is only a step toward true single-dial frequency control, one important conclusion has been drawn from this experiment: A carefully-constructed transmitter, combining all the features described herewith, is an excellent investment in operating pleasure.

² Hints and Kinks, *QST*, June, 1937.

✂ Strays ✂

While rebuilding his rig, W5IQD of Amarillo, Texas called CQ, keying his crystal oscillator without bothering to put on an antenna. He promptly contacted W9FCE of Las Animas, Colo., and worked him for 22 minutes. The report was 449x, the distance 260 miles, the input 1.6 watts and the frequency 7 Mc. — *W9FCE*.

— . . . —

Physics novelty — W9ERG working W9AMP on Sunday afternoon. — *W9EGX*.

— . . . —

Accidentally discovered that a queer audio modulation on my e.c.o. note was caused by the extremely-loud audio signal from my monitoring loudspeaker mounted near the e.c.o. Have heard several on the air evidently having the same trouble. — *W3EEW*.

CIRCULATION STATEMENT

PUBLISHER'S STATEMENT OF CIRCULATION AS GIVEN TO STANDARD RATE AND DATA SERVICE

This is to certify that the average circulation per issue of *QST* for the six months' period July 1st to and including December 31, 1939, was as follows:

Copies sold	44,556
Copies distributed free	502
Total	45,058

K. B. Warner, Business Manager
D. H. Houghton, Circulation Manager

Subscribed to and sworn before me on this 12th day of March, 1940
Alice V. Scanlan, Notary Public

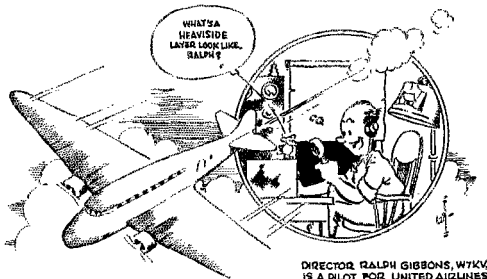

A Receiver for the New Amateur Television System

A 112-Mc. Band Superhet With Three-Inch Kinescope

BY J. B. SHERMAN*

THIS article describes a picture receiver for use in the amateur television system.¹ The receiver is of the superheterodyne type, and is intended to cover the 112-116-megacycle amateur television band. A three-inch Kinescope is used, either the type 3AP1/906-P1 (green screen) or 3AP4/906-P4 (white screen) being suitable.

The complete circuit diagram is shown in Fig. 1, and the chassis layout is shown in Fig. 2. A 956 acorn-type pentode is used as first detector with a 6J5 as oscillator. There is no r.f. stage. There are two i.f. stages using 6AC7/1852's. The second detector is one-half of a 6H6, followed by one 6AC7/1852 video stage. The other half of the 6H6 is used as a detector for synchronizing purposes only. This diode feeds a 6SC7 double triode, the first half of which is used as amplifier and the second half as sync separator. Multi-vibrators containing one 6SC7 each are the scanning oscillators. Each feeds one-half of a 6F8G double triode which delivers the vertical and horizontal saw-tooth deflecting voltages to the Kinescope deflecting plates.

The Kinescope is operated at 1500 volts second-anode potential, obtained inexpensively from a small receiver power transformer with two 5U4G's in a voltage-doubling circuit. This power

supply also furnishes 750 volts for the 6F8G deflecting output circuit. The remainder of the tubes are operated from a low-voltage 5Y3G supply.

Circuit Features

The Aladdin i.f. transformers used in this outfit are designed to tune to 13.25 Mc. This means a difference in choice of 26.5 Mc. in oscillator frequency, depending on whether it is selected above or below the signal frequency. For the sake of improved oscillator performance the oscillator frequency is placed 13.5 Mc. below the signal frequency, so that its tuning range is 97.5 to 101.5 Mc.

These i.f. transformers are well-suited to the requirements of the receiver. When they are peaked at 13.25 Mc., without loading, the overall response from antenna to Kinescope shows a characteristic which is down 50% at both sides of a 1-Mc. band. It will be recalled that the video band delivered by the modulator¹ is approximately 200 kc. wide, making the double-sideband transmission about 400 kc. This band is handled in the receiver with no appreciable loss.

A cathode-bias control on the first i.f. tube provides gain control.

It will be recalled that the synchronizing signals exceed the maximum video level by approximately 25%, and must be extracted from the composite signal by amplitude selection. This is

* Electrical Engineering Dept., Cooper Union, New York City. Formerly with RCA Mfg. Co., Inc., Harrison, N. J.

¹ "A New Electronic Television Transmitting System for the Amateur," by J. B. Sherman, *QST*, May, 1940.

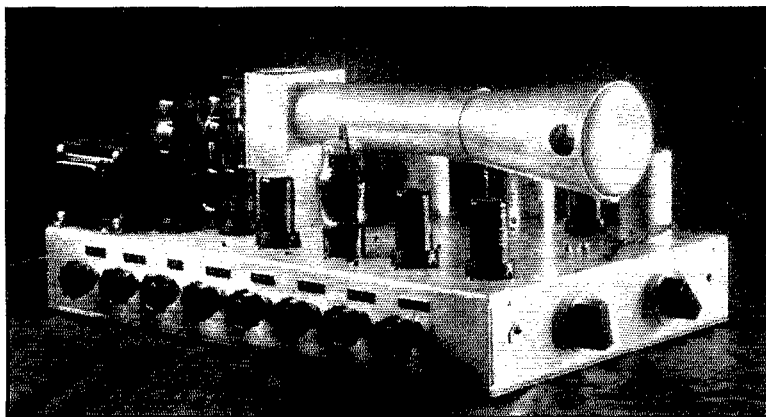

◆
Designed for amateur television reception on the 112-Mc. band, this unit complements the camera-modulator described in May *QST*.
◆

◆

Actual-size unretouched photograph of received 120-line picture, transmitted on a 114-Mc. carrier modulated by the unit described in May *QST*. Due allowance should be made for definition lost in photographing and printing processes.

◆



accomplished in a triode-type separator. The composite signal is supplied with the sync signals, having positive polarity, to the second triode of a 6SC7 (V_2) with grid-leak bias. When the plate voltage is reduced sufficiently the video portion is clipped and only the sync impulses remain. The separator operation is improved by operating its grid with positive bias in addition to the grid-leak bias. Should it be desired to change the clipping level, R_{21} and R_{25} may be varied. The sync impulses appear in the separator output with negative polarity, which is correct for direct application to the scanning oscillators.

A form of multivibrator is used for the saw-tooth-wave generator. Referring to Fig. 1 and selecting the vertical oscillator as example, it is seen that the saw-tooth voltage is developed across C_{23} by charging this condenser through R_{25} . By causing triode V_2 to develop low-plate resistance, C_{23} is discharged. This is accomplished by feeding back voltage from the plate of V_2 to the grid of V_1 , the amplified voltage at the grid of V_2 having the form of a large positive impulse which periodically causes V_2 to be conducting for a short time and thus discharge C_{23} , after which the saw-tooth cycle repeats.

The horizontal and vertical oscillators are similar except for constants, the frequencies being respectively 3600 and 30 cps. The vertical size control consists of the potentiometer R_{28} across the oscillator output, which is perfectly satisfactory for the low frequency and makes the frequency independent of the size control; however, this type of control results in loss of high-frequency components when applied to the horizontal. The horizontal size is therefore controlled by varying the supply voltage with R_{36} . This

voltage control makes the frequency vary somewhat with size, but offers no difficulty in adjustment since the picture is normally of fixed size.

A filter with large time constant ($R_{30}-C_{26}$) is inserted in the vertical oscillator plate supply in order to minimize the effect of line voltage fluctuations. This is not necessary in the horizontal circuit because the constants are such that little fluctuation is transmitted.

The multivibrators offer the advantages of employing inexpensive tubes and parts; of synchronizing reliably with impulses of the order of only tenths of a volt; and of synchronizing directly with impulses of negative polarity, which is the polarity furnished by the type of sync separator used in this receiver.

A technical article on television reception is no novelty in *QST*. There have been over a dozen on the subject during the past several years, as shown by the bibliography elsewhere in this issue. But this particular article is novel because it is the first to describe a television receiver for purely amateur communication using our own standards on our own 112-Mc. band, in contrast to the others which described receivers restricted to use with transmissions from b.c. stations using commercial standards on the lower-frequency television band. The general principles remain the same, of course, and the reader is referred to the other articles listed in the aforementioned bibliography for a liberal education on the fundamentals.

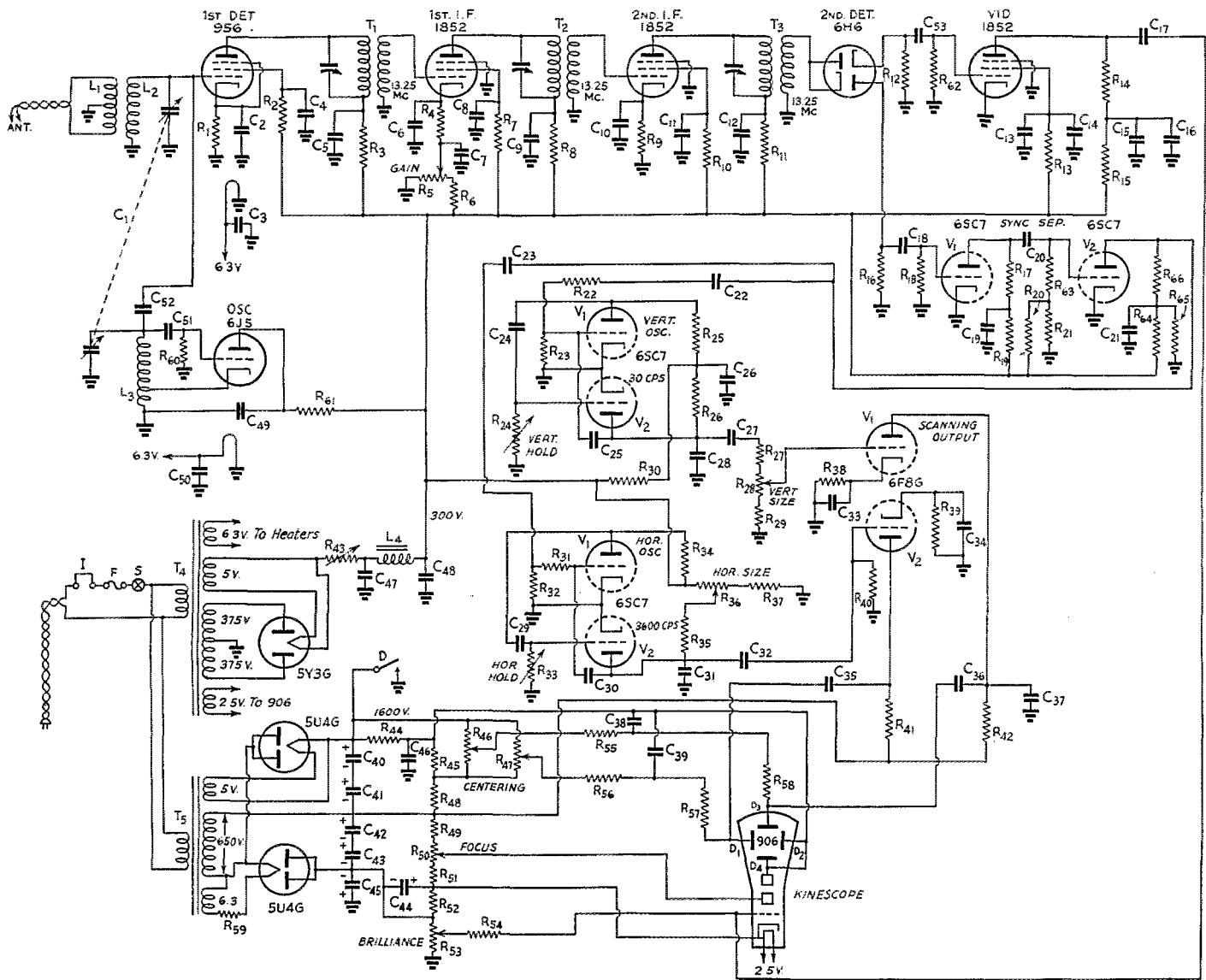

Fig. 1 — Circuit of the amateur television receiver.

- R1 — 3000 ohms, $\frac{1}{2}$ w.
- R2, R26, R28, R42 — 0.2 meg., $\frac{1}{2}$ w.
- R3, R12, R13 — 10,000 ohms, $\frac{1}{2}$ w.
- R4, R9 — 160 ohms, $\frac{1}{2}$ w.
- R5 — 3000-ohm pot.
- R6, R16, R17, R18 — 0.1 meg., $\frac{1}{2}$ w.
- R7, R10 — 60,000 ohms, $\frac{1}{2}$ w.
- R8, R11 — 4000 ohms, $\frac{1}{2}$ w.
- R14 — 75,000 ohms, 2 w.
- R15, R17, R30, R35 — 20,000 ohms, $\frac{1}{2}$ w.
- R18, R33 — 10 meg., $\frac{1}{2}$ w.
- R20, R26, R33 — 1 meg., $\frac{1}{2}$ w.
- R21, R27, R49, R51, R52, R56, R57, R58 — 0.25 meg., $\frac{1}{2}$ w.
- R22, R45 — 0.25 meg., $\frac{1}{2}$ w.
- R23 — 50,000 ohms, $\frac{1}{2}$ w.
- R24, R25, R32, R34, R47 — 1-meg. pot.
- R26, R46, R48 — 2 meg., $\frac{1}{2}$ w.
- R31 — 2000 ohms, $\frac{1}{2}$ w.
- R32 — 1000 ohms, $\frac{1}{2}$ w.
- R36, R50 — 0.25-meg. pot.
- R38 — 12,500 ohms, $\frac{1}{2}$ w.
- R39 — 6000 ohms, $\frac{1}{2}$ w.
- R41 — 0.25 meg., 1 w.
- R43 — 750 ohms, 10 w., slider type.

- R52 — 75,000 ohms, $\frac{1}{2}$ w.
- R53 — 20,000-ohm pot.
- R54 — 5 meg., $\frac{1}{2}$ w.
- R57 — 3 meg., $\frac{1}{2}$ w.
- R58 — 5 meg., $\frac{1}{2}$ w.
- R59 — 0.43 ohm, 5 w. (1-ohm slider-type adjusted to give 5 volts at 5U4G socket).
- R60 — 30,000 ohms, $\frac{1}{2}$ w.
- R61 — 15,000 ohms, 2 w.
- C1 — 2-plate per section, dual midget. Cardwell dual from each section. (See text.)
- C2, C3, C4, C5, C6, C7, C10, C11, C12, C13, C15 — 0.002 μ fd., 400 v., mica.
- C4, C29, C49, C50 — 500 μ fd., 400 v., mica.
- C7, C34 — 5 μ fd., 25 v., electrolytic.
- C14, C16, C22, C40, C41, C44, C45 — 4 μ fd., 450 v., electrolytic.
- C17 — 0.05 μ fd., 600 v., paper.
- C18, C38, C39 — 0.1 μ fd., 200 v., paper.
- C19 — 8 μ fd., 450 v., electrolytic.
- C20, C27, C35 — 0.25 μ fd., 600 v., paper.
- C21 — 8 μ fd., 150 v., electrolytic.
- C22 — 0.01 μ fd., 200 v., paper.
- C23 — 0.003 μ fd., 200 v., paper.
- C24 — 0.02 μ fd., 600 v., paper.
- C25 — 0.006 μ fd., 600 v., paper.

- C26, C28, C29, C37, C43 — 20 μ fd., 450 v., electrolytic.
- C30 — 100 μ fd., 400 v., mica.
- C31 — 0.001 μ fd., 400 v., mica.
- C32 — 0.01 μ fd., 400 v., paper.
- C33 — 40 μ fd., 25 v., electrolytic.
- C35 — 0.005 μ fd., 1000 v., paper.
- C36, C46 — 0.1 μ fd., 1600 v., paper.
- C37 — 0.01 μ fd., 1000 v., paper.
- C38 — 10 μ fd., 200 v., mica.
- C39 — Approx. $\frac{1}{2}$ μ fd.
- C42 — 0.25 μ fd., 200 v., paper.
- L1 — 2 turns No. 16 tinned copper, turns spaced wire diameter, $\frac{1}{2}$ inch inside diameter.
- L2 — 7 turns No. 16 tinned copper, turns spaced wire diameter, $\frac{1}{4}$ inch i.d. (inside L1).
- L3 — 8 turns No. 16 tinned copper, turns spaced wire diameter, $\frac{1}{4}$ inch i.d., tapped at $1\frac{1}{2}$ turns from ground end.
- L4 — 15-henry, 100-ma. choke.
- T1, T2 — I-f. transformer (Aladdin type U100).
- T3 — I-f. transformer (Aladdin type U200).
- T4 — Power transformer (UTC Type R4).
- T5 — Power transformer (Thordarson Type T13R11).
- I — Interlock. (See text.)
- F — Fuse.
- S — Switch.
- D — Discharge switch. (See text.)

Each oscillator feeds one triode of the 6F8G deflection output stage. It will be noted that high plate loads are used, in order to minimize the current requirements. In order not to lose high-frequency components of the horizontal sawtooth with the high plate load, the circuit capacitance should be kept down by dressing the output load and coupling condenser away from the chassis.

All of the low-voltage power supply requirements are furnished by the 5Y3G supply operated from T_4 . Two 5U4G's operating in a doubler circuit from T_5 furnish 1500 volts to the Kinescope and 750 volts to the scanning output stage.

When the receiver is turned on, it is desirable to prevent the appearance of a stationary spot which may damage the Kinescope screen before the scanning starts. A simple circuit arrangement, not conveniently applicable in the camera unit but readily applied in the receiver, accomplishes this regardless of the setting of the brilliance control. It has been pointed out that the 6F8G scanning output tube receives its plate voltage from the Kinescope supply. This supply is connected to ground through the brilliance control R_{53} ; hence the total d.c. cathode current of the 6F8G must flow through R_{53} . In the absence of this current there is no voltage drop in R_{53} . The Kinescope cathode is connected to a point approximately 75 volts above the negative end of the high-voltage supply; hence, if no current flows in R_{53} , the Kinescope grid will be 75 volts below its cathode and the Kinescope will be completely cut off. The voltage drop which appears across R_{53} due to the 6F8G cathode current opposes the voltage across R_{52} . Thus, until the scanning output tube has become heated, the Kinescope is cut off.

Layout and Testing

Fig. 2 shows the layout of parts on the chassis. The Kinescope is housed in a shield of aluminum and further shielding is obtained by three layers of thin sheet iron rolled around the Kinescope, inside the aluminum shield. The iron, of course, must not be magnetized. The Kinescope socket is mounted in an enclosure which supports the shielding and completely houses the connections to the Kinescope. The deflection coupling condensers are also placed in this housing.

As shown in the photographs of the receiver, all of the controls except tuning and gain are placed on the side of the chassis. The centering and focus controls are mounted away from the chassis on a bakelite plate, and the shafts extended with insulating couplings. The bottom cover of the chassis carries pin-jack interlocks which break the a.c. supply when the bottom is removed, and a mechanically-operated discharge switch shorts the high-voltage supply at the same time.

The 956 socket is mounted on the underside of

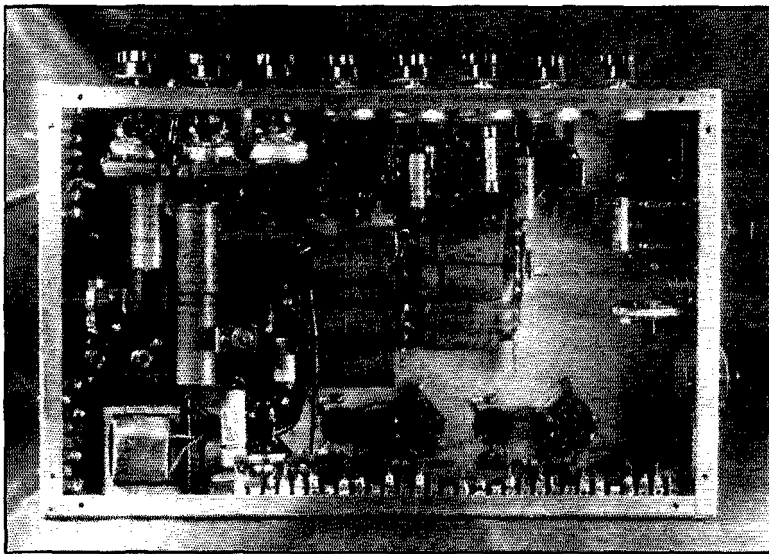

Bottom view of the receiver chassis with base plate removed. Note the interlock jacks at lower left, and the filter-discharge switch to right of the interlock jack strip.

the chassis between the tuning condenser and the first i.f. transformer, so that short leads are had to both. The tuning condenser is a Cardwell dual

No. ER-10-AD with one rotor plate removed from each section. By bending the remaining plate slightly away from the stator, the 112-116-Mc. band is made to occupy most of the tuning range.

It is possible to test the performance of the video amplifier, synchronizing circuits, Kinescope, etc., of the receiver before the r.f. section of the transmitter has been built. For this purpose a simple connection may be made to the camera-modulator unit described in the May issue of *QST*.¹ First remove the 6H6 detector from its socket and by means of a tube-base type plug connect leads to pins Nos. 2, 4 and 5. Pin No. 2 will serve to connect the ground of the receiver to the ground of the camera unit. Pin No. 4 should be connected to the high side of the modulator output. Pin No. 5 should be connected to the grid of the sync amplifier No. 2. Since both grids of this tube are connected together, a clip may be readily attached to the top cap.

Synchronization should be quite positive with this arrangement. It is necessary to adjust the modulator output control to get a satisfactory picture; there should be enough signal available from the modulator to overload the video amplifier of the receiver considerably when modulator output control R_{24} is turned up.

This same procedure may be followed where the construction of a transmitter is not contemplated. Of course, in this case it is not necessary to construct the r.f. and i.f. portions of the receiver. Where distances greater than a few feet are to be covered, the video transmission line must be properly terminated.

A photograph of a picture on the Kinescope screen is shown. This picture was picked up initially by the Iconoscope equipment described

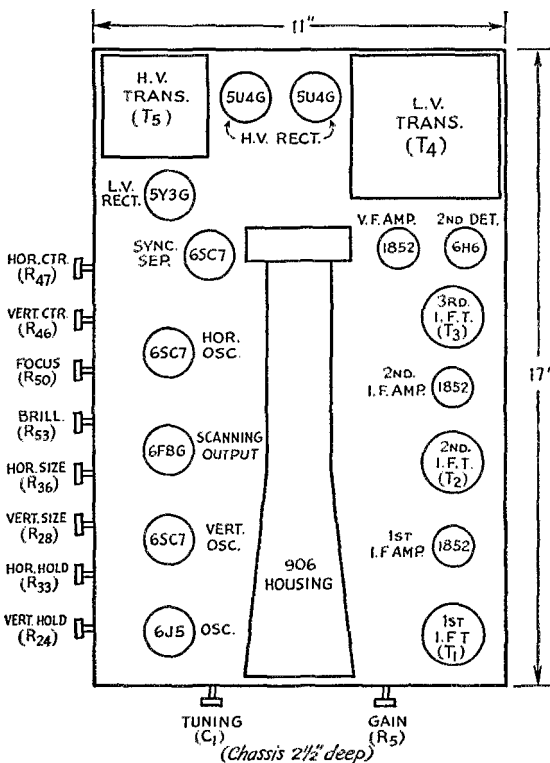

Fig. 2 — Chassis plan of the receiver as viewed from the top.

in May *QST*. The modulator output was connected to an r.f. signal generator operating at 114 Mc., and the picture-modulated carrier was fed to the antenna terminals of the receiver.

BIBLIOGRAPHY OF ARTICLES ON TELEVISION RECEPTION (COMMERCIAL STANDARDS)

- "Radio Amateurs in the Television Picture," by J. J. Lamb, *QST*, Dec., 1937.
- "Introduction to Modern Television," by M. P. Wilder, *QST*, Dec., 1937.
- "Circuit Elements in Modern Television Reception," by M. P. Wilder, *QST*, Jan., 1938.
- "Sweep Circuit Considerations in the Television Receiver," by M. P. Wilder, *QST*, Feb., 1938.
- "A Universal Test Unit for the Study of Television Images," by M. P. Wilder, *QST*, March, 1938.
- "The Construction of Television Receivers," by M. P. Wilder, *QST*, April and May, 1938.
- "Building Television Receivers with Standard Cathode-Ray Tubes," by J. B. Sherman, *QST*, Oct., 1938.
- "A Practical Television Receiver for the Amateur," by C. C. Shumard, *QST*, Dec., 1938.
- "Construction and Alignment of the Television Receiver," by C. C. Shumard, *QST*, Jan., 1939.
- "Using Electro-Magnetic Deflection Cathode-Ray Tubes in the Television Receiver," by J. B. Sherman, *QST*, Feb., 1939.
- "An Electrostatic-Deflection Kinescope Unit for the Television Receiver," by J. B. Sherman, *QST*, March, 1939.
- "A Deflection and Video Chassis for Television Reception," by H. C. Lawrence, *QST*, Feb., 1940.
- "A Design for Living — With Television," by P. Rosenblatt, *QST*, March, 1940. (High-voltage power supply with safety features.)

— J. J. L.

Strays

In attempting to make a "tuning wand," I discovered that plugs of brass and solid-iron rod both produced a decrease in inductance. For the iron-rod plug I substituted a plug made of paste formed by a mixture of collodion and fine iron filings. This produced the desired effect of increasing the inductance. — *W2HKU*.

WSOIW stopped his car in front of his friend's house, blew a CQ on his horn and waited for the OM to come out. The OM did not appear, but a YL came running out from the house next door and said, "Helen can't come out now, but she will see you in front of the ice-cream parlor at eight o'clock." Apparently another ham haunts the neighborhood. — *W8TTN*.

To make the National NC600 neutralizing condenser not only safer but easier to adjust, slip one of those over-size pencil erasers over the adjusting screw. — *W6QQE*.

Do you suffer from a sore arm caused by pressure of the edge of the table on the bone just below the elbow during long hours of brass-pounding? One of the big sponge-rubber ear pads makes a swell elbow pad and is easily held in position with a rubber band around the arm. — *W2GVZ*.

★ New Receiving Tubes ★

1LB4

HYGRADE Sylvania announces another addition to the line of 1.4-volt 50-ma. battery tubes — the 1LB4. This tube is a power-output pentode operating at a maximum plate voltage of 90. The power-output rating is 200 mw. with 10 percent total harmonic distortion. 35 mw. may be obtained with plate and screen operating at 45 volts. The tube has a loktal base and is designed to operate into a 12,000-ohm load resistance.

Several new receiving types have recently been announced by Raytheon.

The 1D8GT is an 1.4-volt battery type with bantam construction. This tube has a diode, a triode and pentode to perform the functions of detector, audio amplifier and power-output stage. The power-output rating of the output section is 200 mw. at a plate and screen voltage of 90.

The 6AB5/6N5 replaces the individual types 6AB5 and 6N5. The electrical characteristics have been designed to retain the sensitivity of the 6AB5 together with the extended cut-off of the 6N5.

The 6AL6G is a 6.3-volt type designed for use as an amplifier in television receivers. The characteristics are similar to those of a 6L6G, but the plate lead is brought out to a top cap to allow a high momentary peak-voltage rating.

The 7H7 is a high mutual-conductance pentode which has been designed to have as wide a cut-off as is consistent with a good ratio of mutual conductance to plate current. This new type will find application in untuned r.f. circuits, wide-band, high-frequency amplifiers and other equipment where the high *gm* characteristics are desirable.

The 35Z6G is a twin diode rectifier designed for use in voltage-doubler circuits in a.c.-d.c. receivers. It is characterized by a plate-current rating of 110 ma. which is somewhat higher than similar ratings for other voltage-doubler tubes such as the 25Z6G.

The 50C6G is a 50-volt power amplifier with characteristics similar to the 6Y6G. It is designed for a.c.-d.c.-receiver use.

The 70L7GT is a dual-section tube containing a half-wave rectifier and a beam power amplifier. The rectifier section is rated at 125 volts, r.m.s. and the d.c. output current as 70 ma. The audio section has an output rating of 1.8 watts at plate and screen voltages of 110.

I.C.A.S. RATING FOR 866

Raytheon announces that in intermittent amateur service, the inverse peak-voltage rating of the 866 is increased to 10,000 volts.

Third U.H.F. Contest and Relay Results

BY J. A. MOSKEY,* WIJMY

MUCH was accomplished in the way of improving the efficiency of already established message routes, and toward the increased use of frequencies above 60 Mc., in the February Contest and Relay. Many participants who are veterans of the previous relays submitted considerably larger numbers of message copies with their logs and were lavish in their praise of the manner in which traffic moved along, even though conditions were seemingly at lowest ebb. 112 Mc. was used more than ever before. A few of the gang even made use of $1\frac{1}{4}$ in handling messages, but more about that later.

W3AC/3 again came through in top place to the tune of 370 points and a total of 32 stations worked. Goyn, as usual, operated portable at High Point Park, N. J., from his Plymouth coupe, and deserves a big hand for providing one of the most reliable links in the numerous networks connecting the New England and Atlantic States. In second place we find W3HOH, who is rapidly becoming a dangerous threat to top men in competitive u.h.f. activities these days! Ken finished with a total of 298 points, having worked 37 stations, and handled 81 messages. A surprise to many will be the news that honors for third place go to a station which was *exclusively on 112 Mc.* W6OFU took advantage of the portable and the $2\frac{1}{2}$ -meter multipliers by taking his 7A4-7B5 transceiver to Strawberry Peak in California. From there he rolled up the very healthy score of 250 points!

The East Coast-Illinois circuit of previous relays was inoperative this time. Operators who wondered why this route was not working will appreciate knowing that W8BHY took it upon

*Communications Department, A.R.R.L.

himself to operate from Savage Mountain, Maryland, in an attempt to fill in the gap formerly closed by W8CIR and W8EUO. Arrangements were made with W3RL at Herndon, Va., to take west-bound messages, but contact with that station was not established. However, credit for making possible the longest circuit that functioned during the relay goes to W8BHY. W8CIR was successfully contacted, and at 12:38 A.M., E.S.T., on the 11th a message, addressed to any W9 station, started from Savage Mountain and reached W9ZHB at 12:46 P.M., C.S.T., via the following: W8BHY/3-W8CIR-W8NYD-W8QDU-W8CVQ-W9VHG-W9ZUL-W9ZHB. A reply returned via the same route and was traced as far as W8NYD. Numerous other messages, addressed to eastern stations, travelled this chain, but were forced to stop enroute due to the gap between Maryland and Virginia.

Conditions at W8BHY/3 were anything but comfortable, what with rain, snow, and a high wind which averaged 40 miles per hour. Other operators braved the wintry elements at various points in the East, and we extend to them three long cheers for their perseverance in sticking with the relay through thick and thin. Theirs is the spirit which has accounted for many brilliant achievements in amateur radio!

The appearance of W3FJ in the contest saw the extension of the north-south routes to Richmond, Va. A message started at this station on 10th at 11:10 P.M., E.S.T., and addressed to W1HDQ was delivered at 11:45 A.M., after traveling over the following route: W3FJ-W3DBC-W3IIS-W3GGR-W3CGV-W3HKM-W3HOH-W2IDV-W1CLH-W1HDQ. The reply was filed immediately and returned during the contest

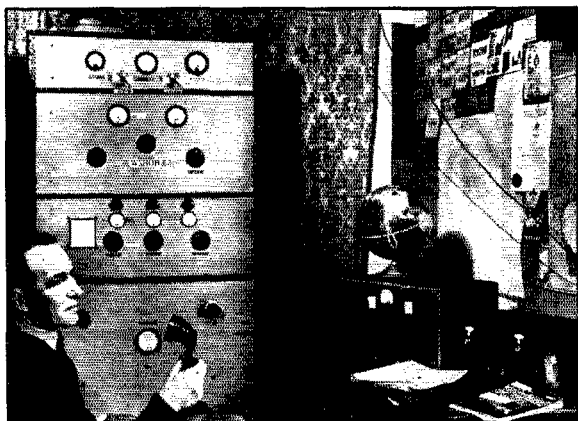

◆
In any type of u.h.f. activity, Ken Kingsbury, W3HOH, usually turns in a very fine performance. His rig ends up with a pair of 100th's running at 250 watts. Receiving equipment consists of a Lester converter ahead of an HQ12OX.
◆

Bob Scrimshner, W1KLJ, relaxes after running up a score of 209 points in the relay. The transmitter employs a pair of T55's in the final with 375 watt's input. On 112 Mc. it ends up with an HK24 doubler at 100 watts. The receiver for Five is a superinfragenerator with two 954 RF stages, and for 2½ a separately quenched 955 detector and two audio stages. Antennas for 56 Mc. include a four half waves in phase stacked vertical, and two collinear sets of six broadside elements with twelve reflectors. On 112 Mc. a rotatable array consisting of 2 collinear sets of 3 broadside elements is used.

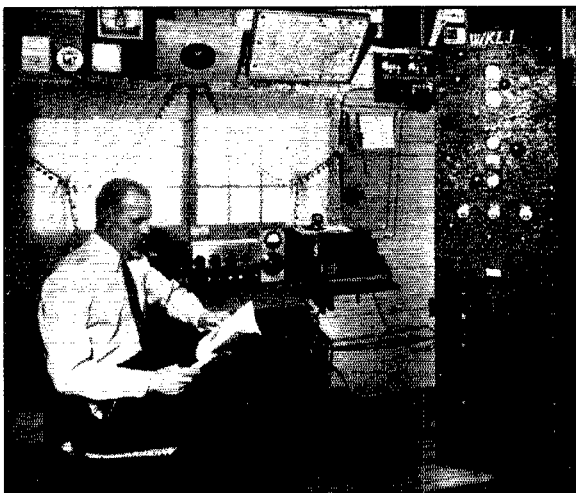

period as far as W3FQS (Stony Creed Mills, Pa.) via W1HDQ-W1CLH-W1KTF-W2AMJ-W3HOH-W3FQS. This message eventually reached W3FJ after the relay.

That the technique of relaying on the u.f.f. bands has improved to a considerable degree is evidenced by the large percentage of deliveries effected. The routes given below each carried a test message to its destination. Asterisks indicate that a reply was started and returned all the way to the station originating the test message. In some cases the return differed slightly, but in general was basically the same.

W1GXT-W1HDQ-W1KLJ-W1CLH-W2IDV-W3HOH-W3BZJ*; **W1DEI-W1KLJ-W2MO-W2IQQ-W3GVX/3-W2AMJ***; **W1LOV-W1MJT-W1HXP-W1GJZ-W1HDQ-W1KLJ-W1KTF-W2KKE***; **W1EYM-??-W2AMJ-W1HDQ**; **W1LSN-W1EKT-W1HXP-W1GJZ-W1HDQ-W2MO-W2AXP-??-W2BW-W2KKE**; **W1JIS-W1EKT-W1COX-W1LPP***; **W1KH-W1EKT-W1COO**; **W1HDF-W1HDQ-W1GJZ-W1HXP**; **W1HXP-W1GJZ-W1HDQ-W1KLJ-W3AC/3**; **W1CGU-W1HXP-WISS**; **W2FBA-W3AC/3-W2MO**; **W2BRI-W2QA-W3HOH**; **W2AXP-??-W2BW-W2QA**; **W2LXC-W2LAL-W3HOH-W3GNA-??-W3FQS-W3CGV**; **W2OG-W2MO-W2LAU-W3HOH***; **W2MO-W2IDV-W1KTF-W1KLJ-W1LFI-W1LPP-W1JNC***; **W2QA-W2HYJ-W2CLA**; **W2MKM-W2LAL-W2GHV-W1KTF-W1KLJ-W1HDQ-W1BDI**; **W2CLA-W2BW-W1KTF-W1CLH-W1KLJ-W1BDI**; **W2ADW-W1CLH-W1KTF-W1KLJ-W1BDI**; **W3CVY-W2AMJ-W1HDQ-W1GJZ-W1HXP-W1DJ***; **W2IQQ-W3AC/3-W1KLJ-W1HDQ**; **W2LAL-W2LXC-W2KKE-W1KTF-W1KLJ-W1LFI-W1EHT-W1EKT-W1HXP**; **W3CVF-W2KKE-W1KTF-W1CLH-W1EYM***; **W3GQS-W3HOH-W2MO-W2KKE-W1KTF**; **W3GQK-W3CGV-W3GGR-W3IIS**; **W3RL-W3DBC-W3IIS-W3GGR-W3CGV-W3HKM-W3HOH-W2IDV-W1CLH-W1HDQ**; **W3FM-W3FBH-W3BZJ-W3HOH**; **W3HEK-??-W3HKM-W3HOH**; **W3HSN-W3CGV-W3GGR-W3IIS-W3GMZ-W3AWS**; **W3AWM-W3DBC-W3IIS-W3GGR-W3CGV-W3FQS-W3FBH-W2MO-W2KKE-W1KTF-W1CLA-W1KLJ-W1BDI**; **W3BZJ-??-W2AMJ-W1HDQ-W1GJZ-W1LSN**; **W3GCR/3-??-W3BZJ-W3HOH-W3AC/3-W1KLJ-W1LFI-W1EHT**; **W3GGR-W3CGV-W3FQS-W3GNA-W3HOH-W3AC/3-W1HDQ**; **W3GQK-W3CGV-W3GGR-W3AC/3-W1HDQ**; **W6IOJ-W6RVL-W6OFU/6-W6OIN***; **W6SGR-W6NCP/6-W6OFU/6-W6RVL**; **W6OIN-W6OFU/6-W6KNF-W6RVL-W6IOJ**; **W6KNF-W6OFU/6-**

W6OIN; **W6SJB-??-W6OFU/6-W6RVL**; **W6RIR-??-W6NGQ-W6RVL**; **W8QQS-W8NKJ-W8QDU-W8CVQ-W8NFM-??-W8TBN-W8CVQ**; **W8QDU-W8CVQ**; **W9VHG-W9ZHB**; **W8NVD-W8QDU-W8CVQ-W9VHG-W9ZL-W9ZHB-W9ARN**; **W8RKE-W8CVQ-W9VHG**; **W8CR-W8NVD-W8QDU-W8CVQ-W9VHG-W9ZHB-W9ARN***.

(Continued on page 114)

SCORES—THIRD U.F.F. CONTEST AND RELAY

(Figures indicate number of stations worked and score.)

W3AC/3.....	32	370	W3FBH.....	14	50
W3HOH.....	37	298	W6IOJ.....	17	48
W6OFU/6.....	17	250	W2BAD.....	25	47
W2MO.....	42	227	W1LPP.....	16	45
W1KTF.....	27	211	W2KDV.....	18	44
W1KLJ.....	30	209	W1CTC/1.....	5	40
W1HDQ.....	29	194	W2MES.....	12	40
W2LAU/2.....	25	136	W1LSN.....	14	39
W3CGV.....	15	131	W2KBP.....	20	39
W1HXP.....	36	130	W2LXC.....	13	34
W8CVQ.....	9	124	W1BDI.....	6	31
W8QDU.....	8	124	W2CLA.....	12	31
WISS.....	33	109	W9ZUL/9.....	4	31
W1GJZ.....	12	103	W3RL.....	10	30
W2KKE.....	28	102	W3BYF.....	6	29
W2LEN/2.....	19	100	W1KIK/1.....	2	28
W2IDV.....	34	96	W3AWS.....	12	27
W2AMJ.....	32	93	W8QQS.....	4	27
W1LFI.....	21	89	W8TBN.....	8	27
W6RVL.....	19	85	W1EHT.....	5	26
W1CLH.....	13	81	W1KJF.....	7	26
W1EKT.....	21	79	W1MDN.....	10	25
W9VHG.....	5	78	W3GMZ.....	10	25
W2HYJ.....	33	76	W2LRE/2.....	11	23
W3IIS.....	9	73	W3AWM.....	8	22
W1MHM.....	11	68	W3EIS.....	8	20
W3DBC.....	14	63	W9ARN.....	3	20
W2LAL.....	19	62	W3FJ.....	3	19
W1DJ.....	20	61	W8TIU.....	2	19
W2FIT.....	25	58	W2LST.....	7	17
W6NCP/6.....	3	56	W3HHC.....	4	16
W8BH/3.....	1	56	W8RFW.....	4	15
W1KSB.....	18	55	W9ZRP.....	4	15
W2QA.....	25	55	W1KHL.....	4	14
W1JIS.....	16	54	W9VWU.....	1	13
W1LOV.....	20	53	W9ZJB.....	1	13
W6KNF.....	9	53	W8UBV.....	2	12
W1AKD/1.....	9	52	W9ASO.....	1	12
W2MEU.....	27	211	W7AXS.....	5	5
W1AIY.....	7	50	W8PK.....	1	2
W1LTB.....	6	50	W9AB.....	1	1
			W9WDV....	1	1

Reactance-Tube Frequency Modulators

A Push-Pull Modulator Circuit for Minimizing Frequency Instability

BY MURRAY G. CROSBY,* W2CSY

WHEN a simple oscillator is frequency modulated by means of a reactance tube, the problem of frequency stability immediately manifests itself. The reason for this becomes apparent when it is realized that the reactance tube is a device which makes the frequency of oscillation dependent upon the element voltages supplied to the reactance tube. Normally this condition is produced so that frequency modulation may be accomplished by applying the modulating voltage to one of the reactance-tube elements. However, at the same time the frequency stability of the oscillator, which normally depended on the oscillator circuit itself, now becomes dependent on the voltages supplied to the reactance tube. This results in rather poor frequency stability unless steps are taken in addition to the mere connection of a single reactance tube across the oscillator to produce frequency modulation.

An obvious method of improving the stability of this simple combination is by the use of a regulated power supply to supply the element voltages to the reactance tube. It is the writer's experience that such an expedient is practically a

necessity where this simple combination is used.

Another method of eliminating the high susceptibility to power supply variations is by means of the push-pull reactance tube circuit shown in Fig. 1. In this circuit two reactance tubes are used which have opposite reactance variations so that they must be modulated in push-pull to cause their reactive effects to aid. Any push-push modulation or power supply variation is then canceled out in the same manner that push-pull circuits cancel hum from the power supply of an audio amplifier.

Tubes *A* and *B* of Fig. 1 are the reactance tubes and the 6J5 is the oscillator. The type 6SA7 tubes were used merely for the convenience effected by the extra grid for applying modulation. The radio-frequency feedback which converts the tube into a reactance tube is fed to the control grid. Tube *A* is connected in the same type of reactance-tube circuit as is conventionally used for a.f.c. in broadcast receivers. Resistance R_1 and the grid-to-cathode capacity of the tube, C_{gk} , form a phase shifter which feeds phase-shifted voltage from the plate to the grid of the tube. R_1 is made large compared to the reactance of C_{gk} so that the phase of the current is determined by the resistance, and is in phase with the voltage

* R.C.A. Communications, Inc., Riverhead, N. Y.

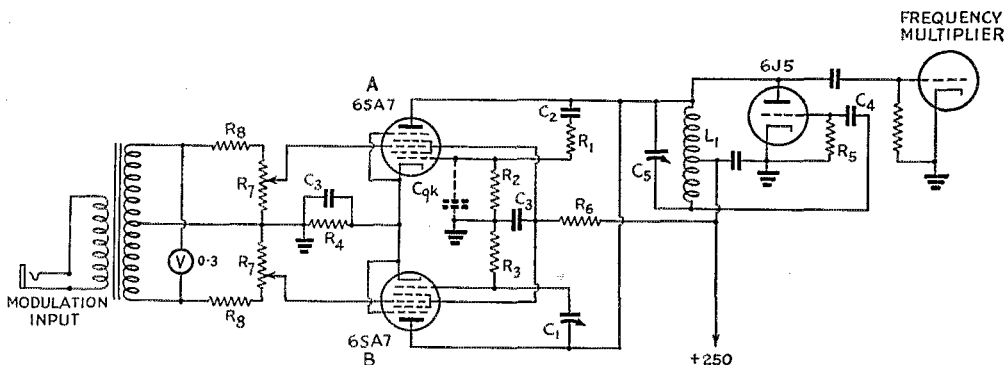

Fig. 1 — Circuit of push-pull reactance-tube modulator. Tube *A* is fed phase-shifted voltage to its grid so that its plate circuit acts like a shunt inductance dependent on the gain of the tube. Tube *B* is fed by a different phase shifter which causes the plate circuit to act like a shunt capacity dependent upon the gain. Push-pull modulation of the two tubes thus produces additive frequency modulation from them both.

R_1 — 50,000 ohms.
 R_2 — 0.5 megohm.
 R_3 — 1000 ohms.
 R_4 — 175 ohms.
 R_5 — 100,000 ohms.
 R_6 — 9000 ohms.
 R_7 — 100,000 ohms, ganged.
 R_8 — See text.

C_1 — 0.2 μ fd. Two-plate midget.
 C_2, C_3, C_4 — Normal by-pass and blocking-condenser values.
 C_5 — (for 5-megacycle oscillator frequency) — 0.25 μ fd. midget variable.
 L_1 — (for 5-megacycle oscillator frequency) — 32 turns No. 22 enameled, 1 inch diameter. Tap at 8 turns.

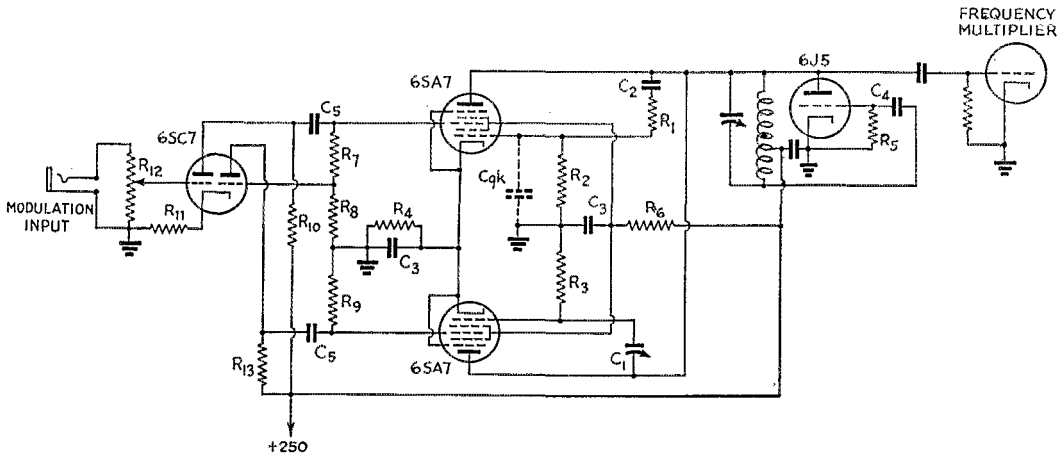

Fig. 2 — Suggested push-pull reactance-tube modulator for a 14-megacycle oscillator frequency.

- | | |
|--------------------------------|---|
| R ₁ — 50,000 ohms. | R ₁₀ , R ₁₃ — 250,000 ohms. |
| R ₂ — 0.5 megohm. | R ₁₁ — 4000 ohms. |
| R ₃ — 300 ohms. | R ₁₂ — 1 megohm. |
| R ₄ — 175 ohms. | C ₁ — 0.2 μ fd. two-plate midget. |
| R ₅ — 100,000 ohms. | C ₂ — 0.001 μ fd. |
| R ₆ — 9,000 ohms. | C ₃ — 0.005 μ fd. |
| R ₇ — 475,000 ohms. | C ₄ — 100 μ fd. |
| R ₈ — 16,000 ohms. | C ₅ — 0.01 μ fd. |
| R ₉ — 500,000 ohms. | |

applied from the plate circuit. This current flows through the grid-to-cathode capacity and causes a voltage drop which lags the current (usually we speak of the current leading the voltage across a condenser, but in this case we are talking about the voltage drop with respect to the current so it is lagging). When this lagging voltage is amplified, the plate circuit is caused to appear as an inductance since its current lags the applied voltage.

Tube *B* uses a phase shifter which feeds a leading voltage to the grid and therefore produces a capacitive reactive effect instead of an inductive effect in the plate circuit. Instead of a low-reactance condenser in shunt to the grid, fed by a high resistance, there is a low resistance in shunt to the grid which is fed by a condenser of high reactance. The series condenser, *C*₁, is small enough to have a reactance which is high in comparison to the resistance, *R*₃, so that the current through the phase-shifter is determined by the condenser and is therefore a leading

current. This leading current also flows through the resistor in the grid of the reactance tube *B* so that a voltage drop is caused which is in phase with the current and is therefore leading. When this leading grid voltage is amplified by the tube, a capacitive effect appears in the plate circuit since the current flowing in the plate circuit is caused to lead the applied voltage.

The reactive effect of the reactance tubes has a magnitude which is proportional to the gain of the tube. Thus an increase in the gain of the inductive tube *A* decreases the effective inductance which is in shunt to a portion of the oscillator tuned circuit. This causes the oscillation frequency to increase. Tube *B*, which acts like a capacity in shunt to a portion of the oscillator circuit, produces a decrease in the effective capacity when the gain of the tube is decreased. Hence the tendency is to increase the frequency for a change in gain which is in the *opposite* direction to that which caused the same direction of frequency change on the inductive tube. Consequently, the application of push-pull modulation causes additive frequency-modulating effects by the two tubes.

It will be noted that when the Hartley oscillator circuit is used as shown in Fig. 1, the reactance tubes are connected across only the plate portion of the oscillator circuit. This somewhat reduces the effectiveness of the reactance tubes as compared to an arrangement in which the reactive effect is connected across the whole tuned circuit, as might be the case if an oscillator circuit were chosen in which one end of the circuit were

The very nature of the simple single-tube reactance modulator makes it difficult to obtain a high order of carrier frequency stability in f.m. transmitters, as the author points out in this article. This defect is overcome in a new circuit, in which unwanted frequency variations are made to balance out by using two modulators of opposite characteristics in push-pull.

grounded. However, in the oscillator circuits with one end of the tuned circuit grounded, the cathode is usually at a radio-frequency potential from ground. Such an arrangement invariably produces hum in the form of frequency modulation. The remedy is to choose a circuit with the cathode grounded as was done in this case. Another alternative is to raise the heater to the same radio-frequency potential as the cathode by means of choke coils.

This push-pull circuit has the important advantage that it may be adjusted so as to neutralize all frequency instability due to power-supply variations. That is, if the oscillator taken alone happens to have reaction between the frequency and power supply, this reaction may be neutralized by proper adjustment of the reactance tubes. In such circumstances the reactance tubes are slightly off-balanced to produce a residual push-push reactance characteristic which is equal and opposite to the reaction characteristic inherent to the oscillator. The adjustment of this balance is made by means of condenser C_1 . For the normally-balanced condition of the reactance tubes, the ratio of the reactance of C_1 to the resistance of R_3 would be equal to the ratio of the resistance R_1 to the grid-to-cathode capacity reactance of tube A. In practice, C_1 may be adjusted by observing the beat note of the carrier and adjusting C_1 so that a variation of the power-supply voltage (obtained by cutting in a series resistance or in some similar manner) does not vary the frequency. For each setting of C_1 , a resetting of the main oscillator tuning is required in order to compensate for the reaction on the oscillator frequency effected by C_1 .

Another method of balancing the reactance tubes may be employed when it is only desired to balance their reactive effects without neutralizing the power-supply reaction which may be inherent to the oscillator. In this method the frequency-multiplied output of the modulator is observed on a frequency-modulation receiver and the modulator grids of the reactance tubes are temporarily tied together so that they are modulated in push-push. Modulation is then applied and C_1 is tuned for a minimum of the frequency-modulation output. Thus the reactive effects of the two tubes are arranged to oppose each other so that the adjustment for the minimum of frequency modulation indicates their equality. After the balance has been obtained the modulator grids are connected back in push-pull for normal operation.

In the circuit of Fig. 1, the push-pull modulation transformer will depend upon the user's requirements. In the writer's usage a 600-ohm input was desired so that this transformer consisted of a line-to-line transformer with the secondary damped with 600 ohms. This low-impedance secondary allowed the connection of the rather low-impedance rectifier-type voltmeter across the secondary without upsetting the im-

pedance matching (the voltmeter had a resistance of 1000 ohms per volt and a full scale reading of three volts, making a total resistance of 3000 ohms). The potentiometers, R_7 , are ganged. Resistors R_3 are chosen to produce full modulation for the maximum position of the potentiometers for a comfortable reading of the meter. Thus, they might be set at a value which gives a 25-kilocycle frequency deviation for the maximum setting of the potentiometer and a 2-volt reading on the meter. This arrangement allows the use of a readable deflection on the meter for normal modulation. Without such a potentiometer arrangement, a 25-kilocycle frequency deviation at 112 megacycles would be produced at about 0.05 volts on each grid (0.1 volts across the transformer secondary). This value is obviously too low to read on an ordinary meter.

The circuit of Fig. 1 used an oscillator frequency of about 5.0 megacycles. While this low frequency makes possible a high degree of modulation and a sensitive modulator, it is felt that for amateur usage a higher master-oscillator frequency can be used. The circuit of Fig. 2 is suggested for a master-oscillator frequency of 14 megacycles. The use of a phase inverter in place of the push-pull transformer is suggested since the added gain of the phase inverter will make possible the operation of the modulator directly from a crystal microphone.

A Stabilized Frequency Modulator

Where the utmost in frequency stability is desired, the circuit of Fig. 3 may be used. This circuit utilizes automatic frequency control to eliminate frequency instabilities regardless of their source. While a circuit employing the same principle has been described in *QST* before,¹ the circuit of Fig. 3 is somewhat different and a few design considerations and a discussion will be given here which will aid the user of this type of frequency modulator. It will be seen that this circuit uses the simple oscillator V_2 and single reactance tube V_1 . Normally this arrangement would be quite unstable if it were not for the automatic frequency control system consisting of converter V_3 , frequency discriminator D and detectors V_4 and V_5 . This automatic frequency control system operates on the heterodyned output from the converter, which is a relatively low frequency so that a small frequency change is a large percentage of the resulting heterodyned intermediate frequency. The crystal oscillator which is used as the beating oscillator for the heterodyning process must have a stability which is at least equal to that desired for the final carrier frequency.

For maximum stability, the intermediate frequency at which discriminator D operates must be as low as possible. For broadcast frequencies

¹D. E. Noble, "Frequency Modulation Fundamentals," *QST*, August, 1939.

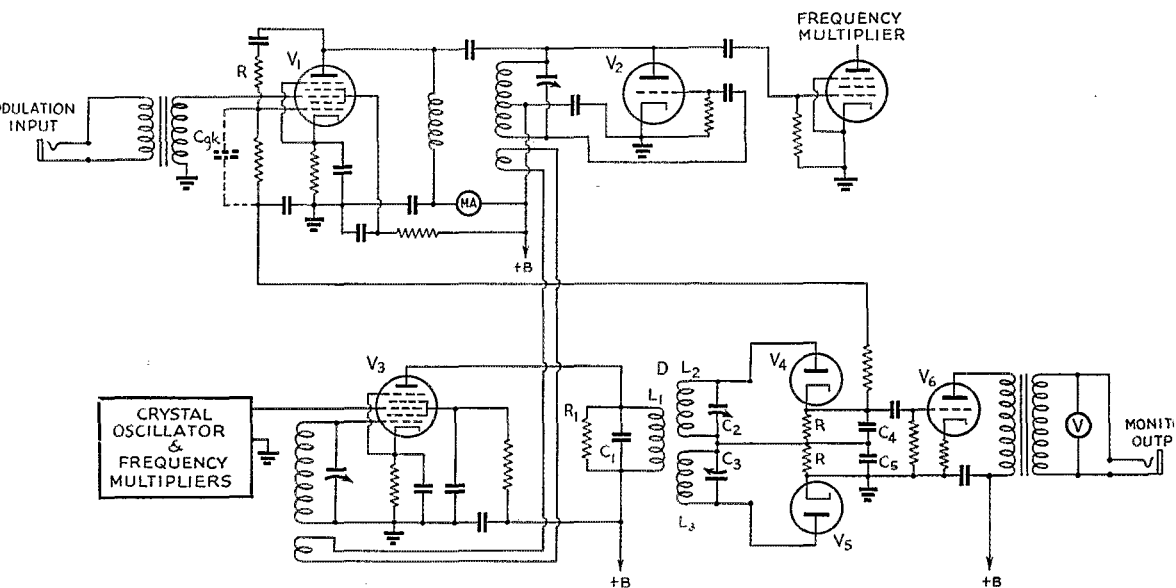

Fig. 3 — Reactance-tube frequency modulator with automatic frequency control. The a.f.c. circuits serve the dual function of maintaining frequency stability and providing a monitoring circuit.

The intermediate frequency of the stabilizing circuit is 460 kc. The following constants are applicable:

C₁, C₂, C₃ — 75- μ fd. midget variable.

C₄, C₅ — 200 μ fd.

L₁, L₂, L₃ — 2.5 millihenrys.

R — 0.2 megohm.

R₁ — 50,000 ohms.

Coupling between L₁ and L₂, 14%; between L₂ and L₃, 2.5%; spacing between primary and either secondary, $\frac{1}{2}$ inch. The input impedances of the diodes damp the two secondaries.

where a high frequency deviation is used, an intermediate frequency in the vicinity of one or two megacycles is used, but for amateur usage the conventional 450-kilocycle broadcast intermediate frequency has more appeal.

In Fig. 3 it will be noticed that discriminator D is somewhat different than the usual Seeley type of a.f.c. discriminator. It consists of a primary circuit which is tuned to the carrier frequency, and two secondaries which are off-tuned to opposite sides of the carrier frequency. The following are approximate empirically-determined rules which may be used in designing the tuned circuits:

$$Q_p = \frac{X_{c1}}{R_1} = \frac{X_{L1}}{R_1} = \frac{F_r}{3 F_d}$$

where Q_p is the Q of the primary circuit, F_r is the discriminator mid-band frequency, and F_d is the maximum frequency deviation (one-half total "swing") of the frequency-modulated wave applied to the discriminator. The Q of each of the secondary circuits is adjusted to be twice as great as that of the primary. This discriminator is merely an alternative to the Seeley discriminator and may be replaced by a Seeley discriminator with equal effectiveness. It may likewise be used as the discriminator in a frequency-modulation receiver using the same empirical design rules. The circuit is easy to align and is exceptionally linear.

The width of the discriminator must be adjusted to receive the full frequency deviation of the frequency modulation present on the intermediate frequency applied to it. This means that if the converter is fed directly by the master oscillator, the discriminator may be narrower than it would be if the converter were fed by a harmonic (assuming that it is desired to generate wide-band modulation where the frequency deviation is several times the maximum modulation frequency). The narrower discriminator is capable of maintaining a greater stability, but if a high harmonic is fed to the converter, the frequency variations fed to the discriminator are multiplied so that the control is more sensitive. These two effects tend to offset one another so that it makes little difference whether the converter is fed by a harmonic or by the fundamental of the master oscillator. Since the latter arrangement is simpler from the standpoint of the amount of multiplication required from the crystal oscillator, it is the logical arrangement to use. On the other hand, where the desired frequency deviation is of the order of an amount equal to the maximum modulation frequency, the discriminator will be of the minimum width (twice the audio modulation band) regardless of which harmonic is fed to the converter. For this case maximum stability is obtained when the highest harmonic is fed to the converter.

The band width of the discriminator shown in

Fig. 3 is such that it is capable of handling the full frequency deviation of 20 to 25 kilocycles which has been proposed by Grammer and Goodman.² With a discriminator this wide, converter V_3 may be fed by the frequency-multiplied radiated wave, instead of by the master oscillator, if desired. If the converter is fed by the master oscillator frequency as shown, somewhat greater frequency stability may be obtained by using a narrower discriminator.

The fact that the discriminator and detectors are available in the circuit of Fig. 3 affords a convenient method of monitoring the quality of modulation and the modulation level. By coupling audio amplifier V_6 to the detected output of the discriminator, the detected frequency modulation is amplified for monitoring and may be fed to a meter which may be calibrated in frequency deviation.

The meter in the plate circuit of the reactance tube V_1 serves the purpose of indicating how much automatic frequency control is being used to hold the carrier on frequency. This meter has a normal reading which occurs when the carrier is in proper tune, and a deviation above or below that reading indicates that a drift or change of some kind has caused the control to operate and bring the frequency back to as near normal as the degree of control allows. Normally the operator would only correct the tuning for large deviations of this meter since the frequency would be quite close in spite of a deflection from the normal.

For improved efficiency of the control circuit, an amplifier stage may be interposed between the converter and the discriminator so that the level fed to the discriminator is as high as possible. This amplifier should have a band pass which is capable of passing the full frequency swing of the modulation present in the intermediate frequency.

Strays

An ordinary dimmer floor switch, made for high- and low-beam control of car lights, makes a fine push-to-talk switch for ham rigs. Pushing it in just so far makes a momentary contact and pushing it in farther makes a permanent contact. One of these mounted on a board on your shack floor leaves both hands free to write in the log, etc. — *W8FU*.

— . . . —

Those who own a Howard 430 may easily rig up an arrangement for code practice by connecting a key between the two terminals at the rear marked V_1 and V_2 after removing the jumper. Then tune in a steady carrier and turn on the beat oscillator. A switch may be rigged up to short-circuit the switch when the key is not in use. — *Charles Ammerman*.

² Grammer and Goodman, "Wide-Band Frequency Modulation in Amateur Communication," *QST*, January, 1940.

While waiting for 20 to open up, I was reading the article about W8RAT in the March issue of *QST*. Upon finishing it, I turned on the receiver and the first signal I heard was W8RAT calling CQ! — *W1CBU*.

★ A.R.R.L. QSL BUREAU ★

FOR the convenience of its members, the League maintains a QSL-card forwarding system which operates through volunteer "District QSL Managers" in each of the nine United States and five Canadian districts. In order to secure such foreign cards as may be received for you, send your district manager a standard No. 10 stamped envelope (standard business size, $9\frac{1}{2}'' \times 4\frac{1}{8}''$). If you have reason to expect a considerable number of cards, put on an extra stamp so that it has a total of six cents postage. Your own name and address go in the customary place on the face, and your station call should be printed prominently in the upper left-hand corner.

- W1 — J. T. Steiger, W1BGY, 35 Call Street, Willimansett, Mass.
- W2 — H. W. Yahnel, W2SN, Lake Ave., Helmetta, N. J.
- W3 — Maurice Downs, W3WU, 1311 Sheridan St., N. W., Washington, D. C.
- W4 — G. W. Hoke, W4DYB, 328 Mell Ave., N. E., Atlanta, Ga.
- W5 — James F. Manship, W5ALE, 910 So. Boston, Tulsa, Okla.
- W6 — Horace Greer, W6TI, 414 Fairmount Ave., Oakland, Calif.
- W7 — Frank E. Pratt, W7DXZ, 5023 So. Ferry St., Tacoma, Wash.
- W8 — F. W. Allen, W8GER, 324 Richmond Ave., Dayton, Ohio.
- W9 — Alva A. Smith, W9DMA, 238 East Main St., Caledonia, Minn.
- VE1 — L. J. Fader, VE1FQ, 125 Henry St., Halifax, N. S.
- VE2 — C. W. Skarstedt, VE2DR, 236 Elm Ave., Westmount, P. Q.
- VE3 — Bert Knowles, VE3QB, Lanark, Ont.
- VE4 — George Behrends, VE4RO, 186 Oakdean Blvd., St. James, Winnipeg, Manitoba.
- VE5 — H. R. Hough, VE5HR, 1785 First St., Victoria, B. C.
- K4 — F. McCown, K4RJ, Family Court 7, Santurce, Puerto Rico.
- K5 — Norman F. Miller, K5AF, 15th Air Base Squadron, Albrook Field, Canal Zone.
- K6 — James F. Pa, K6LBH, 1416D Lunalilo St., Honolulu, T. H.
- K7 — Jerry McKinley, K7GSC, Box 1533, Juneau, Alaska.
- KA — George L. Rickard, KA1GR, P. O. Box 849, Manila, P. I.



CORRESPONDENCE FROM MEMBERS

The Publishers of *QST* assume no responsibility for statements made herein by correspondents.

SWITCH TO SAFETY

324 North Willett, Memphis, Tenn.

Editor, *QST*:

Last December I was on the air with a 600-watt rig trying to work DX and keep schedules with my father in California. About two weeks before Christmas the final and buffer began to do things that they shouldn't. I spent several days trying to find the trouble, and traced it down to a bad 866 rectifier in the 1200-volt power supply. That night I took out the old 866 and put a new one in, leaving the cap hanging on the wire while I ran it on the filament voltage for the time needed. After the mercury had vaporized, I turned the plate voltage on without thinking about the danger and reached for the cap of the new 866. Immediately upon touching it, the 1500 volts that came out of the transformer went into my hand and grounded on my wrist. Somehow I got away but then I saw that the electricity had burned into my thumb and forefinger to the bone and had burned three inches along my wrist and down to a tendon. As a result of this I have already lost most of my thumb and the tip section of my index finger, and am going to have an operation tomorrow to have the thumb removed down to the hand and the bone on my forefinger covered. The long scar on my wrist took three months to fill with flesh and be covered with skin. I afterwards learned that the electricity cauterized a vein that it burned, and because of this I narrowly missed losing a lot of blood after the accident. The amount of voltage was so great that it arced over from the index finger to the middle and ring fingers, and a few volts went through my body and grounded to the panel when I accidentally touched it. This voltage made blisters on the fingertips where it grounded and showed how narrow an escape I had from death. The accident was probably caused by my switching on the plate switch instead of switching off the filament switch which was beside it.

I do not think now that I will ever work on that transmitter anymore. . . .

— Robert Townsley, W4GDH

ANOTHER SOLUTION

7126 Pershing Ave., University City, Mo.

Editor, *QST*:

I have just read W2AOE's article in April *QST* concerning the lack of activity on the ultra-high frequencies. I think he has raised an important question, since u.h.f. research is probably second only to emergency work in the value of amateurs to the nation.

However, I disagree with W2AOE in the best method of populating the u.h.f. bands. The adoption of frequency modulation on the high ends of the 56-Mc. band can do no harm, but I predict that, while the effect will be that there will be a considerable increase in QRM on the high end of the band, the increase in the actual number of hams using "five" will be negligible.

I disagree also with W2AOE's suggestion that new hams should be allowed a 1-year license for u.h.f. work without a code test. In the April ORS/OPS bulletin, the viewpoint of the Wireless Institute of Australia was quoted, a part of which quotation reads as follows: "In this time of emergency an operator capable of handling traffic at 25 w.p.m. is invaluable to his country to-day, below 16 w.p.m. practically useless until he has had further Morse training. Operating ability is the prime asset."

The situation for W hams is similar. If Uncle Sam were to become involved in the war, it will be the fast, experienced operator who will be of greatest service. Also, in local or regional communications emergencies we must have plenty of fast, efficient ops.

Far too many new hams of to-day go on 'phone immediately upon receiving their licenses, never to increase their code speed above about 13 w.p.m. I believe I have a solution to this unfortunate problem, as well as to the method of populating the ultra highs: Forbid the use of 1.8- and 28-Mc. 'phone to new hams until they have been licensed for one year. Let the new ham be eligible for the Class A examination one year after he has had his license modified for 1.8 and 28-Mc. 'phone privileges. The 'phone bands below 28-Mc. are overcrowded, so a small decrease in QRM would be welcomed by hams using those bands. The effect of this plan would be that many who would otherwise go on 160- or 10-meter 'phone would now go on the ultra-high frequencies. When conditions on u.h.f. are bad, they would get c.w. practice on the lower frequencies. This seems to me a practical way of killing two birds with one stone.

— Bill Skinker, W0AEJ

LOW POWER JOYS

713 St. Louis Ave., East St. Louis, Ill.

Editor, *QST*:

The numerous articles and letters appearing from time to time in *QST* regarding the joys derived from using low powered transmitters finally got me. I built a tiny unit of a code squitter for 7 Mc. and I built well.

So what happened? I raised 'em from Maine to California and back again, with practically no power at all. Great stuff, only with few exceptions the amount of intelligence conveyed in these low-powered contacts was confined to getting the calls OK and a hazy remark or two about QRM. Then the inevitable, "Sorry OM lost u in the QRM c u agn 73."

Where before I enjoyed solid and intelligent chats with the 40-meter crowd, I now had spotty and vague contacts. Unfortunately, I am not one of the leisure chappies; having to work for a living, my operating time is necessarily limited. During the time I do have for getting on the air I want good solid contacts, enjoying ragchewing above everything else in ham radio.

This simply cannot be done with mouse-powered toys using anything from a fountain-pen flashlight cell to static off a cat's back for power.

The remarks of W6EAK in May *QST* are typical of the "Joy through no power at all" boys. Maybe I didn't get down to rock bottom, having stopped at 10 watts.

Anyhow the 500-watter is back in operation, and if the blinking lights can be made to behave I will have 'er up to a full 1 kw. shortly.

Would somebody make me an offer on a nice 10-watt transmitter?

— Earl R. Linder, W9DZG

CODE PRACTICE STATIONS

Baltimore, Md.

Editor, *QST*:

Just finished reading the article by Riley Parsons, W8BXY, on code-practice stations. Am I disgusted! It is not an idea of selling a few more copies, as he puts it — it is the idea that a few selfish hams ruin the good name of hamdom. For instance, he has a ticket, why not close up the bands to any new ones now and give the whole thing to him? I'm sure that would suit him fine. I'm an SWL and a prospective ham and think that the bands should be for every one to enjoy and not the selected few. . . .

— Bill Rogers, SWL

A Traffic Transmitter

Ganged E.C.O. on 30 and 40 Meters

BY HAROLD M. BAKER,* W9MDJ/W9EZ

INTEREST in traffic work coupled with the desire for a readily portable transmitter prompted the construction of the transmitter to be described. Stories of portable outfits show rigs varying all the way from knapsack jobs to trailer-transported units, but in our case "portable" meant that the station must be built in easily-handled units that could be carried in the back seat of an automobile and then set up in the new location. Since the transmitter was to be used for daily fixed-station operation, economy dictated a 110-volt a.c. power supply, but we hope some day to have a gasoline-engine generator for emergency use, and a vibrator-pack could be used if necessary. The present a.c. power supply is built in two sections, neither one of which is too heavy to carry easily. The power supplies and the transmitter are interconnected by cables made fool-proof by using a different number of prongs on each outlet.

For convenience in operation, the e.c.o. is ganged with the doubler and final stages. Antenna coupling adjustments are facilitated by inclusion of a swinging link on the output tank coil. Crystal control can be used, when the e.c.o. becomes indisposed or a stabilized power supply is not available, by removing a plug-in condenser and plugging-in the crystal. Inspiration for the oscillator-doubler circuit came from Perrine's article,¹ although some slight modifications were necessary for portable work. His "floating chassis" construction could not be used because of space limitations, the oscillator tuning condenser

was made larger in order to cover the 80-meter band, and the oscillator was keyed in the screen grid circuit for break-in work. The 6V6 doubler tank was likewise modified, and a capacity-coupled 807 final amplifier was added. We are not in a position to undertake much experimental construction, but, following the original specifications, the oscillator gave no trouble at all.

The Circuit

The reader is referred to the original article by Perrine for a detailed description of the development of the oscillator circuit. An oscillator tank capacity in the vicinity of 1000 $\mu\text{mfd.}$ and temperature compensation make for stable operation. The output of the 6SK7 oscillator is in the 160-meter band, the 6V6 doubles to 80 meters, and the 807 operates straight through or doubles to 40 meters. With the constants given and with the oscillator pad, C_3 , wide open, the main dial varies the frequency from about 3480 to 3980 kcs.

The heater and cathode of the oscillator are maintained at the same r.f. potential by heater feed through L_1 and L_2 . The location of the cathode tap on L_1 has an important effect on the frequency-*vs*-voltage characteristic and may need to be varied in another unit. The screen voltage is taken from a divider and further dropped through a resistor. The actual screen voltage is about 145. Simply breaking the screen lead gives chirpless keying.

The 6V6 doubler is capacity-coupled to the oscillator through C_7 . This condenser is soldered into a five-prong coil form. Substituting a crystal for it, as shown in the circuit diagram, makes the 6V6 a crystal oscillator. The cathode of this tube

* Culver Military Academy, Culver, Ind.

¹ Perrine, "An Answer to the E.C.O. Problem," *QST*, September, 1939.

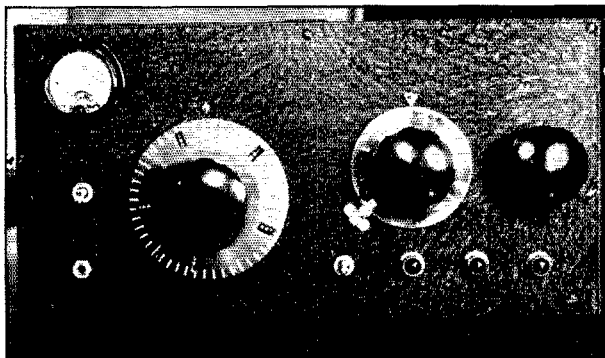

The complete r.f. portion of the ganged transmitter is built in a receiver cabinet. The large PW dial controls the tuning, the smaller dial is a band-set control for the final amplifier, and the knob is for adjusting the variable link on the output coil.

A view inside the cabinet shows the arrangement of the gear. The oscillator section is at the left, the 6V6 buffer-doubler is at the rear behind the tuning gear-box, and the final amplifier is at the right. The large coil at the rear left is the 7-Mc. final tank coil, conveniently stored out of the way. Note that the chassis has been cut away slightly to allow the swinging link a wider range of variation.

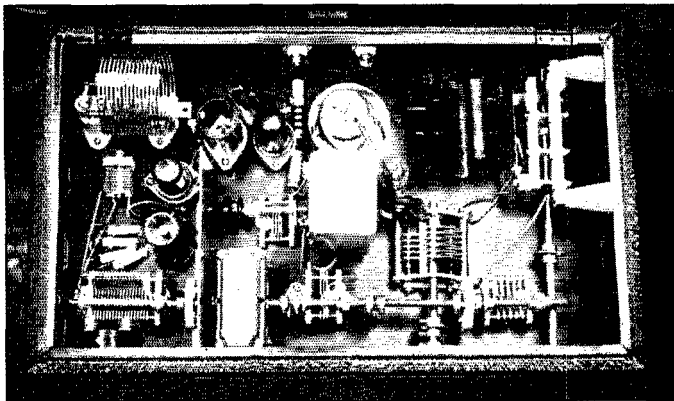

may be keyed through the cathode jack, J_2 . When operating e.c.o., stations report no difference in the keying in either the oscillator or doubler circuit. The second jack is not shown in the photograph because it was added later.

Both the doubler and the final stage use parallel feed to reduce the number of d.c. hot points. The doubler tank coil, L_3 , is removable so that other coils may be substituted for crystal operation on other bands. In order to make it practically impossible to touch a point of high d.c. voltage, insulated connections should be made to the top end of RFC_4 , the 807 plate and the meter.

Switch S_1 shorts the key, and switch S_2 breaks the 807 cathode so that the frequency of the transmitter can be adjusted without going on the air — an important point in good operating technique. Each lead from the power supply to the oscillator-buffer is by-passed at the point where it enters the chassis, in order to eliminate r.f. feedback as much as possible. The oscillator heater is separately switched so that it may be left on all the time if desired.

The final bandset condenser, C_{19} , is brought to the front of the panel so as to be readily adjustable if the antenna load disturbs the ganging. The taps are adjusted with no load.² The main dial may be tuned from one end to the other with the final plate current staying between 10 and 12 milliamperes on 80 meters. With the antenna links specified the final may be loaded to 100 ma. without trouble.

² Mix, "Gang Tuning for the Multi-Stage Transmitter," *QST*, June, 1938.

Here is a transmitter with everything the 80/40-meter traffic and rag-chew man might want in his transmitter. Oscillator keying for break-in operation, ganged tuning for quick QSY, and stabilized frequency control for net operation. And it's small enough to make a mighty nice portable rig.

Construction

The transmitter is built in a National HRO cabinet. Using the components named in Fig. 1 there is not much variety in arrangement possible in the given space. However, the shielding is good and the final coil has plenty of room. The knobs on the front panel are, left to right, the main tuning dial (National PW-O), final bandset condenser, and variable link output. The left-hand switch is S_1 and the switch in the center is S_2 . Another jack has been added just above the one shown in order to key the cathode of the 6V6.

All sockets are supported above the chassis except the one for the 807. This allows short, direct leads and keeps all the r.f. above the chassis except at the final grid. The 807 is underslung in order to fit the cabinet, and this improves the shielding of the tube. The extra plate coil is mounted on standoff jacks at the rear left corner of the cabinet, and thus is stored in space which otherwise would be unused.

The e.c. oscillator is at the left end of the cabinet. What appear to be small resistors near the coil are the temperature-compensating condensers. The one which is hung in the center of the oscillator coil is the one with the negative coefficient. The aluminum shield is fastened securely to the gear box and also to the chassis, in order to make the oscillator as rigid as possible. Further strengthening is obtained by screwing a six-inch length of half-inch angle iron under the chassis at right angles to the aluminum shield. The 100- μ fd. air padder, C_3 , is beside the 6SK7. It may be adjusted through a ventilating hole in the rear of the cabinet.

The coil form which mounts the coupling condenser C_7 can be seen just back of the aluminum shield. This form is plugged into a five-prong socket supported above the base on pillars. Plugging-in a crystal turns the 6V6 into a crystal oscillator, keyed in the cathode.

The 6V6 crystal oscillator-doubler is next to the condenser-crystal socket. In front of the 6V6

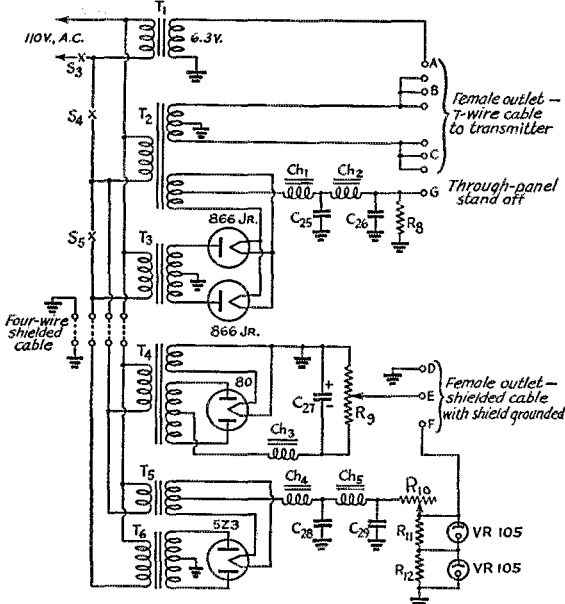
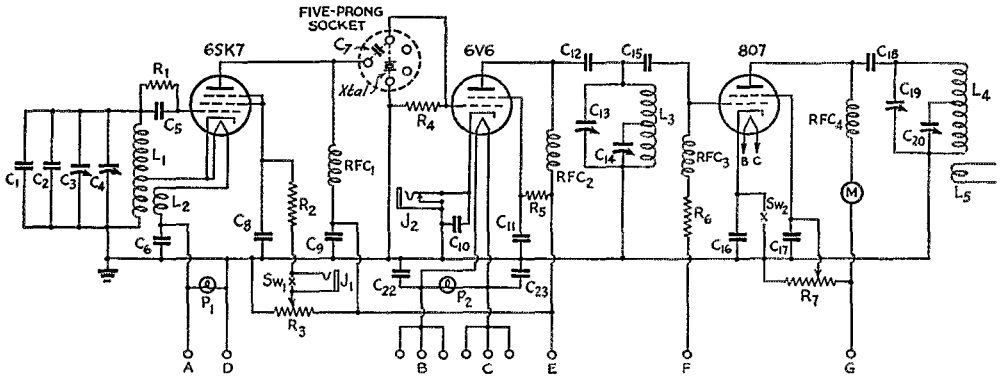

Fig. 1 — Circuit diagram of the transmitter and power supplies.

- C₁ — 10- μ fd. negative 0.0007 temp. coefficient (Centralab).
- C₂ — Four paralleled 200- μ fd. zero temp. coefficient (Centralab).
- C₃ — 100- μ fd. air padder (Hammarlund APC-100).
- C₄ — 260- μ fd. (Hammarlund MC-250-M).
- C₅, C₇ — 100- μ fd. midget mica.
- C₆, C₈, C₁₁ — 0.002 μ d. midget mica.
- C₉ — 0.001- μ d. midget mica.
- C₁₀, C₁₂ — 0.01- μ d. 600-volt paper.
- C₁₃ — 50- μ fd. bandset (Hammarlund MC-50-M).
- C₁₄ — 35- μ fd. (Hammarlund MC-35-M).

- C₁₅ — 500- μ fd. mica.
- C₁₆, C₁₈ — 0.002- μ d. mica.
- C₁₇ — 0.005- μ d. mica.
- C₁₉ — 50- μ fd. (National TMSA-50).
- C₂₀ — 35- μ fd. (Hammarlund MC-35-MX).
- C₂₁, C₂₂, C₂₄ — 0.1- μ d. 400-volt paper.
- C₂₃, C₂₅ — 4- μ d. 1000-volt (Aerovox 1009).
- C₂₇ — 8- μ d. 450-volt insulated mounting electrolytic (Aerovox I-450).
- C₂₈ — 8- μ d. 450-volt electrolytic (Aerovox G450).
- C₂₉ — 12- μ d. 450-volt electrolytic (Aerovox G450).
- R₁ — 1.5 megohms, 1/2-watt.
- R₂ — 15,000 ohms, 1-watt.
- R₃ — 20,000 ohms, 10-watt adjustable.
- R₄ — 100,000 ohms, 1/2-watt.
- R₅ — 20,000 ohms, 2-watt.
- R₆ — 10,000 ohms, 2-watt.
- R₇ — 25,000 ohms, 75-watt adjustable.
- R₈ — 100,000 ohms, 200-watt bleeder (Pyrohm).
- R₉ — 7500 ohms, 25-watt adjustable.
- R₁₀ — 10,000 ohms, 25-watt adjustable.
- R₁₁, R₁₂ — 0.25 megohms 1-watt.
- RFC₁, RFC₂, RFC₃ — National R-100.
- RFC₄ — National R-154U.
- J₁ — Open circuit jack (key e.c.o.).
- J₂ — Closed circuit jack (key buffer or xtal oscillator).
- M — 0-150 milliammeter.
- S₁, S₂ — S.p.s.t. toggle switches.
- S₃, S₄, S₅ — Heavy-duty toggle switches.

- T₁ — 6.3 volts (Thordarson T-19F81).
- T₂ — 6.3 and 2.5 volts, high-voltage insulation (UTC S-65).
- T₃ — 900-800-0-800-900 volts (Thordarson T-19P56).
- T₄ — 240-0-240 volts (Thordarson T-13R19).
- T₅ — 5 volts, good insulation (Stancor P4088).
- T₆ — 350-0-350 volts (Thordarson T-13R13).
- T₇ — 5 volts, 200-ma. (Thordarson T-19C35).
- Ch₁ — 5-20 henrys, 200-ma. (Thordarson T-19C42).
- Ch₂ — 12 henrys, 200-ma. (Thordarson T-19C42).
- Ch₃ — 10 henrys, 65-ma. (Stancor C-1708).
- Ch₄ — 15.45 henrys, 90-ma. (Kenyon T-517).
- Ch₅ — 30 henrys, 90-ma. (Kenyon T-153).
- P₁ — Green pilot light.
- P₂ — Amber pilot light.

is its bandset condenser, with the tuning condenser just to the right of the gear box. The doubler output coil is mounted in a National PB-10 shield. This coil is made removable so that other coils may be substituted in case it is desired to use a crystal working on some other band.

The 807 in its shield is back of the doubler coil shield. The final tank coil is to the right, and the

two tuning condensers are in front. A large r.f. choke was used to shunt-feed the plate of the 807 in order to have different amounts of inductance at RFC₃ and RFC₄.

The leads to L₄ are longer than is desirable but give no trouble at these frequencies. The coil should be at least a half diameter away from any metal, to reduce losses. The end link swings down-

Baker — Coil Specifications

- L_1 — 19 turns No. 26 enameled wound on 1-inch diameter form to occupy $\frac{3}{4}$ -inch winding length. Tap 5 turns from ground end.
- L_2 — 5 turns No. 26 enameled interwound at ground end of L_1 .
- L_3 — 80 meters: 34 turns No. 26 enameled closewound 1 inch diameter. Tap 25 turns from ground end (in National PB-10 base and shield).
- L_4 — 80 meters: 28 turns No. 18, $2\frac{1}{2}$ inches diameter, $2\frac{1}{4}$ inches long. Tap 20 turns from ground end. 40 meters: 11 turns No. 14, $2\frac{1}{2}$ inches diameter, $1\frac{1}{4}$ inches long. Tap 8 turns from ground end.
- L_5 — 80 meters: 3 turn swinging link in series with 2 turns wound over ground end of L_4 (see text) 40 meters: 3 turn swinging link.
-

ward through a hole cut in the chassis. The output terminals are feed-through insulators mounted at the center of the back of the cabinet.

It is both convenient and a safety measure to be able to adjust the load from the front of the panel, particularly in a variable-frequency unit. We use a B & W BVL link assembly with the link moved to the ground end of the coil. The coil is home-made to the $2\frac{1}{2}$ -inch diameter of the link. It is wound in the conventional way on a diagonally-split wooden cylinder. The bottom celluloid strip is heavier than usual and is made long enough to act as a support. Cement is put outside the bottom strip and another piece of celluloid is fastened to the outside. When this dries the coil is removed from the form and supported at one end on a pillar, as may be seen in the photograph. Care must be taken to mount the coil so that the link will just clear the end. The ground end is supported by the short wire lead to the jack on the Alsimag strip. In order to load the final sufficiently on 80 meters, we found it necessary to add a fixed link of 2 turns in series with the variable link.

No picture was taken of the underside of the chassis because its arrangement is not important. It would show power leads, by-pass condensers, R_3 and R_7 , the 807 socket and a filament rheostat which we found necessary for the 6SK7. With other components it might be possible to find room for the oscillator power supply, but we preferred to keep the power supply entirely separate.

Checking Performance

The oscillator should be checked carefully at different frequencies before going on the air. This can be done with a monitor or receiver. In fact, before each operating period or each new frequency the oscillator should be checked in the receiver with switch S_2 breaking the final cathode circuit. A monitor should be used to check the signal of full power input. If there is any roughness in the note, first make sure that the final is tuned to resonance. If the roughness persists, and

if the power supply is not at fault, then r.f. is probably feeding back into the oscillator circuit. Better circuit isolation, better shielding, better choking or by-passing may be necessary.

When good quality output has been obtained, vary the oscillator plate voltage to observe its effect. This may be done by breaking the common lead to the oscillator plate and screen and inserting a resistor of several thousand ohms. If the frequency goes up with this drop in plate voltage, the cathode tap is too high on L_1 . The voltage-frequency characteristic is also affected by the values of R_2 and R_3 . These may need to be changed in a different unit.

When the above tests were applied to the transmitter described, the output was good and a 25-percent drop in oscillator plate voltage produced only a few cycles difference on 80 meters. The adjustments were therefore left as they were. Further experimentation for temperature compensation is possible but did not seem necessary. For ordinary operation on spot frequency nets there is no apparent difference in setting between a cold start and a temperature attained by leaving the oscillator heater turned on for several days.

The Power Supply

The power supply is mounted on two 7×17 inch chassis with perforated metal covers. Figure 2 shows the wiring diagram. There are actually three supplies: oscillator-buffer, bias, and final plate. The supply for the final is larger than necessary, but we wanted such a supply available in the station. The switch S_3 turns on only the oscillator heater, while S_4 turns on all other heaters and the bias supply. S_5 turns on all plate voltages. Each switch position is shown by a pilot light on the transmitter panel. The pilot light working from S_5 gets its power from a spare 6.3-volt winding on the plate transformer T_6 .

The bias voltage is set at about 70 volts. All filament voltages were correct with 115 to 120 volts input except that of the oscillator, and this was corrected with a rheostat. Regulation of the oscillator plate voltage can be checked by varying the input to T_6 with a lamp in series with the line.

R_8 is an inexpensive high resistance bleeder to make sure that the filter condensers will discharge. The transformer T_7 was expected to give 600 and 750 volts d.c. at different secondary taps. Actual measurements, however, show 650 and 800 volts output. The higher value has been used on the plate of the 807 for at least an hour a day every day for the last two months with no apparent ill effects.

In conclusion, we would like to say that this transmitter is presented as one intended to perform a particular job, and it does that job well. Perhaps it will inspire others to modify it for their own needs.

Say It With Words

Some Observations On 'Phone Operating Procedure

BY KENNETH B. WARNER, W1EH*

ONE can not be exposed constantly to 'phone operation without having it sink in that there is a basic weakness somewhere in our 'phone operating procedure. Here we have a most useful and flexible medium for the exchange of intelligence from one end of the world to the other, but we are muffing many of its potentialities by maladroit practices. Our apparatus has been brought to a reasonably high state of satisfaction, but there are a number of bumps in the characteristic curves of our operating procedure which could stand some filtering, so to speak. Some of the practices currently employed in 'phone operation are so foreign to its atmosphere that they are definitely impeding its development. They are preventing the realization of those advantages that are peculiar to voice operation.

Fundamentally the trouble would seem to be that we have never rationalized our 'phone technique. It has just grown up, largely as a carry-over from c.w. practices, and with no standards of its own. Nobody has worried about it, nobody has thought much about his procedure. I hope to show that if we'll each pitch in and do our share, we can make a big improvement.

'Phone operators as a class have never taken kindly to anything that smacked of regimentation. They are individualists. But in all truth it must be admitted that, perhaps for that very reason, there is a great deal of confusion, inefficiency and dumbness in 'phone operating; and it must appeal to any thoughtful person that if we take stock of the situation we can make more pleasure for ourselves.

One of our prime inanities is the practice of carrying over into 'phone operation the jargon that is peculiar to c.w. work. It must sound like all heck to the uninformed public which seems to derive some pleasure from eavesdropping on our conversations and which necessarily judges our intelligence by what it hears. Now in telegraphy, words must be spelled out, letter by letter. It is therefore but natural that abbreviations and shortcuts should have come into widespread use; they make it possible to convey intelligence faster. But they have no part in voice work. It is difficult to understand why we 'phone operators drag in by the heels a bunch of c.w. abbreviations designed for the brasspounder but which have no place in a medium where voice can be used. Perhaps we do it with a bit of pride to indicate that

* Editor; managing secretary, A.R.R.L.; O.P.S.

we are "also c.w." But the two branches of our art are quite dissimilar and each should have its own operating practices. Any 'phone amateur is the proprietor of a medium which, for its purposes and within its (sometimes very definite!) limitations, is superior to c.w. in the facility and felicity of communication.

Have you never been burned up by hearing a 'phone station wind up a transmission with "K, O M, dah-de-dah"? Some of us think that this is about the ultimate in nitwit practices. The letter "K" has been agreed to in telegraphic practice so that the operator will not have to pound out the separate letters that spell the words "Go ahead." But the voice operator can more readily and understandably say the words "Go ahead," or "Over,"¹ or "Come in, please," or whatever form he elects. He should not dip into telegraph parlance. Let him say it with words!

This example illustrates a host of operating evils that could be cited. The similar use of "SK" is one. The use of Q abbreviations is another. To better our 'phone work we ought to abandon the Q code completely; and the sooner the better. There is no place whatever for it. Really, doesn't it sound silly to announce that "The QTH here is Podunk, old man," when we could as well say, "I am located in Podunk," and be done with it? A particularly florid example of this practice is the abuse of the honorable old telegraph term "73." 'Phone men seem particularly prone to saying, "Well, I guess I'll say best seventy-threes now." Mangled as it is, that of course manages to convey the sender's "best best regardses." But here's the point: when we have in our possession the most flexible medium in the world for gracious expression, why should we use a symbol concocted as telegraphic shorthand? Let's say it with words!

And — CQ! Some of us confess to writhing in shame for amateur radio when we hear a voice station saying, "Helloooooow CQ CQ CQ, hello CQ CQ CQ, hello CQ twenty," etc., ad. naus. (B.C.L.'s think we're saying, "Seek you"! Here's another word-sign of telegraphic shorthand, dragged in by the short hair. Certainly it's high time we all came to saying, "Calling any

¹ "Over" is British, derived from "Switching over" or "Changing over." "Come in" has a certain international commercial acceptance but has been roundly rejected by American 'phone amateurs. "Go ahead" is good old U. S. and we therefore vastly prefer it

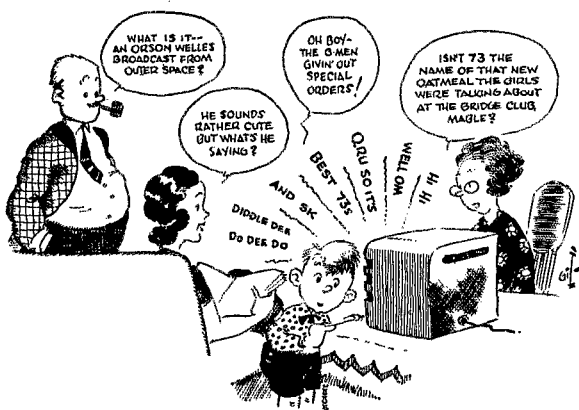

amateur ('phone) station." But not "CQ." Say it with words! Incidentally, there is no longer justification for naming the band.

A word particularly needs to be said about procedure in giving signal reports. (Our system of comparing signals is not satisfactory and remains a subject for grand argument, but this concerns the existing system.) We find a bad combination of bad practices, not only in the use of telegraphic practice but obsolete practice at that. An average report, for instance, informs you that you are "QSA 4, R 8." Now the sender of that report doubtless means to inform you that your readability is 4 on a scale of 1-to-5 and that your strength is 8 on a scale of 1-to-9. But we 'phone men have fallen behind the parade. In the first place, the international abbreviations were changed years ago so that "QSA" now refers to strength, too, and not readability. The proper telegraphic symbol for readability is "QRK." Again, amateur radio years ago abandoned the R scale for strength and adopted the S scale — almost all of amateur radio, that is, except some of us 'phone guys. So, at the least, such a report ought to have gone "QRK 4, S 8." But this is telegraph nomenclature, devised for the c.w. operator who otherwise would have to spell out many words to tell you the state of your signals. We have the ability to say it with words. If we feel that we must give a quantitative report, we can do it with utter neatness and comply with the canons of good voice practice by pronouncing the words, "Readability four, strength eight."² But voice operation ought to be superior to quantitative reports. Changing transmission conditions and the constantly-shifting interference pattern are what limit 'phone communication. The necessary reporting can be done so much more meaningfully with ordinary words: "You are weak but you are in the clear and I can understand you, so go ahead," or "Your signal is strong but you are buried under local interference." Why not say it with words?

² WIAW has always used this form when on voice.

Did you ever laugh over a morse key? If so, you didn't do it by spelling out ripples and peals. You did it by tapping out the letters HI. That is a convention devised to do as good a job of laughing as is possible with inanimate dots and dashes. Do you suppose there is something the matter with the 'phone man who, when he thinks a laugh is indicated, says, "Hi" or "Aitch eye" instead of actually laughing? With a medium that transmits his very breathing and the yelling of the baby in the next room and the rattling of pots and pans in the galley, why does a fellow have to say, "Hi," and generally without a trace of mirth? Here's one place where you *cannot* say it with words.

Another indictment, more serious: It is misleading as the very dickens to use random geographical place names as phonetics for the letters in calls. Oh, sure, we know the system: this call is W1EH and so it's "W 1 England Halifax." Says you! Heaven helping, it will never get aired as W-1-England-Halifax for the good reason that W1EH is neither in England nor in Halifax, and we don't want anybody to think they're hearing an English or a Nova Scotian station when they're not. There is trouble enough identifying spoken calls without adding geographical confusion. Similar emotions apply to home-brewed phonetics that are supposed to be descriptive or cute or humorous but which generally manage to fall somewhere between the painfully dumb and the salacious. Even such good phonetics as Ever-ready, Radio and Yesterday are not universal standards. Now hold everything: 'phone provides an opportunity for individuality, but in the important matter of recognizing the letters in calls, is it not plainly advantageous to us all to have a common standard and to confine our individualities to the ensuing conversations? We need something that everybody uses and instantly understands. Now we have such a system, an A.R.R.L. standard, adopted by vote of the O.P.S.'s after months of study. The only trouble is we don't use it enough. It is the Western Union word list, one that has been scientifically compiled for maximum understandability and which already has widespread adoption in other circles.³ Let's junk the current hodge-podge and stick to our standard, and it only:

ADAMS	DENVER	GEORGE
BOSTON	EDWARD	HENRY
CHICAGO	FRANK	IDA

³ The W.U. list involves a few geographical names and therefore violates one of our private fundamentals. But there are only four such names in it, and we can learn to listen carefully to avoid confusion on that score. O.P.S. appointees, we understand, are going to be asked to consider recommendations for changing these four place names. Meanwhile the adoption of the W.U. list as the A.R.R.L. standard makes it good enough for us.

JOHN	PETER	VICTOR
KING	QUEEN	WILLIAM
LINCOLN	ROBERT	X-RAY
MARY	SUGAR	YOUNG
NEW YORK	THOMAS	ZERO
OCEAN	UNTON	

interference. The study made has resulted, then, in the following suggestions.

Calling CQ

The most useful employment of these phonetics is in identifying *your own* station. There is no need to use them in calling the other station; he'll recognize his own call right enough, phonetics or no phonetics. In applying them to calls, they ought to be directly substituted for the letters. For instance, in the case of W1EH they are not used as "Doubleyou one E-for-Edward H-for-Henry," but directly as "Doubleyou one Edward Henry." Why not? It's simpler and shorter, perfectly understandable, and the identification factor for F.C.C. purposes is absolute, so that there can be no squawk on that.

Some Suggested Procedure

Having come this far along with a critical examination of some of our practices, it becomes possible to compound some of the ideas into a regularized procedure that would offer us improved usefulness. Is it desirable to do this? 'Phone amateurs like the "play of individuality" that voice work affords and any attempt to limit it is likely to meet objection. However, that individuality can have its full play in the conversations themselves and we could benefit from some standardization in procedure. Some simple standards would work wonders for us, particularly in calling, answering and signing. As it is to-day, our variations in method frequently cause confusion between who is calling and who is being called, and they actually waste a considerable part of the contact time in calling and signing — time that could be more profitably employed in conversation itself during the all-too-brief duration of the average 'phone QSO. Having had the opportunity at Headquarters to study much correspondence on this subject from leading 'phone amateurs, and having deliberately experimented with different possible procedures, it has become apparent that if we had a bit of standardization in procedure we could have equal understandability with much greater brevity, saving precious time and

In the examination of calling and signing procedures, the logical first item is the general call. It certainly seems desirable to "say it with words" and avoid the abbreviation CQ. Phonetic identification of our own call is useful. There seems no point any longer in mentioning the band. When these several thoughts are put together, it becomes possible to visualize a form of general call, based on the old rule of "three times three," that meets the requirements we have set up. Of several possible ways of doing this, the one shown as an example is chosen because it is related in style to other suggestions that will be made later. Does not the following seem to meet every test we could make on it for soundness, clarity and good taste?"

Calling any amateur ('phone) station, calling any amateur ('phone) station, calling any amateur ('phone) station. Doubleyou one Edward Henry in West Hartford, Connecticut, calling any amateur ('phone) station, calling any amateur ('phone) station, calling any amateur ('phone) station. Doubleyou one Edward Henry in West Hartford, Connecticut, calling any amateur ('phone) station, calling any amateur ('phone) station, calling any amateur ('phone) station. Doubleyou one Edward Henry in West Hartford, Connecticut, standing by.

Answering a CQ

Answering a CQ may very well take the same form as calling any particular station. The fewer "procedures" we have, the easier it is to do them well automatically. See the discussion next below.

Calling a Particular Station

Under the head of calling a particular station we need a procedure that can be applied equally well to answering a CQ, or to calling a station because we hear it on the air, or to calling somebody on schedule. Whatever the practice, it must avoid confusion between caller and callee. It must unmistakably convey the sender's call. It must show other stations that contact is not yet established. It ought to avoid terms that the gang has rejected, such as "Come in." Contact not yet existing, it might appropriately again make use of the expression "Standing by." Relying just a little on accepted commercial procedure, it might well look like this:

Hello W9UZ W9UZ W9UZ (Chicago). Doubleyou one Edward Henry (in West Hartford) calling. Hello W9UZ W9UZ W9UZ. Doubleyou one Edward Henry calling. Hello W9UZ W9UZ W9UZ. Doubleyou one Edward Henry calling and standing by.

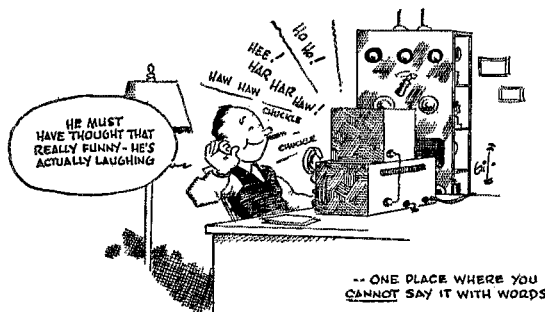

-- ONE PLACE WHERE YOU CANNOT SAY IT WITH WORDS

Answering a Call on Schedule, When Contact Has Not Yet Been Established

Suggestions on answering calls that we may receive in response to our *general* calls are made in the section next below, but before we come to that there is one special case to consider: that of answering when we have been called on schedule but before two-way contact is yet established. In this special case the need is for the replier to let the caller know that the caller has been heard. However, the answerer cannot yet be sure that *he* is being heard, so his response should be a simple reply and should not involve conversation, signal report, etc. Those come later. In other words, the answerer also is just "standing by," waiting to see if he is heard. It is also desirable to have a procedure that takes account of the fact that there may be many other listening stations who are waiting for one or the other of the parties and who, therefore, should be shown that contact has not yet been established. All these things can be accomplished by simply paraphrasing the call to substitute the word "answering" for the word "calling" — which also makes it an easily-remembered system. This way:

Hello W1EH W1EH W1EH. Doubleyou nine union zero answering. Hello W1EH W1EH W1EH. Doubleyou nine union zero answering. Hello W1EH W1EH W1EH. Doubleyou nine union zero answering and standing by.

Beginning All Transmissions After Contact Has Been Established

Contact now existing, what are we waiting for? At this stage in the game it is rank folly to waste time on an elaborate statement of who is calling whom in what cities and why; interference may get us. We want the briefest possible statement. We might do without any, but changing interference conditions dictate a brief identification. Imagining W1EH now going ahead with W9UZ, the simplest preface would be a paraphrase of c.w. practice: "W9UZ from W1EH. . . ." But no soap; the fellows simply refuse to have anything to do with that word "from." Many of us have accomplished the same thing by substituting a pause to denote a comma, such as "W9UZ, W1EH," but this is so dependent upon voice inflection that it does not satisfactorily identify the direction of the contact. On the other hand there is growing acceptance in amateur ranks of the beautifully precise procedure of the airways; you've all heard, for example, "Newark to Flight 16," etc. All things considered, best amateur opinion leans to the use of "to." That gives us this simple beginning:

Doubleyou one Edward Henry to W9UZ. . . .
then going immediately into our conversation without waste of time or effort.

Ending Intermediate Transmissions

There is something mildly bughouse about our method of signing over at intermediate transmissions during a contact. More time is wasted here than at any other part of the proceedings. The purposes of the sign-over are simply (1) to indicate your own identity as required by F.C.C. rules and (2) to signal the other station to go ahead now. There is no legal need to bring in the call of the station being worked. Many of us do mention both calls, and confusion exists from the divers methods. To duplicate the beginning call and say "W1EH to W9UZ" is not appropriate because there is now nothing to W9UZ; it's all been said. To conclude "W9UZ from W1EH" would be fitting but there is that word "from" again. And the alternative of "W9UZ (voice up, pause denoting a comma) W1EH," is frequently unclear and is unnecessarily long. All things considered, and after consulting many good operators on the subject, it is proposed that we simply identify our own stations (for F.C.C. purposes) and say, "Go ahead" for the other fellow's information. And "Go ahead" is preferable to other terms for reasons before stated. So we just say:

. . . Doubleyou one Edward Henry — go ahead!

Speaking of wasted time, there is rarely any sense in "handing it back to you now" with a lot of words to that effect. Why don't we just do so, without mentioning it? We don't engage in such unnecessary prattle-prattle on a land-line telephone. It is possible, and generally advisable, to talk about the subject in hand as much as we wish, and then simply pronounce our own call and the words, "Go ahead." If the contact is any good at all, the other fellow instantly sees that it is his turn to talk. All that palaver is eliminated, the time is saved, and the thread of the conversation suffers the minimum interruption possible in simplex working.

Concluding Work

When we are all through it is desirable to indicate to possible waiting stations that we have finished. There's nothing like being forthright about it. Good practice is agreed that signing off can best be done by using the words "Signing off." A proposal to use the police's "That is all" got the cold shoulder from the O.P.S's. And one should avoid the broadcasting sign-off, "This is Station W1EH. . . ." Keep it simple. So, when we're all through, it's:

Doubleyou one Edward Henry signing with W9UZ. Good evening.

That tells the story. There may be other stations waiting for us. We could well borrow a leaf from the c.w. book and supplement the sign-off

(Continued on page 108)

☆ HAM SHACKS ☆



← W6MVK — Modesto, Calif.

↖ W4DRE — Gaffney, S. C.

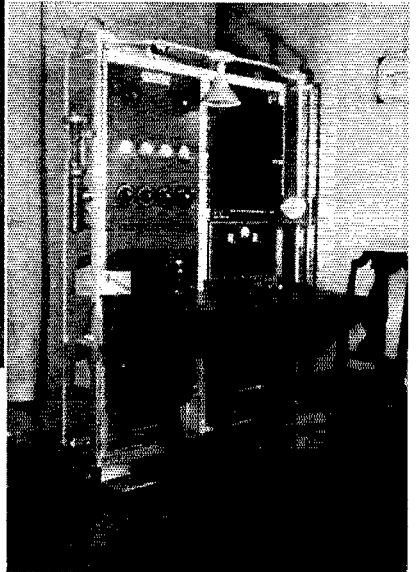

←
H H 2 M C —
Port-au-Prince,
Haiti

W 9 K J F —
Indianapolis,
Ind.

→
W 9 R Q M —
Wausau, Wis.

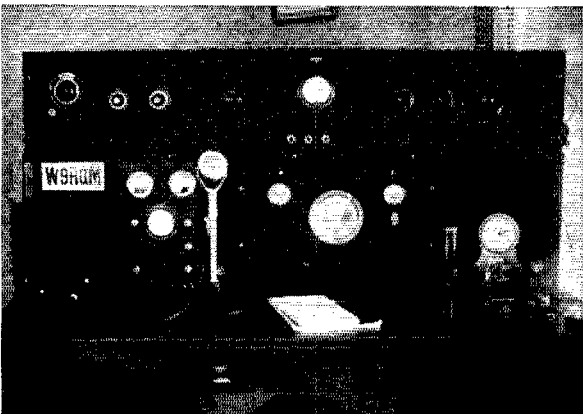

W6MVK

TOM CHOW started in early, establishing records for more-experienced old timers to shoot at. In 1937, with only a little more than a year as a ham to his credit, he broke all previous records in that toughest of contests, the Sweepstakes, setting new marks for high score and number of contacts and working all sections (70) for the first time on c.w. This latter record still stands, since the highest mark registered the following year was 69 sections and last year, with Canada not participating, only 64 were available. In the same year he was the highest W scorer in the W-VE contest. Tom is one of the few who have succeeded in making the DXCC within less than four years after receiving license. At present, he is the only ham holding WAC, WAS, DXCC and WACC (all California Counties) certificates.

The main transmitter is in the rack to the left. The exciter of this transmitter formed the transmitter which set the SS records and which was described in *QST* for October, 1938. A 6A6 oscillator-doubler drives a 6L6G buffer-doubler which, in turn, drives the RK20 output stage. The RK20 drives a push-pull 75T final amplifier which may be modulated by Class-B TZ40's. The speech-amplifier line-up following the Shure 702 mike is 6J7, 6C5 and 6C5 which swings the push-pull 2A3 driver.

The unit next to the HRO Jr. is a modulation indicator. Next to this is a homemade unit which contains a frequency meter, e.c.o., crystal selector and a 100-kc. oscillator. The lower of the two units at the right is a portable transmitter, complete with power supply, built into an Ultra-Skyrider cabinet. A 6C5 Pierce oscillator is followed by a 6V6 buffer-doubler which drives the 211 final which operates at 300 watts input on c.w. on all bands from 1.7 to 14 Mc. or which may be grid-modulated with a three-tube audio section ending up with a 6F6. In changing bands only two coils require changing and these may be removed through the holes in the front panel.

Above this portable unit is a homemade 7-tube battery receiver for emergency work.

Under the operating table is a 3-h.p. gasoline engine which drives a pair of 1-kw. 110-volt a.c. generators as an emergency source of power. This unit is portable and is capable of furnishing power for a separate 500-watt rig not shown in the photo.

The equipment also includes a small portable transmitter similar to the AEC transmitter described in the A.R.R.L. *Handbook*.

A two-wavelength rhombic antenna is used at 7 and 28 Mc. as well as 14 Mc. for domestic and European contacts. Two Sterba six-element arrays are provided for 14- and 28-Mc. work with South America and Asia.

W6MVK has had over 5000 contacts since

starting in the game. He works principally 1.8- and 28-Mc. 'phone and 7- and 14-Mc. c.w. and likes to chew the rag any time he isn't tied up in a contest. He holds an OPS appointment, is registered in the AEC and is EC for Stanislaus County. Although of Chinese parentage, Tom was born in California. His brother George, W6OFD, and sister Betty, W6QMW, are but slightly less well-known on the air.

W9RQM

ANOTHER well-known station without which no contest would be complete is W9RQM reigned over by Reno Goetsch of Wausau, Wisconsin. The entire station equipment is assembled on the one "3 by 5" operating table. The transmitter is mounted on a shelf which extends the length of the operating table where all controls may be reached for quick frequency change from the operating position. Either a 59 e.c.o. or a 6L6 crystal oscillator may be used to drive an 807 buffer-doubler which drives the T55 final. An interesting idea is the manner in which the e.c.o. is mounted to eliminate mechanical vibration. The oscillator is built up as an entirely separate unit with its own panel. The unit is cushion-mounted and a cut-out is made in the main panel for the tuning control. The transmitter works on all bands from 1.7 to 28 Mc.

The speech amplifier at the left-hand end of the operating table consists of a 6SJ7, 6C5, 6C5 and push-pull 45 driver for the HY25 Class-B modulator mounted behind the speaker under the table. The crystal mike is a Shure 700D. Between the speech amplifier and the Breting 12 receiver is a metering panel with switches.

All power supplies are mounted underneath the operating table and are completely enclosed.

W9RQM has taken part in the SS for the last 6 years, leading the Wisconsin Section for the last four consecutive years. He has won every award thus far for his section in the annual A.R.R.L. QSO Party. He has taken part in the last five DX contests and has worked 60 countries. He is an active traffic handler and has held an ORS appointment for the last five years.

HH2MC

ALTHOUGH he has been on the air only since July, 1938, HH2MC is well known in DX circles. Its operator, Emile Cadet, has also built up a reputation as a rag-chewer.

The transmitter, built into an enclosed cabinet, consists of a 6F6 e.c.o., 6L6, 807, RK31 and 203A final, running at 250 watts input. 2MC operates c.w. exclusively. The receiver is a Hallcrafters Sky Champion.

Unfortunately Emile doesn't tell us a great deal about himself, but we know that he has made WAS and WAC within the short time he has been on the air and won the HH award in the

(Continued on page 118)



ON THE ULTRA HIGHS



CONDUCTED BY E. P. TILTON,* W1HDQ

FIVE-METER news of the month in April was the F.C.C. edict opening the territory between 58.5 and 60 Mc. to frequency modulation. While it is too early to report much in the way of progress with f.m. on Five, we believe that this ruling will result in much greater amateur interest in f.m. than was in evidence so long as this type of modulation was limited in use to the frequencies above 112 Mc.

The various advantages of frequency modulation have been covered so thoroughly in *QST* and all other radio publications recently that there is no need for us to go into them in detail here; however, there is one very important reason why every amateur who has a real interest in u.h.f. work should make every effort to use the privileges now available under this new ruling. It has been obvious, for some time, that the territory above 58.5 Mc. was destined to remain practically unused. In former days when "tuning the band" meant turning a single condenser over a range of twenty to thirty dial divisions, it mattered little whether a transmitter was operating on 56 or 60 Mc. The whole range was covered frequently and with ease. But with the general adoption of selective communication-type receivers for 56-Mc. work we have universally adopted the low-frequency habit of tuning from the low end — with the result that the few who had crystals for the high end have, for the most part, put them away in moth-balls.

*329 Central St., Springfield, Mass.

All time mentioned is local time for the station whose work is reported.

If anyone thinks that increased activity would have brought them out again, let him look at the example of the 28-Mc. band, where every weekend hundreds of stations battle the QRM on the low end of the 'phone band rather than move up into the practically unused territory above 29.5 Mc.

Yet our portion of the u.h.f. spectrum is being eyed with great longing by television and commercial f.m. interests. We have prior right to it because we opened it up originally — but unless we make good use of all of it from now on there is certain to come a day when demands will be made which may be hard to resist. Let us guarantee our right to this territory in the future by intensive and intelligent use of it **TO-DAY!**

Operating highlights on Five in April included a recurrence of the magnetic disturbances associated with the 28-day sunspot cycle, a bunch of swell nights for extended-local work, and the first sporadic-E DX of the year.

With the peaks of "aurora DX," detailed in last month's column, coming on February 24th and March 24th, late April found most of the gang with their keys ready for another session of DX on c.w. The first sign of aurora effect was noted late in the evening of April 24th, but it showed up too late for most of the boys and the only contact reported was one between W8CIR and W1KTF at 11:30 P.M. The big night was the 25th, when the short aurora skip was in evidence several times between 6 and 9 P.M. Their lesson well learned from previous futile attempts to work out with any sort of modulation during periods of "aurora flutter," most of the gang went over to c.w. immediately. The list of those known to have been successful during this period includes W1's VC, LLL, and JMT; W2AMJ; W3RL and W3CUD; and W8's PK, PKJ, and FHA.

The characteristic buzz, which has been mistaken by not a few for a power leak, was noted at several other times, notably Saturday afternoon, April 27th, when at W1HDQ we had a noise-level reading of S1 to S7 and healthy sparks jumping from the feeders of our long-wire antennas; but no signals were heard on Five at the time. Erratic conditions were observed on most amateur frequencies during the last week of April but, because of the tremendous splurge experi-

You may "take yours standing up," but you can't help liking this shot of the horizontal "Q" Beam of W9CBJ, Washburn, Ill.

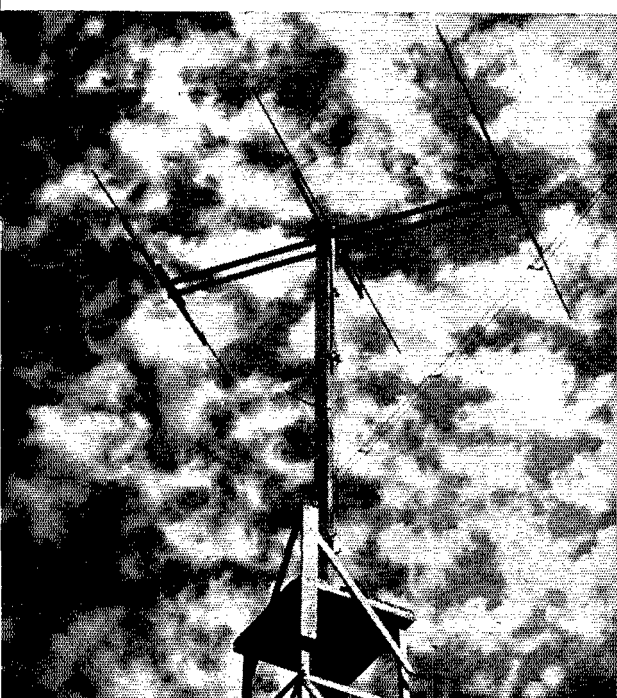

QST for

◆
 These fellows will mean "Iowa" to the 56-Mc. DX-bounds this summer. Jerry Keefe, W9HAQ (right), and B. R. Williams, W9QNG (left); both of Davenport, Iowa.
 ◆



enced in March, these manifestations took on the aspect of an anti-climax.

We've done some inquiring around as to the facts behind the strange doings of the frequencies from 28 Mc. up during these sunspot peaks but all we've been able to turn up to date is already known to most everyone. The peculiar very-short skip is apparently due to a condition not unlike that which produces our sporadic-E DX, except that reflections are produced from a vertical ionized condition (represented visually by the aurora) instead of from a horizontal (or nearly so) sporadic-E "cloud." Aurora DX peaks coincide with sunspot peaks and recur on a 28-day cycle, with the sun turning on its axis, so long as the sunspots retain sufficient vigor to disturb our atmosphere. With relatively weak manifestations in February and April, equally spaced either side of the tremendous peak of March, there will probably be little evidence of this phenomenon in late May. It will bear watching, however, and anyone noticing anything of this nature is asked to report his observations promptly and completely.

During April the 28-Mc. band was open frequently for short skip, giving evidence of the presence of sporadic-E; but on only a few occasions did the ionization become sufficient to produce skip-DX on Five. W5AJG and W6QLZ (they seldom miss) got together again for a brief period at 8:05 p.m., CST, April 15th. W6OVK, Tucson, Ariz., heard weak fading carriers at this same time, and again on the 18th between 7:15 and 8:30 p.m. On the 22nd Jim heard a harmonic

of XDA, S3 to S6, between 5:40 and 7 p.m.; frequency: 57.8 Mc., approximately.

The skip-DX season for the East Coast was officially opened at 7:30 p.m., April 30th, when a perfectly good "Horsetrader Session" was canceled by the appearance of the sigs of W4FLH, Miami, Fla., on the band just as "Admiral Jim," W1FLQ, was about to call the roll. W4FLH was quickly joined by W4EDD and several W1's, 2's and 3's were worked in the brief period we heard them. W4EDD was last heard working W9GGH of Kenosha, Wisc., at about 8:30 p.m. By the time you read this, "skip DX" will have very likely become commonplace again, but the first appearance of the year certainly put everyone on his toes.

The aurora DX session which started on March 24th carried over, intermittently, until April 3rd, with a strong peak on April 2nd. This was another late starter, however, and most of the gang had knocked off for the night before the fun began. W1LLL had western New England all to himself this night and worked W8CIR, W8PK, and W3BYF; and heard W3RL and W8NIQ. Other night-owls who were in on this one included W1FJN, W1IZY, W2AMJ, W3BZJ, W3FJ, and W8PKJ.

HERE AND THERE:

First station to report f.m. transmission on Five is W1KH who wasted no time in converting his regular 56-Mc. setup over to use the f.m. equipment formerly used on 112 Mc. At this writing no checks have been made with stations using f.m. receivers but W1ELP is expected to provide two-way f.m. within a few days.

U.H.F. MARATHON

March Winner: W3BZJ

Call*	Contacts through March 56 112 224	Cumulative Score	April Report ¹	States in 1940
W1AIY	19	53	10	2
W1CLH	35	93	—	5
W1CUC	13 5	24	3	2
W1DJ	69	99	—	4
W1EHT	37	50	5	2
W1EJU	—	70	—	1
W1EKT	41	50	4	2
W1EYR	30	60	—	2
W1GJZ	42	104	—	4
W1HDF	30 10	91	52	4
W1HDD ²	67 18	345	77	6
W1HXP	—	—	—	6
W1JAX	21	29	—	3
W1JJR	20	26	8	3
W1JLK	46 14	96	30	4
W1JP	1 13	27	—	2
W1KH	17 25	67	—	1
W1KRN	—	6	—	1
W1KLI	84 5	269	—	7
W1KME	31	62	—	1
W1KSO	13	26	—	1
W1KVQ	13 45	94	—	1
W1LCC	—	15	—	2
W1LFD	13 48	15	—	1
W1LFT	39	77	—	3
W1LLL	45	163	63	8
W1LPE	35	51	6	3
W1LOX	—	66	—	1
W1LW	—	66	74	2
W1MBS	40	80	48	1
W1MME	6	12	—	1
W1PI	79	160	—	2
W2AMJ	81	295	—	11
W2BZJ	25 80	202	—	3
W2COT	53	69	—	5
W2CTK	23	35	—	2
W2HNY	2 6	23	—	2
W2ION	4	13	—	4
W2LAL	36	44	—	2
W2LEN	—	74	—	2
W2LKO	—	36	72	3
W2VK	13	26	14	1
W3AC	32	78	—	5
W3BYF	20	125	39	8
W3COT	112 7	482	44	10
W3CGV	38	79	44	7
W3CYW	8	52	10	4
W3DI	45	204	—	9
W3EIS	16	30	12	4
W3FJ	6	38	30	3
W3FSM	—	42	—	1
W3FX	23 16	55	22	2
W3HOH	125	305	—	9
W3IIS	30	72	—	5
W3RL	23 1	103	62	8
W4EQK	5	5	—	1
W5AJG	—	10	16	3
W6IOJ	26	54	28	1
W6KYT	51	108	—	1
W6NCF/3	17	32	—	2
W6OVK	1	1	2	1
W6QLZ	—	—	19	2
W6RVL	1 63	157	88	1
W6QNU	—	—	66	1
W7GSE	2	4	—	1
W8MHM	7 6	25	—	2
W8NKJ	11 7	29	41	2
W8PEJ	—	50	—	5
W8QDU	32 9	316	31	8
W8QQS	12	74	—	3
W8RUE	18 7	51	15	3
W8SSN	—	—	22	1
W8TIO	14	107	—	4
W9ARN	14	161	50	7
W9ZJB	7	8	3	2

¹ Includes reports received up to May 7th only.

² Not eligible for award.

³ To conserve space, calls of stations not reporting for two consecutive months have been omitted. These will be re-listed at any time when later reports are submitted.

says he believes that W1JUU of Sanford, Maine, could be enticed into trying Five with a little coaxing. Here's hoping!

W2MO continues his missionary work in behalf of Five on other bands. Through regular pep-talks on 75 Earl has interested W8NUI, Hollidaysburg; W8QCM, Osceola Mills; W8OKC, Shamokin; and W3CBK, Carlisle; all of Pennsylvania. W3BRZ is active in Lancaster and is looking forward to working the boys in York, Reading, and Philadelphia. These fellows, in conjunction with W8CIR and some of the western New York gang, should provide the means for breaking down that N. Y.-Pa. gap which has been the stumbling block in previous relay attempts.

The aurora DX was a real break for the boys in Richmond, Va. The success of W3FJ and W3CYW in working up into W1 and W2 has boosted interest in Five considerably. W3FJ reports that W3BZ, Danville, Va., is about ready to go with an HK-24 and a Skydrier 5-10. Located on the North Carolina line, some 130 miles southwest of Richmond, W3BZ will bring our mythical Maine-to-Florida network a little nearer realization.

Comes news from Tennessee! In Nashville, W4's DDF, BM, BAF, DQH, AWB, ERI, and others are talking Five. How about it, fellows? Let's hear some sigs from Tennessee this summer! With good prospects in Alabama, Georgia and South Carolina, and an active group consisting of W4's EQK, FPC, DZT, DBA, DIN, AKA, and W3IHW/4, in St. Petersburg, Tampa and Clearwater, it looks as though the old stand-bys, EDD, DRZ, FBH and ADU will not have to carry the torch for W4 alone! The Clearwater Radio Club, W4EQK, has up to 700 watts to a pair of 100TH's; three half-waves, vertical, and a rhombic for antennas; and an RME HF-10 receiver.

In Oklahoma City, W5FYF has yet to work a station on Five in 1940! This doesn't discourage Vance — he heard a couple in March and April. We wonder just how long the enthusiasm of some W1's and 2's would last under similar conditions! Vance has several good prospects, including W5HXL, who has an acorn converter with concentric-line circuits under construction. Over in Hugo, Okla., probably beyond the reach of W5FYF, we find an old-timer in the person of W5TW running 200 watts on 58,432 kc. every Sunday. TW also has a pair of transceivers (that's one way to provide activity) and a 75-watt home rig on 112 Mc.

In just about any section of the country you can name you will find at least one fellow who is working his head off to get others on Five. One of these is W6OVK, Tucson, Ariz., who is trying the novel stunt of calling CQ on c.w. each Sunday at 6:20 a.m. (MST) before leaving for work. We have no record of DX having been worked at this hour but that may be only because so few fellows normally get on the air by then. With Daylight Saving Time in general use in the east, this comes up at 9:20 eastern time, which is not too bad for the lazier mortals. Jim's frequency is 56,792 kc. Anyone interested in keeping this sked is asked to drop a card to James W. Brannin, W6OVK, Southern Pacific Telegraph Office, Tucson, Ariz.

Over on the California side of W6 we have a pick-up in 56-Mc. interest reported from several points. W6IOJ, North Hollywood, has been off Five for some time while working 2½ with a crystal-controlled rig. He is back again for the DX season with 250 watts on 56,636 kc. In Santa Clara, W6BPT heard W6IWS in Santa Cruz on April 16th. While this is a matter of only 35 miles or so, it is over a range of "hills" 2000 feet high — a path over which 56-Mc. sigs have never been heard previously. It would seem that the gang on the West Coast should experience about the same degree of lower-atmospheric bending as we note on the Atlantic seaboard. Close proximity to the ocean, or to other large bodies of water such as the Great Lakes, is apparently an important factor in working this type of DX. We'd like to see more in the way of daily activity in all sections of the country, in order that more information may be secured on the variations in u.h.f. signals under all types of climatic and geographical conditions.

Will it be horizontal or vertical? This question faces every u.h.f. enthusiast who is about to build a new beam. It is unfortunate, in a way, that both types are used; for, with the exception of sporadic-E DX, it is almost certain that best results will not be attained when both types are used in any

W1LSN sends a list of stations now active on Five in New Hampshire. Look for W1JOG, East Barrington; W1KTV, Newington; W1COO, Brentwood; and W1JK and W1LSN in Exeter, when looking for New Hampshire on Five. Jerry

one area. W8CVQ and W8QDU are running tests to determine for themselves which to favor. Right now they are strong for verticals. W3RL, working with W3FPL and W3GLV, went through all this some years back and came up with a decision in favor of vertical. W2CUZ lost his vertical in the March storm and has replaced it with 4-element horizontal array. Don is getting nice results with the few stations which are equipped with horizontal arrays (including W1LLL, W1HDQ and W3AIR), but is at considerable disadvantage in local work because of the general use of vertical polarization in the east. The Central Illinois horizontals are well known, and a swell job they do, too; and we'll grant that W4EDD has been one of the most consistent workers of skip-DX — but the records are all held with vertical antennas to date. Much experimental work is now under way and some real light should be shed on this long-debated question before long.

112 MC.:

Boston, New York, and other large cities continue to have rapidly-growing 112-Mc. populations. In the Boston area several fellows have worked more than 100 different stations on 2½, with the number of stations reported active currently running around 175. Some of the "Century Club of 112 Mc." are W1's SS, PI, and JQA. The Boston area has taken a sudden interest in the U.H.F. Marathon, with bales of reports piling in on us this month. Some of these have not been checked so the Marathon box is not complete. If your call is not there, have patience, and we'll try to have everything in order for the next issue.

Though interest in controlled f.m. on 2½ will probably drop, due to the opening of Five to f.m., the f.m. superhet remains as the solution of the receiver problem for the more ambitious 112-Mc. enthusiast. It is the answer, if we are to bring up the range of effectiveness on 2½ to come even close to that now enjoyed on Five. The super-regen will continue to serve most stations, but for the fellow who wants something in "on the ball," improvements in the receiver are of first importance.

News from the entire country shows 2½ taking hold everywhere. Even in Portland, Maine, and in northern Vermont we find them going at it. In Portland and surrounding territory W1's CRP, LNI, AWT, LZL, JRS and PP are working, mostly with portable rigs made over from former 56-Mc. equipment. These boys found 112-Mc. pack sets very handy for timing ski races during the winter and plan to use them for the annual "Soap-Box Derby," and possibly the yacht-club races this summer. In St. Albans, Vt., we find W1KVB and W1KIE having some fun finding the band, in preparation for anticipated work across Lake Champlain to upper New York State.

At Wilbraham, we have found the range to be stretching out gradually with the coming of warm weather and increased atmospheric bending. W2GPO and W2IQF of Huntington, Long Island, constitute our 112-Mc. DX to date; with W2MO, W2HYJ, and other unidentified W2's heard quite frequently. In the meantime we continue to operate each Thursday night on 112,008 kc., aiming at W2 from 7 to 8 p.m. and at Boston from 8 to 8:30.

W2HNY, formerly of Riverhead, L. I., has been transferred to New York City. Matty hopes to settle in New Jersey and will probably waste little time in getting back on 2½. He brings up a point which surely needs to be stressed:

U.H.F. DX RECORDS

Two-way Work

- 56 Mc.: W1EYM — W6DNS, July 22, 1938. 2500 miles.
- 112 Mc.: W9WYX/9 — W9VTK/9, Oct. 7, 1939. 160 miles.
- 224 Mc.: W1AIY — W1KIJ, April 27, 1940. 6 miles.

NEW DX RECORD FOR 112 MC.:

As we go to press there comes news from California of what appears to be a new world's record for 112-Mc. DX. On April 28th, W6BCX, operating portable-mobile on Mt. Santa Ynez, 4300' elevation north of Santa Barbara, Cal., worked W6OIN, San Diego, a distance of approximately 200 miles! Full details have not yet been obtained.

And on Five the whole country is going wild with the traditional May rush of sporadic-E DX. The Five-Meter Band was open every day from April 29th to May 6th, with skip DX being worked in every Call Area. On May 2nd, W5AJG, Dallas, Texas, worked into W1, about 1500 miles, for 1940's best 56-Mc. DX to date.

If you have not already done so, climb aboard the u.h.f. bandwagon and join the fun — and don't forget to report your results promptly and completely.

— W1HDQ.

"Tell the fellows to sign more frequently and carefully." There are numerous times when one listens to some weak and fading sig, only to have the operator finish up his transmission with a mumbled signature or, worse yet, just "What say, old man, go ahead!"

W2LEN, and others, bemoan the small size of the 112-Mc. portion of the u.h.f. department. All we need to make it larger is more interesting dope. If you find this column of interest it is only because some fellows have taken the trouble to write in and tell us what they and their friends are doing.

W3RL has 200 watts to 357's and a National One-Ten on 2½, but finds the going rather tough around Washington, D. C., and has worked only W3GLV (HK-24's, crystal-controlled, and 12-element beam) and W3EIS, also crystal-controlled. W6NCP/3 is now definitely established in a new home at Bethesda, Maryland, and has worked W3BKZ and W3EQZ. We expect to hear a lot more from Beck as soon as he has a chance to get something on the air other than the little portable rig he brought east with him.

From Santa Rosa, Cal., W6BJI reports plenty of mobile rigs in action each weekend, with QSO's up to 50 miles quite common. An expedition to Mt. Saint Helena, 15 miles north of Santa Rosa, is planned for June 16th. With an elevation of 4200 feet, several rigs including mobile transceivers and other jobs up to 50 watts, and a staff of operators including W6's KIN, ADM, ALX, CKL and LJS, this expedition should come up with some interesting results. Remember the date, June 16th, with the schedule covering from 2 to 10 p.m. PST, and be sure to let us know the results.

In Phoenix, Ariz., W6QLZ has an HK-24 running with crystal-control on 112 and 224 Mc. Other Phoenix stations are KVE, KTJ, MLC, LTS, and LKK. A 112-Mc. transmitter hunt was staged by this group during the Arizona Convention, April 21st.

Note that we have a 112-Mc. W7 in the Marathon listing. He is W7GSJ of Whitefish, Montana, who works W7's HSW and GBH in Kalispell, 16 miles south of Whitefish, with more stations coming on soon. Another W7 heard from recently is DUF of Walla Walla who has been working CSS, GMC, and HPG on 112 Mc. All rigs are transceivers.

In Montgomery, Ala., W4FUM has 30 watts working nicely and is building a converter to give 112 Mc. a workout during the summer months.

(Continued on page 67)

★ I. A. R. U. NEWS ★

Devoted to the interests and activities of the INTERNATIONAL AMATEUR RADIO UNION

Headquarters Society: THE AMERICAN RADIO RELAY LEAGUE, West Hartford, Conn.

MEMBER SOCIETIES

American Radio Relay League
Asociația Amatorilor Romani de Unde
Scurte
Associazione Radiotecnica Italiana
Burma Amateur Radio Society
Canadian Section A.R.R.L.
Československá Amatérská Vysílací
Deutscher Amateur Sende-und-Empfangs
Dienst
Eesti Raadio Amatooride Ühing
Experimental Radio Society of Egypt
Experimenterende Danske Radioamatører
Fédération des Emetteurs Belges
Irish Radio Transmitters Society

日本アマチュア無線聯盟 Japan
Lietuvos Trumpuju Bangu Radio Megeju
Draugija
Liga Colombiana de Radio Aficionados
Liga Mexicana de Radio Experimentadores
Magyar Rövidhullámú Amatőrök Országos
Egyesülete
Nederlandse Vereniging voor Interna-
tionaal Radioamateurisme
Nederlandsch-Indische Vereniging Voor
Internationaal Radioamateurisme
Newfoundland Amateur Radio Association
New Zealand Association of Radio Trans-
mitters
Norsk Radio Relæ Liga

Polski Związek Krotkofalowcow
Radio Club de Cuba
Radio Club Venezolano
Radio Society of Great Britain
Rede dos Emissores Portugueses
Reseau des Emetteurs Français
Reseau Luxembourgeois des Ama-
teurs d'Ondes Courtes
South African Radio Relay League
Suomen Radioamatööritto r.y.
Sveriges Sändareamatörer
Unión de Radioamores Españoles
Union Schweiz Kurzwellen Amateur
Wireless Institute of Australia

SOUTH AFRICA

BECAUSE of the financial situation result-
ing from loss of members since the ban on trans-
mitting, the Council of the *South African Radio
Relay League*, after a detailed discussion at a spe-
cial meeting on March 4th, drew up a series of
proposals to be made at the annual general meet-
ing, some of which are as follows: that the *League*
suspend normal activities for the duration of the
war and that only a skeleton organization be
maintained at headquarters to handle only neces-
sary matters; that all memberships in the society
be suspended for the duration; that "QTC" be
suspended; that the paid secretary be asked to
serve now on an honorary basis; that further
general meetings and conferences be discon-
tinued, but local gatherings be urged.

Says the *League's* organ, "The scheme pro-
posed does not by any means convey the idea of
dismembering the society. The fundamental idea
underlying this suggestion is to conserve our

funds so that we can make full and adequate use
of them when the necessity arises. We may go
into recess but we will certainly only be dormant
and will be ready at a moment's notice to take up
the cudgels on behalf of the aims and interests of
amateur radio when the time comes."

EGYPT

WE HAVE failed to report in detail until
now that Egyptian amateurs were closed down in
the early weeks of September, 1939. The *Society*
is in a state of suspended activity pending the
time when authorization will come for amateurs
to return to the air. Many SU's are taking the op-
portunity to make out and ship hundreds of QSL
cards confirming past contacts, a job which they
never before seemed to have sufficient time to
perform.

NEW ZEALAND

"**L**UCKY hams have seals off! — tempo-
rarily," reads "Break-In's" headline, and we read

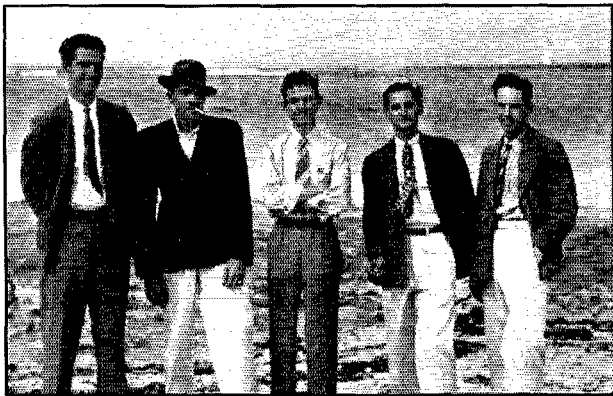

W4DMY got the now-silent VP7's
to pose with him for this shot. L. to r.,
VP7NC, Inglis Lowe; VP7NU, Joe
Forsythe; W4DMY, Hugh Curry, 2nd
op at VP7NU; Lloyd Thompson, en-
gineer at ZNS.

that three amateurs were asked by the government to provide relay broadcast facilities in the absence of landlines in connection with a centennial celebration at Waitangi. ZL1HJ, AI, GC and NH did the job, taking their transmitters to the exposition grounds and setting them up at points where the broadcasting system wished facilities. With the assistance of government employees (imagine having half a dozen men at your disposal for the sole purpose of erecting a shack and operating table, and climbing a 110-foot pine to fasten the antenna!) the installations were effected with no more difficulty than fatality of an occasional electrolytic, apparently weary of long months of inactivity. In addition to providing relay broadcast channels, the stations were used for cross-grounds communication in arranging various activities.

As ZL1HJ commented, "The experience was like giving a drug addict a taste of his favorite drug and then dragging it away again."

NEWFOUNDLAND AMATEUR SPIRIT

THE January issue of "VO News" contains an editorial urging continuation of amateur activities insofar as possible, and we excerpt the following significant portion:

"The copy of the close-down order printed elsewhere in this issue is not necessary to remind members of the blow that fell upon amateur radio with the declaration of war, but is inserted merely as a historical reference for our information in years to come. It is to be stressed, however, that only the transmitting side of our activities is affected and that there is still much useful work for amateurs to do. In the tasks that lie ahead, opportunity will be given to amateurs to make a national contribution in the form of that patience and stick-to-itiveness which is the hall-mark of the born experimenter. The temporary shut-down of transmitting activities gives us a splendid opportunity to improve our receivers and to conduct those experiments with receiving antennas that we have so long promised ourselves. It must also be remembered that in this country, with its scattered population and difficult communication problems, at any time an emergency might arise requiring our services and perhaps our equipment."

NEWS AND NOTES

IN THE "T. & R. Bulletin," G2MI reports reception of a letter from IIR containing the interesting news that Italian amateurs have been negotiating further with their government on the matter of licenses. They recently proposed a set of regulations under which licenses would be issued and the plan was received with approval by authorities, but no official action is expected to be taken until the present international situation is settled. . . . One of two Argentine scientists planning an ascent into the stratosphere, writing

in "R.C.A.," earnestly requests the collaboration of LU hams in monitoring the transmissions, as well as the benefit of any special technical knowledge and advice they have to give him. . . . C.w. men in Argentina, numbering about five per cent of the total amateur body, have been campaigning for more recognition and asking that a portion of each band be set aside exclusively for code work (amateur bands in most of South America are open to either code or 'phone work). The *Radio Club Argentino* is instituting a code course to be transmitted by LU1AA — mainly inspired by a realization of the importance of c.w. in emergency communications. . . . Effective March 1st, German radio law was extended to cover Austria and the Sudetenland regions. . . . VP4TO, a recent visitor at headquarters, reports it was a sad day when amateur stations in Trinidad were closed down by the wireless officer, VP4TI. "The only consolation," says he, "was that VP4TI had to confiscate his own station the next day!" . . .

On the Ultra High

(Continued from page 65)

224 MC.:

W1HDF, Elmwood, Conn., has his HK-54's riding around on the back porch of a rotary 12-element bird-cage — and what a sig that combination lays down! Carl has the distinction of being the first operator to report contracts on all three u.h.f. bands in the U.H.F. Marathon. He is joined this month by W1KLJ who has a single HK-54 putting out nicely on 230 Mc. Almost nightly three- and four-way workouts are held but W1HDF and W1AIY have not made the grade over the hills from Elmwood to Walcott, to date. W1JJR, Hartford, is expected to join the fun any day now.

The report of W6QLZ running crystal-control on 224 Mc., with all other bands up to 160 available on the same chassis, completes our 224-Mc. picture for this month. If there are others working in this band, how about a line or two to let the other fellows hear how you are licking your problems? There's plenty to be learned about these frequencies!

Our U.H.F. DX Record now boasts a 224-Mc. two-way. Who can beat it?

All photos, courtesy of W9ZEB.

Strays

In drilling socket holes in a chassis with a circle cutter, sagging of the chassis can be prevented by blocking up from underneath with a wood block or stack of sections of board nailed together. — W8NAF.

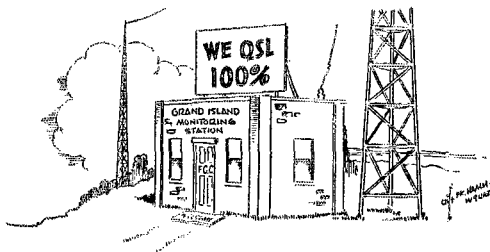



HINTS AND KINKS FOR THE EXPERIMENTER



SOLDERING CONNECTIONS TO POLYSTYRENE SOCKETS

THE low melting point of polystyrene often makes it difficult to make or remove soldered connections to sockets made of this material without damaging the socket. L. T. Fleming, W3HQP, suggests a scheme which will keep the socket cool while soldering the terminals. The idea is shown in the sketch of Fig. 1. An old coffee can is filled with water. A "C" clamp, obtainable at any dime store, is used to clamp the socket to the side of the can in such a position that the

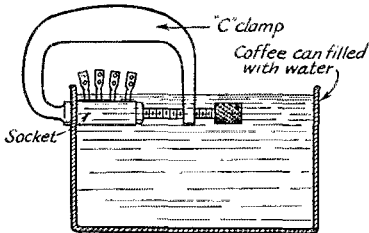

Fig. 1 — Immersing polystyrene socket in water prevents softening of socket while soldering.

polystyrene is covered with water while the prongs project above the surface. Old solder may then be safely removed or, if new connections are to be made, long leads may be soldered to each prong and then cut to the appropriate length after the socket has been mounted. Polystyrene coil forms wound with enameled wire may be treated in a similar manner.

NOTES ON E.C.O. DRIFT

REGARDING the article on the crystal-e.c.o. unit by W6CUH in *QST* for Sept., 1939, after

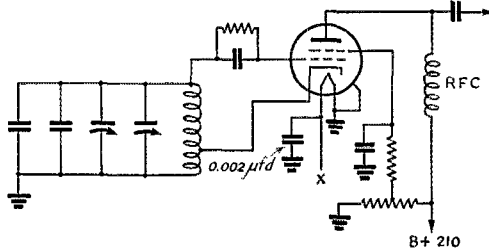

Fig. 2 — Alteration in crystal-e.c.o. circuit to reduce drift.

building one as close to a copy of it as possible, I found it had a tendency to drift to a higher frequency after plate voltage was applied. It drifted approximately 5 kilocycles in a period of 3 minutes and no amount of temperature compensating would eliminate it.

To cure it, the filament coil, which W6CUH uses interwound with his cathode or grid coil, was removed and one side of the filament grounded directly and other side by-passed through a 0.002- μ fd. mica condenser, both connections being made right at tube socket. This reduced the drift to a 30-cycle change in 75 minutes of continuous operation. This may be of help to others who may run into same thing. The circuit is shown in Fig. 2.¹ — Walter King, W7ETK.

FILTER-DISCHARGING RELAY OR SWITCH

I BELIEVE the arrangement shown in Fig. 3 is an improvement over the filter-shorting relay circuit shown some time ago in *QST* in connection with the A.R.R.L. Safety Campaign. It is a scheme which is used by the Italian Marconi

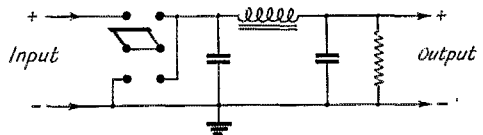

Fig. 3 — Safety switch which opens high-voltage circuit as well as discharging filter condensers.

people in short-wave transmitters in which changes in tank-circuit values are made by operating bare switches in a 3500-volt series-fed circuit.

A double-pole double-throw relay or switch is connected so that the filter is disconnected from the rectifier before the filter is short-circuited. This automatically prevents the possibility of damage to the transformer and rectifier as well as injury to the operator should he fail to switch the supply off before shorting the output or by failure of the shorting relay to operate properly.

As used by the Marconi Co., the switch is manually operated by an insulated control from

¹ Possibly heater current through the coil windings is responsible for a change in coil temperature. If the coils were wound with larger wire, it seems possible that drift might be reduced. — Ed.

the panel. Of course, if a relay is used, the stationary contacts must be well insulated from one another. — Keith Olson, W7FS.

REPLACING THE ANTENNA HALYARD

SEVERAL suggestions have been made from time to time on replacing the pulley on the antenna mast when the halyard breaks. One of

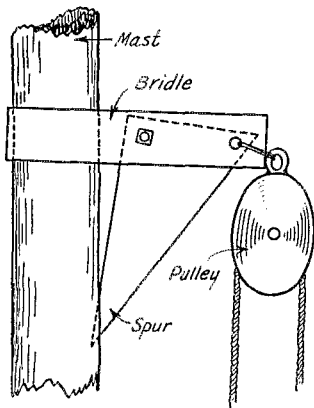

Fig. 4 — Spur suggested by VE4KN to prevent replacement pulley sliding down mast.

the most popular schemes is to rig up a new pulley and halyard and fasten the pulley to a loop of wire or a band of strap iron which may be slipped over the top of the mast or, if no obstructions exist, may be bent around the mast and slipped up to the top.

Quite frequently, however, when the loop is made large enough to slide up or down the pole readily, there is nothing to hold it in position when the desired point is reached. The sketch of Fig. 4 shows a scheme which VE4KN has used successfully to overcome this difficulty. The loop is fitted with a triangular steel spur which pierces the mast and prevents the pulley from sliding down. If it becomes necessary to replace the halyard again, the spur may be released by an upward push with a stick.

A SIMPLE MODULATION MONITOR AND PERCENTAGE INDICATOR

At A in Fig. 5 is shown the schematic diagram of a very simple modulation monitor which can be constructed from parts lying around most any ham shack with the possible exception of the 0-1 milliammeter. None of the values of the parts shown are very critical in operation so that any resistor or condenser having an approximate value to those shown may be used. The tube is any diode, or triode with the grid and plate tied together, so that a tube may be chosen which obtains its filament voltage from the shack's receiver or speech-amplifier filament supply.

To check the transmitter's modulation, the coil, L , is loosely coupled to the tank circuit of the final r.f. amplifier until the milliammeter reads approximately 0.9 ma., or is deflected to the upper end of the scale where the meter will be most sensitive to any change in current. L may be any coil having enough turns so that when it is loosely coupled to the tank circuit it will cause the meter to read at the upper end of the scale. Now the input to the speech amplifier is increased, or the gain turned up, until the meter starts to flicker or rise which will indicate that the percentage of modulation is just above 100 per cent. The gain should then be backed off just enough so that the meter will not rise or flicker when modulating the transmitter. As the power of a fully modulated carrier is one and one-half times that of the unmodulated carrier, to get the most

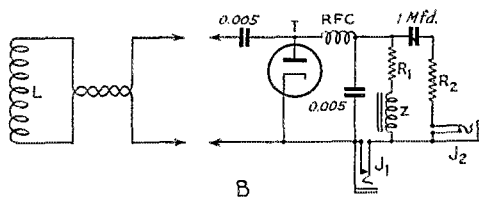
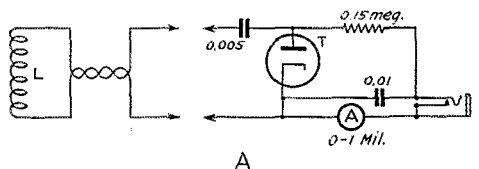
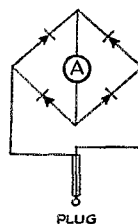

Fig. 5

- A — Circuit indicating overmodulation.
B — Circuit for measuring percentage modulation.



output from the transmitter and not overmodulate, keep the speech-amplifier gain at a point just below where the meter will show a rise or flicker when speaking into the mike. The 'phone jack is provided for monitoring and checking the quality of the modulation with a pair of 'phones but is not necessary. The monitor may be mounted in any convenient place, but the twisted leads to it should not be any longer than necessary. If it is necessary to have the monitor too far from L the tube and resistance should be mounted near L and the meter may then be mounted at any convenient place without regard to the length of leads.

The meter will show a current reading which is in direct proportion to the peak unmodulated carrier current, or which is in direct proportion to the average of the peaks of the modulated carrier. As the average of the peak currents of the modulated carrier is equal to the peak carrier current, the meter will show a steady reading unless the percentage of modulation is more than 100 per cent when the average of the peak currents will be greater than the unmodulated carrier peaks and thus cause the current to rise.

Many variations of the above circuit will suggest themselves to the more advanced radio amateur to meet his special requirements. If a 0-1 milliammeter cannot be found, a voltmeter may be used in place of the 150,000-ohm resistor providing it is sensitive and has an internal resistance of approximately 150,000 ohms or enough external resistance added to bring the total to this value. If a voltmeter is used, a small r.f. choke should be inserted between it and the plate to keep the r.f. current out of the meter.

In Fig. 5-B is shown a circuit which will indicate the percentage of modulation with the copper-oxide-type 0-1 milliammeter plugged into J_1 , L is coupled to the tank circuit as before, and the coupling adjusted until the meter reads full scale. Then the meter is plugged into J_2 . The percentage of modulation will be equal to 140 times the reading of the meter when it is plugged into this second position; for 100 per cent modulation, the meter will read 0.707 ma.

Z should be approximately 30 henrys and the d.c. resistance of R_1 plus Z should be about 150,000 ohms. R_2 should be as nearly equal to the total impedance of R_1 plus Z at the modulation frequency as possible. Both phone jacks should be of the shorting type so that when the meter is pulled out the circuit will be closed.

— Leonard D. Poor, *Ex-W1DGH*.

A NON-CHATTERING OVERLOAD RELAY WITH ELECTRICAL RESET

IT IS easy to re-vamp an old battery-charger relay into an overload relay that will cut the final amplifier stage input to low power and

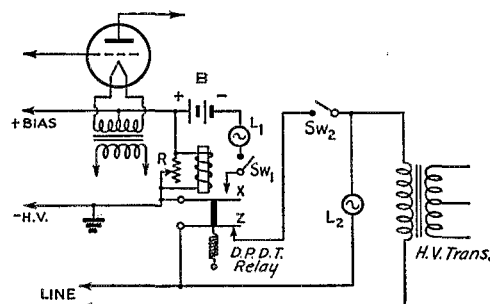

Fig. 6 — Non-chattering overload relay circuit. The relay may be made from a rewound charging relay.

hold it there until a front-panel switch is flipped, re-setting the relay. Rewind the old relay with many turns of small wire so that it will throw on less current than your final draws in normal action, then shunt it with a rheostat to enable it to be adjusted to the exact current value at which you want it to go into action. Connect it to your final as shown in the diagram of Fig. 6. R is a rheostat, 20 ohms. B is 3 volts of flashlight cells. L_1 is a 2.5-volt dial-light bulb in a front-panel pilot-light socket. Sw_1 is the re-set switch. Sw_2 is a switch enabling the operator to cut to low power for tuning-up. L_2 is a 115-volt light bulb (200 watts for my rig) to reduce the voltage applied to the high-voltage transformer primary. Both switches are kept closed for normal operation. Adjust contact X so that it will make as soon as there is the slightest break of contact Z . The purpose of battery B is, of course, to further energize the relay coil and hold contact Z open until the re-set switch is flipped.

— Carl C. Drumeller, *W9EHC*.

Strays

I have found a large Gordon or Crowe hand-wheel a definite advantage on the bandspread tuning control of my SX24. It makes tuning lots easier and eliminates, to a great extent, the bumping and consequent retuning of the band-setting condenser. — *W8KNP*.

For lovely crackle-finish panels, glue sandpaper of the grade desired on the panel and paint with lacquer of any color you choose. Lettering can be set into the panel before lacquering. — *W5IPY*.

A newspaper clipping says, "Somebody telephoned the light company in Kansas City, Mo., that a car had broken off a light standard. When repairmen arrived the standard was gone. Witnesses said that the motorist loaded the pole, valued at \$75, and a transformer, valued at \$50, into his car and drove away with them."

What W9 has a new antenna mast and plate transformer? — *W1LHA*.

To keep my phone cords from twisting, I bought one of those twisted rubber cords which are used on telephones. It fits over the phone cord in the manner in which it is used with telephone cord. I paid 10 cents for the one I use. — *W9YGR*.

A very serviceable and apparently efficient button-type feed-through insulator can easily be made from dress buttons made of clear catalan. These are obtainable from most 5-and-10 stores. Haven't tried them on u.h.f., but they work well on the lower frequencies. These buttons look like glass and may be worked into shape with a file and are easy to drill. You can get 5 pairs for a dime. — *W4GMO*.



OPERATING NEWS

F. E. HANDY, W1BDI, Communications Mgr.

E. L. BATTEY, W1UE, Asst. Communications Mgr.

Do not talk about the war. Do not work belligerent nations' amateurs. Remember, there is surveillance. It should be unnecessary to talk any more about these things. Thus far we hams have been lucky that few amateurs have been on the air in the theater of war. For each unresisted temptation to the DX beginner, or whoever flouts restraint and horse sense, is just one more threat to the general security to be preserved for amateur radio. The aim behind *any* war neutrality operating policy of A.R.R.L. is exactly what you might expect it to be . . . to keep amateur rights available as freely as possible for amateur work. Our situation more or less calls to mind the saying that liberty without self restraint is abused, and even unappreciated until abuses invite curtailment.

The point is this. In the last few weeks an F, and several D's whose capabilities have been approved by the government in power, have got on the air. Some hams have written to inquire or protest the presence of these stations. *A few even have worked 'em!* Some few always insist on legal technicalities or stay out of step with procedures designed for the general interest. We don't want any spy scares or any agitation about our quite harmless amateur radio DX. We should all have the common sense to exert our influence and example on the side of restraint. It is decidedly *not* the time to demonstrate that amateur frequencies can cross international boundaries to Germany and France. That calls for more intensive government monitoring, more surveillance and suspicion to make certain the government responsibilities of a neutral are carried out, and that radio (intentionally or otherwise) gives no "aid and comfort to any belligerent." Let us not walk the road to restriction or curtailment. Responsive to reports, bulletins covering A.R.R.L. neutrality policy have been sent to amateur operators that seemed unaware of or non-coöperative under the stated courses of operating conduct, discussed each month in each QST since the war began. This paragraph is just to urge once again, that we avoid any blackout or curtailment by following the A.R.R.L. Neutrality Code. **DO NOT TALK ABOUT THE WAR. DO NOT WORK BELLIGERENT NATIONS' AMATEURS.**

Copying Bee Winners. Congratulations to the winners, from the rest of us, are surely in order for the five amateurs who got perfect scores on the toughest code copying exercise of the year,

A.R.R.L.'s Sixth Annual Copying¹ Bee. These Bees are opportunity for every real amateur to have some fun and check up on how accurately he can copy what he hears. A good many hams can translate *some* of what they hear, but to *put down on paper* a complicated set of characters *exactly as sent* is the mark of a real operator. Count on trying *your* hand in the next one, the 7th A.R.R.L. Bee, tentatively scheduled for December.

Emergency Readiness. The month of April brought forth flood stage in numerous rivers throughout the Atlantic states. The advance preparations of A.R.R.L. Emergency Coördinators proved wise. The readiness of amateur radio to serve the Red Cross and other agencies at a moment's notice was aptly demonstrated. The record is kept straight by a full report elsewhere in this issue on all the work that went forward.

Coördinator Landis' (W3UA) Susquehanna Net was ably manned throughout its entire territory, handling hundreds of water gauge readings (no light task) accurately and winning commendation from the U. S. Engineers and the U. S. Weather Bureau. Coördinator Berry (W8SBV) at Elmira, N. Y., was called on by the Red Cross to set up at Wellsburg, some miles away, and carried through the desired program without a hitch. Coördinator Johnson, (W9GKP) Duluth, Minn., is likewise to be commended, for the unexpected happened on April 3rd, when a severe sleet storm disrupted power and wire communication at Duluth. Preparedness for such exigencies, and ready coöperation of outside stations made it possible to handle communications efficiently, and to aid in early restoration of wires. W8EKG at Wilkes-Barre, Pa., was appointed a member of the Red Cross communication sub-committee—his station manned for some 72 hours. The advance planning tied S.E.N. with A.A.R.S. and created net controls and relief operators for 80 c.w., 75 'phone (W8SOV-control) and 160 (W8EUI m.c.s.). W8HMH at Newark, Ohio, worked with the Red Cross Disaster Committee, preparing for any eventuality, placing his portable equipment at the message center established at Red Cross local Headquarters. Scores of amateurs in the A.R.R.L. Emergency Corps gave their complete coöperation, and, backed by general assistance from every side throughout the fraternity, excellent communication was accom-

¹ See full report on page 23.

plished. Coördinator Kenney, W2BGO, Bronx, N. Y., kept half hourly schedules with W8EKG handling a large share of his traffic. The efficacy of amateur radio for work "in the public interest" was ably demonstrated, even where threatened floods subsided before passing the danger marks.

The value of having every amateur aligned with the Emergency Corps, and every community considered in studies and advance planning of S.C.M.s and Emergency Coördinators was made amply apparent. We're justly proud of each amateur whose participation has been reported. All hams everywhere may well be proud of the additions to the Public Service Record of the amateur. To all communities without an amateur service Coördinator we ask that the amateurs there make suitable recommendations to the A.R.R.L. SCM to speed early appointment.

If not in the Emergency Corps, get lined up AT ONCE. All F.C.C. licensed amateurs are eligible. A card to A.R.R.L. or a visit to the nearest Western Union office will enable you to send in a.e.c. blanks — bringing you at a later date your identification card in A.R.R.L.'s Emergency Corps.

A.R.R.L. Field Day Time Here. June 22nd-23rd are the days. The vital need of the amateur service, as shown above, often calls for at least some equipment in every amateur shack capable of operating self-powered, able to hop signals over any disruption of power and communication circuits for the vicinity. The Field Day is dedicated to testing portable and emergency equipment. The best way to get fun and profit from an A.R.R.L. "F.D." is to get together with a club or two or three ham friends. Plan an expedition in advance, test your equipment now — and profit from this year's F.D. when it comes. Luck in the 1940 event. See announcement elsewhere in this issue, and CU THERE.

— F. E. H.

— — —

HAMFEST SCHEDULE

June 2nd, at Rome, Georgia: The Northwest Georgia Amateur Radio Club will hold its annual hamfest in Rome, Ga., on Sunday, June 2nd, at the Rome City Club House, on the outskirts of town. Out-of-town hams are requested to meet at the Casey-Kirkland Motor Company at 10:00 A.M., for official escort to the scene of activities. There will be the usual abundance of prizes, speeches, and displays of amateur equipment, with barbecue and Brunswick stew to top it all. The hamfest will be held "rain or shine," and all radio amateurs, their YL's and XYL's and junior ops. are cordially invited to attend.

June 8th-9th, at Valparaiso, Florida: The yearly get-together of hams and hamesses at Valparaiso, Fla., is scheduled for June 8th and 9th, with Jimmie Long and XYL (W4KB/W4FAX) as hosts. These W4KB hamfests have become something of a tradition with the gang, and there is always a big turn-out and a grand time for all. Everyone is invited. Don't miss this enjoyable affair!

June 16th, at Lake Worth, Florida: A big hamfest is scheduled by the West Palm Beach Radio Club in cooperation with the Lake Worth Amateur Radio Club, to be held at the latter's club house at Lake Worth, on June 16th. Many fine features will be incorporated to make this gathering outstanding. Plan to be there.

ARTICLE CONTEST

"Twenty Meters is the Most Interesting Band," says Bayard Allen, W3ATJ, in his prize-winning article this month. So far the merits of the Forty-, Eighty-, Ten- and Twenty-Meter bands have been extolled in our current series of articles. Have you aired your views regarding which is the best band of them all?

For the next several months we are inviting articles for the C.D. contest based on various individuals' ideas of "the most interesting frequency band." Practically every operating amateur has a "favorite" band, one that he would swear by to the bitter end. What is your favorite?

Send in your article on why such-and-such-a-band is, in your opinion, the best available. Each month we will print the most interesting and valuable article received on this subject. Please mark your contributions "for the C.D. contest." Prize winners may select a 1940 bound *Handbook*, *QST* Binder and League Emblem, six logs, eight pads radiogram blanks, DX Map and three pads, or any other combination of A.R.R.L. supplies of equivalent value. Try your luck.

Most Interesting Band

BY BAYARD ALLEN, W3ATJ*

THERE really isn't any argument, there is only one real band, and that's Twenty. It offers everything that any other band will do, yet has none of their disadvantages. For the past ten years, I have operated almost exclusively on the high end of 14 Mc. I will admit that conditions today are not as good as in the past few years. However, that's not the fault of Twenty, but a condition existing because the Four Horsemen are riding again abroad.

Up until September 1939, Twenty sounded like this — From dawn, on through the next few hours, VK's and ZL's slid in accompanied occasionally by some of the rarer Oceanic stations; and then until noon most of the W districts, and in fact almost anything within a radius of 1500 miles, came in S9. About noon the Europeans started to be heard weakly, but building up to good signal strength by dark. After 7:00 P.M. they started to fade away and the South American arrived, here and there in the band, with a scattered African and an occasional U9 or XU during the evening.

Today, a good bit of the DX is gone, but there is still plenty there, if you listen for it. You don't raise DX by calling CQ, although there seem to be a lot of hams that still think so, regardless of all that has been said in *QST* about that practice. A little listening still reveals a DX station here and there, in the band and out of the band. I never could understand why many foreign stations operate outside of 14,400, but they do.

Do you like One-Sixty or Five for short contacts? Well, Twenty will give you those most any evening after eight or nine. Like Eighty for traffic? There's plenty of that on Twenty any time of the day. Like Forty for rag-chewing? There's plenty of that on Twenty these days with not so much DX on the air.

Oh, so you need power for Twenty, do you? Don't believe it, brother. I've worked as much DX there with 20 watts as I did when I had high power (100, count 'em, 100 watts!). If you are really wise, you won't waste that extra cash on the rig. Grab yourself about 50 watts and put up any kind of a beam and go to town. You won't even need the beam; never used one here, but we work 'em just the same. You know, ignorance is bliss. When I built my present transmitter, I thought I had about 750 volts on the 807 final; I figured 75 watts input would go places. It did. The first week on the air, I pulled an S7 out of a VK2 and did as well with South

* 23 Hillside Road, Mount Holly, N. J.

America and Europe. Then, some time later I had an opportunity to really measure my voltage with an accurate meter, and found I had only 500 volts on the 807. Oh, well, 50 watts will work them anyway. In fact a good many years ago, with less than 15 watts input and with, heaven forbid, loop modulation I had a nice 'phone contact with a ZL. You don't need power to work Twenty!

About a year ago, I had an itch to try a little Ten-Meter 'phone. After buying the necessary equipment to modulate it, I proceeded to stay on Twenty for about ten months, until I finally got the audio end wired and started in. Well, sir, I worked a few of the boys on Ten and really enjoyed it, but after about two weeks I found myself back on good old Twenty, carefully listening there once more. It's no use trying, I guess. I'll be spending my days on Twenty. After ten years there, it's more than a habit. Then, too, in the summer when QRN is bad on the lower frequency bands, you can always have enjoyable evenings on Twenty. There is little QRN there, certainly not enough to cause any annoyance.

To sum it all up, I like Twenty because it doesn't have the terrific QRM of One-Sixty; there is traffic there as well as on Eighty and you don't have to wait until dark to hear them; there is plenty of rag-chewing like you have on Forty, but without the QRM, foreign BC and key clicks; and occasional short contact work, when the band goes dead. You can enjoy on Twenty all of the blessings of every other band, without a lot of their disadvantages. I'm afraid the band switch on my receiver will rust with no use, while I travel the realm of "Twenty," the "Most Interesting Band."

BRIEFS

The Gulf Coast Storm Net invites and urges all amateurs located on the Gulf of Mexico to become members of the net. This organization becomes very active at this time of the year, and all applications should be mailed promptly. Address all communications to the Net Headquarters, namely the Galveston Amateur Radio Club, 2021½ Avenue B, Galveston, Texas. The key station, W5DIG, operates on 7181 kc., the net frequency. Alternate station W5BTK will also be found on this frequency. Contacts are solicited with regard to storm net information on Sunday mornings from 10:00 to noon, C.S.T.

Code practice is being transmitted on 1977.5 kc. by W7FET, Everett, Wash., each Tuesday at 2:00 P.M. and Thursday at 4:00 P.M., Pacific Time. W5ILW, Beeville, Texas, sends code lessons on 1865 kc.

W1ZZC's call on his railroad wire is DE. He reports trains to AR. Next station east is GN, and station west of him is VA. Hi! But how about CQ?

On April 13th the Washington (D. C.) Radio Club held its annual Cherry Blossom Hamfest. There were approximately 100 in attendance, including some 25 hams from Baltimore, W2ACB of Schenectady, N. Y., and a W7 from Seattle, Wash. The president, Fred Albertson, acted as master of ceremonies, ably assisted by Paul Thomson, W3LA, who furnished and operated an excellent P.A. system. Entertainment by Dwight Roark of Washington's frequency-modulated station W3XO followed the dinner. Plenty of useful prizes were on hand for those holding lucky tickets.

The Jersey Shore Amateur Radio Association exhibit, consisting of a 'phone-c.w. transmitter in action, "held the spotlight" at the Cavalcade of Progress, held at Asbury Park, N. J., in early April. Considerable traffic was originated from the exhibit station, which signed W2BZJ/2. Thousands viewed the operation each night of the show.

All amateurs are invited to attend the joint meeting and frequency modulation demonstration at Fargo, North Dakota, on June 16, 1940. The Red River Radio Amateurs is Sponsor of the meeting, together with the Fox Radio Club and the Minn.-Dak. Radio Club. There will be no fee for registration. Get final details from W9SEI, Secretary R.R.R.A., 1431 3rd Ave., South, Fargo, North Dakota.

Brass Pounders' League

(March 16th-April 15th)

Call	Orig.	Del.	Rel.	Extra Del. Credit	Total
W4PL	18	46	2235	38	2337
W9QIL	89	265	1689	240	2293
W6IOX	23	76	1543	74	1716
W7EBQ	13	85	1378	53	1534
W3EML	63	300	787	296	1446
W5FDR	609	164	398	156	1327
W3GKO	28	61	1104	54	1247
W5CEZ	50	132	994	26	1202
W6LUJ	151	267	236	264	918
W9LH	14	30	846	17	907
W3QP	260	308	18	306	892
W8RMH*	6	12	862	2	882
W8JF	7	15	842	6	870
W6DH	49	171	532	62	814
W2ITX	24	26	730	21	801
W2LZR	44	88	491	86	709
W3CIZ	38	119	426	115	698
W8GZ	10	12	658	10	690
W9EKQ	4	15	646	21	686
W2PL	220	156	155	145	676
W5MN	23	65	536	49	643
W4GQJ/3	34	13	576	13	636
W2SC	34	167	280	154	635
W9YXH	42	106	388	80	616
W9NCS	23	59	492	39	612
W3BWT	37	58	470	47	612
W9NFL	9	45	492	40	586
W1KKS	72	40	456	9	577
W6ZX	30	200	200	141	571
W5FOM	176	132	140	120	568
W8RMH	14	8	540	4	566
W9OUD	30	64	450	19	563
W5HAG	217	159	34	133	543
W8BJO	31	61	402	48	542
W1E0B	36	38	416	28	518
W2GVZ	29	115	270	104	518
W9RVI	13	39	460	4	516
W3BZX	5	494	6	0	505
W8CJL	11	36	434	22	503
W9ONI	259	120	120	1	500

MORE-THAN-ONE-OPERATOR STATIONS

Call	Orig.	Del.	Rel.	Extra Del. Credit	Total
K4IHR	985	756	249	727	2716
W5OW	168	218	204	156	2546
K4IHQ	355	234	642	223	1454
W9BNT	28	138	590	12	768
W3CXL	9	12	605	7	633
W1AW	101	85	349	79	614

These stations "make" the B.P.L. with total of 500 or over. One hundred deliveries + Ex. Del. Credits also rate B.P.L. standing. The following one-operator stations make the B.P.L. on deliveries. Deliveries count.

W2MT, 231	W5CDU, 145	W9GMT, 110
W9ITQ, 202	W8KWA, 145	W5EOE, 109
W8RYP,* 199	W1FFL, 134	W3AKB, 107
W5ZM, 194	W9QG, 132	W8NCJ, 105
W4FWO, 191	W5CQV, 131	W2CGG, 104
W6NLI, 173	W6MQM, 125	W2CKQ, 102
W8QQK,* 171	W6PCP, 124	W8SCW, 101
W3BZE, 168	W3EEW, 123	W1UE, 100
W6RH, 152	W1JCK, 120	W9WIN, 100
W6IMI, 150	W2KI, 113	W9YWH, 100
W1KCT, 146	W1JXP, 110	More-than-one-opr.
	W8IHR, 110	W4AWO, 149

A.A.R.S.

Call	Orig.	Del.	Rel.	Extra Del. Credit	Total
WLTW (W9QIL)	46	118	447	108	719

MORE-THAN-ONE-OPERATOR STATIONS

Call	Orig.	Del.	Rel.	Extra Del. Credit	Total
WLM (W3CXL)	188	176	3458	107	3929

A total of 500 or more or 100 deliveries + Ex. D. Cr. will put you in line for a place in the B.P.L.

* February-March.

1940 Spring Flood Activities

Pennsylvania and New York State

THE Spring Flood of 1940 which developed on the Susquehanna River, March 31st, and continued through to April 2nd, probably ranks third in magnitude since the 1889 flood. Communications were not disrupted, but a heavy burden was placed on existing public lines which in many cases caused some delays. The Susquehanna Emergency Net, organized in 1937, performed a public service by expediting river reports to the U. S. Weather Bureau for the purpose of forecasting stages for the various cities and towns along the river. The key stations of the S.E.N., observing a potential flood in their area, started reporting in to the control station, and by 3:00 P.M., March 31st, all key points were active.

At Wilkes-Barre, Pa., things were exceptionally well organized. Early in the year, following the appointment of W8EKG as S.E.N. key station, and W8QPU as alternate, Wilkes-Barre amateurs held a meeting to make plans for a local emergency set-up. The completed organization called for two 3.9-Mc. 'phone stations, three 1.75-Mc. 'phone stations and four 3.5-Mc. c.w. stations. W8EKG was appointed a member of the Red Cross Communications Committee. When the flood conditions developed on March 31st, W8SOV (W8CR, chief opr.), 109th Field Artillery station at Kingston, Pa., was selected as control station on the S.E.N. frequency, with W8EUI, alternate. W8EUI also handled the control of the 1.75-Mc. Net, with W8EKG controlling the 3.5-Mc. C.W. Net. Other active at Wilkes-Barre were W8EGH, W8QPU, W8TWE, W8PAF, W8FNV, W8QZO, W8RXP, W8RWW, W8OWN, W8TXM, W8SNB and W8SEH. W8EKG was on the air continuously for 72 hours, with SNB, OWN, SEH, RXP, RWW and QZO as relief operators.

W8SOV was in continuous operation from March 31st until April 10th. W8CR, in charge of this station, had two telephone lines to the radio room tower, set up a local 28-Mc. Net in Kingston and Wilkes-Barre, and as a preparatory measure had two emergency powered sets ready to go, one in Kingston and the other at the Armory, where W8SOV was located. Regular schedules with W8MFD and W8PUZ, Towanda, were maintained to obtain river reports, which were passed down the line to W3UA, S.E.N. main control station. Operators at W8SOV bunked on cots in the radio room, receiving splendid cooperation from the Red Cross. A message center was established in the radio room for the purpose of systematically handling all traffic. Land phone was used between W8SOV, W8EKG and W8EUI for interchange of traffic and other information. Relief operators handled this for the most part, although the XYL at W8EUI deserves credit for taking care of the telephone contact there. W8CNA, Binghamton, W8AVD, Waverly, and W8RRS, Corning, were scheduled regularly by Wilkes-Barre stations.

W8EUI, Kingston, Pa., control for 1.75 Mc., organized a net to reach Binghamton, N. Y.: stations involved were W8EGH, West Pittston; W8LEI, Scranton; W8QGG, Dunmore, and W8RTD, Carbondale. Close cooperation with W8SOV enabled W8EUI to assist in the handling of river readings from Towanda and other points. W8TXM served as relief operator at W8EUI. On the evening of April 2nd, W8EUI kept W8QJP of Sunbury informed of conditions in Wilkes-Barre and to the north, so that he could allay the rising fears of the public in Sunbury. W8QJP was forced by the flood waters to move his equipment to his alternate's home, W8SEL.

W8PIK and W8ITS were on the job at Williamsport, Pa., working into the S.E.N. on 3910 kc. and handling river reports. W8PIK mentions particularly W3LP, W8CMF, W9JO, W8OFL, W8FOV and W8HKF as aiding him in his part of the operation.

W2BGO in New York City put in 28 hours, including one stretch of 27 hours, from midnight March 31st until 3 A.M., April 2nd, monitoring the various stations and keeping half-hourly schedules with W8EKG. W2BGO also worked

W8SBV, Emergency Coördinator at Elmira, N. Y. W8EKG gives special credit to W2BGO for handling most of the traffic from that station, and also mentions W2DW, W8PCN, W8EWR, W8ADE, W8ADM and W8CDT as cooperating. When the Coast Guard lost contact with New York at 12:05 A.M., April 3rd, W8EKG relayed 26 messages for station NRPT from Wilkes-Barre to New York station NMY; this schedule lasted until 4:30 A.M.

Operation of the Susquehanna Emergency Net was officially closed at 1:30 P.M., April 2nd. The control station, W3UA, however, maintained intermittent watch for the next two days. Special praise by the United State Engineer Office and Weather Bureau attested to the smooth functioning of the net. The regular drills and training therefrom paid dividends when S.E.N. was put to an actual test! The following were active in Susquehanna Net activities during the flood crisis: Key stations — W8CNA AVD RRS MFD EKG EA AVK QJP DEC VI CHR BKT W3WX ZD. Alternate and relief operators — W8FPU QPU EUI PIK HHK SNB FNV ITS RJL GZP BQ W3GKM BEI QV NF ADM W4DU ANU. Others — W8PAF OWN SEH EA RXP RWW QZO SOV KBJ BHN HKF W3APO SN LP HAL EWR AIX ESE W11HM W2GG/8.

On Friday, March 29th, rising temperatures and an increasing rainfall caused A.R.R.L. and A.A.R.S. officials in the Southern Tier area of the Western New York Section to start dusting off emergency gear, study road maps and commence their prearranged schedules. These officials included W8PLA, S.C.M. Western N. Y.; W8FCG, State Radio Aide, A.A.R.S.; W8RRS, Asst. A.R.R.L. Emergency Coördinator, Corning, N. Y.; W8SMH, E.C., Binghamton, and W8SBV, E.C., Elmira. For the three days following, these stations maintained almost constant communication, and every change in the river was recorded in each station. All vital information was immediately relayed to the County Red Cross headquarters.

In the early afternoon of Monday, April 1st, the Chairman of the Chemung County American Red Cross called Coördinator Berry (W8SBV) on the telephone, reporting a growing concern regarding the village of Wellsburg, seven miles below Elmira on the Chemung River. All attempts to get information from Wellsburg had failed. A Red Cross unit consisting of two cars with nurses, firemen and supplies was ready to leave. Referring to his Emergency Coördinator records, W8SBV promptly ascertained that W8RTW was available and in a position to make the trip. W8RTW gathered together his portable equipment and left Elmira with the Red Cross group at 3:15 P.M. for the 42-mile journey necessary to reach Wellsburg. Arriving at the isolated town, W8RTW set up in a grocery store, hooked onto an improvised antenna and made contact with W8SBV. Traffic was immediately handled to the Red Cross headquarters reporting on conditions. The news that there were no serious needs at Wellsburg was most welcome, and the Red Cross ordered its unit to return to Elmira. W8RTW used 3.9-Mc. 'phone with a 6L6 final; W8SBV was on 3.5-Mc. c.w. Much credit is due W8RTW for the efficient manner in which he handled his important assignment. Everything worked very smoothly, and the citizens of Wellsburg and Elmira received a lesson in the value of amateur radio in time of emergency! A message from Chairman Palmer of the Chemung County Red Cross was sent to National R.C. Headquarters at Washington, D. C., at 6:30 P.M., Monday night, stating that all was under control and no additional help needed.

Ohio Flood Work

After an all-day rainfall on Friday, April 19th, the Licking River overflowed its banks, and by Saturday morning had flooded over 400 homes in Newark, Ohio. The Disaster Relief Committee of the local Red Cross Chapter was active evacuating those whose homes were in the flooded sections. The Telephone Company was having some difficulty with its system, especially on out-of-town calls, and as the water continued to rise the Communications Section of the Disaster Committee thought it best to prepare for any eventuality although no emergency existed at the time. A message center was established at Red Cross Headquarters using portable equipment of W8HMH, consisting of a two-tube receiver and a transmitter with 15 watts

input on c.w. and about 10 watts input on 'phone. According to plans previously established, this message center station was to contact nearby stations W8LYH at Newark and W8NQZ at Granville, who would work into the Ohio A.A.R.S. Net, because these stations had higher power and better receiving conditions. By this means a message was sent to National Red Cross Headquarters to report the local condition, with W8CIO-W8UW-WLM doing the relaying. Later in the day it was found that W8HMH could work directly into the A.A.R.S. Net, and other local stations stood by in case receiving difficulty should develop, as the low-power station was located in a building downtown. Stations that assisted by standing by throughout the day and evening were, in addition to those mentioned above, W8RMA, W8JLF, W8CJL, W8NAL, all members of the Ohio A.A.R.S., and W8TGU. While no condition developed which required emergency communication, much valuable information regarding flood conditions at other points in the state was secured for authorities, and it was definitely demonstrated that amateur radio is capable of providing reliable communication when needed.

Minnesota Sleet Storm

On April 3, 1940, the most severe sleet storm in five years hit Duluth, Minn., and its vicinity, doing \$100,000 worth of damage. Power and communication lines were down. Duluth was cut off from the rest of the world except for amateur radio. W9GKP, A.R.R.L. Emergency Coördinator for Duluth area, had his gang prepared for emergency, and many messages were handled for power, telephone and telegraph companies. It was not long before line crews from various districts came into the area to begin repairs. The active stations in Duluth were W9KRH, W9WSB, W9VOB and W9GKO operated by W9WSO, W9QZK and W9QVP. Outside stations active were: W9CWB, Crosby; W9KQA, Ironton; W9RTN, Virginia; W9FTJ, Motley, and W9JIE. W9BQY, W9DH and W9HCC took traffic for Twin Cities.

The Duluth papers praised the amateur radio operators for help in sleet storm. The efforts of all who took part in handling the emergency traffic were greatly appreciated.

CORRECTIONS, SWEEPSTAKES CONTEST RESULTS

W9TQL's very excellent 'phone score of 34,581 was erroneously listed with the Illinois c.w. scores in the May QST Sweepstakes Contest report. Actually, W9TQL had the highest Illinois 'phone score, and is the 'phone winner for that Section. In addition, his was the fifth highest score of all voice operators. The transmitter line-up at W9TQL was T21 crystal osc.-T220 buffer-doubler-pair of T40's final. Operation was on 1.75, 3.9 and 14 Mcs. Receiver was an RME69. TQL worked 256 stations in 55 sections.

SS winner in the Ozark Empire Radio Club was W9QMD rather than W9QBJ, as previously reported. W9QMD's score as listed in May QST did not include the low power multiplier. His correct score was 28,420, making the Ozark Club score 58,283. Under the Eastern New York 'phone scores W2JLH's call was incorrectly listed as W2JLU. The correct score for the Elmira (N. Y.) Amateur Radio Association was 174,157, placing that group somewhat higher than originally reported.

CHICAGO CLUB BOWLING LEAGUE

Seven ham clubs competed in the 1939-1940 Bowling League of the Chicago Amateur Radio Club Council. Winner was the Tri-Town Amateur Radio Club, with ten wins out of fifteen and an average of 805. Others competing and their averages: Chicago Suburban Radio Ass'n 795; Hamfesters Radio Club 749; Illinois Ham Club 773; Lake Michigan Amateur Radio Reserve 711; Northwest Amateur Radio Club 677; Milwaukee Radio Amateurs' Club 766. Highest individual was W9DGG of C.S.R.A., with an average of 189.8. Johnson of Tri-Town had an average of 185.12 and C. Brown of Milwaukee, 181. C.S.R.A. bowled the high team series of 2615, and Johnson of Tri-Town the high single game of 255. The bowling took place on five Sundays during the winter. Each bowler paid \$1.00 at each bowling date, 30 cents going into a prize fund. Prize awards totalled \$37.

The Chicago Club Council proposes a nation-wide ama-

teur radio bowling tournament during the '40-'41 winter season. It is believed that a large number of clubs would be interested in competing. Interest in bowling has increased tremendously in the last few years. Every good-sized radio club will be able to get up a team without any trouble. Everybody from young to old can indulge. Plans are now in the formative stage, but the Council is anxious to hear at once from all clubs that are interested. It is suggested that clubs desiring to take part might challenge neighboring clubs, advising the Council of scores by postal card, or by radio with confirmation by mail. The local competition could be a part of the national tournament, making participation more interesting. If your club takes to this idea, make sure that the secretary starts the ball rolling by writing to Rex L. Munger, W9LIP, 2946 N. 77 Court, Elmwood Park, Ill., advising of your intentions to participate, and of any games you already have planned. Keep W9LIP advised of all scores made by your club team.

THE YACHT YANKEE—WCFT

WCFT, the schooner-yacht *Yankee*, is on a world cruise, and at present visiting one South Sea island after another. The radio operator of WCFT is Oakes Spaulding, W1FTR. Schedules have been kept consistently with W1AW since the start of the cruise some months ago. W6ITH worked KF6JEG while WCFT was anchored at Canton Island, April 4th. Oakes is having some difficulty getting through to the east coast now he is at greater distances, and therefore wants to make some additional WCFT schedules with west coast amateurs on 7 Mc.

WCFT, 8280 kc., worked about 100 kc. lower than KFS (8380), and can be identified by a 500-cycle note. He will look for amateurs at about 7280 kc. between 0500 and 0600 G.T. The *Yankee* now goes to Samoa, Gilbert and Ellice Islands, New Guinea, Singapore, Indian Ocean, Africa, South America, and then home. The *Yankee* picked up VR6AY's transmitter at Panama and reinstalled it at Pitcairn — but Andrew Young has been forbidden to go on the air at all on account of the war, so any ham station using his call is a 'bootlegger. Spaulding reports that the hardship stories about Pitcairn are just the product of someone's imagination, and the islanders are indignant about them.

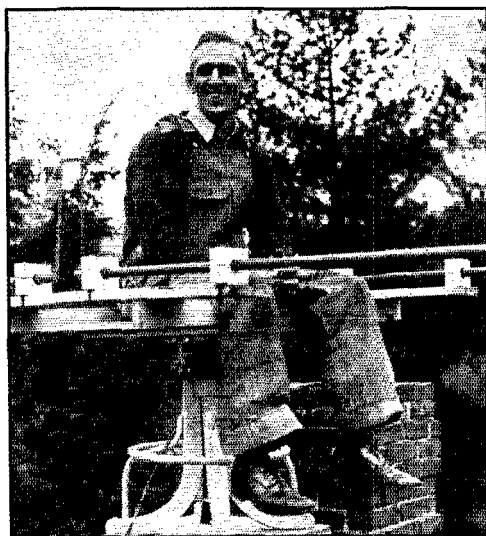

Rotary W1HSX

The 2-element 28-Mc. beam at W1HSX, New Haven, Conn., uses an office swivel chair for rotating mechanism. "Andy" Nelson, the operator, and Connecticut Route Manager, demonstrates its unique construction.



How's DX?

HOW:

THERE seems to be some doubt among the members of the listen-and-pounce brigade as to which countries they should or should not work while certain differences of opinion are being settled the hard and messy way on the other side of the briny. The dope has appeared elsewhere in *QST* but, in view of its importance, it can well be repeated. No one should fail to get it the first time around, it's that simple. All it amounts to is: Don't work belligerents, and don't talk about the war over the air. Belligerents are stations in countries declared to be in a state of war by our government and everyone knows, or should know, which countries they are. We are not to communicate with unlicensed stations, and we are not to work amateurs in countries where ham radio has been closed down. By observing this strict neutrality, we minimize any possibility of our having any of our privileges curtailed.

Now, there are always a couple of smarties sitting in the back row (and they usually eat peanuts and spill the shells all over the floor) who will pipe up and say, "If you're neutral, why do you print stuff in *QST* about belligerent stations that are on the air?" This time we're glad someone tried to heckle, and it's a pleasure to answer the question. We might say we didn't run very much about any belligerent stations, which is of course the story, but that doesn't keep up from feeling that we can tell you all we know about ham stations in belligerent countries without violating any neutrality. As we see it, the purpose of this column is to report what goes on and, in such a capacity, we see no harm in mentioning a few of the stations. However, we refrained from telling all we know because some people seem to think that mentioning the call in this column means the station is OK to work. And that's why we started this whole item — to point out that it doesn't mean any such thing. We would like to say more about the German and French stations on the air, but we're afraid someone (including those peanut-eaters in the back row) would consider it "official sanction" or something. So we'll keep our stories for later on. But please remember, and help to maintain the strict neutrality of the W's by not working any belligerents, etc

DXCC ROUND-UP:

W6GAL suggests that it might be in line to have a get-together of the DXCC members over the air. That sounds like a swell idea to us, and we hope we're not going over the heads of the DXCC presidents if we try and promote just such a gathering. We are setting the date as the weekend of June 29th-30th, and if no one likes the idea and we hear about it, we can still call off the meeting in the July issue. Assuming that the meeting is to be held, any and all members of the DXCC (and the 75-or-better listing) that are interested would get on 20 meters on June 29 and see how many other stations in the list could be worked. No number exchange or anything like that, although we do suggest learning each other's first names, but just a few words of greeting or, if it's someone you've been wanting to ask about something, have a bit of a chew. The thing would start at 5 p.m. EST (2 p.m. PST) on June 29th and would last until Sunday evening, June 30th, at midnight EST (9 p.m. PST). We won't try to make it a two-band affair this time because the main idea is to see how many fellows we can work. If you'll all send in lists of the stations you worked, we'll run the results of the Round-Up in an early issue. Phone and c.w. members can work each other, of course, if they'll give a listen.

Let us know beforehand if you like the idea or not, so that if the interest is low we can kill the party and put the refreshments back in the ice box for Jeeves to nibble on from time to time. But we think you'd have a lot of fun rounding up as many other members as you could over the

weekend. The call will be "CQ CO," and the July DXCC list will serve to identify those invited to the shindig.

WHERE:

THE gang is still managing to scare up contacts with AC4YN. Latest members of the TWA (Tibet Workers of America) are W9ARL, W6GRL, W6NLZ, W6QD and W6ORG. K6KQK also worked him Johnston Island crops up again with **KE6SRA** (14,340 T9c), worked by W8DOD, W9NTA and a flock of others on May 3rd between 9 and midnight, CST. He gives his address as KE6SRA, Johnston Island, care of Postmaster, Honolulu, T.H. A South African correspondent gives the new address of YI2BA as A. Kerim, Port Basrah, Iraq And W8JSU received a card from **EA7AV** (14,395), giving the address as Joaquin Portela, Cadiz, Spain. W1M1W adds to that by saying the address he has for EA7AV is Veedor Str. 15, Cadiz, so putting the two together should bring results W2KZX received a QSL from **EEQ1**, worked on 7 Mc. last year. The station had been operated by EA3BD, EA3EV and EA3CI, apparently from police headquarters in Barcelona If you've worried about no reply from the VP7's you've written to for the all-important pasteboards, you'll want to hear about W1IOZ and W1AVK. They spent some time in VP7 a short while ago, and found that the censorship has been keeping a lot of cards from getting in or out. Further, the VP7's don't have too much money and cards come high to them. However, Ed and Lou brought back the log of ex-VP7NT and left it at HQ, where it is available to anyone wishing DXCC confirmation K7GSC writes to say that standard time in southeastern Alaska is now the same as Pacific Standard Time, and not one hour earlier as Yukon Standard used to be HRSC says to QSL via W4MS W7AYO worked **KB6CBN** (14,365), a new one at Guam **WGFT**, with W1FTR aboard as op, can be found on 8280 kc., 500-cycle note, almost any day from 05 to 06 GMT. He looks for replies from hams around 7280 kc. He's way out in the Pacific now.

WHEN:

NOTHING much this month except 20-meter stuff, with a smattering of 7-Mc. DX contributed mostly by the W6's. For example, W6QKB accounted for J8CL (7130 T9), J2LL (7190 T9), J3CG (7165 T9), J2LX (7200 T9), J2NE (7195 T9), J2OF (7210 T5), J5DH (7160 T8), J8CD (7120 T9), HK2BD (7200 T8), KA1EL (7120 T9), J2OV (7120 T9), KA1HQ (7090 T8) and KB6RWZ (7110 T8), and W6PMA adds LU3DD (7015 T8), K7BZG (7055 T8), K7HNG (7055 T9), K7TP (7050 T8) and KC4USB (7050 T7), hearing KB6OCL (7070 T8) and K7QI (7030 T9) W5DWW worked **K8RQO** (7030 T9), **K6PAL** (7030 T9), and **KC4USB** (7020) at 3:30 a.m. W6AAE raised J8CF (7125), and W4BZ, old W4CBY, got J2KN (7100) and **KF6ROV** (7180).

On 20, W8QQE realizes an ambition of many years' standing by sending in a nice long list. The new rotary must be doing its stuff, because Paul has accounted for **FK1TM** (14,340 T9), **XUOA** (14,390 T8), **KAISP** (14,385 T8), **XU9HH** (14,200 T5), **PK4KS** (14,320 T9), **KA1JK** (14,340 T7), **J2IH** (14,370 T9), **XU8MR** (14,350 T9), **KA1HG** (14,280 T8), **XU4VV** (14,360 T8), **J6DV** (14,340 T9), **J8JJ** (14,370 T9), **XU2MC** (14,350 T9), **KAILB** (14,300 T9), **XU8KW** (14,330 T9), **XU4A** (14,330 T6), **XU8A** (14,335 T6), **XU8HR** (14,360 T8), **XU6CH** (14,365 T7), **JACP** (14,360 T9), **J5DC** (14,370 T9), **J8CH** (14,380 T8), **J8CL** (14,380 T9), and **J3FE** (14,385 T9), all worked in the morning between 6 and 9 a.m. W4FLJ adds

(Continued on next left-hand page)

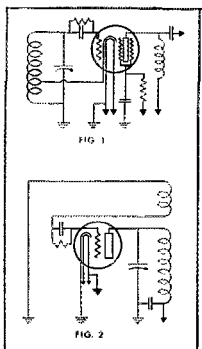

LAST MONTH we promised to tell you about a good high frequency oscillator for receivers. You may be surprised to find that we mean to talk about a tuned-plate grid-tickler oscillator which in itself is not new, but since receivers use electron-coupled, or tuned-grid oscillators almost exclusively, the merits of the tuned-plate arrangement are not generally realized and are therefore "news."

As a start, let us take a look at the electron-coupled oscillator shown in Figure 1. In this, the cathode is at some RF potential above ground. As a result, the inter-electrode capacity between cathode and heater (which is grounded) will be across part of the tuned circuit. In addition to causing hum, this causes instability, since a slight shift in the position of the heater will change the oscillator frequency. This can be kept at a minimum by carefully selecting the oscillator tube. It is particularly important to choose a tube having a "folded heater," rather than a "spiral heater." However, when the frequency is high, the only practical cure is to keep the cathode at ground potential. This is most easily accomplished by using either a tuned-plate or tuned-grid oscillator.

It is our experience that it is much easier to make a tuned-plate oscillator stable than one of the tuned-grid variety. Most of the theory behind this is rather involved, and since this page is no place for vector analysis, we are not going to go into much detail. There is one point that we can cover easily, however.

In the usual tuned-grid oscillator, the grid current places a heavy load on the tuned circuit, which spoils its Q . At the same time, the tickler coil does not provide enough load impedance for the plate. The net result is poor frequency stability due to the low Q , and weak oscillation due to impedance mismatch in the plate.

With a tuned-plate, this situation is reversed, with happy results. The tuned circuit provides an excellent load for the plate, of course. At the same time, by adjusting the coupling of the grid tickler a reasonable impedance match can be obtained in the grid circuit, so that ample grid driving power can be obtained without spoiling the Q of the tuned circuit. The circuit for doing this is shown in Figure 2. Of course there is one disadvantage to this circuit in that it allows DC plate voltage to appear on the condenser stator, but this can be easily avoided by using a blocking condenser.

The plate-tuned oscillator lends itself nicely to electron coupling either by using a separate mixer tube or by a pentode, as in Figure 1. But even without electron coupling we have found that the plate-tuned oscillator is preferable to the types usually found in receivers and possesses the same advantages when used in monitors, "rubber crystals," and the like.

★ ★ ★ ★ ★

By the time this issue of *QST* appears, you will have only a little over a month left to send in your entry to the Contest. (See February 1940 *QST*). The July 1 deadline is final!

DANA BACON



RAIN or SHINE...

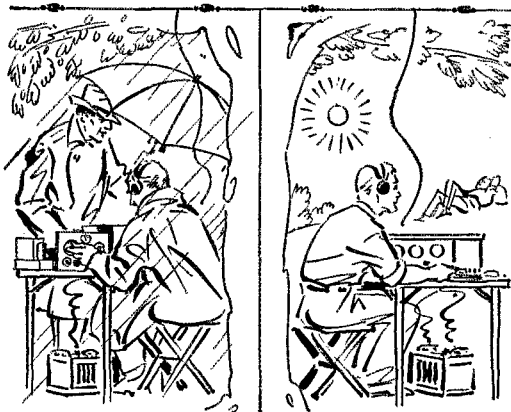

P. R. MALLORY & CO. Inc. **MALLORY** Vibrapacks

(TRADE MARK REG. U. S. PAT. OFFICE)

are always dependable

Every day is Field Day for countless Mallyory Vibrapacks. In 24-hour-a-day regular operation, these Vibrapacks provide unfailing service in police squad cars, in forest fire control stations, in airplane communication equipment, in ship-to-shore telephone and in other similar services from fixed stations and in mobile equipment aboard automobiles, boats and airplanes. The selection of Mallyory Vibrapacks for these applications is logical because of their dependability, lower battery drain and economy.

Amateurs want these same advantages for their Field Day and QRR rigs—especially when genuine Mallyory Vibrapacks cost no more than other forms of power conversion equipment. Learn the advantages of Mallyory Vibrapacks and why they provide "Perfect Portable Power" for receivers, transmitters and P.A. Systems. Ask your distributor for the technical data booklet, form E-555-C, or write—

P. R. MALLORY & CO., Inc.
INDIANAPOLIS INDIANA
 Cable Address—PELMALLO

Use
P. R. MALLORY & CO. Inc.
MALLORY
 APPROVED
 PRECISION PRODUCTS

HC1VT (14,400), KF6SJJ (14,295), KB6RVN (14,310), KB6RWZ (14,270), XU8WS (14,350), KA1HR (14,260), KA1DM (14,340), KA1LH (14,070) W3CPV has TF5C (14,385 T8), and HK6EJ (14,015 T9), and W8QVF brings XU6K (14,300 T9c), XU6AL (14,355 T9) — both Box 15, Kwellin, China — K7GOM (14,340 T9), K7ENA (14,325 T9), KA1FG (14,340 T9), KA1BG (14,330 T9) and KA1EL (14,310 T9) W6SN reports OQ5IM (14,355) — Box 747 Elisabethville, Belgian Congo — and OQ5BF (14,400), while W7BIZ in Montana doesn't let cries of "no DX" bother him, and works J8KM (14,325 T9), J2OV (14,325 T9), HK6ED (14,300 T8) and KA7SV (14,320 T9) — Box 392, Hollo, P. I. W6ONZ has been busy, too, with MX3EH (14,340 T9), XU6WT (14,330 T9), J3HO (14,385 T9), J8GN (14,330), PY2LN (14,350 T8), KB6OCL (14,320 T9), LU9CZ (14,370 T9) and LU9CK (14,345 T9) W9NTA worked J8HQ (14,270 T7), KA1BN (14,350 T9), PK3BM (14,345 T7) and HK6EJ (14,050 T9). ZF6AB (14,270 T9) was heard W1M1W, ex-W6LTM, has list which includes H8C (14,330 T6), H8F (14,360 T7) and TF5C (14,300-400 T7) on it, and W4BZ shows a whole flock of stuff: XU8MC (14,340), J3DJ (14,400), PK1FK (14,290), XU8MA (14,350), XU8LK (14,320), J2OP (14,340), XU8MK (14,275), KA7TT (14,290) and OQ5AV (14,300).

'PHONE:

EITHER these old eyes deceive us, or else someone has stacked the mail, but there seem to be a few more than usual 'phone reports this month. That's OK with us because, as anyone knows, DX is where you find it, 'phone or c.w. On 10 'phone, W5BB reports as active such items as OA4R (28,100), HHAAS (28,190) and HR8T (28,400), and W6ITH adds that KC4USC is on daily, on 28,580 and 29,132, showing up best in W6 at 23-02 GMT.

Apparently there's enough to keep one busy on 20. For example, the "Casey" family is represented by KC4USA (14,150), worked by W2JT, W2IXY and W6ITH, since KC4USC is off for "spring cleaning" Then there's EA9AI (14,070) and KF6JEG (14,160), worked by W2JT — W1AKY gives EA9AI's QTH as Dr. Mora, Melilla, Spanish Morocco — and W3BET gives us XU8AM (14,090), PK1OG (14,050), K7HAR (14,185), K6PLZ (14,200), OA4R (14,030), CE1AR (14,015), and PK2AY (14,040) W5BB writes a nice letter, mentioning HPIA (14,120, 14,075), OA4C (14,380), HH9B (14,130), HR8T (14,030), HR5C (14,120), YS1MS (14,125) and YS1RP (14,050). The QTH of CP2AC is Carlos Godoy, Box 268, La Paz, Bolivia W2IXY tells us that CO4AA, a new-comer, is located on the Isle of Pines Tidbits from Tibbetts (W6ITH to you) this month include CPIEA (14,085), KA1HQ (14,080), CE1AI (14,060), J2KI (14,110), J8FC (14,100), J2XA (14,090), J5CW (14,075), XU8RA (14,300), KA1CD (14,090), XU8TL (14,060), XU8TH (14,060), PK1SI (14,070), J2NL (14,045), J8DU (14,160), J2MC (14,140), KA7AJ (14,150), XU8WM (14,045), and CE1AA (14,055), whose address is Julio Ibaceta, Matta, 525, Anatofagasta, Chile. Reg says the zero in WUOA is the portable indication meaning "no definite location."

WHO:

CONGRATULATIONS are in order to the W6QD's, who recently added a daughter to make it a threesome. We wouldn't know, but the chances are even that her first words will be "CQ W9" The first to obtain that "WPR" (Worked Puerto Rico) award outside of K4 was W8JIW, with 20 watts PY2DV writes to remind W's that IRC coupons are no good in Brazil, because Brazil doesn't belong to the Postal Union, so it's a waste of money to send them to PY's It doesn't pay to give up hope. W8JFC worked a station on 10 'phone in 1936 that was signing ZU9AC. Jeeves and his mob would tag that a phony before anyone was through explaining that ZU9 is Tristan da Cunha, but W8JFC received a QSL a short while back, with an apology for being slow but the boats don't stop there very often. We understand the apology was accepted! The ZU9 doesn't get on much because of lack of power VP5PZ, used as a government h.c. station on 4.75 Mc., now signs ZQI W4EPP has some DX to talk about these days. W4ECI has working KCUSB on 20 and mentioned that W4EPP on 160 was QRX. Elmer, the op at KC4USB, suggested that W4EPP

(Continued on next left-hand page)

High Class..

PERFORMANCE !

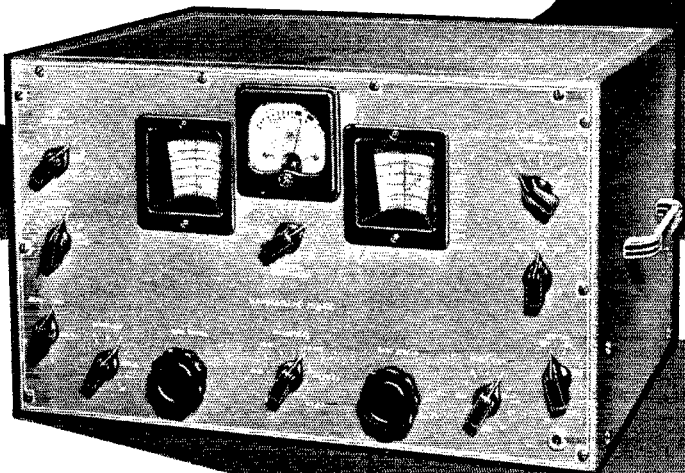

HQ-120-X

THE "HQ-120-X" has earned an enviable place for itself in amateur radio by really doing a great job. This high rating was earned by originality, not by following ordinary design. Variable crystal selectivity; direct calibrated band spread; antenna compensator; six bands, to provide better L/C ratio and many others were features which are now the yardstick for comparing receivers. Of course, it is easy to build a receiver with all these features, but there is more to it than that. To

make them perform exactly the same is quite another story. For, in receivers, as in everything else, there is individuality. This individuality stands out all over the "HQ".

Try one, or ask your friends, and you will have the answer.

SEND FOR BOOKLET!

HAMMARLUND MFG. CO., INC.
424-438 W. 33rd St., New York City

Please send "HQ-120-X" Booklet Q-6-0

Name.....

Address.....

City..... State.....

Canadian Office:
41 West Ave. No., Hamilton



HAMMARLUND

EXPORT DEPT. . . . 100 VARICK ST., NEW YORK CITY

New "Locking" Acorn Socket

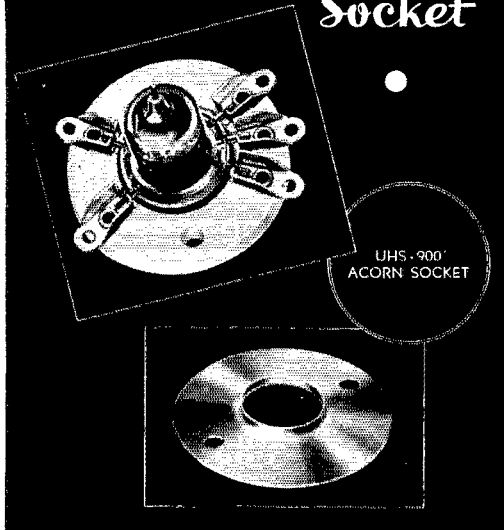

THIS NEW "Locking Acorn Socket" with positive locking contacts and "Iso-Q" insulation, is the last word in acorn tube sockets. With its new contact design, this socket can be mounted in any position without danger of the tube becoming loose. It is ideal for portable amateur equipment and commercial installations where absolute dependability is paramount. The contacts are firmly anchored in the base so that they cannot shift. When the tube is inserted it *snaps* into place. Each socket has a copper shield to complete the internal tube shielding and results in better circuit stability. The use of silver plated contacts and that new super Isolantite, known as "Iso-Q," results in extremely low losses, making this *the* socket for 2½ meter receivers. See it at your dealer's.

SEND FOR CATALOG

HAMMARLUND MFG. CO., INC. Q-6
424 W. 33 St., N. Y. City

Please send 1940 catalog No. 2.

Name.....

Address.....

City.....State.....



HAMMARLUND

CANADIAN ADDRESS: 41 West Avenue No., Hamilton, Ont.

call the base on 160, since 160-meter 'phones had been heard down there. W4EPP did call, suspecting a gag, but almost fell out of his chair when USB came right back (on 20, of course). Now KC4USB plans to try 160 more often, since he thinks he can get through there fairly well W9HLF had a visit from XU8MI, who was on his way to the west coast where he will probably be on with a W6 call soon PK1TM wants Maine and N. H. for WAS. Having made his RCC with WIKHE K4KD finally worked his WAS on 3.5 Mc., as he had set out to do, but he still needs a few fills on the other bands HK2BD, ex-HK2BL and ex-HK3AL, says that anyone who didn't receive his card when he was using the other calls, can get the cards by sending him and a reply coupon to Aurelio Linero Parra, Radio Nacional, Santa Marta, Colombia. Which just about rounds out things for this month. But please don't forget to let us know what you think about the Round-Up. "The more the merrier," if we may coin a phrase.

— W1JPE



BRIEFS

Seven hundred and eighty messages were sent by W9YH at the University of Illinois during the student-presented biennial Electrical Show, March 28th-30th. Operation of the station was in charge of Synton, professional radio fraternity. Operators were W9YST and W9QBJ. More than 7000 persons visited the show and saw W9YH. The 400-watt transmitter is located in the Electrical Engineering Laboratory. Because of interference from other exhibits, the receiver was temporarily located several blocks away in the university armory, and connected by land line to a loud speaker at the exhibit. Much of the traffic was distributed through W9IER, Chicago, N.C.S. for the A.A.R.S. 'Phone Net. The regular 1:15 P.M. Saturday "Ham Forum" over the University's station WILL (580-kc.) was extended from 15 to 45 minutes and broadcast direct from the E.E. Lab. The first 15 minutes were devoted to a dramatized history of amateur radio, and the remaining half hour to interviews with visitors and demonstrators at the show. A national meeting of Synton was held during the week-end.

Chess by Radio

John McCollom, W3CNZ, sends some suggestions for playing chess by radio. He numbers the black squares of his board from 1 through 32, in the manner suggested in the article by W9FB (page 80, March QST). He marks the white squares with letters, A through FF. The board should always be placed so that white squares are at the lower right and upper left corners. When playing chess the two players must agree on which end of the board each will defend and also on which color of men each will use. W3CNZ numbers and letters his board in the two opposite corners of each square, so that it may be read by both players, without either "standing on his head." The markings are in the corners of each square making them easy to see even when a square is occupied by a man.

We understand from SCM Greer, W6TI, East Bay Section, that W6USA will not be on the air this year.

(Continued on next left-hand page)

SUPER PRO

"SERIES - 200"

Built to last a life-time!

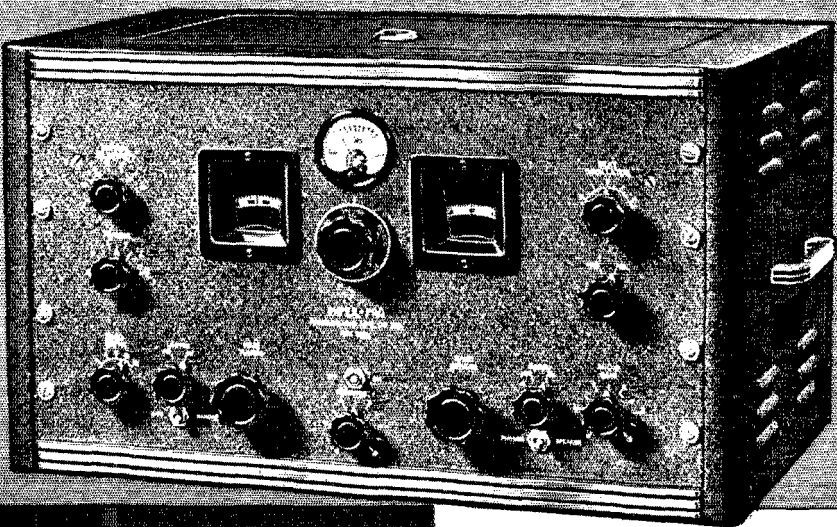

THE "Super-Pro" Series 200 is designed and built to give years of service. It is a *plus* receiver all the way. When you buy a "Super-Pro," you are not only assured of getting a modern receiver, but you are getting one that will still be in a class by itself even after years of use. One happy "Super-Pro" owner puts it this way: "I have owned a half dozen or more receivers of the communications type, but I have bought my last receiver — it is a 'Super-Pro.'"

The "Super-Pro," being a professional receiver, naturally has many features especially appealing to the amateur. Two stages of TRF provide high image ratio and low noise level. Variable I.F. band width and variable crystal

selectivity cover practically every requirement in crowded bands. The "S-Meter" problem is nicely solved with an adjustment that can be made to provide the exact "S-Meter" readings desired.

See your nearest Hammarlund dealer and he will explain how you can own a "Super-Pro" for only a few dollars a month.

SEND FOR BOOKLET!

HAMMARLUND MFG. CO., INC.
424-438 W. 33rd St., New York City

Please send "Super-Pro" Booklet

Q-60

Name

Address

City State



HAMMARLUND MFG. CO., INC.

424-438 WEST 33rd ST., NEW YORK



CANADIAN OFFICE: 41 WEST AVE. NO., HAMILTON, ONTARIO

EXPORT DEPARTMENT: 100 VARICK STREET, NEW YORK CITY

L-C CHECKER

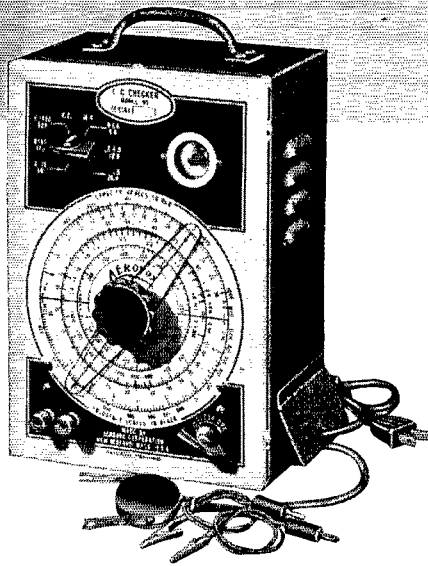

A "must" instrument for radio workers . . .

Aids preliminary tuning of transmitters and receivers.

Serves in neutralization of transmitters.

Measures L to C ratio of transmitting and receiving tuned circuits.

Determines standing waves along transmission lines.

Determines natural period of transmission lines and antennae.

Checks activity of quartz crystals.

Checks frequency of r.f. amplifiers, r.f. chokes and transmission circuits.

Measures inductance and capacitance.

Measures distributed capacity of inductances.

Etc., etc. Yet it costs but \$29.50 net, including tubes!

● Developed originally for radio servicemen, to permit checking condensers while connected in circuit, thereby saving time, money, trouble, the L-C Checker now finds many uses among "hams" and others engaged in communication work.

Indeed, this instrument has so many different uses that you simply must see it and try it for yourself. So . . .

Ask to See It . . .

Your local jobber can show you the L-C Checker. Try it. Notice how easy it is to check so many vital factors. Ask for descriptive folder. Or write us direct.



DX CENTURY CLUB AWARDS

These have been made to the first-listed amateurs, based on contacts with 100 or more countries, the credits all certified by examination of written evidence under the award rules.

W6GRL..... 148	W4BPD..... 132	W8NJP..... 122
W2GI..... 147	W5BB..... 131	W9TB..... 122
W8CRA..... 145	W2CMY..... 131	W6GAL..... 121
G6WY..... 145	W8OSL..... 130	W9FS..... 121
W2GW..... 144	W8OQF..... 130	W5KC..... 121
W2GTZ..... 143	W8ADG..... 130	W8JMP..... 120
W1TW..... 142	W3CHE..... 130	J5CC..... 120
G2ZQ..... 141	W2JT..... 130	W2GVZ..... 120
W9TJ..... 141	HB9J..... 129	W3FRY..... 120
W6KIP..... 140	W1FH..... 129	W1AXA..... 120
W1BUX..... 139	W3EPV..... 128	W1JPE..... 119
W8DFH..... 139	W8LEC..... 127	W9PST..... 118
ON4AU..... 139	W2UK..... 127	ZL1HY..... 118
W1SZ..... 137	W2HHP..... 127	W9ADN..... 118
W3EMM..... 137	W9KG..... 126	W2BYF..... 118
W6CXW..... 135	W2ZA..... 125	W1ADM..... 118
W1TS..... 134	W9ARL..... 125	W8MTY..... 118
W5VU..... 134	W8DWV..... 124	W7AMX..... 117
W2BHW..... 134	W1DF..... 124	VK5WR..... 117
W1LZ..... 133	W4CEN..... 123	W8QXT..... 117
W8DHC..... 132	D4AFF..... 123	W9EC..... 116
G6RH..... 132	W3EDP..... 122	W3EVW..... 116
W8BTI..... 132		

115: W6ADP, W2CYS, G5RV, W1WV, W4CYU, W1HX, G5BD, W1IAS

114: W9KA, W8BKP, W2DC, W1CH, G2DH, G5BY

113: G6CL, W2CJM, W4DRD, W2DSB, W3BES, W2GRG

112: W9GDH, W6FZL, W3EVT, W3GAU

111: W2AAL, W1DUK, VE2AX, W3FQP

110: ON4UU, PA0XF, W9UM, W2AER, W8IWI, W1ICA, W5QL, W2IYO

109: W3DDM, W6FZY, G2MI, W1XCR, W2AV

108: W6HX, ZS2X, HB9BG, W3BEN, VE3QD, HB9CE, VK3QK, W2ARB

107: W2CBO, G5BJ, W3AG, VK2DG, W1BGY, W9CWW, W7DL, W6MVK, W9RBI, W8LFE, W6AHZ

106: G2TR, W8EUY, W6TJ, W9UQT, W1ZI, W1RY, W2VY, W3GEH

105: W2OA, G5QY, J2JJ, VK3CX, W2IOP, W4TO, W2GNO, W1GNE, W8LYQ, W3ZX

104: E1SF, W1ZB, W4AJX, F8RR, W1GDY, W1GCX, W8DOD, W4IO, W2BMX, G6KP, W8KKG

103: W5CUJ, W9RCQ, W3KT, W9NNZ, W3AGV, W4BVD, VK6SA

102: W4CBY, W8AU, W8OXO, W1FTR, VE2EE, W2BXA, W6BAM, W8HGW, W8JAH, LU8EN, W8AAJ, W1IOZ

101: F8RJ, VK3KX, W6DOB, SUIWM, W1CC, SUI5G, G6MK, W4MR, W6GHU, W8JTW, W6KWA, W4EQK, W9VDY, LU7AZ, W1AB, W6ADT

100: G6NF, W6KRI, VK2ADE, ZL1GX, HB9X, ZL1MR, PA0FF, W8BSF, D3BMP, W9LBB, W4CCH, W8KTV, W5ASG, W8JIN, W8QDU, G6GH, W8PQQ, W1AVK, W3AIU

Radiotelephone: W2AZ, W2GW 104: W6OCH 101.

The following have submitted proof of contact with 75+ countries: W2EJ, W9AJA 99: G3JR, LY1J, W1CBZ, W2ALO, W3BAO, W4TZ 98: W2JME, W4TE, W8LZK 97: G8IG, W2CTO, W4DMB, W8BOX 96: F8LX, F8BAB, G6XL, W3EMA, W3FLH, W3OP, W8IQB 95: W3GHD, W6TT, W8CJJ, W9AEH, W9BEE 94: G0ZO, ON4CK, PA0QZ, W2WC, W6FKZ, W6MEZ, W4DP 93: E1LP, W4PJ 92: W1EGC, W1DQ, W8GJ 91: D3CBK, G6YR, ON4FE, SP1AR, W1KID, W8LAV, W9OVU 90: VK3HG, W1KHE, W2BZB, W2CUQ, W8AT, W8JFC, W9VKF 89: G2DZ, W3JM, W9PGB 88: PY2DN, W6CPB, W6LDJ 87: W1APA, W2FLG, W8NLZ, W8DAE, W8FLH 86: YK2TT, W4LHF, W4CPD, W6CK, W8BWC, W8GMH, W8OUK 85: SM6WL, W1BFT, W2AYJ, W6AM, W8WB, W8CED, W9GKS 84: E1LJ, OZTCC, VE2GA, W1BPN, W2AVE, W6DTB, W6KUT, W8BFG 83: W1EWD, W3AYB 82: J2LL, W8EJU, W8GY 81: G8BB, LA2Y, W8BKH, W8LYV, W8BYV, W8BFR, W8PUE, W4QG, W8MHH, W8DGE, W8ITK, W8DIR, W8QMY 80: W4ZZ, W9MRW 79: W3DRD, W4EPV, W8JIN, W9YNB 78: W6QAF, W9UH 77: PA0JMW, W1EH, W3BSE, W3CRW, W3FHY, ZELJI 76: HH2MC, W1NI 75: Radiotelephone: W4CYU 95: W2LXY 91: G5RV, W3EMM, W8LFE 89: W1ADM 86: W1AKY 83: W2IKY 80: W8QXT 78: W1BLO 77: W9TIZ 76: W2GRG, W6IKQ 75.

O.B.S.

The following is a supplement to the list of A.R.R.L. Official Broadcasting Stations in October QST (page 76): W1LOP, W5HME, W6QBD, W7HXX.

(Continued on page 86)

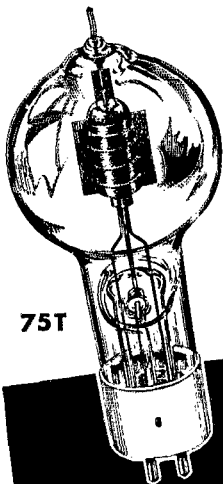

75T

1

AN IDEAL TRIODE

The Eimac 75T tube has a grid, plate and cathode of a design and spacing that approximates the ideal in regard to transit time, electron migration, inter-electrode capacity and thermionic efficiency. This nearly perfect triode unit forms the basis of . . .

THE SENSATIONAL NEW EIMAC MULTIPLE UNIT TUBES

The Newest Development in Radio Equipment

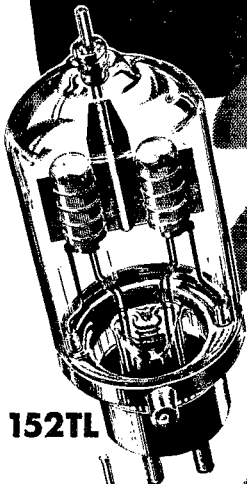

152TL

2

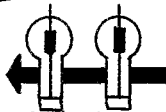

By placing two of these nearly perfect units within one envelop and connecting them in parallel we have a double-unit tube with exactly twice the power capabilities of the single unit tube. The characteristic high electrical efficiencies and low interelectrode capacities of the smaller tube are maintained in the larger one and the results obtained are revolutionary.

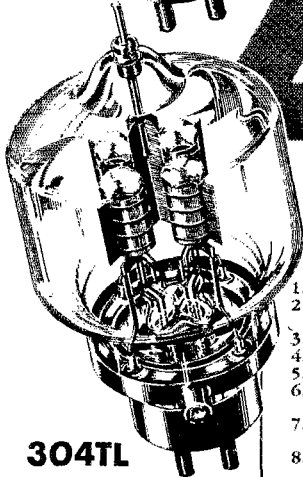

304TL

4

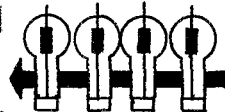

When four of these units are connected in parallel within one bulb the power capabilities are exactly four times the rated value of the single unit . . . but still the same high electrical efficiency and low interelectrode capacity. All these features combined to make Eimac Multiple-Unit tubes practical for use in all types of services; ultra high radio frequencies, class "A" and class "B" audio, class "C" telephony and telegraphy.

Because of these unusual characteristics, Eimac Multiple-Unit tubes are particularly desirable for use in the new FM circuits. A post card in the mail today will bring you full information about Eimac Multiple-Unit Tubes . . . the supply of folders is limited so get your inquiry off today sure.

ADVANTAGES:

1. Small physical size.
2. High power output at low plate voltage.
3. High efficiency.
4. Extremely low driving requirements.
5. Rugged mechanically.
6. Greatly improved base eliminating losses, noise at ultra-high frequency.
7. Either five volt or ten volt filament connection.
8. Operates at frequencies up to 200 megacycles.
9. Extremely high thermionic efficiencies.
10. Low loss rugged grid and plate connections.
11. Gas free EIMAC processed (tantalum electrodes).
12. High plate current capabilities.

EITEL-McCULLOUGH, INC.
788 San Mateo Street, San Bruno, Calif.



HRO

means maximum performance

The maximum performance of the HRO is appreciated most when working under pressure. Its most enthusiastic owners are the men who have proved its capabilities in contests and emergencies. To you, sport or necessity may not make such a receiver as the HRO essential, but you cannot fail to find a new satisfaction in its clean-cut responsiveness and smooth control.

The superb qualities of this receiver are due to painstaking attention to every detail, in engineering, in materials, in craftsmanship and in unhurried hours of testing and alignment. Each part in the HRO is of the highest quality, and each works at peak efficiency. In the strictest sense of the word, the HRO is built for maximum performance and not to meet a price.

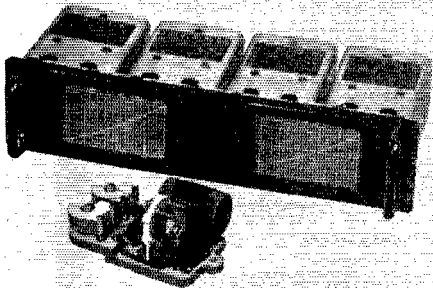

COIL ASSEMBLY

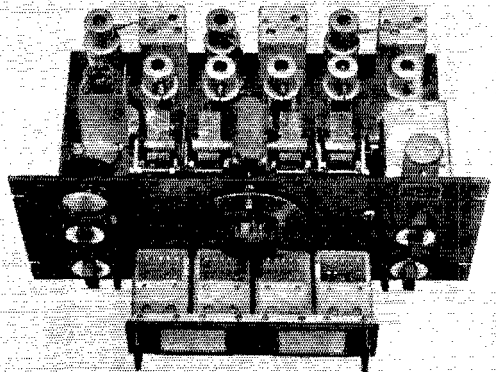

CHASSIS

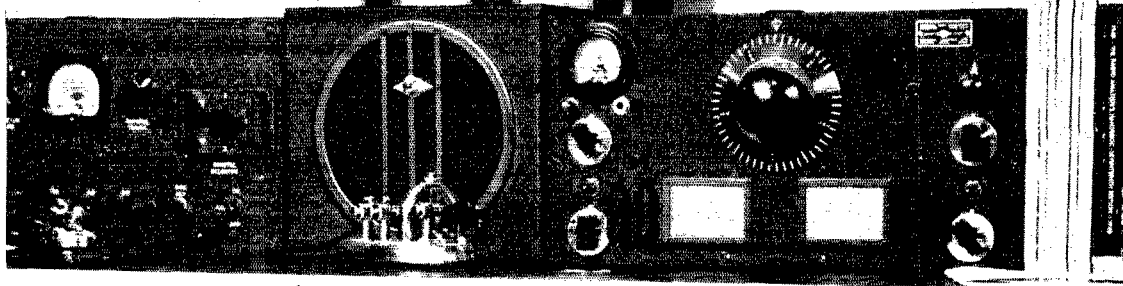

everywhere, all the time.

Specifications:

FREQUENCY RANGE ■ Continuous coverage from 1.7 to 30 MC is obtained with the four coil sets supplied with the HRO Senior. Each coil covers two amateur bands and the spectrum between. A simple switching device is provided which makes these same coils band-spread their respective amateur bands (except 160) over a span of 400 divisions on the dial.

TUNING CONTROL ■ The HRO employs a precision worm-drive condenser with a micrometer dial having an effective scale length of 70 feet. Tuning ratio 20 to 1.

CIRCUIT ■ A superheterodyne circuit is used, having two RF stages preceding the first detector and two high-gain IF stages.

CRYSTAL FILTER ■ The crystal filter is of an advanced type, with selectivity adjustable over a wide range and with especially effective phasing control for heterodyne elimination.

AUXILIARY CIRCUITS ■ A vacuum tube voltmeter for signal strength measurement, a CW oscillator and an AVC circuit are provided.



CONTROLS ■ In addition to the main tuning dial, controls are provided on the front panel for tuning the CW oscillator, for both RF and audio gain, and for crystal phasing and selectivity. Switches are provided for AVC, plate voltage and signal strength meter.

NATIONAL COMPANY, INC., MALDEN, MASS.

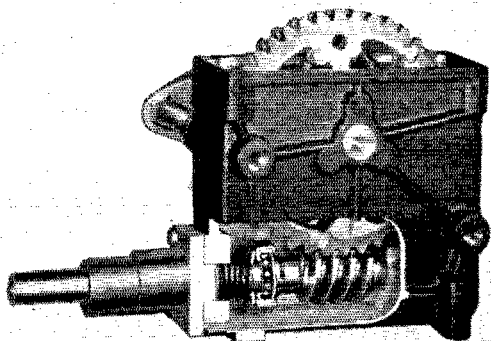

CONDENSER DRIVE

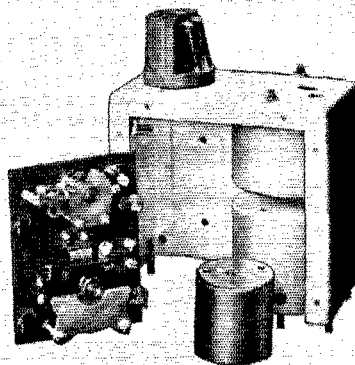

CRYSTAL FILTER

★ Headliners IN AN ALL STAR CAST

Each bearing the familiar hallmark
of **QUALITY**, the **CARDWELL** 

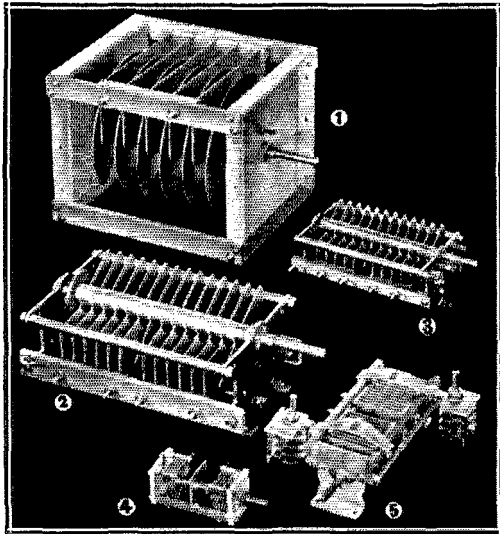

OUTSTANDING PERFORMERS, chosen at random, but representing 5 popular groups of transmitting capacitors, widely used in **TOP FLIGHT** commercial and amateur installations throughout the world.

(1) 1,000 WATTS and up. "P" type, light weight, high power commercial tank tuning unit, 100 mmfd., 10,000 volts peak, 8" x 8" x 10". Mounts readily on any side, with natural foundation for inductance coil mounting on strong folded aluminum end plates.

The safety of the thousands who fly, depends, in part, at least, on U. S. Civil Aeronautics Authority radio course beacons, in which the "P" type and other CARDWELLS are used.

(2) 500 WATTS and up. "T" type, heavy duty condensers with super-heavy brass frame construction. Without doubt the finest condenser in its class. Like the "P" type, it is built (and used) for 24 hour a day service.

(3) 250 WATTS and up. "X" type, medium power type transmitting capacitor, familiar to radio engineers and amateurs throughout the not-so-civilized world.

(4) 50 WATTS and up. "TRIM-AIR" dual section midjet for portables, U.H.F. transmitters and receivers. Single "TRIM-AIRS" shown as neutralizers on the "AFU", No. 5 in photo. USED everywhere.

(5) 100 WATTS and up. "M" type, MIDWAY FEATHERWEIGHT. Immensely popular with amateurs. Shown here as part of the CARDWELL "AFU" Plate TANK CAPACITOR FOUNDATION unit, nucleus of the PA-240 R.F. POWER AMPLIFIER UNIT. Have you FREE drilling template and Instruction Book? If not, see your dealer.

GET A FREE COPY OF CATALOG NO. 41 and pick out the same ultra-husky, dependable condensers used in the finest commercial and government radio services. **SURPRISINGLY INEXPENSIVE.**

**THE ALLEN D. CARDWELL
MANUFACTURING CORPORATION**
83 PROSPECT STREET, BROOKLYN, NEW YORK

W.A.S.

WORKED All States certificate awards have been made in each of the forty-eight states and the District of Columbia, a total of 1263 certificates having been issued to date. First to receive the award in each state were: W4AG Alabama, W6KFC Arizona, W5BMI Arkansas, W6JPW California, W9PGS Colorado, W1GME Connecticut, W3GAU Delaware, W4BDD Florida, W4DAI Georgia, W7AYQ Idaho, W9KA Illinois, W9AQD Indiana, W9LPX Iowa, W9BEZ Kansas, W9DDQ Kentucky, W5BZR Louisiana, W1GKJ Maine, W3BVN Maryland, W1WV Massachusetts, W8DED Michigan, 9DPX Minnesota, W5FHH Mississippi, W9BTD Missouri, W7DRJ Montana, W9DMY Nebraska, W6KBZ Nevada, W1DUK New Hampshire, W2CJX New Jersey, W5GGX New Mexico, W8JTT New York, W4TR North Carolina, W9SNP North Dakota, W8BOF Ohio, W5YJ Oklahoma, W7AOL Oregon, W3BES Pennsylvania, W1BBN Rhode Island, W4DRE South Carolina, W9TY South Dakota, W4ZZ Tennessee, W5DMB Texas, W6KKM Utah, W1FPS Vermont, W3BSB Virginia, W7AYO Washington, W8AZD West Virginia, W9MRW Wisconsin, W7EVN Wyoming, W3BHV District of Columbia.

First in each Canadian province and in each area outside the mainland U. S.: VE1AE Maritime, VE2DG Quebec, VE3JT Ontario, VE4OC Saskatchewan, VE4KZ Alberta, VE4KF Manitoba, VE5HQ British Columbia, OA4J, K6CGK, XE2C, VK6SA, CM2OP, OE3AH, ZL1GX, K5AA, K4DTH, LU7AZ, J5CC, G5BJ, ZS6DW, GM6RG, OZ4H, PY2AC, ES5C, G1GTK, HE2MC, CE3AG, VP2LC.

The following have worked all states on 'phone, and their W.A.S. certificates are so endorsed: W1KJL DQK KZU ATE W2IKV W3GY CCO FGN (14 Mc.) DQ HXV (1.75 Mc.) W4EEE (1.75 Mc.) DSY DDB FNC (1.75 Mc.) BMR DID (1.75 Mc.) W5GKZ (1.75 and 28 Mc.) GZK FY CXH DUK W6ITH ETX MPS PMB (28 Mc.) OCH (14 Mc.) OHC (28 Mc.) FUO (14 Mc.) W7CEO W8JLZ NZQ RED (14 Mc.) REZ (1.75 Mc.) LAC PNF W9PWU VGC WXT NLP ZBR BZT (1.75 Mc.) TZV VE5OT VE4GD K6MVV (28 Mc.) K4EZR (28 Mc.) CO2EG CO2JJ GM6RG (28 Mc.) G6BW (28 Mc.) G6WT G8IG.

W4PL's certificate is endorsed for working all states on both 7-Mc. and 3.5-Mc. W4BQK, W8PLA and W4DWB have endorsement for W.A.S. on 3.5-Mc., while W1GBY and W2KEG worked them all on 7-Mc., and W9VDY and W7FOG all on 14-Mc. W9PGI has a special endorsement for working all states on c.w.

NEW MEMBERS — O.M.R.C.

W1JIS sends a list of new members of "The Old Man Radio Club." This group consists of radio amateurs who are fifty years of age or older. See April QST, page 84, for the first big listing of the O.M.R.C. gang. Additions follow, with ages indicated: W9WZN 73; W5EAY W8CNP 69; W1SL W9GV 67; W1ES W2IB 66; W7FMN 63; W8TRL W9CDE 62; W1KB W5DUK W8HL 61; W6KTY 60; W8MPG W8BWF W8JBD W9JUI 59; W8NW W8COW W9FFB 58; W8RJC W8VU W9WUM 57; W3CA W8GFU 56; W1UR W4PL W5HDH W6CCJ W6QFY W6QGI W9JXY W9OJ 55; W6FMB W7GGY 54; W6ROZ W7HI W7HJU W8ID W8FEE W8BXR W8OTE V2BG W9WLP 53; W1IS W2JLC W5EIN W6ODO 52; W4GFN W8ICD W8PTE W8KQE 51; W1BSJ W7HJK W8LLZ VE4AOZ W9QUI 50.

If you are fifty years of age, or older, send a card to W1JIS with your date of birth. Address Charles F. Loud, 46 Beals Court, Rockland, Mass.

OPERATING VALUES

"... To those who, in the past, have considered that the c.w. man was out of date, and that the learning of Morse was a useless drudgery, a real lesson stands out in this time of emergency. As an operator capable of handling traffic at 25 w.p.m., a Ham is invaluable to his Country to-day, below 16 w.p.m. practically useless, until he has had further Morse training. Operating ability is the prime asset alone. Technical knowledge is naturally of some value, but only as an adjunct . . . from the viewpoint of the Services, operators
(Continued on next left-hand page)

Leading Airlines and Transmitter Manufacturers

CHOOSE

Taylor Tubes

for

- DEPENDABILITY
- BETTER PERFORMANCE
- LOWER OPERATING COST



Taylor Tubes Now Used by— Airlines

American
Eastern
Penn-Central
Braniff
Inland
Delta
Mid-Continental

Chicago-Southern
Northwest

Transmitter Manufacturers

Motorola Bendix Fred Link
Bassett Harvey

Taylor Tubes are also used by the British,
Australian, French, Argentine and
United States Governments.

Taylor Tubes is proud that the highly qualified Radio Engineering staffs of so many of America's Airlines and Transmitter Manufacturers have approved and accepted the quality of its tubes. Taylor Tubes have met and fulfilled the rigid service requirements of exacting 24 hours a day applications. They have built their own record of success under the most adverse conditions of use where tube failures cannot be tolerated.

Get the same dependable "More Watts Per Dollar" service enjoyed by Airline and Manufacturing Engineers by insisting on Taylor Tubes.

"More Watts Per Dollar"

Taylor HEAVY **CUSTOM BUILT** DUTY Tubes

DID YOU GET YOUR MANUAL
Send five cents in stamps or coin
direct to us or get one FREE
from your distributor. All new
material. See T-40 and TZ-40 dual
ratings . . . 1,500 V. at 150 MA.

TAYLOR TUBES, INC., 2341 WABANSIA AVE., CHICAGO, ILLINOIS

IT'S A "HONEY!" NEW

Series 832

31 RANGE Rotary Selective AC-DC. MULTI-RANGE TESTER

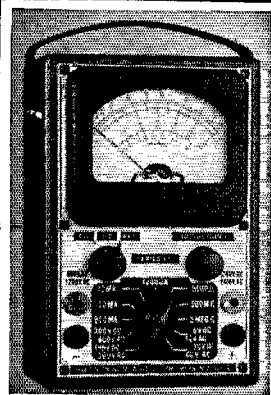

It's really hard to get all excited about such inanimate objects as test equipment, but HERE IS SOMETHING over which we just have to "BLOW OUR HORN."

★ HERE is the LARGEST METER ever provided (3½ inches is the ACTUAL WIDTH) in such a compact instrument, only 7" x 4½" x 3" overall.

★ SCALE LENGTH, VISIBILITY and EASE OF READING never before obtained in small, low-priced multi-range testers.

★ SIMPLICITY? — A single Master Rotary Range Selector allows ALL measurements to be made from ONLY TWO polarized tip jacks, except for the two highest voltage ranges.

★ . . . Talking of RANGES —

6 DC voltage ranges at 1000 ohms per volt:

0-6/30/150/300/600/1200 volts

6 AC voltage ranges at 500 ohms per volt:

0-12/60/300/600/1200/2400 volts

4 DC current ranges to 600 mills.

3 OHMMETER ranges to 5 MEGS, up to 500M

ohms on internal battery

6 DECIBEL ranges (-10 to X 62 DB)

6 OUTPUT ranges to 2400 volts

★ IT'S "PRECISION" BUILT! — 1% wire wound bobbins — 1% matched metallized multipliers — individually sealed calibrating controls — telephone cabled wiring, etc.

★ APPEARANCE! — Attractively etched rich-low brass panel and scale plate — housed in hardwood walnut finished case with leather handle — furnished complete with batteries (less test leads).

Compare this "Precision" Value at only \$14.95 net

This is only one of the more than 40 models comprising the complete "Precision" line of dynamic mutual conductance tube testers, combination set testers, multi-range testers, signal generators, etc. Prices start as low as \$10.95.

PRECISION TEST EQUIPMENT
Standard of Accuracy SEE THEM AT YOUR JOBBER

PRECISION APPARATUS COMPANY
647 Kent Avenue Brooklyn, New York
Export Division: 458 Broadway, New York City, U. S. A.
Cable Address: Morhanex

and more operators are what they need. . . . Also we quote from a letter in *Wireless World*: ". . . far many more operators . . . are required than technical wizards." This is true of all the Services, and time has proved it. . . . Amateurs tend to be individualists, but individualism is out of place in the intricate modern communication system. Team work, precise synchronization, and strict adherence to rules and procedure are essential to a successful Wireless Service. . . . it is up to every Ham in the country to see that he IS an operator, a first-class one. . . ." — From an editorial in "Amateur Radio," Wireless Institute of Australia.

20-YEAR CLUB MEMBERS

When did you first obtain an amateur ticket? If you received your first license (operator or station) 20-or-more years ago, and if you hold a call to-day, you are eligible for the A.R.R.L. "20-Year Club." If you can qualify, send us a brief chronology of your ham career, particularly the date you started in amateur radio, date of your first amateur license, calls you have held during the years and the call you hold to-day.

Here is the roster of 20-Year Club members as of this writing. A contact with any of these fellows should prove interesting, especially if you like to hear anecdotes of the "old days": K4KD K6ONM K6QYI W1AHY AJ AR BB BDI BSI BXC CJA DMF DMP EAO EH ESFA FJE FMP FMV GDY GS HGX HPI HXQ JFN MD NF UP WR W3ADW AX BO BR BYW CJK DI DYT DZA EC ELN EMV GVU HCO HTU IMF IP IZ JF JRG PF W3ACX AVJ BO BYR BZ CA DRO EUY FLH GJ GLH GPA GQL HQW JL KT RR WS JZ W4BZ CNZ DIN WD/5FSI W5AQD CVQ EOW ERJ NT ZA W6AM AVC EAEY GM IT IX KMA KTQ LM MMB MSN NPD OCH OJY PKX VU W7AZX BG COH DZY EMT GCO W8APD AQ AYS CHU CMH CNX DOX FRY GYR IGT KHM ND OA OXH QAN QKQ SDR SQE SQW ZS ZY W9AA AB CS CSZ CX DAX DGM DEM EL ESA EW FRC RWF VFW VKF VS VV WIN WTE WZE YNO.

Re Bk-In

W2MJV emphasizes the importance of using correct "break-in" procedure. When an operator answers your CQ and sends "BK" (inviting you to break-in), you should come back immediately, sending "BK" to indicate that you hear him. Send "BK" only! The caller will then sign in the normal fashion and contact will be definitely established. Even though you are not completely equipped for break-in work, throw on the switches and send "BK." The other operator, who is using break-in and who has so indicated by sending "BK" in the first place, will hear you, even though you cannot hear him when your transmitter is on the air. This procedure saves considerable operating time.

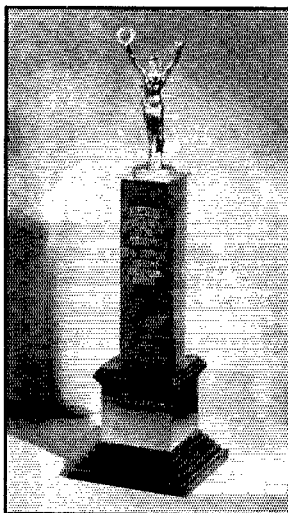

The very attractive VE/W Contest Trophy awarded in the 1939 contest to Larry LeKashman, W2IOP, who made the highest W score — 30,429.

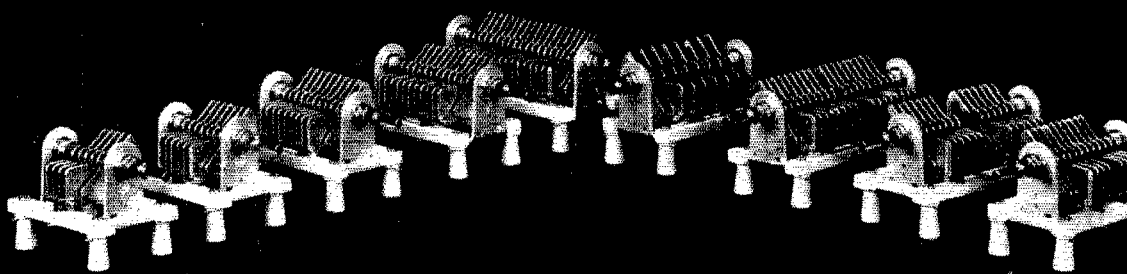

TRANSMITTING CONDENSERS that are "Designed for Application"

The "12000" series of MILLEN transmitting condensers are compact, rugged and inexpensive. Insulating bars are genuine Isolantite. Both rotor and stator plates are extra heavy (.040") aluminum. Models with both plain edge and round polished edge plates are listed. The condensers are mounted on steatite standoffs so as also to be suitable for use in new QST close plate spacing circuits.

12000 SERIES CONDENSERS

.077 air gap is for 3000 volt peak rating

SINGLE SECTION TYPE

CODE	Capacity per section		Number Plates			Thickness of Plates	Air Gap	Finish on Plates	Length Isolantite Bars	Position of End Frames	Net Price
	Min.	Max.	Per Section	Rotor	Stator						
12935	10	37	13	7	6	.040"	.176"	Polished	3 15/16"		\$3.60
12936	10	37	13	7	6	.040	.176	Plain	3 15/16"		3.25
12536	6	43	9	5	4	.040	.077	Plain	3 1/2"		2.00
12551	7	55	12	6	6	.040	.077	Plain	3 1/2"		2.25
12576	9	76	17	9	8	.040	.077	Plain	3 15/16"		2.50
12510	12	101	23	12	11	.040	.077	Plain	3 15/16"		3.00
12515	18	151	35	18	17	.040	.077	Plain	5 1/2"		3.75

DOUBLE SECTION TYPE

12035	6	43	9	5	4	.040	.077	Polished	3 15/16"		\$3.60
12036	6	43	9	5	4	.040	.077	Plain	3 15/16"		3.25
12050	7	55	12	6	6	.040	.077	Polished	5 1/2"		4.25
12051	7	55	12	6	6	.040	.077	Plain	5 1/2"		3.60
12075	9	76	17	9	8	.040	.077	Polished	5 1/2"		5.50
12076	9	76	17	9	8	.040	.077	Plain	5 1/2"		4.50

Modern Parts

for Modern Circuits

JAMES MILLEN
150 EXCHANGE ST



MFG. CO. INC.
MALDEN, MASS.

GAMMATRON

Tubes

FAVORITES WITH PROFESSIONAL HAMS WHO WANT REAL DX

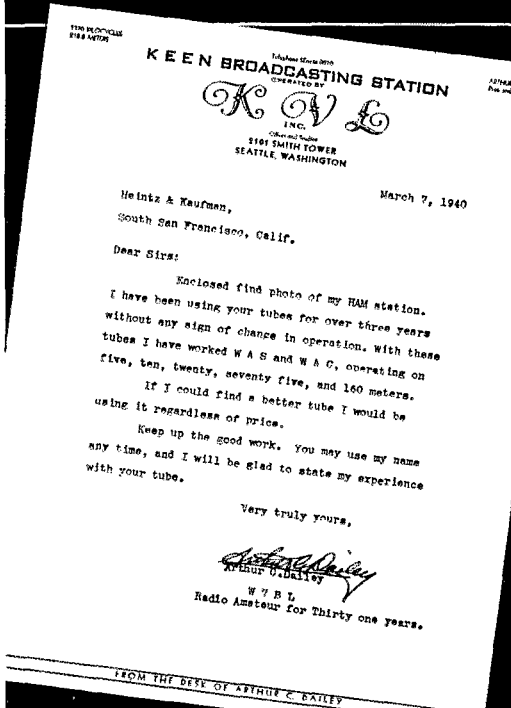

Mr. Dailey's letter is unsolicited. He has been a ham since 1909 and as a broadcaster he knows transmitting tubes. Follow the lead of hams who know.

WRITE FOR DATA

HEINTZ AND KAUFMAN
SOUTH SAN FRANCISCO LTD. CALIFORNIA U.S.A.

ELECTION NOTICES

To all A. R. R. L. Members residing in the Sections listed below:
(The list gives the Sections, closing date for receipt of nominating petitions for Section Manager, the name of the present incumbent and the date of expiration of his term of office.) This notice supersedes previous notices.

In cases where no valid nominating petitions have been received from A. R. R. L. members residing in the different Sections in response to our previous notices, the closing dates for receipt of nominating petitions are set ahead to the dates given herewith. In the absence of nominating petitions from Members of a Section, the incumbent continues to hold his official position and carry on the work of the Section subject, of course, to the filing of proper nominating petitions and the holding of an election by ballot or as may be necessary. Petitions must be in West Hartford on or before noon of the dates specified.

Due to a resignation in the Alaska Section, nominating petitions are hereby solicited for the office of Section Communications Manager in this Section, and the closing date for receipt of nominations at A. R. R. L. Headquarters is herewith specified as noon, Friday, June 14, 1940.

Section	Closing Date	Present SCM	Present Term of Office Ends
Kentucky	June 3, 1940	Darrell A. Downard	April 15, 1940
Maritime *	June 3, 1940	Arthur M. Crowell	June 15, 1940
Alaska	June 14, 1940	Leo E. Osterman (resigned)
Illinois	June 14, 1940	Leslie M. Dickson (deceased)
Philippines	June 14, 1940	George L. Rickard	Oct. 15, 1938
Idaho	June 14, 1940	Carl Eichelberger	June 15, 1939
Alberta *	June 14, 1940	C. S. Jameison	Feb. 18, 1940
Los Angeles	June 14, 1940	Ralph S. Chick	July 1, 1940
W. Penna.	July 1, 1940	Kendall Spear, Jr.	July 10, 1940
Ohio	Aug. 1, 1940	E. H. Gibbs	Aug. 17, 1940
Santa Clara Valley	Aug. 1, 1940	Elbert J. Amarantes	Aug. 15, 1940
W. Mass.	Aug. 1, 1940	William J. Barrett	Aug. 17, 1940
So. Minn.	Aug. 15, 1940	Millard Bender	Aug. 22, 1940
Utah-Wyoming	Aug. 15, 1940	Ernest E. Parshall	Aug. 22, 1940

* In Canadian sections nominating petitions for Section Managers must be addressed to Canadian General Manager, Alex Reid, 169 Logan Ave., St. Lambert, Quebec. To be valid such petitions must be filed with him on or before the closing dates named.

- You are hereby notified that an election for an A. R. R. L. Section Communications Manager for the next two-year term of office is about to be held in each of these Sections in accordance with the provisions of the By-Laws.
- The elections will take place in the different Sections immediately after the closing date for receipt of nominating petitions as given opposite the different Sections. The Ballots mailed from Headquarters will list in alphabetical sequence the names of all eligible candidates nominated for the position by A. R. R. L. members residing in the Sections concerned. Ballots will be mailed to members as of the closing dates specified above, for receipt of nominating petitions.
- Nominating petitions from the Sections named are hereby solicited. Five or more A. R. R. L. members residing in any Section have the privilege of nominating any member of the League as candidate for Section Manager. The following form for nomination is suggested: (Place and date)

Communications Manager, A. R. R. L.
38 La Salle Road, West Hartford, Conn.

We, the undersigned members of the A. R. R. L. residing in the Section of the Division hereby nominate a candidate for Section Communications Manager for this Section for the next two-year term of office.

(Five or more signatures of A. R. R. L. members are required.)

The candidates and five or more signers must be League members in good standing or the petition will be thrown out as invalid. Each candidate must have been a licensed amateur operator for at least two years and similarly, a member of the League for at least one continuous year, immediately prior to his nomination or the petition will likewise be invalidated. The complete name, address, and station call of the candidate should be included. All such petitions must be filed at the headquarters office of the League in West Hartford, Conn., by noon of the closing date given for receipt of nominating petitions. There is no limit to the number of petitions that may be filed, but no member shall sign more than one.

4. Members are urged to take initiative immediately, filing petitions for the officials for each Section listed above. This is your opportunity to put the man of your choice in office to carry on the work of the organization in your Section.

— F. E. Handy, Communications Manager

ELECTION RESULTS

Valid petitions nominating a single candidate as Section Manager were filed in a number of Sections, as provided in our Constitution and By-Laws, electing the following official, the term of office starting on the date given.

Montana	R. Rex Roberts, W7CPY	Apr. 15, 1940
Washington	W. Beale, W7FCG	Apr. 15, 1940
Indiana	Harry B. Miller, W9AB	Apr. 15, 1940
San Diego	Louis A. Cartwright, W6BKZ	Apr. 15, 1940
South Dakota	E. C. Mohler, W9ADJ	May 18, 1940

In the Eastern Massachusetts Section of the New England Division Mr. Frank L. Baker, Jr., W1ALP, and Mr. Carroll O. Peacor, W1GAG, were nominated. Mr. Baker received 143 votes and Mr. Peacor 132 votes. Mr. Baker's term of office began March 11, 1940.

Station Activities on page 100

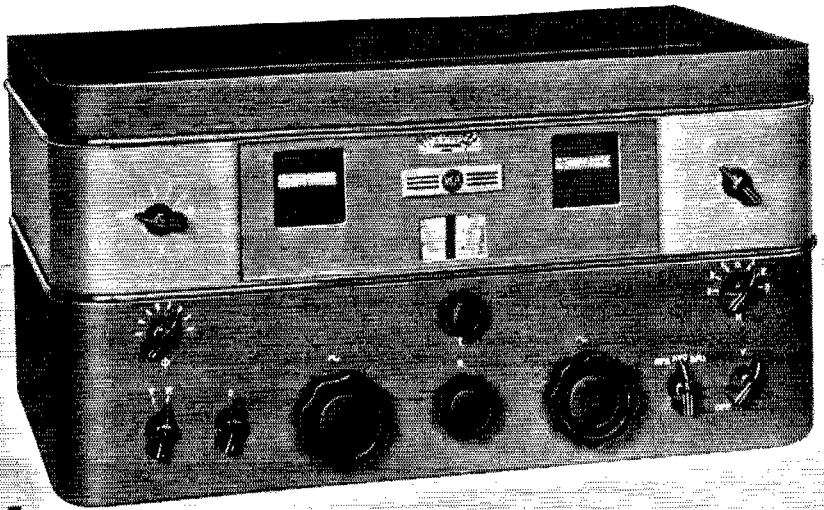

"S-1"

**Signals.. successfully received
through "S-4" ignition noise!**

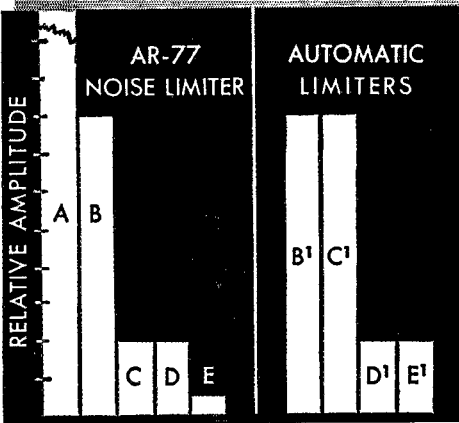

- A—Noise Peak Amplitude at Second Detector
- B—Average Noise Amplitude at Second Detector
- C—Suppressed Noise Peak (AR-77)
- D—Signal Amplitude (100% Mod.) at Second Detector
- E—Average Noise Amplitude after Suppression
- B'—Average Noise Amplitude ("Automatic" limiter circuits)
- C'—Suppressed Noise Peak ("Automatic" limiter circuits)
- D'—Signal Amplitude (100% Mod.) at Second Detector
- E'—Average Noise Amplitude after Suppression

AR-77

COMMUNICATION RECEIVER

Not overlooking its unmatched stability* and truly amazing signal-to-noise ratio**, the new manually-adjusted noise limiter of the AR-77 has probably attracted more favorable attention than any other single feature. And no wonder! Under actual operating conditions in the 10-meter band, "S-1" 'phone signals have been successfully received where ignition noise was pounding away to the tune of an "S-4" reading on the carrier level meter!

The circuit is extremely effective in that peak noise voltage hundreds of times higher than the signal is pulled down to signal level. Since these peak noise impulses occur intermittently, the remaining "effective" noise can appear below the signal level! Weak signals are not smothered because any variation of noise level will not alter the amount of suppression.

Write today for complete, descriptive folder—but, above all, visit your nearest RCA distributor and give the AR-77 a whirl. You be the judge!

*Tests under average conditions show max. drift at 30 Mc to be only 3.0 KC on one hour run, thereby keeping the signal audible.

**A 2-to-1 ratio of signal-to-noise is obtained at an average sensitivity of 2 microvolts throughout range.

Net price, \$139.50 f. o. b. factory. 8" Speaker in matched cabinet, \$8.00



for Amateur Radio

RCA MANUFACTURING COMPANY, INC., CAMDEN, N. J. • A Service of the Radio Corporation of America

YES? or NO? TUBE QUIZ

TUBE PLATE resistance is the ratio of small change in plate voltage to the corresponding change in plate current produced. Yes No

●
Cathode current is the same as heater current and filament current. Yes No

●
Over-all feedback from the output tube to the antenna circuit should be avoided. Yes No

●
Good oscillator frequency stability is obtained through using single-ended pentagrid converter tubes. Yes No

●
In radio receiver circuit applications, mercury vapor rectifiers are generally preferred to high vacuum types. Yes No

●
Frequency conversion may be accomplished with Sylvania pentode triode tubes 6P7G or 6F7 by using the triode as an oscillator and the pentode as a mixer tube. Yes No

IF you aren't positive of the answers to these and thousands of other questions about radio tubes and their application, the latest edition of the Sylvania Technical Manual has all the answers in useful, handy form. 272 pages of information including operating conditions, characteristics and circuit applications on 374 types of tubes. Write to Hygrade Sylvania Corp., Dept. Q60, Emporium, Pa., enclosing 35c for your copy of this great book today.

SYLVANIA

SET-TESTED RADIO TUBES

More on Extended Variable Crystal Control

(Continued from page 18)

cathode current are easily eliminated by an r.f. filter at the key — stronger clicks not so easily eliminated are probably caused by a parasitic in the 6V6 doubler. It should be possible to eliminate the clicks from this source by better grounding and some shielding — we can't say definitely because none were encountered in this version, although they were present in the unit described last month until we decreased the L/C ratio in the plate circuits and rearranged the parts slightly.

The 6V6 mixer shows considerable r.f. in its plate circuit, considering the plate voltage and function, and we recommend this type of mixer to anyone using a conversion-type exciter. Keying the cathode results in no signal with the key up, unlike some of the other circuits.

Results

Crystals of both the VF-1 and VF-2 types, with the correct frequency differences, were obtained from the Biley Company. Two VF-1 units, variable from 3784 to 3790 kc. and from 3984 to 3990 kc. were used to cover the output range from 3500 to 3700 kc., and a 3995-4001-kc. crystal was switched in to replace the 3984-kc. crystal when operating between 3700 and 3900 kc. The VF-2 units were variable from 3778 to 3790 kc. and from 3984 to 3996 kc., to give coverage from 3500 to 3920 kc. Of course the crystals needn't have exactly these frequencies — the only requirements in this particular case (using a multiplication factor of 18) is that the minimum frequency difference between the two crystals be 194 kc. (for 3500-kc. output) and the maximum difference be 217 kc. (for 3900-kc. output).

The drift tests were made by beating the fourth harmonic from the 80-meter output of the unit against a 14.5-Mc. commercial station known to be quite stable and checking the change in beat note.

The VF-1 units showed several kc. drift during the first 15 or 20 minutes of operation, indicating that we didn't have two of exactly the same coefficients. However, after about an hour's warm-up period, the frequency steadied down to the point where it drifted not more than 300 or 400 cycles in 15 minutes' time. It was more or less apparent that the long warm-up period was necessary for the chassis to reach a stable temperature. Very little drift is introduced by actual crystal heating by r.f., since only 150 volts is applied to the oscillators, and the drift due to temperature change induced by r.f. takes less than a minute to die out. It amounts to less than 500 cycles at 14 Mc. Therefore, if the crystals furnished us are a fair sample, it is safe to say that they would be perfectly satisfactory in any unit providing sufficient time is allowed for bringing up the chassis to temperature. This could be easily done by enclosing the chassis in a cabinet and letting the tube heaters run continuously.

FOR EVERY AMATEUR PURPOSE...

**16 Matched
POWER
SUPPLIES**

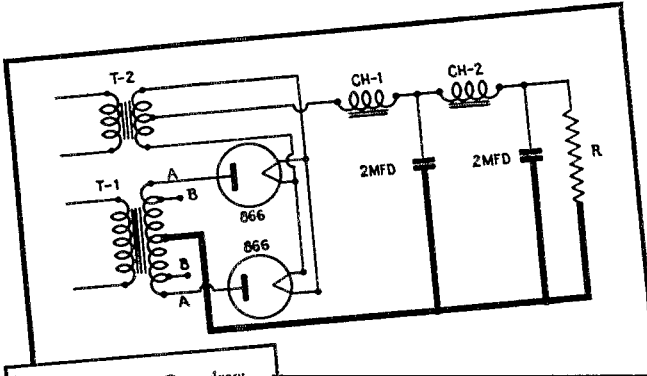

Adjust Bleeder R to draw approximately 10% of Rated Current. Regulation on all types approximately 15%. Ripple on all types approximately 1%. D. C. rating of filter condensers approximately 25% greater than supply voltage.

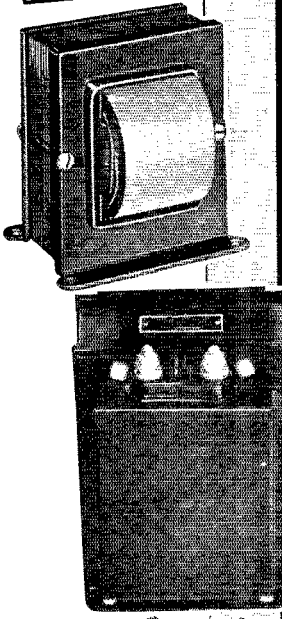

Power TRANS. T-1	DC VOLTS from TAP A	DC VOLTS from TAP B	DC MA	Input Choke CH-1	Smoothing Choke CH-2	FIL. TRANS. T-2	TOTAL NET TRANS. COST
T-19P54	400		150	T-19C39	T-19C46	T-19F91	\$ 8.70
T-19P55	500	400	250	T-19C36	T-19C43	T-19F90	14.10
T-19P56	750	600	225	T-19C36	T-19C43	T-19F90	14.40
T-19P57*	1000	400	125 and 150	T-75C51	T-75C51	T-19F78	15.15
T-19P58*	1000	750	200 and 150	T-19C39 T-19C35	T-19C46 T-19C42	T-19F90 T-19F90	20.10
T-19P69	1000	750	300	T-19C36	T-19C43	T-19F90	17.40
T-19P59	1250	1000	300	T-19C36	T-19C43	T-19F90	19.20
T-19P60	1500	1250	300	T-19C36	T-19C43	T-19F90	20.70
T-19P61	1750	1500	300	T-19C36	T-19C43	T-19F90	21.60
T-19P62	2000	1750	300	T-19C36	T-19C43	T-19F90	23.10
T-19P63	1250	1000	500	T-19C38	T-19C45	T-19F90	32.40
T-19P64	1500	1250	500	T-19C38	T-19C45	T-19F90	35.70
T-19P65	2500	2000	300	T-19C36	T-19C43	T-19F90	27.30
T-19P66	1750	1500	500	T-19C38	T-19C45	T-19F90	39.60
T-19P67	2000	1750	500	T-19C38	T-19C45	T-19F90	44.10
T-19P68	2500	2000	500	T-19C38	T-19C45	T-19F90	48.60

* These transformers designed for double rectifiers and will deliver both secondary ratings simultaneously. If only the lower voltage taps are used the current rating is equal to the current rating of both windings.

Available at Your Thordarson Distributor

THORDARSON
Elec. Mfg. Co., Chicago *45th Anniversary*

"TRANSFORMER SPECIALISTS SINCE 1895"

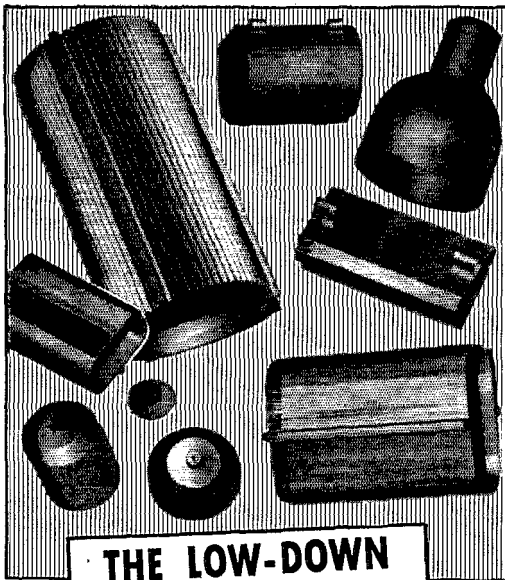

THE LOW-DOWN ON ANODES

The amount of power a tube can handle depends largely on the ability of the Anode to dissipate the heat of operation.

Relative Heat Dissipating Value at 510° C.

Graphite	1.00
Tungsten	0.30
Molybdenum	0.24
Tantalum	0.22
Nickel No. 1	0.025
Nickel No. 2	0.001

Get tubes with Speer Graphite Anodes. List of tube manufacturers and booklet on request.



SPEER

Carbon Company

ST. MARYS, PA.

CHICAGO • CLEVELAND • DETROIT • MILWAUKEE
NEW YORK • PITTSBURGH

Speer Graphite Anodes Make Good Tubes Better

Ⓢ 492

Much the same results were obtained with the pair of VF-2's that were tried, except that they showed somewhat more drift. This was undoubtedly caused by their coefficients having a greater difference than the VF-1's and/or in the wrong direction. In any event, at the end of an hour period the output frequency still wandered back and forth about 500 cycles, possibly caused by slight room-temperature variations. Three years ago, when none of the receivers were stable enough to detect a frequency change of this order, it might have been considered of no importance, but the present trend towards stabilized receivers (at last)! makes the performance none too good. However, two other VF-2's might have showed up much better, and they do have the advantage that only two are necessary to cover the range from 3500 to 3900 kc.

The answers to several other questions came out fine. The keying worked out very well, and of all the break-in keying systems we have encountered, this seems to be by far the most promising. With the key up there is no trace of a signal and, with the key down the signal bites right in and doesn't have a trace of a chirp, sounding exactly like good center-tap keying which, of course, it is. Looking around for birdies and spurious signals, the only ones that could be found were readily identified as harmonics beating with the superhet receiver oscillator harmonics and could thus be blamed on the receiver's shortcomings. Although the shielding was not as good as could be made, and it was possible to hear the steady oscillators in the receiver, no trace of the oscillator energies could be found in the output circuit. It was even possible to tune in one of the steadily-running oscillators in the receiver and beat the output signal against this oscillator, with no trace of r.f. in the output link when the key was up.

Mechanically, the crystal holders furnished with the crystals are not too bad. There had been some fear that mechanical vibration would change the gaps slightly and result in a frequency shift, but jarring the chassis only resulted in a very slight wobble which died out at once. However, there is probably some room for improvement from a mechanical standpoint in these variable-gap holders if they are to be used in a system of this type. It would appear that we will have to depend upon the manufacturers for the development of a variable holder with a high order of reset accuracy, so that a tuning dial can be used with a good possibility of setting to the exact frequency without monitoring equipment.

The Future of the System

At first glance, it might appear that the future of the system lies in the hands of the crystal manufacturers. We are told that, with present methods, it is practically impossible to furnish sets of crystals matched both in frequency difference and temperature coefficients. Possibly technique improved in the future and accelerated by a demand at the present would result in

Modernize YOUR SHACK WITH AN... **MT-8**

MODEL MT-8 is the same Jensen high fidelity Reproducer used by broadcast stations and recording studios for monitoring and audition work.

The unit consists of a completely enclosed cabinet, built of three-quarter inch plywood, and a special Jensen eight-inch PM speaker. The Reproducer utilizes the famous Jensen Bass Reflex principle.

The result is strikingly improved reproduction; speech is crisp and intelligible, whole octaves are added to music, objectionable resonance and "boom" is eliminated; there is no back side radiation; performance becomes practically independent of acoustic environment.

Dimensions are 24 x 17½ x 11¼; and hangers are provided for convenient wall mounting. Complete with special speaker, only \$29.50 list. Amateur's net price \$17.70 at your Jensen Distributors.

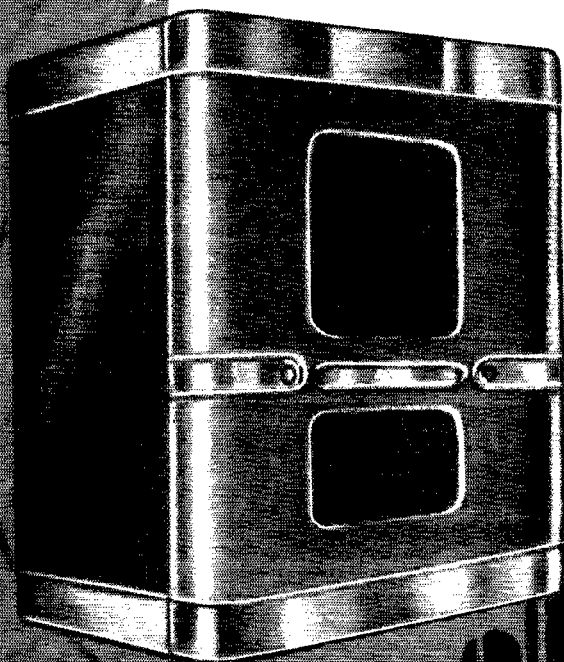

Jensen
Bass Reflex
Speakers

RADIO TRAINING



PORT ARTHUR COLLEGE — not privately owned, not operated for profit, a college built and endowed by the late capitalist-philanthropist, John W. Gates — offers the most thorough practical Radio training in America. P. A. C. owns Radio Station KPAC, which is equipped with the very latest type 1000-Watt high fidelity RCA transmitter, operating on 1220 kc. with directional antenna system. The college is authorized to teach RCA texts. Additional equipment consists of the latest type Marine and Airways Transmitter installation complete; SOS Automatic Alarm; Marine Direction Finder, two-way Television Transmitter and Receiver; Trans-radio Press Receiving Equipment; laboratory facilities where every phase of practical radio assembly technique is taught. Students assemble composite transmitters, audio amplifiers, RF amplifiers, etc. The Radio training covers thoroughly Airways, Press, Announcing, Teletype, Typewriting, Laboratory and practical experience at KPAC transmitter, control room and studios. Announcing is an optional part of this training; nevertheless a number of students annually make successful announcers.

Port Arthur College pioneered the teaching of radio with its first classes in 1909, and for thirty-one years has maintained an active Employment Bureau that is successful in placing graduates in airways, broadcast and marine radio industries.

*If interested in details about the Radio Course,
write for Bulletin R*

PORT ARTHUR COLLEGE
PORT ARTHUR (World-Known Port)
TEXAS

PRECISION CRYSTALS

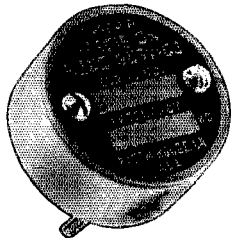

Highest quality crystals carefully prepared for dependable performance.

Low frequency drift Type 4-A unit plugs into tube socket, 40, 80 or 160 meter bands, within 5 kc. of your specified frequency — \$4.00. Calibration 0.03%.

X cut in Type 4 holder — \$3.50.

Crystals for commercial requirements quoted on at your request. Now in our Tenth year of business.

PRECISION PIEZO SERVICE

427 Asia Street

Baton Rouge, La.

readily-available matched crystal sets from the manufacturers, but we doubt it. It isn't likely to be economically practical for any manufacturer to develop a system of matching the crystals and selling them at a price within range of what most of us can afford.

However, it would be very unlike amateur radio to give up a system that holds such promise, simply because the mountains won't come to us. Looking at the other angle, that of our going to the mountain, the problem of temperature control isn't too imposing, particularly if it's the only problem that stands in the way of chirpless break-in keying and crystal control throughout an entire band. It shouldn't be too difficult to hold the temperature of the crystals within a half-degree without too much trouble. Even now, with no temperature control, the performance of the unit with crystals picked at random is superior to that of many so-called crystal-controlled signals using older cuts of crystals in oscillators running as hard as the operator dares push them. With the addition of some temperature control, which isn't too difficult a job, and a happy selection of crystals, we should have close to the ultimate in frequency control. By a "happy" selection of crystals we mean two whose temperature coefficients do not differ by too much, and we see no reason why a little coöperation from the local dealer in allowing a trial of his crystal stock, to select two crystals with the correct frequency difference and similar coefficients, is entirely out of order. The closer the coefficients, of course, the less need there will be for close temperature control, but close control is no great problem with the materials available today.

The use of out-of-band crystals, to prevent signals from the continually-running crystals falling in the bands, is not strictly necessary. Although it is a nice refinement to use out-of-band crystals, the use of two variable crystals allows various combinations of settings to be used to obtain the same output frequency, with the result that the frequencies of the crystals can be set so as not to interfere with break-in work on one's own frequency. The cost of out-of-band crystals is many times more than that of in-band crystals, and the slight refinement in performance isn't worth the additional cost.

New Iconoscope

(Continued from page 15)

bers are according to the RMA system which is conventional for octal bases.

The tube is normally intended for operation in a horizontal position with the tab downward. Therefore, with deflection plates D_3 and D_4 used for horizontal deflection, the socket should be located so that Pins 3 and 6 are in a horizontal line with the base key up. It is suggested that the socket be mounted in a plate with holes for screws slotted circumferentially so that the socket may be rotated through approximately 20° to line up the scanning rectangle (raster) exactly.

Accepted JAMES MILLEN PRODUCTS

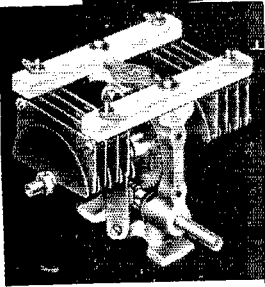

TRANSMITTING CONDENSERS

(Right angle drive)
A new, different, and more efficient transmitting condenser permitting symmetrical circuit arrangements and allowing better neutralization. Center drive rotors for better R.F. frequency current distribution. Isolantite insulation. Rounded, polished, heavy-gauge semi-circular aluminum plates. Voltage rating 3,000; air gap .077.

Cup Mmf.	Net
11035, .45 per sec.	\$5.75
11050, .50 per sec.	5.95
11070, .70 per sec.	6.50

THE HETROFIL

Net \$3.50
When used with a receiver without a crystal filter, it has all the advantages of the phasing control of the crystal circuit. Will operate with TRF receivers also. Further described in September '39 issue of QST.

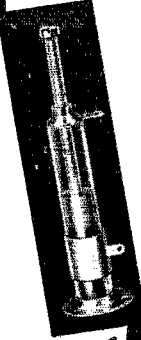
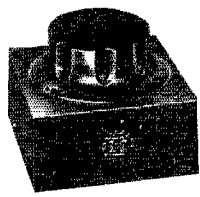

NEUTRALIZING CONDENSERS

Compact, new style, low and medium power neutralizing condensers. Insulation ultra-low loss Quartz Q.

Cup Range	Net
15001, 2 -10 mmf.	\$.75
15002, 2.5-12 mmf.	.95
15003, 1.5- 8.5 mmf.	.95

KIT OF PARTS FOR THE QST 112 MC SELF CONTAINED BATTERY TRANSCEIVER

Described in April '40 QST on Page 28 by Vernon Chambers

All parts of nationally advertised manufacturers, and as recommended in the original article, drilled chassis and panel including cabinet. Complete instructions, layout blue prints, and diagrams.

Net price, less tubes and batteries

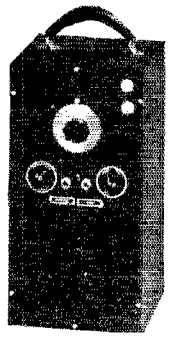

\$10.95

Accessories used in 112 MC transceiver

- 1 Hytron Hy 615..... Net Price \$2.00
- 1 RCA 6G6..... .67
- 1 Kit 4 "B" and 1 6V "A" Burgess batteries..... 4.58

Instantaneous Portable Recording Mechanism

Special Net Price \$32.50

A high quality unit for cutting acetate blank records up to 10" diameter. Composed of a heavy duty recording motor, latest crystal recording pickup, and a crystal playback pickup. Mounted in a beautiful alligator leatherette covered portable cabinet. Includes a volume control and a transformer which matches the cutting head to 6 ohm enabling its operation from the voice coil of a receiver or the output of an amplifier. Surprisingly fine recordings can be made with this unit.



STEATITE SOCKETS

A high quality steatite socket of new design. Better contact, and higher voltage breakdown.

Prongs	Net
33004, 4.....	.24c
33005, 5.....	.24c
33006, 6.....	.24c
33007, 7 large.....	.34c
33008, 8.....	.24c

STEATITE BUSHING INSULATOR

A steatite bushing completely insulates metal screw through insulator. Two sizes.

Hole Size	Net
32100, 3/8" Hole Size.....	.30c
32101, 1/2" Hole Size.....	.35c

ISOLANTITE PLATE CAP

For use on plate caps of transmitting tubes.

For	Net
36001, 866, etc.....	.21c
36002, 807, etc.....	.21c

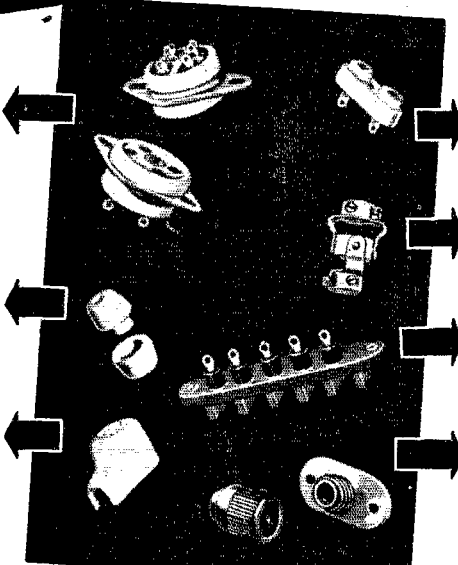

CRYSTAL SOCKET

Steatite body, improved contacts, easy to mount. Requires minimum space.

33002..... .25c

FLEXIBLE COUPLINGS

Something new in flexible couplings. No back lash, yet angle drives with as much as 45°, may be obtained. Isolantite insulation.

39001, Net..... .36c

STEATITE TERMINAL STRIP

Barriers between contacts prevents arc over, and accidental shorts. Easy to mount.

37105, Net..... .45c

BAKELITE SAFETY TERMINAL

High voltage terminal. Insulated bushing extends through chassis. Heavy area pressure contact.

37001, Net..... .35c

The RADIO SHACK

167 WASHINGTON ST., BOSTON, MASS., U.S.A.

New!

TURNER Han-D

CRYSTAL or DYNAMIC Microphones do the Job of Several Mikes — at Low Cost.



Furnished with 8-Ft. Cable Set and Cham-oisette Mike Bag



- Hold it!
- Hang it!
- Use it on desk or floor stand

● Rich brushed chrome finish matches modern desk or floor stands

ONE microphone that fills many needs. Specially engineered response for voice, together with smooth, natural response for music pick-up. Fits snugly into hand or any 1/4-27 stand. Positive contact slide switch permits off-on operation without thumb fatigue. Each unit individually tested in sound pressure room for level and frequency response before shipping.

9D Dynamic hi-Impedance \$25.00 List
9X Crystal \$22.50 List

The TURNER Co.
904 17th St. N.E.
CEDAR RAPIDS, IOWA

Send today for complete information on 9D Dynamic and 9X Crystal Han-D mikes, with prices.

Crystals Licensed Under Patents of The Brush Development Co.

The Iconoscope should be enclosed in a metal (electrostatic) shield, free of magnetization if it happens to be of ferrous material. The diameter of the shield should be sufficient so that there is at least 1/4-inch clearance around the signal-plate metal band at the end of the tube. This means that the inside diameter of a cylindrical shield should be at least 2 1/2 inches. Magnetic shielding should not be necessary if the Iconoscope is properly located with respect to transformers, etc.

The enclosure of the tube should be light-tight except for the lens opening in front of the mosaic. It also might be advisable to blacken the inside of the shield to minimize reflections.

As suggested in Mr. Sherman's May *QST* article, a moving-picture projection lens for 35-millimeter film, about f. 2.3 and 3-inch focal length, may be used satisfactorily. However, many television addicts who are also camera fans will find different lenses adaptable, particularly those of high-grade cameras. In fact, it has been suggested that a good idea would be to mount an open-backed camera of suitable type in front of the Iconoscope mosaic, the distance being chosen to place the mosaic in the position normally occupied by the camera film or plate. Reference to the dimensioned drawing of Fig. 2 will assist the designer in working out both the mounting of the Iconoscope tube and the lens system.

Note that the base connections given here are slightly different from those indicated for the Iconoscope in the circuit diagram of Fig. 1 in Mr. Sherman's article in May *QST*. In the earlier developmental tube the free horizontal deflection plate was designated D_4 . The plate with this designation is now connected to D_2 within the tube, and D_3 is the free horizontal deflection plate. This is simply a change in the deflection plate numbering convention and does not affect the external circuit. The arrangement is such that the picture comes out right-side-to on the monitor and on the Kinescope of the receiver described elsewhere in this issue. The monitor pin connections follow the standard designations for the 902, which should have its socket located so that Pins 3 and 7 are in a vertical line, with Pin 3 above Pin 7. A base plate with circumferentially slotted socket mounting screw holes will permit exact alignment of the scanned area.

Camera-Modulator Circuit Notes

Since the circuit of Mr. Sherman's camera-modulator unit was prepared, two minor modifications have been found to give improved performance. The first of these, which improves the definition somewhat, is to connect the suppressor of the second video amplifier VF_2 to the junction on a voltage divider between ground and positive 300 volts, the values of this divider being 50,000 ohms on the ground side and 150,000 ohms on the high (positive) side of the junction. The second modification, which improves the stability of the Iconoscope, is to connect C_{52} between the Iconoscope blanking lead and the Iconoscope cathode, instead of between the Iconoscope blanking lead and ground. The circuit otherwise remains the same.

You'll REALLY Enjoy CW

WHEN YOU
LEARN CODE

THE
CANDLER WAY!

TAKE A TIP FROM THE CHAMPIONS!

If you think you're enjoying your CW — wait until you've practiced the Candler way for a few weeks! Suddenly you'll notice it's no longer an effort to read a speedy operator, your sending becomes faster, more rhythmic — you'll find yourself reading words — yes, even sentences, without strain or conscious effort — as easy as you read print.

Months, even years, of undirected practice won't help — you need the skilled mental training, the automatic sound sense that Candler gives you, to develop the speed you're really capable of. And, you'll be amazed at your rapid progress, too! Ask any skilled operator. Read what the champions say in your copy of the FREE BOOK OF FACTS. Send for it today!

SEND FOR FREE
1940 BOOK OF FACTS



CANDLER
SYSTEM CO.

Dept. Q-6

Asheville, North Carolina, U. S. A.

A Revolutionary QRM BUSTER! BAND PASS FILTER for Amateur Applications

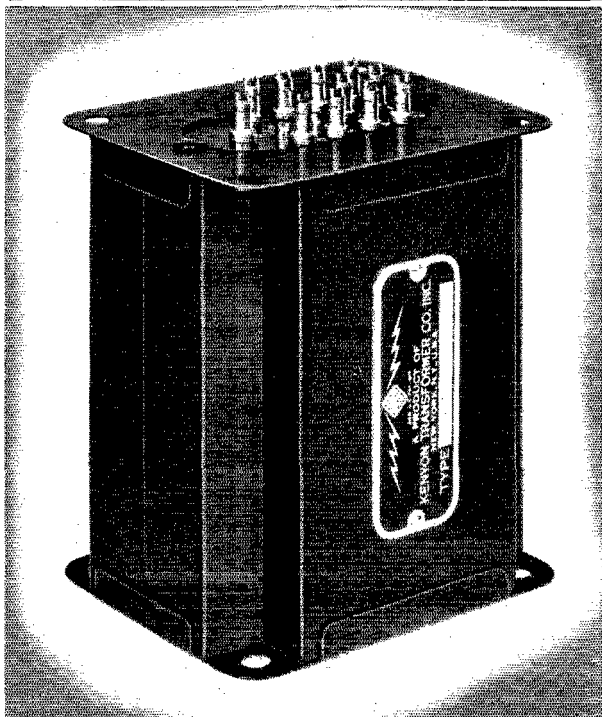

LONGER LIFE FOR TAYLOR HI-PERFORMANCE TUBES

Use the NEW KENYON T-392 with exclusive voltage dropping compensator 7.5 V., 7.7 V., 7.9 V., at 6 amps. Famous T line construction.

Amateur Net \$2.55

HERE is a revolutionary new type of filter which has been designed to help put your signal through the toughest QRM by eliminating those frequencies unnecessary for amateur communication purposes. Formerly made only for air lines, it is now made available to amateurs who wish to eliminate background growls, echos, or other extraneous noises with frequencies above 3000 or below 300 cycles. When used in conjunction with the Peak Limiter (see *QST*, May, pgs. 54, 55, 56) it provides the operator with an outstanding signal of extreme intelligibility. Put one in your rig and be convinced. Ideal heterodyne eliminator for receiving purposes. Insertion loss nil.

KENYON T-800* BAND PASS FILTER

Primary impedance VC/500/10,000 ohms.
Secondary Impedance VC/500/10,000 ohms. Max. level, 6 watts. Amateur Net \$9.00.

Send for complete dope as to application, etc. It's Free!

*Can be used as an interstage, input or output transformer. Also from VC to VC for receiving purposes.

NEW CATALOG READY

Without a doubt the most extensive catalog we have ever published. Complete with beautiful illustrations, graphs, charts, etc.

Send for your FREE copy today



KENYON TRANSFORMER CO., Inc.
840 BARRY STREET NEW YORK, N. Y.

OFFICES IN PRINCIPAL CITIES

Cleveland 3292 Cedarbrook Rd.	Seattle 2605 Second Ave.	New Orleans 618 Girod St.
Chicago 21 E. Van Buren St.	Los Angeles 2412 7th St., W.	Lutz Florida
Kansas City, Mo. 2004 Grand Ave.	Dallas P. O. Box 4116, Sta. A	Richmond, Va. 3106 Edgewood Ave.

Station Activities



HUDSON DIVISION

EASTERN NEW YORK—SCM, Robert E. Haight, W2LU—LSD reports FTS N.Y.C. get together with 88 present at Hotel Knickerbocker. Newest member YL is Eleanor—W2MWY. Purpose of meeting to line up traffic handling at 2USA. KWG just returned from Chicago. EZO reports nice total from Mt. Vernon. MHW schedules nightly with E.N.Y. Army Net and Trunk Line "G," using new rig, 6L6-6L6-809, 60 watts. LU schedules 8GWY and 2MIY, new O.R.S. at Albany. BEW made improvements to RK25 e.c.o./807 rig; FB with 70 watts input. SZ is on 3540 kc. MIY is new O.R.S., strictly c.w. "Dot" is out to take all traffic for Albany on 7 and 3.5 Mc. Welcome and congrats to you, MIY. KPB reports new r.f. section, 6J56 crystal osc., 802 final, running 15 watts, both c.w. and 'phone on 3.5 and 1.75 Mc. LLU finds crystal grinding interesting. Traffic: W2LSD 268 KWG 151 EZO 133 MHW 75 LU 71 BEW 11 SZ 10 MIY 4.

NEW YORK CITY and LONG ISLAND—SCM, Ed. L. Baunach, W2AZV—The Section Net on 3710 kc. is doing wonders for getting traffic in and out of N.Y.C., under the guidance of LR. More stations are wanted in S. I. and towns on L. I. Please get in touch with LR for full information about the net. PL is the N.Y.C. outlet for F.T.S. traffic. LZR handles traffic via the F.T.S. for points west. CKQ is the Brooklyn outlet for the F.T.S. EC handled his traffic while operating portable in the 1st district. MLE schedules daily MIKE for 1.75-Mc. traffic. BGO put in a 28-hour stretch during floods in Pennsylvania, keeping schedules with 8EKG and AIZ, who is again active on 3.5 Mc. AXZ, DBQ, ITX, PF and SC handled their traffic via the A.A.R.S. LYG and LID are members of the 3570-kc. Section Six N.C.R. Net. A new net has been formed on 1810-kc. 'phone by CIT, DLR, HAP, LID, LNQ, JQN, MIQ, 3GVC, solely for rag-chewing; they call it the Nitwit Net. PF and ten members of the A.A.R.S. journeyed to Trenton to attend N. J. State Net A.A.R.S. Meeting, and all had a fine time. HAE worked California and Oregon on 1.75-Mc. c.w., using an 809. FAQ is saving his pennies to increase power. WD inaugurated a new ham service at USA to help hams swap or otherwise dispose of surplus junk. LGK finds that brass solder iron tips stay tinned and last much longer than copper ones. The following are active on 112 Mc.: APM, HBO, HMT, JSV, KPV, KZV and MJL. DOU's new exciter using a 6A6 has more output than an 89. The fisherman's Net on 1.75-Mc. 'phone is getting fan mail from listeners. IBSH is HGO's guest while in the city. LWE is getting near to the W.A.S. mark with his 809 job. On tests made between ITX and LGK with self-power and regular power, no difference was noted. E.C. GDF of Queens County has everything completely organized, and is now looking for more stations to join the A.E.C. and become active on the 3710-kc. Emergency Net at 9:30 p.m. every Wednesday. Section E.C. DBQ wants all active traffic and A.E.C. stations in N. Y. County and Richmond County to get in touch with him. At a recent meeting of the Suffolk Radio Club at HNY, complete details were drawn up for Field Day. The Columbia University Radio Club is again becoming active with about 15 members. AEE, the club station, can be heard on all bands, and will soon be on using f.m. on 112 Mc. MQB/I at New London, Conn., is looking for a schedule on 1.75 Mc. with a station in East Hampton. Between getting a new lawn planted and working nights AZV manages to keep one schedule going.

Traffic: W2LZR 709 ITX 801 (WLNW 382) PL 676 SC 635 MT 428 CKQ 359 LPJ 287 DBQ 153 KI 127 CHK 115 LR 104 LGK-WD 82 AXZ 72 PF 65 AZV 57 EC 53 MLE 47 BGO 43 BDN 29 LBI 28 LYG 23 KYV-LID 18 KDC 14 AA 12 CIT 11 AEE-EYS 10 EXR 7 GDF-AZM-ADW 6 HBO-MCA 4 FAQ-IOQ 3 AEU-HNJ-JGC-DOG 2 HGO-IRC-BMG-DLR 1 WLNW 28.

NORTHERN NEW JERSEY—SCM, Pat Jessup, W2GVZ—Asst. S.C.M. in Charge of Emergency Coördinator, Les Bagley, W2JMX—R.M.'s: BZJ, CGG, GVZ. P.A.M.: HNP. Section Net frequency: 3630 kc. New appointment: O.P.S.—IXI; E.C.—JOC. Cranford. New A.E.C. registrations: AGX, AUI, CNP, COF, FXZ, GLB,

GMF, GNM, HDA, LKH, MAX, MKN, MLD, MNA, MOO, MSR, MWJ, RP, MTI, MNT. Due to pressure of other matters, BCX resigned as R.M., O.R.S. and A.A.R.S. Ray is one of the best operators in the country, and we all hope he comes back soon. IXQ Joined Section Net. Nine of the O.P.S. gang attended the March O.P.S. meeting at HNP's shack, and decided to meet weekly on the air and quarterly in person. IGN, MAX and MBS are interested in becoming O.R.S.; DBY in becoming O.P.S. HNA has new ¼-kw. 28-Mc. rig and new f.m. 112 Mc. LLT got new Hammarlund Super Pro, and two high-power rigs are under construction. GOM is returning after silence of several years. The Sage of Helmetta says "OM say early bird catch worm, but guess he never tried catching them with 20 watts." Incidentally the QSLL bizness is down 90%, from 3500 in March 1939 to 400 in March 1940! MNT pumps 42 watts into 7070 kc.; Bob is 15 years old. The J.S.A.R.A. set up a 450-watt 'phone and c.w. rig at business show at Asbury Park, using BZJ/2, and handled a barrel of traffic. DBY will soon be O.P.S. and MAX O.R.S. MTO in North Bergen uses 42 osc. with 8 watts on 1.75-Mc. c.w. ZA worked KC4USA, KC4USC and KF6JEG on 'phone. HNP schedules with his brother at Univ. of Kentucky, on 14 Mc. JMX gave talk and demonstration of emergency work at Summit. MOO and gang are forming radio club at Ramsay. BZJ is very active as E.C. GKX gave demonstration of ham radio to American Legion in Perth Amboy. A.A.R.S. held annual meeting and banquet in Trenton, and had speeches inflicted on them by SCM's 3CCO and GVZ. The N.N.J. contingent included BZJ, DYQ, KHA, LMN, MAX and MNT. ABS completed a 56- and 28-Mc. car mobile rig and also has remote-controlled and metered 3.9-Mc. rig in the attic. LAG is experimenting with 112 Mc. IINA is building a freq. standard with 100-ke. bar with multi-vibrator, and has applied for O.R.S. 4GKM does a lot of operating there. JYK and MEG, his XYL, will soon take Class A exam. ISZ will soon be on 1.75-Mc. 'phone. AMF wallops 28 Mc. with a half kw. HLC is polishing up a new shack. MW deserted 3.9-Mc. 'phone for 7-Mc. c.w. FSQ came out of the moth balls and came back on 1.75-Mc. 'phone. GZG wants a human fly to shunny up his 75-footer and replace a halyard. BCC works mobile in his car from 28 to 112 Mc. He uses plug-in coils and an e.c.o. IQM has gang-tuned e.c.o. with 35T final. JAME has bandswitch 20-watter on 3.9 and 1.75 Mc. LXI got his W.A.S., and is now looking for an Asian for W.A.C. HXI worked KC4USB on 7 Mc. MNT likes traffic work. SN says that some QSLL's arrive in a censored condition. We still need plenty of alert Emergency Coördinators. We only have 15 so far, and there are about 125 towns and cities in the Section. If you want an E.C. job, see JMX. Also, there are only 150 A.E.C. members out of more than 1500 hams in the Section, and we strongly urge everybody to register. Let's make a big showing on Field Day.

Traffic: W2GVZ 518 (WLNW 9) BZJ 348 CGG 259 LMN 257 (WLNW 45) IYQ 61 JUC 54 HCO 41 KMI 34 MAX 25 MKW 15 IXL-MNT 14 JRU 10 GHQ 9 CJX 8 HXI-KPR 4 CIZ 3 MTO 2 HZY 1.

ATLANTIC DIVISION

EASTERN PENNSYLVANIA—SCM, Jerry Mathis' W3BES—Everything is running smoothly at W3ADE, 3AGV snagged TA1AL, and thinks he is "Kosher." 3AOC divides time between 3.5-Mc. c.w. and 1.75-Mc. 'phone. We have as an O.P.S. now, 3BD, who thumps out a piano recital at the Academy of Music with as much ease as your S.C.M. does an O.R.S. Party. 3BXE and 3KT are conspiring to aid the Frankford Radio Club in their Field-Day "Blitzkrieg." 3DGM now has 300 watts. The Lancaster gang has organized the "Lancaster Transmitting Society," according to advices from 3DRO. 3DRQ has a standing bet on a meal on the O.P.S., O.R.S. parties with 3DGM. This provides 3DGM with at least one square meal quarterly. 3EEW took enough time off from his radio "chess and checkers" to make the B.P.L. 3FLH, with 95 countries in the "hand," is trying desperately to get the other 5 out of the "bush" while there are some. His latest: OQ5BF. Summer means DX time for 3FRY, who plays "Wet Nurse" to a few thousand oil burners which QRX for the summer. 4GQJ/3 (ex-3GJY) reports the formation of the "North Light Radio Club" which, he says, is all set to "take" Frankford in the SS. 8EU has his second "Store boughten" receiver. The first was a Grebe CR13! 8QGQ belongs to the W.A.S.B.N. (Worked all States But Nevada) Club. 8QLW was the call used at Honesdale's first hobby show. The operators were 8CFD, 8QLW, 8QQC, 8QXY and 8RGX.

"Field-Dayitis" is developing in the Chester Radio Club, the York Road Radio Club, the Beacon Radio Amateurs, the Philadelphia Wireless Assn. and the Frankford "Mob." The scrap should prove to be rather "Gory" this year! We need an emergency coordinator for the Harrisburg area. Will some of you fellows select and recommend to your S.C.M. a qualified member of the A.R.R.L.'s Eastern Penna. Section, home of sixty-six O.R.S. and twelve O.P.S., continues to capture its share of operating awards. Non-O.R.S./O.P.S. are missing much enjoyable operating activity. Join up!

Traffic: **W3ADE** 108 **3AKB** 243 **SAOC** 3 (WLQJ 11) **3AQN** 110 **3BXE** 24 **3DGM** 4 **3EEW** 463 **3EPH** 309 **3EML** 1446 **3FRY** 95 **3FXZ-3GDI** 20 **3GKO** 1247 **3GOW** 2 **3GYK** 22 **3GYV-3HCT** 2 **3HFE** 11 **3HRS** 256 **3HZK** 10 **3HZV** 43 **3IAY** 12 **3IGK** 4 **3IKW** 16 **3INH** 11 **3NF** 176 **3QP** 892 **3RR** 3 **3GQJ/3** 636 **8ATF** 23 **3ASW** 263 **8GV** 7 **3OML** 5 **8PAF** 99 **8QLW** 5 **8SNZ** 12.

MARYLAND-DELAWARE-DISTRICT OF COLUMBIA — SCM, Hermann E. Hobbs, **W3CIZ** — R.M.'s: **CDQ**, **CXL**. Chief R.M.'s: **BWT**. **BWT** reports on the Washington Radio Club's Cherry Blossom Hamfest held April 13th. There were about 100 in attendance. ECP has been appointed Official Reporter for the Md. Net, A.A.R.S. EIZ schedules **4GQE** in N. C. **BLX** will be back on, after a long absence, with 250 watts and a pair of 811's on 3.9 Mc. **FPK** is building a signal shifter. **GTN** is organizing a 28-Mc. A.A.R.S. Net. **DRD** will be glad to QSO, QSL for W.A.S. with anyone wishing Del. **GYQ** QSO'd Utah for W.A.S. on 7 Mc., and is looking for QSL's on 3.5 and 14 Mc. **ICT** has new 812 final; is key station for Baltimore F.T.S. **WU** worked **KB6RWZ**, and received cards from **HB1CE** for all W3 stations he has contacted.

Traffic: **W3BWT** 612 **CXL** 633 (WLM 3929) **CDQ** 10 **CDQ** 23 **CIZ** 698 **ECP** 57 **EIZ** 13 **GYQ** 223 **HQU** 181 **HUM** 141 **ICT** 90 **WU** 7.

SOUTHERN NEW JERSEY — SCM, Lester H. Allen, **W3CCO** — Ass't S.C.M. and A.A.R.S. Liaison R.M., Ed. G. Raser, **W3ZI** — Regional Coördinator in charge of Emergency Coördination, Ted Toretti, **W3BAQ** — R.M.'s: **3BEI**, **3BYR**, **3EÜH** — P.A.M.: **3GNU**. Section Net frequencies: O.R.S. — 3700 kc.; O.P.S. — 198 kc. **CWG** and **IDZ** are new O.P.S. Your support is cordially asked in cooperating with E.C. **3BAQ**. From out Minnesota way, **HKO** writes, "Will be home soon. Best regards to the South Jersey gang." **BAY** is still microphoneing on 14 Mc. **OQ** reports his portable working great. **DNU** is still on the sick list and wishes to let the O.R.S. boys know that it was Doctor's orders to give up radio for a while. **CFS** is rebuilding the 3.9-Mc. 'phone rig to a ½ kw. After a few minor adjustments, **GMY** is back on the O.R.S. channel. **FMR** replaced his 4-element rotary with a 3-element beam after the recent wind storm which brought it down. **HOS** and **IET** are co-chairmen for the Pitman gang's Field Day. **AEL** reports back in the O.P.S. Net after working nights for last two months. A new 8-element beam is being added to **ABS'** antenna collection for 28 Mc. **FFE** through a coincidence met **FFJ**; the story is that **FFJ** tried to back his car in a parking space and **Thorn** walked behind the car, and was nearly run over. **CWG** is moving to Succasunna, and will rebuild rig to ½ kw. **IDZ** is running 150 watts to P.P. **35T's** on 1.75-Mc. 'phone and using a 400-foot antenna against ground. **FDO** and **EWK** have Second Class Commercial Phone tickets. There is some talk that **UT** is trying to whip the old Atlantic Radio Club into shape. Lots of luck, **Walt**. **GVO** is one of the new operators at **WBAB**. **GNQ** was a recent visitor at **IHO**. **IHO** and **XYL** attended the Baltimore hamfest. Forty-five attended the 2nd Annual A.A.R.S. Hamfest held in Trenton. Speakers included both New Jersey's S.C.M.'s, **3CCO** and **2GVZ**. **D.V.R.A.'s** motion picture of club activities made its first public appearance at this event. **BZX** is high man again this month, and rates the B.P.L. Nice work, **Harvey**. **FTU** sure has a swell signal on 3.9-Mc. 'phone with only 12 watts input. **HPX** is youngest operator in N. J. State A.A.R.S. Net; he got his ticket when only 13 years of age. **HOH** had nice cross-hand QSO with **ZI** 3.9/56 Mc.; the schedule was arranged via **HPX**, whose father puts out the biggest signal on 56 Mc. in this Section. **HDW** was recently appointed Alternate N.C.S. on the newly organized 7-Mc. A.A.R.S. Net in N. J. **IOK** is hot after the W.A.S. award. **Zland** **CCO** received the Public Service Award for meritorious radio contact work with National Guard and public agencies during the search for lost child on March 7th. **CFT** bought a motor boat; expects to have a 112-Mc. rig aboard. **AID** is

on the air with **ZI's** portable rig and working out **FB. EÜH** is doing a swell job as N.C.S. on S.N.J. 1.75-Mc. 'Phone Net. **CCC** worked a couple W7's on 3.5 Mc. This past month with only 28 watts input. **IRI** is Trenton's newest ham. **CZN**, **CJO**, **CMR**, **BYK** and **YL** attended the recent Baltimore hamfest. **CZN** was the only one in the crowd to win a prize. **EED** is building a 12-tube super. **EFE** is working portable in California. Now that summer is coming along, it is urged that you send along reports so that we can keep up on the Section column. Let us know what is doing in your community. Until next month, 73.

Traffic: **W3BZX** 505 **BYR** 258 (WLVN 24) **EFM** 154 (WLNJ 108) **ZI** 148 **GCU** 77 **FXN** 43 **CFS** 40 **EÜH** 39 **CCC-BEI** 30 **FMR** 29 **HPX** 27 **OQ** 24 **GMV** 23 **IDZ** 22 **AVJ** 21 **ATF** 20 **EWK** 18 **IET** 15 **GUS-AEJ** 11 **DNU** 7 **ASQ** 6 **CCO** 5 **IHO** 2.

WESTERN NEW YORK — SCM, Fred Chichester, **W8PLA** — R.M.'s: **BJO**, **CSE**, **DSS**, **FCG**. P.A.M.: **CGU**. E.C.'s: **FNT**, **GWY**, **SBV**, **SMH**. Net frequency: 3720 kc. **BJO** seems to have made B.P.L. a habit; he did it again this month. **MC** has a portable 'phone rig in his truck, and talks with Mrs. **MC**, at home, between jobs. **DOD** says his call is being bootlegged on 3660 kc. **RGH** has a new receiver. **FNT** has been appointed Emergency Coördinator for Rochester and vicinity, to fill the vacancy caused by the resignation of **RGH**. **TOH** was awarded first prize at Rochester's Science and Engineering Fair for his exhibit of transmitter and receiver, among 150 other hobby exhibits of high school students. **TUQ** got quite a kick out of being televised several times at the Farnsworth Television demonstration, where she played the piano. About 20 Rochester hams attended the Buffalo Hamfest. **ACY** was the only one to win a prize. The Rochester Amateur Radio Assn. held a spaghetti dinner at one of Rochester's Italian restaurants on April 9th. **DHU** is on the road for a couple of months, but stops at **GWY's** shack weekly. **SFD** received a "heard" card from **ON4QW**; **Phil** works 7 Mc. with 300 watts. New calls in the area: **UMF**, **Greigsville**, **UMW**, **Peoria**, on 1.75-Mc. 'phone and **UNX** in Syracuse. **OAO** is back on 3.5 Mc. **BOX** and **DWO** have baby boys. **SVZ** is receiving treatment in Mt. Morris Hospital. **CSE** is out and around, after a long siege of illness. **PCN** finally got up an antenna that works and comes into the net regularly. **SBV** has been chosen to supervise the work for Field Day in the Elmira Club. **AVD** worked an **XU8** on 14-Mc. 'phone, recently, to complete the requirements for W.A.C. During the DX Contest **BHK** worked **7HCV**, formerly of Elmira. **RVM** reports work progressing rapidly with the proposed St. Lawrence Valley Net. **TEP** is on with a ½ kw. **CGU** has new QTH. **MLM** expects to be on soon with 150 watts. **JTT** is working in Buffalo; he is doing his N.C.S. work for the Army through **KYR** and **PCN**. **OXH** operated his station in conjunction with a church fair and originated some traffic. **EX-2ARK** has moved to Mt. Morris. **ROU** has been on 28-Mc. 'phone with 90 watts. **QGN** is working away from home, and only gets on weekends. **LTM** is on 1.75-Mc. 'phone with 90 watts. The Buffalo Hamfest was a great success, with an attendance of about 200. The 150TH door prize was won by **VE3AXZ**. **John Kraus**, **SJK**, gave an illustrated talk and demonstration on antennas. **KYR** went through a tonsillectomy, and is feeling better than ever. Clubs from Jamestown, Niagara Falls, Kenmore and Buffalo are meeting in Buffalo, April 27th, to form a new and better council. Buffalo Mike and Key Club has a new meeting place, Ahl's Hall. The K-B-T Club is planning a great representation on Field Day. They intend to use Grand Island (of all places), N. Y., for their QTH, and have four transmitters with gas generators furnishing power. The following will take part: **NVJ**, **MQX**, **DLK**, **LQC**, **NEL**, **NWH**. They will use **NWH's** call. Your S.C.M. wishes to take this means of thanking the boys who did such excellent work during the emergency in the southern part of the state. **SMH** and **SBV**, working as coordinators, with **RRS** and **RTW** and **FCG** (Radio Aide of the Army Net) giving a hand, did a good job well. **SBV**, **SZK** and **JQE** now have Class "A" tickets. **DX** is working on a cathode-modulated rig.

Traffic: **W8BJO** 542 **AOR** 11 **CSE** 37 **DOD** 125 **DHU** 62 **DSS** 88 **GWY** 217 **JTT** 27 **JIW** 11 **JQE** 305 **MKA** 28 **OXH** 30 **PCN** 202 **PLA** 174 **QQB** 55 **RMR** 22 **RRS** 38 **RKM** 170 **RVM** 16 **SBV** 127 **SZK** 40 **SFD** 8.

WESTERN PENNSYLVANIA — SCM, Kendall Speer, Jr., **W8OFO** — Ass't S.C.M. in charge of Emergency Coördination, R. M. Francis, **W8AVY**. New O.R.S.: **8TTD**,
(Continued on page 104)

PREMAX

AT CHICAGO NATIONAL RADIO PARTS AND TRADE SHOW JUNE 11 TO 14

See the new developments in Premax Antennal Get the new Technical Bulletin! Learn how Premax Antenna Equipment will improve your station! Make the Premax booth your headquarters during the show.

BOOTH 830—STEVENS HOTEL



PREMAX PRODUCTS

Division Chisholm-Ryder Co., Inc.

4020 HIGHLAND AVE. NIAGARA FALLS, N. Y.

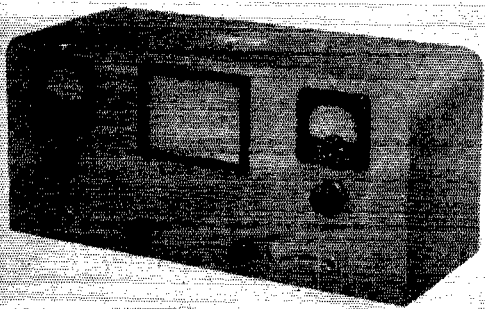

FAR AHEAD of the usual compromise two tube transceivers

the 2½ METER type TR-112 TRANSMITTER-RECEIVER

contains these exclusive features

TRANSMITTER

- Resonant lines 6E6 oscillator 21 watts input
- 6V6's Class AB maximum 18 watts audio
- Illuminated plate current meter

RECEIVER

- 6J5GT detector, 6J5GT and 41 audio delivering real punch to a P.M. dynamic speaker
- Matching illuminated meter type vernier dial

Extremely compact and rugged for mobile or portable as well as for fixed service. Professional gray wrinkle. For use with separate AC or DC pack. **\$39.75**

See it at your dealer. Write for literature

RADIO TRANSCEIVER LABORATORIES

8627 115 STREET RICHMOND HILL, NEW YORK CITY
CABLE ADDRESS: "RATRALAR", NEW YORK

A.R.R.L. Field Day

(Continued from page 29)

for bands and transmitters is required. State the number of transmitting units in simultaneous operation. Attach copies of all messages for which any credit is expected, just as handled and with time and stations indicated. Note the source(s) of plate and filament power, along with the "watts input" for each rig. All reports to count must be mailed on or before July 10, 1940, to constitute an entry.

Clubs are all invited to encourage their members to build portables and to arrange special Field Day activities. Club contests for emergency-set building of members should be instituted. Every amateur is invited to take part, whether or not able to participate in club plans. Join a group or get up a group to get maximum fun and profit from F.D. opportunities. Test equipment in the Field Day. Ask for application forms for registering equipment and availability in A.R.R.L.'s Emergency Corps, if you do not already hold a membership card in this organization.

The presentation of scores reporting on the 1940 F.D. will be by groups. Groupings of participants will be based on the maximum number of *simultaneously operated transmitters* used at any time in the contest period by any entrant. Score groups will thus be proportional to the facilities used. All units or set-ups constituting a score group are placed under the call of one licensee who has made the required advance notification meeting F.C.C. requirements and who is responsible for accuracy of all logs and records.

Design your station equipment, especially exciters and receivers, for portability, connection to battery or emergency supply quickly if power fails and necessity arises. Don't deny yourself the ability and pleasure to set up in any location when radio links to agencies served by amateurs in the public interest may be needed. Surprisingly efficient and useful equipment may be operated from vibrator-type, genemotor, and battery power supplies. You may not have gas-electric power for a full 1000-watt transmitter such as W1AW has, but some provision for power failure should be made. No amateur station should be regarded as complete without *some* measure of self-powered equipment. Get set, in however a modest way for such contingency. Take part in the F.D.; it's often a revelation what 10 or 20 watts can do in a reliable manner!

— F. E. H.

Strays

An inexpensive thermostat may be made from a spiral-type thermometer which may be purchased for 10 cents. Solder a contact on the tip of the pointer and mount an insulated contact on the dial. Circuit connections are made to the insulated contact and to the center of the spiral element. The insulated contact should be made adjustable. — W6BVF.

A Specialized Relay

FOR EVERY PURPOSE

Perfected Antenna Switching — New Antenna Relay

For use with any type of antenna — on any frequency up to 60 mc — this precision-built relay will deliver the goods. Straight-through feed for the transmission lines — highest-grade ceramic insulation throughout — large, oversize contacts to handle a full KW. Uses 110-volt AC coil and incorporates the same operating principle used in telephone service relays for fast, reliable, positive and quiet operation. Heavy steel base and other metal parts are chromium plated.

Model 28-1004.....\$1.20 Net

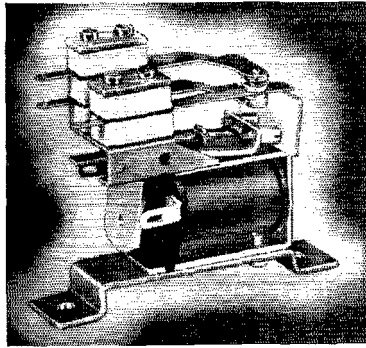
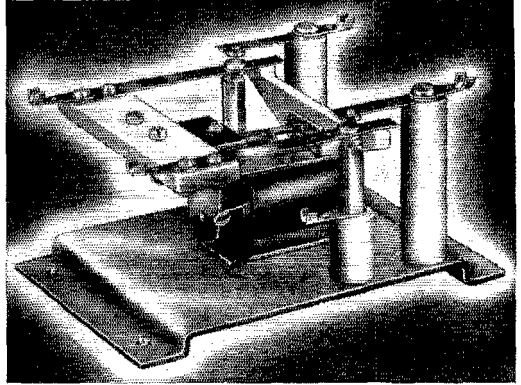

Low-Loss R-F Circuit Changing with these Universal R-F Relays

For use wherever high-frequency circuits require reliable switching — with low losses. Alsmag 196 insulation — permanent-temper phosphor-bronze contact springs — large, stick-proof contacts. Two types — for single-pole or double-pole service. Single-pole type may be used as double-throw or single-throw, normally open or closed. Regularly furnished for 110-volt AC operation, these two relays will fit any application!

Model 28-1001 D-P-D-T.....\$3.30 Net

Model 28-1002 S-P-D-T\$2.70 Net

The old Standby that can "take it" Double-Break Power Relay

An unusually sturdy, ruggedly built power relay to handle any switching requirement where comparatively heavy currents are present at low frequencies. Extra large double-contact system will safely break 20 amperes in non-inductive circuit. Contacts are normally open — oversize energizing coil provides powerful pull for quick, positive action. Designed for operation on 110 volts AC. Provided with heavy steel mounting bracket.

Model 28-1003.....S-P-S-T.....\$2.85 Net

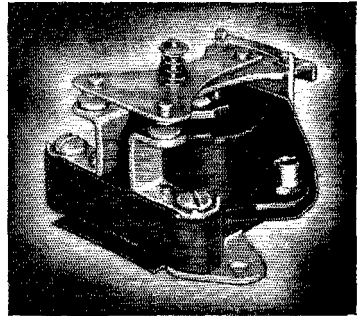

HAVE YOU SEEN THE SIGNAL-SPLICER?

Probably not — for it's a brand new instrument — just out of the Meissner lab! Designed to provide a perfect antenna match for any receiver with any type of antenna. Increases signal tremendously without tubes! Modestly priced — write for details!

WRITE FOR FREE CATALOG

If you haven't received your free copy of the big 48-page Meissner catalog it's still waiting for you. Fully illustrated — lists dozens of items of special interest to you! Communications receiver kits, Signal-Shifter, etc. Write for yours today!

ADDRESS DEPT. Q-6

 **Meissner** MT. CARMEL ILLINOIS

"A FAMOUS NAME FOR TWO DECADES"

(Continued from page 101)

8DXN. B.P.Lers this month: KWA and NCJ. Both on deliveries. KWA is winding up schedules on May 1st. NCJ worked ten countries in the DX contest. Beth at NCJ received a nice QSL from 2USA. TWI, a new O.R.S., likes traffic work. PX reports Silent Key, W8GOR, Mercer. The Warren Club is preparing for Field Day. RAT contacted several South Americans on 14-Mc. 'phone. QEM is busy on 112 Mc. fixed and mobile; reports results similar to 56 Mc. RYC operates NKI at Carnegie Tech. TOJ, SVT, NTJ and JSQ have gone in for 112 Mc. TOJ and BOZ attended the Buffalo Hamfest, April 6th. SFV ran up a nice score in the DX contest. DDC has been trying cathode modulation on 3.9 Mc. The Butler boys are all set for Field Day. OKS is working in the Westinghouse Labs at Baltimore. ZD will have at least three complete emergency outfits going on Field Day with a complete crew of N.C.R. men.

Traffic: W8KWA 304 NCJ 266 MOT 137 RAP 59 CMP 53 TWI 50 PX 40 HK 23 OUT 16 NDE-RAT 12 RIT 8 QEM 5 AXD 4 PER 2.

NEW ENGLAND DIVISION

CONNECTICUT — SCM, Frederick Ellis, Jr., W1CTI — AW is still on top with B.P.L. total. KKS was a close second. UE and JXP B.P.L.'ed on deliveries. CTI spent most of his spare time checking the March contest reports. IKE built a new s.s. receiver; worked one new continent and four new countries. ITI would like to hear from any Hartford c.w. station interested in acting as alternate on the Weather Bureau Net. KFN donated an RK49 as a prize to the station working the most 2-letter calls in the March contest. With the help of CSY, KQY and KFN, TD at last got some grid mills to trickle through to the final and now has 125 husky watts on 3640 kc. five nights a week. CJD donated 100 QSL cards as a prize for the March party. Congratulations to LOC and LZT. They are proud parents of a new baby daughter. GYT wants to become O.R.S. 8MYW/1 will be using 1YU for the remainder of the season. AVB moved to Cos Cob, and is all set up on 14 Mc. APA is installing a new HK 354 "C" and kw. B. & W. swinging link final tank coils. GB is on the air every night on 3535 kc. DJC has a new rig, 6V6X, 6N7, 807, P.P. 812's. JZB, KKS and DJC attended F.T.S. meeting in N.Y.C. MJY/1 and 2MQB/1 worked c.w.-'phone together and exchanged QSL cards 30 seconds after the QSO ended! Fifty-five hams attended the Field Day Round-Up sponsored by the Manchester Radio Club, at the State Trade School in Manchester. April 23rd. BDI, UE, JMY and JEQ were present from A.R.R.L. Headquarters. Representatives from several Connecticut Radio Clubs were present, including: New Haven Amateur Radio Ass'n, Connecticut Brass Pounders' Ass'n, Hartford County Amateur Radio Ass'n and the Willimantic Radio Club. BDI explained the rules for the 1940 Field Day. A member of each club present outlined his club's plans for Field Day. CSC, Regional Coördinator for the Conn. River and the Weather Bureau, told about the net that has been formed to handle weather reports. TD, Regional Coördinator for the New York, New Haven and Hartford Railroad Net, spoke on his work with this important emergency net. E.C.'s BCG, CSC, TD, BAX and KYQ were busy comparing notes during the rag-chewing session after the meeting. Refreshments of sandwiches, twisters and coffee were served to the gang by members of the Club. Sixty stations reported participation in the March 30th-31st Nutmeg State QSO Party. Claimed scores are as follows: W1LOP 6150 (75 QSO's, 41 towns), KFN 5852 (77; 38), KQY 5112 (71; 36), UE 5070 (65; 39), KKS 3712, IKE 3224, KYQ 3072, AGT 2856, MEC 2842, VK 2106, GC 2100, JWG 2050, CPL 1932, IKJ 1840, KXB 1728, LQK 1728, ASO 1480, MHF 1452, BYW 1254, ELD 1388, CTI 1160, LZB 1156, TD 1080, DJC 1064, MBW 1026, MFN 960, HZD 850, JHM 850, HNF 832, KAA 780, IIS 728, MAU 728, JIN 650, DGC, 630, 2MQB/1 532, 1BGP 528, MGT 504, IMP 468, FOB 432, BIH 360, JMY 324, BNB 308, BPL 286, CJD 286, JXP 240, KZC 208, DWK 140, KYQ 105, FMV 84, MMN 84, GB 72, LOC 70, MJY/1 50, BCG 40, BAX 30, BZE 18, ATH 16, MHH 12, HYF/1 8, DWP 2. W1LOP operated on 3.5-Mc. c.w. and 1.75-Mc. 'phone. KFN used 1.75-Mc. 'phone, 3.5-, 7- and 14-Mc. c.w. KQY used 3.5-Mc. c.w. only. The New Haven Amateur Radio Ass'n was the only club to submit a score, running up 19,124 points. KQY worked 10 two-letter calls, and wins the RK49 offered by KFN to the station working the most two-letter-call sta-

tions. KKS worked 9 two-letter calls. HYF operated portable from Norwalk Hospital where he was recovering from an operation. TS, confined to the Bristol Hospital, became aware of the party when a radio in a nearby room blurted forth, "W1VK calling any Connecticut station!"

Traffic: W1AW 614 KKS 577 UE 334 JXP 209 CTI 148 IKE 133 ITI 130 KFN 100 VB 74 MEC 73 KYQ 61 TD 54 KQY 38 CJD 28 LVQ 24 LOC 21 BDI-GYT 14 KSJ 9 GC 8 MJY/1 7 GB-LQK 6 AVB-JTD 4 ACV 1 AMQ (W1GG 10) W2MQB/1 54 W8MYW/1 8. (Feb.-Mar.: W1MJY/1 96.)

MAINE — SCM, H. W. Castner, W1LIE — I am very glad to announce the arrival of 1940 edition YL ops at both BWR and DRZ. If you hear a T9 signal from LHM, it isn't his rig: It's wedding bells. LER added a T20 and is much louder. LKP is new O.R.S. and O.P.S. We worked AFT recently. FB, Hank, Worked GKC recently, and he was on 1.75-Mc. 'phone. (I have notified Ripley, HI.) Everyone is glad to welcome "Pete," GOJ, and "Flo," KOH, back from Georgia. IEF and IFZ are buzzing around 112 Mc. The whole class in radio at MHY, with instructor, visited IIE and saw the Pine Tree Net work. We hear that JGG is with Pan American Airlines. The Auburn National Guard Unit have a station now, and calls itself the "Ether Rover Club." LSK made 60,000 on 14 Mc. only in the DX contest. LRQ is on 7191 kc. LWX is putting in T740's. LHA has certainly "gone to town" on 3.9-Mc. 'phone. Carl has only been on since February, and has done some fine work, never using more than 50 watts. He worked all districts twice in one week. We are glad to report a lot of activity at OR; they run 1 kw. on c.w., and 500 watts, grid-modulated, on 3.5, 7, 14 and 28 Mc. with some 112-Mc. work. The operators are: LHK, FYO, JTN, 3IHW, MHW, ex-W2KSM. The N.C.R. is going strong, and BWR has been on 3600 kc. quite a lot lately. The A.A.R.S. is stronger and more active all the time. When you have the leadership of such men as CFO and his able assistants, you can't help getting results. FAP, S.N.C.S. of the A.A.R.S., recently brought honor to the Maine hams by achieving a score of 40 w.p.m. in the speed contest. LER is new A.A.R.S. FV got a bunch of junk together and was QSO your S.C.M. recently. FAP is moving to Saco. LUU sure "hangs to it" on that 3597 kc. spot, and he must run quite a lot of QSO's in a week. I hope some of you were able to attend the University of Maine "College of Technology Open House." All departments, electrical and communication labs, are thrown open, and it's most interesting. Had a fine letter from JRS. Interest in u.h.f. is increasing in Portland, with CRP and LNI even taking their 112-Mc. rigs to the ski races at Pleasant Mountain and providing communication with battery power. CRP has a fine new "pack" 112-Mc. job weighing 25 pounds, and got a 5-9 report from LNI, 2½ miles away. Carl Mason, ex-W1GHK, who is now 4FSK, has gone up and up the ladder until now he is chief operator of one of the Clippers from N. Y. to Europe. EFR is very active in the A.A.R.S. PF has a new transmitter and receiver for all bands. IRR and Don Jr. have some u.h.f. plans. DEO is going to have even more elaborate rigs in that new Dodge Coupe. The P.A.W.A. is going strong, and one of the good reasons is FBJ. Win sure is a grand guy and a model ham. KVI will have a 6L6 osc., 807 and P.P. 809's on 3.5 Mc. before long. I received a fine letter from Captain "Fred" Westervelt, K6QYI, in Hawaii. Fred is on 14336 kc. and can work 14040 kc. and needs Maine for W.A.S. He says the best time to work now is from 10 to 11 p.m. E.S.T.

Traffic: W1LIE 60 LRP 153 LKP 3 LWK 4 LIC 50 INW 31 VF 4 LER 77 LML 96 DHH 11 GXV 12 LMQ 18 GOJ 1 IBR 13. A.A.R.S.: W1AMR 114 BTA 7 CFO 153 EFR 8 FAP 153 GE 48 GVS 118 GHT 35 IOM 4 LJF 11 IST 36 KMM 20 KOU 232 KTN 18 LAP 25 LIC 49 LML 60 LER 25.

EASTERN MASSACHUSETTS — SCM, Frank L. Baker, Jr., W1ALP — Framingham Radio Club held its 8th Annual Hamfest, with over 200 present, and the usual fine turkey supper and a good time. KH, BYR, GTN and ALP were present, also R. L. S.C.M. HRC. BYR showed his moving pictures on trip to Calif. last year for Director's meeting. FB, We regret to announce the death of William D. Simpkin, W1JHH of Malden. We extend our sympathy to his family. Mystic Valley Radio Club has new 101X receiver, and also had a junior hamfest. Best of luck to new radio club, Lowell Radio Operators' Club; pres., MKX; vice-pres., KMY; secy.-treas., QM, and also COX, OQ; meetings held in Y.M.C.A. first Wed. in month. New O.P.S.: SS, HUV, EHT, IN, LEU. LNN will be O.R.S. soon.

MKN and FSL have applied for O.R.S. and JXU for O.P.S. Anyone else interested? HXE is doing a fine job on emergency work; send your applications and dope to him. Let's make it 100%. BIO gave a talk on 112 Mc. at B.B.'s house to gang in Winthrop. ALP and JXU visited Waltham Radio Club; a swell layout to be envied by any radio club. WV had 151,905 points in DX contest, 76 stations and 39 countries. LMB worked XU8AM for W.A.C., and is moving to new QTH. LTC has new Jr. op. Congrats. KOQ has new beam. 6NWP is now IOX. Welcome to East Mass. IYG moved to Westwood, and will be on 28 and 1.75 Mc. HUV is still doing good job as O.O. IN has new complete portable gear ready for E.C. for Melrose, and he and IQ are new 56-Mc. Minutemen. LZW is working a lot on 112 Mc. KH and ELP are working all a.m. 112-Mc. stations. BYY, IN and EHT have new converters that work from "5000 to 20 meters," without changing coils. JDG has new SX25. LQV is on 3.5 and 7 Mc. New hams in Amesbury: MIB, MDN and MEJ. DYC is going on 1.75-Mc. 'phone. DPD is on 1.75 Mc. LSA and MEZ are on 112 Mc. MKN will be on 14 Mc. DOO, LGY, HXE, LTT, KBP, MNA and LEA are all on 112-Mc. Emergency Net. KH is now fully equipped for f.m. on 112 Mc. Welcome to MHP who moved here from Chicago. EHT worked KA1AB for only contact in DX contest. AAR is on 112 Mc. mobile. DOO is proud father of a baby girl, the first.

Traffic: W1EPE 287 (WLG5 22) AKS 273 JSM 262 JCK 253 (WLVG 55) KCT 244 BDU 183 AGX 67 EMG 56 KH 42 MDU 32 HWE 25 KZT 102 FVQ 38 LNN 12 BB 11 MKN 7 LEA 6 ALP-LQV 5 MNA-KBP-LTT-HXE-LGY-DOO 4 EHT 2 LHW 333 FSL 38 AAR 107. (Feb.-Mar.: W1SS 10 LNN 32 JGQ 1 MDU 51.)

WESTERN MASSACHUSETTS — SCM, William J. Barrett, W1JAH — EOB made the B.P.L. again — that's hitting it regularly, Vic; keep up the good work. BIV has been busy with Chair City Radio Ass'n, which put on Wouff Hong initiation at Worcester Convention. JAH has been testing with one-quarter watt input on 3.5-Mc. schedules. IOR worked overtime completing plans for the N. E. Division Convention. LJJ is on 3.9-Mc. 'phone with cathode modulation. BVR is now completely equipped for emergency-powered work on all bands from 28 to 1.75 Mc. BKG has new band-switching rig complete to buffer stage. FOI changed QTH. GZL is building 56- and 28-Mc. mobile unit for car. Les reports KER now back in West. Mass. COI had to put noise silencer back into receiver, due to continuous power leak. KZU keeps active on all bands. LUA has new preselector. AZW has been testing his emergency set-up.

Traffic: W1EOB 518 BIV 338 (W1GN 70) JAH 160 (W1GH 35) IOR 119 LJJ 90 BVR 65 (W1G 109) BKG 59 FOI 40 JYH 5.

NEW HAMPSHIRE — SCM, Carl B. Evans, W1BFT-DMD — Interest in 112-Mc. activity has been on the increase with activity in the state's three largest cities, Manchester, Nashua and Concord. JDV is using a pair of HY25's, LLD an RK34, TA an HY75, HQS, ICS and FFL using rebuilt 56-Mc. equipment, LIN an HK24, BIT and IVU HY75's. BFT an RK34, DMD (M.V.A.R.A. Club station) a pair of RK37's, LVG a pair of 76's. For receivers a similar variety holds forth with HY615's, 6J5's, 6J5 GTX's, 76's, 6C5's, etc. LIN has a 1/2-wave horizontal matched impedance antenna about 55 feet above ground. The M.V.A.R.A. has found horizontal antennas to be much better than vertical, much to their surprise. The Nashua boys swear by Johnson Q's, so — take your choice. Several of the hams in Milford also report starting activity on this band. Write your S.C.M. and give him the dope on what you are using and what results have been obtained. It may be of interest to the rest of the fellows. OE and FX expect to be on soon. We would like to see some sort of a 112-Mc. Net worked up for N. H. Let's see just how much territory we can cover on this band. AXL and HYO are experimenting with U.H.F. on 112 Mc. also. KPD recently completed W.A.S. on 1.8-Mc. 'phone. Very FB. TP is now on 7 Mc. The Coos Radio Club recently enjoyed a chicken dinner at the Mt. Madison House, in Gorham. GMH and LKK both boast of a new RME-70. APK and IJB have new Howard receivers. HFO is new O.R.S. IVU received Asian card to complete confirmed W.A.C. BHJ is active on 56 and 28 Mc.

Traffic: W1WFL 303 (W1GB 12) KIN 216 BFT 116 ANS 82 JDP 81 GEY 71 JGI 68 TA 64 GMM 56 CMR 53 IDY 50 LNG 38 JKH 37 IP 34 JBM 28 KKQ-KMH 21 KBU 17 JDV 15 EAL 14 CEA 10 LMC 5.

RHODE ISLAND — SCM, Clayton C. Gordon, W1HRC — INT and INU have commercial tickets now. QR is keep-

ing 10 p.m. schedule on 3518 kc. every Thurs. with 3FT8; LWA tried out 7-Mc. loop antenna and put up 133-ft. Hertz for 3.5 Mc.; also joined a newly organized club in R. I. of which MJL and KCS are also members; LWA says anyone else interested should get in touch with him. KCS has portable-mobile f.m. 112-Mc. job in his car which now bears one of the 7388 number plates. From down Newport way we hear BJE has 1851 r.f. circuit in his receiver to receive 56 Mc. which JNO says works FB. JNO is playing around with 28-Mc. crystal oscillator and also is active on 1.75-Mc. 'phone. JNO says there is a lot of traffic on 1.75 Mc. for R. I., and wonders about forming 1.75-Mc. 'Phone Net in R. I. since LJO, LIV, ISE, KTH, BIT, CPI, BVI and himself are generally on about 11 a.m., Sunday. Any of you 1.75-Mc. boys interested? Get in touch with JNO if so. CAB is busy with N.C.R., with his transmitter now ready for all bands on c.w. MEK boosted his power to 85 watts on 3.5 Mc. KZN completed his 112-Mc. transceiver and put up a 112-Mc. beam on his closet door with thumb tacks. It's rotary as long as the hinges work. LYE has HK24 with 25 watts on 112 Mc. feeding 3-element rotary horizontal beam. He has joined the PCN (New England Power Emergency Net) which has practice on Tuesday nights, and says other R. I. stations in it include BEH, MCP and AEI. This is a fine thing for those of you that happen to work for a Power Company, and in an emergency the quicker these boys go to work, the sooner the rest of us without emergency power can get back on. More power to you fellows. The P.R.A. entertained the Westerly and Fall River bunch, April 16th, at the Providence Y.M.C.A., at which time JXA pinch-hitted for me and gave a talk on cutting and grinding crystals. I was supposed to give it, but have been working out of town (in Pittsfield, Mass.), and was unable to do it. Visited FAA's shack and witnessed pencil sparks from QSL-40, and was properly awed. R. I. gang seen at Framingham Hamfest — GTN, JXA, JEZ, ETD, GEF, KZN, JP, HRC & XYL, JXA's XYL, DDY, Mr. and Mrs. Harry Nicholson, Roy VanWart, LYE, LCS.

Traffic: W1LNU 288 INT 179 GTN 153 KYK 106 LDL 99 CPV 76 LAB 65 KOG 33 IEG 30 LWA 27 KIV 23 KKE-HRC 19 KZN 15 KWA 14 BOY 9 QR-MJJ 6 JNO 5.

VERMONT — SCM, Clifton G. Parker, W1KJG — KVB and LFM are busy consolidating their equipment and building a new final using P.P. 812's. New stations recently licensed in this Section: MLJ, South Barre; MMV, Barre; MMU, Bethel, QQ at Derby Line is John Boocock, who returns to the air after an intermission of six years. John previously was located at Lowell, Mass., and is now on with a Sky Buddy receiver and 6L6 crystal osc. Most of his work at present is on 7 and 14 Mc. DPO has been obliged to resign as O.P.S. and P.A.M., and is now receiving treatment at Washington County Hospital at Barre. KJG received pleasant visits from MMU, KUY, KXL and 2JIG. JTS of Malden recently followed up his acquaintanceship on the air by calling on JRU, MCQ and KJG. KUY was active on a new final with 812's while home for vacation. JLF has renovated his 'phone outfit with all units on movable base. BNS and MJU registered in A.E.C. MMV also joined A.E.C. and has 1-kw. emergency-powered rig with antenna supported by a 78-ft. tower. FB! AEA has new Sky Buddy receiver to go with the new YL operator, CBW, KJR and AEA are active on 1.75-Mc. 'phone. MCQ has new 500-watt 'phone outfit going, and is working on new 'phone rig for JRU. LYA is Andrew Penney of Woodstock. CBW has a fine new daughter and a broad grin! Congratulations, Con. MJU was O.R.S. and is new Emergency Coördinator for Waitsfield area north to Waterbury. LRL is now in New Mexico. Vt. QSO party brought forth some close scores. Final results not available until later, but many report a fine time. Looks as though KTB and MJU were out in front on the home stretch. CGX is on 3.5 Mc. and trying to help out on coverage for traffic in southern end of Section. We need traffic outlets in the southwestern and mid-state areas. While a daily schedule is better, once or twice a week on one of the two nets would help a great deal. Hope some of you will communicate with R.M.'s BNS or FSV right away. GQJ is rebuilding a very fine remote-control rig with push-button band-switching. FSV plans to QSP out-of-state traffic during summer months via 3497.5 WLGZ Net where no other outlet available. KWB has an 89 e.c.o. going. This is a very good time to look over your emergency equipment once more and to make plans to participate in the Field Day.

Traffic: W1BNS 57 FSV 150 KJG 116 KOO 100 KTB 86 KWB 32 MJU 70 MLJ 25.

PINCOR DYNAMOTORS

A SIZE FOR ANY JOB

Leading radio engineers agree that Pincor Dynamotors take the grief out of "B" power supply problems. They are built properly to give thousands of hours of smooth, quiet, dependable operation under all conditions. Types and capacities to meet any requirements for aircraft, marine and broadcast service, police units, sound systems, auto radios, etc. 5 to 850 watts. Input, 6 to 110 volts; output, up to 1750 volts. Mail coupon for complete information.

ROTARY CONVERTERS

A complete line for converting 6, 12, 32, 110 or 220 volts D. C. to 110 or 220 volts A. C. 40 to 3000 watts.



PIONEER GEN-E-MOTOR CORP.

CHICAGO, ILLINOIS
Export Address: 25 Warren St., New York, N.Y.
Cable: Simontrice, New York

PIONEER GEN-E-MOTOR CORPORATION
Dept. R-6F, 466 W. Superior St., Chicago, Illinois
Please send information on Pincor Dynamotors, Motor Generators and special power supply units.

Name.....
Address.....
City..... State.....
 Also send me Rotary Converter Catalog

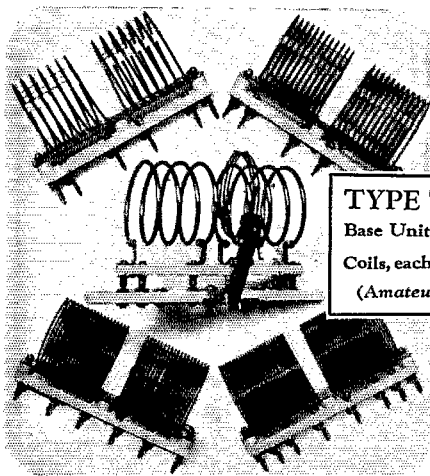

TYPE TVH

Base Unit, \$3.75
Coils, each, \$2.85
(Amateur Net)

MAKE YOUR 500-WATT RIG AN ALL-BAND JOB!

NOW! . . . with B&W TVH Coils, you can readily obtain the same high measure of efficiency at 10 meters as on the lower frequencies! Their novel plug arrangement permits easy selection of various capacity values. The time-tested and approved B&W Variable Link design assures peak performance in all installations.

Interchangeable TVH's are available for the 160-, 80-, 40-, 20- and 10-meter bands. They fulfill every 500-watt transmitter requirement . . . at low cost! See them at your jobbers — or write for details.

BARKER & WILLIAMSON

Radio Manufacturing Engineers • ARDMORE, PENNSYLVANIA

Getting on 56-Megacycle F.M.

(Continued from page 80)

After a few trials, however, locating the zero point becomes relatively easy. The really important point is not to become confused by the other beats which are present. Incidentally, if the carrier shifts appreciably as the modulation is increased to give the first zero point, it is an indication of non-linearity which should be corrected. With the constants given in Fig. 2, a shift of about 200 cycles is representative between zero and full modulation (deviation of 1900 cycles at 7 Mc.).

When the modulator gain control setting for full deviation has been determined, the modulator plate current should be essentially the same as without modulation, indicating good linearity. If there is a plate current change of more than 0.2 ma., approximately, the oscillator tank L/C ratio should be increased somewhat until the plate current remains practically steady at full deviation.

Any form of peak a.f. indicator may be used to indicate deviation if it is calibrated against peak deviation determined as described above. For instance, a rectifier-type voltmeter might be connected across an audio circuit after the gain control; its reading on the audio voltage when the latter is set to give the null will represent a "100% modulation" mark which should not be exceeded in normal operation. An oscilloscope or vacuum-tube voltmeter could be used for the same purpose. Or even a 10-ma. meter in the modulator plate circuit will serve, provided the modulator plate current starts to change at about the point of maximum desired deviation. In the latter case, of course, the object in talking would be to keep below the level which causes the needle to flicker.

Amplitude Modulation

There is little likelihood that, with a set-up of this kind, any undesired amplitude modulation will be present in the final output of the transmitter. Any normally-loaded transmitter circuit is far broader than is necessary to maintain uniform output over a band only 0.05% of the frequency to which it is tuned, which is the case here. Within the deviation limits set there will be no variation in modulated-oscillator output. The test for amplitude modulation is to watch the r.f. current in the final stage or antenna circuit — an antenna ammeter is a good indicator — to see if it varies with modulation. It should be perfectly steady. If there is no ammeter, a flashlight lamp and loop loosely coupled to the final tank will serve the same purpose — and probably serve it better, since there is less inertia in a lamp than in an ammeter. The lamp brightness should be constant with or without modulation. A change in r.f. current at this end of the transmitter probably indicates that the frequency is being swung beyond the limits of linearity, and

(Continued on next left-hand page)

only **\$13.80** down
brings you this improved
HAMMARLUND
Dual Stabilized
HQ-120-X

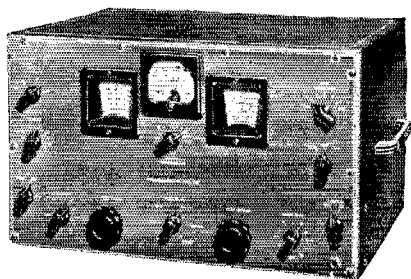

... with Voltage Regulation and Drift Correction
Hammarlund engineers have stabilized the HQ-120-X two ways... (1) by voltage regulation to eliminate see-saw oscillator frequency under unsteady line voltage, and (2) by Drift Correction which takes care of oscillator changes due to increasing temperature. Warming up is a matter of minutes. Specially designed tuning condenser and coil rack to eliminate twist due to heat changes. Cash price, complete with tubes, 10" speaker and crystal, \$138.00. Terms \$13.80 down and \$10.97 per month for 12 months. \$1.00 WITH YOUR ORDER IS ENOUGH TO ESTABLISH CREDIT AT NEWARK.

REPEATING!
NEWARK'S GREATEST
BARGAIN "SCOOP"

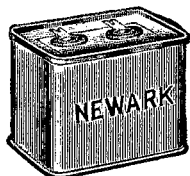

Oil Filled, Oil Impregnated

**FILTER
CONDENSERS**

\$3.75

4 mfd., 3000v., DC. Size 4 1/4" x 3 3/4" x 3 3/8"
Weight 2 3/4 lbs.

\$1.00

2 mfd. 1000v. DC.

Newark's massive buying power enables us to offer these astonishing values again, in face of ever rising costs. Over 50,000 of these condensers in use, by satisfied amateurs.

DC Volt Mfd.	Size	Wt.	Price
2000 2	4 1/4" x 3 3/4" x 1 3/4"	1 3/4 lbs.	\$1.50
1500 4.45	3 3/4" x 1 3/4" x 1 3/4"	1 1/4 lbs.	1.75
1500 5	3 3/4" x 3 3/4" x 1 3/4"	1 3/4 lbs.	1.90
2000 8 5	4 3/8" x 3 3/4" x 2 3/4"	2 1/4 lbs.	2.75

**LIMITED STOCK
GET YOURS NOW**

Newark's
Amateur Dept.
headed by these
outstanding men
G. W. MOSSBARGER .. W9AUH
TED PIECKO .. W9TMT
LEO GIBBS .. W9BSU
... at your
Service!

**YOUR
CALL LETTERS
IN GOLD . . . 10c**
Put these big shadowed de-
calomania letters on your
Ham Shack door, auto win-
dow, etc. Nearly 2" high.
Send dime for yours today.
Be sure to give call
letters.

**FREE
BULLETIN**
8 pages, illustrated. Just out,
and full of Ham bargains,
details of NEW CONTIN-
UOUS TIME-PAYMENT
PLAN. Every item a real
guaranteed value . . . and
savings well worth
while.

... and the **SUPER-PRO**

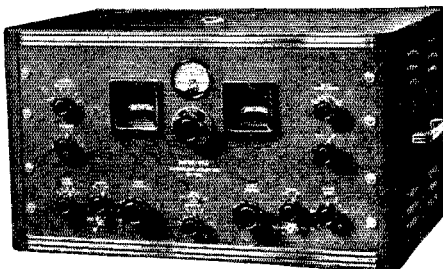

HAMMARLUND SERIES 200
\$27.90 DOWN 1 YEAR TO PAY

New features! Ideal for high frequency phone bands. Improved Noise Limiter and exceptional sensitivity makes 10 and 20 meter operation real pleasure. 13 tubes. Full range crystal filter. Improved "S" meter. Continuous bandspread tuning all amateur bands and thru entire frequency range. Cash price \$279.00 complete with crystal, tubes, 10" speaker, and separate power supply. TERMS \$27.90 down, \$22.18 per month for 12 months. Available in 2 ranges . . . SP 210 X, 15 to 560 meters . . . or SP 210 SX, 1 1/2 to 240 meters. SEND ONLY \$1 WITH ORDER TO ESTABLISH CREDIT.

HOW TO GET CREDIT AT NEWARK
Send only \$1 right now

Think of it! Only \$1 establishes your credit, opens a "charge account" at Newark. You can deduct the \$1 from your down payment when you buy. Select any items you want and pay only 10% down (\$5 minimum down payment). Minimum \$25 purchase required on first order, but you can ADD FUTURE PURCHASES of \$10 or more to your "charge account" at any time. Carrying charge 6%. You make small monthly payments on net balance as follows:
Net balance up to \$50 | \$50-\$75 | \$75-\$100 | \$100-\$150 | \$150-\$200
Monthly payment \$5.00 | \$7.50 | \$10.00 | \$15.00 | \$20.00

ORDER TODAY DIRECT FROM THIS AD

NEWARK Electric Company
323 W. MADISON ST.
Dept. Q CHICAGO, ILL.

Happy as a June Bride!

— *There's a breath of Spring in the air, our step is light and the birds are singing.*

(HARK! — HARK!)

NO, there's not a thing wrong with us. It's just our exuberance. You see, we still get as great a kick out of providing exemplary SERVICE to our many "HAM" friends TODAY as when we first started 'way back in 1922. The only difference is, we now have more of them. Which, you'll admit, is real cause for exuberance. — What can we do for YOU?

BRAND NEW!

MEISSNER F-M R.F. TUNER

BUILD YOUR OWN F-M RECEIVER! Factory wired and aligned chassis — slide rule dial, tuning condenser, ceramic coils. 40-44 Mc. coverage. Amateur Net Price.....\$12.64
I.F. TRANSFORMERS. Amateur Net.....\$1.03
DISCRIMINATOR TRANSFORMER. Net...\$3.53
Write for latest descriptive circular

**GOT YOUR ANTENNA UP YET?
GENERAL ROTARY ELEMENTS
FOR 10-20 METERS — IN STOCK!**

Complete General catalog on request

BLILEY VARI-X with VF-2 CRYSTAL UNIT
Amateur Net Price (less tubes and crystals) ..\$29.90

BROWNING 5-10 METER CONVERTER

Laboratory wired and tested. Complete with 6K8.
Amateur Net Price.....\$24.90

JENSEN MT-8 BASS REFLEX REPRODUCER

Completely enclosed cabinet housing heavy duty PM speaker. High fidelity reproduction. 50-10,000 cps. Size: — 24" x 17½" x 11¾". Amateur Net...\$17.35

BARGAIN SPECIALS!

Interested in acquiring a good used receiver or transmitter at a bargain price? We have a limited number of used receivers and transmitters accepted as "trade-ins" that we are closing out at bargain prices. Write for your copy of "Bargain Sheet" today. Many other fine values listed, too.

NEW YORK'S OLDEST "HAM" HOUSE

W2JEH — W2DXC — W2LFV — W2GCX



SUN RADIO CO.
212 Fulton Street, Dept. HT New York
Cable Address: SUNRADIO NEW YORK

the remedy for that is simply to keep the modulation within the capability of the system.

The only possibility of distortion after the oscillator is in bad mistuning of some subsequent transmitter stage. Tune all these to resonance by the plate-current dip method. Since the usual Class-C amplifier considerations for amplitude modulation do not apply, the final stage might as well be adjusted to give all that the tubes are capable of pushing out in the way of r.f. energy.

Finally, we should keep in mind the fact that there is no excuse for operating off-frequency, either by getting the carrier itself outside the band or by having the sidebands extend beyond the limits. The carrier frequency can, of course, be checked by the usual methods which have been treated thoroughly in past issues of *QST*. With the maximum deviation determined by some such method as just described, it becomes a matter of simple arithmetic to find how far inside the band limits the carrier should be set — making due allowance for measurement error, drift and similar factors. Fortunately there is no need at present to crowd the edges; if such a time does come there are methods available for getting greater stability. At the moment, simplicity seems more important.

Say It With Words

(Continued from page 59)

with an additional statement, depending upon whether we are carrying on or going to bed:

Doubleyou one Edward Henry standing by for any other calls.

or

Doubleyou one Edward Henry closing down.

— — — —

Well, there it is: adequate but not unnecessarily-long calling and answering, clear identification, clear meanings, a minimum of procedural hurrah during the actual contact so as to leave the conversation intact, and a courteous indication to other stations at the conclusion. Do you like it? Try it and you'll find that it helps immeasurably.

Minor Notes

The perpetual use of the editorial "we" at one-man 'phone stations just leaves "us" cold. There is only one Lindbergh.

One of the things that causes confirmed c.w. men to scorn 'phone is the obvious practice of some 'phone operators of talking not so much to the fellows they're working as to their (imaginary!) great big family of listeners. These guys get a b.c. and entertainment complex and it never leaves them; they just know that they have lots of fans. You've heard it: "This is doubleyou nine bluppety-bluppety-blupp in Snerdville, Iowa, signing off with doubleyou four fluppety-flupp in sunny Florida after a very enjoyable 100% practically-perfect-but-somewhat-marred-by-interference QSO." Brrr! Sonny boy, why don't you get a job in a broadcasting station? But then they

NEW Attenuators... at NEW Low Prices

DAVEN



- Noise level below microphonics
- Excellent frequency characteristics.
- Low in price; small in size.
- Complete with dial, knob and shield.
- Now ready for immediate shipment.

Series LA-800

Ladder Network

Compact low impedance mixing controls for use in portable broadcast equipment and public address systems, similar in construction to larger and costlier units.

Because of the low price they may readily be adapted as mixer or master gain control in popular priced systems. Outstanding advantages of these controls are: dependability of service, accuracy of control, noiseless operation, and constant impedance over a large part of the operating range.

Price \$5.75

20 Steps

SERIES	Attenuation		
	DECIBEL PER STEP	CHARACTERISTIC	DECIBEL TOTAL
LA-800	2.0	Tapered	Infinite
LA-801	1.5	Linear	Infinite
LA-802	2.0	Linear	Infinite
LA-803	2.0	Linear	40 Db.

Series CP-800

High Impedance Potentiometers

These are designed for use as gain controls in portable amplifiers and public address systems. They are rugged, compact, and are readily adaptable to popular priced systems. Long and trouble-free service can be obtained from this type of attenuator, thus eliminating the necessity of periodic replacement of the volume control.

Price \$5.75

20 Steps

SERIES	Attenuation		
	DECIBEL PER STEP	CHARACTERISTIC	DECIBEL TOTAL
CP-800	2.0	Linear	Infinite
CP-802	1.5	Linear	Infinite
CP-803	3.0	Linear	Infinite
CP-804	2.0	Tapered	Infinite

FIXED ATTENUATOR (Pads)

Impedances may be secured from 30 to 600 ohms.

"TEE" Network, Type T950

Price\$2.50

Size11/16 x 1 1/8

Overall Height

Balanced "H" Network Type H950

Price\$3.00

Size11/16 x 1 1/8

Overall Height

WRITE FOR CATALOG

THE DAVEN COMPANY

158 SUMMIT STREET

NEWARK, NEW JERSEY

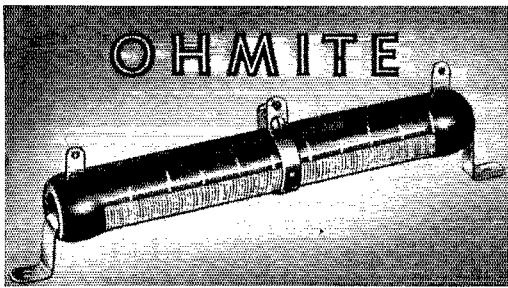

OHMITE

DIVIDOHMS

Hams everywhere find it mighty handy to use Ohmite Adjustable Dividohms. They enable you to change the resistance quickly or make a needed replacement in a hurry. Readily adjustable to the exact resistance you want. One or more taps can be added whenever needed. Sizes from 10 to 200 watts. Resistances up to 100,000 ohms.

Ask Your Jobber or Write for Catalog 17

OHMITE MANUFACTURING CO.
4865 Floumoy Street Chicago, U.S.A.

Be Right with OHMITE
RHEOSTATS • RESISTORS • TAP SWITCHES

Beauty

Time was when the only thing that mattered was to get results, but in this day and age when we take efficiency as a matter of course . . . your rig has to have eye-appeal, too.

Par Metal Racks, Panels, Chassis and Cabinets have done much to bring Amateur Radio and Public Address into "polite company." Equipment made from Par Metal units have streamlined beauty, handsome grey or black ripple finish with chromium trim, and are easy to assemble because they have been accurately machined.

If you build for profit . . . you'll like Par Metal jobs because of their commercial appearance.

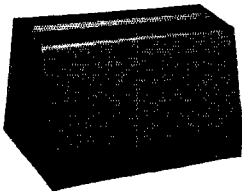
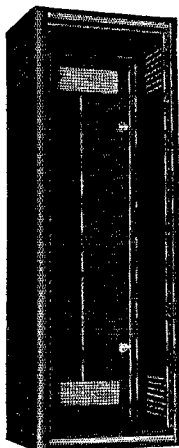

PAR-METAL PRODUCTS CORP.
3258 49th Street, Long Island City, N. Y.
Export Dept., 100 Varick Street, New York, N. Y.

probably won't like your compound adjectives either.⁴

In a recent exchange of impressions with three other 'phone men we agreed that for us the most despised word in the 'phone language is this term "handle." We admit to having names and even front names, and we don't mind using them. But can't we get rid of this overworked expression "handle"?

Another sour note: A contact is either good enough to support conversation or else it isn't. If it isn't, it ought to be buttoned up. If it is, why should there be this "double-talk," repeating everything several times? There is a place for repetition — when handling formal record messages, so that the receiver can receipt for them with assurance and have time to write them down. But in casual conversation it ought to be taboo.

And can anyone think of anything to do to the parrots who repeat back everything? "Yes OM I heard you all okay. Okay on the handle there and okay on the XYL calling you to dinner and using a three-element beam and about your not having been on the air for six months and that you have 125 watts in the final into a pair of 201-A's and okay about . . ." It takes all kinds of people . . . but if they could only hear what they sound like!

We decline to be drawn into a discussion of those female voices that have intentional sex appeal injected into them with a grease gun.

Just in passing: Many amateurs seem to find it helpful to jot down rough notes while listening to a long transmission — reminders of things the other fellow mentioned, on which they'll wish to comment; and also new thoughts that occur to them to mention. Then they don't hem and haw about "something else you mentioned, old man, but it slips my mind now." And if, with the aid of the notes, we ourselves can't find something better to say than, "Okay on the rig there and okay on the weather there" — well, may somebody chop down all our masts this very night!

— — —

Somebody had to bring these things to the front — so here they are. If the criticisms and suggestions appeal to you as a 'phone man, won't you lend your voice in the direction of betterment for us all?

In thinking over where we are going with voice operation, do we give enough serious recognition to the potentialities of 'phone for civilized social intercourse in the making and pursuing of acquaintanceships and friendships? They can be a valuable collateral to our experiment work. This thought can be well illustrated by quoting part of an editorial recently appearing in the *Tulsa Tribune*, wherein the distinguished editor sounded off after an evening of short-wave BCLing:

Short-wave radio is well fitted for the broadcast of police calls, aircraft communication and weather information. As such it is well used. But it is capable of better things. Why don't the amateurs talk about something else besides

⁴ Besides, you lie about the Florida weather!

NEW EXAMS★

Effective July 1

NEW LICENSE MANUAL★ AVAILABLE NOW

★ Effective July 1st there will be brand new examinations for all classes of amateur operator licenses. This will be an entirely new system based primarily on "multiple-choice" questions. This, of course, will require an entirely new kind of approach on the part of the applicant planning to take examination for license. The NEW "License Manual" has been written to make it as easy as possible for the individual to acquire the necessary knowledge to pass the examination with flying colors. Whether you are going up for your Class B or your Class A ticket, if you plan to do so after July 1st this "License Manual" will provide the most direct path to getting that ticket. If you are one of the thousands who always wants a "License Manual" around the shack for ready reference for amateur regulations, it will please you to know that the regulations are very thoroughly indexed.

Price 25¢

(NO STAMPS, PLEASE)

AMERICAN RADIO RELAY LEAGUE

West Hartford, Connecticut



HAMS!
DON'T MISS
THESE SWELL
"BUYS" AT
TERMINAL!

You'll like the hamfest atmosphere at TERMINAL. Visit the TERMINAL "shack" nearest you and let's get acquainted!

X-CUT CRYSTALS — 40, 80 and 160 meters.
Guaranteed, Choice Frequencies. Net **\$1.19**

BLILEY Holder (for above) **.95**

AEROVOX "HYVOL" CONDENSERS

Oil Impregnated, Wax Filled.
Complete with Mtg. Brackets.

1000 V. D. C. W. | **1500 V. D. C. W.**

2 mfd. . . . **\$1.25** | 2 mfd. . . . **\$1.69**

4 mfd. . . . **1.69** | 4 mfd. . . . **2.69**

2000 V. D. C. W. | **3000 V. D. C. W.**

2 mfd. . . . **\$1.98** | 2 mfd. . . . **\$4.25**

4 mfd. . . . **3.35**



BROWNING 5-10 METER CONVERTER

Ideal for mobile work. Complete with 6K8. Measures only 4" x 6½" x 4½". Net **\$24.90**

ADVANCE Antenna-Changeover RELAY

Type 964B — Rugged construction. 10 amp. contacts. D.P.D.T. Net **\$2.88**

All Type Relays in Stock — lowest prices

CALL LETTER PLATES — Cast aluminum, 8" x 2¾", black crackle. For mtg. on car or X-mitter panel. Special **\$1.25**

RECORD YOUR QSO's, Jr. Op's voice, etc. See us for lowest prices of recording equipment and accessories!

BELL Model RC1P Recorder, less amplifier. **\$34.25**

Did you get a copy of our new Public Address Catalog? It's free!

MIDTOWN DOWNTOWN
68 W. 45th St. 80 Cortlandt St.

TERMINAL Radio Corp.

68 West 45th St. • 80 Cortlandt St.
2 stores in NEW YORK CITY
Vanderbilt 6-5050 • Cable: TERMRADIO

their wattage and kilocycles and amperage and how they've got their aerials set up between the chicken house and the privy? Why don't they talk about themselves? Why don't they describe their communities, the things they do on a Sunday afternoon, their jobs and ambitions, and the places they hope to go? . . . Some day in the far-distant future, perhaps, man's social and ethical intelligence will catch up with his mechanical ingenuity. Then, and not until then, would that short-wave dingus perform the service to humanity which it could do to-day — if mankind were smart enough.

Touché! Why don't we? Not that we communicate for BCL entertainment; but are we getting the most ourselves? Here we sit with a "dingus" that all but actually invades the other fellow's home, and many of us never get beyond the weather and descriptions of rigs. Actual technical discussions are interesting to most of us, of course, because we are experimenters. But at that, these things are just the near fringe of conversational possibilities. Should we not regard them more as conversation "openers" and endeavor to explore beyond them the probability of common interests that could make for a real friendship? It must be a pretty difficult art to master, since most of us are dismally inept at it. But to do so should be our goal in 'phone operating, since only in that way can we realize the potentialities that voice working offers us.

Strays

In the course of my work as a research engineer with a local manufacturer, I have run across certain types of connecting wire which should be superior to the types commonly used in wiring transmitters and other high-voltage equipment. Belden No. 8338 is a stranded semi-flexible wire with varnished cambric covering. It is only about ¼-in. diameter and is very good for receiver and exciter high-voltage circuits. Another good type is lacquered "Nu-Cor" made by the Cornish Wire Co. It is a stranded wire about ⅜-in. diameter with a rated break-down voltage of 13,500. Both types come in a variety of colors. — W9SVII.

RADIO COURSES

Start September
RADIO OPERATING • BROADCASTING • CODE
RADIO SERVICING • TELEVISION
• ELECTRONICS — 1 year day course; 2 years eve.
Day and Evening Classes — Booklet upon request
NEW YORK YMCA SCHOOLS
4 West 63rd Street, New York City

Piezo-Electric Crystals Exclusively

• Quality crystals of all practical frequencies supplied SINCE 1925. Prices quoted upon receipt of your specifications.

Our Pledge: **QUALITY FIRST**
SCIENTIFIC RADIO SERVICE

"The Crystal Specialists Since 1925" University Park, Hyattsville, Md.

The HANDBOOK

» The 1940 edition of THE RADIO AMATEUR'S HANDBOOK swings out in harmony with the modern tempo of amateur radio. Not only is it rewritten from the top of its head to the tip of its toes, but its whole internal structure has been reorganized to best and most logically present the picture of technical amateur radio. The 1940 HANDBOOK makes all previous HANDBOOKS hopelessly out of date. Each subject is treated topically and then by its component sections. When you want to learn something in particular about transmitters, you will find your problem segregated. Perhaps it will come under "construction" — in which dozens of modern, proved exciters and amplifiers are described in detail — or under "Complete Transmitters," in which rigs complete to the last power connection and microphone plug are shown. Or your transmitter question may refer to one of the other chapters — that on "Principles," or the one on "Adjustment." There are 32 chapters in this new streamlined HANDBOOK — a complete treatment of practical amateur operating and constructional data. There are two introductory chapters, intended for the newcomer first learning about amateur radio. There are four on Principles and Design — not old-fashioned "theory," but a compact, comprehensive course on 1940 radio fundamentals. There are *fourteen* chapters in the Construction and Adjustment section, ranging from workshop practice through B.C.I. elimination. There are five on antennas, and five more on the Ultra-High Frequencies, with 28 and 56 Mc. in one classification and all above 112 Mc. in another. And finally there are chapters on operating the station and regulations and data. The enlarged index enables the reader to locate easily and quickly the exact references he seeks. The 1940 HANDBOOK is now not only the biggest book of its kind you can buy anywhere in the world for a dollar, it is the whole structure of amateur radio reduced to type and set forth in 576 pages and 830 illustrations.

\$1 postpaid in Continental U.S.A.

\$1.25 postpaid elsewhere

Buckram bound edition, \$2.50

**American Radio Relay League
West Hartford, Conn.**

The BROWNING CONVERTER

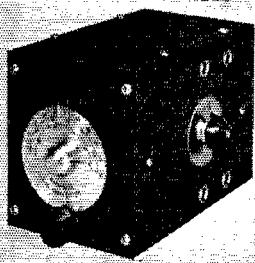

Makes Your

- Auto
 - Stationary
- Receiving Set

A 5-10 METER RECEIVER

Closely follows one described in June, 1939, QST by Thomas P. Chapman, W1KK. Rubber-cushioned mounting bracket and shielded leads supplied for dashboard mounting and connection to auto radio, which serves as IF and audio and supplies filament and plate voltage. Works equally well with stationary receivers.

- Separate coils for antenna and oscillator circuits for both 5 and 10 meters.
- Band switching.
- Antenna throw-over switch.
- All coils air trimmed and air tuned.
- Voltage stabilized.
- 2 1/2" "Sun Ray" vernier drive dial calibrated in approximate frequencies.
- Adjustable to cover frequency bands between 5- and 10-meter bands.
- Indirect dial lighting system facilitates non-glare night use.
- Dimensions only 4" x 6 1/2" x 4 1/2".
- Total current drain, 45 amp. at 6 volts; 10 ma. at 250 volts.

If your jobber hasn't it, write to

AMATEUR NET

\$24.90

Complete with 6K8, laboratory wired and tested



WINCHESTER, MASS.

ABBOTT DK2

2 1/2 Meter Transceiver

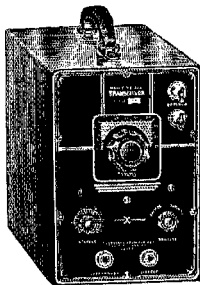

Ideal for spring and summer portable operation—simple and convenient

List Price \$27.50

LESS TUBES AND BATTERIES

40% Discount to Amateurs

GENERAL: The DK2 is a completely self-contained 112 mc. radio-telephone transmitter and receiver, for use in your car, plane, boat, or while being carried, for portable work. It is very simple to operate. The working

range is between 2 to 30 miles depending on the location. Astonishing results have been obtained.

SPECIFICATIONS

CASE: Size 11 1/2" long x 9 1/2" high x 6 1/2" wide, grey wrinkle finish metal, heavy leather handle. All batteries are self-contained in case. Removable side panel for easy access to the batteries and tubes.

FREQUENCY: Will cover 112 mc. to 118 mc. (amateur 2.5 meter band).

BATTERY REQUIREMENTS: Three 45 volt B batteries like Burgess 5308; and four No. 6 dry cells, or two Burgess 2F2H batteries.

TUBES USED: One type 6J5GTX, one type 6G6G.

SHIPPING WEIGHT: 12 pounds.

For car use can be operated from vibrator power supply with an input of 6 to 7 watts

ABBOTT INSTRUMENT, INC.

51 Vesey Street, New York City Bulletin on Request

Third U.H.F. Contest and Relay Results

(Continued from page 45)

We regret that some messages failed to reach their destinations due to the lack of active u.h.f. stations in certain remote sections of the country, and because of unfilled gaps between already existing centers of activity. For the benefit of the fellows whose messages, for these and other reasons, did not reach points of delivery, the tabulation below should be of interest.

Starting Station	Traced To	Starting Station	Traced To
W1SS	W1HXP	W3GPV	W3FJ
W1FRA	W1KK/1	W3GLEF	W3FQS
W1KJF	W1LTB	W3FSS	W3DYE
W1KHL	W3DYE	W3GNA	W2KBO
W1K1J	W3IDS	W3EUA	W2CPD
W1KVO	W1SS	W3AC/3	W3FQS
W1MHM	W3BZJ	W3AWS	W3BKB
W1LLL	W3FQS	W3GMZ	W3IDS
W1KTF	W3BZJ	W3BYF	W3BZJ
W1AYO	W1SS	W3ABQ	W3DBC
W1LPF	W1EHT	W3HEK	W3GGR
W1MDN	W3GGR	W3HVK	W3GGR
W1LFI	W3FQS	W3HHC	W3GGR
W1EKT	W3FQS	W3BMT	W3FQS
W1LFS	W1KH	W3IOM	W1CLH
W1GJZ	W3GGR	W3IDS	W1CLH
W1HDQ	W3BZJ	W3EOH	W1EKT
W1K1K/1	W3FQS	W3FQS	W1HXP
W1KSB	W1K1J	W3AXC/3	W1DEI
W1PI	W1JIS	W3IIS	W1KTF
W1AIY	W1SS	W6RHW	W6OIN/6
W1AH/1	W2KBY	W6OFU/6	W6IOJ
W1AKD/1	W1LFT	W6NCF/6	W6OIN/6
W1BDI	W3GGR	W6SDJ	W6SGE
W1CLH	W3GNA	W6PTR	W6OFU/6
W1UI	W3CGV	W6QUK	W6OFU/6
W1DJ	W1JIS	W6HEA	W6MYR
W1GUJ	W1KH	W6RVL	W6HEA
W1EHT	W3FQS	W6MVL	W6SAE
W2KTW	W2LEN/2	W6NGQ	W6SDJ
W2MES	W2LEN/2	W8TIU	W8NYD
W2MEU	W3GGR	W8RKE	W8BHY/3
W2LXO	W2KTW	W8CVQ	W8BHY/3
W2JCY	W3BZJ	W8QDU	W8BHY/3
W2LKU	W2QA	W8LNV	W8NYD
W2ILK/2	W3FQS	W8TBN	W9ARN
W2COT	W3GNA	W8TCX	W8NYD
W2LAU/2	W3GNA	W8RFW	W9ARN
W2AMJ	W3BZJ	W8UBJ	W8NYD
W2BMK	W3DBC	W8COZ	W9VHG
W2CLS	W3BZJ	W8LL	W8BHY/3
W2BAD	W3D	W9ARN	W8BHY/3
W2LST	W3FQS	W9ZL/9	W9ZHB
W2LRE	W3HKM	W9ZRP	W9ASO
W2LEN/2	W2KTW	W9W	W9ZRP
W2KBP	W3BZJ	W9SQE	W8NYD
W2FIT	W3GGR	W9ZHB	W8BHY/3
W2HYJ	W3GNA	W9WJU	W9ZJB
W2IDV	W3FQS	W9ZJB	W9WJU
W2KKE	W3BZJ	W9RGH	W8BHY/3
W2KDY	W3FQS	W9WIV	W8BHY/3
W2BW	W1DEI	W9VHC	W8BHY/3
W3EIS	W3DBC	W9WOQ	W8BHY/3
W3BKB	W3DBC	W9CBJ	W8BHY/3
W3FBH	W3FQS		

112-224 Mc.

Activity on 2 1/2 continued on both coasts, with many stations ordinarily operating on Five taking advantage of the extra points for 112-Mc. contacts. It is interesting to note that all the activity reported from the sixth district in each relay has been on 112 Mc., with several of the boys operating portable from mountain-tops, and making very fine contacts over distances of 50 to 100 miles. Many of the message routes in the East included stations transmitting on 112 Mc. and tying in with 56-Mc. stations equipped with 112-Mc. receiving gear.

Plug in a
BLILEY LD-2
CRYSTAL
 and
forget about
it!

The Bliley LD2 Crystal Unit for 80 and 160 meters requires no constant supervision, no pampering, no finger crossing. Just plug it in your transmitter and forget it!

Whenever you wish to transmit, this highly active crystal will instantly snap into operation. Warm-up periods or prolonged transmissions will cause no concern because the drift is less than 4 cycles/mc./°C. And, you'll always know your frequency because each unit is accurately calibrated and guaranteed to be correct within .03% in your transmitter.



BLILEY LD-2 CRYSTAL UNIT



"always specify
CENTRALAB"

Centralab plays no favorites

A thoroughly democratic gent is Old Man Centralab... for he keeps his "promises" no matter what "system" you use. Whether you are talking to a handful of listeners or to a frenzied football field... Centralab parts stand up under all decibel deluges. An overwhelming majority of the boys vote for
CENTRALAB VOLUME CONTROLS
— CENTRALAB RESISTORS —
CENTRALAB SWITCHES.

Centralab

Milwaukee, Wisconsin
 DIV. OF GLOBE UNION, INC.



**New BLILEY Vari-X
Variable Crystal Oscillator**

Achieve frequency flexibility with crystal stability on 40 or 80 meters. Complete with six foot length of concentric cable, but less tubes and crystals, **\$29.90 net**

New HYTRON HY75

with carbon plate, ideal for 1 1/4 and 2 1/2 meters. **\$3.75 net**

**New Improved BROWNING
Frequency Modulation Adapter**

with calibrated slide rule dial and power supply, less tubes. **\$43.95 net**

Kit of 7 tubes. **\$4.61 net**

NOW — the only comprehensive book on Frequency Modulation by John F. Rider... **98c net**

**New BROWNING
5-10 METER CONVERTER**

Rubber cushioned mounting bracket and shielded leads supplied for dashboard mounting and connection to auto radio.

- Band switching.
- Antenna throw-over switch.
- All coils air trimmed and air tuned.
- Voltage stabilized.
- Dimensions only 4" x 6 1/4" x 4 1/2".
- Total current drain .45 amp. at 6 volts; 10 ma. at 250 volts.
- Complete with 6K8, laboratory wired and tested. **\$24.38 net**

**MEISSNER F.M. ADAPTER
IN STOCK**

W2JL W2LJA W2KWY

OUR *Best* VALUE IS OUR RECORD OF LOYAL SERVICE

HARVEY

Radio Company of New York

103 WEST 43rd STREET • NEW YORK, N. Y.

CABLE ADDRESS: "HARADIO"

For the first time in any relay, 1 1/4 meters were used in the forwarding of test messages. W1AH, portable at Wolcott, Conn., sent his message via W1AIY on 224 Mc. From there, using the same band, it was relayed to W1HDQ, who was receiving on 1 1/4 and transmitting on 56 Mc.; it then was routed on Five through W3AC/3, W2MO, W2LAU/2 to W2KBP and mailed to the addressee at Manasquan, N. J. W1AIY's message, addressed to W1BBM, also went via 224 Mc. to W1HDQ and thence on Five and 2 1/2 as far as W1SS.

Comments

"One station was worked after he changed to c.w., it being impossible to make him out on 'phone. A wider use of straight c.w. would make possible more DX contact, as many carriers were too weak to copy on 'phone." — W3AC. "This u.h.f. contest was indulged in with great interest by the Southern California gang. I am looking forward to the next and hope to put some time in on the "humps" where some real scores will result." — W6NCP. "The route Detroit to Chicago, W8QDU-W8CVQ-W9VHG, was open during the entire relay. A branch route north to Grand Rapids (W8RKE) was also open during the entire period. The relay was a lot of fun." — W8CVQ. "Please emphasize the importance of working c.w. I am certain that plenty of work can be done if some of the fellows would bias their amplifiers so as to work c.w." — W3DBC. "I am looking forward to the next u.h.f. relay in the spring when the hills will be full of portables, perhaps including mine." — W2KKE. "The net of stations from W8CIR through Illinois functioned perfectly at all times as usual, and the addition of the Five-Meter Net in Illinois helped to swell the message total. You may rest assured that as soon as the gap is filled from the East Coast and a line extended to the West, we here in Ohio and Michigan will guarantee our part in making successful any future relays." — W8QDU. "It is well to note that at all times the signals from my portable location were c.w. since previous experience had shown it to be the best for weak signals." — W8BHY. "I am planning for the next one now and will be on 112 Mc. also." — W1KIK.

Strays

While rebuilding my "Q" I hit upon a kink which might be interesting to others who have had trouble with the plugs at the ends of the bars pulling out or corroding. I removed the plugs, cleaned them with gasoline and carborundum cloth and cleaned the inside of the tubes at the ends. I then bought some 1/2-in. brass hose clamps from a hardware store and placed them over the outside of the tubing and used them to clamp the plugs firmly in place. I finished up by covering the entire joint with several coats of fish-oil weatherproof varnish. I have had no trouble since giving the joints this treatment and the final loads the same in fair weather and foul.

— W6MCQ.

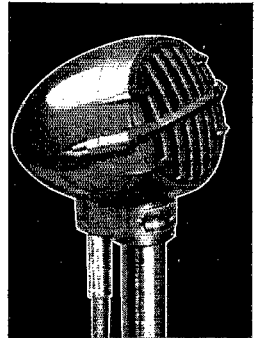

Astatic JT-Series Crystal Microphone. Choice of wide-range and voice-range models. List Price \$16.50

Something to Crow About

LeRoy Anspach (W3BD) of Philadelphia, Pa., pictured here with his rig and pet rooster, explains that the Astatic Microphone shown in photograph has been "in constant use for two and one-half years." Countless other amateurs could report similar satisfactory service from Astatic Microphones. See Astatic's newer models at your radio jobber's.



ASTATIC MICROPHONE LABORATORY, INC.
YOUNGSTOWN, OHIO In Canada: Canadian Astatic, Ltd., Toronto
 Ontario

Astatic Crystal Products Licensed Under Brush Development Co. Patents

Are You PLANNING or WAITING for a Better Job?

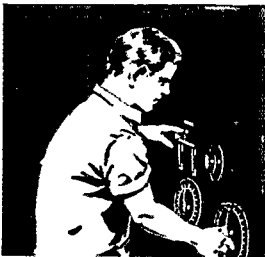

TRAINING is the difference between a future and "just a job" —

Amateur Experience Backed by Technical Training Prepares You for a Career in Radio and Television Engineering

Your future in radio depends upon your ability. Why not take advantage of your valuable amateur experience and use it as the basis for a modern course of training in Practical Radio and Television Engineering? Radiomen like yourself should be the first to visualize the amazing opportunities that radio and television have to offer to men who are technically equipped to step into the new jobs being created every day by new, modern developments. Success is no accident! The only difference between a \$1800 a year man and a \$4000 a year man is ability gained through training. This opportunity is **YOURS . . . now!** The fact that men in more than 300 broadcasting stations select CREI training is proof it *must* bring results. May we send you the complete details?

Your Choice of **HOME STUDY** or **RESIDENCE** Training in **PRACTICAL RADIO** and **TELEVISION ENGINEERING**

- **THE HOME STUDY WAY** — A spare-time study plan covering every important phase of Radio and Television Engineering. Personalized instruction service and helpful guidance. A modern course for men in the radio industry.
- **THE RESIDENCE COURSE** — A thorough one-year course at the school in Washington, D. C. Combines theory with practice on modern, working equipment. 95% of graduates during past 5 years stepped into good jobs.

— In our effort to answer intelligently your inquiry, please state briefly your radio experience, education, present position — and whether you are interested in Home Study or Residence training.

DEPT. Q-6 3224 SIXTEENTH STREET, N. W. WASHINGTON, D. C.

CAPITOL RADIO ENGINEERING INSTITUTE

WRITE FOR COPY OF



"A Tested Plan for a Future in Radio"

Read all the facts for yourself. This interesting booklet may hold the answer to your future success. Sent without obligation. Write today!



HENRY RADIO SHOP

BUTLER, MISSOURI

SELLS EVERY RECEIVER!!

Our experience selling every model amateur receiver, of all makes, enables us to help you get the best set for your use. We are the World's Largest Sellers of Amateur Receivers and Transmitters because we make it to your advantage to buy from us.

You get best trade-in for your receiver. Get our offer.

I finance all terms myself so that I can give you better terms with less cost—less red tape—quicker shipment. Write me for terms.

You get ten day free trial of any receiver. Immediate shipment from our world's largest stock or shipment from the factory if you prefer.

So send to me for any amateur equipment in any catalog or ad. I guarantee you can't buy for less or on better terms elsewhere. We have all Stancor, Thordarson, other kits and can supply wired ready to use. Write me about your needs and wishes. Tell me what you want and how you want everything handled.

73,

Bob Henry
W9ARA



AMATEUR RADIO LICENSES

Day and Evening Classes in Code and Theory

HOME STUDY COURSES

Reasonable, Efficient and Thorough, Hundreds of Licensed Students Now on the Air

American Radio Institute, 1123 Broadway, New York, N. Y.



TAKE THE NEW RADIO EXAMS IN YOUR STRIDE

Newly-written, low-cost, home-study courses, under supervision of Arthur R. Nilson, twenty years co-author of technical radio books. Thousands of professional radiomen use Nilson and Hornung textbooks to keep up to date. Now Arthur R. Nilson will give you direct, detailed lessons, step by step.



**POLICE
AIRCRAFT
FORESTRY
BROADCAST**

SEND FOR FREE 16-PAGE BOOKLET "What the Modern Radioman Must Know." Make this step toward your successful radio career... now!

NILSON RADIO SCHOOL

51 East 42nd St., New York, N. Y.



Ham Shacks

(Continued from page 61)

11th International DX Competition with good prospects of winning it in the 12th. He is also a member of the Rag Chewers' Club and has worked 96 countries to date.

W4DRE

THE neat-looking arrangement in the upper right is W4DRE over which L. M. Sparks of Gaffney, S. C. presides. The transmitter is built up in the left-hand rack. It is a three-stage affair with a 6L6 crystal oscillator, T55 doubler and push-pull T55's in the final amplifier. Two heavy-duty power supplies delivering 1000 and 1500 volts occupy the lower portion of the rack. Above the r.f. unit is an antenna-coupling network which feeds a single-wire matched-impedance antenna system.

In the rack to the right is the HQ-120X receiver, a loudspeaker and a patching panel for connecting the receiver to any one of several receiving antennas. A substantial shelf-type operating table is fastened to the front of the racks. It extends across the width of both racks providing plenty of operating space.

"L. M." has been licensed for about four years, although he has a long history in communications work. At present he handles transmission and the toll cable test board on the Washington-Atlanta Toll Cable. W4DRE must have run up some sort of a record in raising 105 stations of the first 107 called when the rig was first put on the air. He made WAS in two months, winning a silver cup offered by the Chattanooga Radio Club. He holds ORS and EC appointments. Likes to handle traffic and chew the rag.

W9KJF

EUGENE VAN SICKLE's station, W9KJF, is one of the well-known 'phone stations in the Mid-West. A comparison of the photo shown here and the picture of the same station which appeared in the February, 1935, issue demonstrates the striking changes which have taken place in the design of amateur radio gear.

The latest transmitting gear is set up in completely-enclosed rack cabinets. The main transmitter is in the six-foot cabinet at the rear of the shack. In addition to the necessary power supplies, the cabinet houses the transmitter proper—a three-stage arrangement, consisting of 6L6 crystal oscillator, 814 buffer-doubler and T200, all coupled capacitively—and a Class-B modulator in which 203Z's are used. A B&W "band-hopper" is used in the oscillator stage, while plug-in coils are used in the other two stages. The final amplifier may be coupled through a variable link to either a 600-ohm line or a concentric line, depending upon which of the available antennas is in use. The modulator is driven by the Operadio 14-watt audio unit to the left of the HQ-120-X receiver.

A 400-volt power unit supplies plate voltage for the oscillator and bias for the final. A 1400-volt unit supplies the buffer and modulator, while a

Select your frequency
AT WILL



Suppose you want to change transmitter frequency—perhaps to dodge QRM. With the Bliley Vari-X sitting on your operating table, you just rotate the control knob on one of the two VF2 Wide-range Variable Crystal Units plugged into the panel sockets. If the first crystal should not take you where you want to go, you merely flip the selector switch to the second unit. And, of course, you can instantly plug in other VF2 Units which may be on hand for allowing a greater operating frequency spread. See your Bliley Distributor for complete details on this full crystal controlled exciter—ask him for descriptive circular D-2.

PAT. APPL'D. FOR

BLILEY Vari-X FOR GREATER OPERATING PLEASURE

EASY TO LEARN CODE

It is easy and pleasant to learn the modern way—with an Instructograph Code Teacher. Ideal for the beginner or advanced student. ■ Many tapes available ranging from alphabet for beginners to typical messages on all subjects. Speed range 5 to 40 WPM. ■ Always ready, no QRM, beats having someone send to you.

FOR SALE OR RENT

STANDARD with 10 tapes and book of instructions, A.C. motor \$24.50
JUNIOR with 5 tapes and book of instructions (not rented) \$12.00
RENTAL Standard with 10 tapes and book of instructions \$3.00 first month, \$2.25 each additional month. References or \$10 deposit required. All rental payments may be applied on the purchase price should you decide to buy the equipment.
Write for details today

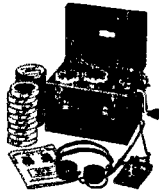

INSTRUCTOGRAPH COMPANY

Dept. Q, 912 Lakeside Place, Chicago, Illinois
 Representative for Canada:
 Radio College of Canada, 54 Bloor St. West, Toronto

RADIO CONTROL

Lightweight, reliable, guaranteed—the only complete line of radio control equipment for models.

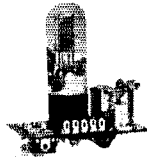

No. 211 Flyweight Receiver
\$6.75

Ask your dealer or send 10c for illustrated Instruction Booklet.

RADIO CONTROL HEADQUARTERS

GRANBY CONNECTICUT U.S.A.



NOW BUNNELL MADE

J. H. Bunnell & Company, manufacturers of high grade telegraph instruments, now offer the new and improved Bunnell-Martin Flash Keys, having acquired the tools, jigs and materials on hand from the Martin Research & Manufacturing Corp., also the "CENTURY" High Frequency Buzzers, as previously manufactured by the Federal AC Switch Company, of Buffalo, New York.

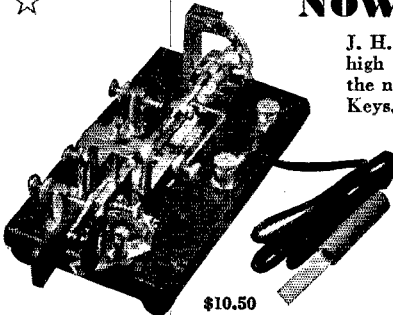

\$10.50



CENTURY BUZZER
 TYPE 17-3
 J.H. BUNNELL & CO., NY.

\$3.00

Write: J. H. BUNNELL & COMPANY, Dept. "T"
 215 Fulton Street New York City

YEARS AHEAD

TRIPLET

1941 Model 1696-A

MODULATION MONITOR

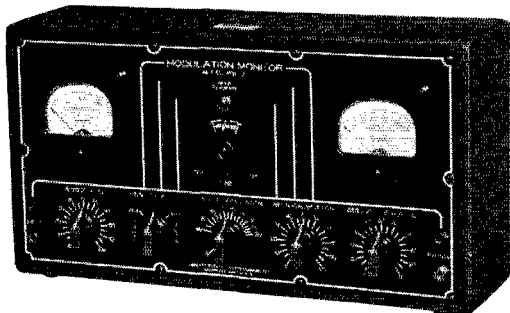

You've solved your problem of getting maximum efficiency from your transmitter when you invest in a Model 1696-A Modulation Monitor. Plug it into your AC line — make simple coupling to the transmitter output and the monitor shows:

● Carrier Reference Level ● Percent of Modulation ● Instantaneous Neon Flasher (no inertia) indicates when per cent of modulation has exceeded your predetermined setting. Setting can be from 40 to 120 per cent.

Helps comply with FCC regulations. Has two RED DOT Lifetime Guaranteed Triplet Instruments. Modernistic metal case. Model 1696-A — Amateur Net Price.....\$34.84

Also available as a rack panel mounting unit

For More Information — Write Section 256, Harmon Drive

THE TRIPLET ELECTRICAL INSTRUMENT CO.
Bluffton, Ohio

CRYSTAL TALK

Informative Bulletin No. 1

By HIPOWER

"WHAT MAKES A LOW DRIFT CRYSTAL?"

Regardless of whether the cut of a crystal is called A, X, Q or Z, if it is cut at an angle from the optical axis, on the mechanical axis of a piece of quartz, and has a temperature coefficient of 0 to 77 cycles per degree centigrade per megacycle, it is a low drift crystal. The degree of the angle determines the amount of drift with temperature change.

HIPOWER "Rubies" are cut at an angle which allows us to guarantee them to have a drift with temperature change of less than 4 cycles per degree centigrade per megacycle. Mounted in holders, especially designed to dissipate heat, they present an outstanding example of an active low drift crystal unit.

The HIPOWER CRYSTAL COMPANY, one of the oldest and largest manufacturers of crystal units for Broadcast, Commercial Aviation and Laboratory use, is able to offer the amateur low drift precision crystal units at attractive prices because of their large production and the exclusive HIPOWER grinding process.



"EMERALDS" Guaranteed to have a drift with temperature change of less than 10 CV. per °C. per MC. With holder. 160-80-40 meters.....\$3.35 Special 20 meter unit.....\$5.50

"RUBIES" One of the finest amateur crystal units available. Guaranteed drift of less than 4 CV. per °C. per MC. With holder. 160-80-40 meters.....\$4.50 Special 20 meter unit.....\$7.25

AVAILABLE AT YOUR PARTS DISTRIBUTOR

HIPOWER CRYSTAL COMPANY

2035 CHARLESTON ST.

CHICAGO, ILL.

third unit delivering 2000 volts takes care of the final.

One rather novel kink in the construction of the rig is the use of a section of automobile radiator as the ventilating louvre at the top of the cabinet. A fan behind this section keeps the air moving so that over-heating, because of the enclosed construction, is avoided. This transmitter is used principally for 4- and 14-Mc. operation.

The unit at the left end of the operating desk is an all-band Temco rig with bandswitching which is used mostly for 1.8- and 28-Mc. work.

"Van" likes to visit other hams and they are always welcome at W9KJF.

Strays

Transmitting tubes of different ages are quite apt to show different characteristics and it is often difficult to get a pair to load evenly in push-pull. The load may be evened up by using the same system sometimes used in Class-B audio amplifiers — that is, by splitting the grid winding at the center and feeding in separate biasing voltages to each grid. The two sections of the grid winding are connected through a blocking condenser and the grid bias of the poor tube adjusted until the tubes load evenly. — W5HNB.

Headline in *New York Times*: "City Votes \$100,000 for Battery Tube." Sub-head: "Calls Outlay for Tunnel to Brooklyn Tremendous." Hi! — W1GJJ.

It should be of interest to those who use primary keying to know that tungsten contacts will stand up indefinitely, while ordinary contacts may not last more than two or three days. I purchased these contacts, of which several styles are available, from a local automobile supply house. They are used in distributors. — W4CCH.

See the NEW VIBROPLEX AT YOUR "CHAMPION" DEALER'S

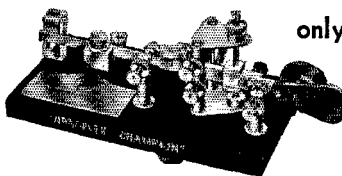

only \$9.95

Standard size black crystal base. Chromium finished top parts. Equipped with 3/16" contacts. Furnished without circuit closer, cord and wedge.

Easy to Learn...Easy to Use

Like all true champions, this new genuine Vibroplex "Champion" defies competition. Amazingly easy to learn, professionally fast and easy to operate and made to last for years. Imagine a genuine full-sized Vibroplex key with up-to-date exclusive Vibroplex features for only \$9.95. If you can use the Standard key — you can send better, faster and with less effort with the "Champion" Vibroplex. Simply press lever — Vibroplex does the rest. Ideal for "Ham" or professional. See the "Champion" at your dealer's today. If he cannot supply you, write or order direct from us. Remit by money order or registered mail. Write to-day for descriptive literature of other Vibroplex models including the sensational 1940 De Luxe models.

Left-hand machines \$1 extra.



The BUG trade mark identifies the Genuine Vibroplex

THE VIBROPLEX CO., Inc.

832 Broadway

New York, N. Y.

Where to buy it

A directory of suppliers who carry in stock the products of these dependable manufacturers.



ALBANY, N. Y. Uncle Dave's Radio Shack 356 Broadway
 ATLANTA, GEORGIA 265 Peachtree Street
 Radio Wire Television Inc.
 BOSTON, MASS. Radio Shack 167 Washington Street
 BOSTON, MASS. 110 Federal Street
 Radio Wire Television Inc.
 BRONX, N. Y. 542 East Fordham Rd.
 Radio Wire Television Inc.
 BUTLER, MISSOURI 211-215 N. Main Street
 Henry Radio Shop
 CHICAGO, ILL. 833 W. Jackson Blvd.
 Allied Radio Corp.
 CHICAGO, ILL. 901-911 W. Jackson Blvd.
 Radio Wire Television Inc.
 CINCINNATI, OHIO 1103 Vine Street
 United Radio, Inc.
 DETROIT, MICH. 395 E. Jefferson Ave.
 Radio Specialties Co.
 DETROIT, MICHIGAN 11800 Woodward Ave.
 Radio Specialties Co.
 HARTFORD, CONNECTICUT 227 Asylum Street
 Radio Inspection Service Company
 HOUSTON, TEXAS 4021 Huey Street
 R. C. & L. F. Hall
 INDIANAPOLIS, INDIANA 34 West Ohio Street
 Van Sickle Radio Supply Co.
 JAMAICA, L. I. 90-08 166th Street
 Radio Wire Television Inc.
 KANSAS CITY, MO. 1012 McGee Street
 Burstein-Applebee Company
 NEW YORK, N. Y. Harrison Radio Co. 12 West Broadway
 NEW YORK, N. Y. 100 Sixth Ave.
 Radio Wire Television Inc.
 NEWARK, N. J. 24 Central Ave.
 Radio Wire Television Inc.
 READING, PENN. 404 Walnut St.
 George D. Barbey Company
 SCRANTON, PENN. 519-21 Mulberry Street
 Scranton Radio & Television Supply Co.
 SPRINGFIELD, MASS. T. F. Cushing 349 Worthington St.
 WASHINGTON, D. C. 938 F Street, N. W.
 Sun Radio & Service Supply Co.

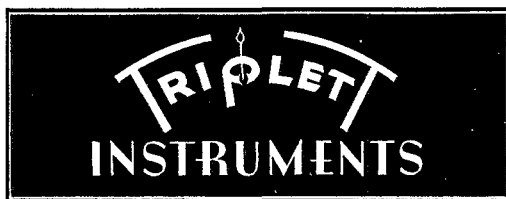

ALBANY, N. Y. Uncle Dave's Radio Shack 356 Broadway
 ATLANTA, GEORGIA 265 Peachtree Street
 Radio Wire Television Inc.
 BOSTON, MASS. Radio Shack 167 Washington Street
 BOSTON, MASS. 110 Federal Street
 Radio Wire Television Inc.
 BRONX, N. Y. 542 East Fordham Rd.
 Radio Wire Television Inc.
 BUTLER, MISSOURI 211-215 N. Main Street
 Henry Radio Shop
 CHICAGO, ILLINOIS 833 W. Jackson Blvd.
 Allied Radio Corp.
 CHICAGO, ILL. 901-911 W. Jackson Blvd.
 Radio Wire Television Inc.
 CINCINNATI, OHIO 1103 Vine Street
 United Radio, Inc.
 JAMAICA, L. I. 90-08 166th Street
 Radio Wire Television Inc.
 LITTLE ROCK, ARKANSAS 409 W. 3rd St.
 Beem Radio Company
 MINNEAPOLIS, MINNESOTA 1124-26 Harmon Place
 Lew Bonn Company
 MUSKOGEE, OKLAHOMA 204 No. Twelfth Street
 Home Radio Mart
 NEW YORK, N. Y. 100 Sixth Avenue
 Radio Wire Television Inc.
 NEWARK, N. J. 24 Central Ave.
 Radio Wire Television Inc.
 READING, PENN. George D. Barbey Co. 404 Walnut Street
 SCRANTON, PENN. 519-21 Mulberry Street
 Scranton Radio & Television Supply Co.
 WASHINGTON, D. C. 938 F Street, N. W.
 Sun Radio & Service Supply Co.

Listings on this page do not necessarily imply endorsement by QST of the dealers or of other equipment sold by them.

RADIO TELEGRAPH APPARATUS Manufactured by

WORLD'S CHAMPION RADIO TELEGRAPHER



You're cordially invited to my booth at the parts show where I'll give demonstrations of high speed telegraphing. You'll be interested in looking over the world's most complete line of gadgets for dots and dashes.

Ted Mac

at Booth 321

T.R. McElroy

100-102 Brookline Avenue,

Boston, Mass.

Exclusive European representative: C. Webb Ltd., 14 Soho St., London, with branches at 58, Victoria Street, St. Albans, Herts, and also Kent Street, Birmingham

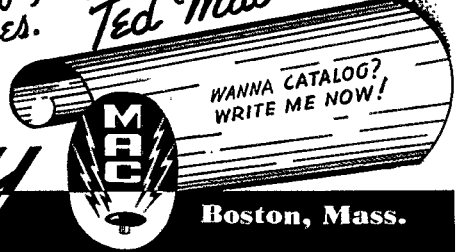

A GOOD NAME GOES A LONG WAY

Ken-Rad makes dependable tubes—the top-performing tubes that every radio user wants. Specify Ken-Rad on your next order.



Ken-Rad Radio Tubes

KEN-RAD TUBE & LAMP CORPORATION - OWENSBORO, KY.

Manufacturers of all types of radio tubes and Ken-Rad Electric Lamp Bulbs

LEARN RADIO • TELEVISION

60-page catalog on request. Oldest, largest and best equipped in New England. Write for new catalog.

MASS. RADIO SCHOOL

18 Boylston Street

Boston, Massachusetts

RADIO

ENGINEERING, broadcasting, aviation and police radio, servicing, marine radio telegraphy and telephony, Morse telegraphy and railway accounting taught thoroughly. 48 weeks' engineering course, equivalent to three years of college radio work. School established 1874. All expenses low. Catalog free.

DODGE'S INSTITUTE, Day Street, Valparaiso, Indiana

GENERAL COMMUNICATIONS CRYSTALS HOLDERS AND OVENS

Precision Made by *Bliley*

WRITE FOR CATALOG 6-11

BLILEY ELECTRIC CO., ERIE, PA.

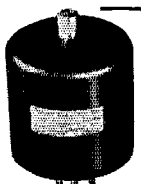
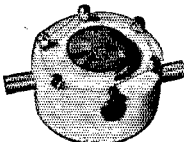
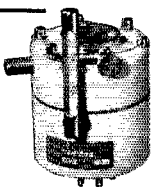

HAM-ADS

(1) Advertising shall pertain to radio and shall be of nature of interest to radio amateurs or experimenters in their pursuit of the art.

(2) No display of any character will be accepted, nor can any special typographical arrangement, such as all or part capital letters be used which would tend to make one advertisement stand out from the others.

(3) The Ham-Ad rate is 15¢ per word, except as noted in paragraph (6) below.

(4) Remittance in full must accompany copy. No cash or contract discount or agency commission will be allowed.

(5) Closing date for Ham-Ads is the 25th of the second month preceding publication date.

(6) A special rate of 7¢ per word will apply to advertising which, in our judgment, is obviously non-commercial in nature and is placed and signed by a member of the American Radio Relay League. Thus, advertising of bona fide surplus equipment owned, used and for sale by an individual or apparatus offered for exchange or advertising inquiring for special equipment. If by a member of the American Radio Relay League takes the 7¢ rate. An attempt to deal in apparatus in quantity for profit, even if by an individual, is commercial and all advertising by him takes the 15¢ rate. Provisions of paragraphs (1), (2), (4) and (5) apply to all advertising in this column regardless of which rate may apply.

Having made no investigation of the advertisers in the classified columns, the publishers of QST are unable to vouch for their integrity or for the grade or character of the products advertised

QUARTZ — direct importers from Brazil of best quality pure quartz suitable for making piezo-electric crystals. Diamond Drill Carbon Co., 719 World Bldg., New York City.

CRYSTALS in plug-in heat dissipating holders. Guaranteed good oscillators. 160M-80M, \$1.25. (No Y cuts.) 40X, \$1.65. 80M vari-frequency (5 kilocycle variance) complete, \$2.95. State frequency desired. C.O.D.'s accepted. Pacific Crystals, 1042 S. Hicks, Los Angeles.

CALBOOKS — Spring edition now on sale containing complete up-to-date list of radio hams throughout entire world. Also world prefix map, and new time conversion chart. Single copies \$1.25. Canada and foreign \$1.35. Radio Amateur Call Book, 610 S. Dearborn, Chicago.

QST's wanted prior to 1923. Floyd Norwine, W9EFC.

QSL's — samples. Brownie, W3CJI, 523 No. Tenth St., Allentown, Pa.

CRYSTALS, mounted, 80-160, \$1.25, V-cut 40, \$2.25. R9 Crystals, 338 Murray Ave., Arnold, Pa.

ALL communication equipment at lowest prices. Sale on used receivers, write for list and details. W9KJF, Van Sickle, 34 W. Ohio St., Indianapolis, Ind.

QSL's, Samples. W5FGE, Hattiesburg, Miss.

1000 watt G.E. transformers 1100-2200-4400 volts each side c.t. Guaranteed. \$13.50. Dawson, 5740 Woodward, Detroit, Mich.

CRYSTALS — police, marine, aircraft, amateur. Catalog on request. C-W Mfg. Co., 1170 Esperanza, Los Angeles.

QSL's — SWL's. 100, 3 color, 75¢. Lapco, 344 W. 39th, Indianapolis, Ind.

TELEPLEXES, Instructographs bought, sold. Ryan's, Hannibal, Mo.

MACAUTO code machines: low monthly rental 50,000 words practice tapes. Write N. C. Ayers, 711 Boylston St., Boston, Mass. GRAnite 7189-W.

CUSTOM ground 40 M X-cut crystals in ceramic holders, \$2.50. 160-80 M crystal, \$1. Koradio, Mendota, Ill.

QSL's, Maps, Cartoons. Free samples. Theodore Porcher, 7708 Navahoe, Philadelphia, Pa.

USED receivers. Bargains. Cash only. No trades. Price list 3¢. W3DQ, Wilmington, Del.

QSL's for 1940. Better in ideas, workmanship, and value. Free samples to hams. W2FJE, 101 Hanson Place, Brooklyn, N. Y.

CRYSTALS: famous P.R., mounted in latest Alsimag 35 holders — 40, 80 meter PR-X, 160 meter PR-Z, \$3, 40, 80 meter PR-Z (low drift), \$3.50; 20-meter PR-20, \$4.50; unconditionally guaranteed. Immediate shipment. Wholesale Radio Labs., Council Bluffs, Iowa, W9GFQ.

QSL's — By W8NOS — 13 Swan St., Buffalo, N. Y.

QSL's? — SWL's? Unbeatable. Patronize a real ham. Samples? W8DED, Holland, Mich.

WANTED: burned out G.E. P-0016A tube used in diathermy equipment. W7GRL.

SELL — teletype Morse xmttr less motor and cord, J. E. Smith radio correspondence course. W9BSJ.

WANT RME-70, HQ-120-X. Sell \$135. Conn saxophone, with case, lyre, reeds. E-flat alto. Silver plated. Gold bell. Pearl inlaid keys. Latest tuning device. Excellent condition. Cash \$85. W9DMY, Hebron, Neb.

HAVE 12 gauge Remington Automatic, 1 inch 1.5 focusing lens for Bell & Howell 8 mm. camera. Want large modulation transformer, pair modulator tubes, receiver, or W6FYR.

SELL Stancor twenty P transmitter. Also fifteen watt speech amplifier. W9QJB.

WANTED — portable 110 v. a.c. generator 300 watts. W3FHY.

SELLING small transmitter equipment, highest offer, get list. Condon Kirk, Niles, Mich.

FBXA complete with preselector, heavy duty National power supply, tubes, speaker, 10 to 160 bandspread and F coils, \$45. W4ELA.

WANTED: HRO Senior for cash. State condition. W4FZW.

SELL 110 d.c. 220 60 cycle 3 phase MG and trans. 3.5 k.v.a., both \$60, 1000 volt kw. d.c. generator, \$15; 50T, \$3. Other bargains. List free. W4DOO, Stuart, Fla.

SHURE 5B double-button carbon mikes — \$3.49, postpaid; mike rings with springs, 49¢; combination — \$3.75 postpaid. W8RRLL, Dymac Radio, 1531 Main St., Buffalo, N. Y.

FOR sale: Collins 30FXB phone transmitter. No reasonable offer refused. W9AR.

WANTED: one set National FB7 20 meter bandspread coils. W1AHX.

USED microphones. Cooper Supply, Quincy, Ill.

COLLINS 30J, 10 and 160 meter coils, crystals, mike, relays, new condition, guaranteed \$475. Harvey UHX-10, 10 and 160 meter coils, crystals, mike, 8 v. dynamotor, two relays. Ward antenna, 10 meter converter. Cost \$160., take \$75. Guaranteed used less than 20 hours. H. E. Hightower, Damascus, Ga.

GENERAL Electric dynamotors 24/750 volts 200 mills, \$12.50. 500 watt 500 cycle alternators with exciters, \$8. 500 watt 6-16 volt Aircraft, \$8. Unused ex-navy material. Henry Kienzie, 215 Hart Blvd., Staten Island, N. Y.

ATTRACTIVE call letter sign — automobile or station, 40¢ — 2 for 75¢ postpaid. Free circular. Andersen, W9ZMQ, 1927 W. 66 St., Minneapolis, Minn.

WANTED: complete QST's for 1920 through 1925; 1927 through 1931. W3HCQ.

QSL — SWL. June bargain prices. Fritz, 455 Mason, Joliet, Ill.

CRYSTALS — AT-cut, \$1., 1750-4000, ideal size. 3 blanks \$1. QSO Crystals, Indiana, Pa.

SACRIFICED complete station. 1 kw. phone transmitter. Xtal Pro with peak preselector. W2DVS, 81 Smith Ave., White Plains, N. Y.

MODERN 200 watt phone transmitter complete, 20 to 160 meters, \$150. W2HUE, Elmsford, N. Y.

QSL's — SWL's. Economical, colorful, illustrations. W9QKS (Meade), 819 Wyandotte, Kansas City, Mo.

SIGNAL Book — boost 'em ten, twenty times with a 3, 4 element Rotary. Rugged all-steel, hi-torque Rotators, Alu-alloy elements, Selynsynchronous indicators, save half your beam costs. Photos, bulletins. Rotary Array Service, W8MLL.

REBUILDING final, sell four good used 204A's, \$5. each; 2 250 watt Johnson tube sockets, \$1.75 each; 2 filament transformers 11 volt 4 amperes, \$2. each. W1JVE.

SELL: 300 watt 110 volt converter, 1/20 Horsepower 110 d.c. reduction gear motor, Teleplex, Victor code records, Mac osc., 10-inch bench saw. Thomas Connor, 258 E. Cottage St., Dorchester, Mass.

QSL's. New samples. Malco, 1805 St. Johns Place, Brooklyn, N. Y.

DOUGLAS Universal modulation transformers. 50 or 100 watts audio. Lowest price. One year guarantee. Postpaid. Write W9LXR, Rice Lake, Wis.

CRYSTALS: set of three Marine frequencies: 2198, 2670 and 2738, low-drift, mounted low-loss holders, within .025%, \$20. Ham Crystals, 1104 Lincoln Place, Brooklyn, New York.

WILL sell — complete 200 watt phone and CW xmitter with Howard 450 receiver — \$185. Details and picture on request. W7HLH, Sidney, Mont.

LOOK, 50 attractive 2 color QSL's, SWL's. Send 30¢. Vachovetz, Glenville, Tarrytown, N. Y.

NATIONAL 1" CRM oscilloscope (new) and Hallcrafters Super-7; both, \$30. W2LUU.

RECONDITIONED receivers at lowest prices. Write for big list — no red tape in buying them on time. Write to Leo, W9GFQ, today.

BARGAINS on power supplies — all new in original cartons: 550 volts at 200 ma., \$10.; 1110 volts at 300 ma. complete with chassis, etc. Write for big list. W9GFQ, Council Bluffs, Iowa.

TRANSMITTER headquarters: 70 watt rigs, \$35.; Utah 40 watt xmttrs with modulators, only few at \$49.50. Lowest prices on special beam tubing — get our specials at terms to suit you. Get acquainted today with Leo, W9GFQ, Wholesale Radio Labs., Council Bluffs, Iowa.

SACRIFICE: new Hammarlund HQ-120-X. Used abt 30 hours. Complete, \$100. W3FYW.

SELL, trade, \$250. Fone transmitter, car? W8QXU.

COMPLETE Ham station, everything new, for \$54.06 — UTC SX25 kit, \$22.56 with tubes, xtal, meter — Hallcrafters Sky Buddy, \$29.50 — Mac key, \$1. — Easy terms. Scell's Radio, Hartford, Conn.

BEST place to get amateur receivers, transmitters, parts is W9ARA. Lowest prices; best trade-in allowances; best terms (financed by myself and arranged to suit you); personal attention to see that you are 100% satisfied. Write. W9ARA, Butler, Mo.

RECONDITIONED guaranteed receivers and transmitters. Nearly all models cheap. Lowest prices. Free trial. Terms. List free. SX-23, \$89. W9ARA, Butler, Mo.

BRAZILIAN quartz — importers of highest quality tested quartz suitable for cutting piezo-electric crystals. Donald M. Murray Co., 38 Pearl St., N. Y.

NATIONAL 600 watt phone transmitter with improvements including NTE-A. Receiver 2 months old NC101XA noise limiter. Description and photos by mail. Make offer. W2BEQ.

CRYSTALS: When comparing crystals note the high power output and keying smoothness of Eidson T9 crystals and don't overlook their fracture resisting features. Fully guaranteed — always the best buy. 40, 80, and 160 meter bands, \$1.60 postpaid. T9 ceramic holder, \$1. C.O.D.'s accepted. Complete line of commercial frequency crystals, inquire. Sold by: Frank Anzalone, 375 W. 46th, N. Y. C.; Henry Radio Shop, Butler, Mo.; The Hargis Co., Austin, Texas; Radio Doc, 721 S. Main, Los Angeles, Calif.; Kerr Radio Shop, El Paso, Texas; Pembleton Labs., Ft. Wayne, Ind.; Valley Radio Distributors, Appleton, Wis.; Casa Edison's, Havana, Cuba; and Eidson's, Temple, Texas.

150 watt transmitter, \$50. 60 watt phone, \$65. 30 watt modulator speech and power, \$21. 300 watt transmitter, \$85. Frampton Radio, Blackwell, Okla.

WANTED: 1250 or 1500 volt, 500 mil power supply, DB20, 5-10X, Thordarson amateur speech amplifier, 300 watt multi-match modulation transformer. Haynes, 2413 Mallory, Flint, Mich.

GIL cartoon QSL's. Samples. W1CJD, Gildersleeve, Conn.

RME-9D special receiver — 10 to 160 meter bands — extra good bandsread. A-1 condition, \$50. 1 filter choke, weighs 85 pounds, wound with No. 22 wire, insulated between each layer — d.c. resistance 50 ohms, 50 Henry, \$25. 1 filament transformer (Thordarson) Type 6414 10 v. @ 6.5 amp. c.t. Tapped primary, \$3. 1 204A RCA tube, good condition, \$10. 1 four cycle three quarter horse power gas motor — Briggs and Stratton, \$20. W8MKM.

QSL's. Samples. W9RUJ, Auburn, Nebr.

SELL new 1940 Sky Champion, \$40. John Hart, 1123 Broadway, N. Y.

SELL: RME-69, vertical xtal speaker, complete — \$90. cash. DB-20, \$25. cash. Don., 901 Ann Ave., Kansas City, Kansas.

BALTIMORE Hams: for sale — Deluxe 250 watt 20 meter phone, CW rig; six meters; PP 35T's final; TZ-40's modulators. Also have Johnson 100CD 110, \$8.; 2 new 100 TH's, \$10. each; 2 used RCA 814's, \$8. each. Local hams visit any eve. Joseph DiPietro, Jr., 2313 Eutaw Place, Baltimore, Md.

HALLCRAFTERS SX-23 — \$75. W5IMO, Bowie, Texas.

SELL: Sky Challenger, perfect condition, \$30. — or trade for lathe. W2CHF, 53114 — 63 St., Maspeth, L. I.

TUBE bargains — New RCA, etc., 210's, 801's, 841's — \$1. each. 211's, \$3.50 each. New RCA, Arcturus, Raytheon 32's, 33's, 34's, 36's, 37's, 38's, 39-44's, 1A8's, 112A's, 48's, 57's, 58's, 75's, 77's, 78's, 85's; metal or glass 6A7's, 6A8's, 6E6's, 6J7's, 6K7's, 6L7's, 6R7's — all 35¢ each postpaid. Amdico, Clearfield, Pa.

GOVERNMENT contract and standard parts at big bargains. Direction finders, loop, receivers, portable transmitters, etc., etc. Send for list. Amdico, Clearfield, Pa.

LIMITED quantity Hallcrafters SX23, \$79.50. Reconditioned at factory, like new, brand-new 90-day guarantee, terms available, trade-ins accepted. The Radio Shack Corp., 167 Washington St., Boston, Mass.

FOR sale: Collins 30FXC complete, coils 10 — 20 — 40 — 80 — 160, antenna relay, D104 mike, 300 watts phone and CW, original cost \$700 plus. Excellent condition, \$450, f.o.b.: No. 1295 Triplett mod. meter \$19.75; RME-69 noise silencer — relay control and speaker \$95. W9THB.

RADIO TECHNOLOGY



RCA Institutes offer an intensive course of high standard embracing all phases of Radio and Television. Practical training with modern equipment at New York and Chicago Schools. Also specialized courses and Home Study Courses under "No obligation" plan.

Illustrated Catalog on request

RCA INSTITUTES, INC. Dept. ST-40
A Radio Corporation of America Service

75 Varick St., New York 1154 Merchandise Mart, Chicago

124



"We ain't showin' any more drift than that
MONITOR CRYSTAL, which hasn't shifted a cyclé."

MONITOR *Piigo* Products Co.

1138 MISSION ST., ★ SO. PASADENA, CALIF.

SICKLES COILS

ALL TYPES OF RF AND IF WINDINGS

Manufactured by

F. W. SICKLES COMPANY

300 Main Street

Springfield, Mass.

READ LIKE AN! SEND CODE EXPERT!

Learn Quickly at Home, Get Real Speed

It's easy, fascinating, to become a good op with the NEW ALL ELECTRIC MASTER TELEPLEX CODE TEACHER to help you. Only instrument ever produced which records

your sending in visible dots and dashes — then sends back to you at any speed you desire. Also sends practice work, recorded by an expert. That is why so many schools teaching code prefer Master Teleplex.

That is why thousands agree this method is surest, quickest — has taught more ops in the past few years than all other methods. We furnish Complete Course, lend you Master Teleplex, give you personal instruction with a MONEY-BACK GUARANTEE. Low cost. Send



today for booklet Q-6; no obligation.

THE "HAM" SPECIAL

Standard Teleplex — a highly efficient code teacher using heavy specially prepared waxed paper tape, having two rows of perforations. Write for Free folder QT-6.

We are the originators of this type instrument

TELEPLEX CO., 67-69 Park Place, N. Y.

In Canada, Write

Canadian Electronic Institute, Toronto, Ontario

Your Nearby Dealer Is Your Best Friend

Your nearby dealer is entitled to your patronage. He is equipped with a knowledge and understanding of amateur radio. He is your logical source of advice and counsel on what equipment you should buy. His stock is complete. He can supply your needs without delay. His prices are fair and consistent with the high quality of the goods he carries. He is responsible to you and interested in you.

One of these dealers is probably in your city — Patronize him!

ATLANTA, GEORGIA

Radio Wire Television Inc.
265 Peachtree Street
"The World's Largest Radio Supply House"

JAMAICA, L. I., NEW YORK

Radio Wire Television Inc.
90-08 166th Street (Merrick Road)
"The World's Largest Radio Supply House"

BALTIMORE, MARYLAND

Radio Electric Service Co.
3 N. Howard St.
Everything for the amateur

NEWARK, N. J.

Radio Wire Television Inc.
24 Central Avenue
"The World's Largest Radio Supply House"

BOSTON, MASS.

Radio Wire Television Inc.
110 Federal Street
"The World's Largest Radio Supply House"

NEW YORK, N. Y.

Radio Wire Television Inc.
100 Sixth Avenue
"The World's Largest Radio Supply House"

BRONX, NEW YORK

Radio Wire Television Inc.
542 East Fordham Road
"The World's Largest Radio Supply House"

NEW YORK, N. Y.

Harrison Radio Company
12 West Broadway
Harrison Has It! Phone WOrth 2-6276 for information or rush service

BUFFALO, NEW YORK

Radio Equipment Corp.
326 Elm Street
W8PMC and W8NEL — Ham, service and sound equipment

PHILADELPHIA, PENNSYLVANIA

Eugene G. Wile
10 S. Tenth Street
Complete Stock of Quality Merchandise

BUFFALO, NEW YORK

Dymac Radio
1531 Main Street — Cor. Ferry
Open Evenings GA. 0252

PROVIDENCE, RHODE ISLAND

W. H. Edwards Company
85 Broadway
National, Hammarlund, Hallicrafter, Thordarson, Taylor, RCA

HARTFORD, CONNECTICUT

Radio Inspection Service Company
227 Asylum Street
What do you want? We have it. Radio exclusively

RICHMOND, VIRGINIA

The Arnold Company
Broad at Harrison St.
W3EQQ — "The Virginia Ham Headquarters" — W3FBL

HOUSTON, TEXAS

R. C. & L. F. Hall
4021 Huey Street (W 9-2713)
"Specialists in Amateur Supplies"

SCRANTON, PENNSYLVANIA

Scranton Radio & Television Supply Co.
519-521 Mulberry Street
Complete Stock of Quality Amateur Supplies

YOU CAN BE SURE
WHEN YOU BUY FROM

QST

ADVERTISERS

“Advertising for *QST* is accepted only from firms who, in the publisher’s opinion, are of established integrity and whose products secure the approval of the technical staff of the American Radio Relay League.”

Quoted from QST’s advertising rate card.

Every conceivable need of a radio amateur can be supplied by the advertisers in QST. And you will know the product has the approval of the League’s technical staff

Index to Advertisers

Abbott Instrument, Inc.	114
Aerovox Corp.	82
American Radio Institute	118
Astatic Microphone Laboratory, Inc.	117
Barker & Williamson	106
Bliley Electric Company	115, 119, 122
Browning Laboratories, Inc.	114
Bunnell & Company, J. H.	119
Candler System Company	98
Capitol Radio Engineering Institute	117
Cardwell Mfg. Corp., Allen D.	86
Centralab	115
Collins Radio Company	Cov. 2
Daven Company, The	109
Dodge’s Institute	122
Eitel-McCullough, Inc.	83
General Electric Company	5
Hallcrafters, Inc., The	1, 2
Hammarlund Mfg. Company, Inc.	79, 80, 81
Harvey Radio Company	116
Heintz & Kaufman, Ltd.	90
Henry Radio Shop	118
Hipower Crystal Company	120
Hygrade Sylvania Corp.	92
Instructograph Company	119
Jensen Radio Mfg. Company	95
Ken-Rad Tube & Lamp Corp.	122
Kenyon Transformer Company, Inc.	99
Mallory & Company, Inc., P. R.	78
Massachusetts Radio School	122
McElroy, T. R.	122
Meissner Mfg. Company, Inc.	103
Millen Mfg. Company, Inc., James	89
Monitor Piezo Products Company	124
National Company, Inc.	Cov. 3, 77, 84, 85
Newark Electric Company	107
New York YMCA Schools	112
Nilson Radio School	118
Ohmite Mfg. Company	110
Par-Metal Products Corp.	110
Pioneer Gen-E-Motor Corp.	106
Port Arthur College	96
Precision Apparatus Corp.	88
Precision Piezo Service	96
Premax Products	102
RCA Institutes, Inc.	124
RCA Mfg. Company, Inc.	Cov. 4, 91
Radio Control Headquarters	119
Radio Mfg. Engineers, Inc.	127
Radio Shack, The	97
Radio Transceiver Laboratories	102
Scientific Radio Service	112
Shuler Supply Company	108
Siekles Company, F. W.	124
Solar Mfg. Corp.	118
Southwest Radio Supply	112
Speer Carbon Company	94
Sun Radio Company	108
Taylor Tubes, Inc.	87
Teleplex Company	124
Terminal Radio Corp.	112
Thordarson Electric Mfg. Company	93
Triplett Elec. Instrument Company, Inc.	120
Turner Company	98
United Transformer Corp.	128
Vibroplex Company, Inc., The	120
Wholesale Radio Laboratories	97
Vaxley	78

Why... the 99 is A GREAT RECEIVER

AMATEUR
\$137.40
NET

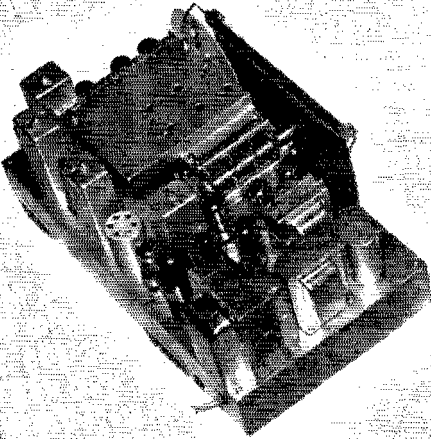
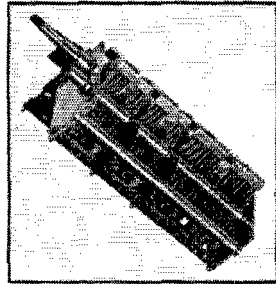

THE new RME-99 communications instrument is a great receiver because it has been ENGINEERED in EVERY detail . . . not just in one, nor in two . . . BUT IN ALL DETAILS.

Not a thing has been neglected or overlooked, from the stabilized power supply to the giant calibrated band spread dial, to bring the finest in communications reception to the amateur and professional operator.

Months of painstaking research in laboratory measurement and in actual operation have been carefully collaborated to produce this receiver which has such high operating characteristics that a much more critical adaptation to standard had to be set up for its actual measurement. The selectivity and sensitivity of the RME-99 is not measured by the usual average standards used heretofore.

The RME-99 was designed around the latest and we believe the most efficient tube types ever built . . . namely, the Loktal series. The very appearance of these new tubes seems to spell EFFICIENCY with capital letters. And in actual service they perform even better than they look!

But we ask no one to take our word. We cordially invite your personal inspection of this great receiver for the biggest thrill in communication reception since the advent of the crystal filter single-signal circuit. Why not step into your nearest amateur supply house and see for yourself? Complete literature is available upon receipt of your inquiry.

ABOVE, in the picture to the left, is shown a rear and top view of the new RME-99. Note in particular the uniform layout of tubes and components on the rigid cast aluminum chassis frame. The incorporation of heavy-duty power parts assures long years of trouble free operation. The straightforward line-up of tubes suggests straightforwardness in operation which is not belied in actual practice.

In the picture to the right is seen the main tuning condenser of the RME-99. Note the split stators and the wide spacing of the oscillator portion of this condenser. The incorporation of such a condenser permits unusually fine control of L/C ratios at all frequencies and the wide spacing between plates assures that this receiver will be substantially free from the common annoyance of mechanical instability.

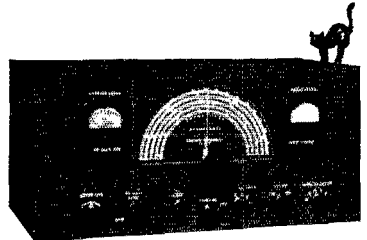

RADIO MFG. ENGINEERS, INC.
111 Harrison Street, Peoria, Illinois

NEW 100 Watt Kits

Using Grid-Cathode Modulation

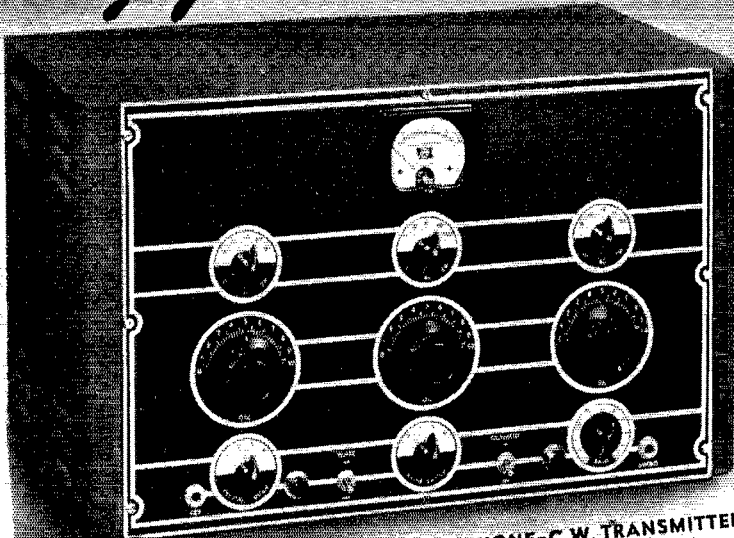

SC-100 BAND SWITCHING GCM PHONE-C.W. TRANSMITTER KIT

The UTC Type SC-100 transmitter kit is a complete 'phone and C.W. transmitter of modern design capable of a carrier output of 50* watts 'phone, 100* watts C.W. Operation on all bands (10-160 meters) is obtained by means of **BAND SWITCHING** coil assemblies (and crystal switch for four [4] crystals). Keying is accomplished in the oscillator cathode circuit, thus permitting break-in operation. A rugged power supply with multi-section filter system furnishes power to the RF and audio amplifiers. The entire transmitter including RF, speech amplifier, Cathode-Modulator, and power supply is mounted on a single chassis.

The output circuit of the SC-100 consists of a link terminated at two insulating feed-through insulators at the rear of the chassis for connection to a low impedance feeder system.

The SC-100 kit includes chassis, cabinet, panel, condensers, coil assemblies, resistors, 3" METER, etc., all completely mounted ready to wire. Crystals and tubes not included. Tubes: 1-807, 1-812, 1-6SJ7, 1-6C5, 3-6F6, 1-SZ3, 2-866. Size: 12" x 12" x 20". Weight: 88 lbs. Amateur net price

\$96.00

SC-101 Same as above, but designed to use standard air wound plug-in coils such as Barker and Williamson or Bud. Less crystal, tubes and coils, net **\$57.00**

* ACTUAL CARRIER OUTPUT UTC ratings are conservative and based on antenna output, not the customary class C input. For example, on C.W., the class C input of these units is 160 watts.

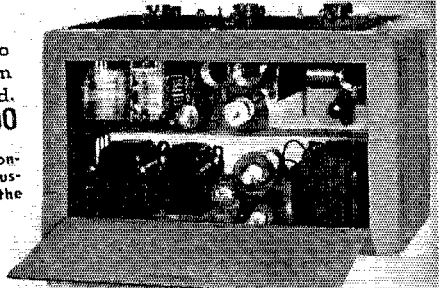

UNITED TRANSFORMER CORP.

Write: COMMUNICATIONS DIV. ★ 150 VARICK ST. ★ NEW YORK, N. Y.

EXPORT DIVISION: 100 VARICK STREET NEW YORK, N. Y. CABLES: 'ARLAB'

QST for June, 1940, EASTERN Edition

PRINTED IN U. S. A.
RUMFORD PRESS
CONCORD, N. H.

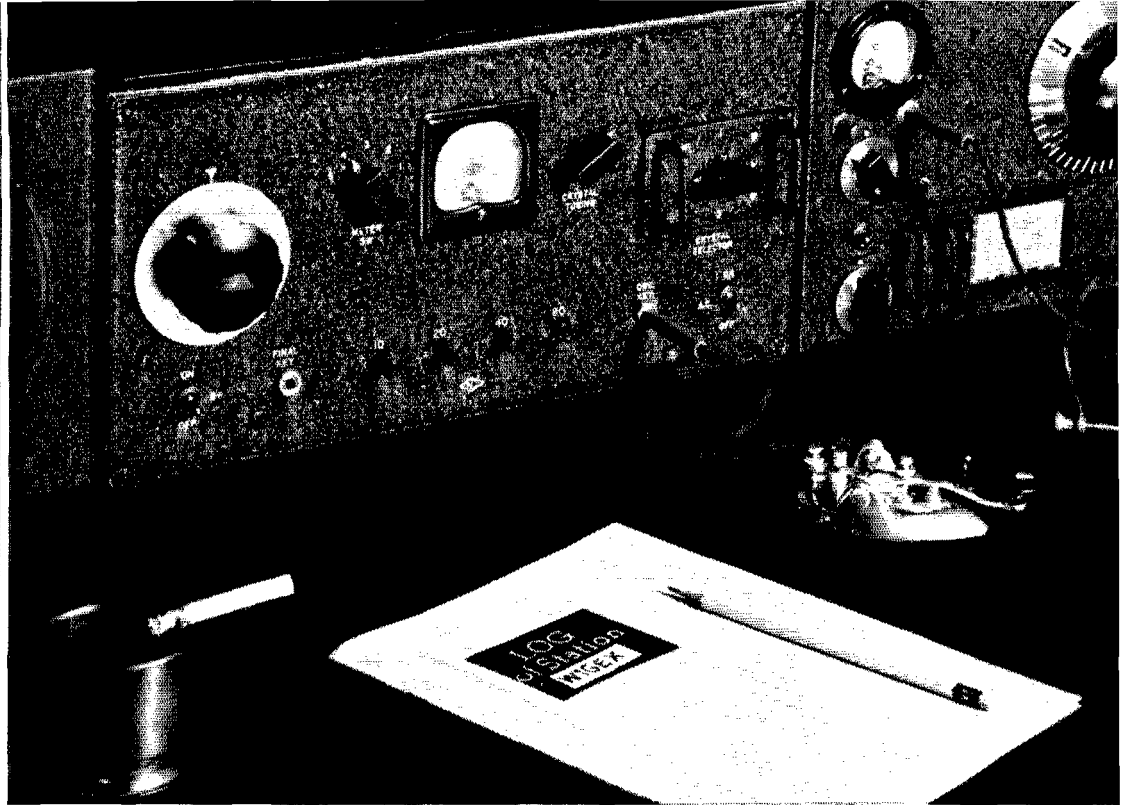

A COMPLETE TRANSMITTER

To the man who makes smart use of his money, the NTX-30 has special appeal. For in addition to being a complete transmitter in itself, it provides an ideal exciter and buffer for a more powerful station. Yet when used by itself, it is everything that a low power transmitter should be. It gives its 30 watts of output *generously*. It is lightning fast in operation, with multiple crystal holders and push-button exciter control for selecting four bands. Its frequency is stable and its note is clean.

To the man who makes smart use of his money, the price is right, too. Only \$117.00 Net, complete with all coils, tubes and crystal holder, but without crystals or key.

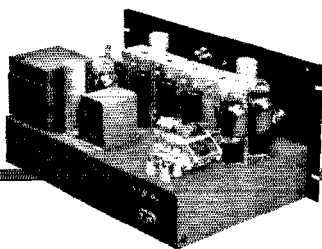

NATIONAL COMPANY, INC.

MALDEN, MASSACHUSETTS



RCA-829

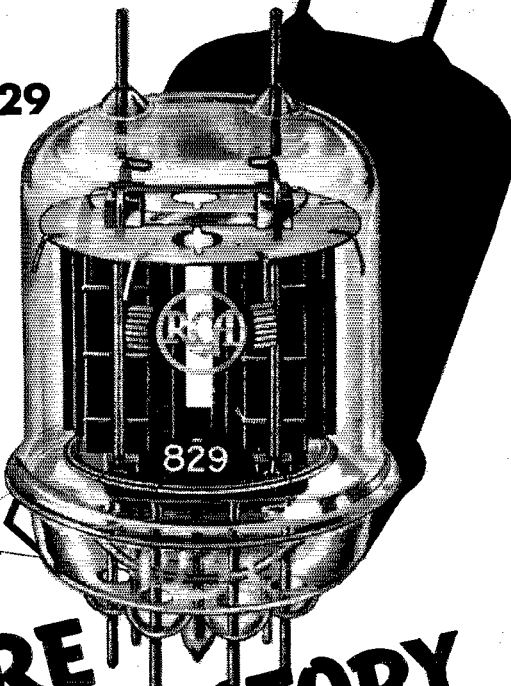

**MORE
TUBE HISTORY
IN THE MAKING!**

"A WHALE OF A TUBE FOR ITS SIZE"

Small enough to lay comfortably in the palm of your hand, the new RCA-829 Twin R-F Beam Power Amplifier is "big" enough so that a single tube in push-pull class C telegraph service can handle 120 watts power input with less than 1 watt of r-f grid drive—at frequencies as high as 200 Mc. At reduced ratings, it may be operated as high as 250 Mc. And don't forget! The 829 is a real money-saver, due to the simplifications it makes possible in transmitter design. *Neutralization is unnecessary.* The twin structure simplifies circuit adjustments. In brief, at the U.H.F.'s the 829 offers exceptional efficiency, high power sensitivity and plenty of power output. The heater can be series-operated from a 12.6-volt supply or parallel-operated from a 6.3-volt supply. Max. CCS (Continuous Commercial Service) Ratings are: D-c plate voltage, 500 volts; total d-c plate current, 240 ma.; and total plate dissipation for both units, 40 watts. At a plate input of 120 watts, typical power output is approximately 83 watts.

RCA-829 Amateur Net Price \$19.50

Take the mystery out of ultra-high frequencies! Write today for complete technical information on these three new tubes to Commercial Engineering Section, RCA Manufacturing Co., Harrison, N. J.

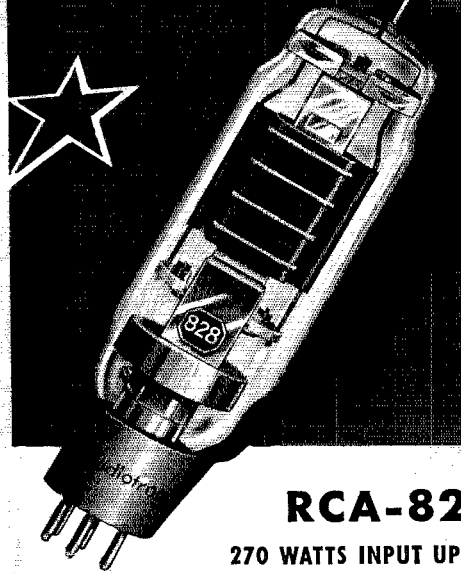

RCA-828

270 WATTS INPUT UP

30 Mc WITH ONLY 2.2 WATTS DRIVING POW

This new multi-electrode Transmitting Beam Power Amplifier offers, we sincerely believe, more for your money than any other tube of its class. It is tops for r-f applications, especially where quick band-change without neutralization is desired. May be operated at max. ratings as high as 30 Mc and at reduced ratings up to 75 Mc. Two RCA-828's may be used in push-pull class AB₁ modulator with 300 watts a-f output and 1% distortion. Maximum ICAS (Intermittent Commercial and Amateur Service) Ratings for class C telegraph service are: D-c plate voltage, 1500 volts; d-c plate current, 180 ma.; and plate dissipation, 80 watts.

RCA-828 Amateur Net Price \$17.50

**RCA-1628 THIS TRIODE TAKES
FULL RATED 50 WATTS INPUT UP TO 500**

The new RCA-1628 is a general-purpose triode with a tantalum grid and plate. It is capable of operating at maximum ratings at frequencies as high as 500 Mc and at reduced ratings as high as 675 Mc. The three filament leads may be connected in parallel through r-f by-pass condensers, thus minimizing the effect of filament-lead inductance at the ultra-highs. D-c grid and plate leads brought out of the bulb through separate seals make neutralization at the U.H.F.'s a simple matter. Max. class C telegraph CCS ratings are: D-c plate voltage, 1000 volts; d-c plate current, 60 ma.; plate input, 50 watts and plate dissipation, 40 watts; typical driving power, a plate voltage of 1000 volts is approximately 1.7 watts; typical power output, approximately 35 watts.

RCA-1628 Amateur Net Price \$32.00



Radio Tubes