

QST

may, 1940

25 cents

30c in Canada

devoted entirely to

amateur radio



Electronics
Keying

BY HARRY BRECHER, W7JLH
An Electrical "Mag" Which Makes Both

No doubt the desirability of a semi-
key which would make dashes as well
as to have many amateurs. No one
noticeable for home construction
and for such a key of
ted work on a key
ably. As

In This Issue—E.C.B. Flexibility with Crystal Control

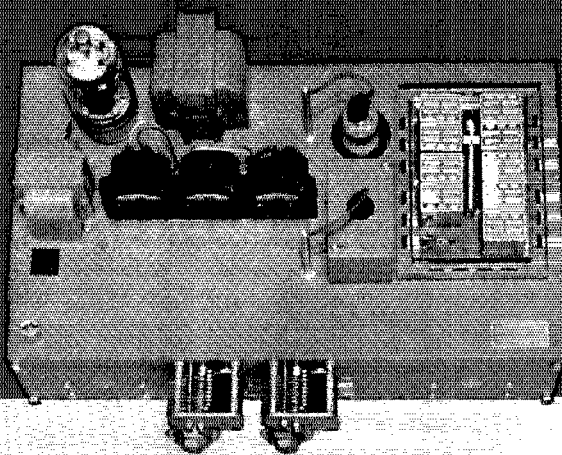
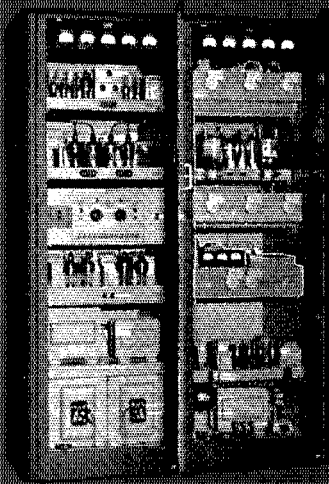

Perfect Keying and Break-in

Crystal oscillators cannot be keyed satisfactorily at high speeds. Consequently conventional transmitters are keyed in one of the stages following the oscillator with the result that the oscillator runs continuously and interferes with break-in reception on the transmitting frequency.

Collins 231C Transmitter utilizes a unique keying system which gives unsurpassed characteristics. The crystal portion of the oscillator operates continuously but is doubly shielded and filtered in the manner of a high quality signal generator so that no "back wave" is observed even in a sensitive receiver located side-by-side with the transmitter and with its antenna in the field of the transmitting antenna. Keying is accomplished by application of cut-off bias to the suppressor grid of the 837 oscillator tube and to the control grid of all succeeding tubes. Keying bias is applied by an inverted 6J7G direct coupled amplifier tube. There are no keying relays which might require critical adjustments.

Plate supply filter systems are designed to minimize supply voltage transients at any keying speed, and perfect keying pulses are produced at all rates up to several thousand bauds per second. Thus, even facsimile keying systems may be used if desired. Further, a simple time constant circuit in the keying amplifier permits control of the pulse shape and is adjusted for minimum band width consistent with sharp keying at normal machine speeds.

This thoroughly modern keying system with Collins Autotune frequency shift device makes the 231C Transmitter really outstanding.



COLLINS RADIO COMPANY

CEDAR RAPIDS, IOWA NEW YORK, N. Y. 11 WEST 67 STREET

The Wreck of the PANDORA



(Above) Radio equipment salvaged from the "Pandora."
 (Below) E. L. Clark WSBBM, radio operator, after the rescue.



Twelve Hours Under Water —but the Receiver Still Works

WHEN the ill-fated trawler "Pandora" sank off Kayak Island with all equipment aboard, the modern search for a "Northwest Passage" was ended. The life of the equipment in the radio shack should have been ended, too. But when it was fished up, twelve hours later, the sturdy Hallicrafters Sky Champion needed only a new RF-AF gain control and a tone control to go back on the air! The transmitter was a total loss.

Your amateur equipment will never soak in arctic seaweed, but it is good to know that it is built to stand up under any conditions.

the hallicrafters inc.
 CHICAGO, U. S. A.

WORLD'S LARGEST BUILDERS OF AMATEUR COMMUNICATIONS EQUIPMENT

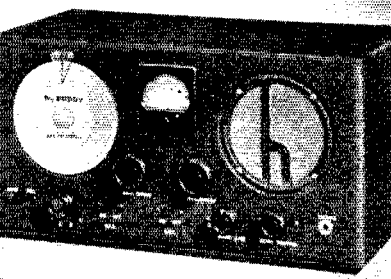

THE COMPLETE LINE OF *Amateur Equipment*

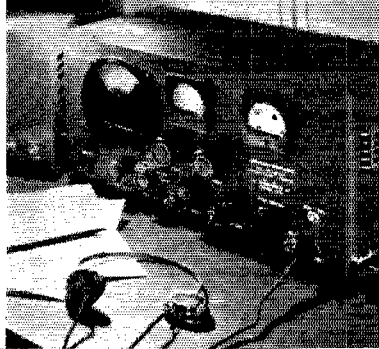

THE SKY BUDDY, we believe, is owned by more amateurs than any other communications receiver. Covers everything from 44 mc to 545 kc. Electrical bandspread, BFO, AVC switch, pitch control, built-in speaker, phone jack. Tunes 10, 20, 40, 80 and 160 meter bands plus broadcast. Complete \$29.50.

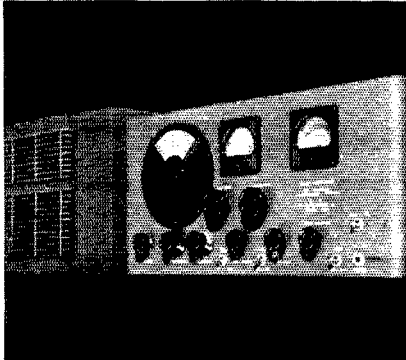

SKYRIDER DEFIANT covers 43.5 mc to 545 kc in 4 bands. Frequency meter tuning on 10, 20, 40 and 80 meter bands. Stage of preselection. Noise limiter. 6-point variable selectivity. Crystal phasing. BFO switch. ANL switch. Meter calibrated in S and DB units. Complete with tubes and crystal (less speaker) \$69.50.



SUPER DEFIANT is the receiver with "everything." Covers 42 mc to 540 kc. 2 stages preselection. Calibrated bandspread dial for frequency meter tuning. Noise limiter. 8 watts output. 6-step variable selectivity. Oscillator compensation. Meter calibrated in S and DB units. Crystal phasing. BFO switch. ANL switch. 10-inch speaker in matching cabinet. Complete for \$99.50.

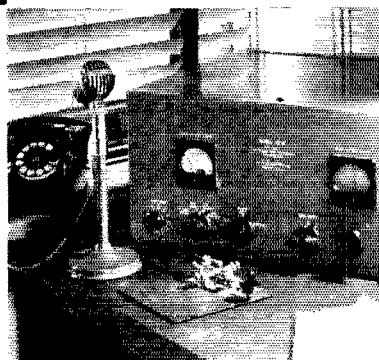

SKYRIDER 23 covers 44 mc to 545 kc. 8 bandswitch positions. Noise limiter. 6-step variable selectivity. Frequency stability both from temperature-humidity effects and line voltage variations. S-DB meter. ANL switch. Pitch control. Crystal phasing. Absolute reset accuracy. Complete with crystal \$115.50.

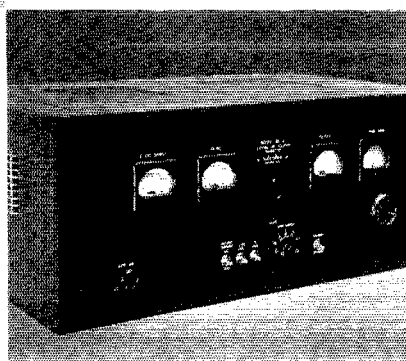

HT-6 25 WATT TRANSMITTER has a range from 1.7 to 60 mc. Coils for any three bands may be plugged in, pretuned and switched from the front panel. Only necessary to retune the final amplifier plate. Excellent voice quality with 100% modulation from any high level high impedance mike. With tubes, less coils and crystals, \$99.00.

LINE OF MARINE EQUIPMENT

THE HT-8 25 WATT RADIO PHONE is rapidly becoming the best seller for ship-to-shore work on both pleasure and commercial craft. Less only crystals, \$290.00.

SKYRIDER MARINE is a special marine receiver. With built-in speaker, \$64.50.

HT-9. 100 WATT TRANSMITTER. Exciter coils for 5 bands can be plugged in, pretuned and switched from front panel. Carrier hum at least 40 db below 100% modulation. Every function controlled from front panel. Less coils and crystals, \$199.50.

FM/AM RECEIVER 450 WATT TRANSMITTER

MODEL S-27 is the first communications receiver to operate on either Frequency Modulation or Amplitude Modulation by throwing a switch. Complete \$175.00.

HT-4 450 WATT TRANSMITTER Complete with tubes, crystals, and coils \$695.00.

the hallicrafters inc.
CHICAGO, U. S. A.

WORLD'S LARGEST BUILDERS OF AMATEUR COMMUNICATIONS EQUIPMENT

MAY 1940

VOLUME XXIV

NUMBER 5



STAFF

Editorial

KENNETH B. WARNER, W1BH
Editor and Business Manager

CLARK C. RODIMON, W1SE
Managing Editor

GEORGE GRAMMER, W1DF
Technical Editor

DONALD H. MIX, W1TS
BYRON GOODMAN, W1JPE
Assistant Technical Editors

EDW. P. TILTON, W1HDQ
Contributing Editor, U.H.F.

VERNON CHAMBERS, W1JEQ
Technical Information Service

JAMES J. LAMB, W1AL
Research Engineer, A.R.R.L.

Advertising

F. CHEYNEY BEEKLEY, W1GS
Advertising Manager

CHARLES BRUNELLE
Asst. Advertising Manager

Circulation

DAVID H. HOUGHTON
Circulation Manager

RALPH T. BEAUDIN, W1BAW
Asst. Circulation Manager



OFFICES

38 La Salle Road
West Hartford, Connecticut

Subscription rate in United States and Possessions, \$2.50 per year, postpaid; all other countries, \$3.00 per year, postpaid. Single copies, 25 cents. Foreign remittances should be by international postal or express money order or bank draft negotiable in the U. S. and for an equivalent amount in U. S. funds.

Entered as second-class matter May 29, 1919, at the post office at Hartford, Connecticut, under the Act of March 3, 1879. Acceptance for mailing at special rate of postage provided for in section 1103, Act of October 3, 1917, authorized September 9, 1922. Additional entry at Concord, N. H., authorized February 21, 1929, under the Act of February 28, 1925. Additional second-class entries to cover sectional editions authorized March 20, 1935.

Copyright 1940 by the American Radio Relay League, Inc. Title registered at United States Patent Office.

QST

devoted entirely to

AMATEUR RADIO

PUBLISHED MONTHLY, AS ITS OFFICIAL ORGAN, BY THE AMERICAN RADIO RELAY LEAGUE, INC., AT WEST HARTFORD, CONN., U. S. A.; OFFICIAL ORGAN OF THE INTERNATIONAL AMATEUR RADIO UNION



CONTENTS

Editorials	7
Splatter	8
15th Annual Hudson Division Convention	8
Extended Variable Frequency Crystal Control <i>Byron Goodman, W1JPE</i>	9
An Inexpensive Electric Key <i>George Grammer, W1DF</i>	12
A Compact 112-Mc. Station <i>Howard C. Lawrence, W2IUP</i>	15
What the League Is Doing	19
U.H.F. Contest and Relay	20
New Receiving Tubes <i>7B4, 7J7, 7L7</i>	21
The YL's Unite <i>Anita Calagni Bien, W8TAY and Enid Carter, W9NBX</i>	22
The West Coast Celebration	28
A New Electronic Television Transmitting System for the Amateur <i>J. B. Sherman</i>	30
Flasher-Type Overmodulation Indicator	37
Quote and Unquote	38
A 56-Mc. Mobile Station <i>Arthur H. Lynch, W2DKJ</i>	40
1939 Sweepstakes Contest Results <i>E. L. Battey, W1UE</i>	44
A.R.R.L. QSL Bureau	49
On the Ultra Highs <i>E. P. Tilton, W1HDQ</i>	50
Narrow-Band Constant-Level Speech Amplification <i>Gene Turney, W2APT and Richard Shimer</i>	54
Book Review	57
Hints and Kinks <i>Series Noise Limiter with Plate Detectors — Simple Rotatable Three-Element Antenna — Voltmeter as Sensitive Neutralizing Indicator — Discharging Tool for Safety — Postscript on B.C.L. Elimination — Simple Bridge for C and R Checking</i>	58
I.A.R.U. News	61
Calls Heard	63
Naval Communication Reserve Notes	64
Correspondence from Members	65
Operating News	66
How's DX?	70
WWV Schedules	92
Ham-ads	122
QST's Index of Advertisers	126

Section Communications Managers of the A.R.R.L. Communications Department

All appointments in the League's field organization are made by the proper S.C.M., elected by members in each Section listed. Mail your S.C.M. (on the 16th of each month) a postal covering your radio activities for the previous 30 days. Tell him your DX, plans for experimenting, results in phone and traffic. He is interested, whether you are an A.R.R.L. member or get your QST at the newsstands; he wants a report from every active ham. If interested and qualified for O.R.S., O.P.S. or other appointments he can tell you about them, too.

ATLANTIC DIVISION			
Eastern Pennsylvania Maryland-Delaware-District of Columbia Southern New Jersey Western New York Western Pennsylvania	W3BES W3CIZ W3CCO W8PLA W8OFO	Jerry Mathis Hermann E. Hobbs Lester H. Allen Fred Chichester Kendall Speer, Jr.	5132 Haverford Ave. 9701 Monroe St. Silver Spring P.O. 704 Quinton Ave. Linden, Maryland Trenton Sonyea Lowber
CENTRAL DIVISION			
Illinois Indiana Kentucky Michigan Ohio Wisconsin	W9RMN W9CGI W9ARU W8DFE W8AQ W9UIT	Leslie M. Dickson Noble Burkhardt Darrall A. Downard Harold C. Bird E. H. Gibbs Aldrich C. Kronos	Edelvyn Farms R. 4, Box 1 116 N. Longworth Ave. R. F. D. 2 405 Broad St. 2702 So. 46th St. Waukegan Indianapolis Louisville Pontiac Wadsworth Milwaukee
DAKOTA DIVISION			
North Dakota South Dakota Northern Minnesota Southern Minnesota	W9WVL W9VOD W9IGZ W9VNQ	Anton C. Theodos Dr. A. L. Russell Edwin L. Rickard Millard L. Bender	Box 444 R. F. D. 3 608 N. Huron Ave. Williston Phillip Keosauqua Spring Valley
DELTA DIVISION			
Arkansas Louisiana Mississippi Tennessee	WSABI W5DWW W5EWD W4DWS	H. E. Velte W. J. Wilkinson, Jr. Jewell W. Cole William Harold Walker	4415 West 12th St. 1523 Laurel St. c/o City of McComb Water Dept. 1901 Cedar Lane Little Rock Shreveport McComb City Nashville
HUDSON DIVISION			
Eastern New York N. Y. C. & Long Island Northern New Jersey	W2LU W2AZV W2GVZ	Robert E. Haight E. L. Baurach Joseph P. Tessup	511 South Holmes St. 102 Central Ave. 131 California St. Scotia Massapequa, L. I. Ridgewood
MIDWEST DIVISION			
Iowa Kansas Missouri Nebraska	W9PIR W9IEG W9OUD W9DI	L. B. Vennard Melvin D. Kirby Miss Letha Allendorf William J. Bamer	P. O. Box 304 1015 W. 3rd St. West Burlington Arlington Ioplin Tobias
NEW ENGLAND DIVISION			
Connecticut Maine Eastern Massachusetts Western Massachusetts New Hampshire Rhode Island Vermont	W1CTI W1IEB W1ALP W1JAH W1BFT W1HRC W1KJG	Frederick Ellis, Jr. H. W. Castner Frank R. Baker, Jr. William J. Barrett Carl B. Evans Clayton C. Gordon Clifton G. Parker	19 Merrill Rd. 147 Church 21 Colby Road 239 Columbia St. 163 South Main St. 70 Columbia Ave., Gaspee Box 537 Norwalk Damariscotta North Quincy Adams Concord Plateau, Warwick Morrissville
NORTHWESTERN DIVISION			
Alaska* Idaho Montana* Oregon Washington	K7GNN W7EMT W7CPV W7DXF W7FCG	James G. Sherry Carl Eichelberger Rex Roberts Harold W. Johnston W. Beale	Route 2 Box 1088 902 N. W. DeSpain R. 4, School Ave. Chichagof Kuna Glendive Pendleton Walla Walla
PACIFIC DIVISION			
Hawaii Nevada Santa Clara Valley East Bay San Francisco Sacramento Valley Philippines San Joaquin Valley	K6ETF W6BIC W6FBW W6T1 W6CIS W6MDI KA1GR W6KUT	Francis T. Blatt Edward W. Heim Albert Amarantes Horace R. Gower Kenneth E. Hughes Vincent N. Feldhausen George L. Rickard Edwin A. Andrews	837 16th Ave. 509 Claremont St. 454 Washington St. 414 Fairmount Ave. 622-36th Ave. 113 South Quincy St. Box 849 2921 North Van Ness Blvd. Honolulu Reno San Jose Oakland San Francisco McCloud Manila Fresno
ROANOKE DIVISION			
North Carolina South Carolina Virginia* West Virginia	W4CVB W4BQE/ANGT W3GWO W8OXO	W. J. Wortman Ted Ferguson Frank S. Anderson, Jr. W. D. Tabler	P. O. Box 566 1213 College St. 4703 New Kent Ave. 238 Watson Ave. Morganton Columbia Richmond Fairmont
ROCKY MOUNTAIN DIVISION			
Colorado Utah-Wyoming	W9EHC W7CLG	Carl C. Drumeller Ernest E. Parshall	819 East Dale St. Salt Creek Electric Plant Colorado Springs Midwest, Wyoming
SOUTHEASTERN DIVISION			
Alabama Eastern Florida Western Florida Georgia West Indies (Cuba-Isle-of-Pines- Porto Rico-Virgin Islands)	W4DGS W4PEI W4AXP W4AGI CM2OP	James F. Thompson Carl G. Schaal Oscar Cederstrom Leland W. Smith Mario de la Torre	12 Clanton Ave. Waucoma Apts. Lakeview Hotel Second St. & Bruce Ave. 2010 Pennsylvania Ave. Escobar 110 (Altos) Montgomery Clermont De Funiak Springs Augusta Habana, Cuba
SOUTHWESTERN DIVISION			
Los Angeles Arizona San Diego	W6MQM W6KMM W6JRM	Ralph S. Click Marson B. Hull Howard K. Breedlove	1038 Milwaukee Ave. 617 North Fourth Ave. R. 2, Box 636 Los Angeles Phoenix San Diego
WEST GULF DIVISION			
Northern Texas Oklahoma Southern Texas New Mexico	W5DXA W5GFT W5MN W5ENI	Lee Hughes Russell W. Battern Horace E. Biddy Dr. Hilton W. Gillett	125 N. Main St. 431 South Buchanan 1746 Schley Ave. Childress Enid San Antonio Lovington
MARITIME DIVISION			
Maritime	VE1DQ	A. M. Crowell	69 Dublin St. Halifax, N. S.
ONTARIO DIVISION			
Ontario	VE3SG	F. H. B. Saxon	302 Lee Ave. Toronto, Ont.
QUEBEC DIVISION			
Quebec	VE2CO	Lindsey G. Morris	Apt. 6, 4510 Girouard Ave., N.D.G. Montreal, P. Q.
VALANTA DIVISION			
Alberta British Columbia	VE4GE VE5DD	C. S. Jamieson C. O. I. Sawyer	581 W. Riverside Drive 2634 West 31st Ave. Drumheller, Alta. Vancouver
PRAIRIE DIVISION			
Manitoba Saskatchewan	VE4AAW VE5AY	A. W. Morley Arthur Chesworth	747 McMillan Ave. 1071 4th Ave., N. W. Winnipeg Moose Jaw

* Officials appointed to act until the membership of the Section choose permanent S.C.M.s by nomination and election.

Plenty of Sock!

Plenty of Saving!

NEVER has economical medium-power performance been easier to get than now, with such favorites as these G-E tubes at your command.

We've come a long way since the day of the seven-dollar 210. Today you get more watt-hours from a \$2.50 GL-809 or GL-1623 than the best '10 ever gave.

Today seven dollars buys a pair of GL-811's or GL-812's capable of handling 450 watts input up to 60 megacycles, in Intermittent Commercial and Amateur Service.

And that GL-807 . . . There's a bottle of per-

formance no ham should overlook. Flexible—yes, and potent, too. Puts out a mean sig even as a crystal oscillator—and two low-cost GL-807's in the final will give you 100 watts output (1CAS, cw) with *less than half a watt driving power!* Yes, sir—**THAT'S "Sock . . . at a Saving."**

You save, too, by investing in G-E quality—famous in radio for a quarter of a century. Your dealer has complete dope on the G-E transmitting tube line. Ask him for your copy of bulletin GEA-3315, or write direct to General Electric, Radio and Television Department, Schenectady, N. Y.

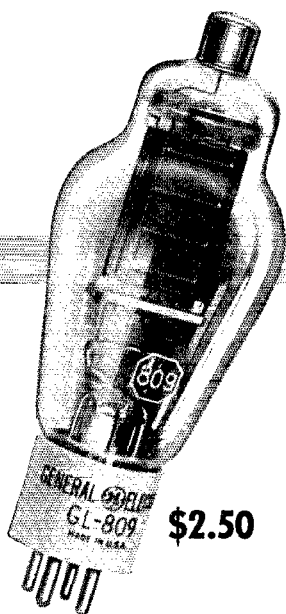

\$2.50

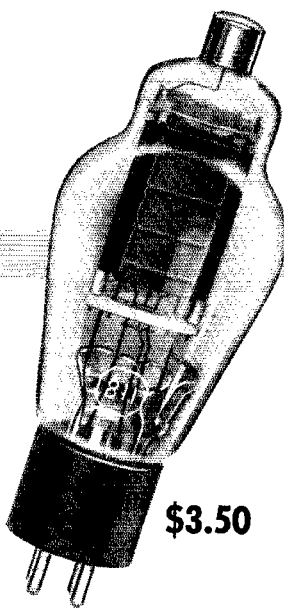

\$3.50

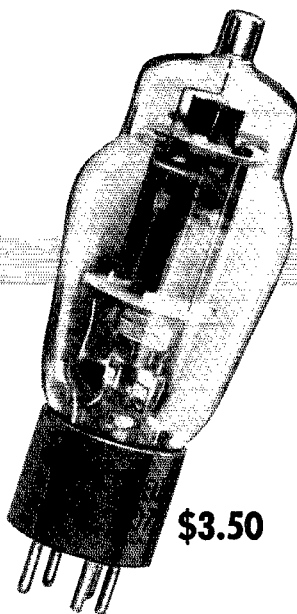

\$3.50

GENERAL  **ELECTRIC**

161-2

THE AMERICAN RADIO RELAY LEAGUE

Directors

<i>President</i>	
EUGENE C. WOODRUFF	W8CMP
234 W. Fairmount Ave., State College, Pa.	
<i>Vice-President</i>	
GEORGE W. BAILEY	W1KH
74 Webster Road, Weston, Mass.	
<i>Canadian General Manager</i>	
ALEX REID	VE2BE
169 Logan Ave., St. Lambert, P. Q.	
<i>Atlantic Division</i>	
WALTER BRADLEY MARTIN	W3QV
Box 612, Roslyn, Pa.	
<i>Central Division</i>	
R. H. G. MATHEWS	ex-W9ZN
4334 Dover St., Chicago	
<i>Dakota Division</i>	
FRED W. YOUNG	W9MZN
107 Hanover St., Mankato, Minn.	
<i>Delta Division</i>	
E. RAY ARLEDGE	W5SI
P.O. Box 286, Pine Bluff, Ark.	
<i>Hudson Division</i>	
KENNETH T. HILL	W2AHC
115 Willow St., Douglaston, L. I., N. Y.	
<i>Midwest Division</i>	
FLOYD E. NORWINE, JR.	W9EFC
7405 Elawatha Ave., Richmond Heights, Mo.	
<i>New England Division</i>	
PERCY C. NOBLE	W1BVR
37 Broad St., Westfield, Mass.	
<i>Northwestern Division</i>	
RALPH J. GIBBONS	W7KV
c/o United Air Lines, Portland, Ore.	
<i>Pacific Division</i>	
J. L. MCCARGAR	W6EY
66 Hamilton Pl., Oakland, Calif.	
<i>Peanoke Division</i>	
H. L. CAVENESS	W4DW
State College Station, Raleigh, N. C.	
<i>Rocky Mountain Division</i>	
GLEN R. GLASSCOCK	W9FA
2164 So. Corona St., Denver	
<i>Southeastern Division</i>	
WILLIAM C. SHELTON	W4ASR
Box 652, Daytona Beach, Fla.	
<i>Southwestern Division</i>	
CHARLES E. BLALACK	W6GG
1273 Main St., El Centro, Calif.	
<i>West Gulf Division</i>	
WILLIAM A. GREEN	W5BKH
801 Ross St., Abilene, Texas	

THE AMERICAN RADIO RELAY LEAGUE, INC., is a non-commercial association of radio amateurs, bonded for the promotion of interest in amateur radio communication and experimentation, for the relaying of messages by radio, for the advancement of the radio art and of the public welfare, for the representation of the radio amateur in legislative matters, and for the maintenance of fraternalism and a high standard of conduct.

It is an incorporated association without capital stock, chartered under the laws of Connecticut. Its affairs are governed by a Board of Directors, elected every two years by the general membership. The officers are elected or appointed by the Directors. The League is non-commercial and no one commercially engaged in the manufacture, sale or rental of radio apparatus is eligible to membership on its board.

"Of, by and for the amateur," it numbers within its ranks practically every worth-while amateur in the nation and has a history of glorious achievement as the standard-bearer in amateur affairs.

Inquiries regarding membership are solicited. A bona fide interest in amateur radio is the only essential qualification; ownership of a transmitting station and knowledge of the code are not prerequisite. Correspondence should be addressed to the Secretary.



HIRAM PERCY MAXIM, FIRST PRESIDENT

Officers

<i>President</i>	EUGENE C. WOODRUFF, W8CMP
	State College, Pa.
<i>Vice-President</i>	GEORGE W. BAILEY, W1KH
	Weston, Mass.
<i>Secretary</i>	KENNETH B. WARNER, W1EH
	West Hartford, Connecticut
<i>Treasurer</i>	ARTHUR A. HEBERT, W1ES
	West Hartford, Connecticut
<i>Communications Mgr.</i>	F. EDWARD HANDY, W1BDI
	West Hartford, Connecticut
<i>General Counsel</i>	PAUL M. SEGAL
	1026 Woodward Building, Washington, D. C.
<i>Address all general correspondence to the administrative headquarters at West Hartford, Connecticut.</i>	

"IT SEEMS TO US—"

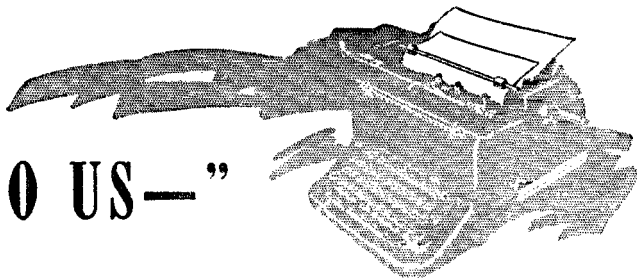

ONE of the most interesting phenomena in radio occurs when a startling new invention is put on display and the art turns out en masse to hear about it. The two weeks' hearing that the Federal Communications Commission gave frequency modulation in March was such an occasion. Frequency modulation of course is several years old; it has, in fact, well passed the experimental stage. But that is what made the hearing particularly important, as those who had pioneered in the new art met to tell the Commission of their successes and to ask for regular facilities. About three hundred people were present, some dozens to testify but most of them to listen. They had come from all over the nation and they were eager to learn. Almost everyone had a notebook, and the meeting building and nearby hotels were filled for hours after the daily sessions with earnest technical discussions and inquiries. The hearing a great deal more resembled the Rochester spring meeting of the technical societies than it did a formal Commission proceeding.

All of which is by way of saying that there are plenty of people besides ourselves and the broadcasters who are interested in f.m.: police, aviation, facsimile, forestry, and numerous other services were there to hear and learn — as we were ourselves. Armstrong's "day in court" turned into a two-weeks' technical session. (Our own attendance, by the way, was not only for the purpose of hearing more about what f.m. could do but to be ready for action if anybody made come-hither gestures at any of our bands. They did not. F.m. broadcasting wants to go ahead around its present frequencies near 43 Mc. and there were no cracks about amateur frequencies.)

The Commission has the subject in tow now and from its deliberations some answer will appear within a few weeks, probably a green light for f.m. broadcasting in some form. As to our own application of the system to amateur radio, we remain in the position where not much more can be seen and determined until the method is put into more extensive use by amateurs. There is no gainsaying some of its advantages, chiefly in the reduction of electri-

cal noise. But only practical experience can tell us what our interference patterns will be or whether we can get reliable communication over a greater distance with f.m. than with a.m. That is why we hope that more of the u.h.f. fellows will interest themselves in giving the new method a practical workout. And that is why great interest attaches to our Board's consideration this month of whether to ask for the opening of parts of our 5-meter and 10-meter bands to this new type of emission. Our technical editors hope you will report your f.m. results. Swing it, hams, and tell us about it!

THROUGHOUT the years of A.R.R.L. contests, the Communications Manager of the A.R.R.L. in choosing his dates has rubbed hard on his rabbit's foot, looked up the ionosphere dope, and relied a lot on practical ham experience. By and large we all must agree that he has done a mighty swell job of it. But didn't he pick a lulu this year, with the greatest ionosphere upset in man's knowledge smack on the wind-up weekend! Hi! The Ides of March have been pretty obstreperous this year. The daily press took cognizance of the situation and for a day or two it looked like the combined imaginations of Messrs. H. G. Wells and Orson Welles were again perpetrating a cosmic incident.

Indeed it was an amazing phenomenon. We heard of one land-line that was said to have experienced a potential of 4000 volts. The disgruntlement of the DX-Contest crowd naturally was complete and dark with the wipe-out of all normal signals. That there was a silver lining, however, is amply attested by the extraordinary behavior of the ultra-highs. Five meters went on a wild orgy, the results of which Ed Tilton reports in his column this month with unconcealed glee. You'll read it in fascination.

This aurora skip business is mighty interesting stuff. It has had the 5-meter gang worked up to fever pitch. Apparently there is little knowledge of the effect in scientific circles. We scouted around for someone that might be able to tell us more about it but

couldn't find anyone who would undertake to say what was happening. There is but little definite data. Auroral displays in these latitudes are generally the accompaniment of magnetic storms and ionosphere disturbances where anything may be happening. We did uncover one thought new to us, the belief that a region where aurora is occurring constitutes a sort of *vertical* layer which could give reflections horizontally instead of vertically — except that no one seems to know whether the proper conditions exist in it for reflections. This is probably one more field in which we amateurs are doing the pioneer observing. We'll be looking around at this spring's U.R.S.I. meeting for anybody who can tell us more about it. Meanwhile, let us hear of your observations.

EIGHT months of the European war and we have demonstrated that amateur activity offers absolutely no hazard whatever to the neutrality of our country. It is a performance of which we can be extremely proud. We have shown individual good sense and judgment and collective trustworthiness, and have earned both praise and confidence at Washington.

We must not ever get careless about this matter, even for a moment. You, the individual amateur, should be constantly alert to escape any possibility of embroilment. We have come thus far successfully. Don't spoil it. It can still be spoiled by a careless or wanton action. Keep in mind the A.R.R.L. neutrality code and test every contemplated act against its standards. Do just that and we'll continue smooth sailing. Don't get careless! K. B. W.

★ SPLATTER ★

The authors of the YLRL story on page 22 did a very thorough job, take it all in all. They forgot just one thing. They didn't tell us about themselves.

To rectify this omission, we put our sleuths on the trail and gleaned the following: W8TAY, publicity officer of the league, gave up a promising career as a dancer to marry W8SSV. She has also done professional publicity (e.g., for Dolores del Rio), was secretary to a vice-president of General Motors, now works at Cleveland's Union Bank of Commerce. Expert at tournament casting and target shooting, it's only natural she should turn to 28 and 14 Mc. DX.

W9NBX, on the other hand, sticks to 40 and 80 — c.w. only. Licensed about a year and a half, she wields a hundred watts to good effect. She is married to W9ERR, O.P.S. — well known, also, for his coyote hunting and his dogs. (Yes, those are his coyotes in the picture.) Incidentally, W9NBX is a bug on cryptography, as befits a loyal A.A.R.S. Ah, me — remember when it was a man's Army?

Our Cover

Once more we feature the electronic key on the cover. George Grammer was convinced he could do away with a few relays and thus simplify and make the key much less costly. The cost of his creation is in the neighborhood of \$10 and is reproduced life size.

— . . . —

Don't fail to read the lead article on Extended Variable Frequency Crystal Control. It should go a long way in curing the ills of variable-frequency

self-controlled oscillators. It is the result of a suggestion we had from W9ZGD.

15th Annual Hudson Division A.R.R.L. Convention

THE 15th Annual Hudson Division Convention is being sponsored by the Union County Amateur Radio Association, Inc., and is to be held on May 11, 1940, at the New Krueger Auditorium, Springfield and Belmont Ave., Newark, N. J.

The program for the one-day conclave is divided as follows:

- 1- 6 P.M.: Demonstrations, technical talks, motion pictures, League organization meetings, code speed contests.
- 6- 8 P.M.: Banquet — informal short speeches by League officials.
- 8-11 P.M.: Real old-time hamfest, including informal speeches, entertainment, demonstrations, motion pictures, prize drawings (over \$1000 in prizes).
- 11- 2 A.M.: Dancing and refreshments.

This convention is open to all persons interested in amateur radio. Admission (including banquet), \$2.25. Convention or banquet ticket separately, \$1.25 each. For tickets or information write Stanley Allen, W2CZS, 116 Poplar Street, Roselle, N. J. (telephone RO 4-2187-J).

Strays

The expression "soup to nuts" must have originated in ham circles — from the soup in the antenna to the nuts that pound the key.

— W3QP.

Every once in a while someone comes along with a new idea that is obvious enough (after it has been proposed) to bring forth a "Why didn't I think of that?" reaction. Such an idea is the one suggested by W9ZGD for extending the frequency variation of a variable-frequency crystal. It's hot enough to make it appear that here is the answer to variable-frequency operation with complete crystal control all the way, and we need suffer no longer from chirpy and rough e.c.o. notes. Incidentally, it allows break-in operation on one's own frequency with the crystals running all the time, and 7-Mc. crystals can be used for 80-meter control. In case you've felt there's nothing new in ham radio, start reading and have your mind changed. — EDITOR.

Extended Variable Frequency Crystal Control

Wide-Range Variation with Quartz Crystal Oscillators

BY BYRON GOODMAN,* WIJPE

Two major avenues of attack have been followed in coping with the amateur's ever-present problem of changing his operating frequency to the right spot in any particular band. One, which has become exceedingly popular in the last few years, is the use of the often-praised (and criticized!) electron-coupled oscillator, and the other employs the "conversion" exciter, which uses a low-frequency self-excited oscillator to beat with a crystal-controlled oscillator. The latter type of control has never reached any particular height of popularity, probably because of its penchant for additional frequency combinations that are sometimes confused with the desired frequency. The electron-coupled oscillator is capable of good performance, providing a reasonable amount of care is used in its construction, but there is too great a tendency for amateur constructors to overlook a few of the fine points so essential for optimum results. Even then the performance can never match that of a good crystal.

One other method of QSY has received some consideration and, from an amateur standpoint, is undoubtedly the most logical. This is the use of variable-gap crystal holders where, by changing the air gap between the holder and the crystal, the frequency of a 3.5-Mc. crystal can be changed

approximately 6 kc.¹ If the range of variation of such a crystal could be extended to cover 100 kc. or so, it would be possible to cover the entire 14-Mc. band with only one crystal, and we would have an ideal control system. It can be done.

The Principle of Frequency Extension

Full credit for the conception of the principle goes to Mr. Keith Hayes, W9ZGD, who wrote to Headquarters suggesting the method. Not having time to try the system himself, Mr. Hayes asked us what we thought of it. That was a superfluous question, as evidenced by our dropping everything else and making a dash for the lab to toss together an experimental model.

The principle is simplicity itself, and was suggested to Mr. Hayes by work on frequency modulation. Referring to Fig. 1, two crystal oscillators, one with a fixed crystal on 3790 kc. and one with a variable-gap crystal on 3984 kc., work with their outputs on the third-harmonic frequencies. These aren't the only frequencies that will work in the system — they are simply used as examples. The third-harmonic outputs from these two oscillators are fed independently to two frequency-tripler

¹ One of the crystal manufacturers has recently announced a variable crystal capable of a 12-kc. variation at 3.5 Mc. — Ed.

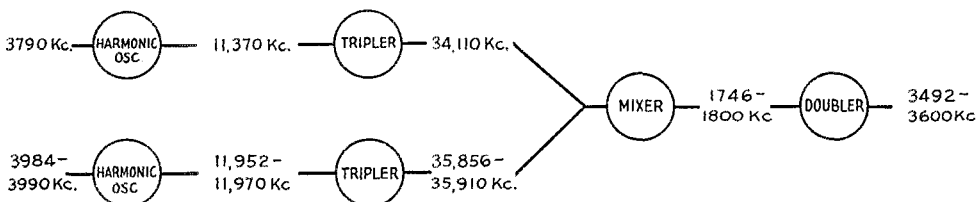
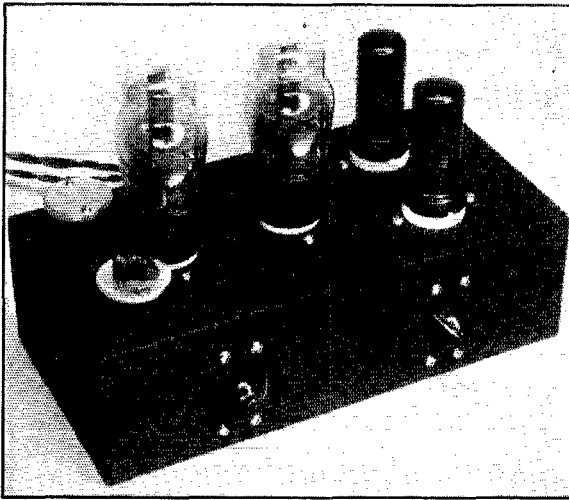

Fig. 1 — A block diagram illustrating the principle of extended frequency variation. The crystal frequencies shown are not the only ones that can be used — they were selected only as examples.



◆
 Four tubes were used in the experimental version of the full-range variable-frequency crystal control unit. The two crystals can be seen at the left — the tubes are two 6A6's and two 6V6's.
 ◆

stages, giving the 9th harmonics of the two crystals, or 34,110 and 35,856 kc. respectively. If this energy is mixed in a converter stage, we can obtain the beat or difference frequency of 1746 kc. The sum frequency of 69,996 kc. could also exist, but by tuning the plate circuit of the converter to 1746 kc., the "image" is completely eliminated. The 1746-kc. output can now be introduced to a doubler stage to obtain 3482-kc. output. When the variable-gap crystal is set to 3990 kc., the 9th harmonic from this oscillator becomes 35,910 kc., and the difference between this and the fixed-frequency oscillator's 9th harmonic is 1800 kc. Doubled, the 1800 kc. becomes 3600 kc., and we have a variation in our output on 80 meters of from 3500 to 3600 kc. with but one variable crystal!

It isn't necessary, of course, to use crystals with exactly the frequencies mentioned — any two 80-meter crystals (one of them variable) with a minimum frequency difference of 194 kc. would give the same result. Nor is it necessary to hold to only the use of 80-meter crystals — 40-meter ones should work just as well, although one or both would necessarily be ground to outside the 7-Mc. band. Practically an infinite number of combinations can be worked out.

In general, it is necessary to have two crystals, one (or both) of which is a variable-frequency unit, that have a frequency difference which when multiplied by the harmonic used will give the fundamental difference frequency required. For example, any two crystals that have a difference of 200 kc. will, when worked on their 9th har-

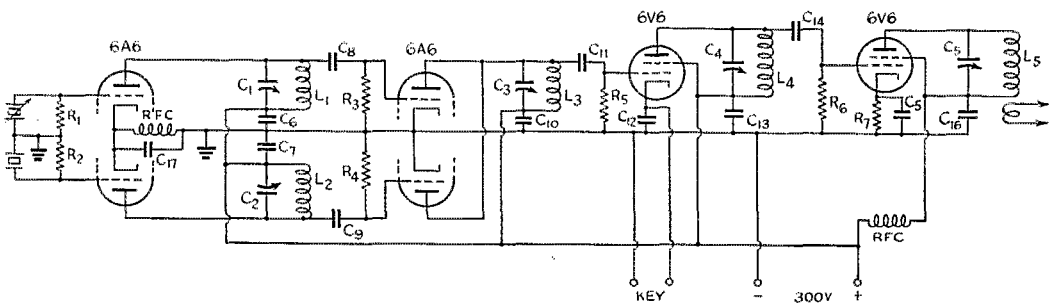

Fig. 2 — Wiring diagram of the experimental version.

- C₁, C₂ — 50- μ fd. midget variable.
- C₃ — 35- μ fd. midget variable.
- C₄ — 100- μ fd. midget variable shunted by 50- μ fd. mica.
- C₅ — 50- μ fd. midget variable shunted by 25- μ fd. mica.
- C₆, C₇, C₁₀ — 0.002- μ fd. mica.
- C₈, C₉, C₁₁, C₁₄, C₁₇ — 100- μ fd. mica.
- C₁₂, C₁₃, C₁₅, C₁₆ — 0.01- μ fd., 400-volt paper.
- R₁, R₂, R₃, R₄ — 50,000 ohms, 1-watt.

- R₅, R₆ — 75,000 ohms, 1-watt.
- R₇ — 300 ohms, 1-watt.
- RFC — 2.5-mh. r.f. choke.
- L₁, L₂ — 14 turns No. 20 enam., $\frac{3}{4}$ -inch diam., $\frac{3}{4}$ -inch long.
- L₃ — 5 turns No. 18 enam., $\frac{3}{4}$ -inch diam., $\frac{1}{2}$ -inch long.
- L₄ — 77 turns No. 34 d.c.c., close-wound on 1-inch diam. form.
- L₅ — 65 turns No. 34 d.c.c., close-wound on $\frac{3}{4}$ -inch diam. form.

monics, give a fundamental frequency of 9×200 or 1800 kc. For reasons to be discussed later, it is advisable to select crystals that have no harmonics within the operating range. The crystals shown in Fig. 1 will have harmonics falling outside the operating range, as would many other combinations.

If both crystals have the same temperature coefficient, the resultant drift will be exactly the same as if one crystal were used. However, by properly selecting the temperature coefficients of the two crystals used, it should be possible to obtain practically a zero coefficient as a resultant.

Perfected Break-In Keying

The major objection many amateurs have to break-in operation is the slight keying chirp that accompanies oscillator keying, particularly on the higher frequencies. Many amateurs key their oscillators satisfactorily on the 3.5- and 7-Mc. bands, but on the higher frequencies the chirp becomes accentuated and undesirable. The oscillator system just described opens up an entirely new field for perfected break-in keying. For example, the operator working on 7000-7200 or 14,000-14,400 kc. with the crystal combination mentioned above can let the crystals run continuously and key the cathode circuit of the converter stage. The crystals, running continuously with a practically constant load (the input circuits of the tripler stages), yield constant frequencies with the key up or down, but when the key is up no signal exists on the operating frequency. The crystals must, of course, run with constant frequency and have no fluctuation caused by voltage changes, since any frequency change will be accentuated in proportion to the amount that the variable range has been increased. This presents no serious problem, however, since it is relatively easy to stabilize the power supply feeding the oscillators. The

harmonics from the crystals are well outside the operating range and are not heard, except possibly as images in a superheterodyne without adequate preselection.

An Experimental Version

The photographs show the experimental model that was hurriedly thrown together to test the new system. As can be seen from the wiring diagram in Fig. 2, the two triodes of a 6A6 are used as oscillators in the so-called "harmonic oscillator" circuit, with a common cathode reactance and their plate circuits tuned to the third harmonics of the crystals. These oscillators are used to drive tripler stages (also 6A6 sections) tuned to 35 Mc. A common 35-Mc. tank circuit is used, since the selectivity of a circuit at this frequency is not so great that a good load isn't offered to both frequencies. The two outputs of the tripler stages are fed to the grid of a 6V6 converter stage, and the plate circuit of the converter is tuned to 1.75-1.8 Mc. Another 6V6 follows, to double to the 80-meter band.

With 300 volts on the plates of all tubes, enough output is obtained on 3.6 Mc. to light a flashlight lamp to half brilliancy, representing an output of about 3 watts and quite sufficient to drive any of the usual beam-power or pentode-type tubes. Keying the cathode of the 6V6 converter, no signal is heard with the key up, and the keyed signal is as rock-steady and free from chirps as any multi-stage crystal rig keyed a stage or two after the crystal stage. The 6V6 doubler following the converter draws plate current with the key up because no provision was made for fixed cut-off bias, but the cathode resistor R_7 limits the key-up current to a normal value. The power output from the converter is not too great, but it is enough to enable the following 6V6 to do a fair job of doubling to 80 meters.

(Continued on page 57)

◆
A view under the chassis of the experimental model shows the arrangement of parts and the coils mounted on or near the condensers. A better version would include shielding of the various stages and other refinements.
◆

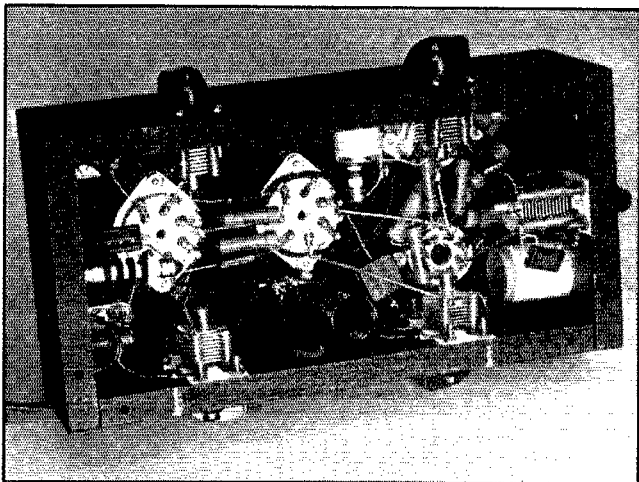

An Inexpensive Electronic Key

A Compact Automatic Dot-and-Dash Unit with Manual Switching

BY GEORGE GRAMMER,* W1DF

CONTRARY to most beginners' beliefs, it is much harder to send than receive — at least after the first hurdle of learning the code has been passed. The doubter can find plenty of evidence surrounding him on any band where the art of amateur c.w. telegraphy is practiced. That's why we believe that a device such as W2ILE's electronic key¹ offers an opportunity for every ham to put more readable code on the air — it makes sending easier. Not only that; it forces the acquisition of a "swing" that goes with the code itself. The other kind of swing is too well known to need comment.

Cost is always an important factor with a large percentage of the ham community, and it is axiomatic that the lower the cost of a thing the more use it is going to get. The key described here represents an attempt to get the cost down to a minimum without sacrificing too many of the advantages inherent in W2ILE's original model. It is presented not primarily as something to be duplicated, but in the hope that it will, as well, generate other and better ideas along manual switching lines, since manual switching is the clue to economical construction.

The basic circuit is, of course, the same as that used by W2ILE. The switching operations necessary for the selection of dots or dashes are performed by a three-pole double-throw spring switch of the type mentioned in April *QST*, with some modification of the mechanical arrangement for moving the springs.

Circuit Details

The circuit, shown in Fig. 1, omits a few of the functions performed by that in April *QST*. There

* Technical Editor.

¹ Beecher, "Electronic Keying", *QST*, April, 1940.

is, for instance, no dot length control, the dot length being set permanently by means of a fixed resistor, R_5 . This reduces the flexibility somewhat, but in practice works out quite well for the range of speeds over which an amateur is likely to use the key. The provision for keeping a small charge in condensers C_1 and C_2 has also been omitted, as experience with the key showed that the lengthening of the first dot or dash was apparent only at quite slow speeds and could not be noticed at moderate and high speeds. It is no doubt still there, but it is difficult to detect. An addition to the circuit is the two-way switch, S_2 , to cut out the automatic dashes when desired, so that the key can be used as an ordinary "bug" or as a straight key with a side motion. This feature is useful for very slow sending, or to enable a visiting ham who hasn't previously used an automatic-dash key to do some operating. The two positions of S_2 close one dotted circuit at a time, leaving the other open. When the upper position is closed the dash contact springs short-circuit the relay coil, thereby closing the external keyed circuit. The circuit will stay closed just so long as the key is in the dash position. At the same time the lower contacts of S_2 are open, disconnecting the moving dash spring from ground when the operating arm is in the neutral position; this is necessary to avoid short-circuiting the 884 plate to ground. Throwing S_2 to the other position, closing the lower contacts and opening the upper set, restores the automatic dash operation.

A number of different sensitive relays were tried, and all worked quite well. The differences between them are largely in mechanical features such as solidity of construction, ease and range of adjustment, size of contacts, and so on. The contact question should be given particular attention

◆
Taking the same table space as an ordinary key, this "economy" version of the electronic key can be built by anyone handy with simple tools.
◆

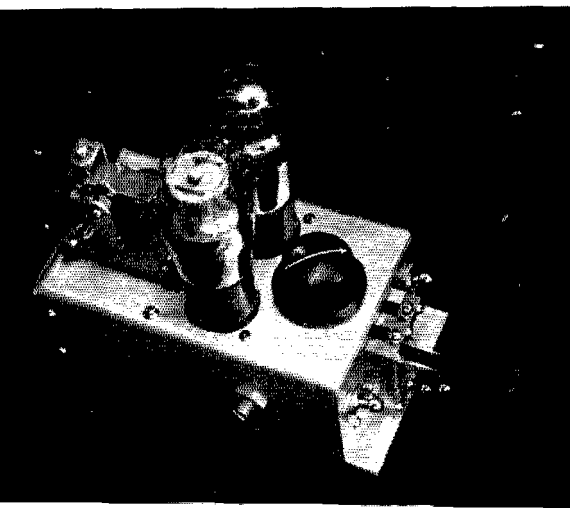

An inside view, showing arrangement of parts on base and chassis. The switch is a standard unit removed from its regular mounting and fastened to a bracket made of sheet brass to bring it to the right height above the base.

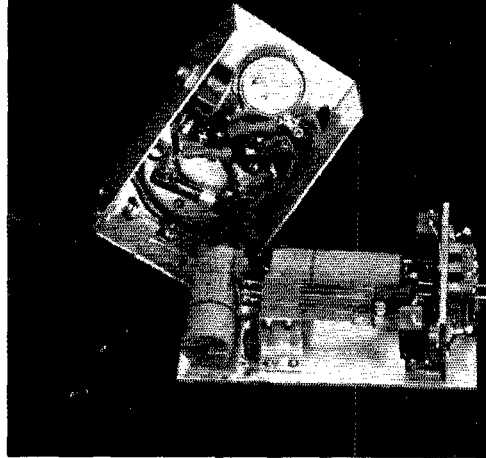

in view of the type of circuit to be keyed; probably all the sensitive relays are best suited to keying relatively low-voltage low-current circuits since the contact spacing is not wide. For blocked-grid keying, or for center-tap keying of transmitters of moderate power, the relays can be used directly. Center-tap keying in a high-power transmitter, or primary keying, undoubtedly would necessitate a separate keying relay. In the present instance we selected a low-cost relay, since we were interested in building the key as economically as possible.

There is no built-in power supply in this model, because in many cases sufficient power to operate the key will be available from a receiver power pack, bias supply, or other low-voltage source. The tube heaters require 0.9 amp. at 6.3 volts, and the plate requirements are very modest — less than 15 ma. at 250 volts.

Construction

In building this key one of the objectives was to keep the dimensions small enough so that no more table space would be occupied than is taken by an ordinary "bug." As shown in the photographs, the key mechanism is mounted on a rectangular base with a small panel. Base and panel are made of $\frac{1}{8}$ -inch aluminum, the base measuring $3\frac{1}{4}$ by

6 inches and the panel $3\frac{1}{8}$ wide by 2 inches high. The panel width is slightly less than that of the base to permit the folded chassis to fit around it and come out flush with the edges of the base. The chassis is $5\frac{1}{2}$ inches long overall and the inside measurements of the folded parts are $3\frac{1}{8}$ inches wide by 2 inches high. The material is 1/16-inch aluminum.

On top of the chassis the speed control, R_1 , is at the front, the two tubes just behind, and the relay at the rear. The keyed-circuit contacts of the relay drop through the chassis top and make connection to a two-terminal strip on the rear folded-down edge. The dash-length control, R_6 , is mounted on the left side of the chassis near the front. Since this control does not need frequent manipulation, the shaft is sawed off and a slot cut in it for screwdriver adjustment. The two switches are on the panel.

The inside view shows how the remaining parts are fitted in. Condensers C_1 and C_2 lie on the base; the spark-absorbing resistors, R_9 and R_{10} , are soldered directly to the wire leads from the condensers. R_7 is mounted between an appropriate pair of terminals on the key switch, S_3 ; one end

Fig. 1 — Electronic key with manual switching. Tube heaters are connected in parallel.

- C_1, C_2 — 1- μ fd. paper, 400-volt.
- R_1 — 40,000 ohms, $\frac{1}{2}$ -watt.
- R_2 — 500-ohm potentiometer.
- R_3 — 600 ohms, 1-watt.
- R_4 — 25,000 ohms, 10-watt.
- R_5 — 25,000 ohms, 1-watt.
- R_6 — 0.25-megohm potentiometer.
- R_7 — 0.15 megohm, 1-watt.
- R_8 — 2 megohms, $\frac{1}{2}$ -watt.
- R_9, R_{10} — 100 ohms, $\frac{1}{2}$ -watt.
- S_1 — D.p.s.t. toggle.
- S_2 — Two circuit, alternate closing, toggle switch.
- S_3 — 3-pole double-throw jack switch (Xaley No. 63).
- Ry — S.p.d.t. relay, to close on 1.5 ma. approximately (RCH-11-D).

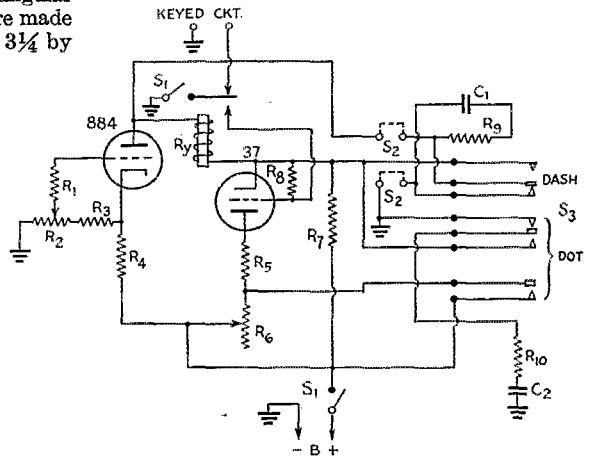

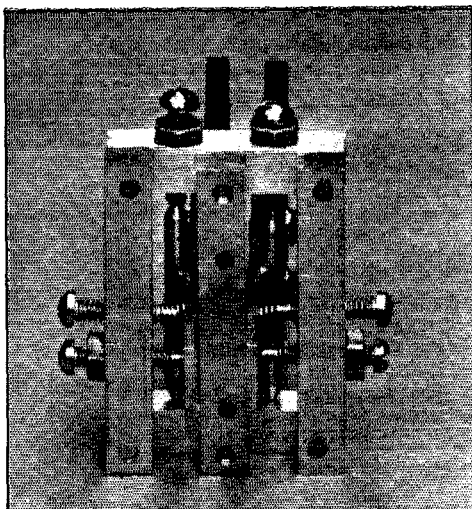

A close-up of the back of the key-lever mechanism. Made of quarter-inch square brass, this assembly mounts on the small panel.

of it is visible under the group of lugs at the rear of the switch. The other resistors are mounted inside the chassis near the tube sockets as shown, with R_4 held in place by a pair of insulated lugs on the chassis. The connecting wires between the base and chassis are bunched into a cable along the right-hand side of the base and run vertically up the rear right corner of the chassis. Base and chassis are fastened together at the rear by means of a short piece of half-inch angle brass tapped for 4-36 screws. The clamping action of the chassis on the panel holds the assembly together at the front.

There is probably no real necessity for making the key highly compact; we were interested, however, in seeing what could be done. Any type of construction will be satisfactory since, unlike r.f. circuits, placement of parts and length of leads have no effect on the performance of the circuit.

Key Mechanism

There are many possible ways in which the necessary switching might be accomplished. The method shown here is not necessarily the best, but it represented a convenient means of obtaining the requisite number of contacts and switching action without undue mechanical complications. The haywire key pictured in April *QST* had two principal defects: Lack of spring tension adjustment (also a kind of spring action which does not have the right "feel"), and lack of positive centering of the key lever in the neutral position. In the present version, the former has been partially overcome by cutting out about half of each spring to make it narrower, and filing down the remaining part to make the action as light as possible. Auxiliary springs are provided on the

key levers for tension adjustment. Centering was taken care of by using a double-lever arrangement, one lever for dots and the other for dashes, so that each lever returns to the back stop independently of the other. Some operators do not care for this type of action, particularly those used to a single-lever "bug." A single-lever key having the necessary centering could be constructed along regular "bug" lines, of course; it seemed to us, however, that the double-lever scheme offered fewer constructional problems.

A small amount of facility in the use of simple metal-working tools will enable anyone to make a practicable key. A hacksaw, file, a couple of drills and a tap are about all the tools needed. The key shown here is constructed from pieces of $\frac{1}{4}$ -inch square brass salvaged from the junk box, plus a small amount of $\frac{1}{8}$ -inch brass rod and half-inch brass strip. A general idea of the construction can be obtained from inspection of the various photographs. The three vertical pieces which hold the assembly together are 2 inches long; the middle piece is the back stop for the levers and the two outer pieces are drilled and tapped for the adjustable front-stop and spring-adjustment screws. The horizontal members are $1\frac{1}{4}$ inches long; both are drilled for 4-36 machine screws which tap into the vertical members at top and bottom to hold the works together. The top horizontal piece is also tapped for the pivot screws, while the lower has small holes drilled in it for the pivots. The pivot screws are drilled likewise, after having been filed flat on the ends. The pivots are pieces of $\frac{1}{8}$ -inch round brass rod filed to a point on each end, with the taper smoothed off with steel wool. The pivot rods are soldered to the key arms, each of which is a 2-inch length of $1/16$ -inch brass strip 2 inches long. The paddles and the arms which push the switch springs are pieces of $\frac{1}{8}$ -inch bakelite; insulation is necessary at the switch end because the springs are carrying voltage. The fibre piece on the switch which normally gangs all three movable springs together is cut so that only the two dot springs are coupled, leaving the dash spring independent.

The small coil springs for tension adjustment on the key mechanism are taken from tire valve insides, cut down to a suitable length to fit. These springs, as a matter of fact, have a highly-satisfactory action for keying purposes. Unfortunately, the springs on the switch still come into the picture and the action of the whole combination is not so good as that of the lever mechanism alone. We think, in fact, that it might be a good idea to discard the switch entirely and mount the contacts on the levers, but this again would introduce some other problems—including that of getting suitable small contacts. W2ILE has suggested using pivoted switch arms, thus doing away with any tension in the switch; this may be the answer. although it would be necessary to

(Continued on page 21)

A Compact 112-Mc. Station

Complete Unit for Portable or Mobile-Use

BY HOWARD C. LAWRENCE, JR.,* W2IUP

LOOKING around for a versatile mobile and portable 2.5-meter companion to the short-lines equipment used at the home station, it was decided to convert to 112-Mc. operation a piece of 56-Mc. equipment built for similar use about two years ago.¹ That equipment had been used extensively up to the time the new regulations went into effect and had proved very satisfactory. It had been used with a storage battery and dynamotor power supply in several different automobiles for communication with a glider, other automobiles, and power-boats, in two different power-boats for relaying news of crew and swimming races to shore, and with the 110-volt a.c. power supply at several different shore locations.

The requirements for the new equipment were essentially the same as for the old. A rig was wanted that could be used for portable and mobile use, powered by either a 6-volt storage battery or an a.c. line. Since this equipment would not be used in any one location for any great length of time, the complete station had to be as compact as possible, with a minimum of extras to be carted along when setting up. Past experience with transceivers had shown the desirability of a separate transmitter and receiver. Duplex operation had shown itself very desirable under certain conditions of operation. The power consumption had to be low to avoid excessive drain on a battery supply and to keep down the cost of the power supply used for mobile operation.

* 704 Redman Avenue, Haddonfield, N. J.

¹ Lawrence, "A Compact 56-Mc. Portable-Mobile Transmitter-Receiver," *QST*, December, 1937.

The complete 112-Mc. station is only 9 inches by 6 inches by 5 inches deep. The transmitter tuning dial is on the left and the receiver dial on the right. The two knobs at the bottom of the panel control receiver volume (left) and regeneration. The power supply is brought in through a cable to the socket at the right, to permit the station's being tucked away in a corner.

Convenience in operation dictated that there be no vernier dials so that the band could be covered quickly; that the transmitter frequency be controlled by a single knob so that it would be easy to shift frequency to avoid QRM or to find a frequency suitable for duplex operation; that the change from send to receive be made with a single control, and that the equipment be provided with a small light to illuminate the control panel and provide sufficient illumination for filling in the log at night. All wires and controls were to be brought out on the control panel so the unit could easily be pushed back against the wall or into a corner.

Operation of the 56-Mc. version indicated that an optional internal carbon microphone voltage supply would be useful when operating from an a.c. line. It was also decided to bring out an input connection that would allow use of an external preamplifier and high quality microphone for some types of work.

The Circuit

The transmitter uses a 6J5 for the oscillator and a 41 as modulator. Shunt feed of the oscillator keeps all high voltage for this stage below the chassis. The receiver is a 6J5 "Minute Man" super-regenerative detector, transformer-coupled to a 6J5 first audio amplifier. For simplex operation the 41 modulator acts as a second audio amplifier driving a loud speaker. Only the first stage of audio amplification is used for duplex operation.

The short leads and low interelectrode capac-



Summer revives interest in portable and mobile work, and the 112-Mc. enthusiast will have a hard time beating this little rig for simplicity and performance.

ities of the type 6J5 metal tubes make them more suitable for use as oscillators at ultra-high frequencies than the type 76 tubes originally used. The first audio amplifier uses a type 6J5 tube in order to keep the number of different types of tubes in the equipment at a minimum, thus decreasing the number of spare tubes that need be taken along on field trips. The modulator stage could use a type 6K6G tube if all octal-base type tubes were desired.

The transmitter circuit was changed slightly from the lower-frequency version to provide more efficient operation at the higher frequencies.

When the transmitter tank-circuit capacity is reduced to a point where the interelectrode capacities are a large portion of the total capacity in the tank circuit, the tube will oscillate better if these interelectrode capacities are allowed to establish the ground point on the tank circuit unhampered by a tap on the coil. For this reason the d.c. ground return of the tank circuit is made through a small r.f. choke, making the oscillator circuit essentially a Colpitts. By tapping this choke on the tank coil at a point of relatively low r.f. potential, the characteristics of the choke become less critical.

Two methods of spreading the desired tuning range over a large portion of the tuning dial were tried. The first was to reduce the capacity of the tuning condenser to a point where it was only a small portion of the total combined tube, distributed and tuning capacity in the circuit. This method was unsatisfactory for several reasons. It was necessary to split the stator plate of the

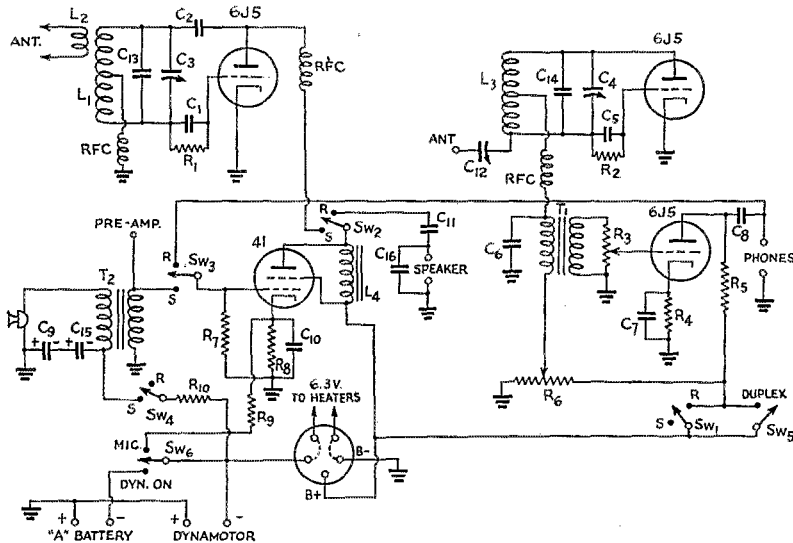

Fig. 1

- C₁ — 22- μ fd. ceramic capacitor (Centralab, RCA No. 33101).
- C₂ — 100- μ fd. mica.
- C₃, C₄ — 15- μ fd. variable with one stator plate removed (Cardwell ZR-15-AS).
- C₅ — 47- μ fd. ceramic (Centralab, RCA No. 33102).
- C₆ — 0.002- μ fd. mica.
- C₇, C₁₀ — 10- μ fd. 25-volt electrolytic.
- C₈, C₁₁ — 0.01- μ fd. 400-volt paper.
- C₉, C₁₅ — 50- μ fd. 25-volt electrolytic.
- C₁₂ — 35- μ fd. compression-type adjustable (Hammarlund EC-35).
- C₁₃, C₁₄ — 5.6- μ fd. ceramic (Centralab, RCA No. 33478).
- C₁₆ — 0.002- μ fd. 400-volt paper.
- R₁ — 10,000 ohms.

- R₂ — 10 megohms.
 - R₃, R₆ — 500,000-ohm midget potentiometers (Clarostat series M).
 - R₄ — 1500 ohms, 1-watt.
 - R₅ — 100,000 ohms, 1-watt.
 - R₇ — 0.5 megohm.
 - R₈ — 500 ohms, 5-watt (Clarostat type 5, wire-wound).
 - R₉ — 1500 ohms.
 - R₁₀ — 200 ohms.
- Unless otherwise noted, all resistors are $\frac{1}{2}$ -watt I.R.C. insulated type BT.
- L₁ — 4 turns No. 14 enameled wire, $\frac{3}{8}$ inch inside diameter, $\frac{1}{2}$ inch long. Tapped at center.
 - L₂ — 3 turns No. 12 enameled wire, $\frac{1}{2}$ inch inside diameter.

- L₃ — 3 turns No. 14 enameled wire, $\frac{3}{8}$ inch inside diameter, $\frac{3}{8}$ inch long.
 - L₄ — 22-henry, 35-ma. choke (Thoradson T18C92).
 - RfC — Approx. 50 turns No. 30 enam., wound on IRC 1 megohm, $\frac{1}{2}$ -watt resistor.
 - T₁ — 3:1 audio transformer (Thoradson Type R-260).
 - T₂ — Single-button microphone transformer (Kenyon type KR-79M).
- SW₁, SW₂, SW₃, SW₄ — 4 p.d.t. rotary switch (Yaxley).
- SW₅ — S.p.s.t. toggle.
- SW₆ — S.p.d.t. toggle.
- Dotted lines on power plug indicate connections made by dynamotor power plug.

A rear view of the 112-Mc. set shows the receiver portion and modulator to the left of the shield and the transmitter on the right. Note the shield under the chassis which runs around the transmitter-tube socket and wiring.

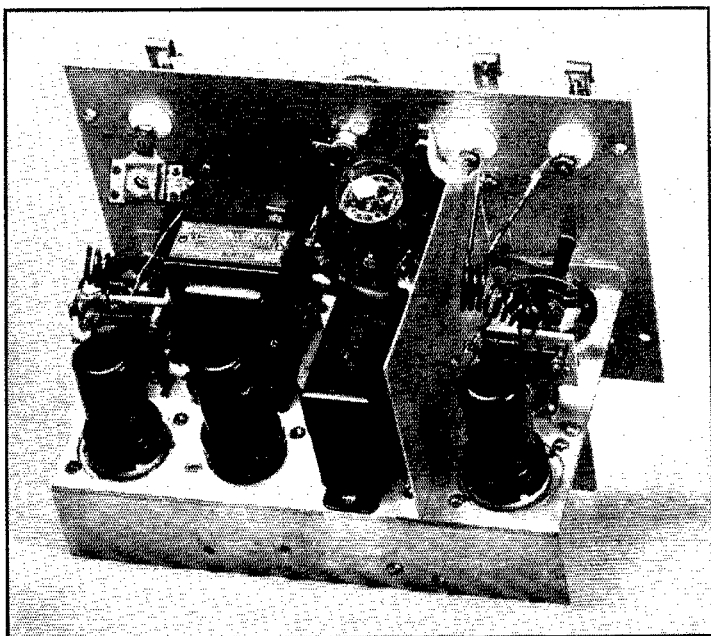

tuning condenser to get a small-enough variable capacity without spacing the stator further away from the rotor than the construction of the condenser would allow. This left only 90° of rotation available for tuning. Cutting down the size of this tuning capacity required that the coil inductance be increased. When low tank capacities are used at these ultra-high frequencies, the leads to the tube form an appreciable part of the tank circuit inductance. This means that when the coil is mounted on the tuning capacitor and leads run from the tuning capacitor to the tube, the tuning capacitor is in effect tapped across only part of the tank coil. This reduces its tuning effect. As the size of the tuning capacitor is reduced and the inductance in the coil increased, the tuning capacitor effectively becomes connected nearer and nearer to the ends of the coil where it becomes more effective in tuning the circuit. Thus a decrease in tuning capacitor size is partially offset by the increased effectiveness of the remaining capacity, making it necessary to decrease the size of the tuning capacitor much more than would at first be suspected.

Decreasing the tank-circuit capacity also decreases the output and stability of the oscillator. For these reasons it was decided to put a small amount of fixed capacity across the variable capacity. A small Centralab tubular ceramic capacitor was used — these capacitors have very low losses even at 112 Mc.

It was necessary to reduce the size of the transmitter grid condenser to prevent superregeneration. The value indicated should be satisfactory

for all transmitters, although it would be well to check the transmitter in this respect. If the transmitter is superregenerating, varying the position of the regeneration control on the receiver while the unit is set up for duplex operation will produce a series of chirps in the receiver as the varying receiver quench frequency beats with that of the transmitter. It is important that this grid capacitor, as well as the oscillator tube socket, be made of some low loss material.

The receiver is very much the same as the transmitter except for the plate voltage and grid-leak values. The position of the tap on the tank coil is not very critical, except that proper positioning of this tap will make up for some deficiencies of the choke. The antenna coupling capacitor, C_{12} , must be adjusted to a suitable value when the receiver is put in operation. The maximum capacity will give the best gain, although a resonant antenna will pull the receiver out of oscillation if the coupling is too great.

Construction

The complete unit is built on a $\frac{1}{8}$ -inch thick sheet aluminum chassis which fits into a black wrinkle-finished steel cabinet 9 inches long, 6 inches high, and 5 inches deep. The aluminum was cleaned and, after all drilling and cutting was completed, given a dull satin finish by dipping it in a solution of lye and water for a few minutes and then washing it well in clean water. All mounting bolts are equipped with lock washers to prevent their shaking loose. Care was taken to see that all resistors and capacitors are securely

supported so that they cannot vibrate and break loose. Paper capacitors that are normally supported by their leads should have short, heavy leads.

Looking at the control panel, the transmitter is on the left and the receiver on the right. The antenna terminal insulators are equipped with Fahnestock clips to make it easy to connect to the portable antenna. The toggle switch next to the transmitter tuning knob turns on all power when a storage battery is used. When using an a.c.-operated power supply, this switch selects either an external battery or the internal voltage supply for a carbon microphone. The duplex switch turns the receiver back on for duplex operation after the send-receive switch in the center of the panel is turned to the "send" position.

The four binding posts in the lower left-hand corner of the panel are for the storage battery and dynamotor when these are being used. The external microphone battery is connected to the battery terminals when one is being used during a.c. operation. The positive side of the battery is grounded as is standard practice in automobiles. Different type binding posts were used here to reduce the possibility of reversed connections; the grounded posts take a straight end of wire, while the negative terminals take a forked lug. The variable controls at the bottom of the panel are receiver volume and regeneration.

The socket in the lower right hand corner takes the power plugs. The plugs and socket are so arranged that the necessary circuit changes are automatically made when going from one type of power supply to the other. When working from the 110-volt a.c. supply the plug furnishes 6.3 volts a.c. to the heaters and the d.c. potential to the plates. The plug used with the dynamotor brings in the positive B and connects the heaters into the battery circuit as shown by the dotted lines in the circuit diagram. The negative B lead is connected to the case containing the dynamotor and filter. Drain on the high-voltage supply is about 60 ma. at 250 volts when working duplex.

One side of each of the circuits terminating in the pin jacks at the lower center of the panel is grounded. This keeps high voltages inside the cabinet and also makes it possible to use a standard three-wire telephone handset for duplex operation. Both of the microphone terminals are in the high side of the circuit. One is the input side of the microphone transformer for use with a carbon microphone, and the other is on the secondary of this transformer for use with an external preamplifier and high-quality microphone. Either the speaker or phone ground terminal is used for the other side of this circuit.

Looking inside the case, the modulation choke and modulator tube are mounted next to the transmitter shield. The first audio amplifier tube is next to the detector. The microphone transformer is mounted under the chassis.

While no control is provided for tuning the transmitting antenna, this circuit should be tuned for best results. The scheme used at this station is to build a general purpose antenna out of some flexible wire and then cut the feeders to the proper length to make them resonate with the coupling coil without any tuning capacitor. The proper length is determined by measuring the transmitter output with a simple field-strength meter consisting of a pickup coil, diode rectifier and a 0-1 milliammeter placed near the antenna, and clipping the feeders until maximum output is obtained. The antenna used most here consists of a 4-foot-long antenna fed at one end by 10-foot-long spaced feeders. The feeders are in line with the antenna so that the whole thing can be put up with one support.

Strays

Why don't they sell antenna wire (and other wire too) in connected coils of 100 ft. like they do with fishing line and clothes lines so a fellow won't have to buy a 1000-foot coil just to get a few hundred feet of unbroken wire?

— W5FGE

— —

Here is a good one I overheard on the five-member band: "Sorry ob, but I must QRT as my ow wants me to put the bottles I am using back in the b.c. set so she can hear FDR give a speech."

— WSOIE

— —

A.A.R.S. Aids C.C.C. Enrollee

FOR BOYD, an enrollee at C.C.C. Company 363, NP-14-VA., Camp Rocky Knob, Woolwine, Va., had a pertensillar abscess which suddenly grew worse while the camp physician, Dr. Russo, was in Roanoke. The camp is located in rough mountainous country and is without telephone service, so the camp radio operator, William H. Kiblinger, contacted W3BTM at Roanoke via A.A.R.S. State Net channels. The situation was explained briefly to W3BTM, who called the doctor's residence and was informed that he was in the vicinity of Simpsons, about twenty miles from Roanoke. The long-distance telephone operator then put in a call to Simpsons, and it was learned that the doctor was already on his way back to Roanoke. Several homes along the route were contacted by long distance, and when Dr. Russo was seen driving along the highway he was halted by one of the many residents who were on the look-out for him. He went to the nearest telephone and was connected with W3BTM, via whom first aid instructions were given directly to the Commanding Officer who was at W3IFZ. The hospital orderly carried out the instructions as ordered and in a short time the doctor arrived to continue the treatment. He now has recovered completely. It required but one hour to contact the doctor and get his instructions. W3BTM (Eldridge Emswiler) is the State Net Control Station of the Virginia A.A.R.S. 'Phone Net and W3IFZ (operated by Wm. H. Kiblinger, W3HBB) is Alternate State Net Control Station for the Virginia A.A.R.S. C.W. Net. W3IFZ and W3BTM express thanks to the fellows who stood by to clear the net frequency so the emergency messages could be handled.

— W3IFZ/HBB/WLQN

★ WHAT THE LEAGUE IS DOING ★

WEST GULF COAST ALTERNATE ELECTIONS

THE West Gulf Division has just held a special election to choose a new alternate director to succeed W. H. Burt, W5BRC, who recently died. The new alternate is William Thomas Caswell, jr., W5BB, of Austin, Texas, who was high man in a field of five candidates. The voting was as follows:

Mr. Caswell.....	151	vote
Carter L. Simpson, W5CEZ.....	97	"
David H. Calk, W5BHO.....	78	"
Fred L. Mason, W5CCB.....	33	"
James F. Manship, W5ALE.....	23	"

Mr. Caswell, a past president of the Austin Radio Club, is manager of the Austin Cotton Gin. W5BB is a well-known DX man, being a member of the DXCC and, of course, WAS and WAC. Although only 23 years of age, he has been an active ham since 1929. His term of office runs until the first of 1943.

BOARD MEETING

THE Board of Directors of A.R.R.L. will hold its annual meeting in Hartford the end of May. Members are cordially invited to write their directors their opinions on pending questions and any suggestions they may have for the betterment of amateur radio.

Most of the items so far on the agenda relate to internal matters of government. A president and a vice-president are to be elected at this year's meeting. The Pacific-Southwestern convention has proposed that the constitution be amended to provide that the president and vice-president be chosen from amongst the division directors, rather than being separate officers, so that some directors will serve both as the representative of his division and as the president of the League, and similarly for the vice-president. It is proposed to simplify the by-laws relating to the eligibility of the Canadian General Manager by simply saying that the same requirements apply as in the case of the U. S. directors, rather than repeating the rules in detail. Mr. McCargar proposes that h.c.i. servicemen be declared eligible to the Board provided they do not service or handle amateur equipment. The Secretary suggests that when no eligible candidate is named in director elections and it is necessary to repeat the solicitation, the procedure be done three months later instead of two months as at present specified, inasmuch as *QST*'s publication date does not make it possible to begin the procedure two months after the original solicitation.

Mr. Mathews will present an application from

the Chicago Area Radio Club Council to hold a national convention in Chicago in 1941. The Pacific-Southwestern convention proposes that each affiliated club and/or A.R.R.L. section be authorized to send to division conventions one delegate for each 25 club or League members, authorized to speak for the clubs.

There will doubtless be a number of suggestions about amateur regulations from the Planning Committee. We do not yet know what these will be. There will be a question whether the Planning Committee should be continued. There will be a proposal to double the 14-Mc. 'phone allocation, and there will probably be some discussion of 7-Mc. 'phone. One item of which we are certain is that the Board will examine the desirability of asking F.C.C. to open portions of the 56- and 28-Mc. bands to frequency modulation.

The Board of course will also be occupied with hearing the reports of its officers and committees, as well as receiving reports and suggestions from each director. As we write, it is nearly two months until the meeting, so there will doubtless be additional proposals as the date approaches.

WASHINGTON NOTES

THE time has come for us all to drop the old punctuation marks for period and comma, and to use the new Cairo marks. (The new period is the old comma; the new comma is the old exclamation mark; and there is now no exclamation mark!) Although only the unchanged interrogation point appears in the amateur copying test, other marks may appear in the sending test, and F.C.C. now require knowledge of the new marks where they appear in examinations. They are in fact coming into general adoption and it is our considered opinion that amateur radio from now on should use only the new marks.

Modifying what we say in the *License Manual*, an applicant for Class A may not take the examination until he has actually served a minimum of a year as a licensed amateur within the last five years (or has held a commercial extra first). It used to be different but was changed when our rules were last overhauled. See Sec. 151.01, which now reads in terms of who is "eligible to apply".

The address of the St. Paul office of the F.C.C. has been changed to 208 Uptown P.O. & Federal Courts Building. The Los Angeles office has moved to 1749 Federal Bldg.

It is *not* true that F.C.C. is reserving the right to change or cancel our present 112- and 224-Mc. bands without hearing or notice. They stuck that label on these bands when they assigned them

tentatively to us in advance of their general u.h.f. allocation. After the latter job was done, in April of 1939, our assignments became definitive, not tentative, and the notation about reserved rights was washed out some months ago, so that these bands have the same status as the other ham bands.

Some confusion is existing about the meaning of a new question recently appearing in the Class-B examination, requiring one to name two basically-different and commonly-used methods of modulation. Everybody being f.m.-minded, there is a temptation to answer this question in terms of amplitude modulation and frequency modulation. But it seems to us that, as the question asks for methods and not for types, a better answer would be plate modulation and grid modulation.

AN ANALYSIS OF ELECTIONS

THE percentage of the voting done in A.R.R.L. elections by members who are not licensed amateurs at the time of voting has now reached very small proportions. We made an analysis of the 1939 elections which showed that only 2.5 per cent of the voting was done by non-licensed amateurs. You may be interested in the figures:

Division	Licensed Amateur		Non-licensed Member	
	Votes	Per Cent	Votes	Per Cent
Canada.....	530	98.3	9	1.7
Atlantic.....	732	95.2	35	4.8
Dakota.....	175	98.3	3	1.7
Midwest.....	340	98.8	4	1.2
Southeastern..	231	99.5	1	0.5
Total....	2008	97.5	52	2.5

U.H.F. Contest and Relay—May 17th-18th

The Contest Period: May 17th (Saturday), 3 P.M. local time, to May 18th (Sunday), 7.59 P.M. local time.

Scoring of Contacts: List all different stations worked in the contest period, and beside the calls show the *location* of the stations obtained as you work them for the claimed points. Contact points depend on the transmitter frequency of the station for which the claim is entered, and the distance covered, in line with the table below:

Distance of Station Worked	Number of Points Score, for Contacts Using Transmitter on		
	56-60 Mc.	112-116 Mc.	Above 224 Mc.
Under 25 miles...	1	2	10
25 to 75 miles....	2	4	20
75 to 250 miles...	5	10	50
Over 250 miles...	10	20	100

Scoring Message Credits: All contacts must be on frequencies assigned amateurs by the F.C.C. To the contact points computed as above may be added points for *message copies submitted, which show proper handling data* such as the station from which message was received, station to which the message was sent by radio, and the time and date of each such transfer of acknowledgments of receipt between stations. The call of the reporting amateur should of course be indicated on each message, too.

For originating and sending a test message of approximately five to ten words, specifically addressed to remote sections of the country and submitting copy with handling data (but one such message per station may receive credit) —10 points.

For relaying such messages away from the starting point toward destination and submitting full copies (1 for receiving by radio, 2 for relay onward) —3 points.

Reply and 3rd party messages *relayed*, with copies submitted, also count as just explained, but for originating stations, but —1 point.

Field Multiplier: Operators at field locations, under portable designation, may multiply the sum of their contact and relaying scores by *two*.

Three successful u.h.f. Contests have been held. With May a month of traditional u.h.f. DX and success, we hope to see new gaps bridged, longer relay routes — and Marathon points and success and fun for everybody.

C.w. is recommended for accurate copy on the messages, and to insure identification of your signal under difficulties at distant points. Scoring is the same for either phone or c.w. After you get your test message off, the aim is to work as many as possible, and push other test communications on their way in a responsible manner. The u.h.f.'s are capable of fine Emergency Communication utilization, and those with relay experience are better prepared to work creditably in a pinch than other amateurs. For a sample message, see p. 33, Sept. 1939 *QST*, or the *Operating An Amateur Radio Station* booklet or *Handbook*.

If you transmit in a different u.h.f. band, the same station may be worked more than once to count in the contact score. 2½-meter work began to come forward more rapidly with the February activity, and routes on this frequency will soon vie with the 5-meter results in some parts of the nation. All amateurs are invited to try the u.h.f.'s and stick a separate rig there for the summer. Fun and results are now assured, and informal week end work will assure happy results for everybody. Above all, don't miss the May 17th-18th u.h.f. Contest. Many more states should be represented in the reports. (Special

medallions are to be engraved at the end of 1940 for the fellows working most states. See p. 23, Jan. *QST*.) Be sure we get your report, with claimed score and message copies, promptly after the May Contest-Relay. Originally set for May 11th-12th, the schedule has been changed to May 17th-18th, to avoid falling on the same date as the Hudson Division Convention.

— F. E. H.

An Inexpensive Electronic Key

(Continued from page 14)

build the switch since nothing of the sort is available ready-made. Although the key shown here is entirely practicable, its "feel" is not exactly like that of a regular "bug," and there is need for a good, easily constructed design which would simulate bug action as closely as possible. Since no two operators like the same kind of action — and have pretty violent opinions about the merits of their own pet adjustments — it is desirable to provide as wide a range of adjustment as possible. Some good suggestions along these lines would be welcome.

Operating

It is not hard to learn to operate an electronic key, despite the fact that most fellows who are used to regular bug keys get badly mixed up on the first attempt or two. About an hour's practice, however, is enough to get the hang of the key, and after that making dashes by hand seems like hard work. Those who have the most trouble are the ones who have the habit of making speedy dots and slow dashes; their timing is all wrong in the first place. And learning to send on an electronic key is almost 100% a matter of correct timing.

The dash-length adjustment should be made with the key set for a moderate rate of speed. One dash plus a space is equal to two dots plus the two spaces associated with them, so in a given period of time the key should make just half as many dashes as it does dots. R_6 should be adjusted to give this timing. After that, regulating the speed is simply a matter of setting R_2 . With the constants given, the speed range is approximately from 20 to 40 words per minute. A higher or lower "B" voltage will change the range somewhat, but does not otherwise affect the operation of the key.

Possibly the most important adjustment to be made is that of the key and switching mechanism. The stops on the levers can be set for whatever length of paddle arc suits the operator; similarly with the adjustable tension springs. From then on it is a matter of getting the switch springs to make contact at the right time, preventing too much "follow" on the part of the springs so that the contacts do not stay closed too long when a lever is released, and similar individual adjust-

ments which will make for best operation. It will be necessary to spend some time bending the front and back contact springs back and forth before the happy medium is reached. Specific instructions are of little value, since personal preferences determine the sort of action that is wanted. But once the right adjustment is found and the operation of the key mastered, sending good clean code becomes practically automatic. And higher speeds are easier to attain.

★ New Receiving Tubes ★

SYLVANIA recently announced several additions to their Loktal tube line. The 1232, a high mutual conductance tube designed primarily for television, is now identified as the 7G7/1232.

The additions include the 7B4, a single-ended high- μ triode similar to the type 6F5G; the 7J7, a triode-hexode converter somewhat similar to the 6J8G; and the 7L7, a single-ended triple-grid amplifier resembling the 7G7/1232 except for lower heater current and mutual conductance.

As with all Loktal tubes, the nominal heater-voltage rating of 7.0 volts corresponds to a 130-volt line condition — the normal 6.3-volt rating of the heater corresponds to a line voltage of 117.

7B4

High- μ Triode

Heater voltage.....	6.3	6.3 volts
Heater current.....	0.30	0.30 ampere
Plate voltage.....	100	250 volts
Grid voltage.....	- 1	- 2 volts
Plate current.....	0.5	0.9 ma.
Plate resistance.....	85,000	66,000 ohms
Mutual conductance.....	1175	1500 μ mhos
Amplification factor.....	100	100

7J7

Triode-Hexode Converter

Heater voltage.....	6.3	6.3 volts
Heater current.....	0.30	0.30 ampere
Plate voltage (hexode).....	100	250 volts
Osc. plate voltage (triode).....	100	*250 volts
Screen voltage (hexode).....	100	100 volts
Control grid voltage (hexode).....	- 3	- 3 volts
Osc. grid resistor (triode).....	50,000	50,000 ohms
Plate current (hexode).....	1.1	1.3 ma.
Screen current (hexode).....	3.1	2.9 ma.
Osc. plate current (triode).....	3.7	5.4 ma.
Osc. grid current (triode).....	0.3	0.4 ma.
Plate resistance (hexode).....	0.3	1.5 megohm
Conversion conductance.....	260	300 μ mhos
Conversion conductance ($E_{c1} = - 20$).....	2	2 μ mhos
Total cathode current.....	8.2	10 ma.

Triode Characteristics

Plate voltage.....	150 volts
Grid voltage.....	- 3 volts
Plate current.....	7.5 ma.
Plate resistance.....	10,400 ohms
Mutual conductance (approx.).....	1350 μ mhos
Amplification.....	14

* Applied through 20,000 ohms series resistance properly bypassed.

(Continued on page 10E)

The YL's Unite!

The Story of the Young Ladies' Radio League

BY ANITA CALCAGNI BIEN, WSTAY, AND ENID CARTER, W9NBX

IT WAS that lace-bordered ad for "Two Hundred Meters and Down" in May 1939 *QST* that started the whole thing. It got W7FWB curious, and just a little bit annoyed. So she sat down and wrote a letter to the editor. "How many YL key-twitchers are there?" she demanded. "Nobody seems to know, but I think we could tell." And she went on to ask YL's everywhere to write to her, telling her all about themselves.

The result is the YLRL — the Young Ladies' Radio League. Little did W7FWB dream, when she suggested "Perhaps we can band ourselves together in a YLRL or something," that the organization would materialize and grow to its present grand estate. From its inception, the YLRL has been fairly pulsating with activity.

The actual organization date was October, 1939. It was then that the Constitution was adopted and temporary officers elected. The officers at present are:

- President — Ethel Smith, W7FWB, Wenatchee, Wash.
Vice-Pres. and Activities Mgr. — Carol Keating, W9WWP, Chicago, Ill.
Secretary — Enid Carter, W9NBX, Bowbells, N. D.
Publicity Chairman — Anita Bien, WSTAY, Cleveland, Ohio.

District Chairmen:

- W1GQT — Lida King, Holyoke, Mass.
W2IXY — Dorothy Hall, Springfield, N. Y.
W3FXX — Mary LeVan, Oreland, Pa.
W4DAI — Mrs. E. F. Sanford, Buchanan, Ga.
W5DEW — Mary Palmer, Port Arthur, Texas
W6RGX — Genevieve Capstaff, Van Nuys, Calif.
W7FWB — YLRL President
W8SBB — Mary Stocking, Cleveland Heights, Ohio
W9CHD — Lenore Kingston, Chicago, Ill.

A low yearly membership fee (the girls have proved their optimism by paying 2 to 4 years' dues in advance!) has boosted the roster to 71 paid members in a few months' time. Thirty states, plus Alaska, Canada, Puerto Rico and Hawaii, contribute to this enrollment. Requests from club-minded individuals are constantly pouring into Bowbells, N. D., from points East, West, North and South. International recognition and A.R.R.L. affiliation are being sought.

The first monthly news sheet was published in November. From a wide variety of names submitted, the girls chose "YL Harmonics." (The OM's offered such helpful suggestions as "Parasitic Oscillations" and "Spurious Radiations"!)

The paper contains district news, Personality



Loretta Ensor, W9UA, Olathe, Kansas. Active since 1923, first YL to span the Pacific, she is best known through W9BSP's code lessons on I60.



Carrie Jones, W9ILH, Alton, Ill. An outstanding "traffic man," one of the faster c.w. ops, active on Trunk Line "G."



Carol Keating, W9WWP, Urbana, Ill. Vice-president and activities manager of YLRL. Another "c.w. only" gal and a crack op.



Lida King, W1GQT, Hol-yoke, Mass. First District Chairman of YLRL. Performed emergency work in 1936 New England floods.

Lenore Kingston, W9CHD, Chicago. Ninth District Chairman of YLRL. Well-known NBC radio actress ("Affairs of Anthony") and model.

Mary Palmer, W5DEW, Port Arthur, Texas. Fifth District Chairman of YLRL. The "Texas Dewdrop," widely known on 10-meter 'phone.

Parades, lists of new members, donations, contests, QSO Parties, requests and explanations of various radio items, etc., with all members cooperating, especially the district chairmen.

The girls have their own net, with spot frequencies and control stations on 40 and 80 meters. Similar operation on all bands is planned. On file in the club headquarters are pictures of members, abstracts covering personal information, characteristics, accomplishments, experiences and affiliations, plus a record of operators' equipment and power for regular and emergency operation. One YL, after filling out the lengthy questionnaire, facetiously offered to supply even her finger prints.

The ordinary feminine reluctance to reveal ages was not evident in the Ladies' League. While amateur radio embraces the younger and the older generation and all creeds, races and professions, a surprising revelation was the wide divergence of ages in the YLRL — 13 to 73. Our 13-year-old member, W9HIG — Jerry Burgett of Flaxton, N. D. — rivals Marjory Allingham, W7HER,

who likewise received her license at the same age. Jerry runs 3 watts on 80 meters and gets out remarkably well. The activities of our senior member command our highest respect and are an inspiration to us all; were it not for her modesty her experiences might furnish an interesting story. The average age is thirty. The president, vice-president and secretary all grace the twenties.

Unmarried leaguers total 39%, with most of them attending colleges or acting as teachers. W1KUI, Ellen Hastings, is a physics teacher and all-around outdoor girl, and no doubt found the exams a simpler matter than most of us. Other single girls' occupations are: secretaries, clerks, cashier, interior decorator, nurses, office manager, etc. The married 61% comprise housewives, secretaries, ex-teachers and active teachers, telephone operators, cosmetologists, Clerk of the Superior Court and other varied pursuits.

Lenore Kingston, W9CHD, and Genevieve Capstaff, W6RGX, are doubly radio-minded, both being radio actresses and also good district chairmen. Lenore leads a dual life as June Daly in the "Affairs of Anthony," an NBC Blue Network presentation, but still finds time to be interested in golfing, sewing and making recordings. Genevieve's double life is being the XYL of an NBC engineer, and she likes ranching when she isn't busy adding to her file of 6th district YL ops — which now totals almost 100, by the way. California will soon far outdistance Ohio in League representation, if Genevieve has her way.

The versatility of the girls doesn't cease in their being good students, homemakers and mothers, as well as good operators — which bears out the fact that the busiest persons are always so well organized that they can still find time to accomplish more things. Many find added recreational diversion in other fields. Among the hobbies listed are:

Skating: VE4VO, W7EIU, W9JWJ. *Swimming:*

What is the YLRL? Well, it seems to be an association of YL's banded together for purposes of mutual protection, admiration and assistance. What is a YL? Apparently, by the new definition, any feminine radio amateur regardless of age or marital condition. (But not regardless of sex: one New England ham of undoubted masculinity found that out when, trading on his feminine-sounding name, he managed to sneak inside the sacred portals of YLRL membership. When his true nature was revealed he was ignominiously expelled by the frilly seat of his disguise!) Anyway, whatever they're called — YL's, XYL's or OW's — we love 'em, and to prove it here is their story.



Enid Carter, W9NBX, hard-working secretary-treasurer of YLRL, co-author of the article. Also editor of "YL Harmonics." A.A.R.S. and O.R.S.

Dot Fitts, VE4VO, Calgary, Alta. An enthusiastic Canadian member, she reports photography is keeping the VE gang together in lieu of ham radio.

Dorothy Hall, W2IXY, Springfield, L. I., N. Y. Second District Chairman of YLRL. Known the world over, she recently worked KC4USC.

W1FRO, W1KUI, W5IRS, W8TLE, W9EXM. *Bicycling:* W8TLE, W9JWJ, VE4VO. *Riding:* W5IRS. *Tennis:* W9ZTU. Lida King, W1GQT, is a typical New England sports girl, fond of hiking, swimming, skiing, bike riding, etc. W7FWB is interested in *woodcarving*, as is also W9ZWL. *Philately:* W9WWP, W9OUD, W1MCW, W1FTJ and W9NLW — so send them commemoratives. *Farm managing* for W9UA. W1KUI likes raising *chrysanthemums*. *Photography* is, however, her chief pastime, which hobby is shared by W1BDN, W5GXT, W8PZA, W9DBD, W9WWP and others, some of them going in for movie cameras. *Gardening:* W1BDN, W2FKA, and W9LW, with *flowers* specified by W9OWQ. *Badminton and bridge:* VE2HI. *Birds:* W1BDN. *Pencil drawing:* W9AFK. *Arts and crafts:* W9JWJ and W7HDS. *Cryptography:* W3AKB and W5GXT. W9OUD also likes cipher busting, plus dancing. *Music:* W1FRO, W4GFO, VE2HI and W9JWJ. *Numismatics:* W1FTJ. *Flying:* W1FRO and W8NAL. Carmella has also experimented with and built radio-controlled model planes. *Boats, canoes or outboard motoring:* W1FRO, W2FKA, W8TLE, VE2HI. *Dogs:* W9OUD. Incidentally, Letha was the only girl who had the temerity or thoughtfulness to mention *cooking* as a hobby, although W9EXM likes to collect recipes (what girl hasn't more than she will ever use!) and W9WWP is studying to be a *dietitian*. *Bowling:* W9ZTU, W5IRS, W7HDS. *Poetry:* W9JWJ. *Model trains:* W1FTJ. W8SBB is going to art school to learn to be an architect. W8TPZ is Assistant Editor of "Mike & Key," a publication of the Greater Cincinnati Amateur Radio Ass'n, a real live coordinated group.

A QSO with any of these operators should not lack for a conversational topic.

Despite all the funning about women liking to talk, three-fourths of the YL's are on c.w. Code operation comes easier for one who has gained a sense of rhythm through music appreciation or typing, and since many have learned such coordination this has aided immeasurably in their good code operation. A listening ear on the 'phone bands will convince you, too, that the

girls can also hand you a critical report and know something about peaks, sidebands and modulation. One of the most consistent signals on 20-meter 'phone emanates from W5DEW's shack. She puts out a real "sock" morning, noon and night. Mary has just been appointed 5th district chairman, and it is a one-sided bet that the YLRL will be hearing from girls in foreign countries, since Mary is on their side.

While the science of electricity is easier for the average male mind to assimilate, the girls must have a high order of intelligence to begin with due to the isolation of such theory from the ordinary feminine routine of work. Many of the boys, however, are unaware how rapidly the YL contingent is gaining momentum.

W9EXM, Emily Schuette (Frenchy) of Kenosha, Wisconsin, has organized a YL Keno Club, and part of the time is spent teaching the women code practice.

Loretta Ensor, W9UA, is kept busy at W9BSP (her brother's station) giving code lessons. This



—WEDNESDAY BRIDGE
WHO KNOWS WHAT THE FUTURE MAY HOLD?

is one of A.R.R.L.'s leading code practice stations and dates back to 1917. (1903 kc., girls, 7:30-8:30 C.S.T.) W9UA is also said to have been the first woman to work across the Pacific by amateur radio, and has been active since 1923.

Among the remarkable personalities in the YLRL is Mrs. Mamie Hamilton, W9OWQ ("Our Wonderful Queen" is the slogan with which she has been tagged). Six years ago, at the age of 50, after the tragic loss of her two operator sons, she decided to take up their hobby, and has become a successful "ham." She has worked enough countries for DXCC eligibility.

While the average YLRL member is a comparative newcomer and still has her biggest thrills and best DX ahead of her, the League's ranks are bolstered by the following early licensees:

May Smith, W1BDN, is unquestionably the senior operator in point of years of radio experience. She is a pioneer experimenter, having been encouraged by her brother, W1HPM. Since

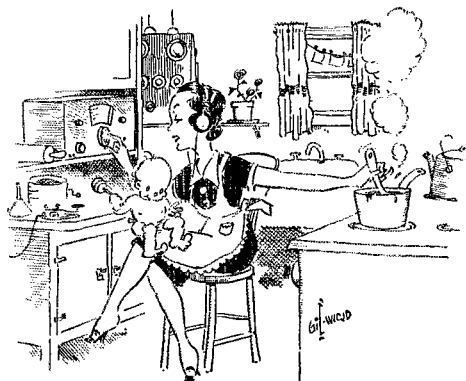

-GOOD STUDENTS, HOMEMAKERS AND MOTHERS-AS WELL AS GOOD OPERATORS

to have been the first licensed YL ham in northern Ohio, if not of all Ohio, and has operated c.w. since 1929. She has been off the air for several years but is resuming operation soon.

W9RNO, W3AKB, W6RGX, W9ILH, W9OUD, W9OWQ and VE2HI have all possessed the coveted "ticket" longer than the average YL ham.

An analysis based on about 46 questionnaires shows the following division of operators:

Class "A," 22%; Class "B," 63%;
Class "C," 15%

Many of the girls hold A-1 Certificates. W8NCJ has copied the Navy Day Message 100% for two successive years.

A breakdown of time spent on the air shows the following allocation:

DX, 14%; Traffic, 20%; Rag Chewing, 66%

The Rag Chewers' Certificates weren't gained by talking about their "operations" or their neighbors' children, either. Chief title claimants: W1FOF, W9DBD and W1GQT.

The DX group is perhaps more venturesome, and the resultant pleasure wholly compensates for the constant dial turning, ear straining, etc. W9OWQ holds a 210DX certificate. W1FTJ admits 60% of her time is spent DX hunting.



Ethel Smith, W7FWB, Wenatchee, Wash. President and founder of YLRL. It was her letter in *QST* that inspired the organization.

becoming licensed, in 1920, she has never ceased having an avid interest in radio development and experimentation. (W1HPM was instrumental in restoring the old Smythe Tower, the stone tower for the Manchester Radio Club. W3MY, May's nephew, has been doing the instrument installation work at the tower.)

Gertrude Palacek Roddy, W8CKH, is believed

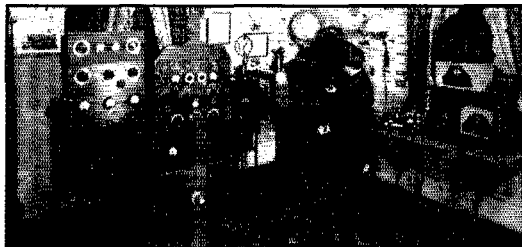

May L. Smith, W1BDN, Manchester, N. H. Well-known old-timer in amateur radio, first licensed in 1920, still an avid experimenter.



Ella Christensen, K6ROJ, Kukuihaele, T. H. The first YLRL member in Hawaii, her big accomplishment is WAS in 29 days on 28-Mc. 'phone.

W9UA earned WAC and WAS before certificates were issued for such merit.

WAS Certificate holders include W1FTJ, W8NCJ, W8PZA, W9LW, W9OWQ, W9OUD, W9RNO, W9WWP, K4EZR and K6ROJ. Eleanor Christensen, K6ROJ, licensed only a few months, worked 47 states in 20 days and took 9 more days to get Vermont, having then snagged



Anita Bien, W8TAY, Cleveland, Ohio. Publicity chairman of YLRL, co-author of the article. Also active in the Cuyahoga Radio Association.

48 states in 29 days on 10 meters — a real accomplishment, using only 40 watts. W2FKA lacks Nevada. W8SFJ needs one more state and W9JWJ almost has her WAS.

WAC certificates have been presented to W8PZA, W9LW and W9OWQ. W2FKA lacks only Asia. W9LW, who has a kilowatt, says 45% of her time is spent looking for DX and she certainly gets it.

Our traffic handlers are the busiest girls of all. Those spending 25% or more of their time on the air in such work are the following:

W1BDN 25% OPS W8PZA 50% — W9NBX 45% ORS
 W1FTJ — ORS W8SJF 75% ORS W9OUD 45% ORS
 W3AKB 80% ORS W9AFK 30% — W9ZWL 90% ORS
 W3FXZ — ORS W9CHD 30% ORS VE2HI * — ORS

* Now inactive.

W5GXT 30% — W9ILH 30% ORS K4EZR 25% —
 W8NAL 90% —
 W8NCJ — ORS (W1FRO is ex-ORS)

Several of the girls are on more than one State Net and also ably handle numerous Trunk Line operations. W8SJF has lately been a consistent leader in the traffic handling of the Central Division.

The following YL's are members of the A.A.R.S., affiliated with the Signal Corps: W3AKB, W5GXT, W7FWB, W8NAL, W8PZA, W9AFK, W9ILH, W9NBX, W9OUD and W9ZWL. (Notice to single girls: 'Tis said that Flora, W6EK, met her OM while he was operating W6ZG-WLV on an A.A.R.S. Corps Net.)

Certificates for Public Service have been earned by many of the girls. Emergency coördination of some of these women is already case history. We cite a few operators deserving of special commendation:

W3AKB, Assistant Section Communications Manager in charge of Emergency Organization, Eastern Pa., Route Manager, and Manager of Trunk Line C, holds the Public Service Certificate. Fran has the added ability to break down Army ciphers expertly. She is a very active A.R.R.L. worker with her ace traffic station.

Letha, W9OUD, has been a very busy Section Communications Manager (Missouri) since her election in 1937, and is one of the few girls so honored. She is also Manager of Trunk Line B, her Midwest Division coöperating splendidly. Letha, too, holds PSC.

Carrie, W9ILH, is busy on Trunk Line G and is an experienced, fast operator. She is also the proud possessor of the Public Service Certificate.

W9WWP, W1FTJ and W1BDN have also assisted in emergency disaster work. Alice, W1FRO, relayed news to the *Union-Leader* of Manchester from Boston during the 1936 Flood.

Lida, W1GQT, First District Chairman, was



L. Eloise ("Cookie") Cook, W1FOF, Springfield, Mass. In charge of YLRL meeting room at N. E. Division's Worcester (April) Convention.



Letha Allendorf, W9OUD, Joplin, Mo. S.C.M., manager of TL-B, NCS-2 in A.A.R.S., an outstanding amateur by any criterion.



Mrs. E. C. Hamilton, W9OWQ, Sedalia, Mo. "Our Wonderful Queen" works c.w. only and has much outstanding DX to her credit.

active on 80 meters in the same flood. Many YL's were active in relay work, but Dot and Cookie did outstanding work. W1FOF, assisted by Guardsmen, is credited with having passed 571 messages in this disaster, maintaining vital contacts. This proves she doesn't always rag-chew 100% of her time.

Second District Chairman Dorothy Hall, W2IXY, has done some notable radio work. Of national magazine and "Hobby Lobby" fame, she is well known for her alert operating and maintaining skeds with DX stations, and for having picked up the plea of the starved descendants of the "Bounty" mutineers on lonely and isolated Pitcairn Island. Through the British Admiralty she got a food ship rushed to Pitcairn and later kept regular schedules with the island's station, VR6AY. When their transmitter broke down, she contacted NY2AE in Panama, and the boys there repaired the Pitcairn transmitter and it was returned to Andrew Young through the kindness of Captain Johnson of the "Yankee." In the meantime, however, the British Government had perforce laid down the QRT rules on transmitting. W2IXY is also the first licensed YL ham to have contacted KC4USC, the Byrd expedition now at the South Pole.

The "quiz" failed to request percentage of time spent in experimentation, yet the following operators volunteered this information: W9OUD and W1BDN are on 5 meters, while W1KUI and W7HDS are learning the mysteries of both 2½ and 5 meters. The latter — Lizette Wolf of Cheyenne, Wyoming — first served as a listening post for some of the OM's last summer and got bit by the bug, so she decided to supply the missing link — that much-needed 7th District u.h.f. QSO — for the boys and girls working all districts. She claims she will hole in on the highest mountain and make the men step lively. Lizette holds a Second-Class radiotelephone license as well as her Class-A.

What made these girls radio-minded? How did they get interested enough to obtain tickets? Most of the girls followed suit since their OM's had licenses. Many of them, however, failed to get interested until their friends or relatives got on 'phone, although a few were intrigued with the dits and dahs sent out by the boys and, rather than become c.w. radio widows, decided to learn code also. Some girls got their licenses just to show their friends and hubbies that they could pass the exams, others to win bets. Some talked to boys at various stations, with friendships and lessons following. (Hams are very cooperative!) Rather than remain the "second harmonics" in the shacks, the girls prefer to have their own operators' licenses, and most of them their own station license as well. Some of the girls went to radio schools, either alone or with their boy friends or relatives, while the majority like W9FRR started from scratch, using the *License Manual*,

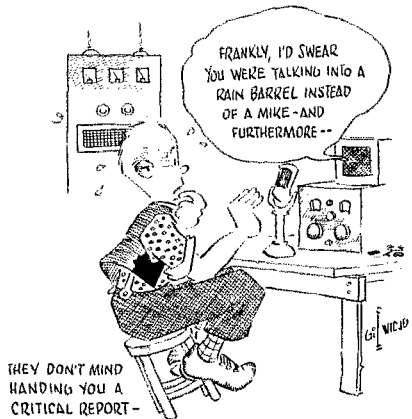

A.R.R.L. *Handbook* and some OM's help. W9ZWL, President of the Aberdeen Amateur Radio Association, got interested at the gigantic balloon ascension at Rapid City in 1935, when she met several NBC engineers. Then W2LV taught her code, and W9TOP the theory. She is now planning for the 1940 South Dakota State Convention.

The OM's will be glad to take a bow for these licensed XYL's in their shacks: W1FTJ/BFT (the latter the OM); W1GQT/EVZ; W1MCW/CRU; W2KUG/IOF; W4GFO/FCU; W6QOG/MBD; W6RGX/ex-2CDQ; W6SGD/RWW; W7EIU/AUH; W7HDS/EUZ; W8CKH/SPI ex-8DJV and W3RD; W8NCJ/NCJ; W8PZA ex-7FKS/8PWY ex-7UJ; W8SJJ/ex-op; W8TAY/SSV; W8TLE/DQZ; W8TPZ/ticket on way; W9AFK/ZKL; W9CHB/YOO; W9EXM/BOB; W9FRR/AKJ; W9ILH/ICN; W9NBX/ERR; W9ZTU/ZTU; W9ZWL/YQR; K4EZR/K4FKC; and K6ROJ/K6OQM.

W6SGD's husband, W6RWW, has been ill and is trying to work a YL in every state. W9SEB in Pierre, S. D., is trying the same stunt, as are many of the YLRL'ers. We wonder which girl will be the first to earn "WYLAS" and "WYLAC" (worked YL All States and All Continents)?

Whether it is a one-watt or one-kilowatt signal you tune in, you are going to hear from the YLRL members, for a CQ means each member is bearing in mind the slogan of the vice-president, W9WWP — "We Women Persist"!

Strays

A coating of finger-nail polish thinned down with cuticle remover will lower the frequency of a crystal in no uncertain terms. If the first coat is too thick, a light application of the emery board will bring it to the frequency desired. No effect upon strength of oscillation has been noticed.

— W4DMC

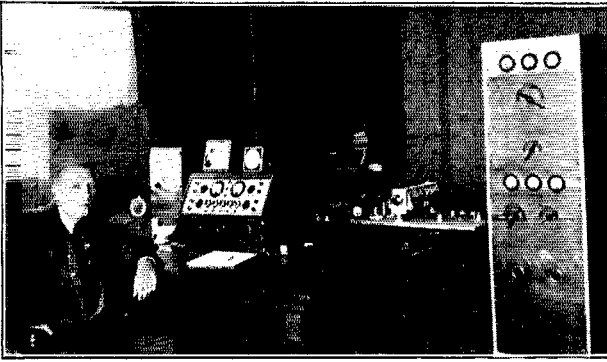

Larry Barton, W6OCH, can afford to relax after having run up a score of 1,287,000 on 'phone in the Contest. The receiver is an RME-69 with DB-20 preselector, and the transmitter is a kilowatt rig. The control unit on the table carries five variable-frequency crystals to cover 20 and the first 150 kc. of the 10-meter 'phone band, switches for selecting any one of five antenna systems, transmitter on-off switches, and a modulation indicator.

The Battle of the Sixes

Or, "California Here I Come"

ANY ideas of fun in the annual DX soiree seemed to get more remote as additional rules were applied and the scoring system became more complicated. With continental European stations barred from the contest as well as French and British colonies, it looked as though DX would be nothing but happy memories of better days gone by.

However, with the revamped rules there was still plenty to do and when the scores started rolling in it was apparent from the start that the West Coast arose as in unison and made good their threat, "Give us a contest without Europe and 80 meters and we'll show you!" Take a squint at the highest scores reported so far and you will note without too careful examination that those were no idle words.

With Century Club leader "Doc" Stuart, W6GRL, at the head of the pack the boys in the Sixth district really went to town. W6GRL didn't call a halt until he added and multiplied to the tune of two and one-half million points! As the scoring system differed from previous

HIGH SCORES*

C.W.	Score	Call	Score
W6GRL	2,500,000	W6RMT	743,690
W6QD	1,800,000	W8OQF	738,000
W6VB	1,700,000	W3FQP	733,000
W6HJT	1,700,000	W5BRR	675,000
W6ITY	1,547,200	W6EAK	653,000
W6OEG	1,500,000	W3FRY	646,000
W3CHE	1,440,000	W3EDP	638,000
W3EMM	1,382,000	W4FIJ	635,000
W2UK	1,303,000	W9CWW	546,000
W4ECI	1,225,000	W8DWV	516,000
W6MUS	1,172,000	'Phone	
W8LEC	1,094,000	W6OCH	1,287,600
W5KC	1,015,000	W6ITH	843,000
W3BES	897,000	W6NNR	840,000
W9IU	894,000	W4EEE	822,000
W8BTI	885,000	W6AM	775,000
W6MRB	793,000	W6EJC	731,895
W6MSM	778,000	W6NHK	655,000
W1IOZ	765,000	W5VU	602,000
		W5VV	563,000

*Scores not checked. Final accurate scores will be published with the final writeup of this contest.

W6QD has a station built for results and operating efficiency. The operating table carries the X-EC frequency-control unit, the NC101X receiver and various control switches. The transmitter winds up with a pair of 250TTL's driven by a 250TH on either 10 or 40 — another final amplifier, permanently on 14 Mc., is cut in for 20-meter operation. The plate voltage is on both finals all of the time and switching is done in the filament circuits. Another driver unit, not shown in the picture, uses 35T's to drive the 250TH. Each final amplifier has its own relay for cutting the tank circuit over to the 600-ohm line feeding the antennas.

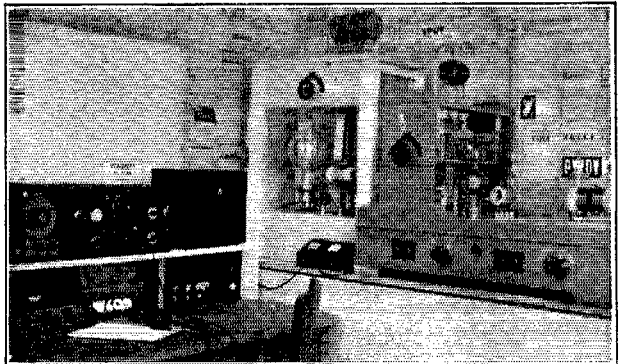

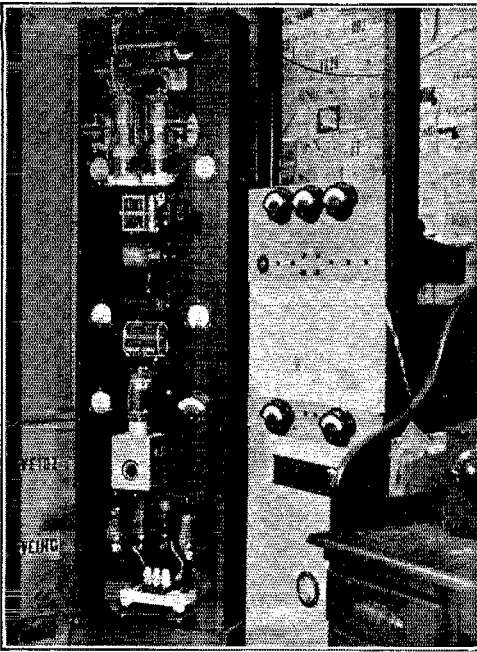

W6VB, located within two blocks of the Pacific Ocean at Playa Del Rey, California, believes in straightforwardness in transmitter design. The output from his homemade e.c.o. feeds directly to the 813 buffer which drives the final push-pull HK345C's amplifier. The receiver is an NC101X.

In running up his score, Glenn used four antennas: two 14-Mc. Sterba curtains, a two-section rotatable W8JK for 10, and a long wire for 40-meter operation.

years it is impossible to do much more than speculate with scores this year and those of years gone by, when it comes to comparison. But with the contest limited to 2 weekends, that figure of 365 contacts by W6GRL certainly speaks for itself.

In second running we find Herb Becker, W6QD, who must have worked more than a few W9's to roll up that score of 1,800,000! In the third track we find W6VB and W6HJT running neck and neck followed by W6ITY and W6OEG. Then we come to that well known EC (East

Coast to you) triumvirate — W3CHE, W3EMM and W2UK — precisely in that order, as it was last year! Of the high scores reported over 500,000 only W2UK shows from the Second District and W1IOZ appears to be the only W1.

This year it was a single contest, c.w. or 'phone, make your choice and bang away at it. Larry Barton, W6OCH, led the tonsil twisters a merry chase and signed, sealed and delivered better than one and a quarter million points. Reg Tibbetts, W6ITH, was his nearest competitor with 843,000 points. It was nip and tuck with W6NNR and final computations may easily swing the honor one way or the other. In fourth place comes Georgia's W4EEE, the only station reporting east of the Fifth District to knock off more than half a million points by 'phone. In fact, the only other stations out of the Sixth District to make this bid for fame are W5VU and W5VV.

Reports from foreign contestants are few and far between at this time. It is certain that there was a terrific eruption in the Hawaiian Islands with the outcome still in doubt, but K6's: SCB; PAH; PIN, CGK and SVU all had more than 600 contacts. Speaking of contacts, XF1A (XE1A of previous years?) is known to have had more than 1300 QSO's three hours before the contest ended, and XE1CM had passed out 1100 numbers with 17 hours still to go!

At times this seemed to be a contest of confusion, with NY4 appearing in Cuba, XF in Mexico and the dilemma of "whether to call or not" when ZC3A stood by — a new country and possible disqualification! The new numbering system came in for its share and we note many who stuck to the well worn "triplets" of former years, 333 and 555 appended to an RST report.

Whether this contest was an international affair (one station reports 26 QSO's and not a one of these outside continental U. S.!) or a "junior Sweepstakes" as we heard it termed, the fact remains that hams the world over can get together, forget everything save the common bond of interest, ham radio, and have fun with it. In the meantime, the final and accurate results of this contest will appear in an early fall issue of *QST*.

The rig at W6OEG ends up with a pair of HK354E's driven by a pair of 35T's, and starts out with the inevitable e.c.o. The receiver is an NC101X.

Antennas in use are two 4-element Sterba curtains for 20, a 7-Mc. Q-fed half wave, and a 3/2-wavelength Q-fed for 10 meters. A single feed line from the shack runs to a "dog house" in the field where the proper antenna is connected by means of relays controlled from the station.



A New Electronic Television Transmitting System for the Amateur

The Complete Modulator Including Iconoscope Camera and Monitor Units

BY J. B. SHERMAN*

THIS article describes all of the equipment necessary to furnish a complete television signal for modulating the r.f. amplifier of an amateur transmitter. For convenience, all of this equipment will be referred to as the "modulator."

Reviewing very briefly, it will be recalled that a complete television signal contains the picture intelligence, horizontal and vertical synchronizing signals, and horizontal and vertical blanking signals.¹ The synchronizing signals cause the lines and frames of the received picture to be started at their proper times; and the blanking signals extinguish the receiving Kinescope spot during the intervals between lines and between frames, so that no retraces appear on the screen.

The essential equipment for producing this composite signal comprises an Iconoscope, or picture pick-up tube, with a video amplifier capable of raising the initial signal to a level sufficient for modulation; a monitor Kinescope on which to observe the picture as picked up; scanning circuits for the Iconoscope and monitor; blanking and synchronizing signal generators, and means for mixing these signals with the video

signal; high-voltage supply for the Iconoscope and monitor; and low-voltage regulated supply.

The Iconoscope used in this outfit is a simplified small-size version of the type in current commercial use. The mosaic is translucent; the picture is projected on one side and the scanning is performed from the other side. Unlike the larger commercial type, the mosaic lies in the same plane as both the image and the scanning raster, which makes it possible to use simple rectangular scanning. Further simplifying steps are the use of electrostatic scanning, and the omission of direct connection to the signal plate. Instead of a direct connection through the bulb, a conducting coating on the inside provides a capacitive coupling to an external band on the tube. This series capacitance means that the video signal will consist of high frequencies alone. The picture thus produced is very acceptable and material advantages result in the design of the video amplifier, as will be pointed out later.

The system to be described is based on a picture of 120 lines, which gives adequate definition in small pictures. The scanning frequencies are 30 frames per second and 3600 lines per second. The video channel width thus required is about 200 kc., which of course means 400 kc. on the air with double-sideband modulation. Inasmuch as the entire 2½-meter amateur band, for which this

* Formerly with RCA Mfg. Co., Inc., Harrison, N. J.

¹ "Introduction to Modern Cathode-Ray Television Reception," by Marshall P. Wilder. *QST*, Dec., 1937. — Editor.

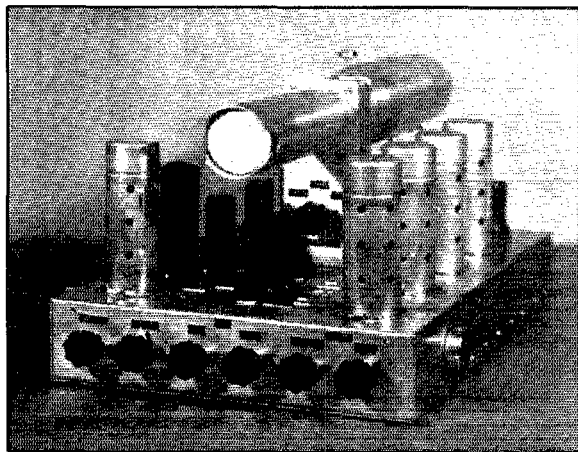

◆
The controls are readily accessible to the operator viewing the image on the monitor from this end of the chassis. The location plan of the tubes and controls is shown in Fig. 6.
◆

◆
 The camera-modulator unit
 as viewed from the Icono-
 scope end.
 ◆

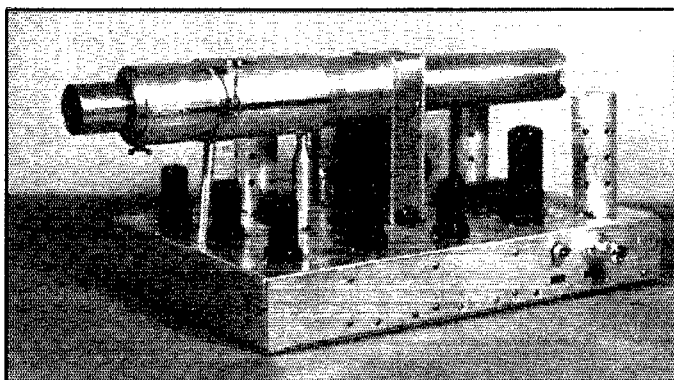

equipment is intended, is only 4 megacycles wide, it is evident that the channel and hence the picture definition must be restricted to minimize interference. This is especially evident when it is considered that the channel required varies as the square of the number of lines in the picture.

The Video Amplifier

By building the entire modulator into a single unit the necessity for an Iconoscope pre-amplifier and transmission line is avoided. Likewise, none of the scanning or power connections need be carried to another unit. Referring to circuit diagram of Fig. 1, it will be seen that the video amplifier contains a 6SJ7 in its first stage, 6AC7/1852's in the second, third, and fourth stages, and a 6L6 in the output stage. The blanking signals are inserted by suppressor modulation of the 6AC7/1852 in the fourth stage, and the synchronizing signals are inserted by screen modulation of the 6L6. The blanking signals drive the 6AC7/1852 to cut-off; hence no video signal passing through the amplifier can have a greater amplitude than the blanking level. The sync signals appear in the output with the same polarity as the blanking and with approximately 25% greater amplitude. This is a true "super-sync"; that is, no adjustment of

picture level can interfere with the sync signals.

In order to obtain adequate signal output from the Iconoscope, a high load resistance (0.5 megohm) is used. This arrangement means that the higher frequencies will suffer because of the shunting effect of the tube and circuit capacitances. To compensate for this effect the cathode circuit of the second video stage is made degenerative by inserting the large resistor R_7 in addition to the bias resistor. The small condenser C_5 then "peaks" the high frequencies only. The values given for R_7 and C_5 are correct for the input capacitance of this particular setup; R_7 at least should be adjusted for a different arrangement. This adjustment is readily made by focussing the Iconoscope on a subject having vertical lines offering good contrast to their background, increasing R_7 until white or black shadows appear after the lines as seen on the monitor and then decreasing R_7 until the shadows just disappear. Optimum high-frequency response is then being obtained.

The first three video stages need pass only the frequencies actually contained in the video signal, and freedom from hum and microphonics is thus attainable by using high-pass interstage couplings. However, the 30-cycle blanking and sync

Practical two-way amateur communication was envisioned when the first articles on modern electronic television were presented to amateurs in the program inaugurated in these pages over two years ago and since that time we have sought continuously for a way to simplify the standard commercial technique in picture pick-up. If that could be done, the rest would be easy. Earlier in this program several manufacturers cooperated by furnishing experimental picture pick-up tubes, but none was obtained that had the requisite sensitivity along with simple scanning requirements — and low enough cost. What we wanted was a low-cost camera tube that would require a minimum of auxiliary pulse-generating and video amplifying apparatus, no critical correction circuits for reshaping a "keystone" raster into a rectangle, and which would be satisfied with an inexpensive lens system. This called for optical focusing and electronic scanning along the same axis, with a short focal-length lens system and a pretty good order of photo-sensitivity.

These once-impracticable general specifications at last have been met by a new type of miniature Iconoscope. A developmental model of this tube is the heart of the purely amateur television transmitting system described by Mr. Sherman in the accompanying article. Complete details of the new tube, including ratings and constructional description, are scheduled for an early issue. — EDITOR.

MODULATOR FOR AMATEUR TELEVISION TRANSMITTER

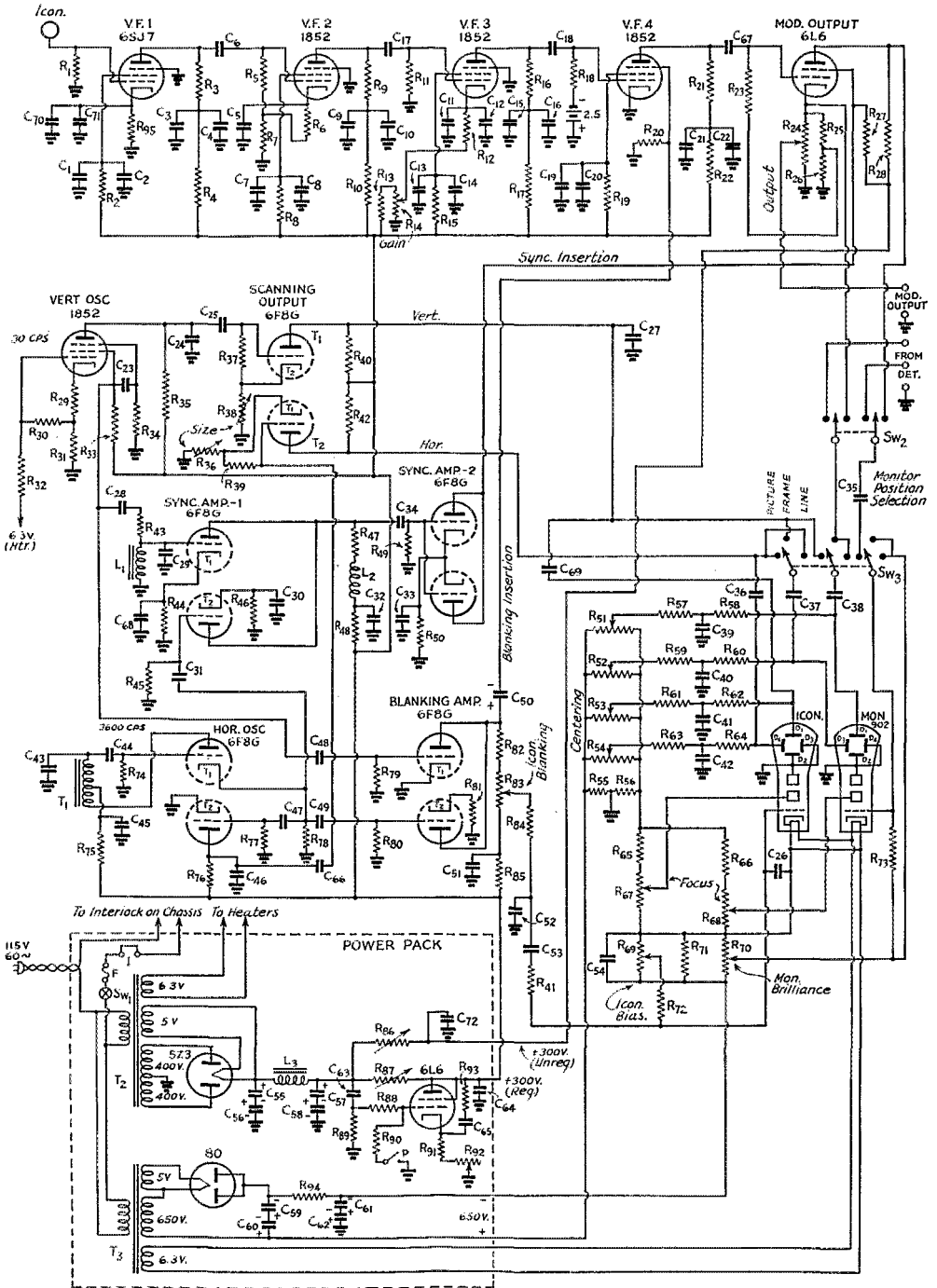

Fig. 1 — Circuit of the complete television modulator and power supply units.

- R₁, R₇₃ — 0.5 meg., ½ w.
 - R₂ — 0.25 meg., ½ w.
 - R₃ — 10,000 ohms, ½ w.
 - R₄, R₈₈, R₉₄ — 50,000 ohms, ½ w.
 - R₅, R₁₁, R₁₈, R₄₂, R₄₈, R₇₁ — 0.1 meg., ½ w.
 - R₆, R₁₂ — 160 ohms, ½ w.
 - R₇ — 4000 ohms, ½ w.
 - R₈, R₁₅, R₁₉ — 60,000 ohms, ½ w.
 - R₉, R₁₀, R₁₆, R₁₇ — 10,000 ohms, 1 w.
 - R₁₃ — 0.1 meg., 1 w.
 - R₁₄ — 5000-ohm pot.
 - R₂₀, R₅₅, R₅₆ — 20,000 ohms, ½ w.
 - R₂₁ — 7500 ohms, ½ w.
 - R₂₂ — 50,000 ohms, 1 w.
 - R₂₃, R₃₂, R₃₅, R₄₃, R₄₅, R₅₇, R₅₉, R₆₁, R₆₃, R₇₆, R₇₇ — 1 meg., ½ w.
 - R₂₄ — 3000-ohm pot.
 - R₂₅ — 1000 ohms, 1 w.
 - R₂₆ — 2000 ohms, 2 w.
 - R₃₁, R₇₅ — 5000 ohms, ½ w.
 - R₃₃, R₆₅, R₆₆ — 0.2 meg., ½ w.
 - R₃₄, R₇₉ — 5 meg., ½ w.
 - R₃₆, R₃₈ — 50,000-ohm pot.
 - R₃₇, R₃₉ — 10 meg., ½ w.
 - R₄₀ — 150,000 ohms, ½ w.
 - R₄₄, R₄₆ — 4 meg., ½ w.
 - R₄₇ — 33,000 ohms, ½ w.
 - R₄₉, R₅₈, R₆₀, R₆₂, R₆₄, R₈₀, R₈₉ — 2 meg., ½ w.
 - R₅₀ — 250 ohms, ½ w.
 - R₆₁, R₆₂, R₆₃, R₆₄ — 1 meg. pot.
 - R₆₇, R₆₈ — 0.25-meg. pot.
 - R₆₉, R₇₀ — 0.1-meg. pot.
 - R₇₂ — 50,000 ohms, ½ w.
 - R₇₄ — 70,000 ohms, ½ w.
 - R₇₈, R₈₁, R₈₄, R₉₀, R₉₁ — 1000 ohms, ½ w.
 - R₈₂, R₈₅ — 20,000 ohms, 1 w.
 - R₈₃ — 500-ohm pot.
 - R₈₆, R₈₇ — 5000 ohms, 25 w., slider type.
 - R₉₁ — 1000 ohms, 5 w.
 - R₉₂ — 1000-ohm pot.
 - C₁, C₂, C₅, C₇, C₉, C₁₃, C₁₅, C₁₉, C₂₁, C₂₇, C₄₄, C₄₉, C₇₀ — 0.002-µfd. 400-v. mica.
 - C₂, C₄, C₈, C₁₀, C₁₄, C₁₆, C₂₀, C₃₂, C₄₅, C₅₀, C₅₄, C₅₉, C₆₀ — 4-µfd. 450-v. elec.
 - C₆, C₁₇, C₁₈ — 0.004-µfd. 400-v. mica.
 - C₁₁, C₂₈, C₃₀, C₃₁, C₄₇, C₆₆ — 0.01-µfd. 600-v. paper.
 - C₁₂, C₇₁ — 25-µfd. 25-v. electrolytic.
 - C₂₂ — 16-µfd. 450-v. elec.
 - C₂₃ — 0.004-µfd. 400-v. mica.
 - C₂₄ — 0.25-µfd. 600-v. paper.
 - C₂₅, C₃₄, C₄₈, C₅₂, C₆₇ — 0.1-µfd. 600-v. paper.
 - C₂₉ — 0.001-µfd. 200-v. mica.
 - C₃₃ — 50-µfd. 25-v. elec.
 - C₃₅, C₅₅ — 0.05-µfd. 1000-v. paper.
 - C₃₆, C₅₈, C₂₆ — 0.05-µfd. 600-v. paper.
 - C₃₇, C₃₈, C₆₉ — 0.25-µfd. 600-v. paper.
 - C₃₉, C₄₀, C₄₁, C₄₂ — 0.1-µfd. 200-v. paper.
 - C₄₃ — 0.006-µfd. 400-v. mica.
 - C₄₆, C₆₅ — 0.001-µfd. 400-v. mica.
 - C₆₁, C₅₅, C₅₆, C₅₇, C₅₈, C₆₁, C₆₂, C₆₄, C₇₂ — 20-µfd. 450-v. elec.
 - C₆₃ — 1-µfd. 600-v. paper.
 - T₁ — RCA output transformer No. 9852 with keeper removed from core. Only primary used.
 - T₂ — Thordarson power transformer No. T-13R16.
 - T₃ — Thordarson power transformer No. T-13R11.
 - L₁ — Thordarson choke No. T-2927, 1080-henry.
 - L₂ — 60-mh. choke.
 - L₃ — 20-henry, 200-ma. filter choke.
 - SW₁ — S.p.s.t. toggle switch.
 - SW₂ — D.p.d.t. toggle switch.
 - SW₃ — Yaxley switch, single-deck three-position.
 - F — Fuse.
 - I — Interlock.
 - P — Pushbutton, normally open.
- 2.5-volt grid-bias battery of V.F.-4 consists of two 1.25-volt Mallory bias cells in series.



Actual-size unretouched photograph of the 120-line image appearing on the 902 monitor screen.

signals require excellent low-frequency amplifier response. This requirement is satisfied by the coupling systems in the fourth and output stages.

The modulator output is taken from the cathode of the 6L6. About 30-volt peak is the maximum available signal. The outfit is specifically intended for grid modulation of an 829, one of the few tubes suitable for 2½-meter operation. Since this requires a modulating signal of about 20-volt peak value the modulator output is ample. The maximum output can be increased or decreased, without changing the amount of sync, by either increasing or decreasing R₂₁, which varies the blanking level.

It is intended that an increase in carrier level shall represent a decrease in illumination of the received picture, in accordance with usual American practice. Hence in the modulator output the blanking, sync and "dark" video appear in the positive direction. If applied directly to the grid of a Kinescope receiving tube, this would produce a negative picture; that is, a picture in which the light and dark values are interchanged. Therefore, in order that the monitor may show the original scene correctly, it is operated from a load in the plate circuit of the 6L6, where the picture polarity is opposite to that in the cathode circuit.

The video gain control consists of a cathode bias adjustment on the third video stage.

Vertical Scanning, Blanking, and Sync

In the interest of simplicity, blanking and sync signals are derived from the same oscillators which supply scanning to the Iconoscope and monitor. The vertical oscillator is a simple relaxation oscillator of the negative transconductance type and uses a 6AC7/1852. This circuit is synchronized with the 60-cycle supply and operates reliably at 30 c.p.s. without the necessity of a speed control. The oscillogram of Fig. 2 shows

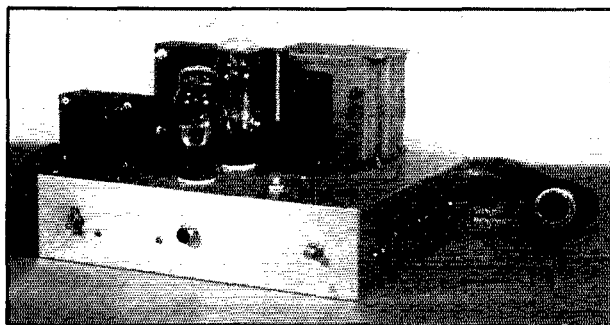

The power-pack chassis carries the main regulated 300-volt supply and a separate 600-volt supply for the Iconoscope and monitor tubes, along with the necessary filament-heating windings.

the form of the vertical oscillator voltage appearing at the screen of the 6AC7/1852. It will be observed that this is a straight-sided impulse at 30 c.p.s., plus a 60-c.p.s. sine wave from the synchronizing source.

The plate circuit of the 6AC7/1852 contains the condenser C_{24} which is charged from the 300-volt supply through R_{35} , and discharged each time the screen impulse occurs because of the resulting low plate resistance. Thus a saw-tooth wave appears across C_{24} at 30 cycles. This saw-tooth wave is amplified in one-half of a 6F8G double triode and applied to the vertical deflection plates of the Iconoscope and of the monitor.

The screen impulse is clipped and amplified in one-half of a 6F8G so that it appears in the plate circuit with negative polarity and no longer has the 60-cycle ripple base. This is the vertical blanking signal, which is applied to the suppressor of the fourth video stage.

The same screen impulse is applied to the choke L_1 , which "differentiates" it; that is, produces from the rectangular wave two narrow impulses of opposite polarity. These impulses are applied to one-half of a 6F8G which clips off all of the negative impulse and most of the positive one so that the plate circuit contains a small, narrow, negative signal. This is then amplified in another 6F8G and becomes a large, narrow, positive signal which is applied to the screen of the 6L6 modulator to produce the vertical synchronizing impulse. It is desirable to have this impulse start slightly after the beginning of the blanking period, so that at the receiver the edge of the scanning raster will be darkened. This is accomplished by placing the small condenser C_{29} across L_1 , which delays the sync impulse. It is also de-

sirable to have the vertical sync impulse narrow enough so that a large part of the blanking period remains after the impulse. The reason for this is that the horizontal sync signals are interrupted for the duration of the vertical sync pulse; for smooth operation of the horizontal oscillator in the receiver the horizontal sync pulse should commence before the beginning of the new frame. The oscillogram of Fig. 3 shows the vertical blanking and synchronizing pulses, and the horizontal sync pulse also can be seen.

Horizontal Scanning, Blanking, and Sync Pulses

In order to have a stable source of horizontal scanning, blanking and sync pulses, without the necessity of synchronizing or making speed adjustments, a sine-wave oscillator is used. One half of a 6F8G is employed, with grid-leak and cathode-resistor bias so adjusted that the operating angle is short; that is, plate current flows for only a small portion of each cycle. The oscillogram of Fig. 4 shows the form of the impulse voltage appearing across the cathode resistor under these conditions.

This positive impulse is applied to the grid of the other half of the same 6F8G, the plate circuit of which contains the time constant combination C_{46} - R_{76} . Condenser C_{46} is charged through R_{76} and is discharged by the low plate resistance of the tube each time its grid is driven positive. Hence a saw-tooth wave appears across C_{46} , which is amplified in the other half of the same 6F8G used for vertical scanning, and applied to the horizontal deflection plates of the Iconoscope and of the monitor. Cathode degeneration controls R_{36} and R_{33} make excellent scanning-size controls.

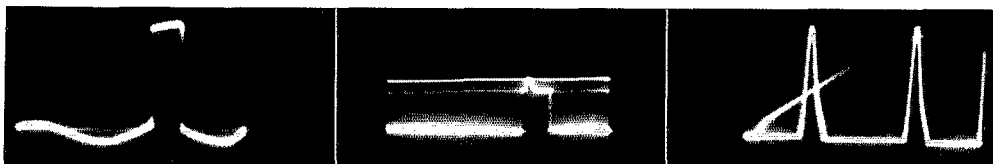

Fig. 2 (left) — Oscillogram of the vertical oscillator impulse. Fig. 3 (center) — Oscillogram of the vertical blanking and sync pulse. Fig. 4 (right) — Horizontal oscillator impulse oscillogram.

The horizontal oscillator cathode impulse is also applied to the other half of the same 6F8G used for vertical blanking, is amplified, and appears with the vertical blanking in the common plate circuit. In this manner the suppressor of the fourth video stage receives both horizontal and vertical blanking pulses. The width of the horizontal blanking pulse can be varied by changing the value of R_{81} . By changing the value of R_{23} in the vertical oscillator, the vertical blanking time can be varied.

Returning again to the horizontal oscillator cathode impulse, the tip of this signal is selected by clipping action in the other half of the first

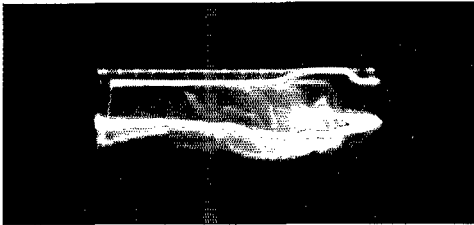

Fig. 5 — Content of one frame as seen on the monitor with SW_3 in "Frame" position.

sync amplifier and appears in the common plate circuit with the vertical sync. To maintain the high-frequency components in the horizontal sync, L_2 is added to this plate circuit. The shape of the horizontal sync pulse can be changed by varying R_{47} . Both horizontal and vertical sync pulses are applied to the second sync amplifier, and then to the screen of the 6L6.

It should be noted that when the unit is to be operated near the transmitter, the 6F8G glass tubes and their grid leads must be shielded to prevent r.f. pickup.

The Monitor

The monitor is an important part of the equipment, since by showing the actual final picture it gives a check on every adjustment, including optical focus. A type 902 2-inch cathode-ray tube is used for this purpose. To avoid a contrast control for the monitor picture, it is desirable to apply to the 902 grid sufficient video voltage to give a good picture when the signal reaches the blanking level; that is, when the "pedestal" is filled. It may be desirable to vary R_{23} somewhat to accomplish this.

The usefulness of the 902 is increased by a switching arrangement which permits it to be used as an oscilloscope as well as a Kinescope, so that the video, blanking, and synchronizing signals can be observed. By switching the horizontal scanning voltage to the horizontal deflection plates, the modulator output to the vertical plates, and no signal to the grid, the content of one line appears on the monitor. Likewise, by applying the vertical scanning voltage to the horizontal plates, the modulator output to the vertical plates, and no signal to the grid, the content of one frame appears on the monitor. Since the blanking period and sync signal occur as the oscilloscope spot returns, the sync pulse appears across the top to an expanded scale, in the reverse direction. Fig. 5 shows this monitor oscillogram.

It is desirable to be able to monitor the signal leaving the antenna, as well as the modulator output. Hence another switch is provided for connecting to an external detector arranged to pick up and rectify the transmitted signal. For direct comparison of this signal with that leaving the modulator, either as picture or oscillogram, it is desirable to have both polarities available from the detector. This can be done readily by using a 6H6 double-diode for the detector.

Bottom view of the camera-modulator unit with base cover removed and shield of first two video stages opened. The locations of the principal components are shown in the chassis plan of Fig. 6.

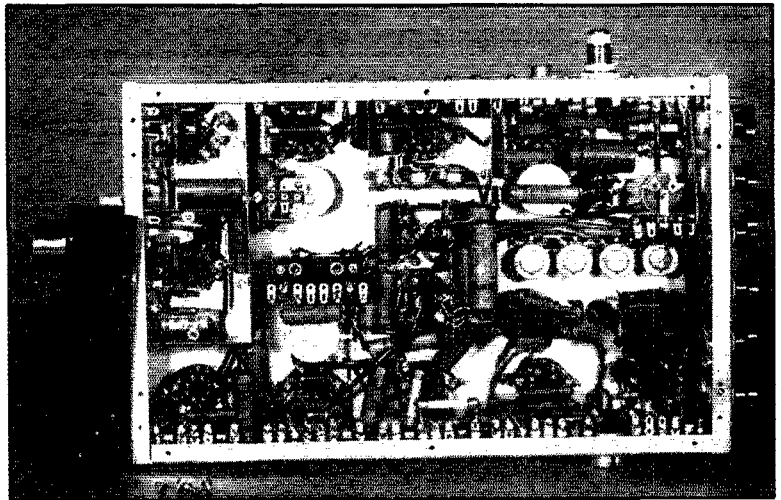

Power Supplies

The Iconoscope and monitor tubes operate at 600 volts from a common supply. In order to keep the Iconoscope's video output circuit near ground potential, the positive side of this supply is operated at approximately ground potential. Long time-constant filtering is used as an aid in obtaining freedom from line fluctuation difficulties.

The low-voltage supply is regulated, using as regulator a 6L6, triode-connected. Because of the large grid resistor used, there is a slight possibility of occasional blocking. Should this occur, pressing the button *P* briefly will restore the regulator operation. The modulator output and second sync amplifier receive unregulated voltage; the rest of the 300-volt requirements are obtained from the regulator output.

Physical Layout

Fig. 6 shows the layout of parts on the modulator chassis. The Iconoscope and monitor are mounted in line so that the chassis can be moved around as desired and the picture observed on the monitor. The controls are all conveniently available to the operator watching the monitor.

The Iconoscope has the same bulb size as the 902, and therefore lends itself to the symmetrical layout. The Iconoscope shielding must be thorough on account of the high gain in the video amplifier. The shield should clear the bulb by at

least $\frac{1}{4}$ inch in order to reduce capacity to the output connection. It will be noted that a draw tube carrying the lens has been fitted to the fixed shield, so that optical focussing is accomplished by moving the sliding tube in and out.

It is desirable to use a large-aperture lens, but it is not necessary that it be of camera quality. A projection lens is entirely satisfactory. In this outfit, a 35-millimeter projection lens of *f*2.3 and 3-inch focal length has been used with good results.

In the photograph of the underside of the modulator chassis it will be noted that the first two video stages are enclosed in separate shielding to prevent any possible pickup. The chassis and power pack are connected by a single cable carrying all the power leads and covered with grounded copper braid. It is advisable to run several wires in parallel for each of the filament leads in order to minimize voltage loss. (This does not apply to the Iconoscope and monitor filaments.) The filaments should not be grounded at the power pack, but at the chassis. One side of each filament goes to ground at the socket. The bottom covers of the modulator chassis and power pack carry pin-jack interlocks which disconnect the a.c. supply when either bottom is removed.

The Iconoscope and monitor should be biased off when the outfit is turned on, so that there will be no stationary spot before the scanning starts. There have very recently appeared on the market inexpensive thermal relays and it is suggested that one of these connected to the 80 rectifier supply would delay the application of the high voltage until after the scanning had started.

In operation it will be found that there is a certain range of Iconoscope bias over which the signal output increases with decreasing bias without hurting the picture quality. Above and below this range, although the picture level may be kept constant by readjusting the gain control, the quality will suffer.

It will be found that there is little need for an iris on the lens. No provision is made on the present outfit for stopping down the lens; it has been used on scenes ranging from sunlight to interior illumination, with adjustment of gain the only necessary change. However, there is one advantage to be gained from stopping down the lens, and that is the improved depth of focus.

EDITOR'S NOTE. — Subsequent articles in this series will describe the receiver and transmitter which complete the new amateur television system, the former by Mr. Sherman and the latter by Mr. L. C. Waller, W2BRO, another well-known *QST* contributor.

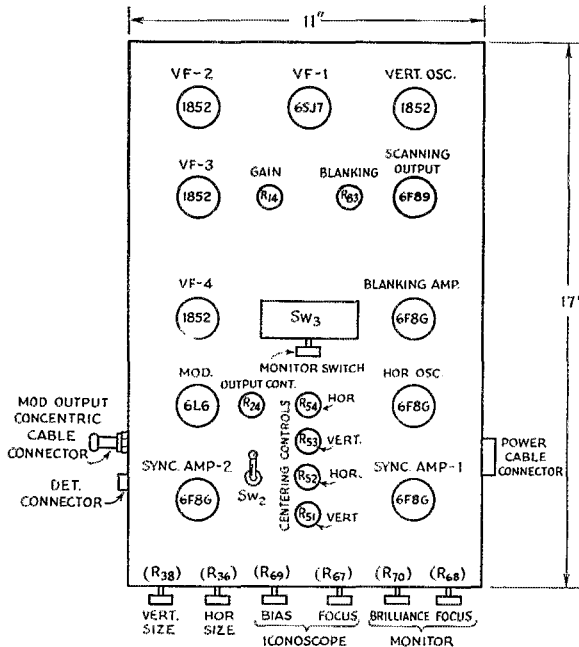

Fig. 6 — Chassis layout plan showing relative positions of the tubes and operating controls. The chassis depth is 3 inches.

Flasher-Type Overmodulation Indicator

A Simple and Inexpensive Visual Negative-Peak Monitor

JUST about the simplest visual overmodulation indicator circuit we have seen was sketched out for us by Irving Strauss, W1CVC, on a recent look-in at Headquarters. Of the negative-peak indicator variety, all it takes in the way of equipment is an ordinary neon bulb and a couple of small resistors. The circuit is shown in Fig. 1.

R_2 is an adjustable resistor of a value such that the total drop across its terminals is about 100 volts. The resistance required will depend upon the current flowing through R_2R_3 . R_3 may be the regular bleeder resistor on the plate supply; a separate unit is not essential. In any event, knowing the current through the circuit, the value of R_2 may readily be calculated by Ohm's Law. A wire-wound slider-type resistor is convenient.

R_1 is placed in the circuit so that the plate current of the modulated stage flows through it, and its value is chosen so that the steady d.c. drop across it is about 30 volts. The value is not especially critical, but the voltage drop must be slightly greater than the difference between the ignition and extinction potentials of the neon bulb.

To adjust the circuit, the switch is thrown to the lower position, so that the bulb is connected across the left-hand section of R_2 . The tap on R_2 is then adjusted so that the bulb just ignites when the plate voltage is thrown on, with the amplifier drawing normal plate current. The more accurately this adjustment is made, the more accurate will be the indication of 100% modulation. No other adjustments need be made.

The operation of the device is as follows: With no modulation and the switch in the upper position, the 30 volts developed across R_1 bucks the voltage between ground and R_2 , and, since this bucking voltage is sufficient to keep the net voltage well below the ignition potential of the bulb, the neon is dark. When the stage is modulated the plate current through R_1 varies with the modulation, between the limits of twice the carrier value and zero. When it hits zero on a negative peak the voltage drop across R_1 also is zero, there is no bucking voltage, and the lamp flashes. On positive peaks, when the plate current is doubled the bucking voltage also is doubled, but is not sufficient to overcome the steady voltage from R_2 and cause the lamp to flash.

If the tap on R_2 is set exactly to the ignition potential of the lamp, the neon will flash at exactly 100% modulation in the negative direction. Increasing the voltage from R_2 will cause the lamp to glow at lower modulation percentages; i.e., the ignition potential will be reached while a certain amount of current is still flowing in R_1 .

The flasher therefore can be set for slightly under 100% modulation as additional insurance that there will be no overshooting.

The by-pass condenser across R_1 should be for r.f. only, and should not be high enough in value

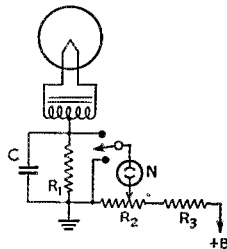

Fig. 1 — W1CVC visual-type overmodulation indicator. The values of R_1 , R_2 and R_3 will depend upon the modulated amplifier and the plate voltage; they are discussed in the text. C is an r.f. by-pass condenser, of the order of 0.002 to 0.01 μ fd.

to have an appreciable effect at audio frequencies. If possible, the d.c. grid return of the amplifier should be made directly to the filament transformer center-tap (or cathode in the case of an indirectly-heated tube) to avoid having to make allowance for the steady voltage drop in R_1 that would result from the flow of rectified grid current through it. Also, the introduction of some of the modulating voltage in the grid circuit might be undesirable. In grid-leak biased amplifiers this simply means returning the grid leak to cathode instead of ground. In amplifiers with fixed bias, the positive side of the bias supply should be connected to the cathode instead of to ground as in normal operation.

— G. G.

Strays

In link coupling low-power stages of a transmitter, an economical link line is made of No. 14 rubber-covered flexible wire covered with $\frac{1}{4}$ -inch copper braid. This makes a concentric line with losses — about one-fifth those of twisted pair at 28 Mc. — W1FGO.

— —

Maps may be mounted on a good grade of wallboard with paper-hangers' paste. The paste should be strained to remove lumps. The sizing in the paste draws the paper tight as a drum-head.

— W4ATS

— —

W6EBH has a brother who runs the QST auto camp on U. S. Highway No. 99, near Lodi, Calif.

★ QUOTE AND UNQUOTE ★

CATHODE MODULATION

THE uncertainty surrounding the design of cathode-modulated amplifiers is dispersed in a highly satisfactory manner in an article entitled "Cathode Modulation," by E. E. Spitzer, A. G. Nekut, and L. C. Waller, in the January-February, 1940, edition of "Ham Tips."¹ The essential

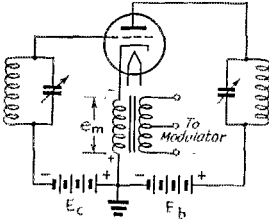

Fig. 1 — The basic cathode-modulation circuit.

information, based partly on theoretical and partly on experimental work, will be of considerable value to amateurs using or contemplating using the system.

It is probably well known that cathode modulation is a combination of grid-bias and plate modulation, the modulating voltage (e_m in Fig. 1) being developed across the modulation transformer winding inserted in the cathode return circuit of the modulated r.f. stage. The a.f. voltages at the plate and grid are in the proper phase to aid each other in producing a modulated signal, and the system takes on more of the characteristics of either plate or grid modulation as the proportion of each type is increased in relation to the other. At the extremes of the scale we have either pure plate modulation or pure grid-bias modulation, with the possibility of an infinite number of combinations between. On the assumption of 100% modulation, pure plate modulation has these characteristics: High plate efficiency in the modulated stage, high r.f. power output, and large audio power requirements (equal to 50% of the d.c. plate input to the modulated stage). Pure grid-bias modulation, on the other hand, is characterized by low plate efficiency, low power output, and quite low audio power requirements. With cathode modulation, intermediate values should be expected all along the line. There has been a dearth of information, however, on just how these quantities vary. This need is supplied by the curves of Fig. 2.

In Fig. 2 the d.c. power input to the modulated stage (W_{in}), plate efficiency (N_p), carrier output

¹ Published by R.C.A. Manufacturing Co., Inc., Camden, N. J.

power (W_c), and audio power required (W_a) are plotted against the percentage of plate modulation in terms of percentage of the Class-C plate-modulated 'phone ratings of the particular tube or tubes considered. Point A is pure plate modulation, points B and C pure grid modulation. The assumed limiting plate efficiencies, which represent normal operating conditions, are 77.5% for pure plate modulation and 33.3% for pure grid-bias modulation. In plotting the curve for audio power, it is assumed that the power required for pure grid-bias modulation is negligible, which is a reasonable assumption for the present purpose.

It will be observed that the plate efficiency, and hence the permissible plate input and the power output, vary with the percentage of plate modulation. The commonly-used figure of 10% for the proportion of audio power to d.c. input gives 20% plate modulation and a plate efficiency of about 44%, which is considerably lower than the efficiency figure of over 50% generally quoted. While innumerable sets of operating conditions can be chosen, the authors suggest that operating with a plate efficiency (55%) midway between grid-bias and plate modulation would represent a reasonable standard. To obtain this efficiency, approximately 40% plate modulation is required, which in turn calls for an audio power output from the modulator equal to 20% of the d.c. input to the stage. The power output is then ap-

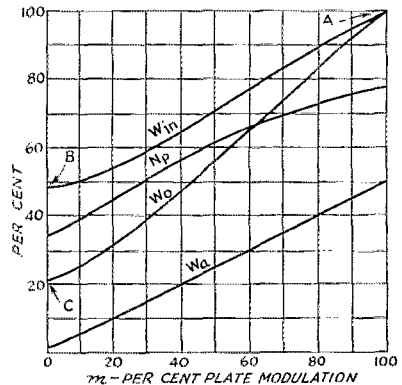

Fig. 2 — Cathode-modulation performance curves, in terms of percentage of plate modulation against per cent of Class-C telephony tube ratings.

W_{in} — D.c. plate input watts in per cent of plate-modulation rating.

W_c — Carrier output watts in per cent of plate-modulation rating (based on plate efficiency of 77.5%).

W_a — Audio power in per cent of d.c. watts input.

N_p — Plate efficiency in per cent.

proximately 48% of that obtainable from the same tube 100% plate-modulated. In round figures, then, with a given tube the carrier power output with cathode modulation is one-half its rated power output with pure plate modulation, and the audio power required is two-fifths of that needed for pure plate modulation.

Besides the necessity for knowing just how much audio power is required for a given set of conditions, it is also just as necessary to know the impedance presented by the r.f. stage to the modulating frequency as it is in ordinary plate modulation. This is stated by the authors to be approximately equal to the peak modulating voltage divided by the peak audio-frequency component of the plate current; or stated in another way:

$$Z_k = m \frac{E_b}{I_b}$$

where m is the percentage of plate modulation, E_b the d.c. plate voltage and I_b the d.c. plate current to the modulated stage. In other words, the modulating impedance of the cathode circuit is the familiar impedance figure used for plate modulation, but multiplied by the percentage of plate modulation in use. With the "standard" for cathode modulation suggested above, the modulating impedance of the cathode circuit is 40% of its value for pure plate modulation, assuming the same d.c. plate voltage and current. Triodes having a normal ratio of plate voltage to plate current will have a cathode modulating impedance in the neighborhood of 6000 ohms; this value is halved when two tubes are used in push-pull.

The curves of Fig. 2 will enable any interested amateur to figure out for himself the economics of the various systems of modulation, for any particular type of tube or for comparisons between different types, particularly in the case where a choice is to be made between small tubes plate-modulated and larger tubes cathode-modulated, for the same carrier output. The increased tube (and possibly power-supply) cost in the latter case must be balanced against increased cost of audio power in the former. The relative amount of 'phone and c.w. operation, and the possibility of operating on higher power on c.w. with the cathode-modulated tubes, also should be taken into consideration. No specific conclusions can be drawn, since the answers to some, at least, of these questions can be given only on the basis of individual preference. For the same carrier output, however, the following comparison may be of interest:

	Plate Mod.	Cathode Mod. ($m=40\%$)	Cathode Mod. ($m=80\%$)	Grid-Bias Mod.
Carrier output, watts	100	100	100	100
D.c. plate input, watts.....	129	178	228	300
Plate dissipation, watts.....	29	78	128	200
Audio power required, watts.....	65	36	23	—

For other carrier powers the figures are of course in proportion.

The preferable method of adjustment of the effective grid modulation percentage is by selection of a suitable tap on the secondary of the modulation transformer, so that optimum a.f. grid-voltage regulation can be secured.

— G. G.

NOTE ON SUPPRESSION OF IGNITION INTERFERENCE ON FREQUENCIES BETWEEN 40 AND 60 MC.

THE following significant information on this subject is taken from the paper "The Ultra-Short-Wave Interference Suppression of the Electrical Ignition System of Motor Vehicles," by W. Scholz, and G. Faust, *T. F. T.*, November, 1939, Vol. 28, No. 11, pages 409-414. The usually recommended scheme of screening the whole ignition system is deemed too expensive as a general solution, while the introduction of high-frequency chokes merely serves to displace the interference to lower frequencies. Furthermore, the use of by-pass condensers large enough to be effective for the ultra-high frequencies reduces the efficiency of the engine, since capacitances greater than 100 $\mu\text{fd.}$ are required. As for resistances, while they are effective for suppression of the ignition interference affecting reception on the standard broadcast band, the suppressing action decreases for frequencies above about 15 Mc. because the capacitive leakage reactance becomes lower than the ohmic resistance value. An effective solution was found in using the distributed type of resistance rather than concentrated resistance units. This distributed resistance is obtained by making the ignition connecting leads of spirally-wound resistance wire on an insulating core. This lead has a resistance of 5000 to 10,000 ohms, about 3000 ohms per foot of special cable. Leads of this type in combination with capacitances of only 10 $\mu\text{fd.}$ and a fixed series resistance of about 2000 ohms gives effective suppression not only on the ultra-high-frequency range 40-60 Mc., but also on the frequencies below 15 Mc. to which the maximum interference was displaced by the inductance of the special spiral-wound resistance lead.

When combined with special spark plugs in which the resistor unit was enclosed, the interference level at a distance of 7 meters was brought down to a field strength so small that it could not be measured, although the field strength with the untreated motor was of the order of 32 millivolts per meter. With ordinary spark plugs the interference field strength was of the order of 13 mv. per meter with conventional suppressor-type resistance units. The field strength of the ignition interference at this same distance was only 4.3 millivolts per meter with the special high-resistance lead and 2000-ohm resistor unit in series in combination with an ordinary type of spark plug.

— J. J. L.

A 56-Megacycle Mobile Station

Storage-Battery Powered Equipment for Aircraft or Car Use

BY ARTHUR H. LYNCH,* W2DKJ

ONE of the most successful 56-Mc. portable rigs we ever used was built in a metal box about half the size of a cigar box, and it had only a single 45 oscillator modulated by a 2A5. That little job gave an excellent account of itself in our car as well as on numerous airplane flights with George Wies, W2BKX, and while using it in the tower at 40 Wall Street, New York City, during one of the A.R.R.L. Field Day Contests we ran up the highest score ever made on the ultra-highs.

But along came the new regulations and it became necessary to cast aside our modulated oscillator, so we decided to go whole-hog into the thing with a good crystal-controlled unit. Then, too, we had never been proud of the very hay-wire contrivance we had been fastening to a piece of Masonite with angle brackets and wood screws, which was tossed on top of the baggage compartment of George Wies's four-place "Waco" when we wanted to do a bit of flying.

Back in 1935 George Shuart, W2AMN, designed and built for us a somewhat different type of super-regenerative receiver. That receiver has been given such a severe beating, ever since the day we got it, and has delivered so much satisfaction that we decided it would be hard to beat, so it will be described a bit later. In passing, however, it may be well to allay some of the fears which some of the brothers seem to have about acorn tubes. As the circuit indicates, a 955 is used and *the very same tube which came with the receiver is still on active duty*, though it is nearly six years old.

Furthermore, this particular receiver has been bumped around for many thousands of miles in

* 17 Damson St., Garden City, L. I.; Managing Director, W2USA Radio Club.

our own car; it was used aboard yachts during the races on Long Island Sound, which were reported by the Garden City Radio Club; it was used at the Headquarters Experimental Station and bounced around hundreds of miles in police cars by the N. Y. City Police Department; and it has been our companion on airplane trips which have carried it many thousands of miles, under all kinds of weather conditions. It has been duplicated by a great many 56-Mc. operators, and in every case has produced enthusiasm by its performance.

Emergency Use

A study of the part which amateur radio has played in past disasters leads to the conclusion that there is a real need for a good, portable complete ultra-high station, which may be operated either from 110-volt power lines or from a six-volt storage battery. From our own experience on the roof of the Hotel New Yorker (over 400 feet high) and from our tower location at 40 Wall Street (over 900 feet high), we are convinced that, entirely aside from the communication which is so important in getting traffic from the stricken area to the outside world, there has always been a crying need for better communication between some high spot within the area and those portions which are actually involved. Better control of the actual relief, at the scene, can be organized if a suitable group of ultra-high portable and portable-mobile stations is available.

As a matter of fact, the unit shown here was originally built for battery operation exclusively. It served its purpose very well, in conjunction with several special events arranged by W2USA at the N. Y. World's Fair, as well as on a few air-

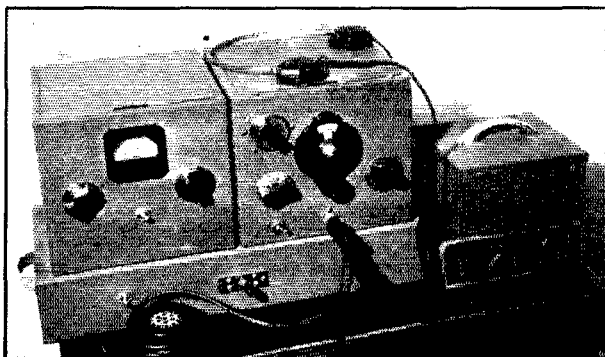

◆
Transmitter and receiver are built in identical small cabinets, both mounted on a steel chassis containing the vibrator power-supply unit. The small metal box at the right houses the transformer and rectifier for a.c. operation.
◆

The Vibrapack and plate-supply filter are mounted underneath the chassis base, along with the antenna change-over and "B" change-over switch.

plane flights. However, on one occasion the batteries were missing, and then and there it was decided that provision for light-socket operation would be a distinct advantage. The filter used with the Mallory Vibrapack would be sufficient for a.c. operation, and all we required was a suitable transformer, socket, rectifier tube and a metal container.

The method of changing from line to battery operation is clearly indicated in the accompanying pictures and diagram.

Constructional Arrangement

Our old receiver had been built in a National type C-SRR steel cabinet, which led us to the

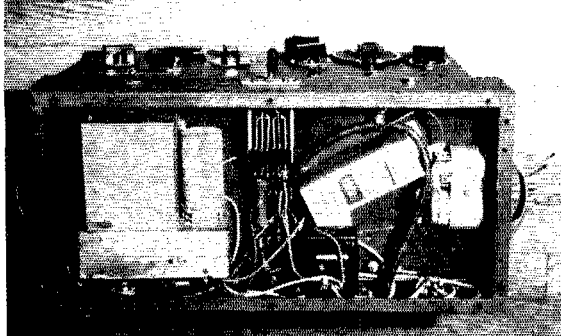

of the units individually and then join them together. Parker-Kalon screws simplified that job for us. The pictures show that connections between the units are made by running heavy wires through rubber grommets. "Hot" connections are passed through the sub-panels, by using Victron through-point bushings. The same procedure has been followed in getting connections from the units mounted under the chassis to suitable points in the transmitter and receiver.

If the receiver or transmitter are to be used for other purposes, it is suggested that all the

◆
Inside the cabinets; transmitter at right, receiver at left. The transmitter uses an RK-34 as an oscillator-doubler, using a 28-Mc. crystal. The circuits are straightforward.
◆

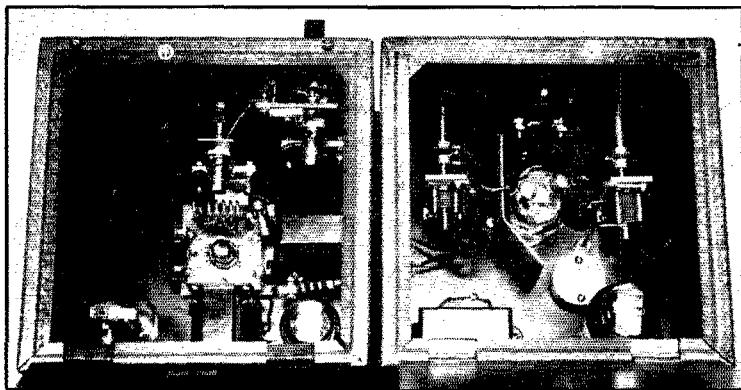

conclusion that it would be well to attempt to get the transmitter into a similar cabinet. Then they would fit together nicely, side by side, on a heavy-gauge chassis which could be used to house the vibrator power supply and the filter circuit.

Since we anticipated keeping the unit together all the time, there was no need to provide for removing either the transmitter or the receiver from the chassis, so the bottom plates were taken off and the same holes were used to hold the cabinets to the chassis, after all the wiring had been completed. It seemed simpler to wire each

wiring for the power supply and switching be made under the chassis, and that an additional plug be attached to each of the power cables coming from the transmitter and receiver. Two additional sockets should be set in the rear of the chassis to take these plugs. Any convenient method of holding the two units to the chassis may be employed, and in such an event it is suggested that the bottoms be left on the cabinets.

In some of our more hay-wire set-ups, switching from transmitting to receiving was accomplished by means of a small d.p.d.t. knife switch, but in the present arrangement we have installed a Federal anti-capacity key, S_3 . In addition to keeping the high voltage off our hands — and we did get a few nasty wallops — the present method seems to be warranted as a means of cutting losses to a minimum. It must be remembered that there is not much power to throw away.

The toggle switch at the left on the chassis (S_2) is used to cut off all power when the rig is operated from a storage battery. With the handle

Constant use has established the practicability of the 56-Mc. outfit described in this article. Standard circuits and constructional methods contribute to reliability, but without increasing bulk or weight unduly. Alternative a.c. power supply is provided.

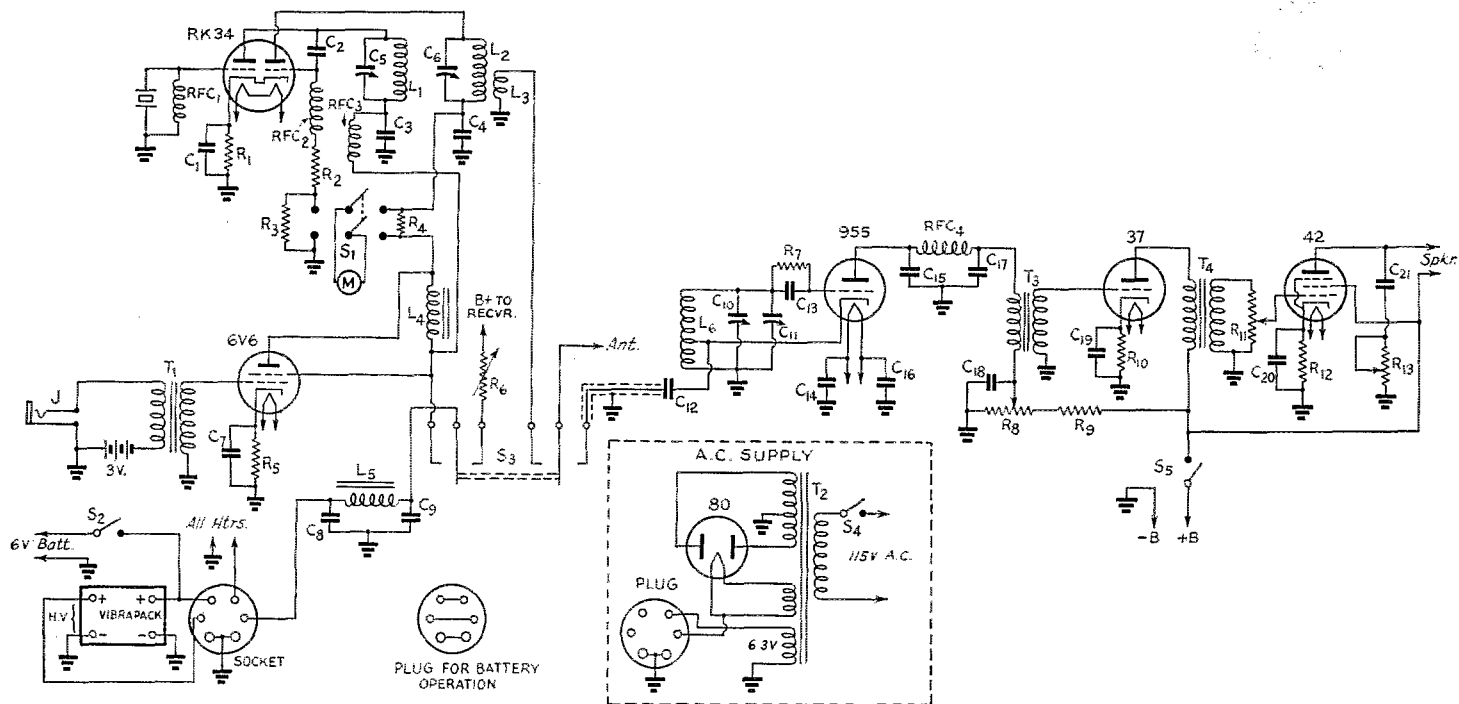

Fig. 1 — Complete circuit diagram of the 56-Mc. mobile station.

C₁ — 0.004- μ fd. mica, 500-volt.
 C₂ — 100- μ fd. mica, 500-volt.
 C₃ — 0.001- μ fd. mica, 500-volt.
 C₄ — 0.002- μ fd. mica, 500-volt.
 C₅ — 75- μ fd. variable (National UM-75).
 C₆ — 35- μ fd. variable (National UM-35).
 C₇ — 10- μ fd. electrolytic, 25-volt.
 C₈, C₉ — 8- μ fd. electrolytic, 450-volt.
 C₁₀ — 30- μ fd. mica trimmer.
 C₁₁, C₁₂ — 15- μ fd. variable (National ST-15).
 C₁₃, C₁₄, C₁₅, C₁₆ — 100- μ fd. mica.

C₁₇ — 0.001- μ fd. mica.
 C₁₈ — 0.25- μ fd. paper.
 C₁₉ — 1- μ fd. paper.
 C₂₀ — 10- μ fd. electrolytic, 25-volt.
 C₂₁ — 0.01 μ fd.
 R₁ — 400 ohms, 10-watt.
 R₂ — 25,000 ohms, 1-watt.
 R₃, R₄ — 20 ohms, $\frac{1}{2}$ -watt.
 R₅ — 500 ohms, 1-watt.
 R₆ — 5000-ohm adjustable, 25-watt.
 R₇ — 0.5 megohm, 1-watt.
 R₈ — 50,000-ohm potentiometer.
 R₉ — 75,000 ohms, 1-watt.
 R₁₀ — 2000 ohms, 1-watt.

R₁₁ — 50,000-ohm potentiometer.
 R₁₂ — 500 ohms, 1-watt.
 R₁₃ — 50,000-ohm potentiometer.
 L₁ — 6 turns No. 12, diameter 1 inch, turns spaced diameter of wire.
 L₂ — 4 turns same as L₁.
 L₃ — 5 turns same as L₁.
 L₄ — 20 henrys, 65-ma. (Kenyon KC-200).
 L₅ — 8 henrys, 165-ma. (Kenyon KC-90).
 L₆ — 7 turns No. 12, diameter $\frac{1}{2}$ inch, length $1\frac{3}{4}$ inches.
 RFC₁, RFC₂, RFC₃, RFC₄ — 2.5-mh. r.f. choke.

T₁ — Single-button microphone-to-grid transformer (Kenyon KSMG).
 T₂ — 350 volts each side c.t.; 75-ma.; 5-volt and 6.3-volt filament windings (Kenyon T-205).
 T₃, T₄ — Interstage audio transformer, 3:1 ratio.
 S₁ — D.p.d.t. toggle.
 S₂, S₄, S₅ — S.p.s.t. toggle.
 S₃ — D.p.d.t. anti-capacity switch (Federal).
 M — 0-50 d.c. milliammeter.
 J — Open-circuit jack.
 Vibrapack — Mallory Type VP-552.

of the anti-capacity key in the center position, as shown in the front view picture, plate voltage is off both units. Throwing it to the left puts the voltage on the transmitter and to the right the voltage is put on the receiver plates. Filaments are kept burning during the entire time of operation.

The toggle switch mounted between the two tuning controls of the transmitter is a d.p.d.t. unit (S_1) and is used to connect the milliammeter into the plate circuit of the oscillator or amplifier portions of the RK-34 when thrown to the left or right, respectively.

As the receiver was not intended originally for its present occupation, a toggle switch was provided for cutting off the plate voltage. It is shown in the lower left-hand corner, next to the head-phone jack. The headphone plug, in the front view of the set, casts a shadow over the microphone plug which is inserted in the jack in the front of the power supply chassis; this jack may be seen to better advantage in the bottom view. The second stage audio output jack in our receiver is on the right-hand side of the receiver cabinet; it would be better to mount it on the front panel under the audio gain control. Another improvement, especially where the operation is to be in crowded quarters, would be to include an output transformer or other form of output circuit in the second audio stage. In building a similar receiver the Garden City Radio Club Technical Committee included a tone control circuit, which does cut down much of the hiss, even though a fixed filter for the same purpose is included in the original circuit. The control knob and variable resistor for the tone control circuit in that case were installed in the upper right-hand corner, in line with the antenna tuning control.

We are not very proud of the wiring in the power supply chassis; it was literally tossed in, in an attempt to get the rig on the air for some job or other. We have never gotten around to squaring it up since the outfit works very well the way it is.

After throwing the transmitter out of adjustment a couple of times by inadvertently brushing against one of the tuning knobs, we added a pair of National type ODL dial locks to the knobs. They have proved to be very well worth while.

The entire assembly for portable use measures 19 inches in width, 10 inches in depth and $10\frac{1}{2}$ inches in height. The photographs show that there is no crowding of components.

Performance

After many trials, both in cars and airplanes, we are convinced that best all-round results so far as mobile operation is concerned are obtained by the use of a quarter-wave vertical antenna. For most of that work we have been very well satisfied

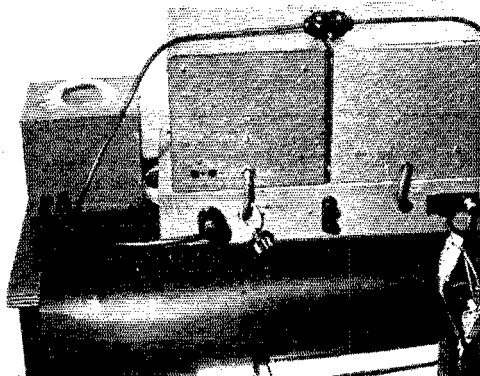

A rear view, showing the method of making power connections between units.

with the performance and the ease of installation which is provided by any good telescoping auto antenna designed for broadcast reception. Most of our work was actually done with a Premax Auto Antenna. One of them was attached to a plane which was piloted by George Wies for the *N. Y. Daily News*, and it remained in place for many thousands of miles.

Results

From a point over Roosevelt Field, which is about a mile from Garden City, L. I., we have worked fellows as far north as Hartford and as far south as Philadelphia. No doubt greater distances could have been covered if more stations had been on the air at the time the flights were made.

On a more recent flight from Roosevelt Field to Hartford with Bob Wormald, W2RZ, we killed the motor when over New York at a height of 7500 feet, and took a glide all the way out to Farmingdale, about forty miles. Up there in the silence we heard stations from Boston to Baltimore, but were not able to raise them — most of them were busy, and our frequency was pretty well down toward the end of the band. Some time we are going to put on a night flight and arrange for stations to be on the lookout for us, just to see what kind of distance we can cover.

At our home station, in Garden City, which is a notoriously poor location for any kind of radio work because of interference from two very active flying fields and three high-tension power lines, as well as an electric railroad at the corner and plenty of auto traffic on three streets which surround the house, we have hooked this little rig to one of W2AMJ's extended double Zepp¹ antennas and worked up to forty miles with reasonable regularity.

¹ Lynch, "More Thoughts on Effective Antennas," *QST*, November, 1939.

1939 Sweepstakes Contest Results

All Records Broken in Tenth A.R.R.L. "SS"

BY E. L. BATTEY,* WIUE

A DECADE of Sweepstakes Contests was completed in November, 1939, as the curtain fell on the Tenth A.R.R.L. "SS." And a gala tenth anniversary it was! Overshadowing its nine predecessors the '39 contest was the greatest national competition of similar nature ever held. From the standpoint of the number of individuals participating throughout the League's Field Organization, the Tenth Sweepstakes has been equalled as an operating activity only by the '39 Field Day.

Competition was extremely keen with 1704 operators submitting reports on their participation! It should be noted that only 64 of the 71 Sections were active, due to the absence of the VE's. Had the Canadians been active, it is estimated that the total of reporting operators would have been approximately 1850, surpassing even the Field Day! We pass along the expression of hundreds of participants when we say to the .E's, "You were missed"!

Since the 1939 contest marked a milestone in Sweepstakes, it is interesting to look back to the first SS in 1930. That first contest had a total participation of 117 operators. How SS interest has increased through the years! In 1939, there were 133 logs from Illinois alone, 98 from Eastern Pennsylvania, and similarly intense competition in the other Sections. The SS must have that certain "something" to warrant the growth it has enjoyed! If you haven't experienced that "something," see your nearest SS-er for details!!

Meet the Winners

The Sweepstakes was actually 64 contests rolled into one. Competition was between the contestants within each individual Section, and the operators in each of the active Sections really made it interesting for their competitors; 1436 individuals submitted c.w. logs, 310 sent 'phone logs, with 42 taking part in both classifications. Snappy tie holders with diamond-shaped charm

* Assistant Communications Mgr.

attached (see page 10, Nov. '39 QST) were offered to the c.w. winner and the 'phone winner in each Section; 63 c.w. awards, 60 'phone awards are being made. The winners are listed in a special table showing their transmitter line-ups, type oscillators, receivers, and bands used. There you have an abbreviated station description of each winner. Give the champs a big hand, gang. Watch for those nifty tie holders at hamfests and conventions, and congratulate the wearers in person. Theirs is a hard won victory!

All Sections Worked

It was a big year for working all sections, eight operators succeeding in snagging the available 64. The usual rare ones, such as KA, K7, etc., were successfully ferreted out by W2HXQ and

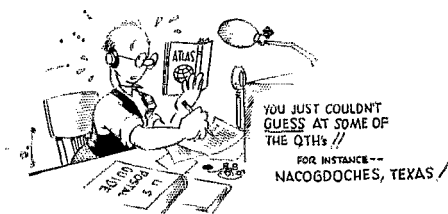

W9RBI on 'phone, and W1TS (all first week-end), W2UK, W6GRL (W4DHZ, op.), W6HZZ, W6NIK and W8DOD on c.w. If you failed to recognize the call, W2HXQ is Kay Kibling, YF of W2EOA. So, congratulations, boys and gal!

Eleven operators missed but one section, and also deserve a place of honor. We list them, indicating the "one that got away." On 'phone — W6DTB (Vermont). On c.w. — W2HHF (K7), W2IOP (K6), W3AGV (KA), W3DUK (K7), W7CMB (KA), W9CWW (KA), W9GKS (KA), W9UM (KA), W9VES (KA) and W9VKF (KA).

The following each worked 62 sections. On c.w. — W1BFT, W1EZ, W1FTJ, W2GVZ, W3BES, W3EDP, W3FRY, W6AXC, W6EPZ, W6PCE, W6QAP, W6QQL, W7UQ (W9AHR, op.), W8BWC, W8IQB, W8LCN, W8OFN, W8QGF, W9GY, W9QCJ, W9YCR and W9ZAR. On 'phone — W3DQ, W5BB, W6ITH, W6OCH and W9YQN.

Club Participation

The clubs really went to town in the '39 SS. Scores were submitted by 60 club groups in competition for the gavel award put up for the

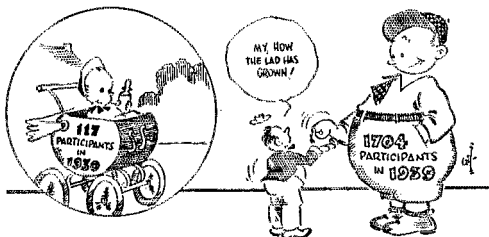



A CLEAN SWEEP
WHZZ WHBK, WZUK, W6RL (W6RZ), W4RBI, W2HXQ, W6DDO AND WYTS WORKED ALL SECTIONS

club having the highest aggregate score. Steadily pursuing its object of "a gavel for every member," the Frankford Radio Club of Philadelphia made its fourth consecutive win with 1,000,164 points! We take pleasure in presenting the gavel to this group of master contest sharks. Well earned, Frankford! Veteran W3BES led F.R.C. Again in second place is the Milwaukee Radio Amateurs' Club, Inc., Frankford's greatest threat. M.R.A.C.'s crew ran up 572,015 points, led by W9EYH (c.w.) and W9TXF ('phone). This gang is after F.R.C.'s scalp! A dark horse, the Greater Cincinnati Amateur Radio Ass'n, jumped into third place with 421,478, headed by W9FS (c.w.) and W8BFB ('phone). Still plugging for first place, the York Radio Club of Elmhurst, Ill., considerably bettered its previous scores and hit 405,366. W9YFV (c.w.) and W9CIU ('phone) were winners in Y.R.C. Third high in '38, the Delaware Amateur Radio Club (Wilmington) slipped into fifth place, 336,769, with honors going to W3DUK (c.w.) and W3DQ ('phone).

Certificate awards are being made to the leaders (c.w. and 'phone) in each club having three or more reporting participants. The remaining 55 clubs eligible for these individual awards are listed in order of aggregate scores, together with the calls of the winners. Except where otherwise indicated the winners used c.w.: New Haven Amateur Radio Ass'n (Conn.), 235,984, W1KQY (c.w.), W1GDC ('phone); Columbia University Radio Club, 228,993, W2IOP; Birmingham Amateur Radio Club (Ala.), 224,213, W4EV; Merrimack Valley Amateur Radio Ass'n (Concord, N. H.), 181,353, W1BFT (c.w.), W1ATE ('phone); Trenton Radio Society (N. J.), 179,936, W3EDP (c.w.), W3AIR ('phone); Queens Radio Amateurs (N. Y.), 173,147, W2CWE (c.w.), W2KCH ('phone); Beacon Radio Amateurs (Phila.), 170,981, W3ATR; North Newark Amateur Radio Club (N. J.), 170,651, W2LXI; Northern Nassau Wireless Ass'n (N. Y.), 163,312, W2AYJ; Chester Radio Club (Pa.), 146,633, W3DGM (c.w.), W3DRQ ('phone); Wisconsin Valley Radio Ass'n, Inc., 144,985, W9RQM (c.w.), W9ZTO ('phone); Richmond Amateur Radio Club (Va.), 143,452, W3FBL (c.w.), W3GWQ ('phone); Wichita Amateur Radio Club (Kans.), 137,611, W9AWP; Elmira Amateur Radio Ass'n (N. Y.), 132,847,

W8DZC; Rochester Amateur Radio Ass'n (N. Y.), 132,075, W8DOD (c.w.), W8ATH ('phone); Austin Radio Club (Chgo.), 129,014, W9ZMG; Southern Connecticut Radio Ass'n, 120,202, W1DOV (c.w.), W1KNY ('phone); Mountaineer Amateur Radio Ass'n, 120,061, W8OXO (c.w.), W8JM ('phone); Hi-Q Radio Club (Lynn, Mass.), 97,781, W1BSG (c.w.), W1ERH ('phone); Twin City Bug Twiddlers (Mpls.), 95,126, W9NYH; Red River Radio Club (Alexandria, La.), 94,800, W5WG (c.w.), W5HBY ('phone); Philadelphia Wireless Ass'n, 93,420, W3HLZ; Seattle Amateur Radio Club (Wash.), 91,523, W7RT (c.w.), W7EKA ('phone); Westlake Amateur Radio Ass'n (Ohio), 86,655, W8HGW; Providence Radio Ass'n, Inc. (R. I.), 83,174, W1KOG; Southern Montana Amateur Radio Ass'n, 81,076, W7JC (c.w.), W7CT ('phone).

South Jersey Radio Ass'n, 76,871, W3HEH (c.w.), W3HDJ ('phone); Utah Amateur Radio Club, 69,900, W6FRN; Chattanooga Amateur Radio Club (Tenn.), 62,100, W4CDC; Dayton Amateur Radio Ass'n (Ohio), 60,595, W8GER (c.w.), W8CDR ('phone); Yakima Amateur Radio Club (Wash.), 59,814, W7AYO (c.w.), W7ALH ('phone); Ozark Empire Radio Club (Springfield, Mo.), 52,599, W9GBJ; Chair City Radio Ass'n (Gardner, Mass.), 51,183, W1BIV (c.w.), W1AUN ('phone); San Mateo Jr. College Radio Club (Calif.), 51,095, W6PBV; York Road Radio Club (Pa.), 49,703, W3DPU; Enid Amateur Radio Club (Okla.), 48,611, W5GFT (c.w.), W5GHN ('phone); Waltham Amateur Radio Ass'n (Mass.), 48,071, W1JOX; Santa Monica Mike & Key Club (Calif.), 48,038, W6LJD (c.w.), W6AQJ ('phone); Starved Rock Radio Club (Ill.), 46,968, W9NGG (c.w.), W9NOO ('phone); Hartford County Amateur Radio Ass'n (Conn.), 44,630, W1CSC (c.w.), W1EAO ('phone); Tu-Boro Radio Club (N. Y.), 39,663, W2KYV; Intercity Amateur Radio Club (Irvington, N. J.), 38,708, W2MAX; Cahokia Amateur Radio Club (Ill.), 37,682, W9EBX (c.w.), W9OAW ('phone); Black Hills Amateur Radio

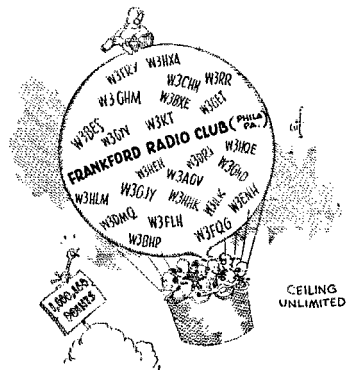

Club (So. Dak.), 34,604, W9YOB (c.w.), W9ADJ ('phone); Bloomfield Radio Club (N. J.), 34,520, W2HZY (c.w.), W2IMT ('phone); North East Amateur Radio Club (Cleveland, O.), 30,292, W8ORM (c.w.), W8PJJL ('phone); Georgia Tech Radio Club, 25,068, W4DYH (W4ERD op.); Bridgeport Amateur Radio Ass'n (Conn.), 23,777, W1GVK (c.w.), W1ACV ('phone); Sunrise Radio

76,073, W1EZ 74,865, W9ASO 70,476, W9YCR 70,293, W8HHF 70,009.

The highest scorer in each district: W1TS 83,120, W2IOP 101,115, W3BES 96,798, W4CYC 61,729, W5KC 67,350, W6GRL 79,552, W7CMB 76,073, W8OFN 96,798, W9FS 99,583.

Leader in number of contacts was W9FS, who worked 658 stations, a new record for Sweepstakes. Also breaking the previous high and going over the 600 mark are W2IOP 646, W6GRL 635, W3BES and W8OFN 626, W3DUK 609 and W2GSA 608. Somewhat lower in contacts but not exactly lagging are: W9EYH 576, W2JAE 565, W3DGM 555, W9YFV 535, W9VES 531, W9VFZ 527, W1BFT and W8OKC 526, W3EDP, W8NLQ, W9RMQ and W9VDY 525, W1TS 520, W8DOD 519, W8JIN 512, W9ZAR 510, W2UX and W4EV 502.

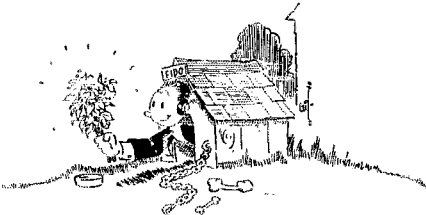

ORCHIDS TO THE YFS AND YLS WHOSE COOPERATION AND TOLERANCE MADE THE HIGH SCORES POSSIBLE.

Club (N. Y.), 20,404, W2EVZ; Iowa-Illinois Amateur Radio Club (Burlington, Ia.), 19,093, W9QVA; Montgomery Amateur Radio Club (Ala.), 18,246, W4GBV (c.w.), W4ECF ('phone); Marin Radio Amateurs (Calif.), 16,985, W6MUF (c.w.), W6GPB ('phone); Pierre Amateur Radio Club (So. Dak.), 15,957, W9SEB; Hamfesters Radio Club (Chgo.), 15,385, W9RBR; Eastern Massachusetts Amateur Radio Ass'n, 11,812, W1WV (c.w. and 'phone).

High C.W. Participants

Scores reached adding machine proportions in the Tenth SS. Twenty-seven operators topped 70,000 points. For the first time under the present rules (40 hours, 1.25 multiplier) an operator went over the one-hundred thousand mark! Credit for this outstanding operating feat goes to Larry LeKashman, W2IOP, who worked 646 stations in 63 sections, and rang the bell at 101,115. We salute you, Larry! Swell stuff!! So near the six-figure mark that it hurts, Bert Brown, W9FS, wound up with 99,583 points, 653 stations, 61 sections. Now if one of those sections hadn't eluded him. . . ! Nice work, Bert.

Near-ties are not new in SS contests, but actual ties are rare, especially among the high scorers. But nothing was ordinary about the '39 fray and W3BES and W8OFN tied for fourth high position with identical results — 626 stations, 62 sections, 96,798 points. Shall we flip a coin for you boys?

W3DUK's tally showed 95,445 points (609 stations, 63 sections), and W2GSA's 92,720 (608 stations, 61 sections). Respectable records on any man's slide rule. FB! Other national highs are W9EYH 86,250, W3DGM 84,638, W9VES 83,554, W1TS 83,120, W8DOD 82,240, W3EDP 81,375, W1BFT 81,298, W9RQM 79,986, W6GRL 79,552, W9ZAR 78,818, W9VFZ 78,700, W9VDY 78,075, W8OKC 77,216, W8JIN 76,425, W8NLQ 76,125, W9RSO 76,097, W7CMB

Leading 'Phones

Maintaining his position as No. 1 voice man in the SS, Reg Tibbetts, W6ITH, set a new high with 55,676 points — 449 stations in 62 sections. Fast talking, Reg! Not too far behind was Larry Barton, W6OCH, 45,694, the result of 370 contacts in 62 sections. Larry continues as W6ITH's toughest competitor. A close third is W9RBI with 44,480, followed by other highs as follows: W6QEU 36,383, W9USH 32,627, W3DQ 31,124, W5BB 31,062, W9YQN 31,000, W6DTB 29,610, W9ZTO 27,592, W2JUJ 25,300, W2HXQ 24,448, W9NDA 23,790, W6AM 23,659, W7HEY 22,880, W9QJB 22,287, W9UVA 21,863, W9DKU 21,775, W9ZVX 21,708, W1ATE 21,417, W9PNX 21,340.

The highest 'phone scorer in each district: W1ATE 21,417, W2JUJ 25,300, W3DQ 31,124, W4DRZ 18,821, W5BB 31,062, W6ITH 55,676, W7HEY 22,880, W8ATH 19,494, W9RBI 44,480.

Working the most stations on 'phone were W6ITH 449, W6OCH 370, W6QEU 301, W9RBI 280, W9USH 279, W3DQ and W5BB 252, W9YQN 250, W9ZTO 242, W6DTB 235, W2JUJ 232, W9DKU 223, W7HEY 211, W9ZVX 204 and W6AM 201.

General Notes

There were two definite classes of SS participants: (1) those using variable frequency oscillators, and (2) those using crystal control. The technique used by the first group

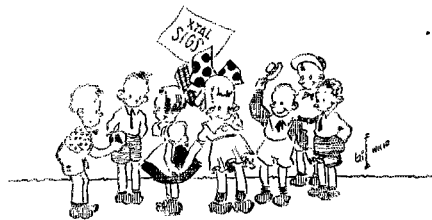

THE E.C.Q. BOYS FLOCKED 'ROUND

WINNERS, TENTH A.R.R.L. SWEEPSTAKES CONTEST

RADIOTELEGRAPH

Section	Winner	Call	Transmitter Line-Up	Type Osc. (E.C.O. or G.C.)	Receiver	Bands Used
E. Penna. Md.-Del.-D. C. S. N. J.	Jerry Mathis	W3BES	6J7-6V6-807-809's	Both	NC101X	3.5, 7, 14
	Clyde L. Bunch, Jr.	W3DUK	802-807-807-HK54	e.c.o.	NC101X	3.5, 7, 14
	Hy Siegel	W3EDP	6SJ7-6V6-6A6-RK39-807's- HK254's	e.c.o.	HRO	3.5, 7, 14
W. New York	Elmer Grabb	W8DOD	802-RK25-RK20	e.c.o.	NC100X	3.5, 7, 14
W. Penna.	D. J. Rairigh	W9YXD/8	6F6-6L6-814	e.c.o.	SX16	14, 7, 3.5
Illinois	Phillip Simmons	W9VES	2A5-42-6L6G-T40	e.c.o.	-----	3.5, 7, 14
Indians	M. W. Macy	W9UM	X-EC Unit-802-RK25-RK20's- 150T's	Both	Comet Pro	3.5, 7, 14
Kentucky	Bert Brown	W9FS	6F6/6V6-807/813	Both	RME69/DB20	3.5, 7, 14
Michigan	F. D. Bornman	W8QDU	6F6-6L6-RK20's-250TH's	e.c.o.	Super Pro	3.5, 7
Ohio	H. E. Stricker	W8OFN	6SK7-6L6-6L6-35T	e.c.o.	HQ120X	3.5, 7, 14
Wisconsin	Walter Wallace	W9EYH	6F6-6L6-6L6's	e.c.o.	Homemade: 6-tube regen. super	3.5, 7, 14
No. Dakota	Carlyle Norman	W9ZOU	6L6G-6L6G-6L6G-100TH	e.c.	Sky Champion	3.5, 7, 14
So. Dakota	Carl G. Strauss	W9FOQ	'47-'10-T40	e.c.	McMurdo Silver 5B	3.5, 7, 14
No. Minn.	C. W. Davies	W9YOR	6SK7-6SJ7-807-808	e.c.o.	RME9D	7, 14
So. Minn.	L. A. Morrow	W9YKF	6K7/6L6-6L6G-6L6G-814	Both	HQ120	3.5, 7, 14, 28
Arkansas	Lester Woolsey	W5EJ	'47-'46's	e.c.	SX24	7
Louisiana	Vincent L. Rosso	W5KC	59-802-807-100TH	e.c.	NC101X-DB20	3.5, 7, 14, 28
Mississippi	Fred L. Ford	W5AVF	6L6-6L6G's	e.c.	NC81X & pre.	7, 14
Tennessee	Paul C. McCampbell	W4CDC	-----	Both	-----	3.5, 7, 14
E. New York	Elbert L. Taylor	W2EWD	'47-'46-TZ20-809's	e.c.	Sky Chief	3.5, 7, 14
N. Y. C. & L. I.	Larry Le Kashman	W2IOP	Meissner Sig. Shifter-814	e.c.o.	NC101X	3.5, 7, 14
N. N. J.	Bob Morris	W2GSA	Meissner Signal Shifter-803	e.c.o.	RME69	3.5, 7, 14
Iowa	C. E. Gross	W9GKS	E.c.o.-T40; e.c.o.-'46-T40	e.c.o.	HRO	7, 14
Kansas	Charles A. Pine	W9CWW	802-807-814	Both	NC101X	3.5, 7, 14
Missouri	Oscar Short	W9RSO	59-6L6-RK39-RK37's	e.c.o.	T.R.F., 3 tubes	3.5, 7, 14
Nebraska	Kenneth F. Peterson	W9ZAR	24A's-T20-809-T55	e.c.o.	Howard 440X	7, 14
Connecticut	Edmund R. Fraser	W1KQY	Meissner Signal Shifter-809-809's	e.c.o.	NC101X	3.5, 7, 14
Maine	Clarence Arrey	W1ASG	6A6's-RK20's-HK54's	e.c.	Homemade 12-tube super	7
E. Mass.	Roger F. Hathaway	W1RY	59-6L6G-808	Both	HRO	3.5, 7, 14, 28
W. Mass.	Victor W. Paounoff	W1EOB	802-RK47	e.c.o.	SX9	3.5, 7, 14
N. H.	Carl B. Evans	W1BFT	RK23-RK20-860	Both	Homemade super; Comet Pro	3.5, 7, 14
R. I.	Casey Iafrate	W1KOG	6F6/2A5-6L6-T40	Both	ACR175	3.5, 7
Vermont	Hal Pratt	W1EZ	'03A	e.c.o.	Det.-Aud.-201A	3.5, 7, 14
Alaska	Arthur B. McBride	K7GOM	802-T20	e.c.	RME69	7, 14
Idaho	E. V. Whitlock	W7GDU	6F6-6A6-6L6-809's	e.c.o.	Sky Champion & homemade pre.	7, 14, 28
Montana	E. M. Van Houten	W7JC	6L6-'10-'10's-211's	e.c.	SX16	7, 14
Oregon	L. James Larsen	W7DZL	6F6-6L6-811	e.c.o.	RME70	3.5, 7, 14
Washington	Harold G. Ingledue	W7CMB	24A-58/42-6L6-HY61-808	Both	Homemade super	3.5, 7, 14
Hawaii	W. Howie Lee	K6OQV	6A6-807	e.c.	SX24 & 1851 pre.	14, 28
Nevada	George H. Osborn	W6QQJL	6A6-6L6G-TZ40's	e.c.o.	S18	3.5, 7, 14
Santa Clara V.	Robert E. Leo	W6PBV	Meissner Signal Shifter-809-211	e.c.o.	NC101X	7, 14
East Bay	Elvin Feige	W6TTT	807/802-807-100TH-250TH's	Both	RME70 & DB20	7, 14
San Francisco	Wm. A. Ladley	W6RBQ	802-841-35T-150T-250TH's	e.c.	HRO; Super Pro	7, 14
Sacramento V.	Wilfred C. Dodds	W6NHA	6K7-6V6-807-50T-HK54's	Both	SX18	3.5, 7, 14, 28
San Joaquin V.	Frank Valentich, Jr.	W6MEK	59-6L6-TZ20-35T	e.c.o.	HRO	7, 14
No. Carolina	Tom Brandon	W4CEN	76/802-807-36L6's-RK47-250TH's	Both	Homemade super	7, 14
So. Carolina	C. W. Jackson	W4DAM	6F6-HY61-HK254	e.c.	HQ120X	7, 14
Virginia	Larry Arnold	W3FBL	802-6L6-807-811	Both	HQ120	3.5, 7
West Va.	W. D. Tabler	W8OXO	89-807-100TH; 89-807	Both	RME69 & DB20	3.5, 7, 14
Colorado	Ed F. Miller	W9WTW	6L6-6L6-809's-T55's	e.c.	SX16	3.5, 7, 14, 28
Utah-Wyo.	George S. Keeler	W6FRN	6V6-6N7-809-T40's	e.c.	SX16	7, 14
Alabama	Reginald R. Cain, Jr.	W4CYC	6SK7-6L6G-RK49-75T	Both	RME69	7, 14
E. Florida	James L. Dyer	W4COB	Meissner Signal Shifter-809- TZ40's	e.c.o.	SX23 & pre.	7, 14
W. Florida	Geo. Eggart	W4EPT	6L6G-T55	e.c.	NC101X	7, 14
Georgia	Wm. F. Fields, Jr.	W4DIA	6F6-6L6-HY61-HK24's	e.c.o.	Comet Pro	7, 14
West Indies	Ramon M. Marti	K4FCV	6L6G-807-35T-100TH's	e.c.	NC101X	7, 14, 28
Los Angeles	Dave Evans, W4DHz	W6GRL	6J7-6F6-6L6-6L6-813-250TH's	Both	HQ120X	3.5, 7, 14
Arizona	Winchell Keller	W6QAP	6L6-809; X-EC-807-812	Both	HRO	3.5, 7, 14
San Diego	Hayes Acton	W6NIK	6L6-807-35T-100TH	e.c.o.	2-tube "blooper"- 57-56	7, 14
No. Texas	R. E. Cowan, Jr.	W5GKA	6L6-HY61	e.c.	SW3	7, 14
Oklahoma	J. H. Vensel	W5BOR	6L6-TZ10-T55	e.c.	Homemade super	3.5, 7, 14
So. Texas	Bruno M. Wojcik	W5CWW	6F6-6L6-807-T125	e.c.o.	HRO	3.5, 7, 14
New Mexico	Sheldon H. Dike	W5HAG	'47-6L6-HK24	e.c.	PR15	3.5, 7, 14

RADIOTELEPHONE

Section	Winner	Call	Transmitter Line-Up	Type Occ. (E.C.O. or C.C.)	Receiver	Bands Used
E. Penna. Md.-Del.-D. C.	Paul J. Thompson Willard S. Wilson	W3DRQ W3DQ	6L6-809-T55 T21-T21-TZ40-TZ40's-T200's	e.c.o. e.c.o.	Bretting 12 HRO; Hallierafter 5-10	3.9, 14, 1.75 28, 14, 3.9, 1.75
S. N. J. W. N. Y. W. Penna. Illinois Indiana Kentucky Michigan	A. E. Williams Chas. F. Snyder R. H. McCague Paul L. Edwards Aldwin G. Ferris W. E. Leatherman Zeph Willison	W3HDJ W8ATH W8KBJ W9NDA W9UTL W9YQN W8JAH	6J7-6L6-807-800-HK254 RK25-RK39-810-276A's 6A6-802-RK20's-HF300's 6F6-6L6-TZ40-35T's-354's 6K8-6F6-6L6-T20-T55 802-807-807-T40's Signal Shifter-807-804-354's; 6L6- HK24-HK24's	e.c.o. Both Both e.c.o. e.c.o. Both	SX23 SX17 NC101X S-20 RME69 FBXA	3.9, 14, 28 3.9, 14, 28 3.9 3.9, 14, 28 3.9 3.9, 14, 28 3.9, 14, 28
Ohio Wisconsin No. Dakota	Robert J. Neff Ross E. Hansch D. M. Beaudine	W8CDR W9RBI W9RPF	59-59-841; 89-802's 807-807-T40; 6C5-6L6-807 6L6G-HY60-T20-T40's	Both Both Both e.c.o.	NC100X NC81X 11-tube homemade super	3.9, 14 3.9, 14 1.75, 3.9, 14, 28 3.9, 14
So. Dakota No. Minn. So. Minn. Arkansas Louisiana Tennessee E. New York	Robert Mattison Jack P. Burke Francis C. Kramer Wayne Chitwood R. K. Andrews Homer Smith Kay I. Kibling	W9USH W9UVA W9DEI W5DYT W5HBY W4DFB W2HXQ	6L6G-807-807's 6L6-807-T55 6L6-807-T55-T200 6A6-807-T55-T55's 6V6-807-HK24's '47-59-809-808's 6L6-809-'03A; 6L6-807-RK47- RK63's	e.c.o. e.c. e.c. e.c. e.c. e.c. e.c.	RME69 & DM36 SX16 Hammarlund Pro RME70 Sky Champion HRO	3.9, 14, 28 3.9, 14, 28 3.9, 14 14, 28 1.75, 28 14
N. Y. C. & L. I. N. N. J. Iowa Kansas	Viola Grossman James A. Wotton Wm. R. McGrew George E. Jauss	W2JZX W2JUJ W9JIS W9PNX	6L6-RK20-T200's 80 -35T-100TH's 6L6-6L6-807's-51Z's Meissner Signal Shifter-T40- TZ40's	e.c. e.c.o. e.c.o. e.c.o.	RME69 & pre-sel. HQ120 HRO HQ120X	1.75, 3.9, 14, 28 3.9 3.9, 14, 28 3.9, 14
Missouri Nebraska	Dow B. Summers Harrison S. Campbell	W9KOH W9ZYX	6F6-6L6-RK39's-RK63 6V6-809-809-809's	e.c. e.c.	SX17 Sky Chief; Howard 438	14, 28 1.75, 28 3.9, 14, 28
Connecticut Maine E. Mass.	F. M. Dingwall V. H. Ashton Webster Reynolds	W1GDC W1C0M W1JNX	6F6-6L6-808-852's 6A6-6L6-T20-T55 6L6-HK54; 6L6-RK49; 35T's; 6L6-RK49-800-HK54's	Both e.c. e.c.	Both RME70 RME70	1.75, 14, 28 3.9, 14, 28 14
W. Mass. N. H. R. I. Vermont Alaska Idaho	Gordon Wiley C. R. Knowlton Leonard Finkle S. F. Martin Herman I. Lerdahl Kenneth M. Rude	W1AUN W1ATE W1LBV W1BJB K7HQZ W7FQT	802-807-T55's 6L6-6L6's-100TH's NTE exciter-HF100 6L6-'10-100TH; 6L6-'10-T55	e.c.o. e.c. e.c. e.c.	RME70 RME70 NC100XA	3.9, 14, 28 3.9, 14 28
Montana Oregon Washington Nevada Santa Clara V. East Bay	Dan Fulton Carl Austin Albert W. Wesley B. E. Edwards H. D. DeVoe D. Reginald Tibbetts	W7FLT W7GNJ W7EKA W6FUO W7MF/6 W6ITH	6D6-6V6-6N7-807-35T 6L6-T20-T55-T55's 42-6L6-6L6-TZ40-50T 6L6-TZ20's-T55's 6A6-6A6-807-150T 6C5-6L6G-807-814-806's	Both e.c. e.c.o. e.c. e.c. Both	Homemade super HQ120X RME69 PR10 & pre. Bretting 12AX Super Pro; Homemade super	1.75, 3.9, 14, 28 1.75, 3.9, 14, 28 3.9, 14, 28 3.9, 14 3.9, 14 1.75, 3.9, 28, 56, 112
San Francisco	Joseph Horvath	W6GPB	RK23-TZ40-HK354	e.c.o.	Comet Pro & Sargent signal booster	14, 28
Sacramento V. San Joaquin V.	W. E. Norsworthy Peter K. Onigian	W6IMV W6QEU	'47-6L6-100TH's 6F6-809-809's	e.c. Both	RME69 9-tube A.R.R.L. super (*38 Handbook)	14 1.75, 28 3.9, 14
No. Carolina So. Carolina	Chas. W. Boyles Wade H. Holland	W4DST W4AZT	6L6-807-35T-100TH's 6V6G-6L6's-805's	e.c. e.c.o.	PR10 Hammarlund Super-pro	1.75, 3.9, 14 3.9
Virginia West Va. Colorado Utah-Wyo. Alabama E. Florida W. Florida	F. S. Anderson, Jr. J. E. Hoffer, Jr. James H. Goss Chester R. Ashby Bill Britton Robert M. Haskins Eddie Collins	W3GWQ W8CWY W9ZIX W6DTE W4ECF W4DRZ W4MS	6L6-807-T40's 6L6-6L6's-T40's-852's 6L6-807-T40's 807-RK20/TZ40-800's 42-807-35T-100TH's 53-53-801's-T125 6A6-RK49's-T55-T200	Both e.c. e.c. e.c.o. e.c. e.c. e.c.	ACR155 Homemade super RME9DS SX16 RME69 RME69-DB20 RME69; HRO; HQ120X	1.75, 3.9, 14 14 1.75, 3.9, 14, 28 3.9, 14, 28 14 14, 28, 56 14, 28
Georgia Los Angeles	Geo. P. Rankin Don C. Wallace	W4BK W6AM	6J5-6L6-809-809's 6A6-6L6GX's-250TH-300T's	e.c. e.c.	RME70 RME69/RME70 & DM36	1.75, 3.9, 14, 28 28
Arizona No. Diego No. Texas Oklahoma So. Texas New Mexico	James B. Stevens R. H. Culbertson W. E. Varley Thomas S. Depew Wm. T. Caswell, Jr. T. J. Fitzsimmons	W6PCB W6CHV W5FAB W5GHN W5BB W5UU	6L6-807-HY51Z 59-802-HF100 59-HY25-HY40Z-HY40's E.c.o./c.c.-6L6-RK28-250TL's 53-RK23-TZ20's-100TH's 6L6-6L6-807-HY25's	e.c. Both e.c.o. e.c.o. e.c. e.c.o.	NC101X Homemade super Homemade super NC101X NC101X SX17	1.75, 3.9, 14, 28 3.9, 14 3.9, 14 3.9, 14, 28 28

was to flit here and there through the bands, alighting on the stations with which contact was desired. This is the proven best method of getting sections. The second group, confined to one or a comparatively few frequencies, put on their best Sunday dress and invited the band-cruising lads to "come to them." CQ's were profitable to this crystal-controlled gang as they cleaned up stations available in the vicinity of their frequencies, and sat tight until a new crop appeared out of the wilds.

34.2% of all winners used e.c.o. entirely, 41.6% used c.c. entirely, and 24.2% used both e.c.o. and c.c. The c.w. contingent went strong for variable frequency work with 41.3% using e.c.o. entirely, while only 26.3% of the 'phones chose exclusive use of this method. 54.4% of the 'phone winners stuck by c.c. throughout the contest, and 19.3% used both methods. 30.1% of the c.w. gang used c.c. and 28.6% used both crystal and e.c.o. These percentages, figured only from the work of the winners, would hold substantially for all contestants.

7-Mc. continues as the most popular and profitable c.w. SS band, with 14-Mc. a close second. 3.5-Mc. is also well used, a comparatively small number using 28-Mc. Among the voice operators, 14-Mc. was most used, followed closely, in order, by 3.9- and 28-Mc. 1.75-Mc. was used about 45% as much as these latter two bands, and 56- and 112-Mc. were not entirely forgotten. W6ITH made contacts on six bands, 112 through 1.75-Mc.

The highest one-band score seems to be that of W9ZAR — 78,818, all on 7-Mc. Also on 7-Mc. exclusively, W2GUP made 57,348, W3HEH 52,987, W4WE 30,648, W8SCW (single frequency) 5,168, W9ZFP 23,368, and W1ASG 17,138. Using only 3715-kc., W2DYO ran up 12,450 points, while W3AKT, operating only between 14,250 and 14,300 kcs., made 10,783. W8CWY, with two crystal frequencies on 14-Mc. 'phone, hit 13,409.

Did you notice that many well-known DX-ers tried their hand at the SS? Such familiar calls as W2UK, W6GRL, W2EHF, W9RBI, W3EDP, W9FS, W5BB, W4CEN and W8ELC and many others were very much in evidence. The DX gang found a new thrill awaiting in the good ole SS! . . . W8LEC made W.A.S. in a total elapsed time of 22 hours, 45 minutes, with less than half of that time actually spent as operating time. . . . Numerous others worked all states and dozens, even hundreds, filled in missing states towards the W.A.S. award. . . . The SS provides the year's biggest opportunity to work the elusive states. . . . Remembering W1EZ (Vt.) on about 7280-kc. in the previous contest, W6PJR bought a crystal near that spot in a studied attempt to get Vermont — he got it, and W1EZ at that. . . . W1BJB took a portable rig to Vermont, not for the contest, but at the request of several W6 28-Mc. 'phones, who were working for W.A.S. His choice of the SS week-ends was a happy one. . . . W9PNE received answers to 35% of his CQ's, while 41.5% of his calls to other stations brought results. . . . Says W9TQL, voicing the feelings of hundreds, "More and more hams are awaking to the fact that the Sweepstakes Contest is by far the greatest contest sponsored by the League, and that pleasure in seeing how many stations and states can be worked is much greater than can be derived from any other amateur activity." . . . Out of 220 stations, W9WQB worked 180 on 3.5 and 7 Mc. with 7 watts to a pair of '45's, the balance with 35 watts to a 6L6. . . .

W9RQM writes, "Operating was faster in this contest than in any I have ever entered, and this was my sixth consecutive SS. Worked 382 stations in '38, and 525 this year in the same time." . . . And W9UM observes, "The contest certainly far exceeded any of the past, and one can only marvel at the skill of operators over that of past years." . . . Did you have any trouble deciphering the names of some of those towns, such as Nacogdoches, Texas?! But think of the poor fellows who lived in those places and had to send such "ten-dollar-words" on each contact! You should have seen how some of the lads guessed at the difficult ones. It was "accuracy last" in some cases. . . . Third highest 'phone, W9RBI, confesses, "I went out to get W1TH's scalp. However, got quite a kick out of working all 64 sections and hope at least to have slight honor of being only 100-watt 'phone to do that." The honor is yours, OM, and not a *slight* one, either. . . . Return postal cards were

sent to hundreds of stations that did not submit contest logs, to obtain confirmations of contacts indicated in winners' logs. These confirmations provided final proof that the winners are rightfully the winners! . . . W4AAQ used more log pages in 36 hours of SS operating than he usually does in six weeks of normal operating. Didn't we all! . . .

(Continued on page 52)

★ A.R.R.L. QSL BUREAU ★

FOR the convenience of its members, the League maintains a QSL-card forwarding system which operates through volunteer "District QSL Managers" in each of the nine United States and five Canadian districts. In order to secure such foreign cards as may be received for you, send your district manager a standard No. 10 stamped envelope (standard business size, 9½" x 4⅞"). If you have reason to expect a considerable number of cards, put on an extra stamp so that it has a total of six cents postage. Your own name and address go in the customary place on the face, and *your station call should be printed prominently in the upper left-hand corner.*

- W1 — J. T. Steiger, WIBGY, 35 Call Street, Willimansett, Mass.
- W2 — H. W. Yahnel, W2SN, Lake Ave., Helmetta, N. J.
- W3 — Maurice Downs, W3WU, 1311 Sheridan St., N. W., Washington, D. C.
- W4 — G. W. Hoke, W4DYB, 328 Mell Ave., N. E., Atlanta, Ga.
- W5 — James F. Manship, W5ALE, 910 So. Boston, Tulsa, Okla.
- W6 — Horace Greer, W6TI, 414 Fairmount Ave., Oakland, Calif.
- W7 — Frank E. Pratt, W7DXZ, 5023 So. Ferry St., Tacoma, Wash.
- W8 — F. W. Allen, W8GER, 324 Richmond Ave., Dayton, Ohio.
- W9 — Alva A. Smith, W9DMA, 238 East Main St., Caledonia, Minn.
- VE1 — L. J. Fader, VE1FQ, 125 Henry St., Halifax, N. S.
- VE2 — C. W. Skarstedt, VE2DR, 236 Elm Ave., Westmount, P. Q.
- VE3 — Bert Knowles, VE3QB, Lanark, Ont.
- VE4 — George Behrends, VE4RO, 186 Oakdean Blvd., St. James, Winnipeg, Manitoba.
- VE5 — H. R. Hough, VE5HR, 1785 First St., Victoria, B. C.
- K4 — F. McCown, K4RJ, Family Court 7, San-turce, Puerto Rico.
- K5 — Norman F. Miller, K5AF, 15th Air Base Squadron, Albrook Field, Canal Zone.
- K6 — James F. Pa, K6LBH, 1416D Lunailo St., Honolulu, T. H.
- K7 — Jerry McKinley, K7GSC, Box 1533, Juneau, Alaska.
- KA — George L. Rickard, KA1GR, P. O. Box 849, Manila, P. I.



ON THE ULTRA HIGHS



CONDUCTED BY E. P. TILTON,* W1HDQ

VIOLENT sunspot activity and its resultant magnetic disturbances, of which the aurora borealis is visual evidence, may raise havoc with our wire services and cripple our high-frequency commercial radio, but it certainly injects new life into the old Five-Meter Band! Though this phenomenon, "aurora skip," has been observed many times in the past, there has probably never been, in the history of u.h.f. communication, a period when the peculiar effects of this condition on 56-Mc. signals have been so pronounced as during the last week of March, 1940. Starting, apparently, on the morning of March 24th, the five-meter band went on a most amazing binge; and only as this is being written, March 31st, does it appear to have sobered up!

Saturday evening, February 24th, also produced a brief but exciting spell of "aurora DX" in the hour between 10:30 and 11:30 P.M. The familiar flutter, now generally recognized as the "tip-off," was noticed on the signals of W2MO during his regular 9:30 sked with the W1's. All

*329 Central St., Springfield, Mass.

All time mentioned is local time for the station whose work is reported.

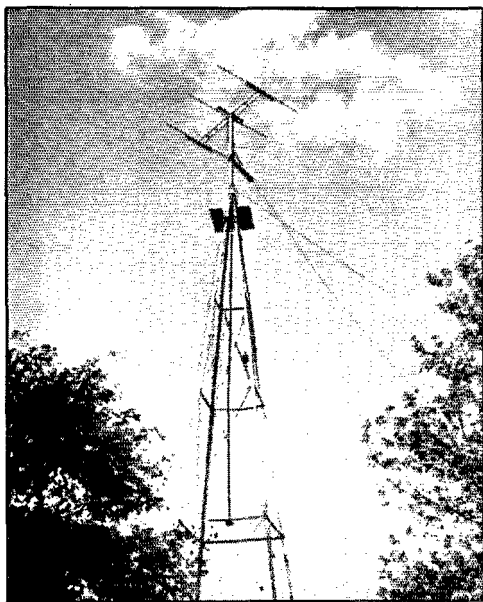

The famous horizontal "Q" Beam at W9ZHB, a quarter-wave spaced affair fed with a two-inch transposed line. Height above ground 65 feet. This beam and two others are rotated by a common mechanism.

signals appeared to broaden out, as though badly frequency-modulated, this condition growing gradually worse until c.w. became the only satisfactory means of communication.

W8QDU, Detroit, started things off at 10:15 P.M. when a c.w. CQ raised W2AMJ, thereby completing the first 25-point contact to be recorded in the 1940 U.H.F. Marathon. This was quickly followed by c.w. contacts with W1IZY, W1HDQ, W3BZJ, and W3BYF; a total of 95 points in one hour, on a band which had appeared dead when Fred first listened in at 10 P.M.!

W3BZJ worked, in addition to W8QDU, W1's IZY and FJN; both in eastern Massachusetts. This may be regarded as a fair indication of the range of effectiveness (200 to 450 miles), as neither of these stations was audible with any degree of strength at W1HDQ, one-third of the way in between. W3BZJ was also much weaker than normal at this time at Wilbraham. W2AMJ, using tone, worked W1IZY; and W1LSN at Exeter, N. H., reported hearing W2AMJ, W3BZJ, and W8QDU. QDU was apparently heard at all points in W1, 2, and 3 where any stations were active.

All this was but a practice session for the recurrence of this phenomenon on the 28-day cycle on March 24th. The disruption of all sorts of communication on this date, by one of the most violent and widespread magnetic disturbances on record, is probably not news to anyone. For our own part, we "missed the boat" quite completely. The winter's deepest snowdrifts—this on Easter Sunday in New England—made roads to our Wilbraham QTH impassable, so we learned about the excitement too late to get in on the best of it. With sincere thanks to those who reported their observations promptly, we offer the following hastily-compiled summary of "stations-heard-and-worked" reports received thus far:

W1HXP, Newton Center, Mass., worked W3's BZJ, DBC; heard W2AMJ, W3FJ, and W8CIR.

W1GUY, Ludlow, Mass., heard W3's DI, DBC, BYF; W8's NYD, VO, CIR. No contacts made because of lack of c.w. facilities. New beam ineffective. Signals of semi-locals weaker than normal. Band equally good March 25th.

W1LLL, Hartford, Conn., worked W3's DI, DBC; W8's CIR, LKD. Heard W3's BYF, BZJ, FJ; W8's NYD, VO, QQS. First signal heard was W3DBC at 11:00 A.M. Signals best around noon and midnight.

W3BZJ, Glenside, Pa., worked W1's VC, DBM, HXP; W3CYW; W8's NYD, LKD,

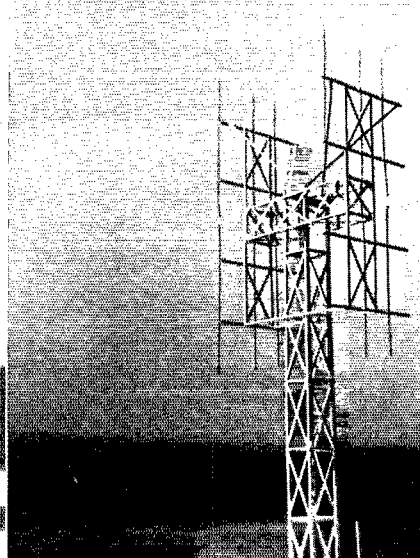
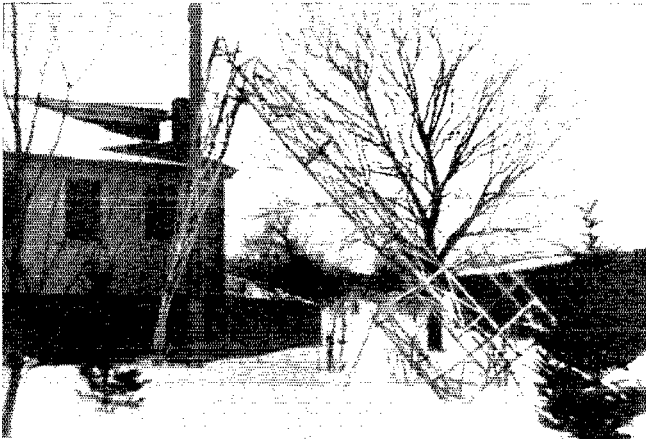

High winds and sleet storms exacted a heavy toll in February and March. The 12-element beam at WIDEI, shown "before and after," was one of the casualties.

CLS. First sign of flutter noted on W2JCY at 11 A.M. Last station worked was W8NYD, 13 hours later.

W3DI, Philadelphia, worked W1's LLL, IZY; W8's CLS, CIR, the latter on Monday night. Heard W1's KLJ, KTF, HXP; W3FJ; W8's RKE, VO; W9's ZHB, GGH.

W3CGV, Wilmington, Del., heard W8's CIR, CLS; W3's EIS, DBC, BYF; W2AMJ.

W3DBC, Washington, D. C., worked W3's CUD, HOH, EIS, BYF; W1's HXP, LLL, CLH, KTF, VC, IZY; W8CIR, and possibly W8VO. All contacts on c.w. Last activity heard at 1 A.M. Conditions apparently similar on Monday night, but no long distance heard.

W3FJ, Richmond, Va., heard W1IZY, W2AMJ, W3DBC, W8CIR, and many unreadable phones. W3DBC, normally S7, a wavery S3. First noted band open at 10:30 A.M.

W8VO, Akron, Ohio, heard W1KTF, W2AMJ, W3DBC, W8CIR. Contacts with these and others awaiting confirmation. High audio-frequency background, apparently about 15,000 c.p.s. at 4 P.M., 10 to 12 db above average noise level. Under this racket, 2 to 5 db down, mixture of sigs which could not be identified until 5 P.M., when W2AMJ was unscrambled. By 6 P.M. interfering noise was down about 5 db, and c.w. sigs began to take shape, and W1's, 2's, 3's and 9's were logged with difficulty. W2AMJ's nice tone sounded like buzz-saw, signal 500 kc. wide, while W8CIR (70 miles away) on c.w. sounded like low drone of airplane motor and was 1000 kc. wide! At one time, around 9:30, W1KTF was nearly 30 db up, 300 kc. wide, practically impossible to copy.

W9ARN, Bartonville, Ill., worked W8's LKD, QQS, TIU, CIR. Heard W3's DI, DBC, EIS, BZJ; W2AMJ, W8's CLS, NYD, VO; W9GGH, and some station standing by for W9GHW at Kirkwood, Mo. First noted high-frequency buzz-

ing on Ten at 1 P.M., getting very bad at 4 P.M. Thought it must be power line. Went out with car radio to check line — no bad spots. Stopped at airport and found teletype haywire. Ten wide open to East Coast all the while. No contacts made until c.w. was arranged for at 10:50 P.M. Called all 56-Mc. stations, using voice previously with no success. Any sig heard never seemed to get more than one "R" above noise level — more like trying to copy very weak local. Best position of beam for W8CIR shifted from north to northeast. Michigan sigs best with beam straight north. Aurora plainly visible during late evening.

W9KQA, Ironton, Minn., heard W8CIR and W9GGH in QSO at 7:52 P.M., both S-6. Heard W9ARN on voice at 8 P.M. Conditions poor on all frequencies all day. All commercial bands dead. 14 and 28 Mc. open at intervals, skip short. Northern lights very bright. Weather was clear and cold.

All the above information, in the form of liberal quotes from an avalanche of letters received between March 26th and 30th, relates to conditions prevailing on the 24th and 25th; but it is not the entire story, by any means. W3BZJ states that every night from the 24th to the 29th, at least one signal was heard which showed aurora effect. On Friday night, the 29th, our compilation of this copy was interrupted by a phone-call from W1GUY telling us that the band was opening up again. A mad dash to W1HDQ ensued — and we're not sorry we went!

The daily weather map, the barometer indications, and general local weather conditions had been screaming "Five-meter DX tonight" at us all day. One of the best nights for inversion bending yet experienced this year — with some aurora refraction thrown in for good measure — added up to one of the most interesting sessions we've had on Five in many a day.

U.H.F. DX RECORDS

TWO-WAY WORK

- 56 Mc.: W1EYM — W6DNS, July 22, 1938.
2500 miles.
112 Mc.: W9WYX/9 — W9VTK/9, Oct. 7, 1939.
160 miles.
224 Mc.: No two-way work beyond a few miles
definitely recorded. 224-Mc. workers, please
report claims.

U.H.F. DX HEARD

- 56 Mc.: VK2NO, heard by Cecil Mellanby,
Pwllheli, Wales, 10,000 miles.*
112 Mc.: Record uncertain. We have reports, as yet
unconfirmed, of Boston-New Jersey recep-
tion. Facts needed.
224 Mc.: Mt. Washington, N. H., heard by
W1FUR, Seabrook, N. H. 99 miles.
* Not substantiated.

It is too late, at this time, to attempt a complete summary of conditions; but due to the extraordinary state of affairs a few observations certainly are in order. At times it was difficult to tell whether the signals were inversion-bent or whether a short "aurora skip" was involved. Between 7:45 and 9 p.m., contacts with W3DI, Philadelphia (200 miles), and W2KLLZ, Johnsonville, N. Y. (100 miles over hilly country), showed a combination of both effects. Both sigs were clear and strong at times, showing no indication of flutter whatsoever; indicating that pure inversion-bending, only, was present. Occasionally the c.w. would weaken and go fuzzy, and at these times the band would fill up with the raspy c.w. of the aurora-refracted W8's and southern W3's. Aurora effect was almost completely absent between 9 and 10, during which time several excellent voice contacts were had with W2's and 3's over distances ranging from 100 to 200 miles. Later these faded out again, and the aurora flutter (and the W8's) reappeared. Between 10 and 11:30, W8's CIR, VO, and QDU; and W3DBC and W3RL were heard knocking off the QSO's in fine style, all of them on c.w. With these and countless W1's and 2's on c.w., the five-meter band presented a strange sight to one accustomed to 'phone or m.c.w. only, after nine years of listening to modulated signals on Five! Though not a few ragged fists were heard (including your conductor's), plenty of real operating was going on, too. The predominance of chirpless T9 c.w. was a far cry from the hash of u.h.f. DX sessions of another day! Significantly, a number of fellows were heard Saturday, March 30th, sending "V's" and getting set for the next time.

Shortly before midnight the aurora effect disappeared and extended-locals came up in strength. An after-midnight chat with W3BZJ brought out the fact that Bob, usually one of the most successful, had been having little luck in raising stations, though his list of calls heard was impressive: W1's IUU, IZY, LLL; W3's RL, DBC, IIS;

W8's BIQ, CIR, QDU, PKJ, LZN, VO, LKD; W9's ZHB, GGH, UDO.

Such, briefly, has been the state of things on Five in late March. Before we leave this aurora business we'd like to ask for observations from fellows beyond the range thus far reported. The most western call mentioned is that of W9ZJB, Kansas City, Mo., who was heard by W8CIR on March 29th. And a word of advice, too: remember that sunspot activity reputedly runs in 28-day cycles — note peaks on Feb. 24th and March 24th. If you are reading this in late April, be sure to keep a close watch on Five. And don't just listen — get out the old key and make calls at frequent intervals — you never know what may be waiting to break!

HERE AND THERE:

INTEREST in Five is growing in nearly every section of the country, it appears, in proof of which we offer a few facts gleaned from SCM reports and correspondence.

In Alabama, W4's GRL, EIJ, CVM, CYM, EAY, EDR, and ELV are reported on Five, or getting ready. Stick with it, boys; we'll be looking for Alabama this spring. Very few of us have it, to date, I'm sure. And in Florida a 56-Mc. Net is in process of organization, with W4's ACZ, GFN, BYD, FNR, DCF, ALP, AKA, EQK, and MS mentioned. Robbie, W4EDD, and W4DRZ are still checking Five daily, and have been recently joined by W4FLH.

In Georgia, W4FBH reports W4AEI and W4DNO getting set. W4GMK (ex-W2LOY) is interested in skeds with W1, 2, 3, and 8. He reports considerable activity in Atlanta weekends.

Another "Century-Clubber" gone wrong is Wilmer Allison, W5VV, who has 600 watts on Five, as promised, and a DM-36-HRO combination. In northern Texas W5IKH and W5FVN are after recruits for a 56-Mc. Net.

W7AXS, Mercer Island, Washington, reports contacts with W7's EUI, Kirkland; DYD, Bothell; CEC, Everett; and GKF, HCU, and GXP, all of Seattle. He says he was doubling in the final when heard on 28 Mc. by W9ZJB, as reported last month. This has now been corrected by re-vamping the exciter so that the final now runs straight-through. He is on each Sunday night at 8 p.m., running 400 watts.

W8's RTW and TXB, Elmira, N. Y., are active on 28, 56, and 112 Mc. They would like skeds with out-of-town stations, with a view to working some u.h.f. DX.

W9ZHB and W9ARN have several new prospects in Illinois and around Davenport, Iowa, where W9HAQ is already on and W9's UKH, QNG, and EWH coming. Another new state is thus in prospect for many of us. ZHB relates that Five worked out very nicely in handling an interesting bit of traffic recently. Contacting CE2BX on Ten, Ed learned that Mr. Poulter (of Byrd snow-cruiser fame) was in Valparaiso, Chile, and was desirous of contacting W9TP. A contact with W9VEG, a 'phone-call by VHG, and W9TP was on Ten to keep the sked.

It has been suggested that we include each month a small "box" listing the current records for u.h.f. DX. Thumbing through our QST file netted the following:

112 MC.:

SEVERAL reports have been received mentioning strange goings-on on 2½ recently, but no word has yet been received of any DX being worked, other than a slight extension of the daily operating range on several occasions. On March 14th, between 4:45 and 5:45 p.m., W2HNY at Riverhead, L. I., heard music, apparently a s.w. b.c. harmonic, on 112 Mc. W2BZB, some 60 miles distant, and W1CPL, 30 miles, were heard fading rapidly at this time. At 7 to 7:45 this same evening, W1HDQ was heard with good strength by W2IQF and W2GPO of Huntington, L. I., nearly 100 miles from Wilbraham, and by several

operators along the Connecticut shore at distances ranging from 60 to 85 miles. W1HWB insists that he heard a German s.w. station and some commercial c.w. on 112 Mc., one day early in March, around noon. These sigs were heard for only a brief period, but both Crawford and his wife heard the signals clearly.

We feel sure that some sort of DX will be worked on this band before the end of 1940. It will be interesting to watch 112 Mc. during periods when Five is obviously "open." The right combination of fortunate conditions might easily bring 112-Mc. signals down at some distant point. We most heartily recommend careful listening on 2½ at such times. This band will bear watching during late April, if the 28-day sunspot cycle manifests itself as anticipated.

Frequency modulation has many new recruits. Users of f.m. now include W1's KH, ELP, JP, EYM, INF, LFS; W2BZB; W3HFE; and W8AGU; with scores of others reported abounding. Some of the crystal-controlled stations are W1's LII, HDF, HDQ, AVV, KLI; W2HGU; W3's FX and EIS; W6's AVR and OIN; and W8QDU.

The real need on 2½ is for more use of the f.m.-type of superhet. The attractive thing about this type of receiver is that, even if there are no f.m. transmitters in your vicinity, it will do a swell job on the modulated-oscillator rigs. Selectivity, while of course not equal to that of the a.m.-type of receiver, is far better than that obtainable with the superregen. Even the worst of the oscillators are quite readable, and if the audio in the transmitter is even decent the quality of the received signal will at least equal that of similar modulation applied to a low-frequency rig.

Acorns, while desirable, are by no means necessary. The Goodman Converter, described in March QST, has demonstrated that the loktal tubes can be made to do a very nice job on 2½. W1KH has put one of these together and is using it in conjunction with a Browning f.m. receiver, in place of the regular 43-Mc. r.f. section. This combination not only does very nicely on 2½ and 5 but works splendidly on the 43-Mc. band also.

From small and moderate-sized cities everywhere are coming reports of increased interest in 112 Mc. In Fitchburg, Mass., for instance, W1KJO sends word that JYA, KYI, LAH, LDV, LXE, LXT, and MBL are on regularly. An Emergency Net is active each Tuesday night, with all 112-Mc. stations participating. Some of these boys will, no doubt, be working portable from the top of nearby Mt. Wachusett, now that mountain-climbing weather has returned. A 50-mile working radius is assured from this 2250-foot elevation with even the simplest equipment.

Here's a good chance for the gang of W2 and W3 to take a crack at working some 112-Mc. DX: On the afternoon of Saturday, May 4th, at about 3 p.m., W3BZJ/3 will be operating from a plane at an altitude of 7000 feet over Washington's Crossing, up the river from Trenton. If flying conditions are unfavorable the event will be postponed until May 11th.

The volume of reports of 112-Mc. activity picked from SCM reports, alone, is such as to preclude the possibility of listing all the active stations mentioned each month. Instead of trying to do this we hope to present a brief résumé of the conditions in one particular area each month. What is going on in your town? Drop us a line and give us the details on your neighborhood.

224 MC.:

W1BBM, at North Harwich, on Cape Cod, reports that he has been heard by W1JLY, Taunton, Mass., some 50 miles away, which is mighty creditable going on this frequency. W1CGY, who spends his weekends on the Cape during the summer, has promised that he will be on 1½ this summer, to keep Bates company.

W1HDF, Elmwood, Conn., has HK-54's running on 224 Mc. Carl says they appear to be able to take plenty more than the 160 watts he's putting into them. He's plenty strong at W1HDQ, and is working to contact W1AIY at Wolcott. They work, with fairly strong signals, on Five, but have not broken down this 18-mile indirect path on 1½ to date, though both insist that they will make it — "or else."

U.H.F. MARATHON

COMPLETE JANUARY AND FEBRUARY REPORT—EARLY REPORTS FOR MARCH

Call	Jan.-Feb. Contacts 56 112 224	Jan.-Feb. Score	March Report	States 1940	
W1AIY	13	2	44	9	2
W1GLH	33	—	66	27	5
W1CUC	10	4	19	—	1
W1DJ	56	—	82	—	4
W1BHT	32	—	43	7	2
W1BKT	38	—	50	4	4
W1GJZ	33	—	80	24	4
W1ADF	26	6	56	—	3
W1HDQ ²	43	13	184	161	7
W1HXP	—	—	—	—	6
W1JAX	15	—	39	—	3
W1JJR	—	—	—	—	3
W1JLK	36	5	59	37	4
W1JP	1	6	13	14	2
W1JTG	—	—	126	—	1
W1EJC	14	63	178	—	3
W1KJL	62	—	175	—	7
W1LCC	12	—	14	—	2
W1LFI	39	—	77	—	3
W1LFS	36	6	82	—	4
W1LLL	33	—	56	107	7
W1LFP	23	—	41	—	3
W1MBS	—	—	—	80	1
W2AMJ	57	—	122	173	11
W2BZB	5	55	129	73	3
W2COT	36	—	49	20	5
W2GAX	18	—	36	—	2
W2HNY	2	3	13	10	2
W2JND	25	—	60	—	3
W2JUN	—	—	—	13	4
W2LAL	28	—	35	—	2
W2LEN	27	—	58	16	2
W2MO	96	—	242	—	8
W2YK	—	—	—	26	1
W3AC/3	32	—	78	—	5
W3AWM	12	—	18	—	3
W3AWS	11	—	50	—	2
W3EYF	13	—	50	—	3
W3BZJ	82	7	281	221*	10
W3CGV	23	—	54	25	5
W3CYW	3	—	7	45	4
W3DI	30	—	40	—	4
W3EIS	10	1	13	17	4
W3EJ	3	—	7	31	1
W3FSM	3	20	40	2	1
W3FX	13	13	39	16	2
W3GMZ	10	—	13	—	2
W3HOH	105	—	211	94	9
W3IIS	23	—	52	20	5
W3EL	15	—	27	71	1
W3AJG	—	—	10	—	1
W3IOJ	26	—	54	—	1
W3KYT	37	—	80	—	1
W3NCP/6	15	—	28	—	1
W3NCP/3	—	—	—	4	1
W3OVK	1	—	1	—	1
W3ONX	1	—	1	0	1
W3RVL	1	46	123	—	1
W7GSJ	—	—	—	4	1
W8AGU	9	6	32	—	1
W8BJG	8	—	8	—	1
W8MHM	4	1	7	—	1
W8NKJ	—	—	—	29	1
W8QDU ³	19	2	141	175	8
W8QSS	6	—	20	—	1
W8RUE	15	1	36	15	2
W8TIU	4	—	9	98	4
W9ARN	5	—	6	155	5
W9ASO	4	—	4	—	1
W9ELJ	1	—	—	—	1
W9VHG	16	—	27	—	3
W9VWU	2	—	4	—	1
W9ZJB	5	—	6	2	2

¹ Includes reports received up to April 7th only.

² Not eligible for award.

³ February certificate winner.

⁴ Looks like tops for March.

A few others are reported "firing up" for 224 Mc. Prospects look good for some interesting doings in the vicinity of Washington, D. C., with W3AWS planning to work from White Oak Canyon in Virginia this summer. This spot is 75 miles from Washington, but it is a clear-vision path and should present a fine opportunity for setting up a two-way record on 224 Mc.

Narrow-Band Constant-Level Speech Amplification

Combining Band-Pass Filter and Output Limiter for More Effective Modulation

BY GENE TURNEY,* W2APT, AND RICHARD SHIMER*

IT HAS been generally realized — although the principle has had little application in amateur 'phone circles — that more effective voice communication could be obtained by limiting the band of transmitted audio frequencies to those which contribute most to the intelligibility of speech. These frequencies, lying between approximately 300 and 3000 cycles, do not ordinarily have as high an energy content as those below 300 cycles; but the latter are the ones which, because of their higher amplitude, set the level for 100% modulation. Therefore if we eliminate frequencies below about 300 cycles the level of the intelligibility-bearing higher frequencies can be boosted appreciably before the 100%-modulation mark is reached, resulting in higher *effective* modulation — from the standpoint of clarity and “getting through” — than is possible when the whole audio band is transmitted.

The elimination of the lower frequencies also removes hum originating in the preceding stages in the speech system, and takes out a good deal of the background noise. Elimination of frequencies above 3000 cycles takes out hiss and the general “shushing” caused by improper enunciation of words at the microphone. The net result is much clearer, more understandable speech which will be highly effective in penetrating through noise and QRM.

* Kenyon Transformer Co., Inc., New York City.

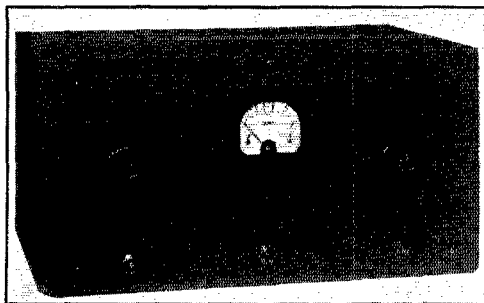

The speech amplifier is built in a standard cabinet for table mounting. Potentiometer controls are the usual volume control and a control for speech compression. A toggle switch is provided for cutting the band-pass filter in and out.

The telephone people know what's needed to get maximum communication with minimum power. Hams could benefit by taking the tip, if they would — even if it meant sacrificing some of that great intangible, “quality.” Voice signals will pack more wallop, especially through QRM.

A band-pass filter of suitable characteristics, combined in the speech amplifier with a modulation-limiting device which will keep the average modulation percentage as close as possible to 100% without “shooting over,” should represent a combination hard to beat in putting the most effective signal on the air. The unit shown in the accompanying photographs was built to do just such a job, and actual use in ham communication has shown that the two features are well worth the small trouble of installing them.

The complete circuit diagram is given in Fig. 1. The amplifier has three stages — 6SJ7 pentode microphone input, followed by a single 6F8G section, which works into the 6F6 output stage — resistance-coupled up to the grid of the 6F6. The band-pass filter is inserted between the 6F6 and the following amplifier, modulator, or whatever is driven. The limiter circuit, using the second section of the 6F8G, is rather novel, and since it occurs first in the circuit will be considered first.

Limiter Operation

The left-hand section of the 6F8G is the limiter tube. The 6F8G plate and 6SJ7 suppressor are at the same d.c. potential, and the value of this potential is initially set, by adjustment of the 6F8G circuit, so that it is approximately the same as that of the 6SJ7 cathode when there is no signal; i.e., no sound at the microphone. Under these conditions the gain through the 6SJ7 is the same as in a normal stage having the suppressor connected directly to cathode. Actual adjustments are made by setting the 6F8G plate and cathode taps on the bleeder, R_{18} , so that the plate current flowing through the 100,000-ohm resistor, R_8 , causes a drop sufficient to bring the plate to the same potential as the 6SJ7

cathode. At the same time, the grid bias should be such that the tube operates practically as a plate detector; that is, the bias is near the plate-current cutoff point. With the 30,000-ohm bleeder

specified for R_{18} , the proper point for tapping on the plate is 4300 ohms from ground, and the cathode tap should be 24,000 ohms higher (1700 ohms from the negative end).

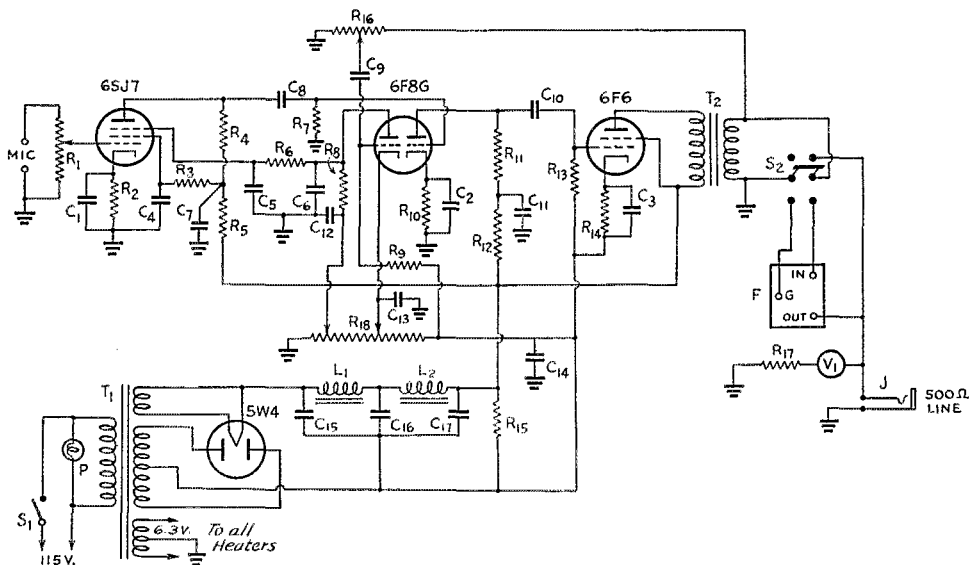
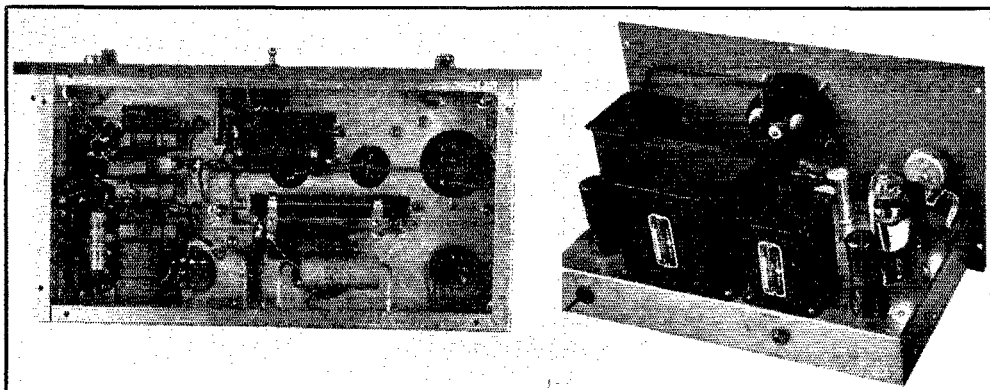

Fig. 1 — Circuit diagram of the band-pass speech amplifier with output limiting.

- C_1, C_2, C_3 — 10- μ fd. electrolytic, 50-volt.
- C_4, C_5, C_6 — 0.1- μ fd. paper, 400-volt.
- C_7 — 0.25- μ fd. paper, 400-volt.
- C_8, C_9, C_{10} — 0.05- μ fd. paper, 400-volt.
- C_{11} — 4- μ fd. electrolytic, 450-volt.
- C_{12} — 8- μ fd. electrolytic, 450-volt.
- C_{13} — 4- μ fd. electrolytic, 450-volt.
- C_{14} — 4- μ fd. electrolytic, 450-volt.
- C_{15}, C_{16}, C_{17} — 8- μ fd. electrolytic, 450-volt.
- R_1 — 5-megohm volume control.
- R_2 — 3000 ohms, $\frac{1}{2}$ -watt.
- R_3 — 2 megohms, 1-watt.
- R_4 — 0.5 megohm, 1-watt.
- R_5 — 50,000 ohms, $\frac{1}{2}$ -watt.
- R_6 — 0.25 megohm, $\frac{1}{2}$ -watt.
- R_7, R_8, R_9 — 0.1 megohm, $\frac{1}{2}$ -watt.
- R_{10} — 2500 ohms, $\frac{1}{2}$ -watt.
- R_{11} — 50,000 ohms, 1-watt.
- R_{12} — 5000 ohms, $\frac{1}{2}$ -watt.

- R_{13} — 0.25 megohm, $\frac{1}{2}$ -watt.
- R_{14} — 440 ohms, 10-watt.
- R_{15} — 0.1 megohm, 1-watt.
- R_{16} — 0.1-megohm volume control.
- R_{17} — Multiplier for volume-indicator meter.
- R_{18} — 30,000-ohm, 25-watt adjustable (see text).
- T_1 — 320 volts each side c.t., with 5- and 6.3-volt windings (Kenyon T-245).
- T_2 — Output transformer, 7000 to 500 ohms (Kenyon T-104).
- M — Rectifier-type meter for volume-level indication.
- L_1, L_2 — 20 henrys, 50 ma.
- F — Band-pass filter unit (Kenyon T-800).
- S_1 — S.p.s.t. toggle.
- S_2 — D.p.d.t. toggle.



The chassis is arranged logically with, in the top view, the amplifier at the right and power supply at the left. The large cased unit is the filter. Under-chassis wiring is neatly arranged and relatively simple.

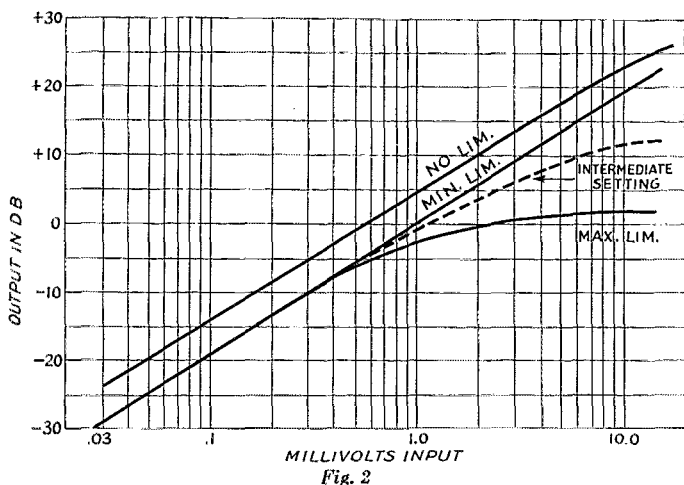

Fig. 2

Under these conditions, when an audio signal is applied to the grid of the limiting section of the 6F8G its plate current increases. The signal is taken from the secondary of the output transformer, T_2 , and applied to the limiter grid through the limiting control, R_{16} , and coupling condenser C_9 . The increase in plate current causes an increased drop in R_8 , consequently the 6F8G plate and 6SJ7 suppressor become negative with respect to the 6SJ7 cathode and the gain of the stage is reduced. C_5 , C_6 and R_6 form an a.f. filter to wash out the a.f. variations in plate current so that only d.c. is applied to the suppressor.

The setting of the limiter control governs the amount of voltage applied to the limiter tube and so controls the gain of the amplifier. The gain in turn determines the maximum output obtainable from the amplifier. The voltages on the limiter tube are chosen so that with maximum limiting — that is, limiter control full on — an output of plus 2 db (zero level, 6 milliwatts) is the maximum attainable for any value of input. With minimum limiting the full output of the 6F6 is available, although there is a small amount of residual limiting action present which tends to reduce distortion caused by overdriving the 6F6. Gain curves showing the normal amplifier, amplifier with limiting control set for maximum, and with the control set for minimum limiting are shown in Fig. 2.

Band-Pass Filter

The band-pass filter, F in Fig. 1, is a newly-developed unit intended for universal application, and may be connected either as a high-pass, low-pass or band-pass filter, capable of working between 10,000- and 500-ohm values of input and output impedances. In the present application it is used as a band-pass filter in the 500-ohm output circuit. A double-pole double-throw switch permits cutting the filter in or out at

will. Curves showing the frequency response of the amplifier with the filter in are given in Fig. 3. The transmission characteristic of the filter alone is flat within a few db between 300 and 3000 cycles, with a sharp cut-off at 4000 and a pronounced drop below 300, but in working out of the 6F6 in the speech amplifier there is a considerable mismatch of impedances with the result that the response curve is changed somewhat. The difference is not serious, however.

Incidentally, the filter is equally useful in reception, where it is valuable in getting rid of high-frequency

heterodynes, carrier hum, and other annoying noises that tend to impair reception.

The authors believe that it would be worth the while of every ham operating in the 'phone bands (which, heaven knows, are congested enough) to consider seriously the incorporation of similar

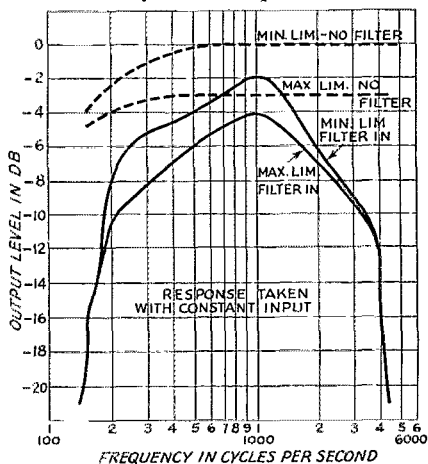

Fig. 3

devices in his speech equipment. Not only will you be doing yourself a favor, but at the same time you'll be doing your bit to help clear up undesirable QRM.

Stras

"My little boy was playing with a neighbor's boy when W9HIU was in the act of calling CQ on 160-meter 'phone. The neighbor's boy said:

"We hear your daddy on our radio, and we always turn the radio off and turn the carpet sweeper on."

(The neighbors have a midget five-tube set!)

—W9HIU

Strays

"It often happens in radio articles that an error or omission has been made that is corrected in another month. I find it helpful to possess a stamp pad and dating stamp. Whenever I see a correction made I set my dating stamp to the date of the correcting article and then go back to the original article and stamp this date at the first and last of this original idea or article. This could also be used to coordinate a series of articles running through several issues, such as those QSL-40 transmitter articles of late."

—Fay O. Wood

Jack Morgan, W3QP, had a 265-foot antenna between chimney and tree broken in the recent Philadelphia earthquake. There's ordinarily nothing very unusual about having an antenna broken, but this one broke simultaneously in two places—one near each end.

Did I ever tell you about the time I had one broken by such a sudden jerk that the wire fell in hundreds of pieces about one inch long?

Extended Variable Frequency Crystal Control

(Continued from page 11)

We wish to point out that this is only an experimental model, and because of its shortcomings, we do not recommend that it be duplicated. In a more finished version of the system, such as one might use in his station, we wouldn't use the type of crystal oscillator circuit shown. The third-harmonic output is not as much as can be obtained from a Tritet working at the same plate voltage and the output depends too much on the activity of the crystal, so that when the frequency of the variable-frequency crystal is varied the output drops off too fast. However, the gadget satisfactorily demonstrated the practicability of the system and that's what we were after. We had a spot of trouble with the 6V6 doubler oscillating, but this was corrected by better separation of the coils and wiring. In a good version, we would shield the various stages from one another to eliminate any such feedback troubles and to reduce the stray radiation. Any stage following the keyed stage can introduce key clicks if it has a tendency to oscillate, and it would be a shame to spoil the beautiful keying characteristic of this system by hanging on a parasitic oscillation somewhere along the line.

The thing we were mainly interested in—whether or not any spurious crystal-controlled frequencies would develop—never showed up. With the key down, the signal frequency and its harmonics were the only ones apparent in the receiver with, of course, the exception of the crystal frequencies and their harmonics. However, these were all far enough away from the operating

frequency to have no effects at all. Neither of the crystal frequencies showed up in the output circuit. With the key up, the signal frequency was clean and showed no trace of a signal.

We had been a little worried about whether or not it would be possible to set the variable crystal frequency accurately, since the frequency changes quite rapidly over the first few degrees of rotation of the adjustment knob on a variable crystal, but we found that it wasn't too difficult a job to set the frequency to zero beat anywhere in the 14-Mc. band. Doubtless a more finished version would be rigged up with a vernier dial for fine adjustments. This particular oscillator circuit wouldn't work over the whole range of the crystal, and we had to use an external oscillator for the experiment. However, a Tritet oscillator will work well over the entire range, as we found out.

Although the system has more advantages for the high-frequency man than for the low-, it should be a natural for trunk-line operators interested in good keying. Two 7-Mc. crystals (one outside the band, however) can be used to give the trunk frequency on 80 meters, with the most perfect kind of break-in keying possible. (Notice we say "keying" — we don't mention "operating" because we still don't know how to make one's own transmitter sound by S3 in his receiver, which would be the ultimate in break-in operation.) It would take several variable crystals to cover the entire 80-meter band, but the 7- and 14-Mc. bands can be covered easily with two crystals. We hope that the crystal manufacturers will soon make available matched sets of crystals for this type of frequency-control system.

Crystal control? Sure — anywhere in the bands.

★ BOOK REVIEW ★

Audel's New Radioman's Guide, by E. P. Anderson.
Published by Theo. Audel & Co., 49 West
23rd St., New York. 765 pages, including index,
519 illustrations. Price, \$4.00.

Theo. Audel & Co. are the publishers of a series of books designed to make the complexities of mechanics, electricity and allied arts simple. Audel's New Radioman's Guide sets out to do the same job for radio theory, construction and servicing, and it does its job well. The highly-trained engineer may complain that at times it over-simplifies, in that some of the analogies are more picturesque than exact and some of the explanations verge on the dogmatic. But this won't worry the man for whom this book is intended — the one who wants to get a rough working knowledge of radio in the easiest and most painless way.

The book is an exceptionally complete one, covering the functions both of a text on fundamentals and a handbook of miscellaneous data. Its 34 chapters provide a range of information from radio principles to the Underwriters' rules, covering such matters *en route* as physics of sound, the various elements of a radio system and the parts used, a description of aircraft and marine radio (including radio compass, beacons and alarms), television, testing and test equipment, trouble shooting and interference suppression.

—C. B. D.



HINTS AND KINKS FOR THE EXPERIMENTER



SERIES NOISE LIMITER WITH PLATE DETECTORS

YOU may be interested in publishing this revised circuit (Fig. 1) of the series diode noise limiter described in October *QST*. The limiter, installed in an NC-100 receiver, has done an excellent job here at W2GQM, located just a few feet from one of the main arteries of traffic in northern New Jersey. Before the receiver was equipped with the limiter 10-meter reception was impossible and even 80-meter reception was difficult at times. Now even the weakest signals on 10 meters may be copied practically 100%. In fact it seems that the weaker the signal, the better the limiter works!

The original diagram was tried without much success. The difficulty lay chiefly with the infinite impedance detector with which we attempted to replace the plate detector in the NC-100. Because the audio output from the infinite impedance detector was so low, the plate detector had to be reinstalled. Also it was found that the diode used in our case, a 6H6 with cathodes paralleled and plates paralleled, required a much greater range of voltage than was provided for in the original circuit.

There is no sharp threshold position for the potentiometer. The best position for operation seems to be at the point, for each individual station, where the distortion introduced by the limiter is not too objectionable. If the limiting action is increased beyond this point there will be little improvement in noise reduction and a considerable impairment of audio quality will result. If the limiting action is carried in the other di-

rection, audio distortion will not be noticeable but the signal to noise ratio will be lowered. The individual operator will find the position most suitable to himself after a bit of experience. Because of the sharp cutoff action of the limiter, high-frequency distortion of both the signal and noise is present, to a certain extent, in the audio output when the limiting action takes place. If the tone control of the receiver is operated to reduce the high-frequency response, this effect will not be noticed. As was mentioned in the original article, when a strong beat oscillator signal is present, the incoming noise will modulate it and the limiter will have a harder job to do. In this case the limiting action can be advanced beyond the point that would be objectionable for 'phone work, because the resultant distortion can be tolerated in c.w. reception.

Although the circuit as shown was designed for an NC-100 receiver, the same circuit may be applied to any transformer-coupled detector. The 100,000-ohm resistor in the plate circuit may be replaced by an audio choke of 250 henrys or more, but it was not deemed necessary because the d.c. drop through the resistor to the plate is negligible in most detectors. The switch shown across cathode and plate is provided so that the operator may disconnect the limiter without disturbing the setting of the potentiometer, although the same result may be achieved by setting the potentiometer to the extreme position away from limiting action. Contrary to what might be expected, there is no noticeable reduction in the audio volume of the receiver when the limiter is in normal use, although of course the extreme setting of the potentiometer will limit everything completely!

The limiter is most effective on auto ignition and least effective on vacuum cleaners and electric razors, although even on these latter it may mean the difference between reading and not reading the signal. — Paul Rafford, Jr., W2GQM.

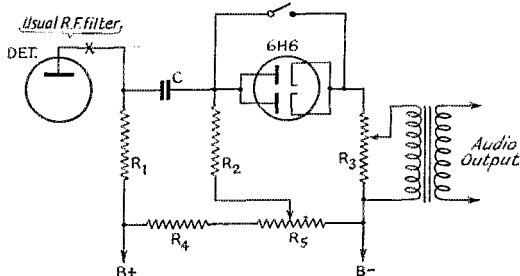

Fig. 1 — Circuit of series noise limiter as used with plate detector.
 R_1 — 0.1 meg. R_4 — 50,000 ohms.
 R_2 — 0.3 meg. R_5 — 50,000 ohms.
 R_3 — 50,000 ohms. C — 0.1 μ f.

SIMPLE ROTATABLE THREE-ELEMENT ANTENNA

W4ANN sends in the sketch (shown in Fig. 2) of a three-element rotatable antenna system which has several unusual features. The system, which is for 14 Mc., is supported by a 66-foot lattice tower. Construction and adjustment of the antenna mounting are simplified by suspending the reflector and director elements

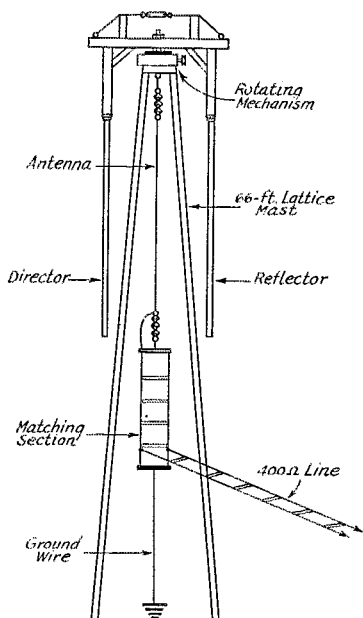

Fig. 2 — Simple 3-element rotatable antenna suggested by W4ANN. Approximate dimensions for a frequency for 14.2 Mc. are: Antenna — 32.9 ft. (0.475λ); reflector — 34.6 ft. (0.5λ); director — 32 ft. (0.46λ); matching section — 32.9 ft. (0.24λ); ground wire — 32.9 ft. (0.24λ); director spacing — 6.9 ft. (0.1λ); reflector spacing — 6.55 ft. (0.095λ).

vertically from the simple rotating arm. The antenna is suspended from the top of the tower and runs down through the tower itself. Since the antenna is fed at the end where the impedance is much higher than at the center, impedance-matching difficulties are reduced. A "J" matching section is used to couple to a 400-ohm open-wire line. The system is automatically protected against lightning by connecting the shorting bar at the bottom of the "J" section to ground with a quarter-wavelength wire, which should not affect the operation of the system. Since the antenna is stationary, there is no trouble from twisting transmission lines.

The director and reflector are made of telescoping copper tubing so that the lengths may be adjusted readily either by climbing the tower to the 30-foot level or by a long pole or stick from a lower level. The matching-section may be adjusted from a height of only 15 feet or so. The dimensions given under Fig. 2 are approximate for 14 Mc. The lengths should be divided by two for a 28-Mc. system.

VOLTMETER AS SENSITIVE NEUTRALIZING INDICATOR

A VOLTMETER makes an excellent indicator of perfect neutralizing. It is considerably more sensitive than the usual indicators such as

neon bulbs, flashlight bulbs and grid current meters. The meter should have a range of several hundred volts and should be connected as shown in Fig. 3. Notice that the connections are reversed; that is the positive terminal of the meter is connected to the negative power-supply terminal of the amplifier and vice versa. The radio-

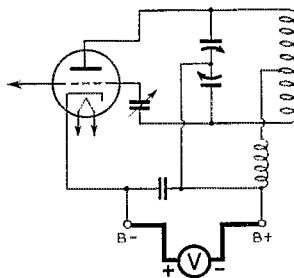

Fig. 3 — D.c. voltmeter connected as sensitive neutralizing indicator.

frequency current present in the tank circuit is rectified by the tube and is indicated by the meter.

Medium- or high-power amplifiers can be neutralized in the usual manner with one of the ordinary indicators and the finishing touches put on with the meter connected. Connections to the power supply should be removed and the neutralizing condenser adjusted for minimum voltmeter reading. With low-power amplifiers the whole process can be done with the voltmeter.

In our amplifier it was found that the voltmeter would register several volts even when the grid meter showed that the amplifier was perfectly neutralized, and even a fraction of a turn of a "micrometer"-type condenser would make a very noticeable change in the voltmeter reading. This permits very accurate neutralizing of even flea power rigs, which sometimes prove to be a problem in this respect.

— Donald Clark, W1MJU.

DISCHARGING TOOL FOR SAFETY

THE bleeder on the power supply for the final r.f. stage at W1EH recently opened up. Thus, even with the main switch pulled, I was due for trouble the next time I shut down the rig to change bands and put my elbows on the chassis and took hold of the final coil to pry it out of its socket. Fortunately for me, I was suspicious of the thing at the time, so I didn't get bitten.

My safety item for this hazard is a discharging tool, consisting simply of a dry 2' dowel bearing at one end a "U" of No. 12 soft tinned bus wire. As shown in Fig. 4, the wire goes through a pair of holes in the end of the dowel so it won't pull off. The wire can be readily formed to any desired shape to form a short circuit across filter output terminals, etc. When I have to change bands or otherwise touch the rig, I not only pull the main

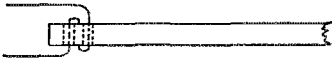

Fig. 4 — Safety gadget for discharging filter condenser.

switch but I apply the tongs across the filter terminals. When nothing happens, I know it is safe and that the bleeder is still doing its stuff. If I get a report like a pistol shot I'll know the bleeder was open and I'll be glad I tried it.

Don't get to worrying about the surge current from the condensers and be tempted into putting a resistor in series with the shorting wire. The resistor might open up the same as it sometimes does in the bleeder. Ordinarily there will not be any current. The first time there is, it's time to fix something. — *K. B. Warner, W1EH.*

POSTSCRIPT ON B.C.I. ELIMINATION

FROM W2APT comes word that he omitted mention, in his article on eliminating b.c. interference last month ("It Did Happen Here . . ."), of the untold thousands of old Majestics which have survived this midget era. These jobs, it will be remembered, use 26's in t.r.f. stages with a 27 detector. When there is trouble it can usually be traced to the detector. W2APT found that in 90% of the cases the interference could be cleared simply by substituting a 56 for the 27 — we can't explain why, unless there is some structural feature of the 56 which would account for it. Oddly enough, shielding of the detector does not seem to help.

The remaining 10% can be cured by changing the detector circuit over to the "power" or plate type of rectifier, which was suggested some years ago in this department. A 10,000-ohm resistor, by-passed by a 5- μ f. electrolytic, should be in-

stalled between cathode and ground, while the grid connection is run directly from the tuned circuit to the grid, omitting the grid condenser and leak installed in the receiver.

SIMPLE BRIDGE FOR C AND R CHECKING

CONFRONTED with several dozen mica by-pass condensers which were not marked as to value, the writer was temporarily stumped. No condenser measuring equipment was at hand, and checking them by the frequency-measurement method was too involved. A raid on the local junk box produced a fairly good 2000-ohm potentiometer of the wire-wound variety and of uniform resistance taper. This potentiometer in conjunction with a few calibrated mica condensers of known dependable quality made possible a quite serviceable yet simple capacity bridge. The audio test oscillator furnished the 1000-cycle audio note for the bridge.

The first model, hastily thrown together, was so satisfactory that it was rebuilt to its final form. As long as it was being built the writer decided to make it applicable to resistance measurement also. A double-pole 11-position switch (Sw_2), also from the junk box, was used to switch from condensers to resistors in the standard position. A simple audio oscillator and power supply were built in so the unit would be complete and permanent. The oscillator can be any audio oscillator giving good headphone volume. The one used here is quite simple, with more than ample output. The only parts which may need adjustment are R_1 and C_1 . They should be changed if necessary to get the desired note. A refinement would be a variable resistor for R_1 .

The bridge was calibrated by substitution of condensers and resistors of known accuracy in the position of the unknown "X". With two resistors or condensers of like value in the two positions of the bridge circuit, a null point (or point of lowest volume in the phones) will be at the center of rotation of the variable resistor. Interchanging two resistors or condensers of known value, one of which is exactly ten times the value of the other (such as 10 ohms and 100 ohms, or 0.0001 and 0.001 μ f.), points can be found on the scale of the resistor control dial where the value of the unknown part is one tenth or ten times the value of the known standard. Other divisions can be found by substituting values of other relationships, such as two-to-one or three-to-one. Additional points can be found by careful interpolation between known points.

While this bridge definitely does not have the accuracy of such a bridge as described in *QST* for July, 1938, it is much simpler to construct, and much cheaper. It is quite adequate for the ham who has only occasional use for such an instrument, and is excellent for calibrating those un-

(Continued on page 88)

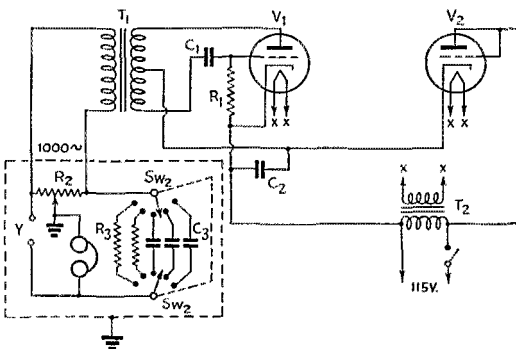

Fig. 5 — Circuit of simple bridge for rough checking of unknown capacities and resistances.

- C_1 — 0.002 μ f. (see text).
- C_2 — 4- μ f., 300-volt filter condenser.
- C_3 — Standard condensers (see text).
- R_1 — 50,000 ohms to 0.1 meg., $\frac{1}{2}$ -watt.
- R_2 — 2000-ohm potentiometer (see text).
- R_3 — Standard resistors (see text).

★ I. A. R. U. NEWS ★

Devoted to the interests and activities of the

INTERNATIONAL AMATEUR RADIO UNION

Headquarters Society: THE AMERICAN RADIO RELAY LEAGUE, West Hartford, Conn.

MEMBER SOCIETIES

American Radio Relay League
Asociația Amatorilor Romani de Unde
Scurte
Associazione Radiotecnica Italiana
Burma Amateur Radio Society
Canadian Section A.R.R.L.
Československá Amatérská Vysílací
Deutscher Amateur Sende-und-Empfangs
Dienst
Esti Raadio Amatooride Ühing
Experimental Radio Society of Egypt
Experimenterende Danske Radioamatører
Federation des Emetteurs Belges
Irish Radio Transmitters Society

日本アマチュア無線聯盟 Japan
Lietuvos Trumpjuju Bangu Radio Megeju
Draugija
Liga Colombiana de Radio Aficionados
Liga Mexicana de Radio Experimentadores
Magyar Rövidhullámú Amatőrök Országos
Egyesülete
Nederlandsche Vereeniging voor Interna-
tionaal Radioamateurisme
Nederlandsch-Indische Vereeniging Voor
Internationaal Radioamateurisme
Newfoundland Amateur Radio Association
New Zealand Association of Radio Trans-
mitters
Norsk Radio Relæ Liga

Polski Związek Krotkofalowcow
Radio Club de Cuba
Radio Club Venezolano
Radio Society of Great Britain
Rede dos Emissores Portugueses
Reseau des Emetteurs Français
Reseau Luxembourgeois des Ama-
teurs d'Ondes Courtes
South African Radio Relay League
Suomen Radioamatööriilitto r.y.
Sveriges Sändareamatörer
Unión de Radioemisores Españoles
Union Schweiz Kurzwellen Amateur
Wireless Institute of Australia

EAST JAVA

WHEN the aviation division of the government of the Netherlands East Indies last December was planning a mass demonstration of the country's aerial forces, it called upon the N.I.V.I.R.A. to provide communications between the various points of operation. Considering that the distances to be covered were large, and that the number of amateurs in the country is small, it required a good deal of planning on the part of the society. With typical amateur thoroughness they did an excellent job, and their communications system enabled government officials to know at all times the positions of the various air squadrons. The accomplishment received praise from the government and it won, we know, much good will for amateur radio.

ESTONIA

QSL Manager Richard W. Paide, ES5C, of the *Esti Raadio Amatooride Ühing*, reports that he has received in the last year a great number of cards (many of them from U.S.A.) to "very fantastic ES calls." The society therefore wishes to have their postal authority's system of issuing calls explained briefly:

All calls for licensed amateur stations in Estonia have only one letter after the number. There are no districts; calls are issued in blocs of nine, one bloc for each final letter. Example: ES1A, 2A, 3A, etc.; then ES1B, 2B, etc. At the present time calls have been assigned up through final letter G and the next is H, so that (with the single exception of ES9M) any Estonian call with a final letter further down the alphabet than H, as well as all two-letter calls, are illegitimate.

E.R.A.U., one of the two member-societies in Europe whose governments now permit amateur

radio operation, held its annual elections in January, and the new officers are as listed under the photograph on page 62.

CUBA

IN THE annual general election of officers of the *Radio Club de Cuba* held in February, the following were chosen: President, Pablo Valdes, CO2PV; Vice-President, Justo Mahia Rivas, CO2JM; Secretary, Eduardo Oliva Radelat, CO2WL; Treasurer, Julio Rodriguez.

It would appear that the rumor we reported last month concerning the Cuban prefixes is true and the prefix "CM" is expected to be applied universally to all Cuban stations before long.

HAITI

WE PROMPTLY reported the temporary close-down on September 14th, last year, of the Haitian amateurs by their government but it was only recently that we received confirmation, through HH2MC, of the removal of this restriction in the case of many amateurs. Our informant himself, along with several others, was permitted to return to the air in November; since that time the restriction has been withdrawn for a number of other Haitian amateurs as well.

LITHUANIA

IN THE official organ of one of our two new societies, L.R.M., we find the following bits of news:

Because war operations came quite close to the Lithuanian border, the amateurs of that country were closed down on the 17th of September 1939. Mobilization called many amateurs into the services. On a military expedition to Vilnius, Lithuania's former capital lost to Poland in 1920 and



The board and special managers of E.R.A.U. for the year 1940.

Left to right, seated: Cashier Alexander Rähn, ES2F; Vice-President Leopold Vedru, ES2C; President Captain Arnold Isotamm, ES5F; Honorary member of E.R.A.U. Ing. F. Olbrei, Director of Estonian Broadcasting Co.; Secretary Paul Sammet, ES7D.

Standing: QSL Manager Richard W. Paide, ES5C; Member of Board Ing. Karl O. Leesment, ES3F; Publications Manager Aleksander Illi, ES7E.

now regained, LY1J and LY1S visited the SP amateurs living there, but they succeeded in finding only a few as most of them had joined the Polish army and had disappeared.

With the restoration of comparatively normal conditions and the cessation of war in eastern Europe, Lithuanian amateurs were permitted to resume operation on January 7th of this year with the stipulation that communication with belligerent states in Europe is forbidden. In general the work of amateurs is subject to the laws issued by the government in 1939. The permit to keep a short-wave transmitter is given to persons not younger than 17 and who have passed the necessary examinations. During the first year the beginner can work only with c.w., but subsequently may use radiotelephony. Fifty watts of power is permitted for the first two years of operation, after which it is possible to ask for authorization to increase power to 1000 watts.

At the present time amateurs are mostly occupied with the further technical development of radio apparatus, and very few are to be heard on the air. A c.w. and 'phone contest is arranged every year (within the state), and the last such contest took place on February 11th-18th on the 40- and 80-meter bands. On the 7th of January, 1940 there was a general meeting of the members in Kaunas, at which a new committee was chosen for the organization. Petras Vanagaitis, LY1J, was chosen President for the second time; Simas Grina, LY1AR, was chosen Secretary; Stepas Dedonis, Treasurer; QSL Manager Antanas Sausionis, LY1BG, and Jonas Vilkaitis as General Manager.

NEWS AND NOTES

THE Danish society, E.D.R., announces a new certificate of achievement for its members, now unable to transmit. It is to be known as the

"R.A.C." (received all continents), and is to be awarded those members who can submit proof of confirmed reception of amateur stations in all continents. . . . "Break-In," official organ of the N.Z.A.R.T., has been further reduced in size and the heavy paper cover omitted to reduce the cost. But we are pleased to note their determination to continue the journal in some form. . . . Although the R.E.F. has suspended all activities, several of the old officers are carrying on in their spare time and on their own initiative, principally to the extent of issuing small printed bulletins ("war numbers") to keep the spark of amateur spirit alive among the members, including those mobilized. . . . In February, the PMG advised the S.A.R.R.L. that the weekly bulletin transmissions of its headquarters station must be discontinued, since it was for "the best interests of the state." The League thinks the restriction unjust, and will protest.

Simple Bridge

(Continued from page 80)

labelled variable condensers and trimmers which clutter up the average ham's junk box. The only precautions in construction are to shield the bridge circuit proper from the rest of the unit, and to keep all leads solid, short and well spaced. The new silver-plated mica condensers made by several reliable companies make good standards, as they can be obtained with accuracies as high as 1% at reasonable cost in the lower-capacity values (up to 500 μ fd).

— Harry K. Long, W7CQK.

Strays

Contest Ditty

O-K es F-B
C-U-L es 7-3

— . . . —

The shell of an extinct metal 6F6 or 6L6 makes a dandy form for winding small air-spaced coils. The coil is started by twisting the end of the wire around one of the prongs. After the turns are spaced, the coil may be strengthened by interweaving cellophane strips between the turns and touching up with coil dope to hold the strips in place. — W6VS.

— . . . —

Why are most commercial code stations always sending, "Fibber McGee, Fibber McGee, Fibber McGee"? — W2FQG.

— . . . —

Arc-back in 866 rectifiers, when the high voltage is first applied, may be eliminated by first applying low voltage for about 2 seconds and then shifting to full voltage. This may be accomplished with a delay relay or switch which cuts out a series resistance or 110-volt lamp in the plate-transformer primary circuit. — W. B. Ferguson.



CALLS HEARD



ex-HB9J, Jean Lips, Switzerland
(*Heard between Jan. 28th and Feb. 6th*)

28-Mc. 'phone band

w1me lw lsw bfj eer apu jgm hvs fgm igd kyj apa bra jsc
w2lku fxb mpa acz izv min jlr jev afr lah lsh fit iyx isy fti
ghv luj ifz kbg
w3hqj ece hhv gdp hud fii af hlz igw gio bgr gev iid dyr
hgm w4eqm gmm ft ezy eje emv byt ayu fwa oc fgb w5zv
fta hqj hlv w6pcb w8fjv kyy hrv pyo bkp lac pwa ppr
sim rer qxv w9za kxx ew wed drz hrc k4fow gig ezi helfg
jv co2wm hi7g

7-Mc. c.w.

w1ink lsj fru w2rv ljc imm bhv w3hrs adi hje hjg qt fat
w4cro gfq ghq hrs w5hwj fwx idr w6qb w7vy w8svh ubu
lrt ojs pen pak qeh w9naw fti ew ki

14-Mc. c.w.

kai1po fg py6aj 7vb

**ex-G6QS, S. Roberts, "Moor View," Belmont Grove,
Rawdon, Leeds, Yorks., England**

(*Heard between Jan. 13th and Jan. 24th*)

28-Mc. 'phone

w1ode apu dqk hsz lfi jas jdv w2eac mid iks lhw hfl lfm
w3hgi gfq jt gro hwn hno igw w8rlt sgh fgv dst feo cog
w9hco akj ny4ad

3.5-Mc. c.w. (Feb. 14th)

w1eru evj lxf

7-Mc. c.w. (Feb. 14th, 15th, 19th, 23th, 29th)

w1zp dxk bez iwp aok lzm hud eqj kbp mgg fnp jro jra llw
hxf hxx bau eof mgw ldu lal mef mg w2guw hus lym jin
ljr bsz kv imm fnn lvi mvd hxx ber mri w3bfd ilx igw hof
igy hsu imv bsz ind tin hsd hrh ipc hox w4ig hkl dza abd
zx gpd aye aye giv w5ul w8rfx ren ueu npa yx phj tgr tdx
w9ggll

28-Mc. 'phone (Feb. 13th, 15th, 18th, 19th, 20th, 27th, 29th)

w1alt lmb tj eqr jrz le lte klv gou juj lkl w2hy lwy kzn
lqu mse lsz ad lbk izy lyo lol
w3hlx cco iid evp bhr bwq cbp awx hhz w4fzq gmi yf fap
drj eur ay w5gkz bek w8oco kyy fco moy rar myj w9cbj
qod lx

**ex-G5CB, Capt. K. Hartridge, 72 Greenway, Tatteridge
N. 20, England**

28-Mc. 'phone (Jan. 7th)

w1khe bmk lev eer ehf inb dal w2lyx aog jfb mjs w3fil bso
w4asz

**Alfred H. Rowe, Jr. (W2BSJ), aboard S.S. Black Gull
c/o American Communications Assn., CIO, Room
302, 10 Bridge St., New York City**

(*Heard at Weymouth, England*)

7-Mc. c.w. (Nov. 12th)

w1lht evj liv kae amq lsk khe ibf lzx jjr ts w2ckq klc uk
w3edp gbk fsp gzh hza w4cyc w6mly w8rei rpb bmx
w9nmy aqz mov vbq voq efa

Nov. 18th-20th

w1khe hsa lpy mfc cse me asg keq ksx ibf aqw cxy lop ftj
ixb mdf ldl lxj jbo ltl eni lvg egy
w2hya iyq ayj av ahc kle jae hzn hop jin gnw bfr gp ltk
inf kir fba kgn bgv uk lzo kzx wz ify egg rv
w3rr eju gyx hee fgb sco hc fsp euj eew duu bkz hqu dpu
dps gkl crw w4dam cyc bsj cen w5ko giw exq w8sjf lcn
qxm okg esk oqf rap szb ofn qdm jtt qdu w9kxk fs fuo,
yfv lwg yxo

**ex-GW3AX, Stan Thomas, "Roseland," Kittle, Bish-
opton, Nr. Swansea, South Wales**

7-Mc. c.w. (Nov. 19th)

w2jbf uk lak wz iyq cuq

w4ezf axl
w5avi
w6bir
w9zir

3.5 Mc. (Nov. 19th)

w3duu
w5dae

**ex-G6MC, J. C. Martin, "Holyoak," Holyoak Ave.
Bingley, Yorks., England**

3.5-Mc. c.w.

w1gg cob w2moy lpy w3og w4ft w8trk edg

3.9-Mc. 'phone

w1ald w8hn uk

7-Mc. c.w. (Feb. 14th-19th)

w1mgg hms fz eof ldu aop llw mef juu jra ixo nfk dtb hgv
lzm lob lxx aok

w2hus qt lo llz bdo mlo mjw mxg lym lrb fnn kms ifg lrg
luc esk gvu jdo dgd clo bfg lkh mid
w3ilx hox ing gig hek iim iln ijk asn ged aae w4fwz fi fy
fgc fce gpd w8vb w8gra oth rcm kel knd ave dpn w9ew reo

**ex-G5PY, R. F. R. Clark, 18 Parkthorne Rd., Clapham
Park, S. W. 12, London**

7-Mc. c.w. (Jan. 28th)

w1luq w2mhe mkg wx w3ale hrj al ihf w8uhf

14 Mc. (Jan. 23th-29th)

w1ch blo dgw w2hnr ixy lir w8ev bkq hzg fst w4dk w8vg
coh k4esh

3.5 Mc. (Feb. 6th)

w1dlx lkp ojd w2kqp

**S. Walker, 18 Crescent, Old Clee, Grimsby, Lincoln-
shire, England**

(*Heard between Feb. 14th and Feb. 13th*)

14-Mc. 'phone

w1axa gkb fbj jkb dq jhd iyl jc bic ire fbx ql jkv fxx aep iso
end w2cqw dmj ixy w3bcs gec ew amj eta w4dsy fb eed
bfy egl yc w8gy cj bf enx okb jps mhnd sd bxy w9ois bra
k4fkc

**ex-G4AB, John B. Burt, The Weaver's House, Bur-
leigh, Stroud., Glos., England**

(*Heard between Dec. 14th and Jan. 9th*)

7-Mc. c.w.

w1aue aw epq dje drv eem ekh elf enk fnp fek hul ifa ira
jku kge krq kxx kua liu lqq lrz lxr lzm mfo mgg mdo or
orf sm sz w8

w2aey agm alp aup ber bhv bj bo bom bpm bqy cgh dkf
esk feq fo fqt hdg hmj ifl iyq jkk kha kms knw ksl kyv
liy ljk lle lsz lny lpy ltj ltz mpz mag maj mal me mei mel
mff mfr mfg mhb mjw mxk/4 mpa mrm mxa ot qpa tp usa
w3alp aup bco bez bev bsz buy evw dal dyb ekk elo fre gdi
gso gyx hdp hdv hkh hhs hqa hrs hsd hus igo igy iif ikr
ilo iwr ktl nlc zb

w4aob bvu ode chrq dah dna drd eep ena end fao fgq fgv
fil fky frr fto fth fth gbj gea gef ggl gkb gin jr

w5dgb fpa ls

w6bic jyx psi qap rqp

w7blk blt exr

w8daq hmz ipm im itf kd kel khm kzb lux mot mfd ngn nhb
nss okl oqf paj pim prd ptf qpb qpu rdk rww sag sfh snm
ssk szn tb tbf tgf tjd tkk tof tud tvj tvi twi txx tzf ueu wf
w9bso bvs dbi dup edp efa gih/9 grf hoe huv iwy jrx
ly lyk nav qmq rcq sao sem spq svh tke yxo

om2bs mb pf pp qc qf 7fr 8ro k4aan k6cgk quj ka1hq lu4pa
py1gc kq uy py2lm 00 py4ae



NAVAL COMMUNICATION RESERVE NOTES

THE NINTH NAVAL DISTRICT

BY J. C. McMANUS, W9FZ
Lieutenant (jg), C - V (S), USNR

THE Ninth Naval District is the largest in the country, both in area and in Naval Communication Reserve personnel. It comprises the States of Ohio, Kentucky, Michigan, Indiana, Illinois, Wisconsin, Minnesota, Iowa, Missouri, Kansas, Nebraska, South Dakota, and North Dakota. For NCR administrative purposes, the District is divided into ten Sections, which for the most part correspond to State boundaries. Each Section is under the command of a Section Commander, with a staff of officers and men to assist him.

In the principal cities and in many smaller centers, Units have been established, there being a total of about sixty Units in the District at present. The standard Unit consists of thirty-one officers and men and is commanded by a Unit Commander.

The District Communication Officer, who is a regular Navy officer, also serves as the District Naval Communication Reserve Commander. He is assisted by a staff of NCR officers, who are assigned duties relating to personnel, instruction, operations, and material for the District as a whole.

Almost all of the officers and a large majority of the men are more or less active radio amateurs. The enlisted men have always been recruited chiefly from the amateur ranks; however, a considerable number have qualified for amateur licenses through the training they have received in the NCR.

A well-rounded training program is provided to enable NCR men to take their places in the communication service of the Navy. It includes Unit Headquarters drills, training manuals and other Navy publications, radio network drills, and training periods aboard ship and at shore establishments.

The Unit Headquarters drills afford basic training in naval radio procedure and methods, naval regulations and customs, seamanship, manual of arms, and other subjects with which a radioman in the Navy should be familiar. These drills are conducted in Naval Reserve armories, when possible; if there is no armory in the city, they are held in a Federal building or in other suitable public or private quarters.

An important part of the training is accomplished through radio network drills, in which the

officers and men, at their own amateur stations or at the various headquarters stations, handle messages and maneuvering signals under conditions simulating those in the Fleet. All drills are conducted on Navy frequencies, seven frequencies being assigned to this District for this purpose. The Navy Department supplies crystals and a certain amount of radio equipment. No equipment is available for installation in NCR members' homes. The millennium has not yet arrived!

The high point in the year's activities is the summer training cruise. The NCR in this District is very fortunate in the opportunities afforded for cruises. It is perhaps not generally known that we have in this inland District a large number of naval vessels devoted exclusively to the training of the Naval Reserve. During the summer months, they assemble on the Great Lakes for several training cruises of two weeks each.

Radio plays an important part in the cruises and it is a real thrill for a radio amateur to go aboard ship as a Naval Reservist and stand a radio watch. The life aboard ship is in itself a new and invigorating experience and shore liberty in unfamiliar places, athletic contests, small boat training and the many other activities which are scheduled make the two weeks pass all too quickly.

A few words about the various ships may be of interest. All of the five larger ships, with the exception of the U.S.S. *Wilmette*, have been in regular Navy service in various parts of the world. The U.S.S. *Wilmette*, whose home port is Chicago, is a former passenger ship entirely rebuilt along naval lines. The U.S.S. *Wilmington*, a veteran of the Asiatic station, is based at Toledo. The U.S.S. *Sacramento* was recently assigned to this District after doing her part in the rescue and salvage operations in connection with the U.S.S. *Squalus*. Her home port is Michigan City. The U.S.S. *Dubuque* and U.S.S. *Paducah* are sister ships which have also seen service in China. The former is stationed at Detroit and the latter at Duluth. The ships range in length and tonnage from 200 feet and 990 tons for the last two mentioned to 275 feet and 1820 tons for the U.S.S. *Wilmette*, which is the flagship.

In addition to the larger ships, there are four sub-chasers and a number of former Coast Guard patrol boats, which have been turned over to the Naval Reserve. All of the ships carry radio equipment and some are fitted with radio direction finders.

(Continued on page 102)



CORRESPONDENCE FROM MEMBERS

The Publishers of *QST* assume no responsibility for statements made herein by correspondents.

KIDDING OURSELVES

4915 N. Sawyer Ave., Chicago

Editor, *QST*:

There may be some truth to the story that most people like to be kidded by optimism — it makes them feel better. Maybe that is why our present-day modern receivers are fitted with a little gadget called an "S" meter which, as a visual indicator, is pleasing to the eye. The correspondence which has appeared in recent issues of *QST* indicates that some amateurs would like to stick to the plain unadulterated truth — no matter what it may be.

Any meter that has a scale reading not in keeping with good engineering practice ought to be regarded as wholly unreliable for intelligent use. Just why any signal-strength scale should be greater than from 0 to 5 is not understood. At the present time there is no standard which has been adopted by all receiver manufacturers, and that is too bad indeed. To be sure, manufacturing costs often dictate the degree to which a meter and circuit may be used.

One possible suggestion is to adopt a standard that is in keeping with good engineering practice and then have all the manufacturers agree to it. Thus, if all agree to the type of meter and the circuit, there can be no chiseling or corner-cutting. Either it is or it is not. For example, suppose the standard meter scale would be made from 0 to 5, with no half-way or fifth-of-a-division markings. Such a scale could then be calibrated on the basis of microvolts input to the receiver, with a scale that would read only 0—1—2—3—4—5. These are the figures which would be of interest to the receiving operator.

The actual standard of calibration would be like this:

S Scale	μv	db
1	10	20
2	100	40
3	1000	60
4	10,000	80
5	100,000	100

That sort of a scale and calibration would require a bit more equipment, such as a v.t. voltmeter, and no manufacturer can incorporate such gear with pins and buttons — it takes money. But, it would do away with liars. Not only that, but to have a signal of S5 it would just about take a 1000-watt transmitter to ram that needle up to S5 if the transmitter was within a distance of a mile. There would be no more of this flapdoodle of S9 plus 72 db, or, "On this meter the signal is S4 but on any other receiver that would be the same as S9 plus."

It wouldn't make one bit of difference insofar as the human error is concerned, because the human error is greater than all others combined, and the great one in this instance is the folly of twiddling and twaddling with gadgets which please the eye such as the ones we now have on our receivers.

Of course, there would still be those ginks who would attempt to employ their "ear meter" to make a wild guess at the input in microvolts between S3 of 1000 μv and S4 of 10,000 μv , or between 60 db and 80 db. But those scales should not appear. Of course, S1 to S5 perhaps isn't a large enough box-car figure to satisfy some birds who will insist upon four to ten numerals whether they know what they mean or not. But let's quit kidding ourselves and become honest.

— F. H. Schnell, W9UZ

EDITOR'S NOTE. — Robert M. Morris, W2LV, has, quite independently, suggested the following scale as a basis for

argument concerning standardization of receiver "S"-meter calibration:

Scale	Microvolts at Receiver Input Terminals	db Above Reference
S0	1	0
S1	3	+ 10
S2	10	+ 20
S3	30	+ 30
S4	100	+ 40
S5	300	+ 50
S6	1000	+ 60
S7	3000	+ 70
S8	10,000	+ 80
S9	30,000	+ 90

A. R. R. L.'s Research Engineer now has this subject under consideration, and will welcome comment.

Q-R-S

700 S. Carpenter Ave., Oak Park, Ill.
748 N. Laramie Ave., Chicago, Ill.

Editor, *QST*:

Since the inception of the R-S-T system for reporting code signals, it has become increasingly apparent that a 'phone reporting system is essential. . . . With that object in view, we undertook, experimentally, a system of our own derivation and applied it to our own 'phone contacts, carefully registering its approval, acceptance, criticism and adoption by the 'phone stations we contacted. We found that it "clicked." Our system, even in its embryonic stage, received practically 100% approval and adoption. Many 'phone men complimented us with, "At last we are to have an honest-to-goodness 'phone reporting system of our own; something that we really have needed." Inasmuch as the number of 'phone stations we were capable of presenting the system to represents but a small percentage of the entire amateur 'phone fraternity, we are herewith submitting our system to be presented through the medium of *QST* for their approval.

Our system is divided into three sections, namely, "Quality-Readability-Strength," or, abbreviating, "QRS." Some criticism may arise in that QRS is an international code abbreviation. That is true. QRS is an international abbreviation applicable strictly to telegraphic communication. We are not applying the letters "QRS" to our system as having any association with the international QRS sign. Ours is simply an abbreviation. . . .

The "Q" section of "QRS" applies to 'phone quality. We sincerely believe that every 'phone man desires good quality, regardless of whether he is using a single-button carbon microphone or a \$50 dynamic. In presenting this system to others, we have found that all 'phone men are anxious to procure a "good quality" report, much as the code man strives for a "T9X" report on his note. Therefore, from a psychological standpoint, we believe this system should be an incentive to 'phone men to work for "Q5" reports on their quality, much as the "T" system helped in clearing up r.a.c. notes on c.w.

We have divided the "Q" section into five divisions, as follows:

- Q5 — Good quality. No hum or distortion present.
- Q4 — Good quality but noticeable hum.
- Q3 — Fair quality because of distortion.
- Q2 — Poor quality because of bad hum.
- Q1 — Poor quality because of bad distortion.

(Continued on page 88)



F. E. HANDY, W1BDI, Communications Mgr.

E. L. BATTEY, W1UE, Asst. Communications Mgr.

Sunspots. Our general transmission conditions are known to vary closely in accordance with the sunspot cycle. Old Sol in addition to giving us light and heat and other radiations, sometimes sends electronic bombardments that are the wonderment and despair of communication men. Impotent humans have no control over such effects. On the week ends of March 24th and 31st it was necessary to record a complete washout of our lowest frequency bands. Occasional attenuated, wavering, weak and fuzzy signals were able to push through on a few DX bands for short and uncertain periods; a few unusual u.h.f. contacts took place. Communication, both wire and radio, was seriously interrupted, except for service on an extremely local basis. Some progress in correlation of sunspot numbers with our communications conditions has been made. The short-time vagaries are as yet beyond absolute prediction. Assuming prediction accomplished the subject remains, like the weather, just something to talk about; one cannot do much about the weather — or the sunspots!

A.R.R.L.'s 12th DX Competition Results. Logs are rolling in, and you will find early returns elsewhere in this issue. In spite of the effects of unexpected solar radiations near the end of the contest, participants were well rewarded for their efforts. Many express thanks to the League for working out a plan for these war-neutrality times, to permit having such an activity this year. Thanks to those that put in the proper licks outside the mainland U. S. A., there were actually new DX contacts reported, in spite of the current shortage of stations representing many countries. The W-portion of W scores kept the gang busy and relieved what would otherwise have been a too one-sided contest with too many e.c.o.'s standing in the waiting lines. Many reported that they found the attempt to work all districts on three h.f. bands in just two week ends a sufficiently difficult accomplishment in itself. The numerous letters that accompany scores are sincerely appreciated. Analysis will enable us to accurately gauge what you want, should we have to approach another March under identical circumstances. The usual excellent contestant response is heart-warming. While there have to be blackouts of European credits due to the war, and far-reaching solar blackouts of signals beyond our control will occur, the log-reports show there was no blackout of DX hopes, but operating fun in plenty in the March 1940 Contest.

Neutrality Operating Precautions. We continue to urge proper common sense and restraint in all amateur operating, particularly that on any frequencies on which signals cross international boundaries. F.C.C. gave us a clear warning some months back. All hams are solidly behind A.R.R.L. in the desire to see every amateur fully living up to neutrality operating policies and responsibilities — lest we black out our own hobby and pleasure by inviting suspicion, curtailment or unpleasant restriction. Reviewing previous issues, *QST* has said:

Follow A.R.R.L.'s Neutrality Code.

Don't talk about the w-r over the air.

Make no calls or contacts with even legitimate stations in belligerent territory . . . no exchanges with the theater of war.

Communicate with no unlicensed stations (unlawful).

Allow no unlicensed operators to use equipment.

Make no international transmissions to receiving points.

Work no amateurs in countries or colonies where amateurs have been shut down as a precautionary measure.

Live up to every F.C.C. amateur service regulation.

Remember, there is surveillance.

U.H.F. Occupancy Due to Progress in May.

The days just to come are days of ultra-high frequency opportunity. Traditionally May brings u.h.f. results, and we trust this year will prove no exception. The dates of the special A.R.R.L. u.h.f. Contest-Relay have been changed to May 18th-19th, not because we claim any wisdom in predicting conditions, but to avoid a convention conflict. The Marathon standings are already looking up. Somebody who starts in May is fully eligible to Marathon listings; may prove to be one of the leaders. The relays have added to the training and emergency value of the u.h.f.'s. There is something of the old pioneer spirit in the increasing accomplishments reported in these. The May activity is bound to be the biggest held. We hold highest hopes for seeing gaps in relay lines filled — be they north, south, east or west. The winter u.h.f. activity reported this issue shows that in dead winter there was hardly any drop from the participation of previous contests. May is going to bring weather in which more of us have the courage to venture forth portable or portable-mobile. Fellows who are going to enjoy u.h.f. all summer are preparing the equipment for greatest operating convenience and effectiveness right now. Why not get in the vanguard and assure yourself of the utmost the ultra-highs can offer? The operating news of the coming months will include new states and records on these bands; there'll be F.M. considerations and news

together with extensions of routes and ranges by simplified and improved 56- and 112-Mc. gear on the conventional pattern. To anyone interested in the fascinating field of antenna experimentation, these frequencies offer all the heart could desire. Opportunity is knocking; don't pass up the u.h.f.'s; make 'em a definite part of your amateur life and you will have no regrets.

— F. E. H.

ARTICLE CONTEST

In this month's prize-winning article, Rus Sackers, W8DED, tells why he considers Ten-Meter 'Phone the "Most Interesting Band." Have you told the world about *your* "pet band"?

For the next several months we are inviting articles for the C.D. contest based on various individuals' ideas of "the most interesting frequency band." Practically every operating amateur has a "favorite" band, one that he would swear by to the bitter end. What is *your* favorite?

Send in your article on why such-and-such-a-band is, in your opinion, the best available. Each month we will print the most interesting and valuable article received on this subject. Please mark your contributions "for the C.D. contest." Prize winners may select a 1940 bound *Handbook, QST* Binder and League Emblem, six logs, eight pads radiogram blanks, DX Map and three pads, or any other combination of A.R.R.L. supplies of equivalent value. Try your luck.

The Most Interesting Band

BY RUS SACKERS W8DED*

HAVING been a ham for over ten years and working every band except the five-meter band, the writer feels competent to judge the most thrilling band of all the bands — the Ten-Meter 'phone band. Many fellows familiar with the band may think this a surprise from an old-timer, because the Ten-Meter band fades out usually after dark and especially during the winter months when the amateur activity is at its height. However, the band has something that the lower frequency bands do not have, something that is more than enough to counter-balance the fade-out — MUCH LESS QRM. Because of the less QRM, real QSO's and memorable rag-chews can be accomplished.

Low power is capable of doing more on Ten Meters than any other band; this feature is appealing to most every ham; 100 watts input will do a splendid job, and many fellows are using but 25 watts with excellent results.

Some will say the fading and fade-outs on Ten are objectionable, but this is not true. Fading is not usually bad enough for a single word to be missed. Fade-outs are not objectionable because there are always other stations coming in when one station or section of the country fades out. The element of the unknown brings a thrill to the Ten-Meter 'phone man because he never knows what is going to happen next.

For DX QSO's the band is excellent because there is much less QRM, and every ham knows what "W" QRM will do to a foreign contact. Still another reason why Ten is the best band is because there is a higher percentage of sociable and friendly hams to work than on other bands. The hams can really get to know each other because of the rag-chews possible on Ten.

* O.R.S., O.B.S., 53 East 7th St., Holland, Mich.

During the summer months there is the "short-skip," which is another thrill all its own. One never knows what section of the country will come through or when. The very strongest signals heard on any band can be heard during short-skip season. Short-skip adds variety to the Ten-Meter band. For the experimenter there are the beam antennas and the struggle to make the transmitter efficient. The Ten-Meter beam antenna, without any doubt, attracts more experimenters than any other single thing. These are the reasons why Ten is "tops" among the ham bands.

Amateur Radio in Sacramento Valley Flood

AGAIN the importance of amateur radio during emergencies was demonstrated in late February and early March when the Sacramento River and its tributaries, swollen by a four days steady downpour in Northern California, overran its banks, broke through dikes and levees and spread out like an inland sea over thousands of acres of farm lands, homes and whole towns, wrecking highways, washing out railroads, destroying livestock and even human life. Amateur radio is credited with an effective program centered in relaying the latest reports of river conditions and hundreds of messages regarding the whereabouts and safety of persons in the flooded areas. In cooperation with the Amateur Net for the American Legion, with stations located in all key points of the state, stations in the flooded areas were in a position to give the news as it happened to the proper authorities. Station W6BDW with Chet Ullom as chief operator and Boyd Benham, W6RPI, as relief operator, acted as control for the net during the entire flood emergency. The station was in operation 24 hours a day and had emergency power in the form of a 1000-watt gasoline engine driven a.c. generator in case of power line failure. At all times W6BDW was in contact with Red Bluff, Corning, Chico, Orland, Butte City, Oroville, Grimes, Glenn, Marysville, Sacramento, San Francisco and Oakland, with reports coming in all the time from local officials and low powered portable transmitters which were scattered all through the affected areas. The following stations and their operators were on duty and active during the entire emergency: W6OEX, W6SLS, Oroville; W6RAQ, W6RHC, W6DPL, Chico; W6KUI, Glenn; W6KYO, Butte City; W6SBE, Red Bluff; W6SGU, Orland; W6GUK, W6GSP, W6GCM, Marysville; W6OJX, Sacramento; W6BDW, W6RPI, Gridley; all working in cooperation with the Amateur Net for the American Legion on 1.75-Mc. 'phone.

During the afternoon of Tuesday, February 27th, equipment at the Naval Reserve headquarters in the Yuba City grammar school building was made ready for communication on the Legion net frequency. At the same time, portable equipment of W6GCM was installed in a station wagon for the purpose of establishing fast communication from any area which might be threatened by flood. W6GUK was placed on the air from Yuba City and acted as contact station for portable W6GCM. W6GUK was manned by Ed Benham, Jr., under the supervision of Lieut. Comdr. Chester D. Winship, U.S.N.R. W6GCM was manned by Gordon H. Jones (W6GUK's licensee). During Wednesday afternoon the station wagon, crewed by Jones, George Johnson, Harold Herr and John Frederick, made a circuit down the Feather River as far as Nicolaus. A stop at Rio Oso was made and W6GUK contacted. The next stop was made on the Nicolaus bridge with flood waters roaring a few feet below. At that time, officials decided to close the bridge as pilings were being undermined. This information was immediately radioed to authorities in Marysville.

At 3:00 o'clock Friday morning word came that serious trouble had developed in western Sutter County in the form of a levee break in the Sutter By-Pass. The portable station was rushed to the scene and communication established with W6GUK at 5:45 A.M. It was found that there was no telephone communication from that point, and word had to be sent to people to evacuate that general area. This information was sent to W6GUK, Yuba City, where Lieut. Comdr.

Winship had evacuation orders broadcast from stations KFBK in Sacramento and KHSL in Chico. Then began a busy day and night of relaying information to and from Yuba City. By mid-afternoon, W6SJM from Grass Valley had arrived and was taken across the flooded area in a motor boat to Meridian, where he set up portable equipment and contacted W6GCM at Longbridge. As night drew on and the need for communication increased, worry was felt as to the ability to carry on successful communication due to interference from other amateur stations. As a result the Longbridge station became a Naval Reserve unit operating under the call DD122 on 2844-ke.

By Friday night the communication was functioning as well as if it had been organized and drilled for several years. Inasmuch as the situation was being handled by several organizations, conflicting and unauthorized messages began to crop up. It was decided that no messages would be transmitted unless signed by an authority in charge, and also that all information passed would be fully confirmed before being accepted for transmission. The matter of secrecy also became very apparent, as it was learned that many radio receivers in the valley were tuned to the frequencies being used, and extreme care was taken to prevent the transmission of anything that might cause the starting of rumors. Saturday saw a repetition of the foregoing day with the exception of the water having reached its crest in the flooded area. The emergency which existed at Meridian the night before had been taken care of on that side. During Saturday afternoon W6FEJ was sent to Meridian to relieve the operator there. Saturday night W6GSP was sent across with additional equipment. Sunday was spent in the almost complete evacuation of refugees from Meridian to Colusa. To aid in the evacuation, W6CC in Colusa joined the net and three-way communication was controlled from Longbridge. Sunday evening at 8:30 telephone communication had been established across the flooded district and amateur radio had accomplished its purpose, and all hands retired for badly needed rest.

W6IAP, Oroville; W6EWB, Sacramento; W6EUH, W6OOP, Redding; W6RYL, Dunsuir; W6KKL, Roseville; W6OGJ, Delevan; W6BYS, Napa; and W6MDI, McCloud, monitored the 7- and 3.5-Mc. bands and stood by on A.A.R.S. frequencies, rendering communication service for their localities whose landline services were temporarily disrupted. W6RYL, Dunsuir, was on for practically the entire emergency. W6BYS in Napa had his portable rig going. Half-hour schedules were maintained between W6MDI, McCloud, W6BYS and W6RYL. Contact was established also between W6RYL and W6NHA, Woodland, for traffic from Red Bluff and vicinity. For two days there was no rail or highway traffic in or out of Dunsuir and W6RYL's portable 30 watts served well. W6RRC, Dunsuir, established contact with San Francisco and with Klamath Falls, Oregon, and handled important traffic for the railroad.

All in all, it was another job well done. Congratulations to all participants!

Byrd Antarctic Expedition

KC4USB, East Base station of the Antarctic Expedition, is now actively on the air. Johnnie Griggs, W6KW, had the good fortune to be the first amateur to contact KC4USB. This was at 2:00 A.M. PST, March 26th, when a two-hour contact took place between USB (with W1LWD at the key) and W6KW. W6AM was the second station to contact the East Base.

W6KW maintains a twice-weekly schedule with KC4USB, on Tuesday and Saturday at 1:30 A.M. PST. KC4USB's frequency is about 7075 kc., while W6KW uses 7104 kc. It is requested that interference to these schedules be avoided since much personal traffic is handled for some twenty-three members of the expedition. It is the policy of all KC4 stations to ignore anyone calling on their frequencies or the frequencies of stations being worked. W6KW has schedules coming up soon with the West Base, KC4USA. W6RJN got a report of 579X from the East Base on 7 Mc.

Another west coast amateur working the expedition reports that the operator of the Snow Cruiser (KC4USC) told him that it would be at least a year before the expedition would attempt to consider the detail of handling acknowledgment cards. It was said that at some later date the expedition will designate some central office in the United States to which any QSL's may be sent from those who may desire confirmation.

The Snow Cruiser, KC4USC, may be heard nightly at this writing at 8:00 P.M. PST on 14248 kc. They are working U. S. hams. W4DSY reports a schedule with USC every night for traffic handling. W2A1W worked KC4USC at 7:32 A.M. on March 6th for a half-hour contact, and also worked KC4USB at 1:18 A.M., March 29th. On this latter contact operator Lamplugh, W1LWD, advised that expedition members there were living in tents and that houses would not be finished for about six weeks. In the meantime radio activity will be limited. 4USB was using 150 watts to a Harvey 1000-watt rig.

Expedition calls, other than amateur, are as follows: Commercial and Broadcast — KRTK, West Base; KRTC, East Base; KRTA, Snow Cruiser. Navy — NUW, West Base; NPQ, East Base; NLC, Snow Cruiser; NKG, Pacific Coast Base. Planes — NUW/1, W. B.; NPQ/1, E. B.; NLC/1, S. C. Base outposts — NUW/9, NPQ/9. Frequencies used: For commercial traffic (KRTK, KRTC, KRTA) Commercial mobile marine bands. For broadcast service (KRTK, KRTC, KRTA) 6424, 9135, 11060, 12862.5, 17310 and 23100 kcs. For inter-service between the bases and the snow cruiser — NLC: 4385, 6355, 7455, 10255, 11390; NUW: 4435, 6230, 7595, 11060; NPQ: 4265 series, 6120, 7305, 10035, 11240. Other Navy frequencies are used for handling official traffic with the United States.

BRIEFS

When a National Guard plane was pressed into service to aid in locating a missing Trenton, N. J., child, W3ZI, operating from the plane under the call DU7 (3295-ke.), and W3CCO, operating from his home on 1.75-Mc. 'phone, provided communication for officials in charge. This set-up functioned for three hours and was highly commended.

Coincident of the month: W9GHH called CQ on 1827-ke. running 8 watts to a 6L6, with a 6-volt vibrator power supply, a double button mike and a DeLo battery operated receiver. The answering station was W9WYH, on the same frequency, running 8 watts to an almost identical rig, and using 6 volt vibrator supply, double button mike and DeLo battery operated receiver. This was their initial contact.



W.P.R.

Here's another one to shoot at, gang — a Worked Puerto Rico certificate. The Puerto Rico Amateur Radio Club offers one of these attractive tickets to every amateur working 25 K4's. Send your 25 verification cards with return postage and this award will be yours. Address all communications to Puerto Rico Amateur Radio Club, P. O. Box 15, Hato Rey, P. R.

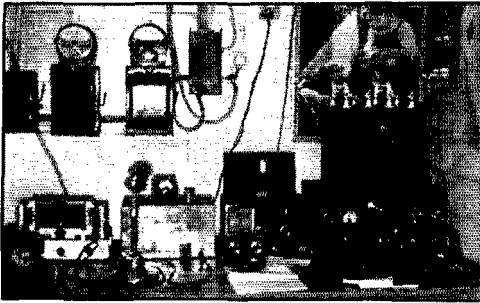

Station "SWL"

Most elaborate bootlegger's (Bridgeport, Conn.) station put out of running by action of Inspectors Charles C. Kolster and Ralph Renton of the Boston office of the Federal Communications Commission. Notice giving names of those apprehended appeared in last *QST*. Note to all (and sundry) little bootleggers: Crime does not pay; it's proper to get a license from F.C.C. first!

Potomac Valley Net

Under the sponsorship of the Weather Bureau the responsibility of the Potomac Valley Net is to furnish in time of emergency, particularly when other communication systems have been disrupted, such communication channels as may be required for the forwarding of weather information from each of the weather offices in the Potomac River Valley to the Weather Bureau at Washington, and to distribute weather forecasts originating in Washington to the community in which a station is located. A secondary objective is to furnish communications for the American Red Cross. This would include reports from county chapter headquarters to Washington and replies thereto.

The net control station is W3CTD in Hagerstown, Maryland. Drills are held on the second Sunday of each month at 9:00 A.M. Eastern Time, on 3935-ke. W3ZD, organizer of the net, assists in controlling the Sunday morning sessions. Net members include W8HSC, W8MOV, W3AQV, W3GME, W3CTD, W3AHC, W3BIG, W3BJX, W3WN, W3ZD, W8KKG, W8RDC, W8GWE, W3OL and W8BCT. Supporting Members are W3ESV, W3UA, W3EMM, W8PX and W3HAL.

— . . . —

Volunteers Wanted for Connecticut Valley Emergency Net

E. J. Christie, Meteorologist U. S. Weather Bureau, Hartford, Conn., has requested the establishment of a network of amateur stations in the Conn. River Valley for handling weather forecasts from weather reporting stations in emergencies. Since only two reports a day will be required it is planned to use the network for other services as well. Conn. State Police have already indicated a desire to tie their radio system in with the net.

Amateur contact in the following places is needed: West Stewartstown, N. H.; N. Stratford, N. H.; St. Johnsbury, Vt.; Bethlehem, N. H.; South Newbury, Vt.; Rochester, Vt.; W. Hartford, Vt.; White River Jct., Vt.; Newport, N. H.; Walpole, N. H.; Brattleboro, Vt.; Keene, N. H.; Montague City, Mass.; Ware, Mass.; Holyoke, Mass.; Springfield, Mass.; Somerset Dam and Hartford, Conn. The names of owners of weather reporting stations will be furnished participating amateurs.

Several points should be noted: (1) A source of emergency power or battery operated equipment is essential. (2) Cross-band operation will be used in any case where necessary to reach the places listed. (3) Both 'phone and c.w. stations will be used if stations of similar service are not available. (4) It is planned to have monthly tests of the network. Those willing to cooperate and located at any of the points listed, are requested to write Harold W. Ballard,

W1CSC, A.R.R.L. Regional Coördinator, 2 Bliss Street, East Hartford, Conn., giving full particulars on the equipment and bands used, previous experience in emergency work, if any, and other information which might be valuable to the net.

Brass Pounders' League

(February 16th-March 15th)

Call	Orig.	Del.	Rel.	Extra Del. Credit	Total
W9QIL	95	248	1106	195	1644
W4PL	23	32	1472	20	1547
W3EML	58	150	804	141	1153
W7EBQ	25	83	942	65	1115
W6DH	44	209	644	191	1088
W9EKQ*	6	12	1036	5	1059
W6LUJ	164	425	38	422	1049
W8GZ	21	20	952	16	1009
W5FOM	116	281	150	266	813
W9JLH	17	33	740	20	810
W3QP	207	283	11	270	771
W5CEZ	29	151	558	23	766
W2SC	29	179	380	176	764
W9YXH	16	64	616	40	736
W9EKQ	6	10	712	2	730
W6LMD	11	16	674	5	706
W6IMI	71	172	294	151	688
W3GKO	33	34	544	30	641
W3BWT	51	73	453	61	638
W8SJV	22	19	574	3	618
W4IR	19	64	494	32	609
W2ITX	34	31	524	13	602
W6FTR	11	33	532	26	602
W5MNI	24	93	408	76	601
W3EEW	68	48	444	35	595
W3CIZ	31	86	363	83	563
W9ABE*	3	3	553	0	559
W1FFL	56	159	290	53	558
W1CCF	58	39	448	9	554
W5FSK-4	232	178	2	120	532
W6IOX	29	27	436	25	517
W6ZM	25	160	180	151	516
W9FAM	7	17	480	12	512
W5FDR	98	131	186	97	512
W1EOB	24	45	406	28	503
W9NPL	16	24	446	17	503
W2PL	249	123	28	102	502
W8JQE	67	44	376	14	501

MORE-THAN-ONE-OPERATOR STATIONS

Call	Orig.	Del.	Rel.	Extra Del. Credit	Total
KA1HR	1208	677	264	638	2787
KA1HQ	500	307	884	299	1990
W5OW	159	230	1378	141	1908
W1AW	64	126	349	115	654
W9BNT	18	159	399	34	610

These stations "make" the B.P.L. with total of 500 or over. One hundred deliveries + Ex. Del. Credits also rate B.P.L. standing. The following one-operator stations make the B.P.L. on deliveries. Deliveries count.

W6PCP, 266	W1JCK, 118	W8ASW, 108
W5HAG, 228	W3ELN, 117	W4DNA, 107
W2MT, 171	W6RH, 117	W5EOE, 107
W8KW4, 158	W1BFT, 115	W6MFF, 106
W2LR, 153	W2CGG, 115*	W2CGG, 105
W9CRO, 153	W2LZR, 114	W2DBQ, 105
W9REH, 153*	W5ZM, 111	W8NCJ, 103
W2KL, 147	W1KCT, 110	W1GTN, 102
W3BZE, 139	W3HRS, 110	W6KOL, 102
W2GVZ, 136	W1EMG, 109	W1UE, 101
W6PGB, 127		

A.A.R.S.

WLNB (W2DBQ) made the B.P.L. on 139 deliveries.

MORE-THAN-ONE-OPERATOR STATIONS

Call	Orig.	Del.	Rel.	Extra Del. Credit	Total
WLM (W3CXL)	144	138	2828	67	3177

A total of 500 or more or 100 deliveries + Ex. D. Cr. will put you in line for a place in the B.P.L.

* January-February.

How's DX?

HOW:

COME to think of it, we might pass along a suggestion or two to some of the newcomers in DX (old-timers can pass this up and jump down to the next paragraph). It has to do with the business of getting all hepped up about the strange calls that sometimes appear on the air. For example, XF1A shows up in the Contest and says he's in Mexico, but a lot of fellows immediately start wondering about him. Heck, why shouldn't he be in Mexico? The normal amateur prefix is "XE" but the call-letter block assigned to Mexico runs from XAA to XFZ, so it's quite OK for a Mexican amateur to sign "XF" if he can talk his government into letting him use it. Or maybe it did it on its own accord, having run out of XE1 calls (but we doubt it). In any event, the idea is to familiarize oneself with the call-letter blocks. On the other hand, when these "ZZ" and "YQ" jobs appear, there's a mighty good chance that they emanate from lads with the salt spray on them or from land-locked goofs trying to be funny. Our point is that if you watch the call assignments and glance at the Call Book once in a while, you can get a pretty fair line on things. There are other tricks, of course, such as knowing that all VP7 calls are VP7N — and things like that, that one just gradually acquires. We don't recommend passing up signals because they sound queer — we just suggest tempering one's excitement. (OK, Jeeves, so I was 97 on my last birthday.)

WHERE:

APPARENTLY we were right in not getting too excited about those cards from TA1AA that came through. The G's seem to have him cold, if the ribbing he gets in

G2MT's DX column in the current *T. & R Bulletin* is any indication Some of the boys got a bit mixed up on NY4AD in the Contest, not knowing what country to count him. He's a Navy station at the U.S. Naval Reservation at Guantanamo Bay, Cuba, but a quick glance at some of the Contest logs shows fellows putting him everywhere from the Canal Zone to Honduras. The station operates within the amateur bands and is licensed indirectly by the F.C.C. by mutual agreement of the F.C.C. and the Navy. Five calls have been assigned, from NY4AA to NY4AE — ex-CO8YB will soon be on with NY4AB. Oh, yes — it counts as *Cuba* in the Contest Jerry Petranek, our hope down in Samoa, says in his latest letter that he has been assigned the call KH6SHS, the first one in Samoa. However, he can't operate without the specific authority of the Governor and, with the various w-rs going on, he's having trouble getting the permission. When he does, he'll be on 14,390 with 10 watts to a 6L6, powered by the 220-volt d.c. main. He won't be able to handle traffic, but wants to get on to give the gang a new country and, in the immortal words of Olsen (or was it Johnson?), "That's yoost what we want!" Jerry says that the KH6RZQ in Samoa reported was very likely KB6RZQ in Guam The following fellows who worked a station signing LZ1ID between Sept. 29th and Oct. 12th last year will be disappointed to learn that they didn't work the Bulgarian one: W1KHE, IKT, BXC, FZ, LVH, IME, GRK, GCL, LSK, W2IOP, ARB, ZA, KYO, KM, BHW, LRG, CJM, BJ, W3EYY, CSY, FGB, EUJ, EKN, ZX, KD, CRW, DPA, GVS, PQF, QT, WAFDA, DBF, W6RRL, W8JDB, DWV, OQF, QIZ, CRA, PUD, ODH, OSL, ADY, W9JDP, VKF, YFV, J2KN, EA5A and HA2N. He was near there but, out of justice to the real LZ1ID, the records should be kept straight, in case you've wondered about not getting a card J9PA (14,400 T6) got on 40 and 20 a bit during the Contest. We assume he was the real McCoy, in the Marshall Islands VP8AF down in the Falkland Islands writes to say that he and VP8AJ are anxious to get going again, as soon as the ban is lifted, and that VP8AD has gone to South Georgia, confirming the rumor that was kicking around recently The TWA (Tibet Workers of America) has several new members, according to prexy W9HLE. They are W2AIW, W8BTI, W9OVU, W8CRA and W2GTZ. The station, of course, is our very good friend whose signal we haven't heard yet, AC4YN. They work him around 1330 GT W4DWU gives the address of HC1VT as Box 756, Quito, Ecuador W6OBK has the address of XUOA as Box 172, Chunking, China, for those who have been anxious to QSL him. W2GT adds dope from XUOA that the new Chinese "division numbers" are arranged as follows:

- XU1 — Mongolia, Heilungkiang, Kirin, Lianin, Ningaia
- XU2 — Jehol, Chahar, Suiyuan, Hoeph, Shansi
- XU3 — Shantung, Honan
- XU4 — Szechwan, Shensi, Kansu, Sinkiang
- XU5 — Yunnan, Kweichow, Sikang, Tsinghai, Tibet (!)
- XU6 — Kwangtung, Kwansi
- XU7 — Fukien, Kiansi
- XU8 — Kiangsu, Anhwei, Chekiang
- XU9 — Hupeh, Hunan

No mention is made of XU0, and Ed thinks that the prefix may be reserved for official C.A.R.L. stations. Don't ask us about that Tibet listing — we've had our argument about that! W8JSU worked a J9PC (7290 T7) one morning recently, but doesn't put much faith in him.

WHEN:

A few things have been happening on 80. W4GNQ knocked over K6CGK (3505 T9) at 4 a.m. with only a 6V6 oscillator, W8SNA raised XE1CA (3650 T9), and W9THS got CM6AC (3780).

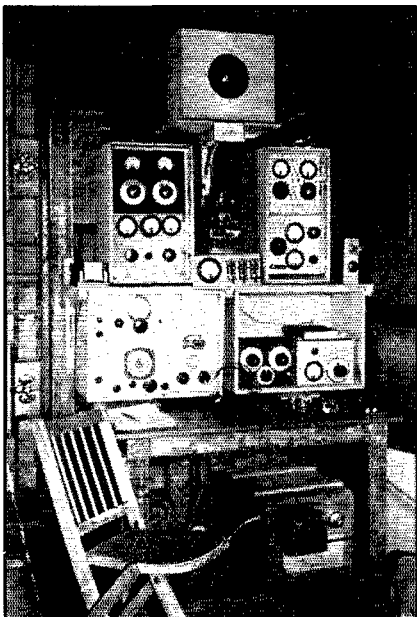

The rig at AC4YN, Lhasa, Tibet. The rig at the upper right is the RK20 oscillator rig which Fox used in several of his W contacts and the black box below is the receiver used on all bands. The other gear is for various frequencies used in other services.

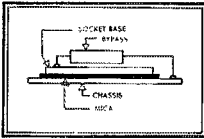

BUILDING equipment for the ultra-high frequencies always presents special problems. These are bad enough with simple circuits, but communication or frequency-modulation superhets present some real headaches for the home constructor. For the benefit of the ambitious amateurs who are working on such gear, we are passing on some "hints and kinks." Of course, the main problem in ultra high frequency circuits has to do with stray inductance and capacity. Either one alone is not so bad, but usually both show up together, making a series or parallel resonant circuit (whichever is worse). To show just how a bypass condenser turns into a wave trap, let's take an example.

The cathode of an acorn tube must be bypassed to ground right at the socket. The National pentode acorn socket accomplishes this by having a large copper plate for the base which is insulated from the chassis (ground) by a piece of mica. This provides a capacity of 500 mmf or so, and does a nice job at high frequencies. At lower frequencies (say 20 meters), more capacity is needed so another condenser is added in parallel. This condenser takes care of the lower frequencies very well, but you will now find that the high frequencies have gone haywire. This is because the leads on the external condenser have inductance, and this inductance will be in parallel resonance with the built-in bypass condenser at some frequency which will probably be within the range of the receiver. Even though the Q of this circuit may be very poor, it will have high enough impedance to spoil the bypassing effect at its resonant frequency. After all, the cathode resistor will only be a few hundred ohms.

This sort of thing will show up all through the circuit. Grid returns on the AVC circuit will probably give trouble. Heater wires will probably be resonant, due to the cathode-to-heater capacity and the filament wiring inductance. And so on.

There is no simple cure-all for this. However, it is always possible to move the resonant frequency of these wave-traps to some point in the spectrum where they are not objectionable. Probably most amateurs will be interested in working only in certain bands, so it should not be hard to find a graveyard where the receiver's dead spots can be buried. The actual adjustment of the frequency is easy: — just move the offending wire or condenser a little, to change its capacity or inductance.

Although this is not a very elegant solution, it is quite practical and straightforward. If you insist on building a wide range receiver without any dead spots, we will encourage you by telling you that it can be done. We will also extend our sympathy to you in your trouble. We have been all through it on the NHU (which has no dead spots).

However, we do have an elegant solution to the high-frequency oscillator problem. We will have to tell you about it next month, as there does not seem to be much space left on this page.

DANA BACON



Which is the BEST ? Amateur Band

Do you favor—

160 meters—the friendly rag-chewers' band for medium and short distance

80 meters—the traffic man's band for distances up to 1,000 miles or more

40 meters—cw only and good for hundreds of miles by day-light and worldwide range at night. But—oh, boy—the QRM

20 meters—worldwide range—but of limited value for medium distance, and usually dead late at night

10 meters—phenomenal worldwide DX with low power—but open only a portion of the day

5 meters—the dandy band for crosstown rag-chewing—with occasional DX to 1000 miles or more

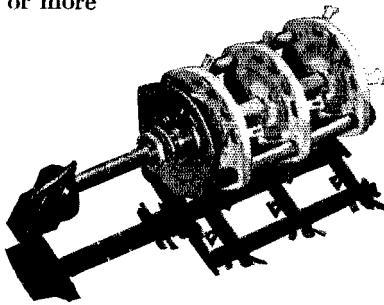

Band Switching is Easy When You Use MALLORY-YAXLEY HamBand Switches

Much can be said of the advantages and disadvantages of each band. But this is obvious—no one band has *all* the desirable characteristics. It is only by rapid band switching that you can enjoy all the benefits that amateur radio can offer.

Band switching is easy when you use Mallory-Yaxley HamBand switches, Type 160C. Designed especially for amateur service, with exclusive long life, high efficiency features.

Find out about these improved transmitting switches. Ask your distributor or write for Form Y-646 which gives complete technical details.

P. R. MALLORY & CO., Inc.
INDIANAPOLIS INDIANA
Cable Address—Pelmallo

Use

MALLORY
APPROVED RADIO
PRECISION PRODUCTS

Use

YAXLEY
APPROVED RADIO
PRECISION PRODUCTS

W6AM skeds **KC4USB** (7050) on Mondays. That's the base station W3ATR, a regular subscriber to the 7-Mc. cause, offers in evidence such worthies as **HC1VT** (7210), **HK6EJ** (7070), **K(B)4AAN** (7298), **PY1JC** (7265), **PY2DV** (7170), **PY2AL** (7140), **PY5AG** (7075), **PY2AC** (7200), **KYHK** (7070), **HC1EM** (7200), **HR4Z** (7180), **LU9AX** (7030), and **OA4U** (7175) To this, **W2EQS** adds **HC3CL** (7195 T8), **HK4DD** (7010 T7), **K7GTB** (7100 T9) and **KAIHQ** (7075 T9), and **W2LXI** brings **HK5EE** (7050 T9), **K6QUJ** (7070 T8), **K6AYD** (7040 T9), **LU7AZ** (7000 T7) and **XF1A** (7030 T8) Out west **W6QKB** has **XUSMI** (7100 T9), **KA3RA** (7020 T9), **J6CD** (7190 T8), and **J8CW** (7085 T9), and **W6RAM** bids with **J2IH** (7045), **J3OP** (7170 T9), **J3OV** (7080 T9), **HK2BD** (7210 T9), **K4ESH** (7190 T9) and **KAIHR** (7140 T9).

W2HEF starts the ball on 20 with one of those nice long lists of his: **KAIAC** (14,390), **KAI1DM** (14,355), **XU5MK** (14,260), **KA7TT** (14,280), **KAIKX** (14,320 T8), **J2LL** (14,360), **KAI1B** (14,260, 14,300), **PK5AB** (14,295), **J3OV** (14,320), **KAIMN** (14,370 T8), **XU6SF** (14,320 T7), **XU8LK** (14,310), **K7BUB** (14,285), **XU9HU** (14,340 T7), **J3CG** (14,310), **KAI1AF** (14,400), **U5AH** (14,390), and **XU6MK** (14,320). Among those heard: **K6NYD/KE6** (14,345 T8), **KF6SJJ** (14,320) and **ZP6AB** (14,020) **W9DIB** drops in with **KAI1E** (14,290), **ES6D** (14,330), **U9AW** (14,400), **IIMS** (14,400), **XU5CA** (14,350) and **XU6K** (14,400-380), while **W1BFA** adds **EA5A** (14,400 T4), **XU0A** (14,400 T9), **XU8WS** (14,395 T9) and **EA7AV** (14,400 T9) **W8MUS'** list includes **PJ3CE** (14,400 T9), **H18C** (14,355 T7), **PK1IM** (14,360 T9), **MX3H** (14,360 T9) and **K8RWZ** (14,400 T7) **W5DYT** keeps busy with **OX1CX** (14,400), **PY2DV** (14,305), **OQ5IM** (14,380) and **U9ML** (14,400), as does **W2EQS** with **KC4USC** (14,350 T9), **HH2MC** (14,390 T9), **HA9U** (14,360 T9), **OQ5AV** (14,400 T4), **HH3L** (14,400 T9), **OA4R** (14,400 T9), **OX1FB** (14,395 T8x), **IIR** (14,400 T9) and **OQ5BF** (14,400 T8) Other frequencies, gleaned from notes from **W2LXD**, **W4FLW**, **W5BGP**, **W8JIW** and **W9PFR**: **HC2HP** (14,040 T9), **HA9Q** (14,000 T9), **HH2PB** (14,350 T8), **OA4U** (14,355 T9), **LY1J** (14,270 T9), **YU7LX** (14,400 T7), **HK4DA** (14,040 T9), **YV4AE** (14,120 T9), **LU5FB** (14,400 T9) and **U8IB** (14,400).

PHONE:

ON 75, **W9THS** worked **H1K6C** (3943), **K6CIB** (3950) and **K7AWH** (3940) And in case you think 160 hasn't possibilities, **W1BES** received a heard report from England during February, from a fellow using a one-tube regenerative or something like that.

Twenty, of course, is the best bet. **W9DIB** worked **KAIME** (14,140), **KAIJH** (14,100) and **HP1A** (14,130),
(Continued on next left-hand page)

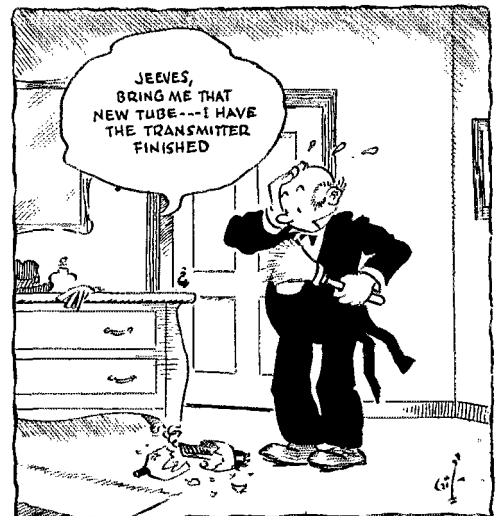

JEEVES

Free - Taylor Manual

NEW 1940 EDITION

48 Pages of Up-To-The Minute TRANSMITTING DATA!

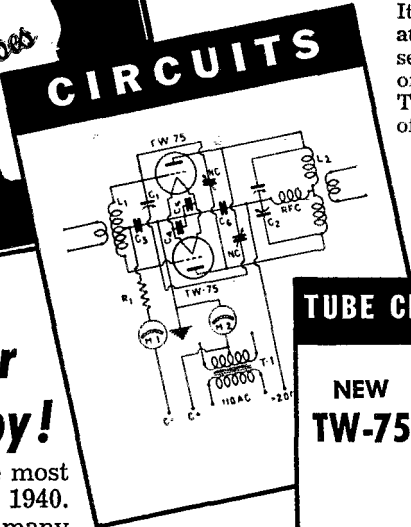
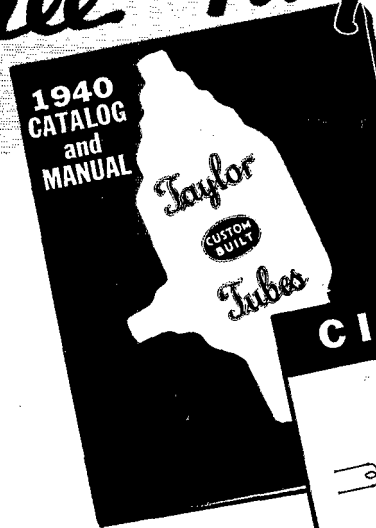

GET YOURS TODAY

It's FREE for the asking at your distributor's, or send five cents in stamps or coin direct to Taylor Tubes, Inc., to cover cost of mailing.

Every Amateur Should Have a Copy!

It's brand new—and one of the most valuable amateur manuals of 1940. Listed here are just a few of the many important features contained in this outstanding catalog and manual.

Photos of new chassis layouts and complete rigs from portables to the new KW Safety Transmitter—Circuit diagrams by the score—New complete L/C ratio data—Tube characteristics—Audio and modulation data—General tube information.

Contains full operating information on the new Thin Wall Carbon Anode Tubes—TW-75 and TW-150, also new dual ratings of the Taylor Wonder Tubes—T-40 and TZ-40. Don't delay—get your copy of this great new book today!

★ INCREASE TUBE LIFE—See Kenyon Transformer Co. ad in this issue, announcing new voltage dropping compensator filament transformer T-392, for T-40 and TZ-40. Furnishes 7.5 V., 7.7 V., 7.9 V., at 6 amps. ★

"More Watts Per Dollar"

TUBE CHARACTERISTICS

NEW TW-75

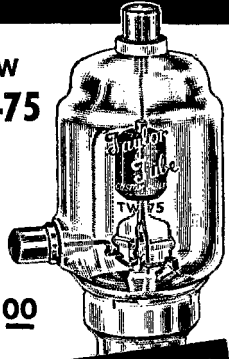

\$8.00

TECHNICAL DATA

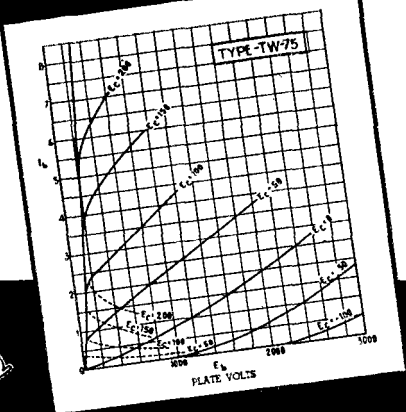

Taylor **HEAVY CUSTOM BUILT DUTY** Tubes

TAYLOR TUBES, INC., 2341 WABANSIA AVE., CHICAGO, ILLINOIS

For Greater
Operating Pleasure



BLILEY Vari-X



It's really a pleasure to sit back in your chair and leisurely choose your transmitter frequency to suit varying conditions. Maybe you'll shift a few kilocycles to dodge bad QRM. Or, perhaps, you'll select a certain frequency for contacting a particular desired station.

Frequency selection is easy with the Vari-X and VF2 Variable Crystal Units. And, you can forget worries about frequency stability (so difficult to obtain with a self-excited oscillator) because the Vari-X is 100% crystal controlled. Here in a single compact 40-80 meter exciter unit, the advantages of crystal and self-excited oscillators are fully combined.

Ask your Bliley Distributor to show you the Vari-X and to give you a copy of descriptive circular D-2.

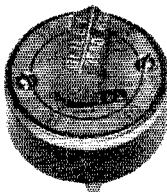

VF2 CRYSTAL UNIT

BLILEY ELECTRIC CO.
UNION STATION BUILDING ERIE, PA.



Ricardo Radaelli, LU2CW (left), and Enzo Sommaruga, CN2AJ, well-known South American DX merchants.

while W5DYT has **OP2AC** (14,300), **CE3BK** (14,020), **CE1AC** (14,130), **HI6Q** (14,110), **YV5ACM** (14,085), **YV5ACA** (14,095), **TI5NA** (14,060), **HK4DK** (14,080), **YS1YO** (14,070), **TG9BA** (14,280) and **EK1AF** (14,075) W8BWC says **KC4USC** (14,250) is plenty "agin" the e.c.o. boys who indulge in muscle tactics and break up QSO's. It happens more on c.w. than on 'phone, apparently W1ZI scared up **YSIMS** (14,100) in the Contest, along with a string of KA's, J's and PK's W6ITH has his usual nice list of stuff: **CE2AR** (14,030), **PY2AC** (14,110), **OA3B** (14,015), **CE1AA** (14,015), **PK1OG** (14,085), **CE3BE** (14,030), **CE1AM** (14,025), **OA4AI** (14,010), **XU8AM** (14,085), **CE1BD** (14,145), **KA1ZL** (14,110), **KA4LH** (14,140), **KA7FS** (14,255), **KE6NYD** (14,240), **J2XA** (14,160), **XU8AM** (14,085), **J7CB** (14,050), **KA1SM** (14,110), **XU8RA** (14,290), **HC1FG** (14,260), **J2KI** (14,140), **KA1TJ** (14,150) and **KA1JJ** (14,140).

On 10, W6PMB reports PK3JK, PK1VM, J2NF, J2KC, J2XA, CX2CO and HC1JV coming through, while W6ITH is more definite on the subject and gives frequencies: **LUSAA** (28,060), **LUIDA** (28,060), **HP1A** (28,100), **XU8AM** (28,170), **PY1GJ** (28,025), **PY5AQ** (28,225), **PY2AC** (28,190), and **CE3BX** (28,300). W6NWK/mobile-marine is out in the Pacific somewhere.

WHO:

W6BIL says W6EMI will be on 40 in Guam soon — he has gone there for four years for Globe Wireless. W6FOF, with PAA, will be on at Midway soon, on 20 K4KD has a new ambition, to work WAS on four bands. It isn't far-fetched, either — he needs Arizona, Arkansas and Wyoming on 80, South Dakota on 40, New Mexico, Utah and Wyoming on 20, and 10 owes him Arkansas, Idaho, Montana, New Mexico, Nevada, Oklahoma and Wyoming. We have a hunch he'll do it before long Z5BZ has dismantled the rig and joined the Air Corps, and is thus unable to answer all the QST cards he has received, but he promises to catch up first thing after the w-r. Let's hope you get the chance real soon, OM Someone should send HI3C a crystal or something. W9EVD caught him creeping from 14,340 to 14,265 during a normal-length transmission. No telling whether he'd be on 20 or 40 if he started to chew the rag. That's one way to dodge the QRM, but it samples it all on the way G6NG says he has caught up on his QSL's to W's but hasn't received a single one in reply and wonders what it's all about. Jeeves suggests that probably the W's have stopped QSL-ing because they're afraid the cards won't reach their destination, which may be good economics but poor ham spirit W4DWU tells us not to worry about the scarcity of DX. No matter how tough things get, that well-known Chinese operator, Wun Long See Cue, will always be going strong. As Confucius never said, "Lid who call CQ too long never paper wall but sure plaster band."

— W1JPE

O.B.S.

The following is a supplement to the list of A.R.R.L. Official Broadcasting Stations in October QST (page 76): W3GKL, W3IDZ, W5CPC, W7CZJ, W8SES.

Dual Stabilized!

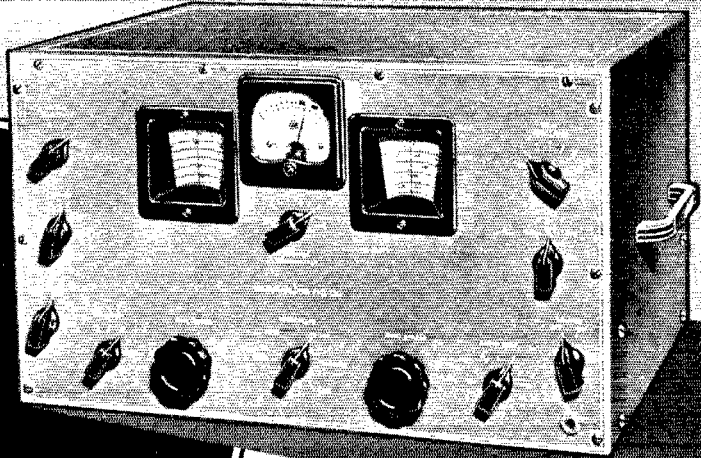

HQ-120-X

VOLTAGE REGULATION DRIFT CORRECTION . . .

STABILITY in the "HQ-120-X" was obtained, first, by a voltage regulator for the high frequency oscillator so that even considerable changes in line voltage have no appreciable effect on the oscillator frequency — the oscillator doesn't see-saw back and forth during unsteady line conditions. Second, the "HQ-120-X" has drift correction which takes care of oscillator changes due to tempera-

ture rise. The usual warm-up period has been reduced to a matter of minutes. Mechanical construction probably has the greatest bearing on stability. In the "HQ-120-X" special attention was paid to design of the tuning condenser and coil rack so as to practically eliminate the possibility of twist during temperature changes. If you are looking for high class performance at a moderate price — try the "HQ."

WRITE FOR 16-PAGE "HQ" BOOKLET!



HAMMARLUND MFG. CO., INC.

424-438 WEST 33rd ST., NEW YORK



EXPORT DEPT. . . . 100 VARICK ST., NEW YORK CITY

NEUTRALIZE with CARDWELLS

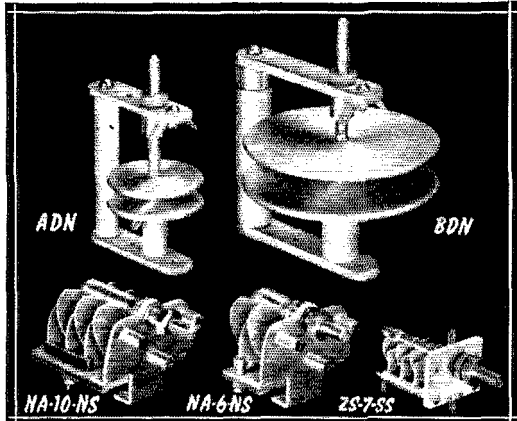

★ Here are essential components of properly constructed triode R.F. amplifiers. Select a proper size and style of neutralizing capacitor to suit your choice of tubes and circuit design.

★ CARDWELL Catalog No. 41 offers you a wide selection of capacity and airgap ranges in mechanical designs best suited to your needs.

★ Disc types for low capacity, high power tubes; a series of five "NA"—6500 V. types for medium power; and a wide selection of Trim-air types up to 4500 volts are represented by the group illustrated.

The CARDWELL "C" on your capacitors is "Trouble Insurance" worth having.

**"Play Safe"
with CARDWELLS**

PARDON PLEASE

The FEX and XE-160-70-XQ Multi-Band Condensers are erroneously listed in Catalog No. 41 with a .084" airgap. Both these condensers have a .100" airgap with a voltage peak rating of 4800 volts.

**THE ALLEN D. CARDWELL
MANUFACTURING CORPORATION**
83 PROSPECT STREET, BROOKLYN, NEW YORK

DX CENTURY CLUB AWARDS

These have been made to the first-listed amateurs, based on contacts with 100 or more countries, the credits all certified by examination of written evidence under the award rules.

W6GRL... 147	W8BTI... 132	W3EDP... 122
W2GT... 147	W4BPD... 132	W8NJP... 122
W8CRA... 145	W2CMY... 131	W9TB... 122
G6VY... 145	W8OSL... 130	W9FS... 121
W2GW... 144	W8OQF... 130	W5KC... 121
W2GTZ... 143	W5BB... 130	W8JMP... 120
W1TW... 141	W8ADG... 130	J5CC... 120
G2ZQ... 141	W3CHE... 130	W2GVZ... 120
W9TJ... 141	HB9J... 129	W3FRY... 120
W6KIP... 140	W1FH... 129	W1AXA... 120
W1BUX... 139	W2JT... 129	W1JPE... 119
W8DFH... 139	W3EPV... 128	W9PST... 118
ON4AU... 139	W8LEC... 127	ZL1HY... 118
W1SZ... 137	W2UK... 127	W9ADN... 118
W3EMM... 137	W2HFF... 127	W8MTY... 118
W6CXW... 135	W9KG... 126	W7AMX... 117
W1TS... 134	W2ZA... 126	VK5WR... 117
W5VV... 134	W9ARL... 125	W9EF... 116
W2BHW... 134	W1DF... 124	W3EUV... 116
W1LZ... 133	W8DWV... 123	W2BYP... 116
W8DHC... 132	W4CEN... 123	W1ADM... 116
G6RH... 132	D4AFF... 123	

115: W6ADP, W2CYS, W1WV, W4CYU, W1HX, G5BD, W8QXT

114: W9KA, G5RV, W8BKP, W2DC, W1CH, G2DH, G5BY, W1AS

113: G6CL, W2CJM, W4DRD, W2DSB, W3BES, W2GRG

112: W9GDH, W6FZL, W6GAL, W3EVT, W3GAU

111: W2AAL, W1DUK, VE2AX, W3FQP

110: ON4UU, PA0XF, W9UM, W2AER, W8WI, W5QL, W2IYO

109: W3DDM, W6FZY

108: W6HX, ZS2X, HB9BG, G2MI, W3BEN, VE3QD, HB9CE, VK3QK, W1BXC, W2ARB

107: W2CBO, G5BJ, W3AG, VK2DG, W1BGY, W9CWW, W7DL, W6MVK, W9RBI, W2AV, W6AHZ

106: G2TR, W8EUY, W6TJ, W9UQT, W1RY, W2VY, W3GEH, W8LFE

105: W2OA, G5QY, VK3CX, W1ICA, W2IOP, W1ZI, W4TO, W2GNQ, W1GNE, W8LYQ, W3ZX

104: EI5F, W1ZB, W4AJX, F8RR, W1GDY, W1GCX, W8DOD, W4IO, W2BMX

103: G6KP, W8KKG, J2JJ, W5CUJ, W9RCQ, W3KT, W9NNZ, W3AGV, W4BVD, VK6SA

102: W4CBY, W8AU, W8OXO, W1PTR, VE2EE, W2BXA, W8JAH, LUSEN, W8AAJ

101: F8RJ, VK3KX, W6DOB, SU1WM, W1CC, SU1SG, G6MK, W4MR, W6GTH, W6BAM, W8JTW, W8HGW, W6KWA, W4EQK, W9VDY, LU7AZ, W1AB

100: G6NF, W6KRI, VK2ADE, ZL1GX, HB9X, ZL1MR, PA0QF, W8BSF, D3BMP, W9LBB, W4CCH, W8KTW, W5ASQ, W8JIN, W8QDU, G6GH, W1IOZ, W8PQQ

Radiotelephone: W2AZ, W2GW 104; W6OCH 100

The following have submitted proof of contact with 75-or-more countries: W1AVK, W2BJ, W9AJA 99; LY1J, W1CBZ, W2ALO, W3AIU, W3A00, W6ADT 98; W2JMB, W4TF, W4TZ, W8LZK 97; G8IG, W2CTO, W4DMB, W8BOY 96; F81X, F8B4, G4X, W3EMA, W3FLH, W3OP, W8IQB 95; W3GHD, W6TT, W8CJ, W8BEZ 94; G8ZO, ON4GK, PA0QZ, W2WC, W6FKZ, W6MKX, W9JDP 93; SP1P, W4RTJ 92; W1BGC, W1DOV, W9GBJ 91; D3CSC, G6YR, ON4FE, SP1AR, W4KID, W8LAY, W9OYU 90; VK3HG, W1KHE, W2CUQ, W8AAT, W9KFT 89; G2DZ, W2BZB, W3JM, W9PGS 88; FV2DN, W6GPB, W8LDJ, W3JFC, W9AEB 87; W2FLG, W6NLZ, W8DAE, W9FLH 86; VK2TL, W4AHF, W4CFD, W6GK, W8GMH, W80UK 85; SM6WL, W1BFT, W2AYT, W3AM, W8EVB, W8EWC, W8CED, W9GKS 84; EI1, GZ7CC, VE2GA, W9AWF, W6DTE, W8KUT, W8BFG 83; W1EWD, W8AYS 82; ZL1L, W1BPN, W9GY 81; G3BS, LA2X, W2BNX, W2HTV, W3VBN, W3EPR, W3FUF, W4OG, W6MHH, W8DCP, W8TK, W9DIR, W9GMV 80; W3EJ, W4ZZ, W9MRW 79; W3BRD, W4EPV, W8FJN, W9YB 78; W6QAF, W9EUV 77; PA6JMW, W1EH, W3BSB, W3FHY, ZE1JI 76; HE2MC, W1NI 75.

Radiotelephone: W4CYU 95; W2IXY 91; G5RV, W3EMM 89; W8LFE 87; W1ADM 83; W1AKY 81; W2IKV 80; W1BLO 77; W2ITZ 76; W2GRG, W8QXT 75.

W2UK

U. S. high scorer in the 1937
and 1938 International DX
contests. The only station
ever to accomplish this feat.



"The very nature of contest work
requires equipment that can stand
up under severe abuse, therefore
my station is 100% powered with
Eimac tubes in addition to KY21
rectifiers and Eimac Vacuum
Tank Condensers"

Ralph E. Thomas, owner and operator of Station W2UK
uses a pair of Eimac 250TH's in the final and a pair of
Eimac Vacuum Tank Condensers with band switching for
two bands. A pair of 75T's used as the driver. Ralph's
success in scoring highest two years in succession is re-
markable—a good illustration of what can be accom-
plished by the intelligent use of good equipment of which
Eimac tubes are a vital part.

Eimac 250TH's

and a pair of Eimac Vacuum
Tank Condensers make up
the final. Eimac KY21 tubes
for the rectifier and 75T's
for the driver.

Eimac TUBES

EITEL-McCULLOUGH, Inc. San Bruno, Calif.

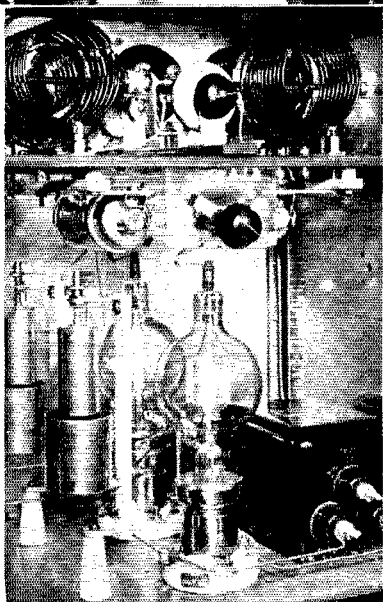

FREEBORN

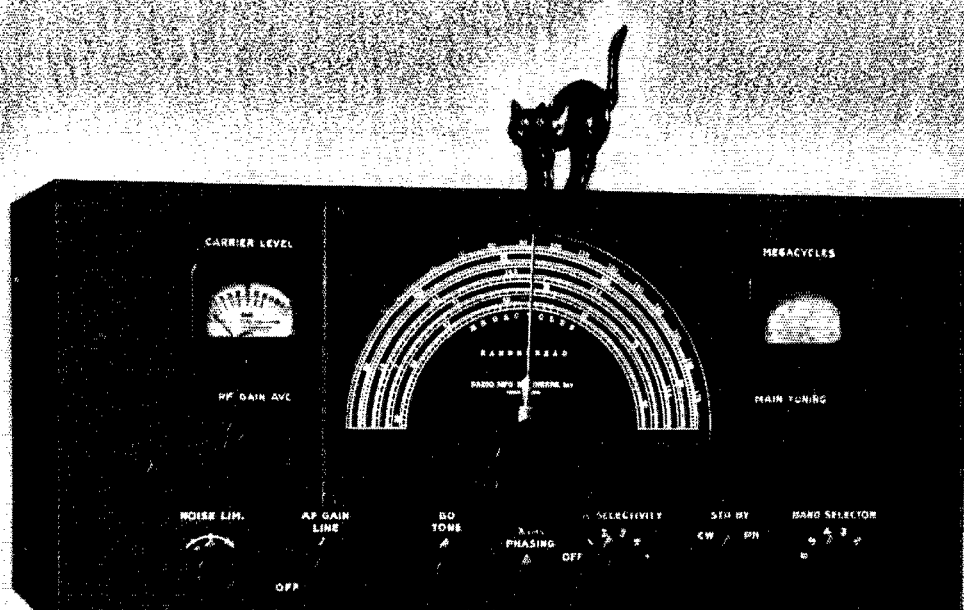

VELVET-SMOOTH CONTROL

The *TIME* has come to announce several years of accumulated receiver research translated into concrete form.

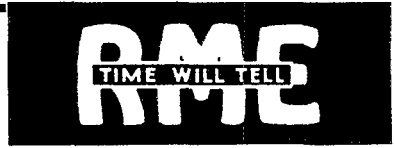

TO THE THOUSANDS WHO HAVE BEEN WAITING FOR IT

The New RME-99 Is Now Ready!

and what a receiver!

NOTE the new calibrated band spread scale laid out on an 8" semicircle. A scale that looks like "BIG BEN" — white lines on a dull black background, illuminated by reflected light. A scale for the 10, the 20, the 40, and the 80 meter bands, with a fifth scale for arbitrary logging.

To the left is the carrier level meter, calibrated in decibels and R values, and to the right the six-band megacycle scale, both of which are indirectly illuminated through translucent material. The total frequency covered extends from 540 kc. to 33,000 kc. on no less than SIX switch positions. not 4 or even 5 would do.

The RME-99 uses the fine loktal tubes in every important circuit adaptation. These new tubes have exceptionally good high frequency characteristics, and when used in a communications receiver lend themselves to better engineering tolerances. What a swell job these are doing in actual operation!

Then there is the new six-position crystal band-pass selector which works like a charm. Pick your favored selectivity, either phone

or c.w. and forget that you ever fiddled with an old-time crystal filter. Even a tone control is passé with this new arrangement.

We licked the drift problem through special adaptation of the VR150 voltage regulator tube on the heterodyne oscillator. Retaining the cast aluminum chassis frame, this new RME-99 is held as stable and rigid as old Gibraltar.

And an automatic noise limiter which follows the peaks, blots them out when they are of the interfering kind, works lightning fast and is adjustable, for percentage of modulation, from the front panel. You'd be surprised what a difference it makes over the purely automatic kind, and this one is also automatic.

A new R.F. stage ahead of the first detector, one which rejects images and performs an admirable job in setting the signal to noise ratio high. With a doublet input circuit, an overall sensitivity of uniform value, an undistorted power output of 4 watts, relay-control and break-in feature added, there is just one other thing left to say:

"TRY ONE . . . And convince yourself"

A booklet on the new RME-99 is available. Write for it, TODAY!

RADIO MFG. ENGINEERS, INC. 111 HARRISON ST.
PEORIA, ILLINOIS

GET SYLVANIA'S New "TUBE FACT" Book

Second Printing
of 5th Edition of
Sylvania Technical
Manual.



The latest Sylvania Technical Manual is a regular encyclopaedia of worthwhile information about radio tubes. Operating conditions, characteristics and circuit applications are given for hundreds of types including many types needed for special applications.

If you ever need technical data on radio tubes, you'll want this book. It's a handy size, easy to use and a bargain at only 35¢. Send the coupon below for your copy today.

SYLVANIA Set-Tested Radio Tubes

HYGRADE SYLVANIA CORPORATION Q50
Emporium, Pa.

Here is 35¢. Please send me a copy of the new Sylvania Technical Manual (2nd printing, 5th edition).

Name

Address

City State

Serviceman Experimenter Dealer Amateur

Syracuse Hamfest

May 25th at Syracuse, N. Y.: Bigger and better than ever, the Central New York Radio Club Hamfest will be held at the Turn Hall, 619 N. Salina St., Syracuse. A full program to satisfy and entertain all. Special program for the ladies. Novelty contests. Ping-pong tournament and exhibition. Bowling. Sound movies. Entertainment by a popular magician. Bingo party for the ladies in the afternoon, with many useful prizes. A midget radio receiver, main door prize. A turkey dinner. A few short but good talks. Many valuable and useful prizes headed by a De-Luxe Signal Shifter, crystal and dynamic mikes, tubes, etc. A hamfest you can't afford to miss. Price \$2.00.

The Dog House Net was organized some three years ago by a group of 1.75-Mc. 'phone operators, with the idea of emergency possibilities and as a means of experimental tests. The net operates at 6:00 P.M. EST on 1935-kc. with the following participating: W8SPT, STZ, TPQ, TPC, DSZ, MEA, RRC, TRX, SXM, UKK, OXG, TGU, SVI and W9QLF.

W9WVZ is organizing a net for the U. S. Weather Bureau in conjunction with New Mexico and Colorado hams. All interested operators should write Wayne F. Buckley, W9WVZ, Box 278, Antonito, Colo., for complete details.

W1AW Operating Schedule

OPERATING-VISITING HOURS.

3:00 P.M.-3:00 A.M. E.D.S.T. daily, except Saturday-Sunday.

Saturday — 8:30 P.M.-2:30 A.M. E.D.S.T.

Sunday — 7:00 P.M.-1:00 A.M. E.D.S.T.

OFFICIAL BROADCAST SCHEDULE (for sending addressed information to all radio amateurs).

Frequencies

C.W.: 1761-3825-7280-14,254-28,600 kcs. (simultaneously)

	Starting Times (P.M.)		Speeds (W.P.M.)								
	E.D.S.T.	C.D.S.T.	M.D.S.T.	P.D.S.T.	M	T	W	Th	F	Sat	Sun
8:30	7:30	6:30	5:30	20	15	25	15	20	—	20	
Midnight	11:00	10:00	9:00	15	25	15	20	15	15	—	20

PHONE: 1806, 3950.5, 14,237, 28,600 kcs.

Each code transmission will be followed in turn by voice transmission on each of the above frequencies.

GENERAL OPERATION:

Besides specific schedules in different bands, W1AW devotes the following periods, except Saturdays and Sundays, to GENERAL work in the following bands:

Time, E.D.S.T.	Frequency
4:30 P.M. - 5:00 P.M.	28,600 kc. Fone/CW
6:00 P.M. - 6:30 P.M.	14,237 kc. Fone
6:30 P.M. - 7:00 P.M.	14,254 kc. CW
7:00 P.M. - 7:30 P.M.	14,254 kc. CW
9:30 P.M. - 10:00 P.M.	3950 kc. Fone
10:00 P.M. - 10:30 P.M.	14,237 kc. Fone
11:30 P.M. - 12:00 A.M.	1760/1806 kc. CW/Fone
1:00 A.M. - 2:00 A.M.	3825 kc. CW
2:00 A.M. - 3:00 A.M.	7280 kc. CW
7:30 P.M. - 8:30 P.M.	Skeds on 80 meters.
10:30 P.M. - 11:30 P.M.	nat'l trunk NCS 3670 kc.

At other times, and on Saturdays and Sundays, operation is devoted to the most profitable use of bands for general contacts and to participation in special week-end operating activities. The station is not operated on legal national holidays.

Give W1AW a call for an accurate frequency measurement, to communicate with any department of A.R.R.L., to rag-chew when time permits, or to pass a message to ham friends, making use of the Headquarters station's multi-band facilities.

Colorado Emergency Service

The morning of March 2d found Lamar, Colorado, entirely cut off from outside communication following a wind, dust and snow storm the previous day and evening. W9CAA, Denver Emergency Coördinator, was requested by the

(Continued on next left-hand page)

**UNMATCHED
STABILITY!**

Tests under average conditions show maximum drift at 30 Mc. to be only 3.0 KC on one hour run, thereby keeping the signal audible.

HIGHEST SIGNAL-TO-NOISE RATIO!

A 2-to-1 ratio of signal-to-noise is obtained at an average sensitivity of 2 microvolts throughout range.

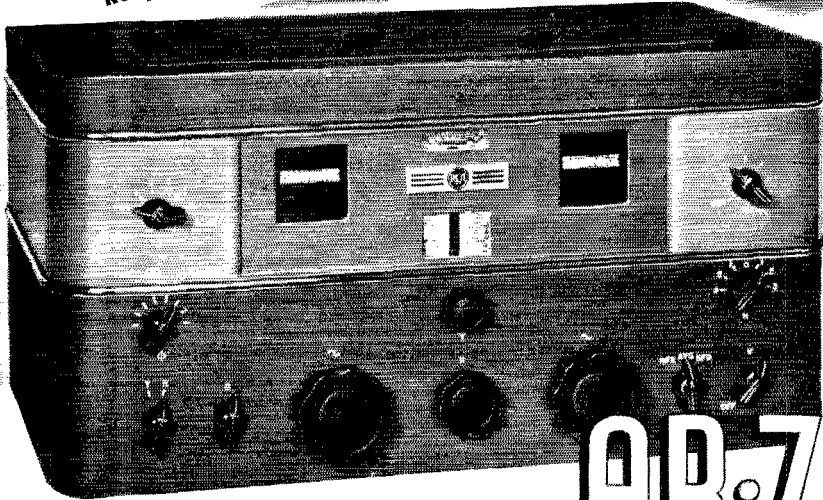

AR-77

**COMMUNICATION
RECEIVER**

Use of an over-size power transformer to reduce heat; Polystyrene insulation at strategic points; a temperature-compensated trimmer that automatically prevents frequency drift, and other RCA features make this new super "tops" in stability of tuning. For instance, during a 60-minute test starting one minute after turning "on", the drift at 30 megacycles was only 3.0 kilocycles. In this same test, when the line voltage was varied from 105 volts to 125 volts the drift at 30 Mc. was only 1300 cycles. Match this performance if you can!

As for sensitivity—well, the AR-77 has the highest signal-to-noise ratio of any receiver made by RCA, and that's saying plenty.

These features are typical of the superiority that has been built into every electrical and mechanical characteristic of this new receiver. In it, RCA engineering has gone the limit in providing the most exacting performance at a moderate price. Try it at your nearest RCA distributor's store. You be the judge!

Complete Technical Bulletin on request.

Frequency coverage, 540–31,000 KC in six Ranges—dual R-F alignment; stay-put tuning; negative feedback in audio amplifier; uni-view dial; calibrated bandspread for 10, 20, 40 and 80 meter bands; accurate signal reset; variable selectivity in six steps with crystal filter; improved image rejection; adjustable noise limiter and many other features.

Net Price, \$139.50 f.o.b. factory. 8" Speaker in matched cabinet, \$8.00.



for Amateur Radio

RCA MANUFACTURING COMPANY, INC., CAMDEN, N. J. • A Service of the Radio Corporation of America

GAMMATRON

*Engineering
Costs no more*

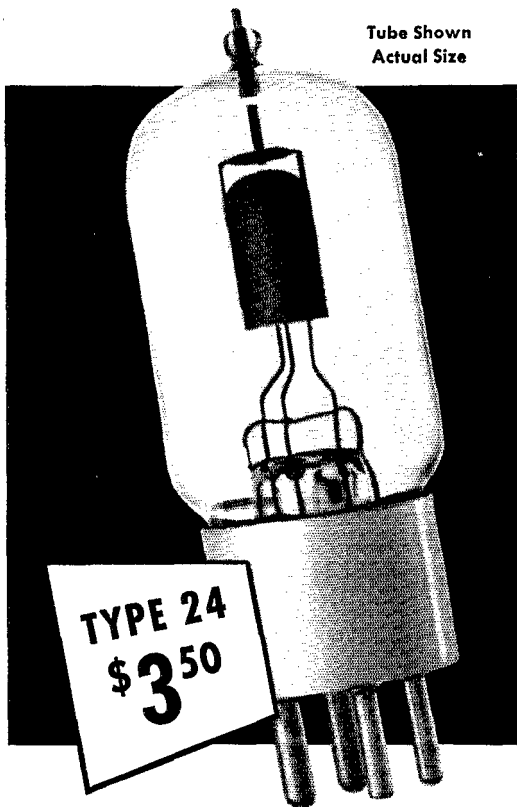

Tube Shown
Actual Size

For the same price as an ordinary tube, the Type 24 GAMMATRON gives efficient performance at even 1 meter. On usual amateur frequencies it will operate with large outputs and high voltages (2000 volts max.) with no danger of failure due to overload. Gammatron engineering plus tantalum construction throughout is your protection. WRITE FOR BULLETINS.

HEINTZ AND KAUFMAN
SOUTH SAN FRANCISCO LTD. CALIFORNIA U.S.A.

telephone company to attempt to establish communication. W9CDE, A.A.R.S., at La Junta was already on the job looking for contacts with Lamar and other points east for the Santa Fe Railroad. In the meantime W9WVB, Emergency Coördinator at Pueblo, had been requested by the A.T.S.F. Railroad to make contact with someone between Las Animas, Colo., and Dodge City, Kansas. They had two trains they had not heard from for 17 hours. W9WVB raised W5FJY/9 in Kansas City, who agreed to cover the 7-Mc. band for stations in the area needed. The aid of stations on 1.75-Mc. was also enlisted. W9WVB, W9CAA and W9CDE were on 3.5-Mc. Broadcasting stations KOKO (La Junta), KGHF (Pueblo) and KOA (Denver) assisted by broadcasting appeals to Lamar amateurs to get on the air. It was about 11:00 a.m. when W9CAA finally succeeded in raising W9AWR, Garden City, Kans. Santa Fe traffic passed from W9WVB to W9AWR via W9CAA, with W9CDE also in the line-up. Contact was later established with W9FKK, Lamar, and through him traffic was handled for the Santa Fe. W9NDM, La Junta Emergency Coördinator, cooperated in this work. Some telegraph company traffic also was handled. Trains were dispatched through the services of ham radio for two days.

Again on March 6th telephone communication in Colorado, Wyoming, Montana and Nebraska was disrupted due to extremely bad sleet storms. Through the cooperation of Western Union, whose lines had not been affected, messages were sent to various amateurs by W9WVB and shortly W7GGG, Cheyenne, Wyo., W9ESA, Denver, W9USP, Durango, Colo., W9AMQ/5, San Ysidro, N. Mex., W9KSE, Walsenburg, Colo., W9GLI, Monte Vista, Colo. and W9AUT, Alamosa, Colo., all on 3.5-Mc., were on the job and ready for any kind of duty. The storm abated and telephone communication was resumed, but the gang was ready for service, had the occasion demanded!

A Unique Contest

Something "different" in QSO contests for its members has been successfully staged by the Chester Radio Club, Chester, Pa. It is called "Alphabetical Soup" and is conducted as follows. Ruled forms are prepared with nine vertical columns, having headings of 1 through 9, and with an outside column with letters A through Z (with the omission of X), thus:

	1	2	3	4	5	6	7	8	9
A									
B									
C									
D									
E									
etc. (minus X)									

The idea is to see how many blocks the operator can fill in, one point being allowed for each block filled. If W1AW were worked, the letters AW would be placed in the "1" column opposite "A"; if W4ABT were worked, ABT would be placed under "4" opposite "A," etc. If another W1A or W4A were worked, it would not count. There are a possible 225 total points. The Chester Radio Club's contest ran for one week and one operator made 84 points. Prizes were given for (1) the greatest number of blocks filled, (2) greatest number filled in any one district and (3) greatest number of any particular letter filled. W3DGM, president of C.R.C. writes, "This contest encourages the less experienced operator to participate and also proves interesting to the seasoned operator." It looks good to us, OM.



11 ACRES FOR ANTENNAS! and a **MIMS DUAL THREE** tops the tower!

WILVK's *Dual Three* installation atop Smyth Observatory is shown here. The Manchester (N. H.) Radio Club, in purchasing this *Mims Beam* from Evans Radio of Concord, N. H., avail themselves of:

- Full efficiency on 10 and 20
- Real Unidirectional pattern
- Two separate arrays in one
- Instant changeover — no tuning

Theirs is a deluxe station, going in for the best of everything.

And it was built for *action* — as the emergency headquarters of a whole state.

The *Dual Three* — and other *Mims Signal Squirters* — may be had by *everyone*, with time payments available from dealers everywhere. And if you want *action* — *more* signal, *where* you want it, *when* you want it there — a *Mims Signal Squirrel* will give it to you. See your dealer now, or write me for details.

Mims Radio Co., Texarkana, Ark. Tex. 73, M. P. Mims, W5BD

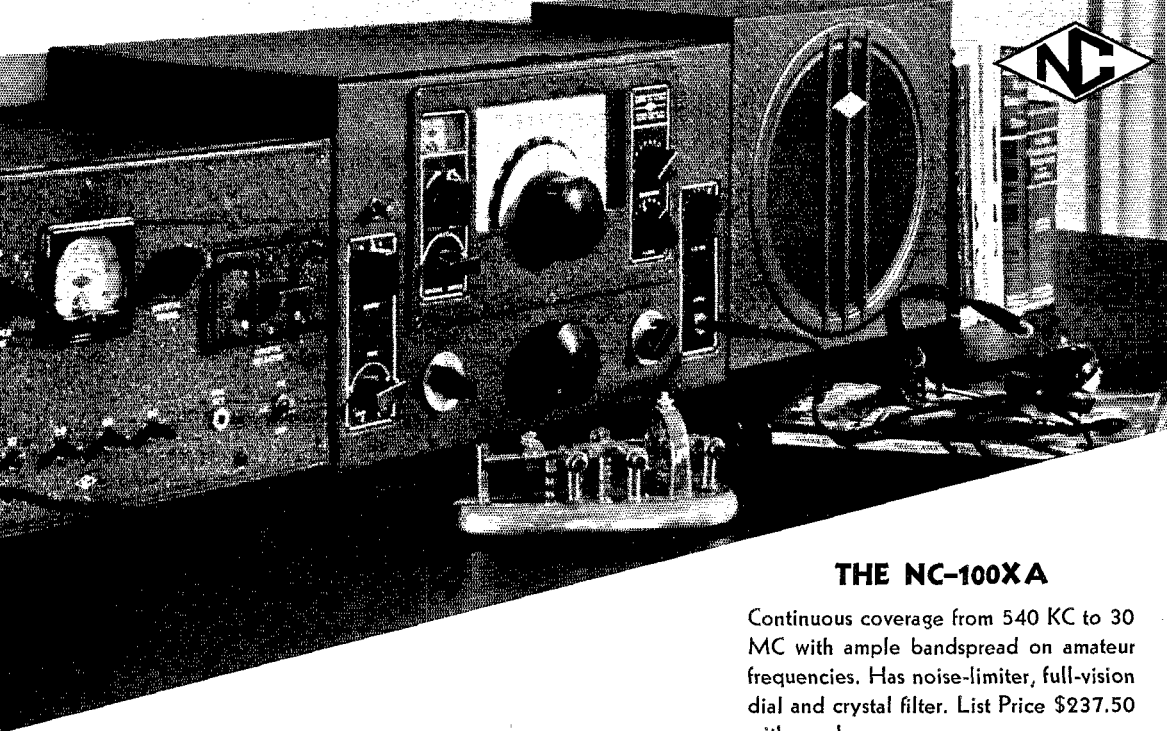

THE NC-100XA

Continuous coverage from 540 KC to 30 MC with ample bandspread on amateur frequencies. Has noise-limiter, full-vision dial and crystal filter. List Price \$237.50 with speaker.

Features that make a Fine Receiver

Receivers of the NC-100 series are thoroughbred communication receivers, built to the most exacting standards. From the first RF stage which is so largely responsible for their high signal-to-noise ratio to the audio output which contributes so much to their splendid tone, these receivers show the mark of quality in every detail.

The NC-100 Receivers are built in a variety of types to suit every purpose. For AC or DC, with or without crystal filter, general coverage or amateur bands only. Look over the model of your choice at your dealers. You will find the quality of its construction as impressive as its performance.

THE NC-101X

Coverage on amateur bands only, with extreme bandspread. Has noise-limiter, micrometer dial and crystal filter. List Price \$215.00 with speaker. Available at the same price with full-vision dial, Type NC-101XA.

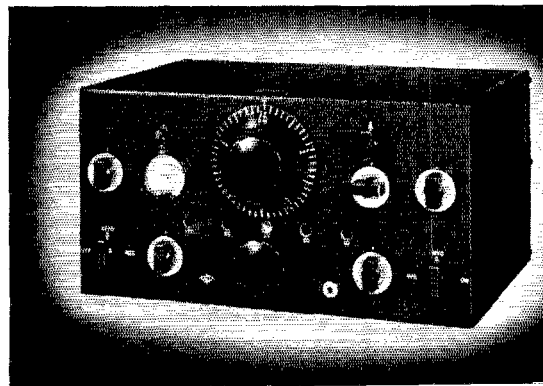

ACCURATE TUNING

A rugged precision condenser, driven through a preloaded gear drive, provides smooth tuning free from backlash. The full vision dial used on the NC-100A, NC-100XA and NC-101XA is shown at the right. Separate direct-reading scales are used for each range. In addition to swinging over the scale, the pointer moves radially when the coil range is shifted so that it points directly to the frequency. A separate vernier dial is added for precise logging.

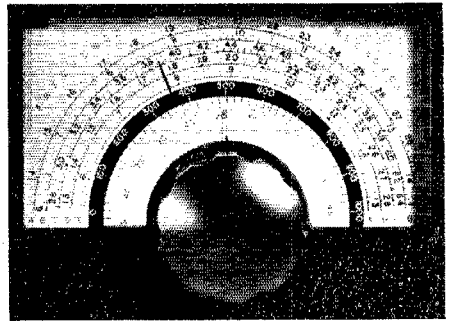

HIGH PERFORMANCE

The 11 tube superheterodyne circuit of these receivers gives high signal-to-noise and great sensitivity and selectivity. To the fine basic circuit have been added all those features which years of experience in building fine communication receivers have shown to be helpful. These include a new noise limiter of truly remarkable effectiveness and (on the "X" models) a crystal filter with wide range control of both phasing and selectivity.

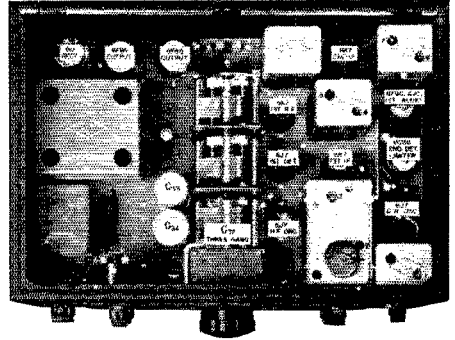

MOVABLE COILS

The movable coil tuning unit combines the convenience of a coil switch with the efficiency of plug-in coils. The large cast aluminum shield in the base of the receiver has a separate shielded pocket for each of the RF and oscillator coils. This heavy shield moves bodily on its track when ranges are changed, bringing the desired coils directly below the main tuning condenser and tubes, thus providing the shortest possible leads. Unused coils are moved out of the way, contributing to the receiver's complete freedom from dead spots.

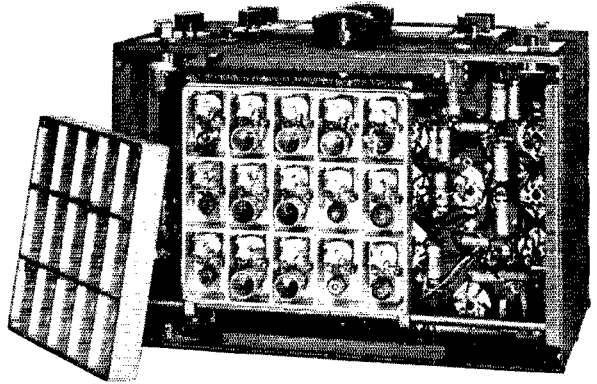

QUALITY PARTS

Quality parts are used throughout, to insure highest performance and long trouble-free service. Typical is the use of air-dielectric trimming condensers throughout RF, IF and oscillator stages. Everywhere you look in this fine receiver you will find abundant evidence that it is built to the finest communication standards, from parts specially designed for communication work.

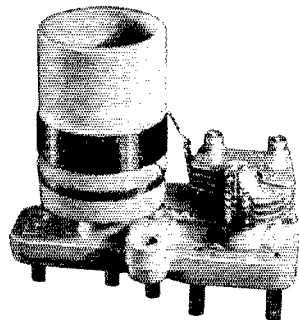

NATIONAL COMPANY, INC., MALDEN, MASS.

QUALITY ABOVE ALL!
SOLAR
 CAPACITORS



TYPE XL TRANSOIL

For permanent filters; surge-proof-leak-proof; temperature stabilized.



TYPE XA TRANSMICA

Current-carrying; low corona losses utmost permanency; humless

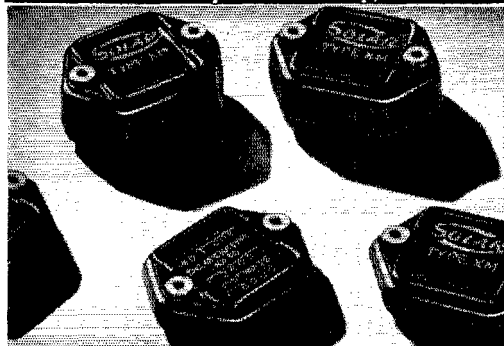

TYPE XM MOLDED MICA

Write for catalog No. 10 which lists all Solar Capacitors with ratings and sizes. Free.

SOLAR MFG. CORP.
 Bayonne, New Jersey

College Ham News

Active and alumni members of Rho Epsilon are invited to contact other members on Rho Epsilon night, the first day of each month between 7 P.M. and midnight, local standard time. Frequencies to be used are 3500-3700, 7000-7300 and 14,300-14,400 kcs. The general call is "CQ RE." The first fifteen minutes of each hour is the best time for establishing contact.

W9YX, Michigan Tech., and W8PZS, Ohio Univ., have joined the midwest section of the N.I.P.A. Net. W7GWT, W7YH and W7HIX, comprising the Pacific Northwest Section of this net, have been holding daily schedules on 7170 kc. at 3:15 P.M. PST. Hams at other colleges may secure information on joining these nets from the National Secretary of Rho Epsilon. W7EOY, drama instructor at Oregon State College, transmitted basketball game stories to W7GWT for the *Univ. of Wash. Daily*. Epsilon chapter members at Armour Tech. have a South Pole beam for W9YW. W7EYD, W7GZD, W7FEH, W7AGE, W7HNT and W7FVZ are new members of Beta Chapter at the Univ. of Wash. Winter-term officers for Eta Chapter at Tri-State were W9LEJ, pres.; W9FLL, vice-pres.; W3HZF, secy.; and VE4AEK, treas. Twenty-one members attended an initiation banquet meeting on Jan. 29th. After the dinner each pledge gave a short "history" of his introduction to ham radio and a few choice experiences in the game. The Theta Chapter Radio Room at Newark College of Engineering was open to visitors on the Annual Visitor's Day Celebration, Feb. 10th. Spectators were permitted to talk for a short time to various stations in Newark and suburbs over the mike at W2JPK. An oscilloscope was the source of considerable amusement for many who were able to "see" their voices. W2LGV, W2JBI and W2GFW operated from their own shacks, while W2HIT and W2KBS operated W2JPK, W9FSC and W9ATW are members of Alpha Tau Omega Fraternity at the Univ. of Kansas. W5DXG, W2IOE, W7EYS, W9HPF and W9HJS attend Parks Air College in East St. Louis, Ill. All ham college students and college radio clubs are invited to send their news notes to Nillo E. Koski, W7LD, National Secretary of Rho Epsilon, 5822 E. Green Lake Way, Seattle, Wash.

— W7LD

Leading O.O.'s in F.M.T

In recent Frequency Measuring Tests, the following amateurs stood highest among the Class I A.R.R.L. Official Observers. A high degree of accuracy was demonstrated. The next tests will be conducted in May and any operators interested in O.O. appointment are invited to send a card to Headquarters at once for bulletin containing details. In this list of highest Class I Observers, the average error, parts per million, is indicated in each case:

W1EAO 4.785; W3IGK 4.88; W9OUI 5.3; W3EEW 5.72; W9RIL 6.71; W2LXQ 8.3; W3CHE 13.96; W6GM 16; W3EMM 17.14; W9FA 18.15.

BRIEFS

W3QP got a message from a lady in Buffalo to go to Manila, and she included an addressed envelope for delivery of the message at Manila! Boy, are we good!!

W7DPU, Concrete, Wash., is sending code practice on 1958-kc., Monday, Tuesday and Friday at 6:30 P.M.

The world's largest W8JK beam? W6HJT reports that W8YX, in the 1.75-Mc. W.A.S. Party, used a "160-meter 8JK of two sections." The thing was 120 feet high and 500 feet long with 118 foot spacing!

A word of caution is in order for the benefit of hams designing QSL cards. Unless you care to slap a 3¢ stamp on each card, take care to keep the size within the U. S. Postal Regulations. For 1¢ mailing, dimensions must not exceed 3 1/4 inches by 5 1/4 inches.

One of W5GWL's CQ's was answered simultaneously by W3IJW and W8SYD/3, both in the same city (Harrisburg, Pa.) and on the same 7-Mc. frequency.

FOR BETTER REPRODUCTION OF ANY SIGNAL

Model MT-8 is a high fidelity Reproducer used extensively in broadcast stations and important amateur stations.

It is a *completely enclosed* cabinet utilizing a special Jensen PM speaker and the famed *Bass Reflex* principle which reproduces sound through a wider frequency band more accurate in character than is possible even with an *infinite* baffle. And the polar characteristic is exceptionally good; it isn't necessary for the listener to be directly on the beam of this speaker.

Bass Reflex — exclusively Jensen — involves the coupling of a cone speaker to an aperture, in an otherwise totally enclosed cabinet so that an acoustic circuit is accomplished, employing the enclosed volume as an element.

With a Jensen MT-8 you will have a clear, crisp reproduction of speech plus a frequency response characteristic from 50 to 10,000 cps — making you ready for Frequency Modulation and giving you high fidelity reproduction with your present equipment.

Note the compact size — 24 x 17½ x 11¼; and hangers are provided for convenient wall mounting. Complete with heavy duty special Permanent Magnet Speaker. \$29.50 list price. Amateur's net price \$17.70 at your Jensen Distributors. The greatest value in signal reproduction.

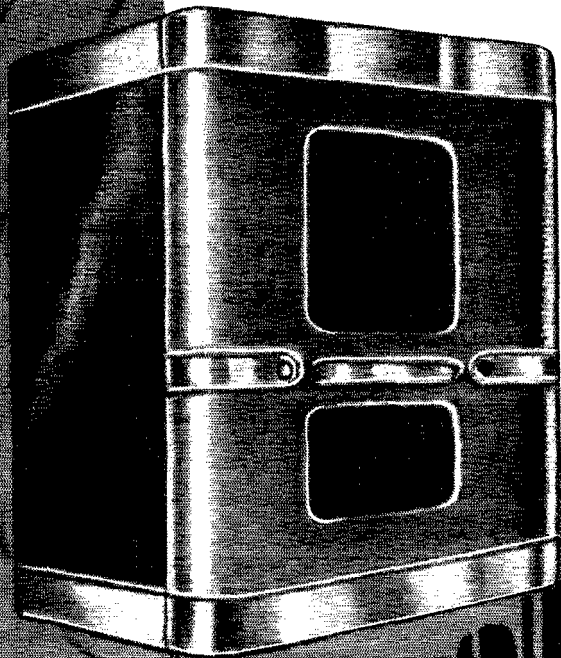

Jensen
Bass Reflex
Speakers

YEARS AHEAD

TRIPLET

1941 Model 1696-A MODULATION MONITOR

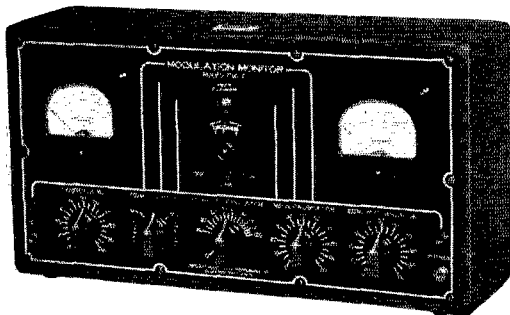

YOU'VE solved your problem of getting maximum efficiency from your transmitter when you invest in a Model 1696-A Modulation Monitor.

And . . . better yet . . . it saves you money by increasing your range without the added expense of remodeling your transmitter. (Amateur experience has shown that a properly modulated 10-watt rig can be as efficient as a 50% modulated 40-watt transmitter.) The Model 1696-A is easy to use. Plug it into your A.C. line — make simple coupling to the transmitter output and the monitor shows:

- **CARRIER REFERENCE LEVEL**
- **PER CENT OF MODULATION**
- **INSTANTANEOUS NEON FLASHER** (no inertia) indicates when per cent of modulation has exceeded your predetermined setting. Setting can be from 40 to 120 per cent.

Use of the monitor permits compliance with FCC regulations. Two RED•DOT Lifetime Guaranteed Triplet instruments. . . Modernistic metal case, 14½" x 7½" x 4½", with black suede electro enamel finish. Black and white panel.

Modulation Monitor Booklet — regular purchase price \$1.00 — Furnished FREE with each Model 1696-A. Tells you what you want to know about this monitor, and includes details, including diagrams, for operation of Model 1696-A.

Model 1696-A. Amateur Net Price (U.S.A.) \$34.84

For Rack Panel Mounting

Also available as a rack panel mounting unit. Monitor is mounted in heavy steel panel, 19" x 10½", with wrinkle finish. Amateur Net Price (U.S.A.) **\$36.18**

For More Information—Write Section 255 Harmon Drive

THE TRIPLET ELECTRICAL INSTRUMENT CO.
Bluffton, Ohio

Correspondence From Members

(Continued from page 65)

Q5 — Good quality doesn't necessarily mean "broadcast quality," a term, we think, that is being run to death. Good quality, here, implies good voice fidelity for amateur use, and not the high fidelity associated with broadcast stations. Therefore, a single-button microphone, together with a speech amplifier that doesn't introduce hum or distortion, can warrant a "Q5" report for good voice fidelity as well as the expensive mike and high-fidelity speech amplifier.

Q4 — Good quality but noticeable hum. (The bugaboo of all 'phone — hum!) Slight hum originating in a speech amplifier or being picked up by a sensitive mike from a humming relay or transformer in the shack. Eliminate the source for a "Q5" report!

Q3 — Fair quality because of distortion. Let us say right now that all distortion is objectionable, and no one can conscientiously pass a "good quality" report to a man whose voice is breaking up on peaks or has slight distortion throughout the entire voice frequency range. Eliminate the distortion and jump from "fair" to "Q5" quality!

Q2 and Q1 — These are to be used where the a.c. hum or distortion is so objectionable that the voice becomes almost unintelligible. It should never be necessary to give a Q2 or Q1 report, but we still hear, occasionally, a case that warrants passing a Q2 or Q1 on, so we incorporated it here to give that extra degree for critical checking. Also, grouping Q1 and Q2 or Q3 and Q4 also illustrates the system's flexibility.

The "R" and "S" sections remain as they are in the R-S-T system. We had thought of reducing the "R" section to three divisions instead of the present five, and the "S" section to five divisions instead of the present nine, but to do this would conflict with the universally accepted and standardized R-S-T system. Therefore, to promote mutual acceptance and sponsorship by c.w. men who do work 'phone occasionally, we decided to leave the "R" and "S" sections in their present set-up, to eliminate possible confusion.

It may serve as a remainder that the "R" simply replaces the old "QSA" and the "S" replaces the old "R" of the antiquated and inadequate "QSA-R" 'phone reporting system.

As another point of interest, QSL cards can be printed with a QRST space for inserting the other fellow's report. Then, a c.w. man would cross out the Q and fill in "RST 599X" for reporting on c.w. and a 'phone man would cross out the T and fill in "QRS 559" for reporting a 'phone signal.

Less confusing, more flexible, and more readily adaptable. Yours for more "QRS 559" signals on 'phone!

— Charles J. Uher, W9ONR and Eugene R. Taylor, W9ADF
834 N. Harlem Ave., River Forest, Ill.

QRM-LESS QSO'S

Editor, QST:

I have seen many gentle hints in the correspondence column about the fact that there are c.w. bands on 160, the "other side" of 20, and on 10. I don't see what on earth the boys can have against these bands. The 1.75-Mc. band in my opinion is every bit as good, if not better, than 80. There is no QRM there, and from here I hear everything except 6's and 7's. I suppose I could work them, too, if I stayed on after midnight.

The "other side" of 20 is very good, too, but does not have quite the possibilities of the one-sixty band because a few of the boys seem to have discovered that it is there. During the contest I worked five foreign countries there, and heard a few more.

The 10-meter c.w. band is one of the best, and the least used. If you don't believe this, just ask anyone who got on 10 c.w. to get extra multipliers for the contest. I heard a lot of the boys working a ZP, which is a nice grab for anybody. For the fellows who don't care for 'phone, the 6's come through during the day, before 20 opens up, so that if you use both 20 and 10, you can have contacts over a reasonable distance during most of the day. During the contest the South Americans were coming through in the middle of the afternoon, when 20 was dead as far as any DX was concerned.

(Continued on next left-hand page)

SUPER-PRO

Series 200

For...

**10
and
20
METERS**

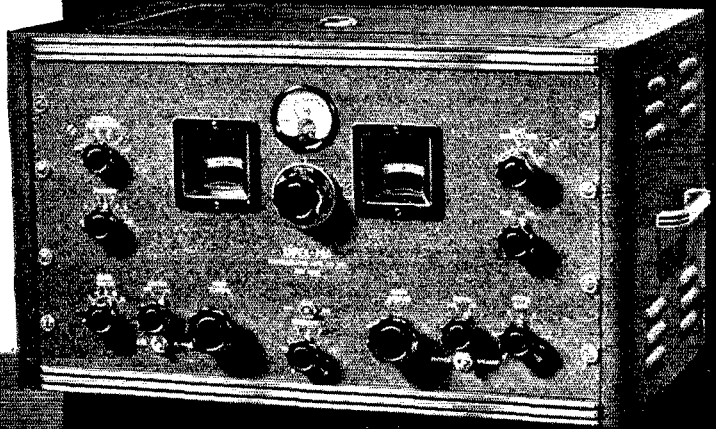

THE Series 200 "Super-Pro" with its many new features represents the ideal receiver for the high frequency phone bands. Its improved noise limiter and exceptional sensitivity make operating on 10 and 20 meters a real pleasure. If stations are coming through you will hear them on a "Super-Pro," because its weak signal sensitivity extends far below the noise level of even the best locations. In the more crowded phone bands, such as 20 and 75, the crystal filter can be adjusted to weed out practically all hash and heterodynes. Two stages of high gain tuned RF amplification, of course, provide image-free reception. Even on 10 meters, images are rarely found. In addition, the "Super-Pro" has an electrostatically shielded input, three stages of I.F. amplification, an abundance of audio power, variable I.F. selectivity, an "S" meter that really means something — it can be adjusted

to coincide with the operator's custom of reporting signal strength, and an accurately calibrated tuning control. When designing the new "Super-Pro," our engineers set out to produce the best receiver money could buy, and we judge from its overwhelming acceptance by amateurs and engineers who really know that this objective has been reached. If you want to be sure, get a "Super-Pro."

SEND FOR BOOKLET!

HAMMARLUND MFG. CO., INC.
424-438 W. 33rd St., New York City

Please send "Super-Pro" Booklet Q-5-O

Name.....

Address.....

City..... State.....



HAMMARLUND MFG. CO., INC.
424-438 WEST 33rd ST., NEW YORK



CANADIAN OFFICE: 41 WEST AVE. NO., HAMILTON, ONTARIO

EXPORT DEPT. . . . 100 VARICK ST., NEW YORK CITY



ONLY SPRAGUES HAVE LIFEGUARDS

TERMINALS
FULLY PROTECTED !

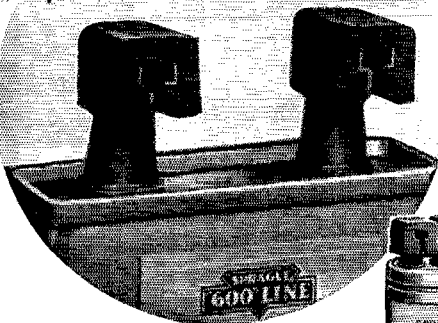

... AND THESE FEATURES, TOO

Four features spell real safety — real efficiency — for users of Sprague high voltage condensers: (1) Lifeguard Terminal Insulation Caps; (2) Terminals perfectly insulated from cans; (3) Automatic grounding of cans through mounting clamps; (4) All condensers oil-impregnated and oil-filled (not oil-impregnated and wax-filled) with SPRACOL, the 500° flash protection oil. Ask for them by name! Big catalog free.

Round or Rectangular with Universal Mounting

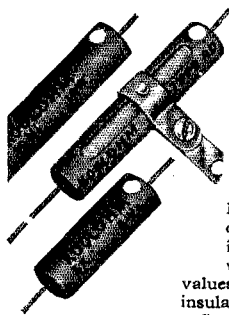

Only SPRAGUE KOOLOHM RESISTORS

Have These Features

New wire coating — every bit of wire insulated before winding — larger wire sizes — layer windings — greater resistance values in smaller size units — fully insulated — new type of pigtail. . . .

Such are but a few of the features that make Sprague Koolohm Wire Wound Resistors tops for any need. They operate cooler — there is no danger of shorted turns — and all resistance values may be used at FULL WATTAGE RATINGS. Truly non-inductive resistors at lowest prices yet. 5% resistance accuracy guaranteed. See Koolohms today at your jobber's or write for catalog.

SPRAGUE

PRODUCTS COMPANY
North Adams, Mass.

I don't see that we have any right to gripe about congestion or want any more frequencies, when we don't use the ones we have now. It is a sort of a "dog-in-the-manger" policy, so why not try one of these less inhabited bands, and for once enjoy a QRM-less QSO?

— John M. Bell, W9EYD

118,000 MILES PER WATT

4358 Franklin Ave., Hollywood, Calif.

Editor, QST:

After reading several reports in QST during the past year concerning field day tests and the fine results the boys were getting with their low-power portables, I was bit by the bug myself. About three weeks ago I built a little portable transmitter. It uses a 6F6 tube in a conventional crystal circuit and normally feeds a 135-foot end-fed antenna. The little gadget is only 6 inches on a side and will almost fit into a coat pocket, but since its inception the big 500-watt rig has hardly been touched. . . .

An input of 5 watts from a bank of "B" batteries brings S9 reports from anywhere in California during the day on 7 Mc. At night, with the same input, contacts have been made with East coast W's, Hawaii, Alaska and Japan. Reports at these distances average S4 to S5. It was a QSO with W6IJB in San Francisco that awakened me to the possibilities of extremely low power. He reported the 5-watt signal RST599 and suggested reducing power. I started down the battery taps and finally wound up on the last tap of the last battery, with W6IJB still reporting RST559. The input at this time was 22 volts at 2.5 ma. — about one-twentieth of a watt. I had no way of further reducing power and decided then to be ready for real QRP in the future. A search in the junk box brought to light a 4.5-volt "C" battery and two 1.5-volt dry cells. The total output of this combination was 7 volts, and the transmitter would still oscillate drawing one milliamperes of plate current — an input of 0.007 watt. On March 6th, at about 1:00 a.m. P.S.T., I successfully worked W9VZZ in Denver, Colorado, with this input. Starting with an input of 5 watts and an RST589 report, the power was gradually reduced. At one-twentieth of a watt W9VZZ reported me still easily readable at S3 to S4, so the 7-volt supply was hooked up and a call made. W9VZZ came right back and reported the signal down to S1, but he was still able to identify the test characters sent. Hollywood, California to Denver, Colorado — 830 miles — on seven thousandths of a watt! This works out to better than 118,000 miles per watt, and unless somebody else has hung up a better score we are offering it as a record for QRP over this distance.

Would somebody make me an offer on a nice 500-watt transmitter?

— Court Matthews, W6EAK

TROUBLE AHEAD

Box 89, Kenil, N. J.

Editor, QST:

Does anybody know how to eliminate broadcast interference in one of the new super-fangdangled no-aerial receivers?

If there is someone who can tell me, let me know soon, please, before you read about W3CWG in "Silent Keys."

— John F. Lee, W3CWG



In connection with some work on television equipment W2CPE has encountered two different types of 6L6, one of which will withstand much higher voltages than the other without arcing over. The high-voltage type has a glass "header" into which the element leads are sealed, while the leads of the other type have the insulation of only individual glass beads. The types may be identified by an inspection of the base. In the high-voltage type, the lower of the two metal flanges extends down to the bakelite piece, while in the other type, the metal portion between the bakelite piece and the lower flange is a separate piece of metal.

TAKES GUESSWORK OUT OF SELECTING TRANSFORMERS



THORDARSON

HOW TO DETERMINE CORRECT DRIVER TRANSFORMER RATIO

THORDARSON

The determination of the correct driver transformer ratio of a driver is important in the design of a transmitter. The ratio of the secondary to the primary of a driver transformer is determined by the load impedance of the secondary. The ratio of the secondary to the primary of a driver transformer is determined by the load impedance of the secondary.

As an example, let the driver transformer have a primary impedance of 100 ohms and a secondary impedance of 1000 ohms. The ratio of the secondary to the primary is 10 to 1.

Let us assume that the driver transformer has a primary impedance of 100 ohms and a secondary impedance of 1000 ohms. The ratio of the secondary to the primary is 10 to 1.

Through a tube may be capable of high power output when used as a power amplifier. It should be noted that a driver transformer is not a power transformer. It is a transformer which is used to match the impedance of the driver transformer to the impedance of the load.

It is frequently necessary to know the ratio of the secondary to the primary of a driver transformer. This ratio is determined by the load impedance of the secondary. The ratio of the secondary to the primary of a driver transformer is determined by the load impedance of the secondary.

The ratio of the secondary to the primary of a driver transformer is determined by the load impedance of the secondary. The ratio of the secondary to the primary of a driver transformer is determined by the load impedance of the secondary.

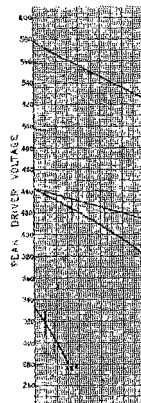

As an example, let the driver transformer have a primary impedance of 100 ohms and a secondary impedance of 1000 ohms. The ratio of the secondary to the primary is 10 to 1.

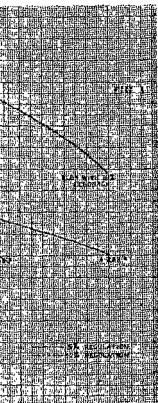

"How to Determine Correct Driver Transformer Ratio" and "Multi-Match and Universal Modulation Transformers" are two bulletins of great technical value to Amateurs. Both are available from your THORDARSON Distributor or may be obtained gratis by writing the factory and asking for SD-442 and SD-423.

THORDARSON
ELEC. MFG. CO.
45th Anniversary

Instruction Sheet For MULTI-MATCH AND UNIVERSAL MODULATION TRANSFORMERS

Through the use of transformer action, it is possible to match the impedance of a driver transformer to the impedance of a load. The ratio of the secondary to the primary of a driver transformer is determined by the load impedance of the secondary.

One should be aware that the ratio of the secondary to the primary of a driver transformer is determined by the load impedance of the secondary. The ratio of the secondary to the primary of a driver transformer is determined by the load impedance of the secondary.

As an example, let the driver transformer have a primary impedance of 100 ohms and a secondary impedance of 1000 ohms. The ratio of the secondary to the primary is 10 to 1.

In order to determine the correct driver transformer ratio, it is necessary to know the load impedance of the secondary. The ratio of the secondary to the primary of a driver transformer is determined by the load impedance of the secondary.

It is frequently necessary to know the ratio of the secondary to the primary of a driver transformer. This ratio is determined by the load impedance of the secondary. The ratio of the secondary to the primary of a driver transformer is determined by the load impedance of the secondary.

As an example, let the driver transformer have a primary impedance of 100 ohms and a secondary impedance of 1000 ohms. The ratio of the secondary to the primary is 10 to 1.

The use of the curves listed follows: 1. Determine the correct ratio of the secondary to the primary of a driver transformer. 2. Determine the correct ratio of the secondary to the primary of a driver transformer.

It is frequently necessary to know the ratio of the secondary to the primary of a driver transformer. This ratio is determined by the load impedance of the secondary. The ratio of the secondary to the primary of a driver transformer is determined by the load impedance of the secondary.

As an example, let the driver transformer have a primary impedance of 100 ohms and a secondary impedance of 1000 ohms. The ratio of the secondary to the primary is 10 to 1.

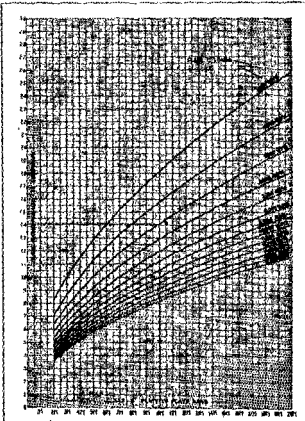

Fig. 1.

THORDARSON MULTI-MATCH AND UNIVERSAL MODULATION TRANSFORMER RATIOS

TRANSFORMER SPECIALISTS SINCE 1895

WWV Schedules

EXCEPT for the special broadcasts of WWV using 20 kw. as described below, WWV is now running a continuous schedule (day and night) on 5000 kc. with a power output of 1 kw. This continuous transmission is modulated with the standard pitch in music, 440 cycles per second.

Each Tuesday, Wednesday and Friday (except legal holidays), the National Bureau of Standards station, WWV, transmits with a power of 20 kw. on three carrier frequencies as follows: 10:00 to 11:30 A.M., E.S.T., on 5000 kc.; noon to 1:30 P.M., E.S.T., on 10,000 kc.; 2:00 to 3:30 P.M., E.S.T., on 20,000 kc. The Tuesday and Friday transmissions are unmodulated c.w. except for 1-second standard-time intervals consisting of short pulses with 1000-cycle modulation. On the Wednesday transmissions, the carrier is modulated 30% with a standard audio frequency of 1000 c.p.s. The accuracy of the frequencies of the WWV transmissions is better than 1 part in 5,000,000.

Sweepstakes Contest Results

(Continued from page 49)

Says W4AAQ, "It sounded like moving day when W6QQJ in Nevada came on and everybody moved to his frequency." . . . W8BEA, operating W8EK, reports, "With only one crystal on hand, all I could do was work my section of the band until it was dry, then shut down until some new stations moved in. One QSO. on 7 Mc. in QR.M. was the result of my 10-second CQ, followed by W7CMB's 5-second call

(W8EK twice, sign once). There were dozens of calls nearly as short, and the effectiveness of short, snappy calling with frequent signing was never more forcibly shown." . . .

So ten Sweepstakes have passed into history. It's going to take some operating to better the all-time high records established in 1939, but you'll have a chance to try in November of this year. Think you can do it? See you in the Eleventh SS — November 9-10 and 16-17, 1940.

Scores

Tenth All-Section Sweepstakes Contest, 1939

(Scores are grouped by Divisions and Sections. . . . The operator of the station first-listed in each Section is winner for that Section. . . . Asterisks denote stations not entered in contest, reporting to assure that stations they worked get credit. . . . The number of sections and number of stations worked by each participant are given following the score. . . . Likewise the "power factor" used in computing points in each score is indicated by the letter A or B. . . . A indicates power up to and including 100 watts (multiplier of 1.25), B indicates over 100 watts (multiplier of 1). AB indicates operation in both power groups. . . . The total operating time to the nearest hour is given for each station and is the last figure following the score. . . . Example of listings: W3BES 96798-62-626-A-40, or, Final Score 96798, number of sections 62, number of stations 626, power factor of 1.25, total operating time 40 hours. . . .)

ATLANTIC DIVISION		W3GJY	53500-50-428-	A-40	
E. Pennsylvania		W3GHD	50780-56-362-	A-37	
W3BES	96798-62-626-	A-40	W3FQG	49815-52-383-	A-39
W3DGM	84638-61-555-	A-40	W3EML	49708-55-363-	A-38
W8OKC	77216-59-526-	A-40	W3DMQ	46295-47-394-	A-40
W3ATR	67270-56-481-	A-40	W3GDI	45820-58-317-	A-37
W3GHM	67125-60-448-	A-39	W3CHH	42012-51-330-	A-25
W3FRY	62775-62-405-	A-39	W3KT	41250-55-300-	A-31
W3GRF	58800-56-420-	A-36	W3GET	41000-50-328-	A-37
W3AGV	56464-63-359-	A-39	W3HLZ	40530-42-387-	A-40
W3CPV	55121-53-418-	A-40	W8FDA	39275-60-259-	A-40
W3FLH	54540-54-404-	A- -	W3BXE	36285-59-246-	A-37

(Continued on next left-hand page)

FOR THOSE WHO WANT THE BEST

MORE POWER ON 1¼ AND 2½ METERS AT LOW COST!

BY USING THE NEW HY75, THE ONLY MEDIUM-POWER, LOW-COST TUBE EXCLUSIVELY DESIGNED FOR ULTRA-HIGH-FREQUENCY OPERATION.

● The HY75 is two to five times MORE EFFICIENT at 1¼ meters, which means that it provides the same output as larger tubes requiring two to five times as many watts plate input. Naturally with lower plate voltages and current, the power supply, modulator, and associated parts cost much less when the HY75 is employed. Further advantage of the HY75 is that for battery-operated transmitters, the battery drain is only one-fifth to one-half that of other tubes providing the same power output. Use the HY75's singly or in push pull for all U-H-F applications including frequency modulation. No special or trick circuits required. Of course the HY75 is even more efficient at 2½ meters and longer wavelengths than at 1¼ meters.

● The HY75 employs a pure tantalum vertical-bar grid, cylindrically-coiled thoriated-tungsten filament, and a SPEER cylindrical GRAPHITE anode. Short leads to twin top caps, small and 100% cylindrical elements provide highest efficiency. Relatively close spacing of electrodes reduces transit-time losses to a minimum. High mutual conductance makes the HY75 very easy to drive, thus increasing output when used as an oscillator. Full power output obtainable at plate potentials from only 350 to 450 volts.

Characteristics of HY75

Filament	6.3 volts @ 2.75 amperes
Plate	450 max. volts and 100 max. ma.
Plate dissipation	15 max. watts
Mutual conductance	2300 micromhos
Average amplification factor	10

Oscillator — Class C Amplifier

	Modulated †	Unmodulated	
Nominal power output* } 224 MC	14	17 watts	
	112 MC	19	24 watts
	56 MC	24	33 watts

*Approximate output. Actual values controlled by associated circuit constants.

†DC plate input reduced 20% when modulated to allow for audio power input from modulator.

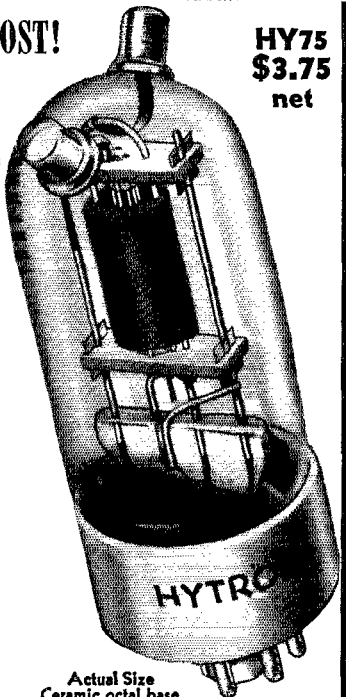

HY75
\$3.75
net

Actual Size
Ceramic octal base

HYTRONIC LABORATORIES

A DIVISION OF THE HYTRON CORP.

23 Derby Street, Salem, Mass.

KENYON

Pioneers Again!

BY PRODUCING THE WORLD'S FIRST TRANSFORMER

WITH TUBE BASE, PLUG-IN FEATURE

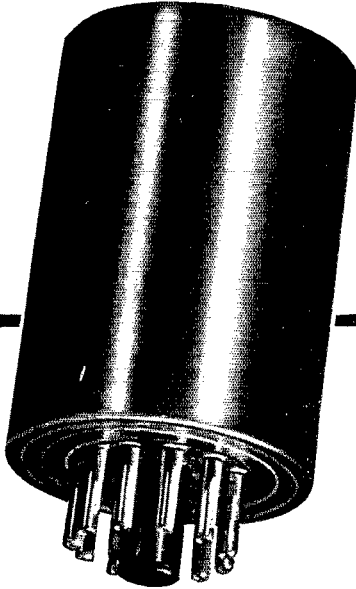

PATENTS APPLIED FOR
Illustration Actual Size

Size 2" high x 1 1/8" diameter. Available in both standard and submerison-proof types to meet all Army and Navy and C.A.A. specifications: line to line, line to grid, interstage, output, high inductance chokes, crystal mike to line, low impedance to grid. (Frequency response with no D.C. in windings plus or minus 2 DB, 30-20,000 cycles.)

CATALOG READY



The finest ever produced by us. Especially valuable to engineers, designers, etc. FREE to those requesting it on their business letter-head.

Again Kenyon sets the pace. Here truly is an amazing new idea in transformer design . . . a unit with an octal base that may be plugged in just like a radio tube. Where space is at a premium and where efficiency must be maintained at a high standard—these new Kenyon "A" Line transformers fill the bill.

We urge you to investigate the possibilities involved for their use particularly in aviation, submarine, mobile or portable equipment—in short any equipment where maximum quality and limited space are the specifications. "A" Line transformers save time in assembly and design. Each unit comes complete with special Kenyon Octal Socket.

AGAIN WE SCOOP!

A brand new filament transformer featuring the now famous voltage dropping compensator which insures longer tube life. Designed especially for the high performing **TAYLOR T-40, TZ40 TUBES**

Primary tapped to give the following secondary voltages: 7.5, 7.7, 7.9 at 6 amp. Be sure you have a Taylor Manual giving complete dope on these tubes and Kenyon Transformers.

T-392 Amateur Net Price \$2.55

KENYON LEADERSHIP RESTS ON VALUE

Compare Kenyon Quality and Kenyon Prices

CATHODE MODULATION TRANSFORMERS

Type	Max. Sec. D.C.	Audio Tubes	Case Size	Net Price
T-471	200 M.A.	SINGLE 6F6	2 A	\$2.40
T-472	300 M.A.	PP 6V6's or 8A3's	3 A	3.00
T-473	450 M.A.	PP 6L6's — AB1 or AB2	4 A	3.60
T-474	500 M.A.	Universal (120 Watts of ALDIO)	6 A	7.20

KEN-O-TAP UNIVERSAL MODULATION TRANSFORMERS

T-489	15 watts audio	3 A	\$ 2.40
T-493	40 watts audio	4 A	3.60
T-494	75 watts audio	5 A	5.40
T-495	125 watts audio	7 A	12.00

SPECIAL AMATEUR PLATE TRANSFORMERS

	D.C. Volts	D.C. MA.		
T-668	500/1750	300	5 1/2 A	\$ 5.85
T-669	1000/1250	300	7 A	9.60
T-670	1500/1750/2000	300	8 A	12.90
T-671	1000/1250	300	8 A	12.90
T-672	1000/1250/1500	300	8 A	11.85

FREE Amplifier Bulletin including impedance chart for Cathode Modulation. Send for latest dope on Kenyon Amplifier Kits.



KENYON TRANSFORMER CO., Inc.

840 BARRY STREET

NEW YORK, N. Y.

OFFICES IN PRINCIPAL CITIES

Cleveland . . . 3292 Cedarbrook Rd.
Chicago . . . 21 E. Van Buren St.
Kansas City, Mo. . . 2004 Grand Ave.

Seattle . . . 2605 Second Ave.
Los Angeles . . . 2412 7th St., W.
Dallas . . . P. O. Box 4116, Sta. A

New Orleans . . . 618 Girard St.
Lutz, Florida . . .
Richmond, Va. . . 3106 Edgewood Ave.

JOHNSON

Tube Sockets

Are Recognized Everywhere For Their Superiority

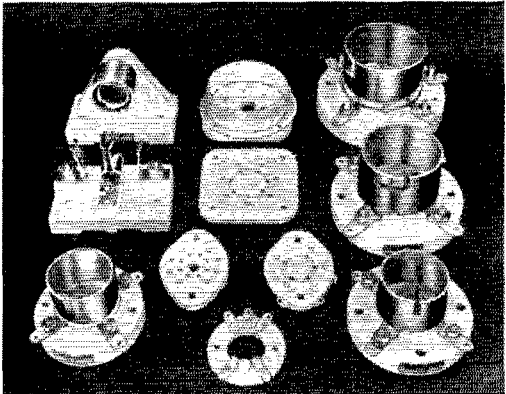

WANT TO KNOW WHY?

Notice the exacting care with which each detail of this No. 225 Socket has been designed to give you better service — and better performance:

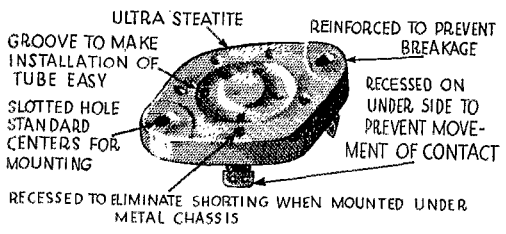

You hear only that thousands upon thousands of JOHNSON Sockets have been used by the U. S. Government, large manufacturers and discriminating amateurs. But back of that (and the reason for it) is the meticulous care with which JOHNSON constantly tests, experiments and improves upon each little detail to give you a better product.

In addition to the sockets above shown and so well known, watch for the new No. 213 Socket to fit the new EIMAC tubes and the new No. 214 Socket with air jet (also for EIMAC tubes).



At your jobber's or write for Catalog 966J

E. F. JOHNSON CO.

WASECA, MINNESOTA
 EXPORT: 25 WARREN ST., NEW YORK, N. Y.
 MANUFACTURERS OF RADIO TRANSMITTING EQUIPMENT

W3FJU	33276-59-282-	B-26	W3BIL	42- 3- 7- B- 1
W3DPU	32340-44-296-	A-30	W3EBP ¹	15- 3- 3- A- -
W3CRW	31875-51-250-	A-39	<i>Mid-Del.-D. C.</i>	
W3BXD	30961-61-262-	B-32	W3DUK	95445-63-609- A-40
W3ADE	30120-60-251-	B-36	W3GZH	58780-61-387- A-40
W3HXA	30015-46-261-	A-40	W3FQZ	65880-51-395- A-40
W3ENH	28560-43-241-	A-38	W3BKZ	44368-59-378- B-36
W3GYX	27560-52-276-	B-40	W3CIQ	43820-56-314- A-34
W3EFH	27370-46-240-	A- -	W3FSP	42798-53-323- A-39
W3RR	26950-44-245-	A-25	W3DPA	40095-44-378- A-35
W3GYV	26908-45-237-	A-39	W3HQU	38400-52-280- A-40
W3HLM	26400-40-265-	A-35	W3GYQ	2777-741-271- A-35
W3ARK	26018-43-275-	B-38	W3BTQ	26381-63-203- A-21
W3HRD	25520-44-233-	A-40	W3DRD	28765-53-202- A-21
W3HHK	25478-43-238-	A-32	W3HC	20875-50-169- A-32
W3BIP	22932-49-234-	B-34	W3HEC	20641-49-169- A- -
W3FHD	20138-45-180-	A-29	W3HUM	15892-39-163- A-15
W3BHP	18460-52-175-	B-21	W3HCO	14014-49-143- B-23
W3NF	18096-48-189-	B-21	W3EUF	11054-37-120- A-11
W3HCH	17850-34-210-	A-25	W3GBB	11050-40-113- A-19
W3HZK	17779-33-216-	A-39	W3CDG	11000-40-110- A-22
W3HAC	17470-37-195-	A-37	W3HQX	10585-29-148- A-30
W3EUC	15800-40-200-	B-36	W3HTK	8973-37- 97- A-27
W3GSS	15470-41-152-	A-24	W3FNI	8710-26-134- A-18
W3HTF	14535-36-170-	A-27	W3FDJ	5887-29-100- B-21
W3ICK	14250-40-145-	A-29	W3MHM	3478-33- 74-AB-23
W3CHU	13770-36-153-	A-19	W3HTW	2403-27- 45- B- 8
W3FXZ	13170-47-194-AB-	-	W3HUP	1903-15- 51- A-11
W3FTQ	12600-42-120-	A-26	W3ER	1197-19- 32- B-12
W3DDX	11857-41-140-	B-28	W3GKP	880-11- 32- A- 5
W3HFO	11395-36-127-	A-18	W3FE	675-15- 19- A-11
W3HNQ	10493-34-127-	A-19	W3EYX	480-12- 22- B- 6
W3HTM	10238-30-138-	A-37	W3HEQ	160- 8- 10- - -
W3GXQ	9820-37-105-	A-23	W3HBE	34- 3- 5- A- 1
W3CSN	8938-30-114-	A- -	W3AQV	23- 3- 3- A- 4
W3OML	8640-27-128-	A-19	W3HLQ	3- 1- 1- A- 1
W3FQA	8603-31-111-	A-21	W3WU	----- 38- - -
W3IAY	8404-27-126-	A-27	<i>Phone</i>	
W3JN	8151-39-107-	B-13	W3DQ	31124-62-252- B-38
W3GLX	7285-31-118-	- -	W3HEC	543-14- 16- A- -
W3CWO	6840-24-115-	A-26	W3HBE	324- 6- 28- B- 6
W3AKB	6583-31- 85-	A-10		
W3HHS	5500-22-100-	A-23	<i>So. New Jersey</i>	
W3EEW	5425-28- 79-	A- 7	W3EDP	31375-62-525- A-39
W3ALB	5220-29- 72-	A- 5	W3HEH	32987-54-401- A-40
W3DRJ	4859-23- 85-	A- 8	W3CBR	42903-51-332- A-38
W3CDY	4169-23- 74-	A-34	W3HGS	35338-47-305- A-38
W3LAP	3978-26- 77-	B-25	W3HPE	32130-51-252- A-39
W3GEW	3930-24- 66-	A-12	W3HTP	12357-42-119- A-16
W3BIL	2546-19- 68-	B- 8	W3FTB	12250-28-179- A-34
W3HRS	2448-24- 51-	B- 8	W3FTH	11385-33-138- A-32
W3GV	2000-20- 50-	B-12	W3HGO	10880-32-136- A-28
W3CWU	1870-17- 44-	A- 5	W3DEA	10878-37-147- B-32
W3GYL	938-15- 25-	A-12	W3AKT	10783-41-132- B-29
W3GKR	875-25- 14-	A- 3	W3AWH	8050-40- 81- A-13
W3EBP	689-13- 27-	B- 6	W3EYH	6580-28- 94- A-19
W3IEG	638-11- 29-	A- 8	W3DNU	3650-20- 71- A-12
W3SNZ	162- 9- 9-	B- 3	W3SJ	3098-21- 59- A-12
W3HFE*	130- 6- 8-	A- -	W3GSR	2703-23- 48- A- 8
W3ILK	10- 1- 4-	A- -	W3FCR	2200-20- 44- A- 9
			W3HAZ	2112-22- 49- B- 9
<i>Phone</i>			W3GUS	1538-15- 41- A- 7
W3DRQ	5925-30- 79-	A-22	W3EWK	1380-18- 60- A-14
W3FFG	5040-30- 84-	B-36	W3HDW	956- 9- 44- A-11
W3BET	4794-34- 71-	B-12	W3AEJ	788-16- 24- B- 5
W3AGE	1320-22- 30-	B-15	W3HWO	490-14- 19- B- 7
W3GSX	660-16- 18-	A- 8	W3GCU	370- 9- 12- A- 3
W3BRZ	448-14- 16-	B- 8	W3GHR	240- 8- 12- A- 3
W3GUF	330-11- 16-	B- -	W3FIS	96- 6- 8- B- 1
W3FPC	330-11- 18-	B- 4	W3HYF*	63- 5- 5- A- 2
W3HRA	100- 4- 10-	A-10		

(Continued on next left-hand page)

¹ Two ops. ² Two ops., W3TXX, W3TOE. ³ Two ops., W3RAP, W3RVL. ⁴ Three ops., W3GLU, W3NQP, W3MUX. ⁵ Central Illinois Amateur Radio Club, seven ops., W3GEO, W3ODX, W3UQT, W3BPV, W3EAF, W3LKN, W3MRT. ⁶ Two ops., W3UIN, W3BUK. ⁷ Starved Rock Radio Club, W3QLZ opr. ⁸ Purdue Amateur Radio Club, score of opr. W3QYX; combined score of opr. W3QYX and W3ITW, C. 35930. ⁹ W3AWX opr. ¹⁰ Three ops., W3QEL, W3BDB, W3GBX. ¹¹ W3BEA opr. ¹² Bucknell Univ. Radio Club, two ops., W2KCB and T. E. Hamner. ¹³ Ohio State Radio Club, W3LOF opr. ¹⁴ Three ops., W3UW, W3CZR, W3GE. ¹⁵ W3ZBP opr. ¹⁶ W3GCG opr. ¹⁷ Dan Boone, opr. ¹⁸ Seven ops., W3CBU, W3FNV, W3EXK, W3ADL, W3EFA, W3DUS, W3GCE. ¹⁹ Score of opr. W3KJ, opr. W3ML, 5175. ²⁰ W3HG opr. ²¹ W3ZBZ opr. ²² W3LVP opr. ²³ W3SCW opr. ²⁴ Score of opr. W4FWW; station score including ops. W3RCQ, W3EKY and W3KBE, 35841. ²⁵ Two ops., W3BNB, W3PJY. ²⁶ W3EFW opr. ²⁷ HQs staff members, not eligible for awards. ²⁸ Score of opr. Geo. Hart, opr. Hal Bubb 5120. ²⁹ Score of Opr. Hal Bubb; Opr. Geo. Hart 310. ³⁰ W3DIA opr. ³¹ Two ops., W3JFX, W3ICD. ³² Associated Radio Amateurs of Southern New England, six ops., W3ERJX, W3AOP, W3KWA, W3LAB, W3BOY, W3CPV. ³³ W3AHR opr. ³⁴ Beta Chapter, Rho Epsilon Frat., U. of Wash., three ops., W7LD 2704; W3EKP 475; W3EPL 280. ³⁵ Div. of N. C. Radio Club, four ops., W4DWB, W4FXU, W2HVO, W4FQV. ³⁶ W4EDA opr. ³⁷ Two ops., W3GAL, W3HAE. ³⁸ Two ops., W3MOE, W3QDC. ³⁹ Georgia Tech. Radio Club, five ops., W4DXI 8048, W4PET 5230, W2ESO 1600, W2KVV 480, W4RZS 360. ⁴⁰ W4ERD opr. ⁴¹ W4DEZ opr. ⁴² Three ops., W5ZG, W3ELG, W3EZA. ⁴³ Four ops., W5GDE, W5FYZ, W5GWX, W5IEM. ⁴⁴ W3GZO opr.

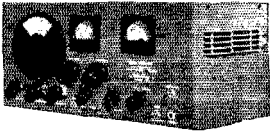

1

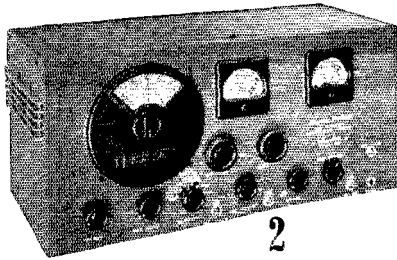

2

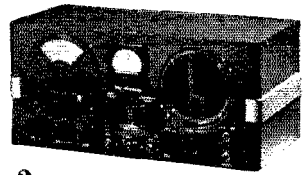

3

HENRY RADIO SHOP

BUTLER, MO.

SELLS EVERY RECEIVER MADE!

That means that YOU can benefit from my experience. Handling every model receiver, all makes, enables me to study and operate them all. I gladly pass along the word about which one will best suit YOU. Ten-day free trial. Liberal trade-in for your set. Careful, prompt shipment.



CASH AND TIME PAYMENT PRICES:

(I finance "time" purchases personally)

Model	Cash Price	Down Payment	12 Monthly Payments
1. SX-25	\$ 99.50	\$19.90	\$7.03
2. SX-24	69.50	13.90	4.90
3. S-20R	49.50	9.90	3.49
4. RME-70	138.60	27.72	9.79
5. HQ-120X	138.00	27.60	9.75
6. Super Pro	279.00	55.80	19.71
7. HRO Sr.	179.70	35.94	12.70
8. NC-101XA	129.00	25.80	9.11
9. RCA AR-77	139.50	27.90	9.85
10. Howard 435	29.95	5.99	2.12



A receiver, like a car, is something that has to be adaptable to your personal needs and inclinations. I want to see that you get the right one. Write me fully: tell me all about yourself and your operating problems — and I will help you choose the receiver best suited to your personal desires.

Bob Henry
W9ARA

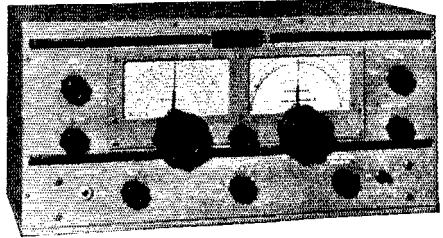

4

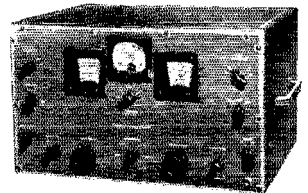

5

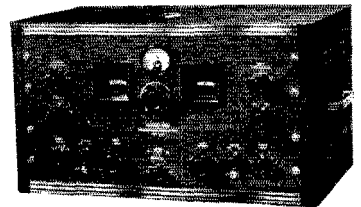

6

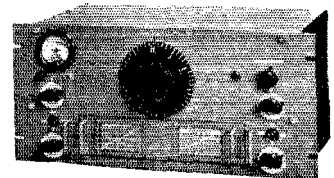

7

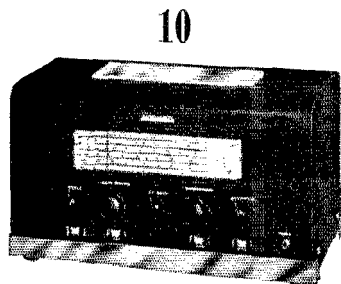

10

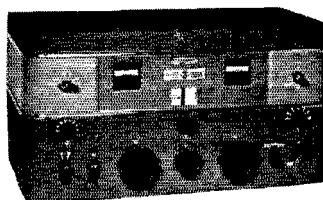

9

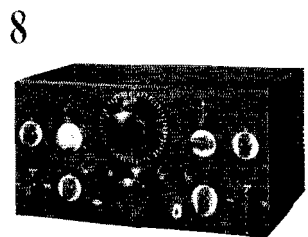

8

AN ORCHID TO W3LE

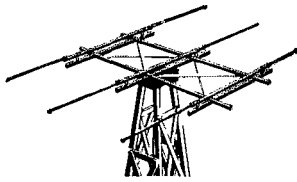

38 ZONES — 115 COUNTRIES

What a record for the winner in the Phone Section of "Radio's" 1939 DX Marathon! That's some accomplishment, even with the Premax Six-Element Array that Lou Bremer is using in Baltimore, Md.

If you would know more about Premax Elements for beams and verticals, ask your jobber for Technical Handbook H-3, containing over 30 proven hookups. If your jobber does not have it, write direct — **IT'S FREE!**

PREMAX PRODUCTS

Division Chisholm-Ryder Co., Inc.

4020 HIGHLAND AVE. NIAGARA FALLS, N. Y.

Piezo-Electric Crystals Exclusively

Quality crystals of all practical frequencies supplied SINCE 1925. Prices quoted upon receipt of your specifications.

Our Pledge: **QUALITY FIRST**
SCIENTIFIC RADIO SERVICE

"The Crystal Specialists Since 1925" University Park, Hyattsville, Md.

LEARN TO SEND AND RECEIVE CODE

Learn to send and receive code signals, like operators on ships at sea and at commercial and amateur land stations. Intercept distress signals, news flashes, bulletins, and dozens of other kinds of interesting radio communications.

MASTER TELEPLEX teaches you to receive code exactly the way the world's best operators do — by sound. A heavy waxed paper tape, running through a machine, operates an automatic key which sends messages to you, at any speed you desire. As you improve in speed, the machine sends faster, gradually preparing you for top-speed amateur and commercial signals. With the new **All Electric MASTER TELEPLEX** you learn to send by sending and the signals you send are repeated back to you, exactly as you sent them, thus enabling you to correct your own errors. We furnish a complete course, lend you the improved All Electric **MASTER TELEPLEX** and give you personal instruction with a **MONEY BACK GUARANTEE**. Send for our new **TELEPLEX FOLDER Q5 TODAY**. **IT'S FREE.**

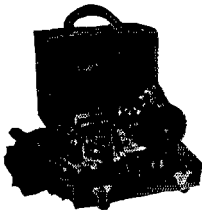

"HAM" SPECIAL
TELEPLEX CO., 67-69 Park Place, N. Y.
In Canada, Write
Canadian Electronic Institute, Toronto, Ontario

Phone			
W3HDJ	17690-58-153	B-34	
W3BEI	4416-32-60	B-20	
W3FIS	3660-30-61	A-5	
W3FMR	3190-29-55	B-12	
W3ASW	1522-21-20	A-13	
W3AEJ	54-3-9	B-4	
W3AIR	10-1-4	A-1	
W. New York			
W8DOD	82240-64-519	A-40	
W8JTT	58725-58-406	A-39	
W8DZC	50680-56-362	A-39	
W8ADV	18675-55-354	A-38	
W8QCH	43304-49-355	A-40	
W8SBV	41310-54-306	A-40	
W8KAU	31320-58-216	A-30	
W8CZB	25542-54-238	B-37	
W8BJH	20436-52-202	B-34	
W8BJO	19776-48-206	B-31	
W8ETH	18352-49-191	B-33	
W8MVQ	14456-45-130	A-34	
W8QQB	14190-33-173	A-23	
W8SEI	12920-38-138	A-22	
W8FYH	11588-30-156	A-25	
W8QMK	10815-35-156	B-19	
W8QZP	10128-48-107	B-20	
W8OCP	8540-28-156	B-10	
W8NPN	7210-28-103	A-17	
W8TNP	6041-27-90	B-21	
W8CSK	5400-30-90	B-13	
W8TXB*	5280-30-80	B-28	
W8PVG	5115-31-66	A-19	
W8TUQ	4505-34-54	A-14	
W8LGU	4500-18-50	A-10	
W8DHU	4313-23-75	A-12	
W8OCQ	4278-31-69	B-12	
W8KJL	3000-24-50	A-16	
W8AQE	2964-19-78	B-	
W8NVG	2875-19-50	A-10	
W8SWB	2120-16-55	A-17	
W8NOU	2100-20-42	A-5	
W8KEL	1864-13-72	B-	
W8TXL	1470-21-28	A-9	
W8SVC*	1375-20-55	A-16	
W8MNV	1350-19-28	A-8	
W8OCY	1296-17-31	A-18	
W8AOR	1294-15-35	A-10	
W8TOH	1268-14-26	A-5	
W8SZG	1257-19-31	A-23	
W8JQE	900-16-20	A-9	
W8BLE	585-12-20	A-10	
W8TC*	374-11-17	---	
W8DTY*	84-6-7	---	
W8DHQ*	72-6-6	---	
W8BCN	3-1-1	A-2	
Phone			
W8ATH	19494-57-171	B-38	
W8ACY	4192-33-62	B-10	
W8GWP	938-15-25	A-8	
W. Pennsylvania			
W9YXD	858520-56-419	A-40	
W8NCJ	55225-58-385	A-40	
W8MJF	44550-55-324	A-44	
W8SFY	38250-60-256	A-40	
W8AQT*	27440-56-196	A-	
W8YH	26082-54-242	B-40	
W8QCM	21178-43-197	A-35	
W8IQE	19220-62-155	B-25	
W8RAP*	15631-41-160	A-40	
W8OLI	14746-37-163	A-19	
W8SNA	14228-30-193	A-38	
W8QES	13065-44-150	B-13	
W8NUR	11506-35-132	A-33	
W8RIT	9072-36-126	B-16	
W8SJA	8100-30-109	A-15	
W8JSU*	7905-24-93	A-11	
W8JMP	7392-42-88	B-	
W8ZU	7013-24-83	A-40	
W8RNH	3590-20-81	A-27	
W8TWT	4253-21-81	A-32	
W8TOJ	3975-30-53	A-32	
W8RWJ	3053-22-56	A-10	
W8TIG	2720-21-53	A-14	
W8NWX	2688-24-56	B-22	
W8SYR	2600-25-52	B-15	
W8NRB*	2484-23-54	B-13	
W8NSY	480-12-16	A-	
W8WIR	63-5-5	A-	
W8RTU	56-3-8	A-	
W8RHD*	2-1-1	---	
W8TFI*	---	52	---
W8GYR*	---	50	---
W8SWX*	---	26	---
W8NRE*	---	7	---
Phone			
W8KBJ	1320-22-32	B-5	
W8RBJ*	882-18-26	B-4	
W8SWK*	300-10-12	A-	
W8HMJ	140-7-8	A-2	
W8RWV*	---	8	---
CENTRAL DIVISION			
Illinois			
W9VES	83554-63-531	A-40	
W9VFT	78700-60-527	A-35	
W9UTB	67135-58-466	A-40	
W9YFV	63240-60-535	B-40	
W9THT	62220-61-408	A-39	
W9GJY	62000-62-400	A-40	
W9WFS	59188-56-439	A-36	
W9ERU	53238-57-467	B-40	
W9ZMG	53000-53-401	A-35	
W9YQE	52510-59-455	B-38	
W9NST	52500-60-385	A-33	
W9MGN	47250-60-316	A-40	
W9PNE	46328-58-323	A-37	
W9A0B	46207-61-306	A-38	
W9TGE	42863-54-318	A-31	
W9MIN	40745-58-281	A-25	
W9NQL	38285-52-297	A-40	
W9TQL	34581-55-256	A-39	
W9WEN	33438-50-368	A-40	
W9UAI	33060-48-276	A-40	
W9VOQ	31725-54-235	A-13	
W9TOT	26365-51-261	B-34	
W9TKN	26325-52-203	A-34	
W9ICO	26123-54-197	A-30	
W9WQB	25850-47-220	A-	
W9YTV	25683-50-208	A-36	
W9MUX	24745-49-203	A-18	
W9WZ	23690-46-206	A-20	
W9ZFP	23363-46-257	B-34	
W9NRB	22800-60-195	B-31	
W9GLU*	22125-50-177	A-19	
W9KXZ	22100-50-222	B-37	
W9NGG	18400-46-160	A-31	
W9IML	17640-51-174	B-31	
W9CKA	17545-55-161	B-36	
W9NFL	17213-45-153	A-18	
W9EUL	15910-45-142	A-19	
W9DBO	15494-37-168	A-37	
W9CMT	15000-40-150	A-20	
W9FAB	15000-50-120	A-20	
W9UQT*	14820-39-152	A-25	
W9AGM	14370-47-124	A-23	
W9LIL	13344-46-139	B-28	
W9EBX	12771-43-149	B-23	
W9YVD	12714-39-163	B-34	
W9EFA	12500-40-128	A-34	
W9YTS	11750-40-118	A-21	
W9EPL	11739-43-137	B-34	
W9LW	11400-40-118	A-31	
W9TCK	11295-36-127	A-35	
W9TGH	10836-35-125	A-27	
W9TJH	10627-39-109	A-25	
W9TTH	10410-34-121	A-33	
W9TTI	10105-43-95	A-23	
W9ZEM	10038-42-123	B-29	
W9QJG	9281-33-113	A-14	
W9BDX	9102-41-111	B-14	
W9DMP	8750-35-100	A-21	
W9BWW	8619-39-111	B-35	
W9RTA	8198-34-120	B-27	
W9NGA	8092-31-105	A-22	
W9YDQ	8000-32-100	A-24	

(Continued on next left-hand page)



Why Wait?

Enjoy that new receiver **NOW** . . . get that kit you've wanted . . . parts you need — *everything* on my

Step out on 112 Mc with the NEW TR-112 TRANS- MITTER- RECEIVER

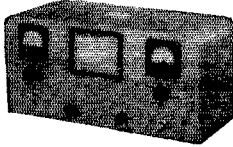

10 Watt Output

RECEIVER: 6J5GT-X, 6J5, 4I, Meter type dial. Built-in PM dynamic speaker, Phone jack.
TRANSMITTER: 6E6 (or RK-34 optional) short lines oscillator. Modulated 100%, by class AB 6V6 with 6V6 speech amplifier.

All compactly and efficiently contained in a rugged steel cabinet 7" x 7" x 15". Modern grey finish.

RTL TR-112. Ready for operation, less **\$39.75** tubes and power. Net

COMPLETE SET OF TUBES **\$4.76**
(With RK-34, \$7.20)

Power requirements: 6.3 volts at 3 amps, AC or DC. 300 to 400 volts at 100 to 200 ma.

RTL Pack. For complete 110 volt AC operation. . . **\$11.50**

Electronic heavy duty pack for 6-volt battery or 110-volt AC supply. Output 400 volts at 200 ma. With tube, **\$19.74**

BUY IT on the HARRISON EASY PAYMENT PLAN!
10% down, 6% carrying charge on balance

EASIER PAYMENT PLAN!

10% down, 6% carrying charge on balance, a year to pay! You figure the terms to your own convenience. Make up your order from this page or **any catalog**. Send it to me with your down payment — and I'll do the rest, **quickly!**

73,
Bill Harrison, W2AVA

MILLEN PRODUCTS "Designed for Application"

Here are just a few of the popular and new MILLEN "Modern Parts for Modern Circuits." — Many more in the big free catalog. *Send for it today!*

*New "12000" series of compact transmitting condensers. Isolantite bars, extra heavy (.040") aluminum plates with rounded and polished edges (plain edge at lower price), steatite stand-offs, rugged construction. .070" air gap.

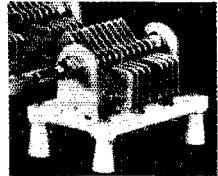

● You can test *everything* in the shack with this new "DEPENDABLE" meter!



●
2000
ohms per
volt
●
DC and AC
●
4½" meter
●
Linear
AC scale
●

READS: .1 to 5,000 volts, DC and AC — 200 microamp. to 25 amp. DC — .0001 to 300 mfd — .05 ohm to 15 megohm — 250 microhenry to 10,000 henry.

Dependable in Performance as Well as Name!

Model 414. Open face hardwood cabinet.

9¼" x 9¼" x 5¼" Net. **\$21.50**

Model 414P. Hardwood case with hinged cover, as illustrated. Net. **\$23.95**

BUY IT ON THE HARRISON EASY PAYMENT PLAN!
10% down, 6% carrying charge on balance

Code	Cap. Per Section		Net Price
	Min.	Max.	
12035	6	43	\$3.60
12050	7	55	4.25
12075	9	76	5.50

SINGLE SECTIONS (With plain edge plates)

12536	6	43	\$2.00
12551	7	55	2.25
12576	9	76	2.50
12510	12	101	3.00
12515	18	151	3.75

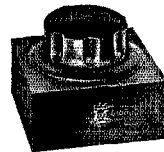

MILLEN HETROFIL — The adjustable audio filter that solves most QRM problems. **\$3.50**

HARRISON HAS IT! Complete stock of MILLEN condensers, sockets, dials, insulators, etc., for immediate delivery.

HARRISON HAS IT!

Everything you need (when you want it!) — prompt delivery of phone and mail orders — friendly assistance — and prices no higher than the very lowest! See for yourself!

HARRISON RADIO CO.

12 WEST BROADWAY • NEW YORK CITY

WOrth 2-6276

RADIO TRAINING



PORT ARTHUR COLLEGE — not privately owned, not operated for profit, a college built and endowed by the late capitalist-philanthropist, John W. Gates — offers the most thorough practical Radio training in America. P. A. C. owns Radio Station KPAC, which is equipped with the very latest type 1000-Watt high fidelity RCA transmitter, operating on 1220 kc. with directional antenna system. The college is authorized to teach RCA texts. Additional equipment consists of the latest type Marine and Airways Transmitter installation complete; SOS Automatic Alarm; Marine Direction Finder, two-way Television Transmitter and Receiver; Trans-radio Press Receiving Equipment; laboratory facilities where every phase of practical radio assembly technique is taught. Students assemble composite transmitters, amplifiers, audio amplifiers, RF amplifiers, etc. The Radio training covers thoroughly Airways, Press, Announcing, Teletype, Typewriting, Laboratory and practical experience at KPAC transmitter, control room and studios. Announcing is an optional part of this training; nevertheless a number of students annually make successful announcers.

Port Arthur College pioneered the teaching of radio with its first classes in 1909, and for thirty-one years has maintained an active Employment Bureau that is successful in placing graduates in airways, broadcast and marine radio industries.

If interested in details about the Radio Course, write for Bulletin R

PORT ARTHUR COLLEGE
PORT ARTHUR (World-Known Port)
TEXAS

PRECISION CRYSTALS

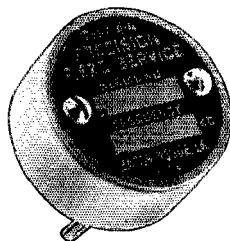

Highest quality crystals carefully prepared for dependable performance.

Low frequency drift Type 4-A unit plugs into tube socket, 40, 80 or 160 meter bands, within 5 kc. of your specified frequency — \$4.00. Calibration 0.03%.

X cut in Type 4 holder — \$3.50.

Crystals for commercial requirements quoted on at your request. Now in our Tenth year of business.

PRECISION PIEZO SERVICE

427 Asia Street Baton Rouge, La.

W9ZOG	7613-30-102-	A-12	Kentucky	99583-61-653-	A-40
W9BWN	7156-25-115-	A-26	W9FS	39555-54-204-	A-39
W9D GK	6698-38-71-	A-22	W9ZWR	36899-59-311-	B-32
W9NIU	6588-33-83-	A-33	W9THS	14550-40-146-	A-33
W9PNB	6496-32-102-	B-31	W9GJO	3272-22-60-	A-10
W9ODX	6480-36-72-	A- -	W9IFM	2501-23-44-	A-17
W9OBW	6338-30-86-	A-20	W9NYW	1587-19-33-	A- 7
W9T WL	6075-27-90-	A-28	W9YGR	885-12-30-	A- 8
W9NMY	5985-28-87-	A-20	W9JIT	270- 9-12-	A- 6
W9RBR	5929-27-88-	A-18	W9ZKW	45- 4- 5-	A- -
W9TLC	5329-20-74-	A-14	W9ZLF	-----103-	-----
W9KZY	5326-30-71-	A- 9	W9PYH*	-----51-	-----
W9QKL	4930-17-116-	A-15			
W9D WQ	4128-26-66-	A-10			
W9FAQ	4125-21-81-	A-33			
W9QAZ	3990-24-67-	A-36			
W9UXO	3990-30-67-	B-12			
W9FXW	3920-35-56-	B-10			
W9TZQ	3920-28-71-	B-11			
W9KWU	3738-26-60-	A-14			
W9EPW	3623-21-71-	A- -			
W9QBA	3375-27-51-	A-12			
W9VQE	3256-22-56-	A- 7			
W9ASF	3107-22-58-	A-25			
W9TAL	3000-20-60-	A-10			
W9END	2875-25-46-	A- 7			
W9TNZ	2550-24-43-	A-15			
W9MRK	2331-21-56-	B- -			
W9VGG	2236-26-43-	B- 7			
W9RFJ	2200-20-44-	A-13			
W9N VW	1876-19-40-	A-12			
W9DXL	1573-17-37-	A- 8			
W9VLT	1120-14-33-	A- 9			
W9AGV	1070-18-27-	A-11			
W9CEO	882-14-31-	B- -			
W9ECD	840-14-25-	A- 5			
W9CZS	680-20-14-	A- 6			
W9HQH*	680-17-20-	B- 2			
W9BIN	495-11-18-	A- 8			
W9CHD	360- 9-16-	A- -			
W9JVC	240- 8-12-	A- 1			
W9D SO*	240-10-12-	B- 2			
W9ZSS	225- 8-13-	A- 2			
W9ARN	160- 8-10-	B- -			
W9UIN*	113- 5- 9-	A- 2			
W9UN	110- 4-11-	A- 5			
W9N	84- 6- 7-	B- 4			
W9IN Y	68- 5- 6-	A- 2			
W9QLZ	53- 3- 7-	A- 4			
W9BAV	30- 3- 4-	A- 4			
W9AKV	2- 1- 1-	B- -			
W9GGG*	-----55-	-----			

Phone					
W9YQN	31000-62-250-	B-40			
W9THS	1250-20-26-	A- -			
W9HRP	15- 2- 3-	A- 7			

Michigan					
W8QDU	58528-59-496-	B-35			
W8RMH	58072-58-401-	A-39			
W8OQF	54312-62-439-	B-40			
W8BCV	53863-61-444-	B-40			
W8BWC	35092-63-285-	B-33			
W8EUD	28470-52-220-	A-35			
W8SCW	25168-52-243-	B-38			
W8DQA	23230-52-171-	A-35			
W8NDC	21560-55-198-	B-25			
W8JVI	19448-44-228-	B-24			
W8LFT	19372-58-167-	B-30			
W8QIZ	13973-43-179-	A-30			
W8OUP	17453-39-170-	A-32			
W9AEW/8	16380-50-117-	A-40			
W8KPL	10950-40-110-	A-23			
W9AAO	10158-43- 95-	A-26			
W8SQQ	8850-30-121-	A-39			
W8RRW	7286-29-107-	A-35			
W8DDJ	6750-40- 68-	A-24			
W8LEC	6018-48- 63-	B- -			
W9VJD	5472-32- 86-	B-15			
W8OAF	5184-32- 83-	B-24			
W8NUV	5180-32- 63-	A-11			
W8SZW	4582-26-71-	A-26			
W8SNM	4500-24-77-	A-13			
W8RXY	4174-21-89-	A- 7			
W8QFH*	4000-32- 64-	B-15			
W8TNN	3610-32-49-	A-17			
W8EGI	3395-28-49-	A-13			
W8ROF	2185-19-47-	A-22			
W8PVI	1608-12-63-	B-12			
W8TCY	1590-20-32-	A- 9			
W8FTW	1292-17-38-	B- 3			
W8SWA	1240-16-31-	A- 8			
W8DM	986-17-29-	B- 6			
W8DBS	713-15-19-	A- -			
W8TVK	595-14-17-	A-14			
W8TLL	540-12-19-	A- 6			
W8XLB	435-12-15-	A- 4			
W8HAN	425-10-18-	A-13			
W8QHA	250-10-10-	A- 7			
W8TM*	36- 6- 6-	B- -			
W8PUP*	-----12-	-----			
W8MQT*	----- 2-	-----			

Phone					
W8JAH	17934-61-147-	B-32			
W8EMP	9246-46-102-	B-40			
W8NNT	7172-44- 82-	B-16			
W8DOO	920-20-23-	B- 8			
W8RXY	200- 8-10-	A- -			
W8QZY	126- 7- 9-	B- -			
W8CUP	30- 3- 4-	A- -			
W8MQT*	-----35-	-----			

Indiana					
W9UM	50589-63-404-	B-38			
W9UYB	40875-80-327-	A-38			
W9KBL	36401-51-288-	A-40			
W9ENH	32640-51-256-	A-35			
W9HUV	29000-50-177-	A-24			
W9AET	21019-69-143-	A-20			
W9YB*	19598-48-215-	B-26			
W8HEY/9	19253-51-151-	A-31			
W9CNG	14060-37-152-	A-30			
W9AMM	11546-46-126-	B-26			
W9EJA*	9840-40-129-	B-36			
W9WCE	5916-34- 87-	B-11			
W9CKP	1850-22-31-	A-12			
W9ZYK	1428-21-34-	A- -			
W9AB	1395-18-31-	A- 4			
W9NVA	840-14-24-	A- 6			
W9EUP	468-11-17-	A- 6			
W9QLW	245- 7-14-	A- 5			
Phone					
W9UTL	4770-30- 81-	B-23			
W9WVK	3564-33- 54-	B-12			
W9DJJ	120- 6-10-	B- -			
W9HFB	84- 6- 7-	B- 1			
W9GWL*	42- 3- 7-	B- -			

Ohio					
W8OFN	96798-62-626-	A-40			
W8JIN	76425-60-512-	A-39			
W8NLQ	76125-58-525-	A-40			
W8HCW	63425-59-430-	A-35			
W8SMC	49518-58-355-	A-40			
W8OYI	45500-56-325-	A-38			
W8ROX	38037-47-320-	A-40			
W8NOE	29700-54-277-	B-24			
W8RSP	27948-51-282-	B-30			
W8SJJ	26244-54-246-	B-33			
W8MOA	24224-52-274-	AB-40			
W8DAE	23940-48-200-	A-28			
W8QED	23836-59-202-	B-19			
W8NHO	23600-46-207-	A-38			
W8TDN	22027-53-184-	B-35			
W8REN	21000-40-217-	A-39			
W8BXM	18720-62-180-	B-33			
W8IEH	18681-49-153-	A-24			
W8ORM	18585-36-207-	A-33			
W8EUI	15570-47-125-	A-19			
W8LVK	15180-46-165-	B-22			
W8QKQ	13110-38-138-	A-39			
W8SUY	12870-33-156-	A-31			
W8QXM	12642-49-130-	B-17			

(Continued on page 106)

Would YOU spend five minutes on the improvement of your station?

Naturally, every wide-awake amateur is always looking toward obtaining better equipment. You are to be especially congratulated, however, that your interest has led you to read about these three outstanding instruments. Five minutes will suffice to tell you about them and the rest is up to you.

When you buy new equipment, your first considerations should be Quality and Performance — see that it provides what you want — and then look at the price tag. These Meissner instruments will not become obsolete — they will always be vital parts of your station equipment, no matter how much you expand in the future. They are your guarantee of success in this grand game.

MEISSNER SIGNAL SHIFTER

Since its introduction two years ago, the Signal Shifter has become the standard unit for reliable ECO operation. Over 1200 units sold to discriminating amateurs. Provides remote frequency control with crystal quality and stability. Self-powered, voltage-regulated, temperature-compensated, ceramic-insulated, precision-tuned — full scale coverage on any band. Especially designed for either CW or Phone operation; built-in keying filter. Complete, ready to operate, except tubes, only **\$44.95** Net.

MEISSNER SIGNAL BOOSTER

A new instrument that has proven its merit in a short time. Used ahead of any receiver, the full frequency coverage of 1600 to 31,000 kc with a gain of 40 DB insures maximum sensitivity on any band. Illegible or inaudible signals are brought up to clearly-readable volume and clarity. Provides two stages of super-gain RF amplification using 1852's. Large linear-scale dial, four bands. Completely self-powered; assembled, aligned and ready to operate, except tubes, only **\$38.25** Net.

MEISSNER MC 28-56 CONVERTER

For outstanding performance on the 5 and 10 meter bands, this versatile unit is unexcelled. Operates as a converter with an output frequency of 7 MC to be tuned in on any receiver. Arranged for use of separate high-frequency antennas, automatically switched as bands are changed. Three tuned circuits, high-gain tubes, precision-tuned with ceramic-insulated condenser. Voltage-regulated for maximum stability. Completely self-powered, assembled, ready to operate, except tubes, only **\$41.25** Net.

TIME PAYMENT PLAN

Any one of the instruments described above, as well as many other Meissner products, may be easily purchased on the Meissner Time Payment Plan. Ask your Parts Jobber for details or write direct to the address below.

WRITE FOR FREE CATALOG

Dozens of other products of interest to the progressive Amateur are described in the big 48-page Meissner catalog. Send for your free copy at once — just mail a postal card to Dept. Q-5, Meissner Mfg. Co., Mt. Carmel, Illinois.

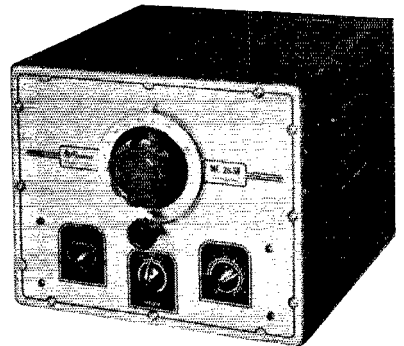
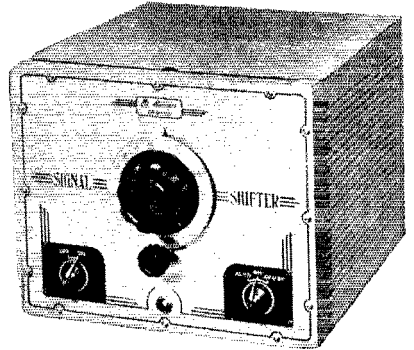

 *Meissner* MT. CARMEL ILLINOIS

"A FAMOUS NAME FOR TWO DECADES"

Station Activities

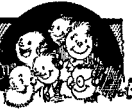

NEW ENGLAND DIVISION

CONNECTICUT — SCM, Frederick Ells, Jr., W1CTI — The following appointments have been made since the last report. O.R.S.: CCF, IKE, 8MYW/1; E. C. for Hartford: KDK; Regional E.C. for the Connecticut River Weather Bureau Net: CSC. AW, CCF and UE hit the B.P.L. In the A.A.R.S. speed contest, LVQ and UE made 45 w.p.m. rating. MHF joined A.A.R.S. ITI has been assigned WLQ. GB has the New Haven Club's new enclosed 3.5-Mc. rig on several nights a week, with different operators each night. ES is recovering from three months' illness and is back on the air. TD's new home-brewed 9-tube superhet perks very FB. The Manchester Radio Club will have a Field Day Round-up at the State Trade School, April 23rd. Admission 25¢ to defray refreshment expenses. The March 3rd and 4th ice storm should be a lesson to all of us. Although there was no communication emergency, some sections were without electric power 5 days. Get your emergency equipment ready now. Test it regularly and plan to take part in the A.R.R.L. Field Day this June. Would you like to see more space taken by the Connecticut Section on this page? Send in the dope.

Traffic: W1AW 654 (WLAK 6) CCF 554 UE 378 KKS 374 CTI 133 JXP 124 KFN 117 IKE 74 KYQ 65 TS 56 VB 49 BDI 33 CJD 32 MEC 31 MHF 28 KSJ 26 ES 14 LOC-LMK 12 TD 11 LQK 7 LZR 2 LVQ 27 8MYW/1 94.

MAINE — SCM, H. W. Castner, W1HIE — They're forming a fine radio club in Lewiston, with LYK taking the lead. I hear much activity between the C.C.C. Camps. KTT was on 1795-ke. c.w. with 125 watts to a T55 final, and received a letter from G6ZR with a fine report; this was at 6:00 p.m. Everyone enjoys the broadcasts from WGAN entitled "Two Hundred Meters and Down." These are really fine. Listen every Wednesday on WGAN, 640 ke., at 7:30 p.m. E.S.T. Don't fail to QSL the station with comments on the program. That new e.c.o. 3.9-Mc. 'phone of ATS sounds fine. The boys who meet on 3.9-Mc. 'phone at noon time sure are interesting. LHA is certainly going places; he never uses over 50 watts, and has worked all districts on 3.9-Mc. 'phone twice in one week and with a good report from K6OQE. Carl is new P.A.M. and R.M.L., and now on the Pine Tree Net. An old-timer is back with his original call. Welcome, Ray, FV. LNI and CRP are on 112 Mc. actively. IQZ is building a fine new rig. LWG has been on 7 Mc. A "G" ham listening in England writes GXY his 3.5-Mc. signals are FB over there. JCT has been transferred to Mass. VF is building a fine new shack. QH is building the rig over. IOQ is back on 7 Mc. HTZ has new modulator. ERO is on 3.5 and 7 Mc. MJR is new Bangor ham. PQ likes to rag-chew on 7 Mc. AID has new 28-Mc. rotary beam. BGQ is on 7 Mc. DLC has an e.c.o. with T20 final. LNY has new modulator. AKR likes 14-Mc. 'phone and c.w. GBV put a motor on his rotary beam. EBJ has a 35T on his 28-Mc. 'phone. AQL has been on 14-Mc. 'phone. UP rebuilt his crystal osc. LBX, AID, LEV, LVJ, HTZ and LNY have quite a time on 28-Mc. 'phone at night for local rag-chewing. DAS sounds fine with those HF100's in the final. DHD is using 812's in the final. AUC has a signal shifter and 812's in the final.AWN is heard on 3.9-Mc. 'phone. JUV has a nice 3.9-Mc. 'phone signal. LIP has been on 3.9-Mc. 'phone with 20 watts. MNI is new Calais ham with 70 watts on 1.75-Mc. 'phone. FIV is still rebuilding. LRP went skiing over on Mt. Mansfield, and took the left-handed bug and a 28-Mc. rig; they tell us he was a grand sight coming down the mountain with the key in one hand and the rig in the other! K8S is giving 3.5 Mc. a try. We are mighty glad to welcome CFO, KOU and the other A.A.R.S. boys as League members. LWG has been trying 7 Mc. for a while. We hear MDG on 3.5 Mc. OR is quite active on 3.9-Mc. 'phone. MLP is on at East Boothbay as the first ham there, we believe. There are several Official Broadcasting Stations in Maine, and the messages are most interesting: IIE 3597 kc. 6:30 p.m. week nights; INW 3750 kc. at 8:30 p.m. Mon. and Wed. and 3597 kc. Fri. 8:30 p.m.; VF 3564 kc. 1:00 p.m. Mon. and Fri. and 7128 kc. Sat. 1:00 p.m.; IQZ 3596 kc. 8:30 p.m. Mon., Tues., Wed. and Thurs., 10:30 p.m. Fri., and 7:00 p.m. Sat. and Sun.; LHA 7008 kc.

12:15 p.m. Mon., Tues., Wed., 7236 kc. at 5:30 p.m. Thurs., Fri. and Sat., and 7236, 3618, 3961 kc. beginning at 3:30 p.m. on 7236 kc. Sun. BWS is visiting APZ; Bob used to live in Lewiston but is now with R.C.A. in Caracas, Venezuela. LCV has been transferred to Maine A.A.R.S. Welcome, Irving. BTA has been called to active duty at a Naval Radio station. The ham ranks will sorely miss you, Bill. A Maine A.A.R.S. hamfest was held at KOU in March, with 12 members present and a swell time as usual. KTN, new A.A.R.S. member, is doing fine.

Traffic: W1HIE 91 LHA 191 GXY 13 LRP 161 LML 75 AFA 1 INW 89 LIC 45 LMQ 11 LER 24. A.A.R.S.: W1AMR 202 BTA 63 CFO 156 EFR 48 FAP 231 GE 72 GHT 27 GVS 174 LJF 43 IOM 13 IST-KMM 41 KOU 381 KTN 56 LAP 75 LIC 57 LML 140 LMQ 5 LCV 20. N.C.R.: 280.

EASTERN MASSACHUSETTS — SCM, Frank L. Baker, Jr., W1ALP — I wish to thank all of the members of the Section that elected me S.C.M., and I hope that all will continue to cooperate as they have in the past. Let us make this Section bigger and better. My address is 21 Colby Road, North Quincy. GAG also wants to express his thanks to those who supported him. JK has old call (formerly FGA). KJ is working on new speech unit. BHW made Class II O.O. Welcome to new brother op's MNU and MOP in Cambridge. JXU has daily schedule with ATS. GOU completed W.A.S. on 28 Mc. HUV is doing fine job as O.O. JDG is still working DX and usual YV's. LZW has new skyhooks for 3.5 and 112 Mc. LMB and LTC now have Class A and are on 14-Mc. 'phone. LEU is working on new dual 4-element for 28 and 14 Mc. FHW put in Class B. KQN worked HA8B for new country on 14 Mc. IN is working on e.c.o. for 56- and 28-Mc. 'phone. AKY has schedule with K4USC. BVL moved to Beverly. ALP is on 7 and 3.5 Mc. and glad to QSO with anyone; the RME-70 is working FB. ELP has fine signal on 112 Mc. with f.m. transmitter. SS is making FB progress with Emergency Net on 112 Mc.; has 25 stations now. CZV is on 112 Mc. as well as 28 Mc. GZ is on 112 Mc. KAO put on swell midget hamfest, good prizes and demonstration of f.m. receiver by CTW. Field Day this summer will go over big, with all the portable rigs coming on. BBM hears 224-Mc. receiver 89 four miles. KNW is putting big rig on 28 Mc. with beam. UX gave the ring for double modulation soon. RH is on 112 Mc. with strong signal. M.A.K. club visited Hi-Q Club of Lynn; pleasant evening. HUP in Weston is on 28 Mc. MEU and EAU are rebuilding. BYY is rebuilding for 56 Mc. EHT is building 200-watt final for 56 and 28 Mc. EKT is now e.c.o. on 56 from 1.75-Mc. e.c.o. GCU is working on new superhet. BHW is back on 3.5 Mc. KTE would like to hear from active hams in vicinity of Parkway Radio Ass'n. IQQ has new e.c.o. on all bands. WV worked R. I. for 44th state on 28 Mc. KH built f.m. converter in Mar. Q87; it works FB. JNU has a pair of HK-24's for 112 Mc. AAR visited hams in Providence.

Traffic: W1EMG 169 LQQ 74 HWE 50 FWQ 35 LQV 26 WV 11 SS 8 LO 1 JCK 311 (WLGV 54) JYJ 107 LWH 289 AKS 304 EPE 278 JSM 328 BDU 122 KTE 5 BB 11 KH 36 JNU 8 QW 26 AGX 42 AAR 129 KZT 72 KCT 190 FSL 49. (Jan.-Feb.) W1JJY 263.

WESTERN MASSACHUSETTS — SCM, William J. Barrett, W1JAH — EOB made the B.P.L. again. Nice going. Vic. A contact with JAH on 1.75 Mc. made five bands for EOB's rig. BIV finally finished his emergency transmitter. JAH added preselector and built 100-ke. standard and monitor to keep tabs on the e.c.o. which now has 11 feet of bandsread for 3.5-Mc. c.w. band. IOR reports C. MS. A.A.R.S. 'Phone Net in full swing. BKG finished bandswitching 807 buffer. FOI is doing swell job typing in the W.M.S. 'Phone and C.W. Nets. BVR has vibrator power supply for receiver now, giving him complete station operation independently powered. DCH worked W6, W7 and K4 on 3.5 Mc. with 25 watts. AJ resumed schedule with NY1AA and had visits from MGE, IIP, MJP, JMH and LPO. BNL moved station up from cellar. COI worked K4USC twice for half-hour QSO. KJO is pounding brass on 14 Mc., and finally got Idaho card for W.A.S. LLY is new Emergency Coördinator for Leominster. How about some nominations for E.C. from the rest of the clubs in the Section? DCH reports KIE, LQS, AUN, LDI and DKX active on 112 Mc. in Fitchburg. LLN worked three K6 'phones on 28 Mc. Nice work.

Traffic: W1EOB 503 BV 257 (W1GN 63) JAH 199 (WLGH 22) IOR 125 (WLJ 17) BKG 76 FOI 67 BVR 66 (WLG 112) DCH 23 AJ 5 BNL 2.

NEW HAMPSHIRE — SCM, Carl B. Evans, W1BFT-DMD — The fifth mobilization of the N. H. Emergency Net was held on Sunday, March 3rd, with 54 operators at 42 stations covering 30 different communities. The following stations have a perfect record for participating in all five tests: BST, CEA, DMD, FTJ, HGV, IDY, ITF, IUI and KMH. Congratulations, and we only wish that the list were longer. ANS deserves special credit during our recent test, as he was the only station to check in on all four nets. FB, George! Those checking in on three nets included DMD, FTJ, LVK, FX and JDP. The following checked in on 100% emergency power: IVU/1, IUI, DUK and AXL. Our next test will probably be held in early fall (Sept.), but more dope on that later. There has been some talk of an all N. H. QSO party. Your S.C.M. would like comments and suggestions concerning this. Tentative plans call for using all bands, with opportunity to work the same station on different bands, possibly combining this party with our next mobilization next fall. Let's hear from you fellows. What do you think of the idea, pro and con??? And don't forget, in case of flood or other emergency this spring, get on and check in on N.H.E.N. Look for the nets on 1840, 3735 and 3840 kc. (7200 in daytime if 3.5 Mc. goes dead). The M.V.A.R.A. initiated a new member, KMC. CPM now has Class A ticket. LTD has done well on 14-Mc. c.w., knocking off AC4JS and J2KN. MIP, new ham in Concord, is on 3.5 and 7 Mc. with about 30 watts input to an RK25. LVG is rebuilding with a pair of 616's in final. BST has been scheduling a K6 regularly for some time on 28 Mc., handling traffic between two young boys in his town to their mother, who is in Hawaii. FBI KLV has new Meissner Signal Shifter. The Manchester Radio Club has started some interest in 112 Mc., and it is expected that several stations will be on there shortly. Plans are being made for a 112-Mc. station there at the tower, which should be an excellent location for ultra-high work. IVU is building some 112-Mc. equipment and making provisions for frequency modulation. AWU has built a 100/1000-ke. frequency standard in his receiver to keep his e.c.o. in the band.

Traffic: W1FFL 558 KIN 312 BFT 138 JDP 94 GMM 76 TA 68 ANS 66 FX 65 IP 52 JBA 51 JGI 50 KBU 42 CMR 40 JKH 39 GEY 28 HGV 25 KKQ 18 CEA 17 IDY 16 HXJ 9 HTO 6 HFO-GVJ 5 EAL 3.

RHODE ISLAND — SCM, Clayton C. Gordon, W1HRC — Let me correct an error which was made in the new officer line-up for the Providence Radio Ass'n for this year. As it was given to me, KZN was one of the newly elected members of the Board of Directors. It should have read HJB where it did read KZN. Our apologies all around — sorry — entirely unintentional. We are in receipt of a fine note from MNC, Bob Hartley, Saylesville, who received his ticket, Feb. 13th and, with his 6L6-809 75-watt and 8X24 Defiant, has worked the 1st, 2nd, 3rd, 4th, 8th and 9th Call Areas for a total of 17 states. LWA is new O.R.S. HJB had B.C.L. trouble from 112 Mc., and found small padding condensers costing 9 cents each were just as good for wave traps as the midget variable experimental type costing 50 cents each. JEZ has been working 3.9-Mc. 'phone with his emergency rig. The AQ bowling team trimmed the P.R.A. team, as is their usual custom. BVI, LJO and JNO came up from Newport to the hamfest at the Stone House in Scituate, where Glenn Browning gave a talk and demonstration of frequency modulation reception. The hamfest had an attendance of about 140. Clam chowder was the pièce de résistance. JNO has been playing with freq. mod. receivers.

Traffic: W1INU 299 GTN 199 LAB 160 INT 158 LDL 119 KYK 105 AOP 56 BOY 54 CPV 53 KOG 50 IEG 49 KIV 29 KZN 26 HRC 16 LWA 12 KKE 9.

VERMONT — SCM, Clifton G. Parker, W1KJG — KYB returned to St. Albans and is operating on 3.9-Mc. 'phone, besides doing some experimental work on 112 Mc. LRL was visited by LRP and XYL. LII is going places on 14 Mc. KOO has portable rig to keep contact with Section during his summer's work. KTB works into N. H. A.R.R.L. Net, and gets on 3.9-Mc. 'phone occasionally. BJP, KJR and friend, CUN and gang of old-timers and newcomers in Barre area visited KTB. KJR and CBW have branched out to 1.75-Mc. 'phone. MCQ is obtaining FB DX on low-powered 1.75-Mc. 'phone, and will have full Utah rig on the air shortly. JRU is rebuilding and has obtained FB7X receiver. JZF is also rebuilding. DQK is on 112 Mc. BLC is on 28 Mc. KEP entertained IEQ and GZL over week-end. MJU, one of our newcomers, is consistently on the air, and think some of the Ot's better watch out for him in the com-

ing contests. AVP has new 56- and 28-Mc. receiver and transmitter running 8½ watts input and using beam antenna. GAN suffered an injury to his hip, keeping him off the air for some time; he is reported improved and has been heard occasionally. CGX is handling some traffic. CBW was appointed S.N.C.S. 6 in Vermont A.A.R.S., to fill vacancy caused by resignation of JRU. F.S.V. is commencing to pile up traffic totals once more. BNS is busy with A.R.R.L. Net and completing final of rig. JVS and KJR are working on 28-Mc. 'phone outfits. AEA is proud father of new YL operator, LVWC, very active newcomer, uses 6L6G crystal osc. and Haynes Clipper receiver. BLC now has ½-kw. rig using pair of '03A's in P.P. and has new Skyriver Defiant receiver. LVO completed new 6L6G "QSL Sixty" per cent QST, and reports FB results. (That's a neat unit around which to make up your emergency-powered outfit, too!) KUY acquired Class A ticket. KWB is building an e.c.o. unit around an 89. KJG is remodeling flea-power portable 'phone for a.c. or 6 volts d.c. operation. Be sure to check on your A.E.C. registration and, if it was issued prior to December, 1939, re-register at once. Forms may be obtained from your S.C.M. or from KOO, FPS, or JVS.

Traffic: W1AVP 7 BNS 60 CGX-DQK 6 FSV 153 KJG 98 KOO 47 KTB 98 KWB 10 LRL 29 MJU 31.

HUDSON DIVISION

EASTERN NEW YORK — SCM, Robert E. Haight W2LU — KWG on 3742 and 3510 is doing a swell job. MHW worked Colo., Kansas, Fla., Calif., Texas and Wis. on 3.5 Mc. with single 6L6G crystal osc., 25 watts input. EZO covers Mt. Vernon for traffic. ISJ reports activities with N.C.R. MIY, YL in Albany district, comes to aid of our Section as a prospective O.R.S. "Dot's" rig is 6V6G crystal osc. with 6NT6 doubler and RK39 final running 11 watts input on 7 Mc. BEW is on E.N.Y. State Net of A.A.R.S. MHW reports KKF and BLU are on 1.75-Mc. 'phone. Ex-W8BHW, waiting for W2 call, is now at Scarsdale on 1907 kc. DVC, O.P.S. is overhauling for much activity this spring. LLU is heard with a swell signal on 3.5 Mc. SZ is operating mostly on 3.5 Mc. MWE is new ham in club. HUV is still active on 112 Mc. JZG is on 3.5 and 7 Mc. with single 6L6. HNH is operating portable in Kingston. LSD reports F.T.S. first anniversary party a grand success. MUB wants to be O.R.S.

Traffic: W2KWG 127 LSD 148 MHW 81 LU 66 EZO 56 ISJ 6 MIY 4 BEW 2.

NEW YORK CITY AND LONG ISLAND — SCM, Ed. L. Baunach, W2AZV — MT and WD are new O.R.S. FF is now one of the benedicts and is at new QTH: 3939 Hill Ave., Bronx. HY is at new QTH in Flatbush, operating on 3.9-, 14- and 28-Mc. 'phone. HNJ is using plug-in type oscillator units, and finds they work FB. LID is boosting power to 150 watts. MLE installed a noise limiter on his receiver; a W6 was contacted on 3545 kc. using 35 watts input. LZR rebuilt rig using a pair of TZ20's; so far the B.P.L. has been made every month this year. LGK is now using a 41 crystal oscillator to drive his P.P. 45's with 12 watts input. BYK has two new 8JK's. WD has all new National equipment, NTX30 and NSM. LWB and MEI helped AEU put up his new antenna. KYV finds his traffic on the 7 Mc. alive with traffic at noon. PL moves his traffic on the F.T.S. AXZ is looking for N. Mex. for W.A.S. LWE is getting out on 7 Mc. FAQ worked K6QUJ on 7058 kc. with 25 watts input. HGO is having a difficult time keeping his 7 Mc. schedules going. 9KJM/2 has portable-mobile rig working on 28 Mc. LYG is working DX on 7 Mc. with low power. B.C.L. QRM has driven LVB to 7 Mc. from 1.9-Mc. 'phone. CEN is using a pair of 52's on 112 Mc. ADW manages to work across the L. I. Sound regularly from Riverhead on 112 Mc. APM is giving 112 Mc. a try. Although away on business, LR managed to operate portable in Hartford and handle traffic. DOG's operating hours are now from 6:30 to 7:30 every morning. SC transmits code speed practice on 3510 kc. every Tues. and Fri. at 8:30 p.m. E.S.T., starting at 15 w.p.m. and going to 45 w.p.m. by 9:00 p.m. CHK has a tough time keeping his A.A.R.S. 'phone schedules through the QRM. Although away from the Section, JBL sends his report every month. JGC has new low-power rig. BGO did some snappy handling of N.C.R. traffic during the ice storm. ITX had to keep his schedules with his battery-operated rig for three days because of complete power failure in his area. EC is a new member of the Section Net. MT is handling Trunk Line "C" in place of

(Continued on page 104)

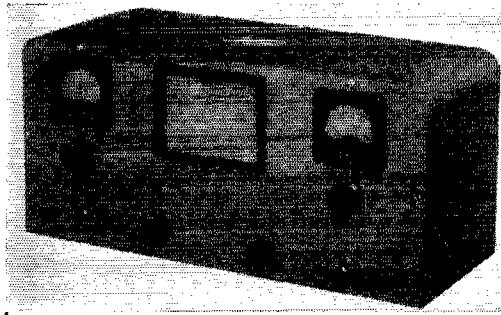

GET ON 2½

With The New TR-112 TRANSMITTER-RECEIVER

A powerful station . . . not a toy

TRANSMITTER

6E6 or RK-34 push-pull Resonant Lines for stability

6V6's Class AB delivering 13 watts for abundance of modulation

RECEIVER

6J5CTX super-regen. detector with panel sensitivity control

6J5CT plus 41 for real volume
P.M. dynamic speaker

All neatly arranged in a 15x7x6 inch cabinet for tucking into your car or desk. Amateur Net Price **\$39.75**

See it at your dealer. Write for literature

RADIO TRANSCIVER LABORATORIES

8627 115 STREET RICHMOND HILL, NEW YORK CITY
CABLE ADDRESS: "RATRALAN", NEW YORK

(Continued from page 21)

7L7

Triple Grid Amplifier

Direct interelectrode capacitances with RMA shield M8-308 connected to cathode and base shell.

Grid to plate.....	0.01 μ fd.
Input.....	8 μ fd.
Output.....	6.5 μ fd.

Operating Conditions and Characteristics

Heater voltage.....	6.3	6.3 volts
Heater current.....	0.30	0.30 ampere
Plate voltage.....	100	250 volts
Suppressor voltage.....	Tied to cathode	
Screen voltage.....	100	100 volts
Grid voltage.....	-1	-1.5 volts
Cathode bias resistor.....	125	250 ohms
Plate current.....	5.5	4.5 ma.
Screen current.....	2.4	1.5 ma.
Plate resistance (approx.).....	0.1	1.0 megohm
Mutual conductance.....	3000	3100 μ mhos
Grid voltage for cathode current cut-off.....	-4.5	-6 volts (approx.)

Strays

To prevent wearing out the December issues of *QST*, tear out the indices and paste them up in a scrapbook. — *W9QLC*.

Neat panel labels may be made by typing the label on a piece of white paper and fastening it to the panel with a piece of transparent Scotch tape over the label. — *W5DLZ*.

NCR Notes

(Continued from page 64)

During the training cruises, NCR men man the Navy radio station (NAJ) at Great Lakes, Illinois, for the purpose of maintaining communication between the ships and the District Headquarters, which are located there. Duty at Naval Reserve air bases in the District is also available from time to time and is eagerly sought after.

Recently, a number of NCR men in this District have had an opportunity to request active duty in the regular Navy, as Naval Reservists and on a temporary basis. Some are taking special training prior to service with the Fleet, while others are on duty at shore radio stations.

Radio amateurs in any of the States listed above, who are between the ages of 17 and 23 and in good physical condition, and who are interested in enlisting in the NCR, may obtain information on this subject by writing to the Commandant, Ninth Naval District, Great Lakes, Illinois.

W2JST

YOUR CALL LETTERS on gleaming black PYRALIN. White inlaid letters 1½" high on 2¼" x 6" plate. 75 cents each, 2 for \$1.25 postpaid. R. A. WATERS, W2JST, 240 Valley Road, Montclair, N. J. Also special sizes and wordings. Send layout for price.

SUPER ACTIVE

HIPOWER

LOW DRIFT CRYSTAL UNITS
AT
"X" CUT PRICES

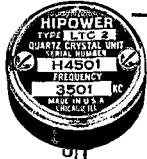

SEND FOR FREE CATALOG

"EMERALDS"

Stability with higher activation. Large production plus exclusive Hi Power. Grinding method makes these pure Brazilian quartz Crystals phenomenal in price.

160-80-40 meter Bands
Special 20 meter Band.....**\$3.35**
.....**\$5.50**

"RUBIES"

Our finest amateur Crystal Units. Hi degree accuracy, precision cut, finest Brazilian quartz.

160-80-40 meter Bands.....**\$4.50**
Special 20 meter Band.....**\$7.25**

AT YOUR PARTS DISTRIBUTOR

Newark, Chicago; Radolek, Chicago; Radio Parts, Madison and Milwaukee; Kerr's Radio Shop, El Paso; Southern Sales, Oklahoma City; Radio Electric Service, Baltimore; Morrissey's Radio Service, Cumberland; Walder Radio & Appliance Co., Miami; Radio Service & Supply, Martinsburg; Auto Service, Birmingham; Arizona Radio, Phoenix; Dutch Village Radio, Portland; Eagle Radio, N. Y. City; Green Mill Radio, Chicago; Bell Radio Supply, Marion, Ohio.

HIPOWER CRYSTAL COMPANY

2925 CHARLESTON ST.

CHICAGO, ILL.

NEWEST AND BEST  EVER BUILT
Own it for only \$14.⁷⁵ down!

RCA TUBES

America's largest stock RCA transmitting tubes. A few best sellers listed below. If we do not list the tube you want, just ORDER it . . . we HAVE it!

803	\$28.50	811	\$ 3.50
805	13.50	812	3.50
806	22.00	813	22.00
807	3.50	814	17.50
808	7.75	866	1.50
809	2.50	866A	2.50
810	13.50	872A	11.00

WRITE for Newark's HAM CATALOG

84 pages, fully illustrated. Thousands of items for the Ham. Sets, parts, accessories, and supplies. Time Payment details included.

**EASY TERMS
10% DOWN**

Order direct from this ad. Send 10% down payment with your order. Add 6% carrying charge to balance and divide into equal monthly payments, up to 12, providing no payment is less than \$5. Include ALL sets and parts you need. We ship immediately upon credit approval. It's EASY to pay the NEWARK way!

★
THE
AR-77
BY
RCA
★
PRICED AT
\$147.50
COMPLETE
WITH 8-INCH
SPEAKER

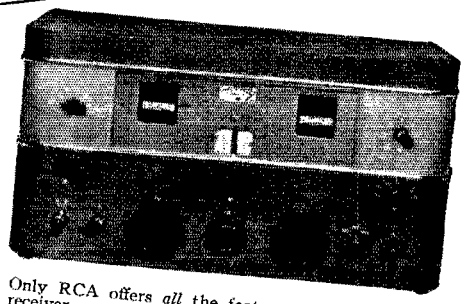

Only RCA offers all the features of this fine new receiver . . . and NEWARK offers you a chance to own one on these EASY TERMS! The features include Dual RF Alignment, POLY STYRENE INSULATION, Lower Circuit Noise, NEGATIVE FEEDBACK, Stay-put Tuning, UNI-VIEW DIAL, Calibrated Band Spread, ACCURATE SIGNAL RESET, Variable Selectivity, IMPROVED IMAGE REJECTION, Improved Noise Limiter, and promote AR-77's . . . plus a dozen other desirable standard specifications.

SEND DOWN PAYMENT WITH YOUR ORDER. Add only 6% carrying charge to balance, and divide into any desired number of equal monthly payments up to 12. You pay only \$11.73 monthly on the 12 month plan. And before you know it, you OWN the finest set RCA has ever built!

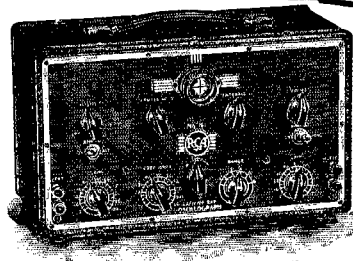

RCA TEST EQUIPMENT

- Available on Newark's Easy Terms when your order totals \$50 or more.
- No. 151, 1-inch OSCILLOSCOPE, complete **\$39.95**
 - No. 151-2, 2-inch OSCILLOSCOPE, complete **49.95**
 - No. 155, 3-inch OSCILLOSCOPE, complete **\$39.95**
 - No. 150, Electronic Sweep Oscillator, complete **64.50**
- Send only 10% down payment with any order of \$50 or more, and 6% to unpaid balance, and divide into equal monthly payments of \$5 or more.

Newark "Scoops 'Em" Again
With this NEW Condenser Bargain

Newark's massive buying power enables us to continue these astonishing values in face of rising costs. Over 50,000 of these condensers already in use, by satisfied amateurs. Get yours now.

DC Volt Mfd.	Size	Wt.	Price
2000 2 4 7/8 x 3 3/4 x 1 3/4	1 1/4 lbs.	\$1.50	
1500 4 4 5 x 3 3/4 x 1 3/4	1 3/4 lbs.	1.75	
1500 5 3 3/4 x 3 3/4 x 1 3/4	1 3/4 lbs.	1.90	
2000 8 5 x 3 3/4 x 3 3/4	2 3/4 lbs.	2.75	

Never before offered . . . and probably never again. Hurry.
4 mfd.
3000 v. DC
Size 4 1/2 x 3 3/4 x 3 3/4 **\$3.75**
Weight 2 3/4 lbs.
Oil Filled . . . Oil Impregnated
2 mfd. 1000 v. DC. **NOW ONLY \$1.00**

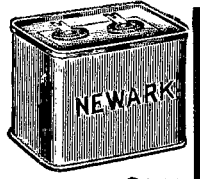

NEWARK Electric Company
323 W. MADISON ST.
Dept. Q CHICAGO, ILL.

(Continued from page 101)

IOP, KJY is building new 100-ke. standard so he can keep up his O.O. work and give some real accurate frequency checks. APZ is also one of the benedicts. ECR has a 75-foot steel tower with a three-element Mims on top. BVE can be heard on 3.9-Mc. 'phone. The Suffolk Amateur Radio Club is now affiliated with the A.R.R.L. DOG is the secretary and welcomes anyone interested in amateur radio to attend their meetings. It is the only active radio club in Suffolk County. JOZ is now president and LXD secretary of the Tenmen Radio Club. The Queens Radio Amateur Club is looking for new members; interested operators living in the vicinity of Ridgewood should get in touch with I.P.J. The Fisherman's Net on 1.75-Mc. 'phone is on every day at 12:30 P.M. E.S.T. It is mainly set up for rag-chewing, and anyone on that band is welcome to join in. Any stations desiring schedules on 3.5-Mc. band should look for the Section and Emergency Net on 3710 kc. every night at 8:30 P.M. E.S.T. DBQ advises all holders of 1940 A.E.C. registration blanks to fill them out and return them to Headquarters. It is not necessary to have complete self-powered equipment to join the A.E.C., and all active operators are wanted and will be needed in time of an emergency in the Section. EVA has been studying for a commercial ticket; he hopes to soon be active on 7090 kc.

Traffic: W2SC 764 ITX 602 (WLNW 300) PL 502 LZR 348 MT 237 LR 204 KI 167 DBQ 159 (WLNW 244) HMJ-LPJ 146 PF 72 AXZ 66 AZV 50 WD 43 LGK 32 CHK 30 MLE 23 KYV 22 BGO-LYG 18 AEU 17 LR/1 13 FAQ 12 EC 11 9KJM/2 10 2AZM 9 GDF 8 IRC 7 CIT 6 LBI 5 ADW 4 AA-BDR 3 JVX-BMG-DOG-HBO-HGO-HNJ-JGC 2 WLNW 7/GZF (WLNK 67). (LKG 24 Dec.-Jan.)

NORTHERN NEW JERSEY — SCM, Pat Jessup, W2GVZ — Asst. SCM in charge of Emergency Coordination, Les Bagley W2JMX — R.M.'s: BCX, BZJ, CGG, GVZ, P.A.M.: HNP. Section Net freq.: 3630 kc. New appointments: E.C.: CEJ, Linden; CQD, Roselle; FQK, Long Branch-West End-Elberon; JME, Plainfield. New A.E.C. registrations: AGM, ASB, CEJ, CQD, EUJ, FUP, ICG, ISW, JLL, KZG, LEK, MDP, MEO, MDZ, QD, FB, we need lots more. Effective at once, all applicants for O.R.S. and O.P.S. will serve a two months' period of probation following the qualifying test before the certificate will be issued. Regular monthly reports will be expected during this period. Les, JMX, is getting bow-legged from running around the Section recruiting E.C.'s and organizing things in general. For any information, inspiration and advice on A.E.C. matters, call on JMX. He is doing a grand job, and needs your cooperation in putting our Section out in front. CGG says that the Livingston Amateur Radio Club has just been formed. MUS has been transferred to W5-Land. MOO is active in Ramsey, MWJ is new opr. at Teaneck. GVZ is alternate to BZJ on T.L. "A." Ten pounds of brand-new relief opr. came to JME's shack. Congrats. GKX and his livewire Woodbridge Twp. gang are grinding rocks for a low-power net on 1896 kc., building emergency-powered 112- and 1.75-Mc. jobs and learning how to operate if the pinch should come. KREH, working in Chicago, expects a W9 call soon. BNU, having finished remodelling his shack, is working on a 28-Mc. beam. 112 Mc. will soon see EQS, KVT and CIO. K8Z is going to try 224 Mc. LYL grabbed his first K6 on 28-Mc. 'phone. Working KC4USC with a '10 osc. for his 61st country is nice going for EQS. CIO tied the knot and moved to Ridgefield. KVT is going on 28-Mc. 'phone. MKV enjoys N.C.R. work. LDB at Fort Hancock joined A.A.R.S. MLM flew home from school for W.A.S. Party and worked as far as Oregon on 50 watts of 1.8-Mc. 'phone. Passaic and Garfield are going in for 112 Mc. with transceivers at KIN, MKT, MRN, MIV and MOP. The score at MOP in a month's time on 7 Mc. with ¼ kw. was 35 states worked. MRI operates MRQ for the Passaic High School Radio Club on 1.75-Mc. 'phone. The J.S.A.R.A. is getting set for the next F.D. AIW worked AC4YN and KC4USC. HWX is experimenting with freq. mod. A battery-operated e.c.o. is under construction at FQK, the new E.C. at Long Branch. FZY is hopefully building an e.c.o. push-button-controlled rig for five-band operation. JUU is now helping the rig out with an indoor skywire. GRG qualified twice for Class I O.O. AOG is an expert on magnetic recording. MRJ is shifting to 7 Mc. LWD is preparing for Com'l ticket. Another successful 112-Mc. station is HNA. HLC is building new shack. DVU is getting out FB on a ¾-wave skywire on 3.9 Mc. KHA, LRB and MKW are on 112 Mc. in Bayonne. MKW also substitutes for KHA in N.N.J. Traffic Net on 3.5 Mc. Shed a tear for ARB, BMK,

GT, TP, VY and others who lost from one to four elements on their rotary beams in the March sleet storm. GVZ writes this during the DX contest and wonders how many countries this column cost him. See you at the Hudson Division Convention.

Traffic: W2GVZ/312 (WLN1 12) CGG 290 HOP 188 LMN 98 (WLNX 25) MUS 92 KMI 59 JUC 55 BZJ 39 HCO 33 ILE 28 KHA 17 DYO/GHQ-HXI 13 JDC 9 CJX-JRU-JKH 6 CIZ-LXI 5 GFW-IZV-IYQ 4 DVU 3 JUU-MOP 1. (Jan.-Feb.): W2CGG 376 KHA 16 MEO 8 CJX 4.)

ATLANTIC DIVISION

EASTERN PENN — SCM, Jerry Mathis, W3BES — 3ADE is trying low power (24 watts) on 1.75-Mc. 'phone. We are pleased to announce that 3AOC is out of the hospital and with us again. 3AQN says, "If the gang wants good East Pa. traffic service, look on page 69, March QST, under E. Pa. Traffic Net." 3BIL is looking for new 1.75-Mc. 'Phone American Emergency Net members. 3BRZ is all set for summer 56-Mc. activity. 3BXE doubled his traffic total. 3EEW is proud of his first B.P.L. 3EFH expects big stuff in the next O.R.S. Party. 3FJU announces a new O.R.S. schedule on 14-Mc. 'phone. 3GYK is trying to corner the market on crystals. 3IPZ is new Germantown call. 3GYY received an S.W.L. card from England, 559X on 3.5 Mc. 3HFE is constructing a 112-Mc. co-axial antenna for F.M. 3HFE is scheduling WTDQ, which is on a training cruise. 3HZK says his local gang is organizing a club and preparing for Field Day. 3IAY is now established at the new QTH with his equipment rebuilt. 3KJ claims three new countries on 14-Mc. 'phone. LY1K, IJKV and HC2HP. 3QP is taking a pile of traffic from KAIHR, 3RR and 3EEW visited 2JDC at the Columbia Univ. Radio Station. 3GQJ/4GQJ is back with us. 8ASW is QRL A.A.R.S. war games. SGV can't see why he is still missing four states after so many years on the air. 8SSA sends nice letter of his activities with the A.A.R.S. 8FLA is plugging along at WLQA. This report is brief due to your S.C.M. getting beat in the DX Contest.

Traffic: W3ADE 49 3AQN 59 3BIL 3 3BXE 79 3CHH 7 3DGM 10 3DXC 7 3EEW 595 3EFH 289 3EML 1153 3FJU 3 3FXZ 6 3GDI 10 3GKO 641 3GUB 3 3GYK 18 3GYY 2 3HCT 20 3HFE 13 3HRS 261 3HZK 56 3HZV 13 3IAY 8 3QP 771 3RR 17 4GQJ 3 2 8ASW 250 8ATF 58 8EU 2 8GV 5 8HKS 12 8OML 11 8PAF 182 8QLW 5 8SNZ 7 8FLA (WLQA 37) (Jan.-Feb.): W3RRR 22 3PAF 232) (Jan.-Mar.: W8SSA 52).

MARYLAND, DELAWARE, DISTRICT OF COLUMBIA — SCM, Hermann E. Hobbs, W3CIZ — CXL, CDQ; R.M.'s: 3BWT; Chief R.M. BHE says visitors are welcome at W.M.A.R. Club, 1st and 3rd Tuesdays, 7:30 P.M., at 61 Prospect Square. The 1.75-Mc. Emergency Net has been taken into the A.A.R.S. as of Feb. 26th. EQK received an S.W.L. card from Christchurch, N. Z., reporting his 3.9-Mc. signals. GMK is using only 30 watts. BTQ got a nice writeup in local paper on his A.E.C. appointment. ITC is putting his transmitter into a rack and panel job and has joined the Forty Traffic System. HUM reports AP T.L. running smoothly, with three new members. IEM is going to rebuild bigger and better with an 812 final. IMN is rebuilding old rig into rack and panel.

Traffic: W3BKZ 252 BWT 638 CDG 7 CIZ 563 ECP 136 EKZ 2 EQK 12 FSP 108 GYQ 91 ICT 55 IMN 14 HUM 167 CDQ 20 CXL 343 (WLM 3177).

SOUTHERN NEW JERSEY — SCM, Lester H. Allen, W3CCO — Asst SCM and A.A.R.S. Liaison R.M., Ed. G. Raser, W3ZI — R.M.'s: 3BEI, 3BYR, 3EUH — P.A.M. 3GNU; Section Net frequencies: O.R.S.: 3700 kc.; O.P.S. 1980 kc. Membership in both O.R.S. and O.P.S. ranks is on the increase. If you are interested in getting lined up, send in your application immediately. The Delaware Valley Radio Ass'n of Trenton announces its Fourth Annual Outing and Hamfest, Aug. 11th, with EUH as Chairman. This affair will be preceded by the 10th Anniversary Party of the Club on Aug. 10th. The Somerset Hills Radio Club announced a complete reorganization with MI and HOH at the helm. Non-members in this vicinity are invited to attend club meetings at HOH's in Bernardsville. GYG has new rig on 28 Mc. FXN has regular schedules with 2CGG and 3BWT. GUS, traveling for a living, reports into the A.A.R.S. between trips. HVO joined the "Y.L.R.L." IFT is new O.R.S. in Pitman. IOW is new call in Trenton. HDW is going to town on the A.A.R.S. 7-Mc. Net; he is now

N.C. 2 The 2nd Annual N. J. State A.A.R.S. Hamfest was held in Trenton, April 14th, everyone having a good time. ZI and CCO aided police in search for lost child on March 7th, after 5-state alarm failed to disclose her whereabouts. ZI operated in Army plane DU-7, keeping in direct touch with local authorities through CCO, who acted as ground contact station on 1880 kc. Amateurs again served their community. IOK is working out FB with 8-watter on 3.5 Mc. AID is on the air with 6L6, after not being heard from since the early c.w. days. Congratulations, Bill. ZI was presented Medal of Honor for 10 years' continuous service in N.J.N.G. at Military Ball held in Newark; Ed is now Communications Chief of the Air Corps Squadron. CCC is getting to be some traffic hound; he reports into the O.R.S. and A.A.R.S. Nets five times a week. Nice going, Eddie. CFT is new member of the Delaware Valley Radio Ass'n. Arn, who won a "Gold Bug" for clean-out fist, is now on 3.9-Mc. 'phone. GQX keeps schedule with his son FMU, who is located in Arizona. CFS is working out FB on 3.9 Mc., the latest achievement being a K6. GCU reports Foreign Broadcasters interfering with 1AW's Official Broadcast's on 7280 kc. If anyone else in our Section is having trouble with this interference, please report it immediately to Headquarters or your S.C.M. CWG and HND are the latest to join the A.E.C. FIS of Phillipsburg reports for the first time, and is anxious to become O.R.S. OQ has cited 24 stations this month for harmonics. Too much cannot be said about this harmonic business, fellows, as the F.C.C. is sending out quite a few "green" tickets. Once again I suggest each and everyone check his transmitter for harmonic emissions. EWK is erecting a new skywire. DNU has been on the sick list for quite a time, but still made the O.R.S. schedules. FB, Charlie. HEO was heard in England and Belgium on 3.9-Mc. 'phone. HES built himself a new 7-Mc. rig. INS has been busy collecting QSL cards for the W.A.S. award; needs only 6 more states. GCU needs only 5 more states for W.A.S. on 3.5 Mc. HOH and HPX lost their beam antennas in the ice storm. ABS, as usual, reports outstanding achievements on 1.75-Mc. 'phone this time, K4ELL being contacted on 2/28/40. FB, Stan. FFE has returned to 3.5 Mc. and 7 Mc. with new rig. IHO, the Official Phone of Salem, needs only 5 more states for W.A.S. on 1.75-Mc. 'phone. HTJ has new final with 400 watts input on 1.75-Mc. 'phone working FB. CFS has a pair of T-40's for 3.9-Mc. 'phone. GAF rebuilt his rig using O3A final. BWF is using an 801 in the final of his 1.75-Mc. 'phone rig, in place of the old faithful 210. IIC has new half-wave on 1.75-Mc. 'phone. HMR completed new 'phone rig, which sounds very good. All O.R.S. and O.P.S. appointees of this Section were mailed a Traffic Map showing the various outlets for QSP, in the East. If anyone other than an appointee would care for a copy of this map, there are a limited number available, free for the asking. Don't forget your reports are always welcome and should be in the hands of the S.C.M. by the 20th of each month. Until next month, 73.

Traffic: W8BZX 422 BYR 150 (WLNW 24) ZI 146 FXN 96 DNU 91 GCU 68 EUH 62 GMY 54 BWK-CCC 51 CFS 47 CCO 46 OQ 43 EFM 41 (WLNJ 5) HPX 34 GRW 3 GMN 30 ATF 27 AEJ 23 (GEF-AVJ-HAZ 22 HSL 17 BWF 15 IFT 12 IHO 10 BAY 5 FFE-ASQ 4 ABS 3 ACC 2.

WESTERN NEW YORK — SCM, Fred Chichester, W8PLA — R.M.'s: BJO, CSE, DSS, FCG, P.A.M.: CGU, E.C.'s: GWY, SBV, SMH. Net frequency: 3720 kc. JQE made the B.P.L. again, with BJO running a close second. The Binghamton Radio Association met the Seranton gang at Halfway House, March 11th. LZD had charge of entertainment, and MPS explained frequency modulation. A good time was had by all. QGS is working on plans for the annual hamfest of the Central New York Radio Club. DHU now has a crystal for net frequency. KDY has a new 'phone rig. KKR is active on 7 Mc. FCG's 211 went west and has been replaced with an 812. CVJ delivered a lecture on "High-Frequency Re-Broadcasting" before the Central New York Radio Club on March 14th. "Free lunch" was served after the meeting. TCB is now on the air. TBZ lost his skywire in a sleet storm. WS is rebuilding. Another old-timer has had his license re-issued, holding his old call, CYD. UJR is after A.A.R.S. membership. RKM and CSE are building emergency-powered equipment for Field Day.

HJM is on 1.75-Mc. 'phone regularly. DSS comes into net again. EIJ gets on 3.5 Mc. now and then. QIO, of Elizabethtown, maintains regular schedule with XYR, who is located on top of Whiteface Mountain. GLP is heard regularly on 1.75-Mc. 'phone. AXN is doing some notable work on 28 Mc. RMR got an 89 report out of Cuba with his low-power 7-Mc. rig. UNE is new call in Ogdensburg. SUV is building a modulator. DHB is on 1.75 Mc. with 125 watts. DNE, formerly of Utica, is now on 7 Mc. from Cortland. OQC, SBV, SZK and JQE took Class "A" exams at Buffalo. ECV, the old 7-Mc. man, is heard on 1.75-Mc. 'phone occasionally with an FB signal. FNT is soon to QRO with a pair of 812's. GZX is passing out cigars again, due to the arrival of a YL, March 8th. BCU is working 1.75 Mc. with 60 watts and a "V" beam. TUQ joined the Y.L.R.L. PWU now has a Meissner Signal Calibrator and hopes to become 1st Class O.O. soon. UMC (ex-9NGG) is new call in Rochester. JAD moved rig from the attic to the parlor and is now very active on 7-Mc. and 1.75-Mc. 'phone. MNW is back on 7 Mc. after a forced absence, due to a broken shoulder suffered in a toboggan accident; he was on 1.75-Mc. 'phone while he was strapped up, and couldn't use a key. BHK, who was O.R.S. several years ago, has been reappointed, and comes into net regularly. DOD, who has been handling traffic for Rochester and vicinity, is now O.R.S. Press of business has forced "Doc" Smith to resign as E.C., but we expect FNT to take over the job in the near future. SMH has been appointed Coordinator for Binghamton and vicinity. The Elmira Radio Club is sponsoring code practice for would-be hams. RRS is building a new rig, keeping the old one intact for net work. RTW is doing some FB 56-Mc. work. The Ithaca Amateur Club now has its club rooms at the Y.M.C.A., and boasts a club transmitter using a Browning e.c.o. JDB is short a few cards to enter the Century Club, but is plugging every day in spite of the scarcity of DX. RVM reports very fine progress with the proposed St. Lawrence 'Phone Net. SFD joined the F.T.S. CMF is on 3.9-Mc. 'phone, using the speech equipment Santa brought him. GWT is using a 25Z5 and 25L6 on 7 Mc. DX is considering cathode modulation. THC gets on 1.75-Mc. 'phone mornings. MKA hears plenty of DX on the high end of 7 Mc. IHG operated portable with QBU at Scouthaven, the Buffalo Council Scout camp. SSS is now operating at YD, State Teachers College. UJW is a new call in Buffalo. PCN finally got up an antenna that really works. New officers of the Buffalo Mike and Key Club are GJ, pres., and FYH, sec. UHI is on 1.75-Mc. 'phone. The Rochester Hamfest was a great success. Good speakers, fine entertainment, a swell feed, lots of prizes and a large attendance in spite of adverse weather conditions. DOD was presented a trophy cup as winner of the Monroe County QSO Party.

Traffic: W8AOR 75 AQE 19 BGL 14 BJO 471 CMF 5 CSE 55 CTX 15 DHU 58 DOD 63 FCG 266 GWY 178 JIW 29 JQE 501 MKA 25 PCN 158 PL 245 QQB 81 RKM 110 RMR 32 RRS 31 RVM 29 SBV 93 SMI 8 SFD 11 SZK 52 SMH 6.

WESTERN PENNSYLVANIA — SCM, Kendall Spear, Jr., W8OFO — Ass'y SCM in Charge of Emergency Coördination, R. M. Francis, W8AVY. B.P.L.'ers this month are NCJ and KWA. This is NCJ's first B.P.L. Welcome to the traffic pounders. RIT enlisted in the N.C.R. QBK received his VK2DG card after a two-year wait. HKU says TOJ worked 43 states instead of 43 countries, as stated in a recent QST. PFW is getting the traffic urge again. RAT decorated his shack with imitation paper. ZAE, FQL and OFO spent Easter week-end in New York City and at the Philadelphia Navy Yard. SFV says UKX, Freeport, Pa., was ten years old when he took his amateur examination and eleven years old when he received his ticket. TTD says TVA won a Hy40Z at the Pittsburgh Hamfest, and is building a new final. RAU won an HY25 tube. IOH is waiting for the balance of the parts to complete his new rig. IBR, President of the Altoona Horseshoe Radio Club, says the new clubhouse is in view of the famous Horseshoe Curve. BOZ is using the Stancor P20 circuit. KYW has the new Stancor P60 rig. QEM would like to see more activity on 112 Mc.

W8QAN 428 NCJ 298 KWA 280 RAP 98 CMP 81 PX 34 RIT 26 TWI-QBK 16 HKU 14 PFW 11 NDE-RAT 10 OFO-SFV 7 AXD-TTD 6 RAU 2 YA (WLMA 159).

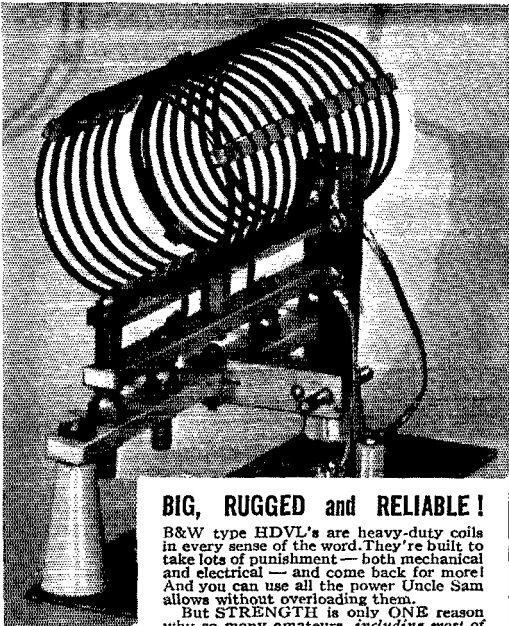

BIG, RUGGED and RELIABLE!

B&W type HDVL's are heavy-duty coils in every sense of the word. They're built to take lots of punishment — both mechanical and electrical — and come back for more! And you can use all the power Uncle Sam allows without overloading them.

But STRENGTH is only ONE reason why so many amateurs, including most of last year's contest winners, have standardized on HDVL's. They've found these big 1-kilowatt coils to be the best possible buy from EVERY standpoint. Ask your jobber — or write for details.

BARKER & WILLIAMSON
Ardmore, Pa.

- 160 HDVL...\$5.25
- 80 HDVL... 4.50
- 40 HDVL... 4.00
- 20 HDVL... 3.75
- 10 HDVL... 3.25
- HDVBASE...5.00

W8SUN	12470-43-146	B-24	W9ZTP	7750-31-100	A-12
W8SZT	11363-30-158	A-28	W9BQZ	7667-41-94	B-22
W8BKE	10500-35-120	A-27	W9PRA	7098-30-91	B-12
W8LCY	9750-39-100	A-7	W9DLJ	6831-33-105	B-25
W8EK11	8629-39-89	A-13	W9UHZ	6800-33-82	A-14
W8AYS	8167-33-99	A-30	W9QGR	5530-29-80	A-16
W8MHM	8160-32-102	A-16	W9CPX	5180-28-75	A-30
W8MOH	8050-28-116	A-16	W9VWG	4350-29-75	B-23
W8FYM	7560-42-90	B-14	W9VVQ	4060-28-58	A-15
W8KZO	7465-34-79	A-12	W9WSY	3998-26-63	A-6
W8SQE	7308-36-102	B-16	W8BSS	3444-19-75	A-12
W8QHV	7200-36-100	B-16	W9YXH	3009-21-54	A-6
W8TSL	5712-34-85	B-18	W9VDD	2160-24-45	B-7
W8SUY	5063-30-68	A-11	W9QYI	2100-21-40	A-14
W8PCS	5550-37-76	B-15	W9LUC	2070-23-36	A-8
W8GER	5400-36-75	B-14	W9RSR	1995-21-40	A-15
W8RPB12	4384-32-73	B-22	W9DWI	1628-22-40	B-4
W8SRD	4225-26-66	A-19	W9LFK	1598-14-57	A-14
W8RHG	4125-30-55	A-6	W9DYO	1445-17-34	A-1
W8SDN	3380-24-113	A-20	W9QCN	1220-16-31	A-8
W8LTP	3240-24-54	A-9	W9EER	945-14-27	A-9
W8QYR	3173-27-47	A-8	W9WZA	660-12-24	A-4
W8SIX	2940-28-42	A-12	W9MNF*	510-12-17	A-3
W8SHD	2900-20-59	A-10	W9JPS	507-14-15	A-4
W8SXT	2363-27-35	A-4	W9ANA	250-10-10	A-2
W8OD	2291-29-79	B-1	W9RKP	219-7-13	B-2
W8SQX	2001-23-44	B-5	W9WXD	195-6-14	A-9
W8SEN	1900-20-38	A-13	W9HRM	150-4-15	A-4
W8LPD	1836-17-54	---	W9JZW*	100-5-8	A-1
W8EOY	1601-21-32	A-16	W9RH	24-3-4	B-1
W9UTT/8	1520-16-38	A-4	W9CUW	4-1-2	A-1
W8TGO	1475-20-30	A-16			
W8OTT	1320-20-33	B-5			
W8QOR	1040-16-27	A-17			
W8RHH	910-14-28	A-7			
W8UW14	673-13-21	A-4			
W8QMN*	618-14-23	B-1			
W8IBM	543-14-16	A-4			
W8SVQ	465-12-16	A-10			
W8OXF	240-10-12	B-7			
W8TEB	144-8-9	A-2			
W8TAE	120-6-8	A-3			
W8TRX	45-3-7	A-5			
W8QQU	32-4-4	---			
W8TRV*	27-3-6	---			
W8KJG*	15-3-3	---			
W8JY*	-----103	---			
W8TY*	-----63	---			

W9ZOU	35844-58-322	B-36	W9BZT	27592-58-242	B-31
W9YJL	32091-57-280	B-33	W9QJB	22287-57-110	B-26
W9ZTL	23400-52-186	A-28	W9TXF	5830-36-58	A-27
W9ENK	4655-35-75	B-9	W9ESI	5680-40-71	B-18
W9DM	3728-21-47	A-10	W9YKH	5226-39-67	B-14
W9SWC	850-17-20	A-3	W9HKE	3132-29-54	B-13
W9NBX	45-3-6	A-3	W9YEL	210-7-12	A-4
			W9KSW	98-7-8	B-3
			W9PRA	30-5-3	B-1
			W9NMH*	2-1-1	B-1
			W9YJC*	2-1-1	---

DAKOTA DIVISION

North Dakota

W9RPI	44480-64-280	A-37
W9ZOU	35844-58-322	B-36
W9YJL	32091-57-280	B-33
W9ZTL	23400-52-186	A-28
W9ENK	4655-35-75	B-9
W9DM	3728-21-47	A-10
W9SWC	850-17-20	A-3
W9NBX	45-3-6	A-3

South Dakota

W9FOQ	33670-56-242	A-33
W9WUU	19538-49-162	A-38
W9YOB	15087-45-155-AB-31	B-28
W9SEB	13838-41-135	A-20
W9GLA	3300-30-55	B-32
W9DUC	1958-18-44	A-20
W9OXC	1478-18-41	B-1
W9KNV	1283-19-28	A-17
W9AKO	705-12-23	A-1
W9BLK	684-15-19	A-15
W9QVY	605-11-23	A-33
W9WLP	38-3-5	A-4
W9GCW	25-2-5	A-2
W9YNW	18-3-3	B-1
W9ANW	16-2-3	A-2

Phone

W9GUSH	32627-50-270	B-37
W9ADJ	13464-50-132	B-31
W9OXC	864-18-24	B-1
W9YKY	40-4-4	A-2

No. Minnesota

W9YCR	70293-62-457	A-39
W9PQP	63665-58-437	A-40
W9LHJ	31040-48-287	A-32
W9LAE	19681-47-169	A-40
W9GFE	17776-44-211	B-31
W9PQP	15494-43-180	B-30
W9DNY	12954-43-121	A-23
W9GRH	4425-30-61	A-24
W9WUQ	2065-25-38	A-21
W9WZG	931-15-31	---

Phone

W9UVA	21863-55-164	A-33
W9RLL	9338-46-107	B-23
W9GFR	2-1-1	B-1
W9OPA*	-----1	---

TAKE IT WITH YOU!



5-10 Meter Mobile Operation with the Browning Converter

Closely follows one described in June, 1939, OST by Thomas P. Chapman, W1KK. Rubber-cushioned mounting bracket and shielded leads supplied for dashboard mounting and connection to auto radio, which serves as IF and audio and supplies filament and plate voltage. Works equally well with stationary receivers.

- Separate coils for antenna and oscillator circuits for both 5 and 10 meters.
- Band switching.
- Antenna throw-over switch.
- All coils air trimmed and air tuned.
- Voltage stabilized.
- 2 1/4" "Sun Ray" vernier drive dial calibrated in approximate frequencies.
- Adjustable to cover frequency bands between 5- and 10-meter bands.
- Indirect dial lighting system facilitates non-glare night use.
- Dimensions only 4" x 6 1/4" x 4 1/4".
- Total current drain .45 amp. at 6 volts; 10 ma. at 250 volts.

**AMATEUR
NET**
\$24.90
Complete with 6K8,
laboratory wired
and tested

BROWNING LABORATORIES
WINCHESTER, MASS.

W9EYH	88250-60-576	A-40	W9ZTP	7750-31-100	A-12
W9RQM	79986-61-525	A-39	W9BQZ	7667-41-94	B-22
W9VDY	78075-60-525	A-40	W9PRA	7098-30-91	B-12
W9QIH	37500-60-252	A-31	W9DLJ	6831-33-105	B-25
W9JUE13	37332-51-385	B-40	W9UHZ	6800-33-82	A-14
W9QJC	36270-62-236	A-35	W9QGR	5530-29-80	A-16
W9YQM	30502-49-250	A-36	W9CPX	5180-28-75	A-30
W9CRK	30380-46-264	A-30	W9VWG	4350-29-75	B-23
W9AQZ	29070-51-233	A-40	W9VVQ	4060-28-58	A-15
W9UTT	27136-53-256	B-34	W9WSY	3998-26-63	A-6
W9RRT	26468-52-260	B-36	W8BSS	3444-19-75	A-12
W9GIL	23292-57-178	B-20	W9YXH	3009-21-54	A-6
W9RPW	22372-47-240	B-29	W9VDD	2160-24-45	B-7
W9NKT	20909-43-198	A-34	W9QYI	2100-21-40	A-14
W9DBI	19750-40-201	A-40	W9LUC	2070-23-36	A-8
W9YMG	16848-52-162	B-27	W9RSR	1995-21-40	A-15
W9KXK	15120-48-158	B-37	W9DWI	1628-22-40	B-4
W9VSO	13056-34-192	---	W9LFK	1598-14-57	A-14
W9YCV	12826-46-154-AB-21	---	W9DYO	1445-17-34	A-1
W9ITJ	12581-33-154	A-24	W9QCN	1220-16-31	A-8
W9DKH	11895-39-154	B-22	W9EER	945-14-27	A-9
W9HMO	10815-29-145	A-17	W9WZA	660-12-24	A-4
W9LZL	10281-35-119	A-11	W9MNF*	510-12-17	A-3
W9HMU	9180-34-110	A-28	W9JPS	507-14-15	A-4

(Continued on next left-hand page)

Question

April 15, 1940

Dear OM:
 Kindly inform me of the
 best. low-power phone
 hook-up that will radiate
 2.5 amps or more.

Sincerely
 George J. Speakman

3941-12th Ave,
 Intervale, Pa.

FRANK A. WELSH, 4457 CHESTER
 E. L. HARRIS, 4100 CHESTER AVE. PHILADELPHIA

HELEN B. WARD, 1000 BUREAU Bldg. BALTIMORE

THE AMERICAN RADIO RELAY LEAGUE

ADMINISTRATIVE HEADQUARTERS
 WEST HARTFORD, CONNECTICUT, U.S.A.

April 19, 1940

Mr. George J. Speakman,
 3941 Twelfth Ave.,
 Intervale, Pa.

Dear OM:

It is quite unusual to classify amateur transmitters in the manner referred to on your post card. It is customary to think in terms of watts output. The output can be very closely approximated by assuming that the amplifiers will work at an efficiency value of 60 to 75 percent. Therefore, the required input necessary to furnish a given output can be readily calculated. Antenna current is not a true indication of power output inasmuch as the reading will depend upon several factors, such as the type of antenna, location of the meters, etc.

It is suggested that you turn to the transmitter construction chapter of the 1940 Handbook after you have decided upon the power which you wish to employ. You will find a large variety of transmitters described in this section of the Handbook, and it will be a simple matter to choose one which meets your demands. The modulations-equipment chapter will supply the circuit and constructional details of the audio equipment which may be used in conjunction with any r.f. layout you select. A third chapter devoted to power supplies will explain the design of the necessary power equipment.

Incidentally, OM, you are bound to be interested in the Complete Transmitter Chapter which explains how several units shown in the Handbook can be combined to furnish complete 'phone-c.w. transmitters. Fortunately, the connections between units are clearly explained. After the construction has been finished, the Handbook adjustment, operation and antenna chapters will be invaluable.

Best of luck - and please write to us whenever we can be of help to you.

73,
 Vernon Chambers
 Vernon Chambers,
 Technical Information Service

Answer

The files of the A.R.R.L. Technical Information Service provide our best "sales talk" for the Handbook. The answers to most questions are to be found in the Handbook. You should have this "information service" right at *your* fingertips.

The Radio Amateur's Handbook is priced at \$1, postpaid in Continental U.S.A.; \$1.25, postpaid, elsewhere. Buckram Bound Edition, \$2.50, postpaid, anywhere.

AMERICAN RADIO RELAY LEAGUE, Inc.
 West Hartford, Connecticut

**DEPENDABLE
•
ACCURATE
•
ACTIVE
•
PRECISION
MADE**

BLILEY

B5

CRYSTAL UNIT *for* 40 METERS

ASK YOUR BLILEY DISTRIBUTOR FOR A COPY OF CIRCULAR A-7

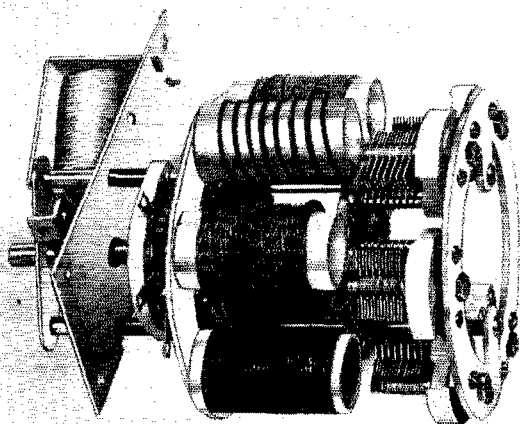

The
**SENSATION
OF AMATEUR RADIO**

The
INDUCTO-CAP TURRET

To the push button operated inductor bandswitch COTO now adds the convenience and simplicity of a capacitor turret. Each condenser is wired to its respective inductor forming a pre-tuned LC circuit on all five bands.

Include COTO INDUCTO-CAPS in your rig and experience the thrill of hopping from band to band with the push of a remote button. No plug-in coils and no retuning.

Other models of magnetic switches for all sorts of purposes. See them at your nearest jobber or write for

BULLETIN No. 800

COTO-COIL CO., Inc.

71 WILLARD AVENUE, PROVIDENCE, R. I.



Not only in May, but day in and day out, 12 months in the year you'll find SUN giving the same sweet satisfaction to its customers—a satisfaction well-merited from plus-perfect service. At SUN, all you pay for are the goods. We throw in the service FREE. Big gobs of it, too.

In the Spring

HEAD FOR THE WIDE-OPEN SPACES
with PORTABLE EQUIPMENT

ABBOTT 2½ METER TRANSCEIVER

A complete, self-contained 112 mc. radiophone transmitter and receiver. Amateur Net Price (less tubes and batteries) **\$16.17**

Descriptive circular on request

GENERAL ROTARY ELEMENTS

FOR 10-20 METERS — GET YOUR ANTENNA UP EARLY!
Also COMPLETE ACCESSORIES — IN STOCK

Send for your copy of latest catalog and price list

LATEST RECEIVERS — JUST OUT!

R.C.A. AR-77, 10 tubes, 540-31,000 Kc. coverage, Dual R.F. alignment, calibrated band spread, variable selectivity. **\$139.50**
noise limiter, Amateur Net Price (less speaker).....

HALLICRAFTERS S-27, First general-coverage U.H.F. receiver to incorporate Frequency Modulation, 3 bands: 27-46 Mc.; 45-84 Mc.; 81-145 Mc. Complete with tubes. **\$175.00**
Amateur Net Price.....

OTHER FAMOUS RECEIVERS IN STOCK

HALLICRAFTERS SX-25, Complete, Amateur Net Price \$99.50
HAMMARLUND HQ-120X, 6 bands, Amateur Net Price \$138.00
HAMMARLUND "200" SUPER-PRO, Amateur Net Price \$279.00

NEW TRANSMITTER — Hallicrafters HT-9

Rated at 100 Watts C.W. and 75 Watts on Phone. **\$199.50**
5 bands, Amateur Net Price, less coils and crystals....

TIME PAYMENTS

★ All receivers and transmitters may be purchased on SUN'S EASY PAYMENT PLAN. Write us for full particulars. ★

BLILEY VARI-X CRYSTAL OSCILLATOR
with VF-2 CRYSTAL UNIT

NOW! ACHIEVE FREQUENCY FLEXIBILITY ON 40 or 80 METERS

Amateur Net Price (less tubes and crystals)..... **\$29.90**

REDUCED IN PRICE!

RAYTHEON RK-49 — formerly \$2.10 — NOW! only.... **\$1.25**
Ideal for Ultra High Frequency circuits. Ceramic base.

JUST TRY US ONCE FOR SERVICE!

We'll bet you'll remain a satisfied customer!

NEW YORK'S OLDEST "HAM" HOUSE

W2JEH — W2DXC — W2LFV — W2GCX

W2GZS	9635-33-121-	A--	W2IB	392-14-17-	B-12
W2EYV	9315-36-104-	A-17	W2OPJ	90- 6- 6-	A--
W2FTK	9071-41- 95-	A-16	W2GFA	50- 4- 5-	A- 7
W2KLC	9040-32-116-	A-39	W2MNT	38- 3- 5-	A- 1
W2GYX	8550-45- 76-	A-19	W2LJR	-----14-	---
W2HDC	7250-29-100-	A-14	W2CNZ*	-----8-	---
W2HBO	6750-27-100-	A-19	W2MLV*	-----8-	---
W2MEM	6300-28- 92-	A-29	W2HRN*	-----7-	---
W2BGO	4713-26- 77-	A- 7	W2HCO*	-----4-	---
W2BYE	4406-25- 74-	A-19	W2CJX*	-----2-	---
W2DCW	4310-25- 73-	A-15	W2JDC*	-----2-	---
W2KSW	4050-27- 60-	A-22			
W2LCL	3578-27- 54-	A-10			
W2AVS	3203-21- 61-	A- 8			
W2KZX	3105-23- 55-	A-13			
W2CJY	2599-27- 39-	A- 7			
W2LJC	2536-26- 41-	A-15			
W2KXB	2395-22- 43-	A-10			
W2KFA	2318-18- 52-	A-19			
W2KFW	2228-19- 47-	A-10			
W2LXD	2118-22- 39-	A-10			
W2HSV	1755-13- 39-	A-27			
W2AEC	1665-13- 37-	A- 5			
W2LHJ	1482-17- 43-	B- 5			
W2LKR	1240-16- 31-	A-12			
W2MCI	1140-16- 30-	A-13			
W2LGI	844-15- 23-	A- 3			
W2APM	704-11- 32-	B-12			
W2EC*	592-14- 19-	B- 2			
W2LPA	400-10- 16-	A- 3			
W2HHW	394- 9- 13-	A- 4			
W2LLI	380- 9- 16-	A- 2			
W2KWR	210- 7- 13-	A- 7			
W2LGG	105- 6- 7-	A- 4			
W2HVD	72- 4- 9-	A- 3			
W2HGO	58- 6- 7-	A-B- 3			
W2LLE*	-----51-	---			
W2CPT*	-----11-	---			
W2CZM*	-----5-	---			
W2DUS*	-----4-	---			

Phone

W2JUT	25300-55-232-	B-19
W2IMT	10114-31-132-	A-29
W2MCF	4090-16-102-	A-31
W2MJC	3422-29-160-	B-12
W2IUV	3300-33- 50-	B- 1
W2KPV	1054-17- 31-	B-12
W2KZW	640-16- 20-	B-14
W2ITD	38- 4-11-	B- 4
W2IQY	64- 4- 9-	A- 3
W2KMK*	40- 4- 4-	A- 1
W2MNT	5- 1- 2-	A- 1
W2MPA*	-----7-	---

Midwest Division

Iowa		
W9GKS	55440-63-355-	A-40
W9ZDS	41820-60-360-	B-36
W9ZQW	39005-58-270-	A-33
W9LDD	21432-57-188-	B-40
W9QHP	15570-36-177-	A-31
W9BYC*	14288-47-152-	B-32
W9YQV	10552-42-103-	A-24
W9QVA	8820-36- 98-	A-18
W9WMP	3663-35-101-	A-22
W8REB/9	3200-32- 90-	A-13
W9SCA*	7120-24- 52-	A-11
W9JAP	2422-19- 51-	A- 1
W9GCL	1810-17- 31-	A-10
W9NYX	1523-21- 29-	A- 7
W9SEF	1238-15- 33-	A- 3
W9BRB*	1050-20- 24-	A- 1
W9MLG	101-14- 27-	A-12
W9LVU	170- 8- 9-	A- 8
W9NRR*	75- 5- 6-	A- 1
W9VFM	63- 5- 5-	A- 3
W9YQQ*	2- 1- 2-	---
W9BLC	-----76-	A- 1
W9KCL	-----52-	A- 1
W9JDV*	-----5-	---

Phone

W9JHS	3193-31- 56-	B-16
W9TJA	1470-21- 28-	A- 4
W9ATF	1448-22- 52-	A-B- 1
W9PNT	769-15- 27-	A-13
W9KCL	60- 4- 6-	A- 1

Kansas

W9GWV	67725-63-430-	A-40
W9AWP	61500-60-410-	A-40
W9VBQ	54290-61-357-	A-36
W9QXQ	49225-55-359-	A-40
W9WCB	36322-53-251-	A-35
W9ZED	25480-49-200-	A-40
W9QIM	22417-49-183-	A-32
W9CWL	18630-54-138-	A-32
W9OWZ	8720-40-122-	B-32
W9WIM	8595-36- 96-	A-18
W9MKU	7290-38- 83-	A-26
W9OZM	6471-31- 84-	A-12
W9CMY	5016-28- 85-	A-11
W9SIL	2306-25- 30-	A-10
W9VZR	1672-22- 38-	---
W9JGG	192- 8- 13-	A- 5
W9TPF	32- 4- 4-	---
W9AWB*	-----130-	---
W9OAQ*	-----61-	---
W9AEF	-----5- 6-	---

Phone

W9PNX	21340-55-194-	B-39
W9ZAW	10428-43-101-	A-18
W9LVZ	7588-43- 90-	B- 1
W9PAH	4680-39- 61-	B-13
W9QQT	841-14- 24-	A-17

Missouri

W9RSO	76097-61-490-	A-39
W9PGI	31313-50-251-	A-40
W4FWW/g*		
W9Z50	27250-50-220-	A-32
W9GBJ	24440-52-235-	B-28
W9QMD	22736-56-207-	A-85
W9LWG	19800-55-180-	B-34
W9AUB	14220-48-119-	A-34
W9HIC	13061-43-122-	A-24

(Continued on next left-hand page)

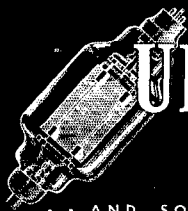

UNITED

TRANSMITTING TUBES

AMATEUR, BROADCAST, COMMERCIAL, DIATHERMY, ELECTRONICS, FILM — SOUND

• AND SO ON THROUGH THE ALPHABET OF POWER TUBE APPLICATIONS —

VERSATILE 70-D

★ INCREASE YOUR POWER with minimum cost and effort if you have been using the lower power types with 40 to 55 watts plate rating.

This heavy duty V70-D has same base style, and 7½ volt filament. It drives easily, and its similar inter-electrode capacities make neutralizing simple when used in place of these smaller tubes.

★ NONEX means non-expansion and high melting point. To be sure a tube is made of NONEX glass, look for tungsten seal wires, rather than copper clad which is used with soft glass. The expansion coefficient of soft glass is 3 times as high as NONEX. This fixes a correspondingly lower limit of safe plate dissipation and input in all soft glass tubes.

\$7.25



VALUING COMPARISONS, V70-D

70 watts plate dissipation
★ Hard glass (Nonex) envelope and stem
Heavy gauge tungsten seal wires
SPEER graphite anode ■ 300 watts plate input

MAXIMUM RATINGS PER TUBE

	R. F. Amplifier Class C Telephony		R. F. Amplifier Class C Telephony	
	*CCS	†ICAS	*CCS	†ICAS
Eb	1000	1500 volts	1250	1500 volts
Ec	—260	—260 volts	—260	—260 volts
Ib	165	170 mils	200	200 mils
Ic	40	40 mils	40	40 mils
Input	165	255 watts	250	300 watts

*CCS—Continuous commercial service.
†ICAS—Intermittent commercial and amateur service.
Filament: 7.5 volts—3.2 amperes.

Amplification factor 20; Rp—7500 ohms; GM—2560 umhos.

Inter-electrode capacitance (MMF) G-P 4.5; G-K 4.5, P-K 1.75.

(Cable "UNELCO")

UNITED ELECTRONICS COMPANY

42 SPRING ST., NEWARK, N. J.

ABBOTT • DK2 •

2½ METER TRANSCIEVER



Ideal for spring and summer portable operation — simple and convenient

List Price **\$27.50**

Less Tubes and Batteries
40% Discount to Amateurs

GENERAL: The DK2 is a completely self-contained 112 mc radiophone transmitter and receiver, for use in your car,

plane, boat, or while being carried, for portable work. It is very simple to operate. The working range is between 2 to 30 miles depending on the location. Astonishing results have been obtained.

SPECIFICATIONS

CASE: Size 11½" long x 9½" high x 6½" wide, grey wrinkle finish metal, heavy leather handle. All batteries are self-contained in case. Removable side panel for easy access to the batteries and tubes.

FREQUENCY: Will cover 112 mc to 118 mc (amateur 2.5 meter band).

BATTERY REQUIREMENTS: Three 45 volt B batteries like Burgess 5308; and four No. 6 dry cells, or two Burgess 2F2H batteries.

TUBES USED: One type 6J5GT_x, one type 6G6G.

SHIPPING WEIGHT: 12 pounds.

For car use can be operated from vibrator power supply with an input of 6 to 7 watts

BULLETIN ON REQUEST

ABBOTT INSTRUMENT, INC.

51 Vesey Street

New York City

Aviation MONITOR
Police MONITOR
Marine MONITOR
Amateur MONITOR

MONITOR PROVIDES THE CRYSTALS WHERE DEPENDABILITY COUNTS!

YOUR INQUIRIES ARE SOLICITED AND PROMPTLY ANSWERED

monitor *Pasadena* Products Co.

1138 MISSION ROAD, SO. PASADENA, CALIF.



★ 2½ Meter TRANSCEIVER KIT

with drilled panel and chassis complete with recommended parts and tubes as described by Mr. Vernon Chambers W1JEQ in April QST. Kit supplied completely assembled and ready for wiring. . . . **\$14.95 net**

Set of Batteries consisting of four Eveready long life Mini-Max B Batteries and one 6-Volt A Battery. . . . **\$4.72 net**

MARION METERS

0-1 MA movement. . . . **\$2.85 net**
Shunts, multipliers and scale for converting to Volt-Ohm-Milliampere. . . . **\$1.75 net**

New ASTATIC Crystal Pick-up. . . . **\$2.94 net**

Kit of Adapter Parts for

Frequency Modulation

Complete Kit with power supply, punched and drilled chassis. . . . **\$21.50 net**
Tubes. . . . **7.45 net**
Wired and aligned with tubes. . . . **40.00 net**

WRITE FOR DATA

LET'S TRADE

Our camera department is ready to make fair trade-in allowances on camera equipment for radio . . . or radio gear for cameras . . . What have you?

W2JL W2LJA W2KWY

OUR *Best* VALUE IS OUR RECORD OF LOYAL SERVICE

HARVEY

Radio Company of New York

103 WEST 43rd STREET • NEW YORK, N. Y.

CABLE ADDRESS: "HARADIO"

W9AEJ	11993-41-118-	A-32	WILKE	360-9-16-	A-3
W9TBU	8603-37-93-	A-22	WIMFN	270-8-14-	A-5
W9EYM	5270-31-68-	A--	WIGME	175-7-10-	A-2
W9IND	5220-36-58-	A-11	WIDLX*	75-5-6-	A--
W9JKI	4620-28-67-	A-17	WIATH	50-4-5-	A-3
W9WCM	4480-32-70-	B-9	WIACV	10-2-2-	A--
W9OUD	3840-32-60-	A-12	WIKOY*	2-1-1-	--
W9GMI	3600-30-48-	A-11	WITS ²⁷	83120-64-520-	A-40
W9QAG	2258-21-43-	A-11	WIUEP ²⁷	48000-60-321-	A-40
W9KIK	2200-22-40-	A-16	WILVQ ²⁷	19170-36-213-	A-26
W9QUY	2000-20-40-	A--	WIJMY ²⁷	13500-36-151-	A-18
W9KSM	1823-18-41-	A-12	WIAW ²⁷⁻²⁸	8774-41-107-	B--
W9ZGS	840-14-30-	--	WIBDI ²⁷	1534-26-30-	B-6

W9BNB ²⁵	403-7-24-	A-7	Phone		
W9NSU	380-8-19-	A-8	WIDDC	15785-55-144-	B-34
W9SOM	250-8-13-	A-6	WIEAO	1216-41-80-	B-24
W9NIP	60-5-6-	B-3	WIEUG	1234-17-36-	B-7

W9KOH	15126-46-181-	B-37	WIDWP	840-15-28-	B-6
W9UYD	13197-53-125-	B--	WIACV	560-14-16-	A-3
W9YAV	686-14-25-	B-10	WITFI	540-9-24-	A--
W9HGB	36-3-6-	--	WIKNY	480-12-20-	B-6
			WIAPA	416-13-16-	B-8
			WIWR	220-10-11-	B-8
			WILTZ	10-1-4-	A--
			WIAW ²⁷⁻²⁹	882-18-25-	B--

Nebraska			WISAG	17138-38-229-	B-39
W9ZAR	78818-62-510-	A-40	WILSK	14456-45-129-	A-24
W9ASO	70478-81-462-	A-39	WICRP	13505-37-146-	A-30
W9ZRP	67329-61-444-	A-40	WIRB	9180-34-108-	A-30
W9MGV	34128-54-320-	B-39	WICBU	6000-24-101-	A-20
W9ARE	23220-55-212-	B-18	WIMDF	5156-25-85-	A-35
W9AZT	19068-52-193-	B-23	WILML	3563-19-76-	A-20
W9QNP	15700-50-157-	B-28	WILMQ	220-8-12-	A-4
W9WPF	12416-43-116-	A-23	WIKVK	36-4-7-	B-1
W9DNW	12400-40-127-	A-24	WIDHH	50-5-5-	B--
W9CGS	8443-43-93-	B-21	WIGXY	1-1-1-	--
W9BZG	6384-38-85-	B-14	WIBU*	-- -- --	-- --
W9RQS	4800-40-60-	B-16			
W9DKC*	875-12-13-	A-9			
W9MTI	175-7-10-	A-5			
W9RYV	130-5-13-	B-2			

W9ZVX	21708-54-201-	B-40	Phone		
W9GDB	15480-48-137-	A-30	WICOM	5928-39-76-	B-15
W9KQX	15360-48-130-	A-20	WIDHH	1037-17-31-	B-9
W9MLB	6982-38-79-	A-14	WILWX	158-7-9-	A-8
W9LEF	439-11-16-	A-9			
W9ARE	45-5-5-	B-1			
W9DMY	8-2-2-	--			

W9ZVX	21708-54-201-	B-40	WISAG	17138-38-229-	B-39
W9GDB	15480-48-137-	A-30	WILSK	14456-45-129-	A-24
W9KQX	15360-48-130-	A-20	WICRP	13505-37-146-	A-30
W9MLB	6982-38-79-	A-14	WIRB	9180-34-108-	A-30
W9LEF	439-11-16-	A-9	WICBU	6000-24-101-	A-20
W9ARE	45-5-5-	B-1	WIMDF	5156-25-85-	A-35
W9DMY	8-2-2-	--	WILML	3563-19-76-	A-20
			WILMQ	220-8-12-	A-4
			WIKVK	36-4-7-	B-1
			WIDHH	50-5-5-	B--
			WIGXY	1-1-1-	--
			WIBU*	-- -- --	-- --

NEW ENGLAND DIVISION

Connecticut			WILYQ	3568-87-315-	B-40
W1KQY	61180-56-437-	A-39	WIBVJ	32330-61-212-	A-40
W1DOV	59010-56-423-	A-35	WIBFB	28356-51-279-	B-39
W1BIH	45600-60-383-	B-40	WIMBP	27500-55-251-	B-37
W1KFN	43120-44-392-	A-34	WIBSG	27300-56-195-	A-30
W1FMV	37520-56-268-	A-29	W1JSM	26838-38-284-	A-34
W1JJR	33258-53-251-	A-38	WILX ³⁰	26400-50-265-	B-39
W1AMQ	28665-52-221-	A-27	W1JOX	26044-45-232-	A-38
W1CSY	26910-46-234-	A-36	W1JEA	24354-54-229-	B-40
W1IED	23430-55-216-	B-22	W1KQU	18612-47-203-	B-32
W1CSC	21840-42-260-	B-26	W1BDU	15985-46-139-	A-29
W1KRV	17987-45-160-	A-33	W1QF	15533-43-147-	A-21
W1JKB	14060-36-157-	A-16	W1JZN	11305-38-120-	A-20
W1GVK	13427-41-132-	A-18	W1HY	10658-42-102-	A-21
W1BYW	11780-31-152-	A-18	W1KMY	8316-42-101-	B-33
W1LTB	10295-29-144-	A-27	W1JNV	7503-42-122-	AB-20
W1IOE	8694-37-90-	A-17	W1LWH	7261-29-201-	A-21
W1LZM	8400-28-120-	A-15	W1WV	7120-40-89-	B-20
W1TD	6755-28-97-	A-20	W1EPE	6750-27-100-	A-20
W1HS	6300-30-84-	A-25	W1HET	6728-26-110-	A-22
W1BHM	5740-35-82-	B-12	W1IGA*	6420-24-107-	A-17
W1JYW	5363-26-83-	A-17	W1LQQ	5600-28-100-	B-19
W1CTI	3850-22-70-	A-6	W1KPB	5280-33-81-	B-17
W1KDK	3820-22-67-	A-21	W1HET	4216-34-62-	B-15
W1MGC	3064-19-65-	A-29	W1MCF	3654-35-75-	AB-15
W1LZT	1935-18-43-	A-10	W1LXB	3577-27-53-	A-16
W1LQK	1550-20-32-	A-23	W1DMG	3415-21-66-	A-8
W1UZ	1318-17-32-	A-3	W1JFX ³¹	3370-20-71-	A-14
W1KDO	1050-15-28-	A-7	W1JBO	3245-22-58-	A-15
W1GYT ³²	784-14-28-	B-4	W1MAN	2944-15-80-	A-16
W1CGD	688-11-25-	A-6	W1LZZ	2010-22-37-	A-18
W1AGT	600-12-20-	A-2	W1ALP	1993-17-47-	A-15
			W1IQH	1806-21-43-	B-8

(Continued on next left-hand page)



The NEW Edition of
**HOW TO BECOME A
RADIO AMATEUR**

*Universally recognized as the standard elementary guide
for the prospective amateur*

This new enlarged 8th Edition makes the book even more valuable than before

THE opening pages are devoted to an explanation of amateur radio, of its competitive phases and the thrill of distant communication. The next section tells how radio works, giving an elementary explanation of electric current, resistance, coils, condensers, resonance, tuning, radiation, vacuum tubes as detectors, amplifiers, oscillators. Then you move on to an explanation of the amateur bands, with a chart showing the various bands assigned for amateur use. In this new edition two different methods of memorizing the code are shown, together with suggestions on ways of acquiring speed in reading the code.

The construction of a complete station for the beginning amateur is described, in fact, two complete outfits are shown, one built on wood and the other on metal, the builder being given his choice of the material with which he prefers to work. Plenty of illustrations and large-labelled photographs make it easy for you to understand the construction. The receiver is a simple yet efficient unit, the operation of which is explained in detail before construction is begun. It is first shown in wooden breadboard style, in this form it may be built for about \$11.00. This receiver using the same parts is also shown built in a metal cabinet. Details for the winding of the coils are

so complete that there is little chance of making a mistake. You are told how to use the receiver and how to understand what you hear.

The next section is devoted to the construction and operation of the transmitter. For the transmitter, as for the receiver, there are the keyed photographs and complete constructional details of either the breadboard or cabinet type of unit. The transmitter, including the power supply, can be built for approximately \$22.00. It, too, can be built on either wood or metal.

In addition the book tells you exactly how to test out each unit after it is built. There should be no question of your ability to make each of these units work. Full information concerning adjustment is given. Various types of antennas which can be used are shown, from these the one most suited to any location can be selected. A chart gives the exact specifications and dimensions for each type.

The concluding section describes the procedure in getting the requisite federal licenses, the cities where examinations are given, and the general requirements. It also gives tips on operating technique for your guidance when you put your station on the air for the first time.

For the man who wants to become a radio amateur, here is

**HOW TO BECOME A
RADIO AMATEUR**

25 cents postpaid

(No stamps, please)

AMERICAN RADIO RELAY LEAGUE, INC., WEST HARTFORD, CONN.

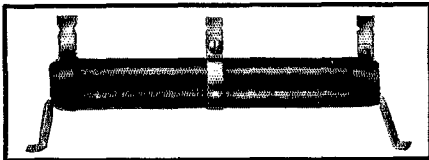
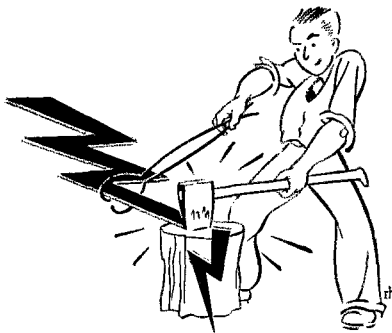

ADJUSTOHM RESISTOR

Adjustable contact saves purchasing an assortment of fixed resistors. Available from 10 to 200 watts.

Send for circular 507

WARD LEONARD ELECTRIC COMPANY

41 South Street Mount Vernon, N. Y.

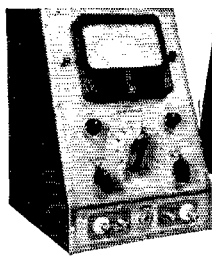

NEW PUSH-PULL ELECTRONIC VOLTMETER-OHMETER
 .05-5000 Volts DC in 9 Ranges!
 .01 Ohm-1000 Megohms in 7 Ranges!

IT'S THE *Rider Volt-Ohmyst!*

Here's a laboratory instrument with ranges so wide it will not only take care of today's engineering requirements—but tomorrow's as well.

It's the Rider Volt-Ohmyst and with it you can measure DC voltages in high resistance photo-cell circuits, television circuits, bias cells, operating voltages across tuned circuits with the signal present—with surprising speed and accuracy. No zero re-set! This instrument measures the actual operating voltage. No circuit loading. Its extremely high input resistances—16,000,000 ohms between .05 and 500 volts and 160,000,000 ohms between 500 and 5,000 volts—makes the Rider Volt-Ohmyst a universal instrument—one that truly *minimizes obsolescence*. Get full details and specifications from your RCA Test Equipment Distributor—or write to the address below. The Rider Volt-Ohmyst is Stock No. 163—net price \$57.50.

More than 3500 RCA Rider Chanalysts are now in use



Test Equipment

RCA Manufacturing Co., Inc., Camden, N. J.
 A Service of Radio Corporation of America

WIKVB	1317-17-	31-	A--	WILWB	300-8-	16-	A-4
WILRO	1080-18-	20-	A--	WILYE	50-4-	5-	A-1
WILYL	810-18-	19-	A-14	Phone			
WILAO	564-13-	19-	A--	WILBV	1-1-	1-	--
WIALG	560-14-	21-	B-4	Vermont			
WILBW	500-10-	20-	A--	WLEZ	74865-62-483-	A-40	
WIFSK	344-11-	13-	A--	WIKTB	36620-54-272-	A-38	
WIRH	330-11-	15-	B-2	WIEJK	20050-40-202-	A-30	
WIJXU	280-8-	14-	A--	WIKOO	1932-41-191-	A-36	
WIKVP	228-7-	13-	A-5	WIKIE	15085-36-171-	A-23	
WIBSM	162-9-	9-	B-3	WIVJS	4440-20-111-	B-14	
WILZX	30-3-	4-	A-1	WIBJB/1	1768-18-40-	A-8	
WIFZH*	10-2-	2-	A-1	WIBZS	880-16-23-	A-10	
WIKYX*	8-2-	2-	A--	WIKJG	80-4-	8-	A-6
WILNN	3-1-	1-	A-2	Phone			
WILVV	-----	171-	----	WIBJB/1	705-12-	24-	A-10
WILXO	-----	106-	----	WIFGO*	2-1-	1-	----
WIPH	-----	28-	----				
WILJT*	-----	10-	----				

Phone				NORTHWESTERN DIVISION			
WIJNX	12358-43-	144-	AB-32	Alaska			
WIWZ	5920-40-	75-	B-26	K7GOM	7118-39-	74-	A-24
WIJXC	5576-41-	89-	B-17	K7HJL*	-----	24-	----
WIAAR	2304-10-	63-	B-18	Phone			
WIJCI	1020-17-	30-	B-14	K7HQZ	2-1-	1-	----
WIJOM	675-12-	23-	A-18	Idaho			
WIERH	648-12-	27-	B-6	W7GDU	42406-59-288-	A-36	
WILOK	300-8-	15-	A-6	W7UCS	41850-62-271-	A-37	
WILEA	240-8-	15-	B-9	W7GHT	7827-31-101-	A-25	
WIVV	132-6-	11-	B-1	W7HDI	956-9-	42-	A-4
WIALB	90-6-	6-	A-3	W7HBN	368-7-	21-	A-4
WIHLL	90-6-	6-	A-6	W7GXC	128-6-	9-	A-3
WIIYW*	50-5-	5-	----	Phone			
WIEZL*	12-2-	2-	----	W7FQT	14750-50-154-	B-28	
WIHW*	8-2-	2-	----	W7GGH	613-14-	18-	A-3

W. Massachusetts				Montana			
WIEOB	66220-61-	408-	A-37	W7JC	47100-60-398-	B-40	
WIKZS	26372-47-	229-	A-37	W7GRR	30730-54-228-	A-33	
WIFNY	26370-36-	292-	A-38	W7FMY	15015-44-139-	A-27	
WIFKI	19140-44-	219-	B-33	W7HCV	13916-49-144-	B-22	
WIBIV	18953-42-	182-	A-32	W7HEM	11914-46-134-	B-30	
WIAZW	18050-38-	190-	A-26	W7ROD	9250-26-	51-	A-14
WILLN	16246-41-	160-	A-40	W7GLM	2925-25-	39-	A-14
WIJLT	16072-49-	163-	B-27	W7BWR	728-13-	29-	B-6
WICGY	15238-46-	130-	A-34	W7CT	120-6-	8-	A-4
WIGRK	10764-46-	117-	B-17	W7HPC	85-4-	9-	A-8
WIDCH	7020-26-	108-	A-18	W7FSP*	50-4-	5-	A--
WIAJ	6840-38-	90-	B-15	W7FTV	40-4-	4-	A-2
WILKU	5203-29-	74-	A-21	W7GWO	37-3-	5-	A-3
WILHY	4758-22-	88-	A-13	W7CPY	8-2-	2-	B--
WIKIK	3798-31-	49-	A-4	Phone			
WIBKG	3300-22-	60-	A-6	W7FLT	18296-52-146-	A-40	
WIKJO	3010-19-	66-	A-7	W7EOI	15016-56-145-	B-22	
WIKOS	2940-21-	57-	A-36	W7CT	1750-25-	35-	B-20
WIBDV	812-13-	25-	A-3	W7BOZ	350-10-	14-	A-4
WIKKT	15-2-	2-	A-1	W7FTV	40-4-	4-	A--
Phone				W7CPY	20-2-	5-	B--
WIAUN	5166-42-	63-	B-26	W7DEN	10-2-	2-	A-1
WIBDV	1120-14-	32-	A-10				

New Hampshire				Oregon			
WIBFT	81208-62-	526-	A-30	W7DZL	43403-54-323-	A-38	
WIFTY	49445-62-	319-	A-49	W7GPP	42488-55-315-	A-36	
WIAWU	16421-29-	227-	A-20	W7EGP	30472-51-240-	A-40	
WIKIN	3138-31-	105-	A-9	W7ECI	22875-50-183-	A-39	
WIKLV	6006-33-	92-	B-21	W7FPR	8908-39-	162-	AB-26
WIP	5938-25-	95-	A-9	W7GVG	8704-33-	106-	A-28
WIEAL	5014-23-	109-	B-21	W7GYU	8282-41-	102-	B-24
WIIDP	4500-24-	78-	A-25	W7GUR	5655-29-	79-	A-4
WIEWF	4700-30-	70-	B-13	W7BOH	4648-26-	72-	A-20
WILIN	1732-21-	83-	A-14	W7HON	1860-17-	45-	A-15
WIMGH	1065-12-	36-	A-16	W7LT	846-9-	47-	B-19
WIKLV*	363-10-	15-	A-2	W7GUP*	-----	25-	----
WIDUK*	5-2-	2-	A--	Phone			
Phone				W7GNJ	13008-48-	136-	B-30
WIAWE	21417-59-	184-	B-36	W7GVX	5282-34-	63-	A-15
WILJB	11040-46-	120-	B-27	W7ADH	1344-24-	28-	B-3
				W7ENC*	1-1-	1-	----

Rhode Island				Washington			
WIKOG	33705-42-	322-	A-36	W7GMB	76073-63-485-	A-40	
WIAQ*	32240-52-	310-	B--	W7AYO	52320-60-436-	B-38	
WIKYK	31569-34-	311-	A-39	W7EK	44820-60-376-	B-37	
WIBBN	24475-55-	230-	B-35	W7RTV	44310-56-324-	A-38	
WIKWA	20600-40-	206-	A-19	W7RT*	35057-59-267-	AB--	
WILAB	20250-45-	226-	B-21	W7AKP	31980-60-289-	B-40	
WILIV	13479-41-	132-	A-30	W7RFQ	30505-52-237-	A-26	
WILDL	11850-30-	158-	A-10	W7HAD	20250-45-	180-	A-36
WIKRQ*	5504-32-	87-	B-16	W7GUV*	18914-49-	193-	B--
WIBLS	3810-30-	64-	B-18	W7FOG	14847-49-	152-	B-29
WIMBM	3125-25-	50-	A-21	W7HBL	13110-38-	140-	A-22
WIBOF	2875-23-	50-	A-9	W7WU	9343-37-	102-	A-25
WIAOP	1825-20-	38-	A-5	W7GVP	9000-36-	100-	A-23
WILCV	1350-15-	36-	A-7	W7HFF	8145-36-	91-	A--
WIAEI	1200-15-	32-	A-6	W7ELC	6743-29-	93-	A--
WILQA	1063-17-	25-	A-5	W7GWT*	6126-29-	86-	A--

(Continued on next left-hand page)

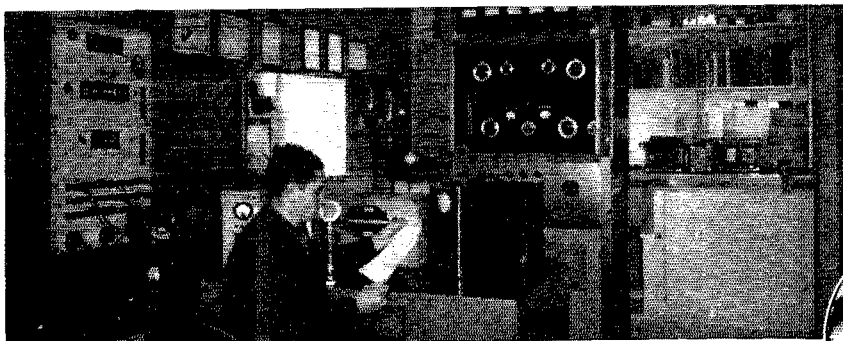

Maurice E. Kennedy,
W6KQ, 415 W. Lexington
Drive, Glendale, Cali-
fornia

MICROPHONES THAT STAY YOUNG

Model D-104 Never Grows Old

Microphones may come and microphones may go, but Model D-104, the "oldest" member of the Astatic Microphone family, stays young, vigorous and efficient. Long the preference of a great host of veteran amateurs, Model D-104, included along with many later models, continues in demand. Years of dependable performance have made this sturdy, "tested and true" microphone a grand favorite.

See Your Jobber or Write for Catalog

ASTATIC MICROPHONE LABORATORY, INC.

In Canada: Canadian Astatic Ltd.,
Toronto, Ontario

YOUNGSTOWN, OHIO

Crystal Products Licensed Under Brush Development Co. Patents

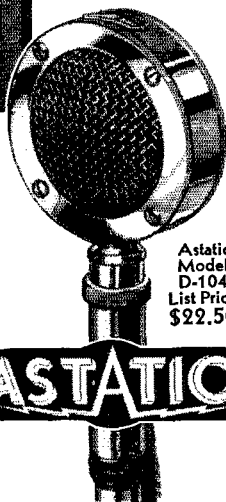

Astatic
Model
D-104
List Price
\$22.50

ASTATIC

RADIO

ENGINEERING, broadcasting, aviation and police radio, servicing, marine radio telegraphy and telephony, Morse telegraphy and railway accounting taught thoroughly. 48 weeks' engineering course, equivalent to three years of college radio work. School established 1874. All expenses low. Catalog free.

DODGE'S INSTITUTE, Day Street, Valparaiso, Indiana

EASY TO LEARN CODE

It is easy and pleasant to learn the modern way — with an **Instructograph Code Teacher**. Ideal for the beginner or advanced student. ■ Many tapes available ranging from alphabet for beginners to typical messages on all subjects. Speed range 5 to 40 W.P.M. ■ Always ready, no QRM, beats having someone send to you.

FOR SALE OR RENT
STANDARD with 10 tapes and book of instructions, A.C. motor \$24.50
With spring-wound motor \$18.50
JUNIOR with 5 tapes and book of instructions (not rented) \$12.00
RENTAL Standard with 10 tapes and book of instructions \$3.00 first month, \$2.25 each additional month. References or \$10 deposit required. All rental payments may be applied on the purchase price should you decide to buy the equipment.

Write for details today

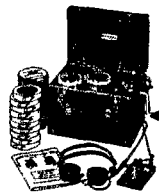

INSTRUCTOGRAPH COMPANY

Dept. Q, 912 Lakeside Place, Chicago, Illinois
Representative for Canada:
Radio College of Canada, 54 Bloor St. West, Toronto

110 VOLTS AC Katolight Plants

Anytime, Anywhere! with
Have special plant for operating radio receivers and transmitters. Close voltage regulation. Full 350 watts AC and 100 watts at 6 volts. Filtered and Shielded.

Amateur's price—JRA3, 350 watt \$67.50
Amateur's price—JRE5, 550 watt \$7.50

Other sizes up to 10,000 watts.
"Ask your jobber"

KATOLIGHT, Mankato, Minn., U.S.A.

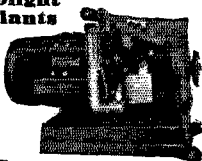

A GOOD NAME GOES A LONG WAY

No expense is spared to safeguard the high quality and performance of dependable Ken-Rad Radio Tubes

Ken-Rad Radio Tubes

KEN-RAD TUBE & LAMP CORPORATION - OWENSBORO, KY.

Manufacturers of all types of radio tubes and Ken-Rad Electric Lamp Bulbs



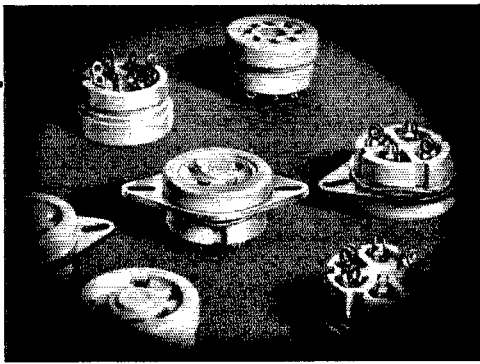

Designed for Application

● The new MILLEN line of MODERN PARTS for MODERN CIRCUITS includes: transmitting condensers, receiving condensers, sockets, QuartzQ coil forms, standoffs, dials, IF transformers, RF chokes, safety terminals, etc., etc.

Catalogue Upon Request

JAMES MILLEN
150 EXCHANGE ST.



MFG. CO. INC.
MALDEN, MASS.

For those who demand "THE BEST"

"PRECISION" Series 870

Automatic Push Button
AC-DC Multi-Range
Tester **29 RANGES**
including **3000 volts**
AC & DC 1200 MIL-
LIAMPERES

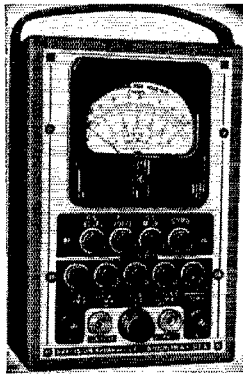

Specifications
★ Six D.C. Voltage Ranges at 1000 ohms per volt to 3000 volts
★ Five A.C. Voltage Ranges to 3000 volts ★ Five D.C. Current Ranges to 1200 milliamperes ★ Three Resistance Ranges: 0-5000 ohms (20 ohms at center of scale) 0-500,000 ohms (powered by self-contained 3 volt battery) 0-5 megohms (powered by external battery) ★ Five Decibel Ranges: -10 to 64 DB
★ Output Meter Indications on Five A.C. voltage ranges
★ Wire-wound shunts and metalized multipliers, both 1%.

Large size 3-inch square meter. Compact walnut finished case. Size 7 1/4 x 3. NET PRICE, with 3-volt battery..... **\$17.95**

More than 40 models in the PRECISION 1940 LINE... 15 Mutual Conductance Type Tube Testers and Set Testers, 16 Multi-Range Testers, Signal Generators, etc. See them at your local distributor

Ask for the PRECISION TEST EQUIPMENT 1940 CATALOG

PRECISION TEST EQUIPMENT
Standard of Accuracy SEE THEM AT YOUR JOBBERS
PRECISION APPARATUS COMPANY
647 Kent Avenue Brooklyn, New York
Export Div.: 458 Broadway, New York, U. S. A. — Cables: Morhanex

W7WY	5750-25-92-	A-28	W6PAR	30409-51-240-	A-34
W7AUP	3750-30-50-	A-11	W6RKM	22250-50-231-	B-40
W7BCS	2910-24-48-	A-13	W6MDI	14600-40-146-	A--
W7ALH	750-15-25-	B-5	W6NKT	8568-42-102-	B-35
W7GVH	420-10-22-	B-11	W6NJQ	2593-17-61-	A-11
W7ETO	338-9-15-	A-4	W6RMT	1733-14-50-	A-17
W7LD	287-5-23-	A--	W6RMP	1710-19-36-	A--
W7AIB*	182-7-13-	B-2	W6HPH	482-13-15-	A-10
W7BSX	160-8-10-	--	W6EUB	330-8-18-	A-7
W7BG	144-9-16-	B-7	W6EFM	----	20--
W7CWN*	5-1-2-	A--	Phone		
W7HKA	3-1-1-	A--	W6IMV	10105-47-111-	B-14
W7HKM	2-1-1-	A--	W6NKT	600-15-20-	B--
W7HJE	----	32--			
W7FWD*	----	30--			
W7H80*	----	9--			
W7EMA*	----	5--			
Phone					
W7EKA	14472-54-136-	B-18			
W7FLG	1755-27-33-	B-8			
W7ANI	1313-10-53-	A-34			
W7FON	460-10-23-	B-8			
W7ALE	84-6-7-	B--			
W7HJE	----	3--			

PACIFIC DIVISION

Hawaii					
K6QQV	12650-44-115-	A-30			
K6QYI	9675-45-86-	A-22			
K6CGK	3402-24-64-	B--			
W6ERG/K6*	18-3-3-	B-1			
K6NSD*	10-2-2-	--			
Nevada					
W6QQJL	59398-62-481-	B-39			
W6PDV	8325-36-94-	A-21			
W6PWE	----	24--			
Phone					
W6FUO	17808-53-170-	B-24			
W6GSB	14831-54-136-	B-26			
W6HCE	4030-31-53-	A-25			
W6CWX*	----	6--			

Santa Clara Valley

W6PBV	50175-60-338-	A-38			
W6NGC	30607-53-232-	A-32			
W6NHW	30510-54-227-	A-40			
W6QNK	21114-51-208-	B-39			
W6LCS	6122-31-79-	A-22			
W6QLO	910-12-28-	A-15			
W6RTD	585-14-17-	A-7			
W6NQU	10-2-2-	A--			

Phone					
W7MFP/6	3024-28-55-	B-16			
W6KDX	2-1-1-	--			

East Bay

W6TT	42822-61-351-	B-39			
W6IMI	25872-56-233-	B-35			
W6HJE	23901-47-205-	A-39			
W6OKK	21890-44-201-	A-31			
W6PHS	19564-52-191-	B-31			
W6CSJ	19260-48-161-	A-34			
W6LMZ	16332-47-139-	A-28			
W6PHZ	11505-39-120-	A-22			
W6OVU	9870-35-143-	B-28			
W6EJA	5292-27-98-	B-23			
W6CIS/6*	1960-20-49-	B--			
W6REP	289-7-17-	A-4			
W6RXW	233-6-16-	A-7			
W6LVI	91-7-7-	B-2			
W6CMG	63-5-5-	A-1			
W6JOH	----	90--			

Phone					
W6ITH	55876-62-449-	B-40			
W6OCH	45694-62-370-	B-31			

San Francisco

W6RBQ	40297-59-349-	B-33			
W6PGB	30936-56-313-	AB-37			
W6CIS	11803-48-123-	B-15			
W6MUF	11558-46-101-	A-16			
W6MCO	9889-48-104-	B-15			
W6ZS	3696-33-56-	B-13			
W6HSA	2580-22-47-	A--			
W6QOC	143-6-10-	A--			
W6PLM*	20-2-5-	A--			
W6SG	3-2-2-	B--			
Phone					
W6GPB	5411-37-59-	A-2-			
W6SG	8-2-2-	B--			
W6ZI*	4-2-2-	--			

San Francisco					
W6NHA	42123-57-370-	B-36			

W6MEK	57493-61-379-	A-39			
W6GUR	26861-57-190-	A-36			
W6CLZ	10170-45-113-	B-21			
W6PYG	9250-37-102-	A-30			
W6PLJ*	3685-22-68-	A-12			
W6GEG	1120-16-28-	A-6			
Phone					
W6QEU	36383-49-301-	A-22			
W6IWU	7438-34-88-	A-34			
W6QON	4419-29-64-	A--			

ROANOKE DIVISION

North Carolina					
W6WEN	48203-59-410-	B-33			
W4WEW*	30648-46-267-	A-40			
W4DW	21244-47-226-	B--			
W4ACA	12361-47-134-	B-20			
W4DLX	4050-27-60-	A-12			
W4ECH*	1190-16-31-	A-5			
W4WX*	----	32--			
Phone					
W4DST	5476-37-75-	B-19			

South Carolina

W4DAM	27248-52-268-	B-40			
W4EZF	13650-39-141-	A-31			
W4EPT	8798-34-107-	A-19			
W4EPJ	6169-31-100-	B-20			
W4CZA	4938-25-79-	A-18			
W4FWO	36-4-5-	B-2			
W4EHF	3-2-2-	--			
Phone					
W4AZT	4160-32-65-	B-12			
W4FWO	60-5-6-	B-6			

Virginia

W3FBL	52782-57-485-	B-40			
W3GKL	47200-59-400-	B-40			
W3FKP	42600-60-356-	B-40			
W3GBK	30537-51-240-	A-29			
W3EQQ	17801-47-153-	A-27			
W3BSB	8550-38-91-	A-24			
W3ALF	6520-32-82-	A-22			
W3CFL	4096-32-64-	B-11			
W3GTS	2376-22-54-	B-4			
W3IHN	1763-17-42-	A-15			
W3HWJ	715-13-28-	A-11			
W3ICL	423-13-13-	A-6			
W3GPV	270-9-12-	A-2			
W3GAL**	----	53--			

Phone					
W3GWQ	11045-47-118-	B-35			
W3FMY	9360-45-106-	B-18			
W3EZR	2856-28-51-	B-13			
W3HAO	420-12-14-	A-3			
W3EQQ	55-4-6-	A-1			

West Virginia

W8OXO	52178-54-388-	A-37			
W8LXC	51584-62-417-	B-40			
W8PSA	46180-56-332-	A-40			
W8PMA	35675-51-282-	A-39			
W8RCN	31620-51-248-	A-37			
W8BTV	26169-53-198-	A-38			
W8RUO	15469-33-188-	A-33			
W8NTV	13490-38-142-	A-30			
W8TGP	11760-48-104-	A-27			
W8MPH	8214-37-113-	B-26			
W8SUT	7789-31-102-	A-22			
W8TDD	3850-28-56-	A-31			
W8EHA	1856-14-51-	A-9			
W8DYB	1628-21-49-	AB-7			
W8DFC	1120-14-32-	A-9			
W8JKN	900-15-24-	A-10			

Phone					
W8CWY	13400-53-128-	B-32			
W8JMN	10165-38-114-	A-37			
W8JKN	10-2-2-	A--			

(Continued on next left-hand page)

BUY ON EASY TERMS • MAIL ORDERS PROMPTLY FILLED • Write for FREE CATALOG

Don't dream - Buy now

AR-77

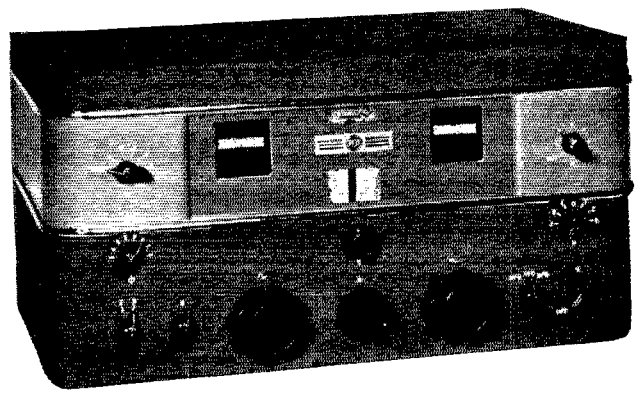

FEATURES

- ★ Lower Circuit Noise
- ★ Negative Feedback
- ★ Uni-View Dial
- ★ Accurate Signal Reset
- ★ Calibrated Bandsread
- ★ Variable, Six Step Crystal Filter I.F. Circuit
- ★ Voltage Regulated Power Supply
- ★ Improved Image Rejection
- ★ Improved Noise Limiter
- ★ 500 to 31,000 KC

Pre-Selector Stage — 10 Tubes — Level Meter — Sensitivity Control — C-W Oscillator Magnetite Core IF Transformers — Headphone Jack — Standby Switch with Terminals for Relay — Modern Styling.

Model		Cash Price	Down Payment	per mo. for 12 mos.
AR77	less speaker	\$139.50	\$13.95	\$11.09
AR77	with speaker	\$147.50	\$14.75	\$11.73

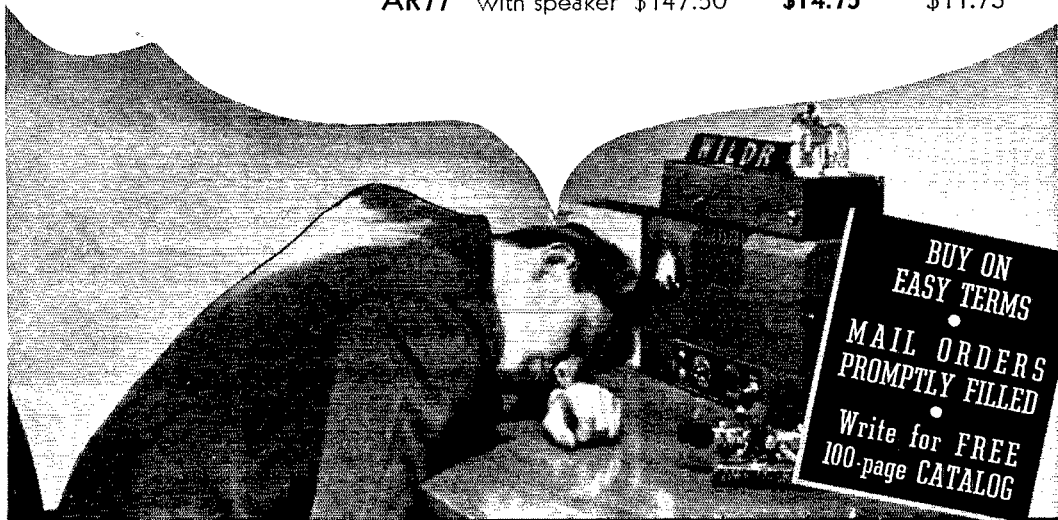

BUY ON EASY TERMS
 •
 MAIL ORDERS PROMPTLY FILLED
 •
 Write for FREE 100-page CATALOG

The RADIO SHACK
 167 WASHINGTON ST., BOSTON, MASS., U.S.A.

Would YOU Like to Be a Famous Amateur?

You will never be well known with a fist like a foot. If you've practiced a long time but still copy "letter-for-letter" at slow speed and send poorly with key or "bug," you know, something is wrong. You've missed that "coordinative knack," necessary to speed and copying behind. No need to worry about it or try further to overcome it by practice. Of course, practice is necessary but you must KNOW the HOW and the WHY of practice for developing the necessary FACULTIES that mean your success as an operator.

Since the all-time speed records are held by Candler-trained operators, don't you believe Candler training should help you to realize your ambition?

T. R. McELROY, official champion, speed 75.1 WPM, says: "Candler training must be good for it gave McDonald and me our speed and skill."



THE NEW BOOK OF FACTS
Tells you the whole story and a postal will bring it to you. No obligation.

CANDLER SYSTEM CO.

Dept. Q-5, Asheville, North Carolina, U.S.A.

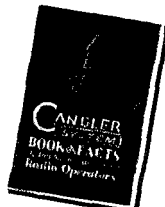

Rocky Mt. Division

Colorado			
W9WTW	42240-60-353	B-38	
W9YFJ	17600-50-145	A-29	
W9SBB	15244-44-173	B-25	
W9CAA	5363-33-65	A-	
W9EII	2915-22-53	A-16	
W9QDC*	2175-20-45	A-25	
W9BML	1733-21-35	A-14	
W9GLG	935-17-22	A-17	
W9QEC	920-16-24	A-12	
W9CDP	420-12-18	B-3	
W9RVV	180-6-12	A-2	
Phone			
W9ZLX	17600-55-161	B-26	
W9CAC	13915-55-128	B-34	
W9UXI	3360-28-48	A-9	
W9IVT	180-9-10	--	

Utah-Wyoming

W6FRN	34762-54-258	A-31	
W6PQT	33488-56-299	B-33	
W7GEE	23790-52-183	A-17	
W7DES	14223-45-128	A-18	
W7GCO	7515-45-84	B-15	
W7HMQ	5142-31-63	A-20	
W6OWV	3578-27-53	A-9	
W6QVY	1650-20-33	A-11	
W6RIM	926-13-20	A-	
Phone			
W6DTB	29610-63-235	B-29	
W7HEY	22880-55-211	B-28	
W7HDS	1083-19-29	B-12	
W6NPU*	10-2-2	A-	

W4PEI	550-11-20	A-3	
W4EEO	108-6-9	B-2	
W4FIH	15-2-3	A-	
Phone			
W4DRZ	18821-50-163	B-22	

Western Florida			
W4EPT	50802-57-359	A-40	
W4BSJ	32895-51-324	B-40	
W4AKP	4065-32-85	AB-31	
Phone			
W4AMS	4224-32-66	B-	

Georgia

W4ADIA	49010-53-341	A-35	
W4FIJ	34155-55-312	B-39	
W4AQL*	24500-49-251	B-40	
W4FVC	12177-41-150	B-33	
W4DYH*	9072-42-108	B-	
W4CRO	9000-36-100	A-20	
W4GIE	3224-28-55	B-13	
W5FIT/4	2222-22-41	A-30	
W4FUP*	----	40-	

Phone			
W4BK	18-3-3	----	
W4FV	2-1-1	----	
W4ERT*	2-1-1	----	

West Indies

K4FCV	18612-47-200	B-25	
K4DTH	16503-41-164	A-28	
K4KD	4090-34-60	B-15	

SOUTHWESTERN DIVISION

Los Angeles			
W6GRL*	79552-64-635	B-39	
W6IJO	59400-60-396	A-39	
W6HJT	33248-64-419	B-39	
W6PUZ	51625-59-350	A-40	
W6NLZ*	45360-60-305	A-30	
W6MLY	44378-61-291	A-40	
W6NLI	43185-61-292	AB-35	
W6MTUO	42630-58-295	A-39	
W6RDR	40390-56-291	A-39	
W6ONG	33748-59-288	B-40	
W6KJG	32828-58-284	B-38	
W6LJD	24084-54-221	B-	
W6PMA	20000-50-160	A-36	
W6MBA	18213-47-155	A-28	
W6FHE	15813-46-139	A-36	
W6MZA	11800-40-120	A-19	
W6FMZ	10090-40-127	B-20	
W6SN	9646-53-91	B-10	
W6DPT*	9503-43-112	B-20	
W6QYE	8140-37-110	B-21	
W6KXS	8000-40-80	A-21	
W6ARO	7200-40-90	B-30	
W6BHY	5544-36-77	B-	
W6BJR	4892-52-78	B-12	
W6MYT	4760-32-60	A-19	
W6QNV	4440-30-75	--	
W6JQB	4318-28-62	B-10	
W6NQG	3922-29-105	AB-20	
W6DIO	3306-29-57	B-9	
W6NNV	3304-28-50	B-11	
W6EAR	2592-16-54	A-14	
W6MQS	2365-22-43	A-	
W6PDF	2312-23-34	A-17	
W6DTY	1495-13-46	A-12	
W6JBP	960-12-32	A-14	

SOUTHEASTERN DIVISION

Alabama			
W4CYC	61729-59-419	A-40	
W4EY	61000-61-502	B-39	
W4ECI	53651-57-351	A-39	
W4EDR	39750-50-318	A-32	
W4AAQ	36225-60-242	A-36	
W4EOX	11224-41-115	A-22	
W4EBZ	10038-42-120	B-	
W4GAG	9810-36-110	A-	
W4FZG	6169-31-107	B-29	
W4AKP	4140-30-69	B-15	
W4EHH	3156-25-51	A-11	
W4FNI	3009-24-51	A-24	
W4GFG	1645-17-30	A-11	
W4CVM	755-14-21	A-8	
W4DS	560-14-16	A-3	
W4GBV	546-13-21	B-8	
W4GGC	210-7-7	A-2	
Phone			
W4BCF	14586-51-143	B-24	
W4FUM	2856-28-51	B-17	
W4FLS	456-12-23	B-11	
W4FTP	312-12-13	B-5	
W4DXI	204-11-13	B-3	
W4AUP	45-3-8	B-2	
W4FYB*	30-3-5	----	

Eastern Florida			
W4COB	30540-60-250	B-37	
W4EPV	29120-56-210	A-38	
W4QN	26373-59-226	B-32	
W4ELA	3188-25-53	A-17	
W4GHP	720-15-24	A-	
W4DTV	570-20-24	AB-9	

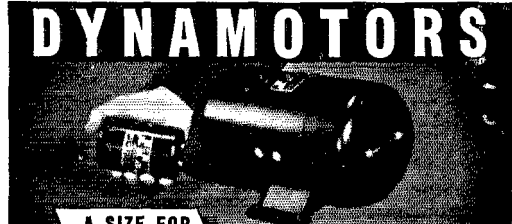

PINCOR

A SIZE FOR ANY JOB

Experience has taught radio engineers everywhere that Pincor Dynamotors provide the last word in dependable "B" power supply units for aircraft, marine and broadcast service, police units, auto radios and public address systems.

Frames and capacities for every requirement. 10 to 850 watts. Input, 6 to 110 volts; output, up to 1750 volts. Sturdy construction to give thousands of hours of trouble-free service. Smooth, quiet, light weight and compact. For information mail coupon below.

ROTARY CONVERTERS—Complete line for converting 6, 12, 32, 110 or 220 volts D. C. to 110 or 220 volts A. C. 40 to 3000 watts.

PIONEER GEN-E-MOTOR CORP.
CHICAGO, ILLINOIS
Export Address: 25 Warren St., New York, N.Y.
Cable: Simonrice, New York

PIONEER GEN-E-MOTOR CORPORATION
Dept. R-6E, 466 W. Superior St., Chicago, Illinois
Please send information on Pincor Dynamotors, Motor Generators and special power supply units.

Name.....
Address.....
City..... State.....
 Also send me Rotary Converter Catalog

(Continued on next left-hand page)

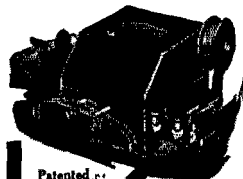

AUTOMATIC SENDER

Postpaid **\$12.50**
in U.S.A.

Patented.
Sends up to 70 words a minute. Motor driven. Built-in tape perforator. Uniform spacing. Excellent practice medium for beginners. Complete with practice tape covering Alphabet, Numerals, Word combinations and ample supply of blank tape. Speed up your receiving. Full operating instructions. If your dealer can't supply, write us.

FULLY GUARANTEED
GARDINER-LEVERING CO. Haddon Heights, N. J. U.S.A.

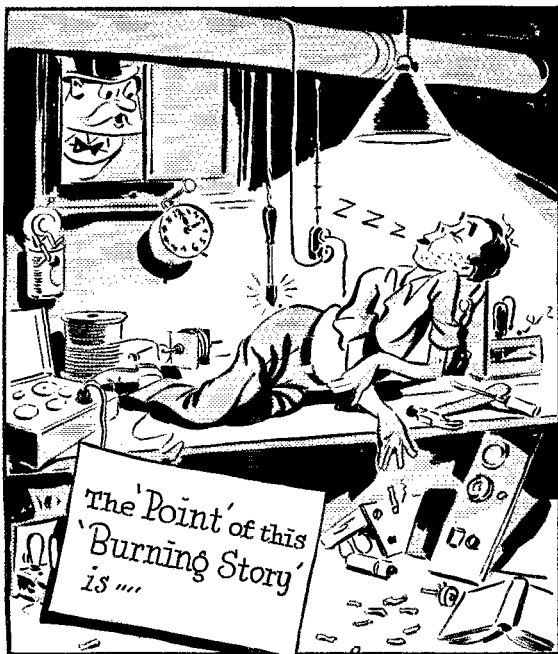

"always specify
CENTRALAB"

Centralab

**Keeps late
hours with the
Servicemen**



With fingers weary and worn the poor lad probes for trouble in the shape of some nice noise, sarcastic shorts, "lousy" leaks and open circuits.

When he finds them . . . Centralab replacement parts end his worries. Hams . . . servicemen . . . or set builders agree on CENTRALAB . . . Fixed Resistors . . . Volume Controls . . . Ceramic Capacitors . . . Switches.

Div. of Globe Union, Inc., Milwaukee

ONAN ELECTRIC PLANTS COMPLETE—READY TO OPERATE

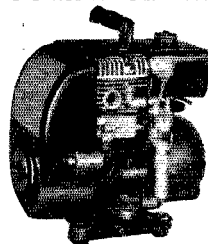

ONAN A.C. ELECTRIC PLANTS are powering AMATEURS' TRANSMITTERS and RECEIVERS all over the world. Used as EMERGENCY power supply when main lines fail.

ACCURATE VOLTAGE CONTROL, NO INTERFERENCE, PORTABLE, RUGGED, DEPENDABLE—thousands in operation.

OVER 40 STOCK MODELS
350 to 10,000 WATTS

Write for Complete Information

D. W. ONAN & SONS

347 ROYALSTON AVENUE MINNEAPOLIS, MINN.

See the NEW **VIBROPLEX** AT YOUR "CHAMPION" DEALER'S

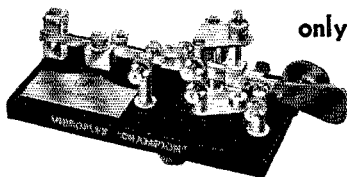

only **\$9.95**

Standard size black base. Chromium finished top parts. Equipped with 3/16" contacts. Furnished without circuit closer, cord and wedge.

Left-hand machines \$1 extra.

Easy to Learn... Easy to Use

Like all true champions, this new genuine Vibroplex "Champion" defies competition. Amazingly easy to learn, professionally fast and easy to operate and made to last for years. Imagine a genuine full-sized Vibroplex key with up-to-date exclusive Vibroplex features for only \$9.95. If you can use the Standard key — you can send better, faster and with less effort with the "Champion" Vibroplex. Simply press lever — Vibroplex does the rest. Ideal for "Ham" or professional. See the "Champion" at your dealer's today. If he cannot supply you, write or order direct from us. Remit by money order or registered mail. Write to-day for descriptive literature of other Vibroplex models including the sensational 1940 De Luxe models.



The **BUG** trade mark identifies the Genuine Vibroplex

RADIO TECHNOLOGY



RCA Institutes offer an intensive course of high standard embracing all phases of Radio and Television. Practical training with modern equipment at New York and Chicago Schools. Also specialized courses and Home Study Courses under "No obligation" plan.

Illustrated Catalog on request

RCA INSTITUTES, INC. Dept. ST-40

A Radio Corporation of America Service

75 Varick St., New York

1154 Merchandise Mart, Chicago

THE VIBROPLEX CO., Inc.

832 Broadway

New York, N. Y.

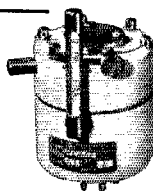

GENERAL COMMUNICATIONS CRYSTALS HOLDERS AND OVENS

Precision Made by *Bliley*

WRITE FOR CATALOG G-11

BLILEY ELECTRIC CO., ERIE, PA.





VALUE!

When you consider **only** price of the quality radio equipment you purchase at Terminal, you may be sure it cannot be bought elsewhere for less!

But we give you more than mere merchandise. We add a wealth of experience, a touch of personal service, a dash of friendliness and many other intangibles which go to make Terminal Service really unique.

New Public Address Catalog

Hundreds of money-saving "buys" are listed in our new P.A. catalog! Amplifiers, microphones, speakers, tuners, etc., at great savings! Write for your copy today!

TERMINAL Radio Corp.
 68 West 45th St. • 80 Cortlandt St.
 2 stores in NEW YORK CITY
 VANDERBILT 6-5050 • Cable: TERMRADIO

W6FK	729-11-27	A-11	Phone		
W6FVD	525-10-21	---	W5FAB	14196-52-140	B-38
W6QAR	217-7-16	B-7	W5FTP	12393-51-123	B-36
W6DHS	160-8-10	---	W5ABN	8303-41-81	A-29
W6YR	30-3-4	A-1	W5LKH*	-----	1- --
W6ACF	3-1-1	A- --			
W6BJC	3-1-1	A- 2			
W6BWH*	1-1-1	---	Oklahoma		
W6PYA*	-----	4- ---	W5BOR	33936-56-303	B-36
Phone			W5LW	33794-61-287	B-40
W6AM	23659-59-201	B-25	W5CEZ	32704-59-278	B-34
W6QOZ	12690-45-143	B-23	W5AQE	22750-52-175	A-30
W6AQJ	12648-51-124	B-18	W5GFT	17388-46-189	B- --
W6CGM	7849-47-84	B-28	W5CPC	17159-53-131	A-37
W6PKZ	7525-43-88	B-29	W5GNQ	10710-42-106	A-28
W6GFB	7401-31-97	A-24	W5HGD	9240-40-116	B-18
W6BUK	1080-18-30	B- 9	W5GCM	7790-41- 95	B-25
W6MHS	280- 8-14	A-10	W5GBI*	5510-33- 88	B-23
W6NCP*	23- 3- 3	A- --	W5CEB	5404-33- 66	A-21
W6LFN*	-----	14- ---	W5GVS	2625-29- 50	A- 8
W6LIP*	-----	3- ---	W5HLD	3139-27- 47	A-13
W6NHK*	-----	2- ---	W5HLD	2184-24- 46	B- 9
			W5FMF	2000-20- 40	A-15
			W5GRQ	1084-17- 26	A-11
			W5HXM	988-19- 31	B- 9
Arizona			W5HFF	350-10- 20	B- 9
W6QAP	54870-62-358	A-32	W5HLD/5	300-10- 12	A- 3
W6PUM	15934-48-168	B-32	W5GRM	136- 8- 9	B- 5
W6RHL	14351-43-135	A-36	W5HBB	120- 6- 8	A- 2
W6RAM	9800-40- 99	A-38	W5CEB/5	40- 4- 4	A- 1
W6GBN	9463-37-105	A-37			
W6OMD*	-----	1- ---	Phone		
			W5GHN	2640-30- 44	B- 7
Phone			W5FQN	1606-22- 37	B- --
W6PCB	9406-35-108	A-23	W5GXL	663-17- 20	B- 5
W6QJK	7280-40- 92	B-20			
W6PQG	4728-31- 62	A-19			
W6OLF	1318-17- 33	A- 8			
			South Texas		
San Diego			W5CWW	51900-60-346	A-40
W6NIK	67200-64-425	A-39	W5FZA	28900-53-215	A-30
W6AXC	53435-62-346	A-40	W5HQA	26193-52-205	A-26
W6PCE	48825-62-316	A-40	W5IGJ	24380-53-234	B-32
W6EPZ	37200-62-300	B-38	W5EWZ	23949-49-201	A-31
W6MUS	25428-52-350	B-27	W5HBI	23893-46-213	A-38
W6ISG	15840-44-144	A-31	W5FJM	23576-56-209	B-37
W6GTM	8960-28- 86	A-18	W5DBR	23014-51-182	A-32
W6FZH	6278-27- 93	A-23	W5DOM	19500-50-150	A-30
W6LUJ	5440-40- 68	B-14	W5HRO	15190-44-142	A-23
W6NGN	3313-25- 53	A-23	W5GWL	8050-40- 31	A-21
W6LXS	735-14- 21	A- 8	W5GWS	1320-22- 31	A- 8
W6GOV	410- 8-21	A-13	W5GJY	675-15- 10	A- 7
W6FCT	53- 3- 7	A- 3	W5HME	488-13- 15	A- 7
			W5HIE	341- 9-18	A- 7
Phone			W5IED	112- 5- 9	A- 3
W6CHV	12000-48-100	A-36	W5ARO	50- 4- 5	A- 4
W6QKI	1100-20- 22	A-15	W5HTB	30- 3- 4	A- 1
			WEST GULF DIVISION		
			W5BB	31062-62-252	B-38
			W5FDI	12688-52-123	B-20
			Northern Texas		
W5GGA	32794-55-241	A-40			
W5GSE	24550-59-275	B-38			
W5AWT	24544-51-194	A-31			
W5BZA*	19250-55-140	A- --			
W5EN	16508-46-145	A- --			
W5DWO	11270-46- 98	A-21			
W5DLM	9130-44- 84	A-21			
W5BYX	7474-37-101	B- --			
W5BAM	5071-33- 85	A-13			
W5FPR	3482-24- 80	A-27			
W5RH	2300-25- 40	A- --			
W5HFN	1470-14- 42	A-19			
W5IEM*	878-13- 27	A-13			
W5HRN	350-10- 14	A- --			
W5CVA*	-----	17- ---			
			New Mexico		
			W5HAG	35490-56-254	A-38
			W5DGP	18840-44-170	A-36
			W5CJP	14194-47-152	B-38
			W5GSD	4030-31- 52	A-11
			W5HJF	1375-20- 28	A- 9
			W5HDN	1140-16- 31	A- 9
			W5HPV	890-16- 22	A- 9
			W5PFZ	40- 4- 4	A- 2
			W5ZM	8- 1- 3	A- --
			Phone		
			W5UW	731-15- 21	A- 8
			W5DWP	2- 1- 1	---

SICKLES COILS
 ALL TYPES OF RF AND IF WINDINGS.
 Manufactured by
F. W. SICKLES COMPANY
 300 Main Street Springfield, Mass.

AMATEUR RADIO LICENSES
 Day and Evening Classes in Code and Theory
HOME STUDY COURSES
 Reasonable, Efficient and Thorough, Hundreds of
 Licensed Students Now on the Air
 American Radio Institute, 1123 Broadway, New York, N. Y.

Where to buy it

A directory of suppliers who carry in stock the products of these dependable manufacturers.



ALBANY, N. Y. Uncle Dave's Radio Shack 356 Broadway
ATLANTA, GEORGIA 265 Peachtree Street
 Radio Wire Television Inc.
BOSTON, MASS. Radio Shack 167 Washington Street
BOSTON, MASS. 110 Federal Street
 Radio Wire Television Inc.
BRONX, N. Y. 542 East Fordham Rd.
 Radio Wire Television Inc.
BUTLER, MISSOURI 211-215 N. Main Street
 Henry Radio Shop
CHICAGO, ILL. 833 W. Jackson Blvd.
 Allied Radio Corp.
CHICAGO, ILL. 901-911 W. Jackson Blvd.
 Radio Wire Television Inc.
CINCINNATI, OHIO 1103 Vine Street
 United Radio, Inc.
DETROIT, MICH. 325 E. Jefferson Ave.
 Radio Specialties Co.
DETROIT, MICHIGAN 11800 Woodward Ave.
 Radio Specialties Co.
HARTFORD, CONNECTICUT 227 Asylum Street
 Radio Inspection Service Company
HOUSTON, TEXAS 4021 Huey Street
 R. C. & L. F. Hall
INDIANAPOLIS, INDIANA 34 West Ohio Street
 Van Sickle Radio Supply Co.
JAMAICA, L. I. 90-08 166th Street
 Radio Wire Television Inc.
KANSAS CITY, MO. 1012 McGee Street
 Burstein-Applebee Company
NEW YORK, N. Y. Harrison Radio Co. 12 West Broadway
NEW YORK, N. Y. 100 Sixth Ave.
 Radio Wire Television Inc.
NEWARK, N. J. 24 Central Ave.
 Radio Wire Television Inc.
READING, PENN. 404 Walnut St.
 George D. Barbey Company
SPRINGFIELD, MASS. T. F. Cushing 349 Worthington St.
WASHINGTON, D. C. 938 F Street, N. W.
 Sun Radio & Service Supply Co.

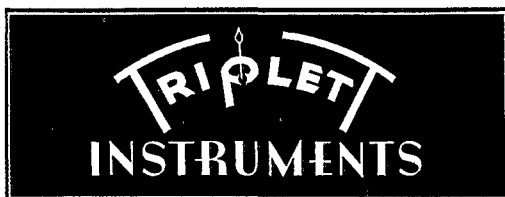

ALBANY, N. Y. Uncle Dave's Radio Shack 356 Broadway
ATLANTA, GEORGIA 265 Peachtree Street
 Radio Wire Television Inc.
BOSTON, MASS. Radio Shack 167 Washington Street
BOSTON, MASS. 110 Federal Street
 Radio Wire Television Inc.
BRONX, N. Y. 542 East Fordham Rd.
 Radio Wire Television Inc.
BUTLER, MISSOURI 211-215 N. Main Street
 Henry Radio Shop
CHICAGO, ILLINOIS 833 W. Jackson Blvd.
 Allied Radio Corp.
CHICAGO, ILL. 901-911 W. Jackson Blvd.
 Radio Wire Television Inc.
CINCINNATI, OHIO 1103 Vine Street
 United Radio, Inc.
JAMAICA, L. I. 90-08 166th Street
 Radio Wire Television Inc.
LITTLE ROCK, ARKANSAS 409 W. 3rd St.
 Beem Radio Company
MINNEAPOLIS, MINNESOTA 1124-26 Harmon Place
 Lew Bonn Company
MUSKOGEE, OKLAHOMA 204 No. Twelfth Street
 Home Radio Mart
NEW YORK, N. Y. 100 Sixth Avenue
 Radio Wire Television Inc.
NEWARK, N. J. 24 Central Ave.
 Radio Wire Television Inc.
READING, PENN. George D. Barbey Co. 404 Walnut Street
WASHINGTON, D. C. 938 F Street, N. W.
 Sun Radio & Service Supply Co.

Listings on this page do not necessarily imply endorsement by QST of the dealers or of other equipment sold by them.

Are You Ready for a GOOD JOB IN RADIO?

Put your valuable radio experience to work for you



Amateur Experience Backed by Technical Training Prepares You for a Career in Radio and Television Engineering

Your amateur experience is a valuable asset in preparing for a career in the professional field. Many top engineers and others in radio today turned their "hobby into a career" and now enjoy good technical jobs. You have the same opportunity, by applying your inherent love for radio to a planned, proven course of training. C.R.E.I. courses are selected by men in the industry who realize that *technical training* is the difference between "just a job" and a real future in radio! Among our students are many amateurs who are now heading into good engineering jobs . . . hundreds of men in more than 300 broadcasting stations . . . more than 700 radiomen in the Navy . . . scores of airways men. C.R.E.I. training *must* bring results. May we show you why?

Your Choice of HOME STUDY or RESIDENCE Training in PRACTICAL RADIO and TELEVISION ENGINEERING

● **THE HOME STUDY WAY**—A spare-time study plan covering every important phase of Radio and Television Engineering. Personalized instruction service and helpful guidance. A modern course for men in the radio industry.

● **THE RESIDENCE COURSE**—A thorough one-year course at the school in Washington, D. C. Combines theory with practice on modern, working equipment. 95% of graduates during past 5 years stepped into good jobs.

— In our effort to answer intelligently your inquiry, please state briefly your background, education, present position — and whether you are interested in Home Study or Residence training.

DEPT. Q-5 3224 SIXTEENTH STREET, N. W. WASHINGTON, D. C.

CAPITOL RADIO ENGINEERING INSTITUTE

WRITE FOR COPY OF

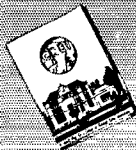

"A Tested Plan for a Future in Radio"

Read all the facts for yourself. This interesting booklet may hold the answer to your future success. Sent without obligation. Write today!

- YOUR METER!

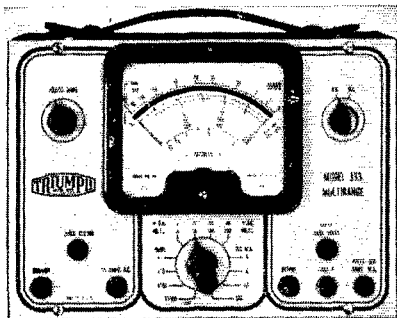

Model 333 Multirange Meter

4 5/8" METER ● 34 RANGES

- Ohms, Amps, Decibels
- AC-DC Volts to 3000!
- Mirror backed scale
- Knife-edged pointer
- Complete with 15 Volt battery

\$21⁹⁵

Amateurs — Jobbers write for catalog

TRIUMPH MFG. CO.
4017-19 W. LAKE ST., CHICAGO, ILL.

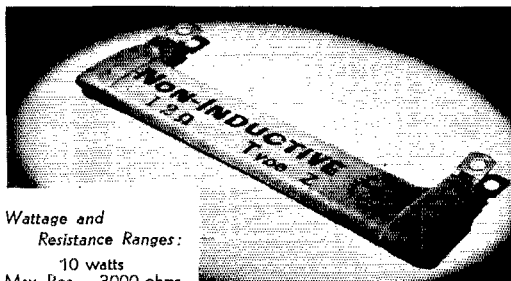

Wattage and Resistance Ranges:

- 10 watts
Max. Res. 3000 ohms
- 25 watts
Max. Res. 7500 ohms
- 50 watts
Max. Res. 12,500 ohms
- 100 watts
Max. Res. 25,000 ohms

You asked for it . . .

★ Clarostat new Series Z non-inductive resistors may be used for (1) Terminating resistance for Rhombic antennae; (2) Dummy antenna for checking before going on the air; (3) For high-frequency applications; (4) Grid leaks; (5) Parasitic suppression; (6) Interstage power measuring instruments. Lowest inductance of any presently-available resistor of this type. Ask local jobber about them. Or write to CLAROSTAT MFG. CO., Inc., 285-7 N. 6th St., Brooklyn, N. Y.



HAM-ADS

(1) Advertising shall pertain to radio and shall be of nature of interest to radio amateurs or experimenters in their pursuit of the art.

(2) No display of any character will be accepted, nor can any special typographical arrangement, such as all or part capital letters be used which would tend to make one advertisement stand out from the others.

(3) The Ham-Ad rate is 15¢ per word, except as noted in paragraph (6) below.

(4) Remittance in full must accompany copy. No cash or contract discount or agency commission will be allowed.

(5) Closing date for Ham-Ads is the 25th of the second month preceding publication date.

(6) A special rate of 7¢ per word will apply to advertising which, in our judgment, is obviously non-commercial in nature and is placed and signed by a member of the American Radio Relay League. Thus, advertising of bona fide surplus equipment owned, used and for sale by an individual or apparatus offered for exchange or advertising inquiring for special equipment, if by a member of the American Radio Relay League takes the 7¢ rate. An attempt to deal in apparatus in quantity for profit, even if by an individual, is commercial and all advertising by him takes the 15¢ rate. Provisions of paragraphs (1), (2), (4) and (5) apply to all advertising in this column regardless of which rate may apply.

Having made no investigation of the advertisers in the classified columns, the publishers of *QST* are unable to vouch for their integrity or for the grade or character of the products advertised

RACK — panel xmtr — 500 watts phone, 750 watts CW. 100TH's in final, ZB120's in modulator. Each stage metered separately, with all tubes, \$350. W4E2P, 149 Barksdale Drive, N.E., Atlanta, Ga.

FOR sale: entire transmitting equipment including complete 500 watt transmitter. Net value \$360. What am I offered? W7HKV, Box 701, Medford, Ore.

ZS72A rectifiers 2.5 amps. 10,000 volts inverse guaranteed. \$7.95. Mason Shaw, Rt. 1, Box 830, Redwood City, Calif.

MUST sell all transmitting and receiving equipment. Write for list. Carl A. Kowalski, W9KHC, 1239 Kinsmoor Ave., Ft. Wayne, Ind.

QSL'S? QSL's? SWL's? (Modernistic? Cartoon? Photographic?) Fastest service. Samples? W8DED, Holland, Mich.

All communication equipment at lowest prices. Sale on used receivers, write for list and details. W9KJF, Van Sickle, 34 W. Ohio St., Indianapolis, Ind.

SELL: 1940 SX24, speaker, \$60. Wanted: oscilloscope, pay cash. Anderson, 28 Park, Jamestown, N. Y.

CRYSTAL blanks, modern cuts, wholesale prices. W8OUE.

QSL's — prices, samples for hams. W2AEY, 338 Elmora, Elizabeth, N. J.

SELL — G.E. recording ammeter, 0-5 amps. Guaranteed FB. G. L. Danforth, Danvers, Mass.

CRYSTALS, X-cut, 160-80 meters, ± 20 kilocycles, 85¢; ± five kilocycles, \$1.35. Blanks, X-cut, 40-80-160 meters, three for \$1.20, including carborundum. William Threm, W8FN, 1833 Elm St., Cincinnati, Ohio.

QSL'S — SWL's. Colorful, economical. W9QKS (Meade) Print, 819 Wyandotte, Kansas City, Mo.

FB7A — coils — pack — tubes — speaker — \$21. W3KJ.

DOUGLAS — Value plus. Modulation transformers. Match all tubes. 50 watts audio \$4.95 pair; 100 watts audio \$7.75 pair. Postpaid in U. S. One year guarantee. Write W9IXR, Rice Lake, Wis.

CARTOON QSL's. Send for free samples. W1CJD, Gilderleeve, Conn.

W8BNP selling out. 1 kw. phone and RME-69. Stamp for list.

GRIEF? Woe? Beam stall swing? Sure cure — install a Hi-Torque all-steel Beam Drive. Positive Worm Lock, Tip-down head, hollow shaft. Contest winning beams, parts. Photos, bulletins. Rotary Array Service, W8ML.

WANTED: 2½ meter converter or substitute. Ruckstuhl, 12 Commonwealth, Boston.

QSL'S. Latest, finest. Samples. Maleco, 1805 St. Johns Place, Brooklyn, N. Y.

RECONDITIONED xmtrs. receivers at lowest prices. Breting 14, \$55; Howard 460, \$55; SX-24, \$49; SX-15, \$39; SX-18, \$44; Utah, Jr. xmtr and many others at real prices, terms to suit you as we finance own paper. Write Leo W9GFQ today, Council Bluffs, Iowa.

FELLOWS: real bargains — lowest prices on aluminum tubing for beams — 70 watt rigs only \$35 — two 6L6 in final modulators complete \$25. Get most ham catalog today from Leo, W9GFQ, who always gives the best deals. Radio Laboratories, Council Bluffs, Iowa.

TRANSFERS for labeling controls, meters, terminals on transmitters, receivers, sound, test equipment. Neat white lettering on decalcomania film, 150 different, 50¢. Trial assortment, 10¢. W6QG, 1117 W. Third, Santa Ana, Calif.

CRYSTALS: Eidson high grade commercial frequency crystal units are available in various cuts and holders at attractive prices. Send for commercial folder and full information. For the amateur: those time-tested, fully guaranteed T9 crystals, 40, 80, and 160 meter bands, \$1.60 postpaid. T9 ceramic holders, \$1. C.O.D.'s accepted. Sold by: Kerr's Radio Shop, El Paso, Texas; Frank Anzalone, 375 W. 46th, N. Y. C.; Radio Doc, 721 S. Main, Los Angeles, Calif.; Pemberton Labs., Ft. Wayne, Ind.; Henry Radio Shop, Butler, Mo.; O'Laughlins Radio Supply, Salt Lake City, Utah; Frank Mayer Co., Corpus Christi, Texas; Valley Radio Distributors, Appleton, Wis.; Casa Edison, Havana, Cuba; and Eidson's, Temple, Texas.

SELL: McMurdo Silver 15-17 receiver with Clifton console, \$110. Gay Morrison, Jr., Box 123, Conway, Ark.

ACR-136, reconditioned, \$20; Electro-bug, \$5; Two-inch oscilloscope, vertical horizontal amplifiers, linear sweep, practically new, \$35. W2CMI.

RACKS: Meinkheim, 614 Main, Toms River, N. J.

HALLICRAFTER SX-23, \$90 or offer. Frank Smith, 133 Wilson, Manoa, Upper Darby, Pa.

DISTINCTIVE QSL's. W4FVC, C3, Gainesville, Ga.

QUARTZ — direct importers from Brazil of best quality pure quartz suitable for making piezo-electric crystals. Diamond Drill Carbon Co., 719 World Bldg., New York City.

CALBOOKS — Spring edition now on sale containing complete up-to-date list of radio hams throughout entire world. Also world prefix map, and new time conversion chart. Single copies \$1.25, Canada and foreign \$1.35. Radio Amateur Call Book, 610 S. Dearborn, Chicago.

QSL'S — By W8NOS — 13 Swan St., Buffalo, N. Y.

CRYSTALS, mounted, 80-160, \$1.25, V-cut 40, \$2.25. R9 Crystals, 338 Murray Ave., Arnold, Pa.

QSL'S, all colors, cartoons, snappy service. Write for free samples today. W1BEF, 78 Warrenton, Springfield, Mass.

TELEPLEXES, Instructographs bought, sold. Ryan's, Hanibal, Mo.

MACAUTO code machines: low monthly rental 50,000 words practice tapes. Write N. C. Ayers, 711 Boylston St., Boston, Mass. GRAnite 7189-W.

QSL'S, Maps, Cartoons. Free samples. Theodore Porcher, 7708 Navahoe, Philadelphia, Pa.

USED receivers. Bargains. Cash only. No trades. Price list 3¢. W3DQ, Wilmington, Del.

QSL'S. Free samples. Printer, Corwith, Iowa.

CRYSTALS: famous P.R., mounted in latest Alsmag 35 holders — 40, 80 meter PR-X, 160 meter PR-Z, \$3; 40, 80 meter PR-Z (low drift), \$3.50; 20-meter PR-20, \$4.50; unconditionally guaranteed. Immediate shipment. Wholesale Radio Labs., Council Bluffs, Iowa, W9GFQ.

QST'S wanted prior to 1923. Floyd Norwine, W9EFC.

QSL'S. Samples. W5FGE, Hattiesburg, Miss.

CRYSTALS: police, marine, aircraft, and amateur frequencies. Descriptive catalog, Ham Crystals, 1104 Lincoln Place, Brooklyn, N. Y.

RADIO control for models by RCH — the only complete line, lightweight, inexpensive, guaranteed. Send stamp for circular. Radio Control Headquarters, Granby, Conn.

QSL'S — samples. Brownie, W3CJI, 523 No. Tenth St., Allentown, Pa.

CRYSTALS in plug-in heat dissipating holders. Guaranteed good oscillators. 160M-80M, \$1.25. (No Y cuts.) 40X, \$1.65. 80M vari-frequency (5 kilocycle variance) complete, \$2.95. State frequency desired. C.O.D.'s accepted. Pacific Crystals, 1042 S. Hicks, Los Angeles.

QSL'S — SWL's. 100, 3 color, 75¢. Lapco, 344 W. 39th, Indianapolis, Ind.

CRYSTALS — police, marine, aircraft, amateur. Catalog on request. C-W Mfg. Co., 1170 Esperanza, Los Angeles.

CUSTOM ground 40 M X-cut crystals in ceramic holders, \$2.50. 160-80 M crystal, \$1. Koradio, Mendota, Ill.

SELL: Collins 4A 40 watt CW xmtr, 2 separate power packs with tubes, \$35. 450 watt T55 amplifier with tubes, \$35. Standard 19 relay rack, \$15. Collins network system, \$20. Sell separately or completely mounted in rack. By appointment only. Geo. Laundrie, 6 Tremont St., Woburn, Mass.

SELL: improved Gross CP60 xmtr including P60 pwr supply, L60M modulator, 35T final, 130 w. input. All tubes, coils, meters ready operate. Sell all \$60 or units. Will install locally. Write — phone — W2ERE.

WESTINGHOUSE double current generator inputs 6-12 v., output 400-800 v. 400 ma. Price \$10. W2LGT.

BEST place to get amateur receivers is W9ARA. Best price; best trades; best terms (financed by myself); free trial. Prompt shipment from world's largest stock. Shipment from factory if preferred. So for best deal write W9ARA, Butler, Mo.

RECONDITIONED guaranteed receivers and transmitters. Practically all models cheap. Free trial. Terms. List free. W9ARA, Butler, Mo.

QSL'S for 1940. Better in ideas, workmanship, and value. Free samples to hams. W2FJE, 101 Hanson Place, Brooklyn, N. Y.

ALL-Star 40 watt CW transmitter, four bands, \$37. Want manufactured receiver. W9QEC.

YOUR Class A or B ticket in a hurry. Simple and easy explanation of amateur theory makes a license possible in thirty days. Code classes 25¢, all theory and code in semi-private. Inquire — Radio License Training School, 728 S. Hill St., Los Angeles, Calif.

COMPLETE station: Harvey 80T transmitter with tubes, coils, meters, two xtals. 160M-10M. National oscilloscope with tubes. 12 tube receiver with xtal filter. 75' Bassett feeder cable — matching transformer. Everything \$175 or make offer for parts. W5CSL, Box 1710, San Benito, Texas.

TRANSMITTER. New 400 watt CW, 250 watt phone. Photo. Sell cheap. Write A. Harrison, % KORN, Tremont, Neb.

LEARN RADIO • TELEVISION

60-page catalog on request. Oldest, largest and best equipped in New England. Write for new catalog.

MASS. RADIO SCHOOL

18 Boylston Street Boston, Massachusetts

OHMITE

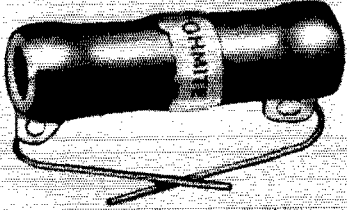

BROWN DEVILS

Amateurs, make a note of this! Ohmite vitreous-enameled "Brown Devil" Resistors *stay on the job* thru thick and thin! Ideal for voltage dropping, bias units, bleeders, etc. Amateur and commercial installations all over the world *prove it!* Popular 10-watt and 20-watt sizes, resistances from 1 to 100,000 ohms.

Write now for Free Catalog 17

OHMITE MANUFACTURING COMPANY
4864 Flournoy Street ★ Chicago, U.S.A.

Be Right with **OHMITE**

RHOSTATS • RESISTORS • TAP SWITCHES

NEW, LOWER COST

**TURNER R22X
Crystal Microphone
Adds Pep to Your Rig**

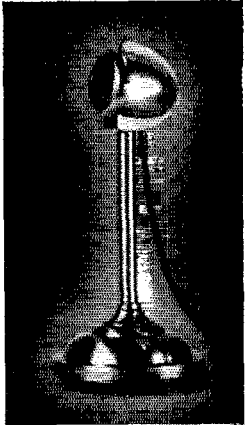

R22X with 8-Ft. Cable, Changeable without Opening Mike; Diagrams, and Chamousette Mike Bag **\$14.95** List

Add \$1.50 for 25-Ft. Cable

For enviable performance and modern, streamline design, choose this handsome R22X. It's identical with the 22X in performance but does not have the swivel and cable coupler, thus affording you a saving.

Range 30-7,000 cycles. Level -52DB. Built in diaphragm guard protects cartridge, which is inertia mounted to absorb mechanical shock and prevent breakage. Crystal impregnated against moisture. Automatic barometric compensation. Large capacity crystal permits long lines with minimum loss of level. Full satin chrome finish.

A rugged, dependable mike, professional looking, bringing you features usually found only in higher priced units.

Model R22X — Shown with Stand Model T1, finished in same satin chrome as R22X, to give perfectly matched desk set. Stand, 9" high. Base 5 1/4". 3 rubber feet to prevent tips and slides. R22X and T1 — Desk Stand, both, \$18.45 List.

The TURNER CO.
904 17th St. N.E.
CEDAR RAPIDS, IOWA

Licensed Under Patents of The Brush Development Co.

SEND FOR FREE
TURNER CATALOG

FOR YOUR TOOL KIT

This SIGNAL
1/4 inch
DRILL

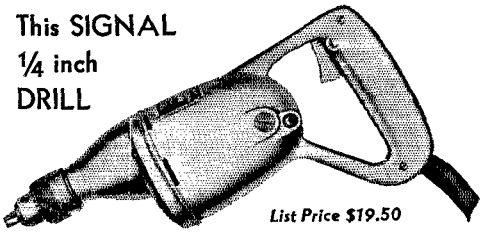

List Price \$19.50

IS TOPS IN VALUE

This is the drill to buy for your tool kit. It is the same drill used by electricians, radio repairmen, and shops. Capacity 1/4" in steel, 1/2" in hardwood; measures 12" long; speed 2950 R.P.M.; trigger switch, 8-foot rubber cord and plug; weight 5 1/2 pounds. SIGNAL drills are dependable because they're well made, and they are outstanding values because they're priced right. If your radio jobber cannot supply you, write us.

SIGNAL ELECTRIC MFG. CO., Menominee, Mich.

Established
1892

SIGNAL

Your Nearby Dealer Is Your Best Friend

Your nearby dealer is entitled to your patronage. He is equipped with a knowledge and understanding of amateur radio. He is your logical source of advice and counsel on what equipment you should buy. His stock is complete. He can supply your needs without delay. His prices are fair and consistent with the high quality of the goods he carries. He is responsible to you and interested in you.

One of these dealers is probably in your city — Patronize him!

ATLANTA, GEORGIA

Radio Wire Television Inc.
265 Peachtree Street
"The World's Largest Radio Supply House"

JAMAICA, L. I., NEW YORK

Radio Wire Television Inc.
90-08 166th Street (Merrick Road)
"The World's Largest Radio Supply House"

BALTIMORE, MARYLAND

Radio Electric Service Co.
3 N. Howard St.
Everything for the amateur

NEWARK, N. J.

Radio Wire Television Inc.
24 Central Avenue
"The World's Largest Radio Supply House"

BOSTON, MASS.

Radio Wire Television Inc.
110 Federal Street
"The World's Largest Radio Supply House"

NEW YORK, N. Y.

Radio Wire Television Inc.
100 Sixth Avenue
"The World's Largest Radio Supply House"

BRONX, NEW YORK

Radio Wire Television Inc.
542 East Fordham Road
"The World's Largest Radio Supply House"

NEW YORK, N. Y.

Harrison Radio Company
12 West Broadway
Harrison Has It! Phone WOrth 2-6276 for information or rush service

BUFFALO, NEW YORK

Radio Equipment Corp.
326 Elm Street
W8PMC and W8NEL — Ham, service and sound equipment

PHILADELPHIA, PENNSYLVANIA

Eugene G. Wile
10 S. Tenth Street
Complete Stock of Quality Merchandise

BUFFALO, NEW YORK

Dymac Radio
1531 Main Street — Cor. Ferry
Open Evenings GA. 0252

PROVIDENCE, RHODE ISLAND

W. H. Edwards Company
85 Broadway
National, Hammarlund, Hallicrafter, Thordarson, Taylor, RCA

HOUSTON, TEXAS

R. C. & L. F. Hall
4021 Huey Street (W 9-2713)
"Specialists in Amateur Supplies"

RICHMOND, VIRGINIA

The Arnold Company
Broad at Harrison St.
W3EQQ — "The Virginia Ham Headquarters" — W3FBL

YOU CAN BE SURE
WHEN YOU BUY FROM

QST

ADVERTISERS

“Advertising for QST is accepted only from firms who, in the publisher’s opinion, are of established integrity and whose products secure the approval of the technical staff of the American Radio Relay League.”

Quoted from QST’s advertising rate card.

Every conceivable need of a radio amateur can be supplied by the advertisers in QST. And you will know the product has the approval of the League’s technical staff

Index to Advertisers

Abbott Instrument, Inc.	111
Aerovox Corp.	108
American Radio Institute	120
Astatic Microphone Laboratory, Inc.	115
Barker & Williamson	106
Bliley Electric Company	74, 109, 119
Browning Laboratories, Inc.	106
Burgess Battery Company	127
Candler System Company	118
Capitol Radio Engineering Institute	122
Cardwell Mfg. Corp., Allen D.	76
Centralab	119
Clarostat Mfg. Company, Inc.	122
Collins Radio Company	Cov. 2
Coto-Coil Company, Inc.	109
Dodge's Institute	115
Eitel-McCullough, Inc.	77
Gardiner-Levering Company	118
General Electric Company	5
Hallcrafters, Inc., The	1, 2
Hammarlund Mfg. Company, Inc.	75, 89
Harrison Radio Company	97
Harvey Radio Company	112
Heintz & Kaufman, Ltd.	82
Henry Radio Shop	95
Hipower Crystal Company	102
Hygrade Sylvania Corp.	80
Hytronic Laboratories	92
Instructograph Company	115
Jensen Radio Mfg. Company	87
Johnson Company, E. F.	94
Kato Engineering Company	115
Ken-Rad Tube & Lamp Corp.	115
Kenyon Transformer Company, Inc.	93
Mallory & Company, Inc., P. R.	72
Massachusetts Radio School	124
Meissner Mfg. Company, Inc.	99
Millen Mfg. Company, Inc., James	116
Mims Radio Company	83
Monitor Piezo Products Company	111
National Company, Inc.	Cov. 3, 71, 84, 85
Newark Electric Company	103
Nilson Radio School	108
Ohmite Mfg. Company	124
Onan & Sons, D. W.	119
Pioneer Gen-E-Motor Corp.	118
Port Arthur College	98
Precision Apparatus Corp.	116
Precision Piezo Service	98
Premax Products	98
RCA Institutes, Inc.	119
RCA Mfg. Company, Inc.	Cov. 4, 81, 114
Radio Mfg. Engineers, Inc.	78, 79
Radio Parts Distributing Company	117
Radio Shack, The	117
Radio Transceiver Laboratories	102
Scientific Radio Service	96
Shuler Supply Company	120
Sickles Company, F. W.	120
Signal Electric Mfg. Company	124
Solar Mfg. Corp.	86
Sprague Products Company	90
Sun Radio Company	110
Taylor Tubes, Inc.	73
Teleplex Company	96
Terminal Radio Corp.	120
Thordarson Electric Mfg. Company	91
Triplett Electrical Instrument Co., Inc.	88
Triumph Mfg. Company	122
Turner Company	124
United Electronics Company	111
United Teletone Corp.	128
Vibroplex Company, Inc., The	119
Ward Leonard Electric Company	114
Waters, R. A.	102
Wholesale Radio Laboratories	110
Yaxley	72

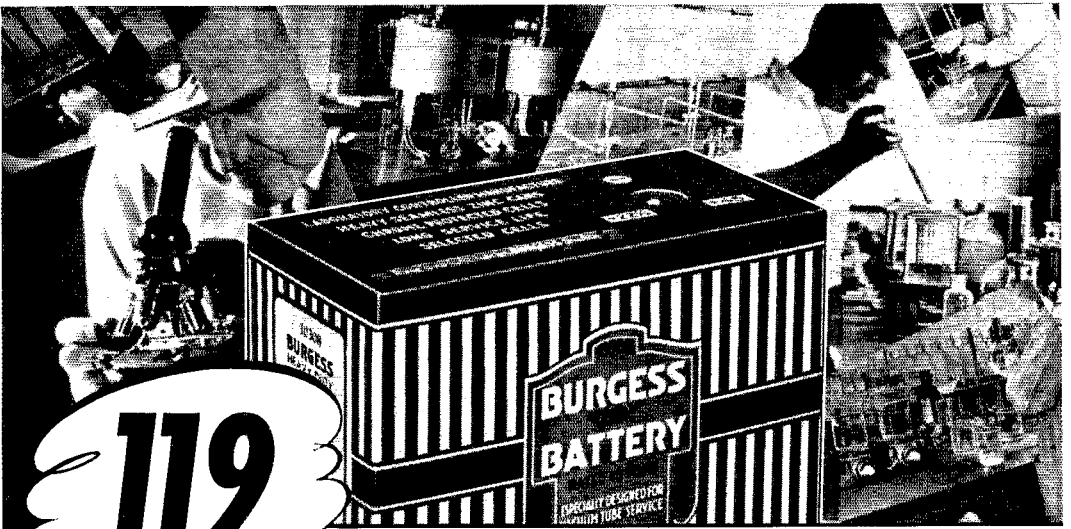

119 TESTS Protect Your Battery Investment

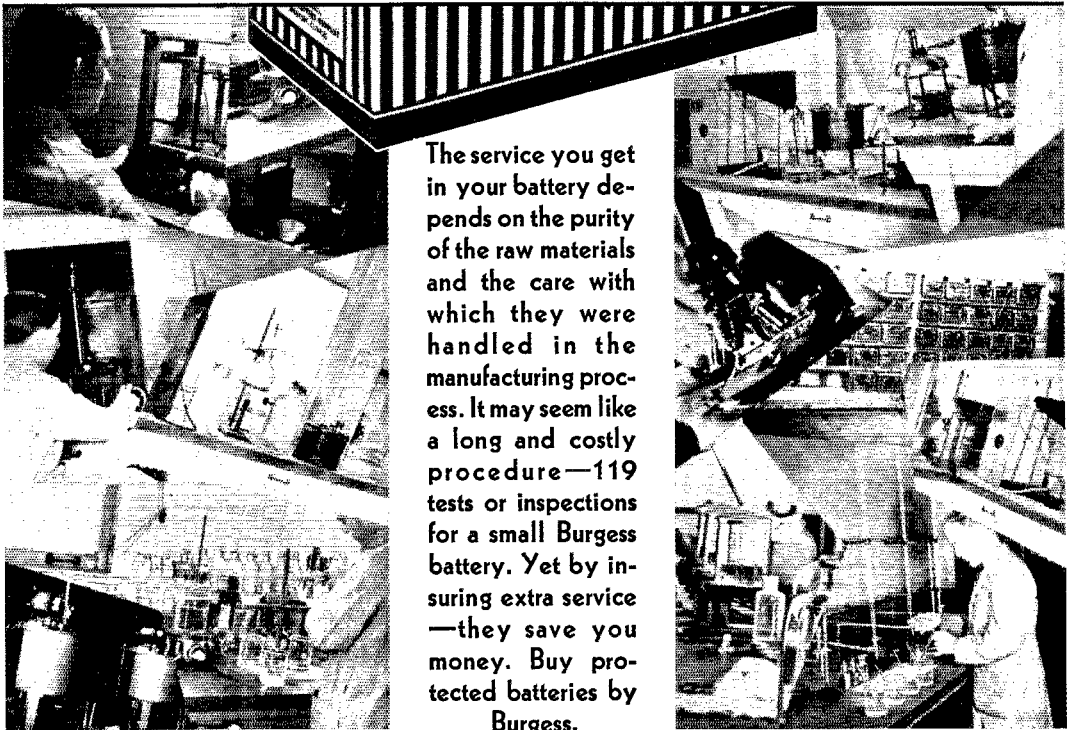

The service you get in your battery depends on the purity of the raw materials and the care with which they were handled in the manufacturing process. It may seem like a long and costly procedure—119 tests or inspections for a small Burgess battery. Yet by insuring extra service—they save you money. Buy protected batteries by Burgess.

BURGESS BATTERY COMPANY
FREEPORT, ILLINOIS

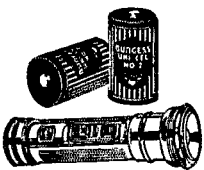

BURGESS



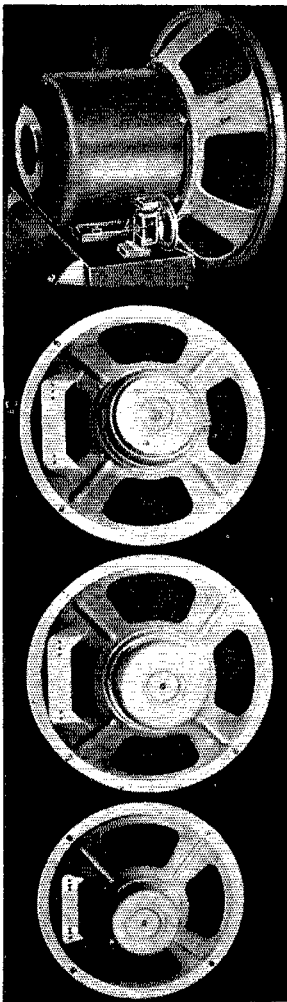

**STANDARD UNIVERSAL
MATCHING TRANSFORMERS**

Universal Primary Transformers are tapped to accommodate all popular tubes.

Type No.	Undistorted Peak Watts	List Price
ST-1	up to 4	\$1.00
ST-2	up to 6	1.50
ST-3	up to 10	2.25
ST-4	up to 15	2.75
ST-5	up to 25	3.50

Universal line matching provide primary impedances of 500, 1000, 1500 ohms.

Type No.	Undistorted Peak Watts	List Price
ST-6	up to 4	\$1.00
ST-7	up to 6	1.50
ST-8	up to 10	2.25
ST-9	up to 15	2.75
ST-10	up to 25	3.50

\$500,000

Expended for Development, Backs Our Slogan
NO FINER SPEAKER MADE IN ALL THE WORLD

**CINAUDAGRAPH SPEAKERS
FEATURES OF PUBLIC ADDRESS SERIES**

- ★ **HIGH POWER** handling ability in these speakers has been provided through careful design consideration of distortion elements, voice coil heat dissipation, and cone structure.
- ★ **FREQUENCY RESPONSE** characteristics of these speakers are ideal for general applications. The design features provide full, true, low notes instead of the false lows frequently encountered, and excellent high frequency definition for voice reproduction.
- ★ **HIGH EFFICIENCY** is obtained through quality Fernalnic magnet structures and good voice coil space factor.
- ★ **RIBBON WIRE** — ACIM voice coils on heavier units.
- ★ **POLYFIBROUS CONES** — **MOISTURE PROOF CENTERING** assure permanent quality and dependability.
- ★ **RUST PROOF** — **DUST PROOF.**

New PA PERMANENT MAGNET SPEAKERS

Type No.	Cone Housing Dia.	Und. Peak Watts	Und. Normal Watts	Peak Power Watts	Voice Coil Dia.	Voice Coil Ohms	Wt. Lbs.	List Price
PM-18-33	18"	33	28	43	3 1/2"	6-8	70	\$115.00
PM-15-18	15"	18	15	23	1 1/2"	6-8	20	30.00
PM-13-25	13 1/4"	25	21	29	2"	6-8	30	40.00
PM-12-18	12"	18	15	23	1 1/2"	6-8	16	27.50
PM-12-16	12"	16	13	21	1 1/4"	6-8	11	18.50
PM-12-13	12"	13	10	18	1"	6-8	8	12.50
PM-10-12	10 1/2"	12	9	16	1"	6-8	7	10.00
PM-10-10	10 1/2"	10	7	14	1"	6-8	6	8.50
PM-8-11	8"	11	8	15	1"	6-8	6	8.50
PM-8-9	8"	9	6	13	1"	6-8	5	6.75
PM-6-7	6 1/2"	7	5	11	3/4"	6-8	4 1/2	4.25
PM-5-5	5"	5	3	8	3/4"	6-8	4	4.00

New PA ELECTRODYNAMIC SPEAKERS

Type No.	Cone Hsg. Dia.	Und. Peak Watts	Und. Norm. Watts	Peak Power Watts	Field Voltage	Field Ohms	Field Watts	Voice Coil Dia.	Voice Coil Ohms	Wt. Lbs.	List Price
PE-18-40	18"	40	35	46	110V. DC	300	35/50	3 1/2"	6-8	78	\$95.00
PE-18-30	18"	30	25	40	110V. DC	350	22/35	3 1/2"	6-8	60	60.00
PE-15-25A	15"	25	20	30	110V. DC	850	14/21	1 1/2"	6-8	28	26.50
PE-15-25B	15"	25	20	30		2500	14/21	1 1/2"	6-8	28	26.50
PE-13-30	13 1/4"	30	25	35	110V. DC	350	22/35	2 1/2"	6-8	40	35.00
PE-12-20A	12"	20	15	25	110V. DC	1000	14/21	1 1/2"	6-8	20	16.75
PE-12-20B	12"	20	15	25		2500	14/21	1 1/2"	6-8	20	16.75
PE-12-16A	12"	16	13	21	110V. DC	1000	10/15	1 1/2"	6-8	12	10.50
PE-12-16B	12"	16	13	21		2500	10/15	1 1/2"	6-8	11	10.50
PE-10-12A	10 1/2"	12	10	16	110V. DC	1000	8/12	1"	6-8	10	9.00
PE-10-12B	10 1/2"	12	10	16		2500	8/12	1"	6-8	10	9.00
PE-8-10A	8"	10	8	14	110V. DC	1000	8/12	1"	6-8	8	7.00

UNITED TELEPHONE CORP.
 150 VARICK STREET ★ NEW YORK, N. Y.
 EXPORT DIVISION: 100 VARICK STREET NEW YORK, N. Y. CABLES: "ARLAB"
 QST for May, 1940, EASTERN Edition

Small Coil Forms
 Pentode Acorn
 Socket
 Electron Terminal
 Strip
 Pentode Acorn
 Socket

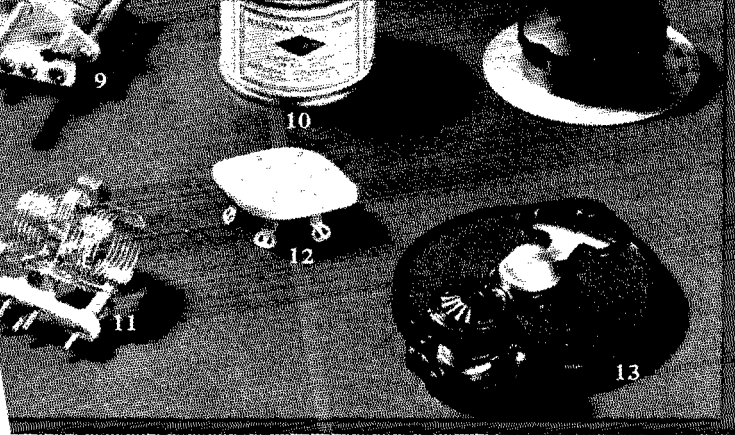
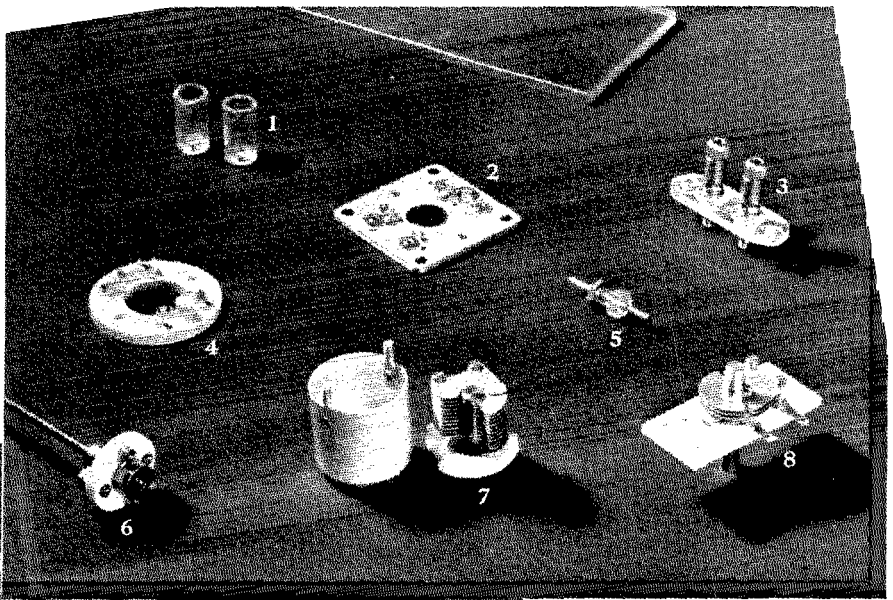

- 5. Victron Bushing
- 6. Flexible Coupling
- 7. Padding Con-
denser
- 8. Tuning Condenser
- 9. Tuning Condenser
- 10. Victron Coil Dope
- 11. 20-meter Induc-
tance
- 12. Low-loss Socket
- 13. Type B Dial

FOR HIGH FREQUENCIES

When constructing ultra-high frequency equipment, you will find that the parts shown above will simplify your problems. All were designed with the actual constructor's needs in mind by men thoroughly familiar with high frequency technique. Among them you will find an acorn socket with built-in by-pass condensers. You will find a flexible coupling that works around corners, so that you can lay out your circuit for electrical efficiency rather than mechanical necessity. You will find tuning condensers small enough to fit in compact layouts, and miniature coil forms to go with them. National makes what you need.

NATIONAL COMPANY, INC.
 MALDEN, MASS., U. S. A.

"ICAS RATINGS?"

**S-a-a-y! I Beat You
Fellows to 'em by 5 Years!"**

"Sure! Those new ICAS Ratings represent a swell 'yardstick' that tells me just what to expect of RCA Transmitting Tubes in my amateur rig—but, shucks! I've known all along an amateur could load a lot more power into RCA's than the old, continuous 'key-down' commercial ratings would indicate. On sprints, I've poured power into a couple RCA-809's to the tune of 500 watts input, although I knew they were rated at only 150 watts—and still they always came back for more. I've done almost the same thing with other RCA's, too. ICAS Ratings? Sure! I'm the guy that invented 'em!"

... So run comments by many amateurs ever since RCA announced the higher ICAS (Intermittent Commercial and Amateur Service) Ratings. And they're right!

For years, RCA Tubes have been noted for their big, extra measure of dependability—and, for years, hams have told us that RCA Ratings were too conservative for intermittent amateur use. So now, the two sets of ratings are given for popular amateur types—the old CCS (Continuous Commercial Service) and the new ICAS ratings. You take your choice. You eliminate guesswork—and, as an amateur, you get higher power output at lower cost *plus* long tube life, *plus* the utmost in economy of weight and space.

**These Ratings Tell Their
Own Story of Values Unexcelled!**

RCA Tube Type	Tube Classification	Amateur Net Price	D-C Plate Input, Watts*	
			CCS Rating	ICAS Rating
802	Pentode	\$3.50	25	33
804	Pentode	15.00	120	150
806	Triode	22.00	600	1000
807	Beam	3.50	60	75
809	Triode	2.50	75	100
810	Triode	13.50	500	620
811	Triode	3.50	155	225
812	Triode	3.50	155	225
814	Beam	17.50	180	225
828	Beam	17.50	200	270

*Class C telegraphy values

FREE! 20-page booklet, "INCREASED RATINGS," giving full information on the new RCA Dual Rating System (originally announced October 13, 1939) gladly sent upon request to Commercial Engineering Section, RCA Manufacturing Co., Inc., Harrison, N. J.

REDUCED PRICES!
(Effective April 1st, 1940)

	Previous Net	New Net
RCA-813 ... Beam Power Amplifier—360 watts input up to 30 Mc.	\$28.50	\$22.00
RCA-832 ... Push-pull Beam Power Amplifier—36 watts input up to 150 Mc.	28.75	17.00
RCA-1624 ... Beam Power Amplifier (Filament type)—54 watts input up to 60 Mc.	4.75	3.50



Radio Tubes

RCA MANUFACTURING CO., INC., CAMDEN, N. J.
A Service of the Radio Corporation of America

FIRST IN METAL — FOREMOST IN GLASS — FINEST IN PERFORMANCE