

september, 1939

25 cents

QST



devoted entirely to

amateur radio

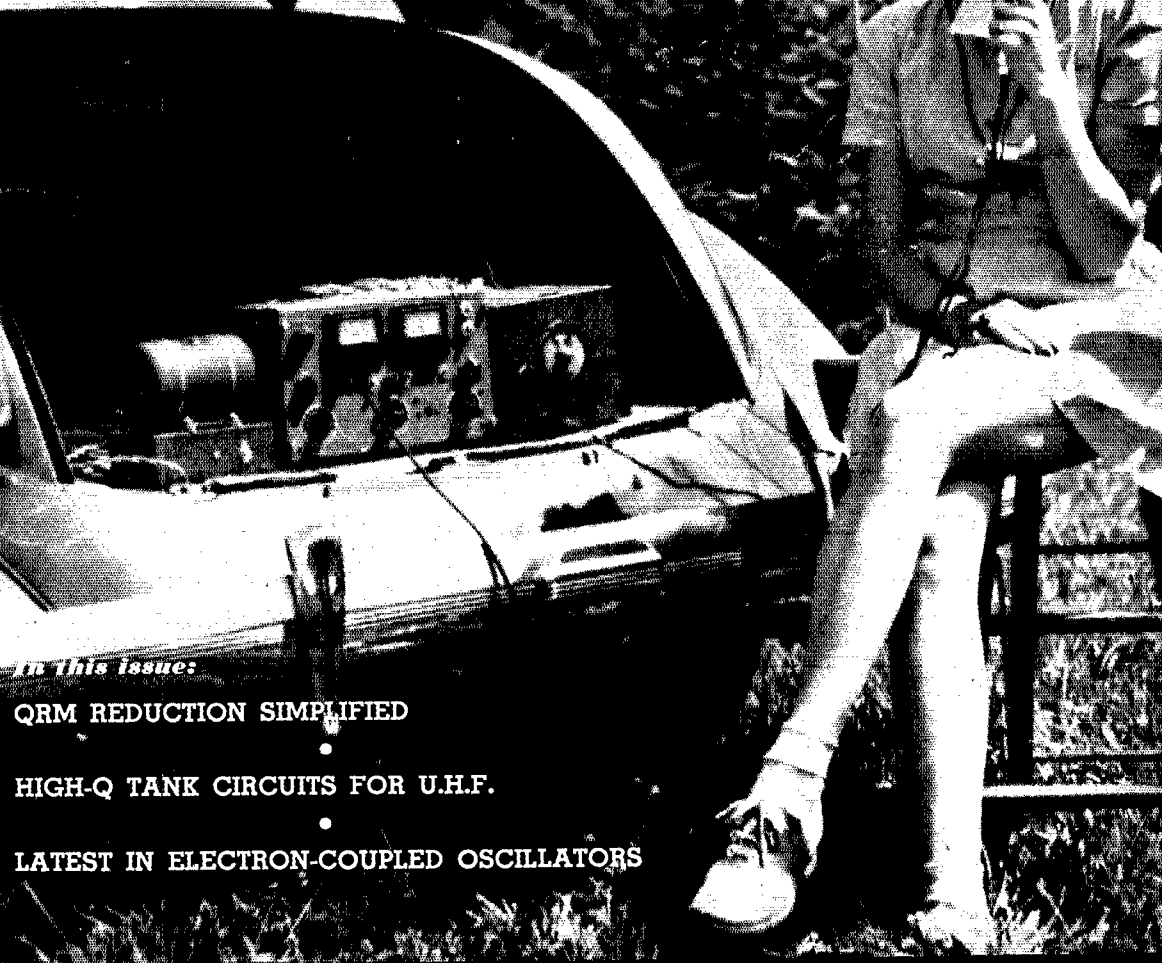

In this issue:

QRM REDUCTION SIMPLIFIED

HIGH-Q TANK CIRCUITS FOR U.H.F.

LATEST IN ELECTRON-COUPLED OSCILLATORS

More U.H.F. Power With the 30J

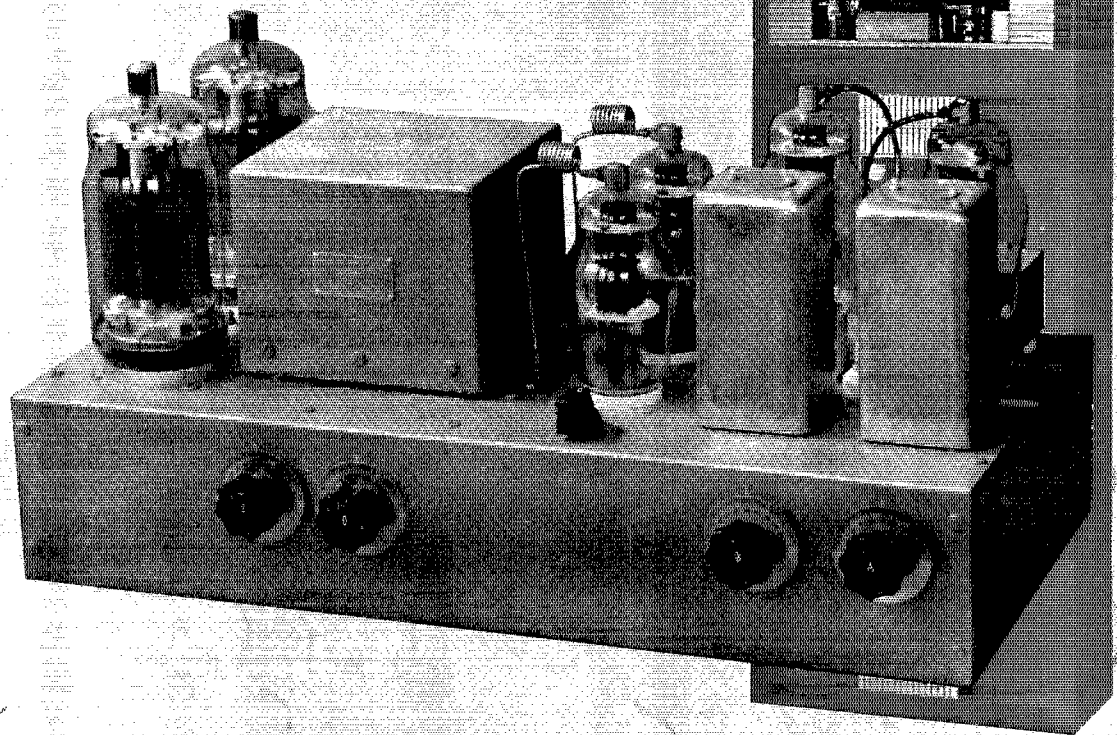

THE use of a pair of 813's in the final amplifier stage has led to a considerable increase in power at the higher frequencies.

There is a 50% excess of grid drive at 60 mc and even allowing for low line voltage, an output of nearly 200 watts may be expected. On lower frequencies, as formerly, the rated power output of the 30J remains at 250 watts.

Controls on the r-f section are reached through the front access door. No neutralizing adjustment is necessary, and the complete r-f chassis is simpler and is as clean a job as you have ever seen.

COLLINS RADIO COMPANY

CEDAR RAPIDS, IOWA

NEW YORK, N.Y.: 11 WEST 42 STREET

"Although we have been building the SX-17 Super Skyrider for two years, its continued acceptance and undiminished popularity encourage us to keep it in the Hallicrafters line for some time to come."

William J. Halligan

5-550 Meters (62MC to 54KC) Continuous Coverage.
2 Stages Pre-Selection. Dickert Noise Limiter. 1000°
Electrical Band Spread. "S" Meter. 6 Bands. Wide
Range Variable Selectivity. Good Sensitivity. 13 Tubes.
High Fidelity Audio.



the hallicrafters inc.

CHICAGO, U.S.A.

A Complete HAM SHACK \$190²⁵

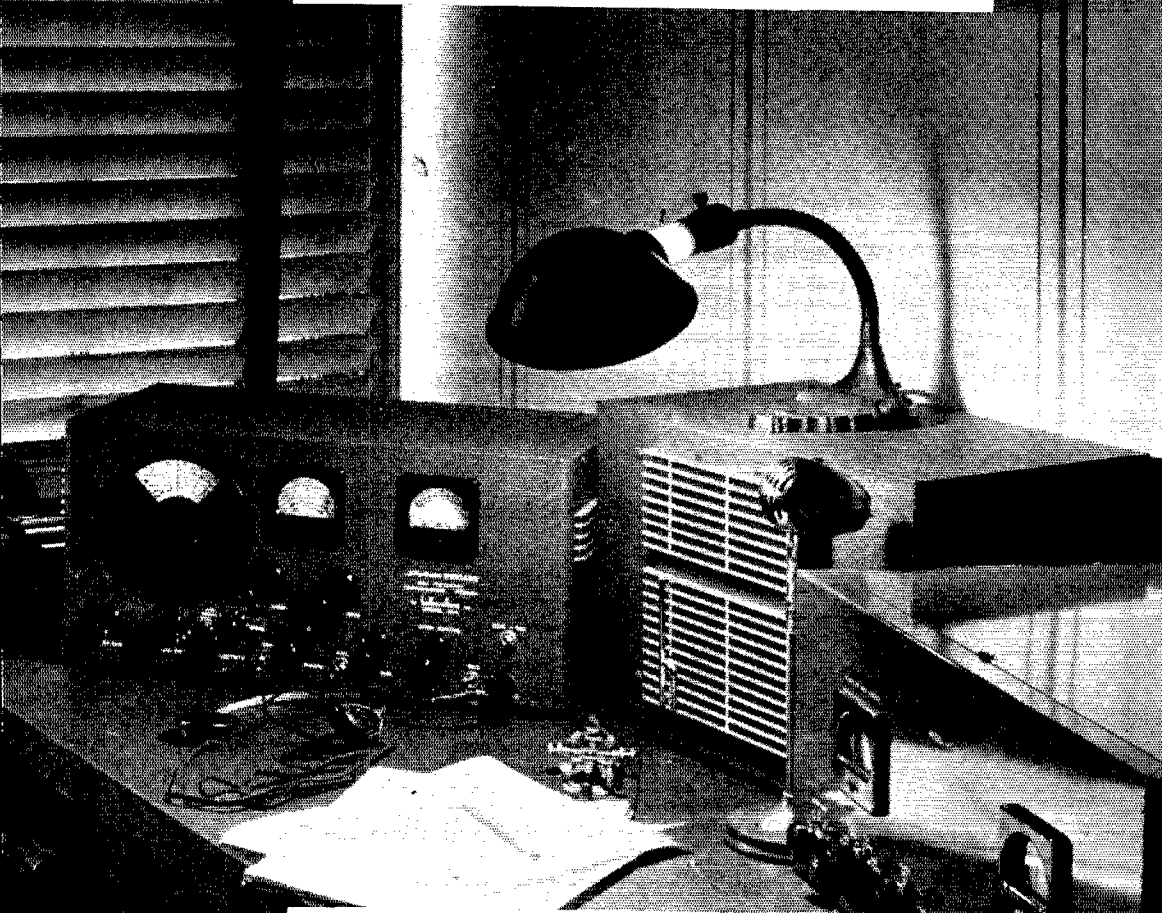

It includes everything you need but a key, a mike and a log book! With the Skyrider Defiant you can "pick your prefixes" all over the world. And with the HT-6 your transmitter is just as capable. They are both at the moment, America's most popular communications equipment. Receiver, transmitter, speaker, crystal and a set of coils are included at \$190.25. They can be yours on easy payments. Ask your Distributor.

the hallicrafters inc.

CHICAGO, U. S. A.

SEPTEMBER 1939

VOLUME XXIII

NUMBER 9



STAFF

Editorial

KENNETH B. WARNER, W1EH
Editor and Business Manager

CLARK C. RODIMON, W1SZ
Managing Editor

GEORGE GRAMMER, W1DF
Technical Editor

DONALD H. MIX, W1TS
BYRON GOODMAN, W1JPE
Assistant Technical Editors

VERNON CHAMBERS, W1JEQ
Technical Information Service

JAMES J. LAMB, W1AL
Consultant

Advertising

F. CHEYNEY BEEKLEY, W1GS
Advertising Manager

CHARLES BRUNELLE
Asst. Advertising Manager

Circulation

DAVID H. HOUGHTON
Circulation Manager

RALPH T. BEAUDIN, W1BAW
Asst. Circulation Manager



OFFICES

38 La Salle Road
West Hartford, Connecticut

Subscription rate in United States and Possessions and Canada, \$2.50 per year, postpaid; all other countries, \$3.00 per year, postpaid. Single copies, 25 cents. Foreign remittances should be by international postal or express money order or bank draft, negotiable in the U. S. and for an equivalent amount in U. S. funds.

Entered as second-class matter May 29, 1919, at the post office at Hartford, Connecticut, under the Act of March 3, 1879. Acceptance for mailing at special rate of postage provided for in section 1103, Act of October 3, 1917, authorized September 9, 1922. Additional entry at Concord, N. H., authorized February 21, 1929, under the Act of February 28, 1925. Additional second-class entries to cover sectional editions authorized March 20, 1935.

Copyright 1939 by the American Radio Relay League, Inc. Title registered at United States Patent Office.

QST

devoted entirely to

AMATEUR RADIO

PUBLISHED, MONTHLY, AS ITS OFFICIAL ORGAN, BY THE AMERICAN RADIO RELAY LEAGUE, INC., AT WEST HARTFORD, CONN., U. S. A.: OFFICIAL ORGAN OF THE INTERNATIONAL AMATEUR RADIO UNION



CONTENTS

Editorials	9
Splatter	10
Hetrofil — An Aid to Selectivity	
<i>Raymond W. Woodward, W1EAO</i>	11
An Answer to the E.C.O. Problem	
<i>Charles D. Perrine, Jr., W6CUH</i>	14
Silent Keys	18
High-Q Tank Circuits for the Ultra-High Frequencies	
<i>Arnold Peterson</i>	19
Conventions!	26
New Hampshire State Convention	26
The Yacht Contender Comes in First	<i>Don C. Wallace, W6AM</i> 27
What the League Is Doing	28
A Portable-Emergency Utility Transmitter	
<i>Louis F. Leuck, W9ANZ</i>	30
Announcing — U.H.F. Field Day and Relay	33
New Ideas in Transmitters	<i>T. M. Ferrill, Jr., W1LJ1</i> 34
Increased Output with Grid-Bias Modulation	
<i>J. A. McCullough, W6CHE</i>	40
Better Phone Operation without Splatter	<i>J. R. Bain, VE5JB</i> 43
A Few Feeder Considerations	<i>Byron Goodman, W1JPE</i> 48
The "Runt Sixty" and the "QSL Sixty"	<i>Fred Sutter, W8QBW</i> 50
More About Amateur Interference with Broadcasting	
<i>G. E. Gustafson</i>	53
South Dakota State Convention	55
Hudson Division Convention	55
Diversity with What You Have	<i>S. Gordon Taylor, W2JCR</i> 56
DX on 56 Mc. Continues Through July	58
Ham Shacks	60
Progress on 225 Megacycles at Mount Washington	
<i>Arthur E. Bent, W1COO</i>	62
I.A.R.U. News	65
How Would You Do It?	67
Hints and Kinks for the Experimenters	
<i>Inexpensive Home-made Crystal Mike . . . Anchoring Lattice Towers . . . Insulated Mounting for Rotatable Antenna Elements . . . Simple Line-Voltage Control</i>	69
Correspondence Department	71
Operating News	72
W1AW Operating Schedule	74
How's DX?	76
DX Century Club	82
A.R.R.L. QSL Bureau	98
S. F. Transmissions	102
Ham-ads	123
QST's Index to Advertisers	126

WE PROMISED—YOU WAITED—

and **HERE IT**

THE FIRST OF THE
TAYLOR TUBES
 WITH

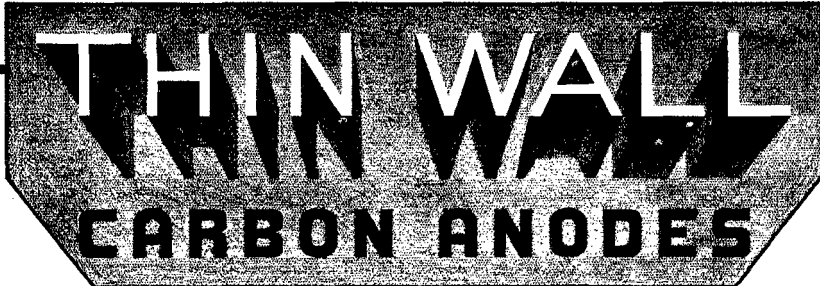

THE TW-150—RADIOS NEWEST TRANSMITTING TUBE SENSATION

Yes—here it is, the first in a series of Thin Wall Carbon Anode transmitting tubes. Once again Taylor Tubes blazes a new path! The past few years have proved to radio amateurs that Taylor Tubes may be counted upon to lead the way. Taylor was first to introduce low cost high performance tubes—first to pioneer tubes in the T-20-T-40 class—first to bring the amateur an inviolate guarantee of operation satisfaction and now, the first to bring you Thin Wall Carbon Anodes, the ultimate development of carbon, radio's "accepted Anode material." Study over the features of the TW-150—check its characteristics—demand of it any feature you want in a tube of this rating. There is no better tube value available today. Eggshell thin carbon anodes that insure lower interelectrode capacities and visual operating temperatures—a tube construction formula that is a definite step forward innovation—a new processed grid an exclusive Taylor Tubes feature which adds to the tube's unusual ruggedness. These and many more features, make the TW-150 a tube without peer in its class.

(Ask your parts distributor to show you this fine new tube today.)

GUARANTEED TO STAND 800% OVERLOAD

Taylor Thin-Wall Carbon Anode Tubes are guaranteed to stand up under temporary overloads of 600% to 800% without releasing gas or damaging the emission. Several thousand amateurs have witnessed demonstrations which prove the truth of this statement.

CHARACTERISTICS

Fil. Volts*	10.0	AS RF POWER AMP.....Class C	
Fil. Amps.*	4.1	DC Plate Volts.....MAX.	3000
Amp. Factor	35	DC Plate Current.....M A.....MAX.	200
INTERELECTRODE CAPACITIES			
Grid to Plate.....MMF	2.3	DC Grid Current.....M A.....MAX.	60
Grid to Filament.....MMF	4.4	RF Driving Power...WATTS...MAX.	20
Plate to Filament.....MMF5	Plate Dissipation ...WATTS...MAX.	150

*Can be supplied on special order only with 5.0 volt 8.2 Amp. Filament and standard UX 4 prong base.



15

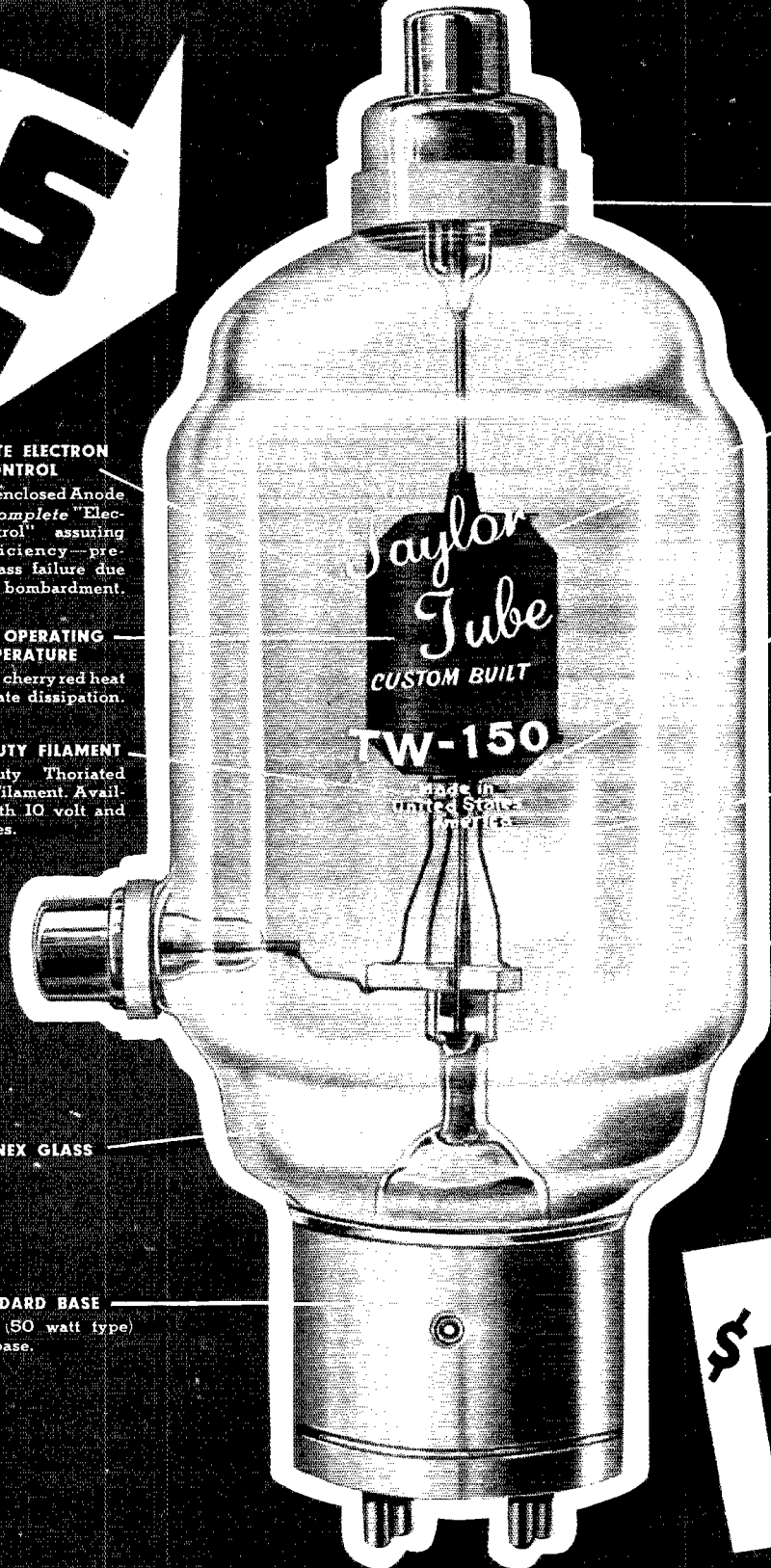

COMPLETE ELECTRON CONTROL

One-piece enclosed Anode — affords complete "Electron Control" assuring added efficiency — preventing glass failure due to electron bombardment.

VISIBLE OPERATING TEMPERATURE

Operates at cherry red heat at rated plate dissipation.

HEAVY DUTY FILAMENT

Heavy duty Thoriated Tungsten Filament. Available in both 10 volt and 5 volt types.

NONEX GLASS

STANDARD BASE

Standard (50 watt type) 4 prong base.

LARGE INSULATORS

Big size caps — plus Alsi-mag insulators protect grid and plate leads mechanically, the safe, sensible way.

WARP PROOF ANODE

Thin-Wall Carbon Anode — Heat-proof — retains its shape under any heat conditions.

LOWER INTERELECTRODE CAPACITIES

Can be operated in class C amplifiers at full rated input — at frequencies up to 60 MC.

PUNCTURE PROOF

New scientific method of mounting the grid structure guarantees against punctures due to heating of glass.

PROCESSED GRID

A new exclusive Taylor feature makes possible a more abuse-proof grid.

LOW DRIVING POWER

Low driving power requirements. A single TZ-20 will do the job easily.

\$15.00

ACTUAL SIZE

"More Watts Per Dollar"

TAYLOR TUBES, INC., 2347 WABANSIA AVE, CHICAGO, ILLINOIS

Section Communications Managers of the A.R.R.L. Communications Department

All appointments in the League's field organization are made by the proper S.C.M., elected by members in each Section listed. Mail your S.C.M. (on the 16th of each month) a postal covering your radio activities for the previous 30 days. Tell him your DX, plans for experimenting, results in phone and traffic. He is interested, whether you are an A.R.R.L. member or get your QST at the newsstands; he wants a report from every active ham. If interested and qualified for O.R.S., O.P.S. or other appointments he can tell you about them, too.

ATLANTIC DIVISION			
Eastern Pennsylvania Maryland-Delaware-District of Columbia Southern New Jersey Western New York Western Pennsylvania	W3QP W3BAK W3CCO W8CSE W8OFO	John B. Morgan Edgar L. Hudson Lester H. Allen Ed Preston Kendall Speer, Jr.	Blue Bell Laurel, Delaware Trenton Tully Lower
CENTRAL DIVISION			
Illinois Indiana Kentucky Michigan Ohio Wisconsin	W9RMM W9QG W9ARU W8DPE W8A0 W9UIT	Leslie M. Dickson Noble Burkhardt Darrell A. Downard Harold C. Bird E. H. Gibbs Aldrich C. Krones	Edellyn Farms Indianapolis 116 N. Longworth Ave. R. F. D. 2 405 Broad St. 3127-A West Madison St.
DAKOTA DIVISION			
North Dakota South Dakota Northern Minnesota Southern Minnesota	W9WWL W9YOD W9IGZ W9YNQ	Anton C. Theodos Dr. A. Russell Edwin L. Wicklund Millard L. Bender	c/o American Cafe Russett R.F.D. 3 608 N. Huron Ave.
DELTA DIVISION			
Arkansas Louisiana Mississippi Tennessee	W5AB1 W5DKR W5EWD W4DWS	H. E. Velte Eugene H. Treadaway Jewell W. Cole William Harold Walker	4415 West 12th St. 2749 Myrtle St. c/o City of McComb Water Dept. 2503 Belmont Blvd.
HUDSON DIVISION			
Eastern New York N. Y. C. & Long Island Northern New Jersey	W2LU W2AZV W2GVZ	Robert E. Haight E. L. Baunach Joseph P. Jessup	511 South Holmes St. 102 Central Ave. 131 California St.
MIDWEST DIVISION			
Iowa* Kansas Missouri Nebraska	W0PJR W0UEG W0WUD W9DI	L. B. Vennard Melvin D. Kirby Miss Letitia Allendorf William J. Bamer	P. O. Box 304 1015 W. 3rd St.
NEW ENGLAND DIVISION			
Connecticut Maine Eastern Massachusetts Western Massachusetts New Hampshire Rhode Island Vermont	W1CTI W1IIE W1IHL W1JAH W1BFT W1HRC W1KJG	Frederick Ellis, Jr. H. W. Castner Larry Mitchell William J. Barrett Carl B. Evans Clayton C. Gordon Clifton G. Parker	19 Merrill Rd. 147 Church 94 Howard St. 239 Columbia St. 101 South Main St. 192 Washington Ave. Box 537
NORTHWESTERN DIVISION			
Alaska Idaho Montana Oregon Washington	K7ENA W7EMT W7FL W7DXF W7FCG	Leo E. Osterman Carl Eichelberger G. A. Woodhouse Harold W. Johnston W. Beale	Customhouse Route 2 Holter Dam 205 North Grant St. R. 4, School Ave.
PACIFIC DIVISION			
Hawaii Nevada Santa Clara Valley East Bay San Francisco Sacramento Valley Philippines San Joaquin Valley	K6ETF W6BIC W6FBW W6TI W6CIS W6MDI KA1GR W6KUT	Francis T. Blatt Edward W. Heim Elbert Amarantes Horace K. Greer Kenneth E. Hughes Vincent N. Feichausen George L. Rickard Edwin A. Address	837 16th Ave. 509 Claremont St. 454 Washington St. 414 Fairmount Ave. 622-36th Ave. 113 South Quincy St. Box 849 2921 North Van Ness Blvd.
ROANOKE DIVISION			
North Carolina South Carolina Virginia West Virginia	W4CYB W4BOE W3UVA W8HD	W. J. Wortman Ted Ferguson Charles M. Waff, Jr. C. S. Hoffmann, Jr.	P. O. Box 566 1213 College St. Box 1212 47 Lynwood Ave.
ROCKY MOUNTAIN DIVISION			
Colorado Utah-Wyoming	W9EHC W7CLG	Carl C. Drummell Ernest E. Parshall	1828 East Kiowa St. Salt Creek Electric Plant
SOUTHEASTERN DIVISION			
Alabama Eastern Florida Western Florida Georgia West Indies (Cuba-Isle-of-Pines- Porto Rico-Virgin Islands)	W4DGS W4DVO W4AXP W4AGI CM2OP	James F. Thompson L. A. Connolly Oscar Cederstrom Leland W. Smith Mario de la Torre	1203 South Perry St. 719 So. Willow Ave. Second St. & Bruce Ave. 2010 Pennsylvania Ave. Escobar 110 (Altos)
SOUTHWESTERN DIVISION			
Los Angeles Arizona* San Diego	W6MQM W6OIF W6JRM	W. J. Wortman Clyck Cameron Allen Howard K. Breedlove	1038 Milwaukee Ave. 513 N. 3rd St. R. 2, Box 636
WEST GULF DIVISION			
Northern Texas Oklahoma Southern Texas New Mexico	W5DXA W5CEZ W5BHO W5BNI	Lee Hughes Carter L. Simpson Dave H. Calk Dr. Hilton W. Gillett	125 N. Main St. 2010 So. 4th St. 6726 Ave. Q
MARITIME DIVISION			
Maritime	VE1DQ	A. M. Crowell	69 Dublin St.
ONTARIO DIVISION			
Ontario	VE3SG	F. H. B. Saxon	302 Lee Ave.
QUEBEC DIVISION			
Quebec	VE2CO	Lindsey G. Morris	Apt. 6, 4510 Girouard Ave., N.D.G.
VALNTA DIVISION			
Alberta British Columbia	VE4GE VE5HP	C. S. Jamieson J. Hepburn, Jr.	581 W. Riverside Drive 335 Foul Bay Road
PRAIRIE DIVISION			
Manitoba* Saskatchewan	VE4BG VE4SV	A. J. R. Simpson Arthur Chesworth	635 Garfield St. 1071 4th Ave., N. W.

* Officials appointed to act until the membership of the Section choose permanent S.C.M.s by nomination and election.

*Amateurs Everywhere
have Compared and they ...*

Prefer KENYON

MANUFACTURERS long have recognized Kenyon Quality by specifying Kenyon Transformers in their equipment. Amateurs, too, have proven again and again the truth of that famous slogan: "What a whale of a difference just a few cents make"! After all when YOU measure "On the Air" hours against Dollar investment . . . KENYON TRANSFORMERS are one of the greatest *values* in the long run!

PLATE TRANSFORMERS FOR STANDARD AMATEUR DUTY

Type	D. C. Volts	MA DC	Net
T-668*	500-750	300	\$ 5.95
T-669*	1000-1250	300	9.60
T-670*	1500-1750-2000	300	12.90
T-671*	1000-1250	500	12.90

*tapped secondaries

KEN-O-TAP UNIVERSAL MODULATION TRANSFORMERS

Type	Watts	Class C Load	Watts	Net
T-489	15	30		\$ 2.40
T-493	40	80		3.60
T-494	75	150		5.40
T-495	125	250		12.00
T-496	300	600		18.00

FILTER CHOKES

Type	Henries	MA	Res	Ins	Net
T-153	30	90	350	1000	\$1.80
T-152	10	200	100	1000	2.10
T-166	11	300	125	1500	4.20
T-167	11	400	80	3000	5.70
T-177	12	500	95	5000	9.00

SWINGING CHOKES

Type	Henries	MA	Res	Ins	Net
T-517	15-45	90-20	350	1000	\$1.80
T-506	5-20	200-30	100	1000	2.10
T-510	6-19	300-30	125	1500	4.20
T-516	5-20	400-50	80	3000	5.70
T-521	6-21	500-60	95	5000	9.00

SPECIAL ANNOUNCEMENT: Kenyon Transformers are now distributed by **STALLMAN** of ITHACA, 128 E. Seneca Street, Ithaca, N. Y.; **BEAUCAIRE, INC.**, 228 Broadway, Rochester, N. Y.; and the 3 stores of **AARON LIPPMAN & CO.**, located at 246 Central Avenue, Newark, N. J., 79 Bridge St., Paterson, N. J., and 54 Albany St., New Brunswick, N. J.

SEND FOR FREE CATALOG



KENYON TRANSFORMER CO., Inc.

840 BARRY ST., NEW YORK, N. Y.

Export Department: 25 Warren St., New York, N. Y.

THE AMERICAN RADIO RELAY LEAGUE

Directors

<i>President</i>	
EUGENE C. WOODRUFF.....	W8CMP 234 W. Fairmount Ave., State College, Pa.
<i>Vice-President</i>	
GEORGE W. BAILEY.....	W1KH 74 Webster Road, Weston, Mass.
<i>Canadian General Manager</i>	
ALEX REID.....	VE2BE 169 Logan Ave., St. Lambert, P. Q.
<i>Atlantic Division</i>	
WALTER BRADLEY MARTIN.....	W3QV Box 612, Roslyn, Pa.
<i>Central Division</i>	
R. H. G. MATHEWS.....	ex-W3ZN 4534 Dover St., Chicago
<i>Dakota Division</i>	
FRED W. YOUNG.....	W9MZN 107 Hanover St., Mankato, Minn.
<i>Delta Division</i>	
E. RAY ARLEDGE.....	W5SI P.O. Box 286, Pine Bluff, Ark.
<i>Hudson Division</i>	
KENNETH T. HILL.....	W2AHC 115 Willow St., Douglaston, L. I., N. Y.
<i>Midwest Division</i>	
FLOYD E. NORWINE, JR.....	W9EFG 7406 Hiawatha Ave., Richmond Heights, Mo.
<i>New England Division</i>	
PERCY C. NOBLE.....	W1BYR 37 Broad St., Westfield, Mass.
<i>Northwestern Division</i>	
RALPH J. GIBBONS.....	W7KY c/o United Air Lines, Portland, Ore.
<i>Pacific Division</i>	
J. L. McCARGAR.....	W6EY 66 Hamilton Pl., Oakland, Calif.
<i>Roanoke Division</i>	
H. L. CAVENESS.....	W4DW State College Station, Raleigh, N. C.
<i>Rocky Mountain Division</i>	
GLEN R. GLASSCOCK.....	W9FA 2164 So. Corona St., Denver
<i>Southeastern Division</i>	
BENNETT R. ADAMS, JR.....	W4AFU 1512 Grove Place, Homewood, Ala.
<i>Southwestern Division</i>	
CHARLES E. BLALACK.....	W6GG 1273 Main St., El Centro, Calif.
<i>West Gulf Division</i>	
WILLIAM A. GREEN.....	W5BKH 801 Ross St., Abilene, Texas

THE AMERICAN RADIO RELAY LEAGUE, INC., is a non-commercial association of radio amateurs, bonded for the promotion of interest in amateur radio communication and experimentation, for the relaying of messages by radio, for the advancement of the radio art and of the public welfare, for the representation of the radio amateur in legislative matters, and for the maintenance of fraternalism and a high standard of conduct.

It is an incorporated association without capital stock, chartered under the laws of Connecticut. Its affairs are governed by a Board of Directors, elected every two years by the general membership. The officers are elected or appointed by the Directors. The League is non-commercial and no one commercially engaged in the manufacture, sale or rental of radio apparatus is eligible to membership on its board.

"Of, by and for the amateur," it numbers within its ranks practically every worth-while amateur in the nation and has a history of glorious achievement as the standard-bearer in amateur affairs.

Inquiries regarding membership are solicited. A bona fide interest in amateur radio is the only essential qualification; ownership of a transmitting station and knowledge of the code are not prerequisite. Correspondence should be addressed to the Secretary.



HIRAM PERCY MAXIM, FIRST PRESIDENT

Officers

<i>President</i>	EUGENE C. WOODRUFF, W8CMP State College, Pa.
<i>Vice-President</i>	GEORGE W. BAILEY, W1KH Weston, Mass.
<i>Secretary</i>	KENNETH B. WARNER, W1EH West Hartford, Connecticut
<i>Treasurer</i>	ARTHUR A. HEBERT, W1ES West Hartford, Connecticut
<i>Communications Mgr.</i>	F. EDWARD HANDY, W1BDI West Hartford, Connecticut
<i>General Counsel</i>	PAUL M. SEGAL 1026 Woodward Building, Washington, D. C.

Address all general correspondence to the administrative headquarters at West Hartford, Connecticut.

“IT SEEMS TO US—”

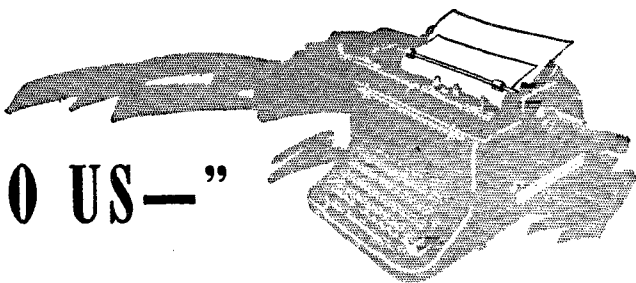

IN THIS issue is an announcement of high interest to the ultra-high-frequency gang: the first of a series of u.h.f. operating contests. We are considerably steamed up over this. It has seemed to us for some time that u.h.f. operation has reached the place where it offers a chance for some real good operating fun and an opportunity to participants to hang up some new records. As a matter of fact we're looking forward (and not so far forward, either) to Transcon Tests on u.h.f. Any 200-meter old-timer can tell you that those were the most exciting days of ham radio, in the early years — when we were first endeavoring to get messages across the nation by relaying, and the answer back to the starting point on the same night. The advent of high frequencies changed all that, with the ability to work almost at will to any old distance. The ultra-high are now at about the point 200-meter work was in 1914 when the League was formed, both as to the number of participants and the ranges of stations. Relaying was (and is!) lots of sport and it makes fine operators, as well as proving out apparatus. Much of the thrill in u.h.f. work has been in the occasional sky-wave DX but, to be frank, we haven't this very much in mind in thinking of u.h.f. relaying. We're thinking more of the opportunities that exist now to organize some chains of stations into routes that can pass messages back and forth by the bucket-brigade relay system. That would offer a prime return to the old relay spirit and to the sport that we used to have. In the old days, when station ranges were about 25 miles, we had to lean on each other to get our communications to greater distances than we could work ourselves. With each man agreeing to cooperate by relaying for the others, we extended our ranges indefinitely. We were interdependent and so we had to cooperate. We built this League on that basis. Now we have an immense opportunity to apply those same fine old principles in the u.h.f. field and to have a jolly spot of sport in the doing of it.

We're thinking ahead, for example, to the time when these stations will group themselves into routes like the old trunklines, for example

running from Boston to Chicago and from Seattle to Los Angeles and from Atlanta to Dallas and from Chicago to New Orleans, and so on, all trying to push test messages through by 25-mile relays, and trying every week or month on test night to get a little closer to the goal. At first the messages will get stuck close to home, but there will be progress, and by and by the messages will get farther before they encounter a hopeless gap. New stations will be lined up to fill the holes. Maybe the route will have to change to take advantage of a new possibility of getting through. Finally will come the great night when the whole system is open from end to end and the message will scoot through and its answer will come tumbling back along the line. That will be a record. That means that it will be something to shoot at, and you can depend upon its being speedily broken, until finally we have something of which to be plenty proud — coast-to-coast relaying by short reliable jumps on u.h.f., with a fast time record.

So ho for some new pioneering in the old manner! Are you on? It'll be no wrap-up, of course. There will be some crushing disappointments at first but persistency will do it and it will be grand fun trying. The present announcement of course is not of an attempted coast-to-coast relay. It's preliminary to that, though, and that will come when the time is ripe. Get in on the fun!

BOTH the international and the national radio regulations define an amateur as a person interested in the *technique* of radio communication. Wise national policy encourages the collateral results of amateur activity: preparedness for emergencies, self-training as skilled operators, and so on. But the primary right by which we hold our tickets is that we are experimenters, interested in the technical aspects of a complex art on the learn-by-doing basis.

How does it happen, then, that so many of us are content to buy our apparatus ready-made or to hire some other fellow to build it? Or how does it happen that, when we can't afford that and have to “roll our own,” we

are satisfied to copy slavishly some published design of a transmitter or receiver? The rush seems to be to get on the air and operate. That's amateur radio, too, to be sure, and the ultimate purpose of all apparatus is to provide communication. But too many of us are content with simply having a station, with doing no experimenting, with having no real knowledge why our gear performs. The foreign amateurs skin the pants off of us in this respect. The average of their technical knowledge is amazingly higher than ours, and we should hang our heads in shame.

We point out that the well-rounded amateur is proficient technically as well as in other respects. Technical articles and handbooks are an invaluable guide, fertile with ideas, but they should be applied as *aids* to the designing of our own stuff. We can't rest on ancient technical laurels. Ragchewing and DX don't make you a perfect amateur; not even traffic-handling does that. It ought also to be a matter of pride with you to be sufficiently proficient from the technical standpoint to be able to design and build most of your own gear, and in a manner different to the other fellow's. Let's have some originality! Let's see some of that talked-of ingenuity and independent thinking of the American amateur!

K. B. W.

★ SPLATTER ★

WE'VE been educated to believe that prizes come in small packages. When we listened to Ray Woodward's gadget called the Hetrofil (pronounced hetro-fil), we were convinced that there really was some truth in the old saw. If you want something for practically nothing, don't fail to give Hetrofil a whirl.

★ ★ ★

The 56-Mc. band has been so hot all summer that it will probably be like pulling teeth to get a group steamed up over some real occupancy of 112 Mc. and above. But there'll come a day when these frequencies will be mighty important, and in the meantime we are scouting around for the best there is for *QST* readers. This month we present dope on transmitter construction, as well as a résumé of what has been going on at Mt. Washington on 225 Mc.

★ ★ ★
Our Cover

Once again W1DQ follows through with a shot that makes a cover. This illustrates 10-meter portable-mobile W1DQ in the country with an assistant op at the mike.

★ ★ ★

Fred Elser, W6GVU (ex-OP3AA and a few W1 calls), puts forth a historical quiz for the old timers. We'll publish the answers next month. How many do *you* remember? They have all appeared in the columns of *QST*.

1. What were "Curkoids?"
2. What was "Sorsinc?"
3. What is a "kilohertz?"
4. What is a "picofarad?"
5. What is a "myriacycle?"
6. What was the "Radiotelescopograph?"
7. For what did the letters WNP stand?
8. What was an OT?
9. What was the "Moduloscope?"
10. What was the first advertised price of the 201-A tube in *QST*?

★ ★ ★

Can you imagine a 412-foot rotary "V" beam? If you want to know how it's done, ask W1EH the next time you contact. We have prevailed upon KB for a description and hope to serve it up hot for our October issue.

★ ★ ★

FEEDBACK

Fig. 4, page 28, August QST:

There should be a connection from the top of S_1 to the plate of the 6L6 as it comes from choke Ch .

— . . . —

Page 45, August QST:

The 112-Mc. antennas as used at W6MAK and W6MYC on their transceivers are only 36 inches long!

★ ★ ★

When you read about W1LJI's latest rig, don't get upset about the small tank-condenser spacings in the grid and plate circuits of the final — they'll handle a kw., fully modulated, at 2500 volts — though only 2000 is recommended.

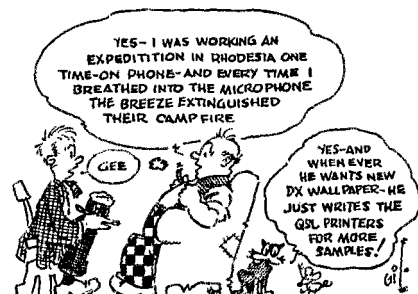

In these days of complicated thises and thats it's rare indeed to find something exceedingly simple and yet exceedingly effective. Hetrofil is a gadget which can profitably be added to any receiver, from the simplest one-lunger up to the most elaborate multi-tuber, calls for no tube or power supply, no digging into the receiver's innards, and can be built from a few inexpensive parts. It does a really remarkable job of wiping out an interfering heterodyne, a point on which you can convince yourself by giving the circuit a try. You won't be able to avoid waxing enthusiastic.

Hetrofil—An Aid to Selectivity

An Audio "Phasing Out" System for Eliminating Heterodyne Interference

BY RAYMOND W. WOODWARD,* W1EAO

THE crystal filter has been a boon to users of communication receivers as an aid in separating two signals, rejecting an unwanted one and accepting a desired one. However, its use is restricted to superheterodyne receivers and generally to the more expensive models as well. Thousands of users of t.r.f. receivers and lower-priced superhets are denied its advantages and, it might be added, many operators having crystal filters fail to use them because they have not mastered the proper operation.

The purpose of this article is to describe a device which can be applied to any receiver and affords a means of rejection similar to the "phasing" action of the crystal filter. It is simple to operate, requires no tubes, and best of all, costs less than a good crystal. Simply plug it into the 'phone jack of the receiver, the 'phones into a new jack on the box and there you have it. By rotating a knob an interfering c.w. signal or a 'phone heterodyne can be eliminated.

The basis of the device is the Wien bridge, which is an alternating current bridge ordinarily

* 849 Farmington Avenue, West Hartford, Conn.

used to measure audio frequencies. For instance, such a bridge might be used in precision measurement of radio-frequency signals as a means of measuring the audio residual or beat note obtained between a 5- or 10-ke. multivibrator and a signal being measured, and in this manner amateur frequencies can readily be measured with an overall accuracy of ± 50 cycles.

It was while using the Wien bridge in frequency measurements that the writer considered the circuit could be applied to receiver outputs and the sharp balance or null point used to remove a troublesome heterodyne. Trial showed the theory was sound so a simplified version of the Wien bridge — "Hetrofil" — was constructed and given operating tests. By its use many a QSO has been carried out that would have been impossible without it (or a crystal filter) on both 'phone and c.w. Now, every ham who comes into the shack wants to know what is in the little box. So here it is.

Fig. 1 shows the basic Wien bridge as used in audio measurements. In this bridge the unknown frequency is applied across *A* and *B* (generally

◆
The Hetrofil fits into a 3 × 4 × 5-inch box with room to spare. The plug goes into the 'phone jack on the receiver; the 'phone plug into the jack on the case.
◆

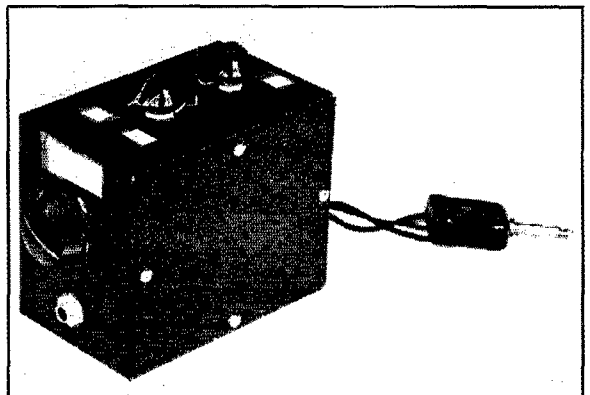

through an isolating transformer) and the resistance R_c and R_d varied until a null or absence of sound is indicated in the 'phones or other detector.

Then the unknown frequency

$$f = \frac{1}{2\pi\sqrt{R_c R_d C_c C_d}}$$

provided also

$$\frac{C_d}{C_c} = \frac{R_b}{R_a} = \frac{R_c}{R_d}$$

Now if C_c is made equal to C_d and R_c equal to R_d as well as the ratio $\frac{R_b}{R_a} = 2$, then the expression for frequency reduces to

$$f = \frac{1}{2\pi R_c C_c}$$

These conditions are easily met, and R_c and R_d can be two identical variable resistors mounted on a common shaft. P is a small variable for aid in establishing final balance.

For measurement work accurate components are necessary, but for the purpose at hand the bridge can be simplified and ordinary parts of commercial tolerances used, although the more accurate they are the more effective the device. In addition, means should be provided for switching the device in or out of circuit as well as to change the frequency range.

Fig. 2 gives the Hetrofil circuit as used for communication purposes, and the photographs show the arrangement of parts in a small box 5 by 4 by 3 inches. A cord out the rear has a plug for connecting to the receiver, while a jack on the front takes the regular 'phone plug. The two knobs on the top control switches S_1 and S_2 and the knob on the front provides the variable control to adjust to the frequency to be eliminated.

The fixed resistors and condensers may be of small size as no power or high voltage is involved. The dual variable resistors should preferably have a logarithmic taper and be of like values. Those at present available in the amateur supply houses do not exactly meet these requirements, but it is hoped that more suitable items will shortly be available for this purpose.

The values shown for R_1 and R_2 have been found satisfactory when working into a receiver

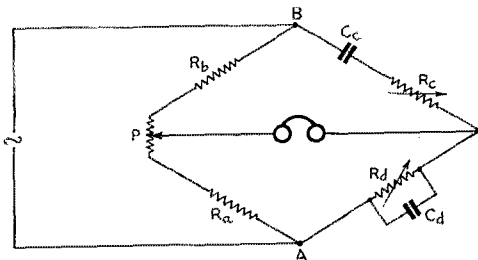

Fig. 1 — Fundamental Wien bridge circuit.

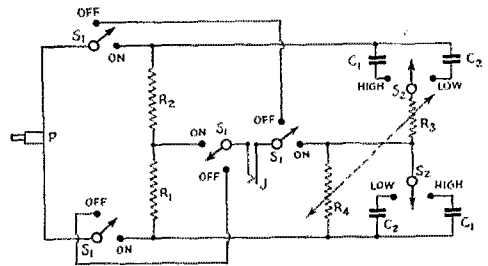

Fig. 2 — The "Hetrofil" circuit.

- C_1 —0.05 μ fd.
- C_2 —0.25 μ fd.
- R_1 —1000 ohms.
- R_2 —2000 ohms.
- R_3, R_4 —10,000-ohm variable.
- J—Open-circuit jack.
- P—Phone plug.
- S_1 —4-pole double-throw switch.
- S_2 —2-pole double-throw switch.

'phone output intended for regular 2000-ohm 'phones. If the device is inserted in a 500-ohm circuit or the low-impedance line to a voice coil the resistors will have to be altered to suit the lower impedance. Proper values can be found by trial, keeping in mind that the ratio of R_1 to R_2 should always be 2 to 1.

Naturally, inserting any resistive network in the audio output will attenuate the signal somewhat. However, this is no great disadvantage as practically all receivers have an excess of audio available and the audio gain can be advanced to offset the loss. Using commercial parts, the model shown has an average loss of 10 to 15 db. With more accurate units and with a more perfect impedance match with the receiver the loss can be reduced to the order of 5 db. There is also some frequency discrimination so that some frequencies are attenuated more than others, as will be shown later. This results in some distortion of 'phone signals, but this also can be tolerated, when it is a case of receiving the signal or not, and is no more a detriment than the use of a crystal filter on 'phone signals.

In use the device normally has the switch S_1 in the "off" position connecting the 'phones straight to the receiver. When an interfering c.w. signal or 'phone heterodyne appears, switch S_1 is thrown to the "on" position and the audio gain advanced if necessary. The dual variable-resistor control is then rotated until a position is located where the interfering heterodyne disappears. The point of complete elimination is quite sharp and effective.

The Hetrofil, of course, completely eliminates only one frequency. If there is harmonic distortion in the beat note being eliminated, as may be the case with exceptionally high audio output or faulty audio circuits, the higher harmonics will remain after the fundamental is removed. Generally, these are too weak to be noticed.

The selection of condenser C_1 or C_2 by switch S_2 is dictated by the particular frequency to be rejected. Calculation using the formulas given above shows that C_1 will have a lower limit of about 320 cycles (when all resistance is in circuit) while C_2 will go down to about 65 cycles. Thus, if the beat note is less than about 350 cycles C_2 has to be used. For all higher frequencies C_1 should be used as it gives much sharper rejection and less attenuation.

A great many transmission curves have been obtained using different values of fixed resistors and condensers with the circuit set to reject various frequencies, from the lowest to the

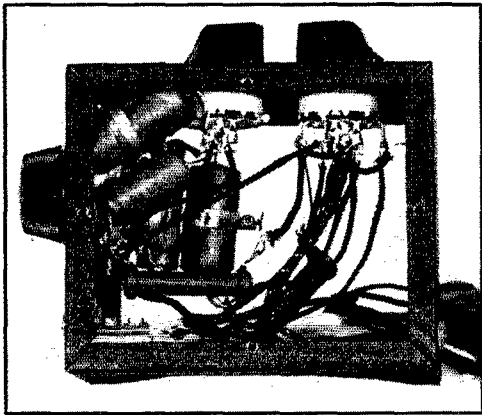

Looking inside, with the side covers removed. The dual volume-control type variable resistor, at the left on the front wall, is partially concealed by the fixed condensers.

highest, and the attenuation throughout the audible range studied. To do this a constant-level source of audio voltage from a beat frequency oscillator was applied to the input of the Hetrofil and the output measured with a General Radio Sound Analyzer. The use of the latter equipment to measure the output eliminated the effect of any residual audio harmonics which might be present at the null point or at any other of the frequencies measured.

Fig. 3 shows curves typical of those obtained. In this case the constants of the Hetrofil circuit shown in Fig. 2 were used and the controls set to eliminate 200-, 500-, 1000- and 2000-cycle signals. The solid lines show the results with S_2 set on the high side or with 0.05- μ fd. C_1 condensers in the circuit, while the dotted line is for the low setting of S_2 with the 0.25- μ fd. C_2 condensers.

These curves were taken with commercial-tolerance resistors and condensers, and it should be pointed out again, do not represent the maximum results possible with more accurate components. With the high setting the peak rejection is about 70 db and at 10 per cent off resonance

(Continued on page 90)

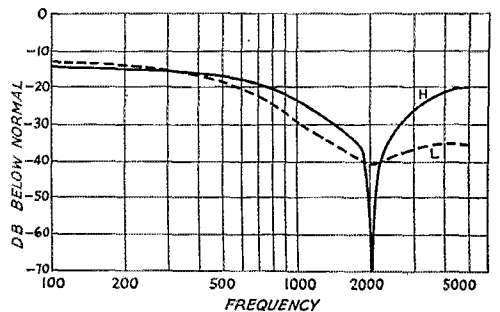
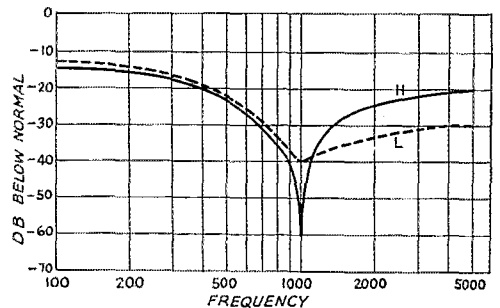
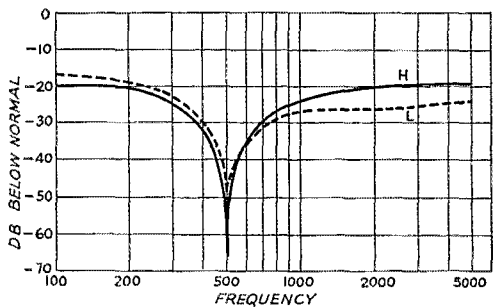
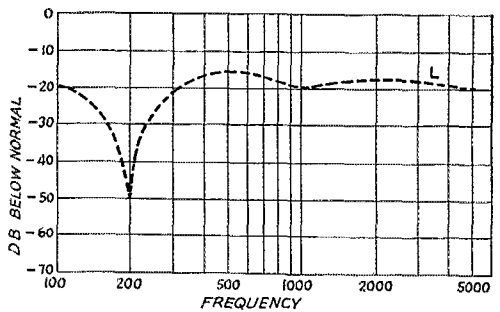

Fig. 3—Attenuation over the band 100-5000 cycles for four representative settings of the rejection frequency.

An Answer to the E.C.O. Problem

Complete Data on an E.C.O. With Assured Crystal Performance

BY CHARLES D. PERRINE, JR.,* W6CUH

Here is an e.c.o.-crystal combination designed for DX operation that comes up to the highest standards of the game. Temperature compensation, careful adjustment of values, voltage stabilization and reduced susceptibility to r.f. feedback—all contribute to the effectiveness of W6CUH's latest contribution.

THIS is an exciter that combines all the advantages of crystal and electron-coupled operation—but with better than average crystal-quality output at all times. Its frequency stability with respect to temperature and voltage is considerably higher than that of the ordinary X-cut crystal, and its design incorporates features that makes its performance independent of varying external circumstances such as r.f. feedback,

* Hughes Aircraft Co., Union Air Terminal, Burbank, Calif.

line-voltage fluctuation and temperature changes.

The unit gives full coverage of the 14-Mc. band from edge to edge. The two crystals used are on each edge (usually 500 cycles inside), temperature maintained, and hold their frequency to 25 cycles over periods of weeks. In between the two crystals, the e.c.o. can be used to within 2 kc. of either band edge with complete safety. The measured temperature coefficient of the e.c.o. is about 8 cycles per megacycle per degree centigrade. With the voltage regulator in use, line-voltage changes have no measurable effect on the transmitter output frequency even at 28 Mc. The oscillator without voltage regulation shifts only three cycles at 14 Mc. for a 20% drop in plate voltage. Such stability means that keying loads will have no effect on frequency, and that the unit can be depended on for frequency measurement work to nearly 0.01% (though it must be remembered that the F.C.C. requires separate frequency measuring means).

These features have been well checked in the

original development model¹ during the past winter. The new model presented here has been both improved and simplified, especially as to station operating efficiency. Approximately 3 watts output is obtained over the range from 3500 to 3600 kc. This gives complete coverage of 14 Mc. and the important c.w. sections of 7 and 28 Mc. The power output is low as exciters go, but this is a frequency control unit and is not intended to be half the source of r.f. power. Two tubes do the job: a 6SK7 for the e.c.o. and a 6V6G for the crystal oscillator-doubler. One crystal is set on 3500.125 kc. and the other on 3599.875 kc.; this places the trans-

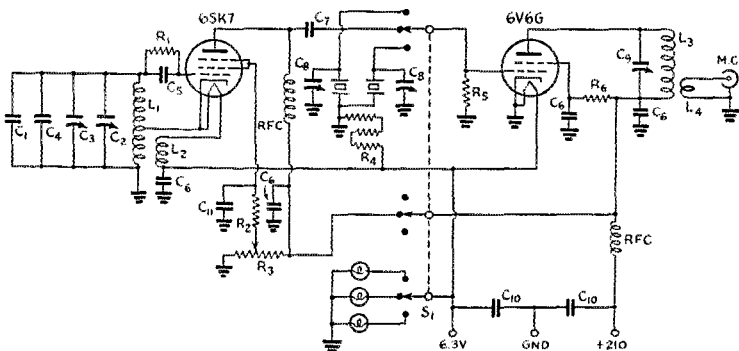

Fig. 1—The circuit diagram of the exciter.

- C₁—10- μ fd. fixed condenser with -0.0007 temp. coefficient (Centralab).
- C₂—100- μ fd. tuning condenser (Hammarlund MC-100-S).
- C₃—100- μ fd. padding condenser (Hammarlund APC 100).
- C₄—Four paralleled 200- μ fd. zero temperature-coefficient (Centralab).
- C₅, C₇—100- μ fd. midget mica.
- C₆—0.002- μ fd. midget mica.
- C₈, C₉—25- μ fd. midget variable (Hammarlund APC 25).
- C₁₀—0.1- μ fd., 400-volt paper condenser.
- C₁₁—0.001- μ fd. midget mica.
- R₁—1.5 megohm, $\frac{1}{2}$ -watt.
- R₂—15,000 ohms, 1-watt.
- R₃—20,000-ohm, 10-watt adjustable wire-wound.

- R₄—Three 2-ohm, 10-watt wire-wound, connected in series.
- R₅—100,000 ohms, $\frac{1}{2}$ -watt.
- R₆—20,000 ohms, 2-watt.
- RFC—2.5-mh. r.f. choke.
- L₁—20 turns No. 26 enam. wound on 1-inch diam. form and spaced to occupy $\frac{3}{4}$ inch. Cathode tap at 5th turn from ground end.
- L₂—5 turns No. 26 d.s.c. interwound at lower end of L₁.
- L₃—45 turns No. 26 enam. wound on 1-inch diam. form.
- L₄—2-turn link at cold end of L₃.
- MC—Microphone connector used to connect to concentric line (Ampheoul).

¹Perrine, "XEC Transmitter Control," *Radio*, Jan. 1939.

mitter 500 cycles inside the edges of the 14-Mc. band. Exact setting of the crystal frequencies is accomplished by the 25- μmf . variable condensers, C_8 , allowing a variation of about 0.5 kc. at the fundamental.

The requirements of effective operating were given considerable thought in arranging the controls. Simplicity was important, as rapid use demands a minimum of controls. The main tuning dial should be large, and, if possible, directly calibrated for each band. Its vernier ratio must not be too great to hinder fast band coverage. A single three-point switch selects the two crystals or e.c.o.; the crystals are on the two outside points with the e.c.o. in between, corresponding to their positions in the band. Instead of the conventional method of switch marking, three new type panel lights are used opposite each switch position. Thus the setting of the switch is clearly evident from almost any angle of view.

The Circuit

The complete circuit is shown in Fig. 1. A 6SK7 with screen and suppressor tied together is used in the e.c. oscillator, chiefly because of its excellent output circuit isolation. In addition, its output is well above that of the 6L7 or 6K8, and oscillation is stable and positive even though working into such a low-impedance, high- C tank. The total tank capacity is close to 1000 μmf . and is a definite improvement over the smaller values normally used. The e.c.o. operates on the 1.75-Mc. band, using the impedance-coupled 6V6G crystal oscillator as a doubler to 3.5 Mc. The e.c. should always operate on a band lower than the succeeding stage, as reaction from higher-powered stages on the e.c.'s frequency band will almost always cause instability. A number of e.c.o.'s shown in the past have operated the oscillator directly on 7 and even 14 Mc.

Most important adjustment of all in e.c. practice is that of the cathode tap that controls the oscillator feed-back. Its position affects the frequency-*vs.*-voltage characteristic of the oscillator more than any other factor. The curves of Fig. 2 show the variation of frequency with plate voltage for various cathode taps. With the cathode tap two turns up, a positive frequency shift of nearly 3 kc. occurs; while at the other extreme, the frequency change is negative 1 kc. For this particular unit, the best position for the cathode tap is at the fifth turn, but this point will not necessarily be the correct one in all cases. Care should be exercised in checking performance, as will be outlined below.

An examination of the circuit will show that the 6SK7 heater is fed through the coil by means of a second wire interwound with the coil between the cathode tap and ground. Ninety per cent of the poor e.c.o. notes are probably due to frequency modulation caused by r.f. feed-back reaching the oscillator via the heater leads and the heater-

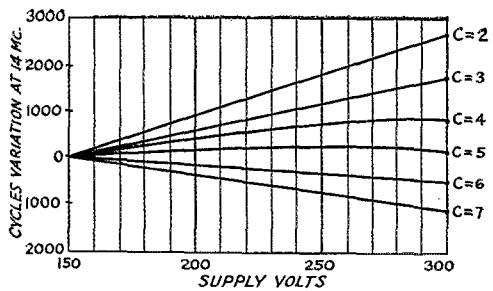

Fig. 2—Showing the variation of frequency with plate voltage for various positions of the cathode tap.

cathode capacity. But this heater feed places the heater and cathode at the same r.f. potential (the same as grounding the cathode which actually can be done only by sacrificing the electron-coupled feature and its voltage stability). Thus r.f. that does reach the oscillator finds no way into the tuned circuit and the grid of the 6SK7.

Another factor greatly influencing the voltage coefficient of the oscillator is the grid-leak value. Raising the leak resistance increases the tube impedance, thereby lessening the effect of tube-voltage changes on the relatively lowered impedance of the tank circuit. It was found that changing from the conventional 0.1-megohm leak to one of 1.5 megohms halved the frequency change for a given plate voltage shift. Fortunately, the 6SK7 output drops but slightly with the higher grid leak value.

The screen voltage supply using a series dropping resistor in addition to the usual divider is the third feature contributing to the low voltage-coefficient of the e.c.o. Note that the screen bypass condenser is only 0.001 μf .; higher capacities do not allow the screen to follow and compensate for rapid changes in plate voltage. Adjustment of the series resistor R_2 is the final step in the voltage stabilization of the oscillator. In this case, the best screen adjustments gave a screen voltage of 145 (180 volts at the divider tap) for the plate voltage of 210. The resulting frequency-*vs.*-voltage curve is shown in Fig. 3. A curve was also run on the crystal oscillator over the same range for the sake of comparison. The two curves show definitely that the e.c. is flatter than the crystal between 200 and 250 volts.

Temperature compensation has proven a simple means of eliminating the changes due to heating. Condenser C_1 does the job, as shown in Fig. 4. The one-kc. drift at the cold end of the curve (compensated) is due to the warm-up and takes place during the first ten minutes. The rest of the curve shows a variation of less than one kc. for normal values of room temperature. Due to adequate ventilation and the low tube heat developed, the interior of the unit remains close to room temperature. The main capacity is obtained from four 200- μmf . ceramic zero-coeffi-

cient fixed condensers — however, though nominally zero coefficient, these condensers can show enough drift to give a 4-kc. change at 14 Mc. As this coefficient can vary from condenser to condenser, it is again necessary to check the initial drift first and then compensate as required.

The rest of the circuit is largely conventional. The 6V6G works into a fixed-tuned tank that, when loaded, is sufficiently broad to cover the range. A concentric link has proven most effective in getting the power to the transmitter. Only three power leads leave the unit, an important point because every extra lead can help introduce r.f. feedback. As an extra precaution, the two hot leads are by-passed at the power plug.

Fig. 5 shows the power supply and voltage regulator. Two VR105 regulators are used to stabilize the 210 volts used on the unit. Individual leads are brought out from the power transformers, so they may be controlled separately. The filter shown has proven adequate, but another section would doubtless be still better insurance against ripple.

Construction

The exciter is mounted on a standard 8 $\frac{3}{4}$ - by 19-inch relay rack panel with 17- by 10- by 3-inch chassis. The photographs tell the story pretty well, so only two or three important points will be discussed. Though not shown in the picture, a heavy metal cabinet is used to cover and shield the unit and is an essential part of any e.c.o., as operation in the open is usually a plain invitation to trouble. The empty space on the right side of the chassis and panel is reserved for the automatic band-change and tuning control of a contemplated transmitter — a three-position

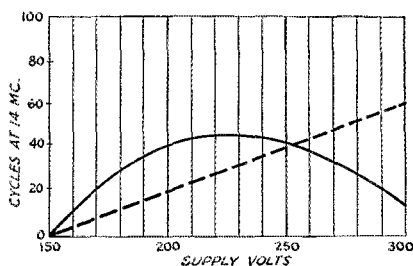
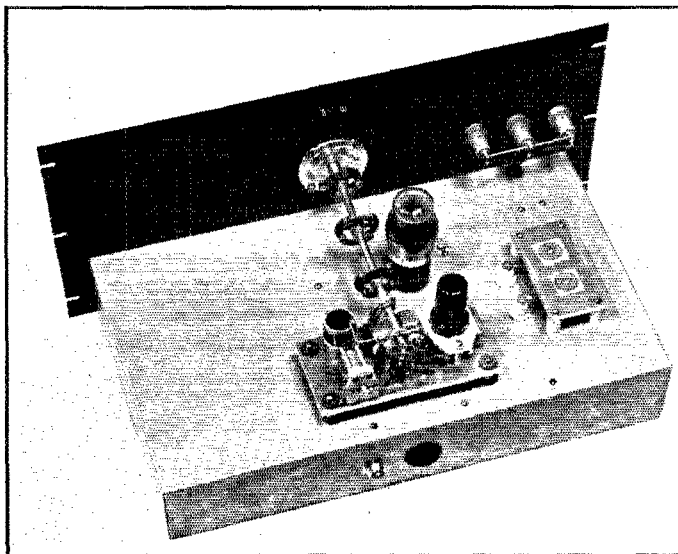

Fig. 3—A comparison between the properly-adjusted e.c.o. (solid line) and a typical crystal oscillator (dotted line).

switch (for the three bands) with lights similar to the frequency selector switch, will occupy the right side of the panel. The lights are a special aircraft type made by the Korry Mfg. Company of Seattle. The bulb extends out into the molded plastic "lens" so that one cannot fail to see it when lighted. The face of the translucent "lens" is flat and has been engraved with the corresponding switch markings. The dial is 5-inch diameter dural engraved directly in frequency with scales for 7, 14 and 28 Mc. It uses the vernier movement from a National Type A dial. The vernier is mounted behind the panel to bring the dial closer to the panel surface.

The e.c. components are all mounted on the shock-mounted dural plate. Rubber grommets and metal spacers are used to raise the plate about an inch above the metal chassis. The e.c. by-pass condensers and the coupling r.f. choke are under the plate. All parts are solidly mounted to prevent vibration anywhere in the unit. Three flexible couplings are shown on the tuning shaft to absorb vibration that might be transmitted



The frequency-control unit combines e.c.o.- and crystal-control operation. The e.c.o. unit is mounted at the rear of the chassis on a dural plate, shock-proofed by rubber mounts. What appears to be four resistors mounted on the tuning condenser (and one inside the coil) are ceramic-type fixed condensers. The condenser in the coil has a negative temperature coefficient; the other condensers have zero coefficients. The two crystals, mounted on the dural plate at the right, are temperature-maintained by resistors under the plate, and a balsa box covers the crystals and plate when in use.

from the panel. It is important that the couplings have no backlash — those in the photograph proved poor in this respect and have since been replaced by the small fiber National units.

The compensating condenser C_1 , mounted inside the e.c. coil, is just visible in the back view. This location greatly improved the smoothness of compensation and the condenser now follows the temperature variations of the coil very closely. Some fellows have complained that the draft from an open window would shoot the frequency up a few kc. — which is simply a matter of the compensator (mounted outside the coil in the earlier model) cooling faster than the coil due to its lower thermal capacity. Putting the compensator inside the coil solves the problem and saves space as well.

The details of the crystal mountings are clearly evident in the photograph. The bottom plate is $\frac{1}{4}$ -inch dural and large enough to have good thermal capacity. It is heat insulated from the chassis by the four pillar insulators (but grounded electrically, of course). The heating resistors are mounted underneath the plate. Not shown is the box of $\frac{1}{2}$ -inch balsa wood that covers the whole crystal assembly, acting as heat insulator and cover. The 6 watts supplied the heating resistors easily hold the crystals well above room temperature (about 125 degrees $F.$). As a result, changes in room temperature have only about one-tenth as great an effect on crystal temperature and hence the frequency.

The most important requirement in using this e.c.o. effectively (or any variable frequency control) is an accurate and rapid means of checking frequency against the receiver setting *without putting the transmitter on the air or disturbing the receiver*. In this case the job is done by the send-receive switch on the operating table; "neutral" is the receive position, "down" the transmitting

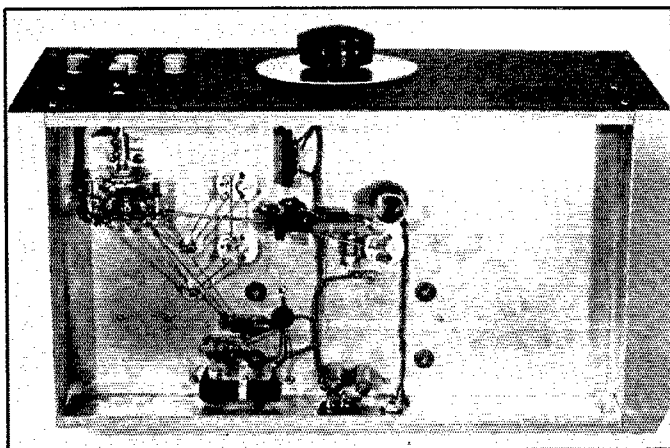

A view of the bottom shows the crystal switch, the two trimming condensers shunting the crystals, and the output tank circuit.

one, and when "up" the exciter alone goes on, along with the frequency monitor. The outputs of the two are fed into the receiver (which remains on the regular antenna) at about an S8 level. The frequency monitor works directly from a b.c. broadcast station of known accuracy (plus or minus one cycle maximum deviation) to give markers accurate to 16 cycles at 14 Mc. Thus the band-edge crystals and e.c.o.-receiver relation can be checked at will, as well as against incoming signals. In case the rest of the transmitter needs retuning to the new frequency, do your tuning with the oscillator set in one place just off the desired spot, then reset it to the desired spot with the transmitter *off*. The worst QRM comes from those who insist on adjusting their e.c.o.'s with the rest of the transmitter going full blast.

Checking Performance

Only half the job is done when the unit is built. Checking its operation before going on the air is even more important. By means of the following simple tests you can adjust it for best results, and at the same time be absolutely certain of its performance. Only systematic checks such as these will show up both the trouble *and the cause*. Reports solicited over the air are well known for their flattery content — chances are the other fellow has a pet antenna or tubercular e.c.o. on which he wants an equally complimentary report.

A thorough check of the note on all bands, with the transmitter at full power, is the main test for r.f. feed-back. A direct comparison of the crystal and e.c.o. notes is best as it eliminates errors arising in the receiver or monitor itself. The most accurate check will be on 28 Mc. because frequency modulation will be greatest on that band. Roughness in the e.c. note is a certain sign of r.f. feed-back (or in some cases, possibly

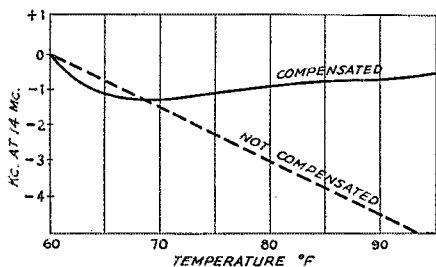

Fig. 4—The effects of temperature compensation.

a lack of power supply filtering), but we'll wager a couple of new countries that, with a properly-built e.c.o., the only way you can tell whether you're on crystal or e.c. will be to look at the selector switch.

The next step is a rough determination of the effect of plate voltage changes on frequency with the e.c.o. running by itself. This is easily done by

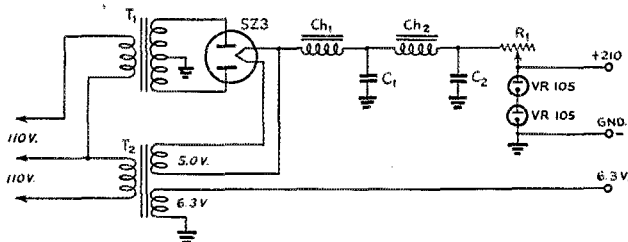

Fig. 5—The power supply wiring diagram.

- C_1 —8- μ fd., 450-volt electrolytic.
- C_2 —12- μ fd., 450-volt electrolytic.
- Ch_1 —10-henry, 75-ma. choke.
- Ch_2 —30-henry, 75-ma. choke.
- R_1 —10,000-ohm, 20-watt adjustable wire-wound resistor.
- T_1 —350-0-350-volt, 75-ma. plate transformer.
- T_2 —Filament transformer with isolated 5- and 6.3-volt windings.

putting a 2000-ohm resistor in series with the high voltage lead to the unit — cutting it in and out will cause approximately a 50-volt change in plate voltage, sufficient to show frequency-*vs.*-voltage variations. A well-warmed up receiver on 14 Mc. can serve as an indicator of the frequency change. An increase in frequency when the plate voltage is dropped indicates a cathode tap too high on the coil — a drop in frequency means too low a tap. If the frequency change is not over 300 to 400 cycles, the cathode tap is probably close enough. Final adjustment of the e.c.o. is done by alternately changing the tap on the screen divider, R_3 , and varying R_2 . R_2 can very well be a 25,000-ohm potentiometer for purposes of the test — a fixed resistor of the proper value has been used in this model, but the same value may not be exactly correct for other units. Properly set, the e.c.o. should not vary much more than 50 cycles (at 14 Mc.) for a 50-volt plate drop. As a double check, it is advisable to shift the line voltage 10 or 20% (with the test 2000-ohm resistor removed) to be sure the VR105's are on the job.

Final step in nailing down the unit is determination of the temperature-compensating capacity required. The simplest way to do this is to let the e.c.o. heat up (with compensator disconnected) through a known temperature range, then check the capacity change in the main tuning condenser C_3 required to return to the "cold" frequency at the start of the run. From the capacity change thus obtained (about 0.5 μ fd. in this case, corresponding to half a degree out of 100 dial degrees on C_2) and the known temperature coefficient of the compensating condenser, the value required in this condenser can be quickly calculated by the following formula:

$$C_0 = \frac{\Delta C}{K(T_1 - T_2)}$$

where, C_0 is the compensating condenser capacity, ΔC is the capacity change referred to above, K is the temperature coefficient of C_0 , and $(T_1 - T_2)$ is the temperature change. An ordi-

nary thermometer laid on the chassis can be used to measure the temperature. The temperature change is obtained by cooling the unit below room temperature by some convenient means and then allowing it to heat to operating temperature.

By now it should be evident that successful e.c.o. operation can be had only by attention to

definite facts — the critters are not controlled by magic or the aspect of the stars, as many past e.c.o.'s often led one to believe. Use of the proper circuit, careful adjustment and checking will give crystal performance to your e.c.o., but it should be remembered that even the best oscillator, crystal or self-excited, can't improve a bad note originating in the rest of the transmitter.

SWITCH TO SAFETY!



Silent Keys

It is with deep regret that we record the passing of these amateurs:

Horace B. Ashworth, W8HNT, Brockport, N. Y.

Henry Edward Benner, W6NVE, Red Bluff, Calif.

Raymond O. Blanqui, W2HKO, South Ozone Park, L. I., N. Y.

S. Thorne Chancellor, W6QXV, Santa Barbara, Calif.

Jerome C. Dodman, W2BMW, Richmond Hill, L. I., N. Y.

D. Guy Good, W7DBE, Ashland, Oregon.

Lt. Lawson E. Hill, W4AGN, Gainesville, Fla.

George E. Hurley, W8FMJ, Hamilton, Ohio.

David Knowles, W9MLQ, Waukegan, Ill.

Rev. Fr. Francis Michael, W7EPU, Boise, Idaho.

Howard Munding, W8TJN, Toledo, Ohio.

Walter S. Peterson, W4AFX, Paisley, Fla.

Robert E. Watkins, W1KQP, Keene, N. H.

High-Q Tank Circuit for Ultra-High Frequencies

Designing U.H.F. Oscillators of High Stability

BY ARNOLD PETERSON *

THE new regulations, which extend the requirements of frequency stability to the 5-meter band, are prompting those amateurs who prefer to use the simplest possible equipment to explore the possibilities of bands located still higher up in the frequency spectrum. Fortunately, a sufficient background in the technique for the $2\frac{1}{2}$ - and $1\frac{1}{4}$ -meter bands has been developed by the early workers in the field so that new arrivals can construct satisfactory apparatus for communication.

Recently some oscillators for these higher frequency bands were designed by the author in accordance with the results of an investigation of oscillator frequency stability at the ultra-high frequencies. This investigation was conducted as a part of a cooperative research program of the General Radio Company and the Massachusetts Institute of Technology. The oscillators include two for the $1\frac{1}{4}$ -meter band, one for $2\frac{1}{2}$ meters, and one for 5 meters. These particular ones have been built for Mr. Henry S. Shaw, W1FGA, and since Mr. Shaw has found them useful for his amateur work, other amateurs may obtain worthwhile information from a description of them. However, because the mechanical details make difficult the construction of these transmitters by the average amateur, this article is not intended to be a how-to-build-it one, but rather a discussion of the reasons for certain particulars of the design with the thought that those working at $2\frac{1}{2}$ and $1\frac{1}{4}$ meters may receive some helpful ideas.

Oscillator Requirements

In the amateur's search for suitable ultra-high-frequency generators, more and more power seems to be the principal end in view. This goal is a natural one, but higher power is not the only means to more reliable communication. In particular, as many amateurs realize, the use of

generators of high-frequency stability will make that power more effective. This consideration may seem to be out of place, since many are going to the higher frequencies to dodge the frequency stability requirement; but a little reflection will show that it is advantageous for the amateur to strive for reasonable frequency stability. For normal transmission with amplitude-modulated signals, any accompanying spurious

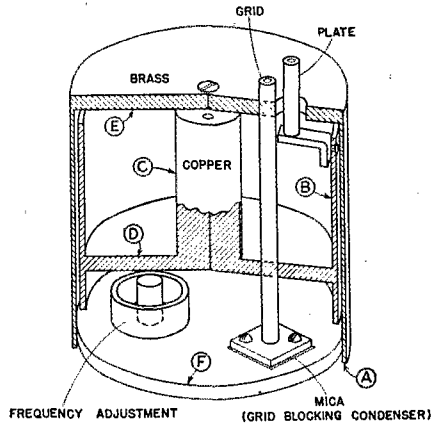

Fig. 1 — Sectional view of the tank circuit.

frequency modulation seems to have harmful effects only. For instance, the usual modulated oscillators for operation at these frequencies have such broad signals that even the moderate selectivity provided by a single good tuned circuit in the receiver can introduce noticeable distortion by not passing all of the frequency-modulated signal. Further, the relative signal-to-noise ratio that can be obtained with the use of simple amplitude modulation decreases as the band width required for the reception of the signal increases. Finally, the ease with which the superheterodyne

* General Radio Co., 30 State St., Cambridge, Mass.

The author covers the basic requirements for the construction of stable u.h.f. oscillators, discloses the shortcomings of ordinary tank circuits, describes a different type circuit — really a “tank” — especially designed for use with oscillators. The new tank is admittedly more difficult to build, but the amateur who is handy with tools will not find those difficulties insuperable. If you pretend to even a casual interest in the ultra-high frequencies you'll have to give this article a careful reading.

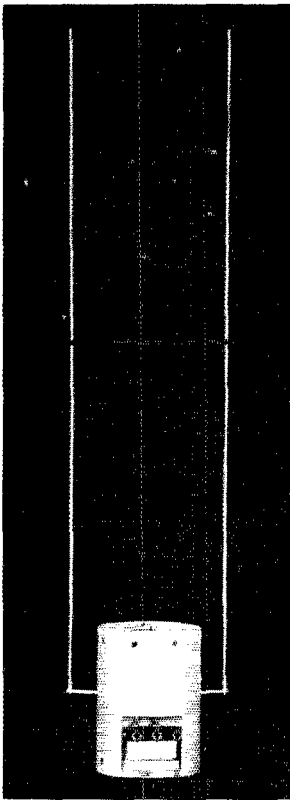

Fig. 2 — 225-Mc. oscillator with closely-spaced half-wavelength radiators. The aluminum cylindrical shield is approximately 5½ inches high.

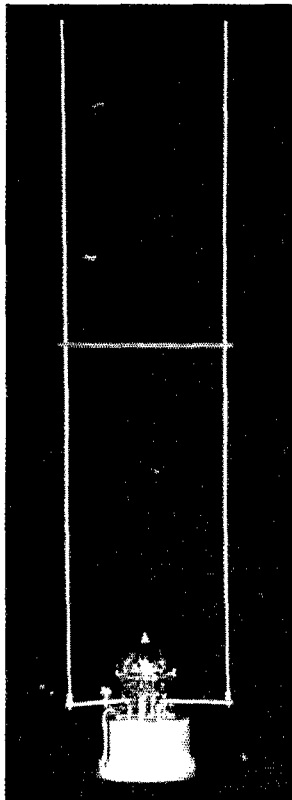

Fig. 3 — A view of the 225-Mc. oscillator with the cylindrical shield removed.

method of reception, with all its attendant advantages, can be applied is directly dependent on the frequency stability of the signal sources. Thus when these bands become more crowded, the stable signals will be more and more appreciated, particularly because of the smaller interference they will cause. At any rate one can see that any gain in frequency stability that can be made is to be desired, especially if this improvement does not involve a noticeable sacrifice in output.

To illustrate a method that can be used to achieve good oscillator frequency stability, the basic construction of the tank circuit¹ used here will be described, and the reasons for the design adopted will be discussed.

Basic Tank Circuit

The basic type of tank circuit used in the oscillators to be described here is shown in section in Fig. 1. This tank circuit is cylindrically symmetrical about the center-line axis and consists

¹ Peterson, Arnold, "An Ultra-High-Frequency Oscillator," *General Radio Experimenter*, XII, 5 (October, 1937).

of a large outer cylinder (A), capped at both ends, with a slightly smaller inner cylinder (B) supported coaxially from one of these ends by means of a central rod (C) and a connecting disc (D) from the rod to the inner cylinder. Although in appearance it does not resemble the usual tuned circuits, nevertheless, schematically it is nothing more than an inductance and condenser connected in parallel. The capacitance is practically that formed between the larger outer cylinder (A) and the smaller inner one (B), and the inductance is practically that resulting from the flux surrounding the central rod (C).

Since the radial flow of current in the connecting discs (D and E) contributes no appreciable inductance, the values of inductance and capacitance for structures of this type can be calculated rather accurately by the standard coaxial line formulas:

$$L (\mu h.) = 0.0046 l_L \log_{10} \frac{b_L}{a_L}$$

$$C (\mu f d.) = \frac{0.242 l_c}{\log_{10} \frac{b_c}{a_c}}$$

- where l_L = effective length of inductance (cm.)
 b_L = inside diam. of outside tube (B) of inductance
 a_L = outside diam. of central rod (C) of inductance
 and l_c = effective length of capacitance (cm.)
 b_c = inside diam. of outside tube (A)
 a_c = outside diam. of inside tube (B)

(If any dimension of the tank circuit exceeds about one-twentieth of the wavelength, these formulas can not be applied.) The capacitance from the lower disc (D) to the end cap (F) can usually be estimated with sufficient accuracy from the ordinary parallel-plate capacitance formulas² and then added to the capacitance of the cylindrical condenser. These formulas and a consideration of the capacitance loading of the oscillator tube will furnish the information needed in the design for operation at a given frequency.

Design Considerations

The fundamental reason for the use of a structure of this type is to obtain a tuned circuit that has low losses and whose elements are relatively fixed by reason of excellent mechanical stability. However, the mere use of this structure is not

² See for instance: *The American Radio Relay League, The Radio Amateur's Handbook* (15th ed.), p. 43.

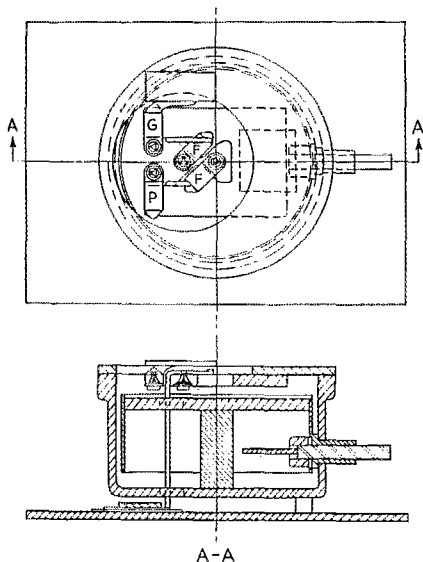

Fig. 4 — A simplified assembly drawing of the Hartley type of 1 1/4-meter tank circuit. The W.E. 316A isolantite socket is shown with the filament connections passing through the field of the inductance and with the grid terminal by-passed to the top cover-plate. A cylindrical aluminum shield, which is not shown, is used to complete the shielding around the tube.

sufficient to ensure that a stable oscillator will result. For this purpose one must arrange that the energizing vacuum tube be connected to the tank circuit in such a manner that variations in the tube's characteristics have as small an effect as possible on the frequency of oscillation. A consideration of the factors that produce instability in oscillators will show how this arrangement can be achieved.

At the ultra-high frequencies probably the most important of the factors that produce frequency modulation when the oscillator is amplitude-modulated is the variation of the effective interelectrode capacitances with electrode voltage. In order to reduce the effect of this variation to the smallest value practical, one has recourse to the standard amateur practice of using a hi-C (high capacity) tank circuit for the oscillator. An equivalent procedure is the use of a low-loss tank circuit and coupling so loosely to it that changes in the tube will not affect the resonant frequency too seriously. This procedure must be

followed when resonant lines are used for the tank circuit if one desires to take full advantage of the low losses of these circuits for obtaining frequency stability. A similar method should be used for low-capacity low-loss circuits of all types. However, by using a hi-C tank circuit, one obtains the advantage of a smaller physical size, and, at the same time, parasitic oscillations are usually not so troublesome when it is possible to connect directly across the main elements of the tuned circuit as opposed to coupling loosely to the stabilizing circuit.

But an attempt to use a hi-C circuit for the oscillator quickly leads to considerable difficulties in producing oscillations at these high frequencies. Generally this difficulty is a result of using components of standard construction, which often have relatively high losses. That these losses are more detrimental for hi-C circuits than for low-C circuits can be seen by the following line of reasoning. The developed impedance of the tank circuit at the operating frequency must be high enough to prevent the tank circuit from loading up the vacuum tube beyond the point at which oscillations can be maintained. For a given loss in the circuit the larger the capacitance used, the smaller is this developed impedance. Then to develop a high impedance with a hi-C circuit one must have a low-loss circuit.

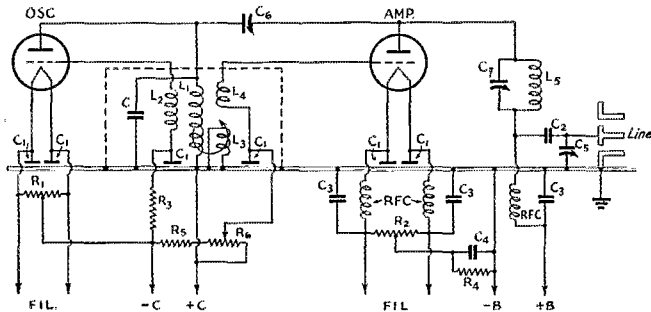

Fig. 5 — The schematic wiring diagram of the 5- and 2 1/2-meter transmitters shown with the output arranged for connection to a coaxial line. The dotted line encloses the schematic representation of the oscillator tank circuit. By-pass condensers that were formed by metal strips separated from the grounded metal chassis by mica sheets are represented by a short line directly above and parallel to the ground plane. The amplifier "C" supply also furnishes plate power for the oscillator. Hence the oscillator filament is not grounded for d.c.

- R1, R2 — Filament center-tap resistors.
- R3 — Oscillator grid leak, 10,000 ohms.
- R4 — Amplifier cathode bias resistor, 300 ohms.
- R5, R6 — Voltage divider for amplifier bias, 20,000 ohms, semi-variable.
- C1 — By-pass condensers, described in text.
- C2 — Plate coupling condenser, 250- μ fd. mica.
- C3 — Plate and filament by-pass condensers, 250- μ fd. mica.
- C4 — Amplifier cathode by-pass, 8- μ fd. electrolytic.
- C5 — Coupling adjustment, 100- μ fd. variable.
- C6 — Neutralizing condenser, 3- μ fd.
- C7 — Amplifier tuning condenser, 50- μ fd.
- L1-C — Tank circuit shown in Fig. 1.
- L2 — Grid rod shown in Fig. 1.
- L3 — Frequency adjustment; see text.
- L4 — Amplifier grid link; see text.
- L5 — Amplifier plate coil, three turns No. 12, as shown in Fig. 10.

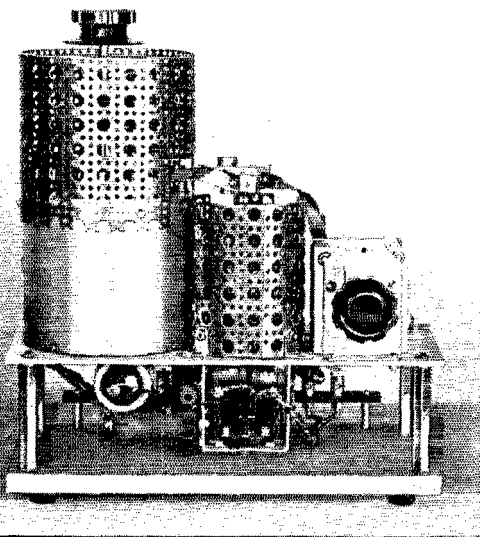

Fig. 6—The 2½-meter transmitter. From left to right, the oscillator stage with the frequency control knob projecting up through the perforated shield, the W.E. 304A amplifier tube, and the amplifier tuning condenser.

To keep the overall losses of the tank circuit small, probably the best procedure is to design the tank circuit as an integral whole. If each component is constructed individually, the advantages gained by an efficient design of both the condenser and the inductance may be lost because of the manner in which the two are connected together. In the tank circuit of Fig. 1 the connections from the main capacitance to the inductance have been made an inherent part of the structure, and in that way the extra loss introduced can be made relatively small.

The fundamental attitude that is taken in designing these low reactance (hi- C) circuits is the minimization of resistance and of inductance rather than the minimization of capacitance. In order to do this successfully one must have in mind the essential nature of inductance and the behavior of current flow when skin effect is complete. Fortunately a simplified account of this behavior is all that is necessary for obtaining qualitative design methods.

It is well known that at high frequencies the current tends to concentrate near the surface of conductors. In fact this tendency is so marked at the ultra-high frequencies for metallic conductors that for most practical purposes one can consider the current as flowing only in a very thin skin layer at the surface without any appreciable penetration of the current into the metal. This phenomenon is commonly known as skin effect.

The limited depth of current penetration implies that for the current in a conductor to go from one point to another it must travel on the surface only and cannot travel by way of the interior of the conductor. To illustrate what this means, consider current flow down the rotor of a variable condenser of normal construction. If contact is made to the shaft bearings, current may flow through this contact along the surface of the shaft until it comes to the first rotor plate. Here one normally considers that the main body of the conduction current travels through the plate while

some of it flows as capacitive current to the first stator plate. However, if the plate is of reasonable thickness (say, greater than 0.001"), at the ultra-high frequencies the current will flow out radially at the surface of the rotor plate, pass over at the edge of the plate to the other side of the rotor plate, and then travel inward radially to the rotor shaft. In doing so of course a fraction of the current flows capacitively to the second stator plate, but the rest continues merrily on its way just skimming the surface. That is, it travels along the surface of the shaft, then expands outwardly along the surface of the plates across the edge and back in again and so on.

Thus at high frequencies the current does not take advantage of the total area of the conductor, and it also ignores paths that require penetration through the interior of the conductor. The corresponding effective resistance of the conductor is therefore enormously increased. These considerations indicate that the small-diameter condenser shaft in the preceding illustration produces a series of bottle-necks for current flow and suggest the disadvantages resulting from forcing the current to flow over paths of small surface area.

For the inductance of the tank circuit, one has the specific problem of designing for a particular value of inductance with the purpose of obtaining that value with the lowest losses possible. Fortunately certain relations that have been worked out for the realization of hi- Q inductances can be used here. The one that is of particular interest is that for an inductance formed by a circular rod and a surrounding tube connected to it at one end by a conducting disc. For this case the desirable relation of dimensions is that the outside tube should have a diameter of about 3 to 4 times the diameter of the center rod. Incidentally, a similar relation exists for simple single-loop inductances, in that the spacing of conductors (diameter of the loop) should be about 3 to 6 times the diameter of the conductor. However, for an open loop of this type where radiation is a serious factor the overall dimensions should be limited to less than about one-twentieth of a wavelength, while the coaxial inductance mentioned above is not so quickly limited. As one might expect, the Q of the coaxial inductance increases as the diameter of the tube and rod are increased, but too large a diameter leads to a system that can no longer be considered as a lumped inductance.

In considering a design for its inherent inductance one should remember that decreasing the spacing, decreasing the length, or increasing the cross-section of conductors will decrease the inductance. Thus, for those conductors that need to have very low inductance only short, heavy leads

that are relatively close to the corresponding return conductor should be used.

Oscillators for $1\frac{1}{4}$ Meters

The above principles of design were applied to the 225-Mc. oscillator pictured in Figs. 2 and 3. This oscillator uses a tank circuit of the type shown in Fig. 1, but it is in this case made of aluminum because aluminum parts for it were available immediately. The oscillator tube is a Western Electric 316A, and the circuit used is known variously as a tuned-plate circuit or reversed feed-back oscillator. The filament is bypassed to ground, the outer enclosing metal structure; the plate is connected directly to the large inner aluminum tube, which can be considered the ungrounded plate of the condenser; and the grid is fed by a lead, which is in reality a $\frac{1}{4}$ " diameter rod, that passes up through the field of the tank circuit. This grid lead is by-passed to ground at the lower cover plate. The general arrangement of the grid and plate leads is that of Fig. 1.

The plate tank circuit can be regarded as a single turn toroid shunted by a cylindrical condenser, while the feed-back is accomplished by the coupling loop provided by the grid lead. The position of this grid lead affects the oscillator operating conditions and the stability with respect to electrode voltages, and, consequently, the best position should be determined by trial.

The Hartley type of circuit is used in another $1\frac{1}{4}$ -meter oscillator. A simplified drawing of its tank circuit is shown in Fig. 4. The plate is here also connected to the ungrounded end of the condenser, which connection is actually made to the upper disc that is fastened to the end of the central rod and that supports the inner aluminum tube; the grid is by-passed to the ground given by the upper disc that closes off the tank circuit; and the filament is fed by a pair of leads passing through the field of the tank circuit. These leads are by-passed to ground at their lower ends. The capacitance actually in the external tank circuit is, for this case, approximately $35 \mu\text{fd.}$, which is considerably larger than that normally used for an oscillator at a frequency of 225 Mc.

In Fig. 4 a rotatable vane, which is of copper-plated brass, is shown in the field of the inductance to permit adjustment of the frequency to any point in the $1\frac{1}{4}$ -meter band. This metal vane acts as a short-circuited turn coupled to the inductance. When the vane is in the position shown, it reduces the natural inductance of the tank circuit by the least amount, and, consequently, this setting is the one for minimum frequency. When the vane is rotated through 90 degrees from the above position, the inductance is reduced the

maximum amount possible with the given vane, and the setting for maximum frequency is obtained. Naturally, in order that excessive losses are not introduced, the vane must be made of copper, copper-plated brass, or some similar good-conductivity material, but it does not need to be made of heavy stock.

In all the oscillators described here the rotatable vane is used to permit the desired frequency adjustment. Another simple method of obtaining a small frequency change is shown in Fig. 1. The capacitance of the tank circuit is varied by means of the eccentrically located cylinder on the bottom disc, and the frequency of oscillation varies accordingly. But this method is not so readily useful as that of the rotatable vane because of the difficulty of producing a reasonable frequency change without using very small air gaps.

One more feature of the 225-Mc. oscillator pictured in Figs. 2 and 3 remains to be described. This is the use of a radiator of two closely-spaced half-wave elements, which are coupled into the oscillator circuit in such a manner that they are fed with equal voltages 180 degrees out of phase. The resulting antenna pattern is the bi-directional one described by G. H. Brown³ and also J. D. Kraus.⁴

The construction used for this 225-Mc. oscillator gives a compact and readily portable signal source, which is at the same time more stable in frequency than the usual oscillators for this frequency. No attempt has been made to load the oscillator tube to its limit, but with a plate voltage of 400 and a plate current of about 50 ma., which is considerably below the maximum rating of the tube, the power radiated by the antenna is about 5 watts as based on measurements made by loading the oscillator with lamp bulbs.

Transmitters for $2\frac{1}{2}$ and 5 Meters

The $2\frac{1}{2}$ - and 5-meter transmitters were designed with a more definite goal with regard to

³ Brown, G. H., "Directional Antennas," in *Proc. I.R.E.*, 25, 1 (Jan. 1937), Fig. 15.

⁴ Kraus, J. D., "Directional Antennas with Closely-Spaced Elements," in *QST*, Jan. 1938.

Fig. 7—A rear view of the $2\frac{1}{2}$ -meter transmitter with the oscillator tube shield removed. Here the coaxial output lead and the padding condenser used for impedance matching can be seen at the left on the aluminum base plate.

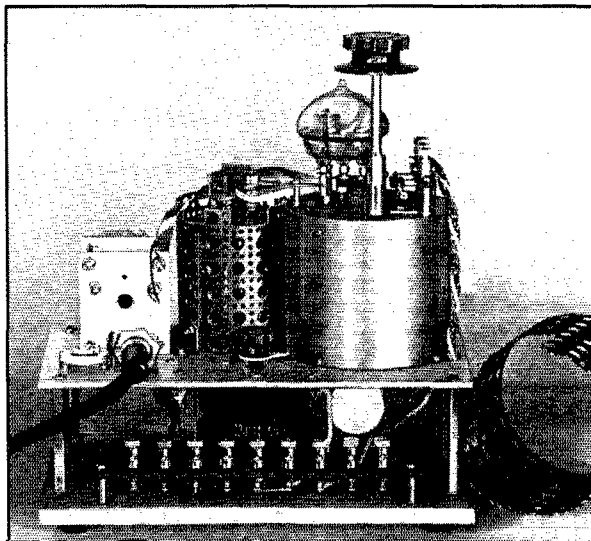

frequency stability than were the $1\frac{1}{4}$ -meter oscillators. The obvious qualitative requirement that should be satisfied is that the signal should be received with broadcast quality on a modern selective superheterodyne receiver. The general recognition of this desirable requirement with its attendant need of frequency stability of a high order, as well as the new regulations, has led to the increased use of crystal control for the 5-meter band. However, most amateurs like to use the comparatively empty regions of the band, but, since these empty regions are not the same at all times, the crystal-controlled transmitter is not the ultimate solution for those amateurs. The use of a series of crystals or of a variable frequency crystal is a partial solution, but in these cases one is limited to a few spot frequencies or to a very narrow band. A discussion of the arguments for and against crystal control is not necessary here, since the significant points are well known, but the problem remains: How can we produce an ultra-high-frequency signal that is readily adjustable in frequency and is at the same time not subject to serious frequency modulation when modulated in amplitude?

One answer to this problem is the use of a vacuum tube oscillator that is designed for the utmost in stability, that delivers only a fraction of its available power to the load, and that uses a

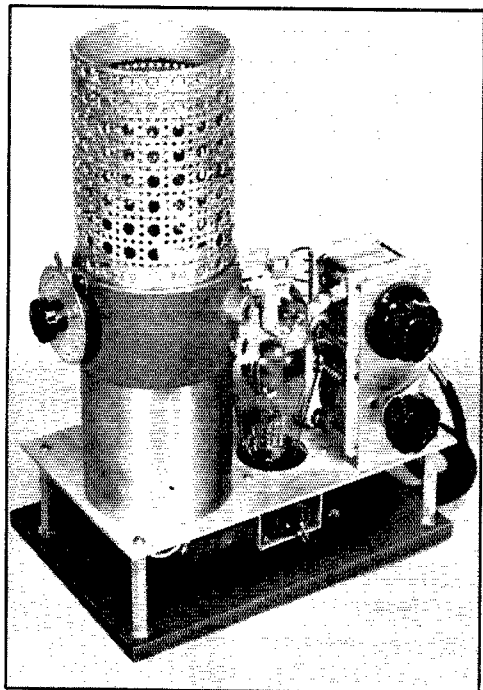

Fig. 8 — The 5-meter transmitter. The frequency-control knob for the oscillator projects out from the side of the oscillator tank circuit.

tank circuit that is adjustable in frequency. Then as a final step one restricts the modulation to a level that will keep any remaining frequency modulation within the desired limits. But I know of no amateur who would be satisfied with this sacrifice in usable power for the desired improvement in stability.

Another solution that is possible is a master-oscillator power-amplifier design. In this case the oscillator and the modulated amplifier are separated by a sufficient number of isolating stages so that the effect of the modulation on the oscillator frequency is within the desired limits. Unfortunately, complete neutralization of an amplifier stage cannot be realized at the ultra-high frequencies. Consequently a modulated stage will present to the preceding stage a load that is variable both in reactance and in resistance, so that a buffer stage between the oscillator and the modulated amplifier is normally required. However, if the amplifier stage can be coupled loosely to the oscillator or if the oscillator has a sufficiently hi-C tank circuit, the buffer stage need not be necessary.

The use of an oscillator of the type described in this article has permitted transmitters for 5 and $2\frac{1}{2}$ meters to be obtained that require no buffer stage and that at the same time are relatively free from frequency modulation. This immunity resulted without the necessity of reducing driving power to the amplifier stage. The 115-Mc. transmitter uses a W.E. 316A for the oscillator and a W.E. 304A for the amplifier, while the 60-Mc. transmitter uses an 801 for the oscillator and a W.E. 304A for the amplifier. The use of the W.E. 316A was not found necessary for the 60-Mc. transmitter. Pictures of these transmitters are shown in Figs. 6 to 10; the schematic wiring diagram is shown in Fig. 5, and since it is conventional, it requires little comment.

The grid of the amplifier stage is driven by coupling to the oscillator circuit in a manner similar to that in which the oscillator grid is coupled to the tank (see grid lead of Fig. 1). This type of coupling was adopted in order to reduce the tuning controls to few in number and to keep the transmitter physically small. The shielding shown in the pictures is necessary to prevent spurious oscillations. All r.f. leads are made short, and wide copper strip is used for those leads that need to be flexible and at the same time must have low resistance and inductance.

Grid neutralization is used because it fits naturally into the arrangement of the transmitter. Careful neutralization of the amplifier stage is important. Rough neutralization can be accomplished by one of the methods outlined in *The Radio Amateur's Handbook*, but for final neutralization, it is essential that a monitoring oscillator be used. The process is simply setting the neutralizing condenser to the point that gives minimum variation of output frequency as the plate volt-

age on the amplifier stage is varied. Thus one uses as the ultimate criterion of neutralization that used in the performance test of the transmitter.

These transmitters have been tested for quality of the transmitted signal by reception on a modern selective superheterodyne receiver. The 60-Mc. transmitter has no noticeable frequency modulation accompanying the amplitude modulation. However, a slight fuzziness denoting some residual frequency modulation is present when the signal from the 115-Mc. transmitter is received on the same superheterodyne as that used for the reception of the 60-Mc. signal. (An RCA ACR-175 was used with reception at 115 Mc. by using the second harmonic of the local oscillator.) With 800 volts on the plate of the amplifier tube and about 90 milliamperes plate current, the power output for each of the transmitters is between 30 and 40 watts.

In the schematic diagram of Fig. 5 most of the by-pass condensers are represented by a short line directly above and parallel to the ground plane. This representation is used to indicate that each of these condensers is formed by clamping thin mica sheets between a metal plate or a wide copper strip and the grounded metal chassis. The copper strip is held with the aid of a top metal ground plate that fastens to the chassis and is insulated from the copper strip by mica. One of these condensers is shown clearly in Fig. 10. It can be seen in back of and connected to the lower amplifier tuning condenser. These built-up condensers are only of value if they are placed at the point that needs by-passing and if short wide strips are used for their connections.

A condenser of this type is used because the residual inductance of the ordinary commercial condenser prevents it from being very effective in by-passing at these frequencies. In order to prevent spurious operation it is necessary to use by-pass condensers that offer a low impedance to frequencies well above as well as in the working range. Consequently, the use of ordinary condensers may lead to peculiar behavior of the circuit, especially at the highest frequencies.

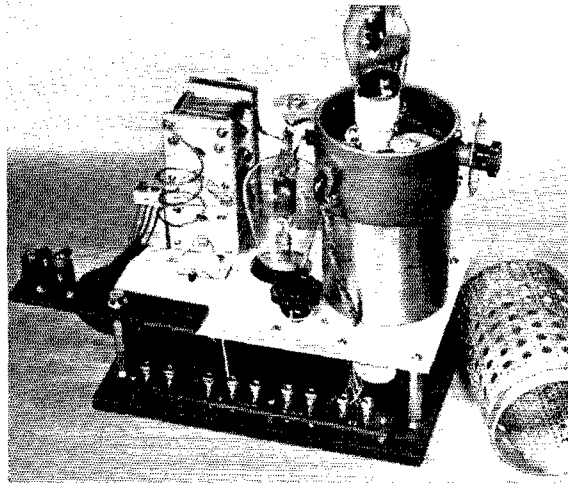

Fig. 9 — A rear view of the 5-meter transmitter with the oscillator tube shield removed. The terminals for the balanced output are shown at the far left.

Transmission Line Phase Inverter

The 60-Mc. transmitter is shown with a transmission-line arrangement for converting from a single-ended matching section to a balanced output. At present both the 60-Mc. and 115-Mc. transmitters are used with coaxial lines and have amplifier output circuits of the type shown for the 115-Mc. transmitter. However, at the time the picture was taken, the 60-Mc. transmitter was used with a parallel-wire line for feeding a half-wave dipole. Such an application required the transfer from a single-ended amplifier to a balanced output. The common inductance coupling methods of transfer were first tried, but the difficulty of obtaining proper adjustment led to their abandonment.

The coupling scheme finally adopted has been used commercially for some time,⁵ but amateurs do not seem to have tried it. This method, which uses a phase-inverting section of transmission line, worked so successfully that it is worth bringing to the attention of amateurs.

The method is based on the fact that in a low-loss transmission line the voltages at successive points one-half wavelength apart are equal in magnitude, but adjacent half-wavelength points

⁵Trevor, Bertram, and O. E. Dow, "Television Radio Relay," in *RCA Review*, I, 2 (October, 1936), pp. 41f.

TABLE I

Frequency	Outer Cylinder (A)		Inner Cylinder (B)		Center Rod (C)	
	Length	Inside Diam.	Length	Outside Diam.	Length	Diam.
60 Mc.	4 $\frac{7}{8}$	3.76	4 $\frac{3}{8}$	3.63	3 $\frac{1}{2}$	$\frac{1}{2}$
115 Mc.	3 $\frac{3}{8}$	3.76	2	3.62	2 $\frac{5}{8}$	1
225 Mc.	1 $\frac{3}{4}$	3 $\frac{3}{16}$	1 $\frac{1}{4}$	3	1 $\frac{1}{4}$	$\frac{1}{2}$

All dimensions are in inches.

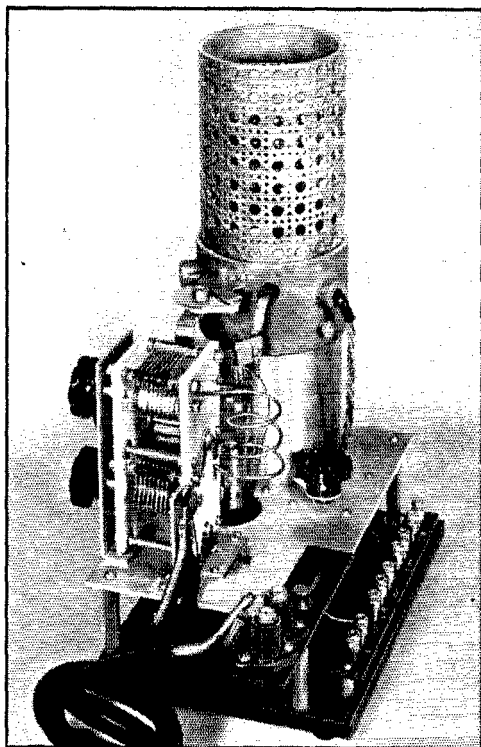

Fig. 10 — This view of the 5-meter transmitter shows more clearly the transmission line arrangement for producing the balanced output.

have voltages that are opposite in phase. Thus if two coaxial transmission lines are connected in parallel at one end to an energy source and if one is made one-half wavelength longer than the other, at the other end the voltage appearing between the two center conductors is balanced with respect to ground; and a balanced transmission line can be used from that point on.

Appendix

Table I shows the important dimensions of the oscillator tank circuits described here. These values are given merely to act as a guide for those that might want to construct such tank circuits. It should be noticed that the lengths and the diameter-ratios are the important dimensions, and the diameters can be scaled up or down over a reasonable range without appreciably changing the resonant frequency. However, the losses in the circuit increase as the diameters decrease.

The values for the 5- and 2½-meter tank circuits were chosen to give a reduced ambient temperature coefficient of frequency. These circuits are constructed of copper and brass as indicated in Fig. 1, then because of the differing temperature coefficients of linear expansion of the two metals, the capacitance decreases and

the inductance increases with increasing temperature. The temperature coefficient of frequency for the 5- and 2½-meter oscillators described is about 5 parts per million per degree C. However, since the temperature coefficient of brass is a function of its composition, no assurance can be given that good temperature compensation will be obtained for tanks that are built according to Table I. The tank circuits for 1¼ meters are entirely of aluminum, and therefore their temperature coefficient of frequency is that of the linear expansion coefficient of aluminum, or about 25 ppm/° C.

Thus, if it can be readily done, the tank circuit should be constructed of copper and brass as shown in Fig. 1, and the brass should be copper plated. The center rod should be solid and of good thermal conductivity (another reason for using copper) to keep the thermal drift small.

Conventions! Conventions!

ANNOUNCEMENTS have already been made of the following conventions, and this additional mention is to act as a reminder that you will be missing a good time if you do not attend: Wausau, Wis., Hotel Wausau, September 2nd-3rd. San Francisco, Calif., Hotel Whitecomb, Sept. 2nd-3rd-4th.

Moncton, N. B., Canada, Hotel Brunswick, Sept. 2nd-3rd-4th.

Columbus, Ohio, Hotel Deshler-Wallick, Sept. 8th-9th-10th.

Wichita Falls, Texas, Marchman Hotel, Sept. 8th-9th.

New Hampshire State Convention

(New England Division)

Manchester, N. H., September 23rd

THE Manchester (N. H.) Radio Club is sponsoring the State Convention this year and will include also the annual Hamfest. The Club extends a cordial invitation to all radio amateurs, XYL's, YL's and friends to gather at the Hotel Carpenter, Manchester, N. H., on Saturday, September 23rd, and help enjoy a full program. There will be some speeches, several events and demonstrations, especially by the N. H. Facsimile Club, the first of its kind in the world.

Our prominent guests will include Mr. George W. Bailey, Vice-President A.R.R.L., Mr. Charles C. Kolster, Inspector-in-Charge, first radio district, Mr. Percy C. Noble, Director New England Division, and several others.

The registration fee is only \$1.75 and includes good "eats" at the banquet.

If you are planning to attend drop a note to Mr. J. Brodie Smith, W1HPM, 83 Bay St., Manchester, N. H.

The Yacht "Contender" Comes in First

Radio Plays an Important Role in Treasure Island-Honolulu Race

BY DON C. WALLACE,* W6AM

Did you ever dream that you could have nearly every kind of radio for two weeks? The radio equipment of the yacht *Contender* was a realization of such a dream.

Captain Dick Loynes obtained radio gear capable of operation on frequencies from 30,000 to 468 kc. (10 to 700 meters). The power supply was a 2000-watt output a.c. generator, to insure good regulation, and this called for a heavy motor drawing something over two kilowatts. National 240 AH 110-volt batteries were installed to supply the motor with power, and this in turn necessitated a three-kilowatt battery-charging plant.

Ordinarily, the 10-meter band is not very good in the summer, so we didn't count on it too much. However, the 10-meter band was open on different days during the race, and on three of these days we had time to operate on 10. On one day 41 amateurs were worked using the call W6AM/K6. The antenna used that day was two Alford phased-elements (see June, July, August, 1938, *QST*), end-fed with Zepp feeders, with the single phasing frame in the center. It was about 50 feet high. The Alford elements give greater gain than the customary two half-waves in phase and, as these were vertical, it gave enough low angle radiation so that a number of amateurs were worked in the Hawaiian Islands, a few hundred miles away, at the same time that W's were being contacted.

The FCC gave the *Contender*, KLRR, permission to work amateurs from the usual yacht frequencies. Many amateurs were worked daily on 8300 kc., the amateurs answering on the 7-megacycle band and, as the distance from the United States increased, the 12,390-kc. band was used, and amateurs in the 14-Mc. band contacted. Twenty-meter 'phone amateurs proved more satisfactory than twenty-meter c.w. amateurs, because the word would be passed around more rapidly that the *Contender* was on the air, and the frequency would be given oftener on 'phone.

In all, 21 broadcasts were given from W6XEJ, the *Contender*, W6AM acting as maintenance man, engineer, mixer, continuity writer, announcer, and master of ceremonies. At the beginning of each broadcast, reference was made to amateur activity, and usually at the close a résumé of the day's amateur contacts was given. Thus amateur radio was given recognition throughout the United States, as 4 of these 21 broadcasts were on the transcontinental network of the

Mutual Broadcasting System (106 stations). The other broadcasts were over the Don Lee Mutual network of 34 stations.

During this last broadcast, a two-hour affair at the finish line, members of the crew cut away most of the antenna gear and threw it over the side, because anything in the way had to be cleared in order to make the best possible time. During this time, the operator and equipment were frequently drenched. At one time, it seemed that almost the whole crew was under water, as the tremendous speed of the *Contender* in coming about drove the hull under in the tricky channel just off the Island of Oahu.

The *Contender's* radio was used as a sort of radio center for the entire fleet. All 18 of the radio-equipped yachts (out of 26 in the race) reported each afternoon, giving their noon positions. Clearing all these positions from the different ships, together with taking any traffic they might have for the commercial services (later sent on the 36- and 24-meter commercial ship bands to either San Francisco or Honolulu) took about an hour. Towards the end of the trip some of the messages were sent directly into Honolulu via K6JPD or K6KRG.

Daily press reports were sent to *QST*, *CQ*, *QTH*, W6DEP, W6USA and W6BIP, at 5 P.M., PST, immediately following the gathering of reports from the yachts themselves. These were immediately given to the newspapers, and it is pretty safe to say that, after the first few days out, all news reports and news dispatches were handled by amateur radio.

The broadcast receiving was done at W6QD, with the assistance of W6OEG. These two did marvelous work, not missing any of the 21 broadcasts, although in one 15-minute broadcast three different frequencies were used.

Daily schedules were maintained with the S.S. *Lurline* on 36 and 24 meters, inasmuch as approximately 30 of the wives and daughters of men on the yachts were aboard. The week following the S.S. *Matsonia* came over, and daily schedules were also maintained with her.

Most of the commercial traffic was given to Globe, Mackay, and RCA, in the order mentioned. Globe seemed by far the easiest to raise, as they have stations both in Hawaii and at Mussel Rock and seemed to watch for the *Contender's* call more than any other. Mackay put in the loudest signal, from their Palo Alto station. RCA

*4214 Country Club Drive, Long Beach, Calif.

(Continued on page 106)

★ WHAT THE LEAGUE IS DOING ★

ELECTION NOTICE

TO ALL members of the American Radio Relay League residing in the Dominion of Canada and in the Atlantic, Dakota, Delta, Midwest, Pacific and Southeastern Divisions:

You are hereby notified that, in accordance with the constitution, an election is about to be held in each of the above-mentioned regions to elect both a member of the A.R.R.L. Board of Directors and an alternate thereto. In the case of the Dominion of Canada the election is to choose a Canadian General Manager and an alternate Canadian General Manager, for the 1940-1941 term. In the case of the United States divisions, the election is to choose a division director and an alternate division director for the 1940-1941 term. Your attention is invited to Sec. 1 of Article IV of the constitution, providing for the government of A.R.R.L. by a board of directors; Sec. 2 of Article IV, and By-Law 12, defining their eligibility; By-Laws 13 to 24, providing for the nomination and election of division directors and their alternates; By-Laws 28 to 35 providing for the nomination and election of a Canadian General Manager and an alternate thereto. Copy of the Constitution & By-Laws will be mailed any member upon request.

Voting will take place between November 1 and December 20, 1939, on ballots that will be mailed from the headquarters office in the first week of November. The ballots for each election will list, in one column, the names of all eligible candidates nominated for the office of director by A.R.R.L. members residing in that region; and, in another column, all those similarly named for the office of alternate. Each member will indicate his choice for each office.

Nomination is by petition. Nominating petitions are hereby solicited. Ten or more A.R.R.L. members residing in any one of the above-named regions may join in nominating any eligible member of the League residing in that region as a candidate for director therefrom, or as a candidate for alternate director therefrom. No person may simultaneously be a candidate for the offices of both director and alternate. Inasmuch as the by-laws were recently amended to transfer all the powers of the director to the alternate in the event of the director's death or inability to perform his duties, *it is of as great importance to name a candidate for alternate as it is for director.* The following form for nomination is suggested:

Executive Committee

The American Radio Relay League
West Hartford, Conn.

We, the undersigned members of the A.R.R.L. residing in the Division (or in the Dominion of Canada), hereby nominate of as a candidate for DIRECTOR (or for Canadian General Manager); and we also nominate of as a candidate for ALTERNATE DIRECTOR (or for alternate Canadian General Manager); from this region for the 1940-1941 term.

(Signatures and addresses)

The signers must be League members in good standing. The nominee must have been both a member of the League and a licensed radio amateur operator for a continuous term of at least four years immediately preceding receipt by the Secretary of his petition of nomination, except that a lapse of not to exceed ninety days in the renewal of the operator's license and a lapse of not to exceed thirty days in the renewal of membership in the League, at any expiration of either during the four-year period, will not disqualify the candidate. He must be without commercial radio connections; he may not be commercially engaged in the manufacture, selling or renting of radio apparatus normally capable of being used in radio communication or experimentation, nor commercially engaged in the publication of radio literature intended, in whole or part, for consumption by licensed radio amateurs. Further details concerning eligibility are given in By-Law 12. His complete name and address should be stated. The same requirements obtain for alternate as for director. All such petitions must be filed at the headquarters office of the League in West Hartford, Conn., by noon E.S.T. of the 20th day of October, 1939. There is no limit to the number of petitions that may be filed on behalf of a given candidate but no member shall append his signature to more than one petition for the office of director and one petition for the office of alternate. To be valid, a petition must have the signatures of at least ten members in good standing; that is to say, ten or more members must join in executing a single document; a candidate is not nominated by one petition bearing six signatures and another bearing four. Petitioners are urged to have an ample number of signatures, since nominators are frequently found not to be members in good standing. It is not necessary

that a petition name candidates both for director and for alternate but members are urged to interest themselves equally in the two offices.

Present directors and alternates for these regions are as follows: Dominion of Canada: Canadian General Manager, Alex Reid, VE2BE, St. Lambert, P. Q.; Alternate Canadian General Manager, Alex Lariviere, VE2AB, Quebec, P. Q. Atlantic Division: director, Walter Bradley Martin, W3QV, Roslyn, Pa.; alternate, Raymond E. Macomber, W3CZE, Washington, D. C. Dakota Division: director, Fred W. Young, W9MZN, Mankato, Minn.; alternate, none. Delta Division: director, E. Ray Arledge, W5SI, Pine Bluff, Arkansas; alternate, E. H. Treadaway, W5DKR, New Orleans, La. Midwest Division: Floyd E. Norwine, jr., W9EFC, St. Louis; alternate, none. Pacific Division: director, J. L. McCargar, W6EY, Oakland, Calif.; alternate, Elbert Amaranter, W6FBW, San Jose, Calif. Southeastern Division: director, Bennett R. Adams, jr., W4APU, Homewood, Alabama; alternate, S. J. Bayne, W4AAQ, Birmingham.

These elections constitute an important part of the machinery of self-government in A.R.R.L. They provide the constitutional opportunity for members to put the direction of their association in the hands of representatives of their own choosing. Members are urged to take the initiative and to file nominating petitions immediately.

For the Board of Directors:

K. B. WARNER,
Secretary

August 1, 1939

HEADQUARTERS NOTES

THE West Hartford headquarters have remained an exceedingly busy place throughout the current summer. Our editorial staff has been engaged in its "spare time" on the preparation of the new Handbook, which is being completely revised along somewhat different lines, and which is scheduled for appearance in October. We expect it will be the best edition yet published. In between other things we're running a course of sprouts on close-spaced antenna systems and are learning a number of interesting things that will eventually find their way into our pages. Through the summer we've had hundreds of ham visitors at Hq. and W1AW, from all over the nation and from many a foreign country — many more than usual because of the New York fair. Work goes along on many projects inaugurated by the Board at its last meeting. Washington has been quiet, with little news worth reporting. United States preparations for the Stockholm C.C.I.R. meeting are well advanced. As I.A.R.U. headquarters we have been in extensive correspondence with the Swedish amateur society to arrange the details of amateur representation at that conference next June, where they will speak for the amateurs

of the world. We have straightened out with the Berne Bureau several cases of misunderstanding which resulted in printed reports that the amateurs of New Zealand, Finland and Madagascar were denied the right to communicate internationally; adequate corrections have now been published. At this writing about 7000 cards have been received at Hq. in the poll of sentiment on the 7-Mc. question and are still coming in about a hundred a day, so it's too early to cast up the results. As part of our job of keeping important people informed on ham radio we recently sent every U. S. Senator and Representative a copy of "Two Hundred Meters & Down — The Story of Amateur Radio." A lot of interesting gear is under construction in our shop and lab. Look in when you're down this way.

Strays

The Editor of the *Tulsa Telegram* spends an evening on short waves, including a brief look at amateur radio:

"The 'ham' band was crowded. A kid up in Taunton, Massachusetts, was calling somebody in Belgium. A fellow in Shawnee was conversing in technical terms with a radio bug in Chicago. And there was a silly woman in Nashville who was carrying on an inane monologue in a coy mixture of southern accent and baby talk. We got to thinking about what a marvelous scientific world we live in — a world that can put into the hands of a female nit-wit an instrument of infinite force. Tonight the vibrations of her voice are whizzing through space at 186,000 miles a second. Next month those vibrations will be passing the outermost moons of Saturn, and centuries from now, centuries after her progeny have disappeared from the face of the earth, after the oceans have shifted and are lapping at the shores of new continents, the faint repercussions of that baby talk will still be kicking around the measureless suburbs of the universe."

How yo'-all feel after that, honeychile?

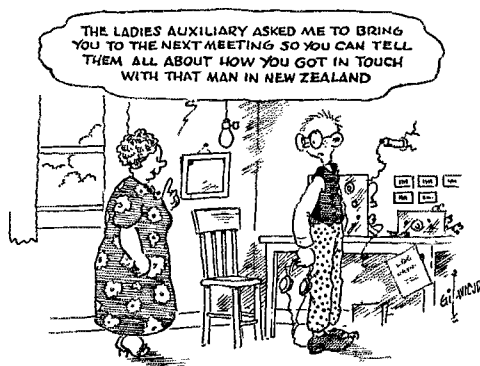

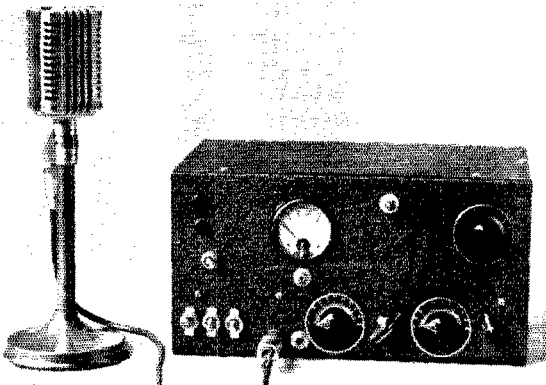

The portable transmitter and power supply, ready to go by connecting to antenna and 6-volt d.c. or a.c. power.

The three switches in the lower left-hand corner are, from left to right, main switch, speech supply switch and plate switch. Directly above these is the switch permitting the power supply to deliver either to the transmitter or to the two pin-jack terminals (for feeding a receiver or other transmitter). The lower controls, from left to right, are oscillator tank, gain control and final tank. The upper right-hand knob is the antenna tuning control — the antenna tap switch is controlled by the knob at the extreme lower right. The antenna is connected to the feed-through at the upper center of the panel. A flexible connection at the back goes to either a 6-volt battery or transformer.

A Portable-Emergency Utility Transmitter

A Complete 'Phone and C.W. Rig for Field or Home

BY LOUIS F. LEUCK,* WQANZ

THIS little transmitter can be used for either 'phone or c.w. on any of the lower-frequency amateur bands. Weighing only 14½ pounds, it is completely self-contained and includes the r.f. section, speech equipment and power supply. It operates equally well from 6 volts d.c. or a.c., and it can be quickly and easily loaded to any antenna. The power input, on 'phone or c.w., is about six watts. All tuning controls, microphone and key jacks, switches, antenna post and pin jacks for supplying plate current to a companion receiver are located on the front of the cabinet.

This transmitter was designed so that all the major components operate at full rated capacity without overloading during transmission. Maximum output for weight and size with dependable continuous operation over long periods is the result.

Plate Supply

A charged 6-volt storage battery is always available and within arm's reach — even when no emergency exists — hence 6-volt operation. The vibrator plate supply is built in the left end of the cabinet with the transformer, 84 tube, and four-prong vibrator unit in the top part and the filter choke and condensers directly below. A non-synchronous four-prong vibrator was chosen in connection with an 84 rectifier tube as being most dependable. In addition, they may be procured for replacement in almost any locality (the same being true of the other tubes and many of the parts in the transmitter). Practically all four-prong vibrators are connected to their pins in one of two ways. Either type may be used if the socket is wired as shown in the diagram.

With an input filter condenser of 8 μ fd. and a 16- μ fd. output condenser, the power supply will

easily deliver 60 to 70 mls of very well-filtered d.c. at 250 volts. This is exactly the correct amount for the transmitter when properly adjusted.

R.F. Section

Type 41 tubes are used in the oscillator and r.f. amplifier because of their small size, low heater current, and the fact that they will really deliver at a plate potential of 250 volts. The oscillator is connected up as a pentode in a "sure fire" arrangement to facilitate doubling, should this operation become necessary. Straight-through operation is, of course, ordinarily recommended. The final is connected as a triode and neutralized, and it can be operated as either a straight amplifier or as a frequency doubler.

The transmitter is keyed in the cathode circuit of the r.f. amplifier. An extra pair of contacts is provided on the keying jack so that the modulation choke is automatically shorted when c.w. is used, to reduce chirp. The cathode circuit is closed when the keying plug is withdrawn.

Speech

A 6C6 and 76 ahead of a 41 modulator, all resistance coupled, provide adequate gain for use with a crystal or other microphone having comparable output. The quality with this layout is really excellent — superior, "believe it or not," to many well-engineered and constructed non-portable rigs. The original plans called for a

There's nothing but straightforward design and construction in this complete transmitter that can be run from either 6 volts a.c. or d.c. And that might be the reason for its excellent performance.

* Leuck Electric Co., Lincoln, Neb.

COIL DATA

Band	Turns	Wire		Taps (from top)
		Size		
160 osc.....	72	24		
160 amp.....	68	24	0-8-16-24-34 (C.T.)	
80 osc.....	43	22		
80 amp.....	56	22	0-7-14-21-28 (C.T.)	
40 osc.....	20	20		
40 amp.....	32	20	0-4- 8-12-16 (C.T.)	

All coils wound on $1\frac{1}{4}$ -inch diameter forms.

single button carbon microphone with one stage less of amplifications, but experience has proven the crystal to be superior in nearly every respect.

As an audio output tube, the 41 again tops the others when output and input heater and plate energy requirements are compared. And, contrary to popular belief, a pentode gives higher quality when used as a modulator than when it works into a speaker. This is because an r.f. final acts as a *constant* load regardless of the audio frequency, whereas even the best speaker is far from this. Class-A Heising modulation is used. A second choke identical to the filter choke serves very well as the common impedance.

Construction

The entire outfit is housed in a Bud steel cabinet, 7 by 12 by 6 inches in size. It will be necessary to have three additional sheet metal pieces made up which serve as shielding and sub bases. Self-tapping screws hold these parts in place. It is well to begin by procuring all the "principal parts," laying everything out and fitting the parts carefully into place with allowance for clearing everywhere, and paying especial attention to the variable condensers.

The antenna tuning unit was designed especially for this outfit. Note that the final tank coil has a center tap, and that the upper half of each of the final coils is again tapped at three additional points and each of the taps brought to a pin on the six-prong coil form. A five-point tap switch wired to the final coil socket, as shown in the sketch, provides a means of matching different antenna impedances to the final tank. C_2 also varies loading. A tip of one plate is bent to cause shorting at maximum capacity, hence the use of a fixed condenser which keeps the 250 volts d.c. off of the antenna. The various fixed condensers and the resistors are mounted and connected at the same time that the wiring is done.

The neutralizing condenser should be mounted so that it can be adjusted through a properly-placed hole drilled in the base plate.

A 50-ma. meter is used. It must be opened and the shunt removed. A second shunt having equal resistance should be prepared and the two of them connected in the circuit as shown in the circuit diagram (R_3).

It is advisable to complete the power supply and test it before proceeding further. It should be capable of delivering 70 mils to a 3500-ohm resistor connected as a temporary load.

Tuning Up for C.W.

Insert the proper crystal and coils for operation on the desired band. Put a 41 tube which has had one heater pin removed in the final socket. Connect the antenna, but put the antenna tap switch on the dead point (center tap). The plate current switch, located directly below the meter, must be to the left to read oscillator plate current. Throw the main switch and the meter will soon indicate a plate current of approximately 15 mils. Tune the oscillator tank condenser for a dip in plate current. Now use a 2-volt, 60-ma. dial lamp with a loop coupled to the final tank and neutralize in the usual manner.

Then throw the plate-meter switch to the right, insert the final r.f. tube and tune its tank for

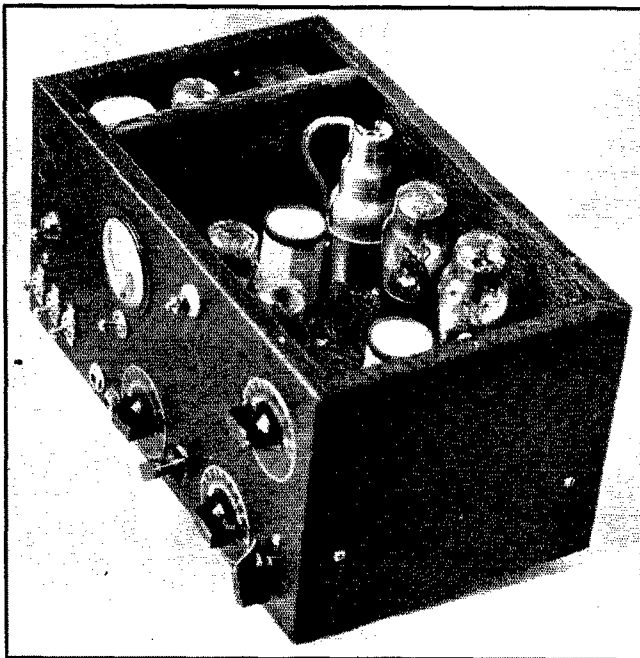

A view inside the transmitter shows the power supply compartment which houses rectifier, transformer and vibrator. In the transmitter compartment, audio tubes mount along the back. Chokes, antenna switch, and oscillator and amplifier tuning condensers are mounted beneath the sub-base.

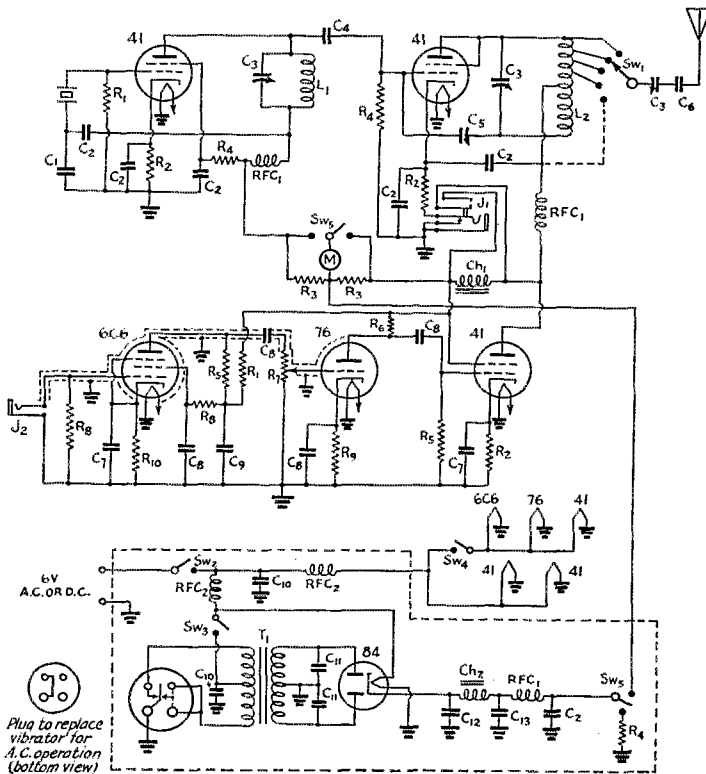

Fig. 1—Circuit of the Utility Transmitter

- C_1 — 0.0005- μ fd., 500-volt mica.
 C_2 — 0.004- μ fd., 500-volt mica.
 C_3 — 100- μ fd. midget variable (Bud).
 C_4 — 0.0001- μ fd., 500-volt mica.
 C_5 — Small 3-25- μ fd. compression-type mica.
 C_6 — 0.01- or 0.002- μ fd., 250-volt d.c.
 C_7 — 20- μ fd., 25-volt electrolytic.
 C_8 — 0.05, 400-volt tubular.
 C_9 — 0.25- μ fd., 400-volt tubular.
 C_{10} — 0.5- μ fd. volt tubular.
 C_{11} — 0.02- μ fd., 1500-volt buffer condensers.
 C_{12} — 8- μ fd., 450-volt electrolytic (Aerovox Dandee).
 C_{13} — 16- μ fd., 450-volt electrolytic (Aerovox Dandee).
 R_1 — 100,000 ohms, $\frac{1}{2}$ -watt. V_7 — 1-megohm g.c.
 R_2 — 400 ohms, 1-watt. V_8 — 2 megohms, $\frac{1}{2}$ -watt.
 V_3 — Meter shunts. (See text.) V_9 — 2000 ohms, $\frac{1}{2}$ -watt.
 V_4 — 5,000 ohms, 1-watt. V_{10} — 1500 ohms, $\frac{1}{2}$ -watt.
 V_5 — $\frac{1}{2}$ megohm, $\frac{1}{2}$ -watt. RFC_1 — 2.5-mh., 125-ma.
 V_6 — 100,000 ohms, 1-watt.
 RFC_2 — "A" choke. 40 turns No. 18 d.c.c. self-supporting, $\frac{1}{2}$ -inch diameter.
 J_1 — Key jack. Shorting type with additional pair of contacts.
 J_2 — Microphone jack.
 Ch_1 , Ch_2 — 65-ma., 10-henry choke (Thordarson T-13C28).
 Sw_1 — 5-point tap switch.
 Sw_2 — Main supply switch, s.p.s.t. toggle.
 Sw_3 — Plate switch, s.p.s.t. toggle.
 Sw_4 — Speech equipment switch, s.p.s.t. toggle.
 Sw_5 — External-internal plate supply switch, s.p.d.t.
 Sw_6 — Meter switch s.p.d.t.
 T_1 — 60-ma., 260-volt vibrator-type power transformer (Thordarson T-14R35).
 V_1 — Four-prong vibrator.
 m — 50 ma. (Model 221 Triplett). (See text.)

resonance. Off resonance, the plate mills will be 40 or 50 and will drop to around 10 at resonance. With this much in operation, set the antenna series condenser near zero and move the tap switch to the first position off the center tap. Increase the antenna condenser capacity. If the final does not load up, advance the tap switch to the next position and try again.

In each case, the final tank condenser should be retuned slightly for minimum dip. The correct adjustment is that where the final plate current is approximately 25 or 30 ma., and the final condenser minimum dip position is the same as with no load — or fairly close to it. Operation will, however, not be appreciably impaired if these two positions differ slightly, providing the current is as indicated above. Practically any length of antenna, from a whip type on up, may be used on any band.

The vibrator primary switch serves as a send-receive switch for either c.w. or 'phone.

'Phone

For 'phone operation, the "speech" switch is thrown. This part comes into operation as soon as the heaters have had time to warm up. The milliammeter reads the modulator current along with the final current, and during 'phone operation the meter will read 40 or 50. If it is desired to read the modulator current separately, simply insert the key into its jack and leave the key open.

Two pin jacks are provided whereby the vibrator plate supply can be used for operation of a receiver. An external-internal switch applies plate power to either transmitter or receiver as desired and may, in this case, be conveniently used as a send-receive switch.

For fixed location operation, an 8-ampere, 6-volt transformer can be substituted for a storage battery. No other change is necessary. However, it will save wear and tear on the vibrator to remove it and substitute a special plug made from an old tube base. Two of the pins are shorted as shown in the diagram. Switching and operation is the same as before in all other respects. This trans-

(Continued on page 55)

Announcing—U.H.F. Field Day and Relay

September 9th-10th¹

IN THIS activity you can take part from your home station, but there is a premium (two times score points) for operation away from the fixed station address, i.e. portable or mobile. Operate any hours you like, within the stated period.¹ Every licensed amateur, yes absolutely everybody, is invited to get in on this ultra-high-frequency relay activity. Your city, town, state, community, or other area will be needed. You may be the one amateur in your region to pass the experimental or test messages along to see HOW FAR they can be sent on the ultra-high-frequency bands alone! Aim to put your town on the u.h.f. map!

Are you a Field Day enthusiast? Most everyone is! Here's another chance to enjoy field work. Having given attention to the low-frequency bands in June, we now focus attention on the u.h.f. bands that were unnecessarily passed up during the June activity. Get set for a second F.D. dedicated to the ultra highs!

All u.h.f. stations, home or afield are wanted in on this relay. There must be stations at strategic points between communities, at high points with DX coverage to help our relay lines along. Portable mobiles require self-power in most cases, and we believe in encouraging that to add to our emergency service potentialities. So there's a score multiplier of two to all fellows who pull up stakes and go afield to help the rest of us along.

Just a glance at last month's QST shows that big new records are in the making, if we hams keep at it in organized fashion on our u.h.f. bands. The purpose of this activity is to encourage concentrated activity on 56-60 Mc., 112-116 Mc., 224-230 Mc., etc. (five meters, two-and-one-half meters, etc.). Concentration of operating at the same days and hours seems just as important as the conditions, so we're going to open this new radio season by inviting every ham to take a whirl at these bands on the September dates — and follow through by reporting monthly general progress. Work on low frequency or in other than the specified bands will not count.

Scoring: A. You report a score for yourself with points for each different station worked. List all stations worked in the test period, and their locations (obtained as you work them) for points claimed. For stations that are airline distances:

Under 50 miles, score 1 point
50 up to 100 miles, score 2 points
100 up to 300 miles, score 5 points
Over 300 miles, score 10 points

¹ Starts September 9th, Saturday, at 3 P.M. local time. Ends September 10th, Sunday, at 11.59 P.M. local time.

B. Each participant that writes and starts a test message² (only one may be started per station), mailing copy to Hq. for credit, may count 10 points for this. For relaying all such messages AWAY FROM the point of origination shown in each preamble the stations handling may count 3 points each (1 for receiving by radio, 2 for relaying onward by radio in a progressive line of direction), but points only count when "copy" with handling³ data is reported to Hq. Messages can be started at any time, but stand the best chance of getting the blue ribbon if started early in the doings.

C. Amateur operators at fixed (home) locations multiply the sum of the above points by one. Field stations multiply total score points by two for the final grand total.

The relay objective: Prominence will be given the reporting stations that demonstrate the longest distance relaying on u.h.f. exclusively in the period of this contest. It's not the single longest hop that counts. The number of relays and the total air-line distance covered by the message are what count. Keep messages moving away from their starting points by town-to-town hops, don't hold them awaiting a big stroke of luck, and don't forever pass them around and around the same town; no credits are given for that. Short hops that are en route in one direction are, of course, OK. Report copies of all traffic² with handling data³ to Hq., with your point total, within a week of the activity.

Advance entry is not required. Use the general call: (A-1, A-2) CQ UHF or (A-3) CQ RELAY. After you get your test message off, your aim is to see how many you can work in the activity and over how great a distance you can get a message coming your way. Stick with it to be ready for the break

(Continued on page 90)

² Test messages originated by each station taking part should be directed, in the address, specifically to remote sections of the country, and should be complete with number, station of origin, check, place of origin, time filed, date started, address, text and signature of the amateur and station starting it. Texts should be limited to five, or not over ten words.

Example:

NR5 W1AW CK _____ NEWINGTON CONN. 3.05
PM SEPT 9 1939
ANY WEST COAST STATION
TRY TO REPLY BEFORE END OF RELAY
HANDY W1AW

³ Handling data refers to the entry of station call, date and time received — and the similar entry of station call, date and time a message is sent forward or relayed by radio on the message blank itself. Every originated message should have one such set of information. Every relayed message should have both sets of notations. Routing and responsibility for handling is properly fixed in this manner.

New Ideas for Transmitters

A Buffer and Amplifier Combining Latest Features in Design and Construction

BY T. M. FERRILL, JR.* WILJI

RELAY-RACK type construction as presently used, while ordinarily resulting in a completed transmitter of pleasing appearance, has a number of very important disadvantages. With the advent of tubes with top and side connections, it has become very difficult to plan an effective panel-and-chassis layout for short r.f. connecting leads and proper circuit isolation. The majority of these tubes should be operated in a vertical position, which suggests arrangement of the plate tank circuit above the tube, and grid tuning circuit beneath the base. Rigid mounting of the plate tank condenser and coil several inches above the chassis often is a problem. In addition, the general shape of this layout makes poor use of the chassis and panel proportions.

Where medium or high power is used, there also is the problem of proper transmitter ventilation.¹ Ordinarily, convection currents of air — heated air rising and being replaced with cooler air from sides and below — would be of help in this respect. The horizontal chassis usually used in relay-rack construction, however, oppose these rising air currents and thus retard cooling of the

* Technical Department, QST.

A high-power transmitter of unusually low cost, incorporating construction and circuit features readily applied to medium-power transmitters as well. Whether the amount of money spent on the amateur station is large or small, the principles given here will be of value to the reader.

These features are included:

1. Economical band change by tapped, permanently linked coils.
2. An unusually flexible and simple antenna coupler.
3. Correct L-C ratios in plate and grid circuits for 5 bands.
4. Circuits permitting grid- and plate-tuning condensers of unusually small spacing.
5. Safety features for operator protection.
6. Fixed neutralization over 5 bands.
7. Latest transmitter construction allowing better tube cooling, shorter r.f. circuit connections, and better isolation of tank circuits, with greatly increased accessibility.

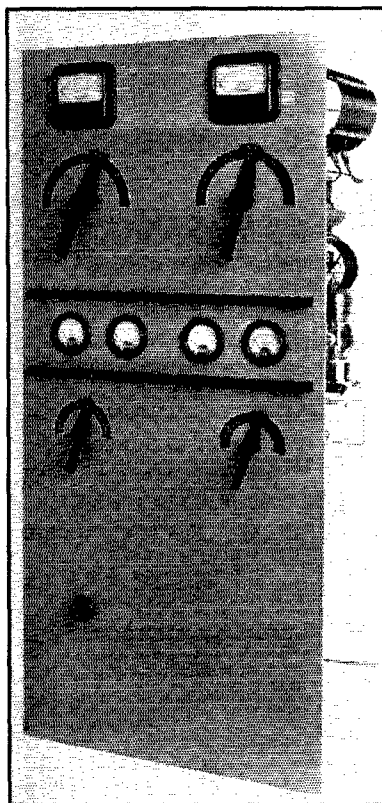

Through new construction methods, circuit accessibility is gained without sacrifice of front-panel neatness.

tubes and parts. This limits the input power of the transmitter.

Accessibility of transmitter parts and circuits for changes or repairs was an important feature of the old open ("breadboard") construction long used by amateurs — indeed, for this reason alone, some still refuse to change to the neater, more compact, more modern arrangement of transmitting gear in racks or cabinets. A single chassis-and-panel unit may be removed conveniently and altered without disturbance of other parts of the rack transmitter. It is sometimes necessary,

¹ Ferrill, "Compact Construction with High Power," QST, March, 1938; reference on page 30 to transmitter cooling problem.

however, to remove a chassis from the rack and then provide temporary connections to the other units for test purposes; this is done at expense of time and effort. It is seldom possible to make a change beneath a chassis without first removing the unit from the rack.

In addition, relay rack mounting requires for each chassis a set of terminals for power connection in addition to terminals for r.f. input, r.f. output, audio, or meter circuits. On the other hand, if a single frame is provided for a buffer stage and a final r.f. amplifier, for instance, r.f. connections are made directly between the two stages, and a single set of power terminals serves both.

An attempt to overcome the above disadvantages resulted in the transmitter of the accompanying illustrations and diagrams. Combining front panel attractiveness with the accessibility and construction simplicity of "bread-board" transmitters, this unit may be used on floor, table or power supply box, or it may be mounted in a standard relay rack. Thus the table- or floor-space economy of the older relay-rack transmitters is not sacrificed. Furthermore, this assembly might well be used to replace antenna tuner, final amplifier, and buffer amplifier chassis of a rack transmitter when r.f. rebuilding is in order. Relay-rack power supplies already constructed thus continue to serve, and the advantages of the rack remain in use.

The utility of this unusual transmitter arrangement is not dependent on rack mounting. It may be used just as shown (provided, of course, that it is not readily accessible to operator or others while in operation). It may be provided with a back panel similar to the control panel, with top and sides then screened for ventilation. Top covering and side doors using "hardware cloth", available at hardware stores in $\frac{1}{4}$ -, $\frac{3}{8}$ -, $\frac{1}{2}$ -, or $\frac{3}{4}$ -inch mesh, allow free air circulation.

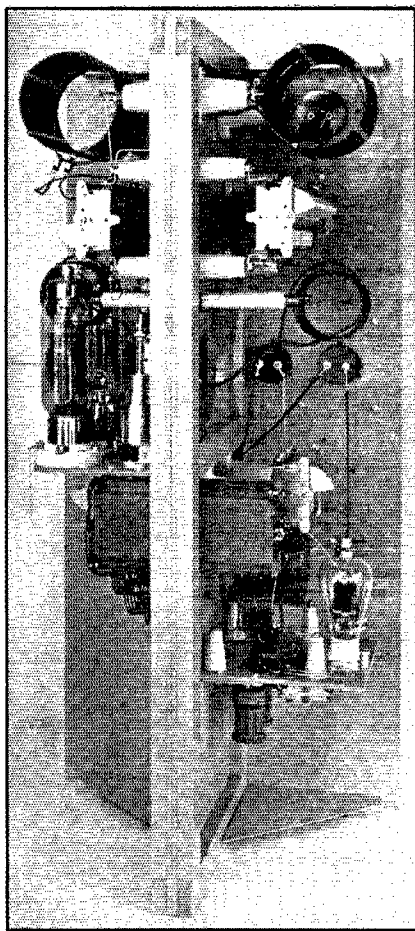

In this illustration can be seen the symmetry of parts mountings which allows one set of holes drilled in front-rear panel to support two similar transmitter parts.

Whereas the other illustrations show RCA 810 tubes in the final amplifier, this one was taken with Taylor T200 tubes in place for 1-kw. input on 'phone. The 810's are limited to 700 watts 'phone input.

A Modern 1-kw. Transmitter

The transmitter shown in the accompanying illustrations is suitable for input power up to one kilowatt, c.w. or plate-modulated 'phone. The buffer uses a T55 tube operated at 1000 to 1500 volts; however, an 808, 35T, HK54, or RK37 may be used here with application of proper filament and grid voltages — no change of r.f. circuits is necessary.

The final amplifier is shown with a pair of RCA 810 tubes, with which 1-kw. input c.w. is possible at 2000 volts. With these tubes, 700-watt input at 1600 volts is permissible with plate modulation. Without any change, the amplifier is suitable for use with a pair of T200 tubes at 1-kw. input, 'phone and c.w. With a lower-voltage filament transformer,

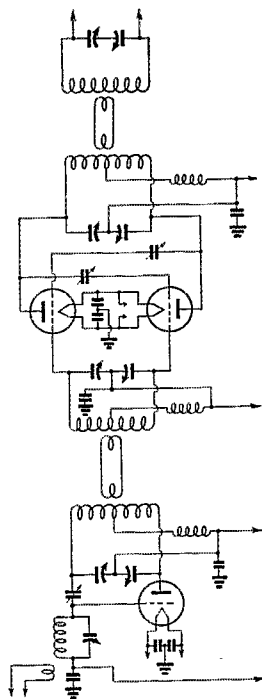
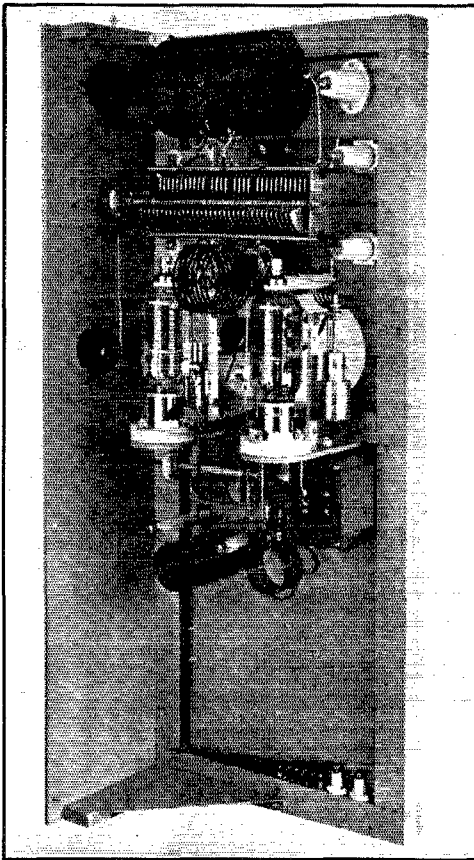

Fig. 1 — General circuit of the transmitter. Coil taps are not shown in this diagram. Aside from the high voltage connections to the tuning condenser rotors, the circuits are completely conventional. Link coupled buffer, link coupled push-pull amplifier, and link coupled antenna tuner are used for ease of obtaining correct match and loading throughout.



The push-pull kilowatt amplifier occupies nearly all of the transmitter's right side.

The vacant space beneath the grid circuit well might be used for construction of oscillator and doubler if separate exciter is not available.

The final amplifier grid coils, like the buffer plate coils, are provided with lug taps soldered to positions for the various band taps. These lugs simplify the task of band-changing, since the wire and turns-spacing of the coils are small. The amplifier plate coils, as well as the antenna coils, are wound with coarse turns, so that bared points on the turns to which taps are made are satisfactory. Note the receiving spacing of the grid condenser and the unusually small spacing of the plate tuning condenser. The latter is a multi-band condenser allowing wide range of tuning capacity. The elongated form of the neutralizing condensers, seen behind the amplifier tubes, adapts them specially for such a layout as this. The amplifier plate coil for 20- and 10-meter operation is mounted between the tubes, supported on National GS-4 insulators. Birnbach $2\frac{3}{4}$ -inch insulators support the 160-, 80- and 40-meter coil at top, as well as the amplifier grid and buffer plate condensers. Four Johnson $2\frac{3}{4}$ -inch insulators are used at the corners of each of the two 11-inch tuning condensers, to insure against mechanical breakage.

250TH, HK354C, RCA806, or RK63 tubes may be used in the final amplifier. In any case, the plate voltage for 'phone operation (plate-modu-

lated) should be between 1600 and 2000, and the voltage for c.w. operation should be between 1600 and 3000, dependent on tube ratings. Lower input power may be run at voltages below 1600, with proportionately reduced plate current.

Band Change by Tapped Coils

The 5-band frequency range of this transmitter, 1.75 to 30 Mc., if provided by the conventional use of plug-in coils, would require ten expensive coils for the buffer, ten for the final amplifier, and in addition, four costly plug-in bases. This large assortment of coils would require table or shelf space near the transmitter, and would make a real task of band changing. On the other hand, an attempt to use only one coil for each tank circuit with r.f.-insulated switches for inductance changing, would result in great loss of efficiency on the high-frequency bands and would again require a large expenditure.

By use of separate coils for widely different bands, as for instance, an 80-microhenry coil for 1.75 Mc. and an 8-microhenry coil for 14 Mc., shorting or tapping clips may be used for connection of a coil into the tank circuit to select the proper inductance for the higher frequency bands. Thus, for operation on 1.75 Mc. with the above coil combination, the 80-microhenry coil would simply be connected to the circuit by means of connections to the opposite ends of the winding. For 3.5- or 7-Mc. operation, the coil clips would then be removed from the ends of the winding and would be connected to appropriate points on the coil to include the desired inductance value. With shorting clips, the ends of the coil would remain connected in the circuit, and additional connections from the ends would be made to intermediate coil points. For 28-Mc. operation, the 80-microhenry coil would be completely omitted from the circuit, and taps would be used on the 8-microhenry (14-Mc.) coil, providing an effective inductance value in the tank circuit of about 3 to 4 microhenrys.

Thus, by use of slight additional space in the transmitter to include two or three separate coils for each tank circuit instead of the single coil ordinarily used, a degree of operating convenience much greater than that of plug-in coils and near that of front-panel coil switches is obtained. Of much greater importance to many amateurs is the large saving made possible by elimination of plug-in coils and bases, and by avoidance of expensive switches.

Tuning Condensers of Small Spacing

An unusual design feature of this transmitter is the use of a split-stator antenna tuning condenser of spacing and physical length equal to the plate tank tuning condenser. The antenna condenser does appear large by comparison with the plate condenser because the latter is much smaller than usual for 1-kw. transmitters. This fact is ac-

COIL TABLE

Coil	Diameter Inches	Wire Size	Turns per Inch	Bands	Turns Between Clips	Total Turns	Manufactured Coil Number	Link Coil
L ₁	1½	20 D.C.C.	25	160 M	25	25		3 Turns
				80 M	15			
				40 M	10			
L ₂	1½	20 D.C.C.	12	20 M	8	8		2 Turns
				10 M	4*			
L ₃	4	14	10	160 M	32	32	B. & W. 160 BX	1 Turn
				80 M	18			
L ₄	2½	12	6	40 M	10	10	B. & W. Un-mounted Coil No. 1	1 Turn
				20 M	10			
				10 M	3*			
L ₅	2½	14	8	160 M	36	36	B. & W. Un-mounted Coil No. 2	1 Turn
				80 M	16			
L ₆	2½	12	6	40 M	10	10	B. & W. Un-mounted Coil No. 1	1 Turn
				20 M	5			
				10 M	3*			
L ₇	3½	8	3½	20 M	8	8	B. & W. 40 HD	1 Turn
				10 M	4*			
L ₈	5	10	5½	160 M	32*	36	B. & W. 160 HD	1 to 3 Turns
				80 M	20*			
				40 M	12*			
L ₉	5	10	5½	160 M	Determined by antenna	36	B. & W. 160 HD	1 to 3 Turns
				80 M				
				40 M				
L ₁₀	3½	8	3½	20 M	Determined by antenna	12	B. & W. 40 HD	1 Turn
				10 M				

*Indicates that unused coil portions are shorted.

L₁ and L₂, together with link windings, are wound on 1½-inch diameter plug-in forms; the other coils are "airwound" (spaced turns made rigid by cemented strips of insulating material). For these coils two unmounted 10-inch lengths of experimenter's coils, and five stock coils without plug bases, were ordered from Barker and Williamson. If preferred by the amateur, all coils may be homemade—those from L₅ to L₁₀ being wound on diagonally sawed "rolling-pin" wood forms on which celluloid strips are first placed. The single-turn link coils used in most of the air-wound inductances are wound of flexible high-voltage insulated wire at centers of the coils.

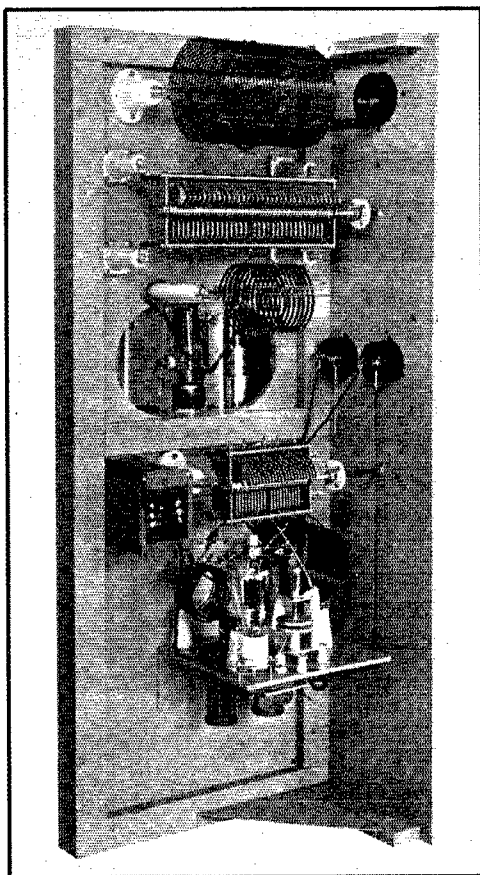

The left side of the transmitter holds the buffer stage and the antenna tuner.

The buffer grid coils are wound on two plug-in forms, mounted beneath the prestwood shelf with the grid tuning condenser. The buffer plate coil for 10-, 20-, and 40-meter bands is between the tube and the mounting panel, while the four-inch diameter coil directly behind the front panel is used for 80- and 160-meter tuning.

No connections are shown in the antenna tuner. Short flexible leads with a clip at each end are used to fit this circuit to the antenna feeders and band of operation. Note that the corresponding coils of buffer plate circuit and amplifier grid circuit, and again of amplifier plate circuit and antenna tuner, are permanently linked together. Of importance to operating convenience is the fact that the coupling provided by these permanent links, once adjusted for one band, is roughly correct for the other bands for which the same links are used.

except the r.f. tank voltage from the condenser plates.²

For increased economy, this new connection is applied not only to the final r.f. amplifier plate tank, but also to the buffer plate and amplifier grid circuits. As a result, the receiving-spaced condenser tuning the final amplifier grid circuit is

² Ferrill, "How Much Condenser Spacing?" *QST*, December, 1938.

counted for by use of the recently developed high-voltage d.c. connection for split-stator condensers, a connection which entirely removes all voltage

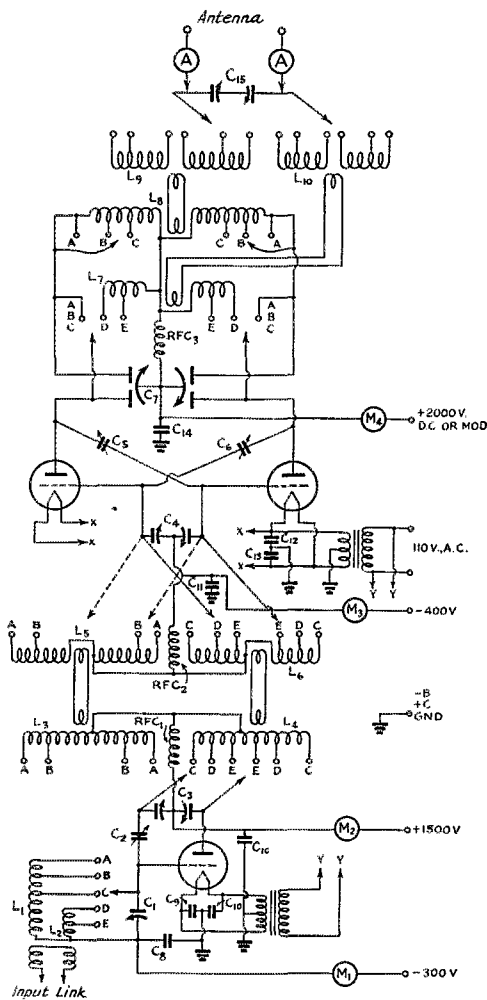

Fig. 3 — Complete circuit diagram, showing tapped coils and permanently located links.

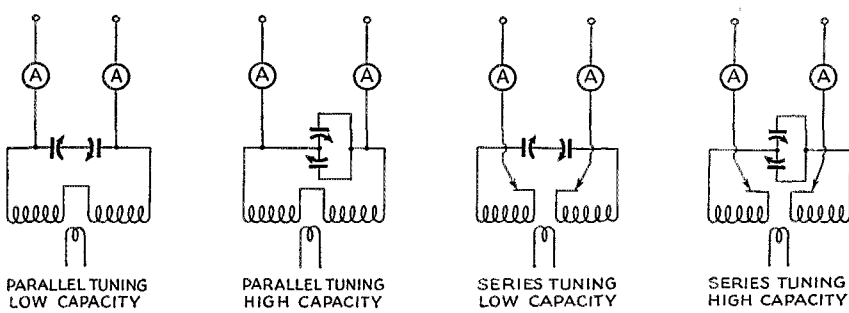

Fig. 2 — Choice of capacity range, inductance value, and series or parallel tuning is allowed by this antenna coupler. With condenser sections series-connected, a minimum capacity value of 16 to 22 $\mu\text{fd.}$ is available, while the maximum capacity value with sections in parallel is approximately 480 $\mu\text{fd.}$

of adequate size, whereas addition of d.c. grid bias voltage would cause condenser flashovers here.³

³ An impressive test of the reliability of this new advance in transmitter design was made when a Cardwell MT-50-GD, a Midway "featherweight" condenser 3 1/4 inches long with 0.07-inch plate spacing, was used to replace a huge tuning condenser of half-inch spacing in a 1-kw. transmitter. The condenser replaced had dwarfed the 250TH tubes it tuned, while the new one — hardly a handful — sat upon the tops of the tubes, supported by their plate connections. The c.w. transmitter worked quite normally at input varied between half- and one-kilowatt, at plate voltage in excess of 3000. With a manufacturer's voltage-per-section rating of 3000, the new condenser was operated with little margin of safety, even with the new rotor connection. The r.f. voltage rating per section of tuning condensers should always be equal to or slightly greater than the d.c. power supply voltage for the circuit tuned — with modulation, equal to or greater than twice this value.

Though inclusion of the tapped-coil details complicates the appearance of the circuit, it is in reality the conventional arrangement of Fig. 1. The actual transmitter wiring is quite as simple as that of a similar unit using plug-in-coils.

- C₁ — 365- $\mu\text{fd.}$, receiving spacing (Cardwell MR-365-BS).
- C₂ — Low-capacity neutralizing condenser (National NC800).
- C₃ — 210- $\mu\text{fd.}$ -per-section, 0.07-inch spacing (Cardwell XT-210-PD).
- C₄ — 500- $\mu\text{fd.}$ -per-section, receiving spacing (Cardwell XR-500-PD).
- C₅, C₆ — 3- to 12- $\mu\text{fd.}$, 0.250-inch spacing (Johnson N250).
- C₇ — Special 0.10-inch spaced condenser, eff. capacity range 9 $\mu\text{fd.}$ to 114 $\mu\text{fd.}$ (Cardwell XE-160-70-XQ).
- C₈ to C₁₃ — 0.002- $\mu\text{fd.}$, receiving mica fixed condensers.
- C₁₄ — 0.002- $\mu\text{fd.}$, 7000-volt fixed condenser (C-D 22C-86).
- C₁₅ — 240- $\mu\text{fd.}$ per section, 0.100-inch spaced variable (Cardwell XE-240-KD).
- C₁₆ — 0.002- $\mu\text{fd.}$, 2500-volt test blocking condenser.
- L₁ to L₁₀ — See coil table.
- M₁ — 0-100 d.c. milliammeter.
- M₂ — 0-300 d.c. milliammeter.
- M₃ — 0-200 or 0-300 d.c. milliammeter.
- M₄ — 0-1000 d.c. milliammeter. Meters used are "2-inch bakelite cased."
- A, A — 0-2.5 r.f. thermocouple ammeters, desirable but not necessary.
- Filament transformers: 7.5-volt, 8-ampere and 10-volt, 10-ampere (UTC S-61 and S-62).

Fig. 4—Constructional details of the tempered prestwood chassis. This type of construction, on a slightly smaller scale, is admirably suited for transmitters of medium power as well as high power. An 809 driver and pair of T55 tubes could be used for buffer and amplifier, with final amplifier plate and antenna tuning condensers similar to that used for buffer in this transmitter.

Sheet metal could be used advantageously to replace the prestwood paneling, providing the property of shielding as well as structural rigidity. Perhaps metal chassis on this plan will be made commercially available.

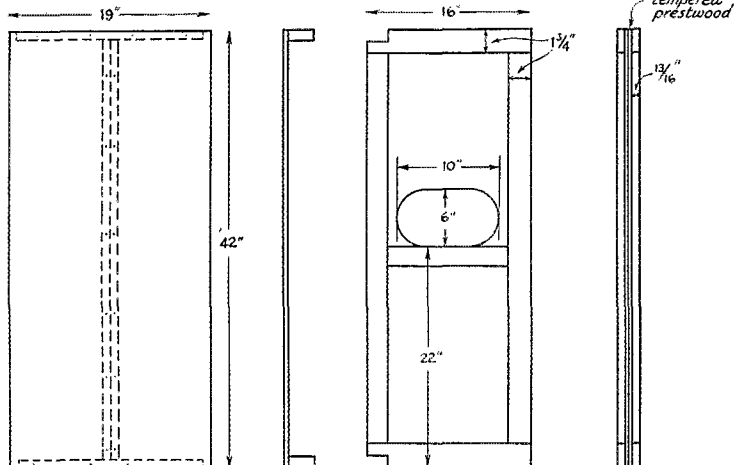

Versatile Antenna Tuner

In Fig. 2 are shown the four circuits in which the split-stator antenna tuning condenser and one of the two antenna coils may be connected. Through this arrangement, when either series tuning or parallel tuning is employed, two condenser sections provide a very wide range of capacity. Of course, separate single-section condensers could be made to accomplish the same function if connected as shown and rotated simultaneously for approximately equal capacities.

The condenser used has a capacity-per-section range of 32 $\mu\text{fd.}$ to 240 $\mu\text{fd.}$ By series connection of the sections, a low-capacity range of approximately 16 $\mu\text{fd.}$ to 120 $\mu\text{fd.}$ is obtained, while parallel connection of the sections results in a high-capacity range, 64 $\mu\text{fd.}$ to 480 $\mu\text{fd.}$ The latter value, nearly 500 $\mu\text{fd.}$, may give an impression of being needlessly high; nevertheless, such a value is oftentimes needed for correct coupling to antenna feeders for 160-meter operation.⁴ It should not be necessary at any time to

depart from the four coupling circuits of Fig. 2, regardless of the length of tuned feeders. If maximum antenna tuning capacity is much lower than 3 $\mu\text{fd.}$ per meter, the feeders sometimes must be removed from their normal position at the ends of the parallel coil and condenser, and must be clipped across a smaller portion of the coils. Decreased antenna tank efficiency, decreased tuning flexibility for frequency changes within the band, and improper loading of the transmitter are the results if the clips are moved too near the center of the coil.

It is easy to avoid the troubles mentioned above by providing the antenna tuner with ample capacity range at the outstart. Use of this transmitter on the 160-meter band therefore dictated a maximum antenna tuning capacity of at least 480 $\mu\text{fd.}$, the value provided. The antenna tuner built into this transmitter is readily capable of coupling any practical antenna system having tuned feeders, for any of the five bands on which the transmitter is operated. Untuned feeder systems may simply be coupled to the plate tank coil by an untuned link coil.

Simplified Construction

The front panel of this transmitter, 42 inches high and 19 inches wide (standard dimensions for relay-rack mounting), is cut from 1/4-inch tempered prestwood. The front-to-rear panel (see Fig. 4), on which is mounted nearly all of the transmitter parts and wiring, is made of two pieces of the same material, 42 inches high and 16 inches wide, clamped back to back at the edges between 13/16-inch by 1 1/4-inch pine binding

(Continued on page 64)

⁴ Increased antenna tuning capacity solved one of the big problems of antenna coupling at W1AW. An attempt had been made there to end-feed a half-wave antenna through tuned feeders 9/16-wavelength long. The original antenna coupler, a large inductance in parallel with a 1/2-inch spaced condenser of 80- $\mu\text{fd.}$ maximum capacity, required feeder taps on the inductance placed near the center of coil to load the transmitter. While this arrangement made the r.f. amplifier plate current of the transmitter rise to the proper operating value, it placed a reactive load on the amplifier, causing the tubes to operate less efficiently and producing excessive r.f. voltage values in the amplifier plate tank circuit, which in turn gave troublesome arcs. In addition, the r.f. voltage across the antenna tank circuit became so great that the 1/2-inch spaced condenser had frequent breakdowns. Furthermore, inefficiency of the antenna coupler was shown by the very high operating temperature of the coil.

Replacement of coil and condenser with a new parallel tank circuit of much lower inductance and greater capaci-

tance (the latter with only a fraction of former spacing), and connection of the antenna feeders to the ends of the coil rather than to taps including few turns, removed all coupling difficulties and resulted in smooth operation.

Increased Output With Grid-Bias Modulation

Raising Modulation-Peak Efficiency to Improve Tube Utilization

BY J. A. McCULLOUGH,* W6CHE

The peak efficiency obtainable limits the carrier efficiency of the grid-bias modulated amplifier. The higher peak efficiencies possible when high plate voltage and high bias are used make it possible to step up the carrier output, as the author describes in this article.

PROBABLY no system of modulation has been in use for a longer period of time than grid-bias modulation, but for various reasons its use has been eclipsed by the so-called "high level" or plate modulation. Still, an examination of grid-bias modulation shows many intriguing possibilities, and it is the author's opinion that it is possible to remove some of the objectionable disadvantages with the result that grid-bias modulation even in the hands of the uninitiated can be quite safe.

To obtain 100% modulation it is necessary that the peak output power be equal to four times the average or carrier power output. In plate modulation the instantaneous peak plate voltage is effectively doubled. This means that the peak power input is increased four times and, assuming that the grid excitation is such as to keep the plate efficiency constant, the peak output is four times the average output, which satisfies the condition for 100% modulation. Both grid-bias modulation and Class-B linear amplification can be considered as "efficiency" systems of modulation, since the plate efficiency of the amplifier must vary in order to satisfy the requirements for 100% modulation. In both these systems the plate voltage remains fixed, but the instantaneous value of plate current varies during complete modulation from zero to twice the average value, though the average value as read by the plate milliammeter remains constant. Also, during complete modulation the plate efficiency varies from zero to twice the carrier value. It becomes obvious that if the instantaneous input is doubled (twice the average plate current) and the plate efficiency is doubled (twice the output for the same input) the conditions for 100% modulation are satisfied.

The theoretical instantaneous maximum plate efficiency of a Class-B linear amplifier is about 78%, and is limited to this value because of the fact that plate current flows for 180 degrees (bias

at cutoff). In normal service a carrier efficiency (one-half the peak efficiency) of 30% to 33% is realized, compared to Class-C efficiencies of 60% to 65%. It is obvious that any steps that can be taken to increase the peak instantaneous efficiencies will directly result in increased usable carrier efficiencies. Grid-bias modulation offers the most intriguing possibilities because it is possible to operate these amplifiers under Class-C conditions (several times cutoff bias) on the modulation peaks which makes practicable a very high order of plate efficiency. In actual operation, it is possible to obtain plate efficiencies of 90% on the instantaneous peaks, with the result that a carrier power of 45% efficiency will result with substantially no distortion, and 50% if a small amount of distortion is permitted on peaks.¹ This brings the grid-bias modulated amplifier at least on speaking terms with the Class-C high-level-modulated amplifier so far as efficiency and output are concerned. For example, with 1000 watts input to a grid-bias modulated amplifier the tube output (carrier) can be as high as 500 watts, while with plate modulation with 1000 watts the output will be of the order of 750 to 800 watts.

Probably the biggest objection to grid-bias modulation has been the rather critical adjustments necessary for satisfactory performance. Fortunately the steps necessary for high peak efficiency also seem to eliminate the "cranky" adjustments.

Stepping Up Efficiency

The line of reasoning applicable to a high-level-modulated Class-C amplifier is also used in designing a grid-bias-modulated amplifier. A simple picture of the conditions for instantaneous peak output can be obtained if we realize that under peak conditions both types of modulation are practically identical. The power input and plate efficiency should be the same if both types of amplifiers are to have the same value of peak efficiency. We know from past experience that some of the more important considerations for high plate efficiencies are high plate voltage, Class-C opera-

¹ Care should be used to avoid going too far in this direction, since distortion introduced in the modulated amplifier, added to that already unavoidably present in the speech system, means that harmonics are generated and consequently that unnecessary side bands are radiated. The signal can be checked by examining the region near the carrier frequency for side bands outside the normal channel, during modulation, by using a crystal-filter receiver.—Ebrroa.

* Eitel-McCullough, San Bruno, Calif.

Fig. 1—Graphical representation of the operating conditions discussed in the text. The dimension *A* shows the interval during which plate current flows with the conventional operating conditions, *B* the smaller interval with high plate voltage and high bias, both for the steady carrier. The plate loss is larger the larger the area under the curve. A similar comparison is given for the positive modulation peak, where *X* represents the interval of plate current flow for ordinary operating conditions and *Y* the corresponding interval with the method described.

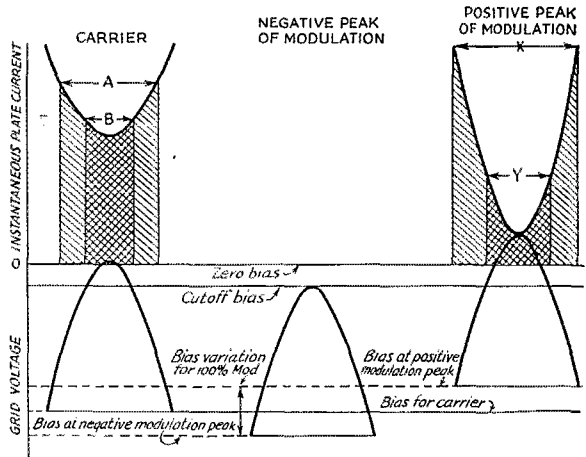

tion, ample driving power and good tank circuits. It seems unreasonable to expect the same instantaneous peak efficiency from a grid-modulated amplifier if, in a high-level modulated amplifier, we consider it necessary to double the plate voltage at the instantaneous peak. If the grid-modulated amplifier is to compare in plate efficiency with the Class-C amplifier at the instantaneous peak, then it is logical to operate the grid-bias amplifier with this higher voltage. High plate voltage is the first point.

It has been customary to operate a grid modulated amplifier so that the operating angle is 180° at the peak of the modulation cycle, with the fixed grid bias at $1\frac{1}{2}$ to 2 times cutoff. The probable reason is that it has been necessary to get maximum output at comparatively low plate voltages. These bias and plate-voltage limitations complicate the adjustments if maximum possible output is to be secured. Tests indicate that bias voltages many times cutoff actually stabilize the amplifier and improve the quality, possibly because the grid pulses have more or less the same shape since even under maximum output conditions the amplifier is still biased to several times cutoff. Those who have experimented with frequency multipliers will appreciate the fact that it takes a huge change in the number of times cutoff bias to affect materially the angle of flow after twice cutoff is past. Thus with high bias automatic biasing resistors are unnecessary to equalize the angle of flow of the plate pulse. In actual practice the grid bias is in the order of 6 to 10 times cutoff under carrier conditions. An important point is that at higher plate voltages the advantages of the low- μ tube disappear. High- μ tubes actually seem superior.

Since it is unimportant what the actual value of bias is, it becomes apparent at once that here is the logical spot to make all of the adjustments for the amplifier. If the grid bias voltage is adjusted in rather large increments it becomes neces-

sary to juggle the antenna coupling and excitation to find the proper point for linear modulation. But if the bias supply has excellent regulation and is continuously variable over wide limits, this adjustment may be used entirely to overcome the excitation and to obtain the proper operating point, regardless of the antenna loading, within the limits of the amplifier's capabilities. The bias voltage is adjusted to the point where the plate milliammeter does not kick up or down during complete modulation.² The adjustment is just that simple and can be done in 30 seconds. If too much bias is used the plate milliammeter kicks up, and with too little the meter kicks down. It will be found that the grid current required under carrier conditions depends entirely upon the antenna loading; more is needed with heavy antenna loading and less with light loading. Many persons have the opinion that grid current is detrimental to good quality, but this is a myth since grid current is no more objectionable in an amplifier of this type than it is in a Class-B audio amplifier, providing the same precautions are taken to insure good regulation of the radio frequency driver bias supply and the audio system.

Bias Supply

So much for background. The question is, does it work out in practice? The answer is, most definitely, yes. The first problem was to provide a bias supply with excellent regulation and at the same time continuously variable over wide limits. The answer was quite simple and extremely effective.³ A 2A3 tube is used as a variable bleeder

² The condition of equal flattening of positive and negative peaks must be avoided, since this will give steady plate current even though the signal is badly distorted. While the plate current should be steady with 100% voice modulation, it should be possible to make it kick upward slightly when the audio excitation is raised.—Eboron.

³ Yates, "Automatic Vacuum-Tube Regulation Control for Bias- and Plate-Supply Power Packs," *QST*, September, 1934.

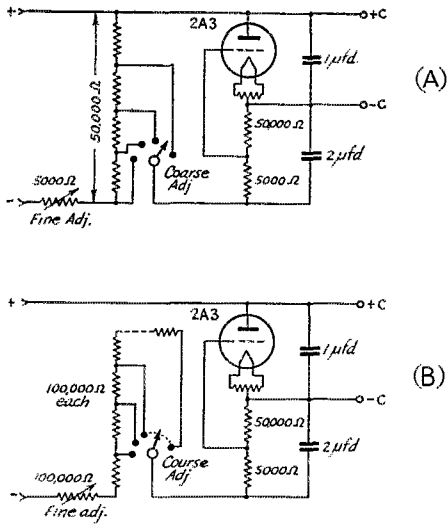

Fig. 2—The fundamental form of bias supply is shown at A; the form used by the author at B. The latter arrangement takes negligible power from the bias transformer.

for the bias supply, as shown in Fig. 2. With the values of resistances finally used a surprisingly large variation of effective bleeder resistance can be secured with just a slight change in voltage. The net effect is that regulation comparable to that of batteries can be secured; in fact, by using more than one 2A3 regulation actually superior to fresh heavy-duty "B" batteries was obtained. If the bias arrangement is used for other service, allow about 70 milliamperes of rectified grid current per 2A3. The power supply only has to furnish enough current to maintain the bias voltage at no load. In actual practice about one to two milliamperes are required from the bias supply. As the bias voltages used are fairly high it may be advantageous to use half-wave rectification and utilize the entire voltage of the transformer secondary. Because the current drain is so low a series dropping resistor is used for voltage variation. Sixteen 100,000-ohm resistors are connected to a 17-point switch, with a 100,000-ohm variable resistance in series to provide fine adjustment. The voltage variation is between about 150 and 700 volts. A variation of this scheme uses a voltage divider for voltage control. This latter system pulls slightly more power from the bias supply.

Operating Notes

Low plate voltages are definitely "out" if the performances described are to be expected. At the lower voltages the point of optimum performance is passed before plate dissipation becomes a limiting factor. The plate voltage should be increased until high carrier efficiency is obtained and plate

dissipation becomes the limiting factor. It is difficult to give a definite rule to apply for determining the voltage, but the typical examples below will give a general idea of the setups used in actual practice:

Plate Input	Plate Output, Carrier	Tubes	Plate Voltage
200 watts	100 watts	2 35T's	2000
500 "	250 "	2 100TH's	3500
1000 "	500 "	2 250TH's	4500

The system uses more r.f. driving power than does the scheme using lower bias. The plate voltage on the driver must be reasonably high to generate enough voltage to overcome the bias. The power, however, is about 50% that required for full Class-C operation.

There is very little difference in the cost of a high-voltage supply over a low-voltage supply for the same power rating. For example, suppose we have power supply delivering 2250 volts, using a 15-henry choke and 4- μ fd. condenser. The supply is capable of 1 kw., or a d.c. output of about 450 milliamperes. To obtain 4500 volts it would be necessary to go to a bridge rectifier (which gives better transformer utilization) using the same transformer as the first case. The four microfarads of condenser will be connected in series-parallel, and filtering action will be the same as initially when the 30-henry choke is changed to 60 henrys at half the current rating. The bridge rectifier is the only unusual part of the equipment.

Some "swamping," or additional loading, of the r.f. driver stage is in order to improve regulation. Dissipating about 25% of the driver output in a resistor is ample.

The amount of audio power required is quite low since the variation in audio voltage is only a few hundred volts even on a one-kilowatt transmitter. About 3 to 5 watts of audio power is sufficient. Normally a 1:1 coupling transformer works well, although the ratio naturally will vary with the audio tubes used.

Operation is simplicity itself. With the bias voltage adjusted to maximum and with grid excitation applied there should be little or no output from the transmitter. The bias voltage is then reduced and with an arbitrary value of antenna coupling modulation is effected. If the plate meter kicks up reduce the bias further. If the plate meter kicks down increase the bias. It is quite possible that at the point where proper modulation occurs the input will be either too high or too low. The antenna is adjusted to give the desired input, repeating the procedure after each change. Proper modulation can be effected at any input by adjustment of the bias supply. It is essential that too much audio input be avoided during preliminary adjustment as erratic "kicking" of the plate meter may result. With the proper adjustment upward modulation, just

(Continued on page 108)

Better 'Phone Operation Without Splatter

Building Out the Modulation Transformer to Overcome Impedance Variations

BY J. R. BAIN,* VE5JB

MUCH has been written on modulation and associated splatter, yet our bands continue to be crowded with overlapping, broadly-modulated signals. The usual comment on these splattering signals is "overmodulation." Much of this interference is due to overmodulation, and some results from incorrect adjustment of the Class-C modulated amplifier, particularly insufficient r.f. driving power. In many cases, however, transmitters using modulator tubes without sufficient maximum power output to achieve 100 per cent modulation of the modulated amplifier are causing nearly as much adjacent-channel interference as those capable of 100 per cent modulation.

It has been pointed out by W9UVC¹ that audio distortion can also cause splatter, and in the writer's opinion this is almost as serious a source of splatter as overmodulation, at least as far as amateur transmitters are concerned. Low-pass filters have been previously suggested for limiting the audio band width and cutting off higher harmonics, but in most cases they have been installed between the lower level stages of the speech amplifier where they have been only partly successful, particularly with regard to their ability to suppress harmonics. The greatest percentage of distortion usually occurs in the later stages — particularly the Class-B modulator.

If distortion is to be avoided in the Class-B modulator, it is not only necessary to give proper attention to driver considerations, but the correct load impedance must be used. However, the impedance rating for many amateur-type modulation transformers for a given secondary load holds true for only a band of frequencies in the lower middle range, and the impedance rises

The distortion is most pronounced at the higher audio frequencies, where the plate-to-plate impedance of the modulation transformer, particularly those designed to carry the d.c. plate current to the Class-C amplifier in the secondary, frequently rises to surprisingly high values. Seventh-harmonic distortion of a 7000-cycle tone impressed on the microphone means that the Class-C amplifier could be modulated with considerable power at 49,000 cycles, which means a bandwidth of nearly 100 kc. without overmodulation! Signals as broad as this are not uncommon from local stations with bad Class-B audio distortion. Third-harmonic distortion is more prevalent, and even with a 5000-cycle fundamental this means a bandwidth of 30 kc., which is far too much in our restricted bands. How can this splattering be

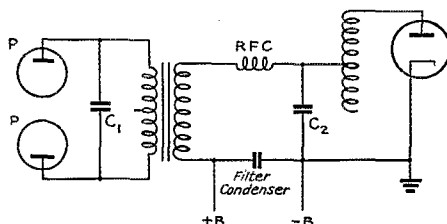

Fig. 2 — Essentials of the practical circuit, including the inductance of the r.f. choke as part of the filter. C1 and C2 correspond with the similarly-designated condensers in Fig. 1-B.

eliminated, even for the man who insists on driving his Class-B modulators hard and doesn't worry about his quality?

By building out the modulation transformer into what constitutes a constant-*K* low-pass pi

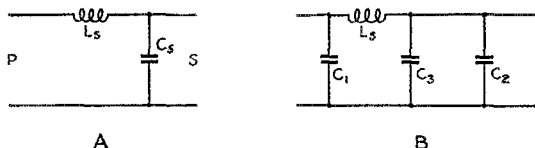

Fig. 1 — The equivalent circuit of the transformer at high frequencies (A) and the pi network formed by adding condensers across primary and secondary (B).

rapidly above the rating at the higher frequencies. This nonlinearity of the frequency-impedance characteristic of the output transformer causes serious odd-harmonic distortion to be generated in the plate circuit of the Class-B modulator.

* 1775 West 14th Ave., Vancouver, B. C.

¹ Douglas Fortune, "Phone Splatter," *QST*, Jan. 1939.

filter as far as the higher frequencies are concerned, two desirable results can be achieved. First, the higher order fundamental and harmonic frequencies are cut off and do not appear at the Class-C amplifier; and second, the impedance of the plate-to-plate load into which the push-pull modulator tubes are working can be made reason-

ably constant up to the cutoff frequency, which means improved quality. The possibilities of this scheme were pointed out by McLean.²

Neglecting the resistance of the windings, the approximate equivalent circuit of a modulation transformer accurate for high frequencies is as shown in Fig. 1, where L_s represents the leakage

characteristic up to the cutoff frequency, a few simple measurements of the plate-to-plate impedance represented by the modulation transformer network coupled to the normal equivalent Class-C load resistance are necessary.

In Fig. 3 the series method is shown for measuring the plate-to-plate impedance offered by the

Fig. 3 — Circuit for measuring the primary impedance of the loaded transformer at various audio frequencies.

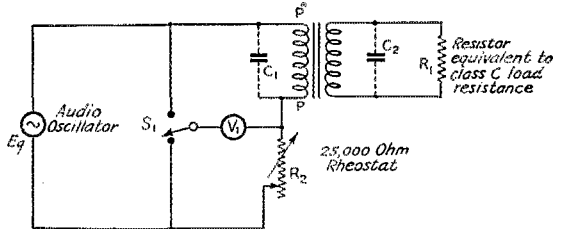

inductance of the transformer considered as located entirely on the secondary side, where most of it actually is. At the higher frequencies, where leakage inductance becomes important, its exact distribution between primary and secondary is not important. C_s represents the distributed capacity of the secondary winding plus a capacity equivalent to the interwinding capacity between the primary and secondary. By adding a condenser of the right size on the primary side from plate to plate of the modulator tubes, and another condenser of the right size across the secondary, a basic pi-type low-pass filter is formed in which the series inductance arm is the leakage inductance of the transformer. The equivalent circuit is shown in B of Fig. 1.

In circuits using an r.f. by-pass condenser on the hot side of the r.f. choke, the series arm of the filter could consist of the transformer leakage inductance plus the inductance of the r.f. choke, and the load side shunt capacity could be the r.f. by-pass condenser adjusted to the correct value for the particular modulation transformer used, as indicated in Fig. 2. By including the r.f. choke in the series arm a slightly lower cutoff frequency is obtained.

Selecting Correct Capacities

To determine the correct values of condensers required to apply this scheme to your own modulator and obtain the constant-impedance charac-

² True McLean, "An Analysis of Distortion in Class-B Audio Amplifiers," *Proc. I.R.E.*, March, 1936.

Another step in the subjection of those off-channel crackles which too frequently accompany 'phone operation. You probably wouldn't suspect the cause of the high-harmonic distortion discussed here, but the remedy for it, fortunately, is not hard to apply.

teristic of a typical modulation transformer designed to carry Class-C plate current through the secondary is shown by curve A. The rapid rise in impedance above 2000 cycles may be rather surprising to the man who has previously measured his plate-to-plate load at one frequency of say 400 or 1000 cycles and assumed that it was correct over the whole range for the particular tubes in use. Transformers designed to carry direct current through the secondary usually have an air gap in the core to prevent saturation, and when an air gap is introduced into a transformer the leakage inductance increases rapidly; consequently the impedance rises rapidly with

Referring to Fig. 4, the impedance-frequency characteristic of a typical modulation transformer designed to carry Class-C plate current through the secondary is shown by curve A. The rapid rise in impedance above 2000 cycles may be rather surprising to the man who has previously measured his plate-to-plate load at one frequency of say 400 or 1000 cycles and assumed that it was correct over the whole range for the particular tubes in use. Transformers designed to carry direct current through the secondary usually have an air gap in the core to prevent saturation, and when an air gap is introduced into a transformer the leakage inductance increases rapidly; consequently the impedance rises rapidly with

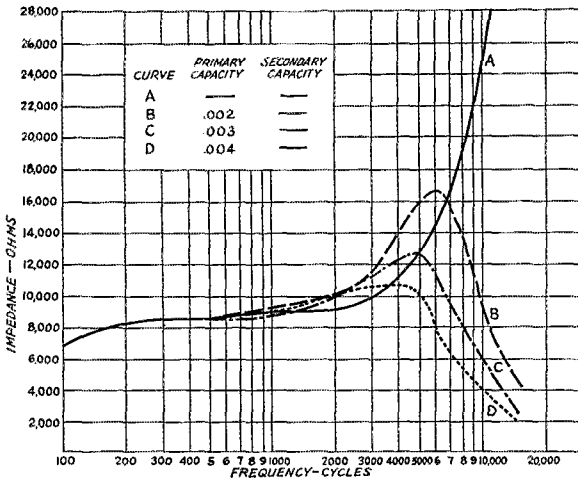

Fig. 4 — Variation of impedance is a typical transformer without shunt capacity (A) and various values of capacity connected across the primary (B, C, D).

frequency. Transformers designed for use without d.c., where the d.c. is carried through a condenser-coupled parallel choke, can be designed with very flat impedance characteristics throughout the audio range. The cost of such a transformer, however, with the associated high-voltage condenser and high-inductance choke is not usually justified for amateur operation.

In using the circuit of Fig. 3 to select values of condensers C_1 and C_2 which will flatten out the impedance curve to the cutoff frequency it is desirable to go about the selection in some orderly manner, rather than trying various hit-or-miss combinations until one is found which shows a constant reading on R_2 up to the cutoff frequency. First leave off C_2 and try various values of C_1 across the transformer primary, plotting several curves as represented by B, C and D, Fig. 4. Then remove C_1 and plot curves for various values of C_2 on the secondary, as represented by curves E, F and G of Fig. 5. By observing the shapes of these curves, the optimum values of primary and secondary capacity can be chosen to give a reasonably flat impedance curve to the cutoff frequency; the correct capacities to choose are those giving curves of the general shape of D for the primary and F for the secondary. In this particular case, using the capacities of curves D and F gave the resulting plate-to-plate impedance curve represented by curve H. These were the final values adopted, but by selecting values of capacity to another decimal point it should be possible to make the impedance curve even

more linear to the cutoff frequency.

Tests conducted on more recently designed modulation transformers than the one used in this example showed characteristics more closely resembling those of derived type of pi filter; namely, the ratio of primary and secondary capacities required was inversely proportional to the impedance ratio of the transformer, and the reflected plate-to-plate impedance increased sharply at the cutoff frequency.

In conducting the tests suggested above low-voltage condensers of known capacity can be used, and when the correct capacity is determined the required high-voltage condensers can be purchased. The r.m.s. working-voltage rating of C_2 will be equal to the modulated amplifier d.c. plate voltage if it is connected directly across the secondary terminals of the modulation transformer. If one side is connected to the cold side of the r.f. choke and the other

side to ground, the working voltage will be twice the d.c. plate voltage. The r.m.s. working voltage rating of C_1 will be the d.c. plate voltage of the Class-C amplifier times the primary-to-secondary turns ratio of the modulation transformer.

So far we have been speaking of the cutoff frequency of the resulting pi network without reference as to how it is selected or whether it can be preselected. For any given transformer, there is just one cutoff frequency possible, if the reflected plate-to-plate impedance is to be maintained at its optimum value over the desired frequency range, and this frequency is fixed by the value of leakage inductance of the particular transformer. By adding some series inductance between the

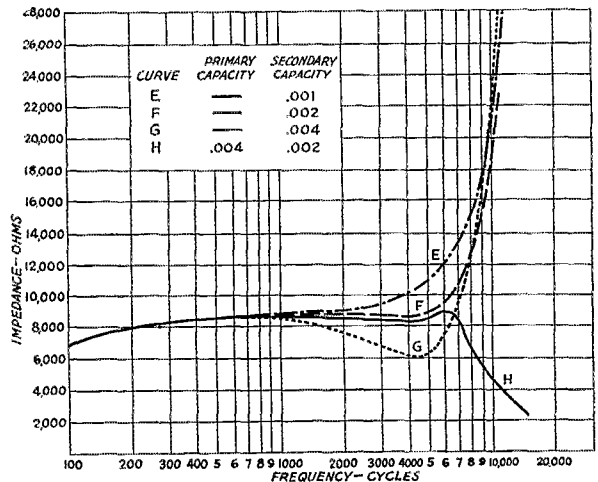

Fig. 5 — Showing the effect of connecting capacity across the secondary (E, F, G), and across both primary and secondary (H).

secondary winding and the secondary condenser, such as the r.f. choke in Fig. 2, and adjusting the condenser values proportionately, the cutoff frequency can be lowered to any desired value. Increasing the value of series inductance lowers the cutoff frequency so long as the condensers are adjusted to keep the plate-to-plate impedance — the input image impedance of the network — at a constant value.

Frequency Response

Fig. 6 shows the frequency-attenuation characteristic of the particular modulation transformer used in these tests before connecting the condensers, and after connecting the condensers used to obtain curve *H* of Fig. 5. These curves represent the relative response of the modulator tubes and output transformer only, since the driving voltage was maintained constant at the grids throughout the frequency range.

The 2 db loss at 6000 cycles can be compensated for by sacrificing a little gain and equalizing at some point in the speech amplifier to give a characteristic rising 2 db at 6000 cycles. At VE5JB this was accomplished as shown in Fig. 7 by the 0.004- μ f. condenser shunted by the 30,000-ohm resistor in the plate circuit of a parallel-fed 56 in the first stage of the main speech amplifier. Following this stage, push-pull 56's are used to drive push-pull W.E. 300-A's which operate Class-A with fixed bias to drive the Class-B RCA 805 modulator tubes. The plate voltage on these tubes is 1500 volts with battery bias of -16 volts.

Distortion

Photographs of oscilloscope patterns were taken to show the reduction in distortion effected by the use of the primary and secondary condensers to smooth out the plate-to-plate impedance. The photographs shown are of the resulting wave-form with approximately 350 watts output, with the secondary of the modulation transformer terminated in a resistor equivalent to the Class-C amplifier resistance.

Fig. 8, taken with no external capacity con-

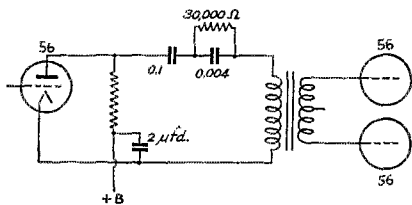

Fig. 7 — Equalizer circuit to compensate for drop in high-frequency response with the built-out modulation transformer.

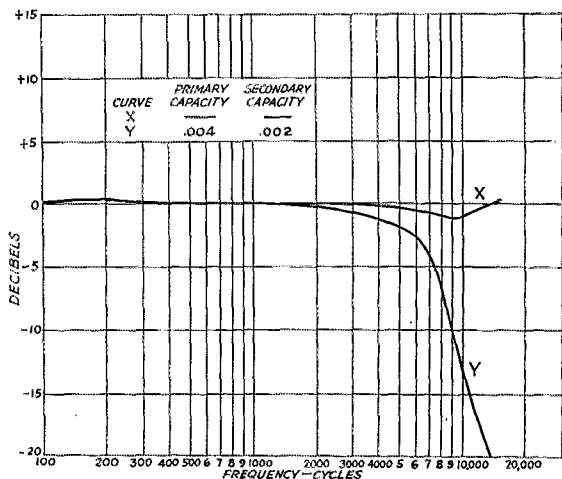

Fig. 6 — Frequency characteristic of the transformer alone (X) and with capacities across primary and secondary (Y). Curve Y corresponds to curve *H* in Fig. 5.

nected to the transformer, shows the output wave shape for 5000-cycle sine-wave input, indicating the presence of considerable out-of-phase third-harmonic distortion.

Fig. 9, also taken with no external capacity connected, shows the output wave shape for 8000-cycle sine-wave input, indicating the presence of considerable third-harmonic content in phase with the fundamental.

Fig. 10 was taken for the impedance conditions represented by curve *D* of Fig. 4, with 0.004 μ f. across the primary only, with sine-wave input of 5000 cycles. Without the secondary condenser, this primary condenser tends to unbalance the push-pull tubes, showing some second-harmonic distortion in the output.

Fig. 11 was taken for the impedance conditions represented by curve *F* of Fig. 5, with 0.002 μ f. across the secondary only and sine-wave input of 5000 cycles. Some out-of-phase third-harmonic distortion is evident, although not as pronounced as in Fig. 8 without the condenser.

Fig. 12 was taken for the impedance conditions represented by curve *H* of Fig. 5, with 0.004 μ f. across the primary and 0.002 across the secondary, with sine-wave input of 5000 cycles. There is a decided improvement over Fig. 8 for the same power output.

The results of building out the modulation transformer at VE5JB have been highly satisfactory. Tests conducted on the air with the condensers connected and disconnected have brought enthusiastic reports of improved quality and absence of splatter up to full modulation, with the condensers in circuit. Similar results have been obtained on other local transmitters after applying correct values of capacity to the Class-B modulation transformer.

Additional Filter Section

Some amateurs who are sincerely thinking of the other fellow and are willing to adjust their modulation transformer networks for a reason-

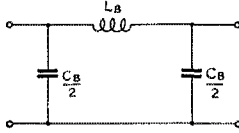

Fig. 13 — The basic pi-section filter.

ably low cutoff might still be generating harmonic distortion of the frequencies in the transmission band in the attempt to obtain more than rated power output from a given pair of modulator tubes. In such cases, the attenuation of the

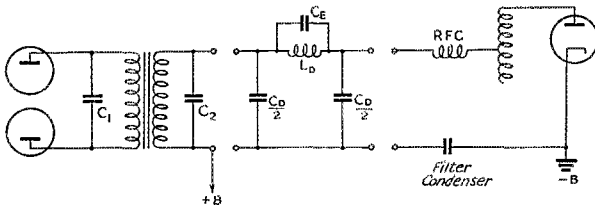

Fig. 14 — Shunt-derived *m*-type filter inserted between modulation transformer and Class-C stage to provide additional attenuation of audio harmonics.

frequencies above the cutoff point by the one-section filter built out of the modulation transformer might not be sufficient to eliminate splashing completely.

If such is found to be the case, an additional pi filter section can be added between the modulation transformer and the plate of the modulated amplifier. Either the basic pi type of filter shown in Fig. 13 or the shunt *m*-derived type shown in Fig. 14 can be used, but the latter type is to be preferred as it can be designed to present an almost constant input and output impedance for the band of frequencies to be transmitted, and at the same time cuts off the unwanted band more sharply than the basic type in Fig. 13.

The impedance characteristic of the type shown in Fig. 13 rises with frequency in a similar manner to the unmodified modulation transformer impedance characteristic represented by curve *A* of Fig. 4, so that the use of this type of filter would introduce the same type of harmonic distortion as was present prior to the modification of the modulation transformer to a constant-impedance basis.

The required values of inductance and capacity can easily be computed from the following standard filter formulas for the desired cutoff frequency, knowing the Class-C amplifier load resistance.

For the basic type of Fig. 13

$$L_B = \frac{R_o}{3.14 \times f_c} \quad C_B = \frac{10^6}{3.14 \times f_c \times R_o}$$

where

R_o = Class-C amplifier load resistance in ohms

f_c = Desired cutoff frequency in cycles

L_B = Inductance of series choke coil in henrys while carrying normal d.c. plate current

C_B = Capacity of shunt arms in microfarads

To obtain the value of the components for the *m*-derived type of filter shown in Fig. 14, the

values of L_B and C_B are found first from the above formula and then

$$\begin{aligned} L_D &= mL_B \\ C_D &= mC_B \\ C_E &= \frac{1 - m^2}{4m} \times C_B \end{aligned}$$

For the flattest possible impedance characteristic to the cutoff point, $m=0.6$. Increasing the value of m above 0.6 will give a rising impedance characteristic, and when the limiting value of $m=1.0$ is reached we are back to the characteristic of the basic-type filter. For values of m less than 0.6, the impedance of the filter decreases as the frequency is increased to the cutoff point. By suitable choice of m , a slightly rising or drooping impedance characteristic of the built-out modulation transformer can be compensated for to reflect a more even impedance on the modulator tubes at all frequencies to the cutoff point.

In Fig. 14, after $\frac{C_D}{2}$ is found from the above

formula, and C_2 experimentally as previously de-

(Continued on page 98)

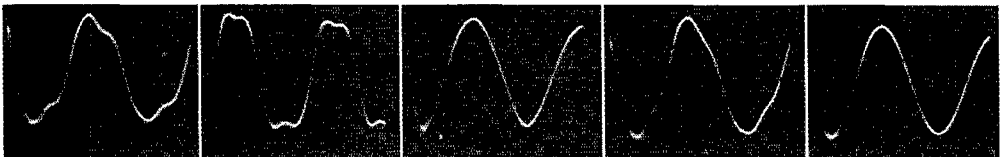

Figs. 8-12 — Oscillograms showing waveshapes obtained without condensers and with various combinations of primary and secondary capacity.

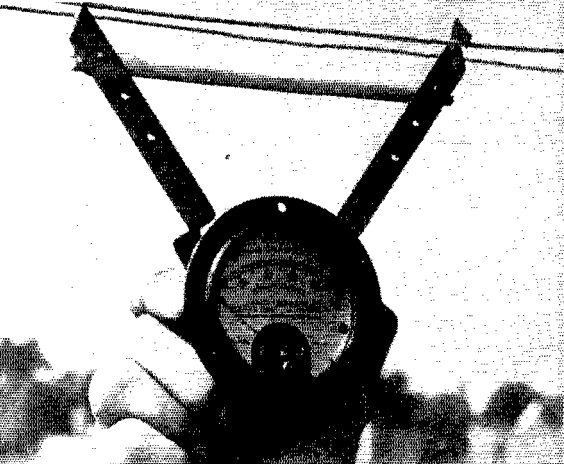

Have you wondered about the losses in your tuned line, or how to remove that last bit of standing wave from your "flat" line and matching stub? Wonder no more, because here are the answers, straight from our roof.

A line-current indicator made from a piece of strap brass and a ceramic antenna spacer. The length of the "bite" can be adjusted by using different combinations of holes to hold the spacer.

A Few Feeder Considerations

Losses in Tuned Lines and Adjustment of Flat Lines

BY BYRON GOODMAN,* WIJPE

DURING the course of some antenna experiments we had occasion to make some measurements on line losses and adjustment, and the results seem interesting enough to pass along. While the general comparative efficiencies of tuned and flat lines are well known, not too much has been said about where the tuned line goes bad and the flat line becomes good, and it has been usually left to some general statement such as "the use of flat lines is recommended where the line is over several wavelengths long."

Losses in Tuned Lines

The line that was used in the experiments was 55 feet long, running 5 feet from the antenna tuner to the window, 36 feet from the window horizontally across the roof at the Headquarters building, and 14 feet up the center of the structure pictured on the cover of last month's *QST*. The line ran across the roof at a height of 6 feet and was a 600-ohm line of No. 12 wire spaced 6 inches with ceramic spacers. All measurements were made at 29 Mc.

A horizontal half-wave antenna was placed at the top of the structure and the feed line connected at the center. The line was tuned and coupled to a transmitter in the normal fashion, and a signal-strength reading was taken at an observation point $1\frac{1}{2}$ miles away. The antenna was removed and a 70-ohm non-inductive resistor substituted, keeping the same amount of power in the system. Slight changes were then made in the length of one feeder at the transmitter end until the signal was a minimum at the receiving

point. It was found that the radiation from the feed line, after it had been properly balanced, was approximately 40 db below the radiation with the antenna connected. While this has little or no bearing on the loss measurements made later, we thought it worthy of mention that an unbalance of only two inches in the length of one wire of the feed line resulted in a change of about 3 db in feeder radiation, at 29 Mc. In any directive antenna adjusted for maximum front-to-back ratio, it would be well to check on the balance of the line in order to keep the stray radiation and pick-up at a minimum. Also worthy of mention is the fact that only a symmetrical antenna system such as a center-fed type can be depended upon for balanced feeder operation over a whole band, since an unsymmetrical type can be balanced at only one point. The symmetrical

LINE LOSS (db)

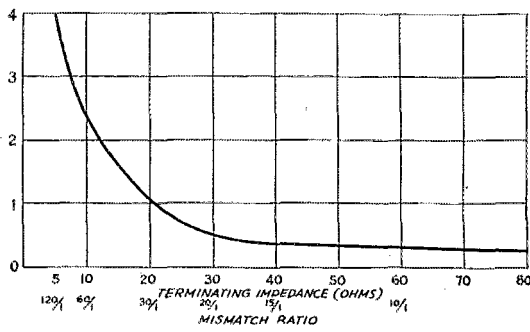

Fig. 1 — An experimentally-determined curve of the line loss in a $1\frac{1}{2}$ wavelength long 600-ohm line with various degrees of mismatch.

* Assistant Technical Editor.

system must of course be truly symmetrical, i.e., equal current in both legs of the line at any corresponding point.

A number of non-inductive resistors were obtained and accurately calibrated. These were of the carbon type and can be depended upon at 30 Mc. to be within 10% of their d.c. value. Actually they seemed to work out more closely than that. An r.f. ammeter and various resistors ranging from 70 to 5 ohms were placed at the end of the line and, for each resistor, the antenna coupling at the transmitter was adjusted so that the input to the transmitter was the same. Thus, for the same input to the transmitter, readings of the current at the antenna end were obtained for each value of resistor. Multiplying the value of the resistor by the square of the current gave the power delivered to the load in each case. The difference between the power delivered and the power available at the transmitter (determined by a dummy-load test at the transmitter) was the loss in the line. Fig. 1 shows how the loss varied as the load resistance was lowered.

As is well known, a line terminated in its characteristic impedance has no standing waves along it and a minimum of loss (amounting to about 0.15 db per wavelength of line). As the load becomes more of a mismatch for the line, the standing waves become more pronounced and the current value at the loops increases, resulting in higher losses. A tuned line feeding the center of a plain horizontal half-wave antenna is terminated in an impedance around 70 ohms (running from about 50 to 100, depending on the height of the antenna above ground) and the losses are relatively small, amounting to about 0.2 db per wavelength in a typical case such as ours. However, if this same line is connected to a low-impedance antenna system, such as some of the close-spaced arrays or systems with close-spaced parasitic elements, the losses can go up considerably. As can be seen in Fig. 1, the loss in a 600-ohm line terminated in a 10-ohm impedance can run about 1.6 db per wavelength, and it wouldn't take much line to have more loss than a simple array might have gain. Lesson No. 1, therefore, is *don't use a long tuned line to feed a low-impedance load* such as an antenna with close-spaced director. On the other hand, when a 600-ohm line is terminated in an impedance higher than 65 ohms (or less than 5000), the tuned line losses are not enough more than those of a flat line to justify the use of the latter. However, the flat line has the advantage of greater ease of coupling and non-critical length.

Adjustment of a Flat Line

We then turned to the use of a flat or untuned line. A half-wave matching section of $\frac{1}{4}$ -inch copper tubing spaced two inches was run from the center of the antenna down the center pole and shorted at the bottom. If a stub is used to match

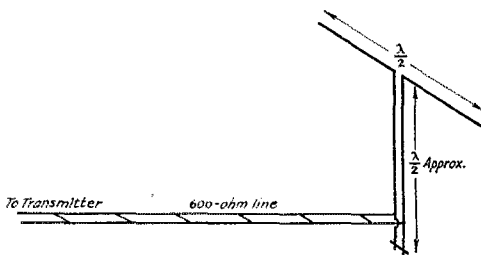

Fig. 2 — In the experiment with matching stubs, the 600-ohm line was tapped on near the bottom of a half-wave closed stub.

only a half-wave antenna, it is not necessary that it be a low-impedance affair such as this, and it can be a section of 600-ohm line. Ours was constructed as described because it was to be used later with low-impedance terminations.

The gadget shown in the photograph was built from a thermo-galvanometer and a piece of brass strap and was used to indicate the line current at any point, simply by hanging it on the line. The sharp points on the gadget can be used to bite through the insulation if enamelled wire is used for the line, but we used bare wire in the line to expedite readings.

The classical method of matching a line to a resonant stub is to excite the antenna and stub system with a nearby antenna, adjust the shorting bar for maximum current and then vary the tap of the feed line on the stub "until the standing waves disappear." It can't be done that way. The standing wave ratio can be brought down to a very low point, about $2\frac{1}{4}$ -to-1 (5-to-1 on a current-squared meter such as we used), but it can't be made absolutely flat. This is because the stub does not show pure resistance all along its length when it is resonant but only at the ends. The obvious thing to do is to detune the stub slightly so that it will show resistance at the point where the feed-line is attached. This was tried and found to work so well that the line was flat within the limits of the meter. Actually, of course, a standing-wave ratio of 2-to-1 or even more results in no serious loss in the line, but the fact that a line cannot be matched exactly by the old method should be of interest.

In practice, the adjustment of the line is quite simple. The antenna and stub are first made resonant as described above, and the line is then tapped on to the stub. The line is tapped up and down on the stub until the lowest standing-wave ratio is obtained. If it is a closed stub (odd multiple of a quarter-wave when feeding an antenna at a high-impedance point; even multiple of a quarter-wave if feeding the antenna at a low-impedance point), the stub should be *lengthened* slightly until the standing-wave ratio starts to increase, after having first decreased. Then a slight readjustment of the tap will result in a

(Continued on page 114)

The "Runt Sixty" and the "QSL Sixty"

Maximum Power from Simple Crystal Oscillators

BY FRED SUTTER,* W8QBW-QDK



A front view of the "Runt 60." Pilot bulbs are used to indicate crystal and plate current.



THE "Runt Sixty" is the latest and smallest arrival in the family of 6L6G crystal oscillators. Since the chassis is only 3 by 3½ by 2¾ inches and it weighs one pound and four ounces complete with crystal, tube and coil, the name "Runt" was quite inevitable. When used with the power supply to be described, it has an output of 60 watts on 80 and 40 meters and slightly less on 20 meters.

It might be well to pause here and say a word about power supplies. The ratings on these various transmitters (the QSL Forty,¹ the Economy Forty² and the present two) are based upon the use of power supplies as specified. While one can use almost any kind of power supply arrangement that is convenient or expedient, if the results seem inadequate just remember that when you pay for a peck of potatoes you don't get a bushel!

Performance

In spite of the fact that it is small enough to go into an overcoat pocket, the "Runt" will give a good account of itself under any reasonable conditions. When it was first put on the air, the first call brought a QSO with W8NPL in Wayne, Mich., near here. Then followed two "nothing doing" calls and a CQ which was answered by some station which was immediately swamped by QRM. The fourth call resulted in a QSO with K7GLL, working portable in Phoenix, Arizona, and the third QSO was with XE3AF in Merida, Yucatan, Mexico. The report from the latter, surprisingly enough, was RST 589x. The latter two contacts were on 40 meters — the first one was on 80. Regarding quality, it might be of interest to quote VE2HI of Montreal: "vy fb rst

* 1000 Kensington Road, Grosse Pointe, Mich.

¹ Sutter, "The QSL Forty," *QST*, Feb. 1938. See also page 48, *QST*, March, 1938.

² Sutter, "The Economy Forty," *QST*, April, 1939.

589x vy strong and clear a grand sig the smaller the rig the better the sig hi." All of which, I submit, is a fair performance for a little transmitter that costs (exclusive of tube and crystal) only \$3.86.

General

Many of the fellows seem inclined to shy away from the spaced-turn self-supported coils previously described in these stories, although there really is no valid reason for doing so. However, to see what could be done with the conventional receiver-type coil forms, the "Runt" was constructed as shown in the photographs. It will be seen that the two feed-throughs for the antenna leads are on the left-hand apron, the plate condenser knob is in front, and the ground screw and feed-through for the key are on the right-hand apron. On top, at the left, is the No. 46 blue bead

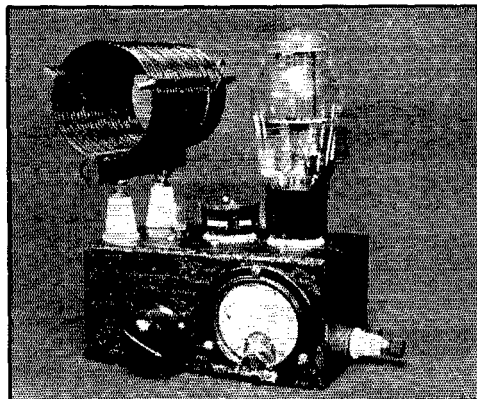

The "QSL 60" uses a plate meter instead of a pilot bulb, and the plate coil is made self-supporting.

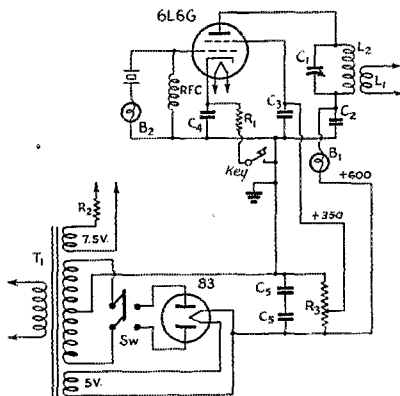

Fig. 1 — Circuit of the "Runt 60."

- C₁ — 100- μ fd. midget (Hammarlund MC100S).
- C₂, C₃ — 0.01- μ fd., 1000-volt tubular paper.
- C₄ — 0.01- μ fd., 600-volt tubular paper.
- C₅ — 20- μ fd. electrolytic, 450-volt working (Solar Minicap).
- R₁ — 200-ohm, 10-watt wire-wound (Brown Devil).
- R₂ — 1-ohm, 10-watt (not needed if T has a 6.3-volt winding).
- R₃ — 35,000-ohm, 75-watt wire-wound (Ohmite No. 0790, with slider set on fourth mark from B-plus end, for screen-voltage tap).
- RFC — 2.5-mh. r.f. choke.
- Sw — D.p.d.t. porcelain-base switch.³
- T — 600-0-600-volt, 200-ma. transformer, with 5-volt and 7½- or 6.3-volt windings.
- B₁ — No. 46 blue head pilot bulb.
- B₂ — No. 40 tan head pilot bulb.
- L₁ — 3.5 Mc.: 9 turns close-wound.
7 Mc.: 9 turns spaced to ½-inch length.
14 Mc.: 3 turns spaced to ¾-inch length.
- L₂ — 3.5 Mc.: 24 turns close-wound.
7 Mc.: 24 turns spaced to 1½-inch length.
14 Mc.: 8 turns spaced to 1½-inch length.

All coils wound on 1½-inch diameter coil forms with No. 18 enamelled wire. One-eighth inch space between L₁ and L₂.

NOTE. — The circuit of the "QSL-60" is the same as above, except that

- C₁ — 50- μ fd. midget variable (Hammarlund MC50SX).
- B₁ — 0-300 d.c. milliammeter (a bulb may be used if preferred).

³ Since this switch is directly across the high-voltage winding, it should be well-insulated and so placed that the metal parts cannot be touched. — Ed.

pilot bulb used for indicating plate current, the crystal is in the middle and the No. 40 tan bead pilot bulb for indicating crystal current is on the right. The tube and coil are behind these. Visible in the under chassis view is the 5-prong power socket on the rear apron. There is not room for the mounting plates of the coil, tube and crystal

A bottom view of the "Runt 60" showing the tuning condenser, stand-offs at the left for the antenna or coupling link, stand-off at the right for the key, and the socket for the power-supply plug.

Still working for simplicity and economy in transmitters, W8QBW describes the latest additions to the line and, what's more, how he gets 60 watts output and still keeps the 6L6G in the socket.

sockets, so these have been removed and discarded and the sockets mounted directly on the chassis. Make the holes *exactly* the size of the holes in the mounting plates to avoid a "cock-eyed" or tipped-up mounting. However, if MIP sockets are available they can be used in the customary manner. The plate tuning condenser must be insulated from the chassis by means of a bit of bakelite and so must the socket for the plate pilot bulb. The socket for the tan bead bulb which indicates crystal current is attached to the chassis by the lug which is in contact with the shell of the socket, so no insulation is required.

Coils

The coils are wound on standard 1½-inch forms as shown in the photograph. The coils are wound with No. 18 enameled wire but the curious-minded can try a larger size if desired. Keep in mind that the inductance, *L*, for practicable coils should be about as follows: 80 meters, 15 to 20 mh., 40 meters, 10 to 15 mh., and 20 meters, 1.6 to 2.0 mh., figured from the formula.

$$L = \frac{.2D^2T^2}{3D + 9L}$$

For coils wound on 1½-inch forms and spaced to occupy a length of 1½ inches, the formula reduces to

$$L = \frac{T^2}{40}$$

Our antennas are 80-meter half-wave Zepps about 132 feet long and 40 feet high. The feeders in one case are about 55 feet long and 44 feet long in the other. I would not like to make an affidavit that the particular coil data given represents the best values for all conditions and arrangements, but it will serve as a starter, and it is easy to try other windings until you find what is best for your antennas and feeders.

If you use some sort of antenna tuning unit,

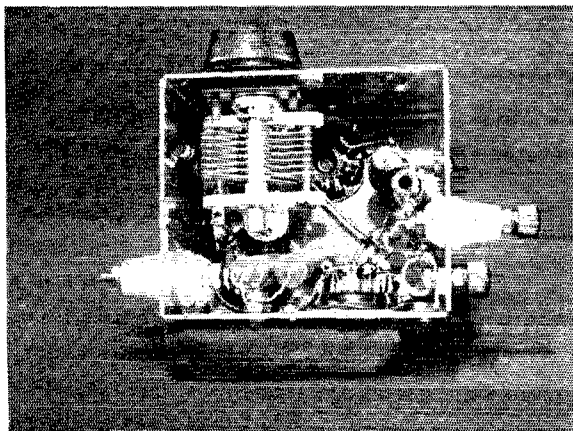

link-coupled to L_2 , use only two or three turns for L_1 instead of the number of turns specified.

If two opposite ribs of the forms are slightly notched with a small file and the notches are prop-

for the legal limit, but the idea behind these stories is to secure the maximum power at minimum expense. Authorities state that if you want a noticeable increase in signal strength over, say, that of a 60-watt transmitter, you will have to go to three or four times that output. A few minutes with pencil and paper will show what *that* means in dollars and cents.

This power supply cost me \$6.22 and it will deliver 600 volts d.c. loaded at 200 ma. A transformer with a secondary of 600-0-600 volts a.c. (i.e. 1200 v. a.c. center-tapped) and a 5-volt and a 6.3- or 7½-volt filament windings is required. There are several of these on the market selling for about \$3.00 or a trifle less. If you make changes or substitutions you may get different results — sometimes quite different, and often disappointing.

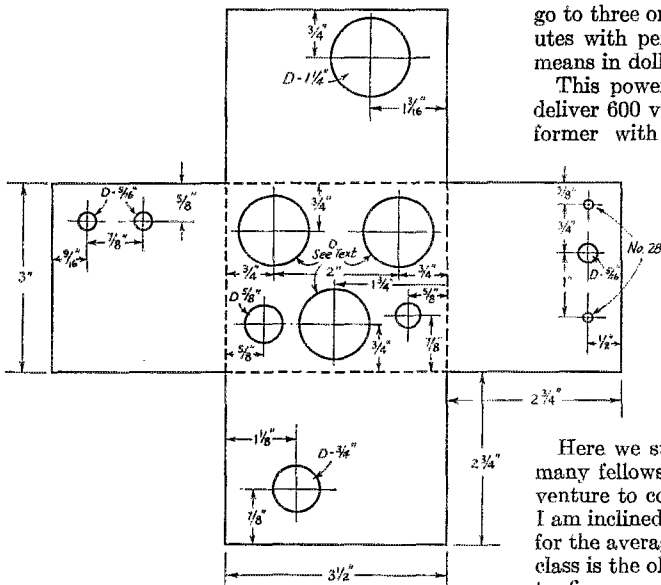

Chassis plan of the "Runt 60"

erly spaced, the 40- and 20-meter coils will wind more easily and evenly. The close-wound 80-meter coil needs no notching. Don't worry if you discover that these coils run warm or even quite warm: I know they do. If you want more efficient, cool-running coils, make them as shown in the April story and use them in the QSL Forty or Sixty or Economy-Forty transmitters.

Chassis

While some sort of bread-board construction might be used, it is urged that a No. 16 gauge aluminum chassis as shown be used for these jobs. Some of the fellows seem to make heavy weather of these chassis, but the trick is really very simple. One good procedure is to cut two wooden blocks the exact size of the top of the chassis from one-inch stock. The aluminum sheet, with the corners properly cut away, is then clamped tightly between these blocks and the sides bent down.

Power Supply

Those financially able to do so can, of course, make up transmitters and power supplies good

Antennas

Here we step into debatable territory, but so many fellows have asked about antennas that I venture to contribute my own two cents' worth. I am inclined to think that the very best antenna for the average ham this side of the sophisticated class is the old reliable half-wave Zepp. It is easy to figure and install, and it is inexpensive. I use 80-meter half-wave Zepps, about 40 feet high, the one at W8QBW running north and south and the one at W8QDK running northeast and south-

(Continued on page 108)

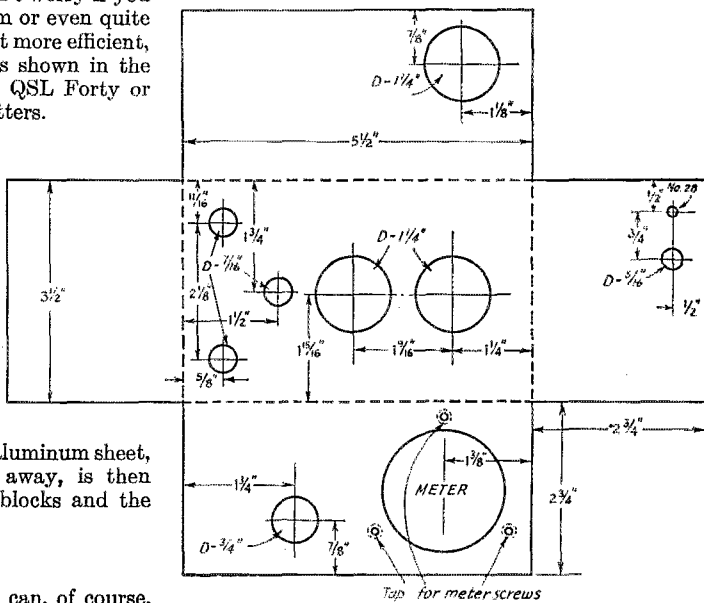

Chassis plan of the "QSL 60"

More About Amateur Interference With Broadcasting

Discussing some Typical "Case Histories"

BY G. E. GUSTAFSON,* W9AQS

THERE have appeared from time to time in *QST* and in other technical magazines, articles on amateur interference with broadcast reception. While there seems to be good evidence that this type of interference is decreasing, it is still of importance.

This article is based on a series of investigations of actual interference cases in the city of Chicago. The survey was made for the purpose of collecting information which might be of assistance to amateurs and others in reducing interference with broadcast reception.

The actual responsibility for the trouble may be either with the amateur transmitter or with the particular receiver in use by the broadcast listener. Regardless of this, in most cases the amateur is blamed for the trouble and usually must make some effort to cure the interference.

Six typical conditions were disclosed by the investigation and each of the cases investigated will be outlined in some detail.

Case No. 1 — The amateur transmitter was located on the first floor of a two-story frame house and was operating on the 160-meter band with an input of about 120 watts. The complainant's receiver was located on the second floor of a brick building immediately adjacent to the building housing the transmitter, and this receiver was being operated with no antenna, but was grounded to a cold-water pipe with a ground lead about 35 feet in length. The receiver was ten or twelve years old and had four stages of tuned radio-frequency amplification.

The owner complained that the modulation on the amateur transmitter came in all over the dial, and this was found to be true. It was impossible to receive even local stations while the amateur transmitter was operating.

* Chief Engineer, Zenith Radio Corp., Chicago, Ill.

In view of the antiquity of the receiver, it was thought advisable to check the performance of a modern superheterodyne in this location. The standard test receiver, which was used throughout the investigation, consisted of a two-gang superheterodyne using an intermediate frequency of 455 kilocycles. With this set in use, it was found that the interference was still very bad. Although not present over the entire broadcast band, the amateur transmitter could be tuned in at a number of places over the broadcast scale.

The transmitting antenna was only about 10 feet from the receiver location and with interference as great as this, it was evident that extremely high levels of signal were present at the grid of the first tube in the receiver. A superheterodyne receiver is subject to a great many types of spurious responses, provided sufficiently high inputs are introduced to the receiver. The explanation is that this strong signal will mix with harmonics of the local superheterodyne oscillator and may produce spurious responses throughout the entire band.

At this location the a. c. line was filtered through the use of by-pass condensers and an isolation transformer. No improvement was noted.

In this particular instance, it was felt that no major improvement could be obtained unless the two antennas were separated further.

Case No. 2 — This was a low-power transmitter with about 50 watts input operating on the 160-meter band. The complainant was located about a block away from the transmitter. Investigation disclosed that the receiver was an antique and appeared to have been built by a home constructor in the days of kits. No metal chassis base was used, nor was there any shielding. It was a t. r. f. set using a neutralized triode. The amateur signal came in all over the broadcast band. A test with

Mr. Gustafson, who is Chairman of the R.M.A. Committee on Intermediate Frequency Standards, undertook the investigation described in this article after a meeting between A.R.R.L. and R.M.A. representatives in which the subject of amateur interference with broadcasting was examined. It is a factual presentation of cases typical of the various types of b. c. l. interference encountered. The concluding suggestions, of special interest to 160-meter operators, have been previously discussed in *QST*, but deserve repetition since they offer a simple means of avoiding interference with the local b. c. stations to which the majority of listeners stay tuned.

the two-gang superheterodyne showed no signs of interference at this location. Another receiver in the same apartment did show signs of the interference and an investigation was made of this trouble. This second receiver was a four-tube t.r.f. set and on this set also the interfering signals came in all over the broadcast band. A wavetramp was tried and this trap removed all of the interference. The trap used was a series-tuned unit connected between the antenna and ground post of the receiver.

Case No. 3 — The transmitter in this case was operating on the five-meter band and located on the fourth story of a five-story apartment building. The antenna was a vertical half-wave mounted on the roof and fed with twisted-pair feeders. The complainant was located on the floor below in the same apartment building, and it was found that the interfering signal came in over the entire broadcast band. When a local station was tuned in, the interference was actually very little, but between stations it could be heard. The test superheterodyne showed no signs of interference. The complainant's receiver in this case was another four-tube t.r.f. set which would barely separate local broadcast stations. Line filters and isolation transformers were tried on this receiver with no improvement. An isolation transformer was also tried on the transmitter, but no improvement was noted. A series-tuned wavetramp connected from antenna to ground at the receiver made a slight improvement, but not enough to make it worth-while.

The trouble in this case undoubtedly was one of insufficient selectivity of the broadcast receiver, and possibly a cure would have been to install a modern doublet antenna as far away as possible from the transmitting antenna and connected to the receiver with a twisted pair.

Case No. 4 — The transmitter was operating in the 160-meter band with an input of about 150 watts. The complainant was located about a block away from the transmitter and using a two-band superheterodyne. Investigation disclosed that this was a case of image interference. The transmitter was being operated on a frequency of 1900 kilocycles, and the receiver intermediate frequency was 456 kc. The image of the amateur station appeared then at 988 kc. on the receiver dial. While this was not a local channel, the receiver was new and the user had been exploring the broadcast band and had run into the amateur station. The interference could not be classified as really objectionable. However, a wavetramp of the series-tuned type was connected between antenna and ground post, and this reduced the interference to a negligible amount. Another wavetramp of the parallel-tuned type was connected in series with the antenna lead ahead of the first trap, and this removed the remaining interference.

Case No. 5 — This involved the use of a superheterodyne receiver of commercial manufacture

in which the radio receiver chassis and power pack were separated in the cabinet and coupled by means of a cable. A five-meter transmitter located some 50 feet away from this receiver could be heard all over the broadcast band. The removal of all tubes up to the second detector did not diminish the interference at all and it was found that the power pack cable was actually picking up the transmitter signal and introducing it into the radio receiver.

The cure consisted of shielding the power cable.

Case No. 6 — A very aggravated case of interference was investigated in which a modern superheterodyne with good preselection experienced strong interference from an amateur 'phone station operating on 160 meters. The receiving and transmitting antenna were located about 40 feet apart and were parallel. The owner tried a complete shield around the receiver with no improvement. Tests showed that the interference was not coming through the 110-volt a.c. cord, but entirely from the antenna. A wavetramp helped to reduce the interference to some extent, but complete reduction was not achieved until the antenna systems and transmitter location had been radically changed. The transmitter change represented a move to the far side of the house, making possible the re-location of the antenna.

An analysis of these typical conditions indicates that cases 1 and 5 were caused by the operation of an amateur transmitter within a few feet of the receiver location and that the trouble was due purely to a relatively tremendous input to the broadcast receiver. Such a condition cannot be cured through any redesign of either the transmitter or the receiver, but only through greater separation between the two locations, or by the use of antennas located as far apart as possible and connected to the transmitter and the receiver through transmission lines.

The second case was attributable primarily to a receiver of poor design, and in the case of the other receiver in this location, the trouble was poor selectivity. The third case was also caused by the use of a receiver having poor selectivity, although the transmitter and receiver location were extremely close, being on adjacent floors of an apartment building.

In the fourth case, the trouble was image response of the broadcast receiver. It must be pointed out that while this trouble was purely in the receiver, that any superheterodyne will show this difficulty if sufficiently strong signals are introduced into the antenna. Fortunately this type of interference can very easily be taken care of. In the case mentioned, the interference was not regarded as objectionable, since the image signal did not fall on a local station. Had the interference fallen on a local station, however, the complaint would have been more serious.

The radio receiver manufacturing industry has

standardized on an intermediate frequency of 455 kc., and because of this standardization, a problem of this nature becomes much simpler. Since the image frequency will be twice the intermediate frequency plus the frequency to which the receiver is tuned, it is easily possible to calculate the frequency which will cause interference to local stations. As an example, if a local station is on 900 kilocycles, the frequency which would cause image interference could be found by adding 900 to twice the intermediate frequency, or 910 kilocycles, which would give 1810 kilocycles.

As has been mentioned, any superheterodyne will show this difficulty, regardless of the amount of preselection, provided a strong-enough signal is present at the receiver input. It is our feeling that an excellent cure for this trouble may be in the proper choice of transmitter frequencies by the amateur for his particular locality, so that image interference will not be produced on local stations. Since there are approximately 25 channels available in this band and since this precaution need only be observed for locals operating between 840 and 1090 kilocycles, this probably would impose but little hardship.

The case of ultra-high-frequency interference represents one of the peculiar conditions which may exist in the vicinity of such transmitters. The local field of 5-meter transmitters can be quite powerful and, therefore, may cause signal pickup in broadcast receivers in unusual parts of the circuit.

Portable-Emergency Transmitter

(Continued from page 32)

mitter can be mounted permanently in a car and run from the car battery if desired. It takes about the same amount of current as a car radio.

For this transmitter, as used at W9ANZ, an auxiliary case of similar size and appearance is used. It contains the spare plug-in coils, crystals, key, microphone, roll of small antenna wire, tape, bit of solder, 20¢ soldering iron, screwdriver, pliers, 6-volt transformer, flashlight, and a few spare parts. Since the transmitter photo was taken, the cover has been hinged and a carrying handle attached. This makes an outfit that is ready for any place, any time, any band, any antenna, and either 'phone or c.w.

Antenna

For use in an automobile, a vertical antenna which will extend out to a total of 15 feet is very effective. In fact, with the antenna extended only 7 feet, a signal is put out that is reliable up to 10 miles, and a 15-foot antenna results in a 15-mile range on 160 meters.

The car antenna is made of a telescoping fish-pole and two lengths of steel tubing which were obtained from a steering column of an old

automobile. They were originally the throttle and spark control.

The mounting consists of a piece of 2-inch by 2-inch wood, approximately 10 inches long, clamped to the rear bumper. A hole is bored lengthwise in the wood block and a small copper strip run down through the hole. The antenna lead to the transmitter connects to the copper strip. The antenna can be completely removed by simply pulling it out — it being held securely by friction. A plug at the bottom of the hole keeps it from dropping down through.

On a well-designed permanent antenna, the possibilities are quite good. Our first night test resulted in an S9 report at 200 miles on 160-meter 'phone.

South Dakota State Convention

(Dakota Division)

Watertown, S. Dak., Sept. 3rd-4th

STAN BURGHARDT, W9BJV, Chairman of the convention committee and the Mike & Key Club, extend a cordial invitation to all Hams, XYL's, YL's and their friends to attend this year's convention of the South Dakota Section to be held at the Grand Hotel, Watertown, S. D., September 3rd and 4th, Sunday and Monday.

A snappy technical program has been outlined and there will be lots of fun and prizes. Our Dakota Division Director Fred W. Young, will be present and other prominent radio amateurs as well. Come to Watertown and find out what the gang looks like in the flesh. Drop a note to Stan Burghardt, Watertown, S. Dak., that you will be there and make him feel good.

Hudson Division Convention

Schenectady, N. Y., October 7th

A WHOPPING big time at the Hudson Division Convention, October 7th. "Save your Sheekels" for Schenectady, N. Y., and watch for next announcement and publicity to be sent out by the Schenectady Amateur Radio Association.

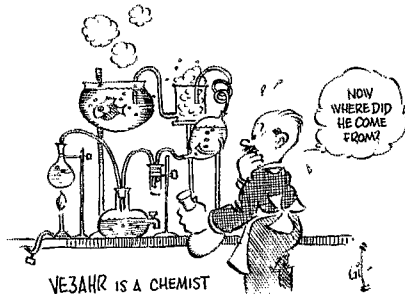

Diversity With What You Have

A Simple Method of Reducing Fading in H.F. Reception

BY S. GORDON TAYLOR,* W2JCR

If you have two receivers, you're all set to take advantage of "diversity" in reception. No changes in wiring; just a headset and a couple of simple antennas.

DIVERSITY reception offers really remarkable possibilities for the ham, just as it does for commercial short-wave telephone stations which are using it extensively in both their telephone and telegraph circuits. For the ham, however, this type of reception has presented a number of complications which have tempered (to say the least) its usefulness, from a practical standpoint.

During the present season a 10-meter diversity system has been in use at W2JCR with such marked reduction in fading that the dope is being passed along here for the benefit of others who may wish to take a stab at it. Not the least of its advantages is that not a single piece of equipment not already in use in the shack was required, and there are many others who have the makings of the system on hand.

First of all, a brief discussion of some of the fundamentals of diversity reception will be in order. No great amount of detail will be included, since articles which appeared in *QST* some time ago covered the subject quite thoroughly.

Contrary to general opinion, the two (or more) antennas required for diversity operation do not involve any particular problem unless one goes in for "space diversity," in which case wide separation of the antennas is necessary if maximum effectiveness is to be obtained. Smaller spacing can be used, however, providing the antennas are erected at an angle of about 90 degrees to each other in the vertical plane. Such an angular arrangement is known as "polarity diversity," and excellent results can be obtained with two antennas spaced as little as a few feet apart — for instance, within the confines of an ordinary back yard or house-top. But more about this later.

The real complication in the past has been in the receiver equipment. Little is to be gained by attempting to mix the inputs of two antennas connected to a single receiver. Fading is caused by the various components of a signal arriving over different paths. If they all arrived in phase everything would be rosy because then they would

reinforce one another. Not only do they arrive in all sorts of mixed phase relationship, but these relationships vary from one moment to the next. The same is true of a signal picked up by two antennas and fed into a common circuit. At one instant the signals may be in phase and will, therefore, be additive at the receiver input, but when one or the other shifts phase a bucking effect takes place and the signal takes a nose dive.

This is equally true where a separate r.f. amplifier is connected to each antenna and the outputs combined in a common mixer tube. So long as the separate components remain in the form of r.f. (or i.f.) voltages this adding and bucking action will continue to take place. It is only after rectification at the second detectors that the components from the two antennas can be mixed and will always be additive. The solution of the receiver problem therefore lies in connecting a separate receiver to each antenna and mixing the audio outputs.

Even this does not mean that there will be no fading. When the signal fades in both antennas simultaneously, the combined signal will likewise fade. It is relatively seldom that this condition exists; much more often, when the signal takes a dive on one receiver it will still be riding through on the other at a good level.

In our own experience with diversity on 10 meters there have been innumerable signals which, with a single receiver, were made difficult and even unintelligible by fading, but which with the simple diversity setup became not only intelligible, but good solid signals. One example was the reception of GM6RG late one afternoon when most of the Britishers had already passed out of the picture. With a single receiver and antenna his signal was so hashed up by a fast fade from S9-plus down into the mud that only about one word out of five was understandable. On switching in the other half of the diversity combination his signal was brought up and smoothed off at a level which rarely fell below S8; a solid and completely intelligible signal:

Receivers

The equipment we are using consists of a Hallcrafters SX17 and a Skyrider "5-10." No changes of any kind were made in either to convert them for diversity operation. These were selected because they happened to be part of the shack equipment. The only fixed requirement for the receiving equipment is that the intermediate

* Consultant, 145 West 188th St., New York City.

frequencies be sufficiently different so that both can be tuned to the same signal without interaction between their oscillators. In the combination employed one has an i.f. of 465 while the "5-10" u.f. is 1600 kc. and both can be tuned to the same signal without any birdies or interaction of any kind.

There are various ways in which the outputs can be mixed, either electrically or acoustically. The first method tried was simply to use each in the normal manner with their respective loudspeakers. The diversity action was there all right, but at instants when the signal dropped to a low level in one channel the rising noise output made an uncomfortable accompaniment for the signal coming from the other loudspeaker, no matter how good the signal was at the moment in this second channel. The next stunt was to plug a single headphone in each receiver, attach these two 'phones to a double headband, and the problem was solved. Noise is normally far less troublesome on headphones and, moreover, the two ears act as a sort of automatic selector in this system, the noise scarcely registering, and after a little practice it goes unnoticed.

The outputs can be mixed by feeding both into a single audio amplifier and loudspeaker, but this arrangement has much the same objection as the use of separate speakers.

Tuning two receivers is somewhat cumbersome, but if dial settings are noted for both receivers for a number of signals a table can be made up from which a station tuned in on one dial can be found almost instantly on the other. In combing the band the most logical procedure is to do the tuning on one receiver, bringing the other into play after a station has been located.

Antennas

Coming back to the matter of antennas, the arrangement used is not in any way special. One receiver is connected to a 10-meter horizontal "Q" with spaced feeders. The other is connected to one side of a spaced line connected to a vertical 5-meter antenna. This happens to be a "pitchfork" or double "J" type, but this is immaterial because only one of the vertical elements and one side of the feeder line are used, so that actually both this feeder wire and the antenna element serve as the antenna, the feeder being vertical or nearly so for its entire length of about 60 feet. Obviously this might be any vertical wire.

That wide spacing between the antennas is not necessary is evident from the photo of this antenna system. Actually the end of the "Q" is within 10 feet of the vertical wire, which runs up the mast to which the "Q" is also anchored. Another interesting feature of the system is that both sets of feeders run down the same court and are spaced an average of only about 3 feet apart. The saving grace here is probably the fact that the feeder system to the "Q" is a balanced line

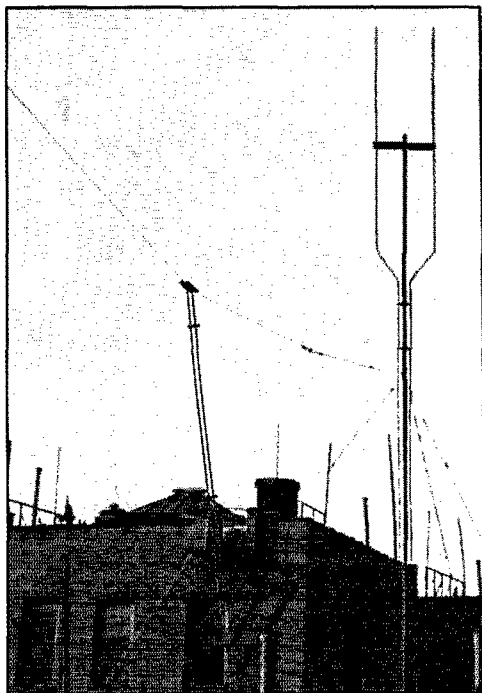

The diversity antenna system includes a horizontal "Q" and one-half of a vertical 5-meter beam, the latter with one side of its spaced feeder being used as a single-wire vertical antenna of random length. Note that the two antennas in this type of diversity system need not be widely separated, as in "space diversity." Here they are both attached to the same mast.

and therefore does not couple to the single wire of the other antenna; otherwise the coupling would probably be sufficient to make the whole system function as a single antenna and nullify the diversity action.

To close with a word of warning: Don't dig out an old receiver that was discarded because of lack of sensitivity and try to team it up with a good receiver in the hope that effective diversity reception will be obtained. Obviously if the sensitivity of one of the receivers is such that DX cannot be heard on it alone, it will serve no purpose in a diversity set-up. Lack of extreme selectivity in one of the receivers can be tolerated because such a receiver will help to level off fading even though it may contribute some QRM. Likewise some of the more modern refinements may be missing in one of the receivers without losing the advantage of diversity. All of which can be summed up by saying that if you have two receivers with widely different i.f.'s, and which work by themselves, they will work in this diversity arrangement.

We will guarantee a thrill the first time you see one of the "S" meters (if they have 'em) drop down to the bottom of the scale with the signal still pouring out of the 'phones in fine style.

DX on 56 Mc. Continues Through July

FOLLOWING the good work in May and June, 56 Mc. continued to tease the gang throughout July, throwing in some very acceptable DX at intervals during the month, and finally putting on a real show on July 27th. W6QLZ, Phoenix, Ariz., worked W3BZJ, Glenside, Pa.; W3RL, Herndon, Va.; W8PK, East Bloomfield, N. Y., and others. W3RL also worked W6KTJ of Phoenix, as did W8PK. W5AJG, Dallas, Texas, worked VE3ADO, Port Colborne, Ontario—the first or one of the first W5-VE contacts. VE3TW worked W4DRZ in Florida, also something of a record. W6QLZ heard W4EDD, Florida. FB!

Elsewhere in this issue is announcement of an U.H.F. Field Day and Relay for September 9th-10th. Don't fail to get in on this. It will provide an excellent test for 56 Mc. as well as other u.h.f. bands. Read the details now, if you haven't done so already, and get ready for a big week-end.

We're not yet taking any bets, but we're looking forward to the day when someone makes W.A.S. on 56 Mc. W3RL has worked 24 states, all districts but the 7th. W9USI has 18 states, all verified, and lacks only the 7th district. And W7 is all W5AJG needs, also. More activity will bring more results — let's keep plugging "56."

Frod Bornman, W8QDU, makes some interesting observations: "Skip DX has been quite scarce here this year with only a few scattered contacts with W4's, 5's and 9's. However, this is not my primary interest in 56 Mc., as I have been very successful in working what I consider exceptional distances consistently on ground wave. The conclusions I have reached so far are that for this ground-wave work a transmitting antenna must have height and low angle radiation. For receiving, a high-gain beam will work much better than for transmitting. Power is important up to a certain point, say around 200 watts and, of course, efficient receiving equipment. Most of my contacts with W8CIR, Aliquippa, Pa. (200 miles), have been S8 both ways, and it seems that we can contact practically any time of the day or night, assuming reasonably favorable conditions." C. E. Williamson, VE3TW, writes: "The gang hereabouts includes VE3VE, OL, TW, ZB, ADO, DC, AYN, GM, AVW, AHT, NH, etc. We are able to keep schedules over distances of 100 miles. VE3ADO, TW, ZB and DC schedule each other every day with practically 100% results. St. Catherines is about 400 feet lower than Buffalo or Port Colborne, but we can put S9 signals in there easily, also to Erie, Pa., over 100 miles. We hear W8CIR regularly."

W9NY Leads R.S.G.B. Contest

H. F. Wareing, W9NY, Milwaukee, Wis., has been awarded a silver loving cup by the Radio Society of Great Britain in recognition of being the leading entrant in the R.S.G.B. 56-Mc. contest, January-December, 1938. W9NY's record for 1938 is an outstanding one. He was on the air on 56 Mc. on 338 days during 1938. A pair of T40's with 300 watts input on 56,012 kc. fed a vertical two-element co-linear in phase antenna. The receiver was a homemade converter using three acorn tubes, feeding into an HRO at 20.5 Mc. No automatic keying was employed, all keying being done by hand for the purpose of establishing contact. D.C. C.W. only was used, as that promised maximum results, except for the fact that only a small percentage of receivers in use at that time permitted reception of C.W. signals. The receiver was so selective that only crystal-controlled 'phone signals could be copied. A total of 42 contacts were made with stations over 200 miles from Milwaukee. An additional 73 contacts were made with stations less than 200 miles from Milwaukee. DX contacts were made in the months of May, June, July and December.

Day-to-Day 56-Mc. Reports

Continuing with the last date for which 1939 work was reported in August *QST*, **June 27th:** Between 5 and 6 p.m. CST, W5AJG worked W8PK, LJP, QQS, JLQ and NXB, heard W8QDU, LBJ and NOB. W3RL worked W4AUU, Macon, Ga., at 7:44 p.m. EST. W8OKC heard W4AUU between 8:45 and 9 p.m. EST, but signals were weak and local noise heavy. W8QDU, Detroit, worked W8PK, East Bloomfield, N. Y. (285 miles) and W8CMK, Erie, Pa. (165 miles). **June 29th:** W6QLZ found the band open from 8:45 to 10:00 p.m. MST. He heard W6IOJ, North Hollywood, at 8:55 p.m. and W7AVO (both i.c.w. and 'phone) for almost an hour between 9:00 and 10:00 p.m., as well as several other unidentified W7's. **June 30th:** W8QDU worked W8CIR, Aliquippa, Pa. (200 miles).

July 1st: W8QDU worked W8JLQ, Holland, Ohio (53 miles) and W8CIR. **July 2d:** W6IOJ worked W7FDJ, Houlton, Ore. W5AJG, Dallas, reported the band open this date, making the fourth straight Sunday, with practically nothing in between. Conditions were rather spotty, and he had a bad lightning storm, but AJG heard the following between 8:30 and 10:30 a.m. CST: W8FXM, W9SQE, W9VHG, W8RKE, W6IOJ and W6DNS (last two on i.c.w.). Between 4 and 5 p.m., W5AJG worked W6VQ, Pacific Beach, Calif., and W6DNS, San Diego, both of whom were using i.c.w., and W6KTJ, Phoenix, Ariz.,

who was using 'phone. W8QDU worked W8CIR from 10 to 11 A.M. and again at 1:30 P.M. **July 3d:** W8QDU worked W8CMK, W8CIR, W8VO, Akron, Ohio (130 miles), W8CVQ, Kalamazoo, Mich. (130 miles) and W8NYD, Kent, Ohio (120 miles). **July 4th:** The band was wide open from Dallas, Texas, to the west coast from 9:30 A.M. to 2:30 P.M. CST or later, and W5AJG worked W6QLZ, Phoenix, for over three hours, as well as the following, all with excellent signals: W6KTJ, W6DNS, W6VQ, W6IOJ, W6OIN, W6MYJ, W6AVR, W6CHY, W6OFU; heard W6RR. W6QLZ worked W5EHM, Dallas, as well as W5AJG; during the long contact with AJG signals did not drop below S6 at any time. QLZ was using a 5-element close spaced array instead of the turnstile, which blew down the day before. W5GMR, Many, La., heard an Arizona station at 10:45 A.M. RS 55/6; he got the call at W6ATZ. W6KTJ, Phoenix, worked W5AFX, Oklahoma City, for about an hour at 10:00 A.M. MST, signals RS 58/9 both ways. W5AFX also worked W6KKQ and W6JFO, both of Phoenix. KKQ was running 15 watts input to an HY60. JFO had about 100 watts. W6KTJ uses an RME DM36 with an RME69 for receiving. For transmitter he has a pair of HK54's in the final modulated with a pair of 6L6's Class AB2. Antenna for both transmitting and receiving is a vertical 3-section 8JK rotary. W8QDU worked W8CIR (10 A.M.) and W8NYD (10:30 A.M.). **July 5th:** W8QDU worked W8NYD, W8CVQ, W8CIR, W8JLQ and W8CMK.

July 6th: From 8:00 to 9:20 P.M. EST, W4FBH, Decatur, Ga., worked W5AFX, heard W9ZJB, Missouri. Between 6:15 and 6:45 P.M. CST, W5AJG worked W9VHG, W9GGH, W9ARN, W9ZHB; heard W9TPI. **July 7th:** W8PK heard W8QDU at 9:30 P.M. EST. **July 8th:** W6OVK, Tucson, Ariz., worked W9USI, Brookings, S. Dak., 6:00 to 6:23 P.M. MST, 'phone and c.w., and W5AFX, 6:24 to 6:43 P.M., S7-9 'phone signals both ways. These were W6OVK's first 56-Mc. contacts outside of local W6OWX. His set-up consists of 120 watts to 809's final and homemade receiver, 6K7 regen, detector, 6F6 audio. Antennas: For receiving, long wire; for transmitting, half wave vertical, 35 feet high, fed from transmitter to zepp feeders with lamp cord. W6QLZ worked W5AFX at 9:45 A.M. MST, W5AJG at 7 P.M. Four of the Phoenix 56-Mc. gang had a round table with W5AFX for an hour, S9 signals all around. W9USI's contact with W6OVK made an additional state for him on 56. He also heard W6KTJ. From 6 to 9 P.M. CST, W5AJG worked W6QLZ, heard W6OVK, W6KTJ, W6DNS, W6IOJ, W6VQ. **July 9th:** W4FBH found the band open practically all day with signals fading in and out about every five minutes. Signals from the south were very strong and steady in the afternoon. Between 9:31 A.M. and 4:50 P.M. EST, W4FBH worked W2FGB,

112 and 224 Mcs.

112-Mc. dope is scarce this month. Let us know what you are doing, gang! W1DWK advises that 112-Mc. portable-marine was tried out July 16th off the Connecticut shores. W1CEJ operated on a 26-foot cruiser with a pair of 6J5G's and an acorn receiver. W1CPL, about a mile inland, reported W1CEJ as S9 when the boat was about five miles off shore. Contact was held until boat neared the shore line. W1LJU of Trumbull, Conn., has a 112-Mc. oscillator all set and will soon be on the air.

224-Mc. work is reported by W3FQB, Washington, D. C. W3AWS, Washington, and W3EIS, Takoma Park, Md., are also on "1 1/4." W3EIS uses door-knob rod oscillator. W3FQB and W3AWS use HK24 oscillators. All three are using acorn tube super-regenerative receivers. Good S8 two-way communication is maintained over a 4-mile path between Washington and Takoma Park. Antennas are half-wave dipoles. W3FQB's A2 signals have been heard in an automobile 15 miles away. Has anyone else tried 224 Mc.? Let's have the information.

All u.h.f. operators should take part in the special U.H.F. Field Day and Relay, September 9th-10th. Details elsewhere in this issue.

W4DRZ, W4EDD, W4FLH and W9ZHB; heard W8JHW and VE3ADO. W4FBH is running 50 to 60 watts input to an RK37 into V and diamond antennas. Receiver is RME69-DB20-DM36. W5AJG worked W6DNS, heard W8QDU and W8CMK, when the band opened for a few minutes around 10:15 A.M. CST. **July 10th:** W8PK heard W8QDU, 9:15 P.M. EST. **July 11th:** W1LLL, Hartford, Conn., worked W9GGH, 6:55 P.M. EST, and W9ZUX, 8:30 P.M., both in Wisconsin. W2AMJ worked W9OFL, Wisconsin, at 7:25 P.M. EST.

July 12th: W6QLZ put up a 7-element Yagi, made the necessary adjustments, then came to the shack about 5:20 P.M. MST and called CQ into an apparently "dead band." W9USI came back S9 and from 5:30 on QLZ worked W9USI, W9BJV, W9ZHB, W9ZJB, W9AHZ, W9ARN, W5AJG and W9CJB, all 100% contacts. Heard but not worked were W9PZI, W9AZE, W5AFX and W7GBI (harmonic). Contact was maintained between W6QLZ and W9USI for over two hours. QLZ says, "Peak seemed about 6:00 P.M. and all signals direct and very low-received angle. Band went out about 8:15 P.M., with W9AHZ, Kansas City, last signal to go." W6KTJ hooked W9AHZ around 8:00 P.M. MST, S8-9 both ways, and heard several W5's S6-8. In addition to the long contact with W6QLZ, W9USI worked W5EIN, Big Spring, Texas. W5EIN also logged W9BJV,

(Continued on page 94)



VP2LC, WINDWARD ISLANDS, B.W.I.

HAM



SHACKS

ZD2H,
LAGOS,
NIGERIA



CT3AB, FUNCHAL, MADIERA ISLANDS



NANCY AT THE
MIKE OF VP6YB



TOM ARCHER
OF VP6YB



VP6YB, BARBADOS, B.W.I.

SM7UC, AKARP, SWEDEN

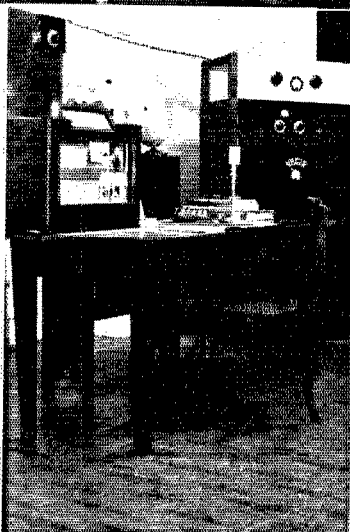
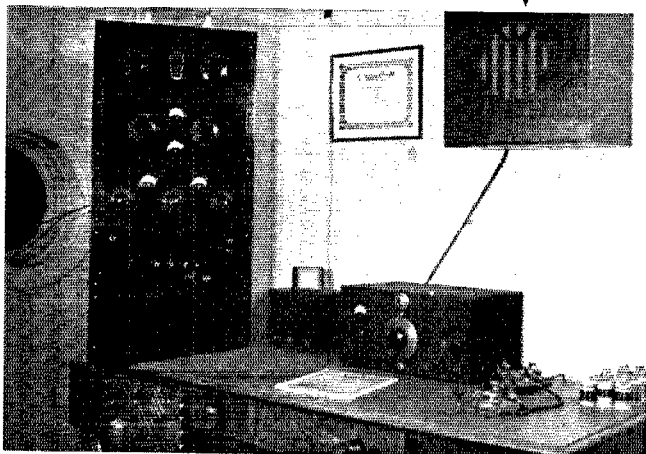

IN THIS month's Ham Shacks, we are proud to present a collection of outstanding DX stations. Each one is a veteran of several International Contests and each is well known to every DX man the world over.

VP2LC

NEED we tell you that VP2LC is owned and operated by an attractive YL of 21? (Don't believe her if she tells you she's 73.) Marie Devaux has been interested in ham radio, among other sports and hobbies, since the tender age of 9, but it wasn't until recently that she had her wish fulfilled. With the assistance of her cousin, VP2LB, VP2LC finally became a reality.

All of the equipment is homemade, including the 8-tube superhet at the right of the operating table. The tube line-up of the three-stage transmitter at the left is: 6F6 crystal oscillator, 6L6 buffer-doubler and push-pull 6L6-G final. Input runs about 70 watts. The 6L6-G Class-AB modulator and 6C5-6C8 speech amplifier are contained in the lower section of the transmitter. Power supplies for both r.f. and audio units are in enclosures underneath the operating table. The single antenna is a 7-Mc. Zepp.

Besides her DX interest, VP2LC can be found rag-chewing almost any morning or early evening on 7- or 14-Mc. c.w. or phone.

ZD2H

ART TOMLINSON is most famous for two things. First, he is the spirit behind ZD2H, until recently the one and only active ham station in Nigeria, and second, he QSL's 100 per cent, which is a man-sized job in itself when you're the lone ham representative of a rare country.

The rig which puts out a good signal to all parts of the world is a low-power affair making use of a 6L6 oscillator and 210 final. Since the high winds which prevail throughout most of the year make an elaborate antenna system impossible, most of the DX work has been done with a simple voltage-fed 7-Mc. antenna. The receiver is a two-tuber, regenerative detector and one stage audio.

Art has some interesting comments on operating ZD2H: "As is natural, the majority of QSO's have been with W's. No matter at what time ZD2H commenced activities, there always seemed to be a W around the corner waiting patiently ready to snatch at that elusive DX. I think I have contacted almost every member of the DX Century Club. Say, do some of you guys ever sleep?"

"On the high frequencies conditions varied from day to day, but in spite of severe local storms, and contrary to expectations, QRN seldom assumed troublesome proportions. Apart from a Sunday evening sked with ZD4AB, small success was achieved on 7 Mc., best being a QSO

with W6. On account of the high noise level, readable ham signals on 3.5 and 1.7 Mc. have yet to be heard. When conditions were good, there was no more hectic method of spending an evening of early morning than putting out a short CQ and appending that seemingly magical call. Half the band rose and smote you! Yes, the A.R.R.L. with their DX Century Club have a darned lot to answer for. In these circumstances, it was found that the most comfortable method of operating was to be attired in shorts only, with all doors and windows open. This practice was found to have one major disadvantage. It provided a free meal for mosquitoes attracted by the light. Occasionally, the only method of effectively counteracting the activities of these pests was to operate from beneath the folds of a fly net. Bug plugging in the tropics is a tiring and thirsty business, but it indeed was pleasurable to reel off those snappy QSO's. In spite of the high license fee, which ranges from \$15 for a 20-watt permit to \$200 for a ticket covering inputs of 50 watts and over, there can be no better hobby (or disease) than ham radio in an isolated country such as ZD2.

"From personal experience, it would appear that the question of QSL's is more important than the national debt! If you haven't had a reply to that QSL, don't blame me, 'cause I sent you one."

After a few months' absence in the Cameroons, where no power was available, Art returned to Nigeria in April where he expects to stay until the end of this year. After that we'll have to depend upon ZD2G whom 2H is getting started and from whom reports are already beginning to come in.

CT3AB

A DX CONTEST without CT3AB? Impossible! Even though he may be silent for months, you'll find him getting into trim on about 7050 or 14,100 around the first of every March. During the contest he's one of the most sought stations.

In spite of the outstanding signal he always seems to have, CT3AB is not a high-power station. Because a.c. is not available, a pair of series-connected 230-volt d.c. generators operating from the d.c. line is used to supply the final amplifier of each transmitter, while a tap provides 230 volts for the exciter stages. Three separate transmitters are available. The one used most frequently is a three-stage affair with a single 809 in the final.

The two homemade receivers at the left have recently been superseded by the RME-69. Joao Ferraz, owner and operator of CT3AB, is interested in antenna work and, at the present

(Continued on page 112)

Progress on 225 Megacycles at Mount Washington

How One-Meter Signals Behave Over Long Paths

BY ARTHUR E. BENT,* W1COO

A STABLE 225-Mc. oscillator using a W.E. 316A tube having been designed by Mr. Arnold Peterson of M. I. T. and the General Radio Company, the next step was to try it out on some of the long paths available. We have adopted a method, known humorously as "leading the signal over," when dealing with new and unaccountable frequencies. It involves setting up a receiver in a car and driving from the transmitter location to the proposed receiving location. In this way a threshold signal can be received which might be quite difficult to pick up immediately at the distant point. Mr. Henry S. Shaw, W1FGA, set up the new transmitter at his station in Exeter, N. H., and Mr. Greenleaf W. Pickard, W1XZ-W1FUR, made an auto trip on October 14, 1937, to lead the signal over to his station at Seabrook Beach, N. H., where it was received modulated with tone and voice. At points on the journey the signal dropped out, at other places it rose to fair levels. The distance was just under ten miles.

Encouraged by this beginning, Mr. Shaw made a test with the Blue Hill Observatory station, W1XW, but nothing was heard there. The distance is about 54 miles, but the Observatory is on a hill 635 feet above sea level, and signal strength on 60 and 112 Mc. is usually quite good. The receiver used at all points was the National 1-10, a superregenerative receiver with tuned radio-frequency amplifier, using acorn tubes. On March 29, 1938, Mr. Pickard made an expedition by car through rolling country in southern New Hampshire, north of Exeter. The transmitter had been arranged so that it was placed on a pole on the roof of Mr. Shaw's house, fed with filament and modulated plate voltage through a long cable, and the half-wave antenna was a part of the unit. The signal was heard at various points along the route and on Haven Hill, in Rochester, about 20 miles away. Continuing beyond, a few bursts of signal could be heard, then nothing more. It appeared that the signal could be heard at many points not on an optical path. The next day the transmitter was placed in the attic at W1FGA and the signal was still heard at W1FUR, but

was much reduced except at certain favorable positions. A few days later Mr. Shaw operated the transmitter again, and both Mr. McKenzie on Mount Washington and Mr. Pear, W1GMT, at the Blue Hill Observatory, listened, again without result. The signal at my station, only four miles from W1FGA, was so strong that I felt I could hear it if I went to Blue Hill and listened, so I made a trip down there and, in order to take no chances, took my own receiver with me and carried it up to the Observatory. Nothing was heard.

At about this time Mr. Peterson designed a beam antenna of two closely-spaced vertical elements which give a bi-directional pattern. This antenna improved the signal over the short paths on which it was already being heard, and we measured its characteristics at our station by observing the readings of an output meter while the transmitter and antenna were being rotated by W1FGA. Although bi-directional, the signal was stronger in one direction than in the other. Mr. Pickard made another car expedition to the north of Exeter, N. H., but the signal was not heard as on the previous trip. On May 18, 1938, the transmitter was taken by W1FGA to the Massachusetts Institute of Technology, where it was operated on the roof. This being only about ten miles from Blue Hill Observatory, a good signal was received there. Moving the transmitter about caused the signal to vary in strength, due to the marked interference patterns which are set up on the ultra-high frequencies. Placing the transmitter behind penthouses or other nearby obstructions on the roof caused the signal to drop down.

Mount Washington, 6288 feet above sea level, the highest peak of the White Mountains in New Hampshire, has figured in a number of long-distance u.h.f. transmissions in the past. A 56-Mc. record of 125 miles was made in 1932, and a 142-mile record on 112 Mc. was established in 1935. Here's the story behind a 92-mile record on 255 Mc. which, incidentally, gives some idea of what to expect in the way of characteristics on this frequency.

* Secretary, Mount Washington Observatory, Box 295, Exeter, N. H., and Research Associate, Blue Hill Observatory, Harvard University.

Shortly after, the transmitter was set up on the roof of the General Radio Company building. A direct line of sight to Blue Hill was cut off by a nearby factory building a few hundred yards away, but it was possible to get out of this "shadow" by placing the transmitter on a board and pushing it out over the edge of the roof. However, it was found that the signal was as good at some points where there was no direct line of sight as at this point where there was, showing that diffraction and reflection from other objects could push the signal around an obstruction.

After these tests it was hoped that the signal would be heard at Blue Hill direct from Exeter, N. H., but results were still negative. It was felt that the attempt to receive the signal on Mount Washington from Exeter was not a very fair test, as receiving conditions there are not favorable due to the electrical noise of the gas-driven generator and the poor exposure of the antenna, which is inside the building, and consequently the decision was made to try a transmitter up there while we listened at our quieter home locations. This transmitter was a one-meter oscillator with resonant filament lines, built by Mr. A. F. Sise, W1ASF, of the Yankee Network, using a W.E. 316A and modified by Mr. McKenzie for 223-Mc. work. After a great deal of listening at W1COO and W1FGA, we finally picked up a tone modulated signal at my station in Brentwood, N. H., 92 miles from the mountain, on December 18, 1938.

In December, Mr. McKenzie, W1BPI, carried a Peterson transmitter on skis to the summit of the mountain, by the eight-mile road which is completely blocked by snow and ice in winter. This transmitter was used in all subsequent tests. On January 6, 1939, W1FGA first picked up the signal at Exeter and not long after it was heard faintly by Mr. Pickard at Seabrook Beach, N. H., the distance in this latter case being about 99 miles.

On February 21, 1939, the weather on Mount Washington was favorable for outside work and a number of interesting comparisons were made, observed by W1FGA and W1COO. First, the oscillator was taken to the 50-foot level of the Yankee Network tower, where we had expected a much stronger signal, as it was by about 40 feet the highest outside point to be used. Actually, the signal proved lower than we had received from some other points, such as at the end of the railroad trestle near the Observatory building. The oscillator was moved about a little on the tower, but no material increase in signal was found and, in order to check the general level in comparison with other days, Mr. McKenzie brought the unit down to its usual place on the trestle. There we found that the signal was far below the usual level and slightly below the level from the position on the tower. During the whole test it was noted that the signal strength was con-

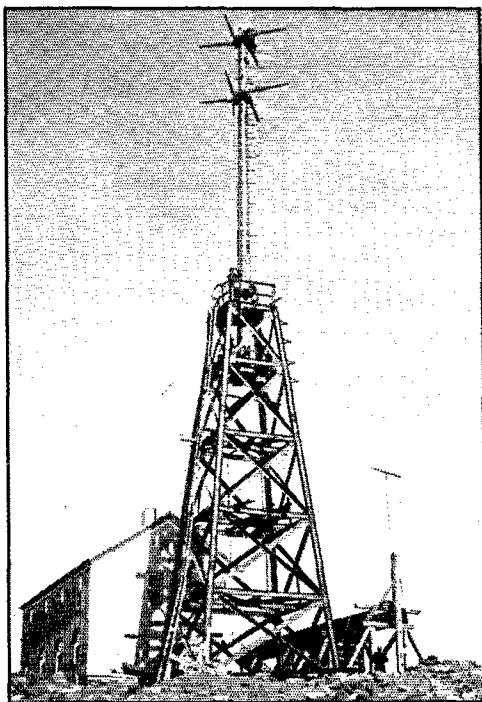

The Yankee Network tower, with Mount Washington Observatory in the background.

tinually varying from minute to minute, and it was also observed that the fading was not synchronous at W1FGA and W1COO. As a further check the oscillator was placed in another position in the attic of the Observatory where we had had occasion to place it before. The outstanding feature of the test was that the improvement resulting from the greater height of the position on the tower was so slight.

Mr. McKenzie and Mr. Shaw, and at times the writer, made a number of tests at various intermediate dates, to find out something more about conditions affecting transmission on these frequencies. It appears that there is fading rather similar to that found on the other ultra-high-frequency bands. Several types of change in signal strength have been observed. Over the longer periods, from hour to hour and from day to day, there are marked differences in signal strength, but whether there is a definite diurnal change is not yet established. A second type of fading is characterized by the signal rising and falling from minute to minute. The signal may rise from a threshold value to quite readable intensity in a few minutes. Another type which has appeared rather obvious to us is one with a very short period of about a second or so. This may be readily detected on an output meter, and is observed as a swinging back and forth of the needle

with a considerably greater amplitude than the variations in superregenerative noise.

These changes in signal strength are presumably the result of changes in atmospheric refraction. The interference pattern is pronounced, so it is important to move an antenna about when trying to pick up a signal, since a change of only a foot or two may make considerable difference. It was noticed that the signal from Mount Washington was much stronger when the transmitter and antenna were outdoors than when inside the building. A person moving about near the antenna affects the signal, so that when making tests it is necessary to move away a substantial distance between each change. At this frequency, the receiver regeneration control has a tuning effect which may be confusing, and the radio-frequency trimmer is quite critical. The condition of acorn tubes that give good results on five meters may offer a serious handicap at one meter, and tubes should be checked before starting any serious work on the higher frequency. The signal at W1COO from Mount Washington, to which there is a direct line of sight, is strong enough to give about thirty per cent suppression of background noise by the carrier, under the best conditions. At this level the signal can be heard on almost any kind of a wire, but the most effective simple antenna is one with single-wire feed. The antenna is so short that a light brass rod can be self-supporting and soldered directly to the end of the feeder which, for the last foot, can be a quarter-inch brass rod passed through a feed-through insulator. In this manner no insulating material is used to support the antenna. It is quite likely that there may be standing waves on this line, in which case it may be well to try adjusting the length at the receiver end, as in some cases the signal can be built up materially in this manner.

The writer has been experimenting through the winter with superheterodyne receivers and converters for use at 225 Mc., and at this time we have heard the Mount Washington signals on several different combinations. As we have learned on the lower frequencies, it seems that the greatest possible stability of transmission is to be aimed for. With present frequency stability, a wide band intermediate frequency amplifier must be used, but under these conditions the signal strength has been the same as with the superregenerative receiver. The 225-Mc. band is recommended to other amateurs as one where a lot of interest and entertainment is to be found, and where it is still possible for the amateur to make worth-while contributions to the known facts.

New Ideas for Transmitters

(Continued from page 39)

strips. A single $\frac{1}{4}$ -inch thickness of the prestwood could be used here with satisfactory rigid-

ity, but two pieces were thought justified by increased strength and smooth finish. Cuts to fit the cross-sectional dimensions of the pine strips were made in top and bottom front corners of the front-rear assembly, and two 17-inch lengths were screwed into horizontal cross-wise position to hold the front panel at top and bottom edges. In addition, a double row of wood screws into the front vertical edge binding of front-to-rear panel holds the front panel tightly in place, adding to the rigidity of the finished framework. Two 7-inch corner braces at bottom of the rack insure against loosening of the joint of front and front-rear panels.

Before addition of the front panel an oval 6 inches high and 10 inches long was cut by means of a key-hole saw from the front-back panel — this provides for further air circulation about the final r.f. amplifier tubes, and enables the operator to see these tubes from either side of the transmitter. Two short pieces of $1\frac{3}{16}$ -inch by $1\frac{3}{4}$ inch wood were then screwed on opposite sides of the double prestwood panel directly beneath the ventilating opening, to increase the rigidity of the rear assembly and to provide for tube mounting shelves. Two pieces $3\frac{1}{4}$ inches wide by $7\frac{1}{2}$ inches long were then cut from the $\frac{1}{4}$ -inch prestwood and screwed to the bottom of one of the panel center cleats. On the outer ends of these prestwood shelves were mounted "50-watt" sockets for the output tubes. A prestwood shelf 9 inches deep by 8 inches wide was mounted on two 4-inch angle brackets at a height of 10 inches, on the side of the center panel opposite the tube socket shelves. This shelf holds the buffer amplifier tube and neutralizing condenser, as well as the two buffer plate coils.

Many labor- and time-saving schemes presented themselves during construction of this transmitter. Probably foremost among these was the use of a single set of mounting holes through the front-back panel (which holds nearly all transmitter parts) to support two similar objects, one on each side. Tuning condensers of the same manufacture, and in one case, of the same length though different models; filament transformers of the same manufacture and similar mounting cases; and amplifier and antenna coils were mounted symmetrically in pairs on the vertical "chassis" as easily as single parts. The material used for the structure, while more than satisfactorily strong, is very easily drilled; and the absence of the large holes usually required in ordinary horizontal chassis for transformer terminals, etc., makes the job simpler and faster.

The entire rack is enameled dove gray (a shade in some paint brands somewhat similar to French gray in others); two coats are quite adequate.

Safety Features

The 4-inch Johnson indicator at left in middle of front panel is attached to the buffer plate con-

(Continued on page 116)

★ I. A. R. U. NEWS ★

Devoted to the interests and activities of the

INTERNATIONAL AMATEUR RADIO UNION

Headquarters Society: THE AMERICAN RADIO RELAY LEAGUE, West Hartford, Conn.

MEMBER SOCIETIES

American Radio Relay League
 Asociația Amatorilor Romani de Unde
 Scurte
 Associazione Radiotecnica Italiana
 Canadian Section A.R.R.L.
 Československá Amatérská Vysílač
 Deutscher Amateur Sende-und-Empfangs
 Dienst
 Eesti Raadio Amatoride Ühing
 Experimental Radio Society of Egypt
 Experimenterende Danske Radioamatorer
 Fédération des Emetteurs Belges
 Irish Radio Transmitters Society

・日本アマチュア無線聯盟 Japan
 Liga Colombiana de Radio Aficionados
 Liga Mexicana de Radio Experimentadores
 Magyar Róvidhullámú Amatőrök Országos
 Egyesülete
 Nederlandsche Vereeniging voor Internationaal Radioamateurisme
 Nederlandsch-Indische Vereeniging Voor
 Internationaal Radioamateurisme
 Newfoundland Amateur Radio Association
 New Zealand Association of Radio Transmitters
 Norsk Radio Relæ Liga

Polski Związek Krotkofalowcow
 Radio Club de Cuba
 Radio Club Venezolano
 Radio Society of Great Britain
 Rede dos Emissores Portugueses
 Réseau des Emetteurs Français
 Réseau Luxembourgeois des Amateurs d'Ondes Courtes
 South African Radio Relay League
 Suomen Radioamatööriliitto r.y.
 Sveriges Sandareamatorer
 Unión de Radioamadores Españoles
 Union Schweiz Kurzwellen Amateurs
 Wireless Institute of Australia

NEWS FROM SPAIN

THE cessation of hostilities in Spain brings us news of amateur friends there for the first time in three silent years. As is to be expected, the news is both good and bad.

It gives us much pleasure, first, to say that the report we published some years ago of the death of Jesús M. de Córdova, EA4AO, formerly EAR96 and perhaps Spain's best-known amateur, is false. He has survived the war unscathed, as shown by our photograph, and is reported to have served the present government in a manner considered most valuable by the Nationalist authorities.

We have deep regret in recording that amongst the names of those executed in Madrid during the war appear Capt. Francisco Roldán, EA4AB, ex-EAR10, president of the *Union de Radio-*



Spanish Amateurs Serve in the War

L. to r.: Srs. Angel Uriarte, EA4AD, prime mover of organized Spanish amateur radio, former president and secretary of both U.R.E. and R.E.; J. M. de Córdova, EA4AO, previously reported executed; and M. Rodriguez Cano, EA4BE, ex-EAR224. All were officials of U.R.E.

emisores Españoles and former president of the predecessor society, *Red Española*; José Lopez Agudo, EA4AR, and his wife; and Rafael Kutz, EA4AE.

It is apparent from information now reaching us that numerous Spanish amateurs served in radio work during the war, taking sides according to their convictions. Those who are known to have served with the vanquished Republican army have been read out of the U.R.E.; some are still in concentration camps in France. It is too early to predict the future of the U.R.E., for there still exists the equivalent of a state of war and it is not yet possible to say what the disposition of the government will be. However, some of the Madrid amateurs prominent in the affairs of the U.R.E. are known to have been able to lend valuable aid to the Nationalist cause and are in a favorable position to reestablish the society and obtain governmental recognition.

SOUTH AFRICAN RESERVE

ANXIOUS to be of service to their country in time of need, and to give proper support to their claim of operation in the "public interest, convenience and necessity," amateurs of the *South African Radio Relay League*, in coöperation with government defense departments, are forming the South African Air Force Civilian Wireless Reserve. Engineered by G. Ross Kent, ZS6L, and patterned somewhat after the U.S.A.'s army amateur affiliation, the new organization contemplates the building of a "reserve of wireless operators and wireless mechanics from men in civil life who are prepared to devote part of their leisure to the task of making themselves efficient for service in emergency."

The formation of such a government liaison is an important recognition of amateur radio. All

too few countries go in for anything of this sort; many others could profitably do so. S.A.R.R.L. is to be congratulated on a real landmark in its history.

NEW ZEALAND HEADQUARTERS

BECAUSE of the great disorganization occurring each year when the location of headquarters is changed, the *New Zealand Association of Radio Transmitters* recently conducted a ballot among its members to decide whether or not they would favor an increase in membership fee in order to appoint a paid official to the headquarters staff. The proposition was favorably voted, and the association is now in the process of reorganization.

It is planned to set up a permanent headquarters in one city, probably Wellington, where a salaried official will handle the details of operation which heretofore have been accomplished by voluntary workers. The Society's constitution will be altered to provide a new method of government, perhaps by an executive committee and directors in various parts of the country.

QSL BUREAUS

IN THE future, QSL cards for Denmark should be sent to E.D.R., Box 79, Copenhagen K. It should also be noted that the Danish postal authorities only permit QSL cards to be sent and received as *letters*, and under no circumstances as printed matter.

A complete and revised list of foreign QSL Bureaus will appear in the October issue of *QST*.

GLEANINGS

POLAND: Over 860 stations reported participation in the recent P.Z.K. contest. ZLIMR won with 323 points, and W2WC and W2UK were next in line with 175 and 154 points, respectively. . . . The call SP3AR has recently been assigned to another amateur, and the former holder, Jan Ziembicki, L.K.K., president, is now using the call SP1AR exclusively. **Netherlands:** N.V.I.R. have secured a special permit to use 250 watts input to their new five-meter station, PAODZ. . . . "CQ-NVIR" has inaugurated a new department called "Ham Twistings," to give its members occasion to write short treatises of interest to hams, particularly those members who do not want to write long articles because of limited time or because they do not think that a long article is necessary. **Egypt:** It has been decided by the E.R.S.E. Council that in the future, the Society will present yearly a "Certificate of Merit" for the most meritorious achievement in the technical field of experimental amateur wireless throughout the world, and a similar certificate for Egypt only. **Australia:** At the 1939 W.I.A. Federal Convention held in Melbourne during the Easter holiday period, the Victorian Division was selected to be head-

quarters division. . . . A P.M.G. representative at the convention stated that the amateur must be prepared to expect commercial allocations to be made on the high-frequency end of the 7-Mc. band in the near future. **New Zealand:** The Radio Emergency Corps, Dunedin Section, recently participated in simulated emergency work in conjunction with military authorities. Six fixed and one mobile stations took part, and all participants gained valuable experience in field operation and military message handling procedure. . . . All license examination fees charged by the P. & T. Department were recently raised; the amateur fee is now 7/6. **South Africa:** S.A.R.R.L. held their annual convention March 26th, with delegates in attendance from all sections. Greetings by radio were exchanged with A.R.R.L. between ZS6L and W1EH. . . . At the recent radio exhibition by Division I, five-meter channels furnished communication between key points, while the main transmitters were QSOing foreign stations. A broadcast was made from the exhibition, and a great many letters of commendation received. They are considering the project as a regular event. . . . D. G. Alison is the new headquarters secretary. **France:** The R.E.F. are cooperating in the widely-publicized "radio tour of France." Three automobiles and a motorcycle, all radio-equipped and operating under the call F8TA, are making a circle tour of the republic. **Switzerland:** The U.S.K.A. sponsored a Field Day on June 3rd and 4th.

GENERAL

THE safety campaign recently instituted by A.R.R.L. has taken on an international aspect; England, Belgium, Mozambique, Egypt, Australia, Brazil and South Africa are among those actively publicizing the value of safety precautions. . . . Foreign amateurs are reminded that under the rules of the I.A.R.U. for WAC certificates, membership in the A.R.R.L. will not automatically make them eligible for the award. Applicants must be members of the local affiliated society; or, if there is none, must pay the required fee of 50 cents, U. S. funds. . . . Failure of some foreign QSL Bureaus to wrap properly and secure packets of cards forwarded abroad sometimes causes breakage of the wrapping and consequent loss of the cards. Occasionally, for example, a U.S.A. district manager will receive the torn wrapping from a packet minus the cards. Mere sealing of envelopes or securing by means of flexible metal clips is not sufficient; string or cord of some kind must be used to insure safe arrival of the packets. . . . Recent visitors to I.A.R.U. Headquarters: Jean Lips, HB9J; F. M. Fisher, ex-AC2RT, XU2AW; L. F. Sherwood, HH4AS; R. Stuber, HB9T; S. Wahlin, SM5YU; George Rea, K60TH; Don Anderson, ZL3AA, and K. B. Schlicher, CP4ANE. An African visitor would have made us "WAC" in two months!

HOW WOULD YOU DO IT?



HOME-MADE RECEIVER COIL-SHIFTING MECHANISM

Solution to Problem No. 28

By Kenneth H. Joy*

THE FOLLOWING is a general description of a mechanical coil-shifting mechanism for a super-het receiver which has worked out very satisfactorily. While it is designed for a receiver with two stages of preselection and five frequency ranges, those requiring a less complex receiver may easily reduce the coil-condenser units to suit.

The drawing in Fig. 1 shows the general principle of operation. The idea resembles somewhat the method used in National type 100 receivers. Here, however, the coil carriage assembly moves forward and backward with reference to the front panel in order to make use of the type PW tuning condenser and to simplify the shifting mechanism. This necessitates a "set-back" arrangement of the front panel.

The various sets of coil units are assembled on a base consisting of laminations of two bakelite sheets $11\frac{1}{2}$ inches by $10\frac{1}{4}$ inches and one aluminum sheet $11\frac{1}{2}$ inches by $11\frac{1}{2}$ inches. Each sheet is $\frac{1}{8}$ -inch thick. The coil units for each frequency range are mounted side-by-side from left to right across the receiver and the sets of coil units one behind the other from front to back.

* Prospect Place, Tudor City, New York, N. Y.

Although not so simple as might be hoped for, Mr. Joy's solution to Problem No. 28 (see *QST* for May) nevertheless represents the first practical design for a coil-shifting receiver for amateur construction we've seen and is a decided step in the right direction. The material required is not difficult to obtain and the constructor of fair ability should be able to duplicate the design without much trouble.

While electrical design in home-built receivers is rapidly approaching a peak, there is room for many ideas which will make it possible to include the many mechanical conveniences furnished in modern factory-built receivers which, we believe, are responsible for the recent decline in home receiver building.

Mr. Joy's was the only qualifying solution received and is, therefore, awarded first and only prize.

The entire assembly travels back and forth on two tracks made of $\frac{1}{4}$ -inch square brass rod. A threaded steel rod, extending from front to rear, is rotatable by means of a crank on a small flywheel on the front panel. This threaded rod engages threaded steel blocks mounted at the center of the coil assembly at front and back. As the threaded rod is rotated, it "screws" the coil unit

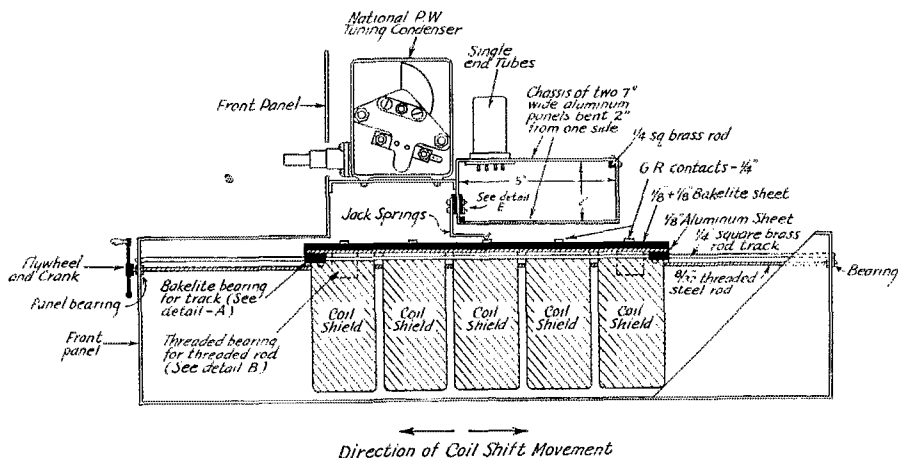

SIDE ELEVATION

Fig. 1 — Side view of receiver showing general plan of construction. The coil unit is moved backward and forward by the rotating threaded-rod control. The arrangement permits short h.f. leads.



HINTS AND KINKS

FOR THE EXPERIMENTER



INEXPENSIVE HOMEMADE CRYSTAL MIKE

THE following is the description of a homemade crystal microphone which will give real crystal quality at a minimum cost. The photographs show the completed microphone and also the component parts necessary for its construction.

A canopy from an electric-light fixture forms the base. It is partially filled with lead to add weight. These fixtures can be secured in a variety of shapes, sizes and finishes from any electrical supply house. The standard is a $\frac{3}{4}$ -inch diameter chromium-plated pipe about 5 inches long and the head is a cowl light from a 1926-model Chevrolet.

A fine-mesh tea strainer forms the wire grille which is backed up with a piece of cloth in the rear to exclude moisture. The unit is a Brush crystal headpiece. A d.p.d.t. switch was mounted on the base to short out the microphone if desired but is not necessary.

The headpiece is mounted rigidly and as close to the mesh grille as possible. A single-conductor shielded cable is brought down through the $\frac{3}{4}$ -inch pipe and through a knock-out in the base. When the microphone was first tested, it was



The completed mike looks like the real thing.

found that a hollow echo effect was present so the vacant space behind the crystal headpiece was packed with cotton and this trouble disappeared entirely and clear crystal quality was obtained.

This mike has been in use for several months and numerous tests as to its quality have been made in comparison with several factory-built microphones and it has been found that, although the frequency response is not so great, the quality at voice frequencies is a little better and more easily cuts through interference. The sensitivity is remarkable and much less amplification is required than with factory types. With a person standing 10 to 15 feet away, talking in a conversational tone, the microphone works perfectly.

For the amateur who is now using carbon, dynamic or velocity-type microphone, the construction of one of these crystal mikes will greatly improve his quality at a minimum of cost. The

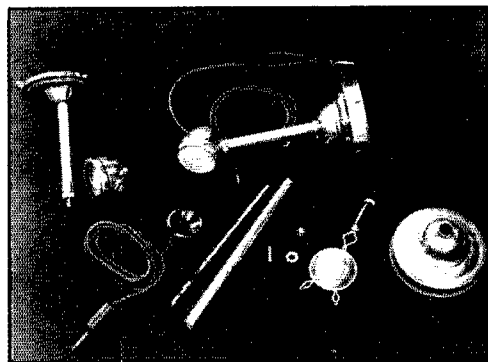

Crystal microphone made from crystal headpiece unit and odd parts. The electric fixture canopy in the lower right is the base, the tea strainer forms the wire grille. A piece of nicked pipe is used for the standard and the shell of an automobile cowl light makes a good-looking head.

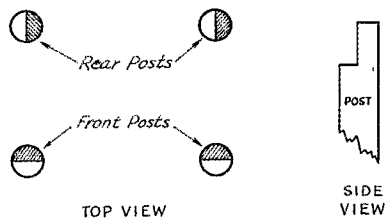

Fig. 1 — Method of anchoring legs of lattice tower to prevent strain. Shaded areas in top view indicate projecting portions of stubs.

completed job cost me \$4.80 which is a saving of \$14 to \$20, and I sincerely believe the difference in quality would not be noticed over the air.

— J. C. Melton, W3NT

ANCHORING LATTICE TOWERS

FOR stub posts to anchor my lattice tower, I used creosote-treated posts since the creosote goes completely through and will prevent decay for years. My stub posts were studded with large spikes for about two feet at the bottom, then set in the hole and cement poured around them to a depth slightly above the spikes,

filling the rest of the hole with dirt. After setting the posts they were slotted properly by using a level. Referring to Fig. 1 the cuts on the front two posts were made at right angles to those at the rear.

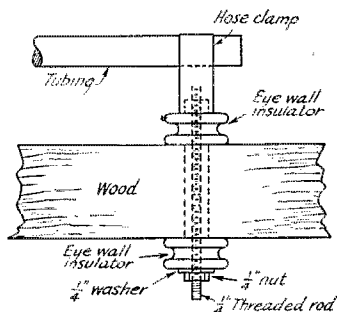

Fig. 2 — Substitute for stand-off insulators in mounting rotatable antenna elements which provides greater mechanical strength.

Two legs of the tower were placed against the front posts and the tower walked or pulled up. The tower was then moved sideways until all four legs were tight against their respective posts, holes were drilled and bolts made fast. This eliminated the use of shims and prevents strain on the tower which is often the case when all slots are parallel and the tower doesn't exactly fit. The only shims necessary may be under one leg to get the tower to stand exactly vertical. Towers of reasonable height will need no guy wires when anchored by this method.

— Robert E. Foltz, W9GBT

INSULATED MOUNTING FOR ROTATABLE ANTENNA ELEMENTS

For those fellows making rotary beams and using 3/4-inch or 1-inch diameter tubing for elements, here is a suggestion for supporting that is stronger than the use of stand-off insulators. (See Fig. 2.)

The hose clamp (stainless steel strap that fits around tubing) can be obtained from Wittek Manufacturing Company, Chicago, at a cost of five cents each. Order them without the wing bolt, style No. 3.

The porcelain eye wall insulators sell for about two cents each at most radio supply houses. Remove the galvanized screw with a heavy screwdriver.

The porcelain tubes cost about 21 1/2 cents for 6-inch lengths. Nick each of them with a file and insert in the wood framework (5/16-inch diameter hole) then break. You will get a clean square break this way and it's a lot easier than sawing.

A threaded rod 1/4-inch diameter completes the assembly with a standard 1/4-inch washer and 1/4-inch square nut carried at all hardware stores. The length of threaded rod depends on the thickness of the wood.

This procedure results in a good substantial mounting, well insulated and a lot stronger than stand-offs.

— Edward E. Schultz, Jr., W9UHA

SIMPLE LINE-VOLTAGE CONTROL

The dodge of using a spare filament transformer as an auto-transformer for compensating for variations in line voltage has often been suggested but apparently has never gained the popularity it deserves. While a primary rheostat gives a smooth control if the line voltage is always sufficiently high, the auto-transformer has the advantage of being able to take care of wide variations above and below the normal line voltage. For example, a 10-volt filament transformer used as an auto-transformer will take care of a 10-volt variation either side of the normal line-voltage value.

In order to facilitate adjustment, a simple switching system can be used, as is shown in Fig. 3. The switch can be any double-pole five-position job that isn't too flimsy. Any of the better switches should do the trick nicely. The transformer can be any spare filament transformer — we use an old 7 1/2-volt one but plan to scare up a 10-volt one for slightly more range of control. The voltage is controlled in steps equal to half of the secondary voltage of the transformer used.

The output side of the auto-transformer runs to the primaries of all the filament transformers in

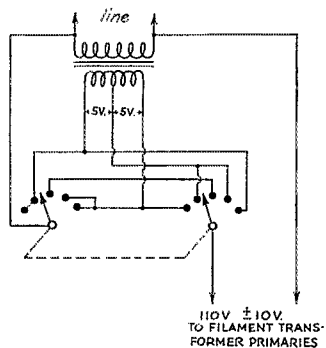

Fig. 3 — Circuit for line-voltage control by means of center-tapped filament transformer.

the transmitter. The primaries are adjusted, by means of their primary taps, so that all of the transformers give the proper secondary voltage at the same value of primary voltage. Then, with a filament voltmeter across one filament winding, the primary voltage is adjusted, by the auto-transformer, until the voltmeter reads the correct voltage, and all of the filament voltages throughout the rig will be correct. Any deviation from normal, due to line voltage change, can then be corrected by the switch on the auto-transformer.

— W1JPE



CORRESPONDENCE FROM MEMBERS

The Publishers of *QST* assume no responsibility for statements made herein by correspondents.

F.C.C. SUPPORT

1016 W. Rockland St., Philadelphia, Pa.
Editor, *QST*:

In the August issue of *QST* W5BQD says: "Maybe if the Federal Communications Commission of the United States were made up of engineers and technicians, and not of men who were given the jobs as political favors, allotments would be made which would be more favorable to everybody concerned."

I would like to take strong issue with this statement, not on the ground of politics in the F.C.C. — about which I know nothing — but on what this organization has done and will (I hope!) continue to do for us. One thing I do know: politics or no, the personnel of the F.C.C. is technically capable and make surprisingly few mistakes, considering the magnitude of their task. A parallel between the A.R.R.L.-F.C.C. liaison, with all its democratic implications, can be found nowhere else in the amateur world. Does it not occur to W5BQD that if frequency allotments today are in such an international mess, this is in spite of, not because of, the F.C.C.? Read up on some of KBW's past conference articles, OM, and see if you don't come to the same conclusion.

I think it is deplorable that an American amateur could be so shortsighted as to indict the only governmental radio agency which has supported amateur radio so unstintedly.

— Louis Seltzer, W3CQG

GROUNDING MICROPHONES

713 St. Louis Ave., East St. Louis, Ill.
Editor, *QST*:

For the second time *QST* reports the death of an amateur by electrocution while grasping a metal microphone stand in one hand forming the ground connection of the fatal circuit.

Why a microphone should ever be built with a metal handle or stand is a mystery, and it seems to me that A.R.R.L. should start a "Switch to Insulated Mike Handles" campaign.

I do not use 'phone at W9DZG, but you can bet your pet crystal that if I did there would be no metal-handled microphones in the equipment.

Another foolish amateur construction practice is the building of high-voltage power supplies on metal chassis. Mine are all built on good old paraffin-soaked wood boxes, thereby eliminating one source of shorts and shocks.

— Earl R. Linder, W9DZG

EDITOR'S NOTE — W9DZG overlooks the point that had W9VYU's microphone and speech amplifier actually been grounded, this fatality could not have occurred. On the other hand, W6NVE's death can much more logically be blamed on the exposed high-voltage terminal than the grounded microphone stand. Re-read the A.R.R.L. Safety Code for transmitter construction (page 20, March 1939 *QST*).

RADIO FOR TRISTAN DA CUNHA

4738 Kenmore Ave., Chicago, Ill.

Editor, *QST*:

In the July issue of *QST* on page 54 you mention what W8IKE found at Tristan da Cunha.

As a member of the A.R.R.L. and the National Geographic Society, I would direct your attention to a most illuminating article on "Tristan da Cunha, Isle of Contentment," in the November, 1938 issue [of the *National Geographic Magazine*] beginning on page 671. . . .

Wouldn't it be a most glorious undertaking for the A.R.R.L., in coöperation with our English brethren or members who are able to donate what equipment they no longer need, utilize the waterfalls for power and provide these inhabitants with some contact with the outside world? And naturally some operator could be found who would spend some time there to see that the equipment is installed and someone instructed how to operate it.

These same waterfalls could be utilized to provide much in modern comforts, too.

In the event that some expedition can be worked out you can call on me for my donation towards helping provide ZD9 with radio.

— J. M. Trittenbach

INFORMATION SERVICE

U. S. Naval Communication Service
Radio Station, Peiping, China

Editor, *QST*:

We have recently noticed many complaints from our fellow brass pounders regarding difficulties encountered in adjusting their speed keys. This same situation arose not long ago at NPP. One of our operators, after several weeks of intensive research, submitted the following report. It was not quite complete but the Chief's reply cleared up the weak points.

"Dear Chief:

"In working over one of the numerous 'beetles' in the station the other evening, I found that the dot alignment was somewhat askew. I took the bug to the armorer and had him

(Continued on page 122)



OPERATING NEWS



F. E. HANDY, W1BDI, Communications Mgr.

E. L. BATTEY, W1UE, Asst. Communications Mgr.,

6:30-8:00 P.M., local time, daily, is known as the *General Traffic Hour*. In this period Official Relay Station appointees (and those OPS with a traffic interest, too) work general with all amateurs and each other for exchange of traffic. Likewise, one member of all League Section Nets and Trunk Lines is encouraged to spend this time in general radio operating outside-the-schedules to help you fellows who do *not* specialize in traffic work in getting your messages on or off the recognized traffic lanes. Elsewhere in these columns we list the calls of stations that will be looking at this hour for any messages *you* want to send to a brother amateur — and those listed will be supplemented on the air by hundreds of others on the nights they are able to keep the same period. These fellows have asked us to list them, since they are starting regular observations and operating at this period, for this season, for your special benefit and to speed up traffic results, effective September first.

This is to suggest that you patronize them and use the General Traffic Period. Give any station identifying itself as a “reliable” by the sine “ORS” after its call, your traffic. If you never have sent an amateur radiogram, you have been missing a big slice of your amateur radio. Messages are tangible, recorded communications, that go places for you and say things. You don’t have to shift frequency, or wait for conditions to be right for DX to send an amateur radiogram. Messages not only carry greetings, they ask questions, bring answers, carry a warmth of fraternal spirit or unexpected and interesting information to and from the uncounted individual locations on our continent. It’s great fun to send a message, and everybody enjoys getting one. Likewise, it’s sport to become proficient handling them. It’s efficient operating to keep up a real amateur correspondence *by* radio. Every ham can be considered a greenhorn or neophyte who lacks something of the full breadth of amateur radio accomplishment who hasn’t yet sent and received his own message with his own hand. All of us should not only know how — but know how to do it *right*, as set forth in an entire section of the Handbook. Yes, it’s *that* important. So this is to suggest that you use this branch of amateur radio — which takes as much skill to do right (some say more) as getting a new DX country or landing a rag chew instead of merely a “formula minded” ham who thinks the report the beginning and end of a QSO. We’re confident that this

September is the beginning of a big year in all branches of ham radio, and especially in the traffic field. If you look into the matter of sending some messages so you’ll have the thrill of getting answers, directed by radio to you personally, we think you should experience a *new* brand of satisfaction. To the chap who isn’t a dyed in the wool traffic expert (or to one who is) we commend the General Traffic Hour. Give your messages to those who sign “ORS” or “TLS” in this period even after you get reliable skeds of your own. Add to your amateur experience and fun by starting some traffic. Keep your SCM informed of your results.

Checking our frequencies regularly was the subject brought up by a July editorial. W4PEI (T.L. “C”) agrees that it’s highly desirable practice, that concluding suggestion for keeping records to *prove* that *regular frequency checks have been made*. And regular procedure in checking frequency is an F.C.C. requirement under Sec. 152.44 of amateur service regulations, you know.

He says his logging of the frequency check is no trouble, and takes just a line of his log, after the date as he opens up each operating session. *To back up your frequency check just be sure that you HAVE a log entry to correspond to it. Don’t just slam in another rock or twist the e.c.o., tune for load, and take off without even a preliminary listen over the band, — and don’t think you must spend a half hour with a precision meter either, unless you’re a band edge hair-splitter, which isn’t necessary to good success any more and in fact has been going out of fashion as the e.c.o. came along.* W4PEI points to his system of making honest checks, and logging each of ‘em, as responsible for his record of nine years of operation without a citation, a record any active amateur might be proud of. Typical lines from his log (to stave off questions) read:

7.01 p.m. Test and check on 3875 kc. for Fla. A.A.R.S Net.
7.45 p.m. QSY, test and check on 3790 kc. for T.L. “C.”

It is sound reasoning, to see that we make log entries to cover our “regular frequency checks,” and elsewhere (no repetition in log called for) have noted down the calibration dates and sources for our frequency standard, with notation of what our checking procedure entails. Yes, indeed, the fact that top-notch hams now log frequency checks is Operating News. According to some logs

we have seen it *would be news* to see an entry about Frequency Check . . . or wouldn't it?

Don't Miss the u.h.f. Field Day and Relay. The dates are September 9th and 10th! Which u.h.f. bands is up to you. Which test relay will go farthest in a straight line from its starting point, in the time allotted? Who will put one over the biggest hop? How many stations can be worked?

This relay is going to answer a lot of questions. Last year these bands were open for DX as late as November and December. We have no doubt, with consistent occupancy that we can go places on u.h.f. the year 'round. The possibility of DX relaying is mighty intriguing. The stations that do the best work in this may be selected as starting or focal points for some later record-breaking u.h.f. cross country relays. Note the high volume of u.h.f. success featured in a half dozen page report in August *QST*, and you cannot fail to be impressed with the great possibilities of this Field Day and Relay. You can find us on the low-frequency bands a lot of the time but, like others who will read this notice, we're dusting off the u.h.f. gear and expect to have a barrel of fun in this Field Day, even if we are a bit wistful and think it would be better way "out in the sticks." As we see it, in the Midwest, stations are fewer and farther between, and our chance at being kept usefully busy at a relay crossroads would be greater there. The privilege of picking a field spot is ours to exercise, in our own neighborhood, however. See the announcement elsewhere in this issue — and c.u. there.

— F. E. H.

HAMFEST SCHEDULE

September 2d and 3d, at Alexandria, La.: The Red River Radio Club will hold a hamfest at Camp Beauregard Club, Camp Beauregard, Alexandria, La., on September 2d and 3d. Registration fee: \$1.50 for men, \$1.00 for ladies, at the door. Preregistration: \$1.25 for men, \$1.00 for ladies. Further information available from E. F. Pinar, W5GUX, Camp Beauregard, Louisiana.

September 4th, at Marquette County Park, Mich.: The Hiawatha Radio Association will hold its first outing and hamfest on Monday, September 4th, 10:00 A.M. to 3:00 P.M. The place — Champion Beach, Marquette County Park, twenty miles west of Ishpeming, Mich., on U. S. Route 41. Plenty of good prizes, eats and a good time in store for all. Admission — 50¢ per person. Everybody welcome — OM's, YF's, YL's, hams-to-be, etc.

September 24th, at Fairfax, Calif.: The Marin Radio Amateurs will hold their annual hamfest and picnic at Deerpark Meadows, Fairfax, Marin County, Calif. Signs will be posted to aid in locating the site. A softball tournament will be held plus various novelty races for both OM's and ladies. Portable equipment, including a gasoline-powered generator will be on hand. The nominal charge of 50¢ will include chance at preregistration prize of a pair of 75T's . . . also many other prizes. Bring the whole family, and don't forget the lunch!

October 14th, at Boston, Mass.: The annual Boston Hamfest will be held Saturday, October 14th, at the Hotel Bradford, under the auspices of the South Shore Amateur Radio Club and the Eastern Massachusetts Amateur Radio Association. Plan now to be on hand for this FB all-day affair, which has the kind of reputation that draws hams by the hundreds each year.

PRIZES FOR BEST ARTICLE

The article by Mr. W. T. Cushing, WICFU,* wins the C.D. article contest prize this month. Each month we print the most interesting and valuable article received marked "for the C.D. contest." Contributions may be on any phase of amateur operating or communication activity (DX, 'phone, traffic, rag-chewing, clubs, fraternalism, etc.) which adds constructively to amateur organization work. Prize winners may select a 1939 bound *Handbook, QST*, Binder and League Emblem, six logs, eight pads radiogram blanks, DX Map and three pads or any other combination of A.R.R.L. supplies of equivalent value. Try your luck. Send your contribution to-day!

Reduce QRM—Use Break-In

BY W. T. CUSHING, WICFU*

"SORRY, OM, only the first part of that transmission OK, QRM very bad." Certainly we have heard that stock amateur radio phrase before, and probably will continue to for some time. Signal interference seems to be the chief inherent weakness of radio communication as we amateurs know it, and consequently long and weighty discourses have been devoted to it, especially regarding its control. We have introduced into our art the more highly selective receiver, first the tuned r.f. receiver, then the superhet with a crystal filter circuit; concerning our transmitters we have done away with self-excited r.c. rigs and in their place have substituted the crystal-controlled jobs. Even more recently the electron-coupled oscillator has been used as a means of procuring rapid frequency change-over to take advantage of the "holes" in the bands. Of course we know that this particular type of rig can create an exactly opposite result concerning the doing away with interference if its use is abused.

In short, QRM has been, is, and no doubt will continue to be our chief bugaboo. It is a phase of amateur radio in which every operator is vitally interested. It can probably be said that up to the last two or three years engineering improvements have kept pace with the steady influx of new stations, but there now seems to arise the question of whether or not we haven't fallen a bit behind. Just listen to 7 Mc. any night and give 14 Mc. a try, too. Listen to the comments concerning QRM, and then work a few of the boys and see how few 100% contacts can be obtained. Or better yet, see how many contacts you can make and get 50% of what the other fellow is saying.

Now in the first place, there is nothing new about using break-in. It is an admitted fact that more stations are equipped for break-in operation now than ever before, but you don't have to do much operating to be convinced that a large percentage are still using the old "blind" method of sending for a while and then telling the other fellow to go ahead, with a hope and a prayer that he received everything of our last transmission or enough at least to get the gist of what was said. Now that isn't smart operating. In fact it isn't even good operating. There isn't any station that wouldn't be better for the installation of a break-in system.

A lot of fellows stall on the word "installation." They picture it as just such with new equipment needed. Break-in to them signifies a bunch of expensive relays, separate bias supplies, operating all stages of the transmitter at cutoff with consequently greater driving power needed, and so on. It can be just that, but the big thing of it is — it doesn't have to be. If you are really interested, turn back to your *QST* for the month of February, 1936. There on pages 58 and 59 of the Experimenter's Section is a diagram with an accompanying article entitled, "Oscillator Keying with Grid Leak Bias

* 536 Walnut St., Newtonville, Mass.

on Amplifiers." Mr. L. V. Blake, W5FFZ, the author, has an excellent idea there which makes break-in operation just about as simple and inexpensive as our most thrifty operator could desire. Briefly the oscillator power supply is used not only to supply power to the oscillator but to bias the amplifier stage or stages to cutoff when the key is open. For the average installation the time required to change over to this system would not be in excess of two or three minutes. Even better — no extra equipment is needed. The only requirements are that a separate power supply is now in use for the oscillator and that the voltage from this supply is sufficient to bias the following stages to the cutoff point. It works very well here at W1CFU, which puts out a 135-watt signal on 14, 7 and 3.5 Mc. To be more specific, the voltage on the amplifier runs around 1150 and the oscillator power supply delivers but 220 volts. This break-in system works perfectly, appears to be foolproof, and is certainly simple enough.

Let us examine the advantages of break-in operation. First of all, it allows the operator a vastly greater amount of control. He is listening while transmitting instead of using the old-fashioned method of turning off the receiver when he turns on the transmitter. Incidentally, in the circuit just described, the receiver is left on all the time. No antenna relay is needed, provided of course a separate receiving antenna is used. On modern-day superhets and even on the tuned r.f. receivers as well, especially on the higher frequencies, only the shortest of pick-up wires is needed. On superhets it is necessary to keep the automatic volume-control switch in the off position. Headphones greatly reduce the key clicking effect heard through the receiver. If loudspeaker operation is desired relays will, most likely, be needed. Let us examine further the advantageous features of break-in. We will allow that such operation is practically indispensable in the handling of traffic. But what about the operator who spends his time with lengthy rag-chewing or going after that elusive DX? It is surprising how much more personal a contact can become if break-in is employed. The 'phone brethren speak highly of the more personal effect obtained in their type of transmissions. They speak of how much more they can say within a given time and what not. Not only does the use of break-in give the C.W. operator a contact with a more conversational characteristic but it speeds up the whole thing as well. Certainly when we converse with a friend we don't do all the talking for two minutes and then let him go to it for two minutes. We don't ask a fellow five questions in a row and then expect to receive five answers. Intelligent radio operation would forbid the same practise.

Break-in eliminates useless calling. If the other station comes back to some one else that fact is immediately made known. If interference erases a word or two the transmitting operator is made aware of this at once, and can be advised to fill in the missing words or can be told to QRX or to QSV while the receiving operator retunes the signal. And of course you will get a bigger "kick" out of this kind of operating. It is more business-like; it stamps the operator using it as being more advanced, more highly skilled. I don't think there are *disadvantages*. Even DX signals are oftentimes of sufficient volume to permit the use of break-in.

If you want to hear some real operating of this type listen on 24 or 36 meters to WCC or to any of the coastal stations where it is normal practise to work three or four ships at the same time on the same band. Our operating technique must keep pace with our engineering improvements. They both must be up to par to afford us the maximum protection against our principal enemy — interference. Give it a try. Not only will you derive a great deal more pleasure from your contacts but you will actually be doing more communicating with less brass pounding due to the absence of useless calling, futile transmissions with entire repeats necessary and a multitude of other operating evils. While not all of us may wish to associate our hobby with its commercial aspect, nevertheless the chief distinction is in operating techniques. Commercial radio finds break-in an absolute necessity. Certainly we aim to match our commercial brethren in engineering skill. Let's not lag too far behind in our operating standards.

W1AW Operating Schedule

OPERATING-VISITING HOURS

3:00 P.M.—3:00 A.M. E.D.S.T. daily, except Saturday-Sunday, effective September 10, 1939.
 Saturday — 8:30 P.M.—2:30 A.M. E.D.S.T.
 Sunday — 7:00 P.M.—1:00 A.M. E.D.S.T.
OFFICIAL BROADCAST SCHEDULE (for sending addressed information to all radio amateurs).

Frequencies

C.W.: 1762.5-3800-7280-14,254-28,600 kcs. (simultaneously)

	Starting Times (P.M.)				Speeds (W.P.M.)						
E.D.S.T.*	C.D.S.T.	M.D.S.T.	P.D.S.T.	M	T	W	Th	F	Sat	Sun	
8:30	7:30	6:30	5:30	20	15	25	15	20	—	20	
Midnight	11:00	10:00	9:00	15	25	15	20	15	15	—	

PHONE: 1806, 3950.5, 14,237, 28,600 kcs.

Each code transmission will be followed in turn by voice transmission on each of the above frequencies.

GENERAL OPERATION: Effective¹ Sept. 10, 1939

Besides specific schedules in different bands, W1AW devotes the following periods, except Saturdays and Sundays, to GENERAL work in the following bands:

Band	Frequency	Time — Eastern Daylight*
1.8 Mc.	1806-1762.5-kc. 'phone/c.w.	11:00-11:30 P.M.
3.5 Mc.	3800-kc. c.w.	{ 1:30- 2:00 A.M. 8:00- 8:30 P.M.
3.9 Mc.	3950.5-kc. 'phone	9:30-10:00 P.M.
7 Mc.	7152/7280-kc. c.w.	{ 2:00- 3:00 A.M. 6:30- 7:00 P.M.
14 Mc.	14,254-kc. c.w.	{ 10:30-11:00 P.M. 11:30-11:59 P.M.
14 Mc.	14,237-kc. 'phone	{ 10:00-10:30 P.M. 6:00- 6:30 P.M.
28 Mc.	28,600-kc. 'phone/c.w.	

At other times, and on Saturdays and Sundays, operation is devoted to the most profitable use of bands for general contacts and to participation in special week-end operating activities. The station is not operated on legal national holidays.

Give W1AW a call for an accurate frequency measurement, to communicate with any department of A.R.R.L., to rag-chew when time permits, or to pass a message to ham friends in other places or on other bands.

¹ See July QST for summer schedule.
 * On and after Sept. 24, 1939, this column becomes E.S.T. and each actual transmission is one hour earlier.

— — —

F.C.C. Disciplinary Actions

On July 26, 1939, the Federal Communications Commission took the following action:

Adopted Order suspending amateur radio operator license with Class "A" privileges of Elgin Lyle Thrapp, W6BEX, Wilmington, Calif., for a period of six months, because said licensee impersonated one of the Commission's Field Officers in an attempt to obtain an amateur radio operator station license by fraudulent means.

Adopted Order suspending amateur radio operator license with Class "A" privileges of Raymond T. Lange, W8ICQ, Piqua, Ohio, for a period of two months, because said licensee while operating his amateur radio station transmitted obscene, indecent and profane language in violation of Sec. 326 of the Communications Act as amended.

— — —

O.B.S.

The following is a supplement to the list of A.R.R.L. Official Broadcasting Stations in October QST (page 71):
 W1GAG, W3CFS, W3HOY, W4FJR, W6NQB, W8FGV, W8RBD, W8SWF.

GUARANTEED TRAFFIC SERVICE

All Official Relay Stations endeavor to keep the "General Traffic Hour" — 6:30-8:00 P.M. (your local time) — to facilitate the movement of traffic from operators who are unable to maintain regular schedules or whose operating time is limited. Effective September 1st, the following listed O.R.S. guarantee to be on during this special period.

Station and Location	Frequencies	Days
VE3EF, New Toronto, Ont.	3762-ke.	Daily
W1AJ, Turners Falls, Mass.	7224, 7176, 7006	
W1KIN, Hudson, N. H.		Mon., Thurs., Fri.
W1TD, West Haven, Conn.	3.5-Mc. band	Mon., Wed., Fri.
W2ISF, Pt. Pleasant, N. J.	3725-ke.	Mon. thru Fri.
W2LEL, Marlboro, N. Y.	7038-ke.	
W3HCT, Womelsdorf, Pa.		Daily exc. Sat. & Sun.
W3IAY, Harrisburg, Pa.		Daily
W5HJF, Portales, New Mex.		Daily exc. Mon.
W6NQB, San Francisco, Calif.	3782-ke.	Daily
W6PGB, San Francisco, Calif.	7043-ke.	Mon. thru Fri.
W6PMV, Los Angeles, Calif.		
W7HAD, Port Orchard, Wash.		Daily exc. Sat.
W8EU, Wapwallopen, Pa.	3553-ke.	Sat. & Sun.
W8GVX, Trinway, Ohio	3645, 3710, 3775	Sat. & Sun.
W8KNP, Pontiac, Mich.		
W8NAB, Bellefontaine, Ohio		Daily exc. Sun.
W8TAQ, Cincinnati, Ohio	3510-ke.	Odd dates of month (exc. Sun.)
	3810-ke.	Even dates of month (exc. Sun.)
W9NCS, Minneapolis, Minn.	3.5-, 7-, 14-Mc. bands	Daily exc. Sun.
W9WVZ, Marshall Pass, Colo.	7018, 7133, 7170, 7231, 14319, 14340, 3810, 3876, 3554.5 kes.	Daily
W9YXH, Sparta, Wis.		Tues. & Thurs.

These and other O.R.S. connect with the various A.R.R.L. Trunk Lines and the numerous A.R.R.L. and A.A.R.S. Traffic Nets. USE THE GENERAL TRAFFIC HOUR and route your traffic through stations signing "ORS." Remember the time — 6:30-8:00 P.M. (your local time).

W9THS, Communications Platoon, Headquarters Troop First Cavalry, Fort Knox, Ky., will remain active during the summer months and is anxious to arrange schedules for traffic handling. Fourteen operators are available and schedules can be maintained at almost any time of the day or night. W9THS runs 450 watts input on 3516, 3810, 7032, 7023, 7180, 14,064 and 14,360 kes. Here is a chance to get in on some good summer traffic work.

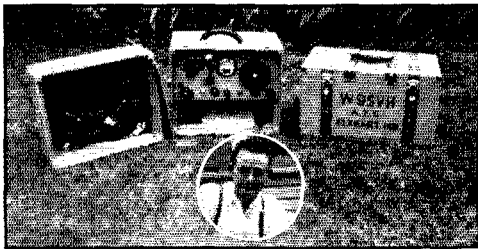

A COMPLETE EMERGENCY STATION

J. P. Gilliam, W9SVH, in line with his emergency preparedness program as A.R.R.L. Emergency Co-ordinator, Elkhart, Indiana, has constructed these readily portable units, which were used successfully in the June Field Day. The case in the center contains transmitter, receiver, key, two pairs of pliers, two screw drivers, neon tuning lamp, spare crystals and message blanks. The lid to this case (at left) contains antenna and

Brass Pounders' League

(June 16th-July 15th)

Call	Orig.	Del.	Rel.	Extra Del. Credit	Total
W9QIL	204	260	696	253	1413
W3EML	86	263	736	259	1344
W6IOX	10	39	844	31	927
W5BN	373	76	184	184	817
W8SBV	7	2	806	2	817
W6DH	67	116	504	109	796
W6QCX	590	140	0	50	780
W4PL	6	30	628	29	693
W3BWT	42	101	392	85	620
W6LLW	21	51	530	9	611
W9LCT	128	64	372	43	607
W6PCP	52	108	398	125	593
W6GPF	133	250	0	200	583
W6PZM	160	229	0	174	563
W2JZX	8	45	227	272	552
W6LUJ	105	120	174	113	512
W6KHZ	3	7	488	7	505

MORE-THAN-ONE OPERATOR STATIONS

Call	Orig.	Del.	Rel.	Extra Del. Credit	Total
W5OW	153	150	720	126	1149
K1IHR	60	357	88	357	862
K5AA	396	80	42	65	583
W8USA	520	4	18	2	544

These stations "make" the B.P.L. with total of 500 or over. One hundred deliveries + Ex. Del. Credits also rate B.P.L. standing. The following one-operator stations make the B.P.L. on deliveries. Deliveries count.

W7AJU/K7, 230	W6NLL, 185 *	W1KH, 114
W5DKR, 219	W3QP, 179	W6PGB, 104
W7APS, 217	W2CGG, 148	More-than-one-opr.
W6NLL, 214	W2KWG, 131	W3ELN, 165
W7GP, 198	W5DAQ, 131	W1AW, 119
W8ASW, 194	W6MFH, 125	

A.A.R.S.

WLTK (W9UHQ) made the B.P.L. on 189 deliveries.

MORE-THAN-ONE OPERATOR STATIONS

Call	Orig.	Del.	Rel.	Extra Del. Credit	Total
WLM (W3CXL)	119	112	2198	74	2503

A total of 500 or more or 100 deliveries Ex. D. Cr. will put you in line for a place in the B.P.L.

* May-June.

insulators, ground wire, connector cables, halyard rope, headphones and logbook. The thin piece of masonite between the lid and case fits in the lid and protects the front of the transmitter from damage from the parts carried in the lid. The transmitter consists of a 6C5 Pierce oscillator and 6L6G amplifier. The receiver is the QST e.c. detector and audio, 6C6-76.

The case at the right contains a vibrator power supply, delivering 300 volts at 100 mills, and a 6 volt, 120 ampere hour storage battery. The ground rod in three sections is also carried in the lid of the box. The vibrator power supply is built around a Thordarson transformer having a 110 volt a.c. and 6 volt vibrator primary. Primary switching is done in the primary connector cable. This power supply is used regularly on 110 volts a.c.

The cases, both built by Coördinator Gilliam, are constructed throughout of 1/4" 3 ply veneer, with 1/2" square corner strips, glued (casein glue to resist moisture), and screwed together. Note the reinforcing bands on the power supply case. The case hardware was purchased at a total cost of about \$1.25, and can be bought from any large hardware or trunk store. W9SVH points out that one secret of making lids fit cases is to make the case in one piece and then saw it open at the desired point.

How's DX?

HOW:

SOME TIME back we suggested a DX expedition to some of the countries where there are no active amateurs, to be financed by amateurs interested in working those countries. We secured enough moral (but not financial) backing to believe that maybe we had something but, like 28-Mc. c.w., it died a lingering but complete death. However, W8DZC pops in with a more practical slant and proves, with a 14-page tome of involved calculations, how it would be cheaper in the long run to finance an expedition to pick up the cards due us by some of the non-QSL-ing DX stations. The plan would involve volunteers from among the DX gang that weigh over 200 pounds, or are over 6 foot 2, or both. Let's see — 22 IRC coupons per station, postage, return envelopes, time, mental strain, etc. — yes, it looks like a smart investment.

In keeping with our policy of disclosing the latest operating secrets, we have the very latest, recounted by W9FS. No. Bert didn't invent it — that credit goes to the W5 who uses it so well — but he was noble enough to pass it along to the milling mob. This new system is known in the inner circles as the "Hit and Slide" approach and simply consists of the W5 sliding outside the band to greet the DX and then not signing his own call until he slowly slides back inside, drawing the naïve DX with him. It works quite well.



A couple of well-known DX stations: I1KN at the top and U2NE at the bottom. No dope on U2NE, but I1KN uses a 6L6G Tri-tet or e.c.o. to drive parallel 6L6G's in the final. An 802 doubler is used to get to 28 Mc. The receiver is a home-made s.s. super, and DX is 14- and 28-Mc. c.w. WAC and 14-Mc. 'phone WAC — 109 countries worked.

as the results testify, and we see no reason why it shouldn't continue to work until he fills on his quota of pink tickets. Like we heard W. C. Fields say once, "What won't they think of next?"

WHERE:

By now that little junket of HB9CE's to Liechtenstein is history, but what history! We can remember some experiences with wolf packs (like the time that blonde Russian gal showed up alone at the swimming pool), but they were nothing compared to the mob that descended on HBICE. Anyhow, we think it was swell of him to get permission and go over there just to give the gang a chance. Let's hope they don't start hounding him for cards—the little pasteboards will come through as quickly as he can get them off As a matter of fact, we don't know but whether we should keep this next item to ourself, on account of the way some of you acted over poor HBICE. But then that might not be fair to the 18% who use e.c.o.'s properly, so here goes. LA6U writes to say that he will soon be operating from Jan Mayen with the call LB6U. As soon as we get some dope on frequency, etc., we'll pass it along. The rub is that, when you do work him, you'll have to wait until next summer for a card, on account of the lack of mail service. That should teach a few certain individuals a bit of patience. (Jeeves, I don't want any bicarbonate!)

FG8AH (7150) tells us that FG8AA was most certainly a phoney and that 8AH has never been on 20 W9AKJ gives the address of CP1ANE (14,270 T9x) as Ray Hoover, Lloyds Aero Boliviana, Cochamba, Bolivia You may have heard BE1AA (14,420 T9c), or even worked him, some time between 10 p.m. and midnight, EST. In case you're worried about him, he's a pal of YV2CU, in the same country, sends us QSO lists and gets his cards from you via us only, please. He's weak, running only a single TGTP 45 with 300 volts on the anode Speaking of undercover fellows, we can QSP cards for you to PJ1LR (14,365 T8). He QSL's W4DWU passes along the story that V14AXE-V14W (7418) says he is VS5AD and will be at N.Y.C. for the Fair (the New York one, not the San Francisco (adv.) one) some time during August. Well, he might be in New York during August, but we don't believe there's any VS5AD W4CEN drops in with the good word that there is a legit LX on c.w.; LX1RB (14,325 T6), on around midnight. He QSL's, too. Tom thinks that CR6AF (14,210), who comes through around 3:30 p.m., if you can dig him out from under the 'phones, is old CR6AI. But W9VDQ doesn't think so, because 6AF gave his address as Jose de Mello, Coembo, Angola. He listens around 14,250 W6PCP heard ZC3A (7250), but he hasn't any dope on the guy A bunch of the Bergen County boys, including W2GT, W2GVZ and W2BHW, worked VS9BC (14,355 T9) one evening around 6. He gives his address as Bob Hawkins, P. O. Box 273, Aden. He's worth keeping one's fingers crossed for, until the postman turns in the verdict W2GT had another; FF3Q (14,410 T9), who gave his address as Martin, 14 Ave. Foch, Dakar. Could be W2GVZ' latest worry is X11AA (14,415 T9). We haven't a thing on him, except a vague recollection that BE1AA used that call once or twice. We're probably wrong, of course, like the time we thought that filter condenser wasn't charged W5HQN picked up a ZD9F (14,415) and W9FWS a ZD3F (14,425), but we're verra suspicious about the whole thing W1KHE says EA4BG (14,350 T7) says ham radio is going great guns over there now. We're glad, and hope to see them all back on shortly.

WHEN:

SEVERAL have suggested that we give the time that some of the better stations come through. We'd like

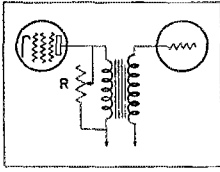

THE VIRTUES of limiting the range of speech amplifiers used in amateur work have been pointed out many times. Telephones have a range of approximately 400 cycles to 2200 cycles, and this is enough for good speech intelligibility. Frequencies above 2200 widen the sidebands and cause unnecessary interference. On the other hand, so much of the power in a voice signal is in the frequencies below 400 cycles that it is possible to maintain a much higher level of "effective modulation" when these frequencies are rejected. This is why a carrier modulated with a narrow range of frequencies will often get through under conditions where a high-fidelity signal is not readable. At the other end, the use of a narrow range amplifier in the receiver reduces background noise.

However, most amateurs want their amplifiers to be capable of high fidelity, if only as a matter of pride. This fact, together with the difficulty of getting a suitable filter, is probably why narrow range amplifiers are not more common. The details of a very simple variable range amplifier are given on this page. When set for high-fidelity, the stage gain is uniform within 2 db from 20 to 15,000 cycles, yet the range can be narrowed down to cover just the speech frequencies with high attenuation of hum frequencies.

The circuit is a conventional transformer-coupled audio stage, except that it uses a pentode instead of a triode. The transformer is a standard unit of good quality, designed to work out of a 10,000 ohm plate. The 6J7 pentode has a 1 megohm plate resistance, but with a 10,000 ohm resistor shunted across the primary, the transformer acts just as it would with a suitable triode, and provides true high-fidelity. However, with the damping action of the resistor removed, the natural resonance of the transformer shows up, with maximum response in the speech frequencies. Curves are shown below for these conditions, as well as for intermediate values of shunting resistance.

Using the 10,000 ohm resistor, the gain is normal (about 28). With no shunting resistance the gain is over 200. If constant amplification is desired, it will be necessary to gang a volume control to the response control. However, for many purposes the change in gain is all to the good. When used as a high-fidelity amplifier, the input signal would probably be fairly strong (such as a phonograph pick-up) so that not much gain would be needed. As a speech amplifier, it would probably work out of a microphone, with high gain necessary.

There is almost complete cut-off at 60 cycles when set for narrow range. This helps so much with the hum problem that it is probably less trouble to use this circuit than not. Of course, it is possible to eliminate hum from a speech amplifier (witness the National NSA!) but anyone who has tried to build one knows what a job it is.

JACK IVERS

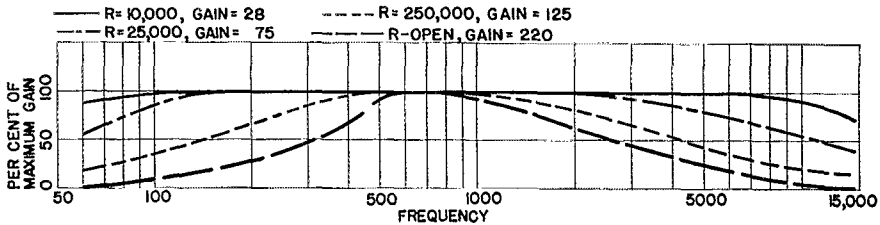

New Convenience, Simplicity and Economy

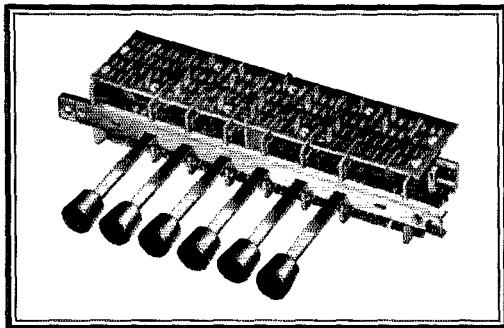

Yours with MALLORY-YAXLEY Push Button Switches

When it comes to constructing and operating radio test equipment, these Mallory-Yaxley Type 2190 non-shorting switches reach a new high in simplicity of application and operation.

Mallory-Yaxley Type 2190 switches make it possible to measure a number of circuits with a single current reading meter. The insertion of the meter in the circuit is accomplished merely by depressing a button. Other circuits connected to the switch remain closed and uninterrupted.

These switches are also suitable for meter switching on low and medium power radio transmitters and public address systems. They afford added safety in the replacement of conventional jack and plug systems.

Send your QSL card for interesting technical bulletin.

P. R. MALLORY & CO., Inc.
INDIANAPOLIS INDIANA
Cable Address—PELMALLO

Use

P. R. MALLORY & CO. Inc.

MALLORY

APPROVED RADIO
PRECISION PRODUCTS

Use

YAXLEY

APPROVED RADIO
PRECISION PRODUCTS

to — that's what this heading was originally intended for — but only a few klick through with that dope. We could use it, particularly on the new and rare stuff.

W6PCP reports good stuff on 40, like KAIHQ (7095), KA9CG (7095), KA3RA (7085), KAIPQ(7085), KA1CO (7000), KA1FS (7095), KB6OCL(7085), KF6QMQ (7300) and lots of VK and ZL W6OAN adds J8CJ (7095), XU8BT (7195), J2PK (7110), J2NB (7110), XU8WM (7010) and J3EK (7090) W9CMY would like some dope on HR4YV (7270) 7-Mc DX isn't only for west coasters — W8ROX worked KB6SIR in Guam the other morning.

G6RH has some nice ones on 20, including YN9G (14,400 T7), W6QQJ (14,350) in Nevada, LZLID (14,405 T8), HP1X (14,350 T7), VS6AF (14,390 T8), VK9XX (14,300 T9) and VK9RM (14,300 T9) W2DSV has a couple: ZC6JW (14,340 T9) and CR4MM (14,410 T8) W9DVQ, old 2AFV, adds MX1A (14,405 T9), CT3AN (14,300 T9x), UK5KA (14,420 T6), UK5KJ (14,425 T5) and U9ML (14,410 T9) W2KUW has a few, like YL2BZ (14,370 T7), FT4AE (14,400 T8) FA3WW (14,360-14,440 T6), KC6BVL (14,360 T9x), who gets on at 3:30 A.M. EST, and YR5ML (14,410 T9) W8LEC grabbed some nice ones: Y1SKR (14,410 T9), VU7BR (14,345 T9), PJ5EE (14,120 T5), XU8MI (14,365 T9), U5YH (14,410 T9), OK3DK (14,320 T9) in Slovakia (not a new country — just part of an old one), and EA3BU (14,370 T5) VK3UM, in a swell letter, tells of HI6O (14,415 T9x), HC1FG (14,415 T9), J8CH (14,360 T8), J6DU (14,340 T9), K6JEG/KF6 (14,385 T9), KA1ER (14,350 T9x), PK4FS (14,340 T9x), VS7RP (14,350 T9x), VU2AE (14,390 T6), XU0RK (14,365 T9x) and J5DC (14,430 T9x) W4BPD, in spite of rebuilding, finds time for ZC6RL (14,360 T8x), KA7EC (14,350 T9x), KB6ILT (14,375 T9x) and FM8AA (14,250 T8x) Latest at W6MZH is HH2MC (14,390 T7), HK4DF (14,020 T9), CE3CB (14,410 T8), VQ2MI (14,350 T9), and heard VRIAJ (14,300) and VQ3HJP (14,400 T8) W3HTG worked UK6WA (14,400 T7) and KB4FCS (14,360 T8), and heard SV1RX (14,400 T8) CM2FA worked LA2X (14,400 T9) and U2NE (14,405 T9), while K4FCV was toying with PK4KO (14,340 T9x) and PK1TT (14,340 T8x) W6OAN winds up the parade with VK9DK (14,285 T9x), PK1TM (14,340 T8x), XU8ZM (14,335 T8), XU6TL (14,310 T9x), VS2AL (14,385 T9x) and XU5YT (14,325 T8).

*PHONE:

Yes, it's like we thought — one brief splurge from the 'phone gang and then back to lethargy, as far as reports go. The only other explanation we can find is that they're so busy working the stuff they don't have time to write, a rumor started by a few c.w. men.

W2KUW kicks through with YN1IP (14,030), HP1A (14,280) and YL2LR (14,400), while W4BPD has EK1AF (14,130) W6IKQ has some nice ones, including FN1C (14,075), IISM (14,050), HB9J (14,010), G15ZY (14,100) and VP5IS (14,080), but threatens to go on c.w. to grab a few more W2LXY reports a QSO with OQ5ZZ (14,350), the Gatti Expedition. She has 98 on 'phone now.

WHO:

WEHAVE a swell letter which, unfortunately is too long to print in its entirety. But it comes from that chap in Surinam whom we've told you about before, and it has to do with public thanks to those who made possible his new rig. It reflects the spirit of a ham that just can't be downed by obstacles and to whom radio means more than some of us can realize. He'll be on soon, under a variety of calls (to escape detection): P2EA, YV1QJ, ZP2SU and PJ2AM, and we'll be glad to forward your cards VP2LC tells us the authorities down there wouldn't let her send out QSL's in packages to the QSL Managers. The cards are on the way, however — we just mention this to show you what some of our foreign friends are up against W2BJ resents the fact that the guy bootlegging his call can't seem to get out of his backyard, if the cards coming in are any indication After reading "Fashions in Antennas," the Frankfort Club is rather proud of the fact that 11 of their members are in the 75-or-over (4 over 100) listing, and none of them has anything much fancier than a 7-Mc.

For Your Finest AUDIO REQUIREMENTS

Tru-Fidelity

by

THORDARSON

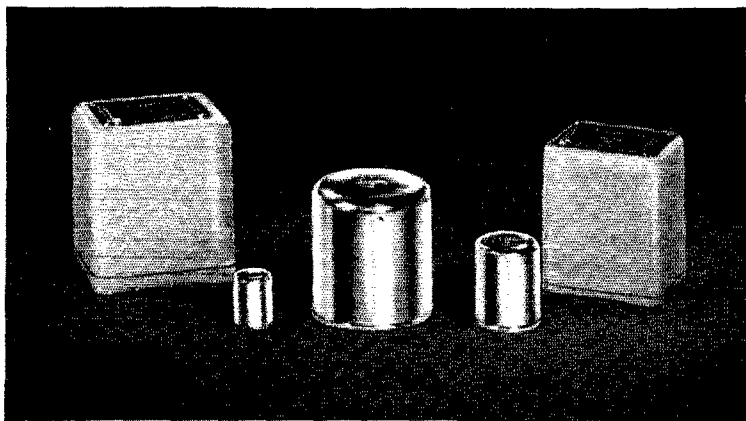

THREE SERIES OF AUDIO TRANSFORMERS "INCHER" — "BANTAM" — "MAJOR"

Each of the three series of Tru-Fidelity audio units is the outcome of months of painstaking research, careful engineering and design, plus rigorous laboratory testing with precision instruments. As a result, each of these series represents a new high in quality.

Tru-Fidelity audio components provide magnetic shielding through both the hum-bucking construction incorporated in the original Tru-Fidelity Series and the use of cast cases or high permeability drawn cases. The tremendous acceptance of these units by broadcast engineers is evidence that for the finest audio requirements it is wise to specify Tru-Fidelity by Thordarson.

For complete information on the full family of Tru-Fidelity by Thordarson see your parts jobber or write factory for free Catalog No. 500-D. In addition to the three audio series, this catalog lists driver transformers, modulation transformers, modulation reactors, plate transformers, current limiting filament transformers, filter reactors and voltage regulators.

THORDARSON ELECTRIC MFG. CO.

500 W. HURON ST., CHICAGO, ILL.

Demand "Power by Thordarson"

Efficiency Plus

CARDWELL QUALITY

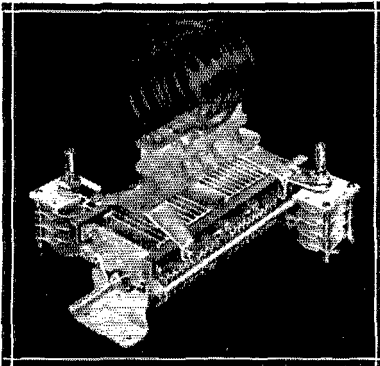

★
**TYPE
"AFU"**

100 WATT CLASS "C" AMPLIFIER PLATE TANK CAPACITOR-BRACKET FOUNDATION

Covers 5 to 80 meters inclusive with stock B & W Type B, BL, or BVL coils, Type "B" Jack Bar, a pair of Taylor T-40's or similar tubes, and CARDWELL "AFU" Foundation which includes:

- 1—MT-100-GD Dual Midway.
- 1—Pair CARDWELL Type "BW" Jack Bar Mtg. Bkts.
- 1—Pair CARDWELL Type "M" Mtg. Brackets.
- 2—Type ZS-7-SS Trim-Air Neutralizers.
- 2—CARDWELL Type "BWZ" "Trim-Air to Midway" Neutralizer Brackets.

TYPE "AFU" Foundation, assembled.....\$7.99

Suggested, proved and used by W-3DGP who sold us on the idea, CARDWELL is happy to provide a simple and inexpensive short cut to a truly efficient cross neutralized Push-Pull Amplifier, of popular power capabilities. Efficient because all leads are eliminated in the "LC" circuit. Tubes are mounted diagonally opposite each other with plate tank condenser between. A complete amplifier might well include a CARDWELL Dual Trim-Air Type EU-100-AD mounted directly under the chassis beneath the MT-100-GD with B & W "Baby" coils or similar units ideal for the grid circuit.

For those who may already have the stock MT-100-GD and the two ZS-7-SS neutralizers, we offer the necessary additional brackets, available at all CARDWELL jobbers.

TYPE "M" MTG. BRACKETS—Fit "M" or "N" type CARDWELLS for necessary low stator-to-chassis capacity condenser mtgs., made of satin finish aluminum.

Type "M" Bracket.....Net ea. **12c**

TYPE "BW" JACK BAR MTG. BRACKETS—Fit B & W Type "B" Jack Bar to CARDWELL MT-100-GD or MO-180-BD. Stamped from heavy aluminum, satin finished.

Type "BW" Jack Bar Brackets—per pr.....Net **21c**

TYPE "BWZ" TRIM-AIR NEUTRALIZER BRACKETS—For mounting any Trim-Air to any Midway. Made of heavy nickel plated brass.

Type "BWZ" Neutralizer Brackets.....Net ea. **11c**

IMPORTANT NOTE: See your dealer or write us for your free copy of the new CARDWELL No. 41 catalog. The handiest guide to every kind of an air capacitor you need.

New single Trim-Airs with solid shafts are listed, but your dealer will have the flexible Trim-Air with detachable shaft which every ham and commercial design engineer just can't seem to be without.

**THE ALLEN D. CARDWELL
MANUFACTURING CORPORATION**
83 PROSPECT STREET, BROOKLYN, NEW YORK

Zepp W3CHE says that XU2AW is still in Peiping, signing XU2MC PY2KX (14,365 T9) wants New Mexico, Vermont, Arkansas, Nevada, Utah, Arizona and South Dakota for the same reason that VK3QK (14,340) wants Delaware W9RBI got a 12-hour WAC, all on 'phone but the Asian: VSLAP (14,350 T9) Our old friend from Chagos, VQ8AS, is now at Mauritius signing VQ8AD. The address is J. Paul Caboche, c/o VQ8AF, Box 163, Port Louis, Mauritius That old faithful of the 7-Mc. band, HK5JD, has had his call changed to HK5ED (7095). He can always be found on around midnight Well, nearly always W5GGX, in New Mexico, is perfectly willing to give New Mexican contacts to all and sundry DX looking for them. C.w.: 14,390 and 14,368; 'phone: 14,176 and 14,190 Wyoming can be had by working W7FZP, in the high end of 20 Definition of DX-tasy (with apologies to HL): When the whole band opens up on a new country and he comes back to you with "Loud-est W on the band!"

WJPE

Results, South African DX Contest

World Winner in the 1939 South African DX Contest, held under the auspices of the S.A.R.R.L., was W. M. Atkins, W9TJ, with a score of 93,654 . . . 66 contacts. South African Senior Section Winner was ZS6DW, 45,426, 339 contacts; Junior Section Winner, ZS6DY, 28,290, 351 contacts. Canadian high was VE3AMK. Leaders in each W district: W1BFA 4000; W2GNQ 55,566; W3HPK 8748; W4QN 7350; W5EUL 14,336; W6QL 2890; W7BTH; W88JI 16,644; W9TJ.

12th Naval District N.C.R. Convention

The Naval Communication Reserve of the 12th Naval District will hold its annual convention September 2nd, 3rd and 4th, over the Labor Day holidays. Saturday evening the officers will hold their annual dinner at the Naval station at Yerba Buena Island. Sunday all activities will be held at the Golden Gate International Exposition on Treasure Island and the day will be known as "Naval Communication Reserve Day" there. Monday will be the Officers Conference at Yerba Buena Island, and for those officers and men who desire, the opportunity to go to the A.R.R.L. convention in San Francisco will be within easy reach. At the Exposition, the meeting place will be at W6USA, which will be taken over by the N.C.R. personnel for the day. This station will be manned by N.C.R. officers and men who are qualified radio amateurs. To anyone worked on September 3rd from W6USA a special N.C.R. QSL card will be sent. The committee is headed by Lt. Comdr. S.J. Fass, U.S.N.R., W6NZ, and Lieut. Wilfred Munter, U.S.N.R., W6DAA.

Unlicensed Canadian Operators Penalized

Two cases against persons owning unlicensed apparatus in the Province of Nova Scotia were concluded, as follows:

Mr. Elmer C. Gregor, 181 Church St., Dominion, N. S., was found in possession of a portable transmitter on the 8th of August, 1938, and the apparatus was seized at that time; subsequently, Mr. Gregor appeared in court and was fined \$5.00, plus \$2.50 costs, and the equipment was forfeited to the Crown.

Mr. William Corrigan, Dominion, N. S., was found in possession of an unlicensed trans-receiver on the 12th of October, 1938, and the apparatus was seized at that time; subsequently, Mr. Corrigan appeared in court and was fined \$5.00, plus \$4.75 costs, and the equipment was forfeited to the Crown.

Members of the A.R.R.L. Emergency Corps should not re-register via the blanks now available at various Western Union offices. Your initial registration is all that is necessary, except that a yearly re-registration is conducted direct from A.R.R.L. Headquarters. The W.U. application blanks are merely for the convenience of operators that have never before signed up in the A.E.C. See page 45, June QST, for full details regarding the availability of A.E.C. blanks at W.U. offices.

it's a pleasure!

TO OPERATE
AN "HQ-120-X"

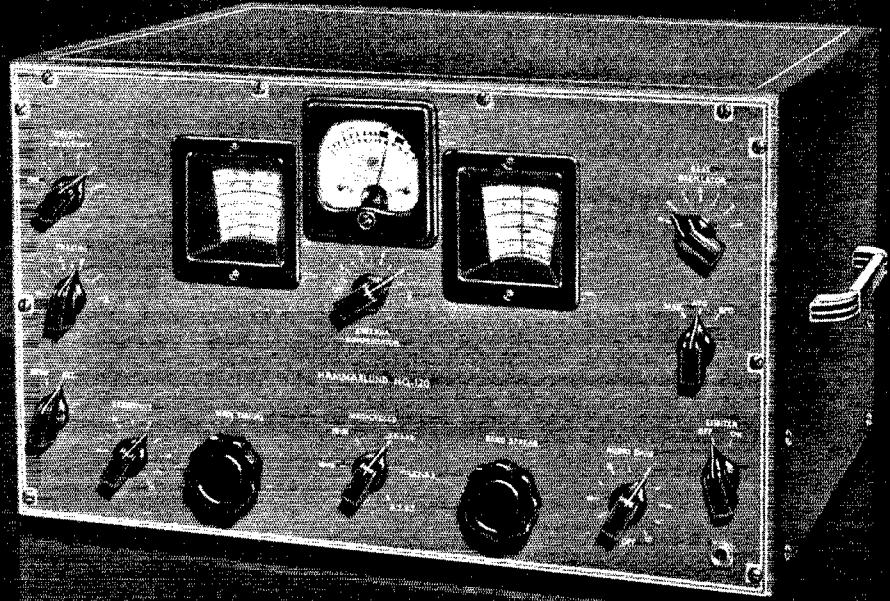

SUPERIOR PERFORMANCE and ease of operation have made the "HQ-120-X" outstanding among 1939 amateur receivers. You don't have to "fight" the "HQ-120-X" in order to pull in weak DX stations, its controls are smooth and accurate. Tuning knobs are at wrist-level height eliminating "tuner's cramp," and the dials are accurately calibrated for instant logging. There are no delicate or critical adjustments necessary when searching for DX, maximum sensitivity is always available. The variable selectivity crystal filter cuts through the worst QRM, either phone or CW, with remarkable results. Automobile ignition interference is reduced to a negligible level with an improved noise

limiter system. Other features include, calibrated band-spread, antenna compensator, and calibrated "S" meter. Ask your dealer to demonstrate the smooth and dependable performance of amateur radio's most complete moderately priced receiver — the "HQ-120-X."

WRITE FOR BOOKLET!

HAMMARLUND MFG. CO., INC.
424-438 W. 33rd St., N. Y. City

Q-9-39

Please send 16-page booklet.

Name.....
Address.....
City.....State.....

Canadian Office: 41 West Ave.
No., Hamilton, Ont.



HAMMARLUND

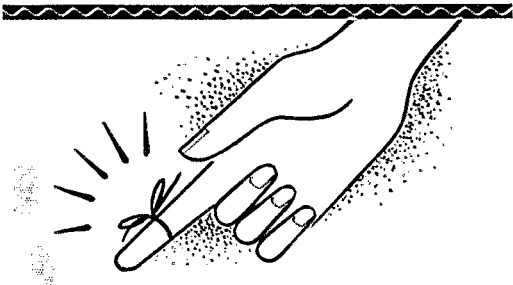

DON'T FORGET

A string tied on the finger is an old-fashioned method but it produced results. Now, we don't insist that you tie a string on your finger but we do want you to remember this: When you're looking around for that new transmitter **DON'T FORGET HARVEY.**

Of the entire Harvey line, made up of seven reasonably-priced units, the 100-T is probably the most popular. Small in size for its high power rating this unit incorporates the latest developments in radio transmission.

Or if you want a low power rig that is a miniature "power house" investigate the UHX-10 — compact, portable and one of the most versatile transmitters on the market today.

Built into these units as well as all Harvey equipment is that "STRENGTH FOR SERVICE" that has made the name **HARVEY** famous the world over.

Remember — you owe it to yourself to investigate a Harvey before you buy.

If there isn't a dealer nearby let us send you a catalog. Write to Harvey Radio Laboratories, Inc., 28 Thorndike Street, Cambridge, Mass.



MEMBERS, DX CENTURY CLUB

G6WY	144	W3EVV	116	W6TJ	104
W6GRL	143	W6ADP	115	W6FZY	104
W8CRA	142	W9EF	115	W3BES	104
W2GT	140	VK5WR	115	H89BG	104
W2GTZ	139	W2CYS	115	W7DL	104
W1SZ	137	W1JPE	115	G6KP	103
W1TW	136	W8NJP	115	W8KKG	103
W2GW	135	W9KA	114	VK2DG	103
W6KIP	135	W9TB	114	J2JJ	103
W3EMM	135	G5RV	113	W1BGY	103
W6CXW	134	W2DC	113	VE3QD	103
G2ZQ	134	W8MTY	113	W4CBY	102
W8DFH	133	W6GAL	112	W8OXO	102
W9TJ	131	W3EVT	112	W1FTR	102
W1TS	130	W3FRY	112	W9CWW	102
ON4AU	130	W2AAL	111	F8RJ	101
W1LZ	129	W5KC	111	VK3KX	101
W8BTI	129	W3GAU	111	W4AJX	101
W4BPD	128	G5BY	111	W6DOB	101
H89J	127	W1HX	111	SU1WM	101
W8OSL	127	G6CL	110	W8EUY	101
G6RH	127	ON4UU	110	W1CC	101
W5BB	127	PA0XF	110	SU1SG	101
W2BHW	127	W2CJM	110	W5CUJ	101
W2CMT	127	W6FLZ	110	W81WI	101
W8DHC	126	W2DSB	110	W6AHZ	101
W3CHE	126	G5BD	110	W1GDY	101
W9RL	125	W3DDM	109	W1CCX	101
W8ADG	125	W4CYU	109	W4OP	101
W1DF	124	W2BYP	109	W4MR	101
W2UK	124	W6HY	108	W6GHU	101
W1FH	124	W8BKP	108	W6MVK	101
W3EPV	124	ZS2X	108	W9NWT	101
W8LEC	123	W1DUK	107	G6NF	100
W2HHF	123	VE2AX	107	W2AER	100
W4CEN	123	W2CBO	107	W6KRI	100
D4AFF	123	G5BJ	107	W9UQT	100
W8OQF	122	G2DH	107	W8AU	100
W5VV	121	W9UM	107	G6MK	100
W8DWW	120	W1ADM	107	VE2EE	100
J5CC	120	G2TR	106	W2BXA	100
W1BUX	118	W1CH	106	G2MI	100
W9KG	118	W2GRG	106	W3BEN	100
ZLHY	118	W1WV	105	VK2ADE	100
W9FS	118	W2OA	105	W8QXT	100
W2ZA	118	W4DRD	105	ZL1GX	100
W8JMP	117	G5QY	105	H89CE	100
W9PST	117	W1AXA	105	H89Y	100
W3EDP	117	VK3CX	105	W9RCQ	100
W9ADN	117	VK3QK	105	W1CA	100
W2GZY	117	E1SF	104	W3TK	100
W2JT	117	W1ZB	104	W1ZI	100
W7AMX	116	F8RR	104	W8DOD	100
W9GDH	116	W3AG	104	W6BAM	100

The following have submitted proof of contact with 75-or-more countries: D8BME, PA0QF, W8EGW, W9AJA 99; W1BXC, W4CC8 98; G6GH, W1RY, W8LZE, W3ZX, W8AAJ 97; W2JME, W3GEH, W4EQK, W5ASG, W8BOX 96; F8LX, F8RAB, G6XIL, W1CNE, W2BAX 95; W2BJ, W2CTO, W3AOD, W8C1J, W8QDU, W9BEZ 94; ON4KG, PA0QZ, VK6SA, W2ALO, W8EMA, W6PKZ, W8BSE, W9RBI 93; W3AGV, W4DMB 92; G6YR, LUTAZ, SP1AR, W3ATU, W6TT, W8JAH, W8KTV 90; G8ZO, W2OP, W8IQB 89; G2DZ, W3JM 88; G8IG, SP1LE, W9AEH 87; E1AJ, W1BGC, W3FLH, W8LFE, W9FLE, W9GBJ 86; W1AVK, W3GHD, W4CFD, W6CK, W8LAV 85; SM6WL, W2CUQ, W8BWB, W8DAE, W9OVU 84; OZ7CC, W1BPT, W2AWF, W6GPB, W8BFG 83; W1EWD, W3AYS, W6KUT 82; VE2GA, W2WC 81; YK2TT, VE3HG, W1DOV, W2BNX, W3BVN, W3EPR, W6LDJ, W8AAT, W8DGP, W9GMV 80; W1OZ, W2BZB, W4TZ, W8JFC, W9MRV, W9VKF 79; W6AM, W6DTB, W8FJN 78; G3BD, W4EPY, W8OUK 77; EA0JW, W2PLG, W3BSE, W6ITK, W9PGS, ZELJI 76; D3CSC, W4OG, W9JDP 75.
Radiotelephone: W2LXY 89; W6GCH 88; W4CYU 86; W21KV 76.

W9LCT is organizing a Chicago Northwestern Railroad Net from Madison, Wis., to Sioux Falls, S. Dak., for emergency uses. Members so far are W9MZN, W9LCT, W9YXH and W9HSK. Other operators located at points along the CNW line should get in touch with W9LCT, Rochester, Minn., regarding participation in this emergency net.

Langley Field, Va. (U. S. Air Corps) has seventeen amateur stations operated by Langley Field personnel. Count 'em: W3AWX, BED, BJE, ELJ, EZH, EZY, DRK, GON, GTS, HCC, HDQ, HEN, HWJ, HXD, HYA, HZU, IBO. And the lads say they have no serious QRM!

Only ONE Standard
The finest of the finest for every Eimac tube

What does this EIMAC 2000T tube mean to amateurs?

Eimac recently announced two extra large, radiation-air cooled triodes: 1500T and 2000T. These high-power tubes are designed especially for use in broadcast and commercial transmitters. No radio amateur is interested in purchasing them for use in an amateur "rig," but every radio amateur should take cognizance of this fact:

Except for its large size and high dissipation rating, the Eimac 2000T is exactly the same as all other Eimac tubes.

This has an important meaning: "Even the smallest Eimac tube is designed and constructed in a manner equal to the requirements of the highest power triodes."

EXAMPLE: Tantalum is recognized by the world's leading engineers to be the best suited material from which to construct plates and grids for vacuum tubes. Eimac engineers pioneered the use of this superior material, and today tantalum elements are to be found in *all* Eimac tubes whether they be designed for operation in large commercial transmitters or in the smallest amateur "rig." Moreover, Eimac has developed a process for improving the characteristics of tantalum for this purpose. This process, too, is used in the production of *all* Eimac tubes. Strict adherence to this "single standard" permits Eimac to make the following statement:

"Eimac tubes are unconditionally guaranteed against tube failures resulting from gas released internally." Momentary overloads as high as 400 to 600 per cent will positively not damage filament emission.

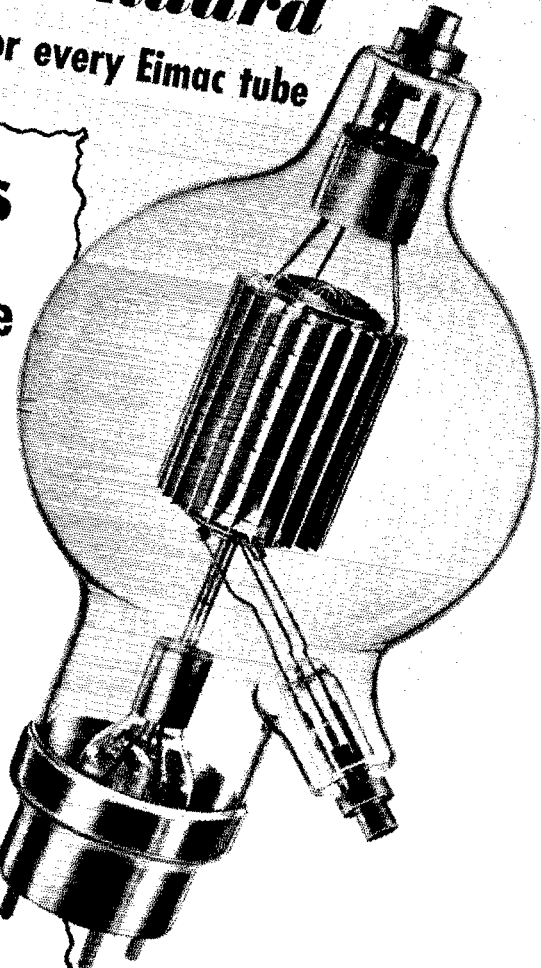

Eimac 2000T tube is capable of operation at over ten times the maximum input allowed the amateur by law. It is fast replacing old fashioned, cumbersome and inefficient water cooled tubes.

Eimac
TUBES

TEL-McCULLOUGH, INC., 770 SAN MATEO STREET, SAN BRUNO, CALIFORNIA

More Watts!
FOR YOUR
DOLLAR

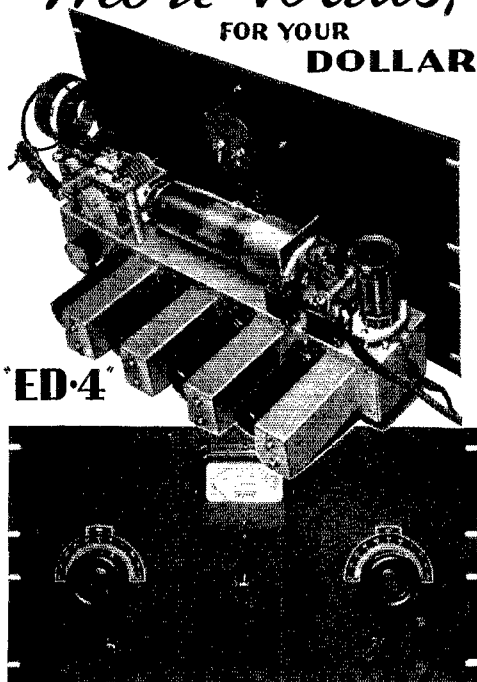

THE most active season in amateur radio is just beginning. All-band operation will no doubt be more favored than ever before. Be prepared to get the most out of Ham radio by building the new "ED-4" 100 watt all-band transmitter. Full output is available on 80, 40, 20 and 10 meters by changing only the amplifier coils. Other stages have both meter switching and band switching. Uses four 6L6's as oscillator and multipliers and an RK47 or 814 as the amplifier. This kit is available at your dealer's with complete constructional data and will provide more watts per dollar investment than you ever hoped for. The "ED-4" will also serve as an exciter and driver for an all-band 1-KW transmitter. The foundation unit includes all hardware completely drilled and machined, ready for assembly.

WRITE FOR FOLDER!

HAMMARLUND MFG. CO., INC.
424-438 W. 33d St., N. Y. City

Q-9-39

Please send 4-page folder.

Name

Address

City..... State.....



HAMMARLUND

Canadian Office: 41 West Avenue No., Hamilton, Ont.

BRIEFS

We've heard it said that directional CQ's never bring results, but they sure click at W6USA. While visiting at USA at the time of the A.R.R.L. Board Meeting in San Francisco, Director Brad Martin, W3QV, called "CQ Philadelphia," hooked a W3 in Philly, and asked him to telephone Mrs. Martin. When the W3 said he didn't have a 'phone, there was heard the familiar sound of an e.c.o. followed by another W3 breaking in to say, "I have a 'phone, Brad, and will 'phone the Mrs." When 3QV finished with his wife, Director Norwine, W9EFC, called "CQ St. Louis"



A.R.R.L. Day at W6USA

and hooked one of the very stations in St. Louis he wanted. Some days later, Director McCargar, W6EY, was at W6USA and an Australian, VK3SI, dropped in. 6EY called "CQ VK3" and the first station heard was not only a VK3 but the fellow's particular friend living near him in Melbourne!

.....
1.75-Mc. Stations Needed to Send Code Practice

Many beginning amateurs find "learning the code" their greatest stumbling block. They call upon licensed amateurs to help them master the dots and dashes but often there are chaps who are unable to get in touch with nearby hams. Each active radio season A.R.R.L. sponsors a program of Code Practice on the "160 meter" band. Operators working on this band are invited to cooperate in this worthwhile work. We were all beginners once and, if we will but think back, we will recall that assistance in getting started was quite welcome. During the past several years the 1.75-Mc. stations sending code lessons have helped hundreds learn the code. This season we would like to have more stations engaged in our program. Just send us the schedule you will follow in sending code practice, being sure to give your frequency (as near exact as possible) and hours and days you will transmit. Please state also on what date you will start transmissions and what date you will conclude same. Code practice stations usually conduct lessons throughout the entire fall-winter season. Hints on how to conduct code practice by radio are sent to all volunteers. The schedules of all 1.75-Mc. code practice stations are mailed to each would-be amateur requesting same—and hundreds of these requests are filled yearly. What say, fellows? Will you lend a hand?

.....
Radio Plays Honor Hams

The determination of the combined radio clubs of Arizona to create in the minds of the general public a more accurate and appreciative understanding of amateur radio operators and their activities has lately taken the form of a series of radio dramas. These presentations, known as QST plays, are presented through the courtesy of stations KTAR and KVOA. They are broadcast every Wednesday night at 9:45 with a cast of local radio actors, under the supervision of George Evans, W6OFS, technician-announcer at KTAR. The fifteen minute dramas portray some incident in the life of a radio ham, showing how these men who spend hours in radio because they love it, have time and again performed services of inestimable value to their communities. The series includes the part played by W5BSF, W5BKE and W5BKZ, in the great flood on the Guadalupe River, Texas, in 1932; the story of white man's magic on the shores of Bristol Bay in Alaska and the part played by K7BCJ; the story of the moose of Isle Royale out in Lake Michigan, a story that is inextricably tied up with the lives of two YL's,

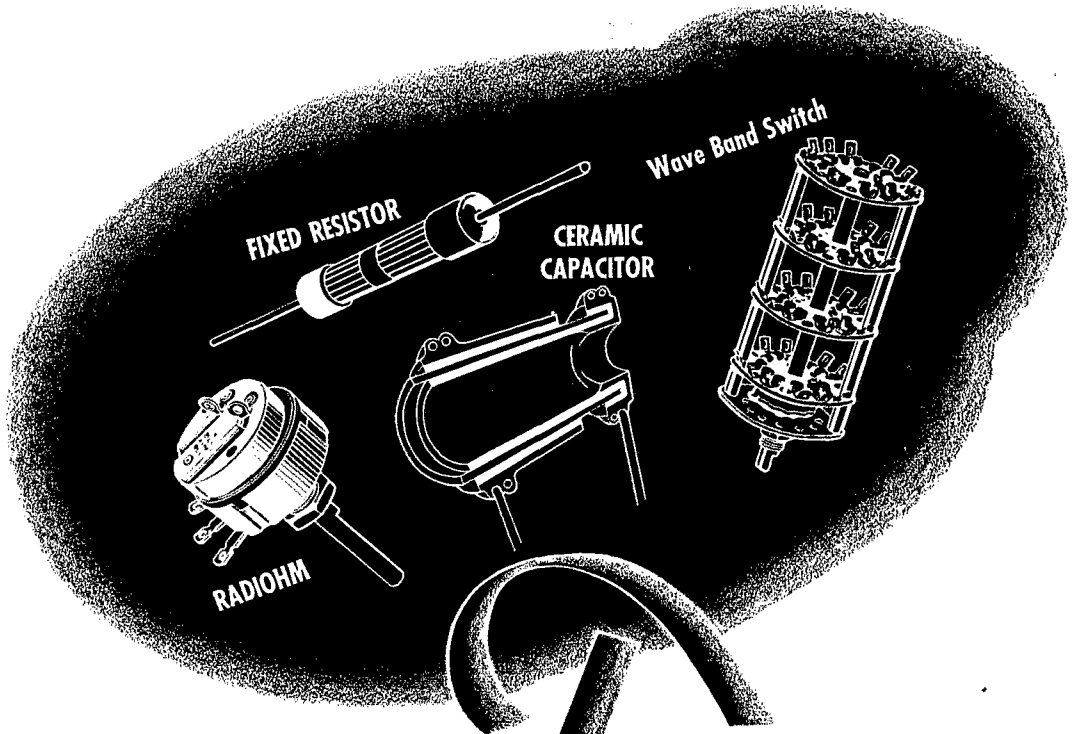

FIXED RESISTOR

CERAMIC CAPACITOR

Wave Band Switch

RADIOHM

"4" - MOST

FAMOUS MEMBERS OF A FAMOUS FAMILY



Numerology plays no part in our business . . . but we can't refrain from admitting that this foursome is so superior that we simply must "play on words" in this advertisement. Individually, or collectively they represent the ultimate in **QUALITY**, workmanship, and precision engineering. In the serviceman's shop, or on the block-long production line . . . it pays to **SPECIFY CENTRALAB**.

RADIOHM

In standard or midget . . . low noise level . . . long life.

FIXED RESISTOR

Insulating and conducting area baked together into one . . . copper sprayed end connection.

CERAMIC CAPACITOR

Where permanence or temperature compensation is important.

WAVE BAND SWITCHES

In Isolantite or Bakelite . . . available in various combinations.

Centralab

Division of **GLOBE-UNION Inc.**, Milwaukee, Wis.

From Power Line to Antenna

OHMITE

parts improve your Rig!

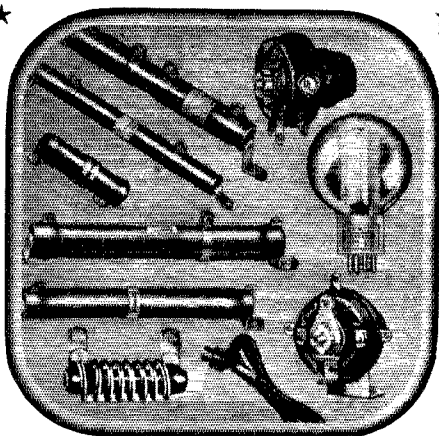

CHECK up! Tune up! Give your transmitter all the professional efficiency you can pack into it with these time-proved dependable Ohmite parts. *At your jobber.*

DUMMY ANTENNA. New Ohmite Vacuum-Type. Used in more than 10 ways to improve transmitter efficiency.

BROWN DEVILS. Popular, dependable, 10 watt and 20 watt resistors.

DIVIDOHMS. Adjustable Resistors — vitreous-enameled. 10 to 200 watts.

RHEOSTATS. All-porcelain vitreous-enameled. Keep power tube filaments at best efficiency.

BAND SWITCHES. Easy, quick band-change with low-loss efficiency.

FIXED RESISTORS. Time-proved vitreous-enameled units in world-wide use.

CHOKES. R. F. Plate and Power Line Chokes for R. F. circuits, interference elimination, etc.

PARASITIC SUPPRESSORS. New, convenient compact Parasitic Suppressors to prevent u.h.f. parasitic oscillations.

Send for Catalog 17 and Bulletin 111 listing "10 Ways to Improve Your Rig"

OHMITE MANUFACTURING CO.
4865 Flournoy Street * Chicago, U.S.A.

OHMITE

RHEOSTATS RESISTORS TAP SWITCHES

Violet and Vivian Johnson, operators of W9PCU; and many other examples of amateur radio "public service."

The plays are taken from the files of the A.R.R.L. and are dramatized by George P. Ludlam. Any ham clubs wishing to conduct a similar series of programs should work through their local N.B.C. outlet in securing the scripts which the N.B.C. will gladly supply.

Emergency Develops on F.D.!

FARTHEST from the thoughts of the fellows who manned stations W9PAT/9 and W9KYC/9, the Minneapolis Radio Club and the St. Paul Radio Club Field Day stations was that an emergency such as the newspapers said they were "practising for" and "ready and waiting for" might ever happen. However, late Sunday afternoon, June 18th, when a tornado of phenomenal violence struck Anoka, a community of 8000 about thirty miles northwest of the Twin Cities, six more or less sleepless amateurs rushed to the scene with what gear was available from two hastily dismantled Field Day stations.

First to arrive was W9IBD, whose 28-Mc. portable-mobile rig had been part of the W9KYC station. With the assistance of W9VED as relief operator, they settled down in the midst of the debris and commenced moving the traffic of the relief agencies via W9OTE to W9NNO and W9QKX. Arrangements for the relay station were aided by W9PKO, who kept in contact with W9IBD on his trip to Anoka. W9OTE, assisted by W9QDX, W9JFH and John Dick, Jr., astounded the gang by making an otherwise fixed station portable in less time than it takes to tell. Setting up the station on the farm of John Dick on the outskirts of Anoka, they relayed messages the remaining distance into Minneapolis where the terminal stations were located. Static, which was as severe as any of the fellows had ever encountered, hampered somewhat the easy flow of traffic; but the hard-working 28-Mc. gang proved its mettle and moved about 25 messages before morning. Later reports indicated that W9MZL with his 28-Mc. portable-mobile rig had been in the area previously but, unable to secure cooperation from the authorities he contacted, had returned to Minneapolis.

But if the 28-Mc. gang thought they had static to contend with, they were far from the uncomfortable situation encountered by the fellows who had set up what remained of W9PAT and W9KYC, and were attempting operation on 3.5 Mc. After two hours of fruitless calling, W9TAT and W9YPT, who had set up the W9PAT rig operating under the call W9CWI in a garage near the partially destroyed Armory, decided that 3.5 Mc. wasn't the band for working the 25 miles into Minneapolis. Meanwhile W9BBL, W9BHY, W9JIE and W9ZWW, who had been given police escort into the area through the efforts of W9BCT and W9GBG, set up the 3.5-Mc. rig that had been a part of the W9KYC station in the Anoka High School. After some more or less scientific antenna research brought on by the inability of W9YCR, W9QDF and W9IFW to penetrate the lines of the National Guard and deliver a pre-cut 3.5-Mc. antenna, the little 3.5-Mc. job, powered by the kilowatt generator from the Field Day set-up, broke through the terrific QRN and was acknowledged by N9BP. Traffic commenced moving immediately, and "Beep," assisted by his XYL and his now famous "Chin Trap" (to prevent the QRN from blowing the fones off his head!), copied the practically inaudible signal of W9KYC/9 all night long. The XYL delivered the messages by land wire as fast as they were received. Special praise is due N9BP for his excellent work in copying traffic from the emergency area through especially trying conditions. Also cooperating to advantage were W9ITQ, W9HCC, W9ZGT, W9BQY, W9BPK and W9ORA. An ironical feature of the storm was that it heaped trees, a roof and a trailer into the house and yard of G. X. Collier, W9CWI, at Anoka — the very house where the permanent amateur radio Disaster Committee of the Twin Cities had its first meeting but a few weeks previously!

Dawn revealed the extent of the destruction, and also the excellent policing and recovery work done by the Red Cross and other agencies. Wire communications having been established during the night, the job for Amateur Radio was done, and the radio crew proceeded to dismantle equipment, return it to its owners, and tuck weary bodies into bed. The emergency was admittedly small in scope and of short duration, but the willingness of the radio amateurs to tackle the job of fighting the terrific QRN which was disabling the

SECOND PRIZE

\$25.00

C. G. ALLEN, G8IG
76 Nightingale Lane
Bromley, Kent, England

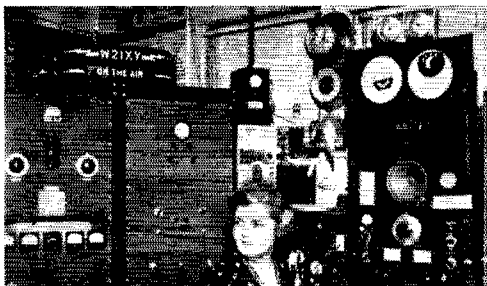

THIRD PRIZE

\$25.00

ALLEN P. SEARS, W3HLH
616 Mellon St., S. E.
Washington, D. C.

FIRST PRIZE

\$50.00

DOROTHY HALL, W2IXY
186 Williamson Avenue
Springfield, Long Island, N. Y.

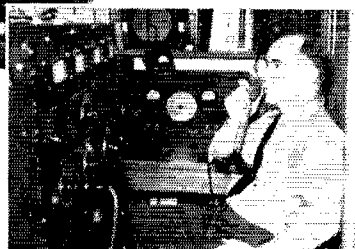
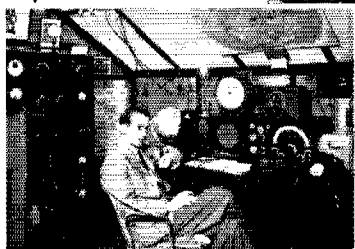

PRIZE WINNERS AND PHOTOGRAPHS ASTATIC PRODUCT PICTURE CONTEST

HONORABLE MENTION

Winners of \$5.00 Each

MR. ALBERT H. DABB, JR., W2CAY
26 West Curtis Street
Linden, New Jersey

MR. LEROY ANSPACH, W3BD
128 East Cliveden Avenue
Philadelphia, Penna.

MR. GEORGE F. NORTON, W4EE
Post Office Department
Athens, Georgia

MR. M. B. ANDREWS, W5GIK
Box No. 127
Handley, Texas
(Engineer ground radio
American Airlines, Inc.)

MR. MAURICE E. KENNEDY, W6KQ
415 West Lexington Drive
Glendale, California
(Operator Los Angeles Flood
Control Station KCFD)

MRS. MARY E. RODEN, W7GPO
319 North Lincoln Street
Pendleton, Oregon

MR. HARRY L. BEAR, W8RG
Curtisville, Penna.

MR. EDMUND C. SKOWBY, VE3PE
47 Britannia Street
Stratford, Ontario, Canada

MR. L. J. WELLS, ZS6FB
Central Telegraph Office
General Post Office
Pretoria, South Africa

MR. EDUARDO OLIVA RADELAT,
O3WL
Calle 21 y Puente Almendares
Marianeo, Habana, Cuba

IN ANNOUNCING the winners in this contest, Astatic Microphone Laboratory, Inc., regrets its inability to reward all of the many entrants whose interest and photographs contributed to its success. To compensate in part for this, however, second and third prizes, not originally planned, were included in the award.

Entries were received from many States, Canada, Europe, South America, South Africa, Australia, and isolated Island Settlements, showing ASTATIC microphones and phonograph pickups *in actual use* the "World Over."

Not since 1933, when Astatic first introduced crystal microphones to the World, has anything transpired that has brought such great satisfaction as the closer relationship with the users of its products, gained by this contest. The enthusiasm shown by users of Astatic microphones and pickups is surely most gratifying.

To each and every individual who took part in this contest Astatic extends sincere thanks and best wishes for continued DX.

Officiating judges were Floyd H. Woodworth, W8AHW; C. M. Chorpeneing, W8MJM; and Albert M. Wearstler.

A complete new Catalog, No. 12, is now available

WRITE FOR IT



ASTATIC MICROPHONE
LABORATORY, INC.
YOUNGSTOWN, OHIO

Pioneer Manufacturers of Quality Crystal Devices

Licensed Under Brush Development Co. Patents.

GET MORE *out* of your STATION with . . .

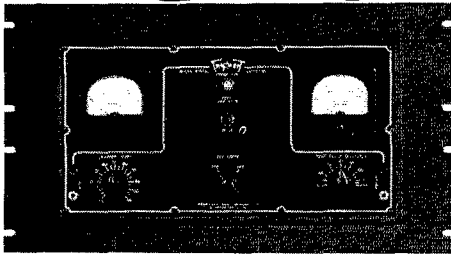

NEW TRIPLET MODULATION MONITOR

Rack Panel Mounting Type . . . Net Price . . . \$33.67

- ★ **USABLE ON ALL AMATEUR BANDS**
- ★ **PERMITS COMPLIANCE WITH FEDERAL REGULATIONS**

- **RED. DOT Lifetime Guaranteed Meters — The Sensation of the Season**
- **110 Volt AC 60 Cycle Operation**
- **Two meters — one for Carrier, one for Per Cent Modulation**
- **Calibrated Neon Light for Instantaneous Peaks**
- **Tip Jacks for Phone Connection**
- **Uses Vacuum Tube Rectification**

HERE is what hams have been waiting for to help them comply with Federal Regulations . . . a real Modulation Monitor at a moderate price. Features and accuracy compare favorably with most expensive types of modulation monitors. High Speed Meter reaches full scale deflection in less than 300 milliseconds — has delay circuit on down-stroke (requires 700 milliseconds for return to zero). Has self-contained carrier level adjustment control and modulation selector can be set for any desired modulation — 50 to 120% on positive peaks; 50 to 100% on negative peaks. Whenever modulation exceeds the pre-set point, neon light flashes. Net Price. . . . \$33.67.

MODEL 1696

New Modernistic Style Case with Black Suede Finish. Size 14½" x 7½" x 4½". Case and panel blend with standard amateur equipment.

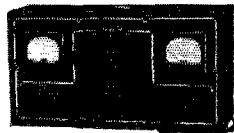

FREE TECHNICAL DATA ON REQUEST

Net Price, \$33.00

THE TRIPLET ELECTRICAL INSTRUMENT COMPANY
259 Harmon Ave., Bluffton, Ohio

Please send me more information on
 Model 1696; Rack Panel Mounting

Name
Address
City State

police radio mobile units, the broadcast mobile unit and the National Guard Field gear remains a tribute to the true ham spirit, and was recognized as such by those in authority at the disaster headquarters. For the hams themselves, the experience was one not to be forgotten, and it provided a Field Day test which was without parallel in any of the simulated emergencies. From this work the fellows are gathering a new slant on emergency preparedness and their own shortcomings, both as to equipment and personnel. While regretting the destruction and suffering imposed upon the people of Anoka, the radio amateurs are thankful that this very real situation provided both experience and incentive from which to create the efficient emergency units which the Twin City area sorely needs, and which the people of the area now appreciate may be of vital significance. It was a real Field Day for the Minneapolis and St. Paul Clubs!

— J. L. Hill, W9ZWW.
Clarence Mithori, W9YPT.

Relay Held for Michigan Governor

On April 15th the Governor of Michigan celebrated his 80th birthday. Prior to this date a letter was sent to all Michigan Mayors and Village Presidents inviting them to send the Governor a message, by amateur radio, a blank being supplied them with suitable explanation. On the day of the celebration, portable station W8NLG of the Detroit Amateur Radio Association was taken to the Governor's home at Charlotte by W8QGD, W8FTW, W8CEU, W8AKN, W8MV and W8JAH and set up in the orchard about 100 feet from the Governor's house. Promptly at 10 A.M. they went on the air, and from that time until 7:30 P.M. a constant string of congratulatory messages poured in. A total of 201 messages was handled. The Governor was very pleased and was impressed by the fact that such a set-up for emergency communication existed.

P.R.R.

R. M. Francis, W8AVY, A.R.R.L. Emergency Coördinator, Pittsburgh, Pa., with the cooperation of other E.C.'s, is mobilizing amateur radio facilities along the Pennsylvania Railroad, for emergency operation. Pittsburgh has been designated as Headquarters and stations on 3.5-Mc. c.w., 3.9- and 1.75-Mc. 'phone are being selected to contact various stations along the line. Arrangements are being made to keep weekly schedules with stations located at important operating points in the region. Consideration is being given to operation of a weekly net on a spot frequency. At present, stations in Pittsburgh are on the air each Sunday from 2:00 to 4:00 P.M. for the purpose of contacting stations along the P.R.R. Amateurs along the line, with whom no contact has been established, are invited to get in touch with W8AVY at 3577 Elmhurst St., Pittsburgh.

WILL/W9XTA

Ham Forum, probably the oldest radio program on the air devoted exclusively to the radio amateur, can now be heard over station W9XTA, ultra-high frequency broadcasting station located at Harrisburg, Illinois, as well as over station WILL. The program consists of amateur news, technical information, editorial comment, miscellaneous information of interest to the amateur, and Ham gossip. While the program has enjoyed great popularity with amateurs in Illinois and Indiana, this new short-wave outlet should increase the scope of Ham audiences markedly. W9XTA operates on a frequency of 26,500 kilocycles with a power of 500 watts; and WILL operates on 580 kilocycles with a power of 5000 watts. The program is heard every Saturday at 1:15 P.M., CST.

The Highest O.R.S./A.A.R.S.

W9WVZ at Marshall Pass, Colorado, 10,856 feet above sea level, lays claim to being the highest O.R.S./A.A.R.S. in the United States. The receiver and transmitter are both d.c. operated from a six-volt storage battery and genmotor. W9WVZ says the popular conception of wonderful DX from high-altitude locations is false, the terrific QRN making the use of normal-sized antennae impossible. A 25-watt, 110-volt bulb can be lighted from the antenna when the QRN gets really tough.

FOR AMATEUR RADIO

Put your ceramic sockets to work!

Use the new Hytron ceramic-base GTX Bantams to take full advantage of those expensive low-loss sockets in your communications receiver

Hytron ceramic GTX Bantam tubes are laboratory-selected and tested especially for use in communications receivers operating at high frequencies. Used where maximum signal gain and circuit stability are essential.

By replacing those black-base tubes in your high frequency stages with low-loss Hytron ceramic-base types, your ceramic sockets cease to be ornaments and become useful. Note improvement at 7 to 60 megacycles.

Hytron ceramic-base GTX Bantams are economically priced—ask for them when you buy a new receiver.



Metal base ring grounded to No. 1 pin. Special shield supplied.

Bantams with Low-loss Ceramic Base

6A8GTX converter	\$.95 net
6J5GTX medium- μ triode	\$.95 net
6J7GTX r-f. pentode	\$.95 net
6K7GTX r-f. pentode	\$.95 net
6K8GTX converter	\$1.30 net

These tubes are interchangeable with both metal and "G" types.

Each tube is supplied with a special shield that is automatically grounded. The shield makes contact with the metal base on the Bantam GTX tubes, which in turn is connected to the No. 1 ground pin. No alterations needed.

For peak receiver performance, every low-loss socket should have a ceramic-base Bantam.

**U-H-F
HY114**



1.4 volt battery-type triode for ultra-high-frequency transmitters and receivers. Operates as power oscillator, R.F. amplifier, and detector with minimum battery drain.

Filament voltage 1.4 volts
Filament current 0.12 amps.
Plate voltage 180 max. volts
Plate current 15 max. ma.
Plate dissipation 2.5 max. watts

\$2.00 NET
Full ratings up to 300 megacycles

New Tubes

**Shielded
866**



Mercury-vapor rectifier with internal shield to prevent ion bombardment of filament. Mesh filament with greater emitting area, spiral-wound to concentrate heat, further increasing emission.

Filament 2.5 volts at 5 amps.
AC plate voltage	... 2650 max. volts
Two Hytron 866's will deliver up to 2385 volts DC at currents up to 500 milliamperes.	

\$1.50 NET
Complete engineering data for Hytron types available on request

HYTRONIC
SALEM



LABORATORIES
MASS.

A DIVISION OF THE HYTRON CORP.

MIMS NEWS

Hetrofil

(Continued from page 18)

about 40 db. It then tapers off to about 13 db at the low frequencies and 20 db at the high frequencies.

With the low setting the peak at the higher frequencies is not so pronounced and the high frequency attenuation somewhat greater. As previously mentioned, this causes some distortion of 'phone signals and accounts for the preference for the use of the high setting where it is permissible. When the low setting (C_2) is used to reject a low frequency beat, say 200 cycles, the transmission curve is, as shown, practically flat as regards frequency distortion.

In using the Hetrofil on c.w. reception the frequency distortion is of no consequence and is only apparent as a "turning over" of the background noise level as the control is varied.

Naturally, many other uses of the Hetrofil circuit will suggest themselves. It is perfectly feasible to use the circuit with a receiver already equipped with a crystal filter and thus afford a means of eliminating more than one interfering heterodyne. Indeed, if the receiver has enough audio gain two or more Hetrofils can be used in series to reject two more heat notes. One might even construct a de luxe model with a stage of audio ahead of two Hetrofil circuits and the switching so arranged that as each Hetrofil is cut in the audio gain would be automatically advanced to keep a constant level. But then the extreme simplicity of the device, its major advantage, would be lost.

If applied to superregenerative receivers the audible interruption frequency can be taken out quite well where a separate tube is used as an interruption frequency oscillator and fairly pure tone is generated. Where a self-quenched detector is used and a hiss of considerable bandwidth is obtained, the Hetrofil will remove the major part of the hiss but not all.

N.H.F. Field Day and Relay

(Continued from page 33)

that brings some real DX messages along! From the data made possible by this activity we hope to announce further tests for lining up some u.h.f. Relay Routes later in the season. Extending the lines of routes will make for progress in knowledge of transmission phenomena at these frequencies at the same time the pioneers will write their names in glorious history to be recorded in these pages.

Directing the test messages: If you live in the South, make the address of your message "any Great Lakes amateur," "any Dakota Division station," or other reasonable or unreasonable distance, as it appeals to you. If you live in the North, send your trial dispatch to "any Gulf Coast amateur," "any Florida station," "any California amateur," "any Delta Division amateur," etc. Hams in the extreme West will try for the Great Lakes, or the Atlantic Coast, or New

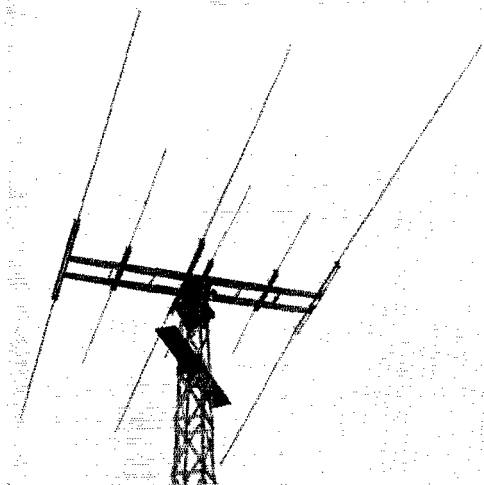

DeLuxe Dual Three—10 and 20

TWO-BAND OPERATION

- Full efficiency 10 and 20
- Real unidirectional pattern
- Two separate arrays in one
- Uses two Inductostubs
- Instant changeover — no tuning

Here 'tis:

NOW — A Signal Squirter with full efficiency on both ten and twenty meters. Precise engineering in placement of the two arrays on the same center section with separate Inductostubs has resulted on one unit with all advantages of two separate arrays. Of course the DeLuxe Rotator with Inductostubs mounted on it is used for control.

Shipments are already being made. There is no delay. It's your best bet for that extra country for the Century Club or WAC.

Inclusion of this latest Signal Squirter in our literature caused delay in mailing. It has been sent to all who requested. In case you don't have your copy, see your Distributor — while there, ask for his easy pay plan. We, too, will be mighty glad to hear from you and your Distributor.

73,
M. P. MIMS, W5BDU

See Your Distributor

MIMS RADIO CO.
SIGNAL SQUIRTER
PRODUCTS
TEXARKANA ARK. TEX.

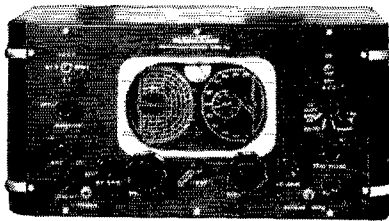
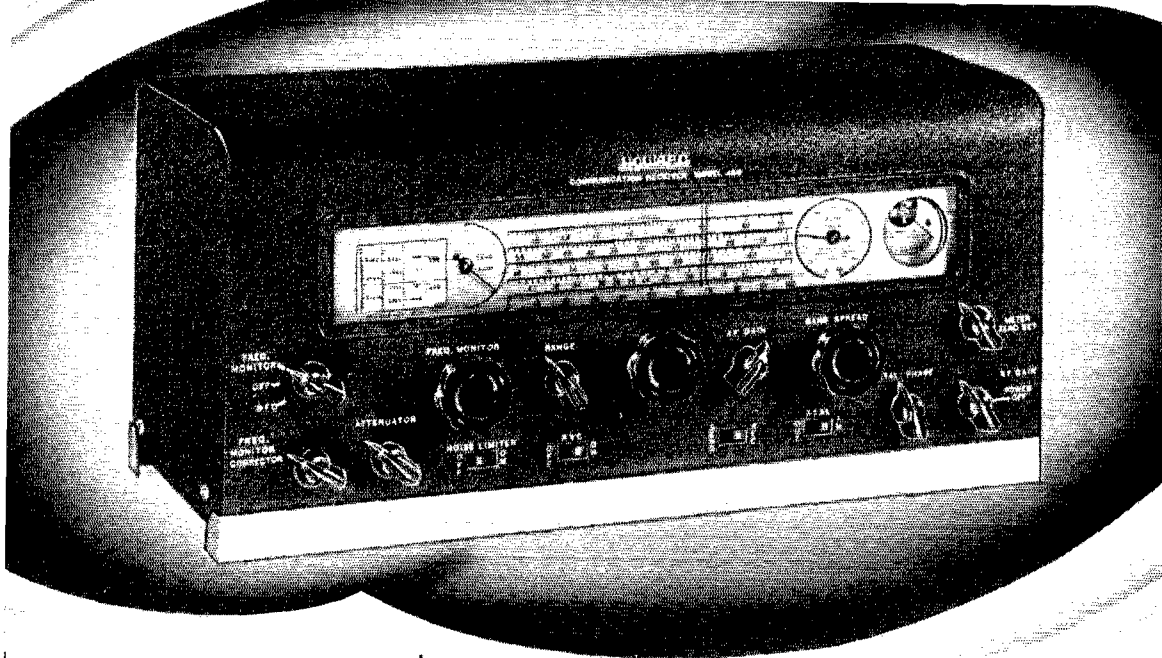

Model 450 A, 12 tube, 6 band, complete. \$105.45

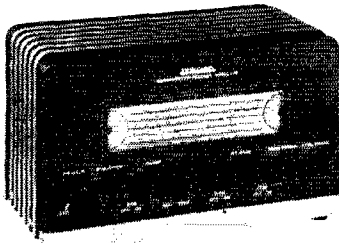

Model 438, 540—43 mc. 8 tubes & xtal... \$59.95

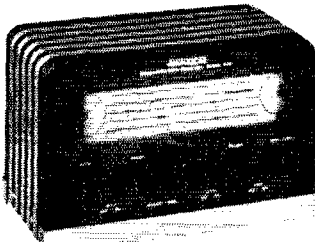

Model 430, 540—43 mc. 6 tubes complete. \$29.95

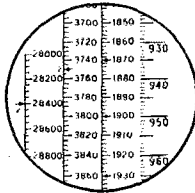

Model 460—The ONLY Radio with Built-in FREQUENCY MONITOR!

Model 460 is the 10 tube communication receiver of the year with the new Howard Frequency Monitor and Noise Limiter. With this precision frequency monitor you can pre-set to any amateur frequency! You avoid errors of drift and parallax. You hear the signal of the frequency monitor on the channel you want. You can check any incoming amateur signal and report back the frequency of the signal! You can check your own transmitter frequency!

Model 460 has two BFO systems, the choice of which is optional. One is the conventional BFO circuit in the i.f. channel, adjustable as to pitch and intensity. The other is a function of the frequency monitor and checks the frequency of the CW signal as it is being received. An extended Electrical Band Spread which can be calibrated against the frequency monitor is a special feature.

A Crystal Filter Circuit is built-into Models 460, 450A and 438 Howard Communication receivers. Its use is optional and the receivers may be purchased with or without crystals. Complete receivers are quoted with crystal, tubes and speaker. The Model 460 complete is only \$89.95, or \$79.95 less crystal. Long-wave models and models for special voltages and/or frequencies available.

On display by all leading Amateur equipment distributors.

HOWARD RADIO CO.

America's Oldest Radio Manufacturer

1735 Belmont Ave. • Chicago, Illinois

Cable Address: HOWARDCO, U.S.A.

Send a penny post-card or letter for complete technical details—FREE.

**GET YOUR SHARE
OF THE FUN ON 2½ METERS
WITH THE
ABBOTT • DK2 •
2½ METER TRANSCEIVER**



SENSATIONALLY LOW PRICE

LESS TUBES AND BATTERIES

\$27.50

LIST PRICE

40% Discount to Amateurs

GENERAL: The DK2 is a completely self-contained 112 mc radiophone transmitter and receiver, for use in your car, plane, boat, or while being carried, for portable work. It is very simple to operate. The working range is between 2 to 30 miles depending on the location. Astonishing results have been obtained.

SPECIFICATIONS

CASE: Size 11½" long x 9½" high x 6½" wide, grey wrinkle finish metal, heavy leather handle. All batteries are self-contained in case. Removable side panel for easy access to the batteries and tubes.

PANEL: Beautifully finished in black enamel with silver scales and lettering.

CONTROLS, ETC.: Two ceramic insulators are supplied for antenna, special large easy tuning knob, volume control on and off switch which acts as such in the receive position and as a gain control in the transmit position, transmit and receive switch, microphone and headphone jacks.

FREQUENCY: Will cover 112 mc to 118 mc (amateur 2.5 meter band).

BATTERY REQUIREMENTS: Three 45 volt B batteries like Burgess 5308; and four No. 6 dry cells, or two Burgess 2F2H batteries.

TUBES USED: One type 6J5GTX; one type 6G6G.

SHIPPING WEIGHT: 12 pounds.

Order from your nearest distributor — if not yet stocked we will temporarily fill orders direct

**Some Territories Still Open to Responsible Representatives
BULLETIN ON REQUEST**

ABBOTT INSTRUMENT, INC.

51 Vesey Street

New York City

England states. Those in the North and East may aim at the Pacific Coast, San Francisco or Los Angeles areas (South or West), etc. It is not to be expected that many messages, limited to u.h.f. will get through — the point is to give each message a necessary direction to see *how far* the best such message can go during the time allotted. Terminal stations, each station starting a u.h.f. "msg," and each amateur holding one for relay at the ending time, should be sure to see that we get copies promptly so full message histories can be reported soon in *QST* with a tabulation of how far they travelled. From results, possible successful routes of the future can be mapped out, points where station coverage is needed will become known, and improved u.h.f. organization and planning can follow.

Every ham with u.h.f. gear should take part in this activity. Here's luck, and let's hear how you make out. Send copies of messages, including handling³ data, with your score.

— F. E. H.

Better 'Phone Operation

(Continued from page 47)

scribed, these two values can be combined in one condenser at the junction of the two filter sections. The $\frac{C_D}{2}$ condenser on the r.f. side of the

filter can be connected from L_D to either the positive of Class-C plate supply or ground, and might logically be the blocking condenser shown

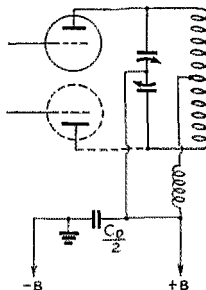

Fig. 15 — The output condenser of the filter may be the plate by-pass condenser on the r.f. stage.

in the popular circuit of Fig. 15, the advantages of which have been pointed out by WILJI.³

In observing Figs. 14 and 15, it will be immediately apparent that the value of a blocking condenser used in the r.f. amplifier between the positive plate lead and ground must be considered as part of — or the total — capacity across the output of the networks described.

A sample calculation follows for a filter suitable for use in connection with a Class-C modulated amplifier operating at an input of 250 ma. at 2000 volts, where the desired cutoff frequency is 5000 cycles:

$$R_o = \frac{2000}{0.250} = 8000 \text{ ohms}$$

³ T. M. Ferrill, Jr., "How Much Condenser Spacing?" *QST*, Dec. 1938.

STANCOR'S

New 1940 Kits

Stancor presents two of the many new 1940 Kits incorporated in the Fourth Edition Stancor Hamanual (out Oct. 1st). The rigs are versatile in design and application and represent excellent values. Additional information may be obtained from the Hamanual.

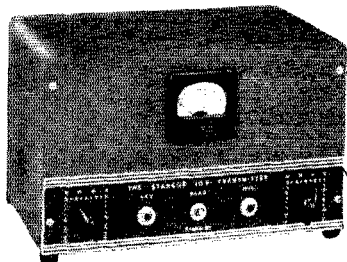

STANCOR "60-P" TRANSMITTER

An entirely self-contained 60 watt phone-CW rig employing the new HK24 in the R.F. amplifier. Its design makes for simplicity of operation and allows either standard rack or table cabinet mounting. Such features as oscillator keying, high fidelity audio channel, well-regulated power supplies and low impedance output termination are all incorporated in this kit.

\$44⁸⁰

Approximate net price
Less tubes, crystal, meter, coils and cabinet

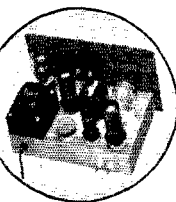

STANCOR "10-P" TRANSMITTER

A compact, multi-band, phone-CW rig allowing operation on all bands from 10-160 meters with three crystals. Uses an oscillator-amplifier circuit involving but one tube circuit. Power amplifier input—12 watts phone—20 watts CW. Approximate net price, **\$19⁹⁵** including cabinet es-cutcheon, etc.

Less tubes, crystal, meter and coil

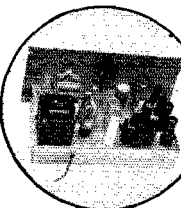
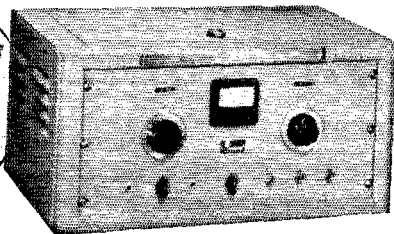

The Fourth Edition Hamanual fully describes these and many other values in transmitter and amplifier kits.

AVAILABLE FROM YOUR STANCOR JOBBER ABOUT OCT. 1st.



Catalog FREE

Stancor's Catalog No. 140A lists transformers for all types of application. The complete listing

is enhanced by valuable charts that assure the correct unit being used at all times. Get it from your Stancor jobber.

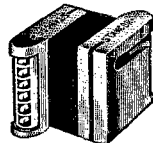

STANCOR THOROBRED

America's first safety plate transformer. The only transformer of its kind—anywhere! Your Stancor Jobber has it—be sure to see it.

STANDARD TRANSFORMER CORPORATION

1500 NORTH HALSTED STREET, CHICAGO

TELEGRAPH SPEED RECORDS SMASHED!

by Two
Candler
Trained
Operators

At the tournament held in Asheville, July 2, title holder McElroy beat his own championship record, made in 1935, by copying from a Creed transmitter at 75.1 words per minute for 3 minutes. McDonald, of Detroit copied 75 wpm. The tape containing the contest material was made by the Federal Communications Commission and delivered to the three judges under seal.



JEAN HUDSON, 14 years old, Candler student, won the championship in Class "B". Jean also holds the championship in Class "E" won at Chicago World's Fair in 1933 at the age of 9.

**THE PROPER
TRAINING
PLUS DIRECTED PRACTICE
IS THE ANSWER!**

No one can assume that telegraphing skill may be acquired without systematic training and without the right kind of practice. It simply cannot be done. Yet, many operators are trying to develop skill by the aid of practice alone, in the absence of systematic training and direction. McElroy, McDonald, Jean Hudson and many other skilled operators were properly trained by Candler in the necessary fundamentals, then they practiced as directed to attain skill and speed.



SEND FOR THIS FREE

BOOK OF FACTS It gives you the story of the champions and many inside tips that will help you. It is FREE, a postal will bring it to you. No obligation.

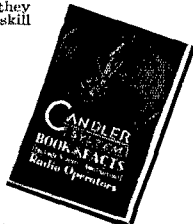

**CANDLER
SYSTEM COMPANY**

DEPT. Q-9, ASHEVILLE, N. C., U. S. A.

$$L_B = \frac{R_o}{3.14 \times f_c} = \frac{8000}{3.14 \times 5000} = 0.510 \text{ henry}$$

$$C_B = \frac{10^6}{3.14 \times 5000 \times 8000} = 0.0079 \mu\text{fd.}$$

$$L_D = m L_B = 0.6 \times 510 = 0.306 \text{ henry}$$

$$C_D = m C_B = 0.6 \times 0.0079 = 0.00475 \mu\text{fd.}$$

$$\therefore \frac{C_D}{2} = \frac{0.00475}{2} = 0.00237 \mu\text{fd.}$$

$$C_E = \frac{1 - m^2}{4m} \times C_B = \frac{1 - 0.6^2}{4 \times 0.6} \times 0.0079 = 0.00211 \mu\text{fd.}$$

If the closest values of commercially-available condensers are chosen for the filter, the impedance and response characteristics will not vary appreciably from the desired values. The inductance L_D will be similar to a small power filter choke and should have an air gap to prevent core saturation and to have the desired inductance with the normal d.c. plate current flowing. It should be adequately insulated for the voltage of the circuit and preferably be potted in compound to prevent "talking." The required choke can be designed from data available elsewhere or any of the transformer manufacturers will make one of the required inductance on special order.

DX on 56 Mc.

(Continued from page 58)

Watertown, S. Dak., and W9AZE, Bellingham, Minn. W5EIN is running 130 watts to a 35T final with vertical antenna, and for receiving uses an RME69 with 3-tube converter. W5AJG worked W9ZUL, Wilmette, Ill., at 8:40 A.M. CST, then no more action until 7:10 P.M., when he heard W9AZE, 7:55 P.M. heard W8QDU, and 8:35 P.M. worked W6QLZ. **July 13th:** W6QLZ worked W9ZJB at 7:30 P.M. MST, reporting poor signals. W5AJG had a good fling from 6:30 to 7:30 P.M. CST, working W8FXM, W8LJP, W8QDU (Mobile), W8SBY, W8BJG, W8RFW, W8MHM, W9UOV, W9VHG; hearing W9SQE and W8ODY. **July 15th:** W2AMJ heard W4EDD and W4DRZ, 9:23 A.M. EST, was heard by both but contact not established.

July 16th: At 8:45 A.M. CST W5AJG heard W3EIS (c.w.) and at 10:10 A.M. W3RL, both quite weak. Between 8 and 9 P.M. CST, AJG heard W8KLQ, W9ZUW, W3HKM; these three also weak. W5EIN logged W9BJV (7:10 P.M.), W9USI (7:30 P.M.) and W9WDA (7:31 P.M.). **July 17th:** W9ZJB was heard at W6QLZ during the evening. A fair opening between 6:30 and 7:30 P.M. CST brought W5AJG contacts with W9BJV, W9ZHB, W9WDA, W9PZI, W9USI and W9AZE; W8GRB was heard. **July 19th:** W5EIN logged W9ARN at 7:20 P.M.

July 27th: This was one of the days that really counted. It almost equalled the date of July 24, 1938, when the first W1-W6 56-Mc. contact took place. As it is we can record contacts between VE3 and Texas, between VE3 and Florida, between W3 and Arizona, and many other



OUR NEWLY HATCHED

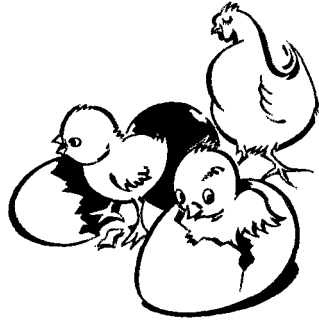

WE have recently reared a new brood and are as pleased as Punch to present them for your inspection. The young ones follow the old family tradition with a background of good breeding (which is to say sound engineering design), and a careful upbringing in our factory. Their entry into the world is sponsored by the hundreds of IRC jobbers who carry a ready stock and make them easily available for your Fall rebuilding.



Particularly useful will be our new type "D" Midget Potentiometers, which have all the features of the larger controls — the pigtail connection to the rotor, phenolic element, and 5-finger contactor. They will help the trend towards smaller receivers, speech amplifiers, etc. (If you do service work you will be interested in the complete array of plug-in shafts and friction drives.)

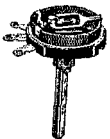

An entirely new line of Wirewound Controls (Type W) is available for applications up to 2 watts total dissipation. They run from

6 up to 10,000 ohms and are 1 1/4" diameter. They, too, have the pigtail connection to the rotor, eliminating one sliding contact.

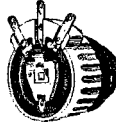

The IRC All-metal Power Rheostat is now also made in a 50 watt size, Type PR-50. It comes up to 10,000 ohms and makes a honey of a bias control for power stages — real panel control with no danger of shock. The ribbed, die-cast housing keeps the full load temperature rise down to 140 degrees C. and the familiar design features, pigtail connection, etc., are all there.



The other newcomers are a line of Step-type Attenuators for the highest quality speech input equipment, theatre work and similar applications. They include every trick we know which will contribute to smooth action and the lowest possible noise level maintained over long periods of field use. They come in potentiometer types, ladder pads, and Bridged "T" pads and, we believe, are as fine as the art offers.

STOP IN at your IRC jobber and see these new gadgets and get one of our new catalogs.

INTERNATIONAL RESISTANCE COMPANY • 401 NORTH BROAD STREET, PHILADELPHIA, PA.

ADVERTISEMENT

Announcing

TWO NEW LINES OF HIPOWER

(Super-Active)

LOW DRIFT
CRYSTAL
UNITS
for
160-80
40-20
METER
BANDS

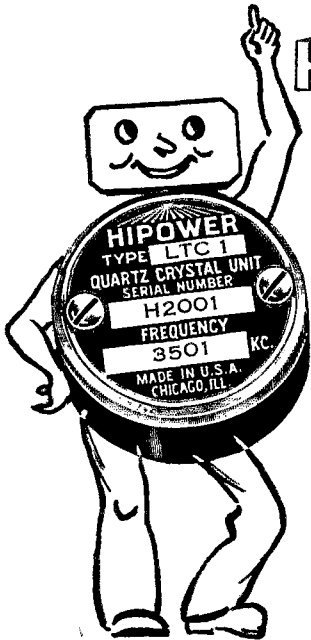

You OSO with R9's using these sturdy, super-active, Low Drift Crystals. Hipower "Rubies" and "Emeralds" completely cover the amateur spectrum. Now get better quality Low Drift Crystals for every amateur frequency.

HIPOWER "RUBIES"

Truly the ultimate development in Low Drift Crystals. Cut and precision ground from the finest Brazilian Quartz. These Crystals stay put and insure you schedule regularity month after month. Hipower "Rubies" meet your most exacting needs. Hipower "Rubies" have a temperature coefficient of 4 cycles or less per MC per °C.

CRYSTAL AND HOLDER COMPLETE

For 160-80-40 meter bands—Complete unit.....\$4.50
For 20 meter band—Complete unit.....\$7.25

HIPOWER "EMERALDS"

Now get quality Low Drift Crystals at X cut prices. These fine crystals combine good characteristics, workmanship, quality and material. Hipower "Emeralds" have a temperature coefficient of 10 cycles or less per MC per °C.

CRYSTAL AND HOLDER COMPLETE

For 160-80-40 meter bands—Complete unit.....\$3.35
For 20 meter band—Complete unit.....\$5.50

SEND FOR DESCRIPTIVE FOLDER

Send now for big descriptive folder. Gives amateur spectrum and catalogs, units showing frequencies, types and prices.

AVAILABLE NOW AT YOUR PARTS DISTRIBUTOR OR WRITE

HIPOWER CRYSTAL COMPANY
2035 CHARLESTON ST. CHICAGO, ILL.

sizable hops. W5AJG reports as follows: "We had an excellent opening of the 56-Mc. band on the 27th. Best this year. The time was between 5 and 8 p.m. CST. Some 25 stations were worked including Canada, which is quite rare here in the 5th district. Signals were high grade, little fading and extremely loud. Worked: W1KLLJ, W2CUZ, W2HGU, W3BYF, W3BZJ, W3CYW, W3FJ, W3FBH, W3RL, W3HDC, W6KTJ, W8NYD, W8CLS, W8CIR, W8MHM, W8RUE, W8FXN, W8OLX, W8SKR, W8PK, W8LZN, W8NED, W8GGA, W9NRA and VE3ADO. Heard: VE3TW, W8EID, W8QQS and W2MO. Lots of other signals, band being packed and jammed, and couldn't get to any more. Boy! the best opening I have ever heard on 56-Mc." W8PK's log shows contacts with W5AJG (7:13 p.m. EST), W9AHZ (7:17 p.m.), W6QLZ (7:35 p.m.), W6KTJ (7:55 p.m.), W9ZJB (8:24 p.m.), VE3ADO (9:01 p.m.). 8PK also heard W9GHW, W4EDD and VE3TW. Among those heard at VE3ADO were W4AUU, W4DRZ and W5FYF. VE3ADO was operating portable at Port Colborne, Ont. VE3TW, St. Catharines, Ont., worked VE3ADO (6:10 p.m. EDST), W9GHW (7:05 p.m.), W4DRZ (6:55 p.m.), W9ZJB (8:00 p.m.), W9AHZ (8:15 p.m.), VE3DC, W8SOK, VE3ZB (3-way, 11:30 p.m.), heard W1KJP, W8NZ, W1KUD, W4EDD, W4AUU, W5FYF, W6KTJ, W9MY. VE3TW uses an 8JK 2-section vertical antenna, 40 feet high, a crystal-controlled transmitter, and for receiving, 1851 r.f.-6C5-76-6F5-41.

W3RL, Herndon, Va., got in some good licks July 27th, working W6QLZ (7:48 p.m. EST), W9AHZ (7:58 p.m.) and W5AJG (8:04 p.m.), hearing W6KTJ, W9USI, W4FBH, W4EDD and W9ZJB. Of the 27th, W6QLZ writes: "No signals came through until about 5:00 p.m. MST, when I heard a W2 sign with W9. There was a Y in the W2's call and I heard Long Island mentioned. Contacted W9ZJB about 5:15 p.m. From then on it was a mad scramble. Band in and out in periods. W4EDD was heard at 6:14 p.m. Heard W9GHW also call W4EDD. The second-hop stations were better than the one-hop ones. W8PK and W3RL were very good and evidently in center of second-hop. W8CIR was just inside the zone and W3BZJ just on outside. A frequency modulated signal on 42.8 Mc. (W2XMN?) was S9 until 7:45 p.m., when he went out. Then the W7's rolled in for over an hour. Signals better than July 24th last year and south skip in across Texas, which didn't occur last year. Contacts: W9ZJB (5:20 p.m. MST), W3BZJ, Glenside, Pa. (5:35 p.m.), W8PK, East Bloomfield, N. Y. (5:40 p.m.), W3RL (5:50 p.m.), W8CIR (6:10 p.m.), W9ZHB (6:40 p.m.), W7AVO, Portland, Ore. (7:15 p.m.) and W7FDJ (8:15 p.m.). Heard also were W9AHZ, W9GHW, W4EDD, W5AJG and unidentified W2." D. D. Warnock of Converse, Ind., with a single-tube receiver (6V6G) and half-wave vertical antenna, tapped 14 inches off center, heard W4EDD between 6:50 and 7:10 p.m. CST calling W9AQQ. From 7 to 8:35 p.m. EDST, VE3DC logged W9GHW, W5AGG, W9AHZ, W4AUU and W9ZJB. W9GHW worked

BEFORE BUILDING

(or rebuilding)

YOUR RIG

*Maximum
Efficiency
and Flexibility
in any circuit*

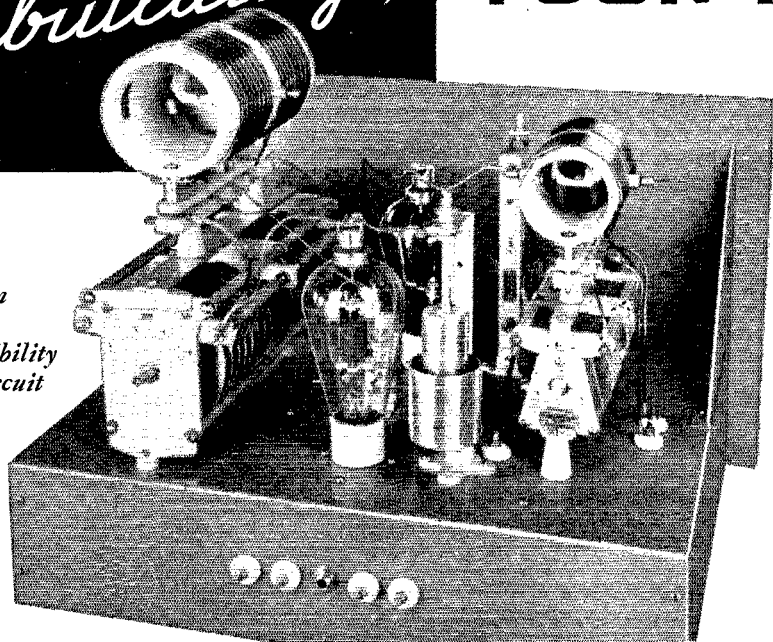

SEE THESE JOHNSON UNITS!

JOHNSON CONDENSERS

KNOWN for their fine precision workmanship and superior materials, Johnson Condensers are chosen everywhere by exacting buyers because they meet requirements in every respect. Hundreds are used daily in commercial and amateur transmitters, diathermy equipment, etc. There is a Johnson size and type no matter what you need from the tiny Type J (small enough to fit inside Johnson Tube Socket Inductor) to the big Type C available in spacings to handle more than a full kilowatt.

JOHNSON INDUCTORS

MANY new improvements feature Johnson Inductors such as low loss, heat and moisture proof high grade porcelain forms, integral coupling coil for feeding both high and low impedance lines, and proper inductance to insure minimum harmonic output. Two sizes are available rated at 1,000 watts and 350 watts input respectively. Also Tube Socket types for exciter and low power amplifier stages rated at 100 watts input.



*"LOOK FOR THE
VIKING HEAD"*

*Ask your jobber or write us for catalog 966J
with complete description and prices*

E. F. JOHNSON CO.

WASECA, MINNESOTA

EXPORT: 25 WARREN ST., NEW YORK, N. Y.

"MANUFACTURERS OF RADIO TRANSMITTING EQUIPMENT"

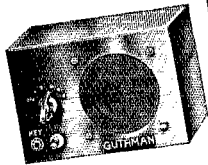

U-35 Keytoner
 .. for Learning Code
 .. FB for Improving
 Your "Fist"

The new GUTHMAN Type U-35 KEYTONER was just what the boys were looking for at the trade show. A simple a.c.-d.c. audio oscillator with choice of 5 tone frequencies between 200 and 3500 cycles, it definitely discourages application of the "left foot" to the key. Just plug in a key and it's just what the doctor ordered for code practice — with speaker volume enough for individual or good-sized code class.

Only 7" x 5" x 4", the "KEYTONER" is a worthwhile addition to any rig. The complete kit, ready to wire in a jiffy, costs only \$6.90 net — or \$9.90 completely wired and tested. One 70L7GT beam power-rectifier tube is needed, at \$1.35 net.

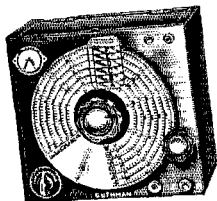

U-10A
 First and Foremost
 Precision
 Frequency Meter
 Monitor

The new GUTHMAN U-10A Frequency Meter-Monitor is an improved model of the well-known U-10 used by broadcast, police and such outstanding amateur stations as W6USA. It is four precision measuring instruments in one. As in U-10s, it is a direct reading frequency meter of high accuracy and stability for 5, 10, 20, 40, 80 and 160 meter amateur bands, as well as a monitor for signals in these bands. In addition, stable 100 kc. calibration oscillator is now built in to give checking points every 100 kc. right up to 15 megacycles. A cathode ray tube has been added to visually indicate frequency shift between transmitter and U-10A — it is now a visual frequency deviation indicator.

We think the U-10A is the best frequency measurement "buy" you can make. In it you get a direct reading frequency meter, monitor, 100 kc. calibration ("Standard frequency") oscillator and a visual frequency deviation indicator — at no increase in price because of the large sales which have made this possible. And in line with regular GUTHMAN policy of non-obsolescence, U-10s in use can be converted to U-10As for \$9.90 net, by prepaying your U-10 (with tubes) to us.

U-10A wired and tested. . . . \$29.25 net
 U-10K tube kit, 6 tubes. . . . 5.85 net

See the new GUTHMAN items at your jobber — or order direct giving us his name if he's out of stock.

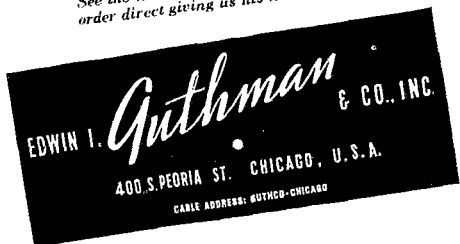

VE3TW, VE3AYN, VE3AHT and VE3AVQ. VE3DC is using P.P. HK24's with 35 watts input, 956-955 receiver, and Yagi six-element beam. W2AMJ, Bergenfield, N. J., worked W4DRZ at 9:59 P.M. EST, heard W4AUU, 9:06 P.M. July 28th: W2AMJ worked W1DEI, Natick, Mass., 7:00 P.M. EST, heard W4DRZ working W1DEI, 6:50 P.M. EST. July 29th: W2AMJ heard W9AHZ and W9ZJB, 6:03 P.M. EST.

— E.L.B.

★ **A.R.R.L. QSL BUREAU** ★

For the convenience of its members, the League maintains a QSL-card forwarding system which operates through volunteer "District QSL Managers" in each of the nine United States and five Canadian districts. In order to secure such foreign cards as may be received for you, send your district manager a standard No. 10 stamped envelope. If you have reason to expect a considerable number of cards, put on an extra stamp so that it has a total of six-cents postage. Your own name and address go in the customary place on the face, and your station call should be printed prominently in the upper left-hand corner.

- W1 — J. T. Steiger, W1BGY, 35 Call Street, Willimansett, Mass.
- W2 — H. W. Yahnel, W2SN, Lake Ave., Helmetta, N. J.
- W3 — Maurice Downs, W3WU, 1311 Sheridan St., N. W., Washington, D. C.
- W4 — G. W. Hoke, W4DYB, 328 Mell Ave., N. E., Atlanta, Ga.
- W5 — E. H. Treadaway, W5DKR, 2749 Myrtle St., New Orleans, La.
- W6 — Horace Greer, W6TI, 414 Fairmount Ave., Oakland, Calif.
- W7 — Frank E. Pratt, W7DXZ, 5023 So. Ferry St., Tacoma, Wash.
- W8 — F. W. Allen, W8GER, 324 Richmond Ave., Dayton, Ohio.
- W9 — Alva A. Smith, W9DMA, 238 East Main St., Caledonia, Minn.
- VE1 — L. J. Fader, VE1FQ, 125 Henry St., Halifax, N. S.
- VE2 — C. W. Skarstedt, VE2DR, 236 Elm Ave., Westmount, P. Q.
- VE3 — Bert Knowles, VE3QB, Lanark, Ont.
- VE4 — George Behrends, VE4RO, 186 Oakdean Blvd., St. James, Winnipeg, Manitoba.
- VE5 — H. R. Hough, VE5HR, 1785 First St., Victoria, B. C.
- K4 — F. McCown, K4RJ, Family Court 7, Santurce, Puerto Rico.
- K5 — Norman F. Miller, K5AF, 15th Air Base Squadron, Albrook Field, Canal Zone.
- K6 — James F. Pa, K6LBH, 1416D Lunalilo St., Honolulu, T. H.
- K7 — Jerry McKinley, K7GSC, Box 1533, Juneau, Alaska.
- KA — George L. Rickard, KA1GR, P. O. Box 849, Manila, P. I.

FIGURE TIME PAYMENTS TO SUIT YOURSELF

Buy the Easy Way — on Newark's 6% Credit Plan

1. SEND 20% DOWN PAYMENT WITH YOUR ORDER TODAY
2. ADD 6% CARRYING CHARGE TO THE BALANCE DUE
3. DIVIDE INTO EQUAL MONTHLY PAYMENTS, 12 OR LESS

A HAM RECEIVER FOR THE HAM

National's Latest NC-101-XA Only \$25⁸⁰ Down
Cash Price \$129.00

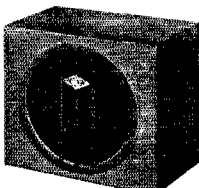
Balance of \$104.20 (including 6% Carrying Charge) payable in equal monthly installments over any desired period up to 1 year.

This receiver is the same as National's famous NC101X except that it has the *Direct Reading Dial* as used in the NC101XA.

ALSO NATIONAL'S NC101X . . . for those preferring the Micrometer Dial. Same Price and Easy Terms.

COMPLETE with Tubes, Crystal and SPEAKER in Cabinet to Match

★ ★ ★ ★

National's New "NHU"
on Easy Payments, too!

Yes . . . as always . . . Newark will have the very latest in ham receivers . . . on the same 6% Easy Credit Plan. Write for details, prices and terms on this New National NHU.

★ ★ ★ ★

PLATE AND FILAMENT TRANSFORMERS

600 VOLTS 200 MILS
Special NEWARK value!
Famous plate and filament transformer made for us only. Thousands used in Ham rigs. 600-0-600 at 200 M.A.; 2.5v. at 10 amps.; 5v. at 3 amps. 7.5v. at 3 amps. Weight, 10 lbs. Use this transformer for your buffer and final amp. stages. Just the thing for 46's, T20's, 807's.
Price (N1000) **\$2.95**

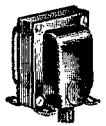

OTHER RECEIVERS AVAILABLE ON OUR 6% TIME PAYMENT PLAN

Simply Deduct Your Down Payment from the Cash Price. Then Add 6% to Balance and Divide by the Number of Months You Want to Pay.

	Cash Price	Down Payment
NATIONAL NC100XA	\$142.50	\$28.50
NC 44	49.50	9.90
NC80-81X	99.00	19.80
HRO DeLUX	179.70	35.94
HAMMARLUND HQ120	129.00	25.80
RME 70	138.60	27.72
69	152.88	30.58
70 DB20 Combination	181.80	36.36
HALLICRAFTERS SX 24	81.50	16.30
SX 23	127.50	25.50
SKY BUDDY	29.50	5.90
SKY CHAMPION	49.50	9.90
SKY RIDER 510	69.50	13.90
SKY RIDER		
MARINE	64.50	12.90

Oil Filled, Oil Impregnated FILTER CONDENSERS

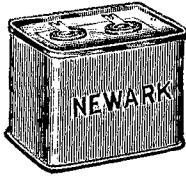

NOW \$1⁰⁰

1000 V. DC. 2 MFD. Size 2 3/4" x 1 1/4" x 1. Weight 1/2 lb.

These are well-known makes, guaranteed at rated voltages. Only a few left of each.

DC Volt	Mfd.	Size	Wt.	Price
2000	2	4 1/4" x 3 1/4" x 1 1/4"	1 1/2 lbs.	\$1.50
1250	3	3 1/4" x 3 1/4" x 1 1/4"	1 1/2 lbs.	1.25
1250	3	3 1/4" x 3 1/4" x 1 1/4"	1 1/2 lbs.	1.25
1500	3	5" x 3 1/4" x 1 1/4"	1 1/2 lbs.	1.50
1500	4.4	5" x 3 1/4" x 1 1/4"	1 1/2 lbs.	1.75
1500	5	3 1/4" x 3 1/4" x 1 1/4"	1 1/2 lbs.	1.50
2000	8	5" x 3 1/4" x 1 1/4"	2 1/2 lbs.	2.75

Get Your Mims Signal Squirter ON EASY PAYMENTS, TOO!

MIMS RADIO CO. has appointed NEWARK as distributor for MIMS SIGNAL SQUIRTER. Now you can buy it on easy terms. Write for prices and payment plan.

Your CALL LETTERS in GOLD 10c

Big shadowed decalcomania letters nearly TWO INCHES high. Put them on your HAM SHACK door, auto window, etc. Send dime for yours today. Be sure to give your call letters.

ALL SETS COMPLETE READY TO USE Shipped in Brand New Original Unopened Factory Cartons

Order Direct from This Ad. Include sets and parts in same order, on Newark's Time Payment Plan.

We Now Stock Full Line Browning Labs Equipment

. . . including the Famous Browning Pre-Selector . . . Visual Frequency Monitor . . . Coil Assemblies . . . Tuners . . . etc. include them with a receiver on your time payment order. Or write for details.

Free! OUT SEPT. 15 NEWARK'S BIG NEW CATALOG

Thousands of items for the Ham. Sets, parts, accessories, and supplies, fully illustrated and described, with lowest prices. Newark's most complete Amateur Radio Catalog.

SEND FOR YOUR COPY TODAY!

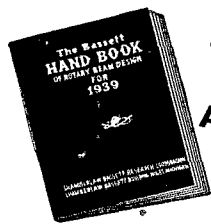

NEW BASSETT BEAM ANTENNA MANUAL

25c

42 pages chock full of real meaty dope on rotary beam antenna design, engineering and operation. The most up-to-date book of its kind on the market today.

NEWARK Electric Company

323 W. MADISON ST. Dept. Q CHICAGO, ILL.

Station Activities



CENTRAL DIVISION

ILLINOIS — SCM, Leslie M. Dickson, W9MRN — DBO has given up his call and is no longer a ham. Sorry to lose you, Elmer. KMN has new emergency rig. OTS is W.A.S. No. 890. Some of QIL's friends in the East say that he gives better service than the regular commercial telegraph companies! EBX has new 8X23 receiver. ZYP is now pres., TCK vice-pres. of the Chaokia Club. BAY, new in Chicago, uses a '47 and an HY25 doubler. I.L.N., the Illinois C.W. Net, will be all set to go in September. All hams who would like to improve their operating ability and have lots of fun while doing so, get in touch with RAIN. The I.L.N. method is "absolutely painless." GDM has schedule going again with K4KD after a lapse of ten years.

Traffic: W9QIL 1413 DDO 65 UN 47 OTS 22 MWU 15 KMN 9 BRY 3 DWQ 11 UHQ (WLTJ 337).

KENTUCKY — SCM, Darrell A. Downard, W9ARU — The Kentucky Net, which has operated on 3810 kc. for a number of years, will open up this year on 1776 kc. and will be, we think, the first State Net to operate in the so-called "160-meter" band. Full information will be published in B.G.E.C. The July meeting of the A.E.T.S. was held at Fort Knox in the form of a picnic, with approximately forty attending. Although "Doc" at KWO is the only amateur in Morehead, he didn't have much opportunity to get on the air during the "Flash Flood" due, it is understood, to caring for the sick and injured.

MICHIGAN — SCM, Harold C. Bird, W8DPE — Michigan Eight's: Your reporter took two weeks' vacation, visiting northern part of state. Visited 8LA at Frankfort, also 8JTK, who is sailing on car ferry between Frankfort and Manitowoc, Wis. Had chance to visit shack on board. SKE is also located here. Saw Bud, PLC, who has couple of fine poles and new rig nearly ready for season. Had dinner with the DYH's and also fine party at Dearborn with newcomer 8TRA. RGV of Mt. Clemens, through contact by radio with prominent doctor of Indianapolis, had operation performed for a paralyzed back. He is resting at Methodist Hospital at Indianapolis, and reported in good condition. The Michigan hams wish you lots of luck and hope operation was a success. PYT is at Naval Training Station at Norfolk and hopes to have rig on from there. JZD had great time F.D. MAS had trouble with masts blowing down. SWA says 1.75-Mc. boys of Detroit have a net called "ECO Net." MQG/9 is working in U.P.; has portable rig there, contacting fellows on 7 Mc. EGI is on 7 Mc., he has fine outlet to Manila. JUQ is moving to new QTH. KNP is working QMN with nice signal. NLG is operating from QTH of QGD. SNM at Harsens Isle reports conditions fine. SLW's new SX24 receiver works fine. NDL is radio officer of S. S. *Wilmette*, Naval training ship; says all radio men aboard are hams. NLV is getting all set for the season. HKT is back after cruise as communication officer on YP32 (NIFJ); these ships are 75-footers, carrying 15 men and 7 officers, powered by gas motors. JAH is still listening for new countries. SKO reports handling message for OFW, who was stranded on Turtle Island on account of boat hitting rock and putting hole in it. RJC is spending summer on 7 Mc. NXT has new portable station complete. DAQ is using parallel 6A6's in portable with good results. DK is working Coca Cola Net nightly. OCC is trying to work some DX on 7 Mc. DYH says, "QMN crystals are available for one buck each. All Mich. stations should be equipped." Ditto — S.C.M. FWU has new Sky Buddy receiver. Barney says 9ARA has rebuilt receivers for sale. AIZ is all set for the coming season. SWF will soon be on QMN with 100 watts. SSQ is putting up rotary for 14 Mc. MQT says anyone wishing dope on good preselector should write him. RYP got his rig back on after lightning nearly ruined it. NQI is moving to new QTH. Michigan Nines: GQF says Hiawatha Club is planning picnic and hamfest for Labor Day, CWR says DVC paid him a visit. YPI reports HPI and HTD applied through W.U. for A.E.C.

Traffic: W8FTW 155 (WLTJ 12) AIZ 61 TCY 59 QGD 39 QK 28 NLG/8 14 KNP 10 EGI 12 MAS 24 AHV 3 EJC 22 SWF 5 DAQ 26 DYH 15 GUN 4 FWU 2 PLC 14 JZD 7 MQG/9 2 SNM/8 3 SLW 1 MCV 2 IHR 8 SKO 2

NUV 8 FX 4 DPE-SQQ 7 TBF 3 OCC 8 DK 9 PYY 6 W9YYA 4.

OHIO — SCM, E. H. Gibbs, W8AQ — As a new season starts, there is always plenty of room for new appointments, so send in your applications for O.R.S., O.P.S. and A.E.C., fellas. We can use a couple more R.M.'s from the ranks of present O.R.S. to help in organizing the traffic set-up this year. RFF continues to lead in traffic. SJF is also pushing traffic and doing good job as E.C. in her area. KZO shoves his share on both 3.5 and 7 Mc. RMZ overhauled rig and tries vertical radiators on 7 and 14 Mc. New rig is perking at NAB. Thanks for first traffic report from OOH. NPF is proud holder of W.A.S. certificate. SJF has worked VK, PA, YV and 45 states with single 6L6 on 7 Mc. Old KLP is taking U.S.N.R. cruise this summer. SCT took Class A exam. IET has rig all set for fall traffic season. EIL, formerly in Cleveland, is in h.c. game in Buffalo and active on 3622 kc. SYG operates portable from Findlay on summer vacation. QBF rebuilt and added beam. CVZ likes his new 6V6X oscillator. Storm took JFC's 60-foot stick, but he added two new countries to make 87. MFV has new HQ-120. TPZ is new YL op in Wyoming. MWD and ODF were active on Field Day. PAK is rebuilding for 500 watts A-3 and A-1. BFB is back on with pair of HK54's and 250 watts. PSE has good results on "2 1/2" with rebuilt transceiver. PNJ built 3-element beam for 28 Mc. FHB is now on 3766-kc. c.w. in addition to 1.8-Mc. 'phone.

Traffic: W8RFF 154 SJF 94 KZO 45 EQN 43 EEQ 41 EG 35 RMZ 24 NAB 23 BAH 16 RN 13 OOH 16 QBF 9 CVZ 7 HER 6 JFC-NPF 2. (May-June: W8KZO 58 NAB 34 CRI 25 SYG 6.)

WISCONSIN — SCM, Aldrich C. Kroner, W9UIT — State Net Frequency: 3775 kc. UIT visited the Wausau gang and found them a wide-awake bunch of go-getters. The State Convention, September 2nd and 3rd, should be very successful with those fellows sponsoring it. YXH turns in his usual fine traffic total, summer conditions notwithstanding. SDG, visiting in Wisconsin, will be in the State Net soon. FHA, E.C. at Kohler, has new Howard 460. BGC is operator on Coast Guard Cutter *Antietam*, stationed at Milwaukee. OEB plans to get on 3.5 Mc. PRM and LED are working up a new net to operate on 3775 kc. This net is designed to line up Wisconsin towns in case of emergency; it operates on Tuesday nights starting at 6 p.m. ZTO and QJB have new rotary beams. PRM moved to new QTH. OBZ has new signal shifter. RLB is building new 500-watt rig.

Traffic: W9YXH 340 OEB 16 EYH 14.

MIDWEST DIVISION

IOWA — SCM, L. B. Vennard, W9PJR — AJI is new E.C. at Cedar Rapids. QQQ is new E.C. at Ft. Madison, with 750-watt A.C. job. BHW is new Burlington ham. FNT got a.c. generator for his emergency job. QED sent fine bulletin of N.L.R.T.A. at Mason City. ZQA needs 5 states for W.A.S. BTN is running kw. on 28 Mc. REV, secy. C.B.R.O.C. at Co. Bluffs, reports that club held 56-Mc. picnic, June 25th; new club officers: B.V.Y., pres., P.G.G., treas. WTD visited Hq., had fine time. YRO built a Class B modulator. DWN got commercial ticket. YQY and UPX are on 14 Mc. PJR will be on Ia. State Net, Aug. 26th — 1759 kc. Write for new certificate. Get in on Emergency State Net, Thurs., 7:00 p.m., 1763-7 kc. Low power will do it. FB. We are short 72 Emergency Coordinators in Iowa. Get in your nominations, gang, and let's be ready when trouble comes. 73—Les.

MISSOURI — SCM, Letha Allendorf, W9OUD — High traffic man this month was QXO, who is maintaining a fine bunch of 7-Mc. schedules. AOP, new Columbia ham, has a 6L6 on 3.5 Mc. QOB is building a new beam. NIP is on 7 Mc. ZJK will be moved into the new N. G. Armory in the fall. HTR is the NYL you hear on 1.75 Mc., and JWJ has been working her 1.75-Mc. 'phone portable in Chicago for a couple of weeks. YWH has been working on the emergency set-up in K.C. EYM visited the S. F. Fair and 6USA. VDG, WNX, YTW and TGG attended the annual fish fry at Dam 53, Grand Chain, Ill. QAQ, who works for the U. S. Airways, has been transferred from Advance, Mo., probably to K.C. BLD is a new ham at Advance. TGG uses a Harvey UHX-10 on 28-Mc. 'phone from a 32-volt light plant, and is building a 3-element close-spaced rotary beam. WIS is new O.R.S. KEF has been working on an all-wave converter for car radio. VMH is rag-chewing on 1.75-Mc. 'phone. KIC spends most of his time rag-chewing and DXing. OWD schedules other 56-Mc. stations. KIK is still delivering

St. Louis traffic. TGN took Naval Reserve cruise on the Lakes. SRH is back from Indiana U. with her M.A. in Math. PST has new Jr. op. NSU has new 7-Mc. rig. OUD has new 7-Mc. doubler for receiving or transmitting. PYF will receive the Missouri Traffic Cup, at present held by AJJ who is now in Salina, Kansas. High traffic stations for the last season were OUD, PYF and QXO. All stations interested in traffic schedules for next fall, please advise. The M.E.N. is maintaining a weekly coverage of the 3.5-Mc. c.w. band at 8 A.M., Sunday, with OUD and QCO as control stations. Thanks for the news, and keep it coming.

Traffic: W9QXO 199 OUD 91 KJK 23 WIS 13 TBU 11 HIC 9 VMH 3 KEF 1.

NEBRASKA — SCM, William J. Bamer, W9DI — ZFC schedules west coast, attended 56-Mc. picnic at Council Bluffs, put up new antenna, and had a visit from NSH. EWO's new rig will be 6L6-807-T55. GDB is working DX on 14-Mc. 'phone. KQX has been appointed Emergency Co-ordinator and, in connection with the Radio Amateurs of the North Platte Valley, is doing a good job of emergency preparation and organizing stations in the A.E.C. MZF has a long list of DX worked on 14 Mc. EHW is using 1.8-Mc. 'phone a little. ARE came to North Platte from Iowa, where he was S.C.M., and should be a big boost to us. VST will soon be busy as Emergency Co-ordinator with the Northeast Nebraska Amateur Radio Club. TBF has new HQ120X. DHO is building modulator for YMU. ZAR has new Howard 440. AGH built a 28-Mc. transmitter. YRM is rebuilding. Winside gets two new stations — 7HHG is at C.C.C. camp and 9MHA is teaching there. WGL received his Class "A" ticket. KQX is using a new rotary beam on 14-Mc. 'phone. MGV is moving to Hemingford. RGK completed an all-band portable. INR is using 7 Mc. and has new receiver. AZT is waiting for his African cards for W.A.C. confirmation; has worked them all on 28 and 14 Mc. CDL, new station at Scotts Bluff, is starting on 7 Mc. RWV plans to go on high power on 1.75-Mc. 'phone. WKP has been experimenting with antennas and new portable equipment using vibrapack. WOA had portable transmitter near Dorchester during his vacation. LEF is building portable. TQD had two days' visit from his friend, 80NK of Detroit. DMY and DI had visits from 9TQD and 80NK, and took in the fair at N. Y. PLO is using various bands on c.w. DI and TQD visited YNS. CSW is using 1.75-Mc. 'phone some during the summer. RDT is on 7 Mc. NFO was at Fairbury several days and visited many hams in the vicinity. FDX had visit from RWV, and is using 1.75-Mc. 'phone almost daily. The Emergency 'phone Net is still going strong during summer. The South East Nebraska Radio Club held its July meeting at LPU at Brownville, and elected officers: EDY, pres.; OWR, vice-pres.; DLK, secy. The amateurs of North Platte Valley had a picnic at Lake Minatare. The club is going strong after organization for emergency preparation. The Northeast Nebraska Radio Club held its annual meeting in June at MJL, and elected officers: Pres., RWN; Secy., MPY; Treas., JED.

Traffic: W9ZFC 220 GDB-DI 3.

DAKOTA DIVISION

NORTH DAKOTA — SCM, Anton C. Theodos, W9WWL — Greetings from your new S.C.M., fellows. Following are new calls: AFK, Minot; NBX, Flaxton; ABQ and ABT, Bo Bells; JMF, Portal; BBY and LMA, Flaxton; HBR, Rawson. JYN visited WWL. WWL and XYL visited ERR and NBX (Mr. and Mrs. to you). DHQ moved to Mandan. CGM, who was in Mandan, moved to Moorehead, Minn. NZC joined Engineering Staff at local BC station, where NUK was promoted to Chief Engineer. IDR is working portable from Kildeer. YJW joined the C.C.C. at Foxholm. LYH, PQW and UJH joined A.E.C. How about a few more applications for A.E.C.? Also need some Co-ordinators and an O.O. in this Section.

SOUTH DAKOTA — SCM, A. L. Russell, W9VOD; SEB: R.M. The big news is the State A.R.R.L. Hamfest, September 3rd and 4th, at Watertown; register at the Grand Hotel. BJV, convention chairman, says lots of fun, prizes and high jinks in general will be on tap; come on out and see what the gang looks like in person. SPU writes in to say he is still in Arvada, Colo., and doesn't know where the rumor started that moved him to Kadoka. EYB takes on the big job as E.C. for the Pine Ridge Reservation area. HRR is operating SEO on 7 Mc. APT, YJX, KNV, CVR and SWV worked with Forest Service as ops during Black Hills fire. APT has new rack and panel on 7 Mc. AKO worked W6-7-

8-9 with rack and panel job during first month on air. BLK is going great guns on 7 Mc. ADJ and YOB were called used by Rapid City Club directing Soap Box derby; handled dope between start and finish lines with low-power 1.75-Mc. 'phone rigs. GCW is back on 7 Mc. after vacation in Glacier Park. AOZ is on 7 Mc. VOS has new job with Montana Utilities. GLA furnished R.C. Club with 2-kw. power supply for Field Day. YOB ran his string of countries to 10 on 14 Mc. Traffic season opens in a few days; like to see you all on 3717.5 kc.! JYL worked 42 VK's and ZL's during the first part of July, and says the boys down under are looking for S. Dak. and are on 14,360 kc.

NORTHERN MINNESOTA — SCM, Edwin Wicklund, W9IGZ — WUQ visited YXY, who is at a C.C.C. Camp. QCM is on 3.5 Mc. CBS is new Mora ham. ZTF is on 3.9-Mc. 'phone and also has a new call, CLU, for operating at Mora. YKV is on 1.75 and 7 Mc. running 40 watts input. LBR acquired an XYL. Congratulations, OM, ICU, now Class A, is getting ready for 14-Mc. 'phone. WFO is planning ½-kw. rig for this fall. KDA is using 54's. AXG, new Boyd ham, will use a battery-powered rig. CUE, new ham at New York Mills, uses an 89 ose, 6L6 amp. CGG has new three-element rotary beam for 28 Mc. LSC moved from Laporte. FEP built a wind charger. YAP has his antenna tied in a church steeple. Your S.C.M. is revamping his receiver. GKP has been appointed Emergency Co-ordinator for Duluth area. You fellows interested in traffic, how about joining the Minn. Net? Write 9LCT, 73 — Ed.

SOUTH MINNESOTA — SCM, Millard L. Bender, W9YNQ — Dick Kirby, W9LCT, Acting SCM. At this writing your S.C.M. is enjoying a vacation up at Ottertail. The State Net is really going to town now in preparing for fall activities in cooperation with the State Police. The freq. is 3795 kc. All interested write So. Minn. R.M. Those planning activity shortly: LCT, HEN, HEO, YNQ, ZLZ, MZN, HCZ, CRO, ITQ, UKB, OMC, NCS, BRA, QMW, ZOB, FXV, RIL, GNR, AGO, FTJ, USY, YAP, ICU, SYX, ZWW, BHY, BR, TOZ, ZAD, BXY, BBL, FNG, KKO, QDF; others applying every day. GLE visited FNK at Bovey; FNK moved there from Rochester in June. ZSX is busy making O.O. citations. CCF, KET, JOI and ZCF visited YNQ and WDL. JOI and ZCF are husband and wife. KUI has 2-kw. generator. Jackson County Radio Club had an outing and had a lot of fun with several transmitters. OMC has new antennae 55 ft. high. DCM rebuilt to 400 watts. NCS schedules QXO daily, 6:00 a.m. LCT schedules YXH and 6KHZ daily. Along with regular net traffic every night, LCT is listening all over high end of 3.5 Mc. for traffic calls. Minnesota Net Control is on from 6:15 to 6:45 a.m. and 7:15 to 8:00 p.m., daily, for traffic on net frequency. LCV moved to Mpls, NIW moved to Billings. BHY, Twin City Emergency Co-ordinator, has the Twin City Disaster Committee Net all in A.E.C. and the State Net. FUH of Denver visited LCT and CJX. The Olmsted County Chapter of the Red Cross bought the Emergency Corps of the Rochester Amateur Radio Club a gas-engine-driven 400-watt, 110-volt generator. Anybody like the idea of another So. Minn. Field Day? Those who went out for the last one had a lot of fun, and with more participation we could make a real event out of it. That's all 'til YNQ gets back at the helm.

Traffic: W9LCT 607 ITQ 18 ZWW 2 CRO 3 NCS 21 ZAD 1.

SOUTHEASTERN DIVISION

ALABAMA — SCM, James F. Thompson, W4DGS, R.M.'s: 4DS, 4EV, 4EVJ; P.A.M.'s: 4DHG, 4BMM; E.C.'s: 4ECL, 4CRG, 4OA. Old 4APU, our Southeastern Dir., is now 4EV, having been reassigned his old call. FB, Ben, GFQ, new ham and protégé of CIU at Guin, has a 6L6 on 7 Mc. ENO is interested in O.R.S. EAV has new Telephone 1st ticket and has P.P. 100TH's on 14 Mc. CPN has 242A and new Class A ticket. FVV, a new ham who moved in from Yankee-land, has T40 rig. CVS is rebuilding for 14 Mc. JI, an old timer, is back again. APJ has new rig: 6L6-RK18, 100 watts on 7120 kc. DEW has 150 watts to T20's on 1.75 Mc. CBI joined the A.E.C. ERM was visitor to DGS and applied for O.P.S.; he has 6L6-807 rig on 1.75 Mc. ERM is the only ham in his county and the four surrounding ones. CVM, CYL and XYL's visited ERM. FVO at Auburn had ERM for visitor. DQW, the old A.A.R.S. boss, was visitor to WMPM and DGS. DQW has call GET for rig at Ft. McClellan. DD won an 802 in the closing A.A.R.S. contest. DQW has started an ambitious antenna-building program 3.5- and

(Continued on page 104)

PRECISION TEST EQUIPMENT

As Good as it Looks!

YOU can get the REAL reason for such increasing popularity only from the instruments themselves. This photograph and specifications tell a "partial" story . . . You must see the actual unit.

Walk into ANY good parts jobber and ask to see ANY piece of PRECISION test equipment. Open it . . . examine it carefully INTERNALLY . . . note the craftsmanship and infinite care in construction and wiring . . . Compare it in quality . . . Compare it in price . . .

Series 844 — 34 Range AC-DC VOLT-OHM-DECIBEL-MILLIAMMETER



including ranges of

6000
Volts AC-DC

10
Megohms

and

12
Amperes

Provides complete facilities for obtaining all measurement requirements for Amateur, Service, Laboratory, Television and Industrial use.

- Large 4 1/2" Precision square type meter; D'Arsonval type; "bridge type" construction; 400 microamperes full scale sensitivity.
- Precision wire wound shunts and matched molded metallized multipliers of an accuracy within 1%.
- Individually calibrated and sealed against laboratory standards assuring 2% DC and 3% AC overall accuracy.

SPECIFICATIONS

- * SIX A.C. and D.C. VOLT-AGE RANGES at 1000 ohms per volt; 0-12; 0-60; 0-300; 0-600; 0-1200; 0-6000 volts.
- * SIX D.C. CURRENT RANGES: 0-1.2; 0-12; 0-60; 0-300; 0-1200 MA; and 0-12 Amperes.
- * FOUR RESISTANCE RANGES: 0-400; 0-100,000; 0-1 Meg.; and 0-10 Megs.
- * Provisions for Mounting Ohmmeter Batteries (4 1/2 and 45 volts) on inside of case.
- * SIX DECIBEL RANGES from -12 to 70DB.
- * SIX OUTPUT RANGES: 0-12; 0-60; 0-300; 0-600; 0-1200; 0-6000 volts.

844-L — Housed in walnut finished hardwood case with carrying handle. Compact in size (7 x 8 x 4). Less batteries and test leads. Net \$22.95

844-P — Closed type with removable cover and tool compartment \$24.95

STANDARD OF ACCURACY



PRECISION TEST EQUIPMENT

SEE THEM AT YOUR JOBBER

PRECISION APPARATUS COMPANY
647 Kent Avenue Brooklyn, New York
Export Division; 458 Broadway, New York City, U. S. A.
Cable Address: Morhanex

★ S. F. TRANSMISSIONS ★

Date	Schedule	Station	Date	Schedule	Station
Sept. 1	B	W6XX	Oct. 6	A	W6XX
Sept. 8	A	W6XX	Oct. 13	BB	W6XX
Sept. 15	BB	W6XX	Oct. 14	BX	W6XX
Sept. 16	BX	W6XX	Oct. 15	C	W6XX
Sept. 17	C	W6XX	Oct. 20	A	W6XX
Sept. 22	A	W6XX	Oct. 27	B	W6XX
Sept. 29	B	W6XX			

STANDARD FREQUENCY SCHEDULES

Time (p.m.)	Sched. and Freq. (kc.)		Time (p.m.)	Sched. and Freq. (kc.)	
	A	B		BB	C
8:00	3500	7000	4:00	7000	14,000
8:08	3600	7100	4:08	7100	14,100
8:16	3700	7200	4:16	7200	14,200
8:24	3800	7300	4:24	7300	14,300
8:32	3900		4:32		14,400
8:40	4000				

Time Sched. and Freq. (kc.)
(a.m.) BX

6:00	7000
6:08	7100
6:16	7200
6:24	7300

The time specified in the schedules is local standard time at the transmitting station. W6XX uses Pacific Standard Time.

TRANSMITTING PROCEDURE

The time allotted to each transmission is 8 minutes divided as follows:

- 2 minutes — QST QST QST de (station call letters).
 - 3 minutes — Characteristic letter of station followed by call letters and statement of frequency. The characteristic letter of W6XX is "M."
 - 1 minute — Statement of frequency in kilocycles and announcement of next frequency.
 - 2 minutes — Time allowed to change to next frequency.
- W6XX: Don Lee Broadcasting System, Los Angeles, Calif., Frank M. Kennedy in charge.

WWV Schedules

EACH Tuesday, Wednesday and Friday (except legal holidays), the National Bureau of Standards station, WWV, transmits with a power of 20 kw. on three carrier frequencies as follows: 10:30 to 11:30 A.M., E.S.T., on 5000 kc.; noon to 1:30 P.M., E.S.T., on 10,000 kc.; 2:00 to 3:30 P.M., E.S.T., on 20,000 kc. The Tuesday and Friday transmissions are unmodulated c.w. except for 1-second standard-time intervals consisting of short pulses with 1000-cycle modulation. On the Wednesday transmissions, the carrier is modulated 30% with a standard audio frequency of 1000 c.p.s. The standard musical pitch A=440 c.p.s. is also transmitted from 4:00 P.M. to 2:00 A.M., E.S.T., daily except Saturdays and Sundays, on a carrier frequency of 5000 kc., power 1 kw., 100% modulation. The accuracy of the frequencies of the WWV transmissions is better than 1 part in 5,000,000.

Q R V ?

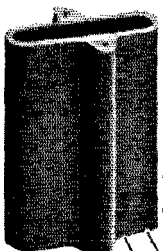

PROPERTIES	SPEER GRAPHITE ANODES
1 WARP PROOF	✓
2 HEAT PROOF	✓
3 PUNCTURE PROOF	✓
4 GAS ABSORBING	✓

1. 2. 3. Overloading cannot damage SPEER Graphite Anodes. They cannot warp, fuse, blow out or soften.

4. SPEER Graphite Anodes tend to absorb gases given off by other tube elements — help keep tubes gas-free.

Why be Satisfied with Less ?

SPEER Graphite Anodes have all these important properties. Why be satisfied with less? List of tubes with SPEER Graphite Anodes and Anode Booklet No. 80 mailed on request.



SPEER CARBON COMPANY

ST. MARYS, PA. CHICAGO CLEVELAND DETROIT MILWAUKEE NEW YORK PITTSBURGH

Ⓢ 9266

(Continued from page 101)

7-Mc. doublet, 14-Mc. rotary, all fed with EO-1. BHY has new Harvey 80T rig. AIY has 80-ft. vertical steel tower and is using it as a radiator. EYV has new rig. BKN is finishing new rig. DTN went over for Class A exam. JX still DXes. FQP has portable rig at Ormond Beach, Fla., for talking to his father, FXT, back in B'ham. The B'ham Club had election of officers: EBZ, Pres. and ERW, Treas. DGS and AUP visited B'ham Club. CUE, B'ham Club, has nice Breting 12 receiver. EOX is new O.R.S. EVJ is new R.M. for all Ala. north of Cullman County. All hams in that area are invited to get in touch with him if interested in O.R.S., O.P.S. or traffic schedules. EOX has radio telephone first ticket and took Class A exam. FXT has new all-band rig. FYF has new HY25 rig on 1.75 Mc. mod. with 2A5's, and also has new antenna. GDU and EW took portable rig to Nat'l Guard Camp near Jacksonville, Fla., to keep schedules with GDV (Mrs. GDU). GDO is new call in Mtgy. on 7 Mc. with 6L6. EFD has new radio shack. FYC bought ECF's 100TH final and TZ40 mod. to go on 28 Mc. AUP and BCU took their families and took a ham's vacation at Cheaha State Park, which is 3000 ft. above sea-level, and set up portable rigs with aircraft dynamotor for power. They had AUP's Sky Champion rigged up to operate from the dynamotor also, and with 3.9-Mc. doublets did some nice operating. EAY has mobile 28-Mc. rig in his auto. DMZ is back on 3.9 Mc. FUM has new HQ120. FAZ was visitor to DSG at WMPM. GDO visited Greenville and Evergreen gang. AUP, HB and DGS received Public Service Certificates for work in the Wetumpka flood of 1937. EV (ex-APU) has improved the e.c.o. and has 100-ke. oscillator going up. AWQ has new jr. op. Congr. OM. EV has P.P. 250TH's installed and is now a high-powered guy. EEU enjoyed seeing the movie short "Radio Hams," and says for us to watch for it at our theater. GBV and EVJ keep good traffic schedules right through summer. EBZ representing FTV was a visitor at WMPM. FTV is installing rig at the Bankhead Hotel in B'ham. BLG has new antenna for 14 and 28 Mc. FZC is a prospective O.R.S. BYW took nice trip via Army bomber, flying to West Coast and visiting 6USA, etc. The fall and winter traffic season will soon be along and DQW, ERW and RS will be glad to hear from all hams interested in joining their nets. 73 — JIM.

Traffic: W4EVJ 74 CWB 3 GBV 34.

EASTERN FLORIDA — SCM, Lewis A. Connolly, W4DVO, Asst. S.C.M., Forrest W. Dana, W4AGR, R.M.'s: 4COB, 4PEI, P.A.M.: 4DDB, DBA and COW applied for O.P.S. AKJ is "Sparks" aboard M.V. "Berlanga" hauling bananas between Honduras and Tampa. TZ is trying best AKA to Century Club. TZ added 12 countries to his list during first part of July. Hope all had great time at hamfest at Juniper Springs, July 30th, managed by WS. These 3.9-Mc. 'phone fellows know how to put things over. DNA had the misfortune to have his rig hit by a bolt of lightning, which did considerable damage. We should all remember that Florida has more lightning than any other state, and ground the antenna when not in use, or the results may be serious. DNJ took unto himself an XYL. BGL is operating at Forestry Station at DeLeon Springs. ASR on vacation visited World's Fair at N.Y.C. St. Pete Radio Club has new call, GEU, and the rig is a new Hallicrafter 500-watt. DWU is back on the air on 7 and 14 Mc. ERU is working portable at Clearwater Beach. EGL and GAD visited Miami shacks. FQR is rebuilding. COZ got Class "A" ticket and says 14-Mc. 'phone is fine business. DYZ is "Sparks" aboard S. O. Tanker "Benjamin Brewster." DWG got his first S. American station on 28.5-Mc. 'phone. DAH has 50-ft. steel pole vertical radiator. AFQ, one of our most active hams, has been transferred to Charleston, S. C., with Eastern Air Lines, and his loss is greatly felt by all. GBC has new rig with RK23 final and is getting big kick out of traffic handling. BNR is back on 28.5-Mc. 'phone with pair of 6L6's final. 73 — DVO.

Traffic: W4DVO 45 CNZ 13 DNA 62 DWU 7.

WESTERN FLORIDA — SCM, Oscar Cederstrom, W4AXP — R.M.'s: 4FJR, 4EPT, 4DXQ, FJR, Jola and EPT, Geo., are our newest R.M.'s. FJR is regular R.M. and EPT is R.M. for the A.A.R.S. 6ANU/4 from San Diego is now at Lynn Haven. GAM and FOX, returned from C.M.T.C. at Ft. Barrancas, will be back on 7 Mc. BJB is still building. CUR from Georgetown, S. C., visited his folks at Millville and dropped in on ECT at Panama City. FRQ is on 7 and 14 Mc. EZV is all set to give 28 Mc. a whirl. EGO is on 7 Mc. at times. DLO is building a 500-watt Utah rig and

will be on 7 and 1.75 Mc. EAP reports that the new radio quarters will soon be completed. MS has been working some juicy DX on 'phone, PK6XX, VK9VG, VK4HN on Papua. PK1BM in West Java and four ZS's in South Africa. Eddie is getting the A.E.C. stations lined up and affiliated with the Red Cross for emergency work. EJQ, EZL and FBN were visitors at MS. DAO is knocking them over on 14 and 7 Mc. BFD is getting on again. FHQ, from Chattanooga, is in Pensacola now, and will be heard with a swell signal on 7 Mc. Bill Mapoles, Jr., with the Motor Vehicles Dept. at Tally, is active with the A.A.R.S. 3.5-Mc. Net, is operator at SC and has own call, EIC. Milton Blake, ex-ABK, has taken exams in California, and will soon be on with a new W6 call. A queer accident happened at AXP's shack this month. Some folks were in out of a shower and severe electrical storm. One was leaning against door jamb or facing between transmitter room and radio repair shop, when an extra heavy bolt struck the transmitting antenna, inducing quite a charge in light wiring, part of wire running above door in which the man was standing and up in the attic, leaving about three feet clearance to the man's head. A charge ran down woodwork, onto his shoulder, out at ankle and on woodwork again to ground, making a slight burn at ankle, but otherwise no injury except fright. Lightning can do queer things in spite of all precautions. The transmitting antenna was grounded dead and entirely disconnected from building. Thanks for nice reports. Let's keep the ball rolling. 73 and Cheerio 'til next month. Oscar AXP.

Traffic: W4FJR 207 EPT 27 AXP 8 KB 2.

GEORGIA — SCM, Leland W. Smith, W4AGI — R.M. and E.C., 4VX and 4ECZ. The Crisp County Radio Club held its first hamfest on July 2nd, and reports a large attendance with hams from south Georgia, Alabama and Florida all having a splendid time. BB, an old timer recently returned to the air, is heard on 1.75-Mc. 'phone. VX and ECZ, touring Great Smoky Mountain National Park, have portable rig with them, keeping daily schedule with their home in Columbus. ADA, VM and DXW are on 28-Mc. 'phone. EYK continues to claim the record for YL QSO's. GCK, GDD and GFF are new comers. ERS and FWD report the A.A.R.S. 'Phone Net functioning regularly during the summer. MA is still rebuilding. AOB, with his efficient 7-Mc. schedules, continues to handle plenty of traffic during the summer. AGI lost his masts again in high winds. The new A.A.R.S. season opens the first Monday in September. Non-members who are interested in affiliating should write to 4IR, 73 — Leland.

Traffic: W4AOB 280 ERS 42 ECZ 20 AGI 19 VX 17 ANN 10 FDJ-EYK 9 FCW 4 FWD 5.

WEST INDIES — SCM, Mario de la Torre, CM2OP — Thanks to all the hams in this Section for sending good reports. K4FCV is looking for New Mexico to complete W.A.S. CM2MB is going to put up a vertical antenna. CM2AD assists S.C.M. with FB reports, and wishes to work Nevada to make his W.A.S.; his frequency: 14362 kc. CM2AF is already W.A.C. K4FHR and K4KD are pals at WMDU. CO2HY came back from Mexico. CM2FA is starting his 'phone work. CO2CC and CO2SV are also very active 'phone hams. The S.C.M. worked W1AW, WIBDI and WITS, Hqs. stations, during last O.R.S. Party. If you are interested to take a place in the activities report lists of this Section, drop me a card at once and you'll get information by return. 73.

WEST GULF DIVISION

NORTHERN TEXAS — SCM, Lee Hughes, W5DXA — BKH is active mostly on 14 Mc. and had a fine time at the Okla. State Convention at Tulsa. IDE and IDN, new Abilene stations, are active on 7 Mc. AZB is on 7 and 14 Mc. EOE left for N. Y. World's Fair and plans to visit Hqrs.

Traffic: W5BAM 152 AUL 105 DXA 6.

OKLAHOMA — SCM, Carter L. Simpson, W5CEZ — CEZ received a set of crystal headphones for winning ZCB Birthday Party in 8th C.A. FOM, back from furlough, is holding down Ft. Sill position on State Net. EIO has been doing a real service handling traffic for party in Ponca City whose wife is critically ill in hospital at Okla. City. GPT has final rebuilt and is all set to step out this fall. DAK reports all set for that cruise with the Naval Reserve on the Gulf of Mexico. HXU is a new Lawton ham. The Oklahoma State Net is continuing to operate during the summer. Your S.C.M. commends those taking part and hereby expresses

appreciation for cooperation shown during hot summer months.

Traffic: W5CEZ 235 (HESC 21) FOM 51 EIO 43 GFT 33 (WLJE 4) FSK 26 DAK 11.

SOUTHERN TEXAS — SCM, Dave H. Calk, W5BHO — MN reports the Hit-and-Bounce Net covers practically all states and is giving good service during the summer months to Panama, Philippines, Hawaii, Guam and parts of China. There are about eight stations working from 4 to 7 every morning. EWZ won first place in low-power division for W5 district in 1938 VK-ZL contest. GST rebuilt into relay rack. CVQ's garage apartment burned and also his rig; he is still active with a small portable. CTW has new steel tower and Mims 3-element rotary. HEP is putting up 4-element rotary. BB is in Maine for the summer. EUN is in Wyoming vacationing. EVH is in Calif. HBH schedules CVQ daily. GAB reports AQY on 1.75-Mc. 'phone during the summer. GAB schedules 50W every day at 5 P.M. FWB has a new receiver and worked G2, PY2 and PA. 8GSH is operating portable from Brownsville. DPA, Houston Amateur Radio Club, is active on 7 Mc. The West Gulf Division Convention will be at Wichita Falls, Texas, Sept. 8th and 9th. Your S.C.M. will be glad to see you there. EQW at Willis is a real "flea power" station. The highest plate voltage used is only 32 volts from a far light plant. Receiver is an SW3, working on 32 volts. EQW has had 350 rag chews of 50 to 600 miles using a 48 crystal and 48 final with about .5 watt input and an antenna only 15 feet high!

Traffic: W5OW 1149 MN 449 FDR 189 HNF 30 HBH 26 CVQ 25 DLZ 35.

NEW MEXICO — SCM, Dr. Hilton W. Gillett, W5ENI — HPV keeps five schedules. ENI kept schedules with ETM at home from portable location in mountains during vacation period. ZM is on occasionally for rag chew. CGJ, ex-S.C.M., is heard. GSD schedules HOV daily. The New Mexico Net is important for fall activities.

Traffic: W5HPV-ENI 5 ETM 2.

DELTA DIVISION

ARKANSAS — SCM, H. E. Velte, W5ABI — 5HCP is active on 1.75 Mc. BJR is revamping receiver. HFP is active on 7 Mc. DFX came through his old home town, Paragould, and saw all the boys; he is active on 7 Mc. in Camden now. HSQ is on 1.75 Mc. regularly. HWO is consistent on 1.75 Mc. HAE will be on 3.9 and 14 Mc. very soon. HWS has new vertical on 7 Mc. HBV is completing new modulator. WK and HSK, his daughter, dramatized his life in radio over WMC in one of the current ham programs over that station. GYR has new Browning Preselector. HDC has new SX24 and Browning Preselector. IAI has new rig on 7 Mc. GJL traded his Breting 9 for new Guthman U-17. HUX is putting a 211 on 1.75 Mc. as linear amplifier. IDH will be on 7 and 3.5 Mc. very shortly. GSC has his oscillator working on 7 Mc. DNS has 200 watts on 7 Mc. from the transmitter room of KLCN. ENH will be on all bands with T21, T21, T40, 190 watts. GQX is back from New Mexico Military Institute where he operated 5ZM-WLJG; he is on 1.75-Mc. 'phone. EWX has new skywire and a fine portable shack on wheels. HNR has e.c. good as crystal on all bands and has portable a.c. power now. GTS is on 7018 kc. GTS is back on the air. GWT is new R.C.C. member in Ft. Smith. GWT is new Ft. Smith ham. HWK, a fair Mrs. in Eldorado, is planning a new rig for "2½ meters" and would like to hear from any of the gang interested in this band. Write her. ABI has new 100-watt rig under construction. GYR has been appointed O.P.S. GNV keeps 7-Mc. schedules with EIB. GCV is back in L.R. IGY in Smackover has FB 1.75-Mc. 'phone with over 100 watts input. BCZ has very consistent 1.75-Mc. 'phone in L.R. and goes to town on 40 watts. HLW has rig in new cabinet. ICF is expected on 7 Mc. in L.R. soon. ICG and ICN are new hams in L.R. GUG spends quite a bit of time on 14 Mc. GQG breaks through summer static nicely on 1.75-Mc. 'phone — HLW worked Canada on 1.75-Mc. 'phone in June, and BCZ worked 6NUR in San Francisco on 1.75-Mc. 'phone. B & SB Net still holds together on 3.9-Mc. 'phone. HTJ is now at New Iberia, La.; DMR did a little visiting around L.R. on trip to Alexandria, La. The "Hoodlum" Net works daily on 1.75-Mc. 'phone, and the Arkansas Section is kept well in hand by HNK, QI and GED.

Traffic: W5GNV 5 ENH 7 HNR 69 GTS-HFP 1 GED 1. LOUISIANA — SCM, Eugene H. Treadaway, W5DKR — R.M.'s: 5BN, 5DWV, 5GHF. P.A.M.'s: 5CXH, 5GUX. E.C.'s: 5DAQ, 5EGK, 5FSI, 5MH. O.O.'s: 5DAQ, HVI is

active in Baton Rouge after a long lay-off; his old call was 5WD dating back to 1921. HMV has been keeping 28-Mc. 'phone schedules with K5AT. GMR has new rig running 400 watts on all bands and an FB 3-Element rotary beam on 28-Mc. 'phone. FVD has new NC44. GPE is making a comeback. DRX visited FVD. ERV is O.P.S. and does a great job on 28-Mc. 'phone. DXW changed QTH to Texas-kana. AGZ and DXL visited ERV. EBB changed QTH from New Orleans to Shreveport. EQP is putting in pair of HK 254's. GTP is building new rig using 825 final. GMO has a new op at his shack; the visitor is ELR. GHR is active e.w. station working 3.5, 7 and 14 Mc., and handling traffic. The Alexandria gang organized a club under the name of Red River Radio Club; officers elected: AXD, pres.; GUX, vice-pres.; HJJ, secy. and treas. JW and his FB coaching have made it possible for several youngsters to pass the exams and become new and active stations in New Orleans; we present IAO, IBD and HTU. Take a bow, boys. EDY is again breaking into the DX column. FMO has an FB new shack. CXQ has new rotary beam. GND is telling the Fifth District boys about all the DX cards at the QSL Bureau and how to get 'em! CJO gets FB reports on his new homemade mike. AOZ is pounding brass on 7 Mc. AEH built a keen new receiver. GUK is building new rig. DKR visited 4DSF at Atlanta, Ga. HRD has good-looking streamline homemade mike. HHT is looking for 28-Mc. 'phone contacts. HOU is new vice-pres. of New Orleans Radio Club. FMO is erecting new 35-foot tower for rotary beam. GMF is building complete new station. DAQ operates 7 Mc. every Sunday with The Gulf Coast Storm Net. AOO and DAQ visited BUK. FCZ put in a modulator. 4DMQ visited DAQ. HUT is getting 89 reports from across the pond since using his new three-element rotary, and is proud owner of new HQ12OX receiver. HQN is working portable in New Iberia. 9BUC is now 5HNV in Lafayette. GPS and GRE work lots of nice DX. GDU and GHV have nice signals on 14-Mc. 'phone. GMR reports hearing 6ATZ on 56-Mc. 'phone Q5 S6 at 10:45 A.M., July 4th. FVD reports the gag returned from the Tech Radio Club Field Day trip sleepy, hungry, and chewed up by mosquitoes and red bugs, but the gang enjoyed working 66 stations with three rigs; the location was at Rogers camp in the wilds of Black Lake Swamp. The Monroe Amateur Radio Club runs a code class three nights a week for the beginners. DKD, back in Monroe, is punishing 7 Mc. FVD and GPE are working 7 and 14 Mc. HEJ and HEK have 400 watts to a '52 on 14- and 28-Mc. 'phone. IDK opened new station with commercial rig, and lightning hit antenna and burned up transmitter and receiver! But he grinned, overhauled outfit and is back on 1.75-Mc. 'phone. 4CNW of Memphis is visiting with Monroe gang. HOS is QRL at new QTH. DXL is rebuilding using T55's in final. BDJ returned to Monroe from Baton Rouge. HFN changed QTH to New Iberia and will operate 7 Mc. EPQ is building a kw final. GTP moved from the dining room to a keen new shack in the attic. ADJ is active on 1.75-Mc. 'phone. AXU is receiving a flock of nice DX cards. KC, DGB and AAT are doing a great job in Plaquemine. EQP enjoys 14 Mc. HLH burns up 14 Mc. with his homemade e.c.o. CTU, with his 46's, is working out nicely. HNJ has NC-101X. HCM, after building his sixth rig, is planning another. IAO has lots of fun with a 6L6 oscillator. ECO has new HRO receiver. Our Section's Emergency program is going forward under the leadership of the following Emergency Coordinators — DAQ, New Orleans; EGK, Monroe; FSI, Alexandria; and MH, Baton Rouge. All active stations are called upon to join the Emergency Corps. HMW has new rig. HCY has new modulator. ACY is working plenty of DX. EVS is still working up activity for the N.O.R.C. gang. DXX would like to see more activity in New Orleans on the 1.75-Mc. 'phone band. FUS wants the gang to meet him on 56-Mc. 'phone. EGG has his 807 e.c.o. perking P.B. AFW makes trips to New Orleans for his DX cards. BRR likes plenty of power. FZQ works DX with his one-tube oscillator. IBD is building a receiver. BN, the old brass pounder, handles a lot of traffic. HHV is kept active by three ops. Many thanks, fellows, for all the swell reports. Let's hear from you all on the 16th of each month. Hope to meet you all at our coming State Convention. ICV, ex-IG, is putting a pair of 211's in final to work 1.75-Mc. 'phone. SX reports from Fort Worth, Texas. CEW is looking for a 58-Mc. contact. Once again may I remind each and everyone interested in obtaining automobile plates with our call letters on them to write the Baton Rouge Amateur Radio Club, which has full charge for the Section. GQW is on 7 Mc. with a 6L6.

Thanks for
the "Plug,"
NEWSWEEK!

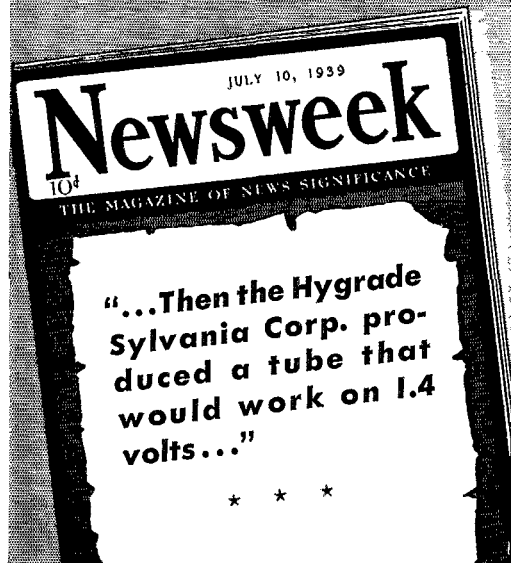

But originating the "low-drain 50 mil" tube is only one of many SYLVANIA contributions to radio

BACK of every Sylvania Radio Tube is a total of 37 years of manufacturing and research that has developed numerous improvements as outstanding as the present 50 mil low-drain battery tube.

So, when you buy a SYLVANIA RADIO TUBE — today, tomorrow or next year — you are sure of getting the most advanced scientific developments PLUS the precision engineering that the name Sylvania stands for.

SYLVANIA

SET-TESTED RADIO TUBES

Also Makers of Hygrade Lamp Bulbs

HYGRADE SYLVANIA CORP. EMPORIUM, PA.

The Yacht "Contender" Comes in First

(Continued from page 27)

originated most of the traffic for the yacht fleet, and passed it on to us through the *Matsonia* or the *Lurline*, through their Honolulu station, or direct.

Pan American Clippers were QSO'd on 6380-kc. 'phone.

Amateur schedules were kept at a minimum, in an effort to allow at least one hour or two a day for general amateur operation. This was not always possible, but ordinarily some time in the evening KLRN would come on with a "CQ 20" and soon would have the entire band calling us, making operating a real pleasure.

Eleven antennas were aboard, most of them beams, and sometimes as many as three would be up simultaneously, swung between the 100-foot mainmast and the 50-foot mizzen. Because of the elements, the phasing frames, and the feeders, this meant a very complicated system of halyards, which was very fine except when the ship had to come about. Then it took from a half hour to an hour for the operator to get the aerials in shape so that the maneuver could be completed.

The 500-kc. distress frequency proved handy in calling for special information, such as the lining up of schedules with the *Lurline*, although after schedules were once established the 36- and 24-meter bands proved much more useful. The evenings were pretty well spent in preparation for the broadcast programs, the actual rendering of the programs, and the "post mortem" hour which followed the broadcasts. At this time members of the families of the crew would be on hand at the network headquarters to talk with the crew members.

The Treasure Island Trophy for the first yacht across the line was presented to the *Contender*. The Governor of Hawaii Trophy, based on the corrected handicap time, went to the *Blitzen*. The *Contender* finished third in Class A (boats over 60 feet).

All of the boats that won cups carried harborphone radio transmitters. Perhaps the radio helped them get there more quickly. At least they had the daily use of reports as to the relative positions of the other boats, and they also could have time signals from the *Contender*, as the time signals were received once or twice a day aboard the *Contender* and relayed over the 2738-kc. harborphone frequency to all the boats.

All in all, this was a really fine radio trip. Every amateur band was used from 160 to 20 meters while the *Contender* was at dock at the St. Francis Yacht Club at San Francisco or tied up at the Treasure Island dock. While there, amateurs were worked in the Philippines as well as in Honolulu. While at sea, amateurs were contacted almost at will, and as soon as an amateur was raised we instructed him to call us "KLRN 12,390 kc.," thus building up an additional listening audience for QSO's. While at sea, amateurs were worked in Australia (thanks to W6CW), al-

Station Operating Supplies

Designed by A.R.R.L. Communications Department

★
**THE
 LOG
 BOOK**
 ★

As can be seen in the illustration, the log page provides space for all facts pertaining to transmission and reception, and is equally as useful for portable or mobile operation as it is for fixed. The 38 log pages with an equal number of blank pages for notes, six pages of general log information (prefixes, etc.) and a sheet of graph paper are spiral bound, permitting the book to be folded back flat at any page, requiring only the page size of $8\frac{1}{2} \times 11$ on the operating table. In addition, a number sheet for traffic handlers is included with each book. The LOG BOOK sells for 35c per book or 3 books for \$1.

OFFICIAL RADIOGRAM PADS

The radiogram blank is now an entirely new form, designed by the Communications Department to comply with the new order of transmission. All blocks for fill-in are properly spaced for use in typewriter. It has a strikingly new heading that you will like. Radiogram blanks, $8\frac{1}{2} \times 7\frac{1}{4}$, lithographed in green ink, and padded 100 blanks to the pad, are now priced at 25c per pad, postpaid.

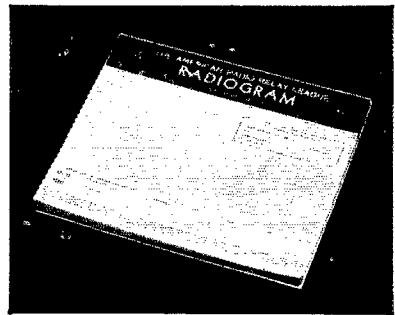

and MESSAGE DELIVERY CARDS

Radiogram delivery cards embody the same design as the radiogram blank and are

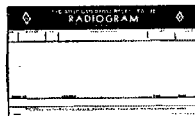

available in two forms — on stamped government postcard, 2c each; unstamped, 1c each.

AMERICAN RADIO RELAY LEAGUE, Inc.

West Hartford, Connecticut

TIBBETTS

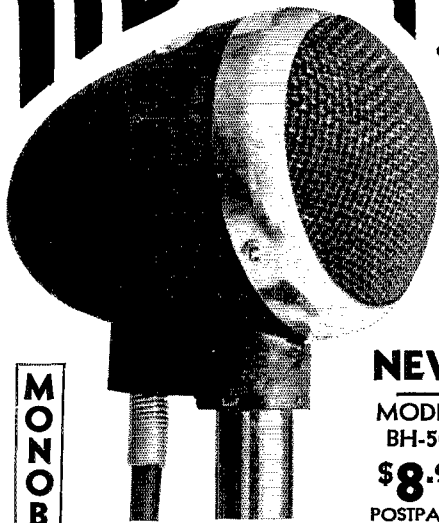

MONOBAR

NEW
MODEL
BH-50
\$8.90
POSTPAID
IN U. S. A.

OUTPUT, -42 db.
RESPONSE 30 to 8000 C.P.S.

CRYSTAL MICROPHONES

ALWAYS SHIPPED DIRECT

A FULL RANGE ALL PURPOSE INSTRUMENT—commanding leadership this season. New engineering features that make possible extremely high output with exceptional quality and by shipping direct, we save you real money. Equipped with 7 feet of cable with spring protector. Finished in baked on black crinkle enamel and polished chrome. **An Outstanding Value**—Order Direct. Other models available.

Write for descriptive literature

GUARANTEED PRODUCTS OF
TIBBETTS LABORATORIES
CAMDEN, MAINE

PRICES REDUCED!

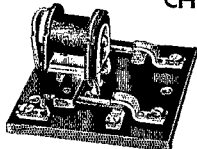

STACO
Antenna
CHANGE-OVER RELAYS

- Mycalex Insulation
- 4 Ampere Contacts
- Ball-Bearing Pivot
- Shorter R. F. Path
- No AG Chatter
- Floating Armature

Type ABA. XPLW Insulation, 110v, AC } ~~WAS \$3.00~~
Type ABD. XPLW Insulation, 6v, DC } **NOW \$2.55**
Type AMA. MYCALEX Insulation, 110v, AC } ~~WAS \$4.50~~
Type AMD. MYCALEX Insulation, 6v, DC } **NOW \$3.45**

All prices net. See your jobber or write for details

STANDARD ELECTRICAL PRODUCTS COMPANY
316 Sibley Street St. Paul, Minnesota

though due to the heavy amateur, commercial and broadcast schedules, we soon found it necessary to minimize our DX activities in favor of QSO's with the United States. There was also some pretty heavy work to be done on checking the chargers, storage batteries, answering the call "all hands on deck—and Wallace!" (The "Wallace" was necessary, otherwise the radio operator didn't pay any attention to the call.)

The *Contender* showed itself the fastest sailing boat on the Pacific Ocean. The radio may have helped, for time signals and frequent weather reports gathered daily from 40 or more ships in the Pacific Ocean were available to Captain Dick Loynes.

Increased Output with Grid-Bias Modulation

(Continued from page 48)

as in any other system of modulation, will result.

Various transmitters using different tubes and having a range of power capabilities have been tried with equally gratifying results. W6CHE has been on the 14-Mc. band with a transmitter with 1-kw. input and the ease of handling and the performance left little to be desired.

The "Runt Sixty" and the "QSL Sixty"

(Continued from page 52)

west. So far as my own, perhaps uncritical, observation goes, these get out about as well in one direction as another. As I am not interested in one-hand directional affairs, I have no idea what these rigs would do on fancy antennas. If any chap is willing to put up with ole W8QBW, I am delighted to work him and don't care whether he is near or far, east or west, or up or down! As an example, W8NGO replaced a 40-meter single wire, off-center fed antenna by a 40-meter half-wave Zepp only about 20 feet high, and he gets 579x in Arkansas using a QSL-Sixty rig. He has worked K6, G and South America. And Paul Nelson, of Fort Smith, Ark., writes me that with a QSL Forty running at less than

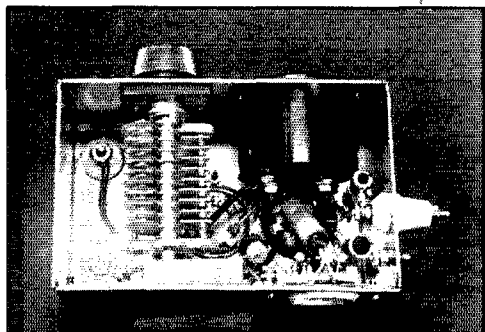

A bottom view of the "QSL 60" shows the location of parts. The stand-off at the right is for one keying lead, the other key lead going to the ground screw on the chassis.

On Our Toes to Give You Fellows the Latest in Ham Radio!

SPECIAL

Low Priced Beam Tubing
75-Watt Modulator
Tuning Inductor for Vacuum Condenser
Parts Deal on Low Payment Plan

Let's Get Acquainted
Write to W9GFQ
TODAY

	Cash Price	Down Payment	12 Months
Sky Buddy.....	\$29.50	\$5.90	\$2.08
Howard 430.....	29.95	5.99	2.11
SX-24.....	69.50	13.90	4.90
Howard 460.....	79.95	15.99	5.64
SX-23.....	115.50	23.10	8.16
HQ-120X.....	129.00	25.80	9.11
NC-101, XA and 101X.....	129.00	25.80	9.11
RME-70.....	138.60	27.72	9.79

FREE

A swell 3½' by 4½' map of U.S.A. that all the fellows are talking about. This map is worth at least one dollar — all we ask is to send 5c postage to cover mailing costs. This is just one of the reasons our house is so popular with the hams.

ASK FOR OUR CATALOG TOO



GENUINE HAM VALUES

THE TRANSFORMER BUYS OF THE SEASON

	Sensational NEW	Outstanding	6 Tube
Breting 6.....	\$32.40	\$6.48	\$2.28
Breting 9.....	\$54.00	\$10.80	\$3.81
NC-100XA.....	142.50	28.50	10.07
HRO De Luxe.....	179.70	35.94	12.70

—WRITE TO LEO (W9GFQ) TODAY—

For Satisfaction Guaranteed — No Red Tape — We Handle Our Own Finance for Quicker Service and Less Cost. Order — Today — from One of the Largest Stocks in Country.

In Stock for Immediate Shipment

A FINE XMTR AT LOW COST

Type U-36 — 6-Band Phone — CW Transmitter

6-Volt Storage Is All That's Needed for Mobile Work

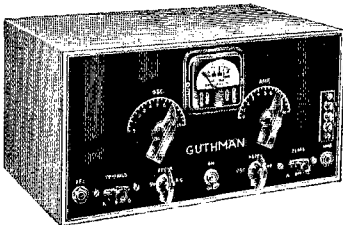

6 and 110 Volt Operation

For Home, Mobile or Portable Work

Look at These Features:

- 18 Watts Input
- 3 Position Crystal Switch
- 5 to 160 Meters
- Key Jack
- Crystal or Carbon Mike

Compact 12¼" x 7" x 7½"
U36 Kit Less Meter, Crystal and Tubes..... \$29.37
U36 T-Tube Kit..... \$3.82
Above Kit — Wired with Tubes, Meter, Crystal, ready to operate.
Our Special Price.... \$44.95

Thousands of these units are now in use. We were fortunate to buy limited number of these transformers. 1200V. C.T. @ 200 M.A. 7.5V. @ 3 amp. C.T., 2.5B. @ 10 amp. C.T., and 5V. @ 3 amp. C.T. Weight 10 lbs. Fine for buf. and final stages for use with such tubes as 46's, T-20, 807 and many others. Order now — type W101..... \$2.95

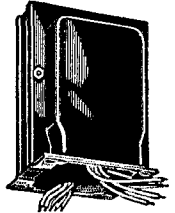

Also same transformer available with HI-voltage as stated but with 6.3V. @ 4 A. — 6.3V. @ 2.5 A. and 5 Volt @ 3 A. Type W102..... \$2.95

State which type when ordering.

- W103 — 950V. C.T. @ 200 M.A. \$1.45
- W104 — 1340V. C.T. @ 200 M.A. \$2.35
- W105 — 1400V. C.T. @ 135 M.A. and Two — 7.5V. @ 2.5 A. and 2.5V. @ 9.5 A only..... \$1.75

TAKE ADVANTAGE

of our low 6% terms on Mims Beams as well as other types. Write for low prices on wiring any kit or transmitter. We maintain special dept. for this type work.

—WRITE TODAY—

WHOLESALE RADIO LABORATORIES

Everything for the Amateur

COUNCIL BLUFFS, IOWA

W9GFQ

W9GFQ

YOUR INQUIRIES

Invited

It will pay you to write to me for any amateur equipment. You get personal attention you can't get elsewhere; 6% terms financed by myself so you can buy with less cost and more convenience; and my cooperation to see you are 100% satisfied.

I make it my business to be able to supply all amateur receivers, transmitters, kits, antennas, parts at the lowest net prices in any catalog or advertisement. I will help you get the best equipment for your use.

Order your receiver from the world's most complete stock of amateur receivers. You get ten day trial of all receivers and liberal trade-in for your receiver. Do you prefer shipment from Butler, Missouri or direct from factory?

Model	Cash Price	Down Payment	12 Monthly Payments
HQ-120X	\$129.00	\$25.80	\$9.11
RME-70	138.60	27.72	9.79
SX-24	69.50	13.90	4.90
SX-23	115.50	23.10	8.16
NC101X and NC101XA	129.00	25.80	9.11
HRO Sr.	179.70	35.94	12.70
Howard 460	79.95	15.99	5.64
Breting 9	54.00	10.80	3.81

Similar terms on all other receivers and on Harvey, Hallcraft, Temco, National, Thordarson, Utah, UTC and all other transmitters, kits, parts

THESE AMATEURS SERVE YOU:

W9AYC — W9BRN — W9DLC — W9NCO
W9ARA

★ ★ ★

You can reach me by letter, telegram, phone, or visit nearly 24 hours a day, 365 days a year. Your inquiries and orders invited. Foreign orders solicited too.

Bob Henry
W9ARA

HENRY RADIO SHOP
Butler, Missouri

rating, and a "hay-wire" antenna, he got RST 459 in Australia and 469 in Venezuela. Maybe the antenna was not so haywire at that, but it would appear that there is room for much experimentation in this field.

It is urged that means be employed to indicate antenna current, for this removes all doubt and guess-work from the tuning process, and it then becomes a simple matter to adjust for maximum antenna current with minimum plate current. An antenna current indicator that costs only a few cents but is as satisfactory in nearly every way as an expensive r.f. ammeter is described in the October, 1938, issue of *QST*.⁴ One advantage of the bulb indicator over a meter is that it can be adapted to various values of antenna current by inserting lamps of appropriate current-carrying ability. Also, there is a chart in the March, 1939, issue of *QST*⁵ which will be helpful in determining current values for the different degrees of brilliance of the pilot bulbs.

The "QSL-Sixty"

This is nothing more or less than the "QSL-Forty" with 600 volts on the plate, and there is little to say about it which has not already been said in previous articles. If the plate condenser is in good shape as to even spacing, smooth plates and freedom from dust, there will be little chance of flash-over. However, some changes are suggested. The plate condenser is replaced by a 50- μ fd. (double-spaced) job, and it is just as well to use a statite socket for the 6L6G tube. While the chassis remains the same size, 3½ by 5½ inches, some slight rearrangement of parts was found necessary, and the new template should be carefully followed. The 0.1- μ fd. paper tubular condensers were replaced by others of 0.01- μ fd. capacity. This transmitter will be found to light a 60-watt Mazda dummy to a trifle more than normal brilliancy. For the construction and constants of the coils, reference is made to the April, 1939, issue of *QST*. The power supply should be the one described in the present article.

Once more the cautionary injunction is repeated; don't sit on the key! The reason for this will be obvious when it is stated that the plate current is 200 ma. or a little more. The plate pilot bulb will burn bright white but not full (dazzling) brilliancy.

⁴ Sutter "What, No Meters?"

⁵ Page 62.



Lucky AMATEUR

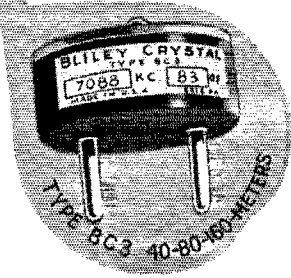
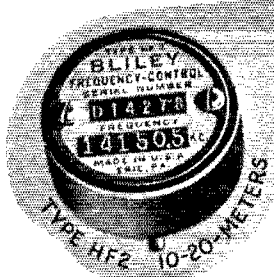

Lucky amateur! You continually demand new and better equipment in keeping with current radio development — and you get it! Furthermore, by reason of your numbers, the best equipment is available to you at the low prices made possible by savings in production.

Bliley Crystal Units are a definite example of a thoroughly engineered, technically modern and production priced product for amateur applications. Each unit is specifically designed for its particular frequency band, carefully manufactured and rigidly inspected throughout each processing step. Extreme care is taken to insure maximum performance and highest quality.

Circular A-6 contains complete descriptive information on Bliley Crystals—ask your Bliley Distributor for a copy. Bliley Electric Co., Erie, Pa.

BLILEY CRYSTAL UNITS

RADIO COURSES

New Fall Classes Start in September

RADIO OPERATING • BROADCASTING • CODE
RADIO SERVICING • TELEVISION
• ELECTRONICS — 1 year day course; 2 years eve.

Day and Evening Classes — Booklet upon request

NEW YORK YMCA SCHOOLS

4 West 63rd Street, New York City

NOW enjoy
THIS LATEST
MODEL GENUINE
VIBROPLEX

FOR AS
LITTLE AS **\$13.75**

and lower

This is the same Great New Easy-Action Genuine Vibroplex which formerly sold for \$17 — the same fine instrument that is preferred for its ease of operation, fine quality signal and all 'round satisfying performance.

VIBROPLEX JUNIOR

Smaller and more compact but in all other details the same as Vibroplex Improved Model, only **\$12.50**

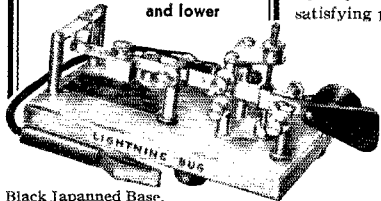

Black Japanned Base.
Nickel-plated, \$2 additional.

This unusual low price offer is limited and may be withdrawn without notice. Don't miss this opportunity to own the BUG you've always wanted. Mail us your order today. Money order or registered mail. Write for new catalog showing models from the smallest, lightest and handiest to the Standard model illustrated. All famous the world over for outstanding quality and sending performance.

THE VIBROPLEX CO., Inc.

832 Broadway

New York, N. Y.

New Prices!

Your generous acceptance has made it possible for us to reduce prices on these popular items.

CONTROL WHEELS

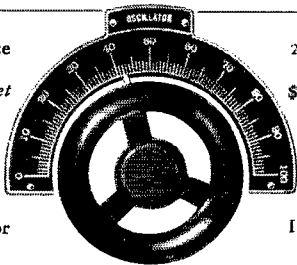
3 1/4" size CI-40 \$1.20 net		2 1/4" size CI-45 \$1.02 net
CI-41 .90 net		CI-46 .78 net
Less Indicator Plate		Less Indicator Plate

R. F. CHOKES



CI-11—125 ma..... 30¢ net
CI-12—250 ma..... 36¢ net

RADIO



PRODUCTS

PROVIDENCE

RHODE ISLAND

What —

Is the F.C.C. Regulation Re: ?

- Operation in times of emergency
- Measurement of xmitter frequency
- Operation of 'phone transmitters
- Measurement of transmitter power
- Frequencies for ham television
- New ultra-high-frequency bands
- Stability of signals up to 60 Mc.

THE ANSWERS will be found in
the current (tenth) edition of

THE RADIO AMATEUR'S LICENSE MANUAL

Going after your first ham "ticket"? You need the manual for its instructions on where to apply, how to go about it in the right way — and, most important of all, for the nearly 200 typical license exam questions and answers.

Already licensed? The manual is still necessary for its dope on renewal and modification procedure, the Class A exam (with typical questions and answers), portable procedure, etc.

ALL the dope on every phase of amateur licensing procedure, and, of course, the complete text of the new regulations and pertinent extracts from the basic radio law.

25¢ postpaid

THE AMERICAN RADIO RELAY LEAGUE
West Hartford, Connecticut

Ham Shacks

(Continued from page 61)

time, is engaged in testing a stationary antenna with rotatable pattern.

VP6YB

VP6YB is undoubtedly one of the DX 'phone stations best known to W hams. With Tom Archer, the OM and Mrs. Archer (better known as Nancy), both ardent hams, the station is probably the most active of any in the West Indies.

Tom started out in 1930 with a 10 Hartley which was soon converted into an m.o.p.a. rig. A year or so later, Tom married. Although she had shown little previous interest, Mrs. Archer soon became as enthusiastic as the OM himself. A crystal-controlled rig was soon built and a short time later a modulator was added. Since then, VP6YB has been operated on 'phone almost exclusively, although Tom swears that he has a key in the circuit.

The present transmitter covers the 7-, 14- and 28-Mc. bands. The 802 Tri-tet drives an 807 buffer-doubler which provides sufficient excitation on all bands for the p.p. 35T final. Normal input is 175 watts. On the audio side, a Brush B-1 mike feeds into a 57 pentode-57 triode-2A3's speech-amplifier driver unit. Type 800's are used in the modulator.

The main antenna is a 2-section 8JK affair directed towards U. S. A. The feeders are tuned so that it may be operated on any of the bands. There is also a pair of half-waves in phase fed by two single-wire m.i. lines directed towards Europe. A doublet is used for Australia and the Far East. The most popular antenna, however, is the 3-element rotatable antenna for 28 Mc. elevated 40 feet above the ground.

The receiver is a ten-tube superhet made by Philips.

Tom is a technical assistant in the Submarine Cable Division of Cable and Wireless, Ltd. Both he and Nancy are yachting enthusiasts. Nancy's flawless operating was one of the high lights of the last DX 'phone contest.

SM7UC

ANOTHER station without whom no DX contest would be authentic is SM7UC. Axel Nordgren (28 years of age) has been the highest scoring SM in three A.R.R.L. DX Contests, one DJDC contest and in four SM contests. He started back in 1935 with a 10-watt Hartley. (How familiar that sounds!) A year later, he built the rig which he uses at present and which, he says, is still going strong. It's the panel job at the left of the operating position. It is a three-stage arrangement with 59 c.o.-e.c.o., RK23 and p.p. 10's. The modulator, identical to that described in *QST* for June 1936, consists of 6L6's, Class AB. Maximum input is 150 watts on c.w. and 75 watts on 'phone.

Two antennas are in use at the present time.

Put in a PYRANOL Capacitor, OM, and You'll Finish Your QSO's

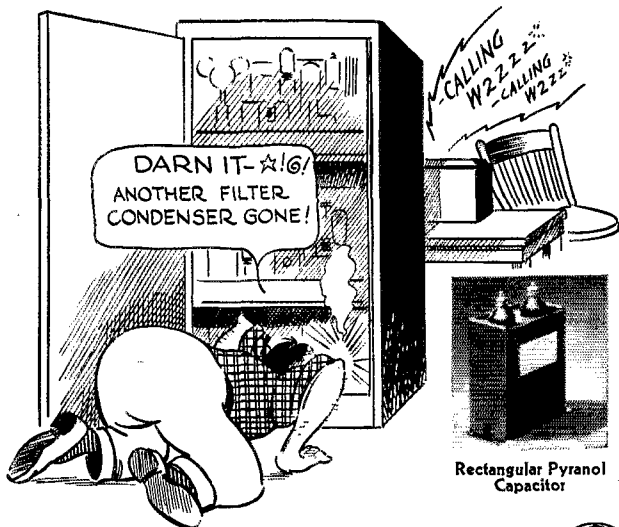

Yes sir, you can depend on G-E Pyranol capacitors because they'll take plenty of punishment. They can take it because they are designed with an ample margin of safety. Then, before they are O.K.'d for your use, they must pass a *double-rated-voltage test* at the factory. That's added assurance that will stand up under severe power surges.

General Electric Pyranol capacitors now come in both rectangular and cylindrical shapes and at new low prices. See your dealer about them or write for Bulletins GEA-2021A and GEA-3018. Radio Department, General Electric, Schenectady, New York.

If you live in the Northeast (U.S.A.) or on the West Coast, write for one of our azimuthal maps which give bearings and distances to any point.

GENERAL ELECTRIC

900-17



TWO Popular VALPEY Products

TYPE VM2 — X-cut mounted crystal 1.7, 3.5 and 7 Mc. bands only.....\$3.00

TYPE V5 — Frequency drift less than 4 C/Mc/°C mounted in a low loss molded holder. 1.7, 3.5 and 7 Mc. bands only.....\$4.80

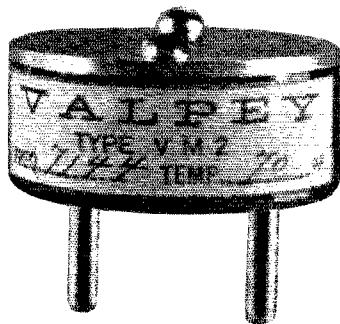

THE VALPEY CRYSTALS

Box 321

HOLLISTON, MASS.

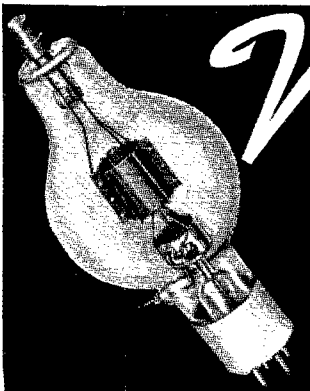

Now! Sheldon 100TH

★ *Features:* Momentary overloads as high as 6 times the rating of the tube will not injure it — Produces a positive, sharp signal and is easy to neutralize — A TANTALUM Grid and a TANTALUM Plate insure against failure due to the release of gas during the life of the tube and assure many hours of satisfactory and dependable operation.....Net Price \$13.50

SHELDON 35T. *Features:* Tantalum Plate and Grid — Absolutely gas-free — Rugged Construction — Improved type of filament suspension...Net Price \$6.00

These are two of the finest tubes Sheldon has ever made. See them and other Sheldon Tubes (KY866-866-866A) at your dealer's or write for technical data today!

SHELDON 35T



SHELDON ELECTRIC CO. 76 COIT STREET, IRVINGTON, N. J.
Chicago Office: 626 W. Jackson Blvd.

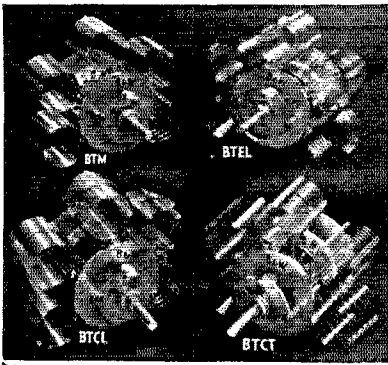

New! B&W BABY TURRETS for Low-Power Band Switching!

HERE at last is a compact, practical 5-band switching unit for low-power transmitters and exciter stages! Each Turret covers amateur bands from 10 to 160 meters and may be tuned in all types of service with any of the 100 mmfd. midget condensers.

Their sturdy construction and exclusive B&W design assure permanent coil alignment and maximum efficiency with a minimum number of tubes. Rated at 35 watts, Baby Turrets are available in four types — BTM, straight untapped — BTCT, center tapped — BTCL, end linked — BTCL, center linked. Amateur Net Price, \$8.50 each.

Ask your jobber, or write, for complete electrical and mechanical details.

Don't Miss the "BAND-HOPPER"!!*

This trim little unit squeezes in most anywhere — delivers quick, accurate front-of-panel band switching in low-powered capacity coupled stages. Amateur Net Price, \$3.25.

* Prize-winning name for the Type 1A Switch.

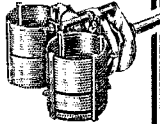

BARKER & WILLIAMSON
Radio Manufacturing Engineers • ARDMORE, PENNSYLVANIA

RADIO ENGINEERING



RCA Institutes offer an intensive course of high standard embracing all phases of Radio and Television. Practical training with modern equipment at New York and Chicago schools. Also specialized courses and Home Study Courses under "No obligation" plan.

Illustrated Catalog on request

RCA INSTITUTES, INC. Dept. ST-39

A Radio Corporation of America Service

75 Varick St., New York 1154 Merchandise Mart, Chicago

EASY TO LEARN CODE

It is easy and pleasant work to learn the modern way — with an **INSTRUCTOGRAPH Code Teacher**. Ideal for the beginner or advanced student. ■ Many tapes available ranging from alphabet for beginners to typical messages on all subjects. Speed range 5 to 40 WPM. ■ Always ready, no QRM, beats having someone send to you.

FOR SALE OR RENT

STANDARD with 10 tapes and book of instructions.....\$20.25
JUNIOR with 5 tapes and book of instructions (not rented).....\$12.00

RENTAL Standard with 10 tapes and book of instructions \$3.00 first month, \$2.25 each additional month. All rental payments may be applied on the purchase price should you decide to buy the equipment.

Write for details today

INSTRUCTOGRAPH COMPANY

Dept. Q, 912 Lakeside Place, Chicago, Illinois

Representatives for Canada:

Radio College of Canada, 863 Bay Street, Toronto



One is a single-wire-fed 130-foot wire used on 3.5 and 7 Mc. The other is a 14-Mc. doublet with a director arranged so that it can be swung over for either of two directions.

The receiver is a home-built 12-tube superhet with crystal filter and Lamb noise-silencer. To the left of the receiver is a cabinet containing a 100-ke. crystal oscillator with multivibrator and r.f. amplifier. It is checked frequently against WWV's 20-Mc. standard.

SM7UC has worked all states except Nevada and New Mexico and is lacking only a few confirmations for the DXCC. He is a radio technician by profession.

Feeder Considerations

(Continued from page 49)

truly flat line. If an open stub is used, it should be shortened slightly.

There may be some slight difference in current in the two wires of the feeder even though there are no standing waves present. Or there may be a slight standing wave on one wire and not on the other. For this reason, it is well to keep the line as symmetrical as possible. No definite rule can be given here because of the many factors involved, and we can only recommend that you examine the line closely for lack of symmetry or other irregularities. Some unbalance in our case was eliminated by running the line as straight as possible and maintaining even spacing and distance to ground.

One more thing: Adjusting a line is an interesting job and not nearly as tedious as it might appear. However, it is rather essential that portions of the line be readily available, as well as the end of the stub and the point where the line taps on, so that adjustments can be made easily. But what a sweet feeling it is to run that meter up and down the line and see the current show no peaks but only a very gradual attenuation towards the antenna!



**ALWAYS
BE
CAREFUL**



★ ★ ★

(A) Kill all transmitter circuits completely before touching anything behind the panel.

(B) Never wear 'phones while working on the transmitter.

(C) Never pull test arcs from transmitter tank circuits.

(D) Don't shoot trouble in a transmitter when tired or sleepy.

(E) When working on the transmitter, avoid bodily contact with metal racks or frames, radiators, damp floors or other grounded objects.

(F) Keep one hand in your pocket.

(G) Develop your own safety technique. Take time to be careful.

★ ★ ★

Death Is Permanent!

BUILD YOUR ANTENNA WITH PREMAX CORULITE ELEMENTS

Sturdy, Lightweight Arrays for Every Purpose at a
New Low Cost!

Six complete kits for 10- and 20-meter beams — Individual Elements for the experimenter — favorites with hams because of their simplicity, low cost and exceptionally efficient operation. Send today for complete listing of the famous Premax Telescoping Corulite Kits and Elements.

A COMPLETE LINE OF NEW TELESCOPING VERTICAL RADIATORS

IN STEEL, ALUMINUM, MONEL

Each type is fully telescoping and adjustable at any height by means of the special Premax Locking Clamps. Goes up in small space — very efficient. Send for special technical bulletin showing the new methods of installation and feeding.

SEND FOR SPECIAL BULLETINS ON BEAMS,
VERTICALS, FRAMES, TOWERS, INSULATORS,
ROTOMOUNTS AND ACCESSORIES

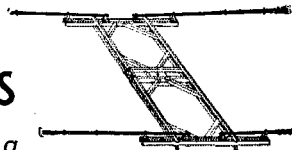

Radio's Latest Technical Bulletin on Antennas

Over 30 methods of erection and feeding shown and fully described. Send today for FREE Technical Bulletin H-3.

Premax Products
Division of Chisholm-Ryder Co., Inc.
4020 Highland Ave., Niagara Falls, N. Y.

Piezo-Electric Crystals Exclusively

- Quality crystals of all practical frequencies supplied SINCE 1925. Prices quoted upon receipt of your specifications.

Our Pledge: QUALITY FIRST

SCIENTIFIC RADIO SERVICE

"The Crystal Specialists Since 1925" University Park, Hyattsville, Md.

SICKLES COILS

SECURE A COPY OF OUR NO. 939
CATALOG FROM YOUR JOBBER

F. W. SICKLES COMPANY

300 Main Street

Springfield, Mass.

EFFICIENT in EMERGENCY As Well As the Regular QSO

The TYPE HFM Portable Transmitter

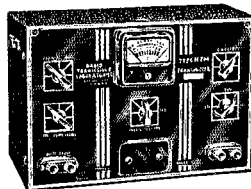

- Six Bands 1715-60,000 K.C. on two crystals
- All Frequencies Crystal Controlled
- Instantly Changeable Mobile or Portable
- Final Tube Input 21 to 36 Watts.

Net to Amateurs... \$57.60

WRITE for completely revised literature just released on all models.

RADIO TRANSCEIVER LABS.

8627 115 Street

Richmond Hill, New York City

Cable Address: "RATRALAB"

A GOOD NAME GOES A LONG WAY

In every detail of Ken-Rad production the highest known standards are maintained. Careful buyers everywhere use and specify Ken-Rad Radio Tubes.



Ken-Rad Radio Tubes

KEN-RAD TUBE & LAMP CORPORATION - OWENSBORO, KY.
Manufacturers of all types of radio tubes and Ken-Rad Electric Lamp Bulbs

For DX!

THE
AMATEUR

RADIO MAP OF THE WORLD

★ On a sheet of heavy map paper 30 x 40 inches Rand McNally, world's premier map-makers, have — to A.R.R.L. specifications — imprinted in six colors and black every single bit of map information useful to the radio amateur.

The special modified equidistant azimuthal projection permits great circle distance measurements in miles or kilometers accurate to better than 2%. Local time in all parts of the world is shown, as well as Greenwich corrections. The official I.A.R.U. WAC continental sub-divisions are given. Principal cities of the world are shown, including, in the U. S., all district inspection offices and examining points.

Perhaps most useful of all is a list of countries of the world, arranged on a basis of geographical and political divisions — clearly shown by color breakdown and the detailed reference index. There are 230 countries shown, 180 prefixes (the prefixes in large open red lettering that you can't miss). More than that, all known national districts and other sub-divisions are shown.

Entirely new in conception and design, large enough to be *useful*, complete in every detail — here is the map radio amateurs have been waiting for these many years. Make a place for it on your wall now — it'll be the most *interesting* object in the shack.

PRICE **\$1.25**
POSTPAID

**American
Radio Relay League**
West Hartford, Connecticut

New Ideas for Transmitters

(Continued from page 64)

denser, while that at right tunes the final amplifier grid circuit. Isolantite-insulated flexible couplings are used to insulate the d.c. grid and plate voltages of the condenser rotors from the extension tuning shafts, and as an operator safeguard, the metal panel bushings in which the tuning shafts turn are connected to the transmitter ground circuit.⁵

The 6-inch indicator at top right tunes the final amplifier plate condenser, and the similar dial at left is for antenna tuning. The antenna condenser is used with a flexible coupling similar to those of the 4-inch indicator shafts, while the final amplifier plate tank condenser shaft, with peak voltages as high as 4000, is insulated by a heavy-duty coupling. Bushings for these shafts are also grounded.

Two large 2.5-ampere thermocouple ammeters are provided at the top of panel. Though not absolutely essential, these increase the ease of adjustment of transmitter and antenna coupler. These meters, along with the other parts of the antenna tuning gear, are isolated from the d.c. voltage of the transmitter.

The 2-inch meters in the horizontal row slightly above the center of the panel are, left to right: buffer grid current, buffer plate current, amplifier grid current, and amplifier plate current. These meters are placed directly in the high-voltage sides of their circuits; consequently, it was necessary to insure operator protection from contact with the meter zero-adjustment screws (which, though bakelite insulated, afford inadequate protection at the plate voltages of buffer and final amplifier). For this purpose, a sheet of glass (the grade used for small window panes) was obtained, cut to the required dimensions of 4½ inches by 17 inches, from a hardware store. The cost of this important safety precaution is less than 25 cents! Four strips of ¼-inch prestwood were cut to ½-inch width, 17½ inches long. Two of these were used to clamp the bottom of the glass window, with a strip of rubber (cardboard would serve as well) ⅜-inch wide added to the ½-inch edge of glass to make the mounting square and secure. Screws through the outer prestwood strip, the rubber spacer, the inner strip, and the front panel of the transmitter were then used to complete the lower clamp. Similarly, a top clamp for the glass was assembled, and the two additions to the panel were black enamelled. Since the thickness of the rubber spacer is that of the glass pane, making a ⅛-inch deep groove in each clamp, the glass pane may be slid out at the side of the mounting for meter adjustments or replacement.

Operation

Although some readjustment of the coil tap positions remained to be made, the first tests of the buffer and final amplifier unit were highly successful. With 5000-ohm grid leak connecting buffer bias terminal to ground terminal, and a 2000-ohm leak similarly used for the final ampli-

⁵ Grammer, "Safety Technique in Transmitter Operation and Construction," *QST*, March, 1939.

● TELEGRAPHY—TELEVISION—TELEPHONY ●

AVIATION
 TRANSRADIO
 PRESS
 TELETYPE
 TYPEWRITING



PRACTICAL
 EXPERIENCE
 STUDIO —
 TRANSMITTER —
 ANNOUNCING

The major technical training equipment owned by Port Arthur College and in operation on the college campus consists of the 500-Watt Commercial Broadcast Transmitter of Station KPAC; two-way Television Transmitter and Receiver; Latest Type RCA Marine and Airways transmitter installation complete; SOS Automatic Alarm; Marine Direction Finder; Trans-radio Press Receiving Equipment; and Laboratory complete where students assemble composite transmitters, amplifiers, audio amplifiers, R. F. amplifiers, etc.

Port Arthur College pioneered the teaching of Radio with classes in 1909, and for thirty years has maintained an active Employment Bureau for the placement of its graduates.

If interested in details about Radio Course, write for Bulletin R

PORT ARTHUR COLLEGE ■ **PORT ARTHUR (World-Known Port), TEXAS**

THE COIL YOU WANT!



Whether it's a band expanding I.F.; Iron Core High Q High Gain I.F.; Regenerative Iron Core I.F.; B.F.O.; Noise Silencer; Oscillator; Multi-Band; or any other coil used in communications or broadcast receivers, or in UHF transmitters — you will find it in the latest catalog of DX precision made coils. DX Coils are used by well-known receiver manufacturers, engineers, service men, set builders, etc. Teachers of radio and students praise the color coded circuits shown in the catalog (DX Coils are color coded too) and say they are easy to understand. Leading radio parts jobbers have DX Coils

or can get them for you at attractive prices. Send 15 cents today with your jobber's name and receive the De Luxe DX catalog illustrating all coils in full size photos.

Also manufacturers spiderweb loop antennas used on latest model receivers

DX RADIO PRODUCTS COMPANY

1575-D Milwaukee Avenue Chicago, Illinois, U.S.A.

110 VOLTS AC Katolight Plants

Anytime, Anywhere! with Katolight Plants

Have special plant for operating radio receivers and transmitters. Close voltage regulation. Full 350 watts AC and 100 watts at 6 volts. Filtered and Shielded.

Amateur's price—JRA3, 350 watt **\$66.00**
 Amateur's price—JR55, 550 watt **\$7.50**

Other sizes up to 10,000 watts.
 Both gasoline and Diesel.

KATOLIGHT, Mankato, Minn., U.S.A.

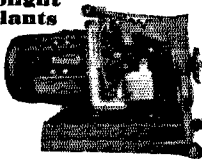

QUALITY ABOVE ALL



TELEVISION CAPACITORS

For Advanced Amateur Experimental Use
 Wider High Voltage Safety Margins
 Write for Our Bulletin T-1

SOLAR MFG. CORP.

Bayonne • New Jersey

PRECISION CRYSTALS

Highest quality crystals carefully prepared for frequency stability and maximum output — rigidly tested to assure you of dependable operation. Be sure of your transmitter

frequency — use **PRECISION CRYSTALS.**

Low frequency drift units supplied within 5 Kc. of your specified frequency in the 40, 80 or 160 meter bands calibrated to within .03%. Supplied in holder as illustrated to plug into G.R. type jacks or in round holder to plug into a tube socket. (See Jan. issue QST). Price \$4.00. Highest quality 'X' cut crystals supplied within 5 Kc. of your specified frequency in the 40, 80 or 160 meter bands and calibrated to within .03%. Supplied mounted. Price \$3.50. Please state if holder as illustrated or round holder for tube socket is wanted.

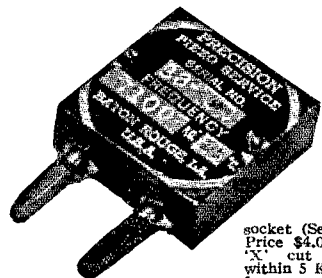

Precision crystals for commercial requirements quoted on at your request. Now in our tenth year of business.

PRECISION PIEZO SERVICE

427 Asia Street Baton Rouge, La.

Space SAVER

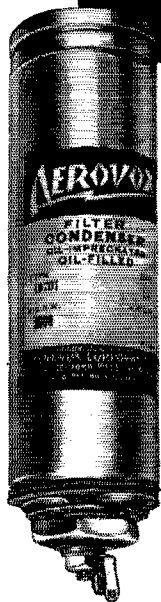

● If space in that assembly is at a premium, or if your pocketbook is lean, you'll find these inverted-mounting HYVOLs just the thing. A lot of oil-filled high-voltage paper condenser in mighty compact size — and moderate in cost.

Grounded can may be insulated from metal chassis by special insulating washer. 0.5 to 4 mfd. 600, 1000 and 1500 v. D.C. working. Conservatively rated. Cool operation. Long life.

New CATALOG . . .

Ask your jobber for a copy of latest catalog listing AEROVOX X-mitting condensers and essential resistors. Or write us direct.



RADIO

ENGINEERING, broadcasting, aviation and police radio, servicing, marine radio telegraphy and telephony, Morse telegraphy and railway accounting taught thoroughly. 48 weeks' engineering course, equivalent to three years of college radio work. School established 1874. All expenses low. Catalog free. DODGE'S INSTITUTE, Day Street, Valparaiso, Indiana

LEARN CODE

the way you'll be using it
by SOUND

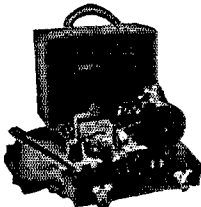

The best way to learn to read code is by listening to code. The best way to learn to send code is by hearing your own sending repeated back to you. With the new All-Electric Master Teleplex Code Teaching Machine, you learn code the natural, easy, fascinating way. Only instrument ever produced

which records your sending in visible dots and dashes — then SENDS BACK your own key work at any speed you desire. That's why practically every school teaching code uses TELEPLEX. We furnish complete course, lend you All-Electric Master Teleplex, give you personal instruction with a MONEY BACK GUARANTEE — all at a surprisingly low cost per month. Write today for FREE catalog Q. 3. No obligation.

"HAM" SPECIAL

Standard Teleplex — a highly efficient code teacher using heavy specially prepared waxed paper tape, having two rows of perforations. Write for Free folder "Q.T.9."

TELEPLEX CO., 67-69 Park Place, New York

In Canada, Write

Canadian Electronic Institute, Toronto, Ontario

fier, 1250-volt supply was applied to the buffer and a 2000-volt supply was used on the final amplifier.

Excitation for the transmitter was provided by an exciter previously described in *QST*⁶ — any exciter capable of 10 to 15 watts output on the bands of transmitter operation may be used satisfactorily. The vacant space at lower right of the transmitter unit may be adapted to the construction of such a simple exciter as a 6L6 crystal oscillator and 6L6 or 807 doubler.⁷

With excitation of approximately 30 ma. buffer grid current, the buffer operated at approximately 100 to 125 watts input on each of the 5 bands, and gave a correspondingly nearly constant excitation to the final amplifier of 130 to 150 ma. grid current on each band. The input of the final amplifier was 1 kilowatt on each of the 5 bands. There is a very slight decrease of output to be noted with 10-meter operation, though the efficiency of both buffer and final amplifier remain safely high in this band.

An important feature of the transmitter is the fact that buffer and final amplifier, once neutralized properly, remain correctly neutralized for operation on any band, 10 to 160 meters. This represents a great improvement over transmitters in which excessive stray coupling of input and output circuits requires frequent re-neutralization with band change. Neutralization adjustment is made in this transmitter on the 10- or 20-meter band — it is more critical at the higher frequencies — by use of the grid current meters as indicators. Bakelite screwdriver-point rods inserted from above neutralizing condensers are employed as safe and convenient adjusting shafts. This conventional method of high-power neutralization is explained in *The Radio Amateur's Handbook*.

Use of this form of transmitter construction cannot be appreciated fully until such a transmitter has been built and operated. The construction method should be useful for ultra-high-frequency transmitters with linear tank circuits, just as for well-designed low-frequency units. Possibly metal panels and parts for this new construction will be made available soon by metal cabinet and rack manufacturers.

⁶ Ferrill, "Refinements in Combination Exciters," *QST*, October, 1938.

⁷ Ferrill, "One Crystal — Two Tubes — Five Bands," *QST*, March, 1939; reference to economical two-tube exciter admirably suited for use with this transmitter.

How Would You Do It?

(Continued from page 68)

facts are arranged on the base above each coil unit and also the arrangement of the mounting lugs and padder adjusting opening. The positioning shown is essential to avoid accidental contact with the jack springs as the assembly is shifted. Detail D is a side elevation showing how the base is drilled for the G.R. switch points used as contactors. An accurate template should be made and holes made with a No. 10 drill through the two bakelite sheets and also the aluminum

THE AMATEUR'S BOOKSHELF

A balanced selection of good technical books, additional to the A.R.R.L. publications, should be on every amateur's bookshelf. We have arranged, for the convenience of our readers, to handle through the A.R.R.L. Book Department those works which we believe to be most useful. Make your selection from the following, add to it from time to time and acquire the habit of study for improvement. *Prices quoted include postage.* Please remit with order.

RADIO THEORY AND ENGINEERING

FUNDAMENTALS OF RADIO, *Second Edition*, by R. R. Ramsey. A modernized revision of the author's work which has been a favorite with amateurs and experimenters since 1929. 426 pages, 439 illustrations. 2nd Edition, 1935. \$3.50

RADIO ENGINEERING, by F. E. Terman. A comprehensive treatment covering all phases of radio communication. An all around book for students and engineers, 811 pp., 474 illustrations. 2nd Edition, 1937. \$5.50

ELEMENTS OF RADIO COMMUNICATION, by Prof. J. H. Morecroft. This is the 2nd edition of this book by the author of the well-known "Principles." It is about half the size of the larger work, and the subject is treated in more elementary fashion. Simple algebra is sufficient. An excellent book for the "first-year" student. 279 pp., 170 illustrations, 1934. \$3.00

PRINCIPLES OF RADIO, by Keith Henney. This book is chock-full of meat for the experimenter. The subjects treated range from the fundamentals of electricity to the modern concepts of modulation and detection. 477 pp., 306 illustrations. 2nd Edition, 1934. . . . \$3.50

COMMUNICATION ENGINEERING, by W. L. Everitt. A general text for both first year and advanced courses. Complete treatment of network theory, including mathematical analysis of radio circuits and tube operation, 727 pp., 411 illustrations. 2nd Edition, 1937. . . . \$5.00

PRINCIPLES OF RADIO ENGINEERING, by R. S. Glasgow. Mathematical presentation of the fundamentals of radio communication and their application. A large portion of the book is devoted to the theory and use of the vacuum tube in communication systems. 520 pp., 6 x 9, 1936. \$4.00

FUNDAMENTALS OF VACUUM TUBES, by Austin V. Eastman. Treats the laws underlying operation of the principal types of tubes—high-vacuum, mercury vapor, photo and special tubes—with engineering analysis of their more important applications. 438 pages, 6 x 9, 1937. \$4.00

FUNDAMENTALS OF RADIO, by F. E. Terman. An elementary version of the author's "Radio Engineering," with simplified treatment and intended for readers of limited mathematical ability. Suitable as a text for an introductory course in radio, and features problems for class-room work. 458 pages, 278 illustrations, 1938. . . \$3.75

ELECTRON OPTICS IN TELEVISION, by I. G. Naloff and D. W. Epstein. Covers the theory of electron optics and practical design problems in constructing cathode-ray tubes for television work. An introductory section outlines the principles of cathode-ray television. 299 pages, 197 illustrations, 1938. \$3.50

ELECTRICAL ENGINEERS' HANDBOOK, VOL. V, ELECTRIC COMMUNICATION AND ELECTRONICS, edited by H. Pender and K. McIlwain. A comprehensive handbook covering the field of communication, both wire and radio, and electronics. 1022 pages, 3rd edition, 1936. \$5.00

RADIO EXPERIMENTS AND MEASUREMENTS

MEASUREMENTS IN RADIO ENGINEERING, by F. E. Terman. A comprehensive engineering discussion of the measurement problems encountered in engineering practice, with emphasis on basic principles rather than on methods in detail. 400 pages, including an appendix of outlines for laboratory experiments and a comprehensive index. 210 illustrations, 1935. \$4.00

THE CATHODE-RAY TUBE AT WORK, by John F. Rider. Devoted to cathode-ray tube theory, sweep circuits, a.c. wave patterns and description of commercial oscilloscope units including actual photographs of screen patterns representing about every condition likely to be encountered in audio- and radio-frequency amplifiers, power supplies, complete receivers and transmitters. 322 pages, 444 illustrations. \$2.50

HIGH-FREQUENCY MEASUREMENTS, by August Hund. A thorough, modern book, especially useful in advanced laboratory work. Includes a chapter on piezo-electric determinations. 491 pp., 373 illustrations, 1933. \$5.00

EXPERIMENTAL RADIO ENGINEERING, by Prof. J. H. Morecroft. An excellent laboratory text directed specifically to emphasizing the principles involved in the operation of radio apparatus and intended as a companion to the same author's "Principles." Following an introductory chapter on instruments and accessories, 51 choice experiments are outlined. 345 pp., 250 illustrations, 1931. . . . \$3.50

EXPERIMENTAL RADIO, by Prof. R. R. Ramsey. Fourth Edition. A splendid book for the experimenter. This is a laboratory manual, describing 132 excellent experiments designed to bring out the principles of radio theory, instruments and measurements. 167 illustrations, 196 pp., 3 1/4 x 7, 1937. \$2.75

RADIO FREQUENCY ELECTRICAL MEASUREMENTS, by Hugh A. Brown. A laboratory course in r.f. measurements for communications students. Contains much practical information on methods of measurement. 384 pages, 177 illustrations, 1938. . . . \$4.00

COMMERCIAL EQUIPMENT AND OPERATING

PRACTICAL RADIO COMMUNICATION, by A. R. Nilson and J. L. Hornung. A new modern treatment meeting the expanded scope of today's technical requirements in the various commercial fields. The first six chapters are devoted to principles, the remaining nine to latest practice in broadcasting, police system, aviation radio and marine communication. 754 pages, including an appendix of tabulated data and a complete topical index. 434 illustrations, 1935. \$5.00

THE RADIO MANUAL, by George E. Sterling. Another excellent practical handbook, especially valuable to the commercial and broadcast operator, and covering the principles, methods and apparatus of all phases of radio activity. Over 900 pp., 1938. \$6.00

RADIO TRAFFIC MANUAL AND OPERATING REGULATIONS, by Dueson and Drew. A book for students, amateur or radio operators who contemplate entering the commercial field. It will enable you to learn quickly and easily all the government and commercial traffic rules and operating regulations. 181 pp. \$2.00

RADIO OPERATING QUESTIONS AND ANSWERS, by Nilson and Hornung. A companion volume to "Practical Radio Telegraphy" by the same authors. The latest Revised Edition is very complete, covering Commercial and Broadcasting, Amateur, Aeronautical and Police Radio, Beacons, Airways, Meteorology, and Teletype Operating. 389 pp. 5 1/4 x 8, 1936. \$2.50

HOW TO PASS RADIO LICENSE EXAMINATIONS, by Charles H. Drew. Question and answer material on various types of commercial operator examinations. The commercial equivalent of the A.R.R.L. License Manual. 201 pages, 73 illustrations, 1938. . . \$2.00

RADIO OPERATOR'S MANUAL, by the Radio Dept., G. E. Co. Primarily a manual to qualify an applicant for the radiotelephone classes of license (including police), but also provides material of general interest to users of commercial radio equipment. 181 pages, 56 illustrations, 1938. \$1.00

MISCELLANEOUS

THE RADIO AMATEUR CALL BOOK. Lists all U. S. and foreign amateur radio stations, a.w. commercials and broadcasters. \$1.25 (Foreign \$1.35)

MAKING A LIVING IN RADIO, by Zeh Bouck. 222 pages, 25 illustrations. A worth-while book for the radio amateur who is considering entering the Commercial Radio field in its many branches; explodes the bunk, points out the pitfalls. \$2.00

RADIO DATA CHARTS, by R. T. Beatty. A series of graphic charts for solving, without the use of mathematics, most of the problems involved in receiver design. 82 pp., 8 1/2 x 11. \$1.50

SERVICING RECEIVERS BY MEANS OF RESISTANCE MEASUREMENTS, by J. F. Rider. 203 pp., 94 illustrations. An excellent book for the service man and amateur constructor. . . \$1.00

SERVICING SUPERHETERODYNES, by John F. Rider. Theory and practice of superheterodynes, with adjustment and troubleshooting data. 278 pages, 94 illustrations. \$1.00

The following books published by the American Radio Relay League, *The Radio Amateur's Handbook*, *The License Manual*, *Hints & Kinks*, *How to Become a Radio Amateur*, *200 Meters and Down*, *Building an Amateur Radiotelephone Transmitter*, and of course *QST*, comprise the foundation of every Amateur library.

AMERICAN RADIO RELAY LEAGUE, INC., WEST HARTFORD, CONNECTICUT

THE RADIO AMATEUR'S *Library*

For some time our advertising in *QST* has carried a by-line reading "Number in the Series entitled Radio Amateur's Library." Many requests have been received for copies of this list and now we present it in *QST* in its complete form — to give a comprehensive picture of our publishing services to the amateur.

No.	Title	Price
1.	<i>QST</i>	\$2.50 per year*
2.	List of Stations	Pre-war Out of Print
3.	Map of Member Stations	Pre-war Out of Print
4.	Operating an Amateur Radio Station (Formerly called Rules & Regulations of Communications Dept.)	Free to members; to others 10c
5.	The Story of The A.R.R.L.	Out of Print See No. 13
6.	The Radio Amateur's Handbook	\$1.00**
7.	The Log	35c each; 3 for \$1.00
8.	How to Become a Radio Amateur	25c
9.	The Radio Amateur's License Manual	25c
10.	Hints & Kinks for the Radio Amateur	50c
11.	Lightning Calculators:	
	a. Radio (Type A)	\$1.00
	b. Ohm's Law (Type B)	1.00
	c. Wire Data (Type C)	50c
	d. Decibel (Type D)	50c
	e. Parallel Resistance — Series Capacity (Type E)	50c
	f. Resistance Calculator (Type F)	50c
12.	Amateur Radio Map of the World	1.25
13.	Two Hundred Meters and Down: The Story of Amateur Radio	1.00
14.	Building an Amateur Radiotelephone Transmitter	25c

*In the United States and Possessions and Canada.
Other Countries \$3.00 per year.

**Postpaid in Continental U.S.A. — \$1.25, postpaid, elsewhere.

**THE AMERICAN
RADIO RELAY LEAGUE, INC.**
West Hartford, Connecticut

sheet. The holes in the aluminum sheet are then enlarged to $\frac{1}{4}$ -inch diameter. The holes in the upper bakelite sheet are also enlarged to this diameter to permit accurate countersinking of the contact points. These points project $\frac{1}{16}$ -inch above the surface of the base. They should be beveled on the leading and trailing edges to enable the jack springs to slide readily over the contacts. Notches filed across the face of each contact will assure accurate positioning of the jack-spring connections. It has been found adequate merely to force the switch contacts into the No. 10 holes without using nuts in addition. The wiping motion of the springs across the contacts keeps the contact surfaces clean and bright and no noise has developed at this point.

Detail E shows how the jack springs salvaged from old 'phone jacks are bent and fastened to the chassis by insulating strips. By-pass condensers to ground should be connected to the a.v.c. and B-plus spring mounting bolts inside the chassis. By placing these two connections at the outside of each group of four contacts (as shown at C) a measure of shielding is provided between grid and plate springs of adjacent stages and has been found adequate to prevent interaction, although in some applications the use of small baffle shields might be found desirable. (It would seem of greater importance to provide isolation between grid and plate in each stage, in which case the grid and plate terminals might better be placed on the outsides. — Ed.)

Each coil and padder-condenser unit is mounted in a shield can 2 inches by 2 inches by $4\frac{1}{2}$ inches. Each consists of the proper inductance wound on a 1-inch diameter form and a midget air padder condenser, the coil form being mounted on the rear end of the condenser by means of a copper connecting strip on one side and braced by a No. 14 connecting wire on the other. Each coil is provided with an inductance trimmer in the form of a $\frac{3}{4}$ -inch diameter copper disk mounted on a brass machine screw for adjustment. At frequencies above 14 Mc., the disk trimmer should not be used. Inductance trimming may be accomplished by bending a portion of the end turn back and forth.

With the style of construction shown and the use of single-ended tubes in the r.f., mixer and h.-f. oscillator stages, short, direct connections to the coil contactors are possible. For the sake of clarity, certain bracing supporting the chassis at either end has been omitted from the sketch. The entire unit is mounted on a $10\frac{1}{2}$ -inch rack panel. The i.f. amplifier may be assembled on the vertical five inches of clear panel space or, as an alternative, in a line behind the h.f. tubes.

This construction has been used successfully at frequencies up to 16 Mc. without losses in the bakelite insulation becoming apparent. As a matter of fact, the receiver has more front-end amplification than was needed to get down to the local QRN level with the two-stage i.f. amplifier operated at half maximum gain. If operation at 28 Mc. is required, it might be advisable to substitute insulation of better characteristics.

Where to buy it

A directory of suppliers who carry in stock the products of these dependable manufacturers.



ALBANY, N. Y. Uncle Dave's Radio Shack 356 Broadway

ATLANTA, GEORGIA 265 Peachtree Street
Wholesale Radio Service Co., Inc.

BOSTON, MASS. Radio Shack 46 Brattle Street

BOSTON, MASS. 110 Federal Street
Wholesale Radio Service Company, Inc.

BRONX, N. Y. 542 East Fordham Rd.
Wholesale Radio Service Company, Inc.

BUTLER, MISSOURI 211-215 N. Main Street
Henry Radio Shop

CHICAGO, ILL. 833 W. Jackson Blvd.
Allied Radio Corp.

CHICAGO, ILL. 901-911 W. Jackson Blvd.
Wholesale Radio Service Company, Inc.

CINCINNATI, OHIO 1103 Vine Street
United Radio, Inc.

DETROIT, MICH. 325 E. Jefferson Ave.
Radio Specialties Co.

DETROIT, MICHIGAN 11800 Woodward Ave.
Radio Specialties Co.

HARTFORD, CONNECTICUT 227 Asylum Street
Radio Inspection Service Company

HOUSTON, TEXAS 4021 Huey Street
R. C. Hall & L. F. Hall

JAMAICA, L. I. 90-08 166th Street
Wholesale Radio Service Company, Inc.

KANSAS CITY, MO. 1012 McGee Street
Burstein-Applebee Company

NEW YORK, N. Y. Harrison Radio Co. 12 West Broadway

NEW YORK, N. Y. 100 Sixth Ave.
Wholesale Radio Service Co., Inc.

NEWARK, N. J. 24 Central Ave.
Wholesale Radio Service Co., Inc.

READING, PENN. 404 Walnut St.
George D. Barbey Company

SPRINGFIELD, MASS. T. F. Cushing 349 Worthington St.

WASHINGTON, D. C. 938 F Street, N. W.
Sun Radio & Service Supply Co.

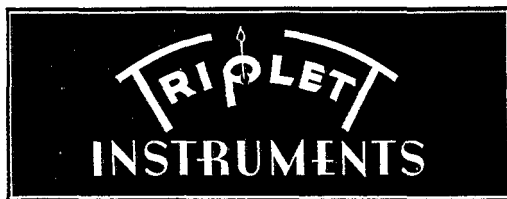

ALBANY, N. Y. Uncle Dave's Radio Shack 356 Broadway

ATLANTA, GEORGIA 69 Forsyth Street, N. W.
Garvin Electric Company

ATLANTA, GEORGIA 265 Peachtree Street
Wholesale Radio Service Company

BOSTON, MASS. Radio Shack 46 Brattle Street

BOSTON, MASS. 110 Federal Street
Wholesale Radio Service Company, Inc.

BRONX, N. Y. 542 East Fordham Rd.
Wholesale Radio Service Company, Inc.

BUTLER, MISSOURI 211-215 N. Main Street
Henry Radio Shop

CHICAGO, ILLINOIS 833 W. Jackson Blvd.
Allied Radio Corp.

CHICAGO, ILLINOIS 25 North Franklin Street
Electric & Radio Supply Co., Inc.

CHICAGO, ILL. 901-911 W. Jackson Blvd.
Wholesale Radio Service Company, Inc.

CINCINNATI, OHIO 1103 Vine Street
United Radio, Inc.

JAMAICA, L. I. 90-08 166th Street
Wholesale Radio Service Company, Inc.

LITTLE ROCK, ARKANSAS 409 W. 3rd St.
Beem Radio Company

MINNEAPOLIS, MINNESOTA 1124-26 Harmon Place
Lew Bonn Company

MONTREAL, CANADA 285 Craig Street, West
Canadian Electrical Supply Co., Ltd.

MUSKOGEE, OKLAHOMA 204 No. Twelfth Street
Home Radio Mart

NEW YORK, N. Y. 100 Sixth Avenue
Wholesale Radio Service Company

NEWARK, N. J. 24 Central Ave.
Wholesale Radio Service Company

READING, PENN. George D. Barbey Co. 404 Walnut Street

WASHINGTON, D. C. 938 F Street, N. W.
Sun Radio & Service Supply Co.

Listings on this page do not necessarily imply endorsement by QST of the dealers or of other equipment sold by them.

Insure Your Future!

Start training now for a better job in
**PRACTICAL RADIO ENGINEERING
AND TELEVISION**

New opportunities for trained men!



F. H. Rietzke
Pres., CREI

Radio, today, is progressing faster than any other industry. New developments — new equipment — and the new fields opened by facsimile transmission and television — have created exciting opportunities that should spur every ambitious man to take advantage of them. What are YOU going to do about it? The difference between an \$1800 job today and a \$4000 job tomorrow — is your qualification as an engineer. That means training now!

Train Yourself for the Job You Want

You can step ahead into a better job, just like the hundreds of other men we train each year. Don't say you never had the opportunity — for *here it is!* Radio and TELEVISION want you — and need you — for those important new jobs. But, you must have *training first*.

New Booklet Just Off the Press!

Profusely illustrated and with complete details of our home-study and residence training and new courses in TELEVISION. It's free — send for it today!

CAPITOL RADIO

ENGINEERING INSTITUTE

Dept. Q-9

3224 16th St., N.W., Wash., D. C.



Correspondence Dept.

(Continued from page 71)

star gage the barrel. He reported that this piece of apparatus had a decided eccentricity in the dot propagator which caused continuous 180-degree inversion. Following up your dope on the antennae boresighting, I applied the same principle to the bug. The results have been disconcerting. The dots now follow a helical trajectory which causes the receiving operator constantly to inform the user of this bug that it is missing dots. In reality the dots are not being missed, but due to the above stated trajectory, quite often do a 'loop-the-loop' around the receiving antenna. Also in working over the bug I desired to prepare it for the use of the higher speed operators, however, I was so diligent that the speed of the dots was increased to such an extent that they were out of the audible range. Your advice in the immediate future would be greatly appreciated.

"As ever, in a quandary,

"JEEP."

And the reply:

"Dear Jeep:

"Your difficulties may be overcome by hooking two empty Prince Albert cans in series with your fones. Each can suspended like an earring. Missing dots may be retrieved from the cans as desired. It is also suggested that you ground your typewriter to the spit-kitt.

"HG."

For the benefit of those who desire further information on any subject, it may be obtained by addressing a self-addressed, stamped envelope to Corporal J. E. Gebhart, U. S. Marines, or Chief Radioman Steven B. Haines, U. S. Navy, care of the Naval Radio Station, Peiping China.

— Robert J. Greenway, W6OCD

CHANGE OF ADDRESS

19 Brushwood Drive,
Chorley Wood, Herts., England

Editor, QST:

I feel you ought to be given full credit for a real bit of service. On the date I knew of my removal from the old address I wrote you advising you of my new address. QST arrived at the old address and the local people were good enough to forward it. Immediately afterwards I received the second copy which you . . . sent to this address so that I shouldn't miss my monthly study. Thanks a lot. Such things show the real ham spirit. The second copy went to a fellow ham. . . .

— J. Y. Newson, G3GY

EDITOR'S NOTE. — Always notify the Circulation Manager of changes of address well in advance. In the U. S. second-class mail matter is not forwarded; if your copy of QST is sent to an old address it is lost. Cooperate with us by keeping your correct address always on file.

SWITCH TO SAFETY!



REMEMBER

Only Until September 1

To take advantage of the combination offers as advertised in the July and August issues.

LOW COST STEEL ANTENNA TOWER

*Used and Endorsed by
FEDERAL, STATE, COUNTY, CITY GOV'TS.,
FORESTRY, HIGHWAY PATROLS
and HAMS everywhere!*

ONLY 60¢ PER FOOT Complete!

This remarkable low price is possible only because we produce many thousands of these towers each year for use with our Wincharger. Price includes necessary guy wires and tower sections of 10 or 20 ft. lengths with 5 ft. tapered stub top.

LIGHT, STURDY, RIGID

Thousands in use as vertical radiators and horizontal antenna supports. Scientifically braced. No points of undue strain. Both vertical angles and cross braces now hot dip galvanized.

SAFELY ERECTS TO 200 FT.

Quickly and easily erected, without skilled assistance, to heights of from 25 ft. to 200 ft. Enthusiastically used and recommended by police and broadcasters for thoroughly satisfactory service.

READ U. S. FORESTRY LETTER!

"Your tower was installed on Signal Peak, a Lookout Station on the Yakima Indian Reservation, at an elevation of 5,111 ft. above sea level. We have found the Wincharger tower 100% satisfactory and it has stood up under 70 mile winds, snow and ice which are severe at almost a mile up from sea level." Thomas L. Carter, Forest Supervisor, Office of Indian Affairs, U. S. Department of the Interior, Toppenish, Wash.

Order Direct From

WINCHARGER CORPORATION
Sioux City, Iowa

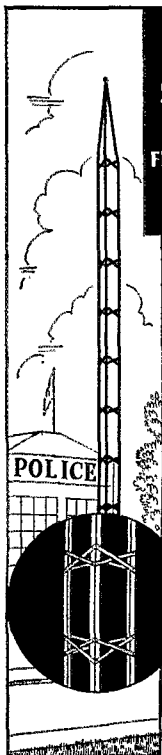

HAM-ADS

(1) Advertising shall pertain to radio and shall be of nature of interest to radio amateurs or experimenters in their pursuit of the art.

(2) No display of any character will be accepted, nor can any special typographical arrangement, such as all or part capital letters be used which would tend to make one advertisement stand out from the others.

(3) The Ham-Ad rate is 15¢ per word, except as noted in paragraph (6) below.

(4) Remittance in full must accompany copy. No cash or contract discount or agency commission will be allowed.

(5) Closing date for Ham-Ads is the 25th of the second month preceding publication date.

(6) A special rate of 7¢ per word will apply to advertising which, in our judgment, is obviously non-commercial in nature and is placed and signed by a member of the American Radio Relay League. Thus, advertising of bona fide surplus equipment owned, used and for sale by an individual or apparatus offered for exchange or advertising inquiring for special equipment, if by a member of the American Radio Relay League, takes the 7¢ rate. An attempt to deal in apparatus in quantity for profit, even if by an individual, is commercial and all advertising by him takes the 15¢ rate. Provisions of paragraphs (1), (2), (4) and (5) apply to all advertising in this column regardless of which rate may apply.

Having made no investigation of the advertisers in the classified columns, the publishers of *QST* are unable to vouch for their integrity or for the grade or character of the products advertised.

QUARTZ — direct importers from Brazil of best quality pure quartz suitable for making piezo-electric crystals. Diamond Drill Carbon Co., 719 World Bldg., New York City.

USED receivers. Bargains. Cash only. No trades. Price list 3¢ W3DQ., Wilmington, Del.

QSL'S. Free samples. Printer, Corwith, Iowa.

CALLBOOKS — Summer edition now on sale containing complete up-to-date list of radio hams throughout entire world. Also world prefix map, press schedules and new time conversion chart. Single copies \$1.25. Canada and foreign \$1.35. Radio Amateur Call Book, 610 S. Dearborn, Chicago.

CRYSTALS, mounted, 80-160, \$1.25, V-cut 40, \$2.25. R9 Crystals, 338 Murray Ave., Arnold, Pa.

QSL'S. Finest at lowest prices. Samples. Maleco, 1805 St. Johns Place, Brooklyn, N. Y.

WHY not get better deal? Used receiver list free. W9RA, Chi-Rad, 415 So. Dearborn St., Chicago.

QSL'S. 1939 designs. Best stock and workmanship. Free samples to hams. W2FJE, 101 Hanson Place, Brooklyn, N. Y.

CRYSTALS: marine, police, and amateur frequencies. Descriptive catalog. Ham Crystals, 1104 Lincoln Place, Brooklyn, New York.

QSL'S. SWL's. 100 — 3 color — 75¢. Lapco, 344 W. 39th, Indianapolis, Ind.

MACAUTO code machines: low monthly rental 50,000 words practice tapes. Write N. C. Ayers, 711 Boylston St., Boston, Mass.

QSL'S — samples. Brownie, W3CJI, 523 No. Tenth St., Allentown, Pa.

CRYSTALS in plug-in heat dissipating holders — 160-80, \$1.25; (No Y cuts); 40X, \$1.60. State frequency desired. C.O.D.'s accepted. Pacific Labs., 1042 S. Hicks, Los Angeles.

QSL'S, all colors, cartoons, snappy service. Write for free samples today. W1BEF, 78 Warrenton, Springfield, Mass.

SELL: 200 watt all-band CW, phone transmitter — \$125. Want candid camera. W2CIZ.

CALLS — for panel mounting. Half-inch white translucent letters, black background, 1" x 3 3/4". Can be rear illuminated. \$1. R. T. Daiton, W2MJC, 36 Ridge Rd., Rutherford, N. J.

IPS rubber crystal. QSY remotely, varies completely 160 to 10 meters. Approximately 20 watts output. \$19.80. All Electric Co., 1522 No. Clark, Chicago, W9IPS.

QSL'S. Maps. Cartoons. Free samples. Theodore Porcher, 7708 Navajo, Philadelphia, Pa.

CRYSTAL blanks, AT, BT, X. Low-drift spot frequency crystals, \$2.75. Commercial frequencies on application. Crystal Shop, Barre, Vt.

SELL: Gross 25-watt transmitter, \$15.; All-Star receiver, \$10.; 400-watt CW — phone, \$250.; 75-watt CW, \$40.; 300-watt CW — phone, \$100.; write for details. Want RCA-813, 810's, Howard receiver. C. Kowalski, 1239 Kinsmoor Ave., Ft. Wayne, Ind. W9KHC.

SELL: McMurdo-Silver 5 C-X complete, A-1 condition. Make offer. W9BBB.

SACRIFICE: 230-watt all-band CW transmitter, \$75. Austin Harrison, W9OJL, Carthage, Mo.

WANTED: Grebe CR8. W9WTD.

TRADE 2 Pyranol 2000 volt, 2 Mfd., 2 Flechtheim 1 Mfd. 3000 volt, and Esco motor-generator 1500 v., for binoculars. W8KJN.

QSL'S? — Printed to your specifications. Samples? W8DED, Holland, Mich. (Bliley crystals, QST subscriptions.)

FOR sale: new CW transmitter 20 x 72 steel panel, 7 Weston fan-type meters. 2A5, 46, '10, 860, 3 power supplies. \$150., cash. O. Alford, 587 Lincoln. Glencoe, Ill.

COMPLETE station. Collins 30FXB, rebuilt for higher power. 450-600 w. RME-69 & DB-20, 20 meter 3 element electrically driven rotary beam. Write for complete description and price. W9AR.

MUST sell: 1000 watt CW xmitter. Details on request. W6QJW, 1220 So. St. Andrews Pl., Los Angeles, Calif.

QSL'S made to instructions. Get sample and price. Naney, Sellersburg, Ind.

HALLICRAFTER 5-10, practically new, only \$50. John Aufero, 446 Crown St., Brooklyn, N. Y.

WANTED: Comet-Pro. W7GQ.

SELL: 32v. d.c. — 110v. a.c. converter, transformers, condensers, and parts to 250-watt rig. Write for list. W3BBV, York, Pa.

PRE-WAR and later QST's for sale. W9VKF, Minneapolis, Minn.

CRYSTALS: police — marine — amateur. Write. C-W Mfg. Co., 1170 Esperanza, Los Angeles.

VIBRATOR power packs, complete, \$3.25. W9HKR, 614 Preble, Kokomo, Ind.

TRANSMITTERS constructed — complete or sections — your parts or new — write. Howard Radio, 5904 Race, Chicago. (Austin 9897)

QSL — SWL's. Samples. W5GG, Cleveland, Miss.

SELL pole trans., Weston 301 meters, etc.; Seeley, 824 No. Ogden, Hollywood, Wyoming 0436.

SELLING surplus equipment. 852's, 276A, Weston fan-type meters, fil. transformers, power supplies, condensers, etc. Also a complete 100-watt phone. Stamp for list. W9EFC.

BEAM buys you can't beat. Rugged 2 1/4" hollow shaft rotor, built-in Selsynchronous indicator, tip-down head, quiet motor, \$39. Tapered, telescoping aluminum elements, \$5.50 — 20; \$3.

— 10. Complete 3, 4 element beams. Bassett cable, handbooks. Get our beam bulletins, photos. Rotary Array Service, W8ML.

BEST cash offer takes ACR-175 receiver, good shape. Atsey, 8 Midvale Rd., Baltimore, Md.

SELL SX16; speaker. \$60. W2AIT.

TRADE 6V6-807 transmitter complete, Vibroplex for good camera. McCann, 251 Lafayette, Grantwood, N. J.

QSL'S. Fritz, 455 Mason, Joliet, Ill.

FOR sale: complete 300-watt phone and CW rig. Write for details. W1JUL, Framingham, Mass.

CRYSTALS: You can save with safety and complete satisfaction by using Eidson T9 crystals. Accurately calibrated, high performance X-cuts: 40 and 80 meter bands, \$1.60 postpaid. T9 ceramic holders, \$1. C.O.D.'s accepted. Each crystal fully guaranteed. Fine commercial crystals supplied on order. Sold by: Florida Distributors, Inc., Tampa, Fla.; Frank Anzalone, 375 W. 46th St., N. Y. C.; Radio Doc, 721 So. Main, Los Angeles, Calif.; Henry Radio Shop, Butler, Mo.; Hieronymus Radio, 88-84 209th St., Queens Village, N. Y.; Casa Edison, Havana, Cuba; Wholesale Radio Co., Toronto, Ontario, Canada; Hamrad Wholesale, London, Eng.; or Eidson's, Temple, Texas. Australian distributor wanted.

QSL'S. Samples. W9RUJ, Auburn, Neb.

WAC 450-watt phone — CW rig in enclosed sectional rack, RME-69, microphone, Triplet volt-ohm-ammeter. Best offer takes all. Inquiries answered until sold. W1JUG, Howard, R. I.

SELL Hallicrafter SX18 with speaker, \$70. W8FPX.

WHETHER you pay cash, trade equipment, or buy on terms financed by myself, it pays you to write W9ARA, authorized factory distributor for all amateur receivers, transmitters, parts. Write. W9ARA, Butler, Mo.

RECONDITIONED guaranteed receivers and transmitters shipped on ten-day trial. Practically all models at big savings. Any receiver can be traded back within three months for full credit. Terms. List free. W9ARA.

HYTRON tubes, HY40Z & HY51Z; also shielded 866's in stock. H.B. Reynolds Radio Lab., Oneida, N. Y.

FBXA, 10 and 20 meter coils. Offer. A. Roe, Jr., 457 W. 57 St., N. Y. C.

TRADE: 1500v. 250m. power supply; sell QST's from 1928. Want 6v. genemotor. W9DDJ.

SELL — One new 1939 model National 81-X communications receiver, complete in factory carton. \$85. Cash only. Write or wire W4CWB.

SELL—New carbon 203-A, ceramic socket; filament transformer for same, \$10. Premax 34" vertical, excellent condition, \$10. Cash only. W4CWB.

COMMERCIAL transmitter, 60 watts, practically new. Description on Page 105 of Wholesale Radio's catalog 73. New cost, \$163.; must sell by September 15. W3DTD, Newark, Del. 1.5 volt synchronous vibrator supplies. Improved efficiency. Weight 3.5 pounds. \$7.95. See August Hamads. W9GZ; W. Parisoe, 1406 Chicago Ave., Evanston, Ill.

New—1.5 volt 5 tube dry cell operated communications receivers. Write to W9GZ; W. Parisoe, 1406 Chicago Ave., Evanston, Ill.

CRYSTALS: famous P.R., mounted in latest Alsmag 35 holders—40, 80 meter PR-X, 160 meter PR-Z, \$3.; 40, 80 meter PR-Z (low drift), \$3.50; 20-meter PR-20, \$4.50; unconditionally guaranteed. Immediate shipment. Wholesale Radio Labs., Council Bluffs, Iowa., W9GFQ.

RECEIVERS—reconditioned and guaranteed. Send for bargain list at terms to suit yourself. Specials on transformers, tubing, etc. Write for catalog. Thordarson, Stancor and all other kits wired by us and tested on air, at low terms. Write. W9GFQ.

SELL used NC-100XA. Ray J. Goodman, Box 303, Concord, N. C.

WANT high power equipment. Have to offer—key cutting machine, code books, cutting guides, 1,400 blanks. W6PYR, 586 Hampton Rd., Hayward, Calif.

SELL—NC-81X, Meissner signal shifter, final PR TZ-40's in PP 200 watts, including power supply, coils 20 and 40. Used three months slightly, \$125. W6QDO, Crockett, Calif.

SECURE your amateur or commercial license easily and quickly—our illustrated method of instruction brings you a license in record time—semi-private classes—rates low. Inquire about our home study courses. Radio License Training School, 728 S. Hill St., Los Angeles, Calif. VA-8370.

TELEPLEXES. Instructographs, omnigraphs bought, sold, traded. Ryan's Hannibal, Mo.

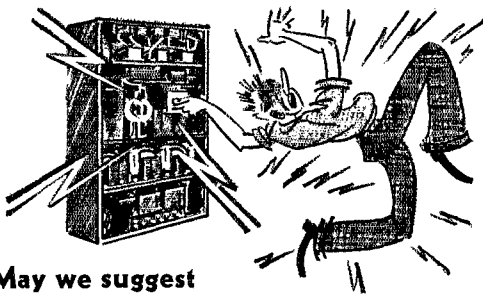

May we suggest

A SAFETY RELAY?

The new Ward Leonard Safety Relay is an essential piece of equipment. It automatically discharges the built up high voltage in filter condensers. This relay protects the operator . . . it protects the set. Full information in data sheet No. 5070.

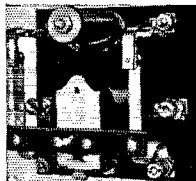

Ask your supplier about the new low prices of Ward Leonard Relays.

Send for Data Sheet No. 5070

WARD LEONARD ELECTRIC COMPANY

41 South Street

Mount Vernon, N. Y.

LEARN RADIO • TELEVISION

60-page catalog on request. Oldest, largest and best equipped in New England. Write for new catalog.

MASS. RADIO SCHOOL

18 Beylston Street

Boston, Mass.

AMATEUR RADIO LICENSES

Day and Evening Classes in Code and Theory
HOME STUDY COURSES

Reasonable, Efficient and Thorough, Hundreds of
Licensed Students Now on the Air

American Radio Institute, 1123 Broadway, New York, N. Y.



DYNAMOTORS

for Aircraft, Police, Marine and
Amateur Xmitters and Receivers

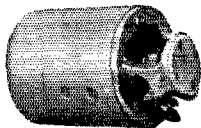

Write for Data Today

ROTARY
CONVERTERS
to change D. C. to A. C.

UTILITE PLANTS
generate A. C. or D. C.

EICOR INC. 513 S. Laflin Street
Chicago, Ill., U.S.A.

FOR YOUR TOOL KIT

This SIGNAL

1/4 inch

DRILL

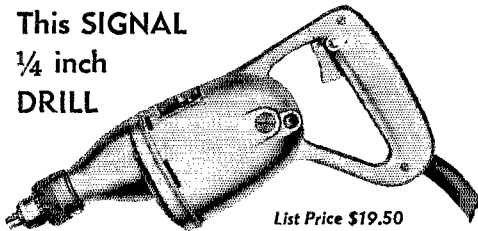

List Price \$19.50

IS TOPS IN VALUE

This is the drill to buy for your tool kit. It is the same drill used by electricians, radio repairmen, and shops. Capacity 1/4" in steel, 1/2" in hardwood, measures 12" long, speed 2950 R.P.M., trigger switch, 8-foot rubber cord and plug, weight 5 1/2 pounds. SIGNAL drills are dependable because they're well made, and they are outstanding values because they're priced right. If your radio jobber cannot supply you, write us.

SIGNAL ELECTRIC MFG. CO., Menominee, Mich.

Established
1892

SIGNAL
ELECTRIC MFG. CO.

Your Nearby Dealer Is Your Best Friend

Your nearby dealer is entitled to your patronage. He is equipped with a knowledge and understanding of amateur radio. He is your logical source of advice and counsel on what equipment you should buy. His stock is complete. He can supply your needs without delay. His prices are fair and consistent with the high quality of the goods he carries. He is responsible to you and interested in you.

One of these dealers is probably in your city—Patronize him!

CHICAGO, ILLINOIS

Allied Radio Corporation
833 West Jackson Blvd.

Complete standard lines always in stock—W9IBC, W9DDM, W9GEZ

DETROIT, MICHIGAN

Radio Specialties Company
325 E. Jefferson Avenue
Ham Supplies — National & Hammarlund Sets and Parts

KANSAS CITY, MISSOURI

Burstein-Applebee Company
1012-14 McGee Street
"Specialists" in supplies for the Amateur and Serviceman

CHICAGO, ILLINOIS

Chicago Radio Apparatus Company
" 415 South Dearborn Street (Est. 1921)

W9RA and W9PST — Amateurs since 1909

KANSAS CITY, MISSOURI

Radiolab
1515 Grand Avenue
Amateur Headquarters in Kansas City

MILWAUKEE, WISCONSIN

Radio Parts Company, Inc.
538 West State Street
Complete stock Nationally Known products

CHICAGO, ILLINOIS

Wholesale Radio Service Company, Inc.
901-11 West Jackson Boulevard

"The World's Largest Radio Supply House"

MINNEAPOLIS, MINNESOTA

Lew Bonn Co.
1124-26 Harmon Place
W9BP — W9TLE — W9ZXV — W9DKL — W9VED

SEATTLE, WASHINGTON

Northern Radio Company
2208 Fourth Avenue
W7AWP, W7MB, W7VP, W7XL, W7XK, and W7CR to serve you

DES MOINES, IOWA

Iowa Radio Corp.
1212 Grand Avenue
Complete amateur stock, W9OCG — W9EMS — W9KAY

ST. LOUIS, MISSOURI

Van Sickle Radio Company
1113 Pine Street
W9OWD invites you to amateur headquarters in St. Louis

YOU CAN BE SURE
WHEN YOU BUY FROM

QST

ADVERTISERS

“Advertising for QST is accepted only from firms who, in the publisher’s opinion, are of established integrity and whose products secure the approval of the technical staff of the American Radio Relay League.”

Quoted from QST’s advertising rate card.

Every conceivable need of a radio amateur can be supplied by the advertisers in QST. And you will know the product has the approval of the League’s technical staff

Index to Advertisers

Abbott Instrument, Inc.	92
Aerovox Corporation	118
American Radio Institute	124
Astatic Microphone Laboratory, Inc.	87
A.R.R.L.: Operating Supplies	107
Reminder (Spec. Offer)	122
Bookshelf	119
Barker & Williamson	114
Bliley Electric Company	111
Candler System Company	94
Capitol Radio Engineering Institute	122
Cardwell Mfg. Corp., Allen D.	80
Centralab	85
Collins Radio Company	Cov. 2
Coto-Coil Company, Inc.	111
DX Radio Products Company	117
Dodge’s Institute	118
Elicor, Incorporated	124
Eitel-McCullough, Inc.	83
General Electric Company	113
Guthman & Co., Edwin I.	98
Halicrafters, Inc., The	1, 2
Hammarlund Mfg. Company, Inc.	81, 84
Harvey Radio Company	120
Harvey Radio Laboratories	82
Henry Radio Shop	110
Hipower Crystal Company	96
Howard Radio Company	91
Hygrade Sylvania Corporation	106
Hytronic Laboratories	89
Instructograph Company	114
International Resistance Company	95
Johnson Company, E. F.	97
Kato Engineering Company	117
Ken-Rad Tube & Lamp Corporation	115
Kenyon Transformer Company, Inc.	7
Mallory & Company, Inc., P. R.	78
Massachusetts Radio School	124
Mims Radio Company	90
National Company, Inc.	Cov. 3, 77
New York YMCA Schools	111
Newark Electric Company	99
Ohmite Manufacturing Company	86
Port Arthur College	117
Precision Apparatus Corporation	102
Precision Piezo Service	117
Premax Products	115
RCA Institutes, Inc.	114
RCA Manufacturing Company, Inc.	Cov. 4
Radio Manufacturing Engineers, Inc.	127
Radio Shack, The	109
Radio Transceiver Laboratories	115
Scientific Radio Service	115
Sheldon Electric Company	113
Shuler Supply Company	112
Sickles Company, F. W.	115
Signal Electric Manufacturing Co.	124
Solar Manufacturing Corporation	117
Southwest Radio Supply	116
Speer Carbon Company	104
Standard Electrical Products Co.	108
Standard Transformer Corporation	93
Sun Radio Company	112
Taylor Tubes, Inc.	4, 5
Teleplex Company	118
Terminal Radio Corporation	116
Thordarson Electric Manufacturing Co.	79
Tibbetts’ Laboratories	108
Triplett Electrical Instrument Co., Inc.	88
United Transformer Corporation	128
Valpey Crystals, The	113
Vibroplex Co., Inc., The	111
Ward Leonard Electric Co.	124
Wholesale Radio Laboratories	109
Wincharger Corporation	122

EMERGENCIES DO NOT SEND MESSENGERS AHEAD

They have a habit of suddenly breaking unheralded and unannounced.

A BEACON SIGNAL IS ALWAYS ON DUTY

a constant emergency messenger against danger.

COMPLETE PORTABILITY

is the answer to thousands of emergency radio communication problems. The ME-14 receiver is the answer — Range 180 to 4100 KC.

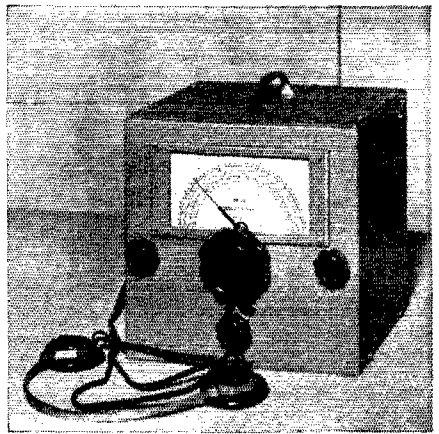
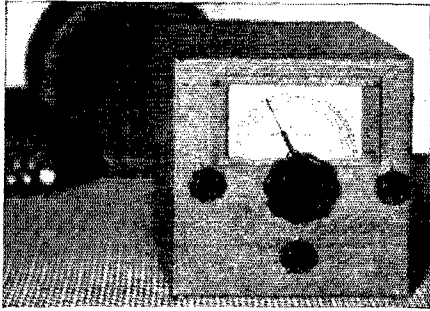

“A CAR RADIO IS NO LONGER A LUXURY,

but a semi-nuisance

unless it will also perform on 5 and 10 meters,” says the ham.

SO WHY NOT A CONVERTER

in every car. You'll have twice the contacts, going after them. A DM-36A knows the answer.

WHY DO I WANT TO LISTEN TO THE 90 KC TO 600 KC SIGNALS?

Every 'old timer' does — and with so much communication in aviation, weather, coastal telegraph, distress, and other signals constantly on the air, the practical application of the LF-90 low frequency converter suggests a multiplicity of uses. *That's right* — it connects to any communication receiver without electrical alteration to the set.

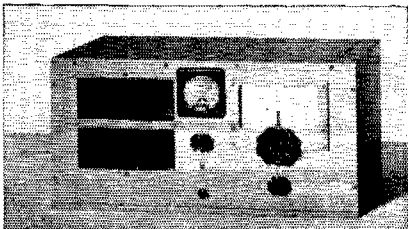
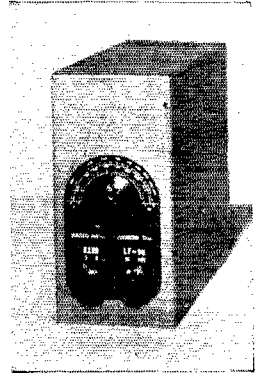

WHAT WE MEAN BY COMPACT

is typified in the 5 and 10 meter receiver, the HF-10. A super with speaker, power supply, R-db meter, vernier dial scale and ready for real performance.

A NEW 12-PAGE CATALOGUE IS NOW READY
—YOUR COPY IS WAITING FOR YOU

RADIO MFG. ENGINEERS, INC.
ONE-ELEVEN HARRISON STREET
PEORIA « » ILLINOIS

QST for September, 1939, CENTRAL Edition

THE NEW PLANT

Now housed at 150 Varick Street,
New York City.

Increased facilities, to assure prompt attention to our increasing volume of business. New equipment — new production technique, to insure still higher UTC quality standards.

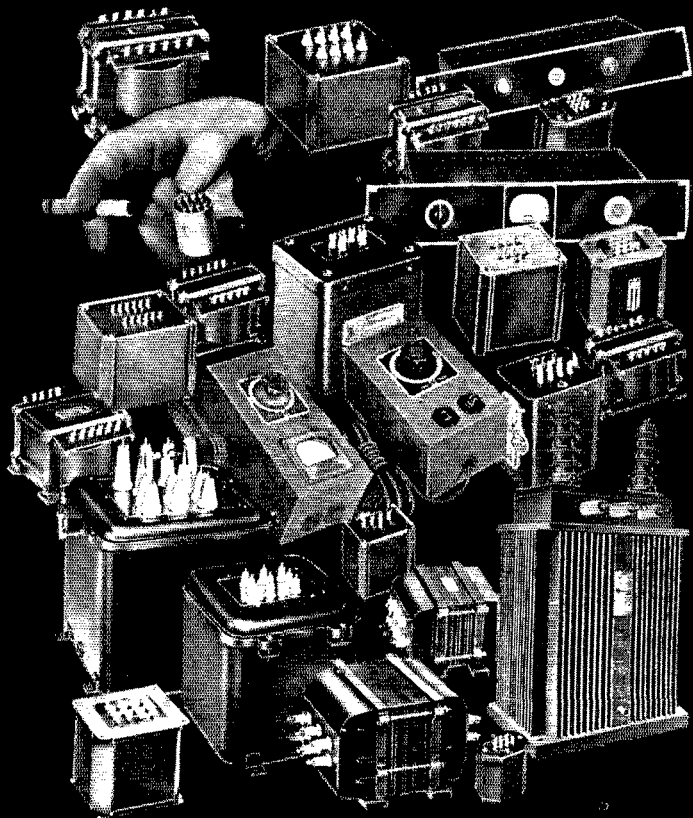

Twenty times the size of the UTC plant in 1933, this new plant is made possible by the wide recognition of UTC achievements in the quality transformer field. It is significant that, on the whole, difficult jobs find their way to UTC — jobs requiring unusual engineering ingenuity; improved design features and materials; advanced production methods. UTC transformer products cover the range from $\frac{1}{8}$ oz. aircraft units to 100 KW Broadcast Station components.

Nowhere in the world can one obtain finer transformers than those produced by UTC.

UNITED TRANSFORMER CORP.

Write: COMMUNICATIONS DIV. ★ 150 VARICK ST. ★ NEW YORK, N. Y.
EXPORT DIVISION: 100 VARICK STREET NEW YORK, N. Y. CABLES: "ARLAB"

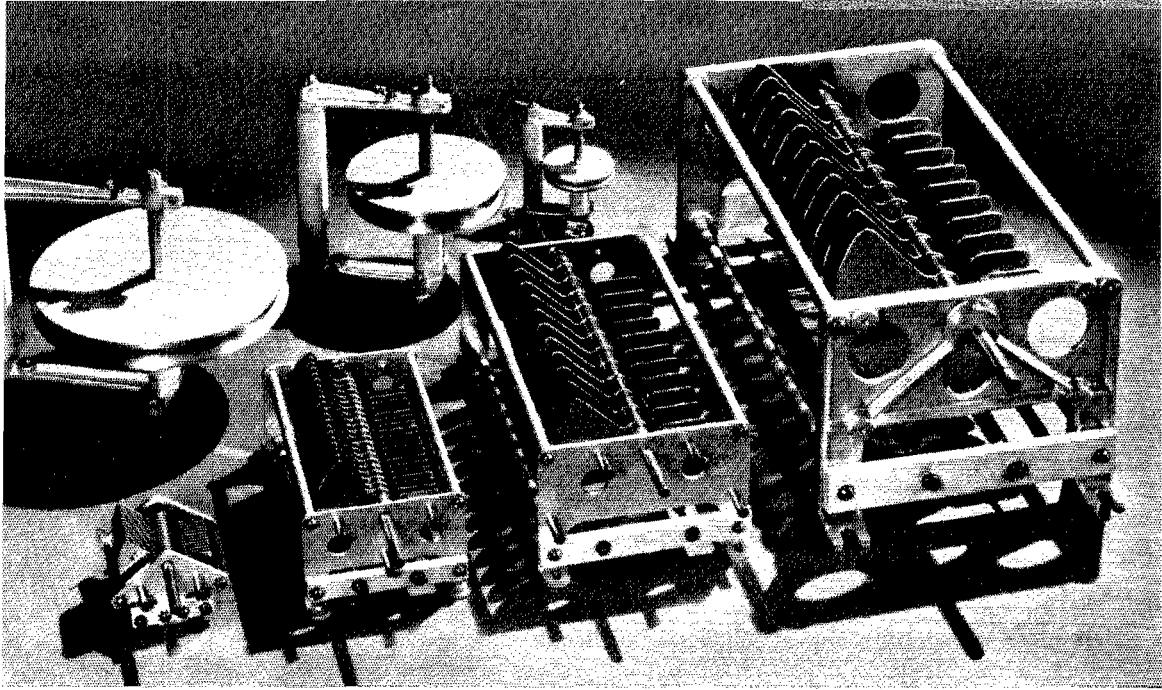

NATIONAL *Transmitting Condensers*

► These are the condensers which you see so often in illustrations of outstanding transmitters, and hear so much about in articles describing high performance gear. They have an impressive record for efficient, dependable operation, for conservative rating, for ability to stand punishment. And equally important, prices are moderate too. Even the big TML with cast aluminum end frames sells for only \$9.90 net in the 50 mmf, 15,000 volt size. Your dealer has them.

NATIONAL COMPANY, INC., MALDEN, MASS.



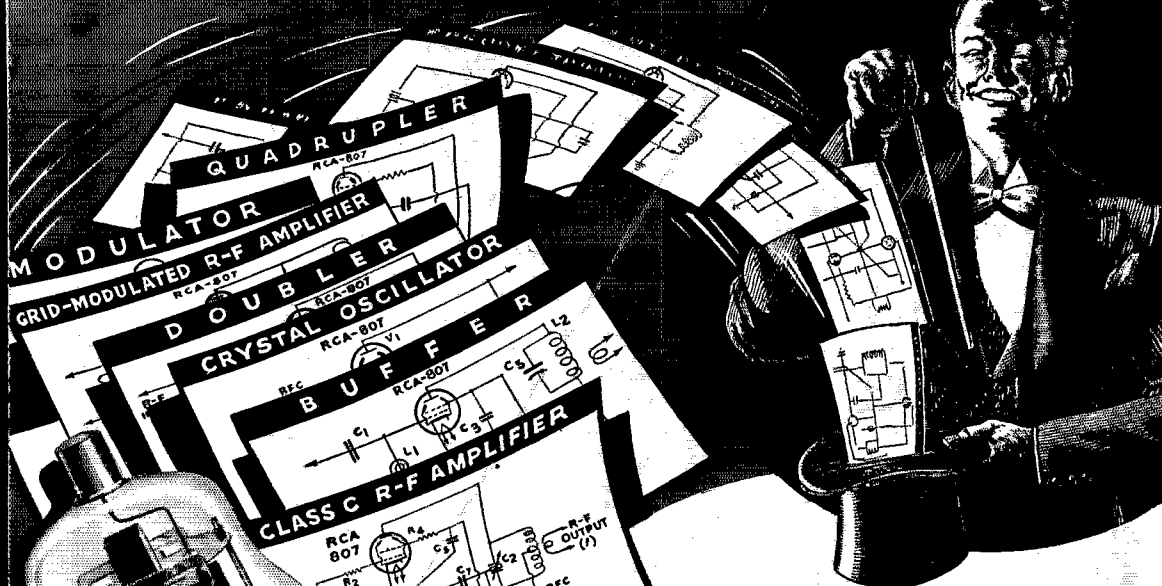

"LITTLE MAGICIAN OF TRANSMITTING TUBE

In the 807, RCA engineering has provided a tube that has excelled for versatility, unsurpassed in performance for literally dozens of jobs. Crystal oscillator, doubler, quadrupler, buffer, Class C r-f amplifier, grid-modulated amplifier, modulator—almost like magic the RCA-807 fits them all. There's always a use for this tube around any station, big or little—and, whatever the job assigned to it, you may be assured of top performance and long life. The RCA-807 is by far the handiest, most economical and most widely used tube you'll ever be likely to handle. Rigs may come and rigs may go—but here is a tube that never goes—except from one rig into another!

HAM TIPS . . . Free!

A helpful little publication brimful of worthwhile information for amateurs—free—at all RCA Power Tube Distributors. See March-April, 1939, issue for data on RCA-807, including details on a push-pull beam power r-f amplifier having 75 watts output for Class C telegraph service.



Visit RCA Television Exhibits at Golden Gate International Exposition and New York World's Fair.

RCA-807 BEAM POWER AMPLIFIER

"Half a dozen
tubes in one"

Maximum ratings for
Class C Telegraphy:

- D. C. Plate Voltage, 600 volts.
- D. C. Plate Current, 100 milliamperes.
- D. C. Plate Input, 60 watts.
- Plate Dissipation, 25 watts.

Amateur
Net
\$3.50



RCA MANUFACTURING
CO., INC., CAMDEN, N. J.

A Service of the Radio
Corporation of America

Radio Tube

FIRST IN METAL—FOREMOST IN GLASS—FINEST IN PERFORMANCE