

July, 1939

25 cents

QST 

devoted entirely to

amateur radio

In this issue:

HIGH-EFFICIENCY GRID MODULATION

•
STEPPING-UP RECEIVER PERFORMANCE

COLLINS 12Y

REMOTE AMPLIFIER

SIZE: 3¾" high x 6¼" wide x 7" deep.

WEIGHT: 4¾ lbs. without attachment cord.

NUMBER OF CHANNELS: One.

GAIN: 84 decibels, maximum.

INPUT IMPEDANCE: Modified Collins Universal Input System giving 30/50 ohms, 200/250 ohms or direct to grid of tube. Change of impedance is accomplished by a simple internal wiring modification.

OUTPUT IMPEDANCE: 500 ohms.

POWER OUTPUT: Plus 8 decibels at 1.0% distortion.

TUBES USED: 1—6F5, 3—6C5, 1—6X5.

FREQUENCY RESPONSE: Uniform within 1 decibel from 40 to 10,000 c.p.s.

GAIN CONTROL: High resistance potentiometer with control knob on panel. Semi-adjustable control furnished on special order.

FINISH: Both panel and cover are finished in black anodic aluminum.

CARRYING CASE: A hard leather carrying case with shoulder strap may be obtained as an accessory. The size is 7" high x 7" wide x 7½" deep. It weighs 2 pounds, 3 ounces.

POWER SUPPLY: The rectifier and filter system is self-contained for a-c operation. The power transformer is external and is part of the attachment cord furnished with the amplifier. The weight is 2 pounds, 11 ounces complete.

Equip your broadcast station with the latest in remote amplifiers — COLLINS NEW 12Y.

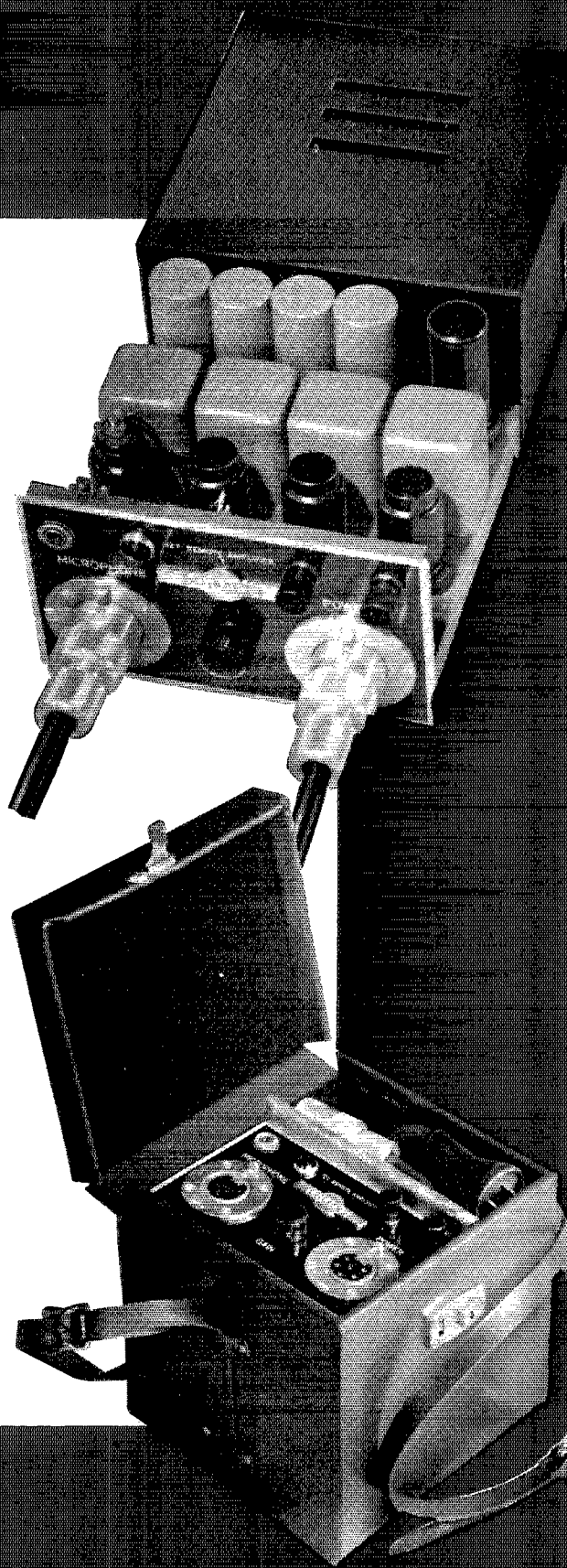

COLLINS RADIO COMPANY

— CEDAR RAPIDS, IOWA
NEW YORK, N. Y. 10011 WEST 42 ST.

HERE IT IS!

the Skyrider

DEFIANT

MODEL SX 24

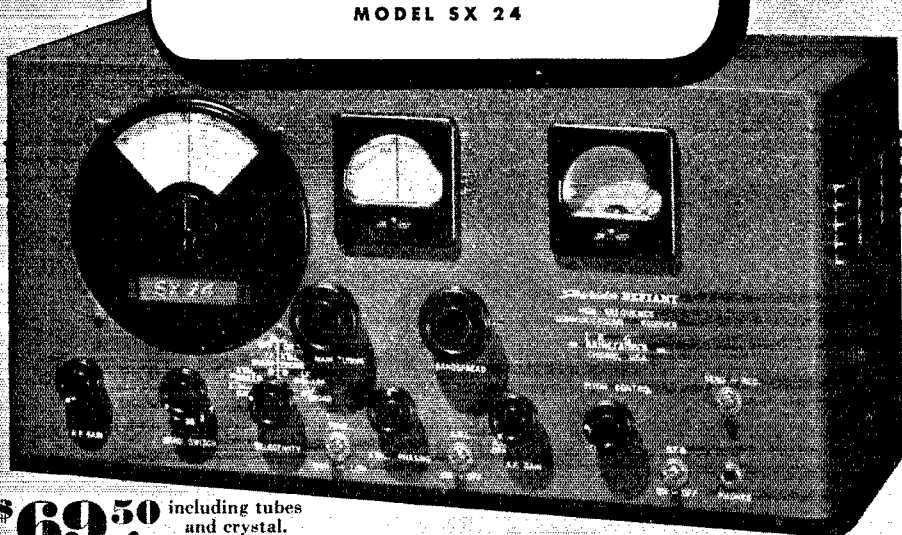

\$69.50 including tubes
and crystal.

WITH FREQUENCY METER TUNING*

True to Hallicrafters tradition, the Skyrider DEFIANT offers the amateur radio operator more advanced engineering, more quality construction and finer performance for every dollar of cost than he has been offered before.

The Model SX 24 is an improved 9 tube receiver built according to latest engineering practice to meet present day amateur radio requirements. It offers Built-In Frequency Meter Tuning, with directly and accurately calibrated 330° Band Spread dials for each of the 80, 40, 20 and 10 meter amateur bands that will bring in signals *on their frequencies as indicated on the dial*. It has a built-in Noise Limiter, a 6-Position Variable Selectivity Switch, an S-Meter, Crystal Filter, every control needed for convenient and efficient operation, and coverage from 43.5 to .54 MC.

And all this for less than Seventy Dollars!

See the Skyrider DEFIANT at your Hallicrafters Distributors or Write for Complete Information.

* Copyright, The Hallicrafters, Inc.

FEATURES

- ★ Built-In Frequency Meter Tuning*
- ★ 330° Band Spread for each of 10, 20, 40, 80 Meter Bands
- ★ 9 Tubes
- ★ 6 Position Selectivity Switch
- ★ Improved Crystal Filter Circuit
- ★ Electrical Band Spread

the hallicrafters, inc.

2611 Indiana Avenue, Chicago, U. S. A. Cable Address: HALLICRAFT, Chicago

“WORLD'S LARGEST BUILDERS OF AMATEUR COMMUNICATIONS EQUIPMENT”

FOR
5 Meter
TRAFFIC
the
Skyrider 5-10

WHEN YOU HEAR the Ultra-High-Frequency specialists on the air, you can be sure that there is a better than average chance that a Skyrider 5-10 is doing its share toward a perfect QSO. Amateurs handling 5 meter traffic *know* what this receiver can do!

Ask H. H. Robinson, W4EDD, of Miami. He promised to work W9WZE in Chicago on 5 meters. And when the band opened up his signal came into Chicago, calling for Bill Halligan. Unfortunately W9WZE was working 20 meters at the time, so W4EDD worked another Chicago amateur, W9MQM, who subsequently relayed his message to W9WZE.

You will find more and more Ultra-High-Frequency specialists like W4EDD using the Skyrider 5-10 as the most dependable receiver for these critical high frequency bands. Ask your Hallicrafters distributor about the Skyrider 5-10, or write for complete information.

The Skyrider 5-10

An 8-Tube Super with built-in Automatic Noise Limiter, Built-in Speaker, and a frequency coverage from 27 MC to 68 MC on two bands.

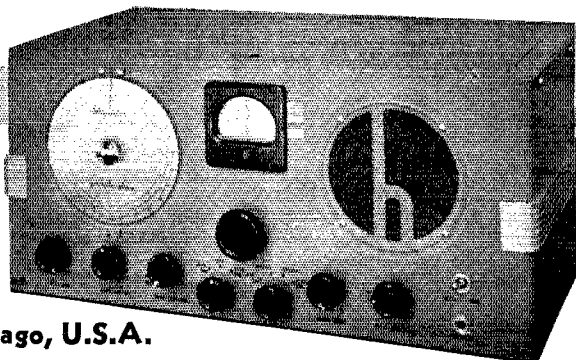

the
hallicrafters, inc.

2611 Indiana Avenue, Chicago, U.S.A.

Cable Address: HALLICRAFT, Chicago

"WORLD'S LARGEST BUILDERS OF AMATEUR COMMUNICATIONS EQUIPMENT"

JULY 1939

VOLUME XXIII
NUMBER 7



STAFF

Editorial

KENNETH B. WARNER, W1EH
Editor and Business Manager

CLARK C. RODIMON, W1SZ
Managing Editor

GEORGE GRAMMER, W1DF
Technical Editor

DONALD H. MIX, W1TS
BYRON GOODMAN, W1JPE
Assistant Technical Editors

VERNON CHAMBERS, W1JQ
Technical Information Service

JAMES J. LAMB, W1AL
Consultant

Advertising

F. CHEYNEY BEEKLEY, W1GS
Advertising Manager

CHARLES BRUNELLE
Asst. Advertising Manager

Circulation

DAVID H. HOUGHTON
Circulation Manager

RALPH T. BEAUDIN, W1BAW
Asst. Circulation Manager



OFFICES

38 La Salle Road
West Hartford, Connecticut

Subscription rate in United States and Possessions and Canada, \$2.50 per year, postpaid; all other countries, \$3.00 per year, postpaid. Single copies, 25 cents. Foreign remittances should be by international postal or express money order or bank draft negotiable in the U. S. and for an equivalent amount in U. S. funds.

Entered as second-class matter May 29, 1919, at the post office at Hartford, Connecticut, under the Act of March 3, 1879. Acceptance for mailing at special rate of postage provided for in section 1103, Act of October 3, 1917, authorized September 9, 1922. Additional entry at Concord, N. H., authorized February 21, 1929, under the Act of February 28, 1925. Additional second-class entries to cover sectional editions authorized March 20, 1935.

Copyright 1939 by the American Radio Relay League, Inc. Title registered at United States Patent Office.

QST

devoted entirely to

AMATEUR RADIO

PUBLISHED, MONTHLY, AS ITS OFFICIAL ORGAN, BY THE AMERICAN RADIO RELAY LEAGUE, INC., AT WEST HARTFORD, CONN., U. S. A.:
OFFICIAL ORGAN OF THE INTERNATIONAL AMATEUR RADIO UNION



CONTENTS

Editorial	9
Honolulu Bound Don C. Wallace, W6AM	10
Stepping Up Receiver Performance J. P. Veatch, W9CJJ and D. D. Kahle, W9AUJ	12
A Hurricane Emergency Transmitter and Power Supply Gale M. Smith, W4BPB	18
Northwestern Division Convention	22
Our Cover	22
1938 Paley Trophy Awarded to WIBDS	23
Rotating the Rotary Gilbert Williams, W1APA	24
An Animated Radio Diagram	26
What the League Is Doing	27
High-Efficiency Grid Modulation in Portable 14-Mc. 'Phone Transmitter Frank L. Denton, W4ATI	33
Simplicity on 112 Mc. B. W. Griffith, W5CSU	38
Dixie Jones' Owl Juice	39
The "Double Pitchfork" Antenna William J. Breur, W6TE	40
Ham Shacks W5DYM, W3CVK, W5BRR, W9IQZ, VE3AGM, W8BQ, VO4A	42
Second "A.R.R.L." QSO Party Results E. L. Battey, W1UE	44
Hints and Kinks	47
Correspondence	49
Operating News	50
56-Mc. Open for DX	52
How's DX?	54
Century Club	60
Hamfest Schedule	64
"Switch to Safety!"	76
Mid-American and Dakota Division Convention	80
Roanoke Division Convention	82
Safety ABC's	84
Silent Keys	86
Hamads	91
QST's Index of Advertisers	94

SUMMER TIME

During JULY and AUGUST



M
E
M
B
E
R
S
H
I
P

W
I
T
H

12

I
S
S
U
E
S

O
F

Q
S
T

No. 1

or

with either

No. 2

or

No. 3

Any one of the three combination offers for \$3.00 (\$3.25 U. S. Possessions and Canada, \$3.75 elsewhere) when sent **DIRECT** to American Radio Relay League, West Hartford, Connecticut, U. S. A. Otherwise combination prices do not apply. This offer applies to new entries, renewals or extensions.

is Special Offer Time

3 COMBINATION OFFERS

The Radio Amateur's Handbook

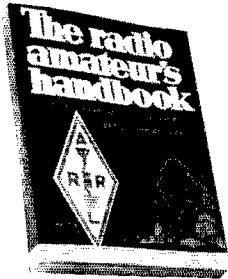

Three Log Books

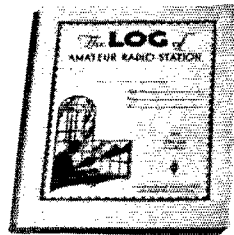

Four Pads Radiogram Forms

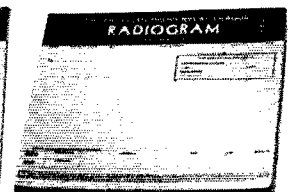
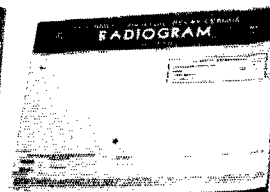
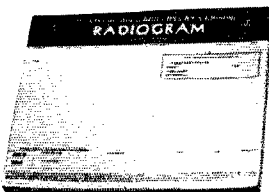
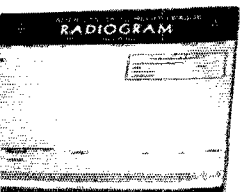

Please enter my membership-subscription for a period of one year. Begin QST with issue and send combination number.....to.....

Section Communications Managers of the A.R.R.L. Communications Department

All appointments in the League's field organization are made by the proper S.C.M., elected by members in each Section listed. Mail your S.C.M. (on the 10th of each month) a postal covering your radio activities for the previous 30 days. Tell him your DX, plans for experimenting, results in phone and traffic. He is interested, whether you are an A.R.R.L. member or get your QST at the newsstands; he wants a report from every active ham. If interested and qualified for O.R.S., O.P.S. or other appointments he can tell you about them, too.

ATLANTIC DIVISION				
Eastern Pennsylvania Maryland-Delaware-District of Columbia Southern New Jersey Western New York Western Pennsylvania	W3QP W3BAK W3BEI W8CSE W8OFO	John B. Morgan Edgar L. Hudson W. W. Filson Ed Preston Kendall Speer, Jr.	Blue Bell Laurel, Delaware Audubon Tully Lowermer	
CENTRAL DIVISION				
Illinois Indiana Kentucky Michigan Ohio Wisconsin	W9RMM W9QG W9ARU W8DPE W8AQ W9UTT	Leslie M. Dickson Noble Burkhart Darrell A. Downard Harold C. Bird E. H. Gibbs Aldrick C. Krone	Edellyn Farms R. 4, Box 1 116 N. Longworth Ave. R. F. D. 2 405 Broad St. 3127-A West Madison St.	Waukegan Indianapolis Louisville Pontiac Wadsworth Milwaukee
DAKOTA DIVISION				
North Dakota South Dakota Northern Minnesota Southern Minnesota	W9RZA W9VGD W9IGZ W9VNG	Ernest Bloch Dr. A. L. Russell Edwin L. Wicklund Millard L. Bender	Box 202 R. F. D. 3 608 N. Huron Ave.	Thompson Philip Kenington Spring Valley
DELTA DIVISION				
Arkansas Louisiana Mississippi Tennessee	W5ABI W5DKR W5EWD W4DWS	H. E. Velte Eugene H. Treadaway Jewell W. Cole William Harold Walker	4415 West 12th St. 2749 Myrtle St. c/o City of McComb Water Dept. 3503 Belmont Blvd.	Little Rock New Orleans McComb City Nashville
HUDSON DIVISION				
Eastern New York N. Y. C. & Long Island Northern New Jersey	W2LU W2AZV W2GMN	Robert E. Haight E. L. Baunach Fred C. Read	511 South Holmes St. 102 Central Ave. 1014 North Ave.	Scotia Massapequa, L. I. Elizabeth
MIDWEST DIVISION				
Iowa* Kansas Missouri Nebraska	W9PIR W9FEG W9OUD W9DI	L. B. Vennard Melvin D. Kirby Miss Letha Altendorf William J. Bamer	P. O. Box 304 1015 W. 3rd St.	West Burlington Arlington Pondlet Tobias
NEW ENGLAND DIVISION				
Connecticut Maine Eastern Massachusetts Western Massachusetts New Hampshire Rhode Island Vermont	W1CTI W1IIE W1HIL W1JAH W1BHT W1IRC W1KJG	Frederick Ellis, Jr. H. W. Castner Larry Mitchell William J. Barrett Carl E. Evans Clayton C. Gordon Clifton G. Parker	19 Merrill Rd. 147 Church 94 Howard St. 239 Columbia St. 163 South Main St. 192 Washington Ave. Box 537	Norwalk Damariscotta Melrose Adams Concord Providence Morrisville
NORTHWESTERN DIVISION				
Alaska Idaho Montana Oregon Washington	K7ENA W7EMT W7FL W7DXF W7FCG	Leo E. Osterman Carl Kichelberger G. A. Woodhouse Harold W. Johnston W. Beale	Customhouse Route 2 Holter Dam 205 North Grant St. R. 4, School Ave.	Wrangell Kuna Wolf Creek Pondlet Walla Walla
PACIFIC DIVISION				
Hawaii Nevada Santa Clara Valley East Bay San Francisco Sacramento Valley Philippines San Joaquin Valley	K6ETF W6BIC W6FBW W6TI W6SG W6MDI KALGR W6KUT	Francis T. Blatt Edward W. Heim Elbert Amarantes Horace R. Greer Alan D. Whittaker, Jr. Vincent N. Feldhausen George L. Rickard Edwin A. Andress	837 16th Ave. 509 Claremont St. 454 Washington St. 414 Fairmount Ave. 19 Elmor Ave. 113 South Quincy St. Box 849 2921 North Van Ness Blvd.	Honolulu Reno San Jose Oakland Mill Valley Concord Manila Fresno
ROANOKE DIVISION				
North Carolina South Carolina Virginia West Virginia	W4CYB W4BOE W3UVA W8HD	W. J. Wortman Ted Ferguson Charles M. Waff, Jr. C. S. Hoffmann, Jr.	P. O. Box 566 1213 College St. Box 1212 47 Lynwood Ave.	Morganton Columbia University Wheeling
ROCKY MOUNTAIN DIVISION				
Colorado Utah-Wyoming	W9EHC W7CLG	Carl C. Drumeller Ernest E. Parshall	1828 East Kiowa St. Salt Creek Electric Plant	Colorado Springs Midwest, Wyoming
SOUTHEASTERN DIVISION				
Alabama Eastern Florida Western Florida Georgia West Indies (Cuba-Isle-of-Pines- Porto Rico-Virgin Islands)	W4DGS W4DVO W4AXP W4AGI CM2OP	James F. Thompson L. A. Connolly Oscar Cederstrom Leland W. Smith Mario de la Torre	1203 South Perry St. 719 So. Willow Ave. Second St. & Bruce Ave. 2010 Pennsylvania Ave. Escobar 110 (Altos)	Montgomery Tampa De Funiak Springs Augusta Habana, Cuba
SOUTHWESTERN DIVISION				
Los Angeles Arizona* San Diego	W6MOM W6OIF W6JRM	Ralph S. Click Cameron Allen Howard K. Breedlove	1038 Milwaukee Ave. 513 N. 3rd St. R. 2, Box 636	Los Angeles Phoenix San Diego
WEST GULF DIVISION				
Northern Texas Oklahoma Southern Texas New Mexico	W5DXA W5CEZ W5BHO W5ENI	Lee Hughes Carter L. Simpson Dave H. Galk Dr. Hilton W. Gillett	125 N. Main St. 2010 So. 4th St. 6726 Ave. Q	Childress Ponca City Houston Lovington
MARITIME DIVISION				
Maritime	VE1DQ	A. M. Crowell	69 Dublin St.	Halifax, N. S.
ONTARIO DIVISION				
Ontario	VE3EF	Dr. D. R. Gunn (for VE3SG)	Ontario Hospital	New Toronto, Ont.
QUEBEC DIVISION				
Quebec	VE2CO	Lindsay G. Morris	Apt. 6, 4510 Girouard Ave., N. D. G.	Montreal, P. Q.
VANALTA DIVISION				
Alberta British Columbia	VE4GE VE5HP	C. S. Jamieson J. Hepburn, Jr.	581 W. Riverside Drive 335 Foul Bay Road	Drumheller, Alta. Victoria
PRAIRIE DIVISION				
Manitoba* Saskatchewan	VE4BG VE4SY	A. J. R. Simpson Arthur Chesworth	635 Garfield St. 1071 4th Ave., N. W.	Winnipeg Moose Jaw

* Officials appointed to act until the membership of the Section choose permanent S.C.M.s by nomination and election.

*Amateurs Everywhere
have Compared and they ...*

Prefer KENYON

You fellows who are keen shoppers, comparative buyers and who carefully weigh all facts *FIRST*, realize that *QUALITY* has no price tag, that performance is always more important than price.

Perhaps this, more than anything, is the reason for the outstanding popularity of Kenyon Transformers with amateurs everywhere, the answer to why amateurs are willing to pay a few cents more to get the *BEST!*

Measuring "On-the-Air" hours against dollar investment, *KENYON TRANSFORMERS* are the greatest value in the long run.

HEAVY DUTY AMATEUR PLATE TRANSFORMERS

Type No.	Primary Connection	Secondary No. 1			Secondary No. 2			Net Price
		D.C.	A.C.	M.A.D.C.	D.C.	A.C.	M.A.D.C.	
T-664		600	740-0-740	150				\$ 4.50
T-655	High	450	575-0-575	250				4.80
	Low	350	460-0-460	250				
T-656	High	750	925-0-925	300				6.60
	Low	600	740-0-740	300				
T-657	High	1000	1170-0-1170	200	1000	1170-0-1170	200	13.80
	Low	750	900-0-900	200	750	900-0-900	200	
T-665	High	1250	1470-0-1470	250				12.00
	Low	1000	1180-0-1180	250				
T-666		1250	1460-0-1460	350				14.40
T-661		1750	2080-0-2080	200				12.00
T-652	High	1750	2080-0-2080	450				
	Low	1500	1760-0-1760	450				22.80
T-651	High	1750	2080-0-2080	300				18.00
	Low	1500	1760-0-1760	300				
T-653		2000	2360-0-2360	300				19.20
T-663		2000	2360-0-2360	600				36.00

STANDARD AMATEUR PLATE TRANSFORMERS

Type No.	Secondary Voltage	D.C. Volts	D.C. M.A.	Net Price
T-668	1000/750-0-750/1000	500/750	300	\$ 5.95
T-669	1460/1180-0-1180/1460	1000/1250	300	9.60
T-670	2360/2080/1760-0-1760/2080/2360	1500/1750/2000	300	12.90
T-671	1460/1180-0-1180/1460	1000/1250	500	12.90

Special Announcement: Kenyon Transformers are now distributed by Springfield Radio Co., 405 Dwight St., Springfield, Mass., and Hatry & Young, 203 Ann St., Hartford, 1172 Chapel St., New Haven, and 195 Cannon St., Bridgeport, Conn.



KENYON TRANSFORMER CO., Inc.

840 BARRY ST., NEW YORK, N. Y.

Export Department: 25 Warren St., New York, N. Y.

THE AMERICAN RADIO RELAY LEAGUE

Directors

President
EUGENE C. WOODRUFF W8CMP
234 W. Fairmount Ave., State College, Pa.

Vice-President
GEORGE W. BAILEY W1KH
74 Webster Road, Weston, Mass.

Canadian General Manager
ALEX REID VE2BE
169 Logan Ave., St. Lambert, P. Q.

Atlantic Division
WALTER BRADLEY MARTIN W3QV
Box 612, Roslyn, Pa.

Central Division
R. H. G. MATHEWS ex-W9ZN
100 East Ohio St., Chicago

Dakota Division
FRED W. YOUNG W9MZN
107 Hanover St., Mankato, Minn.

Delta Division
E. RAY ARLEDGE W5SI
P.O. Box 286, Pine Bluff, Ark.

Hudson Division
KENNETH T. HILL W2AHC
115 Willow St., Douglaston, L. I., N. Y.

Midwest Division
FLOYD E. NORWINE, JR. W9EFC
120 South Fourth St., St. Louis, Mo.

New England Division
PERCY C. NOBLE W1BVR
37 Broad St., Westfield, Mass.

Northwestern Division
RALPH J. GIBBONS W7KY
c/o United Air Lines, Portland, Ore.

Pacific Division
J. L. McCARGAR W6EY
66 Hamilton Pl., Oakland, Calif.

Roanoke Division
H. L. CAVENESS W4DW
State College Station, Raleigh, N. C.

Rocky Mountain Division
GLEN R. GLASSCOCK W9FA
2164 So. Corona St., Denver

Southeastern Division
BENNETT R. ADAMS, JR. W4APU
1512 Grove Place, Homewood, Ala.

Southwestern Division
CHARLES E. BLALACK W6GG
1273 Main St., El Centro, Calif.

West Gulf Division
WILLIAM A. GREEN W5BKH
801 Ross St., Abilene, Texas

THE AMERICAN RADIO RELAY LEAGUE, INC., is a non-commercial association of radio amateurs, bonded for the promotion of interest in amateur radio communication and experimentation, for the relaying of messages by radio, for the advancement of the radio art and of the public welfare, for the representation of the radio amateur in legislative matters, and for the maintenance of fraternalism and a high standard of conduct.

It is an incorporated association without capital stock, chartered under the laws of Connecticut. Its affairs are governed by a Board of Directors, elected every two years by the general membership. The officers are elected or appointed by the Directors. The League is non-commercial and no one commercially engaged in the manufacture, sale or rental of radio apparatus is eligible to membership on its board.

"Of, by and for the amateur," it numbers within its ranks practically every worth-while amateur in the nation and has a history of glorious achievement as the standard-bearer in amateur affairs.

Inquiries regarding membership are solicited. A bona fide interest in amateur radio is the only essential qualification; ownership of a transmitting station and knowledge of the code are not prerequisite. Correspondence should be addressed to the Secretary.



HIRAM PERCY MAXIM, FIRST PRESIDENT

Officers

President EUGENE C. WOODRUFF, W8CMP
State College, Pa.

Vice-President GEORGE W. BAILEY, W1KH
Weston, Mass.

Secretary KENNETH B. WARNER, W1EH
West Hartford, Connecticut

Treasurer ARTHUR A. HEBERT, W1ES
West Hartford, Connecticut

Communications Mgr. F. EDWARD HANDY, W1BDI
West Hartford, Connecticut

General Counsel PAUL M. SEGAL
1026 Woodward Building, Washington, D. C.

Address all general correspondence to the administrative headquarters at West Hartford, Connecticut.

“IT SEEMS TO US—”

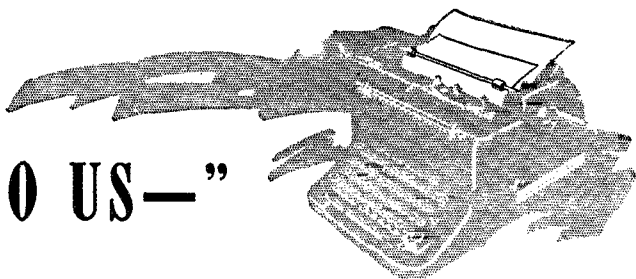

THE F.C.C. inspectors have a sort of dilemma on their hands. Here's this new regulation of ours that says we must employ means to verify our frequency. They want to know how they can tell, when they inspect our stations, whether we are complying. If we haven't "established procedure for checking the frequency regularly," it's the same as violating any other reg, they say, and the only way to tell is for us to keep a written record of the dates and times that we do check up on our rigs. Well, maybe the rule should so require, but it doesn't. Perhaps it would be a helpful practice. But it seems to us that that wasn't contemplated when the rule was drafted and that it would unnecessarily complicate the already extensive "bookkeeping" that a modern station requires. You can't tell by looking at a station whether its operator puts out profane language; it's up to him not to. Similarly, we think of this reg as intended to make an amateur more frequency-conscious. It of course is incumbent upon the licensee to comply but he shouldn't have to be perpetually proving that he does. If an amateur is cited (correctly) for being out of a band, he has not only violated the rule specifying our frequencies but his performance is plainly defective under the new rule requiring the measuring and checking of frequency. It becomes then a double violation. It seems to us that that should be sufficient "enforcement." But, as a matter of personal pride and because it's good business, most amateurs will want voluntarily to keep some sort of auxiliary record of their checking procedure; it's always a useful record.

THE greatest problem the QSL Managers face is the negligence amateurs show in claiming their cards. It breaks their hearts to have thousands upon thousands of choice foreign DX cards on hand unclaimed. These QSL Managers sort and file hundreds of thousands of cards every year. They do it as an uncompensated labor, just to help along the game. Their boxes bulge with juicy DX reports you haven't sent for. Have you got a stamped addressed envelope on file with your QSL Manager? Do you send a new envelope each

time you receive a batch of cards? Your cards ought to be worth that little effort to you. See the simple directions and the address of your QSL man, published in every issue of *QST*. Send for your cards!

THE good old summer time, she's here! And Field Day coming up. The fun the fellows have been having in recent years has been talked around, and we miss our guess if F.D. this year doesn't turn out to be a madhouse comparing with the DX Contest.

There's a lot of summer fun to be had with ham radio. We can really work now, an awful cry from 200-meter spark days when all one could hear from out of town was crashing static. It's a good time, by the way, to do some playing with kites to lift antennas, a field in which we ought to be able to develop something useful. That reminds us, of course, of the ultra-high frequencies. We ought to be getting after $2\frac{1}{2}$ and $1\frac{1}{4}$ more energetically than we are; our laurels need a bit of polishing up. Summer offers the ideal opportunity, when it is pleasant to rove the hilltops and when a picnic basket seems the natural complement of u.h.f. gear. Which brings to mind our perpetual astonishment that more amateurs haven't got 5-and-10 portable-mobile equipment installed in their cars. What a chance for interesting communication you're missing during the touring season, particularly this summer of the two World's Fairs when everybody is gadding about the continent like mad!

There's no dearth of things to do with amateur radio this summer, is there?

STILL yearning for new fields to investigate? Well, here's another. Remember the F.C.C. rule that legitimized remote control of broadcast tuners and phonograph-record players by means of a miniature unlicensed transmitter? What that rule says in effect is that these devices may be used without licenses up to a distance which may be calculated in feet by dividing the wavelength in meters by 2π , provided the field strength at that distance does not exceed $15 \mu\text{v}/\text{m}$ and provided no

(Continued on page 88)

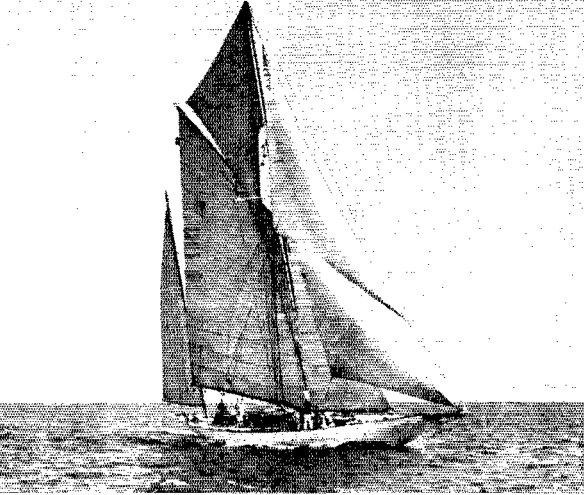

Honolulu Bound

WGAM Sails in Honolulu Yacht Race

BY DON C. WALLACE,* WGAM



The yacht "Contender" under full sail. Six different antennas can be hoisted into place.



Now that 10-meter mobile operation is permissible on the high seas, there will be at least two 10-meter yacht outfits in operation from July 4th to July 17th or thereabouts, during the Honolulu Yacht Race. One of these outfits will be on board the yacht "Contender."

The "Contender" is a yacht fit for a king. In fact, it was built for a king. It was formerly owned by the Hohenzollern family of Germany, and was frequently used by Kaiser Wilhelm and by the Crown Prince. Old-timers will remember the stories of this yacht, built in Kiel, Germany, and the frequent trips the Royal Family took in it. At that time it was called the "Armgarde." As the Kaiser liked yacht racing, the big 107-foot yawl entered many a European yacht race.

After the war, it was purchased by an East Coast yachtsman, and used for some time on the East Coast. Eventually it reached the West Coast, having been brought out by Paul Whittier as the "Poinsetta," and was outfitted at a cost of \$45,000 by Walter Horn, of Long Beach. Later it was purchased by Dick Loynes, international speed boat champion, who is sailing it to Honolulu.

Dick Loynes has secured local men, all expert in sailing, to be his crew. They are twelve in number, including the radio operator.

WGAM took the "telegraph first" and "telephone first" F.C.C. examinations so as to have the proper credentials for the trip. If plans work out, he will join the yacht just before it sails from Treasure Island, July 4th, bound for Honolulu, along with between 20 and 40 other boats.

This race is a handicap race and has been run approximately every odd-numbered year since 1906. It is the original transoceanic race. Later on, the Bermuda race started off the East Coast, so now these races are run on alternate years. This year it is being sponsored by the International Exposition at Treasure Island.

The yacht "Contender" once arrived first, under the previous owner, but went across the wrong finish line. By the time this was discovered it was two hours later, so they came in second. Another time the "Contender" came in second,

so if there is plenty of wind, the ship has a fine chance to make a good showing.

Dick Loynes has spared no expense in getting the very finest radio equipment that could be put aboard.

Fifty-five brand new 300 ampere-hour heavy duty storage cells have been installed. A Delco 3000-watt gasoline-driven charger will charge these batteries whenever necessary. The ship's auxiliary motor is attached to a 5000-watt generator, so ample charging facilities are provided. Four hundred gallons of gasoline will be carried in order to assure the radio department uninterrupted service. Thus 15 kw. of primary current is available.

Just before the ship leaves on the trip, it will be placed in dry dock. There the propeller and propeller shaft will be taken off to lessen the drag through the water; so the engines will be used solely to supply radio power, via the battery or floating on the line.

An Esco 2000-watt motor generator will furnish 110-volt a.c. to the radio transmitter, which is a Temco Model 350. This transmitter ordinarily covers all bands from 10 to 160 meters. The excitation is all controlled by switches on the front of the panel. To change bands it is necessary only to change the final tank coil. By supplying an overabundance of excitation it is not necessary to change a large number of coils when going from band to band. In addition, this particular transmitter has been provided with ranges extending to 500 Mc. (the ship's calling and distress frequency).

In this manner it will be possible to QSO commercial operators along the ship lanes, whenever advisable, and also to be able to secure compass bearings from points along the Pacific Coast shore, as well as compass bearings from the liners plying to the Orient and to Hawaii.

Four times during the trip the Pan-American ships will pass overhead, and it is anticipated that position reports will be exchanged with them.

There is a new halyard rove in the peak of each mast and at the end of each yardarm, so there are six halyards in all to hoist antennas. The

*4214 Country Club Dr., Long Beach, Calif.



Capt. Dick Loynes, owner of the "Contender."

antennas are made from 7/20 stranded wire, using maple dowel insulators one inch in diameter and a foot long. The feeder bars are of 5/16-inch maple dowel. Both the insulators and dowels were boiled for two hours in a 50-50 mixture of paraffin and beeswax. Thus, when the antennas are dropped to the deck no crashing of porcelain will occur, as it did during one of the shake-down cruises. The antennas will be coiled and tagged and stored below when not in use.

The top side ventilating port from the radio room has six holes drilled in the glass. These, fitted with bolts, will serve as the lead-in ports, thus allowing a total of three antennas to be up simultaneously. All frequencies of the antennas are transmitting frequencies, although if cross-band operation is used, and the signals are weak, another antenna suitable for the received frequency can readily be hoisted.

During the stay in San Francisco and the first 50 miles of the race, 5-meter operation is contemplated. The hills of Oakland and San Francisco make good 5-meter locations and there is a fine gang to work there, as was discovered when W6AM mobile drove into town a few years ago.

The RME-70 receiver is equipped with the RME LF-90, which covers from 1550 kc. to 90 kc. W6AM will also bring his own receiver, so that the amateur bands can be watched consistently during the entire trip without interfering with any commercial operation which may become necessary.

Two 110-volt d.c. to 110-volt a.c. dynamotors

W6AM rigging antennas.

July 1939

of 150- and 500-watt capacity supply the current to five receivers, including a radio compass.

A large number of frequencies will be available in the high-frequency spectrum. At this writing the F.C.C. has been requested to allow amateurs to be contacted from the regular yacht frequencies assigned, both 'phone and c.w.

Twenty variable crystals will also be along, for operation on the 10-meter band en route and as a portable on other bands while in San Francisco Bay before the trip or at anchor in Hawaii.

A complete 10-meter transmitter operating from half the Delco 24-volt starting battery is also aboard. This is the 12-volt transmitter formerly installed in the car of Les Bowman, W6PQY, director of engineering in C.B.S. Pacific Coast division.

The W6AM suitcase portable, described in October, 1931, *QST* as "The Traveling Man's Portable," will be along as an emergency rig.

The antennas are so arranged that they can be hoisted promptly after the sails have been set. In that way the large free space between the two masts can be used to advantage. The mainmast is 96 feet above sea level, and the mizzenmast 50 feet. The wide-open space between the two masts makes an ideal place to set antennas.

The antenna problem was a tough one to figure in detail. The antennas must not interfere with good sailing, and must suit the frequency used, so a good signal can be put into the U. S. A. at all hours of the day or night. In all probability the ship will be headed almost due West because of the consistent trade winds during July, so the antennas are laid out for directivity to the States, *i.e.*, aft.

While the ship is at anchor at Hawaii or other islands of the Pacific, all amateur bands — 14, 7, 4 and 2 Mc. inclusive — will be used, signing "Portable K6." We hope to QSO hams in every district, so be on the lookout for KLRR-W6AM, July 3rd to 18th.

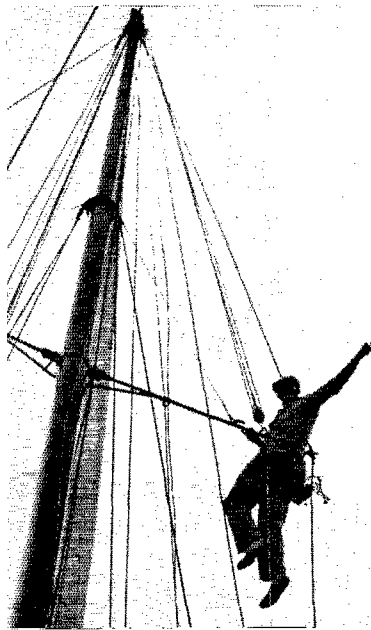

Stepping Up Receiver Performance

A New Approach to the Problems of High-Frequency Reception

BY J. P. VEATCH,* W9CJJ, AND D. D. KAHLE,** W9AUJ

ONLY one new idea can be claimed as an excuse for this article, the noise silencing arrangement. This, however, is not simply another paper on noise silencers; in addition, an attempt will be made to describe some circuit ideas which show promise of improving amateur reception.

Unfortunately, it will be impossible to go into detail on all of the circuit arrangements which will be discussed. Complete information on the various items can be found in the *Handbook* and past issues of *QST*. Basically, the receiver is a superheterodyne with two intermediate frequencies instead of one.

Of course a super with two i.f. amplifiers is not new. Major Armstrong included such an arrangement in his original superheterodyne patents. Ross Hull used the principle in the superinfragenerator,¹ the first really outstanding ultra-high-frequency receiver. In this case, a low-frequency first i.f. was used to provide selectivity, and a high-frequency second detector used to obtain the advantages of superregeneration.

In the receivers to be discussed, two intermediate frequencies are used to provide a basis for the noise silencer as well as many other advantages.

First, a few things must be made clear. Although this system will be complicated, all of the difficult details are in the i.f. amplifiers and once correctly adjusted can be forgotten. This is of course superior to a lot of controls which must be adjusted during operation.

Second, the receivers to be suggested are not a cheap way to get fair results from home-made

equipment. Experienced constructors should find in the various arrangements a layout which will give very greatly improved performance over previous compromise systems. The cost will depend on how far one wishes to go in creating a better receiver. Less experienced amateurs may find some interest in the writers' ideas regarding what is wrong with present systems.

The inherent noise in an amplifying system originates principally in the first stage. After the first two stages, the signal is much stronger than the noise generated in subsequent stages, so that the number of tubes does not matter much, provided reasonable judgment is used.

Intermediate Frequencies

The use of 465 kc. as the intermediate frequency in present-day receivers is a compromise between the selectivity and gain obtainable at low frequencies, and image ratio. It is generally recognized that 465 kc. does not give adequate image ratios at the higher frequencies and that higher intermediate frequencies are less selective. High intermediate frequencies do give better image ratios, and frequencies lower than 465 kc. give better selectivity. Obviously, the thing to do is use both. Select a frequency for the first i.f. which will give an adequate image ratio on the highest band desired, and a second intermediate frequency which will give adequate selectivity.

The selection of the first i.f. depends on several things besides the image ratio, and these other requirements will be discussed later. For the present, the following frequencies are suggested: If adequate image ratios are to be maintained at 60 Mc., a 3000-kc. i.f. amplifier is recommended; if 30 Mc. is the limit, use 1500 kc.; and if 7 Mc. is the limit, use 465 kc.

* 7006 West 26th Ave., Denver, Colo.

** 738 Lincoln Street, Denver, Colo.

¹ R. A. Hull, "A New Receiving System for the Ultra-High Frequencies," *QST*, November, 1935, and December, 1935.

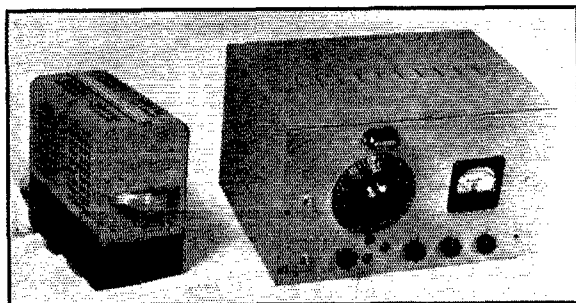

◆
This receiver incorporates the various circuit features described in the text. The left-hand unit is the power supply.
◆

The second i.f. is a 'phone problem. For c.w., the 465-kc. crystal filter is ideal. A 262-kc. second i.f., with infinite rejection, appears to be better suited for 'phone reception and will be discussed later.

The Noise Silencer

J. J. Lamb's first two papers² on noise silencing systems covered the situation very well. Others' attempts since then have been toward a simple system with automatic operation the only requisite. In all of such other systems tried, the results were far from those Lamb's article had led us to expect. The reason was obviously violation of one or more of the requirements of effective silencing. The system to be discussed is an improvement of the original i.f. type silencer and, although more complicated than other arrangements, has repeatedly shown its superiority.

As shown in the original *QST* articles, a noise silencer is primarily a device which, when properly adjusted, will disable the receiving system during high amplitude pulses of short duration and thereby prevent their transmission to portions of the system where overloading can occur, with subsequent noise output not comparable to the actual noise received. In other words, high amplitude pulses, not capable of serious interference themselves, cause secondary effects in our receiving systems which can totally spoil reception. The amount of reduction possible depends on the wave-form of the voltage of the particular noise. Ignition noise, which has an extremely high peak compared to the average voltage, is most easily reduced.

Experience has shown that nearly every type of noise has a much greater peak to average ratio than the signals we wish to receive. If this is true a good silencer should be able to reduce any noise to a certain extent. Signals are deliberately concentrated in a narrow band of frequencies while noise is distributed over a wide band. If the silencer can work on a relatively wide band and reduce the value of noise over this entire range to the peak value of the signal, the noise in a limited band will be much less than the signal. This effect is particularly noticeable on c.w. when the silencer is followed by a crystal filter.

The noise silencer must precede the a.v.c. rectifier in the receiver. If it does not, loud noise will create high a.v.c. voltage and reduce the gain of the set to such an extent that weak signals will

² J. J. Lamb, "A Noise-Silencing I.F. Circuit for Superhet Receivers," *QST*, February, 1936; "More Developments in the Noise-Silencing I.F. Circuit," *QST*, April, 1936.

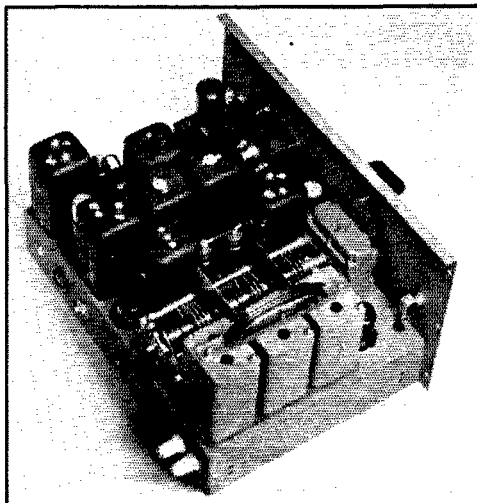

The chassis view shows exceptionally business-like construction. In the foreground is the r.f. coil assembly, three units fastened together so that all are plugged in in one operation.

not be amplified. This requirement brings up one of the disadvantages of the i.f. type silencer; that is, if the threshold adjustment is set to a critical value for a weak signal, a strong signal can go through the noise amplifier and rectifier, and bias the silencer to cut-off. The signal is then removed from the a.v.c. stage for a long enough period for the gain of the receiver to come up, further increasing the input to the noise rectifier and creating a complete "block" of the system. All arrangements protecting the a.v.c. are subject to this trouble. In the new system blocking has been reduced to a great extent and will not occur if the adjustments are made correctly.

As mentioned previously, high-amplitude, short-duration noise is heard because of overloading or transient effects. It follows, therefore, that overloading ahead of the silencer must be prevented. On the other hand, an i.f. silencer must work at fairly high level. It is therefore desirable to obtain just enough gain ahead of the silencer for proper operation and to allow for high amplitude noise without overloading.

It has been repeatedly stated that the silencer must be ahead of any highly selective circuits. However, the silencer must be adjusted, manually or automatically, to the incoming desired signal level, so enough selectivity must be provided to

This is not a "how-to-build-it" article; its purpose is to examine logically the high-frequency receiver problem and to offer some circuit ideas which promise better overall performance than is possible with the best of present-day receivers. Whether or not you're content with your present receiver, this article deserves careful reading.

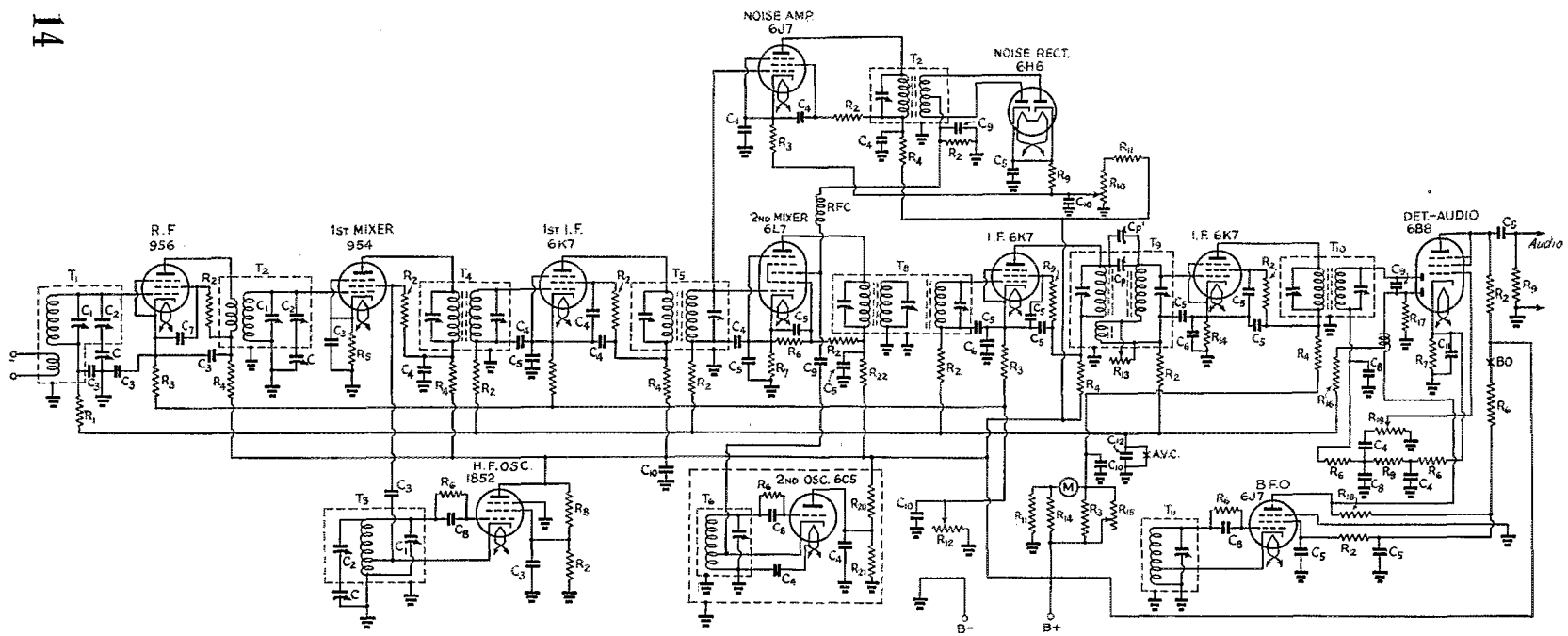

Fig. 1 — Circuit diagram of the double-i.f. receiver.

- C_p — 25- μ fd. midget.
- C_{p'} — 25- μ fd. midget stripped of all plates except one rotor and one stator (Hammarlund).
- C — Tuning condensers.
- C₁ — Band-set condensers.
- C₂ — Band-spread condensers.
- C₃ — 0.01- μ fd. mica.
- C₄ — 0.01- μ fd. paper.
- C₅ — 0.05- μ fd. paper.
- C₆ — 0.1- μ fd. paper.
- C₇ — 0.005- μ fd. mica.
- C₈ — 100- μ fd. mica.

- C₉ — 50- μ fd. mica.
- C₁₀ — 0.5- μ fd. paper.
- C₁₁ — 10- μ fd. 25-volt electrolytic.
- C₁₂ — 0.02- μ fd. mica.
- R₁ — 0.5 megohm, $\frac{1}{2}$ -watt.
- R₂ — 0.1 megohm, $\frac{1}{2}$ -watt.
- R₃ — 500 ohms, $\frac{1}{2}$ -watt.
- R₄ — 3000 ohms, $\frac{1}{2}$ -watt.
- R₅ — 2500 ohms, $\frac{1}{2}$ -watt.
- R₆ — 50,000 ohms, $\frac{1}{2}$ -watt.
- R₇ — 2000 ohms, $\frac{1}{2}$ -watt.
- R₈ — 50,000 ohms, 1-watt.
- R₉ — 0.25 megohm, $\frac{1}{2}$ -watt.
- R₁₀ — 3000-ohm variable (noise-silencer control).

- R₁₁ — 30,000 ohms, 2-watt.
- R₁₂ — 10,000-ohm variable (r.f. gain).
- R₁₃ — 20,000-ohm variable.
- R₁₄ — 300 ohms, $\frac{1}{2}$ -watt.
- R₁₅ — 1000-ohm variable.
- R₁₆ — 1 megohm, $\frac{1}{2}$ -watt.
- R₁₇ — 2 megohms, $\frac{1}{2}$ -watt.
- R₁₈ — 10,000 ohms, $\frac{1}{2}$ -watt.
- R₁₉ — 1-megohm variable (audio gain).
- R₂₀ — 30,000 ohms, 2-watt.
- R₂₁ — 10,000 ohms, 2-watt.
- R₂₂ — 4000 ohms, $\frac{1}{2}$ -watt.
- T₁, T₂, T₃ — Plug-in coils.

- T₄, T₅ — 3000-kc. iron core transformers. First stage type (Miller).
- T₆ — Oscillator transformer (3262 kc.) (Miller).
- T₇ — Special diode transformer (Miller).
- T₈ — 3-circuit 262-kc. i.f. transformer (Miller).
- T₉ — Special 262-kc. infinite rejection coupler (Miller).
- T₁₀ — 262-kc. iron core interstage (No. 2) transformer (Miller).
- RFC — National R-100 choke.

OST for

◆
 A close-up of the r.f. coil assembly,
 showing the mounting base, coils and
 trimmer condensers.
 ◆

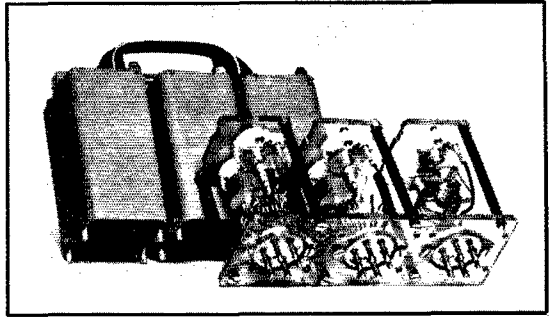

prevent strong signals on adjacent channels from blocking. A complete solution to this problem is extremely difficult, but some suggestions will be included later.

Referring to Fig. 1, it will be seen that the arrangement is very similar to the original Lamb silencer except that the 6L7 is used as a converter instead of an i.f. amplifier. The 6C5 triode oscillator is coupled into the No. 3 grid of the 6L7, which grid is also used as a silencer grid.

Silencer Operation

The operation is as follows; the noise is amplified by the 6J7 and rectified by the 6H6. T_2 is a special noise diode transformer with only the primary tuned and the secondary very tightly coupled. The pulsating d.c. voltage developed by rectification is applied through *RFC* to the No. 3 grid of the 6L7. The resulting increase in bias will stop conversion. As the 6L7 grid and plate circuits are related only by conversion, capacity transfer of strong pulses through the tube is eliminated. Instability is likewise eliminated because no great number of stages is used at one frequency.

The oscillator injection voltage is made small and the 6L7 operated at high bias and low screen voltage to reduce the conversion gain. When properly adjusted, the rectification caused by the oscillator voltage on the No. 3 grid of the 6L7 will bias the 6H6 to a certain extent. Also, under these conditions, small changes in bias on the 6L7 do not materially change the gain. The result is an initial setting of the silencer conditions which will allow for 100 per cent modulation of a 'phone signal without distortion.

In order to make the system practically automatic, a 250,000-ohm resistor and a 0.05- μ fd. condenser are used in the 6H6 cathode to allow it to adjust itself automatically to the correct threshold. This, combined with the initial threshold, and a.v.c. on the noise amplifier, results in an almost completely automatic system which it is very hard to block.

Although threshold adjustments cannot be made as closely as in the original system, the fact that capacity transfer is eliminated, and all of the other requirements met, makes it a more effective silencer. In addition, the silencing action is sharp,

the bias can vary considerably with only a minor change in gain, but after a critical point is reached the unit silences immediately and completely.

Because it is necessary to hold down the selectivity ahead of the silencer, a great many signals may reach the noise rectifier on a crowded band. If this happens very serious cross-modulation can occur. It is then necessary to back off the silencer to clear the trouble. Juggling the silencer control and the r.f. gain will generally allow noise reduction which will permit reception even under these conditions. The frequency of the first i.f. becomes important to the noise silencer because a low frequency i.f. will give better selectivity. Practice has indicated a 1500-kc. i.f. with loosely-coupled No. 1 transformers. If 60-Mc. operation is seriously desired it is recommended that a 3000-kc. amplifier be used with a slight sacrifice in noise silencer performance on 14-Mc. 'phone. Experimental receivers using a 300-kc. first i.f. with loosely coupled transformers have been very successful.

The foregoing discussion may lead to the impression that the adjustments are extremely critical. To a certain extent this is true. The most practical way to obtain the correct operating conditions is, first, to use the values suggested in Fig. 1. Thorough investigation has shown that reasonable variation in these values will not affect operation. Variations in tubes have no practical effect. The diode coupling transformer T_2 , however, is somewhat particular. None of the units available to us had sufficient coupling, and it was found necessary to remove the secondary pie and rewind with No. 26 silk-covered wire on each side of the primary and as close to it as possible. Twenty-five turns each side are used for 3000 kc.; 60 turns each side wound in the same manner should be used for 1500 kc.

The only requirement for proper operation of the silencer is that the gain ahead of it and the gain after it be reasonably proportioned. Maximum gain in the first i.f. is not desirable because the second converter may be overloaded by loud signals. Slightly high bias on the 6K7 i.f. amplifier stage should be used, and it should not be attempted to obtain maximum first converter efficiency. If the gain preceding the silencer is too

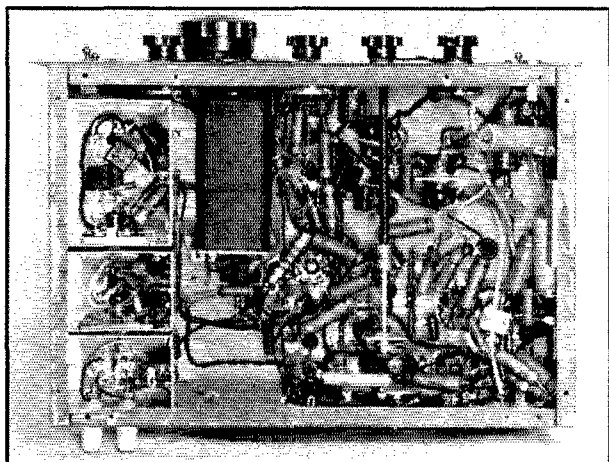

◆
 The r.f. and mixer tubes — acorns — are mounted in the shield boxes at the left end of the chassis, each underneath the corresponding coil socket. The antenna-input section also is shielded.
 ◆

low the silencer will not operate. This, however, has never occurred in our experimental models. The second i.f. amplifiers suggested later have correct gain and should be maintained approximately the same should the experimenter try a few of his own ideas. It is better to have a little too much gain in the second i.f. than too little.

When the gain is correct the receiver should silence, with no signal input, when the silencer control is full on. If silencing occurs over more than one-eighth of the control the coupling of the first i.f. transformer should be reduced, or the first 6K7 cathode resistor increased until silencing occurs at the correct point. Of course, if the receiver will not silence, the opposite steps should be taken.

Previous experimenters with double i.f. supers have had trouble with harmonics from the low-frequency conversion oscillator. No harmonics have been found in this receiver, probably due to careful shielding and by-passing, coupled with the fact that the 6C5 triode oscillator is operated with very low plate voltage and relatively high *C*. The oscillator does prevent reception on 3262 kc., its operating frequency in the cases tested, but even here does not block, and reception 10 kc. either side was possible. Further investigation would probably show harmonics at 6524, etc., but no trace could be found at 29,538 kc., or on the 56- to 60-Mc. band.

The Front End

Let us go back now to the first part of a typical receiver. It has already been indicated that images are to be taken care of by using a high-frequency first i.f. amplifier. Preselection, as a means of image reduction, is therefore of minor importance. It was also mentioned that most of the noise in our receiver will be developed in the first stage. Obviously, an r.f. stage capable of high gain and low noise is indicated. At 60 Mc. the 954 is still

the best, with its super-control brother, the 956 a close second. Because of the super-control characteristics, the 956 is to be preferred. On 30 Mc. there may be some question between the 956 and 1851. The writers' tests indicate the 956, probably because of the high input impedance. Under other conditions the 1851 might be better.

Keeping in mind the noise problem, the first tuned circuit should be well designed and closely coupled to a good antenna. Incidentally, protection of this tube from the tremendous r.f. field of a transmitter is a good idea. A 500,000-ohm resistor and 0.01- μ f. condenser in the grid return of the first stage will give enough protection ordinarily. In this case the a.v.c. line to the other stages must be shorted during transmission. If not, the receiver will take several seconds to "come back."

The converter tube can be your favorite. High gain is not necessary so long as a high noise level is not created. Excellent results have been obtained with a 954 or 6J7 with screen grid injection. Incidentally, "pulling" between oscillator and detector is a function of the frequency separation of the two circuits. With a 1500-kc. or 3000-kc. first i.f., pulling at 30 Mc. is greatly reduced. In fact, screen-grid injection to a 954 with a 3000-kc. i.f. doesn't "pull" any more than the usual 6L7 arrangement when used with a 465-kc. i.f.

The oscillator is quite important, principally from the standpoint of stability. The 1852 is highly recommended if used with a regulated power supply, which, incidentally, is a very good idea anyway. Drift caused by heat can be reduced by careful layout, or compensated for by using a bimetallic unit to vary capacity. Past issues of *QST* cover these points adequately.

The coil-changing and band-spreading arrangement can be any of the various arrangements described in *QST* or the *Handbook*. The receiver illustrated uses ganged plug-in coils.

This arrangement is highly recommended for amateur construction. Another similar set uses switched coils with good results.

Most important is a good mechanical job in the coil-changing and tuning arrangement. A good dial and condenser are highly important.

The Low-Frequency I.F.

We have taken care of noise, images and tuning. The only thing left is selectivity, or, more properly, adjacent channel selectivity. C.w. selectivity should be obtained with a crystal filter. Thorough treatment of the various types can be found in the *Handbook*. One high-gain i.f. stage following the filter will take care of the c.w. situation adequately. 'Phone work requires more careful treatment.

Because the second i.f. is to be used primarily for selectivity many possible arrangements can be tried. The favorite at the moment is a 262-kc. i.f. as shown in Fig. 1. The coupling between the converter and 6K7 amplifier is a three-circuit iron-core transformer. The pies are separated about $1\frac{1}{2}$ inches. This gives a highly selective element as the input circuit. The next transformer is used in an infinite-rejection arrangement, variable from the panel. The last transformer is an inter-stage unit used as a diode coupling transformer. This combination gives good selectivity on 'phone, in fact the single-signal effect is pronounced when used on c.w. Tests have indicated that additional selectivity would seriously impair the readability of 'phone signals. The infinite rejection control allows the complete rejection of an interfering carrier at any frequency. At 262 kc. the rejection can be brought within 500 cycles of the desired signal without serious attenuation of the desired signal. Infinite rejection is very handy because it not only will remove a heterodyne, but by removing the carrier of the undesired signal leaves nothing for the modulation frequencies to beat against except themselves and other carriers, resulting in a tremendous decrease in the power of the interference.

It is our opinion that infinite rejection is more desirable than the variable-selectivity crystal arrangements, principally because the rejection properties of the crystal filter depend upon the selectivity setting (very greatly so with some filter circuits), and operation of the filter at a point which gives best rejection gives too much selectivity on 'phone.

Infinite rejection circuits themselves are quite broad, so a good selective element should precede them to reduce the off-frequency interference. Two variable infinite rejection circuits were tried but were found very hard to handle. Unlike crystal rejection, this system is capable of rejecting at resonance. In the case of two variable rejectors it is extremely easy to reject the desired signal as well as the undesired. A solution would be to arrange each rejection control so that one oper-

ates on the low side of resonance and the other on the high side with a mechanical stop preventing either from going through resonance. Although this arrangement would limit the effectiveness slightly the operating convenience would overcome this disadvantage. A low-frequency i.f., 262 or 175 kc., is desirable when using rejection circuits because it will allow closer approach to the fundamental frequency before serious attenuation occurs.

An idea which has not been tried, but seems promising, is to replace the three-pie 262-kc. input transformer with a variable-selectivity crystal filter. In this case the second i.f. would be 465 kc. The circuit described by D. K. Oram in December, 1938, *QST*³ should be very good. With this arrangement the crystal element would give the initial high selectivity, variable over a wide range, and the infinite rejection would supplement the crystal rejection. This could be carried still further by using a 262-kc. i.f., although the additional cost of the 262-kc. crystal filter might not be worth while.

It should be pointed out that the infinite rejection transformers are low-gain units, which accounts for the additional stage necessary when this circuit is used.

Many other arrangements are possible to suit individual requirements. We think that another year's work on this i.f. may give us an ideal 'phone receiver.

The "S" Meter

The "S" meter is operated in the familiar bridge circuit and controlled by the plate current of the last i.f. amplifier. This stage has a.v.c. but not manual volume control. Since changing bands and band conditions cause tremendous variation in signal strength it was found desirable to adjust the total receiver gain to meet these conditions. In testing many receivers it was found that overloading and consequent cross modulation would occur in the first stages when connected to a good antenna and on a "hot" band. The only practical solution seems to be reduction of the gain of the first stages.

With this in mind the r.f. gain control was applied to the r.f. stage, first i.f. stage, and the first stage of the second i.f. By not controlling the last i.f. stage the "S" meter can be used at any gain setting. The "S" meter is adjusted to read full scale when overloading just starts. If the gain ahead of and following the silencer is properly proportioned, as described previously, this will occur at about $7\frac{1}{2}$ volts bias from the a.v.c. circuit.

The "S" meter should be adjusted to read zero at no bias, grid grounded on the 6K7 last i.f. stage, and full scale at 7.5 volts bias. The plate

(Continued on page 68)

³ D. K. Oram, "Full Range Selectivity with 455-kc. Quartz Crystal Filters," *QST*, December, 1938.

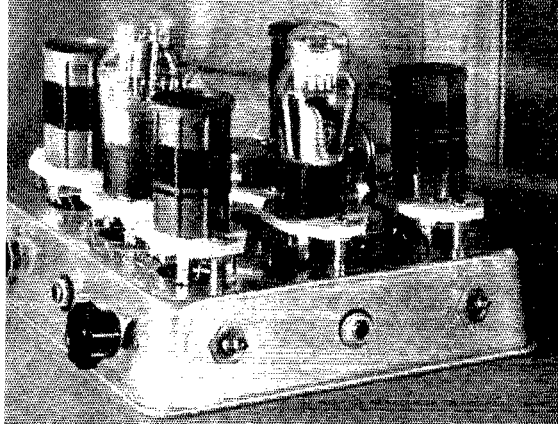

A flea-power cake-pan transmitter. The crystal can be seen at the left of the 30 amplifier tube, and the neutralizing condenser at the right. On the left side of the chassis are the oscillator and doubler tuning knobs; the amplifier and antenna tuning knobs are on the right-hand side. This arrangement was used because it made extremely short leads possible. The meter jack for the doubler stage is on the front. The jack between the two knobs is the oscillator meter jack, while the amplifier jack is on the right side, which cannot be seen in the photograph. The switches are for doubler bias and filament. Note the clearance between condenser shaft and chassis. The unit weighs less than two pounds.

A Hurricane Emergency Transmitter and Power Supply

*In Conjunction With the Receiver¹ an Effective Station
Is at Hand for Portable or Emergency Work*

BY GALE M. SMITH,* W4PBP

WHAT can the average amateur do in the event of a real communication emergency, such as the chaotic condition caused by a destructive hurricane? He is helpless if he has only a.c. powered equipment, unless he is one of the few fortunate owners of a gasoline engine-driven a.c. generator. Even then the outfit is often not sufficiently portable to be carried about the country, or to be set up far from a main road. If, however, the equipment is battery powered, it can be taken to almost any place and operated under all sorts of conditions.

The function of such light equipment should be to communicate over short distances back to a more powerful fixed station which can relay the traffic if necessary. There are a few well-equipped amateurs who have high-powered fixed stations with complete emergency power supplies and they can adequately take care of long-distance traffic. The need of the average amateur is for something small, light, and low-powered, with which he can go out in the field and work back to a base station.

With this in mind, plans were drawn up for a low-powered battery transmitter which would give a satisfactory signal with the least possible battery drain. When batteries have to be carried over rough country, it is important to use as few as possible, and to make them last as long as possible. This consideration limited the choice of tubes to the 30 and the 19, tubes which use little filament current, and which will still put out a

fraction of a watt if the plate voltage drops as low as 22½ volts.

The Circuit

It is absolutely essential with a low-power transmitter to have a steady note so that the man at the receiving end can copy accurately. With very low power, a chirpy or wavering note will be completely masked by noise or interfering stations. For this reason, an oscillator-amplifier type of transmitter was considered most desirable. A 19 was selected as an oscillator-doubler to drive a 30 final. This arrangement was chosen because it appeared to allow the utmost in flexibility. It is possible by this arrangement to secure all-band operation merely by plugging in the appropriate coils and crystals. Further flexibility is gained by making provision for placing a crystal in the oscillator plate coil socket, operating the doubler section of the 19 as the oscillator, and leaving the oscillator section idle. This permits the use of one crystal on either of two bands. Still more flexibility, in case of crystal trouble, is assured by providing untuned coils to be placed in the crystal socket, making it possible to operate the first stage as a conventional TNT oscillator.

The oscillator is biased by a cathode resistor, R_3 , inserted between the filament circuit and ground, and the doubler is biased by a combination of cathode bias and grid-leak bias. In case the doubler section is to be used as the crystal oscillator, to secure output on the fundamental frequency of the crystal, the grid-leak bias can be shorted out by means of switch S_2 . The ampli-

¹ Smith-Hurricane Emergency Receiver, April, QST.

* 4170 Ingraham Highway, Coconut Grove, Fla.

fier stage is also biased by a combination of cathode and grid leak, the bias potential reaching the grid, as in the other stages, through a small r.f. choke.

The amplifier stage is quite conventional. The stage is neutralized by a center-tapped plate coil and a small neutralizing condenser, C_{13} . The antenna circuit contains some rather interesting features which were included to take care of varied conditions which might be encountered in the field. Two terminals, A_1 and A_2 , are provided for connecting a doublet antenna to the small pickup coil wound on the center of the plate coil form. An additional coil socket was installed so that a loading coil might be used in the event that a Marconi-type antenna appeared desirable. This is simplified by using the plate coil wound for the next highest frequency band as the loading coil. When the coil is plugged into the loading coil socket, the link winding automatically connects the antenna tuning condenser, and the plate winding of the coil is placed in series with the antenna. A separate antenna connection, A_3 , is provided for the use of a Marconi antenna. The transmitter is keyed in the common negative lead, for power economy.

Construction

When the transmitter was constructed, every attempt was made to secure the greatest efficiency obtainable, as it was realized that the maximum output would, at best, be very small. With this in mind, the parts were laid out on the chassis in such a way that no lead was over an inch long. Two good-sized by-pass condensers were connected directly to the filament pins of each tube socket, and their common connection was used as the ground for the stage. No reliance was placed upon the functioning of the chassis as a ground, and bus bar was used to tie in the grounds of the different stages.

The chassis was the result of an inspiration obtained by strolling through the culinary department of the local nickel and dime emporium. An aluminum cake pan 8 inches square was selected and, turned upside down, it makes a very satisfactory chassis. It is rigid enough to hold the few light parts used, and thin enough to be worked with a jackknife or other sharp instrument.

The cake-pan universal power pack. The two switches are for turning on a.c. or d.c. At the left is the terminal strip for power connections. Another similar strip on the right side provides for the various output voltages.

This is the companion unit to the "hurricane" receiver described 3 months ago. Complete with antenna and versatile power supply, it is a thoroughly practical portable-emergency rig for the none-too-opulent amateur.

In the pan, $1\frac{1}{8}$ -inch holes were cut beneath each of the coil and tube sockets, to allow short leads to drop directly from the socket lugs to the parts beneath the chassis. With a deeper pan, it would have been possible to mount the sockets flush, and thus provide a better looking job, but the sockets on hand had metal rivets projecting through them, preventing flush mounting on a metal surface. The tuning condensers were mounted directly below the sockets, and the leads between coils and condensers were thus reduced to less than one-half inch in length. A Bud 6L6 neutralizing condenser was used to neutralize the final stage. In its original form it would have required leads longer than one inch, and it was rebuilt to mount in a horizontal position. This was done by taking off the bottom cone insulator and mounting it on the chassis. The pillar insulator holding the two plates of the condenser was then clamped firmly in place in a horizontal position by means of a copper strip; the ends of the strip were tightened down under the nut on the stud at the top of the cone insulator.

The five-power supply leads to the transmitter are connected to a terminal strip which is mounted on spacing collars on the back side of the chassis. The leads run through the chassis in short pieces of spaghetti, to protect them from accidental shorting. The tuning condensers, which have their rotors at a d.c. potential above ground, are mounted clear of the chassis on small spacing collars. The shaft holes cut in the chassis must be large enough to provide good clearance. The metering jacks are insulated by means of fibre washers.

Tuning Procedure

In operation, a Burgess 4F2H battery is connected to the filament terminals of the connection

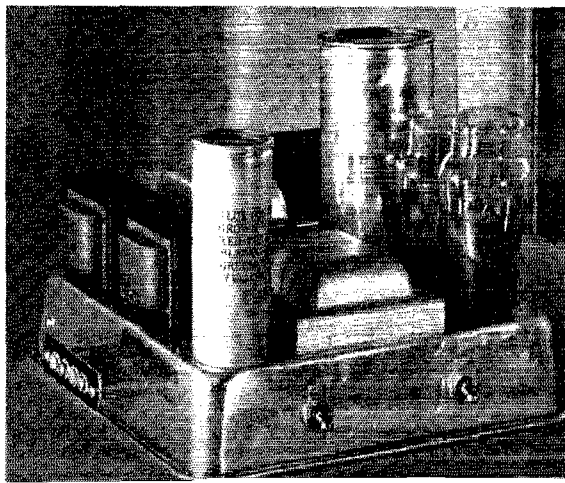

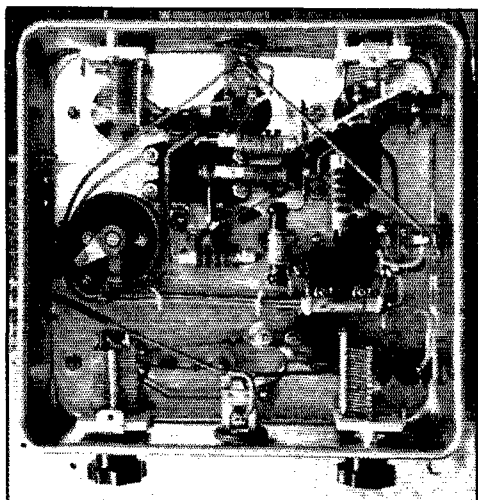

Inside the cake pan

No cook book will recommend these ingredients, but they produce very satisfactory results. Oscillator tuning condenser at the lower left, doubler tuning condenser at the lower right, double-spaced final tank condenser at the upper left, and the large condenser at the upper right is the antenna tuning capacity. The filament rheostat is at the right in the center. A full-sized socket hole directly below each coil and tube socket permits short leads from coil socket terminals to tuning condensers and from the tube socket terminals to associated circuits. The 19 socket is at the center in the bottom row of holes, and the 30 socket is at the center left.

strip, and the filament switch, S_1 , is turned on. The filament rheostat, R_4 , is then adjusted to give a reading of two volts at the tube sockets. A crystal or an untuned coil is then placed in the crystal socket, with the proper coil in the plate coil socket of the oscillator section of the 19. A meter is plugged into jack J_1 , the batteries are connected in the plate circuit, and tuning condenser C_1 adjusted for minimum plate current.

Plugging the meter into jack J_2 and coil L_2 into the plate coil socket of the 19 doubler section, the tuning condenser C_2 is adjusted to give a minimum plate current reading. The final stage is now ready to be neutralized, which can be done

The complete hurricane emergency unit, shown on the running board of a car. In use, it fits on the shelf behind the driver's seat. At the left is the power supply, filament batteries alongside, transmitter in the center and receiver at the right.

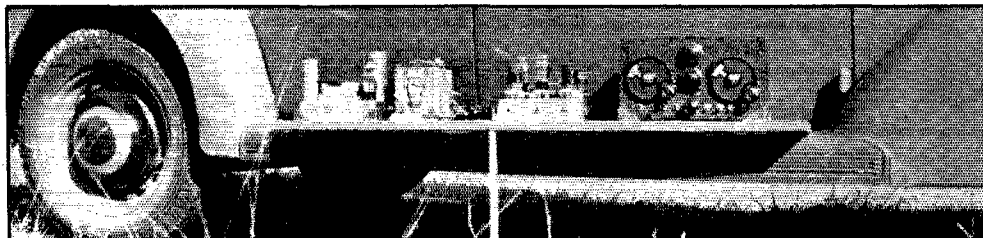

with a field-strength meter or other indicator in the usual manner. It will be necessary to retune the final tank condenser C_3 slightly when neutralizing adjustments are being made. Now plug in an antenna loading coil, connect a piece of wire to the antenna terminal A_3 , apply the plate voltage to all stages, and tune antenna condenser C_4 for maximum reading of the plate current of the 30 amplifier, having plugged the meter into jack J_3 .

When the transmitter was completed and had been tested, the thought occurred that it would be a good idea to save the batteries for emergency work, and to use the little rig on a power supply at other times. For use at the station, an a.c. power supply would be necessary — a vibrator power supply would do the trick in a car.

With this in mind, another trip was made to the 10¢ store, and another 8-inch square cake pan was purchased for a power supply chassis. With considerable squeezing, it was possible to combine both power packs in the same unit. This was accomplished by utilizing the same filter for the a.c. and storage battery power supplies. By using half-shell-type transformers, it was possible to confine all the wiring beneath the chassis. A binding post strip was mounted on one side of the chassis, providing four terminals for 110-volt and 6-volt leads. A binding post strip was installed on the other side for the high voltage and filament supply connections. Two switches were mounted on the front, one for the a.c., and the other for the d.c.

Realizing that the a.c. power supply would come in handy, and might be required to carry heavier loads than that of the little battery transmitter, it was decided to use an 80 type tube as rectifier. To reduce tunable hum which might be present when using the unit with a regenerative receiver, a small radio-frequency choke and condensers C_{15} , C_{16} and C_{17} were included in the circuit. To obtain good filtering and suitable regulation, a choke-input filter of three sections was used.

The vibrator power supply consists of a vibrator V , a vibrator transformer T_2 , and an 84 rectifier. Some trouble may be expected with this type of power supply on reception, as it is apt

COIL TABLE

	80-Meter	40-Meter
L_1	Open condenser C_1 and plug-in 80-meter crystal	Same as L_2
L_2	30½ turns	Same as L_4
L_3	2 19-turn sections with 5-turn link between	2 9-turn windings with 3-turn link between
L_4	15½ turns on loading coil, link 3 turns	9½ turns on loading coil, link two turns.

The above coils are wound with No. 22 enamel on 1¼-inch ribbed forms. All coils are close wound except the 40-meter final tank coil, which is spaced wire diameter. The above coil combinations will give two-band operation with an 80-meter crystal.

to produce a great deal of "hash" on the higher frequencies. By-pass condensers C_{21} , C_{22} , C_{23} and buffer condenser C_{24} were included in the design to overcome this difficulty. C_{22} and C_{23} seemed to be the most effective in eliminating hash. After they were installed, hash disappeared completely, except over a portion of the 80-meter band. No bleeder was placed in the power supply, as it was considered advisable to keep the load on the vibrator as light as possible. A vibrator with double sets of contacts was chosen, with a view toward providing reliability and large current-carrying capacity.

Just a few words of caution: It is important to note that one side of the 6-volt input is grounded. This terminal should always be connected to the chassis of the auto, and the other terminal may be connected to the hot side of the car battery, or to the hot side of the ignition switch, by means of a flexible wire with a battery clip attached. Care must be taken to use condensers with a high-voltage rating on the secondary side of the power transformers. Receiving type mica condensers

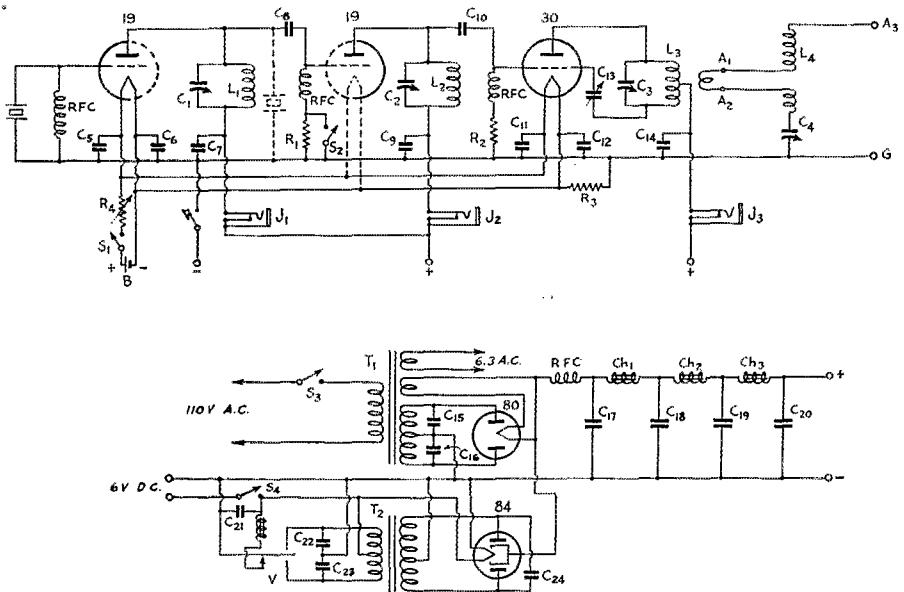

Fig. 1 — Transmitter and power supply circuit.

- C_1 — 100- μ fd. midget variable (Hammarlund HF-100).
- C_2 — 35- μ fd. midget variable (Hammarlund HF-35).
- C_3 — 30- μ fd. double-spaced midget variable (Hammarlund HF-30-X).
- C_4 — 140- μ fd. midget variable (Hammarlund HF-140).
- C_5 , C_6 , C_7 , C_9 , C_{11} , C_{12} , C_{14} — 0.002 μ fd. (Illini).
- C_8 , C_{10} — 0.0001- μ fd. mica fixed condensers (Illini).
- C_{13} — 6L6 neutralizing condenser, rebuilt (Bud) (see text).
- C_{15} , C_{16} — 0.001- μ fd. mica, 5000 v. (Sangamo).
- C_{17} , C_{21} , C_{22} , C_{23} — 0.002- μ fd. mica, 600 v. (Aerovox).
- C_{18} , C_{19} , C_{20} — 8- μ fd. three-section electrolytic (Mallory RM-265).
- C_{24} — 0.01- μ fd. (Aerovox Type I131) (see text).

- R_1 — 15,000 ohms, 1-watt carbon.
- R_2 — 10,000 ohms, 1-watt carbon.
- R_3 — 400 ohms, 1-watt carbon.
- R_4 — 30-ohm filament rheostat (Yasley).
- RFC — R. f. choke (Hammarlund CHX).
- S_1 , S_2 , S_3 , S_4 — S. p. s. t. toggle switches.
- B — 3-volt dry battery.
- T_1 — 700 v. c. t. at 85 ma., 5 v. at 2 a., 6.3 v. at 3 a., broadcast receiver power transformer.
- T_2 — Vibrator transformer (Inca C-50).
- Ch_1 — Thordarson T-5751.
- Ch_2 , Ch_3 — Thordarson T-4402.
- V — Replacement vibrator (Mallory Type 500-P)

of 600-volt rating installed at C_{15} and C_{16} promptly blew. In exasperation, a pair of 5000-volt mica transmitting condensers were substituted. Needless to say, no further difficulty was noticed. The buffer condenser C_{24} is also important. It is better to buy a regular shielded 1500-volt buffer condenser made for that purpose. Dropping resistors must be used when the batteries are replaced by the power supply, as the voltage will otherwise be excessive. One final word of advice — without a bleeder, it takes about five minutes for the condensers to discharge. Failure to remember this may cause the unwary experimenter to receive the discharge.

The combination of flea-power transmitter, vibrator power supply, and the little receiver¹ is just the thing for a portable outfit to toss in the back of the car. But it was very unsatisfactory to have the three separate units, with their connecting wires, scrambling together every time the car made a turn or hit a bump, and the arrangement shown in the photograph was devised.

A piece of 1-by-8-inch cypress was cut to fit on the shelf behind the driver's seat. Small brass trunk corners, obtainable at any 10¢ store, were screwed to this board. Four of these brass corners were used for each unit, spaced so that the unit could be dropped down in place and rigidly held in position until lifted out. A double-pole, double-throw switch was installed to switch the antenna and power supply negative lead from transmitter to receiver. Additional brass corners were provided to hold the two Burgess 4F2H filament batteries (for receiver and transmitter) which were used to avoid having to tap off a cell in the car battery for 2 volts. The complete unit is light enough to be carried with ease by one man, or it may be carried over rough country stretcher-style by two men. Two short leads with battery clips are provided for power connections, one of which is fastened to the ignition switch under the dashboard and the other is fastened to a body bolt. One more lead is required for the antenna.

The antenna used consisted of fifty feet of stranded antenna wire, provided with aviation-type strain insulators. A 50-foot piece of carpenter's chalk line was used to erect the antenna. The car end of the antenna was fastened to a door hinge by means of a piece of chalk line, and a short piece of insulated ignition wire was used for a lead-in to the send-recvie switch. The antenna and chalk line were wound on a simple bobbin made of two laths.

Operation in the field turned out to be ridiculously simple. The car was pulled up to the side of the road and the antenna and chalk line unrolled on the ground. A small rock was fastened to the line and thrown through a crotch in a tree. When the rock fell to earth, the line was pulled until the top end of the antenna was well up in the air. It was then only necessary to fasten the cord to a branch, hop in the car and pull

ahead until the antenna was taut, turn the switches, and go on the air. To knock down the station, the cord was untied, pulled back out of the tree, wound on the reel, and tossed in the car.

After a little marksmanship practice with a rock, it was found possible to work a station, sign off, take down the antenna, drive a mile or so, put up the antenna again, and be on the air and in contact with another station inside of ten or twelve minutes, completely unaided. The only sad mistake made during these tests was in erecting the antenna in a poison oak tree, a practice which is not to be recommended for complete enjoyment of portable operation.

Northwestern Division Convention

Yakima, Wash., August 25th to 27th

AN OLD-FASHIONED amateur radio convention is planned this year under the auspices of the Yakima Amateur Radio Club, for the Northwestern Division, and it will be held at Donnelly Hotel, Yakima, Wash. REMEMBER the dates: August 25th-26th-27th — Friday, Saturday and Sunday. Friday afternoon starts with registration at the hotel, with side trips and hamfesting. Saturday will see the technical meetings, A.R.R.L. Forum, N.C.R. and Army Net conferences, ending the day with a banquet and dance. Sunday: Picnic, boating, swimming, and contests.

Bring your equipment for display and prizes.

Registration fee, \$4.00 each, for hams and ladies, with special drawing for registrations received prior to August 10th. Special plans are being made for the entertainment of the ladies, and there will be non-radio prizes of interest to them. Registration covers bowling, banquet, dance, theater party, and picnic.

Send registration to Stan Velikanje, W7ETX, 415 Miller Building, Yakima, Wash.

Our Cover

THIS composite photograph shows two shots of the latest in "rotaries" at W1CND. The guyed 80-foot ship's spar holds a 3-element array at the 40-foot level and another 3 elements are stacked $\frac{1}{2}$ -wave above.

The enlarged shot shows the top elements starting up, and the view at the right was snapped as they were about to be dropped into place and pulled into a horizontal plane. The elements are fixed on the spar and the entire structure rotates on a ball-and-socket joint at the base, driven by a quarter-horse motor.

Our thanks to W1DQ for the photos.

1938 Paley Trophy Awarded to W1BDS

In Recognition of Outstanding Hurricane Work

SELECTED by a distinguished Board of Awards as having made the outstanding contribution among radio amateurs to the American people during the past year, Wilson E. Burgess, W1BDS, received the William S. Paley Amateur Radio Award for 1938 at a presentation luncheon at the Hotel Pierre in New York City on June 6th.

The ceremonies were broadcast over the Columbia system. In making the presentation, Mr. Paley, president of C.B.S., lauded the work of amateurs as a body in generous terms, and reviewed W1BDS' emergency work during the New England hurricane of last autumn. Burgess, in accepting the award, shared the honor with his co-workers, W1KRF, W1KRQ, and W1KCG and said that he appreciated the fact that this trophy came to him as a representative of the amateur fraternity, hundreds of whose members had been of service in the hour of need.

Following the presentation, the permanent custody of the trophy was returned to the A.R.R.L., in whose behalf Secretary Warner expressed the appreciation and gratitude of the amateur fraternity.

Burgess was selected for the 1938 honor from a long list of nominations by a board of five judges, consisting of the Hon. Norman H. Davis, chairman of the American Red Cross; Dr. J. H. Delinger, Chief of the Radio Section, U. S. Bureau of Standards; Lieut.-Commander Charles P. Edwards, Chief of Air Services, Department of Transport, Ottawa, Canada; Dr. A. E. Kennelly, Professor Emeritus of Electrical Engineering at Harvard University; and Rear Admiral Russell Randolph Waesche, Commandant, U. S. Coast Guard.

W1BDS' selection was based on his heroic performance during the devastating New England hurricane of September, 1938.

On the afternoon when the gale struck he was at work in the store of Montgomery, Ward & Co. in Westerly, R. I., where he is employed as manager of the appliances department. When the wind blew out windows in the store, sending panicky people screaming up and down the aisles, Will Burgess knew that it was no ordinary blow

— that it would eventually mean death, destruction of wire lines . . . and a crying need for amateur radio to set up contact with the outside world for help.

So he started for home, carrying "B" batteries and one large storage battery for emergency power. Trees fell behind and in front of him as he struggled up the street. After a short distance he met George Marshall, W1KRQ, and together they commandeered a small truck. But they had gone only a few yards in it when the way was blocked by fallen trees. Again they hauled the batteries by hand, over a long detour on a dirt road — death in the form of flying debris and trees missing them by inches time after time.

When they finally reached his home, Burgess found that his antennas and the garage that held one end were both gone — swept away by the wind. In the midst of the 65-mile gale he set to work, erecting another antenna. But still there was no transmitter — power was gone, and the 600-watt rig was useless. So, using parts which W1KRQ struggled home to get, they put together a little 42 crystal oscillator, powered by "B" batteries.

The first QRR went out at 8 P.M., to be answered by W2CQD. But the signal was weak and interference strong, so W2CQD turned the contact over to W1SZ in West Hartford. For the next 56 hours, Burgess left the transmitter only once — and then for a brief snatch of two hours' sleep. Aided by W1KRF, W1KRQ and W1KCG, for two days they provided Westerly's sole contact with the outside world. Red Cross authorities, Boy Scouts, police, reporters, tearful survivors invaded his home. Message after message poured out — names of Westerly's dead, calls for boats to save those marooned in their homes, pleas for bread, power, serum, planes, caskets. . . . For three days the tiny radio room off the kitchen in the frame house on a hilltop was Westerly's only contact with the outside world.

More than 800 messages of life and death passed through Burgess' hands during the period from Thursday through Sunday.

When Monday morning dawned, however, he was

(Continued on page 74)

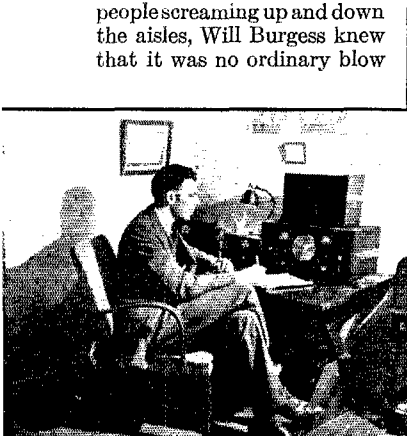

Rotating the Rotary

A Simple Reduction System for Motor-Driven Beams

BY GILBERT WILLIAMS,* WIAPA

A $\frac{1}{4}$ -hp. motor drives a bicycle sprocket wheel through a "V" belt and pulley reduction system. Polishing heads are used to support the pulleys.

MANY articles have been written on beams and arrays but apparently very little has been said about the actual mechanical means used to rotate them. At least, it seemed that way after an extensive search through the contemporary radio literature.

A regular "flat-top" rotatable beam, using Premax elements, was installed at WIAPA on the top of a 40-foot telegraph pole. Thanks to the splendid article by W2DKJ,¹ no serious difficulty was experienced in building a suitable "gondola" to support the elements. The beam was rotated by hand for a while but the need for motor drive

* 170 Dixon St., Bridgeport, Conn.

¹ Lynch, "Some Thoughts on Rotary Beam Antennas," QST, October, 1938.



The "flat-top" rotatable antenna is turned by a motor and reduction system housed in the "dog house" mounted at the base of the supporting pole.

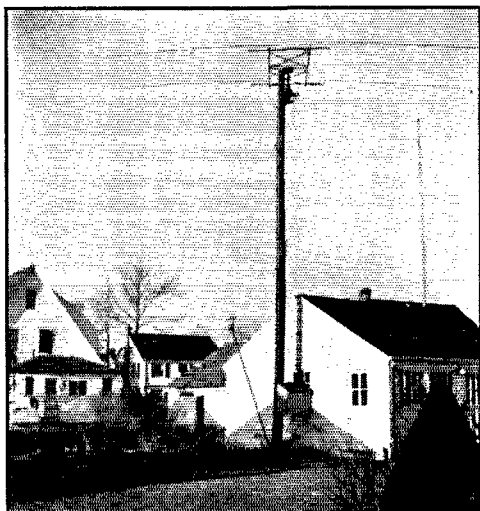

soon became apparent. As many articles as could be found were studied for ideas, and it was finally decided that an automobile rear-end was the most practical foundation unit for the rotatable support of the gondola.

A Dodge rear-end was picked up at a local second-hand automobile parts dealer for \$3.00. The Dodge rear-end is only slightly heavier than the more commonly used Ford assembly and seems to have several advantages over the latter. All one has to do is to cut off the housing and pull out one-half of the axle, while the Ford unit requires that the axle be cut. Further, the propeller shaft does not have to be cut, since the universal joint is bolted together. Merely unbolt the joint and you are all ready to start. This leaves a convenient plate with four holes in it to bolt a pulley or sprocket to, on the end of the shaft.

A block of wood was cut from a piece of 2" by 6" to the exact size of the open end of the housing where the housing had been cut off. This wood block was bolted, with a single carriage bolt, to the supporting platform made from a piece of 2" plank cut 12" square. Two sets of angle brackets were made out of 1-inch by $\frac{1}{4}$ -inch stock to fasten this platform to the telegraph pole, and the brackets were fastened to the pole with 5-inch lag screws. A second set of brackets was made of 1-inch by $\frac{1}{8}$ -inch stock and fastened to the plate cover, to hold the mid-section of the rear-end assembly to the pole. Two of the studs that hold the plate cover were removed, and the brackets were bolted on to the rear-end with these same studs. One other bracket, a "U" affair, was bolted around the housing directly under the brake drum. One through bolt was used here to hold the bracket to the housing. Three-inch lag screws were used to fasten the bracket to the pole.

The next step was to find a second-hand bicycle

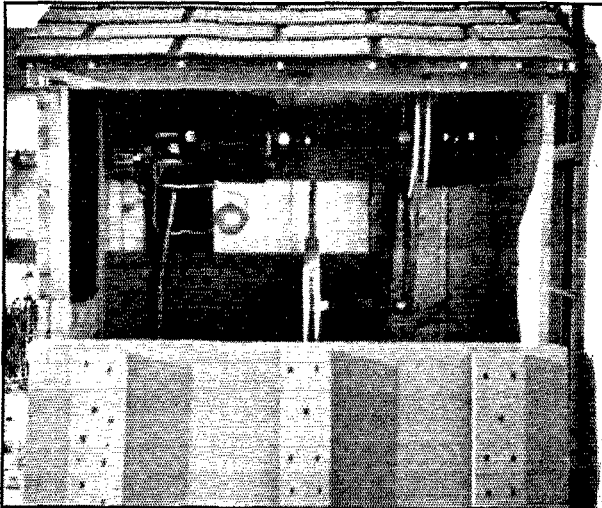

The "dog house," complete with padlock and asbestos shingles. The control cables pass through the roof of the dog house and run up to the assembly at the top of the pole.

sprocket at some bicycle store. One was found, "believe it or not," that had four holes, besides the center hole, that matched up with the four holes in the universal plate. This sprocket was then bolted to the universal plate on the propeller shaft with four 1/4-inch machine screws.

After much scratching and chasing around to all the second-hand stores looking for suitable reduction gears, it was decided that the cheapest and easiest way out was to make our own reduction system, using a series of belts and pulleys. Reduction gears are nice and possibly preferable, but the price was prohibitive in our case. We finally hit upon the idea of using small "polishing heads" or "mandrels." These were obtained at the local Sears & Roebuck store for \$1.10 each ("Companion" polishing heads). They are easy to mount and are equipped with bronze bearings and oil cups. Since we had a sprocket at the top of the pole, on the rear-end assembly, it was necessary to use one at the bottom for positive chain drive, and a small bicycle "rear wheel hub assembly" was obtained. The sprocket had too large a hole in it to mount directly on the polishing head shaft, so the whole "left-hand right-hand" thread cone assembly had to be used. As this unit was highly tempered, it had to be annealed before it could be worked. We were stumped for a while as to how we could anneal without the convenient gas stove (our house is all-electric) until finally, after a little thought, it was decided to use the oil burner. The entire hub assembly was hung in the furnace on a piece of wire, where the flame would hit it. The thermostat was shoved up a few notches to start the oil burner, and in a few moments the hub assembly was annealed, as pretty as you please. The cone

was cut off with a hacksaw as close to the sprocket as possible, it was put in a lathe and a 1/2-inch hole drilled through it so that it could be mounted on the polishing head shaft.

Ordinary bicycle chains were used at the top and bottom of the pole, connected together with flexible cable of galvanized stranded steel wire. A couple of turnbuckles were used to keep the chain and cable drive taut. Several strain type insulators were also inserted at the turnbuckles to break up the long closed loop. Three bicycle lengths of chain were used at the top, and three lengths at the bottom. This was found to be sufficient for 180-degree rotation and, with the amount of chain used, there is never any danger of the chains running off the sprockets.

As can be seen from the photograph, the polishing heads were mounted on 2" by 6" planks which were bolted to the pole by means of 6" lag screws. 10" and 1-inch pulleys, with 3/8-inch "V" belts, 42 inches long, were used for the rest of the reduction system. (See Fig. 1.)

A 1/4-hp., 1700 r.p.m. reversible motor (G.E. type KH, form B) was used to drive the system. Perhaps a motor this large is not necessary, but these "washing machine" motors are priced very reasonably, and ours works out nicely. The speed of the rotating head has been timed accurately, and we find that it turns 1.2 r.p.m., which is not too fast.

(Continued on page 78)

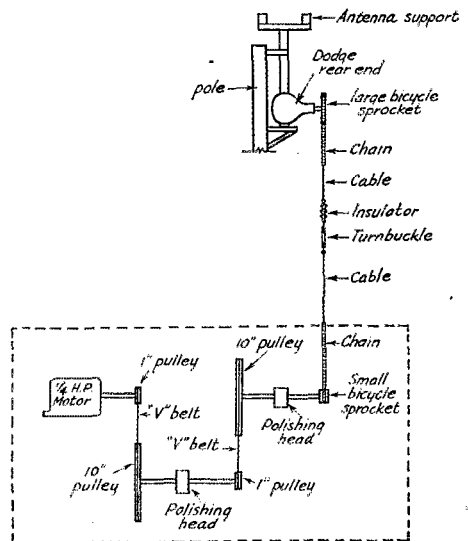
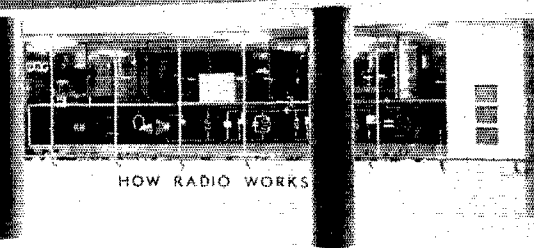

Fig. 1—A schematic diagram of the complete system used for rotating the beam.



HOW RADIO WORKS

An Animated Radio Diagram

Through the coöperation of the Westinghouse Electric and Manufacturing Co., The American Institute of the City of New York, and RCA Institutes of New York, the ARRL has been able to present at the New York World's Fair a unique educational display which gives, in a glance, a beautiful portrayal of what goes on in amateur transmitter and receiver circuits. (See page 24, June QST.)

Above: A view of the transmitter side of the exhibit, showing circuits from crystal to antenna. Actual apparatus, hooked up and in operation, is arranged on the counter in front of the panels.
Below: A close-up of the modulated final amplifier.

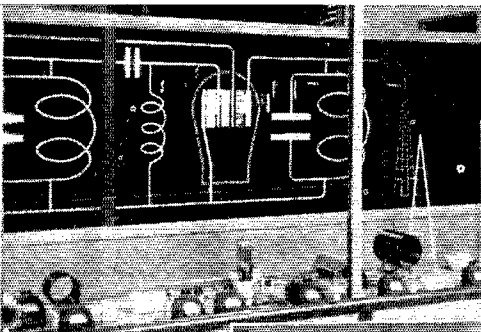

At right: Front of the switch which, with its two hundred rotary cams and associated contactors, run through gear-trains by the motor shown in the center, control the seven thousand colored lights in the whole exhibit. Below is a view looking down on the back of the switch with a portion of the bank of transformers which supply power to the various circuits. This switch gives life to the exhibit, making visible the electrical action which takes place in each circuit and component.

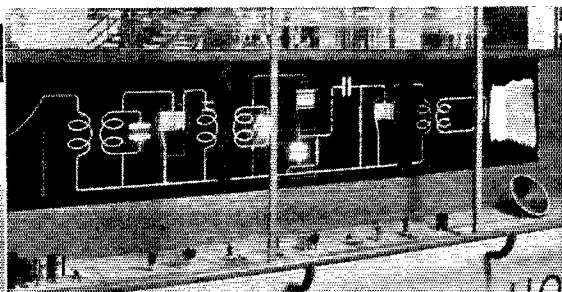
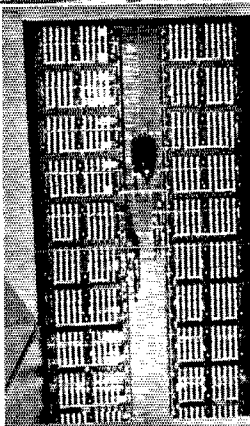

Above: The receiver side showing antenna, R.F. amplifier, diode detector, A.F. amplifier and loud speaker.

At left: Wiring on back of panel for the sound wave which comes from the loud speaker. There are over one thousand lamps in this single circuit.

Below: General view inside the exhibit, showing back of panels and wiring. Transmitter side is at left and receiver side at right. Beyond receiver panels is the back of the switch with cabled connections running to the various panels. Over three miles of wire run between some twenty thousand soldered connections.

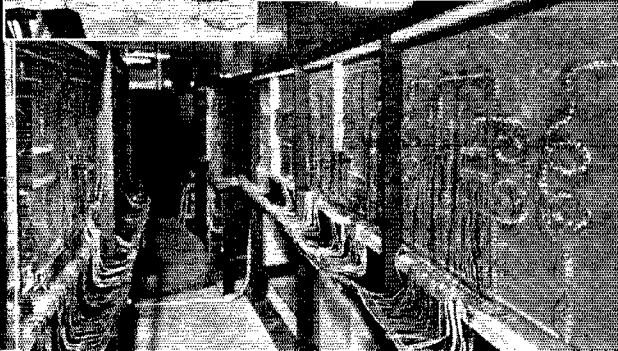
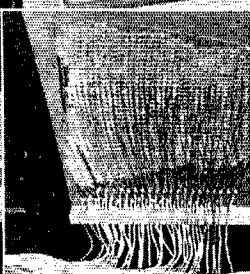

Below: Looking down on back of the final-amplifier panel of the transmitter. Flow of current in all circuits is portrayed by successive flashing of adjacent lights, every fourth light lit at any one moment, in the "border chasing" technique used in electric signs. Direction of flow changes with alternating current. Condenser plates and tube elements are shown to charge and discharge and space currents in tubes flow during proper parts of cycle.

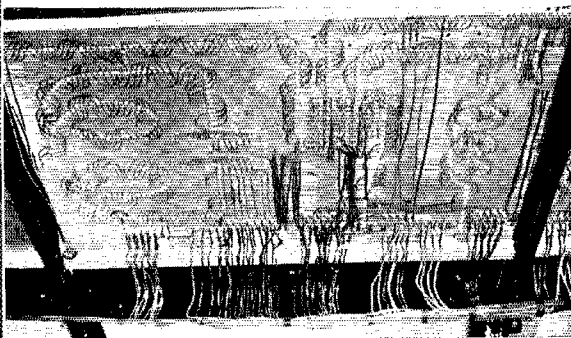
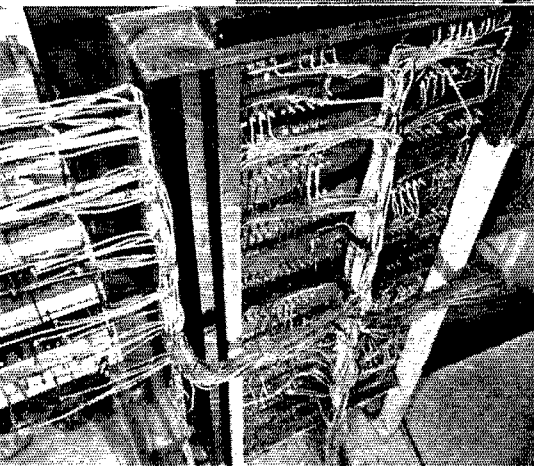

★ WHAT THE LEAGUE IS DOING ★

BOARD MATTERS

THE attention of all the United States and Canadian amateurs is drawn to an announcement elsewhere in this issue of a poll of amateur sentiment on the question of opening some of the 40-meter band to 'phone to permit successful competition with expected interference from foreign broadcasting stations. There is a mailing card annexed to the article. Look it up and do your part.

The Board's request to the F.C.C., to remove the restriction against idling carriers when operating on 'phone on frequencies above 112 Mc., is viewed favorably in Washington. It is felt that every encouragement ought to be given the development of u.h.f. We have reason to hope for an early amendment.

This is a good place for us to call your attention to the fact that the annual reports of the officers to the Board of Directors, for the calendar year 1938, are available to members at the cost price of 50¢ per copy, postpaid.

Last month, in a telegraph dispatch from San Francisco, we gave you a résumé of the actions of the Board at its annual meeting. We now print the minutes in full, with the suggestion that you will find them worth reading. Next month we shall print an abstract of the minutes of the Executive Committee meetings held in the year between the Board meetings and now ratified by the Board.

MINUTES OF THE ANNUAL MEETING OF THE BOARD OF DIRECTORS, AMERICAN RADIO RELAY LEAGUE

May 5-6, 1939

In compliance with the Constitution and responsive to due notice, the Board of Directors of the American Radio Relay League, Inc., convened in regular annual meeting at the Cliff Hotel, San Francisco, Calif., on May 5, 1939. The meeting was called to order by Dr. Eugene C. Woodruff, President, at 10:04 A.M., P.S.T. The roll was called, showing the following directors present:

Eugene C. Woodruff, President
George W. Bailey, Vice-President
Alex Reid, Canadian General Manager
Bennett R. Adams, Jr., Southeastern Division
E. Ray Arledge, Delta Division
Charles E. Blalack, Southwestern Division
Hugh L. Caveness, Roanoke Division
Ralph J. Gibbons, Northwestern Division
Glen R. Glascock, Rocky Mountain Division
William A. Green, West Gulf Division
Kenneth T. Hill, Hudson Division
Walter Bradley Martin, Atlantic Division
Ralph H. G. Mathews, Central Division
J. L. McCargar, Pacific Division
Percy C. Noble, New England Division
Floyd E. Norwine, Midwest Division
Fred W. Young, Dakota Division

Thus all divisions were represented. There were also present Secretary K. B. Warner, Communications Manager F. E. Handy, General Counsel Paul M. Segal and Assistant Secretary A. L. Budlong. At the invitation of the Board there was also in attendance, as a non-participating observer, Alternate Director Elbert Amarantes, Pacific Division.

On motion of Mr. Caveness, unanimously VOTED that the minutes of the 1938 annual meeting of the Board of Directors are approved in the form in which they were issued by the Secretary.

On motion of Mr. Norwine, unanimously VOTED that the annual reports of the officers to the Board of Directors are accepted and the same placed on file.

On motion of Mr. Blalack, after discussion, VOTED that all acts performed and all things done by the Executive Committee since the last meeting of the Board, and by it reported to the Board, are ratified and confirmed by the Board as the actions of the Board. Mr. Young requested that he be recorded as voting opposed.

On motion of Mr. Blalack, unanimously VOTED that the Board, having considered its mail action in which it decided that the wording of By-Law 12 requires a candidate for director to have been continuously both a member of the League and a licensed amateur radio operator for at least the four years immediately preceding receipt of nomination, now ratifies the action taken and decides to take this action as of Sept. 19, 1938.

On motion of Mr. Adams, unanimously VOTED that the Board, having considered its mail action in which it decided to request the Federal Communications Commission to open the sub-band 2000-2050 kc. to 'phone operation when the 1715-2000-kc. band is shifted to 1750-2050 kc., now ratifies the action taken and decides to take this action as of Oct. 14, 1938.

On motion of Mr. McCargar, unanimously VOTED that the Board, having considered its mail action in which it decided to permit alternate directors to attend the 1939 Board meeting as non-participating observers at their own expense, now ratifies the action taken and decides to take this action as of Feb. 8, 1939.

On motion of Mr. Blalack, unanimously VOTED that the Board, having considered its mail action in which it decided to adopt certain rules and procedure to govern A.R.R.L. conventions, as submitted in Secretary's Letter No. 406, now ratifies the action taken and decides to take this action as of March 21, 1939.

On motion of Mr. Arledge, unanimously VOTED that the Board, having considered its mail action in which it decided to refrain from bringing formal action against the Federal Communications Commission as a result of the order re-allocating ultra-high frequencies, now ratifies the action taken and decides to take this action as of March 29, 1939.

Mr. Martin, chairman of the special committee on a pension plan for the headquarters employees of the League, presented a report on behalf of his committee and moved that the Board of Directors approve "The Recommendations of the Committee on Pension Plan for the Employees of the American Radio Relay League," and appropriate from League surplus the necessary funds to put the plan in effect July 1, 1939; that the General Manager be instructed to make an arrangement with Treasurer Hebert mutually satisfactory which will entitle him to benefits for retirement by reason of his exclusion from the Employee's Pension Plan, such arrangements to be approved by the President and Vice-President. On motion of Mr. Blalack, VOTED that the report of the committee is accepted and that consideration of its recommendations and the pending motion is deferred until the morrow.

Mr. Reid presented his report as Canadian General Manager. In turn, every division director rendered a report on conditions in his division.

The Board was in recess from 11:46 to 11:53 A.M.
Proceeding to a consideration of subjects raised by individual directors at their own initiative, by alphabetical order of divisions:

On motion of Mr. Martin, unanimously VOTED that the Communications Manager is directed to prepare a suitable plaque to the memory of the League's late Vice-president, Charles H. Stewart, to be placed in the reception room of Station W1AW, at no expense to the League.

Unanimous consent was given Mr. Mathews to add certain newspaper cuttings to his annual report.

Moved, by Mr. Mathews, that the position of QSL Manager be abolished and that the entire work of distributing QSL cards be centralized in the Communications Department at headquarters. But, discussion indicating that no problem existed outside the W9 call area, Mr. Mathews with unanimous consent withdrew his motion. Whereupon, on his further motion, it was unanimously VOTED that the Communications Manager is directed to study means and to provide any necessary arrangements for giving relief to the W9 QSL Manager.

Moved, by Mr. Mathews, that our representatives be instructed to suggest to the Federal Communications Commission permission to use photostat copies of operator licenses in portable and mobile operation. But, after discussion, unanimous consent being given, Mr. Mathews withdrew the motion.

Moved, by Mr. Young, that Sec. 2 of Article IV of the Constitution, which provides in part, "Directors shall serve without compensation from the League in any capacity," be amended as to the part above set forth to read and provide as follows:

"The compensation of each of the directors of the League shall be the sum of \$1,000.00 per annum, exclusive of expenses allowed by the League; provided that, in the event the nature of the employment of a Director makes it impossible for him to accept such compensation, then said Director may elect to serve without compensation."

After discussion, the yeas and nays being ordered, the said question was decided in the negative: Whole number of votes cast, 16; necessary for adoption, 12; yeas, 1; nays, 15. Mr. Young voted in the affirmative; every other director voted in the negative except the Chair, who did not vote. So the proposal was rejected.

The Board recessed for luncheon at 12:43 P.M., reconvening at 1:49 P.M. with all directors and other persons hereinbefore mentioned in attendance.

Moved, by Mr. Young, that the Board employ a full-time representative, legally qualified to practice before the F.C.C., to organize and carry out the defense of our present frequency assignments; the said employee to be responsible to the Board and to make frequent reports and recommendations to them, and attend all their meetings at League expense for the same purpose; that the Secretary and General Manager, as well as the Treasurer and Communications Manager, be hereby directed to offer every facility and resource of the League to said employee, subject to the approval of the Board if they feel necessary; that the sum of \$10,000 be hereby appropriated for this project during the present year, any unused portion to be returned to surplus; that the Board set up a committee at the present meeting to get this project under way as soon as possible. But, after extended discussion, the motion was rejected — Mr. Young requesting to be recorded as having voted affirmatively, Mr. Reid requesting to be recorded as having abstained.

On motion of Mr. Young, after discussion, unanimously VOTED that the Secretary-General Manager is directed to draw up a detailed set of specifications for the printing and mailing of *QST* magazine which he feels are adequate, and then to call for bids for such service; and that the Board urges such action for all League printing.

Moved, by Mr. Arledge, that Sec. 1 of Article IV of the Constitution be amended to read as follows:

"1. The affairs of the League shall be managed by a Board of Directors under the Constitution and By-Laws and the general provisions of the laws under which it is incorporated. The Board of Directors shall consist of the President, one Director from each of the several territorial divisions of the League in the United States and

Possessions, elected by the members of the League thereof, and a Canadian General Manager."

After extended discussion, on motion of Mr. Mathews, VOTED to amend the pending resolution to provide that the suggested change be made effective at the end of the present Vice-President's present term — Mr. Bailey requesting to be recorded as not voting. After further discussion, the yeas and nays being ordered on the proposal as amended, the said question was decided in the negative: Whole number of votes cast, 15; necessary for adoption, 12; yeas, 9; nays, 6. Those who voted in the affirmative are Messrs. Adams, Arledge, Blalack, Green, Mathews, McCargar, Noble, Norwine and Young. Those who voted opposed are Messrs. Caveness, Gibbons, Glasscock, Hill, Martin and Reid. The President and Vice-President abstained. So the motion was rejected. Moved, by Mr. Mathews, that this question be submitted to the members for an advisory, informative poll under the procedure established last year. But, after discussion, the said motion was rejected, 7 votes to 8.

On motion of Mr. Arledge, unanimously VOTED that the unexpended portion of the appropriation made last year for reimbursement of the traveling expenses of Section Communications Managers to attend conventions, and now due to be restored to surplus, be continued on the books for the same purpose during the next twelve months, any unexpended portion then remaining to be returned to surplus. At the further motion of Mr. Arledge, after discussion, VOTED that the arrangement is expanded to include the QSL Managers in the above appropriation under the same restrictions.

Pursuant to motion by Mr. Arledge, seconded by Mr. Mathews and unanimously adopted, the Board made a careful examination of League advertising policy.

On motion of Mr. Hill, unanimously VOTED that the Board authorizes the expenditure of not more than one hundred dollars (\$100) for a memorial plaque in commemoration of Ross A. Hull and his work for the amateur and the art of amateur radio, the necessary arrangements to be made by the Executive Committee and the plaque to be placed at Station W1AW.

Moved, by Mr. Norwine, that the Secretary be directed to request the Federal Communications Commission to attempt to exchange our present 160-meter authorization of 1715-2000 kc. for 2208-2500 kc. But, after discussion, the said motion was rejected.

Moved, by Mr. Norwine, that Sec. 10 of Article IV of the Constitution be amended to read as follows:

"10. There shall be an Executive Committee consisting of the President, Vice-President, General Manager and two members of the Board of Directors who shall be elected by the Board at their regular session during each odd-numbered year. Those two members so elected shall reside west of the Eighty-Fifth Meridian. This committee shall act in the place and stead of the Board of Directors during the intervals between meetings of the Board. Any action taken under this section shall be promptly reported to the Board and shall be subject to the approval of the Board at its next subsequent meeting."

After discussion, the yeas and nays being ordered, the said question was decided in the negative: Whole number of votes cast, 15; necessary for adoption, 12; yeas, 2; nays, 13. Those who voted in the affirmative are Messrs. Norwine and Young; those who voted opposed are Messrs. Adams, Arledge, Blalack, Caveness, Gibbons, Glasscock, Green, Hill, Martin, Mathews, McCargar, Noble and Reid. The President and Vice-President did not vote. So the motion was rejected.

The Board recessed for dinner at 5:58 P.M., reconvening at 7:38 P.M. with all directors and other persons hereinbefore mentioned in attendance.

On motion of Mr. Noble, unanimously VOTED that each director is authorized to delegate his alternate to attend meetings, hamfests and conventions from time to time, the expenses of the alternate to be approved by the director and, upon such approval, the alternate director to be reimbursed from the appropriation made for the administrative expenses of the director.

Moved, by Mr. Noble, that the present regulations covering the affiliation of radio clubs with the League be amended

to require not only that 51% of the licensed members be League members but that at least 51% of the club members be licensed amateurs. But, after discussion, the said motion was rejected.

Moved, by Mr. Gibbons, that the Board make request upon the manufacturers of amateur radio equipment, through the Radio Manufacturers Association, that all radio parts hereafter manufactured contain or have attached to them permanent metal labels showing the relevant constants, values and tolerances of the equipment so labeled, and that it express its disapproval of paper, fiber or cloth labels. But, after discussion, the said motion was rejected.

Moved, by Mr. Gibbons, that no person shall be employed by the League at a salary or commission of \$2500 or more per year except upon a one-year basis, that is, for the calendar year from January 1st until December 31st; and that such employment shall be subject to the express approval of the Board of Directors at its annual meeting preceding the calendar year provided for; and that these requirements be made applicable upon a fractional basis to the half-year period July 1, 1939, to December 31, 1939. After discussion, on motion of Mr. Glascock, VOTED to amend the figure specified for salary or commission to read \$3000. After extended discussion, on motion of Mr. Caveness the pending motion was laid on the table. On motion of Mr. Gibbons, unanimously VOTED that the Board will now review those headquarters salaries that the Board deems necessary and instruct the Secretary regarding its views thereon. On motion of Mr. Gibbons, VOTED that the Secretary is instructed to arrange for an advertising manager at a 10% commission and not over \$7500 maximum per year. After further discussion, on motion of Mr. Gibbons, VOTED to reconsider the matter. On motion of Mr. Mathews, VOTED, 12 votes to 3, to amend the pending proposal to provide that the advertising manager be put on a commission of 7% of the net advertising income — this being a maximum rate at the discretion of the General Manager — plus traveling expenses, with a minimum of \$4000 per year. Whereupon, the question being on the adoption of the original motion as thus amended, the same was ADOPTED. On motion of Mr. Gibbons, after extended discussion, unanimously VOTED that the Board instructs the Secretary to pay Consultant James J. Lamb the sum of \$1800 per year for a period not exceeding one year from date.

The Board adjourned at 10:44 P.M., under order to reconvene the morrow by 9:00 A.M. The Board did reassemble at the same place on May 6, 1939, and was called to order at 9:06 A.M. with all directors and other persons hereinbefore mentioned in attendance.

After a discussion of *QST* advertising policy, on motion of Mr. Mathews, VOTED that a committee is appointed consisting of the Secretary, the Advertising Manager, Vice-President Bailey and Canadian General Manager Reid, instructed to formulate and put into effect an advertising policy for *QST* that will state specifically the reasons for accepting or rejecting accounts.

On motion of Mr. McCargar, after discussion, unanimously VOTED that the Board of Directors shall engage a firm of qualified efficiency experts to make a complete survey of the business management of the A.R.R.L., the report of this survey to serve the Board as a guide in placing the business management of the A.R.R.L. on as high a plane of efficiency as possible. On the further motion of Mr. McCargar, unanimously VOTED that a committee consisting of Messrs. Bailey (chairman), Reid, Caveness and McCargar is hereby appointed with plenary power to act for the Board in selecting the firm to conduct the survey, in compensating that firm, and to receive the report and publish the same to the Board; and that the sum of twenty-five hundred dollars (\$2500) is hereby appropriated from the surplus of the League as of this date for these purposes, any unexpended remainder of same to be returned to surplus.

On motion of Mr. McCargar, unanimously RESOLVED that it is the sense of the Board that, whenever an advisory informative poll is taken through the columns of *QST* as provided for by the Board's resolution of May 13, 1938, then there shall be provided a detachable post card in the pages of

QST to be used for balloting purposes; and the call for such poll, and information published concerning it, shall be printed in reasonably prominent form, using type and headings no smaller than those used for articles in the same issue.

Moved, by Mr. McCargar, that By-Laws 16 and 32 be amended to read respectively as follows:

"16. The Directors shall have the authority to appoint committees and assistants to aid them in the discharge of their duties. In case of the death of any Director or his inability to perform the duties of director, then the Alternate Director shall notify the Secretary of the death, or the Director shall notify the Secretary of inability to perform, and, with the receipt of such notice, the Alternate Director shall assume all the authority, powers and duties of Director and be subject to all provisions of the Constitution and By-Laws affecting Directors. The giving of notice by the Director of an inability to perform shall be effective for the balance of his term as Director unless the notice shall specify a definite period of time, in which case the authority, powers and duties conferred upon the Alternate Director shall be for the specified period only."

"32. The Canadian General Manager shall have the authority to appoint committees and assistants to aid him in the discharge of his duties. All such appointees shall be Canadian members of the League. In case of the death of the Canadian General Manager or his inability to perform his duties, then the Alternate Canadian General Manager shall notify the Secretary of the death, or the Canadian General Manager shall notify the Secretary of inability to perform, and, with the receipt of such notice, the Alternate Canadian General Manager shall assume all the authority, powers and duties of Canadian General Manager and be subject to all provision of the Constitution and By-Laws affecting that office. The giving of notice by the Canadian General Manager of an inability to perform shall be effective for the balance of his term as Canadian General Manager unless the notice shall specify a definite period of time, in which case the authority, powers and duties conferred upon the Alternate Canadian General Manager shall be for the specified period only."

After discussion, the yeas and nays being ordered, the said question was decided in the affirmative: Whole number of votes cast, 16; necessary for adoption, 11; yeas, 16; nays, 0. Every director voted in the affirmative, except the Chair, who did not vote. So the by-laws were amended.

Moved, by Mr. McCargar, that a reasonable set of prices be drawn up by the League and paid to these amateurs who send in engineering or technical data accepted by the editors and published in *QST*; such modest payment to be in proportion to the size and value of the article; the purpose of such payments being to make it worth while for experimenters to forward reports of their discoveries to *QST*, and to reimburse them for their expense in so doing; said payment for articles to be taken from the revenue of the newsstand and subscription sales of *QST*. But, after discussion, the said motion was rejected.

On motion of Mr. McCargar, VOTED that the management of A.R.R.L. is directed to furnish to the Division Directors and Section Communications Managers who request it, a copy of the list of members in their respective divisions and sections.

The meeting recessed for luncheon at 12:04 P.M., reconvening at 1:30 P.M. with all directors and other persons hereinbefore mentioned in attendance except Director Young and General Counsel Segal.

Moved, by Mr. McCargar, that, upon request, any member of the League shall be furnished with a set of verbatim minutes of the meeting of the Board of Directors. But, after discussion, the said motion was rejected, Mr. McCargar requesting to be recorded in favor and Mr. Gibbons requesting to be recorded as not voting.

Moved, by Mr. McCargar, that the sum of \$3375 be hereby appropriated from the surplus of the League, as of January 1, 1940, for legitimate administrative expenses, said amount allocated to the Canadian General Manager and to the Division Directors as follows:

Canadian General Manager.....	\$250.00
Atlantic Division Director.....	200.00
Central Division Director.....	300.00
Dakota Division Director.....	200.00
Delta Division Director.....	200.00
Hudson Division Director.....	200.00
Midwest Division Director.....	225.00
New England Division Director.....	200.00
Northwestern Division Director.....	250.00
Pacific Division Director.....	250.00
Roanoke Division Director.....	200.00
Rocky Mountain Division Director.....	200.00
Southeastern Division Director.....	200.00
Southwestern Division Director.....	250.00
West Gulf Division Director.....	250.00

\$3375.00

any unexpended remainders of these funds at the end of the year 1940 to be restored to surplus. During the ensuing discussion, Mr. Young entered the meeting at 1:37 P.M. and Mr. Segal at 1:41 P.M. and Mr. Gibbons retired from the meeting at 1:40 P.M. On motion of Mr. Martin, VOTED, 9 votes to 5, to amend the pending motion by increasing the amounts in the foregoing tabulation \$50 in each of the cases of the Central, Dakota, Delta, Pacific and West Gulf Divisions, thus increasing the total to \$3,625.00. Whereupon the original motion, as thus amended, was ADOPTED.

Moved, by Mr. Glasscock, that the League discontinue the granting of commissions to affiliated clubs and strictly require the payment of \$2.50 dues by all individuals. But, after discussion, the said motion was rejected.

On motion of Mr. Adams, affiliation was GRANTED by unanimous vote to the Georgia Tech Radio Club, Atlanta, Ga.

On motion of Mr. Adams, unanimously VOTED that the Board invites the Alternate Directors to attend all meetings of the Board as non-participating observers at their own expense.

At the suggestion of Mr. Adams, the Board unanimously concurring, the Chairman agreed to cast a vote on all proposals to amend the Constitution or By-Laws.

The Board was in recess from 2:34 P.M. to 2:42 P.M., at which time Mr. Gibbons rejoined the meeting.

Moved, by Mr. Adams, that the by-laws be amended by the adoption of a new by-law to follow By-Law 20 and to be known temporarily as By-Law 20a, and a new by-law to follow By-Law 29 and to be known temporarily as By-Law 29a, respectively as follows:

"20a. If there be no eligible nominee, the procedure provided for by By-Laws 19 and 20 shall be repeated two months later and, if there again be no eligible nominee, that procedure shall be repeated again at two-month intervals as often as may be necessary until an eligible nominee shall be elected. The person so elected shall serve only for such portion of the term as may remain after his election and qualification."

"29a. If there be no eligible nominee, the procedure provided for by By-Laws 27 and 29 shall be repeated two months later and, if there again be no eligible nominee,

that procedure shall be repeated again at two-month intervals as often as may be necessary until an eligible nominee shall be elected. The person so elected shall serve only for such portion of the term as may remain after his election and qualification."

The yeas and nays being ordered, the said question was decided in the affirmative: Whole number of votes cast, 17; necessary for adoption, 12; yeas, 17; nays, 0. Every director voted in the affirmative. So the new by-laws were adopted.

Pursuant to special order, Mr. Martin called up for determination his pending motion of the previous day to approve the recommendations of the Committee on Pension Plan and to appropriate therefor. The yeas and nays being ordered, the said question was decided in the negative: Whole number of votes cast, 16; necessary for adoption, 9; yeas, 1; nays, 15. Mr. Martin voted in the affirmative; all other directors voted in the negative except the Chair, who did not vote. So the motion was rejected.

On motion of Mr. Blalack, ORDERED that any action taken by the President to submit for rescinding an action taken in annual Board meeting shall be done only after the proponents and opponents of the original action have had an opportunity to submit their side together with the President's letter requesting reconsideration.

On motion of Mr. Blalack, ORDERED that the next annual meeting of the Board of Directors shall be held in Hartford, Conn., beginning on May 31, 1940.

On motion of Mr. Blalack, ORDERED that the order of submitting Directors' reports be moved up four positions each year on the printed agenda for the meeting, and that Directors' Motions follow in the same order.

On motion of Mr. Blalack, VOTED that the Directors are allowed the extra expense and necessary additional cost of transportation to attend the Los Angeles hamfest on the evening of May 9, 1939.

Moved, by Mr. Blalack that the first sentence of By-Law 12 be amended to read as follows:

"12. Any candidate for the office of Director shall have been both a member of the League and a licensed radio amateur operator for a continuous term of at least four years immediately preceding the receipt by the Secretary of his petition of nomination, as hereinafter provided; provided, however, that a lapse of not to exceed ninety days in the renewal of operator's license and a lapse of not to exceed thirty days in the renewal of membership in the League, at any expiration of either, during the four-year period, will not disqualify the candidate."

Moved, by Mr. Norwine, to make the figure in respect of a membership lapse ninety days; but there was no second, so the motion was lost. The yeas and nays then being ordered, the original question was decided in the affirmative: Whole number of votes cast, 17; necessary for adoption, 12; yeas, 16; nays, 1. Every director except Mr. Young voted in the affirmative; Mr. Young voted opposed. So the by-law was amended.

On motion of Mr. Blalack, after extended discussion, unanimously VOTED that there is established a permanent committee of three, to be known as the Committee on



Members of the Board visit W6USA

Standing at the left is Stewart Ayres, W6GEA, Chairman, W6USA Committee. Horace Greer, W6TI, W6 QSL Manager and Publicity Chairman, W6USA Committee, is shaking hands with President Woodruff. Art. Fonseca, W6NYQ, President of San Francisco Radio Club and Chairman of Installation, W6USA Committee, is standing at the right of the table. Photo by W6CBF.

Amateur Frequency Assignments, this committee to advise and consult with the General Manager and the General Counsel on the accomplishment of the following objectives:

- (1) Generally, preservation of the amateur frequency assignments;
- (2) Specifically, the education of Congress, the federal regulatory agency and the general public looking toward this end;
- (3) Specifically, research into and the development and prosecution of any possible and suitable methods of protecting amateur assignments;

and that this committee shall be appointed from among the members of the Board, individual members to be appointed by the President for one-year terms at each meeting of the Board.

Moved, by Mr. Blalack, that the revised plan of the Royal Order of the Wouff Hong, copies of which have been submitted to the Board, be now adopted. After discussion, moved, by Mr. Norwine, to amend the motion to provide that the President shall appoint a committee to work in collaboration with the League's legal department to this end. But, after further discussion, with unanimous consent, both Mr. Norwine and Mr. Blalack withdrew their motions. On motion of Mr. Norwine, unanimously VOTED that the President is authorized to appoint a committee to examine the proposed constitution and by-laws of the Wouff Hong plan as submitted, and report its recommendations to the Board of Directors at the next meeting of the Board.

On motion of Mr. Green, unanimously VOTED that the Secretary is instructed to provide directors' pins to the two directors who retired as of the end of last year, in appreciation for past performances.

On motion of Mr. Caveness, unanimously VOTED that there is hereby appropriated from the surplus of the League, as of this date, the sum of six thousand five hundred dollars (\$6500), for the purpose of defraying the expenses of holding this meeting of the Board of Directors, any unexpended remainder of the sum to be restored to surplus. On motion of Mr. Martin, VOTED that the Secretary is instructed to advise the Board, by means of a Secretary's Letter as soon as practicable following the Board meeting, the exact cost of holding same, itemized by divisions, President, Vice-President, each headquarters member and other costs.

On motion of Mr. Norwine, ORDERED that the President's suggestion of nomination of candidates for president and vice-president at the elections at the 1940 Board meeting by means of written ballots is adopted.

Moved, by Mr. Hill, that the Board instruct Messrs. Warner and Budlong to attend the Santiago, Chile, conference to be held next year, and that there be hereby appropriated from the surplus of the League, as of this date, the sum of three thousand two hundred dollars (\$3200) for the purpose of defraying their expenses, any unexpended remainder to be restored to surplus. Moved, by Mr. Young, to amend the motion by striking out the reference to Mr. Budlong and by reducing the appropriation to \$1600. But, after discussion, the amendment was rejected. On motion of Mr. Adams, VOTED to amend the motion to provide that General Counsel Segal shall act as Mr. Warner's associate if he is able to attend the conference, Mr. Budlong so to act if Mr. Segal cannot attend. The question then being on the adoption of the motion as thus amended, the same was unanimously VOTED.

On motion of Mr. Bailey, a suggestion in the Secretary's report concerning longer terms of office for directors was laid on the table.

On motion of Mr. Blalack, VOTED that the Secretary is authorized to condense the minutes of Executive Committee meetings when publishing the same in *QST*, to save space.

On motion of Mr. Blalack, the Board, by unanimous vote,

Some shots taken while the Board was in session

From Top to Bottom: Handy, sightseeing; Reid, Quisting with Bailey at left, Alternate Amarantes, and Hill at the right; Caveness, l. and Blalack, r.; Young, l., with Glasscock, c., and Green, r.; In session, with Glasscock having the floor. Photos by Segal.



July 1939

extended a cordial expression of thanks and appreciation to the QSL Managers and to the Standard Frequency Stations for their splendid services to amateur radio. On motion of Mr. Martin, the Board, by unanimous vote, expressed its thanks and appreciation to Director McCargar and those who assisted him in providing the splendid arrangements for the holding of this meeting of the Board. On motion of Mr. Mathews, unanimously VOTED that the Board expresses its hearty thanks to the members of the Planning Committee for their services, and authorizes the continuance of the committee for another year.

On the question of the desirability of seeking an amendment to regulations concerning 'phone operation in the 7Mc. frequency band, after a very extended discussion, on motion of Mr. Martin, unanimously VOTED that an informative poll shall be forth with taken to obtain amateur opinion on the question: "Should A-3 emission be authorized in the 7.2-7.3 Mc. range, if authority can be obtained, for the purpose only of protecting regularity of amateur communication in the presence of broadcast interference?" And on the further motion of Mr. Martin, it was unanimously VOTED that after the informative poll has been taken the Secretary is directed to inform the Board of the results, together with the submission of the following question: "Shall the Secretary be directed immediately to institute all necessary steps to obtain authorization for Class A, B and C amateur licensees to use A-3 emission in the 7.2-7.3 Mc. range?"

On motion of Mr. Hill, unanimously VOTED that the Board petitions the Federal Communications Commission to permit "duplex," or carrier-on-the-air, between separate voice transmissions, but only in the frequency bands above 112 Mc.

On motion of Mr. Gibbons, by unanimous vote, approval was granted the holding of a joint convention of the Pacific and Southwestern Divisions in the vicinity of San Francisco over Labor Day week-end, 1939, under the auspices of the Unified Committee of Bay Area Amateurs, subject to the joint approval of Messrs. McCargar and Blalack.

On motion of Mr. Young, by unanimous vote, affiliation was granted the Jackson County Amateur Radio Association, Jackson, Minn.

On motion of Mr. Hill, by unanimous vote, approval was granted the holding of a Hudson Division Convention in Schenectady, N. Y., the first week-end in October, 1939, under the auspices of the Schenectady Amateur Radio Association.

On motion of Mr. Mathews, the Board adjourned, sine die, at 8:47 P.M.

(In the course of its deliberations, the Board also discussed, without formal action, five-meter regulations, war plans, Thursday-evening sessions of the Board, headquarters correspondence with *QST* contributors, earlier reports by officers, emergency stations, the financial position of the League, and Philippine Island 'phone. Total time in session, 17 hrs. 54 mins. Total new appropriations, \$15,825.)

K. B. WARNER,
Secretary.

HQ. STAFF HONORS WARNER

On page 14 of the second post-war issue of *QST* (July, 1919), there appeared a picture of a serious-looking young man in the uniform of an Air Corps lieutenant who signed himself "Your

new editor." When that issue appeared this young man — yes, it was Kenneth B. Warner — had about completed his second month in the job of revivifying the A.R.R.L. after eighteen months of war-time dormancy. In March the League's Board had met, voted to reorganize and to purchase *QST* from C. D. Tuska, and elected Warner their paid secretary-editor as soon as his release from the Air Corps could be effected. In latter April of 1919 he was on the job — in a dilapidated office building on lower Main Street in Hartford, with an ancient desk, one table and hatrack.

Last April 20th the President and Vice-president of the League and the other officers and 32 staff members gathered at dinner in the Hotel Bond in Hartford to celebrate K.B.W.'s twentieth anniversary as managing secretary of the League. It was an evening of reminiscent good fellowship, of harking back to the early days — days back in 1920, for example, when the "staff" consisted of one stenographer, or even in 1922, when a dozen paid employees constituted the entire headquarters establishment. The tales went back even farther than that — back to that March in 1919 when, with a vision of amateur radio's destiny, eleven men pitched a hundred dollars into a hat in a New York hotel room to produce the first post-war bulletin issue of *QST*. It was with this sum as its assets that K. B. Warner set out to rebuild the League.

And it was an organization of world-wide influence and renown that he surveyed on the occasion of his twentieth — and its twenty-fifth — anniversary. Instead of a hundred dollars in a hat there was an annual disbursement of over a quarter million dollars. Instead of indebtedness exceeding four thousand dollars, a surplus of more than a hundred thousand. Instead of one paid official (who was forced to make his expenses from the point of his Army discharge in Washington to Hartford by selling *QST* advertising en route), a headquarters organization totalling 37 persons. . . .

On behalf of the Headquarters Gang, Secretary Warner was presented with a desk set by Dr. Woodruff. If you come to West Hartford you can see it on his desk. The inscription reads:

KENNETH BRYANT WARNER
WITH THE AFFECTIONATE REGARD OF HIS STAFF
A.R.R.L.
1919-1939

(Continued on page 90)

Testimonial dinner for K. B. Warner



High-Efficiency Grid Modulation in a Portable 14-Mc. 'Phone Transmitter

Circuit Design and Tuning Procedure in the New Terman System

BY FRANK L. DENTON,* W4ATI

IN A recent paper, F. E. Terman and J. R. Woodyard explained the operation of a new type of modulated r.f. amplifier,¹ and the writer has used their information and suggestions in the construction of a portable 20-meter 'phone transmitter with 40 watts output to the antenna, the entire set being constructed in a suitcase 2 feet by 1 foot by 8 inches. Valuable information was also obtained from A. W. Shropshire and J. W. Hillegas, transmitter engineers at WSB, who had built up an experimental transmitter of this type. But before proceeding, it must be mentioned that this type of transmitter is not very practical for all-band operation, and also that it is not very much cheaper for low power than a plate-modulated transmitter. The great advantage of the circuit is the high overall efficiency obtainable, making possible the use of a smaller and lighter power transformer and filter choke, and also lower-voltage filter condensers. Since those parts are usually the largest components of a transmitter, the advantage of the use of this circuit in a portable outfit is obvious. For the advanced amateur, the circuit is also definitely advantageous because of its money-saving possibilities when it is used in high power rigs.

The circuit diagram and list of parts of the transmitter used here are shown in Fig. 1. The r.f. section consists of a 6L6 oscillator driving a pair of 10's arranged in the high-efficiency circuit. The audio end works from a double-button carbon microphone through a 6C5 and 6L6, the latter grid-bias-modulating the final stage. One power supply handles the r.f. end, and the second supplies bias for the final stage as well as plate power for the speech amplifier. First, the tuning of the circuit will be discussed in conjunction with a few points on the construction. This is done for the benefit of the fellows that want to use the circuit without having to delve into the theory underlying its operation.

Excitation Adjustment

The pilot lamp in series with the crystal is very important. About 15 watts must be taken from

the oscillator circuit,² and if the plate tank condenser is adjusted to the wrong setting there is danger of fracturing the crystal. The bulb provides a means for measuring the r.f. crystal current, and also it acts as a fuse if the maximum crystal current is exceeded. Also, the oscillator tube should be a metal 6L6 with its shell tied to the cathode, since the shell causes the crystal current to be lower for the same power output compared to the 6L6-G. Before turning on the high voltage to test the oscillator, make sure that voltage cannot reach the plates of the final tubes. A convenient method of doing this is to put open plugs in the plate current jacks in series with the final plate circuits. Now the high voltage can be switched on, and when the plate tank of the oscillator is tuned to give the exact minimum plate current, the crystal current will be low. But off to one side of this setting the current becomes excessive, and this will be indicated by the pilot light. Next, 100 volts bias is applied to both final tubes by means of the adjustable taps on the bleeder resistance of the bias supply.

Couple in some r.f. from the oscillator to the final grids by means of the link coupling shown. First, turn C_3 and C_2 about half way in, take No. 2 tube out of its socket, and tune C_1 for maximum r.f. to tube No. 1's grid, as shown by maximum grid current. (The oscillator tank will have to be retuned slightly as C_1 is varied.) No. 1 tube is neutralized at this point by any of the conventional methods. The "grid current dip" method was used here, the neutralizing condenser being adjusted until tuning the No. 1 plate tank circuit (with coil L_6 removed from its socket) caused the change in grid current to be minimum. Next, No. 2 tube is returned to its socket and C_1 is again tuned for maximum r.f. to the grid circuits. A plate-current maximum for the oscillator will be passed through at series resonance between C_2 and L_1C_1 , which is the correct adjustment. C_3L_3 should also be tuned for resonance, but this adjustment is not critical since it just loads the oscillator a little more, producing a little more plate current. The oscillator here is operated with

² Space and weight are important considerations, this being a portable outfit. For installations where an extra tube or so does not matter, the oscillator could be operated at lower power and a buffer or doubler used to obtain the necessary driving power for the final tubes. — Editor.

* Transmitter Engineer, WMAZ, Macon, Ga.

¹ F. E. Terman and J. R. Woodyard, "A High-Efficiency Grid-Modulated Amplifier," *Proc. I.R.E.*, August, 1938.

The new system of grid-bias modulation described in this article gives plate efficiencies of the same order as with plate modulation. It is ideal for portable work, since no power-consuming high-level modulator is required. Resembling the Doherty amplifier in principle, it is, however, more readily adaptable to amateur work, and will give somewhat higher output for the same tube capacity.

80 ma. plate current and the plate does not show color (a 6L6-G was inserted for this test). Tube No. 2 should be neutralized at this point.³ Next, measure the grid current to both tubes, and if the current on No. 1 grid is greater, turn C_2 out a little (less capacity) and retune C_1 and C_3 . If No. 2 grid draws the most current, turn C_2 in, giving more capacity. Retune C_1 and C_3 . A balance will be found where both tubes draw the same grid current, and this is the proper adjustment for them. Next, the bias on tube No. 2 should be raised to about 320 volts and the setting of C_1 tested to be sure it is exactly correct for maximum grid drive. 320 volts bias should be about the proper value for the amount of r.f. grid drive obtainable from the oscillator. At any rate, the correct value of bias is the amount required to let the No. 2 tube draw between zero and 10-ma. plate current when the plate circuits are properly tuned. The exact amount can be determined later. Coil L_6 is now returned to its socket.

Adjusting the Plate Circuits

Now we can proceed to the tuning of the plate circuits. First, a non-inductive load resistance of the proper value is connected directly across the output tank L_5C_5 . The proper value for this transmitter is 1000 ohms, and the proper value

³ In some cases it is possible to get satisfactory operation without neutralizing this tube. Because of the high bias and the heavy loading the regeneration in the No. 2 tube (which helps supply the modulation peaks only) is small at carrier levels. The regeneration increases on the positive peaks, which is often beneficial to the operation of the peak tube, but with lower power sets, at least, does not reach a high enough value to cause oscillation.

W4ATI's high-efficiency grid-modulated transmitter is built in a suitcase for easy portability. The system gives the advantages of high carrier output with minimum power-supply requirements, which makes it ideal for portable work. This rig has been giving a good account of itself on 14-Mc. phone.

for any set-up can be figured from equations given later. The non-inductive resistor can be built up from 2-watt carbon resistors in series-parallel, if enough of them are used. Remember, this load must stand about 35 watts for a short while. Plate voltage is now applied to No. 1 tube only, by removing the spare plug in the plate-current jack. Condenser C_4 is then adjusted for minimum plate current of tube No. 1, while C_5 is adjusted for maximum plate current. It will be found that the setting of C_4 for minimum plate current depends on the setting of C_5 , and that the setting of C_5 for maximum plate current depends on the setting of C_4 . C_5 may be changed in steps of one or two divisions while varying C_4 slowly back and forth, until the particular combination giving the highest possible minimum is found. This procedure must be followed since it is not possible to arrive at the correct adjustment by tuning first one and then the other separately. The plate circuits are now tuned if coil L_6 happens to have the correct amount of inductance, but this coil may have to be spread a little or a turn taken off or put on.

For proper operation, the r.f. voltage across L_4C_4 should be exactly twice that across L_5C_5 . Some method must be used to determine if this condition exists. A 913 oscilloscope tube was used here, since it was already on hand to be used as a modulation indicator. One of the deflecting plates can be connected to the audio circuit, and the audio can be used as the sweep voltage when using the tube as a modulation indicator. The other deflecting plate can connect to a piece of insulated wire that will reach to either of the plate leads. This piece of wire is not connected to the plate leads directly, but is wrapped around another

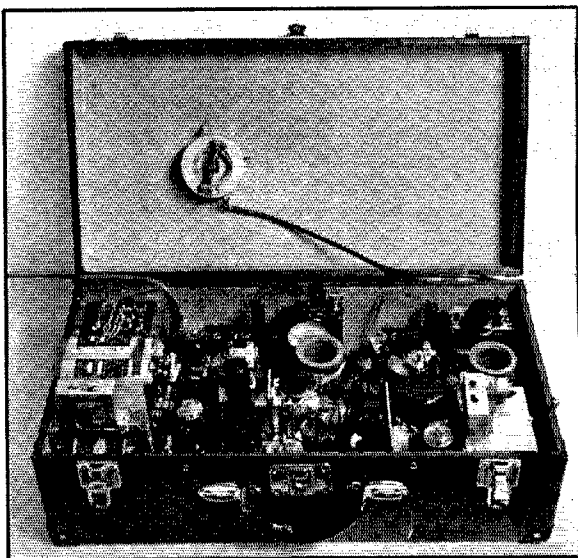

very short wire which can be connected directly. Only about four short "twists" are necessary to give the very small amount of capacity needed. It is convenient to put a "pee-wee" clip on the end of the short wire so that it can be clipped from first one plate to the other. The same amount of capacity must remain between the wires while using them for tuning. Now, to proceed, if the oscilloscope lead is connected to No. 1 plate, the length of the line shown should be almost exactly twice the length of the line shown when the oscilloscope lead is attached to No. 2 plate. (No sweep voltage is used now.) If the line shown for No. 1 is less than twice that of No. 2, the inductance of L_6 must be increased by adding a turn;

if the line shown for No. 1 is more than twice the other, the inductance of L_6 must be reduced by spreading it or taking off a turn. C_4L_4 and C_5L_5 must be retuned for each trial, but all of this is not as hard to do as it sounds.

When the correct adjustment for the plates is reached, the load resistor may be disconnected from L_5 and the antenna can be coupled in. An off-center Hertz matches up very nicely here. Since an off-center Hertz has about 600 to 700 ohms impedance, it will give 1000 ohms across L_5C_5 when it is clipped about one or two turns from the plate end of L_5 . C_4L_4 and C_5L_5 may have to be readjusted slightly, but very little. The antenna should be coupled in until the oscillo-

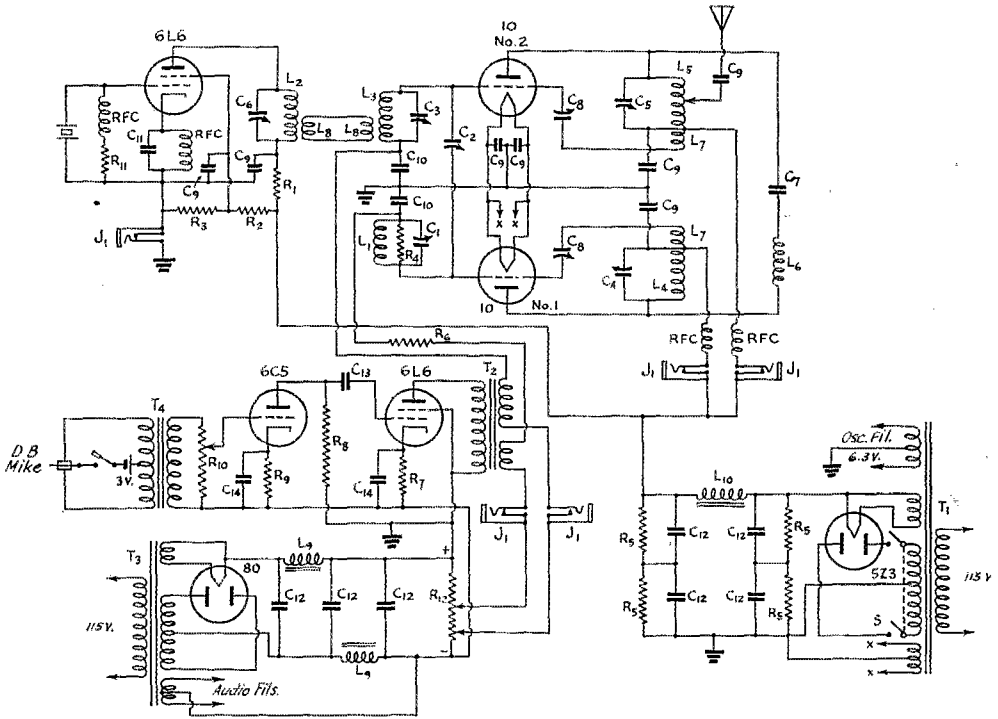

Fig. 1

- C_1, C_3, C_4, C_5, C_6 — 100- μ fd. mid-gaget variables.
- C_2, C_8 — 25- μ fd. mid-gaget variables.
- C_7, C_{10} — 0.002- μ fd. mica, 1000-volt.
- C_9 — 0.006- μ fd. mica, 1000-volt.
- C_{11} — 150- μ fd. mica.
- C_{12} — 8- μ fd., 450-volt electrolytic.
- C_{13} — 0.1- μ fd., 25-volt electrolytic.
- R_1 — 1500 ohms, 2-watt.
- R_2 — 30,000 ohms, 1-watt.
- R_3 — 100,000 ohms, 1-watt.
- R_4 — 30,000 ohms, 2-watt.
- R_5 — 150,000 ohms, 1-watt.
- R_6 — 5000 ohms, 2-watt.
- R_7 — 300 ohms, 15-watt.
- R_8 — 30,000 ohms, 1-watt.
- R_9 — 1500 ohms, 1-watt.
- R_{10} — 250,000-ohm variable.

- R_{11} — 25,000 ohms, 5-watt.
- R_{12} — 25,000 ohms, 15-watt.
- L_1, L_3 — 5 turns No. 24 d.c.c., spaced one wire diameter, on $1\frac{1}{4}$ -inch form.
- L_2 — 7 turns No. 16 enameled, diameter $1\frac{1}{4}$ inches, length $1\frac{1}{2}$ inch.
- L_4, L_5 — 5 turns No. 14 enameled, spaced one wire diameter, on $2\frac{1}{4}$ -inch form.
- L_6 — 33 turns No. 14 enameled, close-wound on $1\frac{1}{4}$ -inch form.
- L_7 — Neutralizing winding, 5 turns No. 24 d.c.c., close-wound.
- L_8 — Link coils, 2 turns No. 22 d.c.c., close-wound over L_2 and L_3 .

- L_9 — 15 henrys, 100-ma.
- L_{10} — 15 henrys, 200-ma.
- J_1 — Closed-circuit jack.
- T_1 — 600-volt, 200-ma. plate transformer with 7.5- and 6.3-volt filament windings.
- T_2 — Class-B driver transformer with separate secondaries (built to match one to 6L6 to two Class-B 6L6's).
- T_3 — 350-volt, 80-ma. transformer with 5- and 6.3-volt filament windings.
- T_4 — D.B. microphone transformer, 200 ohms to grid.
- S — D.p.s.t. switch.

scope shows that the right voltage conditions exist for the plates. If some other type of antenna is used, it must be in resonance by tuning it with a conventional system, and it must be coupled in to L_5 so that the correct voltage conditions are obtained. Any of the antennas with lead-in impedances of about 1000 ohms or lower should work well. A Johnson "Q" antenna with a 400-ohm transmission line was available here, and good results were obtained with it by connecting one of the line leads to ground and the other about half way up the tank. Incidentally, if the impedance of the antenna lead-in is known, it might be possible to get along without the 1000-ohm non-inductive load resistor. Just clip the lead-in at about the proper place on L_5 to give 1000 ohms load across the tank. No load resistor will be needed if the plate of No. 1 tube can be made to load up to 90 or 95 ma., and at the same time have the relations across the plates correct. Now, the plate voltage is applied to No. 2 tube. If the plate current is over 10 ma., the bias should be raised a little; or lowered, if no plate current can be seen on the meter.

The transmitter is now ready for modulation, and a tone (sine-wave if it is available) may be applied to the audio input. The 60-cycle a.c. mains may be used, or if nothing better can be found, a steady whistle will do. Since the audio is being used as a sweep on the oscilloscope, a fairly perfect triangle should be obtained when the r.f. lead is attached to plate No. 2 and 100% modulation applied. The best linearity will usually result when the audio voltage applied to the No. 2 tube grid is about two-thirds that applied to No. 1, but the adjustment is not critical and practically as good results can be secured with equal audio voltages applied to the two tubes. This would be the case with a transformer at T_2 having two identical secondaries. If desired, a 10,000-ohm, 10-watt semi-variable resistor can be connected across the secondary feeding T_2 and the resistor tap adjusted to give the best modulation pattern.

When the amplifier is correctly adjusted and modulated 100%, the plate current of the No. 1 tube will remain substantially constant, and the current to the No. 2 tube will increase to about one-third that of the No. 1 tube. Theoretically, the current to No. 2 tube should increase to practically one-half that of the No. 1 tube, but this is for sine-wave modulation, and no distortion. The distortion in this type of amplifier will run as low as 3% to 5% up to about 75% modulation. Then the value increases fairly rapidly to about 10% or 12% for 100% modulation. For

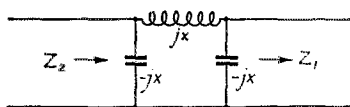

Fig. 2—The coupling filter between the plates can be resolved into the familiar low-pass circuit.

voice modulation, this is satisfactory and about as good as most amateurs can do ordinarily.

Theory of Operation

It has been generally believed that high efficiencies were to be attained only by plate-modulating the final stage. This new system, however, permits grid-bias modulation to be employed in

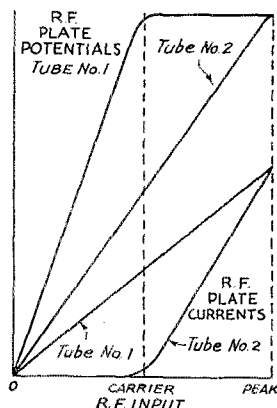

Fig. 3—R. F. plate voltages and currents on the two tubes over the modulation cycle.

the usual manner, and the efficiency of the amplifier is 65 to 70%. For the same carrier output, the power consumption is approximately cut in half and the plate dissipation reduced to one-third that of the conventional grid-modulated amplifier.

Efficiency in power amplifiers is directly proportional to the ratio of r.f. plate voltage to d.c. plate voltage. The conventional grid-modulated amplifier must operate at low average efficiency to respond to the positive peaks of a completely-modulated wave, rarely though they may occur; and the r.f. plate voltage, and hence the efficiency, with unmodulated carrier must not be more than half of the maximum possible value. The efficiency is ordinarily about 35% at carrier level, and it increases to about 65% on the peaks of modulation.

But suppose we adjust the amplifier to operate at an efficiency of 65% at carrier level. Then the r.f. plate voltage will be the maximum obtainable, and the amplifier will be unable to supply the additional r.f. plate voltage necessary for the positive modulation peaks. But an increase in the current in a circuit will increase the power, as well as an increase in voltage. Therefore, although we can obtain no more r.f. plate voltage on the peaks, if we arrange some scheme to cause the load impedance to decrease in value, the r.f. current in this load impedance will increase and the power output will increase. If on the peaks we are able to decrease the value of the load impedance to one-half its carrier value, then the output of the amplifier will be doubled, provided the r.f. plate voltage remains the same. But four

times as much power must be obtained for peaks than for the carrier. Therefore, the remaining power needed must be obtained from another tube that operates only on positive modulation peaks. The new Terman amplifier operates in this manner exactly.

An impedance-inverting filter is connected between the plates of the two tubes for the purpose of lowering the load impedance on the carrier tube, No. 1, on the modulation peaks. This is a low-pass filter of the type shown in Fig. 2. The tank circuits, when in tune, will be capacitive to supply the capacitive branches of the network. The peak tube, No. 2, begins to supply power to the antenna on positive peaks. This effectively raises the impedance across the output of the filter, but since it is an inverting filter, the load impedance across the carrier tube is lowered, fulfilling the necessary requirements. Each leg of the pi-section has a reactance of X ohms, either inductive or capacitive, as the case may be. Further, this relation is true

$$Z_0 = \sqrt{Z_1 Z_2} = X \quad (1)$$

where Z_0 is the characteristic impedance of the filter section.

Solving (1) for Z_2 ,

$$Z_2 = \frac{X^2}{Z_1} \quad (2)$$

If the filter is terminated in a resistance, R_1 , instead of an impedance, Z_1 , then

$$Z_2 = \frac{X^2}{R_1} = R_2 \quad (3)$$

or the filter appears as a resistance of magnitude R_2 when terminated by R_1 . So if R_1 varies, R_2 will vary in the opposite direction. Herein lies the secret of the high efficiency obtainable.

In addition to the peculiar impedance-inverting characteristic, the filter introduces a lagging phase shift of 90° . This phase shift is not necessary for the operation of the amplifier, but is an inherent and unavoidable characteristic of the filter. It is obvious that the r.f. voltages on the plates of the two tubes are 90° out of phase. It is equally obvious that the grids of the two tubes cannot be excited in phase, but must also be 90° out of phase. This is accomplished by inserting a filter, with a leading phase shift, between the grids. A load resistor, R_2 , is used across one end of the filter to fix the input and output resistances. The peak tube is adjusted to have just a little more r.f. excitation than the carrier tube. This is taken care of in the adjustment as explained.

Going back to the filter between the plates, if R_1 in equation (3) is replaced by $\frac{R}{2}$, it is seen that the carrier tube is working into a resistance of $2R$. $\frac{R}{2}$ represents the output load. The carrier tube is operating Class-C with 65% efficiency or

better, with a load of $2R$. As the excitation on the tubes increases beyond the carrier point, tube No. 2 begins to contribute power to the circuit, and the output of the amplifier increases by virtue of the combined effects of a rapidly increasing output from tube No. 2 and a correspondingly rapid reduction of the load impedance to tube No. 1, which permits the latter also to increase its output without having to increase its already high r.f. plate voltage. At the instantaneous peak of a completely modulated wave, each tube is delivering twice the carrier power into an effective load of R ohms. Fig. 3 shows how the r.f. plate potentials and plate currents in the two tubes vary with grid excitation.

Calculation of the Value of L_6

It is necessary to calculate the characteristic impedance of the plate-circuit filter, basing it on the output expected. L_6 , the critical element in the filter, must have a reactance equal to the characteristic impedance of the filter. C_7 is a blocking condenser included so that the currents of the tubes may be measured separately. The following calculations show the method used to arrive at the inductance of L_6 :

Given: $E_p = 620$ volts d.c.

Assume: Carrier power = 36 watts (plus about 4 watts from peak tube).

Efficiency = 67%.

Maximum r.f. plate voltage =

$$\frac{0.9}{\sqrt{2}} E_p = \frac{0.9 (620)}{\sqrt{2}} = 400 \text{ volts r.m.s., near enough.}$$

$$\text{Input} = \frac{36}{.67} = 54 \text{ watts}$$

and $I_p = 87$ ma.

Under these conditions, the carrier tube must "see" the following resistance:

$$R = \frac{E_{r.f.}^2}{P} = \frac{(400)^2}{36} = 4444 \text{ ohms.}$$

As had been shown, this resistance is twice the characteristic impedance. So $Z_0 = 2222$ ohms. The load resistance to be coupled into the output of the filter is $\frac{Z_0}{2} = 1111$ ohms, or about 1000 ohms.

Since the reactance of L_6 must be equal to Z_0 , from $X_L = 2\pi fL$ is found the value of L_6 at 14,200 kc.

$$L_6 = 25 \mu\text{h.}$$

Incidentally, very little coupling should exist between any of the coils, except the link coupling.

~~Strays~~

An easy way to fasten feeder spreaders to the wire is to thread the feeders through the holes in the spreaders and hold them in place with a drop of solder on the wire on each side of the spreader.

— W2GPO

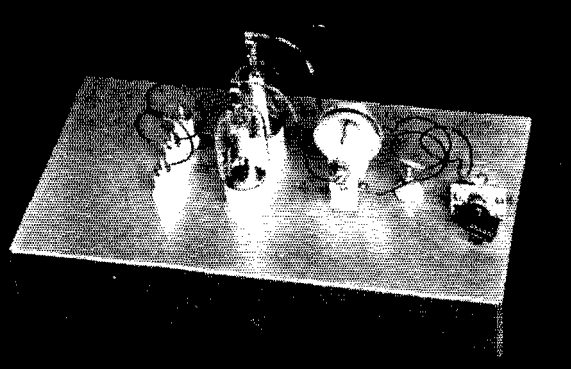

Power up to 100 watts output on 2½ meters from this little rig. The chassis, 13 inches long, 7 inches deep, and 2 inches high, provides ample space for the few parts used. Left to right in this view are seen the grid coil, the HK-24's, the plate condenser, plate coil, and antenna coil and condenser.

Simplicity on 112 Mc.

An Easily-Constructed Transmitter Capable of Outputs up to 100 Watts

BY B. W. GRIFFITH, JR.,* W5CSU

THE more stringent regulations concerning the stability of signals on 5 meters seem to have greatly influenced the number of stations operating on that band. Many amateurs who used frequency-stabilized transmitters on 5 are now doing most of their operating on the 10-meter band, while those who are interested mainly in short-distance 'phone contacts without going to the expense involved in a multi-stage transmitter have migrated to the more technically lenient region of 2½ meters. From all indications the 112-Mc. band seems to be just about as good for ground-wave work as is 56 Mc., and very little trouble has been experienced in obtaining excellent results from the erstwhile 56-Mc. receivers of the "37-41" variety and others on 112 Mc. The principal difficulty, it appears, is in getting the self-excited oscillator to operate stably and at good efficiency at this frequency.

The type 45 tube, always looked upon as the old standby for ultra-high-frequency operation, does not work well in the simpler circuits. A glance over the u.h.f. section of the *Handbook* gives one the impression that only line-controlled circuits will operate on 112 Mc., which is probably quite true with tubes which most amateurs are willing to buy for use on this band. The line-controlled oscillators, however, are rather clumsy to construct and operate, and certainly take up quite a bit of room for an oscillator of so short a wavelength.

The recent introduction of the HK-24 tube, however, has made available to the amateur a tube of considerable power, designed for ultra-high-frequency operation, at a very reasonable cost. A pair of these tubes makes an excellent set-up for a 112-Mc. transmitter.

* M.I.T. Dormitories, Cambridge, Mass.

Circuit and Construction

The incomparable simplicity, both electrical and mechanical, of the T.N.T. circuit makes it unquestionably the circuit to be used in this outfit. With tubes of conventional design, the inter-electrode capacities are generally so large that the tank coil practically disappears at this frequency. Here, though, there is no such effect; the tank coil is large enough to make possible relatively high efficiency, and enough capacity can be added to provide quite good stability and make for ease in adjustment. The parts are mounted on a 7- by 13-inch electrical chassis, which is nonmagnetic and very easy to drill. Room has been left for the addition of grid-tuning and neutralizing condensers in case it is decided to use the set as a neutralized amplifier at some later date. Since the grid leads of the tubes are in the bases, the grid coil is mounted on feed-through insulators near the tube sockets. The plate tank condenser is a Hammarlund N-10 neutralizing condenser, providing a small variable capacitance with good insulation. No stand-off insulators are used to support the plate tank coil; the only supports for this coil are the connections to the tank condenser and the feed-through insulator which brings the high voltage to the center of the coil. The plate and grid coils are the same size, each consisting of two turns 1½ inches in diameter. The grid coil is 2 inches in length, the plate coil 1 inch long. The coils in the filament circuit are a necessity for proper operation, and are each 30 turns of No. 14 wire wound to a diameter of ½ inch. No by-pass condensers are used with the circuit; in fact they seem to be a hindrance to its operation. No r.f. choke is necessary in the grid circuit, the wire winding of the 2000-ohm grid leak being quite sufficient at this frequency.

Antenna coupling in this particular transmitter

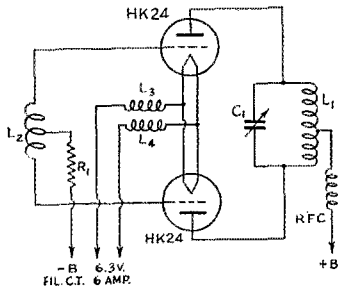

Fig. 1 — The 112-Mc. oscillator circuit diagram.
 L_1, L_2 — 2 turns No. 14 wire, diameter $1\frac{1}{2}$ inch (see text).
 L_3, L_4 — 30 turns No. 14, diameter $\frac{1}{2}$ inch.
 R_1 — 2000-ohm, 10-watt wire-wound resistor.
 C_1 — Hammarlund N-10 neutralizing condenser.
 RFC — Ohmite Z-1 u.h.f. choke.

is accomplished by means of a single turn of wire partially meshed with the plate coil and tuned with a 25- μ fd. Cardwell "Trim-Air," since an antenna employing a resonant feed-line is used at this station. A 5-meter Johnson "Q" mounted so that the radiator is vertical makes an excellent $2\frac{1}{2}$ -meter antenna, where it operates as two half-waves in phase. Many u.h.f. stations are already equipped with this type of antenna system.

Power inputs of 100 to 165 watts are used, with plate voltages of 750 to 1000 volts. The circuit operates at an efficiency in the neighborhood of 60 per cent, giving r.f. outputs of as much as 100 watts. If one is in the arc-drawing mood (in spite of the safety rules!) a fat arc, an inch in length, can be drawn from the plate circuit when the antenna is not connected. This is reduced to about $\frac{1}{4}$ inch when the antenna load is applied. The circuit seems to be extremely stable, even when modulated. This is probably to be accounted for by the very strong feed-back voltage which appears in the grid circuit, as well as the comparatively high C in the plate tank circuit. No frequency drift is noticed when the rig is in operation; in fact, this particular transmitter is set within 0.1 Mc. of the edge of the band, where it provides a frequency marker for the rest of the $2\frac{1}{2}$ -meter stations around Boston. The tuning gear has not been touched since the frequency was originally adjusted to 112.1 Mc., and no deviations noticeable on the frequency measuring equipment at this station have been observed. The tank condenser plates at this frequency are $5/32$ inch apart.

The below-chassis construction is equally as simple as that on top. A 4-prong socket for the power cable connections is mounted in the left edge of the chassis. The ends of the filament coils and grid-leak resistor are connected to three of the socket lugs, while a long wire connects the positive plate supply lug to the end of the plate choke at the right in this view.

Pipe-fitting experience is not necessary to build this 112-Mc. outfit. The old reliable T.N.T. is put to work with some of the newer tubes — with results that may surprise you.

Stations have already been contacted as far away as thirty miles, with reports indicating that the signals are still S9 at that distance. I'm still waiting for someone to get on the air at some greater distances so that I can see if the rig is "getting out." This transmitter is modulated by a pair of 6L6's in push-pull, Class AB_2 ; any type of plate modulation can be used. The entire cost of the oscillator is in the neighborhood of twelve dollars, seven of which go for the tubes; so save up your pennies and join the gang on "two and a half"!



DIXIE JONES' OWL JUICE

TRUTH is stranger than fiction because ya don't hear it so much. Take for instance if ya wanto find out whatcha signal sounds like off a piece wye ya crank up ya stuff and yowp up in the air and spear one guy right after another and ask 'em all: "Sow's my higs?" and all ya get back from all of 'em is RST 599 — and the next day the mail toter brings ya a blue ticket for having a lousy signal. The first guy oughto of told ya. They all oughto of told ya. But they don't do it because they're skeered to. Didja ever tell a guy he had a lousy signal when he had it? Ya can just see him swellin' up fit to bust and gittin' red. He don't believe it, and it gits ya in the dawghouse. So most guys just say RST 599 and let this jasper roll his hoop on down the street, but I don't. I tell 'em the bitter truth and if they don't like it they can lump it.

— *W4IR of the Dixie "Squinch Owl"*

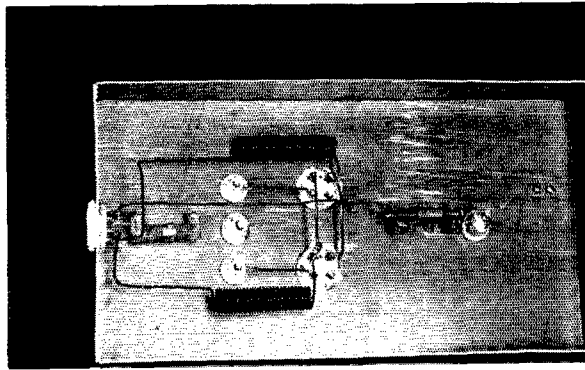

The "Double Pitchfork" Antenna

Variable Directivity with a Fixed Array

BY WILLIAM J. BREUER,* W6TE

WHILE out at Wake Island, I did some experimenting with vertical antennas and finally evolved a flexible, non-rotating but variable system that seems hard to beat. Upon returning to the States, a similar system was installed and tested and the results confirmed. Since the system requires but little more space than a simple vertical antenna, it may be of interest to the cramped-quarters contingent.

Parallel half-wave elements spaced from a tenth- to a quarter-wavelength and excited out of phase will give maximum radiation in a line through the centers of the two elements. This

untuned line. If they are connected as in Fig. 1B, with 1-3 and 2-4 in parallel, the maximum radiation will be along the line as shown, and if 1-2 and 3-4 are connected together and properly fed, the maximum radiation will be along a line at right angles to the direction shown. Two other directions are also available, since if only 1 and 4, or 2 and 3, are excited out of phase (Fig. 1C) the maximum radiation will be in a line through the elements. Thus, with suitable switching at the juncture of the elements, four different combinations can be obtained, giving rather thorough general coverage.

As used at W6TE on 14 Mc., the system is supported by a 40-foot pole which has two sets of 9-foot diagonal spars mounted on it. One set is mounted near the top of the pole and the other set is about 10 feet above the ground. The 9-foot diagonals give close to tenth-wavelength spacing on a side, but one-eighth or even one-sixth wavelength spacing would probably give slightly greater gain. However, the 9-foot spars were available and so were used.

The vertical portion of each antenna element is a 29-foot 6-inch piece of No. 12 wire, supported between the ends of the diagonal spars. There is no reason why, if the height is available, the full half-wave element cannot be hung vertically, since the additional wire necessary to reach to the central junction will simply shorten the matching stub (if used) by that amount.

The element-ends that are brought in to the center can best be shifted by a d.p.d.t. switch. We rigged up one that was operated remotely by means of a pull cord and spring retract, housing it in a small box at the junction point. Two methods of connecting the elements are shown in Fig. 2. The system shown in Fig. 2B is the easiest

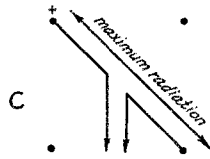
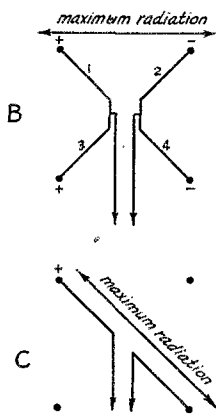
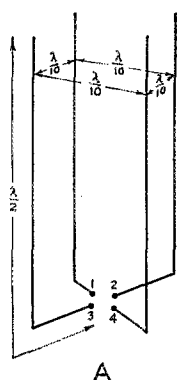

Fig. 1—Four vertical elements arranged as at A form the basis for the "double pitchfork" antenna combination. When the elements are fed as in B, the maximum radiation is as indicated, with a null at right angles to this line. By switching so that 1-2 and 3-4 are excited out of phase, the radiation pattern is rotated 90 degrees. Two other major directions can be obtained by exciting a pair of the elements, as shown at C.

principle is employed in the familiar "flat-top" beam. The same elements excited in phase will give maximum "broad-side" radiation, although the gain is small until the spacing exceeds a quarter wavelength. Both of the above principles are applied in the "double pitchfork" antenna.

As shown in Fig. 1A, four vertical half-wave elements are grouped in a square with tenth-wavelength sides. The ends of the four elements are brought to the center of the square, where they are fed by a tuned line or by a matching stub and

* 1720 South Catalina St., Los Angeles, Calif.

You don't have to use a rotatable antenna to change the direction of maximum radiation. As a matter of fact, you don't need a lot of room and it doesn't cost much more than it does for a simple vertical half-wave to try one of these latest additions to the close-spaced-array family.

to tune and balance, but we prefer the arrangement shown in Fig. 2A because it seems to have more gain. This gives, in effect, the two combinations of the connection shown in Fig. 1B.

A stub and untuned line is used at W6TE, although a tuned line could be used. The adjustment¹ of the stub and line is similar to that used with other systems. The whole system should be completed first, with the phasing switch in working order, before any effort is made to tune the stub and match the line.

Results

Because of the lack of field equipment, much less a field to use it in, I have had to rely on reports and results in order to plot the field pattern of the antenna.

During receiving tests it has been possible to copy European signals easily with the beam when they are just barely audible on a comparison doublet antenna. When the phasing is switched, the signals disappear entirely. The lobes seem to be fairly broad-nosed, since the gain does not change appreciably over an arc of about 40 degrees.

Transmitting tests show a five S-point front-to-side average ratio, and a three S-point gain over a vertical J-fed half-wave antenna.² That is, a receiving station on the beam may report the signals S8 and only S3 when the phasing is switched. A signal from the comparison vertical half-wave at the same time would be S5.

Several other connections have been tried but discarded as either useless or no improvement. Connecting the elements so that three elements were in phase and the fourth out of phase, in an effort to get greater radiation along the diagonal line (similar to Fig. 1C, but with 1, 2 and 3 all excited in phase with each other and out of phase

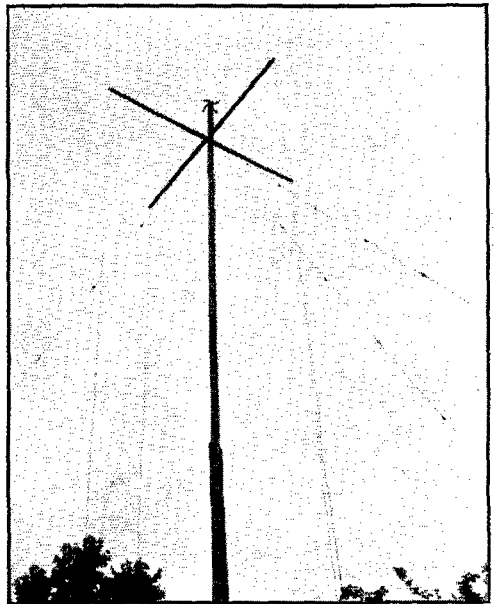

The "double pitchfork" antenna is supported from a 40-foot pole by two 9-foot cross-pieces. A switching system at the bottom (not shown) changes the direction of maximum radiation.

with 4) resulted in not much more than one S-point gain over a single vertical half-wave antenna, which was the same order of improvement that was obtained with all four elements in parallel and acting as a single element. Connecting the elements so that 1 and 4 are in phase with each other and out of phase with 2 and 3 seems to be a waste of time, with a decrease in strength all around.

Properly oriented so as to hit the difficult directions the hardest, the system shown in Fig. 2A will give good coverage and considerable improvement over a half-wave vertical.

¹ Lynch, "Feeding Vertical Antennas," *QST*, January, 1939.

² The actual gain is probably something between 4 and 5 db. — Editor.

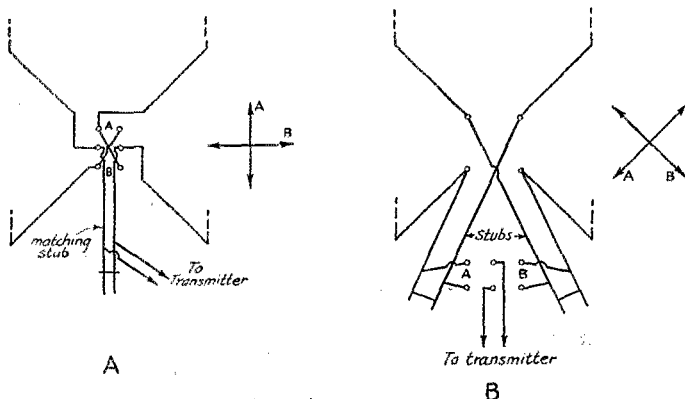

Fig. 2—Two methods of switching the double pitchfork antenna for variable directivity. With the switches at "A" the maximum radiation is along the "A" direction, and at right angles to this with the switches in the "B" position.

W5DVM

LOUIS STAFFORD, W5DVM, down in Fort Smith, Arkansas, likes to work 14-Mc. 'phone when his job of nursing a dial telephone exchange doesn't interfere. He likes to design and build his own equipment. His success in this direction may be judged from the appearance of the speech-amplifier and 2A3 Class-B driver units on either side of the Hammarlund Super-Pro receiver on the operating table. Unfortunately, his panel-type transmitter does not show in the photograph. It consists of RK23 Tri-tet, which quadruples to 14 Mc., RK23 buffer, 801 and 860, link-coupled to a push-pull 852 final which is modulated by Class-B 242A's.

W3CVK

W3CVK is familiar to many. It is the call of the station owned and operated by Paul S. Hamilton of Atlantic City, N. J. The transmitter is a 1-kw. rig working on all bands. An RK34 crystal oscillator drives 807 and 800 buffer-doublers. 100TH's are used in the push-pull final. The 800 may be grid-modulated and, with 50 watts input, all districts have been worked on 1.8-Mc. phone. The receiver is an FB-7XA.

He has two vertical 14-Mc. half-wave antennas, a "Q" and a 3.5-Mc. Zepp.

W5BRR

A GLANCE at the array of cards on the wall should be enough to confirm the claim of George De La Matyr, W5BRR, that he is primarily a DX man. Formerly a W6, he moved to Louisiana in 1931. Since then, he has gradually worked up to a 1-kw. job.

Above the power-supply units, which occupy the lower half of the rack, is a band-switching exciter unit using two 6A6's and an 807, link-coupled to the 100TH buffer above it which drives the 250TH final. The receiver will be recognized as the National HRO.

On 14 Mc. W5BRR normally uses a "Q"-fed half-wave antenna, but he switches to a 7-Mc. doublet, designed as a Collins multi-band antenna, for 7- or 28-Mc. work. He is an engineer for the Baton Rouge Electric Company.

W9IQZ

M. W. MITCHELL, W9IQZ, Yankton, S. Dak., solves the space problem by mounting his receiver in the rack with the transmitter and thus dispenses with the usual operating table.

The three-stage r.f. section is a compact unit just above the SX-11 receiver. A 6L6 crystal oscillator and 809 buffer-doubler drive the T55 final amplifier. Link-coupling is used throughout. The output amplifier feeds the antenna through a pi-section network at the top of the rack.

The lower portion of the rack contains power supplies and a 6L6 grid-bias modulator driven by a 6J7 and 6C5.

The antenna is a 102-foot flat-top with single-wire feed, designed primarily for 14-Mc. work as an antenna three half-waves long, but used also for occasional excursions to 7 and 3.5 Mc.

W9IQZ is a broadcast-station operator.

VE3AGM

VE3AGM, located at Kirkland Lake, Ontario, is owned and operated by C. E. Dunlap, who broke into ham radio about three years ago. He will be heard most often operating in the 7-Mc. band, although he works 14- and 3.5-Mc. c.w. as well.

The transmitter is in the popular standard rack style. The apparatus is arranged so that all controls come above the level of the operating table. The first r.f. unit contains a 59 Tri-tet oscillator and 841 doubler, followed immediately above by a link-coupled push-pull buffer of 801's which drives the push-pull 100TH final amplifier. The top section contains the pi-section antenna coupler. Input to the final ranges between 700 and 900 watts. The antenna is a full-wave 7-Mc. Zepp, 50 feet high.

W3BQ

WHILE there are plenty of old-timers on the air, few can boast of the record of Herb Walleze, who has been an active amateur ever since 1912. He changes his gear regularly about once a year, each time hoping he has arrived at the ultimate. Maximum operating convenience is the chief feature attained in his latest creation shown in the photograph. The transmitter is a band-switching outfit covering 1.7 to 14 Mc. The tube line-up consists of an 802 self-excited oscillator, an 807 doubler and RK20 final which he normally operates at 150 watts input.

The receiver is a home-made 8-tube superhet covering 16 to 2 Mc. and 500 to 300 kc. It includes a monitor coupled to the i.f. channel. The unit to the left of the receiver is a 100-kc. crystal and multivibrator which he uses in his duties as Official Observer.

VO4A

LOCATED up in the northwestern tip of Newfoundland at Curling, VO4A, owned by K. O. Garcin, is one of the less frequently heard fourth-district stations. The equipment consists principally of a Sky Chief receiver and a Gross CB25 transmitter. The parallel 46's in the final amplifier are modulated by Class-B 46's. Normal input runs about 50 watts. The antenna is a 132-foot center-fed affair, coupled through a pi-section network. VO4A operates 'phone and c.w. on 14 and 3.5 Mc., and is often active on 7-Mc. c.w.

Second "A.R.R.L." QSO Party Results

BY E. L. BATTEY,* WIUE

FOUR HUNDRED AND FIFTY-EIGHT operators submitted logs in the Second A.R.R.L. QSO Party — for members only — held on the first week-end of January, 1939. It was an even greater success than the first of these get-togethers for our "A.R.R.L.-family," held one year previously!

Hail to the Winners!!

Entries were received from 69 A.R.R.L. Sections (all except Alaska and P.I.). The leader in each Section is receiving a distinctive bronze watch charm medallion (illustrated) with his call letters thereon. Congratulations to the lucky winners! — *W1AVJ W1BVR W1DFQ W1EVJ W1KQY W1KTB W1LAB W2GSA W2HMJ*

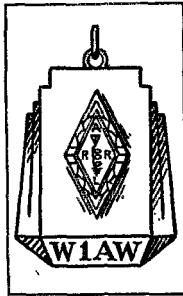

Each winner in the Second "A.R.R.L." QSO Party receives one of these classy watch charms, engraved with his personal call letters.

W2ISQ W3BES W3FBM W3FPQ W3GTS W4ABT W4AGI W4APU W4AUW W4CXY W4EFM W4EPT W5AWT W5BDX W5CJP W5EGP W5FGE W5FZD W5KC W6BIP W6CW W6EY W6GTM W6IWU W6MXN W6NCO W6NHA W6QAP W7AYQ W7CMB W7ECI W7GCO W7GLM W8DOD W8KUN W8LCN W8NUV W8OFN W9AET W9CWW W9RQM W9RSO W9SBB W9SEB W9THS W9VFZ W9VKF W9YCR W9ZAR W9ZQW W9ZTL VE1CU VE2DR VE3OI VE4AGA VE4GD VE4QZ VE5VO CM2OP K6CGK. Those eighteen whose calls are in italics were also winners in the 1938 Party. It's interesting to note three A.R.R.L. Directors among the winners: *W1BVR, W4APU and W6EY!*

Reactions

"The party was more fun than six weeks of ordinary operating." — *W2ISJ*. "A few more contests like this one would be helpful in uniting more closely the A.R.R.L. fraternity." — *W9ZAM*. "Boy! What a week-end. Tripled last year's score. Three new states. Let's have another." — *W9AB*. "Met lots of new fellows. It

provided quite a test for my operating ability and equipment. It showed up weak spots in my rig that I'll try to eliminate before next time." — *W8FOV*. "Real fun, this A.R.R.L. Party. Worked 26 stations in one hour the first evening on 3.5 Mc." — *W9RQM*. "Meeting these old contest hounds that one hasn't seen for a year is the biggest kick in ham radio for me." — *W4CXY*. "I experienced excellent clean-cut c.w. operating during this contest. Was surprised that the 'phone operators didn't take it more seriously." — *W2HXQ*, opr. *W2EOA*. "Break-in was used at all times and accounted for 90% of the contracts." — *W2LOQ*. "Averaged 11.3 QSO's per hour for my best contest record. You can't beat an e.c.o. and BK." — *W9LEZ*. "I worked 45 states in the party — all but Nevada, Vermont and Utah." — *W9CWW*. "Met several I hadn't heard in nine years." — *W5AWT*. "Had more fun in this contest than in the SS." — *W6NHA*. (That's praise enough for *any* contest! — *E.L.B.*) "I met plenty of old air-friends. Incidentally, many stations worked said, 'Thanks for new section,' and of course that helped, too." — *W4FOY*. "The A.R.R.L. Party went over with a bang in this part of the country." — *W6QAC*. "The best feature of the contest I noted was the great percentage of participants who used break-in." — *VE3GT*. "It was a lot of fun. In fact I enjoyed it more than the last two SS contests and plan to enter every year from now on." — *W6DTY*. "Long may they continue . . . make a lot of friends and improve individual operating." — *W1BDU*. "I found very little interest in the QSO Party on 'phone." — *W2ACB*. "I think it's one of the best contests on the amateur bands. Met a lot of old friends and had a great time." — *W2ISQ*. "It was very interesting to watch the activity shift from spot to spot as some new station would come on and the 'sharpshooters' would gang up on him." — *W5BDX*. "Sure had a great time! More fun than any other contest — including DX contest!" — *W8SQE*. "I noticed some very poor listening habits on the part of some of the contestants. Some of them never tuned more than a few kilocycles from their own frequencies and some seemed to tune habitually on only one side (always the same) of their frequencies. This unquestionably lost them many more contacts." — *W9OHA*. "These contests give a fellow the opportunity of contacting many states that would take years to work otherwise." — *W8ADV*. "The 7-Mc. band seemed to be alive with 'ARRL de' . . ." — *W1ALP*.

* Assistant Communications Manager.

<i>Tennessee</i>		<i>Missouri</i>		<i>Montana</i>		<i>W9QIR</i>	1664-32-26	<i>Oklahoma</i>	
W4CKY	7844-106-37	W9RSO	13939-132-53	W7GLM	4940-65-38	W9HFC	140-10-7	W5EGP	13056-128-51
W4FCU*	4760-70-34	W9GBJ	9936-108-46	W7GSU	1488-31-24			W5BOR	9760-122-40
W4FDT	1584-33-24	W9QMD	5184-72-36	W7FL	1364-62-22	<i>Utah-Wyoming</i>		W5AQE	6396-82-39
W4PL	1080-27-20	W9OUD	2520-45-28	W7GDB	484-22-11	W7GCO	1872-38-26	W5CJZ	1008-24-21
HUDSON DIVISION		W9KOH	1080-27-20	W7EXF	406-15-14	W6FYR	850-25-17	W5AIR	900-25-18
		W9PYF	280-14-10						
		W9ZGS	208-13-8						
<i>Eastern New York</i>		<i>Nebraska</i>		<i>Oregon</i>		SOUTHEASTERN DIVISION		<i>Southern Texas</i>	
W2ISQ	16848-162-52	W9ZAR	18928-169-56	W7ECI	4588-62-37	<i>Alabama</i>		W5FZD	6920-88-40
W2EWD	9823-106-47	W9MGM	16632-150-56	W7BOH	2240-40-28	W4APU	16063-152-56	W5EWS	4080-60-34
W2EOA*	7056-84-42	W9FWW	5698-78-37	W7GKM	1380-30-23	W4DQW	1900-38-25	W5HNF	364-28-16
W2ISJ	6784-106-32	W9DMY	1488-31-24	W7GVG	980-25-20	W4AAA	253-12-11	W5FDR	308-14-11
W2LDS	2116-46-23	W9AZT	325-13-13	W7GKA	319-15-11			W5GCU	60-6-5
W2LSD	1380-30-23	W9GDB	200-13-10	W7AIG	168-12-7	<i>Eastern Florida</i>		<i>New Mexico</i>	
W2FCG	976-31-16			W7GKJ	18-3-3	W4EFM	8900-100-44	W5CJP	1817-41-23
W2ACB	532-19-14			W7GUA*	2-1-1	W4FOY	4672-73-32	W5ZU	216-12-9
W2DVC	60-6-5					W4DDB	32-8-2		
<i>N. Y. C. & L. I.</i>		NEW ENGLAND DIVISION		<i>Washington</i>		<i>Western Florida</i>		CANADA	
W2HMI	2896-258-56	<i>Connecticut</i>		W7CMB	19470-165-59	W4EPT	10750-126-43	<i>Maritime</i>	
W2ESO*	12604-137-46	W1KQY	17542-170-49	W7AKP	11832-133-52	W4FJR	270-15-9	VE1CU	3360-60-28
W2KIK	12212-142-43	W1BIB	6210-104-30	W7FHW	11083-116-48	W4FXR	230-12-10	VE1EK	1610-35-23
W2BWC	10600-136-49	W1EAO	5810-83-35	W7FIQ	8772-102-43			VE1LP	364-27-16
W2IRV	10160-127-40	W1KRV	5402-73-37	W7GJ	1840-40-23			VE1ND	900-25-16
W2KKA	9840-120-41	W1JKB	3186-59-27	W7CZO	1380-30-23	<i>Georgia</i>		VE1NO	660-22-15
W2FTX	6897-94-37	W1CSC	2596-59-22	W7EZO	972-27-18	W4AGI	15180-173-44	VE1EV	225-13-9
W2JIN	5310-80-30	W1JHN	2320-58-20	W7GUU	72-6-6	W4VX	8880-111-40		
W2HUG	5265-68-39	W1ITI	1720-43-20			W4ECZ	7372-97-38		
W2KZP	4620-68-35	W1TID	1620-45-18	PACIFIC DIVISION		W4FIJ	448-16-14		
W2BGO	4060-70-29	W1CTI	1122-33-17	<i>Hawaii</i>		W4MA	220-11-10	<i>Ontario</i>	
W2GTL	3920-70-23	W1BHM	900-25-18	W6CGK	1302-31-21	W4FDJ	4-2-1	VE3OI	23320-212-55
W2KAM	3484-67-26	W1KOY	828-23-18	K6OQV	1044-30-18			VE3ES	18144-162-56
W2ALJ	3248-59-29	W1JEB	720-30-12			<i>West Indies</i>		VE3GT	11312-102-56
W2KMZ	2308-63-23	W1HYF	572-22-13	<i>Nevada</i>		CM2OP	1160-29-20	VE3EF	10560-120-44
W2LR	2592-54-24	W1JUD	572-22-13	W6CW	2146-37-29			VE3AIB	6102-97-33
W2GP	2016-48-21	W1GKM	240-12-10			SOUTHWESTERN DIVISION		VE3ZE	1722-41-21
W2GIC	1628-37-22	W1HAX	154-11-7	<i>Santa Clara Valley</i>		<i>Los Angeles</i>		VE3DC	1296-38-18
W2AHC	1026-27-19	W1TGS	91-7-7	W6NCO	5143-71-37	W6MXN	7567-82-47	VE3SQ	800-25-16
W2KOH	840-30-14	W1TSS	26288-212-62	W6PBV	1610-35-23	W6NLI	6384-76-42	VE3DU	672-21-16
W2LRI	806-31-13	W1AW*	18370-168-55	W6FBW	60-6-5	W6ONG	5106-69-37	VE3IW	330-15-11
W2LOQ	726-34-11	W1UB*	16848-163-52			W6DTS	3960-55-36	VE3APS	193-11-9
W2GDF	616-22-14	W1BDD	3294-61-27	<i>East Bay</i>		W6PMV	1748-38-23	VE3IR	50-5-5
W2LPZ	224-14-8	W1JFN*	3250-63-26	W6BY	1280-32-20	W6KSY	952-28-17		
W2CUE	96-8-6	W1ES*	546-21-13	W6DHS	230-12-10	W6MYT	98-7-7	<i>Quebec</i>	
W2KFW	34-7-6			W6ITH	2-1-1	W6KX	98-7-7	VE2DR	9512-116-41
W2JXK	80-8-5	<i>Maine</i>		<i>San Francisco</i>		W6FYW	3-2-2	VE2LC	5472-76-36
W2LNN	45-5-5	W1DFD	4686-71-33	W6BIP	15730-143-55	W6IOX*	2-1-1	VE2MV	1980-45-22
		W1DKJ	4278-69-31	W6GPP	8648-92-47			VE2CO	1932-46-21
		W1AQW	3328-52-32	W6PGB	6180-82-40	<i>Arizona</i>		<i>Alberta</i>	
		W1BAD	850-25-17	W6ZS	3885-56-35	W6QAP	2156-40-28	VE4GD	5100-75-34
		W1RAP	600-20-15	W6PH	3468-51-34	W6NRP*	1254-33-19	VE4ADW	610-20-16
		W1GQP	168-11-8	W6LMD	408-17-12	W6GBN	30-5-3		
						W6OLF	2-1-1		
						W6KFC*	30420-234-65	<i>British Columbia</i>	
		<i>E. Massachusetts</i>		<i>Sacramento Valley</i>				VE5VO	5143-71-37
		W1EVI	14484-143-51	W6NHA	17050-155-55	<i>San Diego</i>		VE5SW	4536-64-36
		W1IGN	10500-125-42	W6PAR	10134-111-47	W6GTM	7998-93-43	VE5QP	1872-36-26
		W1KMS	3120-60-26	W6MDI	1428-34-21	W6QAC	6660-95-37	VE5AFW	80-8-5
		W1BDU	2550-43-30			W6LJQ	4059-62-33		
		W1JEA	1560-33-24	<i>San Joaquin Valley</i>		W6LJD	2128-39-28	<i>Manitoba</i>	
		W1LNN	912-30-16	W6IWU	468-19-13	W6ISG	896-28-16	VE4AGA	13113-141-47
		W1QW	520-20-13	ROANOKE DIVISION		W6NDF	2-1-1	VE4SR	507-20-13
		W1ALP	98-7-7	<i>North Carolina</i>				VE4AHE	162-9-9
		W1IQO*	2-1-1	W4ABT	14496-151-48	WEST GULF DIVISION		<i>Saskatchewan</i>	
				W4DQ	3770-65-29	<i>Northern Texas</i>		VE4QZ	8256-97-43
		<i>W. Massachusetts</i>		W4CFR	1716-39-22	W5AWT	9552-100-48	VE4AMQ	5472-76-36
		W1BVR	3726-60-27			W5DXA	5143-70-37	VE4AJT	1320-33-20
		W1FKI	3484-67-26	<i>South Carolina</i>		W5HCR	2380-44-28	VE4RS	364-14-13
		W1AJ	2400-50-24	W4AUW	3663-56-33	W5BKH*	884-26-17	VE4KJ	50-5-5
		W1BIV	1140-30-19	W4EHT	1224-36-17				
		W1KOS	374-17-11	W4CZA	1134-33-18				
		W1EOB	360-15-12	W4CQG	308-14-11				
				W4BQE	84-7-6				
		<i>New Hampshire</i>		W4ECG*	2-1-1				
		W1AVJ	17296-184-47	<i>Virginia</i>					
		W1KIN	5162-89-29	W3GTS	3000-60-25				
		W1IIP	5040-84-30	W3BWA	2024-44-23				
		W1BFT	4608-48-48	W3CYV	128-8-8				
		<i>Rhode Island</i>		<i>West Virginia</i>					
		W1LAB	8532-119-36	W8LCN	14798-151-49				
		W1IQF	6438-87-37	W8PSR	11880-132-45				
		W1KLR	1332-37-18	W8OXO	8000-80-50				
				W8JJA	7308-102-36				
		<i>Vermont</i>		W8JMN	1584-38-22				
		W1KTB	11960-130-46						
		W1JXS	5301-68-39	ROCKY MOUNTAIN DIVISION					
		W1FSV	2400-60-20	<i>Colorado</i>					
		W1JVS	1020-30-17	W8SBB	5700-75-38				
		W1AVP	112-8-7	W9EII	2322-43-27				
		NORTHWESTERN DIVISION							
		<i>Idaho</i>							
		W7AYQ	9768-111-44						
		W7FFQ	8326-93-46						

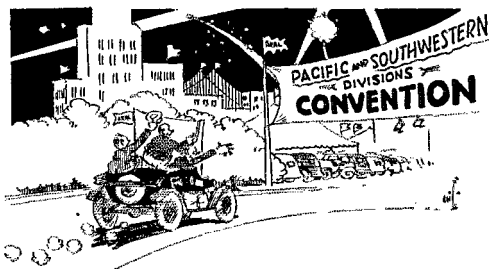

Official A.R.R.L. joint convention of the Pacific and Southwestern Divisions, San Francisco, Sept. 2-4, 1939. Start Saving Your Money.



HINTS AND KINKS FOR THE EXPERIMENTER



SIMPLE NOISE LIMITER FOR PUSH-PULL AUDIO

I HAVE a noise-limiter circuit which I believe has not appeared in print and is very easily adapted to any receiver with a push-pull input transformer. I installed it on my SX16 Sky rider and it works very well. Parts required are: one 6H6, one socket, one 10-ohm resistor and one

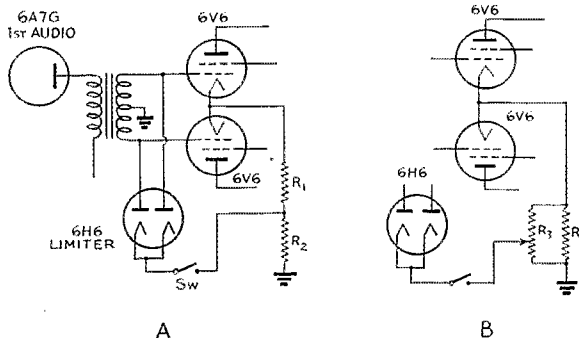

Fig. 1 — Simple noise limiter which may be easily added to any receiver with push-pull audio stage. The arrangement at B provides variable adjustment.
 R_1 — Regular cathode-biasing resistor in receiver.
 R_2 — 10 ohms.
 R_3 — 10,000 ohms.

switch. With types of output tubes other than 6V6's, the bias might have to be changed on the 6H6. Fig. 1 shows an optional bias circuit for the 6H6 to provide for a variable threshold control. By setting the bias on the 6H6 to $\frac{1}{2}$ volt (in my case), any audio level up to this is unaffected but a noise impulse over $\frac{1}{2}$ volt is shorted through the 6H6 because at over $\frac{1}{2}$ volt the 6H6 plates are positive and current flows and the noise peaks aren't heard.

— Carl Mowery, W8NMA

SAFE AND ECONOMIC TRANSMITTER CONTROL UNIT

AS THE trend to-day in transmitter design is toward safe and foolproof operation rather than watts per dollar, we believe that the control unit to be described will be of interest to many hams.

This unit, which is a combination of the ideas of several other hams and the result of studying the cause of the misfortunes of still others, has

been incorporated in the rig here at W1K5J and has been in use for the past several months with very good results. Its features are as follows:

1. Provides protection against some causes of accidents, since the high voltage cannot go on unless the transmitter is grounded to earth.
2. Prevents overload of high-voltage supply.
3. Provides high-voltage time delay.
4. Provides a very steady source of bias voltage.
5. Protects tubes against bias failure.

Referring to the diagram of Fig. 2 the operation is as follows: When the main transmitter switch SW_1 is closed, all the filament transformers are on and the "hot" side of the 110-volt line is applied to the cathode of the 83V tube. When the tube reaches operating temperature (about 20 seconds), the current flows through the bias voltage divider, the R_{y2} winding and the normally-closed contacts of R_{y1} to the transmitter frame, and thence back through the ground lead to the a.c. line. This energizes the R_{y2} and applies a.c. to the high-voltage transformer primary.

In the event of overload on the high-voltage transformer, the current flowing through the selected portion of the winding of R_{y1} pulls open the pair of contacts in the bias circuit between R_{y2} and ground and, immediately afterward, closes the bias circuit again through the whole coil of R_{y1} and holds it in that position. To reset the circuit it is only necessary to push the push-button switch SW_2 which shorts out R_{y1} and R_{y2} and allows them to return to their normal position. SW_2 may be located on the operating table.

Most of the parts will be found in the average ham junk box and are all ordinary receiver parts. The only part requiring special treatment is R_{y1} which is an old "AB" power-pack relay rewound with approximately 600 turns of No. 24 enameled wire. This is tapped at about every 100 turns, accuracy not being essential. This provides a range of adjustment for wide differences in current values. The 20-ohm rheostat R_2 provides fine adjustment.

And now for a few precautions — the relay R_{y2} should have as stiff a spring action as possible and its contacts should be kept clean so that they will not stick at the time its protection is

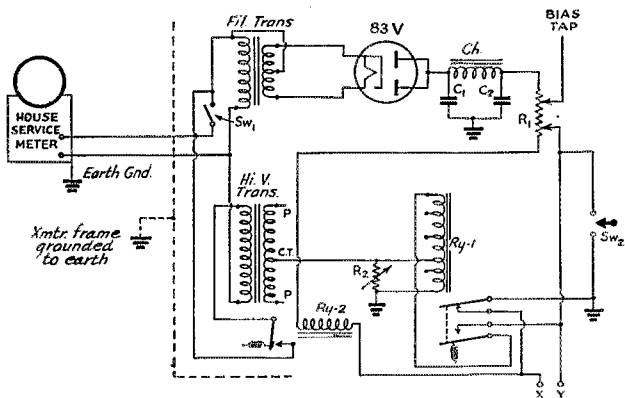

Fig. 2 — Circuit of the transmitter control system. All switches are shown in the non-operating position.

- C₁, C₂ — 16- μ f., 250-v. filter condensers.
 R₁ — 400 ohms, 25-watt.
 R₂ — 20-ohm wire-wound rheostat.
 SW₁ — Main transmitter switch. SW₂ — Push-button bell switch.
 Ry₁ — See text.
 Ry₂ — 200- to 500-ohm d.c. relay (heavy duty contacts).
 Ch — 300-ohm, 30-henry choke.

most needed. In case the time delay is not sufficient for the rectifier tubes (866's at high voltages for instance), the push-button switch SW₂ may be held down for an additional 15 seconds, although this was not found necessary here with a 1000-volt supply. The slider on the bias divider which controls the voltage to the entire coil of Ry₁ should be set as near as possible to the ground end so too much current will not be drawn by the 83V when SW₂ is closed. In fact, it will work properly at the ground end with most current values.

The values shown on the diagram will vary somewhat, depending on the resistance of Ry₂ and of the choke Ch and are not intended to be followed exactly. They are shown rather as an indication of what to expect. The second tap on Ry₁, to which the centertap of the high-voltage transformer is connected, was found to give the best operation here with a current of approximately 250 ma.

If complete break-in operation is not desired or for any reason it is felt desirable to be able to shut off the high voltage and leave the filaments and bias supply on, a switch similar to SW₂ may be installed across points X and Y on the diagram. Then, if the switch is pressed, the additional magnetism in the coil of Ry₁ will cause an effect similar to that of an overload and, of course, the relay would hold shunt until the push-button SW₂ is used to reset the circuit. Should this additional control be used, it will be found necessary, however, to adjust the overload action within closer limits by means of R₂ than would otherwise be necessary.

The bias supply was found to be very steady

and showed only about a 12 per cent change in voltage from zero to 50 mils of grid current to the final stage. Since the buffer stage here is also supplied from the same source and its grid current must also be added in, we believe that the regulation is quite adequate.

— Roger F. Hamilton, W1K5J

ILLUMINATION FOR METERS

Fig. 3 shows the method I use to illuminate meters mounted behind the transmitter panel. A hole is cut in the panel of such a size that the scale of the meter may be seen clearly. The meter is then mounted at an angle by using long spacers on the mounting screws at the bottom of the meter and a short spacer on the top mounting screw. The ends of the spacers should be filed to correspond to angle of tilt.

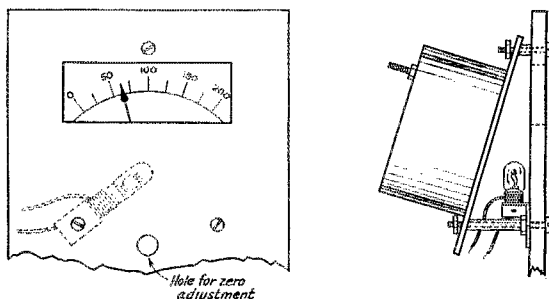

Fig. 3 — A method of mounting meters for indirect illumination. It also removes danger of contact with the adjusting screw when the meter is in a high-voltage circuit.

The bracket for the dial light may be fastened underneath one of the lower mounting screws and a hole drilled at the center for inserting a screwdriver for setting the zero-adjust screw whenever this becomes necessary. The position of the light should be varied until there is no reflection from the meter glass.

Incidentally, this is one way of mounting meters so as to comply with the A.R.R.L. code.

— J. F. Greenbaum, W1LIG

Strays

This town (Marblehead, Mass.) has recently been honored in having one of its residents graduate from the ranks of s.w.i. to that of ham. His name is Biggs, he stands four feet, seven inches, he is 14 years old and his call is — W1MAN!

— W1LXJ



CORRESPONDENCE FROM MEMBERS

The Publishers of *QST* assume no responsibility for statements made herein by correspondents.

THOSE CHEAP RECEIVERS AGAIN

45 E. Sixth St., Houghton, Mich.

Editor, *QST*:

I read with pleasure, "BCL QRM Menace," May, *QST*. I agree with W4EPJ that something must be done, but what?

I have not yet heard anyone mention the fact that these same cheap supers cause a lot of interference between 1000 and 5000 kc. Perhaps this interference is not generally recognized for what it is. But here at W9YX, due to low signal levels and unfortunate frequency selection for WHDF (1370 kc.), we find it impossible to copy signals from 3600 to 3700 from 4:00 to 6:30 p.m. on our NC101XA. We do not use 160, but we have observed the same interference there. The number of continuous signals indicates that some of these sets are S7 at about 10 blocks.

And we get called on the carpet for beating with their prolific harmonics at several places on the dial. It ain't right!

I have been called several times to "fix that squalling" on 1120 kc., and they don't look very convinced when you tell them it is other receivers set to CKPR, 560 kc.

We can never make the public buy good receivers or t.r.f.'s by trying to show them this. But the Commission should eliminate receivers which interfere with police, aeronautical, forestry, special emergency, harbor 'phone, and broadcast stations.

There is our wedge! Servicemen won't kick.

— Herbert Brooks, W9SDG

HERE IS WHAT THEY THINK

414 W. Elm St., East Rochester, N. Y.

Editor, *QST*:

This is a reply to . . . T. T. Frazier, who apparently has no conception of the work done by A.R.R.L. for ham radio. . . .

The A.R.R.L. is not a "self-acclaimed head of the hams of America" — the A.R.R.L. is the head because we want it to be, because no one else in the country knows better the problems presented to the status of amateur radio, and no one else or anything else could possibly do so much for us, in the past, present or future, as the A.R.R.L. is doing or has done. . . .

— Francis L. Sherwood, W8NCM

Easton, Maine

Editor, *QST*:

. . . Pages wouldn't tell the world my gratitude to the amateur fraternity and good old A.R.R.L. . . .

— H. E. Gray, W11BR

Damariscotta, Maine

Editor, *QST*:

A friendly letter to "Beer Baron" Frazier, W8QEP:

Here is one guy who read your letter in May *QST* with interest. It was on page 88 but it didn't exactly mean "love and kisses." . . .

Thousands of us hams just filled out a long list of instructions to our director and told him just what we wanted him to do at the May meeting of the Board in San Francisco. We run this "shooting match" and all the officials are nothing more than our "hired help." . . . I happen to know many of the commercial men who were at Cairo. I also know precisely and definitely that had it not been for a whale of a fight by A.R.R.L. alone, at Cairo, we should have lost the whole 40-meter band. Those poor fellows had to fight the whole world single-handed, and it is a miracle that they were able even to effect a compromise. . . .

If you see those holes in the old A.R.R.L. boat, dive in and swim out and give the rest of us a hand. Don't stand there on the shore hollering. . . .

— H. W. (Old Hot Wire) Castner, W11IE

Sparta, Wis.

Editor, *QST*:

I thought I noticed a peculiar odor, rather obnoxious, I might add, when I removed the wrapper from May *QST*. Sure enough, there on page 88. . . .

— Glen C. Daniels, W9YXH

4139 West 35th Ave., Denver, Colo.

Editor, *QST*:

Perhaps strange to say, I smelled a rather pungent odor from the time I received the current issue of *QST*, and finally traced the cause to page 88. No, it wasn't the smell of ink. . . .

— Jim Shearer, W9JRN

(Continued on page 84)



OPERATING NEWS

F. E. HANDY, WIBDI, Communications Mgr.

E. L. BATTEY, WIUE, Asst. Communications Mgr.

Harmonics, check for them to-day, please. The F.C.C. quite properly requires that amateur stations, like other classes of stations, reduce or eliminate harmonic emissions and other spurious radiations, in accordance with good engineering practice, to prevent interference on any other than the normal transmission frequency. This past season all too many interference complaints have reached A.R.R.L. Hq. from the Airways, A.T.&T. monitoring station, Tropical Radio, and others. *Harmonic interference* is the chief difficulty, and *right now*, in the period or season of less intensive schedule keeping and general operating, therefore, is suggested as an excellent time to go over every amateur transmitter with attention to voltages, adjustments, and harmonic content, to remedy any such condition as may be detrimental to your standing or the amateur service. There's a good possibility you may find a way to increase the effectiveness of that transmitter on the fundamental frequency, too!

Examination of some of the interference case histories, at once discloses that the trouble is not confined to any one band, and that harmonics as high as the fourth from our lowest frequency band are sometimes responsible. Some of the stations and agencies needing our cooperation and assistance in reduction of harmonic interference can be listed, as of interest: LSN6, 21,020 kcs.; TSA, 21,080 kcs.; WKK, 21,420 kcs.; WNB, 10,675 kcs.; OCI2, 10,970 kcs.; GBW, 14,440 kcs.; TYE4, 7,654 kcs. On this latter circuit, the fourth harmonics of 160-meter phones have been noted, while third harmonics are the most troublesome to services using the 10- to 12-Mc. frequencies. Ten amateurs, whose harmonics are improperly strong and fall *near* specified channels, may be logged for every one that lands squarely on a public service channel. There is sometimes trouble on the 6905 kc. ship-shore radiotelephone frequency. CKCY's operator wrote us of his serious difficulty trying to copy press through 3.9-Mc. 'phone harmonics. Likewise Tropical Radio protested a "9" second harmonic breaking its 14,578 kc. (TGA7) circuit. Most serious practical possibilities reside in the interference caused by harmonics that fall on the *Airways Channels*, since these carry vital life giving signal direction and weather information reports for aviators. The 3rd harmonic of 1.8-Mc. stations, which falls in 5.5-5.7-Mc. Airways assignments, is usually the trouble.

A.R.R.L. Official Observers have for some months been hard at work on this problem of monitoring the harmonic shadows of all our bands, and advising amateurs by warning postal cards or radio notices, to keep the faulty transmitters from getting someone in a serious jam. In addition to using wire service and mail, the League Hq. station, WIAW, has been called upon a number of times to drop all other program services, and go to some special frequency to look for an amateur station that has been reported, but that cannot be reached immediately by long distance telephone or other means, and we have got results in a matter of minutes in some of these cases, too. We want to ask *all* amateurs not only to check their own transmitters, but to do some listening in the harmonic shadows, and then start a message or a postal to any hams heard as a friendly tip to look into transmitter adjustments and antenna coupling schemes. We want more Official Observers appointed for regular work, to insure increased self-policing and help on this problem, too. If you can assist, drop a line to your S.C.M. telling about your equipment, especially if you have a 100-kc. standard, such as necessary for precision measurements, and required of observers who undertake such.

Our main point: Let's make our transmitters better! Balance the P.P. stages, reduce excessive bias and plate voltages, and shift coupling schemes to reduce radiation on frequencies that hurt amateurs. Some of us will find that the absorption type wavemeter will show up harmonic energy. With low power sets, actual test with stations at the right distance to receive the harmonic favorably (if there is one) will be best. Tube efficiency is something to desire in moderation, but to eliminate harmonics and put all the energy into the fundamental radiation is still more important! Please check harmonics, and help other hams do the same. Tku.

56- and 112-Mc. go to town: The five-meter band week-end tests, announced in May *QST*, turned out to be most successful. As reported elsewhere in these columns, there was DX in plenty for 56-60-Mc. workers. As we write this report at the end of May, it appears that good DX work was not confined to the week-ends by any means, and this year will show another fine record of accomplishments. The five-meter band is coming back into its old popularity, and with the better, stabilized transmitters, new

communication records are being made daily.

Regular eighty-mile, two-way DX work is the latest confirmed operating accomplishment, and the high point of the season's u.h.f. operations reported to us to date. For the last two weeks of May, WISS at Arlington, Mass., and W1BBM at North Harwich, Mass., have kept up two way tests with entire reliability, using the two and one-half meter band, S8 signal reports being common with power as low as 15 watts. We want to encourage more scheduled tests between all amateur stations for purposes of definite experimentation. Such work always adds to knowledge of what may be expected, and checks the theories and records of transmission phenomena, as well. This year seems to offer unusually excellent opportunities to all amateurs to get started on the way to new ultra high frequency successes on 2½ as well as 5 meters. Let us use those bands to the utmost!

— F. E. H.

PRIZES FOR BEST ARTICLE

The article by Mr. Frederick H. Schnell, W9UZ * wins the C.D. article contest prize this month. Each month we print the most interesting and valuable article received marked "for the C.D. contest." Contributions may be on any phase of amateur operating or communication activity (DX, 'phone, traffic, rag-chewing, clubs, fraternalism, etc.) which adds constructively to amateur organization work. Prize winners may select a 1938 bound *Handbook, QST, Binder* and League Emblem, six logs, eight pads radiogram blanks, DX Map and three pads or any other combination of A.R.R.L. supplies of equivalent value. Try your luck. Send your contribution to-day!

How to Become a 1st Class "Lid"

BY FREDERICK H. SCHNELL,
W9UZ*

THESE hints may be of help to a number of holders of amateur radio licenses, but many won't need any hints. They are going along top speed, some of them. Like all things where the physical objective must be motivated by positive reaction of the brain (if any), certain coordination is desirable. To attain proficiency without undue delay, something approaching perfection in coordination may be accomplished by auto-suggestion. This has been known to help in certain cases. These suggestions, then, are contemplated with that thought in mind. It is to be assumed, of course, that a complete transmitter and receiver are at hand — no matter how haywire, in fact, the more haywire, the better, perhaps.

1. The very instant you sit down to do some brass-pounding or bug-wiggling, shove the transmitter on the air and start calling CQ. Call nearly as fast as you can, but give yourself time enough to get warmed up. Whether your transmitter frequency is in the amateur band — well, why bother about that? Let the FCC check it for you — why should you be bothered with a frequency meter! Getting a love note in pink or green from the FCC — that is a special distinction, don't you think — or, don't you? Call CQ at least 39 times before you sign a call and then sign your own; that is, if you can. Sign just once. You see, you save a lot of time this way.

*4915 N. Sawyer Ave., Chicago, Ill.

While you have been calling CQ, your receiver has been warming up. Good idea, eh?

2. Then listen for 3 or 4 seconds, not longer, because you want to keep that ole transmitter warmed up. You probably won't hear anybody calling you but don't let it get you down. Didn't know that, did you? S-O-o-o —

3. Start calling CQ again. This time mix (mix, not mess) it up so there will be plenty of variety. Variety, yea, that'll get 'em. Make CQ sound like N N G T and K W A or any other combination, just so there won't be two CQ's that sound alike. Increase the tempo, too. Call 57 times, but this time when you sign (just once as usual) really pour it on.

4. Listen again. If you don't get an answer to the variety call, maybe the fuses are weak in your 110-volt line. Put in new ones and jam more power into the final. Take the weights off the bug and throw them down the sewer — how can a guy send with a bunch of weights on a bug, anyway? Open up those contacts on the dot side of the bug so they will be very chippy. With more power in the final, you can't make those dots too long and run a chance of blowing fuses.

5. Now give 'er the oil and gas this time. With more power in the final and the weights off the bug, boy, that ought to mow 'em down, especially when you call 146 times before signing. Just about the time you have called CQ 116 times, they'll be itching to find out who you are — they'll be sitting with their ears glued to the cans, and how! But don't you let them get wise — sign your own call (just once as usual), but sign it so even you yourself can't read it. That's the stuff!

6. So, back to the receiver and if by chance somebody does answer you, go back at the guy at least five times as fast as he can take it and six times as fast as you can send — for your own enjoyment. That slays 'em. Dish out a RST 599X plus, even if you can barely hear him. Then if he gives you only RST 599, you tell him about the weather (at least twice) "hr in Sleepy Hollow" and give him the dope on your rig. When you dish it up twice, it will make him think you suspect he is holding out on a signal report, if he gives you only RST 599 — you kinda make him ashamed of himself too. Then toss in a chain-lightning 73, and SK. The guy at the other end will think you are some big shot.

7. When you are working a guy (if ever) who is sending faster than you can copy (if that is possible), never tell him to QRS. He'll think you are a lid and you aren't yet, you know. Give him QRN or QRM or anything but QRS.

8. Always start your QSO by giving the guy at the other end a long line of flapdoodle about your weather, even though he is a thousand miles away and whether he is interested or not. Knock it into his cans — never mind what he likes. Give it to him no matter how punk his receiving conditions are. It isn't your fault if he is bothered with a number of those things which can make for rotten reception, is it?

9. Remember — it is more noble to give than to receive.

10. If the foregoing hints don't help to make a 1st class lid, nothing will. Then some circuit is out of resonance between the brain (or no brain can be found) and the wrist, hand and fingers. In that case, shift and use the left foot on the key.

— . . . —

BRIEF

KA-NA-DA-HI Expedition

During the approximate dates of July 6th to July 26th, station W2JQB will be operated portable from the Chuska Mountains in the northeastern section of Arizona. Operation will be in conjunction with a small expedition, whose object is to explore the area in search of the ruins of ancient Indian cliff dwellings, and to map the location of any sites discovered, for future archaeological study. The transmitter will be used primarily to act as communication in case any emergency should arise. A small amount of traffic will also be handled. Since the rig will probably have to be back-packed a considerable distance, very low power must be used. Most used frequencies will be 3506, 3684, 7012 and 7255 kc. Calls from anyone hearing W2JQB/6 will be greatly appreciated, and QSL's sent to all who handle traffic will consist of an attractive enlarged photograph of the section being explored.

56 MC. OPEN FOR DX

For the fifth consecutive year 56 Mc. opened for some good DX contacts during the month of May. Special weekend periods, in which to concentrate on 5-meter DX work, had been announced, but the band for the most part picked other days to come through. Many excellent contacts have been reported, which we will enumerate by dates.

May 4th: W5AJG, Dallas, Texas, reported 56 Mc. open from 9:00 A.M. until noon, CST, with FB results. He worked W8IEF, Ohio, and W8NZ, W8SLU and W8CVQ, Michigan. All five stations were in contact for three hours. W5AJG runs 50-watts input, c.e. on 57.5 Mc., and uses 1851-6J8G converter. His antenna used for both transmitting and receiving on these contacts was a 14-Mc. 8JK, 70 feet high. **May 8th:** W3BYF, Allentown, Pa., worked W4EDD (phone) at 9:00 p.m. EDST, and also worked W2CUZ (c.w.) Yonkers, N. Y. From 11:15 to 11:45 p.m. he heard W8SLU and W8RV on c.w. Heard on 'phone by W3BYF were W1HDQ, W2JCY, W2ISY, W2KLV and W3AIR. BYF is using 75-watts input. Antenna is a single section 8JK vertical, rotatable, fed with Bassett cable. **May 12th:** The band was open at Dallas for about fifteen minutes, 12:45 to 1:00 p.m. CST and W5AJG worked W8TGT, S9, and heard W8NED on c.w. W3GSX reported W5AJG heard at 12:45 p.m. CST. **May 14th:** W1LLL, Hartford, Conn., reports contacts taking place between W1 and W9 from 11:55 A.M. until about 12:15 p.m. EDST, with W9ARN working W1HDF; W9ZHB working W1DEI; and W9LVN working W2ISY. At 1:12 p.m. EDST W1LLL's CQ was answered by W9WDA, Duluth, Minn. This QSO lasted for twenty minutes. W9WDA also heard W1EER, W1LLL runs 65 watts to a pair of 6L6's and has a Q antenna. Receiver is Skyriider 5-10. W9WDA runs 200 watts to P.P. 35T's. Antenna is vertical $\frac{1}{2}$ -wave J, receiver SX16-DM36 exp.

May 15th: This was apparently the biggest day of the month. W9GGH, Kenosha, Wis., reports as follows: "First station heard here was W1KTV testing at about 4:45 p.m. CST. Later at 5:15 p.m. the band was really open and stations were coming through in fine shape. At first the stations were located in the North Atlantic states and as time went by we heard stations farther south until, when the band closed at 7:15 p.m., we heard mostly stations around Washington, D. C., and Virginia. It sure was great while it lasted. I worked the following: W1LSN, W1DEI, W1JRY, W1JPM, W1GRV, W1LLL, W1SI, W2AMJ, W5CSU (portable at Cambridge, Mass.), W1KGE, W3GQS, W1COS, W2GPO, W3DI, W3BYF, W3FQS, W3DBC and W3RL. Since that time (up to May 25) I have worked W9VHG, W9ZUL, W9MQM, W9TVT and W8CVQ. We have found that we can work stations to the south as far as Chicago (51 miles) and to the east to Kalamazoo, Mich. We are keeping a schedule with W9VHG, Glenview, Ill., daily, and so far have had no miss. We are trying to see what different conditions do to our signals. On May 18th we had a four-city QSO consisting of Chicago, W9MQM; Wilmette, Ill., W9ZUL; Glenview, Ill., W9VHG; Kenosha, Wis., W9LVK and W9GGH. The contact lasted for over two hours and at one time W9UDO, Union, Ill., was also in the party. We are getting more of a kick out of 56 Mc. these days." During the work on May 15th W9GGH was running about 30 watts to an 807. He has a 3-element beam, which is used for both receiving and transmitting. Receiver is a 5-meter super. W9GGH is of the opinion that greater use of good receivers would improve the every day capabilities of 56 Mc.

Also on the 15th, W1EHT, Stoneham, Mass., between 7:30 and 9:30 p.m. Eastern Time, worked W8SCS (c.w. RST 589) and W9MIW (phone S7-9), and heard W8CBQ, W8NZ, W9ANA, W9ARN, W9AHZ, W9GGH, W9EMF, W9RGH, W9SWE, W9VHG, W9ZHB and W9ZUL. His receiver is National HFC into FBXA with preselector and Lamb silencer; transmitter, RK34 final, 40-watts input; antenna, 2 $\frac{1}{2}$ waves in phase, vertical, W1HUV, Winchester, Mass., worked W9FQE (7:47 p.m. EDST), W8NZ (8 p.m.), and W9ARN (8:10 p.m.), and heard W9UUI, W8CVQ and W9ZHB. W8JLQ, Holland, Ohio, heard W4EDD, Miami, Fla., between 7:10 and 7:30 p.m. EST. W9VMA, Belleville, Ill., heard W1SI, W8JHW, W1YT and W1DEI from 5:50

to 6:45 p.m. Central Time; W3's and W2's were too weak to identify; others were S7 to 9. W9TCX, Belleville, Ill., worked W1DEI using about 10-watts input, c.e. W8OKC, Shamokin, Pa., heard W9ZHB, W9VHG, W9SQE and W8CVQ, all S6-7 peaks, from 7:00 to 7:46 p.m. EST. Between 5:50 and 7:20 p.m. CST W9WDA, Duluth, worked W2HWX, W3FQS, W3EZM, W3BMT, W3HDC, W3RL, W3DBC, W3HJQ, W8RUE and W8CLS. W8CLS was also contacted again at 7:57 p.m. W1LLL, Hartford, worked W9GGH, W9ANA, W9LVK, W9MQM, W9SQE and W8TCX, in the period 6:20-7:40 p.m. EST. Between 8:00 and 9:30 p.m. EDST, W3BYF worked W9ZUL, W8NZ, W9GGH, W9RGH and W9ARN, and heard W9ANA (c.w.), W9LVK, W9ZHB and W9AHZ. W1KJC raised W9UOV at 8:00 p.m., EDST. John Fitzpatrick of Port Reading, N. J., logged W9ZHB, W9GGH and W9RGH, all at about 8:30 p.m. EDST.

May 16th: W1LLL reports three W4's working through FB from 5:15 to 8:40 p.m. EDST. W4EDD and W4DRZ, both in Florida, were worked by W1LLL. These W4's were heard working W1's, 2's, 3's and 8's. W4FBH, Georgia, was also coming through. W1HUV heard W4EDD at 7:03 p.m. EDST. W8OKC logged W4DRZ from 6:00 to 6:45 p.m. EST, with S6 peaks. W3BYF worked W4DRZ and heard W4EDD, W4FLH, W4FDH and W4AUA (c.w.), from 7:00 to 9:30 p.m. EDST. W8JLQ reported hearing W4EDD and W4DRZ between 7:27 and 8:50 p.m. EST. **May 24th:** W1KJC, Hartford, Conn., worked W4EDD (6:40 p.m. EDST) and W4DRZ (6:50 p.m.), with husky signal strength all around. VE3DC heard W8AGU, Penfield, N. Y., at 7:55 p.m. EDST. **May 25th:** W1LLL worked W4EDD and W4DRZ. These stations were coming through well and were workable from about 5:25 until 8:00 p.m. EST. VE3DC logged W8RV (10:25 p.m. EDST) and W8FQS (10:40 p.m.), Buffalo, N. Y., and Niagara Falls, N. Y., respectively. **May 26th:** W6DNS, San Diego, reports W5AJG's l.c.w. test signals heard at 10:10 A.M. CST. W5AJG worked W4EDD at 6:45 p.m. CST. VE3DC heard W4FLH (6:05 p.m. EDST), W4DR working W8PAT (6:23 p.m.), W8FQS working W8SOE (10:00 p.m.) and W8RV (10:30 p.m.). W1LLL heard W4DRZ and W4FLH from 5:30 to 5:50 p.m. EST. **May 28th:** Between 2:45 and 3:15 p.m. CST W5AJG worked W8TGT, W8QFX, W8CIR, W8VO and W8QA, all S9 signals. **May 29th:** The band opened for a few minutes this date, W5AJG working W8NOR, Tonowanda, N. Y., at 7:25 p.m. CST.

It appears that a banner year is in store for the 56-Mc. gang. Don't fail to get in on the fun! Consistent operation and regular schedules maintained on this band will bring best results. Please report on all DX heard or worked. W3BYF urges more use of c.w., which he maintains is more easily copied through severe auto ignition, etc. He has heard many carriers, obviously originating at DX points, but has been unable to distinguish the voice. A little more use of the keys might be in order. Number One pest on 56 Mc., especially during periods when DX is coming through, is the "CQ DX" hound. Keep your calls of a reasonable length, gang, lest you spoil the band for the rest! Let us hear of more of this type of 56-Mc. work!

W1HDQ, operating from Wilbraham Mt., has a daily sked with W2MO that is "sure-fire" and over a 140-mile path. During May stations in Kansas City, Washington, D. C., Virginia, Delaware, Baltimore and Philadelphia have been contacted.

2 $\frac{1}{2}$ Meters Perking Up

Results on 112 Mc. are definitely on the upturn. W1SS, Arlington, Mass., and W1BBM, North Harwich, Mass., are among the leaders in the development of this band, maintaining regular schedules for observations to improve antennae and equipment. Their schedules started when W1SS' signals were reported heard by W1BBM on May 1st. W1SS went to work and built a Yagi beam and a rig using a pair of HK24's with 125-watts input. W1BBM uses 15 watts to a 6J5G; his antenna is highly directional with parabolic reflector. The distance between SS and BBM is approximately 80 miles. Contact was established on May 21st, lasting from 7:30 until 10:15 p.m. when they signed. They also QSO'd a week previously. Out of 28 nights on schedule, W1BBM

heard W1SS 22 nights, W1SS heard W1BBM 16 nights. Contact was established on four nights, with S8 signals both ways.

On June 1st W1JUN, West Warwick, R. I., maintained a 100 per cent contact with W1BBM, a distance of 74 miles, from 10:45 p.m. until midnight, S8 at both ends. W1JUN runs 100 watts to a pair of 801's. His antenna is a matched impedance, 4 or 5 feet off the ground, and indoors; elevation, 120 feet above sea level. On the same night W1BBM also worked W1LEM, Boston. 65 miles distant. W1LEM is running 14-watts input, W1JUN consistently hears and works a dozen or more stations in Providence, R. I., 8 miles north, and several in Fall River, Mass., namely W1BOO, W1CRN, W1JCD and W1IVA. He has worked about 20 stations on 2½. On May 26th W1LEM worked W1JQA, North Randolph, Mass. W1BBM has heard W1JQA and W1LSR, both 65 miles distant and has been reported by W1EYR, about 70 miles away. W1SS (Arlington, Mass.) worked W1JUN (R. I.) at 11:00 p.m., June 2nd.

W2VJ and W2JRG, both of Eastchester, N. Y., are constructing 7-element Yagi arrays for 112 Mc. and are also putting rigs in their autos for extensive tests through the summer months. W2KZP, St. Albans, L. I., N. Y., reports on activities in his area. He has worked W2TY, W2KYT, W2KDB, W2LQD, W2TP, W2KXC, W2LFL, W2MFJ, W2EPD and W2LLR, all within about 7 miles, and W2BZB, Palisade, N. J., about 15 miles. Other active stations are W2JXS, W2JRL and W2LJJ. W2KZP runs 50 watts to P.P. HY40's. W3HVH and W3IBB of Philadelphia are interested in arranging schedules for two-way DX contacts on 112 Mc. Those interested are requested to write W3IBB, stating what type of equipment is available and what time of day or evening would be convenient. Address Bob Freeburger, 1229 S. 54th St., W. Philadelphia, Pa. W3EX, W3DSP, W3GXR, W3HHI and W3GRS are all actively



Frankford Radio Club Gang

Left to right; Front row: W3GYV, W3GHM, W3GET, W3KT, W3FOG. Center row: W3FRY, W3DVE, W3AGV, W3GHD, W3RR. Rear row: W3ENX, W3CHH, W3DMQ, W3FLH, W3ENH, W3BES. Other members, not shown in photo: W3EML, W3EON, W3GFG, W3HHS, W3GJY.

One of the most outstanding groups of operating amateurs, this gang, flying the Frankford Radio Club banner has been three-time winner of the club award in annual A.R.R.L. Sweepstakes and has placed second in both the Field Day and the DX Contest. On the F.R.C. roster are individual leaders in traffic and DX; holders of Public Service, WAS, A-1 Operator Club, WAC, DX Century Club, and other operating awards; O.R.S. and O.O. appointees; A.A.R.S. and N.C.R. personnel; and Emergency Corps members. It is not surprising to find that the president of this active club-group is well-known brass pounder W3BES! Vice-president is W3FRY, secretary W3CHH.

Brass Pounders' League

(April 16th-May 15th)

Call	Orig.	Del.	Rel.	Extra Del. Credit	Total
W7EBQ	0	0	1740	0	1740
W4PL	13	42	1637	34	1726
K6QUJ	949	132	526	0	1607
W2SC	31	184	1122	178	1535
W9QJL	60	143	923	134	1260
W8LUJ	129	344	282	337	1092
W6TOX	13	32	368	31	944
W5FDR	264	148	410	115	937
W8HUL	30	7	854	0	891
W9ZDZ	9	22	786	16	833
W8GZ	3	22	728	20	773
W1INU	50	41	668	0	759
W5DAQ	246	121	187	187	741
W9NPL	2	3	652	2	659
W9VS	5	75	463	58	604
W5CBZ	25	119	402	21	567
W3BWT	21	79	358	63	521
W5EOE	28	131	342	18	519
W4TR	8	85	366	59	518
W6PMV	31	35	420	28	514
W6LMD	7	4	487	3	501

MORE-THAN-ONE-OPERATOR STATIONS

Call	Orig.	Del.	Rel.	Extra Del. Credit	Total
KA1HR	889	504	516	0	1909
W5OW	180	210	1270	91	1751
W9ASF	501	1	0	0	502

These stations "make" the B.P.L. with total of 500 or over. One hundred deliveries + Ex. Del. Credits also rate B.P.L. standing. The following one-operator stations make the B.P.L. on deliveries. Deliveries count.

W5MN, 386	W5BN, 180	W3GVZ, 110
W3QP, 274	W3BZE, 148	W1KH, 109
W6NLL, 263*	W8FUW, 148	W3GKO, 103
W9ESA, 242	W5BAM, 130	W1WV, 100
W3EML, 237	W9EDQ, 123	More-than-one-opr.
W2HMI, 236	W8LZE, 120	W1AW, 165
W5DKR, 222	W8QGD, 119	W9BNT, 123
W7APS, 185		

A.A.R.S.

WLTK (W9UHQ) made the B.P.L. on 100 deliveries.

MORE-THAN-ONE-OPERATOR STATIONS

Call	Orig.	Del.	Rel.	Extra Del. Credit	Total
W1M (W3CXL)	115	268	3095	95	3573
WLMA (W8YA)	20	18	468	15	511

A total of 500 or more or 100 deliveries Ex. D. Cr. will put you in line for a place in the B.P.L.

* March-April.

interested in 2½-meter work in the Philadelphia region. W9ZGD, Milwaukee, has worked two-way with W9JPU, Cedarburg, Wis., 14 miles. Let us hear of your progress on 112 Mc.

British 28-Mc. Tests

The Experimental Section of the R.S.G.B. is sponsoring a series of 28-Mc. Summer Tests from May 1st to September 17th. British stations will transmit at the following times using phone and c.w.: Mondays, 1230, 1330, 1500, 1800; Tuesdays, 1230, 1330, 1500, 1800, 2000; Wednesdays, 1330, 1830; Thursdays, 1230, 1330, 1500, 1800, 2200; Fridays, 1230, 1330, 1500, 1800, 2000; Saturdays, 1400, 1600, 1800, 2000; Sundays, 1000, 1200, 1400, 1600, 1800, 2200. All times are Greenwich. Procedure at the times listed will consist of a 3-minute call, 3-minute listening period, 3-minute call, 3-minute listening period, 12 minutes from start to finish. If no contact is established. Phone stations are requested to reply to c.w. test calls and vice versa. Among other active British stations will be G2MQ, G5BM, G5ZT, G6KS and G8SA. Support is requested from stations all over the world. Reports should be sent to L. F. Coursey, Christ Church Village, Cheltenham Spa., Gloucestershire, England.

W5ZG, Galveston, was QSO W9EKY, St. Louis, and his memory wandered back some 17 years. "How'd you like to have one of my special QSL cards?" he asked of W9EKY. "Yep" was the reply, and several days later EKY received back the card he had sent 5ZG in 1922!



HOW:

HAVE you been having trouble raising DX, even though you have a good antenna, fair power, good receiver, passable e.c.o. and a certain amount of patience? If you have, then it simply shows that your methods of attack are old-fashioned. We don't take any credit for the new approach to the subject — our only part in it is the pride with which we present this brain-child of a brilliant mind.

Nor does the credit go to W9V DX, who tells us about it, other than that he was a keen-enough observer to recognize the true merit of the procedure. However, that in itself is enough to earn him a permanent niche in the Hall of Fame.

The real hero of the story is the W2 whom W9V DX overheard calling YV5AK one afternoon. This W2 was using standard operating procedure, i.e., he was calling on the YV's frequency. The fact that that frequency was 15 kc. outside the high end of 20 isn't anything to an intrepid soul like our friend the W2, as you all know. However, after staying with the YV for a half hour with no luck in raising him, the W2 decided that these old methods were no longer effective enough for one such as he and, before you could say "Please QSL" there was K7AEP, same frequency, fist and tone as the W2, calling YV5AK. Naturally, he raised the YV first call. The QSO was very exciting for both stations; YV5AK eager to extract a promise of QSL, and the Long Island K7 anxious to get the YV to listen for "his friend, W2. . . ." So, the next station the YV worked was our ingenious W2 friend, and ON4AU was left holding the bag, because he opened up on the K7 as soon as the QSO was finished!

See how old-fashioned we've been? What we need, fellows, is a new approach, a new slant on the whole scene. You know, the kind of improvement over our old methods that shooting fish in a barrel is over catching them in their native haunts with light rod and tackle. Nuts!

WHERE:

DON'T pass up **VS6BF** (14,135) for just another VS6. That's the call being used by the *Pang-Jin*, bound from Hong Kong to the World's Fair in New York. Of course it won't give you a country for the CC, but they have been stopping at some nice places that will furnish a check on your signal, and they're anxious to keep in touch with this country. . . . You wouldn't think anyone would take URAK9 seriously, would you? Particularly after he tells everyone that he's on Dog Island. We wouldn't even mention the phoney except for the fact that one fellow, among the bunch that has been taking him seriously, found that there is a "Dog Island," located below the Marquesas and more often called "Pukapuka." Of course, it depends on how you pronounce your "u's" Even W1TW and W2KL, who worked him, don't hold out much hope for ZA2X (14,430). HB9J told us that he'd never known of a legit ZA PX2B (14,415) is in the same category. That is, HB9J says they've never found a legit PX. . . . That **VQ6SS** we mentioned last month has also signed FL8SS and ST6SS but was on a boat at the time, according to W8CRA. His frequency is around 14,330 G6RH and W1BOD both worked **ZB2B** (14,140 phone and c.w.), who gives his address as P. O. Box 201, Gibraltar. He's quite OK, although we have always understood that they are plenty tough on hams over there. . . . Dope on the Pacific islands, from W2GT, W6DOB and W6KUT: **KB6LIT** (14,360 T9), Box 47 Agana, Guam; **KD6QH X** (14,375 T9), **KC6BVL** (14,370 T9), **KF6JEG** (14,375 T9) **PJ5EE** (14,325-14,410 T9) is quite OK, as are **PJ3CO**, **PJ1AF** and **PJ1RK** We wouldn't know about this VS5AD (14,425 and 7210 T9), reported by W3ZX and W5GZN, but he deserves an awfully big question mark. . . . W9TJ says **VS5AC** (14,275) is best around

14 GT, and **VS4JS** (14,310) is in around 14 GT. . . . Bill has the address of **U5YH** (14,410) as Wladimir Menialo, Sowetscaia 25, Kertch, Crimea, U.S.S.R. . . . W4TO, W3KT and W8EUY have **ZC6RL** (14,335 T9), best at round 0230-0430 GT. . . . It looks like **VQ1TR** was a phoney; and the only active station there is a spark and crystal detector affair, with no ham rig near. However, **VQ3HJP** may take his vacation in Zanzibar, during July. . . . W2GVZ sent one of his SWAP ("sealed with a prayer") cards to Y15CR (14,410 T8), worked at 8:30 p.m. . . . **VK9VG** says all **VK9** cards can be forwarded by the New Guinea QSL Bureau, Box 2, Salamaua, New Guinea. . . . If you want to **QSL VK9RM** (14,300 T9) direct, shoot the card to R. B. Monfries, Bulolo, New Guinea, says W5DWO. . . . W8PCS helps those who have looked in vain for the QTH of **HK5JD** (7095) by giving it as P. O. Box 24, Palmira (Valle), Colombia. . . . No one ever heard that expedition that was going to Tristan da Cunha, did they? **W8IKE** tells us he was on a boat that stopped there (that is, within a few miles while the natives came aboard) and, in talking to the Minister there, found that the only radio gear on the island is a broken-down all-wave receiver. Guess we'll have to get the DX Expedition going again.

WHEN:

APPARENTLY it wasn't such a hot month for DX as months go. On 40, for example, about all there was to choose from was **VP1JR** (7290 T5) and **PJ3CO** (6990 T9) at W5GWD, **EA9L** (7300 T8) and **VP2SC** (7250 T7) at G6RH, and **KF6QM Q** (7240 T8) at W1LQS and W7GBW. . . . Of course there was also K6, ZL, VK, VP4, ON, FA, G, CT, VP7, SU, CF3, HC, HH, PY, SP, YR and HI, if you cared to look for it.

Things weren't much better on 20, although W4BPD heard stuff like **VS2AE** (14,380 T9), **PK1TT** (14,365 T9), **PK4KO** (14,380 T9), **XU8NR** (14,360 T8), **KA1SP** (14,395 T8) and **J8CA** (14,100 T9) in the morning between 6 and 8:30. . . . W9YFV didn't let it get him down either, and added **XU8MI** (14,350 T9), **KB6OCL** (14,250 T9), **KAILB** (14,250 T9), **VQ3TOM** (14,320 T7), **J8FJ** (14,410 T9) and **USCY** (14,430 T9) **CR4MM** and **CR4HT** (14,420-14,320 T7) are on around 18-23 GT. . . . Other stuff includes **FM8AA** (14,270 T8), **U2NE** (14,400 T9) at 03 GT, **VQ2HC** (14,380 T9), **OQ5AV** (14,300 T8c), **ZB1X** (14,360 T9), **VK4HN** (14,365 phone and c.w.) in Papua, **VQ3HJP** (14,415 T8) and **VK9RD** (14,350 T8)

WHAT:

AS WE see it, there are two kinds of troubles with an e.c.o. One comes from the way a fellow uses it, and if a fellow wants to be a rat let him be one. "If a fellow wants to be a rat, let him be one," we always say, sort of half-heartedly, recalling that peachy Pied Piper story and wishing there was another guy like the Piper available. The other trouble is with the kind of broken-down prehistoric signal the things put out, and that's a trouble that can be cured. So how about going after those chirpy, poopy jobs this summer, when the DX won't be quite so abundant? Lots of the trouble comes from bum r.f. returns, putting the e.c.o. above ground. If you get a rough signal when you tie the transmitter on, even though the thing is p.d.c. when by itself, look to the grounds. Try grounding the link that runs from the e.c.o. unit to the rig instead of floating it as many do. Also, try grounding the link both to the e.c.o. and to the transmitter proper. If you still get a rough note after trying everything you and your friends suggest, try burying the e.c.o. under about four feet of soil (it doesn't matter much what kind but dark, rich loam is best) and going back to crystal. That really works.

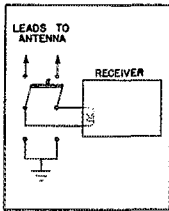

WE SAW a receiver the other day in which the antenna coil had been burned up with unusual thoroughness. We will not mention which of our receivers it was, for other receivers take similar punishment every day, with similar results. We will spare the feelings of the amateur whose set it was, for many amateurs do the same thing unwittingly.

This particular receiver was in a station which used the same antenna for both transmission and reception. The changeover was made by a relay mounted on the wall close to the lead-in bushings. The leads from relay to receiver were long enough to act as a half-wave antenna (8 feet is enough on ten meters), and judging from results they must have picked up plenty of power during transmissions.

From the letters we receive, we know that damage to receivers during transmissions is not at all uncommon. In Number 1 of *QST's* "How Would You Do It" Contest, Our Hero was presented with a number of solutions to this problem. However, all of the schemes were aimed at protecting the first RF tube, not the input circuit. This is OK for low powered rigs, but we have seen enough charred coils to know that it is not the answer when high power is used. As a matter of fact, devices to protect the RF tube actually make the input circuit take more punishment, since higher voltages are built up when the loading due to tube losses is removed.

Unfortunately, we know of no simple way to cure this trouble. A relay or switch connected as shown in the diagram, and mounted close to the antenna terminals of the receiver, is quite effective. This disconnects both leads, and grounds both input terminals. Neon lamps and the like connected across the input are not very much good. They reduce the efficiency of the antenna and do not give much protection. Ten to twenty volts is required to fire even the special low voltage types, and trouble begins at lower voltages than this. Of course, careful location of antennas, leads and equipment will reduce pickup. But whatever precautions you take, do not rely on smelling smoke. If you have any doubts, measure the input current. It should not exceed about 100 MA.

On page 78 of this issue, you will find an advertisement on a new RF choke. It is similar in electrical characteristics to the R-100, but is designed to mount on the chassis and has terminals instead of leads. These terminals are actually cotter pins. They work fine, but are not very beautiful. We have had a lively discussion about them here, some of us feeling that they were not fancy enough. We finally decided that since we were in the business of making gear for amateurs, and intended to stay in it, we might as well let our customers decide. So if you do not like cotter pins, let us know.

Incidentally, the safety scheme we described last month for putting meters in the grounded parts of circuits has an additional advantage. In case of insulation failure, the short circuit current does not pass through the meter in most cases. We are told that this is swell. Apparently some amateurs are more enthusiastic over schemes to prevent meter burn-outs than they are over ways to prevent operator burn-outs. Well, it is all in a good cause.

EUGENE SIMMS



Have you sent for your copy of the new

P. R. MALLORY & CO. Inc.
MALLORY
Vibrapack
Booklet?



It's FREE!

Coincident with Mallory's announcement of 3 new Vibrapacks is this new and complete Vibrapack booklet. It's yours absolutely free . . . but you'll find it invaluable for your own use, or for service requirements.

Complete Technical and Installation Data

This new 8 page booklet contains complete descriptions of all Mallory Vibrapacks, with application suggestions, technical data and full installation instructions.

Here's everything there is to know about these outstanding power supplies for portable and mobile transmitters, receivers and other systems where commercial AC current is not available. Get your copy from your Mallory-Yaxley Distributor or send to us for your copy now!

P. R. MALLORY & CO., Inc.
INDIANAPOLIS INDIANA
 Cable Address — PELMALLO

Use
P. R. MALLORY & CO. Inc.
MALLORY
 APPROVED RADIO
 PRECISION PRODUCTS

Use
YAXLEY
 APPROVED RADIO
 PRECISION PRODUCTS

'PHONE:

We were kidding last month that 'phone men don't work any DX, thinking we might get a few reports from them that way, but we didn't. We didn't realize that we were quite close to the truth — apparently they don't work any DX Except possibly W4BPD, who brings home stuff like **CR7AU** (14,255), **CP1AA** (14,285), **EK1AF** (14,090) and **SV1CA** (14,160). **XU8AH** (14,300) was heard Or **W6IKQ**, with **VK4BF** (14,300) in Papua, **K4KFC** (14,150, 14,250), **SM5SI** (14,285), **VP7NU** (14,120) and **T14JG** (14,250) **W6KR** worked **XU8KL** (14,025) and **XU7TH** (14,010), and heard **FN1C** (14,075) We can't leave out **W5AKZ** and **PK6OM** (14,150). He adds that **J2NG**, **J2MI**, **J2PU**, **J2KN** and **XU8AM** are good in the low end of 20 around 7-8:30 A.M., which is also a good time for the ZS stations coming the long way around We don't have the frequencies, but 'phone DX is good at W8LFE if you consider **VQ4ECJ**, **VQ2PL**, **ZE1JX**, **11IT**, **CT2BP**, **VU2BG**, **PK4JD**, **G6IA**, **VK9VG**, **VK9WL**, **V86AG**, **XZ2JB**, **FB8AH** and **FA3JY** good, which we do **ZD2EI** on 'phone is a phoney Stan Clarke, a Canadian SWL, does as well as any in logging **YR5AA** (14,020), **KA7HB** (14,290), **CX2CO** (14,060), **CE2BX** (14,275), **PK3WI** (14,040), **ES5D** (14,050), and a lot more.

WHO:

We're slipping badly. We might have guessed that **XX2JQ** was none other than **ZL2JQ**, en route to Europe to Calcutta. Incidentally, ask John to tell you some time about the time they broadcast his departure from this country on the *Queen Mary* — it was really something We recently received another QSO list from **YV2CU**, in case you've been waiting **VE2QO** thinks **F88AA** was a phoney because he didn't check on the beam. He hasn't kicked through with any word yet, so guess he was Some of the phoneys read this stuff, if the fellow that's signing **PH1Y** is any indication. And we had that one reserved for our own use! **W9TJ** recently sent out 1700 cards, covering 1938 and 1939-to-date activity It's rumored that **LZ1ID** QSL's only to stations that have QSL'd all the HB's they've worked. Which may be why you didn't get your card. . . . You may think you know what "TWA" stands for but, in radio circles, it has nothing to do with flying. It's the name of a club of three members: **W9HLE**, **W2CMY** and **W2JT**. Since they're the only W's who have worked **AC4YN**, they've formed the "Tibet Workers of America." It's very, very exclusive. (How well we know it!) **G6BY** pulled a stunt that's interesting. To celebrate his birthday, he started a serial number around the world, to see how long it would take. Each station handling the number added "1" to it, so when the number came back it was apparent how many stations had handled it. He first gave it to **W4OC**, who passed it on to **W6EQA**. Two hours and 55 minutes later he heard **F3IC** call "CQ London" and found that he had the serial number, seven numbers higher. **F3IC** had received it from a **YI** station **VU2PP** is a phoney in England, and **HB9BO** on 20 'phone is a phoney, the real **9BO** confining his activity to 80 meters **J2MI** is going to North New China this summer, and will try to get on in Mongolia (wherever that is), with the prefix "MZ" **ZS4U** needs North and South Dakota, Nebraska, Delaware and Nevada for that old familiar reason **HR7WC** is coming back to the States and, on good authority, will soon have those long-awaited cards in the mail. He'll probably be on from **W6** **W3DPA** (14,350) in Delaware claimed that Handbook that **G2MI** offered for his first Delaware QSL'd QSO **J8AA** and **TA1AA** look phoney **FQ8BS** (14,070, 14,300 T8) is old **F8BS**, the 28-Mc. expert If **W9TJ** can work a **YL** station in Africa, he'll have a **YL WAC**, what with **J2IX**, **G6YL**, **HC1FG**, **VK3HQ** and **VP6YB** already worked. Which reminds us of the time **W6QD** set out to make **WAC** of the dance halls in San Jose, Calif., one night. But, as usual, he spent all his time calling a red-headed **W9** from Iowa. That was before the present days of crystal control, of course **EL2A** will be off the air for a spell because of difficulties with the authorities, according to **W8PA**, but hopes to get back on again after the stir has died down. It might be wise not to even write to him right now because the "unusual" mail might be the last straw in jeopardizing his position If



HQ-120-X

variable

CRYSTAL FILTER

for

PHONE OR CW

DX

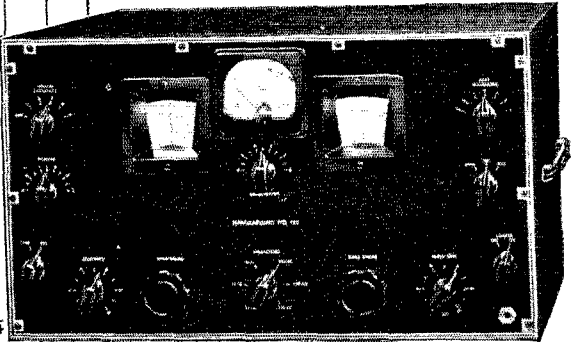
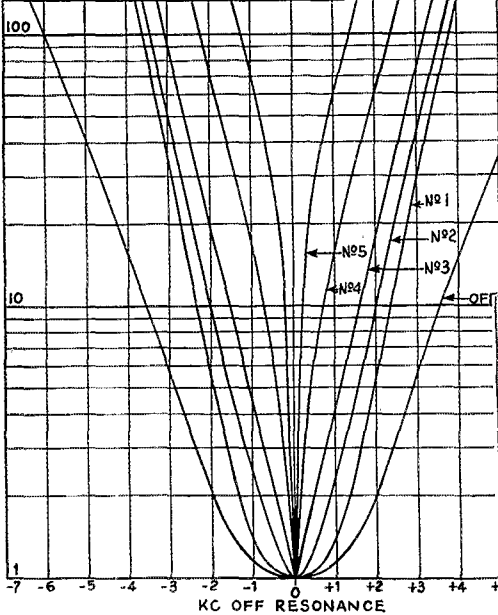

THE VARIABLE SELECTIVITY crystal filter used in the "HQ-120-X" is an exclusive Hammarlund development and will be found only in Hammarlund receivers. This crystal filter is unlike all others in that an entirely different principle is employed. This new system, originally developed in the Hammarlund laboratories, permits perfect control of selectivity and allows the operator to adjust the crystal filter circuit to conform with practically any given set of operating conditions. The actual selectivity characteristic for each position of the 6-point switch is shown in the illustration. By selecting the proper position of the switch, the operator is assured of the maximum fidelity obtainable without interference from other stations. The output of the crys-

tal filter remains constant throughout its selectivity range, the response curve is smooth, it is easy to adjust, and there is absolutely no interlocking of the controls. If you are interested in DX, phone or CW, try an "HQ-120-X" and note the smooth, unflinching performance of the crystal filter. You will also find the phone bands not half as crowded as they seem.

WRITE FOR BOOKLET

HAMMARLUND MFG. CO., INC.
424-438 W. 33rd St., N. Y. C.

Q-7-39

Please send 16-page booklet

Name.....

Address.....

City..... State.....



Canadian Office: 41 West Ave. No.,
Hamilton, Ont.

HAMMARLUND

Active

An active crystal is easily excited; it snaps into oscillation rapidly, faithfully follows keying, and has a high Q. All B5 40-meter Crystals have a high relative activity because they are accurately cut, precision lapped, individually finished to rigorous performance standards, and mounted in a correctly designed holder.

Accurate

Each B5 40-meter Unit is calibrated by reference to a primary standard of frequency. The measured value is stamped on the holder name-plate and is guaranteed to be correct within .03% in any standard oscillator circuit. Precise calibration assures frequency accuracy—low drift insures frequency stability.

Dependable

Rigid manufacturing standards and careful inspections are applied during every processing operation. As a final check for perfect crystal quality and the ability to withstand adverse operating conditions, each crystal is subjected to an exacting overload test. Dependable performance is built into B5 40-meter Crystal Units.

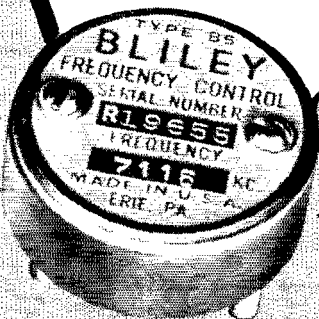

Price
40-Meters
+ 5 Kc.
\$4.80

BLILEY

B5 40-METER CRYSTAL UNIT

you didn't get your card from XU6MK, you might try another of yours to John Tan, College of Science and Engineering, Kwangsi University, Tafu Hsiang, Kueilin, Kwangsi, China, says W8PEN PZ1AB will probably get that transmitter that W4CCH is making, thanks to W8OQF, W4CEN, W8JAH, W4DCG, W8PTD, W8MCC and W8OXO, who all helped in the way that counts YS2LR, who is now definitely off the air and out of jail by the skin of his teeth, says that his call was bootlegged right after the 'Phone Contest, on 20 c.w. and 10 'phone. He further suggests that YS1FM, nominally designated as the QSL Manager down there, not be sent any more cards because he has been under police supervision for some time ZS3F finally came through with cards for all the lads, which confirms our faith in human nature If a rat is a dark-colored rodent with a long tail, and a skunk is a burrowing carnivore related to the weasel, how do you describe a roommate who shaves twice a day with an electric razor?

— W1JPE

— . . . —

W1AW Operating Schedule

JULY-AUGUST OPERATING-VISITING HOURS

7:00 P.M.-1:00 A.M. E.D.S.T. daily,¹ including Saturday-Sunday

ADDITIONAL VISITING HOURS²

1:00 P.M.-7:00 P.M. E.D.S.T. daily, except Saturday-Sunday

OFFICIAL BROADCAST SCHEDULE (for sending addressed information to all radio amateurs):

Frequencies

C.W.: 1762.5-3800-7280-14,254 kcs. (simultaneously)

	Starting Times (P.M.)				Speeds (W.P.M.)					
E.D.S.T.	C.D.S.T.	M.D.S.T.	P.D.S.T.	M	T	W	Th	F	Sat	Sun
8:30	7:30	6:30	5:30	20	15	25	15	20	--	20
Midnight	11:00	10:00	9:00	15	25	15	20	15	15	--

PHONE: 1806, 3950.5, 14,237 kcs.

Each code transmission will be followed in turn by voice transmission on each of the above frequencies.

GENERAL OPERATION:

Besides specific schedules in different bands W1AW devotes the following periods,¹ except Saturdays and Sundays, to GENERAL work in the following bands:

Band	Frequency	Time — Eastern Daylight
1.8 Mc.	1806-1762.5 kc. 'phone/c.w.	10:00-10:30 P.M.
3.5 Mc.	3800-kc. c.w.	8:00- 8:30 P.M.
3.9 Mc.	3950.5-kc. 'phone	9:30-10:00 P.M.
7 Mc.	7152/7280-kc. c.w.	11:00-11:59 P.M.
14 Mc.	14,254-kc. c.w.	7:30- 8:00 P.M.
14 Mc.	14,237-kc. 'phone	7:00- 7:30 P.M.

On Saturdays and Sundays operation is devoted to the most profitable use of bands for general contacts and to participation in special week-end operating activities. The station is not operated on legal national holidays.

Give W1AW a call for an accurate frequency measurement, to communicate with any department of A.R.R.L., to grab chew when time permits, or to pass a message to ham friends in other places or on other bands.

¹ Except for weeks of July 23rd-29th and Aug. 20th-26th.
² Except for week of July 2nd-8th.

— . . . —

BRIEFS

If you send a QSL card to W6USA following your QSO with the S. F. Fair station, you may be sure you will receive one in return. The operators say that all cards will be QSLed.

— . . . —

VE2BU believes in using all bands. In one day he kept five prearranged schedules on five bands, as follows: 6:30 A.M., W4FJR, 7296 kc.; 7:00 A.M., W1GKM, 3850 kc.; 5:00 P.M., VP6FO, 14,110 kc.; 6:45 P.M., VE2AX, 57092 kc.; 8:00 P.M., VE2KS, 28,546 kc.



*Have it
your own way but
have it the
long way*

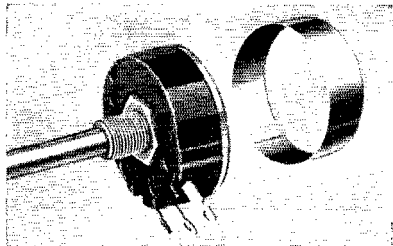

STANDARD RADIOHM

The old reliable "Standard" that is 1 3/8" in diameter . . . used wherever sufficient space for this control is available.

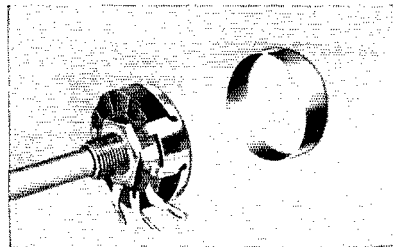

MIDGET RADIOHM

1 1/8" in diameter . . . this small size necessary for replacements in a great many modern sets.

Old Man Centralab is willing to be neutral as to your choice of Volume Control as long as you select one of his famous products . . . with the wall type resistor strip that hugs the inner circumference of the bakelite housing. Choose one of the Centralab family — STANDARD . . . MIDGET . . . or ADASHAFT . . . and be assured of

- Maximum resistor length for case diameter
- Close uniformity between resistors
- Accurate tapers
- Lower specific resistance and attendant low noise level
- Better power dissipation
- Longer life

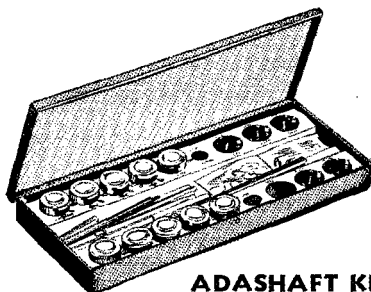

ADASHAFT KIT

Housed in metal box, hinged, contains ten Midget Radiohms, five types of attachable shafts, etc. . . . for more than 400 makes of receivers.

Centralab

Division of Globe-Union Inc., Milwaukee, Wisconsin

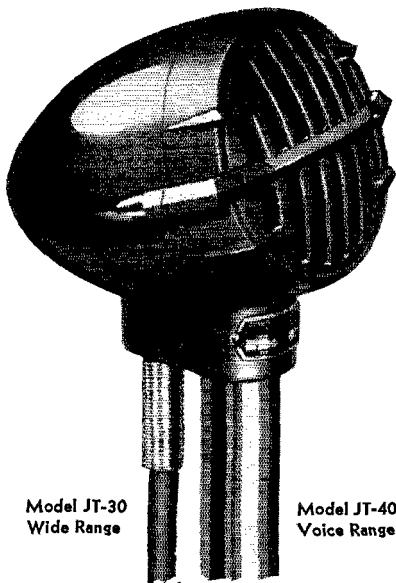

Model JT-30
Wide Range

Model JT-40
Voice Range

New JT-Series CRYSTAL MICROPHONES

*In Voice and Wide Range Models,
with or without Cable Connectors, at a
Popular Low Price*

Here is a new Astatic semi-directional crystal microphone for universal use, available in four models and three different finishes. The JT-Series embodies advanced ideas in construction and acoustical engineering that are destined to make this the microphone sensation of 1939. Standard equipment includes spring cable protector and 7-ft. shielded cable. Standard finish, opalescent gray.

LIST PRICE \$16.50

See your Astatic Jobber or write for literature



**ASTATIC MICROPHONE
LABORATORY, Inc.
YOUNGSTOWN, OHIO**

Licensed Under Brush Development Co. Patents

MEMBERS, DX CENTURY CLUB

G6WY (No. 5).... 144	W6FZL (No. 48).... 109
W8CRA (No. 1).... 140	W4CYU (No. 78).... 109
W6GRL (No. 15).... 139	W2BYP (No. 102).... 109
W2GZT (No. 12).... 138	W6HX (No. 21).... 108
W1SZ (No. 7).... 137	W8BKP (No. 65).... 108
W2GT (No. 32).... 136	W3DDM (No. 72).... 108
W1TW (No. 3).... 135	W3GAU (No. 96).... 108
W8DFH (No. 14).... 133	W1HX (No. 119).... 108
W6CXW (No. 4).... 132	W2JT (No. 131).... 108
G2ZQ (No. 6).... 132	W2AAL (No. 81).... 107
W6KIP (No. 28).... 131	W1DUK (No. 82).... 107
W1TS (No. 9).... 130	G5BJ (No. 93).... 107
W2GW (No. 11).... 130	G2DH (No. 101).... 107
ON4AU (No. 40).... 130	W9UM (No. 108).... 107
W8BTI (No. 56).... 129	W1ADM (No. 110).... 107
W3EMM (No. 58).... 129	G5BY (No. 118).... 107
G6RH (No. 36).... 127	VE2AX (No. 84).... 107
W8DHC (No. 27).... 126	G2TR (No. 83).... 106
W9ARL (No. 18).... 125	W1CH (No. 91).... 106
W9TJ (No. 67).... 125	W2CJM (No. 47).... 105
HB9J (No. 13).... 124	W4DRD (No. 94).... 105
W8OSL (No. 23).... 124	G5QY (No. 103).... 105
W1DF (No. 29).... 124	E1SF (No. 19).... 104
W5BB (No. 37).... 124	W1ZB (No. 62).... 104
W2BHW (No. 39).... 124	W2OA (No. 73).... 104
W1LZ (No. 10).... 123	W2CBO (No. 86).... 104
W2UK (No. 33).... 123	W3AG (No. 107).... 104
W4BPD (No. 70).... 123	W6FZY (No. 115).... 104
W1FH (No. 71).... 123	HB9BG (No. 12).... 104
W3EPV (No. 74).... 123	G6KP (No. 45).... 103
W2CMY (No. 68).... 122	W1AXA (No. 104).... 103
W8LEC (No. 25).... 121	W8KKG (No. 109).... 103
W2HHF (No. 54).... 121	VK2DG (No. 112).... 103
W3CHE (No. 87).... 121	W1BGY (No. 128).... 103
W8OQF (No. 30).... 120	ZS2X (No. 124).... 103
J5CC (No. 46).... 120	W4CBB (No. 20).... 102
W8ADG (No. 63).... 120	W1WV (No. 69).... 102
W8DWW (No. 17).... 119	W8NJP (No. 90).... 102
W1BUX (No. 2).... 118	F8RR (No. 98).... 102
W9KG (No. 16).... 118	W1FTR (No. 123).... 102
W5VY (No. 38).... 118	F8RJ (No. 8).... 101
W9ADN (No. 61).... 117	VK3KX (No. 57).... 101
W9PST (No. 35).... 116	W4AJX (No. 75).... 101
W3EVW (No. 55).... 116	W6DOB (No. 76).... 101
W9FS (No. 77).... 116	SUIWM (No. 89).... 101
W8JMP (No. 22).... 115	W8EUY (No. 97).... 101
W7AMX (No. 26).... 115	W1CC (No. 105).... 101
W6ADP (No. 34).... 115	SUI5G (No. 117).... 101
W9EF (No. 44).... 115	W3BES (No. 121).... 101
W2CTS (No. 52).... 115	J2JJ (No. 125).... 101
ZL1HY (No. 59).... 115	W5CUJ (No. 130).... 101
W1JPE (No. 66).... 115	VK3CX (No. 134).... 101
D4AFF (No. 99).... 115	W6AHZ (No. 140).... 101
W9GDH (No. 41).... 114	W1GCX (No. 142).... 101
W2GVZ (No. 80).... 113	W2DSB (No. 100).... 100
W8MTY (No. 129).... 113	G6NF (No. 105).... 100
W9KA (No. 42).... 112	W2AER (No. 111).... 100
W6GAL (No. 50).... 112	W6KRI (No. 113).... 100
W3EVT (No. 51).... 112	W6TJ (No. 114).... 100
W4CEN (No. 60).... 112	W9UQT (No. 116).... 100
W3FRY (No. 85).... 112	W8AU (No. 120).... 100
W2ZA (No. 88).... 112	W8OXO (No. 122).... 100
W9TB (No. 95).... 112	G6MK (No. 132).... 100
G5RV (No. 64).... 111	VE2EE (No. 133).... 100
W5KC (No. 92).... 111	W2BXA (No. 135).... 100
G6CL (No. 24).... 110	G2MI (No. 136).... 100
ON4UR (No. 31).... 110	W3BEN (No. 137).... 100
VK5WR (No. 49).... 11) 110	W81WI (No. 138).... 100
W3EDP (No. 53).... 110	VK2ADE (No. 139).... 100
W2DC (No. 79).... 110	W1GDY (No. 141).... 100
G5BD (No. 126).... 110	W8QXT (No. 143).... 100
PA0XF (No. 43).... 109	VE3QD (No. 144).... 100

The following have submitted proof of contact with 75-or-more countries: D3BMP, PA0QF, W6GHU, W9AJA, W9RCC 99; W1ZL, W4CCH 98; G6GH, W1RY, W8DID 97; W1BXC, W3BOX 96; F8BAJ, W1GNE, W2GRG, W2OP, W3GEH, W3KT 95; W8AAJ 94; PA0OZ, VK6SA, W3ZX, W6BAM, W6FKZ, W8BSF 93; G6XL, HB9CE, W2BMX, W5ASG 92; HB9X, W8CJ, W8QDU 91; G6YR, LU7AZ, W8AU, W4EQK, W8MVK, W8KTV, W9CWW 90; G2DZ, G2ZO, W3A0O, W3JM, W9RBJ 88; SP1AR, W2ALO, W3EMA, W9AEH 87; W3OP, W4DMB, W4MR, W6TT, W8IQB, W8JAH, W9FLH 86; W3FLH, W4CFD, W6GK, W8LAV 85; G8IG, SM6WL, W2CUQ, W3AGV, W8BWB, W9OVU 84; OZ7CC, W1EFT, W2AWF, W2BJ, W6GFP, W8BFG, W8BEZ 83; W1EWD 82; VE2CA, W6TUT, W9DAE 81; VK2TL, W2BNX, W3BVN, W8EPR, W8LDJ, W8AAT, W8DGP 80; SP1LE, W1AVK, W3AYS, W3GHD, W3JFC, W9MRW 79; W4TZ, W6AM, W8EUN 78; W1ICA, W9GMV 77; PA6JMW, W1BGC, W2FLG, W3BSB, W6DTB, W8LFE, W8LZK, W9PGB, ZL1L75; D3CSG, VK3HC, W4EPV, W40G, W9JDP 75. Radiotelephone: W4CYU 86; W2IXY 83.

W6USA

Automatic band switching

Built by Wunderlich Radio, Inc.,
South San Francisco, Calif., in
co-operation with Eimac engineers.

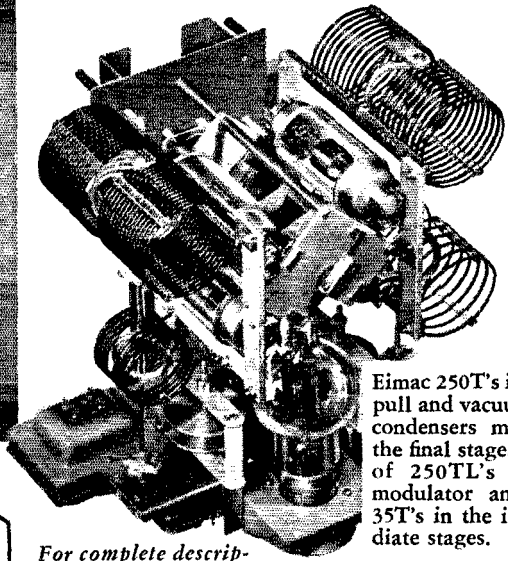

Eimac 250T's in push-pull and vacuum tank condensers make up the final stage. A pair of 250TL's in the modulator and four 35T's in the intermediate stages.

Final stage
4 complete
tank circuits

For complete description of this transmitter consult the June issue of "Radio."

Eimac tubes and vacuum condensers find their true expression in the sensational transmitter at radio station W6USA. Automatic band switching, extreme efficiency, and dependability in operation of this transmitter are a tribute to the superior characteristics of Eimac tubes — convincing proof that the vacuum tank condenser paves the way for drastic improve-

ment in the design of transmitting equipment.

All the skeptical amateur needs do to convince himself of these facts is to get a schedule with W6USA or, better yet, come to the Golden Gate International Exposition and operate this transmitter.

Auto-resonator

Eimac TUBES

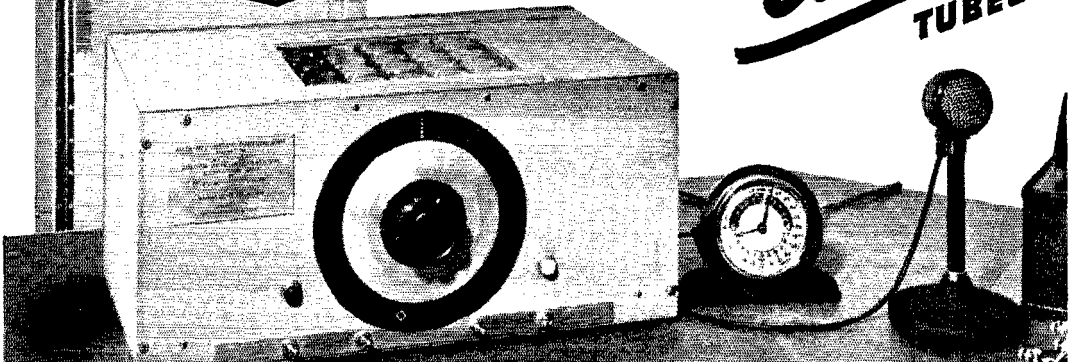

EITEL-McCULLOUGH, INC., San Bruno, California

April '39 O.R.S.-O.P.S. Parties

NEW LOW PRICES on CARDWELL 500 Watt Standard "XC" Types

In appreciation of your splendid acceptance of the "XC" series, CARDWELL has picked out the most popular condensers of the group, to offer to you at new low prices, made possible by their increased production to meet your demand.

Compare these outstanding values — check again these familiar specifications, and convince yourself that:

"IT PAYS TO BUY CARDWELL"

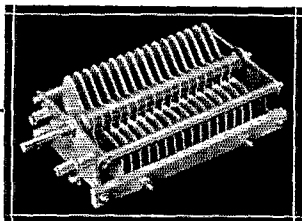

SINGLE SECTION

Type No.	Capacity	Old List	New List
XC-18-XS	18 mmfd.	\$5.50	\$4.50
XC-40-XS	40 mmfd.	7.50	6.50
XC-65-XS	65 mmfd.	9.50	8.50
XC-100-XS	100 mmfd.	11.50	10.50

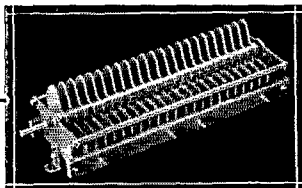

DUAL SECTION

Type No.	Capacity	Old List	New List
XC-40-XD	40-40	\$13.00	\$11.50
XC-75-XD	75-75	17.00	15.00

SPECIFICATIONS ON "XC" SERIES

MATERIALS — Frame rods, tie rods, spacers and stator blocks are nickel plated brass.

PLATES — .040" thick, non-corrosive aluminum, buffed and polished with rounded edges.

SHAFT — Cadmium plated steel, on which rotor assembly is securely locked.

BEARINGS — Long nicked brass shoulder bearing at front with integral serrated section which smoothly clasps shaft, insuring perfect contact to frame. Adjustable ball thrust bearing at rear with phosphor bronze split spring wiping against accurately machined rotor hub face.

AIRGAP — Entire "XC" Series has airgap of .200" and peak voltage rating per airgap, of 7250 volts.

INSULATION — New G.E. Mycalex No. 1364; the finest grade of H.F. insulation.

MOUNTING — All supplied with pillars and screws for panel mtg. as well as heavy N.P. brass mounting feet for chassis mounting.

**THE ALLEN D. CARDWELL
MANUFACTURING CORPORATION**
83 PROSPECT STREET, BROOKLYN, NEW YORK

W3BES continues to add to his victories, the latest being a fourth-time win in the quarterly O.R.S. Parties. He leads the April battle by a good margin. WITS lands in second place for the second consecutive time and appears to be "Jerry's" stiffest competition at the moment. Congratulations to the high ten and other high scorers listed below!

The XYL's seem to have the OM's on the run in the O.P.S. Parties. W2JZX (YF of W2JDG) led the January Party and now W2HXQ (YF of W2EOA) tops the list in the April doings, and she is 1350 points ahead of her nearest competitor at that! Nice work, gals! But you can't say the boys didn't try — there are some nice scores there. Keep fighting, men!

Official Relay Station Scores

Station	Score	Dfj. Stns.	Dfj. Sects.	Heard	(Watt) Power Input	Operating Time
W3BES	13,638,944	207	51	18	250/750	20 hrs.
WITS	10,780,207	189	52	7	350	16 hrs.
W3BKZ	7,953,660	170	50	13	—	18 hrs., 30 mins.
W3GZK	6,794,628	158	46	2	500-200	13 hrs., 12 mins.
W3DGM	6,454,000	157	43	40	—	20 hrs.
WILLX	6,391,318	156	41	14	80-700	17 hrs., 18 mins.
W3GJY	5,398,440	151	42	10	60	18 hrs., 45 mins.
W8JTT	5,560,480	139	45	—	150	13 hrs., 47 mins.
W4DWB	5,175,180	133	47	21	250	15 hrs., 5 mins.
W3GDI	4,747,776	132	44	20	—	16 hrs., 24 mins.

Station	Score	Stns.	Sects.	Station	Score	Stns.	Sects.
W4APU	4,498,800	115	48	W4AXP	2,188,220	95	39
W5FZD	3,961,075	110	45	W5K5C	2,154,600	92	43
W8RMH	3,986,028	125	38	W6GAC	2,134,660	71	39
VE3EF	3,858,702	123	44	W3EEV	2,044,383	83	40
W9TQD	3,773,475	107	48	W8SFF	2,028,372	81	41
W9NEP	3,580,752	127	41	W5BAM	1,528,200	76	44
W1UE	3,499,059	119	38	W4NC	1,518,155	79	31
W2DBQ	3,040,512	111	37	W9ZJS	1,508,580	80	36
W9RQM	2,630,160	98	46	W1IOT	1,476,078	83	29
W2GVZ	2,573,480	105	35	W9YCR	1,409,382	75	39
W3HUM	2,522,490	106	35	W6NRP	—	—	—
W2KHA	2,490,964	107	35	(6MNH. opr.)	1,396,022	61	40
W1KQY	2,382,500	113	37	W6MYT	1,388,525	57	38
W8PIH	2,275,910	92	38	W3ADE	1,319,010	84	36
W4PEI	2,260,050	91	39	W9OUD	1,307,361	67	40
				W1EOB	1,258,740	72	36

The score of W1AW, not competitive with any of the above, is recounted for the information of members: W1AW (Geo); 3,790,420; 117; 41; 9; 1000; 10 h.

Official 'Phone Station Scores

Station	Score	QSO's	Sectons	Heard	(Watt) Power Input	Operating Time
W2HXQ	8,850	66	25	12	200	5 hrs., 43 mins.
W4CYB	7,500	52	25	20	600	5 hrs., 45 mins.
W8MOL	7,222	54	23	22	500	5 hrs., 43 mins.
W8BTP	7,008	52	24	16	100	8 hrs.
W8VZ	6,950	56	23	10	625	5 hrs., 38 mins.
W4CVQ	6,556	50	22	24	800	5 hrs., 38 mins.
W8ICQ	6,210	48	23	15	130	5 hrs., 46 mins.
W9WXL	5,773	47	23	8	200	6 hrs., 36 mins.
W8PUN	5,704	46	23	9	220	5 hrs., 50 mins.
W2JZX	5,336	38	23	21	650	4 hrs., 27 mins.

Station	Score	QSO's	Sect.	Station	Score	QSO's	Sect.
VE3KM	5,292	48	21	W8BOZ	3,610	36	19
W8MBW	4,508	38	23	W8QVQ	3,439	31	19
W8PFM	4,464	40	18	W2CBO	3,384	30	18
W4EM	4,410	38	21	W2DC	3,132	30	18
W1DWP	3,790	30	18	W1RAO	2,992	35	16
W3BEI	3,690	37	18	W8NNJ	2,992	25	16
W8JTI	3,667	29	19	W3HOY	2,756	34	16
W8KNF	3,618	35	18				

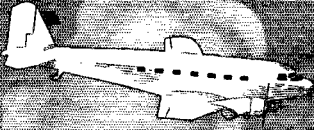

TOP FLIGHT *Performance*

Two Airlines Adopt Harvey 200-C

TOP flight performance, combined with dependability and ease of operation won approval for this 200-C Airport Transmitter-Receiver by two prominent eastern airlines. Both of these lines are now operating a number of these units as ground stations at various points along established runs.

All tuning controls on the 200-C are locked behind the front panel and frequency shift is accomplished by the single large knob on the top panel. Control of the "transmit" and "receive" positions is maintained by a button on the microphone itself. This unit can be easily operated by third class license holders.

The receiver is a National, Type RCE, modified for this service and well known for its mechanical excellence and stability.

Without exception, the aircraft industry maintains the highest standards of manufacture in the world today. To comply with these rigid standards we have built into this unit as well as in *all Harvey equipment* the finest parts obtainable. For example, one of these units now in use transmits and receives on the average of 25,000 times a month. Harvey equipment is built to stand this terrific strain.

As we leave *no stone unturned* in our efforts to build top flight equipment, we believe you should do likewise and see and operate a Harvey before you buy.

Export: 25 Warren St., New York City

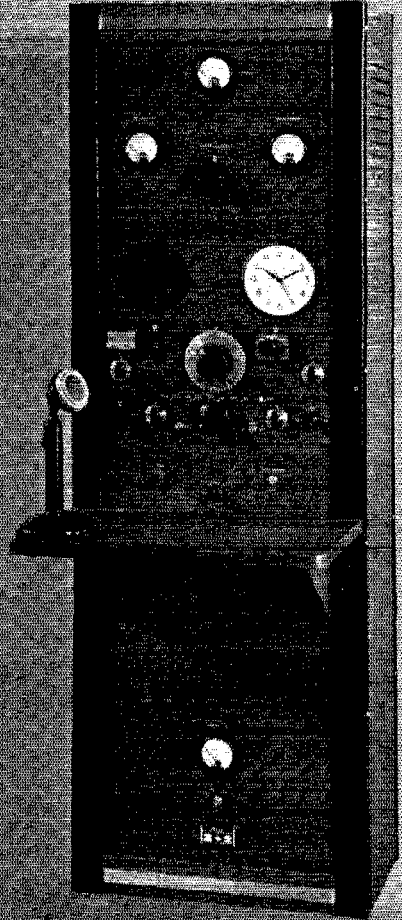

Twenty of these 200-C units are now in daily operation by two prominent eastern airlines.

HARVEY RADIO LABORATORIES, INC.

25 Thorndike St., Cambridge, Mass.

Mims News

NOW—Better Service for you. Effective at once all Signal Squirters are available on Bob Henry's 6% terms from Henry Radio Shop, Butler, Mo. Write Bob for the details. Additional outstanding amateur dealers are being prepared to serve you, too. Our desire is to make it possible for every amateur desiring a Signal Squirrelter see his dream fulfilled.

73.
M. P. Mims, W5BDB



SS39-10 Signal Squirrelter at W3EMM

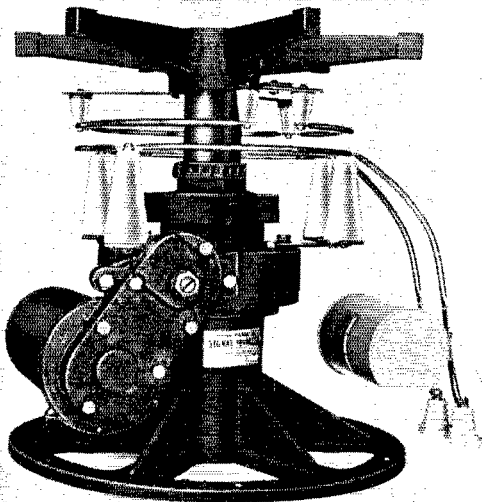

THE INDUCTOSTUB gives you:

- Continuous Rotation in either direction.
- Instant reversal at any point.
- Highest Efficiency Inductive Coupling.
- No Brushes, No Liquids, No Trouble.
- Open Wire, non-resonant feed line.
- Definite precise impedance match.
- An Outstanding Signal.

MIMS RADIO CO.
SIGNAL SQUIRTER
PRODUCTS
TEXARKANA ARK. TEX.

Hamfest Schedule

July 2nd, at Asheville, N. C.: The Annual Asheville Hamfest, sponsored by the Asheville Amateur Radio Club, will be held this year in conjunction with the North Carolina Floating Club and N.C.R. meetings on July 2nd. Registration will begin at noon at the George Vanderbilt Hotel. Group meetings covering every phase of amateur activity will be held, chief among these being the N.C.R. meeting conducted by Lieut.-Comdr. Oleh, D.C.O., and Lieut. Gluck, W4CQ, N.C.R. Commander, 6th Naval District. The principal technical talk will be delivered by Sherwood Githen, Jr., Ph.D., W4EQX. Other speakers will include A.R.R.L. Director Caveness, W4DW, and SCM Wortman, W4CYB. Registration fee is \$1.00, covering business and technical sessions, banquet and the South's greatest code contest. This contest, being arranged by Walter H. Candler, will feature Ted McElroy, world champion, L. R. McDonald, W8CW, winner of code contest at A.R.R.L. National Convention, and Jean Hudson, W3BAK. Contests will be held in several classes, starting at 13 w.p.m. Trophies will be awarded for each class. For advance registration write to R. M. Gibbs, Secy. A.A.R.C., Box 128, Asheville, N. C.

July 9th, at Rolling Green Park, Pa.: The Susquehanna Valley Amateur Radio Club will hold its Second Annual Hamfest at Rolling Green Park, between Selingsgrove and Sunbury, Pa., on July 9th. A good program has been prepared, with plenty to do for everybody. Registration will start at 1:00 P.M. For more information write to John W. Fisher, Secy.-Treas., R. D. 2, Selingsgrove, Pa.

July 15th and 16th, at Glacier Park, Mont.: The Fourth Annual Glacier Park Hamfest will be held July 15th and 16th at Avalanche Camp Grounds, about 5 miles north of the McDonald Hotel on Lake McDonald in Glacier Park, Montana. Avalanche Camp Grounds are located right on the highway going from Bolton, the west entrance to the Park, by the way of McDonald Hotel on the Lake toward Logan Pass and to the east side of the Park. There is no registration fee. Plenty of activities have been planned and further details may be obtained from W7DSS, Great Falls, Mont., W7AQK, Kellogg, Idaho, W7FYO, Anatone, Wash., F. M. Haines, Kimberley, B.C., Canada, or James Smalley, Sr., Calgary, Alta., Canada.

July 22nd and 23rd, at Edmonton, Alberta: The Northern Alberta Radio Club is staging the Alberta Hamfest at the Masonic Temple in Edmonton, Alberta, Canada, on Saturday and Sunday, July 22nd and 23rd. Admission \$1.50. Anyone interested in amateur radio is invited.

July 23rd, at Waterloo, Wis.: Come to Firemen's Park, Waterloo, Wis., on July 23rd for the Annual Hamfest of the Rock River Radio Club. Everybody is welcome. Come early. Stay as late as you like. Registration in advance 75¢ for YL's, \$1.00 for OM's; at the gate \$1.00 and \$1.25. Lots of eats, fun, and a large prize drawing at 6:00 P.M. Reservations and complete information may be obtained from John Janczak, 112 West Burnett St., Beaver Dam, Wis.

August 6th, at Trenton, N. J.: The Delaware Valley Radio Association announces its Third Annual Outing and Hamfest, to be held Sunday, August 6th, from 10:00 A.M. to 8:00 P.M. (If rain, date will be August 13th). The place: Trenton State Fair Grounds, Nottingham Way, Trenton, N. J. There is direct bus service from the Pennsylvania Depot. Among the many attractions will be a Championship Baseball Game, Second Call Area vs. Third Call Area. In addition there will be contests of all kinds, two orchestras for dancing, professional entertainment, plenty of prizes for both ladies and gentlemen, and an unlimited supply of tasty food and beverages. Tickets: \$1.50 per adult, \$.50 per child, at the gate; \$1.25 per adult if bought before August 1st. Mail all reservations to William E. Wilbur, W3GNU, Hightstown, N. J.

The Elmira Amateur Radio Association has been issued the call W8USA for use at the Tenth Annual National Soaring Contest to be held at Elmira, N. Y., June 19th through July 9th. The license was issued for a period of three months, May 1st until August 1st. An attractive QSL card will be sent to each station contacted during the time that W8USA is on the air.

O.B.S.

The following is a supplement to the list of A.R.R.L. Official Broadcasting Stations in October QST (page 71): W3GRW, W3HAL, W4FIX, W6PMV, W7JC, W8PAK, W9FA, W9GFA.

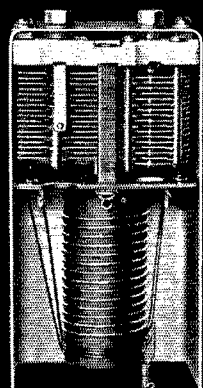

ETU

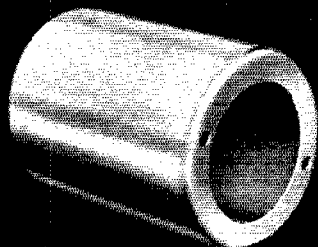

PTS



XS-2

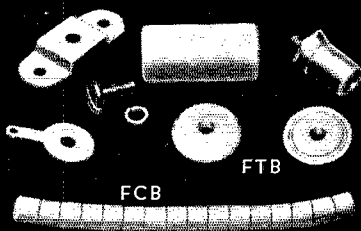
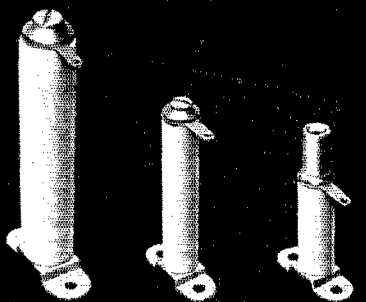

FCB

FTB

INSULATORS

BUILD *with* CONFIDENCE *Use* HAMMARLUND PARTS

SEVERAL new small parts were recently added to the Hammarlund line and they have enjoyed immediate acceptance. The "ETU", ready wound exciter tuning unit, is rapidly becoming as important in transmitter construction as the I.F. transformer is in receiver building. These ready wound units are available for 80, 40, 20 and 10 meters. Its small size, 2" X 4" X 1 7/8" makes it ideal for compact band-switching exciters.

"PTS" tube shield, designed for the 807, 802, and other similar tubes, eliminates feedback due to improper tube shielding. This shield is essential for stable operation of highly sensitive pentodes and beam tetrodes. Another shield, the "PTSH", designed for use with higher power pentodes and tetrodes such as the "RK-20" and 814 is also available. Both are punched for mounting with standard Hammarlund sockets.

The "XS-2" Isolantite crystal socket is a great space saver and provides a firm positive-contact mounting for all standard crystal holders. Can be mounted above or below base or inside SWF coil form. It measures 1 1/8" in diameter and takes up little more than half the space of a regular socket.

Hammarlund's Isolantite standoff insulators, insulating beads and bushings, cover every amateur requirement. Write for catalog containing complete line of amateur parts.

MAIL THIS COUPON!

HAMMARLUND MFG. CO., INC.
424-438 W. 33rd St., N. Y. C.

Q-7-39

Please send me "39" catalog

Name.....

Address.....

City..... State.....



HAMMARLUND

Canadian Office: 41 West Ave. No., Hamilton, Ont.

HERE IT IS... HAMS

A New
AC and DC
Pocket
Volt-Ohm-
Milliammeter

with ranges to
5000 Volts—
Self-Contained



Size:
3 1/16"
x 5 7/8"
x 2 1/8"

MODEL
666-H

\$14.50
Net Price

TRIPLET

*Will handle all
Amateur Requirements*

● A new Triplet AC and DC Pocket Volt-Ohm-Milliammeter that will handle voltages to 5000 volts without external multipliers. It will check the high voltages and circuits of transmitters and receivers — just the instrument for amateur use.

Ranges: AC-DC Voltage at 1000 Ohms per volt 0-10-50-

250-1000-5000; DC Milli-ampères 0-10-100-500; Resistance 0-300 ohms shunt type 10 ohm reading at center scale; 0-250,000 ohms series type, 3700 ohms at center scale.

Model 666 — Uses same case as 666-H... Reads to 1000 volts at 1000 ohms per volt... Net Price.....\$14.00

Triplet Manufactures a Complete Line of Precision Panel Instruments in 18 Styles—2" to 7" Round, Square, Fan and Twin Cases

INVESTIGATE THESE AND OTHER OUTSTANDING VALUES

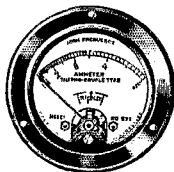

THERMO AMMETERS

Thermo Ammeters (High Frequency — Accuracy 2% — with internal couples). Models 341, 346, 347-A. Ranges .5, 1, 1.5, 2.5 or 5 amps... Net Price.....\$4.50

WRITE FOR CATALOG

SECTION 257 HARMON AVENUE, BLUFFTON, OHIO

THE TRIPLET ELECTRICAL INSTRUMENT CO.
Bluffton, Ohio

Stepping Up Receiver Performance

(Continued from page 17)

voltage should be 180 volts. This bias can be obtained from a battery connected directly from grid to ground. After the meter is adjusted, the r.f. gain is set so that the loudest signals on a given band are "S9" or about 0.85 ma. on a standard 1-ma. meter. Of course, when looking for a weak DX signal, the r.f. gain should be full on. Practice in using this arrangement will readily show its advantages.

Results and Possibilities

Besides the reduction of signal overloading by reducing gain, certain types of extremely loud noise should be similarly handled. In experiments using an electric razor as a noise source it was found that if the razor was brought close to the receiver the noise would overload the first i.f. stage, seriously handicapping the silencer. When the r.f. gain was reduced slightly to prevent this overload the silencer went to work and permitted reception under otherwise impossible conditions. Most of our comparisons have been made with the electric razor as a noise source. No silencing system except the regular i.f. type would allow even a reasonable reduction of this noise. The new system does an astounding job on 'phone, allowing reception of all but the weakest signals without serious trouble. When the system is used on c.w., ahead of a crystal filter, the results are almost miraculous.

Another extremely interesting possibility should be mentioned. Many 'phone amateurs are seriously handicapping each other by operating with high power on the narrow 'phone bands and located within less than a mile of each other. An infinite rejection circuit ahead of the first i.f. circuit would allow removal of a strong local carrier before it can reach the silencer. Removal of the carrier would prevent blocking, and the silencer will reduce modulation hash left. With a 1500-ke. i.f., operation to within 10 ke. of the local carrier should be possible. In this case the rejection transformer must precede the i.f. amplifier tubes. Because of the reduced gain due to rejection, it may be desirable to use another amplifying stage.

In discussing the noise silencer, it was pointed out that the limited selectivity ahead of the silencer would allow cross-modulation or blocking of the silencer by a strong signal when the receiver is tuned to a weak one and the silencer control set for critical adjustment. The infinite rejection system could be used to remedy this situation. In actual practice this type of trouble does not occur frequently enough to justify the additional complications. However, some work on arrangements to reduce the skirts of the selectivity curve ahead of the silencer without decreasing the width of the nose should be a great help.

Several receivers have been constructed in order to test the various phases of operation. These receivers have been tested against good

(Continued on page 70)

AN OPEN LETTER TO ALL AMATEURS

Last month we predicted that the new Taylor Thin-Wall Carbon Series would be ready for you about July first. It is now evident to us that the increasing heavy demand for our types T-40, TZ-40, T-55, 203Z, T-125, 866, 866 Jr's, etc., will not permit us to meet this announcement date. To those of you who have been patiently waiting these sensational new tubes, we owe an apology and explanation. We are naturally stepping up our production facilities to meet the new demand. We will announce the first of these new tubes very soon.

The Thin-Wall Carbon Anode Series will not replace any of our present type tubes. Essentially, they are specially designed for Peak Performance on the Ultra High Frequencies and will offer many outstanding features — "Puncture-Proof" Construction — Visible Operating Temperatures — Enclosed Anode "Controlling" Electrons, etc. We repeat — you can buy any of our present types with our assurance that the New Thin-Wall Tubes, when announced, will not injure your investment.

May we call your attention to the preponderance of amateurs who are using T-40's, TZ-40's, and T-55's on 10 and 20 meters!! Notice especially how many ZS's, ZL's, VK's and G's are pounding through with these husky Taylor Tubes. Here's another evidence of how Taylor Tubes are appreciated in every country in the world.

Taylor Tubes

P.S. Through an error in proof reading, we recently advertised our 866 Jr. as selling at \$1.50. The price should read \$1.00 — the same big value it has always been.

TAYLOR TUBES, INC., 2341 WABANSIA AVE., CHICAGO, ILL.

Station Activities



ATLANTIC DIVISION

EASTERN PENNSYLVANIA — SCM, John B. Morgan, W3QP — Asst. SCM in charge of Emergency Coordination, W3AKB. R.M.'s: 3AKB, 3AQN, 8ASW. Traffic may be routed all summer over 3EML/3CIZ/4PL "Hit-n-bounce" line. 3AKB is going in for DX and rebuilding during the summer. 3AOC, Bob Shaw, is laid up for several months in Presbyterian Hospital, Philadelphia, and would like to hear from any of the gang who can spare a postal. The Eastern Penna. Traffic Net will continue to operate as usual during the summer; present active members are 8ATF, 8OML, 3HCT, 8SSP, 3EFH, 3DXC and 3AQN, Manager. Q80 any of these stations at any time and benefit by their first intra-Section service. Imagine 3BES with a pair of 810's! 3BRZ suggests more of the 'phone men of the Section handle some traffic. 3DGC's total is for one night's work! E.C., 3DPU has lined up matters with Red Cross and others in the Phila. three-county area. 3DRQ had a visit from 5ECB. A new system, the Forty Traffic System (FTS), is in operation in the Eastern U.S.A., snapping traffic around nicely; 3EEW is the Phila. key station. 3EFH has been working as N.C. of Trunk Line "C." 3GMK is on the U.S.S. *Cimarron*, the Navy's largest tanker, for several months. 3GHD, 3GYK and 3HBJ are rebuilding. 3HCT has new 1.75-Mc. 'phone. 3HDB is breaking into 14-Mc. 'phone! 3HQJ is working for Class "A" ticket. 3HQK is looking for cross-band contacts, 1.75/112-Mc. 'phone, in either direction. 3HXA's total was all DX traffic. 3HYD, new O.R.S., is using SW5, and 24A e.o.o. 6L6G buffer, '10 final with 40 watts on 3700 kc. 3QP had a visit from operator "HS" of OA4U, who told interesting tales of life 11,000 feet up in the Andes. 3HRS has a fast route running K6PUS-W6PGB-3HRS-2LOQ-IQW-YE??, for anyone who has traffic. 3RR worked ZD4AB for first African. 8ASW says trout fishing spoiled his total — Look at it! 8ATF is using crystal and buffer stages while rebuilding final. SCR is in A.A.R.S. PA-2 Net and active on 3710 kc. 8LZD moved to 613 Main St., Peckville, and is using two Windom antennas. 8SSP rebuilt to pair of 35T's running ½ kw. 8SVW visited 2LIP while at Newark hamfest. SVW has new NC44. Many O.R.S. misunderstand instructions on report cards for listing traffic: NO EXTRA CREDIT FOR DELIVERIES UNLESS THE DELIVERIES ARE MADE AND LISTED ON THE SAME REPORT CARD. Many list Extra Credit with no deliveries!

Traffic: W8ADE 32 3AKB 99 3AQN 11 3BES-3CHH 2 3DGC 18 3DGM 20 3EEW 21 3EFH 55 3EML 450 3FRY 12 3GHW 3 3GKO 339 3GYK 12 3HBJ 7 3HCT 8 3HDB-3HFE 5 3HQE 28 3HQJ 8 3HRS 130 3HRW 24 3HXA 4 3IAY 3 3QP 333 3RR 2 8ASW 409 8ATF 46 8CR 16 8FLA 18 8HKS 7 8LZD 51 8OML 12 8PWJ 2 8RHE 17 8RKZ 19 8SNZ 26 8SSP 3 8SVW 4.

MARYLAND—DELAWARE—DISTRICT OF COLUMBIA — SCM, Edgar L. Hudson, W3BAK — 3CXL, 3CQS: R.M.'s. 3BWT, Chief R.M. DRE is rebuilding with 808 final. IDK is new ham in Delmar, Del. GUT is in hospital recovering from pneumonia. GKN has been in hospital with appendicitis; he bought new HQ-120X. GZK will move to Boston. CDG worked VK9RM for 82nd country. HUM reports trunk line AP handling lots of traffic. ECP/WLQM used 2.7-watts input to a '19 tube in A.A.R.S. emergency test April 29th, with dry battery power. CIZ is visiting West coast and other places. GYQ received W.A.S.; he has been assigned A.A.R.S. call WLNP. HSB has new rig with 115 watts to TZ-40; he will move to Brookline, Mass., and will attend Harvard. HAL accepted appointment as State Supervisor of American Emergency Net for Maryland. The net has held several practice drills on Mondays at 10 p.m. on 1888 kc. Stations in the net are: GUT, BFX, FQL, BHE in Cumberland; AKX in Frederick; EQK, GRT in Baltimore; DKE in Catonsville. HAL is located in Towson, HJM in Rockville, HLI in Denton and GXH in Fishing Creek. HAL is operating central station from Towson, Maryland.

Traffic: W8BWT 521 CXL 369 (WLM 3573) ECP 223 CIZ 122 GYQ 86 HUM 66 HSB 16 ARK 12 HAL 11 CDQ 8 CDG-WU 5 HQU 4.

SOUTHERN NEW JERSEY — SCM, W. Walter Fil-

son, W3BEI — Some of the gang wish to continue S. J. Net through the summer due to World's Fair traffic. AQ, D.V.R.A. was on all bands at the Y.M.C.A. Hobby Show, Trenton, May 10th-13th. 4EOW is working portable on 1.75-Mc. 'phone at Fort Dix. HWO is confined to bed for a month and is working the rig from position in bed. AFH is building rotary beam for 28 Mc. ZI made his first appearance as O.P.S. in the last party. AZZ is on 1.75-Mc. 'phone with 100TH. The D.V.R.A. Outing and Hamfest will be held Aug. 6th (Sunday) instead of Aug. 13th. GEV has three antennas for 28-Mc.-V Beam, Diamond and two sec. 8JK. EED is rebuilding for 14-Mc. 'phone after three years' absence. CCO has contacted all district on 28 Mc. GRW works good DX on 14-Mc. 'phone. FTU has 300 watts on 56-Mc. 'phone and is working Md., Del., Penna. and Conn. from his Hightstown QTH. FMR with 500-watts input and NC81X receiver W.A.C.'d in last DX contest on 'phone. HOJ has 6C5-6L6G rig described in Dec. '38 QST on 3.5 and 7 Mc. HHY has 76 crystal 802 on 3.5 and 7 Mc. HUZ has 50 watts to RK39. C.R.C. Net is functioning well with fair turnout on Sun. eve. DOR is in the Signal Corps. Dr. Haigis was speaker at last C.R.C. meeting in Mar. BEI, along with BGP, keeps weekly schedules with 9AQN, ex-3AN.

Traffic: W3BZX 229 BYR 137 (WLWN 11) ZI 102 EFM 69 (WLNJ 6) DNU 44 GMY 17 EWK 14 BEI 11.

WESTERN NEW YORK — SCM, H. E. Preston, W8CSE — R.M.'s: 8BJO, 8DSS, 8FCG, 8JTT. P.A.M.: 8CQU. E.C.'s: 8GWY, 8RGA. Section O.R.S. net frequency: 3720 kc. Several leading traffic men have cancelled schedules for the season. Take a good rest, fellows, and next fall let's put W.N.Y. on top. Clark Rodimon, ISZ, visited clubs in Auburn and Elmira and attended Syracuse Hamfest. The Elmira Radio Association held special meeting at Y.M.C.A. in honor of the occasion. Elmira will hold a hamfest July 1st. Knowing their reputation for putting on a real show everyone should plan to attend. The call 8USA has been obtained for use of the Association at the glider meet. USA is both O.R.S. and O.P.S. and will operate on several bands, 'phone and c.w. CHU took in Syracuse Hamfest. RTW has new conductor pipe mast. KBW received card from Newfoundland, DZC gathered one from Chile. PVG is putting in lot of hard work to make sure that ham activity at the coming glider meet will be most successful. IGT plans on putting the 250TH on 14 Mc. AVD worked VQ4EJCJ on 14-Mc. 'phone. JU has new 28-Mc. crystal. OCP bought a bug; RZF has no bug now. (2 plus 2 equals?) RXA of Booneville is on with Browning all-band switching crystal and e.e.o. rig, beam antenna and new NC101X. MUQ is building an e.e.o. The Finger Lakes Transmitting Society of Auburn held a supper at Woodcock Hotel in honor of ISZ's visit. AQS moved to Syracuse. BDV has four transmitters. BGV has one that sure pokes a hole in the ether. DSU is proud father of another YL op. RNG is going in for high power. HQW is thinking of building 200-watt portable. SEB keeps 1.8-Mc. 'phone band hot with 125 watts to pair of 809's. SEA contemplates joining him on 1.8-Mc. 'phone. SEI works a few Europeans on 7 Mc. RTX finds two half waves in phase of 1.75 Mc. raises his signal strength. KDY has excellent quality on 1.8-Mc. 'phone. AYL is active on 1.8-Mc. 'phone. RKM moved from Cortland to McGraw. QLT has Class "A" ticket. BJI is active in Syracuse. TJK is new Warners call. SVC operates from Groton on 3.5 Mc. AKX in Dolgeville has nice new 'phone on 1.8 Mc. MYT has new HQ120 receiver. RTX bought a Bud 500-watt amplifier kit. RTB uses crystal control on 56 Mc. TJJ and TIL are new Rochester hams. RQQ is moderately active on 7 Mc. MNW and NBG room together and work 7 Mc. ACY knocks off DX on 14-Mc. 'phone. OSX has 100 kc. oscillator. ILO shows a little life on 7 Mc. ETJ lost 28-Mc. beam in a storm. TEX is new Rochester ham on 14 Mc. 2CEQ is staying in Rochester and listening in to the world with new HQ120X. Thanks to RQX for dope on activity around Rochester. RNG has Class A ticket now. TJN is new Seneca Falls call. To FCG, State N.C.S. of Army Net, goes the honor of being high traffic man this month. ABN has new XYL. IJAH and his better half were recent callers at CGU. 2JZR was present at Syracuse Hamfest. Also attending said Hamfest was PLA, who, with YF and daughter was guest of the S.C.M. for the week-end. Don't forget to send in activity news items for this column.

Traffic: W8SBV 98 PCN 72 CSE 60 DSS 81 QUN 37 BJO 16 RKM 49 JTT 213 PLA 59 FCG 304 CTX 31 SEI 6 DHU 15.

WESTERN PENNSYLVANIA — SCM, Kendall Speer,

Jr., W8FOF — Over eighty attended the annual South Hills Brass Pounders indoor gabfest. Western Pennsylvania is very pleased to hear that our Atlantic Division Director, Walter Bradley Martin, 3QV, has been ordered to permanent active duty as Commander, Fourth Naval District, N.C.R. Congrats from the gang, Brad, and best wishes, B.P.L.ers this month: HUL, FUW and WLMA (8YA). 3GXV, formerly 8HHM in Altoona, is now located at Norfolk. SHN moved. TJI is new N.C.R. member at DuBois. OFO passed exam for promotion to Radioman Second Class in N.C.R. NCJ and XYL visited VE3SF in Toronto. KXP is moving to 14 Mc. for the summer. QAN is using his rig with 100TH's final from 3.5 to 28 Mc. inclusive. ROA has new rig with T40 final modulated by pair of 809's Class B. RJT enjoyed O.R.S. party. DGL says KF's father died April 31st. Our sympathies. MCW has a Hammarlund receiver. KWA has been laid up with infected foot. RAT says SWT is going on the air with HT4 rig. RAZ, RBM and RAU have been trying a Hallcrafters "5 and 10," IZS made 974,000 points in O.R.S. party. New Ham-Johnstown-TIK. 8YA (WLMA) alternates for WLM, Washington, one night a week. (GHJ says GHK is on 1.75-Mc. c.w. QNG moved to Harrisburg. GHU needs Nevada only for W.A.S. New O.R.S.: R4P. PJJ says QEL got his 1-kw. rig on. OSI says the band switching arrangement is working fine. AVY says the emergency tests have been fairly successful. He will go in as Emergency Coordinator for the Pennsylvania Railroad in their new emergency plans. ASE is on 14 Mc., first time off 7 Mc. in 9 years!

Traffic: W8HUL 891 FUW 246 DNX 156 SHN 149 MJJK 143 QBK 133 GYB 115 ZAE 98 AQN 84 MDT 79 OFO 76 SIL 66 ZD 64 KTM 59 NQQ 47 DYY 43 NCJ 40 HBG 37 NDE 35 KXP 34 QAN-QWI 32 KD 31 ROA 16 OUT 8 IOH-RIT 7 AXD 6 DGL-RAT-RAU 5 IZS 2 KWA 1 YA (WLMA 511). (Mar.-Apr.: W8KWA 495.)

NEW ENGLAND DIVISION

CONNECTICUT — SCM, Frederick Ellis, Jr., W1CTI — A large delegation of Conn. operators attended the New England Division Convention at Springfield, Mass., May 20th and 21st. AW leads the Section in traffic. AMQ is building a combination e.c.-crystal exciter. JXP will keep skeleton schedules this summer. JYJ was laid up after appendicitis operation. ITI's portable rig perked nicely from camp. BDI attended Board Meeting on the west coast. LVQ, ex-9KJY, will be O.R.S. when he gets his new 250-watt rig perking. The Nutmeg Net closed for the summer May 15th, after a very successful season of traffic pushing. Your S.C.M. wishes to thank all those who took part. 3640 kc. is now well known as the hangout of the Conn. gang, Nutmeg and A.A.R.S. Nets. Let's plan for an even better net next fall.

Traffic: W1AW 249 (WLMK 6) AMQ 145 CTI 95 JXP 94 JMY 78 ITI 47 KFN 35 TD 29 UE 27 KQY 24 ES 17 BHM 14 BDI-APW 7 GB 3.

MAINE — SCM, Winfield A. Ramsdell, W1FBJ — New O.R.S.: LHL, LMQ, LML and DFQ. New O.P.S.: AUC and D.F.Q. We need at least 25 Emergency Coordinators in this Section. At the present time there are only 4. This is one branch that must be taken more seriously. If you are able to do anything about it get in touch with the S.C.M. at once. ERO has new rig: '47 osc., pair '46's final. IIE has been giving code practice to a large class, Mon., Wed. and Fri. at 4:30 p.m. MAP is new Farmingdale ham. DHH has Class A ticket and is operating on 3.9 Mc. LDC has new Harvey 75T. FQJ has taken job as radio instructor at C.C.C. camp in Southwest Harbor left vacant by KPA. LMQ visited KOU and GE. KJJ has new final pair 810's. KAS and FBJ attended New England Division convention at Springfield. This is my last report and I want to thank every one for the fine support given the past two years. I feel that we have made quite some progress and I expect to help keep the Section going up toward the top. Let's call this a beginning and get firmly behind the new S.C.M. and go to the top. Thanks a million and best regards. — Win.

Traffic: W1GOJ 167 IIE 54 FBJ 33 GND 16 LMQ 10 ERO 4 DHH 3 LRP 2 LYK 6. (Feb.-Mar.: W1FAP 144.) (Mar.-Apr.: W1FAP 152.)

EASTERN MASSACHUSETTS — SCM, Larry Mitchell, W1HLL — AKS is high traffic man. JSM is good traffic man. EPE is in A.A.R.S. and O.R.S. Nets and T.L. "C." KZT keeps five schedules daily at 7 p.m. EMG is another A.A.R.S. man. HWE, A.A.R.S., is active on 56 Mc. BYF is new E.M.N. man. New Asst. S.C.M.'s, GAG and JYJ are

doing fine work. GAG has lined up O.P.S. in great shape, also getting O.O. stations lined up. JYJ is doing good job on c.w. men, also lining up net for New Bedford Power and Light. Prospective O.R.S. — LMO; O.P.S. — KTE, EREH, IIM. Let's have more. New officers for South Shore Amateur Radio Club: ALP, pres.; JCX, 1st vice-pres.; BLO, 2nd vice-pres.; FWS, secy.; JDV, treas. They are having all-hand inter-club contest to keep up interest. KH, though leaving early for Board Meeting, made B.P.L. KCQ worked CR4HT and PJ3MS for 49th and 50th countries. LMD asked to serve as Boston key station for new 7-Mc. traffic net. LMB worked 60TU in Nevada for W.A.S. SS works 80 miles on "21½." LEU has Collins 30-J. 6NWP-1 is going back to Calif. LHV is on 1.75 Mc. with 1.1 watts. LTC is going mobile on 28, 56 and 112 Mc. BJB has kw. on 28 and 14 Mc. WV scheduled VO3X during absence of KH and made B.P.L. All O.R.S. and O.P.S. look at your certificates. If they require endorsement kindly mail in at once. BDU and WI are active on 7 Mc. LZXX is new Wellesley Hills ham. LNN reports new net on 7 Mc. Anyone interested contact AJ or LNN. BMW is back from cruise to S. A. on U.S.S. Davis. JGQ wants 1.75-Mc. O.P.S. Net. JCX gets reports from Europe for IXAL. QW wants summer schedules on 7 Mc. LXQ is new ham. A word of warning to all A.R.R.L. appointees who have not reported since the present S.C.M. took office: Will give one month's grace over my statement in April QST. All who do not report by July 16th will have appointments cancelled. Let's have the reports if you want to hold your appointments.

Traffic: W1AKS 331 JYJ 196 KH 161 JCK 152 (WLGV 69) JSM 141 WV 122 EPE 121 LBY 85 IUQ 84 KZT 71 AGX 60 EMG 56 HWE 46 QW 19 (CC1E 12 CC1C 32) BYF 15 IGX-BDU-KCQ 4 JCX 2. (Mar.-Apr.: W1FWQ 22 QW 14 (CC1E 15 CC1D 10 CC1C 40).)

WESTERN MASSACHUSETTS — SCM, William J. Barrett, W1JAH — JAH visited BIV, AJD, BVR, EOB and KUW during the month. DUZ is going to do the usual rebuilding in preparation for active season in the fall. BKG assisted in operation of station at Pittsfield Hobby Show. DUV is moving to Baltimore in June to take up new position. Sorry to have you leave the Section, Bob. FOI has been heard pounding brass to prove he isn't 100 per cent 'phone. KRS schedules K6PEJ early Sunday mornings on 7 Mc. AJ moved to new QTH. BVR attended A.R.R.L. Board Meeting in San Francisco, also taking in the World's Fair. Perce attended ham meetings in Chicago, Oakland, Calif., and Los Angeles, while en route to and from the meeting. KLN reports for KJK, who is still in Racine. BDV put up 119-ft. center-fed doublet for 3.9-Mc. 'phone. LDE reports for first time. Jim did a beautiful job at the Division convention. We want to congratulate BSI for the nice affair. BNO lost 3.9-Mc. antenna for seventh time since hurricane.

Traffic: W1IOT 178 (WLGN 60) BIV 137 JAH 81 (WLGH 22) DUZ 76 BKG 76 IOR 44 DUV 36 FOI 28 KRX 14 AJ 13 BVR 10 (WLG 84) KJK 7 BDV 4.

NEW HAMPSHIRE — SCM, Carl B. Evans, W1BFT-DMD — The Third Test Mobilization of the N. H. Emergency Net was held on May 7th. Despite poor conditions results were the best yet. Forty-one stations and 56 operators covering 30 different communities were mobilized. GEY, I reported from Hollis, CME, I from Bedford, GDE/I from Auburn, LIN/I from Dunbarton and APK/I from Epsom. Due to the interest, particularly in portable work, our next test mobilization is scheduled for Sunday, August 6th, with schedules in the morning. Let's make this a real field day for N. H. hams. Get a portable and set up in the field on August 6th, check in on N.H.E.N. and then operate for a while. It's a "lotta fun." Ask anyone who has been out. APK now has a gas-driven 110-volt a.c. generator and two complete portable stations. JNC reports increased activity on 56 Mc. How about trying out a 56-Mc. Net with the N.H.E.N.? Contact your S.C.M. if you are interested. IVU has three-element rotary beam on 14 Mc., using new Pre-max units. LLK, St. Paul's School Radio Club, is active on 1.8-Mc. 'phone and 3.5-Mc. c.w. The Manchester Radio Club, LVK, is on from its new home in Smythe Tower. HFO has left Manchester for the far South. His many friends wish him the best of success in his new undertaking. CME is having FB results with new facsimile receiver. LVG is going on 1.8-Mc. 'phone with low power. LSY, new ham in Hillsboro, is on 28-Mc. 'phone. FLASH!!! Sixth Annual N. H. State Hamfest and A.R.R.L. convention will be held at the Hotel Carpenter in Manchester on Sept. 24th. Keep

(Continued on page 72)

NEW SHURE *Streamliners*

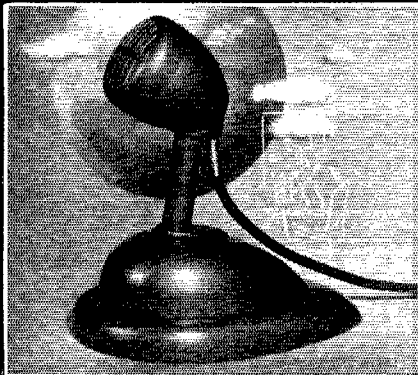

Communications - Type Crystal and Dynamic Mikes

1. Insulated for Safety
2. R. F. Filtered
3. High-Efficiency
4. New Low Cost

They're entirely new — designed especially for amateur and professional 'phone communications — with value and performance never before available at such low cost. For the first time, you can have a microphone with circuit completely insulated from the operator for extra safety, and with filtering which protects against R.F. burn-outs. And, of course, you get the famous Shure high-efficiency speech characteristic for clear, crisp signals. Beautiful new streamlined desk stand. Available in Crystal and Dynamic (high-impedance) types, complete with 7 ft. cable.

Model 7S. Crystal Type, complete with desk stand. List Price..... **\$19.50**

Model 7SH. Less desk stand. List..... **\$16.50**

Model 5S. Dynamic Type, complete with desk stand. List Price..... **\$24.00**

Model 5SH. Less desk stand. List..... **\$21.00**

Crystal and Dynamic Streamliners also available in general-purpose models for P.A. use.

*Ask Your Jobber or Write
for Data Sheets 121 and 182*

Shure Patents Pending. Crystal Microphones licensed under patents of Brush Development Co.

communication receivers to determine whether or not it is worth the trouble. In a noisy location there is very little question about the superiority of the new system. If any question does arise the electric razor is turned on and the question immediately settled. Images are noticed by their absence. The weak-signal response is as good as on receivers with several stages of preselection, with the added convenience of only one tuning control. The operation of the receiver illustrated is really a pleasure. The various controls are set for band conditions and the speaker volume desired, and tuning is accomplished with the main dial only. The a.v.c. is so complete, because of the large number of stages controlled, that variations in signal strength over wide ranges will not change the audio level noticeably. If interference occurs, a slight readjustment of the rejection control will generally clear it up. Everyone who has heard one of these receivers in operation has been almost as enthusiastic as the writers.

Limited measuring equipment made comparative noise tests difficult. With this in mind the following information may be taken for what it is worth. Our measurements showed the new silencing arrangement superior to all other systems except in one case. This case is when medium noise and medium signal were applied to a receiver using the original silencer circuit ahead of a crystal filter and with the crystal in. The noise was reduced about 30 db on the new receiver and more than 40 db with the original system. However, when the noise voltage was increased the effectiveness of the original system dropped rapidly because of capacity transfer, while the ratio remained almost constant on the new receiver until the 3000-kc. i.f. amplifier tube was overloaded.

Comparison with various types of noise limiters showed the silencers to be surprisingly more effective. On 100 per cent modulated 'phone signals the ratio of signal to "pistol shot" noise from automobiles was 40 to 50 db on the new arrangement, 20 to 30 db on the original silencer, and from 10 to 12 db on various noise limiters. Under one condition a noise limiter gave a ratio of 30 db, but the ratio of input signal to noise was critical.

The amount of automatic action was checked under the same conditions. With a 20-db signal-to-noise ratio on both the improved and original systems, the input signal was increased to determine when blocking would occur. A 12- to 15-db increase, about two "S" units, would block the original silencer circuit, while more than 30 db was usually required to cause trouble with the new arrangement.

Measurements were also made with an electric razor, but the results could not be evaluated similarly because of the high average value of this type of noise. On 100 per cent modulated 'phone signals the new receiver was capable of reading signals 20 db lower in level than with the original system. It should be mentioned that the original silencer was apparently operating in a satisfactory manner.

(Continued on page 74)



Versatility

3 in 1

with the Thordarson Amateur Speech Amplifier

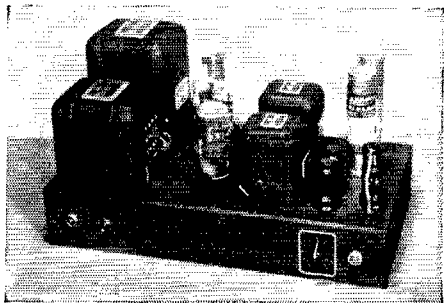

- New peak limiting circuit.
- Popular over-modulation control circuit.
- Conventional speech amplifier circuit.

YOU TAKE YOUR CHOICE

Most versatile speech amplifier ever offered amateurs. Choice of three circuits adaptable to any transmitter. The over-modulation control circuit and the peak limiting circuit eliminate over-modulation and side band splatter. Both effectively increase the average side band power. Available with 500 ohm output or variable ratio driver transformers. Table or rack mounting (see illustrations below). Build with C.H.T. Multi-Match or regular Thordarson transformers. Foundation unit furnished with complete diagrams and instructions for easy assembly by any amateur.

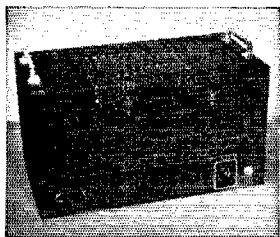
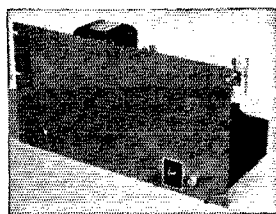

Table Mounting

Complete Constructional Book

Full layout and constructional data for all three circuits. Includes photos, diagrams, parts lists, performance data and operating procedure. Write for SD-387BS. 15c postpaid.



Rack Mounting

SEE YOUR PARTS DISTRIBUTOR OR WRITE FACTORY
FOR FREE DESCRIPTIVE BULLETIN SD-389-D

THORDARSON ELECTRIC MFG. CO.

500 W. HURON ST., CHICAGO, ILL.

Demand "Power by Thordarson"

(Continued from page 69)

the date in mind. More details will be announced later.

Traffic: W1LN 272 KIN 201 JBA/1 97 BFT 30 APK 24 JDP 22 DMD 16 LIN 2.

RHODE ISLAND — SCM, Clayton C. Gordon, W1HRC — A tendency is noted on the part of some O.R.S. appointees to take that appointment too lightly, including failure to clear traffic within 48 hours, etc. In this Section we insist that the rules of the appointment must be followed by all O.R.S. There are plenty of fellows willing to play the game honestly. We don't want the other kind. Let this be a warning to those who think that O.R.S. means nothing! INU, KKE, GTN and KOS have portable 3.5-Mc. rigs that have stood the test of time in the field. LDL and FAH are operators at the forest fire net control station in Scituate. LOX is experimenting with low power; he has a schedule with 4BZQ. HJB has new daughter. JRY has converter working on 56 Mc. EWB is building 3.5-Mc. rig. HCK joined P.R.A. LCH, LCS, HRZ and JP are after 56 Mc. in a big way. JP is building 3.5-Mc. portable. LDM and IWA are on 7 and 3.5 Mc. HRC has been heard a bit on 14-Mc. 'phone.

Traffic: W1INU 759 INT 167 LAB 158 GTN 102 KYK 86 LDL 67 IEG 62 KWA 60 CPV 59 KOG 46 JDX-LQG 20 KKE 32 KIV 17 KTH 15 LOX/1 4.

VERMONT — SCM, Clifton G. Parker, W1KJG — KTB is now O.B.S. and O.R.S. LZO is new Lyndonville amateur with 700-watt completely emergency powered transmitter. KOO was appointed Emergency Coordinator, Northeastern Vermont area, and has appointed JLF Asst. Coed. for St. Johnsbury and KTB for Lyndon areas. 2JBL/1 is active O.R.S. DPO will soon leave Sanitarium. KVB attended S.A.R.A. meeting. 5EWD, S.C.M. for Miss., is on 7145 kc. and looking for Vt. to finish his W.A.S. KXY is Signal Officer at Ft. Ethan Allen. IJU is very active on 14 Mc. JRU transmits code practice on 1.75 Mc. at 7 p.m. Tues. and Thurs. KJG visited KXY. FSV was visited by DPO, IQG and KXY. GAE lost his appendix, but convalescing in hospital speedily. BJP lined up for supporting service in emergency set-up.

Traffic: W1KXY 354 FSV 210 KTB 106 KJG 16 KOO 12. W2JBL/1 37.

ROANOKE DIVISION

NORTH CAROLINA — SCM, W. J. Wortman, W4GYB — Activity in Asheville is at a high point for the big hamfest in July. KI is at new QTH. AXZ and QA are working 28-Mc. portable-mobile. DPF and FVD moved to 28 Mc. FSE lost mast when guy wire broke. BWT returned to air after long layoff. TS is building new 14-Mc. rotary. ECW is at Duke Univ., EJ at Wake Forest, ZM at Indiana. RF gets out FB on 56 Mc. DWO is on 'phone with new rig. DOP and CJM are on 7 and 14 Mc. and both work at WANL, State Police Radio. FCB and DLX both broke a million in O.R.S. Party. BSS has new 500-watt rig on 3.9 and 14 Mc. EIZ is at Duke Univ. with Hallicrafters rig. ADG has new speech equipment on 3.9-Mc. 'phone. FVR, an ex-W2, now at WBT, is working XUs and Js which the fellows can't hear. AHF, FUA, EYF and EJE are on 28 Mc. DST has been sneaking up to 14 Mc. after saying he would never leave 3.9. FJS will be at C.C.C. Camp, Cape Hatteras, for the summer. AAK has gone to 14-Mc. 'phone. CVQ made nice score in O.P.S. Party. AMF, AGO, AKC and CCO received their old calls back. AMF and AGO are on 28 Mc., AKC and CCO on 7 Mc. DGU keeps 14-Mc. schedule with 1KRW to talk to his folks. FEV moved to Liberty and may be found on 1.75-Mc. 'phone. BBS has new HQ-120X. DW had nice trip to Board Meeting; he operated 6USA, C'XF, CWD, BCG, GAP, UB and BRT graduate from State College. BV has 8JK beam on 14 Mc. DOR and DKF are on 28 Mc. OG is working for DXCC, and has 85 countries. DGV is putting up vertical tower for 28-Mc. antennae. I want to express the North Carolina fellows' appreciation to the Winston gang for swell hamfest held last Sunday in April. Don't forget the big hamfest of the North Carolina Club in Asheville on July 2nd. See you there.

Traffic: W4DLX 133 FCB 127 FIX 10 CCO 6 BHR 5 BV-AAK-CYB 4 FJS 2.

SOUTH CAROLINA — SCM, Ted Ferguson, W4BQE — FEH is working on new 28-Mc. antenna. CUR has schedules on 7 Mc. AUW, now W.A.C., likes his Johnson rotary. FMZ schedules CZN and CZA. DPN is rebuilding power supplies. EXJ is doing FB work on 7 Mc. DQY will be married in June. Lots of luck, OM. EZF is active on 1.75-Mc.

Net. DRE is on with FB rig. CE returned to the air using T40 on 'phone and c.w. ANK operating c.w. handles traffic for Columbia area. CZA is active on T.L. and nets. CQU schedules CZN, CZA and DXF. Don't forget the hamfest, Asheville, N. C., July 2nd. See you there!

Traffic: W4CZA 92 DXF 51 FMZ 30 BDT 12 CQU 11 ANK 9 EXJ-EZF 8 DPN 4 DWG 3 DRE 1.

VIRGINIA — SCM, Charles M. Waff, Jr., W3UVA — R.M.'s: GTS, HDQ — P.A.M.'s: AIJ, GWQ. HAE reports Norfolk Radio Club progressing nicely. FBL reports 7-Mc. DX setting good. JG using a '10 on 3.5 Mc., would like to QSO Va. hams. HBH, at Woolwine C.C.C. Camp, would like to form C.C.C. Net; all interested write him. BZE enjoyed W-VE Party with 30 watts. GKL gave up 1.75-Mc. 'phone for 7-Mc. c.w. GIC is on 7007 kc. DZW likes his new 14-Mc. "Q." GWQ has two rigs on 1.75-Mc. 'phone. FJ, CYW, and CFL are on 56 Mc. looking for DX. ELN would like to QSO Va. station on 3.5 Mc. HLC is new O.P.S. AIJ says: "90 per cent rag chewing, 10 per cent experimenting." EMM and CHE are neck and neck, each with 141 countries worked; EMM has 129 confirmed, CHE 123. BFW is using 7269 kc. with 1-kw. input. EVA added P15EE for new country and 6JQL for Nevada and W.A.S. AHQ is on c.w. for first time in years. FQO lost antenna pole in wind storm. The Norfolk Hamfest Committee announces June meeting of VIRGINIA FLOATING RADIO CLUB will be held June 24th-25th at the Terrace Beach Club, Virginia Beach, Va. Saturday will be play time and Sunday meeting time. Registration will include dinner and swimming privileges. Hope to see you all there. BZE makes the B.P.L. on deliveries.

Traffic: W3HTD 246 BZE 230 ELN 202 GIC 74 HAE 34 HBH/3 39 GKL 22 HLC 6 FBL 4 AHQ 2.

WEST VIRGINIA — SCM, C. S. Hoffman, Jr., W8HD — Dr. Friend (O.R.S./O.P.S.) 8KIU/DSJ, one of the most faithful appointees, leaves W. Va. Univ. in June, to take up work at Harvard U. He will be missed by hams in his local city. RCN, NIY and BWK are members of the Ohio River Emergency Net on c.w., KSJ and MOL on 'phone. TID is Mayor of Bethany besides being Prof. at the College. Hil "Dad," Sr. opr. of KSJ is now TCP. KSJ worked Costa Rica on 3.9-Mc. 'phone. New officers Wheeling Radio Club: TCP, pres.; BTV, c.pres.; KRU, 2nd vice-pres.; Ex-8EEO, secy. MLW moved to East Beckley. TJY is new Dunbar ham. QWM is working with low power. JKN was "interviewed" on "Amateur Radio," a broadcast on W. Va. Wesleyan program from WMMN. LEK and PGL moved to Clarksburg. JM now has W.A.C. New Fairmont ham: TFF. TDQ is new Huntington station. NEU uses portable on fishing trips. SDU is on 112-Mc. JM is new O.R.S. OXO has been QRL Trunk Line "B." QBS is at Durbin C.C. Camp. The S.C.M.'s appointees as of June 1st: O.R.S.: PQQ, BTV, BWK, HD, PSR, CDV, GBF, FTJ, LCN, ELJ, ELO, OLV, RDH, PHY, LIJ, JM, OXO; O.P.S.: AHF, KSJ, BDD, MOL, QFN, MOP, SES, JM, BRE, RJG; O.B.S.: NEU, JRL, CFB, BOK; O.O.: OJ; R.M.'s: OXO, PTJ; P.A.M.: BDD. The S.C.M. would be very glad to hear from others interested in the various appointments.

Traffic: W8OXO 176. LIJ 97 PHY 6 PSR 5 BWK 4 KSJ-BTV 2.

HUDSON DIVISION

EASTERN NEW YORK — SCM, Robert E. Haight, W2LU — KWG keeps West Point well covered. LSD has new rig completed. HXQ invites all hams visiting World's Fair to look for the Ham Shack. LRW and JJC joined the A.E.C. LLU plans to try 'phone. HNH is on 3.9- and 1.75-Mc. 'phone with 35 watts to a '45 final. IKV relayed information on OQ5ZZ special broadcast to amateurs to A.R.R.L. ACB completed precision e.c. exciter unit for use on 3.9 Mc. KJD hails from W.N.Y.; welcome, OM. SZ held open house. Don't forget to report to your S.C.M. on the 16th. CGT is working 14 Mc. HES, HVS and DOS get on 7 and 3.5. Mc. from time to time. AGZ is just getting around to building up his own rig; he spent the last two or three months building up a fine portable-emergency rig for the Mid-Hudson Club. AFI gets on 7 Mc. regularly with HF-100. CDM is pounding away on 14 Mc. with 700 watts. BJX is in the process of rebuilding.

Traffic: W2KWG 122 KXF 82 LU 48 LSD 29 HXQ 13.

NEW YORK CITY AND LONG ISLAND — SCM, Ed. L. Baunach, W2AZV — New appointments: AXZ, O.R.S.; ESO, O.O. LZR sent his first report. IOP received D.J.D.C. DX award for district, also made 30,000 points in

W-VE contest, SC made the B.P.L. plus! AHG is working on JZX's portable, CXP is working on rig for new car. JWX rebuilt HF100 rig. KYO worked 500th "G." JBL, 1 operated in O.R.S. party from Vt. IXQ is on 7 Mc. with new e.c.o. LOK is rebuilding for 1.75 Mc. BMT has a new Sky rider 5-10. KUY and LBK put up new antennas. LKX is on 1.75 Mc. The Suffolk Amateur Radio Club is now formed with following officers: Pres., HNY; vice-pres., GAH; treas., BIU; secy., DOG. Meetings are held at Town Hall, Riverhead, and membership is open to anyone interested in amateur radio residing in Suffolk County. For further information get in touch with DOG. LVB is new Riverhead station. HGO is building a rack for 56-Mc. outfit. HYJ has been building radio control equipment for his ten-foot model airplane; on May 15th he worked 9MXK on 56 Mc. JUX is experimenting with u.h.f. oscillators. LJJ on 112 Mc. worked ten miles with 10-watts input. DMM has new 56-Mc. rig in car. LGK gets crystal reports with his P.P. '45 rig with 5-watts input. APM, HBO and ON are on 112 Mc. BMW is rebuilding his RK20 final for 3.5, 7 and 14 Mc. At a Bowling Match on May 2nd the Queens Radio Amateurs defeated the Tu-Boro Radio Club. BGV gave up 7 Mc. to work DX on 14 Mc. LEN moved to Manhattan Beach. PF is QRL getting World's Fair traffic nets going. LOQ is N.Y.C. Out for trancon net to P.I. on 7104 kc. LOE reports for Brooklyn Tech. H.S., CXN; 18 are licensed out of a membership of 175. EC is on the A-P trunk line on 7260 kc. BGO is looking for more A.E.C. registrations in the Bronx. The E.C.'s of the section are on 3710 kc. every Sunday at 11 a.m. The following stations are on the N.Y.C. and L.I. Section and Emergency Net at 7:30 p.m. every night (LR is control station for traffic; AZM is emergency control station): DBQ, CEN, ESO, GDF, GIC, HMJ, ITX, JHB, KI, LBI, LEB, LHP and LPA. More stations are invited to join the net and have some good QSO's. LR and LBI are planning portable outfits for an A.E.C. field day. Self power has proved itself useful more than once at AZV. KDS keeps 'phone schedules with VK2AGR.

Traffic: W2NC 1535 HMJ 400 ITX 220 (WLNW 96) DBQ 96 (WLNW 225) GDF 91 KI 85 LR 79 JZX 78 LOQ 67 AZV 65 BGO 57 AXZ 56 AHG 39 PF 27 LBI 20 AZM 19 JHB 18 FF 17 IOP 16 CET 15 ESO 14 LZR 13 CHK 12 AA 11 CIT-KYO 10 EC-DLR 9 JBL-ADW 8 LPA-DKJ 7 IRC-FLD 5 DMM-BYL 4 HGO-EXR 3 JDG 2 DOG 1.

NORTHERN NEW JERSEY — SCM, Fred C. Read, W2GMN — N.N.J.-1 Net closed its regular schedules for the season June 1st. Net members had a get-together June 2nd at the home of CMC in Haworth. KHA completed contacts for W.A.S. BCX and GVZ attended A.A.R.S. meeting in Trenton, April 29th. GVZ has worked 124 countries. KIF runs 75 watts to a 6L6G. IZF has new rig with T55 final. GME is awaiting Asia card for W.A.C. KTM rebuilt for higher power. HFN is using 14-Mc. 'phone. IOZ is on 1.75-Mc. 'phone. LMB using 1.75-Mc. 'phone has worked 27 states and Canada. New officers of Jersey Shore Amateur Radio Assn.: FZY, pres.; LMB, secy.; John Hollywood, treas. BRO has 832 on 112 Mc. New 14-Mc. rotaries are ordered for ZA, KM, CCJ, AVO, ALO, GJF, KGJ and CBL. The 14-Mc. gang has been showing HB9J how we do things here (and learning how they do things there). GYY has new motorboat and plans 56-Mc. operation. FLB is putting 1.75-Mc. 'phone in steel rack. BCC has 56-Mc. converter for BC receiver in car. JWT, formerly active in E.N.Y. section, sends FB report from new location in Jersey City; he has been appointed O.R.S. 3GNU calls attention to outing of Delaware Valley Radio Assn. at Trenton State Fair Grounds Sunday, August 6th. Everyone is welcome to this very popular annual affair. CGG is new Route Manager. HWI is looking for more schedules; he is on 7030 kc. during day and 3515 kc. after 6 p.m. Another member of the North Newark Amateur Radio Club, MDF, has obtained license. The club had swell time in A.R.R.L. Field Day. The following kept transmitters on all bands: IGT, IWY, IYQ, JBY, JFB, J LX, JSF, KON, KRA, LGY, LLJ, LJY, LTI, HOZ and BPV. IWY acted as field manager with IYQ as chief operator. A motion picture record of the club's activities was part of the fun on Field Day. LUI is rebuilding to take in 28 Mc. HRZ is redesigning the rig. LMQ and LEY continue active on 1.75 Mc. LXI has great success with new beam on 14 Mc.

Traffic: W2HWI 474 CGG 154 GVZ 282 (WLNI 29) KHA 107 KMI 77 CMC 27 HHY 23 LAO 15 BZJ 14 HXI 12 LMN 11 CIZ-KIF 4 HDJ 2 HQL 13 (WLNK 24) KTR 1 JWT 79 (Mar. 16-Apr. 15 CGG 207).

The New England Division Convention

It is not very often that a radio club has an opportunity to celebrate its twentieth anniversary and at the same time help in the celebration of the twenty-fifth anniversary of the A.R.R.L., by holding the annual New England Division Convention and featuring the two events. The honor for this unique event goes to the Springfield Radio Association, the sponsor of the 1939 New England Division Convention held at the Hotel Charles, Springfield, Mass., May 20th-21st.

With a fine address of welcome by His Honor, Mayor Putnam, to which an answer was made by A.R.R.L. Treasurer Hebert, the convention activities started off right. With the guiding hand of "Ike" Creaser, assisted by "Jimmie" Finnerty and John D. Burdett, the program was carried out with clockwork precision. All meetings were well attended and every one had an opportunity to hear W. J. Barrett, WJAH, S.C.M. for Western Massachusetts; F. E. Handy, WIBDI, Communications Manager, A.R.R.L.; Director Percy C. Noble, WIBVR, who gave a report on the annual board meeting held in San Francisco. Ed. Tilton gave the dope on 5- and 10-meter 'phone operation. John H. Ferguson, WIIM, President of the New England Radio Club Council, had charge of the meeting pertaining to the activities of the council. All radio clubs should be a member of the council. It has a very definite place in the activities of the N. E. Division.

The Red Cross, through the kindness of Mr. Curtis F. Brace, gave a demonstration of artificial resuscitation. The Army Amateur Radio System meeting carried on its tradition of being ready and as usual the meeting was of interest. Not to be outdone, the Naval Communication Reserve, under the direction of Ensign Kozacko, made a trip to the Naval Armory and the large group of N.C.R. members were well repaid for the trip, as the Springfield unit is one of the few with headquarters to be proud of, and explains the enthusiasm of the unit. Television Equipment from the F. W. Sickles Company was on display.

While all these events were taking place, the ladies were being entertained. A new form of entertainment was introduced at the Saturday evening party by local entertainers, known as the Thespians of East Springfield, under the direction of Hilda Maddock. Songs, dances, banjo and guitar solos and short skits proved entertaining.

The banquet was the big event of the convention with really good food being served. The toastmaster, Vice-President Geo. W. Bailey, acquitted himself of his duties by properly introducing Col. Van Horn, chief signal officer for the First Corps Area; A. A. Hebert, WIES; F. E. Handy, WIBDI, and Director Percy Noble who were the guest speakers. As a *finale* came the drawing of prizes with appropriate prizes for the ladies.

— A. A. H.

"LIFEGUARD" TERMINAL PROTECTION

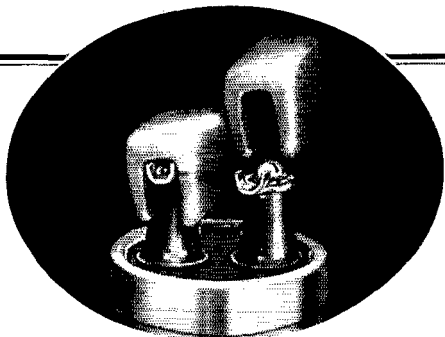

SPRAGUE'S ANSWER to the SAFETY PROBLEM

DON'T electrocute yourself! Insist on Sprague Transmitting Condensers with the exclusive new Lifeguard Terminal Insulation Caps. Caps fit snugly over terminals — give full protection against ever-present danger of shock from stored-up charge which may be retained in condensers for days.

FREE . . . Lifeguard Caps are supplied at no extra cost with every Sprague Transmitting Condenser — or you can buy them for your old condensers at 25c list for a pair. Thus, at no more than the cost of ordinary condensers, you get full Sprague quality plus the Sprague protective features.

4 SAFETY FEATURES make SPRAGUES safest!

- Lifeguard Terminal Insulation Caps.
- Terminals insulated from cans for at least twice the working voltage.
- Metal cans can be grounded automatically through mounting clamps.
- All Condensers oil impregnated — oil filled (not oil impregnated and wax filled) with SPRACOL 500 degrees flash protection oil.

ALL ROUND and RECTANGULAR TYPES

Unconditionally guaranteed.
Typical values: Type OT
(round), 2 mfd., 1,000 V., net
\$1.65 — 2 mfd., 2,000 V., \$2.55
— 1 mfd., 3,000 V., \$4.50.

Type GR (rectangular) 2 mfd.,
1,000 V., \$2.40 — 2 mfd., 2,000
V., \$3.30 — 1 mfd., 3,000 V.,
\$7.20.

Write for catalog of all
Sprague Condenser types
for all applications

Sprague Products Co.
North Adams, Mass.

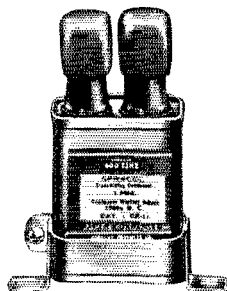

SPRAGUE

TRANSMITTING CONDENSERS

Stepping Up Receiver Performance

(Continued from page 70)

Sensitivity comparisons on 30 Mc. with manufactured receivers in the \$120 to \$170 class indicated that acorn tubes and good tuned circuits are worth while. In several instances, readable 'phone signals on the new receiver could not be found on the manufactured sets. No images have ever been heard on the 28- to 30-Mc. band in over a year of operation and tests.

'Phone selectivity is still a problem. The infinite rejection arrangement makes possible separation of two equal signals only 500 cycles apart, and of signals of widely different strengths if 1000 cycles or more apart. Many tests have been made in practical operation and the writers feel that infinite rejection is superior to any other arrangement for 'phone use. In order to carry this to a real conclusion, a new second i.f. is being constructed to use five infinite-rejection couplers, two at plus and minus 2500 cycles, two at plus and minus 4000 cycles, and the fifth variable from the panel.

While it is felt that only a very rough outline has been given, amateurs seriously interested in greater possibilities in their receiving systems should find a number of leads to work on. Checking through the *Handbook* and past issues of *QST* will give details of the particular circuits referred to.

It was not our intention to give details of a particular receiver, but rather to invite experimentation in order that our receiving systems may keep pace with our transmitters. We may have another receiver developed some time in the near future more nearly approaching the ideal. When and if it is finished we shall pass along the constructional details.

Paley Award to WIBDS

(Continued from page 23)

back at the store — on the dot. "It wasn't anything," he told a reporter recently. "Any amateur would have done it. Otherwise he wouldn't be a ham."

Burgess is the third recipient of the Paley Award, which is presented annually "to that individual who, through amateur radio, in the opinion of an impartial Board of Awards, has contributed most usefully to the American people, either in research, technical development or operating achievement, and to be open to all amateur radio operators in the United States and Canada." The first award went to Walter Stiles, Jr., W8DPY, of Coudersport, Pa., and the second to Robert T. Anderson, W9MWC, of Harrisburg, Ill.

The trophy, which is in the permanent custody of the A.R.R.L. and is on display in the Headquarters lobby, is a modernistic representation of the symbolism of amateur radio, designed by Alexander Calder, internationally known sculptor.

Mr. Paley announced establishment of the award shortly after the eastern states flood dis-

Get the Low-down on TELEVISION

WITH A

 *Meissner*

**TELEVISION KIT
COMPLETE . . . SAFE
. . . GUARANTEED . . .**

**\$139⁵⁰ INCLUDING
ALL TUBES**

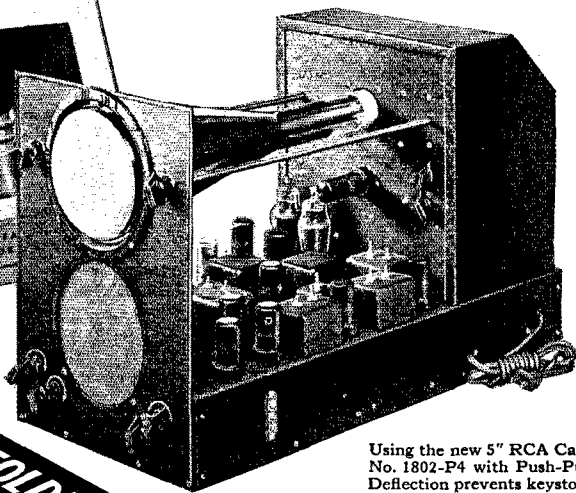

SEND FOR FOLDER

Using the new 5" RCA Cathode Ray Tube No. 1802-P4 with Push-Pull Electrostatic Deflection prevents keystone (distortion at edges) and permits perfect focusing. Kit complete in every detail.

Meissner has developed this Kit—your OPEN SESAME to the thrilling World of Television—expressly for the Nation's HAMS and experimentors.

The Meissner Television Set has been engineered to the most exacting specifications. It gives you a Video and Audio Receiver, that is highly sensitive, flexible and efficient. You'll not only get superb results but cash in on your technical knowledge and skill by turning out a Set that will be the envy of all who see it—and, of course, at a

great saving over the commercially assembled sets the layman buys.

Get the whole story. Mail coupon for Folder shown above. It tells all about this brilliantly engineered, up-to-the-minute Set...explains its many unique features in detail...including the SPECIAL SAFETY Devices which automatically protect you from all danger of shock from the High Voltage Current.

WRITE FOR OUR NEW 1939-40 CATALOG—OFF THE PRESS JUNE 15TH

YOUR OPPORTUNITY

The early radio experimentors are to-day's leaders in the industry. Television now offers you a similar opportunity to get in on the ground floor. Get started by building the Meissner Television Receiver.

MAIL IN ENVELOPE OR PASTE ON PENNY POSTCARD

MEISSNER MANUFACTURING COMPANY
Mt. Carmel, Illinois, Dept. Q-7

- Send me the Television Kit Folder
- Send me Meissner's complete new 1939-40 Catalog

Name.....

Address.....

City..... State.....

 *Meissner* MT. CARMEL, ILLINOIS
A FAMOUS NAME FOR TWO DECADES

★ **RCA** ★

**TELEVISION RECEIVERS
ON DEMONSTRATION**

★

**IN STOCK ANDREA
TELEVISION RECEIVERS**

In kit form and factory wired!
Complete parts less tubes....\$79.95

★

MEISSNER

TELEVISION KITS IN STOCK

Most practical and complete kit on the market

Extreme Flexibility

Due to the flexibility of the circuits, accessibility of controls, and provisions made for further adaptation and experimentation, the Receiver is exceptionally versatile.

The Set is designed to receive the standard R.M.A. signal (441 lines). It is provided with a switch for tuning in both the 44-50 and the 50-56 megacycle channels.

Also, space is provided in the switch assembly for the addition of two more coils, thus enabling you to easily and inexpensively expand the set for 4-station reception.

★

**New HOWARD
460 RECEIVER**

With the new built-in Frequency Monitor and Noise Limiter

Model 460 is a ten-tube Communication receiver with four bands covering 540 KC to 43 megacycles with a new NOISE LIMITER and the precision frequency monitor by which ham frequencies are calibrated against popular broadcast stations! Crystal I.F. filter optional.

With separate matched dynamic speaker, complete...\$79.95
Crystal filter extra..... 10.00

★

**HALLICRAFTER
FREQUENCY METER**

Model HT-7. It may be used to set or check existing calibrations or to make initial calibrations. By following a simple procedure it is possible to check the frequency of any signal within close limits.

★

**STACO Antenna
CHANGE-OVER RELAYS**

Mycalex insulation up to 60 mc.....\$4.50
Bakelite insulation efficient up to 14 mc..... 3.00
Available in 110 volts AC. Guaranteed not to hum

OUR *Best* VALUE IS OUR RECORD OF LOYAL SERVICE

HARVEY
Radio Company of New York

103 WEST 43rd STREET • NEW YORK, N. Y.

CABLE ADDRESS: "HARADIO"

asters in early 1936 when amateur radio operators rendered outstanding service to their stricken communities. "In the development of major industries, as in the growth of sports," he declared, "the amateur precedes the professional, and we in commercial broadcasting owe a debt of gratitude to those thousands of experimenting enthusiasts who first broke the ground in the limitless field that is radio to-day."

"Switch to Safety!"

Duplicate Prizes Awarded

AMATEUR radio's penchant for shattering precedents extended to *QST*'s safety slogan contest, announced in the March issue, when *four* entrants instead of one received prizes for submitting, "Switch to Safety." Two received the full amount of the award — \$25 each — for submitting the exact slogan chosen. They are George P. Huntley, W6LIF, and Joseph A. Hoffman, W2DIJ. Henry Maher, Jr., W1KRN, and R. K. Brown, W5COE, received consolation prizes of \$10 for slogans closely resembling the one chosen.

Nearly 3000 entries were received, coming from ten different countries. The task of selecting a winner was a formidable one. First, the members of the headquarters staff read through the entire lot (entries being identified only by numbers, with author's names omitted). About 120 were selected as possibilities. A second ballot reduced the number to 15, from which the winning entry was chosen.

Among the entries receiving persistent support were "You are an amateur — Death isn't," "A ham alert is a ham unhurt," "Shut it off; you're not that lucky," "Caution, please — no Silent Keys" (loyally supported by WITS, our S.K. editor), and "Seek (C) You (Q) Safety."

Striking as it is that the winning slogan should have been submitted by four entrants, the similarity of many other suggestions is even more amazing. There were hundreds of variations on the dismal themes of "burnt hams" and "fried hams," as well as "Kill the transmitter before it kills you," "Silent Keys" and "Remember Ross Hull." There were other hundreds of trick phrases based on abbreviations such as "SOS," "QST," "QRT," "ARRL," etc.

The rhymers and jinglers were out in full force. There was little to choose between, "Too cute to electrocute" and, "Volts are red, ohms are blue, amps are sweet but not in you." One practical-minded soul thought it well to "Be careful — we need your subscription."

The winning slogan, "Switch to Safety," seems to meet all the qualifications. It is catchy and easy to remember. Not only does it imply the use of switches and switching as an essential element of safety, but it suggests the idea of change of — acquiring safety habits. Then, too, it does emphasize the fundamental idea of *safety*, itself. All in all, it well typifies the spirit and purpose of the A.R.R.L. Safety Campaign.

Remember — "Switch to Safety!"

— C. B. D. and J.H.

FOR AMATEUR RADIO

New Tubes

In fulfillment of our pledge to develop tubes for interesting experimental work at modest expense, we announce:

HY51Z \$3.95 NET ZERO BIAS

Zero-bias Class "B" modulator, R.F. Class "B" and "C" power amplifier, frequency doubler. High- μ , high-efficiency triode with thoriated-tungsten filament.

- Filament voltage 7.5 volts
- Filament current 3.5 amps.
- Plate voltage (DC) . . 1000 max. volts
- Plate current 175 max. ma.
- Grid current 35 max. ma.
- Plate dissipation 65 max. watts
- Amplification factor 85
- Mutual conductance 7200 μ mhos

Interelectrode capacitances

- Grid to plate 7.5 μ f.
- Grid to fil 6.0 μ f.
- Plate to fil 2.0 μ f.

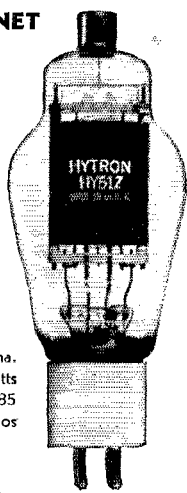

Ceramic base
Graphite anode

Bantams with Ceramic Base

Laboratory-built tubes, specially-tested for use in high frequency communications receivers, where maximum signal gain and circuit stability are needed.

6A8GTX \$.95 Net

Pentagrid converter. Will replace metal 6A8 and glass 6A8G.

6J5GTX \$.95 Net

Medium- μ triode. Replaces 6J5 and 6J5G.

6J7GTX \$.95 Net

Sharp cut-off pentode amplifier. Replaces 6J7 and 6J7G types.

6K7GTX \$.95 Net

Remote cut-off pentode amplifier. Will replace 6K7 and 6K7G.

6K8GTX . . . \$1.30 Net

Triode-hexode converter. Replaces 6K8 and 6K8G.



Ceramic base
Grounded metal shell

New Prices

Living up to our pledge to encourage experimentation through lower costs, we announce the following price reductions:

6L6GX Ceramic base
Beam tetrode

Was \$1.55 Net

NOW \$1.25

HY51A - HY51B 65-watt
triode

Was \$5.00 Net

NOW \$3.95



HYTRONIC LABORATORIES

SALEM

MASS.

A DIVISION OF THE HYTRON CORP.

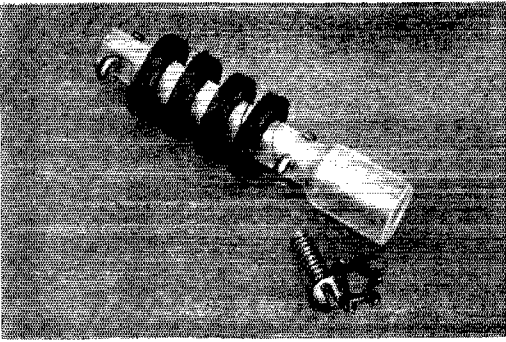

A NEW NATIONAL CHOKE

Similar in electrical characteristics to the well-known R-100 Choke, the new R-100U is designed to mount on the chassis like a stand-off insulator and has terminals instead of leads. Specifications: Inductance $2\frac{1}{2}$ mh., Distributed Capacity 1 mmf., DC Resistance 50 Ohms, Current Rating 125 MA. Length $2\frac{1}{2}$ ", Diameter $\frac{1}{2}$ ".

Type R-100U, List Price \$6.60

NATIONAL COMPANY, INC.
MALDEN, MASS.

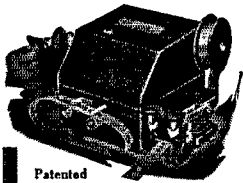

A Perfected AUTOMATIC SENDER

Patented
Postpaid in U. S. A. **\$12.50**

Patented

Save your fist. Let the Automatic Sender raise your stations for you. Repeats calls or messages indefinitely. Length of messages practically unlimited. Sends from 2 to 70 words a minute. Motor driven. Entirely automatic. Built-in tape perforator. Absolute uniformity in spacing of characters.

Speed up your receiving. Connect Automatic Sender with a buzzer or oscillator. Accustom yourself to receiving any speed you select up to 70 W.P.M. Makes excellent code teacher for novice. Complete with 6 rolls of tape and full instructions. No extra equipment needed. If your dealer can't supply, write us.

\$13.50

West of
Denver

FULLY GUARANTEED

Gardiner-Levering Co. Haddon Heights
New Jersey, U. S. A.

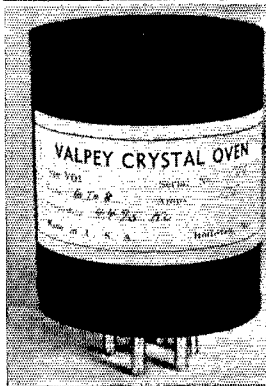

NEW VALPEY Type VO 1 CRYSTAL OVEN

This new and improved crystal oven has been designed so that any crystal unit which mounts in a five prong tube socket can be plugged into it. The oven in turn plugs into the socket from which the crystal has been removed.

The oven operates on from 6 to 8 volts at .75 amperes and will hold the temperature constant to 1 degree centigrade. Heater voltage may be taken from the oscillator filament supply.

Descriptive folder available from your dealer or direct

THE VALPEY CRYSTALS
815 321 HOLLISTON, MASS.

Rotating the Rotary

(Continued from page 85)

A 110-volt a.c. relay is used to reverse the field of the motor and change its direction of rotation. A single pole make-and-break type relay (110-volt a.c.) is used to start and stop the motor. The two reversing field leads are removed from the two studs in the little case on the end of the motor and brought out to the relay. A four-wire cable (rubber-covered G.E. type "S," four No. 16 conductor) runs from the relays at the pole to the operating position in the shack and terminates in a control box on the operating table. Each pair carries 110 volt a.c. at relay current only. (A 3-wire cable, with one side acting as a common ground, could have been used, but we had the four-wire cable on hand.)

A toggle switch controls the relay which reverses the field, and a push-button make-and-break switch controls the start and stop relay. By using this method, it is impossible to get a.c. on either the starting or reversing windings of the motor separately. This is important, as a good many fellows have ruined perfectly good motors by burning out a winding when a.c. was applied separately to one winding or the other, even only momentarily.

A "dog house" was built around the reduction system, to protect it from the weather. The chains enter through two slits in the roof. A trouble light was wired in the "dog house," in case of emergency repairs at night, and a lock put on the door to the "dog house," to short-circuit any curiosity the neighborhood youngsters might develop.

This beam and reduction system has been in use since November, 1938, in all kinds of "good old New England weather" — snow, ice, sleet, and freezing temperatures — and to date has functioned properly with very little trouble. This concoction may not be the ultimate, and may leave many things to be desired, but it certainly solved the problem here at WIAPA, and economically too.

The writer wishes to acknowledge many helpful suggestions and actual manual labor involved, by one of Bridgeport's coming hams-to-be, Luther A. Okerblom, and also WIAVC, Charlie Kovac.

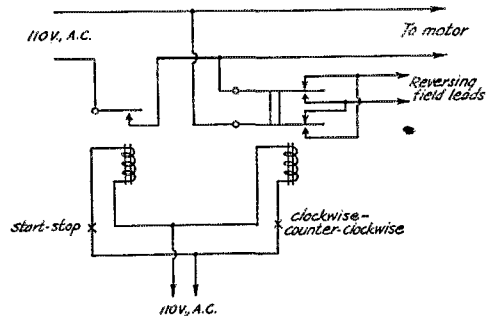
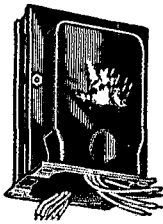

Fig. 2 — Wiring diagram of the electrical control system.

Buy on CREDIT ... AND BUY FOR LESS AT NEWARK

No CARRYING CHARGE

PLATE AND FILAMENT TRANSFORMERS



**600 VOLTS
200 MILS**
Special NEWARK value! Famous plate and filament transformer made for us only. Thousands used in Ham rigs. 600-0-600 at 200 MA; 2.5v. at 10 amps; 5v. at 3 amps; 7.5v. at 3 amps. Weight, 10 lbs. Use this transformer for your buffer and final amp stages. Just the thing for 46's, 120's, 807's,

etc. Only 59c extra down payment when included with time payment order. Price (N1000) **\$2.95**

Oil Filled, Oil Impregnated FILTER CONDENSERS

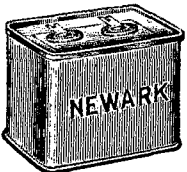

Only \$1.25
(1250 v. DC; 3 mid; 3 1/4 x 3 1/4 x 1 1/4; 1 1/4 lbs.) Included in your time payment order for only 25c to 55c extra down payment. These are well-known makes and only a few left of each. Guaranteed at rated voltages.

DC Volt	Mid.	Size	Wt.	Price
2000	2	4 1/4 x 3 1/4 x 1 3/4	1 1/4 lbs.	\$1.50
1250	3	3 1/4 x 3 1/4 x 1 1/4	1 1/4 lbs.	1.25
1500	3	5 x 3 1/4 x 1 1/4	1 1/4 lbs.	1.50
1500	4.4	5 x 3 1/4 x 1 1/4	1 3/4 lbs.	1.75
2000	8	5 x 3 1/4 x 3 1/4	2 1/4 lbs.	2.75

Your CALL LETTERS in GOLD 10c

Big shadowed decalcomania letters nearly TWO INCHES high. Put them on your HAM SHACK door, auto window, etc. Send time for yours today. Be sure to give your call letters.



NEW BASSETT BEAM ANTENNA MANUAL

25c

42 pages chock-full of real meaty dope on rotary beam antenna design, engineering and operation. The most up-to-date book of its kind on the market today.

Full line of amateur equipment, sets and parts totaling \$25.00 or more now available on a new credit plan. Pay only 20% down. Balance in FOUR EQUAL MONTHLY PAYMENTS and no carrying charges — no interest — no service fees. All merchandise shipped immediately, from big stock on hand, as soon as credit is ok'd.

NATIONAL

- NC 101X **\$129.00**
Only \$25.80 down, \$25.80 per month. Four months to pay — No carrying charge.
- NC 100XA **\$142.50**
Only \$28.50 down, \$28.50 per month.
- NC 44 **\$49.50**
Only \$9.90 down, \$9.90 per month.
- NC 80-81X **\$99.00**
Only \$19.80 down, \$19.80 per month.
- HRO DE LUXE **\$179.70**
Only \$35.94 down, \$35.94 per month.

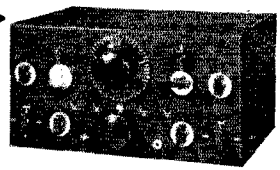

HAMMARLUND

- HQ 120 **\$129.00**
Only \$25.80 down, \$25.80 per month. Four months to pay — No carrying charge.

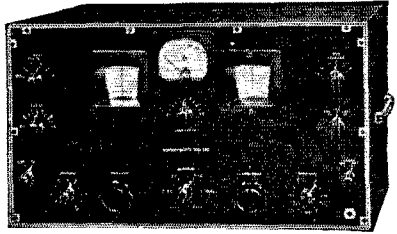

RME 70

\$138.60

- Only \$27.72 down, \$27.72 per month. Four months to pay — no carrying charge.
- RME 69 **\$152.88**
Only \$30.58 down, \$30.58 per month.
- RME 70 — DB 20 combination **\$181.80**
Only \$36.36 down, \$36.36 per month.

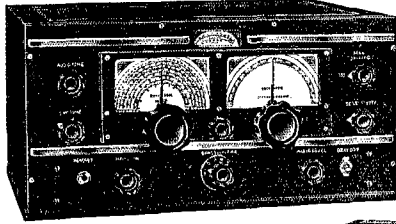

HALLICRAFTER

- SX23 **\$127.50**
Only \$25.50 down, \$25.50 per month. Four months to pay — No carrying charge.
- SKY BUDDY **\$29.50**
Only \$5.90 down, \$5.90 per month.
- SKY CHAMPION **\$49.50**
Only \$9.90 down, \$9.90 per month.
- SKY RIDER 510 **\$69.50**
Only \$13.90 down, \$13.90 per month.
- SKY RIDER MARINE **\$64.50**
Only \$12.90 down, \$12.90 per month.

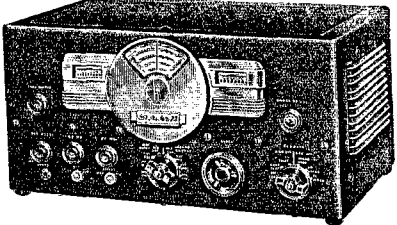

Newark can supply all new ham equipment as advertised anywhere and any time by any reputable manufacturer — on the same four-month credit plan — no carrying charge. It's easy to pay the Newark way!

ORDER Direct from NOW This Ad

★ NEWARK'S FAMOUS 6% EXTENDED PAYMENT PLAN

is also available on orders of \$60 or more, sets and parts, for those desiring a longer time payment period. Send only 20% DOWN PAYMENT with your order. Add 6% carrying charge to the remaining balance and simply divide by the number of months you wish to pay, up to 12 months.

WRITE TODAY FOR OUR FREE CATALOG

NEWARK Electric Company

323 W. MADISON ST. CHICAGO, ILL.
Dept. Q

QUALITY ABOVE ALL



TELEVISION CAPACITORS

For Advanced Amateur Experimental Use
Wider High Voltage Safety Margins
Write for Our Bulletin T-1

SOLAR MFG. CORP.

Bayonne • New Jersey

You'll get MORE QSO's after CANDLER TRAINING!

Skilled operators avoid the "lid" with the rotten fist and slow reception! But they welcome a call from Candler trained operators! Because with Candler training you acquire a smooth, rhythmic fist that's a pleasure to read — and you yourself can receive fast code without strain or conscious effort, copying behind on your mill as easily as you would read a printed page.

Many and many an operator thought he was permanently stuck, only to find after a few weeks of Candler training learning sound consciousness. that he was receiving and sending code at a speed he never dreamt he could attain. Send for your FREE "Book of Facts" today! Read what Candler training has done for other operators. Remember Candler has courses for beginners and advanced operators.



CANDLER SYSTEM CO.

Dept. Q-7, Box 331, Asheville, No. Carolina

British Address: Room 56, Craven House
Kingsway, London, W.C.2.

Mid-American and Dakota Division A.R.R.L. Convention

APPROXIMATELY 500 Hams from Minnesota, Wisconsin, Illinois, Iowa, North Dakota, South Dakota and Canada met for three days of concentrated activity, May 12, 13 and 14 at the West Hotel in Minneapolis, Minn.

Instead of the mayor presenting a key to the city to the convention, the Mid-American presented Hizzoner with the "Key to Hamerica." Mayor Leach of Minneapolis is a general in the U. S. Army Reserve and the key had a Navy knob! Lt. Comdr. Boyd Phelps, of the U. S. Naval Reserve, did the presentation honors, adding humor to this situation.

Highlights on the convention program included an Open Forum meeting the evening of the opening day in which Dakota Division Director, Fred Young, spoke to a packed house outlining the various decisions of the A.R.R.L. Board. (See minutes in July *QST* and also the June issue.) Conventioneers next retired to the "Rathskellar" for entertainment in a lighter vein including dancing, refreshments, and a showing of motion pictures which had been taken around the Dakota Division of approximately 100 amateur stations and operators. This film turned out to be one of the convention's outstanding features.

A Trade Show, in which many items of interest to amateurs were exhibited, was very successful and well attended. Besides the generous showing of Ham parts, the exhibitors also took charge of displaying the various prizes which they had assisted the committee in purchasing and which were drawn for after the banquet on Saturday evening.

The technical program of the convention presented well-known speakers such as Gerry Cole, Jim McLoughlin, McMurdo-Silver, Dr. Henry Hartig, F. E. Handy, Les Carr, H. R. Skifter, Forrest Nelson, Rex Munger, L. A. Morrow, Boyd Phelps, Karl Kopetzky and many others. Talks and demonstrations covered *every phase* of amateur radio such as beam antennas, micro waves, airways radio, plural modulation, modulation monitoring, external cross modulation, facsimile, crystal control, frequency measurements, receiver and transmitter design, remote radio control, army and navy amateur reserve activity, etc.

The program on Saturday was stopped momentarily when an apparent electrocution took place. Hams were suddenly *astounded and horrified* when Jack Hill, local amateur taking part in an apparatus demonstration, suddenly let out a yell, stiffened, and fell over backward. Before confusion grew too rampant, an announcement over the loudspeaker system assured everybody that it was purely fictitious, whereupon the local Red Cross authorities proceeded to demonstrate artificial respiration.

In publicizing the convention in advance, amateur radio was also popularized by means of

★ **THIRD** ★
ANNIVERSARY
SALE
NOW ON!

Why do amateurs prefer TERMINAL?
BECAUSE — 'TERMINAL' is staffed by men who **KNOW** radio, many of whom are active "hams" themselves.
BECAUSE — Quality is never sacrificed to create "bargains." Every item is guaranteed, regardless of its low price.
BECAUSE — 'TERMINAL' has two completely stocked, easily accessible stores in N. Y.

HUNDREDS
OF RADIO
AMATEUR
SPECIALS!

X-CUT FINISHED
CRYSTALS
40 — 80 — 160 METERS
 Large choice of frequencies.
SPECIAL ... \$1.19
BLILEY Holder .95

SPECIAL! THORDARSON
PLATE
TRANS-
FORMER
 Type 16P00.
 DELIVERS
 830/830 or 660/
 660 A.C. volts,
 650 or 500 D.C.
 volts @ 200 ma.

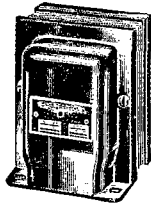

SPECIAL!
AEROVOX
"HYVOL"



Oil impregnated, wax filled condensers. Furnished with universal mounting brackets.

SPECIAL! CINAUDAGRAPH
 P. M. SPEAKERS
 Voice coil imp. 2½ ohms
 6" **\$1.49**
 8" **1.98**
 Universal output transformers **.39**

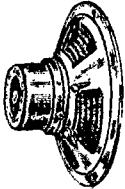

SPECIAL \$2.69
MASONITE RELAY RACK
PANELS
 Black crackle finish, 19" wide
 3½" 34¢ | 8¾" 59¢
 5¼" 46¢ | 10½" 72¢
 7" 51¢ | 12¼" 81¢

1000 v. D.C.W. 1500 v. D.C.W.
 2 mfd. \$1.25 | 2 mfd. \$1.69
 4 mfd. 1.69 | 4 mfd. 2.69
 2000 v. D.C.W. 3000 v. D.C.W.
 2 mfd. 1.98 | 2 mfd. 4.25
 4 mfd. 3.35

ANTENNA WIRE
 Solid Copper Enameled
 No. 14, per 100 ft. **35¢**
 No. 12, per 100 ft. **49¢**
 No. 10, per 100 ft. **85¢**

RECEIVER
HEADQUARTERS!
 We Are Authorized Distributors
 New Receivers in Stock
 Hallicrafters SX-24..... \$ 69.50
 Hallicrafters SX-23..... 115.50
 Hammarlund HQ-120X..... 129.00
 Howard 160..... 79.95

Complete Stock of
TRANSMITTING
TUBES
 RCA • HEINTZ & KAUFMAN
 TAYLOR • RAYTHEON
 EIMAC • HYTRON

Porcelain Feeder Spreaders
 2"—6¢ 4"—8¢ 6"—10¢

Others on demonstration at both TERMINAL stores in N. Y. Liberal allowance for your old set.

SPECIAL FEATURES
 At 80 Cortlandt St. store. Special floor devoted to P.A. On demonstration: Amplifiers — micro-phones — hi-fidelity tuners — pickups — Lansing hi-fi speakers. TELEVISION SETS AND KITS.

PAR-METAL
RACKS — CABINETS
CHASSIS — PANELS
 Ours is the largest complete stock in New York. Visit our showrooms, see them all.

HALLICRAFTERS HT-6
TRANSMITTER \$99.00
HALLICRAFTERS HT-7
CRYSTAL MONITOR
\$29.50

At 68 West 45th Street store. All popular and classical records — BCL receivers — P.A. — Television.

SPECIAL!
Pi Wound RF CHOKES
 on ceramic forms. 2½ mh.
 @ 200 ma. **19¢**

RELAYS — In Stock
 Guardian • Ward Leonard
 Gordon • Struthers Dun
 Leach

At BOTH stores. Two big floors of everything in radio for the amateur and engineer.

EXPORT
DEPT.
 Our customers the world over find it profitable to deal with TERMINAL.
 Write for details

TERMINAL Radio Corp.
2 STORES IN NEW YORK CITY
80 CORTLANDT ST. • 68 WEST 45th ST.
 Cable Address: TERMRADIO

MAIL
ORDERS
 Prompt attention to mail and phone orders. Orders above \$5.00 shipped prepaid.
 Phone: V. A. - 6-5050

OHMITE BROWN DEVILS

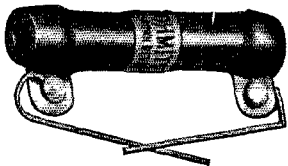

You're *sure* of continuous trouble-free service when you use Ohmite "Brown Devil" Resistors for voltage dropping, bias units, bleeders, etc. Their dependability is proved in countless amateur and commercial installations the world over. "Brown Devils" are built right from the core out — sealed tight and permanently protected by Ohmite Vitreous Enamel. They stay on the job. Popular 10-Watt and 20-Watt sizes, in resistances from 1 to 100,000 ohms.

At Your Jobber or Write for Catalog 17

OHMITE MANUFACTURING CO.
4863 Flournoy St., Chicago, Ill., U. S. A.

Be Right with **OHMITE**
RHEOSTATS • RESISTORS • TAP SWITCHES

**DIRECT
READING —
CRYSTAL
STABILITY**

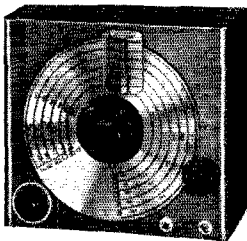

OF the several methods of frequency measurement possible to amateur and commercial transmitters, we believe the continuously tunable — and hence direct reading — frequency meter is the best. The use of our U-10 Frequency Meter-Monitor in amateur, broadcast and police stations numbered by the hundreds seems to prove we're right.

But this idea is no good at all unless the instrument is so built as to be truly stable — truly dependable as to dial calibration.

With such an instrument as the U-10 having a 7 1/2" direct reading dial, plus large size calibration sheets, direct reading of an unknown frequency is possible — no guesswork is involved as to how far away from a fixed checking point the unknown frequency may be. Instead, it is read directly to amazing accuracy.

And of course this flexibility gives that ability to set a warming up receiver "right on the nose" of a new "sked" — to get his first call instead of hunting for him. Users tell us this is invaluable.

See the U-10 — and other fresh new items at any up-to-the-minute jobber, or write for full data.

If you have a U-10, send us its serial number and name of jobber purchased from, and we'll mail you big amateur band calibration charts free.

EDWIN I. *Guthman* & CO., INC.

400 S. PEORIA ST. CHICAGO, U. S. A.

CABLE ADDRESS: GUTHCO-CHICAGO

several 15-minute transcriptions, dramatizing the amateurs' part in normal and emergency operations. These were used by dozens of broadcast stations in the Dakota Division in addition to some in Iowa and Wisconsin. The transcriptions were presented at the convention for the benefit of several who had not heard them. The broadcast stations were very cooperative in presenting the amateur's cause to the public.

The convention closed Sunday at 5 P.M. with a re-showing of the Ham station motion pictures. The entire series of technical discussions Sunday, including Communication Manager Handy's address, were well attended. It was a colorful affair throughout marked by busy and profitable sessions, interesting exhibits of QSLs and ham station photos, and high class banquet entertainment.

The attendance record (a new high), the varied program, the several outstanding features, the Trade Show and the splendid cooperation on the part of the Hotel management, all combined to make the 1939 Mid-American and Dakota Division A.R.R.L. Convention an outstanding success.

— Ward Jensen

Strays

Thousands of radio hams will be sorry to learn that "Dick" Bartell — the "Pepper Pot" and newly acquired shortstop of the Chicago Cubs — is not a radio amateur. Richard Bartell started his career with the New York Giants in 1935. From the very beginning, he was a veritable "ball of fire" on the baseball diamond. One day, while they were going to the dugout, one of his teammates said, "You're worse than one of those short-wave hams for jabbering." "Short Wave" stuck with him. Newspaper and magazine articles had him listed as a short-wave ham. Walter Winchell and Clem McCarthy mentioned it in their columns. Hams all over the United States have written to him and the burden of answering the flood of correspondence has not been a small one. Many times he asked the newspaper writers to correct the error, but to no avail. He had never seen *QST* until recently — not until I visited him in the hospital to ask him what call he is using. So, Mr. Winchell and Mr. McCarthy and all the hams know now, through *QST*, that Dick Bartell is not a radio amateur — but, boy, when sweeter shortstops are made they'll have to be better than Richard Bartell.

— W9UZ

Roanoke Division Convention

DATE: August 5th and 6th.

PLACE: Charleston, W. Va.

HOTEL: Daniel Boone.

Further information may be obtained from Mel Swellinger, W8NLT, Box 154, Charleston, W. Va.

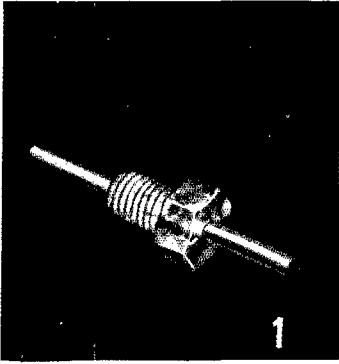

1

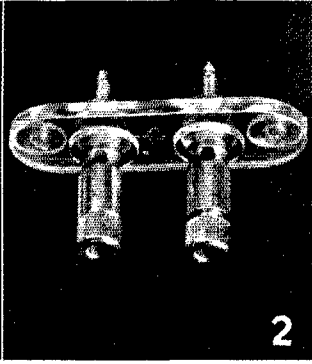

2

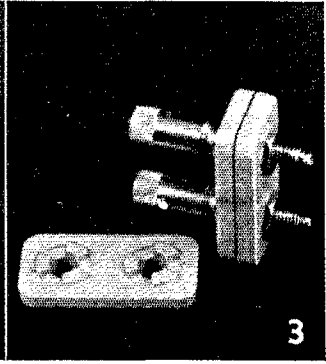

3

EASY TO INSTALL, EFFICIENT IN USE

ONE: The Through Point Bushing, of injection-molded Victron, is ideal for a variety of uses, particularly as a bushing or as a standoff. It is supplied with a .093" conductor molded in, but this can be removed without damaging the material. Losses are very low. The price is only \$.45 net per box of 12.

TWO: This terminal strip is of injection-molded Victron, and was originally designed for antenna connections on the ultra-high-frequency ONE-TEN receiver, where low losses are essential. The

binding posts accept banana plugs at the cap, and clamp wires firmly through the hole. Type FWB Terminal Strip, Net Price \$.06 each, without binding posts. Type FWA Binding Posts, Net Price \$.15 each.

THREE: Type FWC insulators may be used either with binding posts or jacks. The serrated bosses interlock so that they can be clamped on the thinnest panel. They are molded of R-39 for low losses. Type FWC Insulators, Net Price \$.21 per pair.

NATIONAL COMPANY



MALDEN, MASS.

QSL Cards

Individual QSL Cards printed as you want them, at reasonable prices.

Samples gladly submitted on request.

HINDS & EDGARTON, INC., W 9 W R
Ex. W9APY
19 South Wells Street, Chicago, Illinois

Piezo-Electric Crystals Exclusively

- Quality crystals of all practical frequencies supplied SINCE 1925. Prices quoted upon receipt of your specifications.

Our Pledge: **QUALITY FIRST**
SCIENTIFIC RADIO SERVICE

"The Crystal Specialists Since 1925" University Park, Hyattsville, Md.

• TELEGRAPHY—TELEVISION—TELEPHONY •

AVIATION
TRANSRADIO
PRESS
TELETYPE
TYPEWRITING



PRACTICAL
EXPERIENCE
STUDIO —
TRANSMITTER —
ANNOUNCING

The major technical training equipment owned by Port Arthur College and in operation on the college campus consists of the 500-Watt Commercial Broadcast Transmitter of Station KPAC, two-way Television Transmitter and Receiver, Latest Type RCA Marine and Airways transmitter installation complete, SOS Automatic Alarm, Marine Direction Finder, Trans-radio Press Receiving Equipment, and Laboratory complete where students assemble composite transmitters, amplifiers, audio amplifiers, R. F. amplifiers, etc.

Port Arthur College pioneered the teaching of Radio with classes in 1909, and for thirty years has maintained an active Employment Bureau for the placement of its graduates

If interested in details about Radio Course, write for Bulletin R

PORT ARTHUR COLLEGE ■ **PORT ARTHUR (World-Known Port), TEXAS**

It Will Pay You!

When you need amateur equipment it will pay you to write me. I make it my business to be able to supply all amateur receivers, transmitters, kits, antennas, and parts at the lowest net prices in any catalog or advertisement. I try to be the first to supply the newest equipment. I will help you get the best equipment for your use. All equipment is available on W9ARA's 6% terms financed by myself so you can buy with less cost and more convenience.

You get personal attention you can't get elsewhere; fair trade-in value for your receiver and equipment; ten day trial of all receivers; and my co-operation in every way to see that you are 100% satisfied. No wonder W9ARA's customers are boosters. You will be too.

Your inquiries and orders invited. You can reach me by letter, telegram, phone, or visit nearly 24 hours a day, 365 days a year. Foreign orders solicited too. Write for full information.

Bob Henry

BUTLER

W9ARA

MISSOURI

PRACTICAL RADIO ENGINEERING

Complete COURSE in ONE YEAR!

Train now for new opportunities in Radio and Television Engineering. One-year residence course begins Sept. 18 in our new building. Learn by theory and practice in modern-equipped shops and "labs". Write today for details about CREI courses. Free book sent on request.

Dept. Q-7, 3224-16th St. N. W., Washington, D. C.

SEND FOR FREE CATALOGUE

CAPITOL RADIO ENGINEERING INSTITUTE

SICKLES COILS

SECURE A COPY OF OUR NO. 939 CATALOG FROM YOUR JOBBER

F. W. SICKLES COMPANY

300 Main Street

Springfield, Mass.

EASY TO LEARN CODE

It is easy and pleasant work to learn the modern way — with an Instructograph Code Teacher. Ideal for the beginner or advanced student. ■ Many tapes available ranging from alphabet for beginners to typical messages on all subjects. Speed range 5 to 40 WPM. ■ Always ready, no QRM, beats having someone send to you.

FOR SALE OR RENT

STANDARD with 10 tapes and book of instructions \$20.25

JUNIOR with 5 tapes and book of instructions (not rented) \$12.00

RENTAL Standard with 10 tapes and book of instructions \$3.00 first month, \$2.25 each additional month. All rental payments may be applied on the purchase price should you decide to buy the equipment.

Write for details today

INSTRUCTOGRAPH COMPANY

Dept. O, 912 Lakeside Place, Chicago, Illinois

Representatives for Canada:

Radio College of Canada, 863 Bay Street, Toronto



ALWAYS
BE
CAREFUL



★ ★ ★

(A) Kill all transmitter circuits completely before touching anything behind the panel.

(B) Never wear 'phones while working on the transmitter.

(C) Never pull test arcs from transmitter tank circuits.

(D) Don't shoot trouble in a transmitter when tired or sleepy.

(E) When working on the transmitter, avoid bodily contact with metal racks or frames, radiators, damp floors or other grounded objects.

(F) Keep one hand in your pocket.

(G) Develop your own safety technique. Take time to be careful.

★ ★ ★

Death Is Permanent!

Correspondence

(Continued from page 49)

10 Craigmiller Ave., Hamilton, Ont.

Editor, QST:

Regarding the "Beer Baron's" letter in May QST, I believe that I may have to discontinue my subscription to your magazine when it runs out. I feel that the League is not doing its work. My crystal oscillator has been oscillating without any plate voltage now for over a year, and you have never done anything about it. . . .

— Mel Riddell, VE3QU

403 Lexington Ave., Rockford, Ill.

Editor, QST:

. . . Please tell the man for me that I don't think it was right for him to quit school while he was still in the third grade.

— Fay C. Sweeney, W9CZB

417 11th St., Huntington, Pa.

Editor, QST:

Regarding a letter by W8QEP in May QST, my thoughts can't be printed — so I'm giving him RST 09+0 (the 9+ being for one or two loud "phooies")!

— Charles H. Donelson, W8OISI

Lenoir City, Tenn.

Editor, QST:

. . . I belong to several clubs, fraternities, and in particular to the National Dental Association. We would ostracize a guy like that like nobody's business. They can't even get

All the Latest Developments in Vertical Radiators and Beam Antennas

No matter what type of beam or array you plan, you can build it better with Premax Elements. Send for catalog and special prices.

PREMAX PRODUCTS

DIV. CHISHOLM-RYDER CO., INC.

3919 Highland Ave.

Niagara Falls, N. Y.

SEND FOR TECHNICAL BULLETIN H-3

The RADIO SHACK

presents for the first time, the..

HAMMARLUND 100 Watt ED-4 TRANSMITTER KIT IN COMPLETE FORM

INCLUDING UTC HIGH AND LOW VOLTAGE POWER SUPPLIES AND MODULATOR WITH SPEECH AMPLIFIER

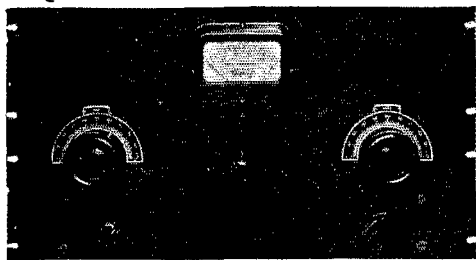
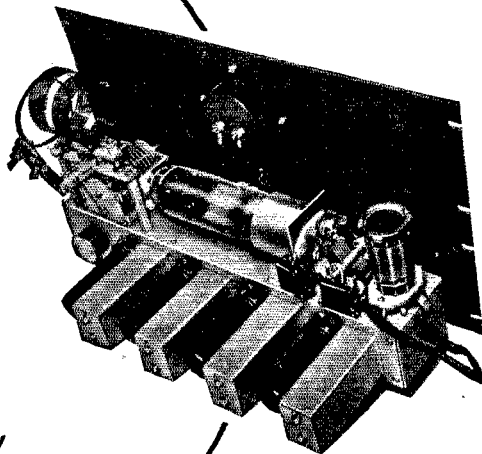

All chassis and panels drilled, the only tools necessary are pliers, screw driver and a soldering iron. Complete instructions supplied.

HAMMARLUND 4-BAND 100-WATT EXCITER AND FINAL STAGE KIT

Parts used are as specified by Hammarlund. Includes a Triplett meter, Coto control wheels, IRC resistors, and Cornell-Dubilier condensers, all the necessary Hammarlund parts, foundation unit, and one 10 1/2 x 19 drilled rack panel.
NET PRICE, less crystal,* tubes,* and final stage coils*.....\$49.84
* Prices shown below for accessories

ACCESSORIES

B and W coils	10 BVL	30 BVL	40 BVL	80 BVL
NET EACH.....	\$1.40	\$1.45	\$1.65	\$1.90
BVL base assembly net price.....				2.50
4 Raytheon 6L9 tubes, \$1.13 each.....				4.52
1 Raytheon RK-47 or RCA 314.....				17.50
Biley BC-3 X-cut crystals, 2,000 to 7,000 KC				
NET PRICE EACH.....				3.35
Biley B-5 or LD-2, 2,000 to 7,000 KC				
NET PRICE EACH.....				4.80

UTC HIGH-VOLTAGE POWER SUPPLY KIT

Includes UTC transformers and chokes, Cornell-Dubilier condenser, IRC resistor, and all miscellaneous parts.

Complete kit with instructions less two 860's and foundation unit. NET PRICE.....\$20.14
Two Taylor 860's.....\$3.00
NET PRICE \$1.50 ea.....\$3.00

UTC LOW-VOLTAGE POWER SUPPLY KIT

Consists of UTC, Cornell-Dubilier, and IRC products. Supplied complete including miscellaneous parts and instructions. NET PRICE, less 83 tube and foundation unit.....\$12.33

1 Raytheon 83 tube.....\$7.90

HIGH- AND LOW-VOLTAGE POWER SUPPLY FOUNDATION UNIT

Both power supplies are mounted on one chassis, dimensions 10 x 17 x 3, rack panel 10 1/2 x 19. Complete foundation unit, one drilled panel and chassis, including hardware and layout. NET PRICE.....\$39.90

UTC (S-60) 60-WATT MODULATOR KIT

This modulator kit includes complete parts, instructions, hardware, and miscellaneous parts. Designed to modulate the ED-4 transmitter kit 100%. NET PRICE, less tubes.....\$51.45

Tubes required for modulator kit: 1—6J7, 1—6C5, 2—6F6, 4—6L6, and 3—83. NET PRICE for 11 tubes.....\$9.46

BUY ON EASY TERMS
MAIL ORDERS PROMPTLY FILLED
EXPORT DIVISION
9 CORNELL ST., BOSTON, MASS., U.S.A.

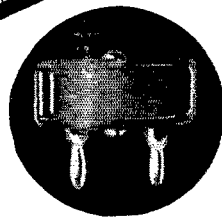

X-CUT 40-METER MOUNTED CRYSTAL

7000 to 7200 KC ±
Supplied within 10 KC of your desired frequency.
SPECIAL NET PRICE \$1.95

UNMOUNTED CRYSTALS 7000 KC TO 7300 KC

Within 10 KC of your desired frequency.
SPECIAL LOW PRICE \$1.35

46 BRATTLE ST. - BOSTON, MASS. - U.S.A.

CORNELL-DUBILIER

StarHit ★★ ★★
OF THE MONTH

**TYPE
SM**

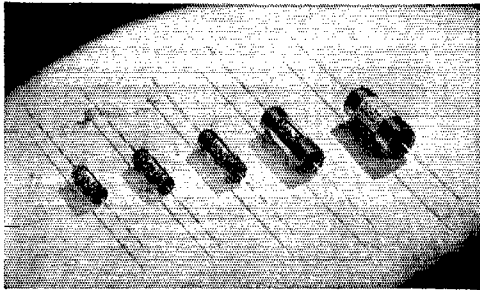

**TYPE SM PAPER TUBULAR CAPACITORS
FEATURES**

Halowax Impregnated — Decreased physical size. • Hi-Purity Aluminum Foil — Lower R.F. resistance; light weight. • Hi-Purity Multi-Laminated Kraft Tissue — Higher voltage breakdown; minimum leakage. • Vacuum Dried and Impregnated — Lower equivalent series resistance; longer life. • Oil-Cooled — Higher voltage breakdown. • Protective Aluminum Shield — Affords electrostatic shielding. • Wax-Dipped Outer Cardboard Sleeve — Further humidity protection. • Small Size, Non-Inductive — "Short-Path" R.F. bypass.

For a complete listing of the entire Cornell-Dubilier line, send for Catalog No. 165A, FREE ON REQUEST.

MICA • PAPER • DYKANOL • WET AND DRY ELECTROLYTICS



**CORNELL-DUBILIER
ELECTRIC CORPORATION**

1013 Hamilton Boulevard, South Plainfield, New Jersey
Cable Address: "CORDU"

RADIO

ENGINEERING, broadcasting, aviation and police radio, servicing, marine radio telegraphy and telephony, Morse telegraphy and railway accounting taught thoroughly. 48 weeks' engineering course, equivalent to three years of college radio work. School established 1874. All expenses low. Catalog free.

DODGE'S INSTITUTE, Day Street, Valparaiso, Indiana

HOW TO LEARN CODE

Whether you wish to enter radio as a career or as a hobby, the All Electric Master Teleplex Code Teaching Machine will show you how. Teleplex records your sending in visible dots and dashes on a specially prepared waxed paper tape and then sends back to you at any speed you desire. It does not merely show you code. It is code. No experience needed.

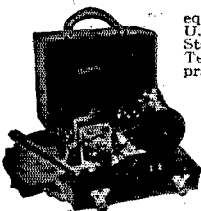

While not designated as standard equipment, Teleplex is used at many U. S. Army Posts, Naval Training Stations as well as by the American Telephone & Telegraph Co. Also by practically every private school in the U. S. teaching code; and many foreign governments.

FREE BOOK

We furnish you complete course, including practice messages, the All Electric Master Teleplex, plus a personal service on a MONEY BACK GUARANTEE. Low cost. Easy terms. Without obligation write for booklet "QT."

TELEPLEX CO. 67-69 PARK PLACE
NEW YORK, N. Y.

In Canada write:

CANADIAN ELECTRONIC INST., TORONTO, ONT.

professional insurance, nor even the monthly magazine, unless they stay in the good graces of the local, state and national organizations. . . . Keep the pages of *QST* cleaner by not publishing such silly criticism.

— Dr. Roy R. Campbell, W4DFR

53 Silver St., Patchogue, N. Y.

Editor, *QST*:

Three, yea even four, cheers for that chap W8QEP (The Beer Baron) for his nifty letter in May *QST*. If anyone ever took the words right out of my mouth and put it in writing, that fellow did. He expressed my sentiments to a "T." I think he deserves a dozen cheers, by gum.

Anyone think the same as we do? Speak up, men.

— Ed Wright, W2HAC

ATTENTION, YL'S

9 S. Emerson, Wenatchee, Wash.

Editor, *QST*:

That lace-bordered ad of "Two Hundred Meters and Down" brought up a point that has had my curiosity aroused for some time: How many "YL key twitchers" are there?

Nobody seems to know, but I think we would tell. I should like to have you publish this letter or some kind of a request to have the YL's make themselves known. I'd like to know how many there are, how old they are, how they got interested, whether they're key twitchers or tonsil busters, how long they've had their tickets, and what they think we should do about these authors.

So how's about it, YL's? Please send all the dope to me. Perhaps we should band ourselves together in a YLRL or something to that effect and make these woman-ignoring authors sit up and take notice.

— Ethel Smith, W7FWB

Strays

Another idea for keeping bugs where they belong is to make use of a piece of friction tape under each rubber foot. I'll guarantee it won't slip.

— W6MUR

Silent Keys

It is with deep regret that we record the passing of these amateurs:

E. A. E. Bruneau, VE2BH, Montreal, Quebec

Charles A. Hansen, W8GFV, Gloversville, N. Y.

Dr. William J. Keefe, W1KST, Auburn, R. I.

David Knowles, W9MQN, Waukegan, Ill.

George H. Lockard, W8LAH, Akron, Ohio
Howard Francis McIntosh, K6ONM, Honolulu, T. H.

Walter A. Ryan, VE1BM, St. John, N. B.
W. T. Young, VE5AG, Vancouver, B. C.

AMATEUR RADIO LICENSES

Day and Evening Classes in Code and Theory
HOME STUDY COURSES

Reasonable, Efficient and Thorough, Hundreds of
Licensed Students Now on the Air

American Radio Institute, 1123 Broadway, New York, N. Y.

GAMMATRONS

WILL TAKE HIGH PLATE VOLTAGES

This is possible because the GAMMATRON design provides that all internal insulators are eliminated. Elements are supported only from the envelope. Thus, long leakage paths provide almost perfect insulation even at ultra high frequencies. Even the diminutive 24 GAMMATRON will operate at 1500 plate volts at 5 meters. High voltages mean greater efficiency, larger power outputs, and more DX. Write for data on GAMMATRONS.

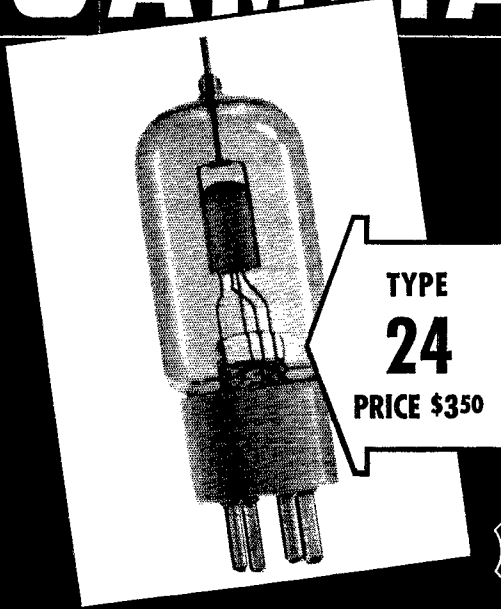

TYPE
24
PRICE \$350

HEINTZ AND KAUFMAN
SOUTH SAN FRANCISCO LTD. CALIFORNIA U.S.A.

SKYROTOR

Bee-Line Skyrotor will mount on any horizontal surface which is 11 inches in diameter. A cross boom of special design is furnished with the Bee-Line Beam Kits to enable installation to be made quickly with a minimum of tackle and man power.

The Bee-Line Skytower is a cage tower of circular cross section which has been designed to resist the strains peculiar to selective antenna operation. Maximum resistance to torque is a necessary element in the design as well as rigidity and ease of operation. Furnished in kits or assembled sections.

The Bee-Line from Detroit

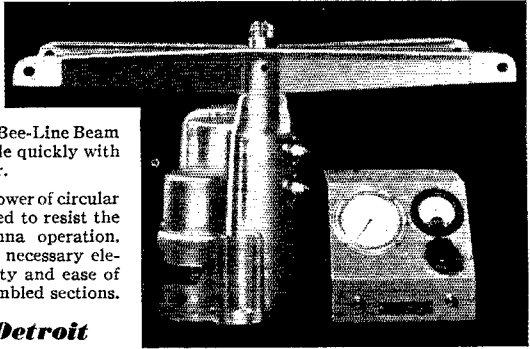

W 8 J K

The Flat-Top-Beam is best adapted to two band operation. Relay switching enables band selection from the operating position.

Write for descriptive literature on Bee-Line Skyrotor, Skytower and various antenna kits.

**BEE
ENGINEERING
COMPANY**
7665 Grand
River Avenue
Detroit, Mich.

A GOOD NAME GOES A LONG WAY

High engineering standards, multiple inspection, close-limit testing, make Ken-Rad Radio Tubes the logical choice of careful buyers.



Ken-Rad Radio Tubes
KEN-RAD TUBE & LAMP CORPORATION - OWENSBORO, KY.

Manufacturers of all types of radio tubes and Ken-Rad Electric Lamp Bulbs

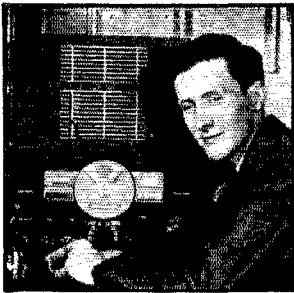

Owen J. Dowd — W2JHB
winner of Maxim Memorial
Award for 1938



**Congratulates
W2JHB**

"We are proud to
number 'Red'
Dowd among our
valued customers"
SUN RADIO

Conform with F.C.C. — Check Ur Freq.

The Communication Measurements Labs type 100KX does the work of the most expensive and elaborate frequency standards, just as accurately. Provides standard signals every 100 Kc. (.1 Mc.) up to and including 60 Mc. Complete, including tube, power supply, low drift 100 Kc. crystal, ready to use.

Priced within the reach of every amateur. **\$15.00**
Frequency Checkers kept in stock for immediate shipment — or write for descriptive circular.

Prompt Delivery — Courteous Service

Sun Radio is known, not only in New York, but throughout the globe — as Radio headquarters. If you live too far from New York — mail your Radio needs to Sun Radio. Whether you order a small resistor or a receiver or transmitter, you will be pleased with our prompt and intelligent service. All merchandise is carefully packed and shipped the fastest and cheapest way.

Guardian Antenna Relay

Double Pole — Double Throw
Handles up to 1 Kw.
Frequencies up to 28 Mc.
Alsimag Insulation. **\$3.50**

Sun Radio now stocks Kenyon

We are pleased to announce that we have added the Kenyon quality line of transformers to our large and complete stock of radio equipment and accessories. Ask for your copy of the Kenyon catalog, containing a complete listing at Amateur prices, and useful tables, charts and diagrams.

Visiting New York World's Fair?

Stop in at Sun and meet the boys personally—
W2JEH—ED Berliant W2LFV—ED Riny
W2DXC—BILL Green

U.T.C. SPECIAL

Filter and Swinging Chokes

6 Hy.	175 Ma.	95 ohms	\$1.62
5/25 Hy.	175 Ma.	95 ohms	1.62
15 Hy.	225 Ma.	120 ohms	2.06
5/25 Hy.	225 Ma.	120 ohms	2.06
15 Hy.	300 Ma.	90 ohms	2.94
5/25 Hy.	300 Ma.	90 ohms	2.94

See It at Sun

Latest Models In Stock:

- Halicrafters Defiant SX-24
- Howard 460 Receiver
- Halicrafters HT-7 Frequency Standard
- Eimac 75-T Tube
- Meissner Television Kit

Be sure to get your copy of free circulars on any of above

- ★ EXPORT ORDERS SOLICITED
- ★ MAIL ORDERS PROMPTLY FILLED



RADIO CO.

212 Fulton Street, Dept MT New York

Cable Address: SUNRADIO NEW YORK

"It Seems To Us —"

(Continued from page 9)

interference ensues to radio reception. Now get out your slide-rule and go to work. Looks as if 5000 meters was good for about half a mile, or roughly one mile of working allowed for every 10,000 meters of wavelength. How about a new unofficial ham band at say 30 kilocycles, consisting exclusively of fellows working within a radius of a mile? Trouble, of course, is about antennas. A half-wave dipole for that band would be only a little over three miles long; maybe a back-fence telegraph line would be better — it would require less wire. But how about loops or condenser antennas? Possibilities, yes. But then, who's got a 10,000-meter receiver these days?

Oh, well, it's an idea to tinker with.

MAJOR E. H. ARMSTRONG'S frequency-modulated system of u.h.f. broadcasting is giving sensational results. It is providing interference-free broadcasting reception of superlative quality. Complicated, like Einstein's math, only a few people really understand how it works. What a record that man Armstrong has! He was a radio amateur when he invented the regenerative audion circuit; then came the superheterodyne, then super-regeneration, and now frequency-modulation — all his discovering. Each has been ahead of its time, so to speak; each has had the experts shaking their heads, each has eventually proved to be a natural. We're proud of the fact that Armstrong started as an amateur, has long been one; and we shall always think of him as one. We consider that he has the greatest gifts in radio to-day. Saluting him is saluting the accomplishments of a major amateur, and no pun intended, either. Whenever he starts to reach into his hat, we're going to stop work and watch. For Howard Armstrong has never been wrong!

K. B. W.

NEWS ITEM: NEWARK MAN HEARS WOR WITHOUT RADIO-SET. MOLAR FILLINGS MAY FUNCTION AS DETECTOR.

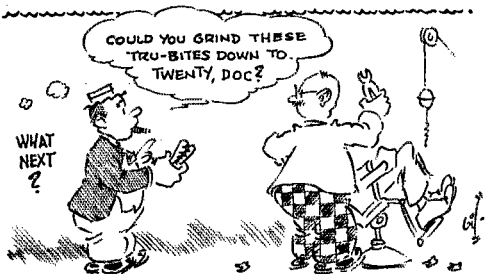

LEARN RADIO • TELEVISION

60-page catalog on request. Oldest, largest and best equipped in New England.

MASS. RADIO SCHOOL

18 Boylston Street

Boston, Mass.

Where to buy it

A directory of suppliers who carry in stock the products of these dependable manufacturers.

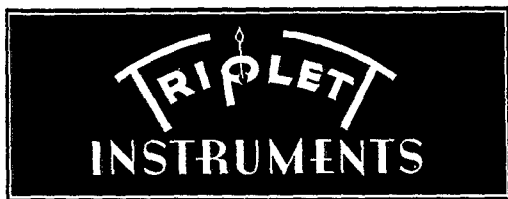

ALBANY, N. Y. Uncle Dave's Radio Shack 356 Broadway

ATLANTA, GEORGIA 265 Peachtree Street
Wholesale Radio Service Co., Inc.

BOSTON, MASS. Radio Shack 46 Brattle Street

BOSTON, MASS. 110 Federal Street
Wholesale Radio Service Company, Inc.

BRONX, N. Y. 542 East Fordham Rd.
Wholesale Radio Service Company, Inc.

BUTLER, MISSOURI 211-215 N. Main Street
Henry Radio Shop

CHICAGO, ILL. 833 W. Jackson Blvd.
Allied Radio Corp.

CHICAGO, ILL. 901-911 W. Jackson Blvd.
Wholesale Radio Service Company, Inc.

CINCINNATI, OHIO 1103 Vine Street
United Radio, Inc.

DETROIT, MICH. 325 E. Jefferson Ave.
Radio Specialties Co.

DETROIT, MICHIGAN 11800 Woodward Ave.
Radio Specialties Co.

HARTFORD, CONNECTICUT 227 Asylum Street
Radio Inspection Service Company

HOUSTON, TEXAS 4021 Huey Street
R. C. Hall & L. F. Hall

JAMAICA, L. I. 90-08 166th Street
Wholesale Radio Service Company, Inc.

KANSAS CITY, MO. 1012 McGee Street
Burstein-Applebee Company

NEW YORK, N. Y. Harrison Radio Co. 12 West Broadway

NEW YORK, N. Y. 100 Sixth Ave.
Wholesale Radio Service Co., Inc.

NEWARK, N. J. 24 Central Ave.
Wholesale Radio Service Co., Inc.

READING, PENN. 404 Walnut St.
George D. Barbey Company

SPRINGFIELD, MASS. T. F. Cushing 349 Worthington St.

WASHINGTON, D. C. 938 F Street, N. W.
Sun Radio & Service Supply Co.

ALBANY, N. Y. Uncle Dave's Radio Shack 356 Broadway

ATLANTA, GEORGIA 69 Forsyth Street, N. W.
Garvin Electric Company

ATLANTA, GEORGIA 265 Peachtree Street
Wholesale Radio Service Company

BOSTON, MASS. Radio Shack 46 Brattle Street

BOSTON, MASS. 110 Federal Street
Wholesale Radio Service Company, Inc.

BRONX, N. Y. 542 East Fordham Rd.
Wholesale Radio Service Company, Inc.

BUTLER, MISSOURI 211-215 N. Main Street
Henry Radio Shop

CHICAGO, ILLINOIS 833 W. Jackson Blvd.
Allied Radio Corp.

CHICAGO, ILLINOIS 25 North Franklin Street
Electric & Radio Supply Co., Inc.

CHICAGO, ILL. 901-911 W. Jackson Blvd.
Wholesale Radio Service Company, Inc.

CINCINNATI, OHIO 1103 Vine Street
United Radio, Inc.

JAMAICA, L. I. 90-08 166th Street
Wholesale Radio Service Company, Inc.

LITTLE ROCK, ARKANSAS 409 W. 3rd St.
Beem Radio Company

MINNEAPOLIS, MINNESOTA 1124-26 Harmon Place
Lew Bonn Company

MONTREAL, CANADA 285 Craig Street, West
Canadian Electrical Supply Co., Ltd.

MUSKOGEE, OKLAHOMA 204 No. Twelfth Street
Home Radio Mart

NEW YORK, N. Y. 100 Sixth Avenue
Wholesale Radio Service Company

NEWARK, N. J. 24 Central Ave.
Wholesale Radio Service Company

READING, PENN. George D. Barbey Co. 404 Walnut Street

WASHINGTON, D. C. 938 F Street, N. W.
Sun Radio & Service Supply Co.

Listings on this page do not necessarily imply endorsement by QST of the dealers or of other equipment sold by them.

YOU CAN'T GO WRONG

If you check frequency in the same fashion and with the same accuracy as the ARRL Official Observers. And that is just what you do with the 100KX Secondary Standard. This compact unit features a built-in power supply, low current drain, the precision obtainable only with a low drift single frequency 100 kilocycle bar, and an unusual circuit that generates usable check points at 100 kilocycle intervals all the way to 60 MC. Stripped of all nonessentials — it represents an outstanding value in precision measuring equipment complete with tube and low drift crystal at the remarkably low price of **\$15**

Speaking of measurements, why not bring along your receiver for realignment while you visit the New York World's Fair? With measurement facilities identical with those employed in the design of communications receivers, and as the factory service station in New York for the leading manufacturers, you are assured of optimum performance. We can supply an effective noise silencer for HROs, SX 16s and several other models that are not regularly equipped with this useful device. Prices on your particular receiver problems will be given by return mail.

COMMUNICATION MEASUREMENTS LABORATORY

136 Liberty St., New York City

RADIO ENGINEERING



RCA Institutes offer an intensive course of high standard embracing all phases of Radio and Television. Practical training with modern equipment at New York and Chicago schools. Also specialized courses and Home Study Courses under "No obligation" plan.

Illustrated Catalog on request

RCA INSTITUTES, INC. Dept. ST-39

A Radio Corporation of America Service

75 Varick St., New York 1154 Merchandise Mart, Chicago

PRECISION CRYSTALS

Highest quality crystals carefully prepared for frequency stability and maximum output — rigidly tested to assure you of dependable operation. Be sure of your transmitter frequency — use **PRECISION CRYSTALS**.

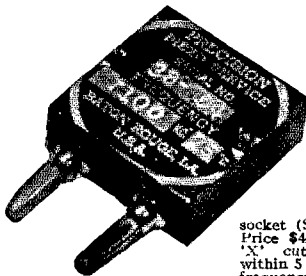

Low frequency drift unit supplied within 5 Kc. of your specified frequency in the 40, 80 or 160 meter bands calibrated to within .03%. Supplied in holder as illustrated to plug into G.R. type jacks or in round holder to plug into a tube socket (See Jan. issue QST). Price \$4.00. Highest quality "X" cut crystals supplied within 5 Kc. of your specified frequency in the 40, 80 or 160 meter bands and calibrated to within .03%. Supplied mounted. Price \$3.50. Please state if holder as illustrated or round holder for tube socket is wanted.

Precision crystals for commercial requirements quoted on at your request. Now in our tenth year of business.

PRECISION PIEZO SERVICE

427 Asia Street

Baton Rouge, La.

What the League is Doing

(Continued from page 32)

FINANCIAL STATEMENT

THE first quarter of the year is one of the best from the League's business standpoint. The routine activities of the League in the first three months of this year yielded a net of nearly \$9700 before disbursements against Board appropriations. By order of the Board, the operating figures are here published for your information:

STATEMENT OF REVENUE AND EXPENSES EXCLUSIVE OF EXPENDITURES CHARGED TO APPROPRIATIONS, FOR THE THREE MONTHS ENDED MARCH 31, 1939

REVENUES	
Membership dues	\$16,634.05
Advertising sales, QST	24,232.32
Advertising sales, Handbook	3,380.47
Advertising sales, booklets	400.00
Newsdealer sales, QST	11,631.41
Handbook sales	13,390.48
Spanish edition Handbook revenues	39.10
Booklet sales	4,735.16
Calculator sales	522.14
Membership supplies sales	2,786.68
Interest earned	547.94
Cash discounts received	505.34
Bad debts recovered	101.26
	\$78,006.35
<i>Deduct:</i>	
Returns and allowances	\$ 2,889.92
Exchange and collection charges	20.39
Cash discounts allowed	484.65
Increase in reserve for newsdealer returns of QST	264.73
	3,659.69
Net Revenues	\$75,246.66

EXPENSES	
Publication expenses, QST	\$17,837.77
Publication expenses, Handbook	9,354.44
Publication expenses, booklets	1,855.45
Publication expenses, calculators	211.07
Salaries	24,298.13
Membership supplies expenses	1,503.97
Postage	1,639.79
Office supplies and printing	1,876.91
Travel expenses, business	778.91
Travel expenses, contact	256.58
QST forwarding expenses	1,107.15
Telephone and telegraph	541.38
General expenses	987.52
Insurance	418.89
Rent, light and heat	1,140.45
General Counsel expenses	253.04
Communications Dept. field expenses	157.20
Headquarters Station expenses	265.85
Alterations and repairs expenses	6.75
World's Fair exhibit expenses	404.51
Bad debts charged off	5.70
Provision for depreciation of:	
Furniture and equipment	297.37
Headquarters Station	448.88
Total Expenses	65,547.71
Net Gain before expenditures against appropriations	\$ 9,698.95

TELEVISION CYCLOPEDIA

Defines and explains all television terms now used and gives actual applications. Covers in detail every phase of modern cathode-ray television. Every radio man, amateur, and student of television needs this new book. It will simplify TELEVISION for you. Compiled by M. N. Beitman.

Only \$1.00, postpaid

SUPREME PUBLICATIONS 3727 West 13th St. Chicago, Illinois

HAM-ADS

(1) Advertising shall pertain to radio and shall be of nature of interest to radio amateurs or experimenters in their pursuit of the art.

(2) No display of any character will be accepted, nor can any special typographical arrangement, such as all or part capital letters be used which would tend to make one advertisement stand out from the others.

(3) The Ham-Ad rate is 15¢ per word, except as noted in paragraph (4) below.

(4) Remittance in full must accompany copy. No cash or contract discount or agency commission will be allowed.

(5) Closing date for Ham-Ads is the 25th of the second month preceding publication date.

(6) A special rate of 7¢ per word will apply to advertising which, in our judgment, is obviously non-commercial in nature and is placed and signed by a member of the American Radio Relay League. Thus, advertising of bona fide surplus equipment owned, used and for sale by an individual or apparatus offered for exchange or advertising inquiring for special equipment, if by a member of the American Radio Relay League takes the 7¢ rate. An attempt to deal in apparatus in quantity for profit, even if by an individual, is commercial and all advertising by him takes the 15¢ rate. Provisions of paragraphs (1), (2), (4) and (5) apply to all advertising in this column regardless of which rate may apply.

Having made no investigation of the advertisers in the classified columns, the publishers of QST are unable to vouch for their integrity or for the grade or character of the products advertised.

QUARTZ — direct importers from Brazil of best quality pure quartz suitable for making piezo-electric crystals. Diamond Drill Carbon Co., 719 World Bldg., New York City.

USED receivers. Bargains. Cash only. No trades. Price list 3¢ W3DQ, Wilmington, Del.

QSL'S. Free samples. Printer, Corwith, Iowa.

CALLBOOKS — Summer edition now on sale containing complete up-to-date list of radio hams throughout entire world. Also world prefix map, press schedules and new time conversion chart. Single copies \$1.25. Canada and foreign \$1.35. Radio Amateur Call Book, 610 S. Dearborn, Chicago.

QSL'S. Cuts. Cartoons. Free samples. Theodore Porcher, 7708 Navahoe, Philadelphia, Pa.

IPS rubber crystal, QSY remotely, varies completely 160 to 10 meters. Approximately 20 watts output, \$19.80. Radio Apparatus Mfg., 1522 No. Clark, Chicago, W91PS.

MACAUTO code machines: low monthly rental 50,000 words practice tapes. Write N. C. Ayers, 711 Boylston St., Boston, Mass.

QSL'S, SWL's. 100 — 3 color — 75¢. Lapco, 344 W. 39th, Indianapolis, Ind.

BRAND new, guaranteed, radio tubes — 25¢ each. Details — Box 37, Sta. P, Brooklyn, N. Y.

CRYSTALS, mounted, 80-160, \$1.25, V-cut 40 \$2.25. R9 Crystals, 338 Murray Ave., Arnold, Pa.

QSL'S — samples. Brownie, W3CJI, 523 No. Tenth St., Allentown, Pa.

SELL: 200 watt all-band CW, phone transmitter — \$125. Want candid camera. W2CIZ.

QSL'S. W8OKP, Wilkinsburg, Pa.

CRYSTALS — unconditionally guaranteed, X-cut, 1750-2000; 3500-4000; ± 20 kc., \$1.; ± 5 kc., \$1.50; spot frequency, \$2.50. Three small, X-cut, 80 meter blanks, including carborundum \$1.45. Holders, \$1. William Threm, W8FN, 3071 Moosewood St., Cincinnati, Ohio.

JONES oscillograph kits. Comply with F.C.C. regulations by incorporating this serviceable instrument in your station. Uses RCA 913 and type 80 rectifier. Develops trapezoidal pattern indicating percentage of modulation, driving power, bias, proper neutralization, etc. Kit price including tubes, \$12.95. Wired and tested, \$2.50 additional. Shipping weight, 3 lbs. Jones Radio Co., E. Norwegian & George Sts., Pottsville, Pa.

HAMS, experimenters — QST, Handbook and other radio publications' kits, wired or unwired. Free punched and drilled chassis. W8KPP, Sigmon's, 104 E. Washington, Charleston, W. Va.

RME-69 & speaker, excellent condition, \$90. W3BES.

TRADE movie camera 16MM Bell & Howell, Eastman projector, screen & flood humidifier for A-1 modern superhet receiver. R. Kewley, 1204 Hood Ave., Chicago, Ill.

QSL'S? QSL's printed to your instructions. Samples? W8DED, Holland, Mich.

FOR sale — complete station 450 watt 10 and 20 meter phone — CW transmitter. Latest tubes, 6 power supplies, G-R Variac filament control, 9 Weston meters, Triplet modulation monitor. Super-Pro SP-120-SX receiver. Much extra equipment. \$625. Write or phone Alan W. Brown, Green Hill Rd., Madison, N. J.

WANTED: crystal microphone. All offers answered. W7BPI, Celilo, Ore.

WANTED FB-7 — prefer receiver available in Canada. VE3HT.

FB7A, National supply, tubes, 80 m. coils. Cash. Stamp. WJFX.

PORTABLE transmitters — new and used parts. Write Harvey Delson, 2536 No. Fifth St., Harrisburg, Pa.

SELL NC101X. Complete; speaker. \$95. f.o.b. W2IBJ.

QSL'S printed by W2AEY. Samples.

BAKELITE strips, panels, tubing, rod. Send dimensions for price. Hackbush Bakelite Supplies, 297 Schenk, No. Tonawanda, N. Y.

TELEPLEXES, Instructographs, omnigraphs bought, sold, traded. Ryan's Hannibal, Mo.

QSL'S. Finest at lowest prices. Samples. Maleco, 1805 St. Johns Place, Brooklyn, N. Y.

2.5-5-7.5 v. transformers, 50¢. S.P.D.T. relays, 50¢. Rod King, Girard, Pa.

SELL complete station, cheap. Write for details. W8MQU Lawton, Mich.

SACRIFICE — UTC SX80, 80 watt transmitter complete, Vibroplex, 9 tube Browning 35 superhet complete. All — \$75. — will break up — offer. Leeds, 425 Riverside Dr., N. Y. C.

PRACTICALLY new RME-69 with DB-20 built in. \$150. W4TO, Box 609, Asheville, N. C.

DIXIE amateurs. Ham gear complete. All leading lines. Quick service. Try us. E. E. Forbes & Sons, Birmingham, Ala. W4FJA, W4FVU.

PRACTICAL radio and communication engineering course for home study offered by Smith Practical Radio Institute, Dept. Q79, 1311 Terminal Tower, Cleveland, Ohio. Information booklet free.

PHILCO closeout. 2 watt resistors, 1¢. 400 volt bypass condensers, 5¢. Send for list. Hill, 3859 20th St., San Francisco.

QSL'S. Superior workmanship. July bargains. Fritz, 455 Mason, Joliet, Ill.

SELL: Master Teleplex, new condition complete with key, tapes, and ink: \$15. W3FUL.

SELL or trade: crystal model Comet-Pro, also used 852: Need 1" or 2" oscilloscope. Haynes, 1912 Begole, Flint, Mich.

WANTED: Two Bradley 500 watt radiostats. W3TC.

NATIONAL NC100X excellent condition. Complete, \$75. W3PYW.

SELL: complete CW station: 250 watt xmtr, 3 power supplies. Superhet, receiver with R.F. stage and xtal filter. Bug, monitor. For particulars write W1JZS, 181 Blanchard St., Berlin, N. H. **HOWARD** 450 good as new, \$75. R. J. Holcombe, Box 609, Asheville, N. C.

BEAM drives for less \$\$\$\$. Complete continuously rotatable quiet motorized head, 2 1/4" hollow drive shaft, \$34. Selsynchronous indicator built-in. Light, strong tapered allumalloy elements, tilting heads, Bassett cable. Beam bulletins, photos. Tilting head gives you 10-foot reach. \$5. Rotary Array Service, W8ML.

WHO wants f.b. 125 watt plate modulated 160-meter rig for \$95? W9QJC, Kewaunee, Wis.

FOR sale. Practically new General Electric 1/2 kw., 1/2 amp. 1000 volt, compound wound, type BD-43Y separately excited generators. Also: Gen. Elec. 1/2 kw. 1 amp. 500 volt comp. wound, type BD-35Y generator. Fully guaranteed. Write Motor Repair & Mfg., 1561 Hamilton Ave., Cleveland, Ohio.

SACRIFICE — high quality phone transmitter using P.P. 809's final. Complete, \$100. W3FTC.

CRYSTALS airmailed. July special: 40X, \$1.50. Commercial crystals from 50 kilocycles to 18 megacycles. C-W Mfg. Co., 1170 Esperanza, Los Angeles.

TRADE 300 w. 20 CW transmitter for motorcycle. W9BDW.

CRYSTALS in plug-in holders. Any frequency; 40X, \$1.80; 160-80, \$1.25. (No Y Cuts.) C.O.D.'s accepted. Pacific Labs., 344 Fetterly, Los Angeles.

WHY not get better deal. Used receiver list free. W9RA, Chidard, 415 So. Dearborn St., Chicago.

NEW Type AB low drift crystal mounted in ceramic holder — 40, 80, 160 meters, \$2.50 each. Faberadio, Batavia, Ill.

WANTED: complete transmitter and receiver — stationary or mobile. Cash basis. Denis Madden, 513 E. 84, N. Y. C. Regent 7-0587.

WANT iron core IFT's and crystal. W7BIZ.

STOP — read — save. W9LXR offers you the biggest 50 or 100 watt pair of Douglas Universal modulation transformers at the lowest price obtainable. Postpaid, one-year guarantee. Write W9LXR, Rice Lake, Wis.

CASH or trade Westinghouse dynamotor — inputs 12 v., 6 v.; outputs 1000 v. 400 ma, 500 v. 200 ma. Price, \$10. W2LGT.

GENERAL Radio — Roller-Smith 0-1.5 and 0-2.5 R.F. meters, \$1.95. U. S. Signal Corps VT frequency meters, \$1-16, \$79.; NC100, \$69.; NC80X, \$69.; Breeting 14, \$59.; Ultra-Skyrider, \$49.; National one-ten, \$34.; Comet-Pro, \$29.; DB-20, \$24.; 510X, \$24.; FB7's, \$19.; Sky Buddies, \$15. Others. Terms; list free. W9ARA.

WHETHER you pay cash, trade equipment, or buy on my economical 6% terms, it pays you to write W9ARA, authorized factory distributor for all ham receivers, transmitters, parts. Write. W9ARA, Butler, Mo.

RECONDITIONED guaranteed receivers and transmitters shipped on ten-day trial. Practically all models at big savings. HRO, \$129.70; NC100XA, \$99.; RME-69, \$69.; PR-15M, \$79.; SX-16, \$79.; NC100, \$69.; NC80X, \$69.; Breeting 14, \$59.; Ultra-Skyrider, \$49.; National one-ten, \$34.; Comet-Pro, \$29.; DB-20, \$24.; 510X, \$24.; FB7's, \$19.; Sky Buddies, \$15. Others. Terms; list free. W9ARA.

CRYSTALS: You needn't hold your breath for fear of fracture when you plug in an Edison T9 crystal — they can take it; their fracture-resisting feature assures this. 40 and 80 meter bands, \$1.60 postpaid. Fully guaranteed. T9 ceramic holder, \$1. C.O.D.'s accepted. Commercial crystals on order. Sold by: Cleveland Radio Supply, 464 E. 117th, Cleveland, Ohio; Radio Doc, 721 So. Main, Los Angeles, Calif.; Hieronymus Radio, 88-34 209th, Queens Village, N. Y.; Henry Radio Shop, Butler, Mo.; Pemberton Labs., Ft. Wayne, Ind.; Frank Anzalone, 375 W. 46th St., N. Y. C.; Casa Edison, Havana, Cuba; Hamrad Wholesale, London, Eng.; and Eidson's, Temple, Texas.

WANTED: Raytheon 60 or 120 watt automatic voltage regulator, cash deal. Would consider equivalent. W5AMK.

HARVEY 80-T transmitter, \$99. Collins 45A less than half price. Brand new Hallcrafters S19 Sky Buddies — factory sealed cartons, \$19.50. W9ARA, Butler, Mo.

EASY terms on guaranteed reconditioned receivers — plenty of bargains. Rigs professionally built, \$5. per chassis. Aluminum tubing for beams — lowest prices. Everything for the Amateur. Time payments. Send for catalog. Wholesale Radio Labs., Council Bluffs, Iowa. W9GFQ.

CRYSTALS: famous P.R., mounted in latest Alsimag 35 holders — 40, 80 meter PR-X, 160 meter PR-Z, \$3.; 40, 80 meter PR-Z (low drift), \$3.50; 20 meter PR-20, \$4.50; unconditionally guaranteed. Immediate shipment. Wholesale Radio Labs., Council Bluffs, Iowa.

75 watt transmitter complete with power. Rack and panel type, new, \$37.50. Complete modulators, etc. Frampton Radio, Blackwell, Okla.

QSL'S. 1939 designs. Best stock and workmanship. Free samples to hams. W2FJE, 101 Hanson Place, Brooklyn, N. Y.

NC-81X — 1938 model, \$65. Percy C. Noble, W1BVR, 37 Broad St., Westfield, Mass.

QSL'S. Three colors. Samples. W9RUJ, Auburn, Neb.

YOUR photo on your QSL's, \$1. in lots of fifty. Send negative or photo, tell size wanted; I'll enlarge or reduce it. Pay when they come. Stick 'em on like stamps. The Ham Picture Man. 52 Robert St., Pawtucket, R. I.

LOW COST STEEL ANTENNA TOWER

Used and Endorsed by
FEDERAL, STATE, COUNTY, CITY GO'VTS.,
FORESTRY, HIGHWAY PATROLS
and HAMS everywhere!

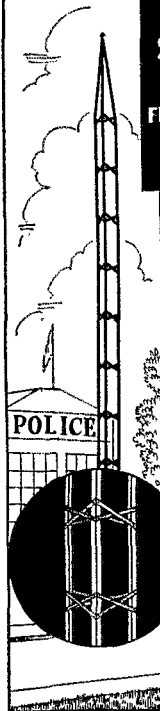

ONLY 60¢ PER FOOT Complete!

This remarkable low price is possible only because we produce many thousands of these towers each year for use with our Wincharger. Price includes necessary guy wires and tower sections of 10 or 20 ft. lengths with 5 ft. tapered stub top.

LIGHT, STURDY, RIGID

Thousands in use as vertical radiators and horizontal antenna supports. Scientifically braced. No points of undue strain. Both vertical angles and cross braces now hot dip galvanized.

SAFELY ERECTS TO 200 FT.

Quickly and easily erected, without skilled assistance, to heights of from 25 ft. to 200 ft. Enthusiastically used and recommended by police and broadcasters for thoroughly satisfactory service.

READ U. S. FORESTRY LETTER!

"Your tower was installed on Signal Peak, a Lookout Station on the Yakima Indian Reservation, at an elevation of 5,111 ft. above sea level. We have found the Wincharger tower 100% satisfactory and it has stood up under 70 mile winds, snow and ice which are severe at almost a mile up from sea level." Thomas L. Carter, Forest Supervisor, Office of Indian Affairs, U. S. Department of the Interior, Toppish, Wash.

Order Direct From

WINCHARGER CORPORATION
Sioux City, Iowa

An Amateur Version of a POLICE CAR TRANSMITTER popularly priced.

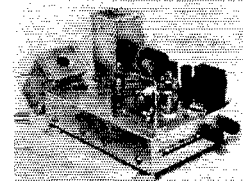

Type T-510 — 12 watt Crystal Controlled PORTABLE MOBILE TRANSMITTER with 28 and 56 Mc. Band Switching. See our line of APPROVED transmitters at our permanent QTH, the nearest radio factory to the NEW YORK WORLD'S FAIR grounds.

Completely revised literature just released on all models.

Type T-510 Kit. . . . \$21.80

RADIO TRANSCIVER LABS.

8627 115 Street

Richmond HILL, New York City

Cable Address: "RATRALLB"

BUILD A LOW COST MONITOR

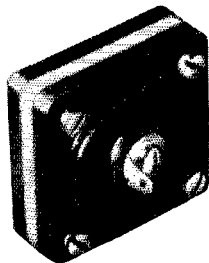

A dual-frequency crystal calibrator and your receiver makes an accurate inexpensive frequency monitor. January QST or Bulletin E-7 (free) gives constructional details.

**BLILEY
SMC 100**

DUAL FREQUENCY CRYSTAL

STACO Antenna CHANGE-OVER RELAYS

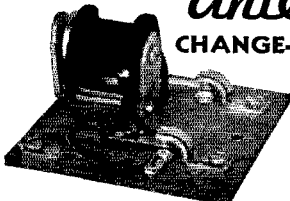

- Mycalex Insulation
- 4 Ampere Contacts
- Ball-Bearing Pivot
- Shorter R.F. Path
- No AC Chatter
- Floating Armature

Type ABA. XPLW Insulation, 110v, AC } \$3.00 net
Type ABD. XPLW Insulation, 6v, DC }
Type AMA. MYCALEX Insulation, 110v, AC } \$4.50 net
Type AMD. MYCALEX Insulation, 6v, DC }

See Your Jobber or Write for Details

STANDARD ELECTRICAL PRODUCTS COMPANY
316 Sibley Street St. Paul, Minnesota

Your Nearby Dealer Is Your Best Friend

Your nearby dealer is entitled to your patronage. He is equipped with a knowledge and understanding of amateur radio. He is your logical source of advice and counsel on what equipment you should buy. His stock is complete. He can supply your needs without delay. His prices are fair and consistent with the high quality of the goods he carries. He is responsible to you and interested in you.

One of these dealers is probably in your city—Patronize him!

ATLANTA, GEORGIA

Wholesale Radio Service Company, Inc.
265 Peachtree Street
"The World's Largest Radio Supply House"

BALTIMORE, MARYLAND

Radio Electric Service Co.
3 N. Howard St.
Everything for the amateur

BOSTON, MASS.

Wholesale Radio Service Company, Inc.
110 Federal Street
"The World's Largest Radio Supply House"

BRONX, NEW YORK

Wholesale Radio Service Company, Inc.
542 East Fordham Road
"The World's Largest Radio Supply House"

BUFFALO, NEW YORK

Radio Equipment Corp.
326 Elm Street
W8PMC and W8NEL — Ham, service and sound equipment

JAMAICA, L. I., NEW YORK

Wholesale Radio Service Company, Inc.
90-08 166th Street (Merrick Road)
"The World's Largest Radio Supply House"

MONTREAL, CANADA

Canadian Elec. Supply Co., Ltd.
285 Craig St., W.
Quality parts and equipment for discriminating buyers

NEWARK, N. J.

Wholesale Radio Service Company, Inc.
24 Central Avenue
"The World's Largest Radio Supply House"

NEW HAVEN, CONNECTICUT

Hatry & Young, Inc.
1172 Chapel Street
National, Taylor, Kenyon T Line, Radiotron, Howard, etc.

NEW YORK, N. Y.

Wholesale Radio Service Company, Inc.
100 Sixth Avenue
"The World's Largest Radio Supply House"

NEW YORK, N. Y.

Harrison Radio Company
12 West Broadway
Harrison Has It! Phone WOrth 2-6276 for information or rush service

PHILADELPHIA, PENNSYLVANIA

Eugene G. Wile
10 S. Tenth Street
Complete Stock of Quality Merchandise

RICHMOND, VIRGINIA

The Arnold Company
Broad at Harrison St.
W3EQQ — "The Virginia Ham Headquarters" — W3FBL

TORONTO, CANADA

A & A Radio Service Supply
101 Queen Street, West
Canada's Foremost Radio Supply House

WINNIPEG, CANADA

Electrical Supplies, Ltd.
306-10 Ross Avenue
Western Canadian Amateur Headquarters for Leading Lines

YOU CAN BE SURE
WHEN YOU BUY FROM

QST

ADVERTISERS

“Advertising for *QST* is accepted only from firms who, in the publisher’s opinion, are of established integrity and whose products secure the approval of the technical staff of the American Radio Relay League.”

Quoted from QST’s advertising rate card.

Every conceivable need of a radio amateur can be supplied by the advertisers in QST. And you will know the product has the approval of the League’s technical staff

Index to Advertisers

American Radio Institute.....	86
Astatic Microphone Laboratory, Inc.....	60
Bece Engineering Company.....	87
Bliley Electric Company.....	58, 92
Candler System Company.....	80
Capitol Radio Engineering Institute.....	84
Cardwell Mfg. Corp., Allen D.....	62
Centralab.....	59
Collins Radio Company.....	Cov. 2
Communication Measurements Laboratory.....	90
Cornell-Dubilier Electric Corp.....	86
Dodge’s Institute.....	86
Eitel-McCullough, Inc.....	61
Gardiner-Levering Company.....	78
Guthman & Company, Edwin I.....	82
Hallcrafters, Inc., The.....	1, 2
Hammarlund Mfg. Company, Inc.....	57, 65
Harvey Radio Company.....	76
Harvey Radio Laboratories.....	63
Heintz & Kaufman, Ltd.....	87
Henry Radio Shop.....	84
Hinds & Edgarton.....	83
Hytronic Laboratories.....	77
Instructograph Company.....	84
Ken-Rad Tube & Lamp Corp.....	87
Kenyon Transformer Company, Inc.....	7
Mallory & Company, Inc., P. R.....	56
Massachusetts Radio School.....	88
Meisner Mfg. Company, Inc.....	75
Mims Radio Company.....	64
National Company, Inc.....	Cov. 3, 55, 78, 83
Newark Electric Company.....	79
Ohmite Mfg. Company.....	82
Port Arthur College.....	83
Precision Piezo Service.....	90
Premax Products.....	84
RCA Institutes, Inc.....	90
RCA Mfg. Company, Inc.....	Cov. 4
Radio Mfg. Engineers, Inc.....	95
Radio Shack, The.....	85
Radio Transceiver Laboratories.....	92
Scientific Radio Service.....	83
Shuler Supply Company.....	81
Shure Brothers.....	70
Sickles Company, F. W.....	84
Solar Mfg. Corp.....	80
Southwest Radio Supply.....	85
Sprague Products Company.....	74
Standard Electrical Products Company.....	92
Sun Radio Company.....	88
Supreme Publications.....	90
Taylor Tubes, Inc.....	67
Teleplex Company.....	86
Terminal Radio Corp.....	81
Thordarson Elec. Mfg. Company.....	71
Triplett Elec. Instrument Company, Inc.....	66
United Transformer Corp.....	96
Valpey Crystals, The.....	78
Wholesale Radio Laboratories.....	88
Wincharger Corp.....	92
Vaxley.....	56

BRAND NEW

the: —

1. HF10 The HF10 introduces an RME receiver designed to cover the 5 and 10 meter amateur bands. Ten tubes are used in the superheterodyne circuit; R-meter and automatic noise suppression is incorporated along with a six inch permanent magnet speaker. Choice of either a 110 volt AC, or 6 volt DC power supply may be had. This receiver is ideal for the home station set up or for a semi-portable installation.

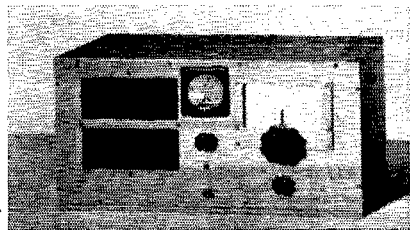

2. ME14 Here is a completely self-contained portable superheterodyne receiver. This unit uses 6 low drain battery type tubes, weighs only 11 lbs. with batteries, 100 milliwatts output with a 15 foot antenna, and covers the range 180-4100 KC in three steps. Airports, private pilots, beacon stations, and amateurs will find use for this unit.

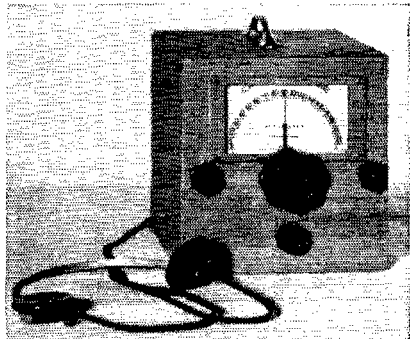

3. DM36A The DM36A is a smaller addition of the DM36 band expander. This unit is designed to be used in conjunction with an automobile broadcast radio for the reception of 5 and 10 meter signals. By means of this band expander one may have excellent superheterodyne type of reception while driving in an auto . . . and at a fraction of the cost needed to construct a receiver of equivalent performance.

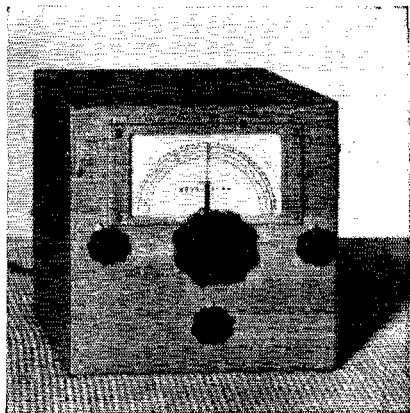

4. LF90 Some of you old timers who have had an urge to listen once more on the 600 meter band can now do so at small expense with the aid of the new LF90. The LF90 is an inverter designed to function in conjunction with any receiver capable of tuning to 1550 KC. The range of this unit is 90-608 KC. Incidentally, the LF90 and DM36 used in conjunction with an "all-wave" super provides an excellent receiver for all frequencies from 90 KC to 60 MC!



RADIO MFG. ENGINEERS

INC.

111 HARRISON STREET

PEORIA, ILLINOIS



VARITRAN CONTROLS

METHOD OF OPERATION

The UTC Varitran is a simple autotransformer whose turns are arranged on one layer with the insulation removed so that every exposed turn may be used as a tap of the winding. A special non-fusing contact, having sufficient resistance to minimize circulating currents, is mechanically arranged so that it can be moved to any position on the winding, permitting the exact voltage desired to be obtained. The regulation and efficiency are excellent and no distortion of wave form occurs.

VARITRAN RATINGS

Standard Varitrans are designed for 115 or 230 volt service. The respective output voltages are 0-130 and 0-260 volts. The Varitran autotransformer current and wattage rating is based at 115 volts. As the voltage is reduced, the wattage output is reduced correspondingly. The maximum current can be taken at any point from 0 to 20 volts and from 95 to 130 volts. Between 20 and 95 volts the current capacity tapers off from the two ends to approximately 50% of the rated maximum current at the 65 volt point.

Among the new features in the UTC Varitran:

- Oversize Heat Radiating Disc
- Roller Contact to minimize wear
- Rectangular core structure for rigidity
- Glass insulated Wire
- Panel, chassis, or laboratory bench mounting

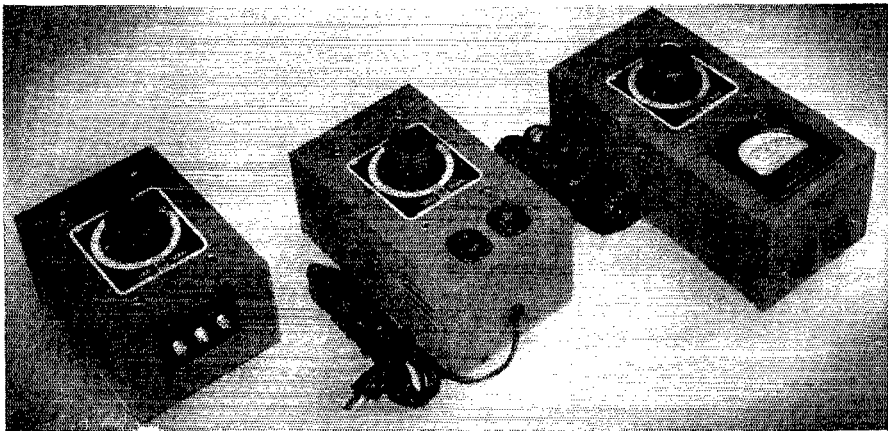

A

B

C

Type	Input Voltage	Output Voltage	Watts	Maximum Amps.	Figure	Approx. Dimensions	Approx. Weight, Lbs.	Net Price
V-0	115 volts	0-130	230	2	A	4 x 6 x 4 3/4	8	\$ 7.50
V-0-B	230 volts	0-260	230	1	A	4 x 6 x 5 3/8	10	9.50
V-1	115 volts	0-130	570	5	B	5 x 8 x 4 1/2	11	10.00
V-1-M	115 volts	0-130	570	5	C	5 x 10 x 4 1/2	12	15.00
V-2	115 volts	0-130	570	5	A	5 x 7 x 4 1/2	11	9.00
V-2-B	230 volts	0-260	570	2.5	A	5 x 7 x 5 1/4	14	11.50
V-3	115 volts	0-130	850	7.5	A	5 x 7 x 5 1/8	14	14.00
V-3-B	230 volts	0-260	850	3.75	A	5 x 7 x 6 1/8	18	18.00
V-4	115 volts	0-130	1250	11	A	6 3/8 x 9 3/4 x 6	32	20.00
V-4-B	230 volts	0-260	1250	5.5	A	6 3/8 x 9 3/4 x 7 1/4	38	25.00
V-5	115 volts	0-130	1950	17	A	6 3/8 x 9 3/4 x 7	45	32.00
V-5-B	230 volts	0-260	1950	8.5	A	6 3/8 x 9 3/4 x 8 1/2	56	37.50
V-6	115 volts	0-130	3500	30	A	6 1/2 x 10 x 13	90	60.00
V-6-B	230 volts	0-260	3500	15	A	6 1/2 x 10 x 13	90	70.00
V-7	115 volts	0-130	5000	44	A	6 1/2 x 10 x 18	120	87.00
V-7-B	230 volts	0-260	5000	22	A	6 1/2 x 10 x 18	120	95.00

UNITED TRANSFORMER CORP.

Write: COMMUNICATIONS DIV. ★ 150 VARICK ST. ★ NEW YORK, N. Y.
 EXPORT DIVISION: 100 VARICK STREET NEW YORK, N. Y. CABLES: "ARLAB"

QST for July, 1939, EASTERN Edition

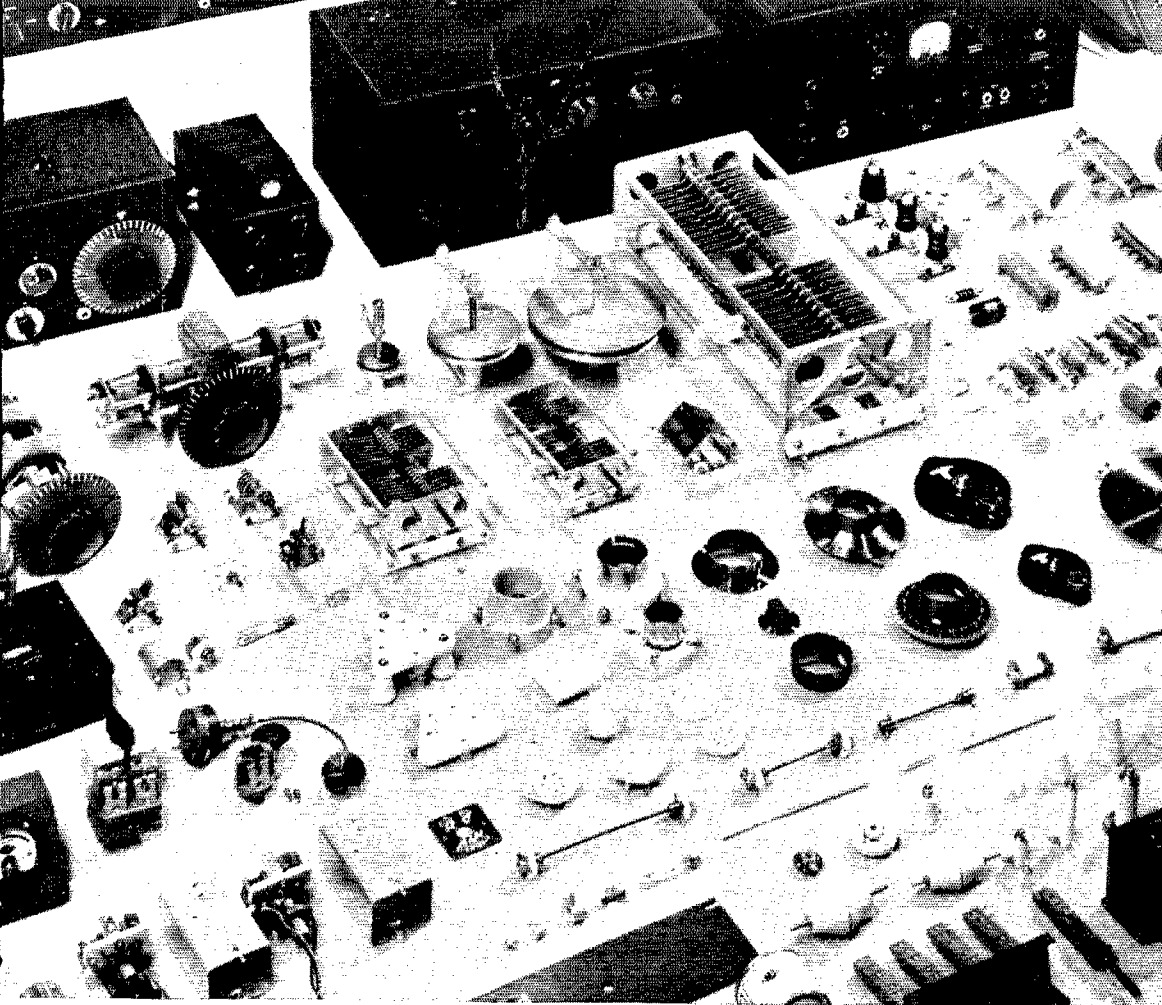

FOR THE AMATEUR

National Parts have a special fitness for amateur work that makes the rig "go together" more easily, perform better, and last longer. Throughout this quality line, from complete transmitters to acorn sockets, each part is designed to meet the amateur's problems squarely, and built to serve him long and well.

NATIONAL COMPANY, INC., MALDEN, MASS.



NATIONAL COMPANY

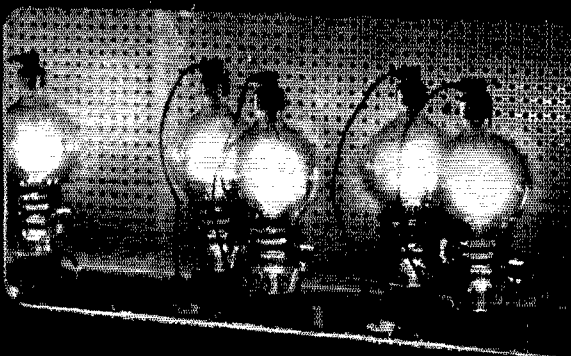

TEST AND RE-TEST . . . Every RCA Transmitting Tube gets an extreme overload "aging" run prior to the final check-up where it must show normal characteristics.

—the "SECRET" of Choosing the Right ANODE for the Right Job.

Built into every RCA Tube is an invisible ingredient that is the most important of all—Experience. This experience extends through every phase of Radio, and every material that goes into radio equipment. Take Anodes as a single instance:

This one subject alone calls for a knowledge of chemistry, metallurgy, and mineralogy, together with expert engineering and invaluable experience—and RCA brings them to you in full measure. A good Anode must dissipate an amazing amount of power. It must not liberate gas. It must have low vapor pressure and it must have suitable mechanical properties.

That's a big order for any one material to fill—and RCA's research has proved there are many materials which must be considered. Among these are carbonized nickel, graphite, tantalum, molybdenum, and tungsten. Each is used in one RCA Tube type or another and for one reason only. *It has proved itself best by long and painstaking test for that particular job.*

When you buy an RCA Transmitting Tube you invest in Experience—not Experiments. You are assured of intensive research behind every detail of every tube. That is your guarantee of best results, longest life, lowest cost. RCA's will not let you down.

Typical! Here are just a few examples of the careful selection of the best Anodes for best results:

RCA-809 CARBONIZED NICKEL
The performance of the famous RCA-809 proves the effectiveness of this Anode material in an inexpensive tube where operating temperatures are relatively low.
RCA-809 . . . 55 Watts* . . . \$2.50

RCA-810 GRAPHITE
Special processing assures maximum thermal emissivity and a minimum of gas in the Graphite Anodes of many RCA Tubes such as this popular high permeance triode.
RCA-810 . . . 375 Watts* . . . \$13.50

RCA-806 TANTALUM
A totally enclosed Tantalum Anode provides the utmost in efficiency and performance, especially on the higher-frequency bands.
RCA-806 . . . 450 Watts* . . . \$22.00

*Power output ratings for Class C Telephony

Visit RCA Television Exhibits at Golden Gate International Exposition and New York World's Fair.

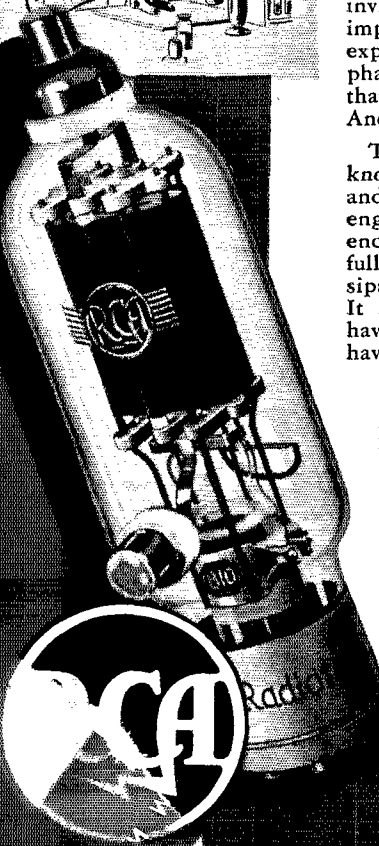

Radio Tubes

FIRST IN METAL—FOREMOST IN GLASS—FINEST IN PERFORMANCE

RCA MANUFACTURING CO., INC., CAMDEN, N. J.
A Service of The Radio Corporation of America

Should 7200-7300 Be Opened to 'Phone?

**The Board of Directors Wants Your Opinion
Use the Card Herewith**

OUR recent experience with the French broadcasting station *Paris Mondial* has raised the question of whether we are to have serious interference from European and Asiatic broadcasters in the range 7200-7300 kc. after September 1st. There has been much discussion in amateur circles as to whether we in North America ought to ask our governments for some changes in our regulations. The fear has been expressed that the usual 40-meter c.w. signal won't be able to compete effectively with strong carriers of foreign broadcasters. Even more often one has heard it said that c.w. amateurs, having a relatively large number of frequencies at their disposal, would be likely simply to move out of 7200-7300 if it became filled with foreign carriers, abandoning the frequencies. Now we need every kilocycle we can get and we must not abandon any of them to any other service. It is important to keep every kilocycle busy with some form of transmission that can operate there effectively. We amateurs are also concerned about letting any foreign broadcasters build up American BCL audiences in our bands, and we feel that our interests require us to occupy these frequencies so vigorously that BCL reception thereon is impossible.

While there has been some talk of trying to get the power limit raised for these frequencies, and some discussion of asking for permission to use A-2 there, the suggestion most often heard is that this 100-kc. range ought to be opened to

'phone operation by all amateurs. The A.R.R.L. Planning Committee seemed to think well of the idea. It is argued that 'phone transmission would be better able to compete with carrier interference from foreign broadcasters. It is argued that the 'phones, happy to have some more frequencies, would use them even if the going were tough, where c.w. stations would give up the fight and move out. And there can be no doubt that 'phones given the chance, would make thoroughgoing occupancy and prevent the building up of any American audiences for these foreign stations.

On the other hand, this would clash with all our tradition: the whole 40-meter band has always been exclusively c.w. in the United States and Canada. By and large over the solar cycle, it is our major DX band and at times it is our only one, and we have always felt we needed it for c.w., which of course accommodates a much greater number of stations. Moreover, 7050 to 7150 kc. is already available under the Habana treaty for the use of 'phone stations in Latin-America (only), so that, if 7200-7300 kc. were opened to 'phone here, two-thirds of this band would be occupied by radiotelephony.

This was the situation confronting the A.R.R.L. Board of Directors when it examined the question at their recent San Francisco meeting. It is an important subject and the Board determined to make haste but slowly. It means so much to so many of us that the Board decided that the first

*Please
Detach
and
Mail
This
Card
Now*

PLACE
POSTAGE
STAMP
HERE

American Radio Relay League

West Hartford

Conn.

U. S. A.

thing to do was to get an expression of opinion on it from as many amateurs as possible within the sphere of the A.R.R.L. — not only League members but all W, K and VE amateurs, *whether A.R.R.L. members or not*. They therefore ordered that the subject be presented in *QST*, together with a post card on which you can express yourself on the subject. You will find it on this page. When you have studied this article and made up your mind, detach the card, indicate your choice, sign and stamp it, and drop it in a mail box. By late August it is hoped that the Board will have a very accurate idea of amateur sentiment on the question. The Board then proposes to study your expressions in the light of the actual interference situation found to exist after September 1st. On the basis of these two factors it will decide whether to request a change in regulations that opens 7200-7300 to 'phone by all classes of U. S. amateurs. It *may* not so request. It is going to consider how many of you reply and how your opinions divide. In particular, it is going to see what the actual interference situation is before it makes up its mind. It is not going to ask for the change unless it believes that the interference situation requires it. It may decide that the change is not called for at the time it first examines the problem; and later in the winter it may find the interference growing and decide to ask for the change. Some details of this matter are to be found in the Board minutes in this issue.

The Board has dictated the exact form that the question takes as put to you on the annexed card. It asks your opinion whether 7200-7300 should be opened to 'phone (if authority can be had), but solely for the purpose of protecting the regularity of amateur communication in the presence

of broadcast interference. In other words, the Board would not contemplate such an action simply to increase the facilities assigned to 'phone stations; it would contemplate it only if you amateurs generally say that you believe that 'phone operation is the only kind of operation that could compete successfully, and that would actually compete, with the interference and at the same time do a successful masking job. The basis on which you should now give your opinion is whether or not you think that c.w. can and will compete successfully and do a good masking job in the event that QRM of serious proportions does occur. Is it your judgment that we should put 'phone in there? After looking at all sides of the situation, do you think that the protection of our interests makes it desirable for us to request the opening of this range for 'phone transmission?

A reply is desired from all W, K and VE amateurs whose eyes meet these lines. Canadian amateurs, as much as United States amateurs, are asked to respond. Their replies will be tabulated and turned over to the A.R.R.L. Canadian Manager, Mr. Alex Reid. If the Board of Directors decides to ask the F.C.C. for a change in U.S.A. regulations, Mr. Reid will probably move in parallel with them in respect of the Canadian authorities, so that W and VE regulations may be uniform. Replies are sought only from licensed amateurs. Amateurs other than VE, W and K need not reply, since the League is concerned only with regs in the United States and the Dominion.

You are urged to reply as soon as possible. The best time to do it is right now, while you are reading *QST*. This poll of sentiment is A.R.R.L. democracy at work. Do your part!

K. B. W.

General Amateur Poll No. 1

Should A-3 emission be authorized in the 7200-7300 kc. range, if authority can be obtained, for the purpose only of protecting the regularity of amateur communication in the presence of broadcast interference?

YES

NO

Name

Call

City and State

Are you a member of A.R.R.L.? _____