

QST

March, 1939
25 cents

Devoted entirely to

amateur radio

this issue

W. U. H. E.
HOETS

AND SWITCHING
S. S. S. S.

NO-TUNE
CIRCUIT FOR
VE BANDS

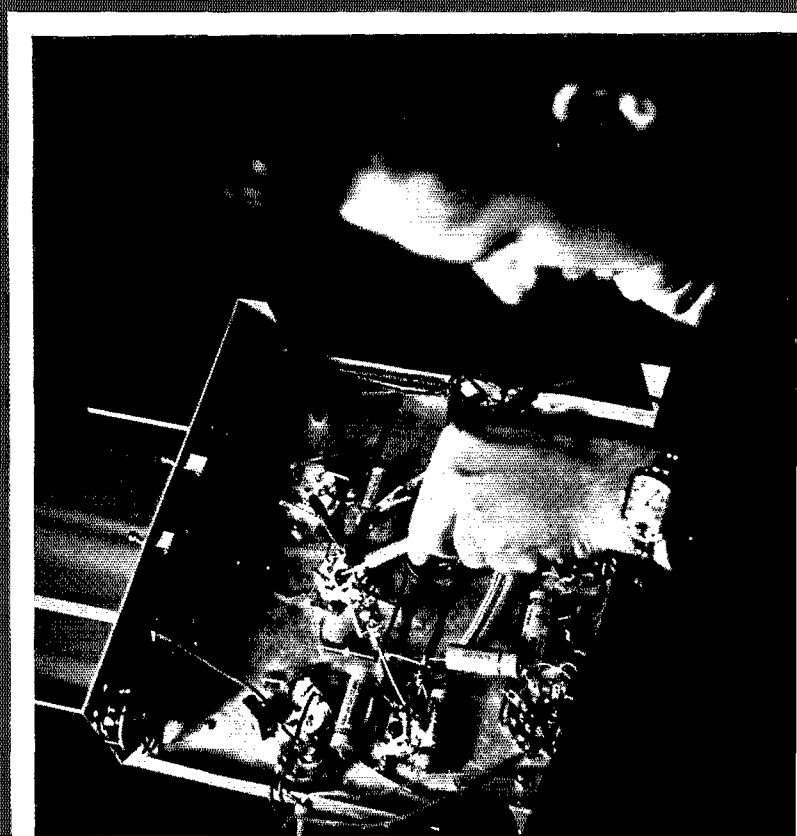

COLLINS 50S Five Installation

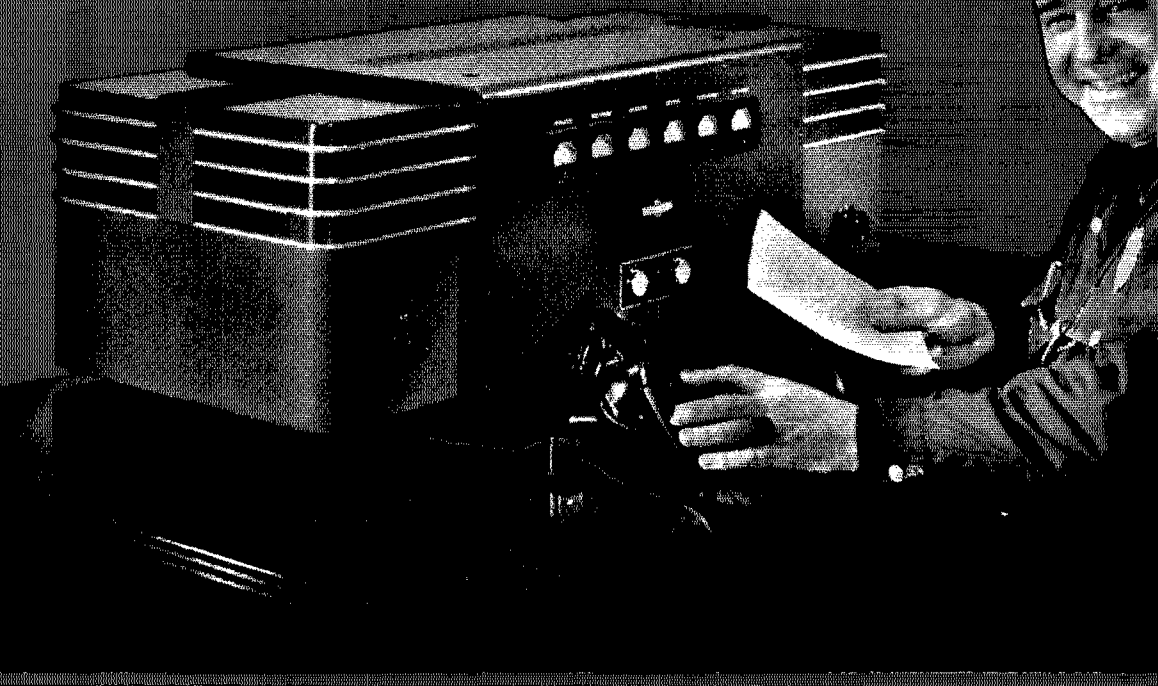

Collins 50S is a brand new idea in police radio. One attractive cabinet that fits comfortably on your desk contains all the necessary equipment, transmitter, frequency monitor, receiver and loud speaker.

In one-way operation, the station goes on the air when the handset is lifted from the hook. In two-way, you press a button on the handset to talk, release it to listen. No complicated maneuvers—simpler than telephoning.

Alone or in combination with our 18J Mobile Transmitters, the 50S will give you more intelligible transmission, clearer reception, easier operation and more efficiency.

The 50S is priced moderately, too. Write COLLINS RADIO COMPANY at Cedar Rapids, Iowa, or at 11 West 42 Street, New York, N. Y., for your bulletin and for other information. It's yours for the asking.

Attention Signal Automatic Modulation Control Safety Interlock

Full 50 Watts Output Integral Frequency Monitor Built-in Receiver

Complete Metering

Loud Speaker

A Complete Radio Station in One Cabinet

95 AMPERES OF H.F. FROM 16-TYPE RK 38'S IN PARALLEL!



U. H. F. TANTALUM TRIODES

	Plate Dissipation	Your Price
RK 35	50 Watts	\$ 6.95
RK 36	100 Watts	14.50
RK 37	50 Watts	6.95
RK 38	100 Watts	13.50
RK 63	200 Watts	22.00

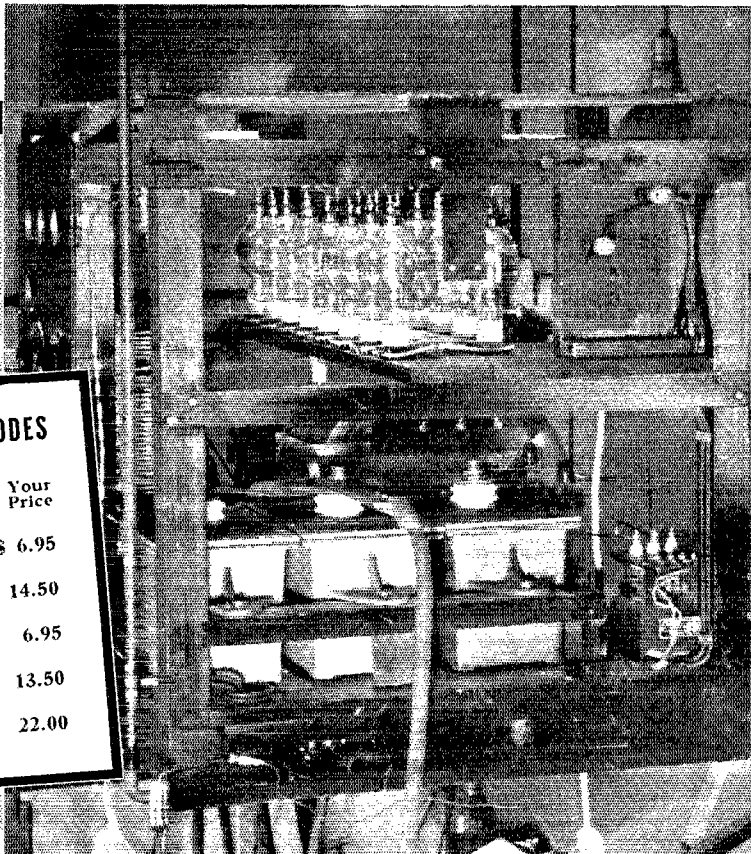

Twenty-four hours a day—month in and month out—these 16 RK 38's are pounding away to produce 95 amperes of high frequency for the induction furnace heater coils in the Raytheon plant. They've got to be good—the world's largest exclusive tube manufacturers can't stop for weak bombarder tubes!

You've got to have real hard tubes, tubes with exceptionally low capacities, to run 16 of them in parallel. And you've got to have tubes with tough filaments to stand these 3,000 volts. It takes Raytheon RK 38's to be still going strong after more than 4 months of continuous operation.

Sixteen RK 38's costing \$216.00 are now doing the work of six 400 watt tubes costing \$810.00—proof of Raytheon quality at low cost!

These RK 38's are typical of Raytheons ultra high frequency tantalum tubes. Although prices are slashed—quality is better than ever before!

Here's real evidence of RK dependability—Raytheon uses them for their own bombarders where a faulty tube means a closed plant, idle workers and thousands of dollars loss. Next time insist on a dependable Raytheon tantalum triode.

RAYTHEON RK TRANSMITTING TUBES

NEWTON, MASS. • NEW YORK • CHICAGO • SAN FRANCISCO • ATLANTA

"WORLD'S LARGEST EXCLUSIVE RADIO TUBE MANUFACTURERS"

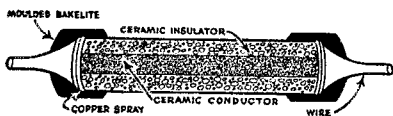

CENTRALAB Fixed Resistors

Baptized in fire at 2500 degrees . . . hard as stone. Center ceramic core, and ceramic jacket fired together to form a single shock-proof unit. Pure copper covers resistor end for wire lead contact.

Old Man Centralab took his baptism in a furnace at 2500° F. ■ He laughs at such temperatures as 200 degrees . . . the sort of heat he has to take sometimes when he is parked near a ballast resistor or a transformer in a radio receiver. ■ Even where chassis temperatures ARE elevated the Centralab resistor, with its complete ceramic construction baked at 2500 degrees, laughs at a mere 200 degrees. Where ordinary fixed resistors break down under temperatures of 200 or even less, Centralab is positively unaffected. ■ Join the thousands of Centralab addicts . . . specify Centralab for original equipment or replacements.

CENTRALAB DIVISION OF GLOBE UNION, INC., MILWAUKEE, WISCONSIN

MARCH 1939

VOLUME XXIII

NUMBER 3



STAFF

Editorial

KENNETH B. WARNER, W1EH
Editor and Business Manager

CLARK C. RODIMON, W1SZ
Managing Editor

GEORGE GRAMMER, W1DF
Technical Editor

DONALD H. MIX, W1TS
BYRON GOODMAN, W1JE
Assistant Technical Editors

VERNON CHAMBERS, W1JQ
Technical Information Service

JAMES J. LAMB, W1AL
Consultant

Advertising

F. CHEYNEY BEEKLEY, W1GN
Advertising Manager

CHARLES BRUNELLE
Asst. Advertising Manager

Circulation

DAVID H. HOUGHTON
Circulation Manager

RALPH T. BEAUDIN, W1BAW
Asst. Circulation Manager



OFFICES

38 La Salle Road
West Hartford, Connecticut

Subscription rate in United States and Possessions and Canada, \$2.50 per year, postpaid; all other countries, \$3.00 per year, postpaid. Single copies, 25 cents. Foreign remittances should be by international postal or express money order or bank draft negotiable in the U. S. and for an equivalent amount in U. S. funds.

Entered as second-class matter May 29, 1919, at the post office at Hartford, Connecticut, under the Act of March 3, 1879. Acceptance for mailing at special rate of postage provided for in section 1103, Act of October 3, 1917, authorized September 9, 1922. Additional entry at Concord, N. H., authorized February 21, 1929, under the Act of February 28, 1925. Additional second-class entries to cover sectional editions authorized March 20, 1935.

Copyright 1939 by the American Radio Relay League, Inc. Title registered at United States Patent Office.

QST

devoted entirely to

AMATEUR RADIO

PUBLISHED MONTHLY, AS ITS OFFICIAL ORGAN, BY THE AMERICAN RADIO RELAY LEAGUE, INC., AT WEST HARTFORD, CONN., U. S. A.; OFFICIAL ORGAN OF THE INTERNATIONAL AMATEUR RADIO UNION



CONTENTS

Editorials	17
Splatter	18
Safety Article	George Grammer, W1DF 19
A Modern Band-Switching Superhet	Robert B. Parmenter, W9PLM 23
"Frequency Measurement and Regular Check"	A. K. Robinson, W7DX 30
What the League Is Doing	33
A Portable Station for A.C. or Battery Operation	Harley E. Steiner, W7DTJ 34
A Miniature 100-Watt Amplifier	James Millen, W1HRX 38
Army-Amateur Radio System Activities	40
With the Affiliated Clubs	41
One Crystal — Two Tubes — Five Bands	T. M. Ferrill, Jr., W1LJI 42
Naval Communication Reserve Notes	46
Poor Man's Rotary Beam	F. G. Southworth, W5EOW 47
A 15-Watt Crystal-Controlled Five-Meter 'Phone	Glenn H. Pickett, W2IDV 48
An Electrostatic-Deflection Kinescope Unit for the Television Receiver	J. B. Sherman 52
A New Idea in V. T. Voltmeter Design	R. E. Pollard, W8PCI 56
Hamdom	59
Ham Shacks	60
Hints and Kinks	62
Silent Keys	64
I.A.R.U. News	65
Change in Problem Contest Dates	66
Correspondence Department	67
Operating News	68
Standard Frequency Transmissions	102
Hamads	123
QST's Index of Advertisers	126

Introducing the

Some years ago, in the wee small hours following a typical ham fest, several well-known amateurs and communications engineers sat around a smoke-filled room discussing the ideal communications receiver. Each had his own pet ideas, but, strangely enough for radio engineers, they were all agreed on several basic principles.

Returning to Chicago, two of the Hallicrafters engineers started to build this ideal receiver as a separate, private project of their own, purely experimental. As it grew and passed through several changes and modifications, it became the "pet" of the laboratory.

At the time, there was no thought of making this a Hallicrafters model, although its performance was brilliant. The limitations in the technique of parts manufacture, then prevailing, made it entirely impractical from a production standpoint. But there it stood, its sparkling performance a constant challenge.

In the meantime several things happened. The manufacturing technique for radio parts made tremendous strides in a relatively short time. Much that was impractical is now perfectly feasible. Simpler methods were discovered for accomplishing certain purposes with even better efficiency. Suddenly we discovered that our theoretically "ideal" but "impractical" receiver no longer belonged in that category. It *could* be built as a Hallicrafters receiver, and at a price well within the average amateur's purse.

Today we find ourselves building this ideal receiver, different from anything the Hallicrafters have produced in the past—new in conception, new in design, new in performance. Because its design is based on functional principles, and because it embodies the newest developments in the art of building communications receivers, it is extremely unconventional as compared to receivers designed even as late as a year ago.

The Skyrider 23 may not be every amateur's ideal receiver. We all have our preferences. But, it is our belief that the Skyrider 23 more nearly approaches the ideal communications receiver of the majority of amateurs.

W. J. Halligan

President

the hallicrafters inc.



Skyrider 23



The speaker for the Skyrider 23 is mounted in a separate, matching cabinet of harmonious design. The speaker itself is mounted on a generously-sized baffle, inside the speaker cabinet, that contributes materially to tone quality and volume.

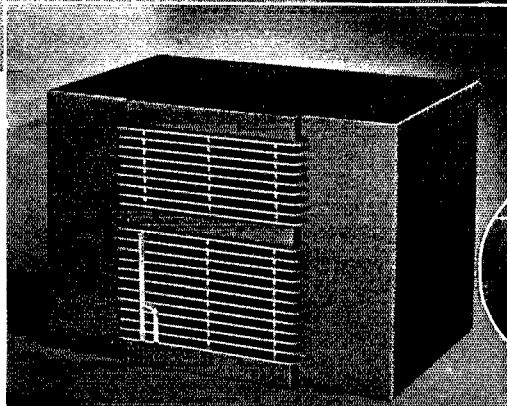

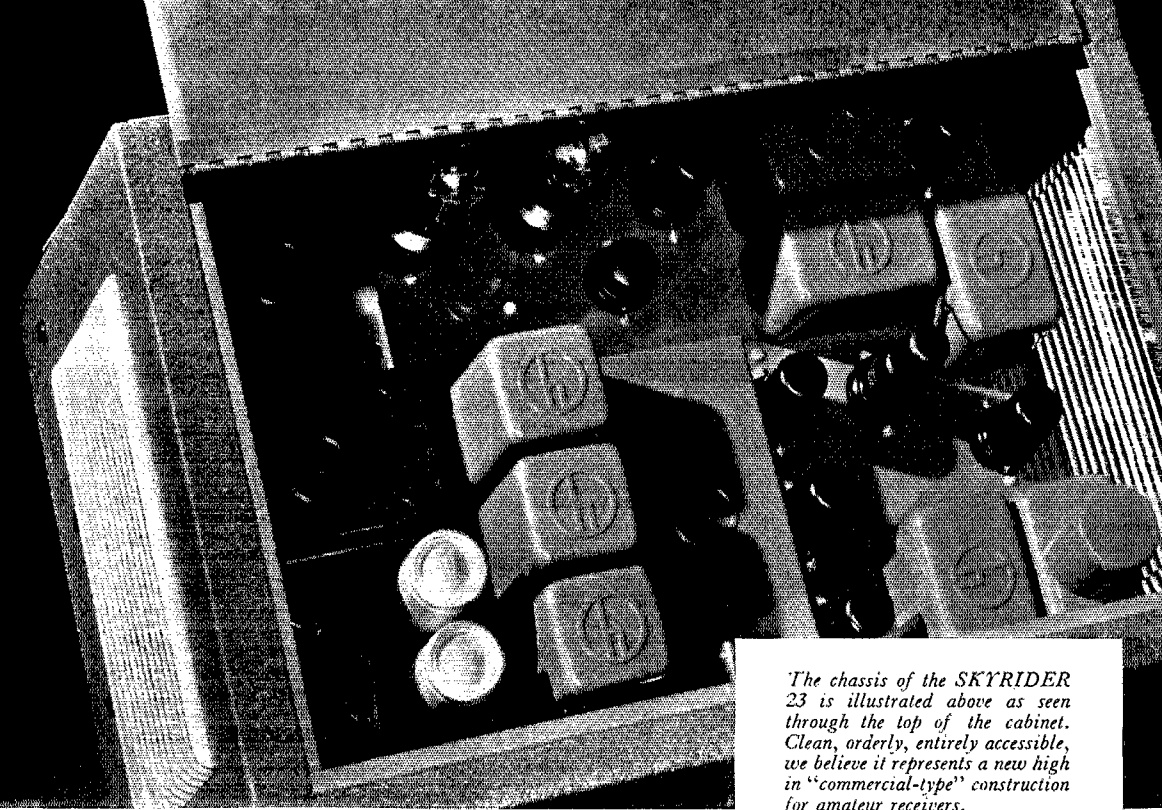

The chassis of the SKYRIDER 23 is illustrated above as seen through the top of the cabinet. Clean, orderly, entirely accessible, we believe it represents a new high in "commercial-type" construction for amateur receivers.

FREQUENCY STABILITY

THE ORIGINAL "ideal" receiver from which the Skyrider 23 evolved, achieved frequency stability by the use of fixed condensers in the oscillator circuit in a rather unique manner. Frequency drift, with an inherently stable circuit and a steady power supply, is caused by temperature change in the oscillator components. In previous practice, for oscillator circuits of a high order of stability, the components have been maintained at a fixed temperature.

In a modern, simple and more practical approach to this problem, condensers and coils were constructed of materials with temperature coefficients causing frequency changes that compensate for each other. Thus, when a coil producing a *positive* frequency change with an increase in temperature is used in conjunction with a condenser that has a *negative* frequency change for the same temperature variation, a *zero* frequency change results.

In this laboratory receiver, such "compensating" condensers and coils were built. They were impractical for production purposes at that time, but a tremendous improvement in manufacturing technique has taken place during the last few years. Today it is possible to build coils and condensers compensated for frequency stability at normal temperature ranges. Practical frequency stability is accomplished in the new Skyrider 23.



TUNING DIAL

The design of the tuning dial on the Sky-
rider 23 is purely functional. To minimize
inaccuracies due to warping and expansion,
it was made of metal. But the difficulty of
properly illuminating a metal dial presented
a problem, especially on a communications
receiver, where tuning requires almost con-
stant visual effort.

According to illuminating engineers, in-
direct lighting is least tiring to the eye. But
how to apply it effectively to a communica-
tions receiver dial? The popular Venetian
Blind, an efficient device for controlling light
intensity, proved the answer—and its prin-
ciple is used in the dial of the Skyrider 23.
Illumination is ample, but soft and restful
to the eyes.

The four general coverage dials are accu-
rately calibrated in megacycles. The outer
or Band Spread dial is calibrated with an
arbitrary scale for easy logging of stations.

"S" METER

In the unusual "S" meter dial, the same
illumination principles were utilized. Cali-
brated in "S" units and "db" units, it is use-
ful not only for indicating the intensity of
signals, but also the power difference be-
tween transmission for beam rotation mea-
surements from distant transmitters.

BAND INDICATOR

The Band Indicator on the Skyrider 23 is
designed to harmonize with the "S" meters,
with the same efficient indirect illumination.
Eight band positions provide general cover-
age from 8.8 to 556 meters and Band
Spread coverage over the full 330° dial of
four amateur bands (10-20-40-80 meters).

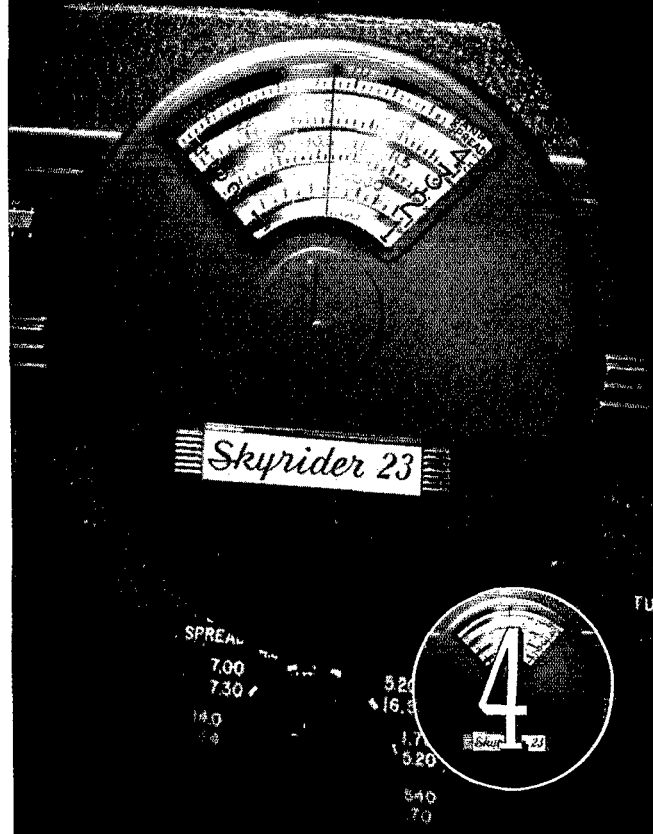
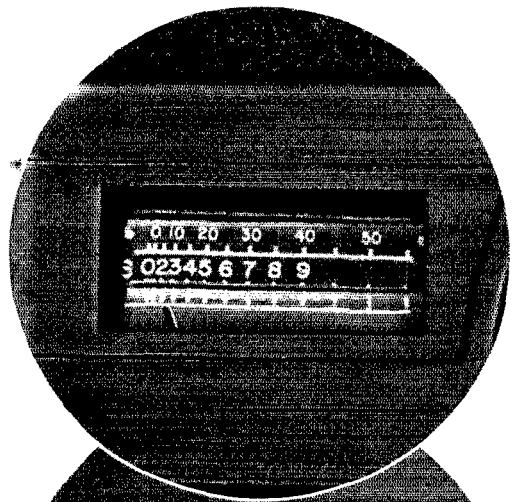

the



THE PANEL LAYOUT of the Skyrider 23 is not entirely conventional, being designed in accordance with functional principles, rather than tradition. The principal operating controls are all placed at convenient height to reduce operating fatigue. The knobs are not of some stock pattern, but are especially designed for easy manipulation. The main tuning knob is large, for fine tuning with a minimum of effort. The band switch and selectivity switch provide a convenient and firm grip for the operator and

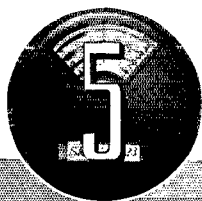

Skyrider 23

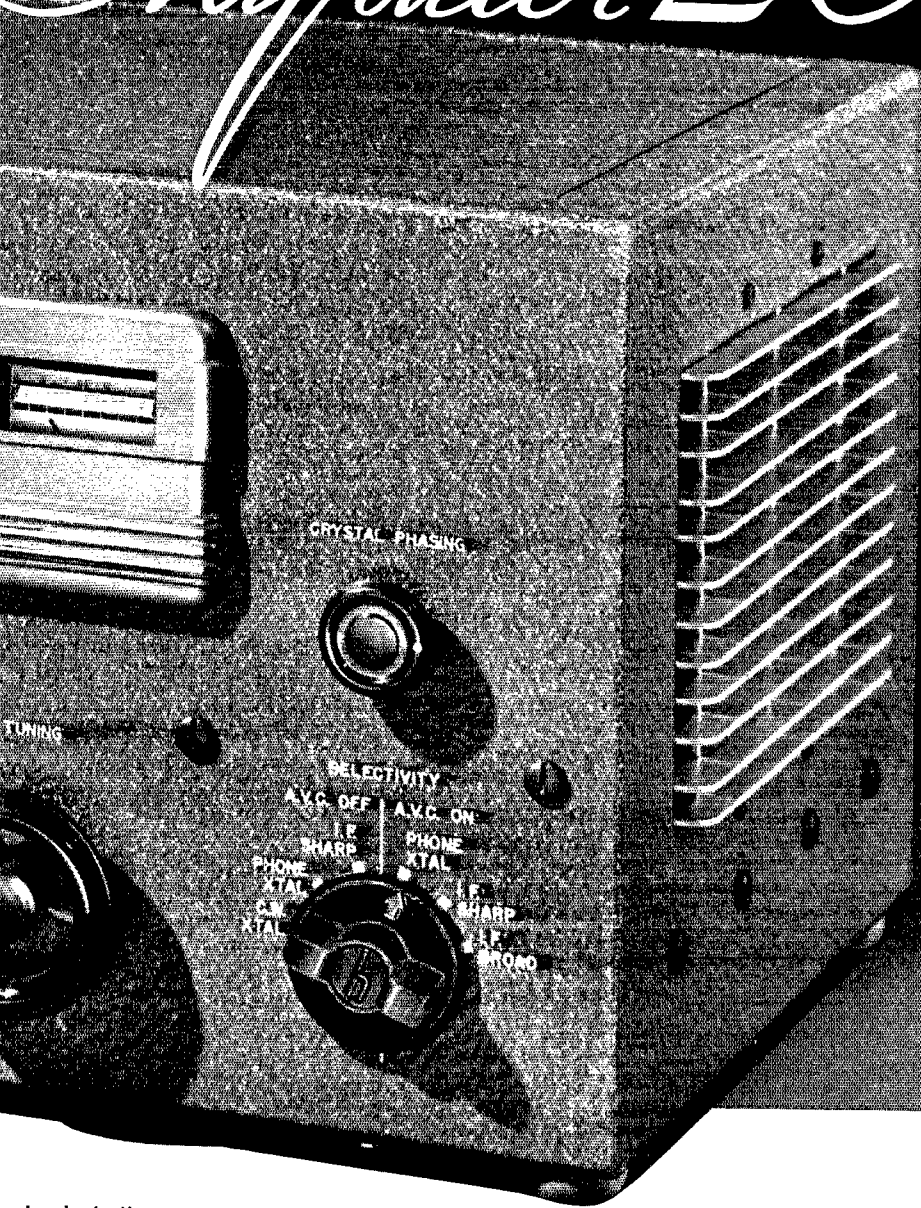

clearly indicate switch position. The entire arrangement has been carefully considered for the maximum efficiency and operating convenience. Even the color, a clean, "machine-tool" gray with gunmetal escutcheon and chrome trim, creates an impression of modern efficiency.



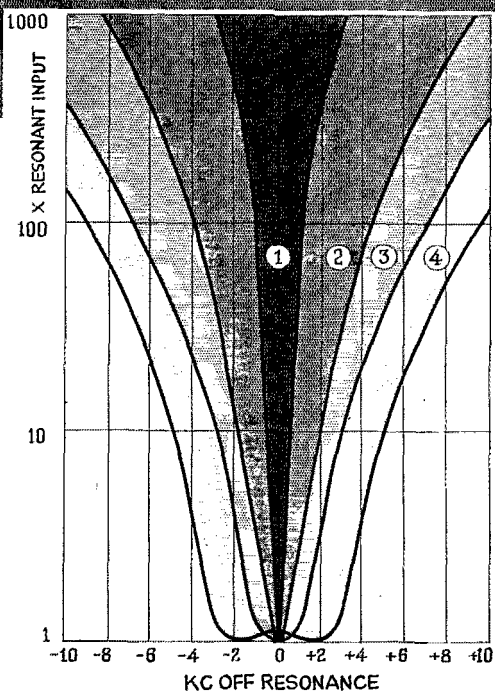
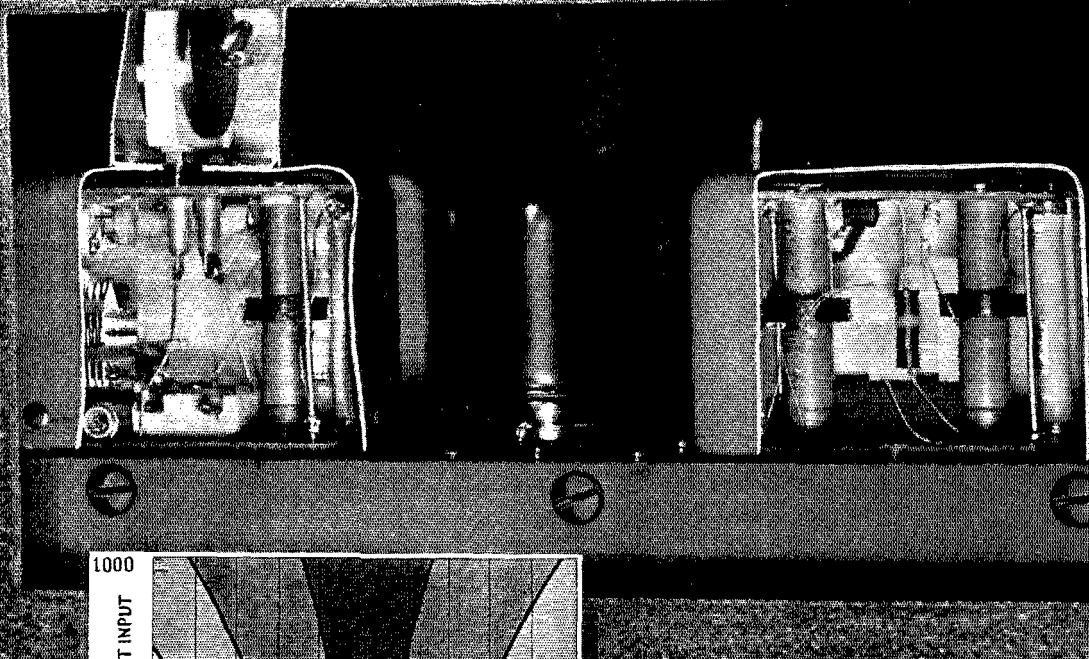

Chart showing the variations in selectivity obtainable with Sky-rider 23 Wide Range Variable Selectivity.

The illustration above shows a cut-out view of the crystal-filter unit and the newly developed Hallicrafters Permeability Tuned I. F. Transformer Unit as seen through the opening for the ventilation grill.

CRYSTAL FILTER

The heart of the new variable selectivity circuit is the crystal filter unit. It is completely shielded with a separate shield compartment for the plug-in crystal. The permeability tuned coil is designed with a slightly *negative* temperature coefficient shunt condenser to compensate for the *positive* temperature coefficient of the coil.

PERMEABILITY TUNED I. F. TRANSFORMER

The cut-away view above shows one of the New Hallicrafters Permeability-Tuned I. F. Transformer Units complete with its temperature compensating condenser and decoupling circuit. Notice the absence of loose leads coming through the chassis; instead each unit has a High-Dielectric terminal base with its leads soldered to lugs. This provides cleaner wiring and the elimination of shifting wires, and results in a more stable I. F. System.



WIDE RANGE VARIABLE SELECTIVITY

In the Crystal Circuit, the Skyrider 23 again departs from convention. The Selectivity Switch offers 6 positions of control, providing 4 degrees of selectivity, with and without Automatic Volume Control.

Selectivity Switch Positions

1st Position—Crystal Sharp	—I.F. Sharp—A.V.C. off—For CW
2nd Position—Crystal Medium Sharp	—I.F. Sharp—A.V.C. off—For CW—Phone
3rd Position—Crystal Out	—I.F. Sharp—A.V.C. off—For Phone
4th Position—Crystal Medium Sharp	—I.F. Sharp—A.V.C. on—For Phone
5th Position—Crystal Out	—I.F. Sharp—A.V.C. on—For Phone
6th Position—Crystal Out	—I.F. Exp.—A.V.C. on—For High Fidelity Phone

As a further aid to selectivity, the rejector circuit can be used to knock out interference near resonance by careful adjustment of the phasing control

The Selectivity Switch Positions as shown above provide wide range variable selectivity suitable for all phases of communications work.

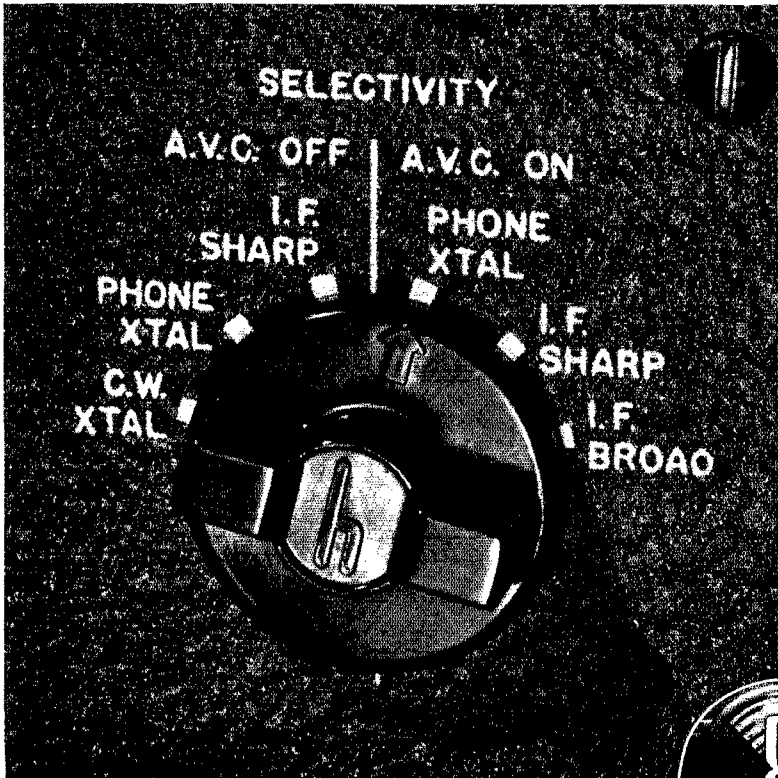

Feature

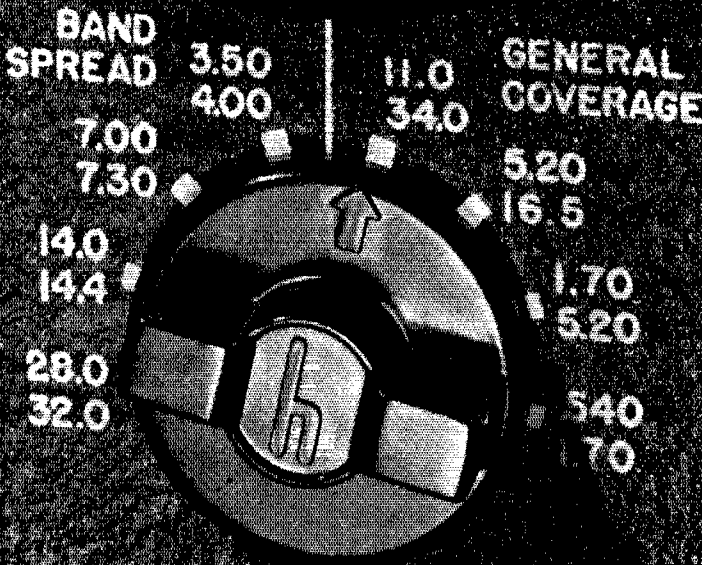

BAND SPREAD

THE MAIN FEATURE of the new bandspread system employed in the Skyrider 23 is its reset accuracy. There is no band set dial to fuss with. The same station always comes in at the same place on the dial.

Each amateur band is spread out over the entire outer calibration scale of the large 5½" diameter dial allowing, of course, sufficient margin at each end of the scale for edge of band transmissions and foreign amateurs.

IMPROVED NOISE LIMITER

No modern receiver that pretends to offer communications reception is complete without a noise limiter. Naturally, the Skyrider 23 includes an Automatic Noise Limiter, of new and improved design, that substantially reduces the noise level on the higher frequencies. No noise limiter can be effective unless the switch is located closely adjacent to the noise limiter tube. Leads over 3" long reduce its effectiveness to a considerable degree. In the Skyrider 23 these facts were taken into consideration and the switch of the Noise Limiter is mounted directly adjacent to its tube and mechanically linked to the Noise Limiter Switch on the operating panel.



the Skyrider 23

★ General Coverage—34 to .54 MC (8.8 to 556 Meters).

GENERAL COVERAGE

★ 8 Band Positions—Band 1—11.0 to 34.0 MC Band 3— 1.7 to 5.2 MC
Band 2— 5.2 to 16.5 MC Band 4— .54 to 1.7 MC

BAND SPREAD

Band 10— 3.5 to 4.0 MC Band 40—14.0 to 14.4 MC
Band 20— 7.0 to 7.3 MC Band 80—28.0 to 32.0 MC

★ Tube Complement—Total Number of Tubes—11.

1st R.F. —6SK7	2nd I.F. —6SK7	B F O —6SJ7
1st Det. —6SA7	2nd Det., 1st Audio—6SQ7	Rectifier —80
H.F. Osc —6SJ7	Amplified AVC —6B8	Noise Limiter—6N7
1st I.F. —6SK7	Power Output —6F6G	

★ Audio Output—5 Watts.

★ Temp. Compensated Permeability-Tuned I. F. Trans. Units (455 K.C.)

★ Completely Shielded, Permeability-Tuned Crystal Filter Circuit

★ 6 Position Variable Selectivity Switch

★ Controls:—

Pitch Control	Selectivity Switch	Automatic Noise Limiter Switch
Tone Control	A.F. Gain	Crystal Phasing Control
Band Switch	R.F. Gain	Phone Jack
Standby Switch	Main Tuning Knob	

★ S Meter calibrated in "S" units and db's.

★ Directly calibrated, Indirectly illuminated, "Venetian Blind" Tuning Dial.

★ Modern ventilation grills.

★ Speaker—P. M. Dynamic in separate cabinet of matching design.

★ Cabinet Finish—Machine Tool Gray, Crystal finish with Gunmetal and chrome finish escutcheon.

★ Cabinet Dimensions—Width—19", Height—9¼", Depth—12½".

the hallicrafters inc.

2611 INDIANA AVE., CHICAGO, U. S. A.

CABLE ADDRESS: "HALLICRAFT", CHICAGO

WORLD'S LARGEST BUILDERS OF AMATEUR COMMUNICATIONS EQUIPMENT"

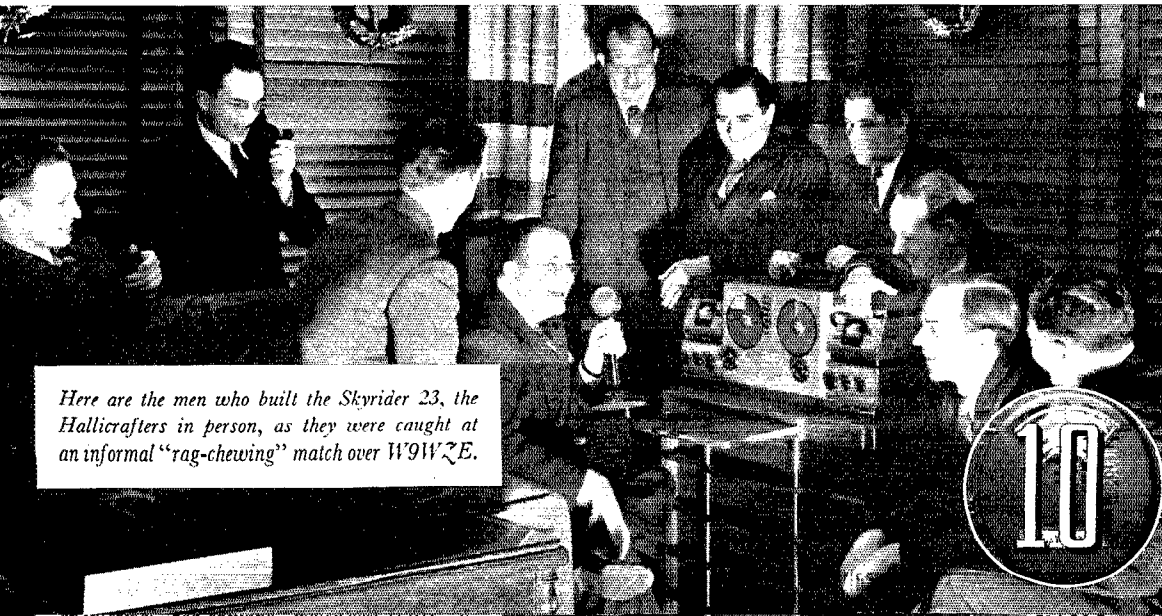

Here are the men who built the Skyrider 23, the Hallicrafters in person, as they were caught at an informal "rag-chewing" match over W9WZE.



Section Communications Managers of the A.R.R.L. Communications Department

All appointments in the League's field organization are made by the proper S.C.M., elected by members in each Section listed. Mail your S.C.M. (on the 16th of each month) a postal covering your radio activities for the previous 30 days. Tell him your DX, plans for experimenting, results in phone and traffic. He is interested, whether you are an A.R.R.L. member or get your QST at the newstands; he wants a report from every active ham. If interested and qualified for O.R.S., O.P.S. or other appointments he can tell you about them, too.

Eastern Pennsylvania Maryland-Delaware-District of Columbia Southern New Jersey Western New York Western New York		W3QP W3BAK W3BEI W8CSE W8QFO	ATLANTIC DIVISION		John B. Morgan Edgar L. Hudson W. W. Filson Ed Preston Kendall Speer, Jr.	247 E. Atlantic Ave. 10 Lincoln Ave.	Blue Bell Laurel, Delaware Audubon Tully Lowber
Illinois Indiana Kentucky Michigan Ohio Wisconsin		W9RMM W9QG W9ARU W8DPE W8AQ W9UTT	CENTRAL DIVISION		Leslie M. Dickson Noble Burkhart Darrell A. Downard Harold C. Bird E. H. Gibbs Aldrich C. Krones	Edelwyn Farms R. 4, Box 1 116 N. Longworth Ave. R.F.D. 2 405 Broad St. 3127-A West Madison St.	Waukegan Indianapolis Louisville Pontiac Wadsworth Milwaukee
North Dakota South Dakota Northern Minnesota Southern Minnesota		W9RZA W9VGD W9IGZ W9VNG	DAKOTA DIVISION		Ernest Bloch Dr. A. L. Russell Edwin L. Wicklund Millard L. Bender	Box 202 R.F.D. 3 608 N. Huron Ave.	Thompson Phid Kensington Spring Valley
Arkansas Louisiana Mississippi* Tennessee		W5ABI W5DKR W5GHF W4DWS	DELTA DIVISION		H. E. Vette Eugene H. Treadaway Robert E. Barr William Harold Walker	4415 West 12th St. 2749 Myrtle St. 301 Boscobel	Little Rock New Orleans Lucedale Nashville
Eastern New York N. Y. C. & Long Island Northern New Jersey		W2LU W2AZV W2GMN	HUDSON DIVISION		Robert E. Haight E. J. Baunach Fred C. Reed	511 South Holmes St. 102 Central Ave. 1014 North Ave.	Scotia Massapequa, L. I. Elizabeth
Iowa Kansas Missouri Nebraska		W9ARE W9UEG W9OUD W9FAM	MIDWEST DIVISION		Clyde C. Richelieu Melvin D. Kirby Miss Letha Allendorf Samuel C. Wallace	Radio Farm 1015 W. 3rd St. Green St.	Burlington Arlington Joplin Clarks
Connecticut Maine Eastern Massachusetts Western Massachusetts New Hampshire Rhode Island Vermont		W1CTI W1FBJ W1WJC W1WGD W1BFT W1HRC W1GNF	NEW ENGLAND DIVISION		Frederick Ellis, Jr. Winfield A. Ramsdell Sam Gross William I. Barrett Carl B. Evans Clayton C. Gordon Alvin H. Battison	19 Merrill Rd. 1188 Washington Ave. Pleasant St. 239 Columbia St. 163 South Main St. 192 Washington Ave. 1 Central St.	Norwalk Portland Warshfield Hills Adams Concord Providence Windsor
Alaska Idaho Montana Oregon Washington		K7ENA W7EMT W7RF W7DXF W7FCG	NORTHWESTERN DIVISION		Leo E. Osterman Carl Richelberger G. A. Woodhouse Harold W. Johnston W. Beale	Customhouse Route 1 Holter Dam 205 North Grant St. R. 4, School Ave.	Wrangell Kuna Wolf Creek Pendleton Walla Walla
Hawaii* Nevada Santa Clara Valley East Bay San Francisco Sacramento Valley Philippines San Joaquin Valley*		K6OTH W6BIC W6FBW W6TTV W6SGZ KA1GR W6NJQ	PACIFIC DIVISION		Hugh Cecil Rea Edward W. Heim Elbert Amarantes Harold J. Burchfield Alan D. Wittaker, Jr. J. L. C. Buckenham George L. Rickard Clarence Ramer	1925 Keeaumoku St. 509 Claremont St. 454 Washington St. 2240 106th Ave. 79 Elinor Ave. 2931 24th St. Box 849 941 Clinton Ave.	Honolulu Reno San Jose Oakland Mill Valley Sacramento Manila Fresno
North Carolina South Carolina Virginia West Virginia		W4OG W4BQE W3UVA W8HD	ROANOKE DIVISION		H. S. Carter Ted Ferguson Charles M. Waff, Jr. C. S. Hoffmann, Jr.	P. O. Box 111 1213 College St. 2607 Stuart Ave. 47 Lynwood Ave.	Winston-Salem Columbia Richmond Wheeling
Colorado Utah-Wyoming		W9EHC W7CLG	ROCKY MOUNTAIN DIVISION		Carl C. Drummeller Ernest B. Parshall	1828 East Kiowa St. Salt Creek Electric Plant	Colorado Springs Midwest, Wyoming
Alabama Eastern Florida Western Florida* Georgia West Indies (Cuba-Isle-of-Pines- Porto Rico-Virgin Islands)		W4DGS W4DVO W4AXP W4AGI CM2OP	SOUTHEASTERN DIVISION		James F. Thompson L. A. Connolly Oscar Cederstrom Leland W. Smith Mario de la Torre	1203 South Perry St. 719 So. Willow Ave. Second St. & Bruce Ave. 2010 Pennsylvania Ave. Escobar 110 (Altos)	Montgomery Tampa De Funiak Springs Augusta Habana, Cuba
Los Angeles Arizona San Diego		W6MQM W6KIC W6JRM	SOUTHWESTERN DIVISION		Ralph S. Click Victor C. Clark Howard K. Breedlove	1038 Milwaukee Ave. 747 E. Polk St. R. 2, Box 656	Los Angeles Phoenix San Diego
Northern Texas Oklahoma Southern Texas New Mexico		W5DXA W5CEZ W5BHO W5CGJ	WEST GULF DIVISION		Lee Hughes C. Simpson Dave H. Calk Joseph M. Eldodt	125 N. Main St. 2010 So. 4th St. 6726 Ave. Q	Childress Panca, City Houston Chamita
Maritime		VE1DQ	MARITIME DIVISION		A. M. Crowell	69 Dublin St.	Halifax, N. S.
Ontario		VE3EF	ONTARIO DIVISION		Dr. L. R. Gunn, (for VE3SG)	Ontario Hospital	New Toronto, Ont.
Quebec		VE2CO	QUEBEC DIVISION		Lindsay G. Morris	Apt. 6, 4510 Girouard Ave., N.D.G.	Montreal, P. Q.
Alberta British Columbia		VE4GE VE5HP	VANALTA DIVISION		C. S. Jameson J. Hepburn, Jr.	581 W. Riverside Drive 335 Foul Bay Road	Drumheller, Alta. Victoria
Manitoba Saskatchewan		VE4RG VE4SY	PRAIRIE DIVISION		A. J. R. Simpson Arthur Chesworth	635 Garfield St. 1071 4th Ave., N. W.	Winnipeg Moose Jaw

* Officials appointed to act until the membership of the Section choose permanent S.C.M.s by nomination and election.

TO A KING'S TASTE

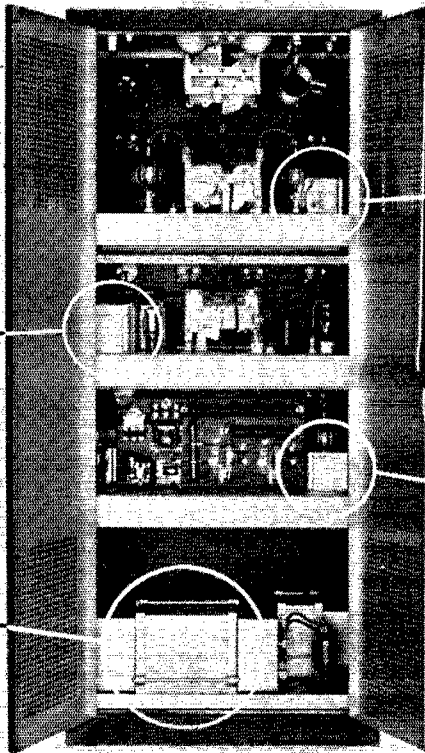

Kenyon low voltage transformer and chokes. Also Kenyon filament transformer for 100-TH and 807 stages.

Main power supply. Kenyon plate transformer, 2500 volts, 1200 mills D.C. Supplies 100-TH driver, class "B" and class "C" stages. At right is 5 to 15 henrys, 1000 mill Kenyon swinging choke.

Kenyon Filament Transformer. 5 volts at 21 amps. Filaments of P.P. 250-TH class "C" stage.

Kenyon class "B" input. P.P. 2A3 plates to P.P. 250-TH Class "B" grids.

Recently purchased from Transmitter Equipment Mfg. Co., by a well-known Eastern potentate, this new 1 KW transmitter is designed for point to point service on 9000 KC. Completely Kenyonized from top to bottom, it is a fitting "rig for a King".

Here is another example of the superiority of Kenyon Transformers which were chosen to be installed in this transmitter when Quality was above all consideration of price.

Send today for our new 1939 catalog describing the complete line. It's complimentary.



KENYON TRANSFORMER CO., Inc.

840 BARRY ST., NEW YORK, N. Y.

Export Department: 25 Warren St., New York, N. Y.

THE AMERICAN RADIO RELAY LEAGUE

Directors

<i>President</i>	
EUGENE C. WOODRUFF	W8CMP
234 W. Fairmount Ave., State College, Pa.	
<i>Vice-President</i>	
GEORGE W. BAILEY	W1KH
74 Webster Road, Weston, Mass.	
<i>Canadian General Manager</i>	
ALEX REID	VE2BE
169 Logan Ave., St. Lambert, P. Q.	
<i>Atlantic Division</i>	
WALTER BRADLEY MARTIN	W3QV
Box 612, Roslyn, Pa.	
<i>Central Division</i>	
R. H. G. MATHEWS	ex-W9ZN
100 East Ohio St., Chicago	
<i>Dakota Division</i>	
FRED W. YOUNG	W0MZN
107 Hanover St., Mankato, Minn.	
<i>Delta Division</i>	
E. RAY ARLEDGE	W5SI
P.O. Box 286, Pine Bluff, Ark.	
<i>Hudson Division</i>	
KENNETH T. HILL	W2AHC
115 Willow St., Douglaston, L. I., N. Y.	
<i>Midwest Division</i>	
FLOYD E. NORWINE, JR.	W9EFC
120 South Fourth St., St. Louis, Mo.	
<i>New England Division</i>	
PERCY C. NOBLE	W1BVR
37 Broad St., Westfield, Mass.	
<i>Northwestern Division</i>	
RALPH J. GIBBONS	W7KV
c/o United Air Lines, Portland, Ore.	
<i>Pacific Division</i>	
J. L. McCARGAR	W6EY
66 Hamilton Pl., Oakland, Calif.	
<i>Ronoke Division</i>	
H. L. CAVENESS	W4DW
State College Station, Raleigh, N. C.	
<i>Rocky Mountain Division</i>	
GLEN R. GLASSCOCK	W9FA
2164 So. Corona St., Denver	
<i>Southeastern Division</i>	
BENNETT R. ADAMS, JR.	W4APU
1512 Grove Place, Homewood, Ala.	
<i>Southwestern Division</i>	
CHARLES E. BLALACK	W6GG
443 Main St., El Centro, Calif.	
<i>West Gulf Division</i>	
WILLIAM A. GREEN	W6BKH
801 Ross St., Abilene, Texas	

THE AMERICAN RADIO RELAY LEAGUE, INC. is a non-commercial association of radio amateurs, bonded for the promotion of interest in amateur radio communication and experimentation, for the relaying of messages by radio, for the advancement of the radio art and of the public welfare, for the representation of the radio amateur in legislative matters, and for the maintenance of fraternalism and a high standard of conduct.

It is an incorporated association without capital stock, chartered under the laws of Connecticut. Its affairs are governed by a Board of Directors, elected every two years by the general membership. The officers are elected or appointed by the Directors. The League is non-commercial and no one commercially engaged in the manufacture, sale or rental of radio apparatus is eligible to membership on its board.

"Of, by and for the amateur," it number within its ranks practically every worth-while amateur in the nation and has a history of glorious achievement as the standard-bearer in amateur affairs.

Inquiries regarding membership are solicited. A bona fide interest in amateur radio is the only essential qualification; ownership of a transmitting station and knowledge of the code are no prerequisite. Correspondence should be addressed to the Secretary.



HIRAM PERCY MAXIM, FIRST PRESIDENT

Officers

<i>President</i>	EUGENE C. WOODRUFF, W8CMP
	State College, Pa.
<i>Vice-President</i>	GEORGE W. BAILEY, W1K
	Weston, Mass.
<i>Secretary</i>	KENNETH B. WARNER, W1E
	West Hartford, Connecticut
<i>Treasurer</i>	ARTHUR A. HEBERT, W1E
	West Hartford, Connecticut
<i>Communications Mgr.</i>	F. EDWARD HANDY, W1BD
	West Hartford, Connecticut
<i>General Counsel</i>	PAUL M. SEG
	1026 Woodward Building, Washington, D. C.
<i>Address all general correspondence to the administrative headquarters at West Hartford, Connecticut.</i>	

"IT SEEMS TO US—"

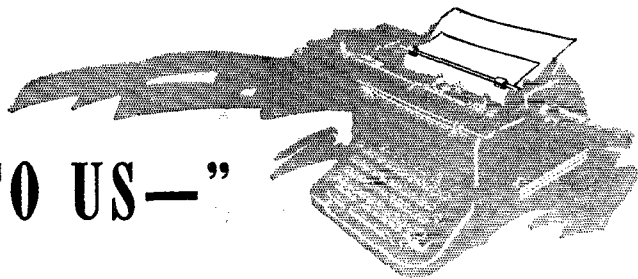

"THE ONLY GOOD INDIAN . . ."

WE PUBLISH this month the first of the promised articles on safety in the operation of amateur stations. As we mentioned last month, the active amateurs on the headquarters staff have been holding a series of meetings in which we have discussed these subjects inside out and back again. We are reaching certain conclusions.

The first of these is that the most important element in maintaining safety is the personal conduct or actions of the operator and that there are certain rules which, if only he will apply them, will keep him safe. The second is that there are a number of building precepts which, incorporated in our apparatus, will immensely reduce the element of hazard. Third on our list come devices and gadgets that may serve to protect even a careless operator. The first two aspects of this matter are treated in George Grammer's article this month.

A word concerning the safety rules for construction: We offer these as an A.R.R.L. safety code. The members of the headquarters staff at this writing are engaged in making careful check on their own transmitters to see wherein they may deviate from these recommendations. We now wish to call most forcibly upon every member of the League to digest this article and, with article in hand, to check carefully both the circuit and the physical arrangement of his present transmitter to see whether it complies. Almost certainly it will not. We then urge that the necessary steps be taken immediately to bring it into line with the A.R.R.L. code. It won't cost much, and the money it does cost will be tremendously well spent. At the least, it will be very valuable to know and be warned against any features of the transmitter that do not comply with the code, if for any reason it is found impossible to correct them.

Rules for personal safety are more important than construction. If made a part of one's routine habits they can protect an operator from a dangerous rig. We plead for an earnest study of our recommendations in this respect. But there is only one wholly safe rule and that is our first one, the one we emphasize: Always

kill the transmitter before touching *anything* behind the panel. We recommend this even for changing coils and we mean killing the entire transmitter, including the filaments. This may sound like an extreme viewpoint but it is the only safe rule. Another person in the station, perhaps a child, or even an animal or even a freak electrical accident, might serve to turn on the high tension. You may forget to turn it off yourself, and signal lights and alarms have a habit of burning out, particularly when there is trouble. Relays sometimes stick down, or can be accidentally pushed closed while working on the set, or jarred into contact by something so remote as the slamming of a door. Something might fall on the key or switch. And the low-power supplies and the bias supply and even the 115 are themselves dangerous.

Are you good at hand lettering? We suggest the following for your shack:

THE PRIMARY SAFETY RULE IN THIS STATION IS NEVER TO TOUCH ANYTHING BEHIND THE PANEL UNTIL THE ENTIRE TRANSMITTER HAS BEEN SHUT DOWN, INCLUDING THE FILAMENTS, WHILE THE KEY IS HELD DOWN TO BLEED CONDENSERS.

Don't complain about the time this will take. What is time to a dead man? Don't beef about what this policy will do to tube life. Filament life is cheaper than human life. Follow this most important of all rules and the transmitter will always be dead and you'll always be alive. But live transmitter, dead ham!

GOOD OL' DAZE

WE JUST awoke to the realization that in ten days of pretty heavy operating on four bands we had heard almost nothing of the other headquarters fellows on the air — WIAW and one very weak harmonic from another of the fellows, to be exact. This caused us to investigate how many of the Hq. Gang had been on the air during this period and we found that twelve of them had, with a total operating time of several hundred hours — yet only two of them had encountered our own signal. While the operating hours on the same band frequently don't coincide, one would think

that the percentage would be much higher. We then checked up on the eight most active stations of our group who had used the 3.5-Mc. band during this period. These eight stations had operated 253 hours in ten days. If each of them had encountered all the others, a total of 56 intercepts would have taken place. But of this possible 56, just 37 had actually happened. These figures included W1AW, with a nearly perfect score. With W1AW eliminated, the figures became 24 out of a possible 42.

Interference is surely plenty tough, and we're not going to say it isn't! But we were just contrasting these results with the old spark days and reflecting that it is at least a shade less irritating to experience our interference from distant stations than from a local who wipes out the whole band. We were thinking particularly of what used to be called the Chicago Plan back in the spark days, and wondered how many of you fellows remembered it. This was a cooperative plan under which high-powered stations stayed off the air until about 9:30 P.M., letting the earlier evening hours be devoted to local work by spark-coil sets in the hands of the young fry. After 9:30 the "locals" had to pipe down and the air belonged to the big-shot transformer chaps. Since cooperation was the only thing that made any work possible, only one station could work at a time while the others stood by. As additional stations came on the air for the evening they were obliged not only to listen first but to inquire whether the air was clear for them to proceed by sending, just once, the Morse letter "C." A hasty "AS" from the man who was copying would hold the pack at bay for a reasonable period, but if he attempted to hog the air too long a perfect flock of impatient "C's" quickly made him change his mind.

Imagine, if you can, conditions in which only one amateur station in a whole large city could operate at a time! Compare it with conditions under which a dozen of your close friends and neighbors, over a ten-day period, don't even know you've been on the air! Why, it took an Egyptian station to tell us the other morning that a friend about a mile away was calling us on our own frequency!

K. B. W.

★ **SPLATTER** ★

FEBRUARY starts out with a bright spark in the first day's mail:

"I have the makings of two or three Owl Juices knocking around in my noggin but they don't pop out on paper. I seem to have lost the common touch. But I shall try to eke out one or two to

appease the public clamor and brighten the dull and lifeless pages of *QST*."

— Dixie Jones, W4IR

And we know they will!

★ ★ ★

Does the name of the author of the "**Modern Band-Switching Superhet**" have a familiar ring, or should we say swing, to it? Right — it's none other than "RP," of W1MK for years. It is certainly fitting that Bob should be the author of the latest SS receiver with everything on it but the kitchen stove, for it was he who constructed Jim Lamb's original SS baby back in 1932 and stroked the fur of the finished product for many months in regular service at MK. (Need we GBA on W1MK for the young squirts?)

★ ★ ★

"Not that it makes much difference, but in the S.F. listings Schedule B has been listed as 7100, 7100, etc., for over a year now. Is it too expensive to reset that 7100 to 7000?"

— W3EEW, O.O.

★ ★ ★

On the heels of the above we are pulled up by the bootstraps by W9OSM who points out to us that the Arctic must have peculiar effects upon film — page 11, Jan. *QST*. And Bob is correct; 8-mm. film doesn't have sprocket holes on both sides. That's what comes of being a single-hobby hobbyist. We wrote the cut label and can't blame Gerry Sayre for it.

★ ★ ★

Oh, boy, what a safety cover we ran last month! Do you remember it? The operator was kneeling on damp earth in the rain, with a microphone in one hand and the other hand behind the panel of a portable transmitter, and a pair of 'phones around his neck! Put it down as a horrible example of how not to do things.

★ ★ ★

W8QBW brings up an important point regarding the treatment accorded *QST* authors. He says that the majority of those who write the author for further information, not contained in *QST*, have the same common failing — they neglect to enclose postage for reply!

This may seem like a small point to grouse about, but it is only common courtesy to include postage for a reply, and better yet, include it on a self-addressed envelope. The author wrote that story to benefit his brother hams — and received no pecuniary return for his efforts.

Don't neglect this in the future, gang.

★ ★ ★

"**Frequency Measurement and Regular Check**" was F.C.C.-approved for publication in *QST*. And if that doesn't give it enough authenticity, the writer, A. K. Robinson, W7DX, happens to be an F.C.C. Inspector in the Seattle office.

Safety Technique in Transmitter Operation and Construction

Introducing the A.R.R.L. Safety Codes—Study Them

BY GEORGE GRAMMER,* W1DF

WE'VE been told that the American pioneers once had a saying, "The only good Indian is a dead Indian." We'd like to paraphrase that slogan and shift the phase by 180 degrees: "The only good amateur is a *live* amateur." And then never forget it when we're working around radio equipment.

Far more amateurs die from natural causes, or from accidents not connected with radio, than are killed by electrocution in the course of ham operating or experimenting. That is fortunate. "Fortunate" is exactly the right word, too, because nearly every amateur can tell of a narrow escape from death or serious injury by electrical shock—we know, because we've heard of innumerable cases since the untimely deaths of Ross Hull and Phil Murray. And most hams, having come through such an experience without serious damage, never realize by what an exceedingly small margin they made good their escape. With a small change in atmospheric or bodily conditions, or a slight difference in the layout of equipment or bodily position at the time of contact, there might have been an entirely different story to tell—with someone else doing the telling.

We've talked a lot about safety among ourselves here at Headquarters in recent months. What could be done to make amateurs safety-conscious, to instill in them a healthy respect for electrical circuits? What should be done to transmitters to make them more safe to operate and adjust? We spent days in round-table discussions examining suggestions, contributed by amateurs in the field as well as ourselves, from all angles to expose their weak as well as strong points. We consulted safety codes of other organizations in the electrical field. We came to the realization that much could be done to make equipment, particularly transmitting equipment, safer, but that, at least at the present stage of the game, no transmitting equipment could be built that would permit the operator to blindfold himself, stick his hands in the works with all the power on, and be perfectly safe while doing it. We realized, too, that a lot of inertia had to be overcome—no one is going to get involved in constructing safety devices when, after all, he's

not going to be guilty of carelessness in handling dangerous voltages. And so we found that the subject of safety naturally divided itself into three sections: First, a set of rules for personal conduct in the handling of transmitters; brief, easily memorized, designed to prevent shock when operating or adjusting *any* transmitter. Second, a set of constructional precepts which, although involving no special hardships or expense, would minimize danger of shock in normal operating or adjustment; really, a code of good practice in transmitter construction. Third, special devices such as interlocks, warning signals and the like, whose purpose is to protect the operator from the disastrous consequences of a moment of forgetfulness.

With so much that can be said and done about safety, we must confine ourselves to the first two classifications for the present; special safety devices will be reviewed in a future issue.

The "personal" code is most important. Its seven simple points should be remembered as automatically as the characters of the international telegraphic code, and applied as instinctively. They are displayed prominently elsewhere in this article, but are so fundamental that they deserve repetition here:

(A) Kill all transmitter circuits completely before touching anything behind the panel.

If we could be sure this rule would be followed unflinchingly by everyone, we could almost end the discussion right here. After all, no one is ever hurt by a "dead" circuit. But far-reaching though it is, this rule is not quite enough. Phil Murray, remember, was handling only a microphone, supposedly as safe a piece of equipment

Every amateur should make it a point to read this article thoroughly. It summarizes the results of much individual thinking and many intensive group conferences into two simply-applied safety codes, one covering precautions that should be taken when working around transmitters, and the other, methods of making the transmitter itself less dangerous in ordinary operation. Read them; put them into effect at once!

*Technical Editor.

to touch as anything about a transmitter. When changing coils, making internal adjustments, or shooting trouble inside the transmitter, kill *all* the power circuits before handling anything. If you have to see what happens with the power on, don't close the switch until after you're clear. Does the risk seem worth the few minutes saved by disregarding this rule?

(B) Never wear 'phones while working on the transmitter.

Headphone circuits usually work back to ground, and the cord insulation isn't intended to stand high voltages. When you get a shock, your hand is nearly always at one end of the circuit; your chances are pretty slim if your head is at the other end.

(C) Never pull test arcs from transmitter tank circuits.

R.f. may not shock you, but it can cause bad burns. And it can readily travel through a pencil or screwdriver — possibly to be followed by high-voltage d.c. Like s.w.l. cards, the arcs may impress the visitors but they don't mean much.

(D) Don't shoot trouble in a transmitter when tired or sleepy.

And, we might add, after a convivial evening. Your reactions are slow, you're more likely to forget to take normal precautions. Get some rest first.

(E) When working on the transmitter, avoid bodily contact with metal racks or frames, radiators, damp floors or other grounded objects.

One side of the high-voltage circuit is, or should be, grounded. You don't want to contact ground with any part of your body while working on some part which may be at high potential. This is a precaution which, if made a habit, may save you should you forget "A".

(F) Keep one hand in your pocket.

This can also be made a habit. Its purpose, of course, is to prevent the two hands from being the opposite terminals of a circuit through the vital parts of the body.

(G) Develop your own safety technique. Take time to be careful.

We all develop operating habits which become practically automatic. Make it a point to develop *safety* habits, too. You can, for instance, train yourself to open the main switch without conscious thought every time you push back your chair to get up from the operating table. Work out a routine for safe operation, practice it, make it a part of your second nature.

CODE FOR TRANSMITTER CONSTRUCTION

We've conceded that no transmitter can be made completely shock-proof under any and all conditions. But *all* transmitters can be constructed so that all operations such as tuning and switching normally carried on from in front of the panel are perfectly safe. And much can be done to "safetyize" the inside of the set.

In formulating the construction rules to follow we had a dual idea in mind: First, to eliminate danger from sources where it should not normally be expected, such as at front-panel controls. Known "hot" spots in the transmitter are still to be treated with utmost respect; still, it is possible to make some of them innocuous. Second, to minimize the danger to life should there be a breakdown somewhere in the equipment. This seldom-considered point is highly important, as the Murray case proves. Altogether there are eighteen rules, most of them already in common use by the more thoughtful constructors, at least. The majority deal with methods rather than specific equipment, and none of them appreciably raises costs. Those not already observed in existing transmitters can be applied quite readily, often with but little inconvenience. The reason, for each one should be obvious, but we'll devote a few words of explanation to each. Here they are:

(1) Grounds — With chassis construction, all negative terminals of plate-voltage supplies and positive terminals of bias supplies should be connected to chassis and to a good ground. Chassis should be connected together and to the rack, frame or cabinet, if of metal.

With breadboard construction, negative terminals of plate-voltage supplies and positive terminals of bias supplies should be connected together and to a good ground.

The important thing here is that everything supposed to be at ground potential actually *should be grounded*. Then if a transformer or other component breaks down, no harm can come to the operator from touching a normally "dead" component or structure. Fuses may blow, and some equipment may be damaged, but such things can be replaced. Phil Murray would be alive to-day if there had been an actual ground on the speech amplifier.

It has been suggested that both sides of power-supply circuits should be insulated from all metal chassis, the r.f. returns being made to chassis through by-pass condensers. Thus the chassis and either side of the circuit could be touched simultaneously without danger of a greater jolt than the discharge from a small by-pass condenser. But this system gives no protection from defective equipment, and we believe

it better to conform to the standard practice of connecting one side of each supply circuit (negative in the case of plate supplies and positive in the case of bias supplies) to the chassis, and *then grounding the chassis*. Of course, there is no large metal surface in the usual type of breadboard construction, but the general principle should be followed just as faithfully.

(2) Control Shafts — All shafts, jack frames and other metal parts protruding through panels should be grounded, regardless of whether the panel is metal or insulating material.

For safety in tuning, this rule is extremely important. Obviously, there should be no possibility of getting "bitten" from a control which one has to handle. Condenser shafts, in particular, only too often are at the full plate voltage above ground, and only such insulation as the tuning knob may have protects the operator. Even though the knob may be good bakelite, there is still a set screw coming too close to the fingers for comfort. The only safe way is to make the shaft dead, either by using a circuit which permits grounding the condenser rotor, or by using an extension shaft to drive the condenser through an insulating coupling. In the latter case the extension shaft alone is not enough; it should be grounded to the panel, if metal (the panel in turn being grounded), or directly connected to ground by wire. Then if the coupling breaks down the only damage is to the plate supply. Extension shafts and panel bushings are readily obtainable and inexpensive.

(3) Plugs, Jacks and Cords — When plugs and jacks are used for meter switching, the circuit should be arranged so that the jack frames can be grounded. The plug cord should be heavily-insulated flexible cable, or shielded cable with the shield connected to the plug sleeve.

This rule is very commonly disregarded — mostly, it must be admitted, in connection with supposedly non-dangerous low-voltage circuits. Certainly no jack on the front panel of a transmitter should be at anything except ground potential; it is only too easy to touch it accidentally. Practically, this means that the meter jack must be connected in the negative plate-supply lead or positive bias-supply lead; if it cannot be connected in this way because a common supply is used for two or more stages, then some other method of meter switching should be used.

Note that additional precautions should be taken with respect to the cord. This is not just one of those things to "make assurance doubly sure" but is an essential part of the rule. Should the meter develop an open circuit, a considerable difference of potential — possibly depending



**ALWAYS
Be
CAREFUL.**



★ ★ ★

(A) Kill all transmitter circuits completely before touching anything behind the panel.

(B) Never wear 'phones while working on the transmitter.

(C) Never pull test arcs from transmitter tank circuits.

(D) Don't shoot trouble in a transmitter when tired or sleepy.

(E) When working on the transmitter, avoid bodily contact with metal racks or frames, radiators, damp floors or other grounded objects.

(F) Keep one hand in your pocket.

(G) Develop your own safety technique. Take time to be careful.

★ ★ ★

Death Is Permanent!

upon the circumstances, the full plate voltage — will appear across the wires of the cord. There should be no possibility of insulation breakdown which might result in a serious shock. The safer of the two alternatives is to use a shielded cord, with the shield connected to the plug sleeve and thus automatically to ground, through the jack frame, before the meter circuit is made.

(4) Cases and Cores — Transformer and choke cores, cases and other metal work not normally a part of the electrical circuit should be grounded.

This is a measure against equipment failure. Breakdown of a winding to the core is probably the commonest of transformer and choke failures. Since the core and case are normally dead such a breakdown can be doubly dangerous, because the appearance of voltage on them is totally unexpected. Don't take it for granted that the bolts holding the units to the chassis make a ground connection; test with an ohmmeter and make sure of both core and case. Units with the core enclosed are best, since the laminations of the core are usually insulated to some extent to prevent eddy-current loss.

(5) Master Switch — There should be one powerline switch, in a conspicuous and easily-accessible location on or near the transmitter, which controls all power to the transmitter.

Without such a switch, the habit of turning off all power before going behind the panel may be difficult to form. Make it *easy* to kill the transmitter — you're more likely to follow the cardinal "A" of the "ABC's."

(6) Power Supply Enclosures — Power supplies should be so enclosed or constructed, or so located, that accidental bodily contact with power circuits is impossible when adjustments are being made to r.f. or audio units.

A grounded cover over a power supply is the safest type of construction. With relay racks, the power supplies are usually at the bottom where a leg or knee may come in contact with exposed wiring when adjustments are being made. Lacking a cover, the next best thing is to use construction without exposed high-voltage points; this is covered in some of the following rules. Alternatively, the power supply may be located well out of reach when work is being done on the transmitter; this means, however, that it cannot be on the same rack or frame with the transmitter proper.

(7) Bleeders — A bleeder resistor should be connected across the d.c. output terminals of each rectified a.c. power supply.

From the electrical design standpoint, every power supply of this type ought to have a bleeder anyway. As a safety precaution, to discharge filter condensers, the bleeder is absolutely essential. Filter condensers can store up quite a charge, particularly on circuits over 1000 volts, and even though the discharge may not last very long it is not to be lightly dismissed — there may be enough energy available to be as dangerous as a continuous contact. And a lot of things can happen in the reaction; the uncontrollable jump you give may result in damage both to yourself and the apparatus.

Even with a bleeder on the supply, it doesn't pay to take it for granted that the condensers are discharged when the power goes off. Bleeders can open up with no warning. Special methods of making sure of the bleeder will be discussed in subsequent issues.

(8) Resistors — Resistors should be so located or protected that accidental bodily contact is impossible. When one side of the resistor is open for adjustment, the resistor should be mounted with the exposed side in such a position that it cannot be touched. Sliders, when used, should be insulated or protected by barriers.

Tubular resistors, unfortunately, are made with exposed terminals. This is also true of the slider on the semi-variable type. Equally unfortunately, a resistor usually has to be mounted in a rather exposed location if it is to dissipate the power it is rated to carry; for the same reason, it cannot ordinarily be mounted inside a box. A lattice or cane cover, which would give the necessary protection and still allow plenty of air circulation, would be a good thing to have. Without it, install the resistor where it can't be

touched unintentionally, or put a grounded metal barrier, large enough to prevent accidental contact, in front of it.

Don't depend on the coating for insulation — it's there to protect the resistance wire, not you.

(9) Plate Milliammeters — Plate milliammeters preferably should be connected in the negative plate-supply lead so that one side of the meter can be grounded. If this is not possible, the meters should be mounted behind the panel (behind glass if possible) so that accidental contact is impossible.

This practice will protect the meter as well as the operator. Even bakelite-cased meters are rated for only 500 volts or so when mounted on a grounded panel. The danger point on a meter is the reset screw, which is responsible for more than one shock, and the screw therefore should be kept at ground potential. If the meters *have* to be connected in the positive leads, by all means put them where they can't be touched. An insulating mounting behind a relay-rack panel, with a slot for viewing, is not hard to rig up, and should always be used when the meters are above ground.

(10) H. V. Leads — High-voltage leads should be a good grade of high-tension wire insulated for at least two to three times the peak operating voltage.

Insulation should be good enough so that a high-voltage lead can be run along a grounded chassis or frame without danger of breakdown. Then there will be no danger to the operator should the wire be accidentally touched. Note that peak operating voltage is specified — this is at least twice the steady d.c. plate voltage when the stage is plate-modulated. Automobile high-tension wire, in the better grades, is inexpensive and amply rated for most amateur plate supplies.

(11) Terminals — Exposed terminals and tube caps should be protected by insulating coverings. Barriers should be placed over exposed transformer terminal boards.

High-voltage terminals, tube caps and the like are highly dangerous points and, usually, only too easy to touch unless deliberate care is taken to avoid them. Insulated caps for tubes have been obtainable for a long time, although not generally used by amateurs. They cost little and are not troublesome to install.

We need a new type of high-voltage terminal to replace the feed-through insulator generally used for the purpose. It could be built much along the same lines, but should have a ceramic cap which screws or otherwise fastens to the body of the insulator and which covers the actual connection after it is in place. There's an opportunity here

(Continued on page 86)

A Modern Band-Switching Superhet

Alternate General Coverage-Band Spread Ranges; Acorn Preselection; Noise Limiting; Antenna-Matching Network

BY ROBERT B. PARMENTER,* W9PLM

FOR the past few years it has been possible to buy a receiver for almost any price one can afford to pay. Only the most hardy individuals attempt to build their own, and even the operator who insists on building all transmitting equipment usually will buy a receiver. The reason appears to be that present-day receivers are somewhat complicated and represent quite a lot of work. At the same time one can't do the job much more cheaply, for when the cost of parts is added up the total comes to practically the price of a factory-made receiver.

In spite of this it is our conviction that it is still possible to build a better receiver than many of us can afford to buy, since any of the manufactured receivers are quite expensive when all the latest gadgets and features are added to them. Manufacturers have been rather slow in discarding models and adding new features as they appear. However, from our point of view many of these features are needed, which is an argument in favor of building your own and adding all the necessary trimmings.

There are so many features that may be incorporated in a receiver that it is likely no two persons would agree on all of them, and some compromises are always necessary. Referring to the schematic in Fig. 1, the following features have been incorporated: An impedance-matching network, preceding the first preselector stage, with which it is possible to obtain a match using either a tuned or untuned line; two preselector stages using 956 acorn tubes; one tuning control; full electrical and mechanical band spread. The coil-switching system adopted is arranged so that full band spread is obtained on alternate

* c/o WHAS Transmitter, Anchorage, Ky.

This panel view shows the arrangement of controls—a formidable array, but giving a high order of flexibility in operation. The actual tuning is, of course, single-control. Filament- and plate-supply switches, gain control, band switch, and antenna network controls are grouped at the left. At the right, beat-oscillator, a.f. gain, tone, a.v.c., noise-silencer, and crystal-filter controls. The pilot lights indicate the band in use.

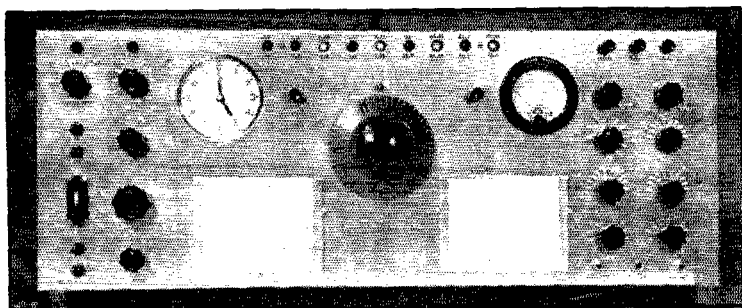

Here is a receiver which incorporates practically all the features considered desirable in a present-day ham super. Ample gain, plenty of preselection, a good method of getting both complete bandspread as well as general coverage, antenna-input tuning, a.v.c., noise reduction, and of course a crystal filter. Elaborate? Naturally. Nevertheless, a lot of the ideas can readily be applied to any home-built receiver, and some of the gadgets can be added to manufactured sets as well.

contacts and general coverage on the other contacts. Included in the i.f. amplifier is an adjustable noise suppressor using Lamb's original circuit. With the idea of reducing unwanted pick-up to a minimum the a.c. input to the receiver is brought directly into a shielded r.f. line filter which is mounted under the chassis.

The frequency range is 550 to 30,000 kc., with practically complete coverage except in the b.c. band. The band-spread and padding-condenser arrangement used is similar to that in the HRO, with the exception that no plug-in coils are used. Such a system, while both bulky and expensive, is ideal from an operating point of view since it gives complete band spread on each band. Only enough fixed padding capacity is used across each coil to limit h.f. oscillator drift to a minimum. The parallel capacity arrangement used in some receivers is by far the cheapest way out, but it can readily be seen that the fixed capacity across each coil either will be too high, limiting the gain of the front end, or it will be too small, resulting

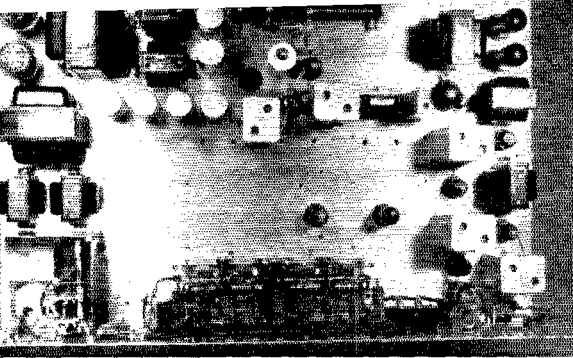

Except for the four-section tuning condenser and the antenna-input network (at lower left), all r.f. circuits are below the chassis. This top view shows the power supplies, left, and i.f. and audio sections, rear center and right. The two tubes behind the gauged tuning condenser are the mixer and h.f. oscillator.

in oscillator drift. The original plans called for a set of coils covering the 56-Mc. band, but because of the necessarily long leads through the coil switch it was impossible to have sufficient inductance in the coils themselves, and the results were very poor. If plug-in coils had been used it would have been a simpler matter to include this band, but one must make compromises with coil switching.

The total number of tubes is 17, which may seem like overdoing it; however, all serve a useful purpose. The total includes two rectifier tubes and a push-pull Class-A 6L6 stage which could have been replaced by a single pentode with some drop in quality and power output.

The Matching Network

In these days of directive antennas of all types it is a decided advantage to be able to vary the input impedance of a receiver over quite a range in order to obtain a match under all conditions. About the only disadvantage is the addition of two more controls, but this is a minor detail since the network may be arranged to be switched out of the circuit when not wanted. A great deal of noise is eliminated by the use of a Faraday screen on the coupling coil; the screen is effective on all bands so long as the network is switched in. Almost as much automobile ignition noise is eliminated by the network as is eliminated by the noise suppressor.

There is really nothing unusual about the circuit, and similar arrangements have appeared from time to time in past issues of *QST*. A brief description will be given as we have figured this one to cover all tuned lines from 3.5 to 30 Mc. and the mechanical end is the most difficult. The tapped inductance, L_1 in Fig. 1, is space-wound on a thin sheet of celluloid with the turns held in place with Duco cement. It has 40 turns of No. 22 enameled wire, and is 4 inches long and $1\frac{1}{2}$ inches in diameter. A $\frac{3}{8}$ -inch gap is left at the center so that the coil really is wound in two sections. A small pick-up coil of three turns is arranged to move in and out of this gap. Taps are provided every 4 turns on L_1 , which gives plenty of variation. Since the midpoint of L_1 is grounded and the three turn pick-up coil is completely shielded on both sides by the Faraday screen, very little capacity coupling can exist between the antenna or feeders and the front end

of the receiver. The screen is part of the pick up coil and moves with it whenever the coupling is changed; it is made by bending a small sheet of celluloid over the pick-up coil and space winding it with No. 28 d.s.c. wire, cementing the turns in place. After allowing it to dry thoroughly the open edge is trimmed off to the same shape as the coupling coil. The winding is then carefully sanded on the closed edge and a ground wire soldered across each turn. This operation is rather tricky and several screens were ruined with the soldering iron before a perfect coil was secured, but it is possible to do it. The complete wiring of the network and in-and-out switch is shown in Fig. 1.

The Front End

The r.f. section is 18 inches long, $10\frac{1}{2}$ inches deep, and $5\frac{1}{2}$ inches high, which does seem quite bulky; however, when it is considered that the unit is a complete front end and contains a 12-section isolantite coil switch, 24 coils, 40 padding condensers (most of them air condensers), two 956 tubes, a 6A8 and a 6F6, the size seems more reasonable.

The front end was the first part of the receiver finished and all coils were trimmed and the circuits lined up before proceeding further. This was done by feeding the output of the 6A8 mixer into the first i.f. transformer of another receiver — a very convenient way of doing it since the construction does not permit ready access to the coils after the unit is mounted in place under the chassis. This method is good practice in any case, since you know when you have finished that at least half of the job is in operating condition. The peculiar "underslung" construction used for mounting the coils and all tuned circuits keeps all circuits carrying high-frequency r.f. well down below the tubes, which are the main source of heat and thus the chief cause of drift.

It was impossible to take any photographs of the inside of the coil compartments so a brief description is in order. The outside photograph shows the rows of padding condensers mounted below the coils. The 956 acorn tubes are mounted on the side walls of the coil compartments, which brings a grid connection inside one section and a corresponding plate lead in the following section. We used the acorn tube sockets having a mica-insulated metal base, which have a small capacity

at each base terminal. These sockets turned out to be a real headache due to voltage break down to the copper base through the mica sheet, and finally had to be completely re-insulated with a heavier sheet of mica. Anyone using these tubes would do well to use the isolantite type of socket since the direct by-passing at the terminals really is necessary only at 56 Mc. and higher.

All padding condensers are of the air dielectric type except for the 1.7-Mc. and b.c. bands. Isolantite-insulated padding condensers are used on all frequencies above 4 Mc. The coil switch is likewise isolantite insulated, and was a special job kindly supplied by Centralab. It has 12 sections with 9 contacts per section. It is of the shorting type; that is, it shorts between each set of contacts until thrown completely over to the next contact. This prevents the plate circuits from opening, and thus no sparking can occur to cause a noisy contact later on. Although 18 inches long, this switch has very little twist in the shaft and should be ideal for changing coils in an exciter. The switch extends through the entire unit and is driven by a set of right-angle beveled gears from the front panel. This is a rather inconvenient type of construction but the National PW 4-section condenser and dial can only be obtained with shaft parallel to the front panel, so for the sake of shorter leads we were compelled to "dig" our way out by this means.

The shaft which drives the coil switch extends back under the chassis far enough to accommodate an auxiliary switch at the far end, and this is used to complete the circuit to a row of indicator lights on the top of the front panel. This circuit is not shown in Fig. 1 but is simply a series circuit to each light through the switch. The lights indicate the particular frequency range in use. The nine W.E. sockets were obtained from a junked telephone switchboard without cost and the indicator lights themselves are W.E. type E-1. The price is prohibitive, since they cost \$4.20 per dozen, but the sad news wasn't learned until after the bulbs had arrived, or some other type would certainly have been used.

All padding condensers are mounted on the side walls of the coil compartments near the proper coils. The coils are similarly mounted and all are mutually at right angles to each other. In addition to this, only those coils which are separated at least two ranges are in the same end of the compartment (the 28-Mc. and 7-Mc.

A view of the r.f. coil section during assembly, showing the method of mounting the trimmers. This unit fits under the chassis. The switch runs lengthwise through the compartments, with the control shaft projecting at the left.

INJECTOR GRID VOLTAGES AT EACH END OF TUNING RANGES

Frequency Range	High-Freq. End	Low-Freq. End
0.55- 0.90 Mc.	35 volts	15 volts
1.5 - 3.0 Mc.	40 volts	20 volts
3.49- 4.05 Mc.	25 volts	17 volts
3.9 - 7.10 Mc.	18 volts	10 volts
7.0 - 7.35 Mc.	18 volts	18 volts
7.3 -14.0 Mc.	18 volts	10 volts
14 -14.45 Mc.	18 volts	18 volts
14.0 -28 Mc.	12 volts	5 volts
28 -31.0 Mc.	10 volts	12 volts

coils are near each other, etc.). These two details eliminate all mutual coupling.

Although acorn tubes are still quite expensive they are really necessary in order to keep the r.f. gain up at 14 Mc. and higher. Receivers using standard glass or metal tubes in the front end show a decided drop in gain at 28 Mc. This is due, of course, to the much lower input impedance of a standard tube at high frequencies. Quoting from a paper which appeared a few years ago in *I.R.E. Proceedings*,¹ "the input impedance of a Type 57 tube is 27,000 ohms at 30 Mc. while at the same frequency the input impedance of a 954 is 200,000 ohms." When it is considered that the tuned circuit is directly across this impedance it is easy to see why there will be more voltage built up across the higher impedance, and consequently more gain.²

It is unfortunate that none of the tube manufacturers have developed an acorn version of the 6A8 or some similar type. Some loss results from using the 6A8 as the mixer, but the good internal shielding and element isolation reduces interaction between the mixer and h.f. oscillator, so for that reason it was used. A 956 was not actually tried in the mixer position but it seems reasonable to expect interaction, particularly at 28 Mc., with no greater choice of elements to which the oscillator may be coupled.

¹ W. R. Ferris, "Input Resistance of Vacuum Tubes as Ultra-High-Frequency Amplifiers," *Proc. I.R.E.*, January, 1936.

² The television tubes (1851-52-53) also will give high gain, by virtue of their exceptionally high mutual conductance. Their input impedance also is low, however, so that the selectivity is low compared to that obtainable with acorns. This factor is worth consideration when a standard i.f. is used, since high signal-frequency selectivity is necessary to give a good image ratio.—Edron.

³ J. J. Lamb, "A Noise-Silencing I.F. Circuit for Super-het Receivers," *QST*, February, 1936; "More Developments in the Noise-Silencing I.F. Circuit," *QST*, April, 1936.

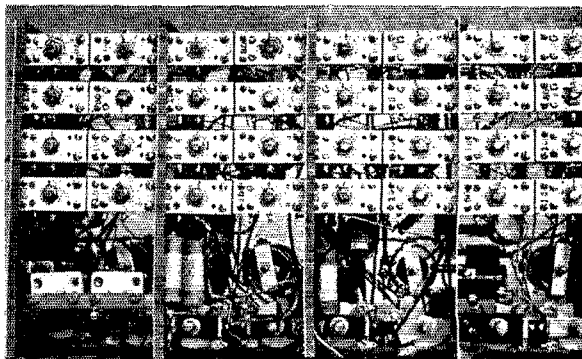

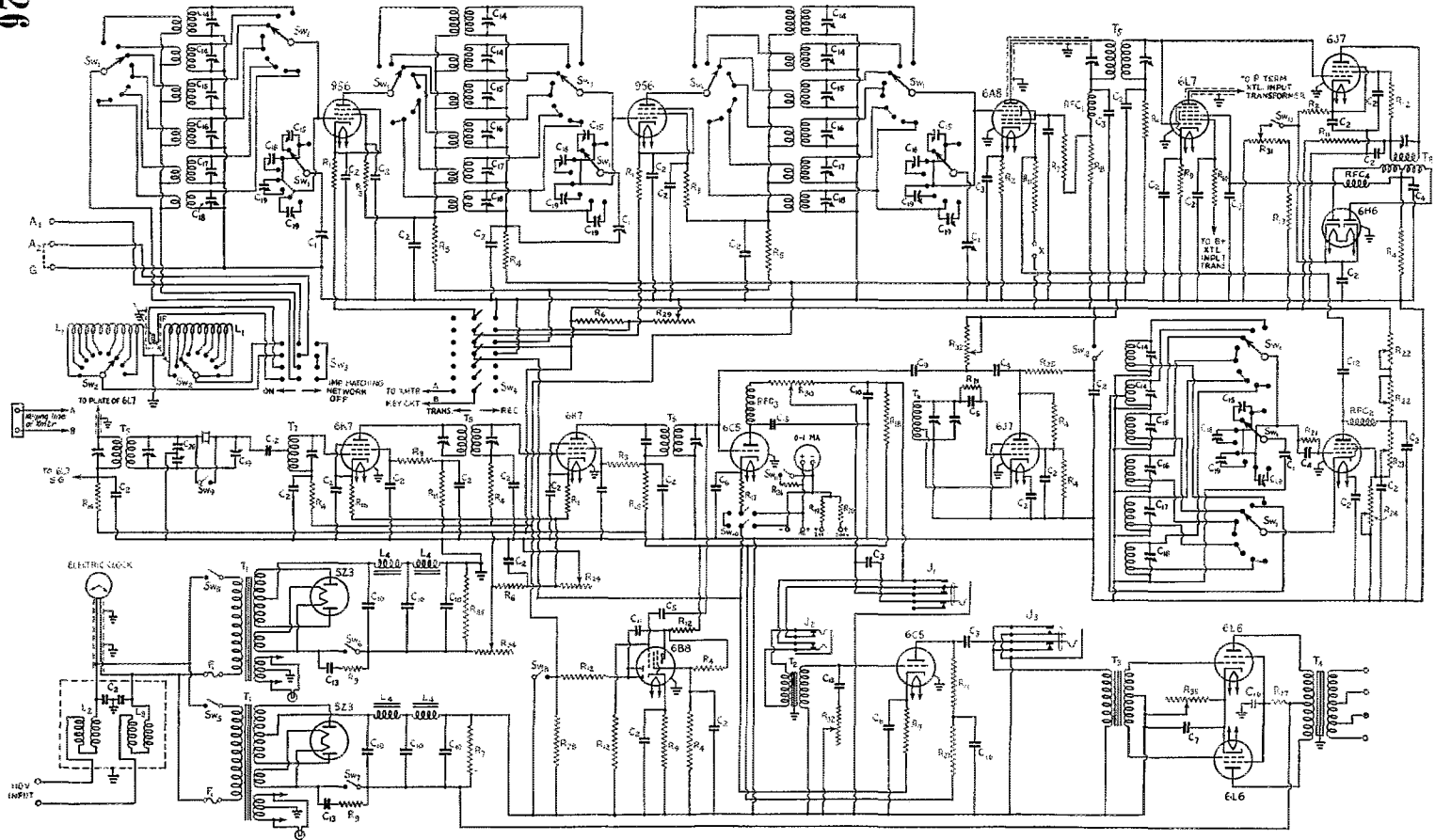

Fig. 1 — The receiver circuit diagram.

C₁ — 4-section ganged condenser, 175 μ fd. per section, and dial (National PW-4).
 C₂ — 0.1- μ fd., 600-volt tubular paper.

C₃ — 0.25- μ fd., 600-volt tubular paper.
 C₄ — 100- μ fd. mica.
 C₅ — 0.001- μ fd. mica.

C₆ — 25- μ fd., 50-volt electrolytic.
 C₇ — 25- μ fd., 100-volt electrolytic.
 C₈ — 0.005- μ fd. mica.

- C₀ — 2-μfd. mica (approximate value).
 C₁₀ — 8-μfd. electrolytic.
 C₁₁ — 500-μfd. mica.
 C₁₂ — 50-μfd. mica.
 C₁₃ — 0.01-μfd., 600-volt tubular paper.
 C₁₄ — 140-μfd., variable mica padders.
 C₁₅ — 100-μfd., variable air (Siar midgeets).
 C₁₆ — 75-μfd. (National UM75).
 C₁₇ — 50-μfd. (National UM50).
 C₁₈ — 35-μfd. (National UM35).
 C₁₉ — 15-μfd. (National UM15).
 C₂₀ — 50-μfd., selectivity control (National STD50).
 R₁ — 500 ohms, 1-watt.
 R₂ — 300 ohms, 1-watt.
 R₃ — Two 40,000-ohm, 1-watt units in series.
 R₄ — 100,000 ohms, 1/2-watt.
 R₅ — 14,000 ohms, 1-watt.
 R₆ — 100,000 ohms, 1-watt.
 R₇ — 50,000 ohms, 1-watt.
 R₈ — 25,000 ohms, 1-watt.
 R₉ — 20,000 ohms, 1-watt.
 R₁₀ — 2000 ohms, 1-watt.
 R₁₁ — 30,000 ohms, 1-watt.
 R₁₂ — 40,000 ohms, 1-watt.
 R₁₃ — 250,000 ohms, 1/2-watt.
 R₁₄ — 5000-ohm, 10-watt adjustable.
 R₁₅ — 10,000-ohm, 10-watt adjustable.
 R₁₆ — 20,000-ohm, 10-watt adjustable.
 R₁₇ — 250,000 ohms, 1-watt.
 R₁₈ — 300,000 ohms, 1-watt.
 R₁₉ — 350,000 ohms, 1-watt.
 R₂₀ — 400,000 ohms, 1-watt.
 R₂₁ — 450,000 ohms, 1-watt.
 R₂₂ — 500,000 ohms, 1-watt.
 R₂₃ — 550,000 ohms, 1-watt.
 R₂₄ — 600,000 ohms, 1-watt.
 R₂₅ — 650,000 ohms, 1-watt.
 R₂₆ — 700,000 ohms, 1-watt.
 R₂₇ — 750,000 ohms, 1-watt.
 R₂₈ — 800,000 ohms, 1-watt.
 R₂₉ — 850,000 ohms, 1-watt.
 R₃₀ — 900,000 ohms, 1-watt.
 R₃₁ — 950,000 ohms, 1-watt.
 R₃₂ — 1,000,000 ohms, 1-watt.
 R₃₃ — 10,000 ohms, 50-watt.
 R₃₄ — 100,000-ohm, 25-watt adjustable.
 R₃₅ — 200-ohm rheostat.
 RFC₁ — 10 mh.
 RFC₂ — 2.5 mh.
 L₁ — 1 1/2" dia., 4" long, space-wound with No. 22 enam. wire, tapped every 4 turns with 3/4" space between the two halves of the coil.
 L₂, L₃ — 4 coils 3/4" dia., 3 1/2" long, close-wound with No. 12 enam. wire.
 L₄ — Filter chokes, 15 henrys, 80 ma.
 See table for r.f. coil data.
 SW₁ — 12 section, 9 contacts per section, isolantite-insulated coil switch (Centralab).
 SW₂ — 2 section, 10 contacts per section, isolantite-insulated coil switch (Centralab).
 SW₃ — 4-p.d.t. switch (Yaxley).
 SW₄ — Multi-contact key switch (W.E.).
 SW₅ — 110-volt toggle switches.
 SW₆ — S.p.s.t. (d.c. to r.f. end of receiver).
 SW₇ — S.p.s.t. (d.c. to 6L6 amplifier).
 SW₈ — S.p.s.t. (a.v.c. on-off).
 SW₉ — S.p.s.t., crystal on-off (built on rear of phasing condensers).
 SW₁₀ — D.p.d.t. (voltmeter switch).
 SW₁₁ — S.p.s.t. (2-ma. range on meter).
 SW₁₂ — S.p.s.t. (h.o. on-off).
 J₁ — No. 5 jack (Yaxley).
 J₂ — No. 4 jack (Yaxley).
 J₃ — No. 4A jack (Yaxley).
 F — Faraday screen on coupling coil.
 F₁ — 2-amp line fuses.
 T₁ — Plate and filament supply transformer, 700 v. c.t., 145 ma. with 50- and 6.3-volt filament windings (Thordarson T-70R62).
 T₂ — Interstage a.f. transformer.
 T₃ — Single plate to p.p. grids.
 T₄ — P.p. output transformer to 5-, 8-, 15-, or 500-ohm loads.
 T₅ — 465-kc. air-tuned i.f. transformer.
 T₆ — 465-kc. h.o. unit.
 T₇ — 465-kc. crystal-filter output transformer (Sickles 54658).

The 6F6 is an excellent oscillator, at least as high as 28 Mc. However the output does begin to drop off above 14 Mc., indicating that even in this position an acorn tube would be useful. With any particular mixer and h.f. oscillator combination there will be a certain value of injector (No. 2) grid voltage which will provide the highest output from the mixer plate circuit. If the injector grid voltage is too much above or below this value it is impossible to realize maximum gain from the combination. At lower frequencies this is not so important, but at 14 and 28 Mc. it begins to mean something and an otherwise excellent receiver will not perform right at all. Quite a lot of time was spent on the front end, particularly on the h.f. oscillator, adjusting the output to the proper value for each band. Some interesting things were found which may be of use in similar cases.

Inserting a milliammeter with a 1-mil scale between ground and the ground end of the 50,000-ohm injector grid resistor, R₁₁ in Fig. 1, provides a convenient way of reading the injector grid voltage or the oscillator output. Converting the current as read on this meter into terms of the voltage across R₁₁ gives a multiplier of 5, so that each main division on the meter will actually represent 5 volts and full scale will then be 50 volts.

Since the oscillator output will naturally be lowest on the highest-frequency band, one should begin with that band and work back towards the b.c. band. Actual tests using the 6A8-6F6 combination indicate that the injector grid voltage should be around 8 or 10 volts for best conversion on the 28-Mc. band. Even 15 volts would probably be slightly better but is difficult to get with the 6F6 without running the plate voltage beyond reason. The cathode tap on the oscillator coil is moved towards the grid end to raise the output and of course the other direction to lower it. This adjustment was carried out on each individual oscillator coil, with the oscillator plate voltage previously set at some medium value, in our case 160 volts. A continuous check should be made on oscillator drift with a stable frequency meter when such changes are being made, and by this means a happy medium reached where the output is near that desired and the drift at a minimum. Throughout these adjustments the oscillator plate voltage is permanently left at 160 volts.

Several different form factors were tried on the 28-Mc. coil in an attempt to obtain maximum output with a low value of plate voltage on the tube. The highest output occurred with a self-supported coil of heavy wire and small diameter with the turns spaced about one wire-diameter. This coil gave 40 per cent more output than any of the others tried, and the injector grid voltage was 12 volts at 28 Mc. All of these things do require time but are well worth the trouble in the final results. To make it plain that all this fussing

COIL DATA

Band	Position	Dia.	Length	Turns	Wire	Remarks	
BC.....	1st r.f.	Meissner antenna coil No. 6862					
BC.....	2nd r.f.	Meissner r.f. coil No. 6864					
BC.....	detector	Meissner r.f. coil No. 6864					
BC.....	oscillator	1 1/8"	3/4"	66	No. 30 enam.	close-wound, cathode tap 16th t.	
1.7 Mc.....	antenna	1 1/8"	...	28	No. 30 enam.	ant. and plate windings wound over the grid windings at the ground end of grid coils, two layers of cellophane wrapping between	
1.7.....	1st r.f. grid	1 1/8"	3/8"	37	No. 30 enam.		
1.7.....	1st r.f. plate	1 1/8"	...	17	No. 30 enam.		
1.7.....	2nd r.f. grid	1 1/8"	3/8"	37	No. 30 enam.		
1.7.....	2nd r.f. plate	1 1/8"	...	17	No. 30 enam.		
1.7.....	det. grid	1 1/8"	7/16"	37	No. 30 enam.		
1.7.....	oscillator	1 1/8"	3/8"	26	No. 30 enam.		
3.5.....	antenna	1 1/2"	...	5 1/2	No. 28 d.s.c.		close-wound 1/8" from grid coil
3.5.....	1st r.f. grid	1 1/2"	1 3/8"	38	No. 28 d.s.c.		space-wound
3.5.....	1st r.f. plate	1 1/2"	...	16	No. 28 d.s.c.		space-wound between turns of grid coil
3.5.....	2nd r.f. grid	1 1/2"	2"	38	No. 28 d.s.c.	space-wound	
3.5.....	2nd r.f. plate	1 1/2"	...	16	No. 28 d.s.c.	space-wound between turns of grid coil	
3.5.....	det. grid	1 1/2"	2"	38	No. 28 d.s.c.	space-wound	
3.5.....	oscillator	1 1/2"	2"	34	No. 24 enam.	space-wound cathode tapped 3 turns up	
7.....	antenna	1 1/2"	...	4	No. 28 d.s.c.	close-wound 1/8" from grid coil	
7.....	1st r.f. grid	1 1/2"	1 7/8"	24	No. 24 enam.	space-wound	
7.....	1st r.f. plate	1 1/2"	...	16	No. 28 d.s.c.	space-wound between turns of grid coil	
7.....	2nd r.f. grid	1 1/2"	2"	24	No. 24 enam.	space-wound	
7.....	2nd r.f. plate	1 1/2"	...	16	No. 28 d.s.c.	space-wound between turns of grid coil	
7.....	det. grid	1 1/2"	2"	24	No. 24 enam.	space-wound	
7.....	oscillator	1 1/2"	2"	22	No. 24 enam.	space-wound cathode tap 5th t.	
14.....	antenna	1"	...	4	No. 28 d.s.c.	*space-wound 1/8" from grid coil	
14.....	1st r.f. grid	1"	1 3/8"	14	No. 22 enam.	*space-wound	
14.....	1st r.f. plate	1"	...	10	No. 28 d.s.c.	*space-wound between grid coil	
14.....	2nd r.f. grid	1"	1 1/2"	14	No. 22 enam.	*space-wound	
14.....	2nd r.f. plate	1"	...	10	No. 28 d.s.c.	*space-wound between grid coil	
14.....	det. grid	1"	1 1/8"	14	No. 22 enam.	*space-wound	
14.....	oscillator	1"	1 1/8"	14	No. 22 enam.	*space-wound	
28.....	antenna	3/8"	...	7	No. 20 enam.	†space-wound‡	
28.....	1st r.f. grid	3/8"	1 1/2"	7	No. 14 enam.	†space-wound	
28.....	1st r.f. plate	3/8"	...	8	No. 22 enam.	†space-wound	
28.....	2nd r.f. grid	3/8"	1 1/2"	7	No. 14 enam.	†space-wound	
28.....	2nd r.f. plate	3/8"	...	8	No. 22 enam.	†space-wound‡	
28.....	det. grid	3/8"	1 1/2"	7	No. 14 enam.	†space-wound	
28.....	oscillator	3/8"	1 1/2"	6	No. 14 enam.	†space-wound	

* 14-Mc. coils are wound on clear celluloid sheeting, plate windings wound between turns of grid windings, turns cemented in four narrow strips with Duco cement. Mounting bases are made of Victoron.

† 28-Mc. coils are similar to 14-Mc. coils.

‡ Plate coils are wound on celluloid sheeting and made small enough to fit concentrically inside of grid coils. This method is necessary to get sufficient coupling for good gain at 28 Mc.

around pays, the injector grid voltage with the original 28-Mc. coil was only 4 volts and the gain was down accordingly.

The final injector grid voltages are given in the table, page 25. The variation indicated on the b.c. band is due to the inclusion of a 10,000-ohm resistor in the cathode tap of the coil, which was necessary in order to lower the oscillator output on this band. Every known remedy was tried without lowering the plate voltage, but nothing would reduce it enough. The same applies to the 1.5-3.0-Mc. coil except here the cathode tap is so far down on the coil that the output varies considerably. Both of these coils give excellent results, however. The other variations in oscillator output are due to the large value of capacity across the coil as the tuning condenser approaches the low-frequency end of the tuning range. It should be noted, however, that optimum results are obtained on all amateur bands.

Because of the high gain of the 956 there was some tendency toward oscillation in the preselector stages. With all circuits well shielded and resistance capacity filters in each plate lead, the only thing that could be done was to remove an equal number of turns from each plate winding until all circuits could be tuned on the nose without instability. An alternative method of coupling would be to use one winding and capacity-couple to the plate. It is our opinion that this method gives a poorer image ratio, but it is easier to attain perfect tracking without the plate windings.

NOTE.—The turns values given above must be considered as approximate only, since the coils must be individually adjusted for exact alignment when installed in the receiver. This is particularly true of the high-frequency sets, where length of switch leads and stray capacities become increasingly important.

A separate gain control is used on the second preselector stage. It is useful in working through strong signals.

Each band may be spread as little or as much as desired simply by varying the minimum to maximum capacity ratio. In our case we like maximum band spread, and all band-spread ranges are adjusted to give about 400-division spread on the National dial. This is approximately 1 kc. per division on the 14-Mc. band and varies slightly on the others. Since each division is nearly $\frac{1}{4}$ inch on this dial this is certainly all the band spread one could ever use.

Noise Suppressor

The noise suppressor will be recognized as the original circuit of Lamb's which appeared in *QST* several years ago.³ If it is built into the receiver, where it should be, it is still the most effective arrangement and will give suppression of all sorts of noise. It is equipped with a threshold adjustment to prevent blocking on strong signals. As has been mentioned before this blocking is due to insufficient selectivity in the noise amplifier and could probably be improved by the addition of two more stages in the noise amplifier. More will be said later about the results.

Crystal Filter and I.F. Amplifier

The crystal filter circuit is conventional. It has both input and output transformers, providing a match into the first i.f. grid circuit and giving maximum gain with the crystal in the series position. A center-tapped capacity rather than a center-tapped inductance is used in the phasing circuit as this method has always seemed to provide better neutralization and results in the elimination of practically all image response in c.w. reception.

All i.f. transformers, including those in the noise suppressor and crystal filter circuits, are individually shielded at the bottom of the shield cans; all leads then come through the copper sheet and then through the chassis. All units are mounted above the chassis with brass spacers and are thus grounded at only the two points where the lugs come through the chassis. This method provides a completely-shielded unit independent of any part of the chassis for shielding.

As shown in Fig. 1, all plate leads are resistance-capacity filtered. These filters are effective on both r.f. and plate supply frequencies and provide better isolation than do r.f. chokes. It is of course necessary to have a plate supply which has sufficient output voltage to take care of the drop through the resistors and still maintain the correct voltages for the tubes. The values depend on the combined screen and plate currents which flow through them, and will be different for different types of tubes.

All tubes are mounted so the plate leads will be short and direct and all are shielded. Every pre-

caution has been taken to prevent feedback, as any tendency to oscillate will result in a heavy hiss when the gain is raised. An amplifier that is operating properly will be practically dead with the input shorted and b.o. off, when listening with headphones.

Second Detector and A.V.C.

Although it may look like a "throwback," a triode second detector is used because of its greater sensitivity. A great deal of noise is eliminated by feeding the headphones directly from the second detector. Receivers which connect the headphones in the a.f. or across a portion of the a.f. output transformer generally have a heavy background of hiss and often a.c. hum. The 6B8 a.v.c. circuit is a simple one and is merely a d.c. amplifier, with a.v.c. voltage applied to the second preselector stage and the three i.f. stages, but not to either detector.

A.F. Amplifier

The a.f. amplifier consists of a 6C5 driving a push-pull 6L6 stage. The 6C5 is provided with both input and output jacks so that the a.f. may be used for headphone operation, or the 6C5 and 6L6 stage may be used on other equipment. The 6L6 stage has a 200-ohm variable resistor in its cathode circuit so that the bias may be adjusted. The output transformer provides taps for 5-, 8-, 15- and 500-ohm loads.

Combination Output Meter and D.C. Voltmeter

The output meter, a 0-1 milliammeter, is connected in the second detector cathode circuit. An output meter is really an essential part of a receiver and probably the most useful purpose is in keeping the front end and the i.f. lined up at all times. It is such a simple matter to add a few resistors and a change-over switch and further increase its usefulness that this was done. This provides either a 200- or 500-volt d.c. voltmeter simply by throwing the switch. The cathode then goes directly to ground so the receiver is still in operating condition. The voltmeter terminals are on the rear of the chassis and are useful for checking voltages in the receiver and for trouble shooting.

The Beat Oscillator

The b.o. is conventional in every way except for the location of the output control. This is usually done by varying the screen voltage, which causes the frequency to shift. By using a 500,000-ohm output potentiometer and isolating the d.c. plate voltage with a 0.005- μ fd. condenser only the actual r.f. output is varied, all terminal voltages on the 6J7 remaining fixed. No loading occurs on the 6C5 detector grid at low values of resistance in the output control since there is

(Continued on page 98)

"Frequency Measurement and Regular Check"

Crystal-Checking of the Freqmeter to Increase Accuracy

BY A. K. ROBINSON,* W7DX

THE new regulations require (Sec. 152.44) that: "The licensee of an amateur station shall provide for measurement of the transmitter frequency and establish procedure for checking it regularly. The measurement of the transmitter frequency shall be made by means independent of the frequency control of the transmitter and shall be of sufficient accuracy to assure operation within the frequency band used."¹

By describing a simple and accurate frequency meter it is desired to show that full compliance with this rule is not as difficult as it might at first appear.

Most amateurs are familiar with the simple

* 808 Federal Office Building, Seattle, Wash.

¹ Rule 152.44 does not necessarily require the use of a frequency meter in each amateur station. The requirements of the rule may be satisfied by an amateur subscribing to a commercial radio-frequency measuring service, or the measurements can be made on a calibrated receiver provided it has a high degree of stability and the cycles per tuning-dial degree are not excessive. (See December, 1938, *QST*—"We Have New Regulations.")

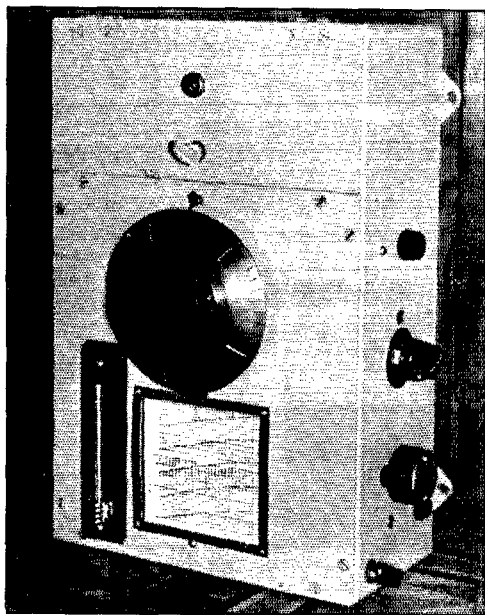

electron-coupled frequency meter and its operation; in fact many of these instruments now in existence can be easily converted to the unit described. The electron-coupled frequency meter is a comparatively stable oscillator which, when once calibrated against standard-frequency stations, gives a general check on transmitter frequency by beating either the fundamental or a harmonic against the oscillator under measurement. However, the degree of accuracy obtainable in measurement is dependent, among other things, upon variables such as vibration, temperature, and voltage.

The frequency shift due to these variables can be almost entirely eliminated by incorporating a crystal standard in the instrument. In other words, if a crystal oscillator is provided in an appropriate circuit in conjunction with the electron-coupled oscillator, harmonics may be used as reference points and the electron-coupled oscillator calibration corrected. The accuracy of the instrument then depends upon the crystal error and the human error involved in calibration and adjustment.

Now the first thought is that a reliable crystal for such a standard would be one of the more expensive low-drift 100-ke. bars. This is *not* the case; it is possible to use any crystal of any frequency provided it is reliable and of the low-drift type. Therefore, any one of the standard amateur crystals such as the Biley LD2 or equivalent is satisfactory. What amateur station does not have one or more such crystals available?

When such a crystal is used, harmonics or sub-harmonics of the electron-coupled oscillator are used to beat against the fundamental, harmonics or sub-harmonics of the crystal. Plenty of reference points are thus obtained no matter what frequency is under measurement. It is then only necessary to correct the electron-coupled oscillator calibration with the nearest known crystal point to the frequency under measurement, to obtain a reliable frequency check.

The author's frequency meter is neatly fitted out in an aluminum case. The crystal which provides the check points plugs into a socket at the lower end of the right-hand wall. The auxiliary condenser controls also are on the same side of the cabinet, leaving only the main tuning control on the front.

Fig. 1 is a diagram of a simple yet highly accurate frequency monitor whose cost is well within the means of most amateurs. A standard electron-coupled circuit is used for the heterodyne oscillator, the chief difference from the ordinary arrangement being in the use of a large semi-variable capacity at C_1 to produce stability and provide for wide band-spread. C_2 is the main tuning condenser and should be of good quality and provided with a reliable dial; both condenser and dial should be rigidly mounted. An additional variable condenser, C_3 , is for band setting. A "correction" condenser C_4 consists of a very small variable capacity whose use will be explained later.

V_1 is a triple-grid detector-amplifier Type 6J7 (it is understood that other tubes available might be substituted). The heterodyne oscillator is coupled to the crystal mixer tube V_2 , a 6A8, by a 30- μ fd. mica condenser. The isolation provided by the extra grid in the heterodyne oscillator tube and this small coupling condenser, together with the excellent coupling of grid No. 4 in the 6A8, eliminates all tendency for these oscillators to be "pulled" or locked in.

Resistance coupling is recommended in all audio stages as it is important that a flat audio-frequency curve be obtained in the output, especially at low frequencies, to permit close adjustment to zero beat. However, good quality

Here is an idea which should greatly increase the accuracy and reliability of the e.c. freqmeter, providing as it does crystal-generated check points and compensation for temperature and voltage variations. Best of all, any good-quality ham-band crystal can be used — no special frequency necessary — and it is still available for use in the transmitter. Provision is made for monitoring as well as direct frequency-checking.

audio transformers can be used with a considerable increase in output due to the low plate voltage used.

The crystal is connected between grid No. 1 and the grounded cathode of the 6A8, but is mounted outside the cabinet. It was found that the room temperature varied less than that of the interior of the cabinet because of the heat given off by the tubes. Also, it was desired to have the crystal available for use elsewhere. Grid No. 2 has the crystal tank circuit, the size of which depends entirely upon the frequency of the crystal used as standard. A circuit having a high LC ratio should be used and, once adjusted for stable crystal oscillation, should be left alone. In fact, it is recommended that L_2 be

used without shunting capacity and resonance obtained with the crystal by adding or removing turns, after which no further adjustment is necessary.

Switch Sw_2 is placed across the crystal to prevent oscillation while making measurements.

Any type of power supply may be used, either built in the unit or as a separate auxiliary. However, the circuit design is such as to permit good operation with a

90-volt "B" supply, thus allowing the use of two small "B" batteries and 4 dry cells as a complete power unit. The only precaution necessary is to use approximately the same voltage for measurement as was used for calibration.

For external coupling a 30- μ fd. mica condenser is connected from grid No. 4 of the 6A8 to the antenna post. The sensitivity of the unit is such that it is very seldom necessary to use more than a few inches of wire as an aerial, even when it is desired to beat the heterodyne oscillator against an incoming signal in the receiver.

Before calibration, the crystal and electron coupled oscillators should be checked for stable oscillation, pulling, and backlash in the tuning condensers. Too much care cannot be taken

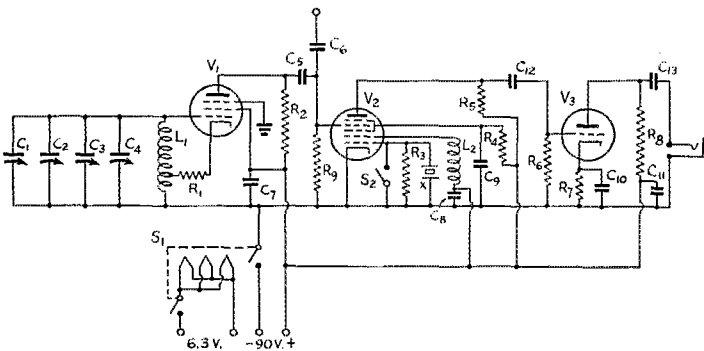

Fig. 1 — Circuit diagram of the crystal-checked frequency meter.

- C_1 — 150- μ fd. variable.
- C_2 — 35- μ fd. variable.
- C_3 — 100- μ fd. variable.
- C_4 — 5- μ fd. variable.
- C_5, C_6 — 30- μ fd. mica.
- $C_7, C_8, C_9, C_{10}, C_{11}$ — $\frac{1}{2}$ - μ fd. paper.
- C_{12} — 0.05- μ fd. mica.
- C_{13} — 3- μ fd. paper.
- R_1 — 5000 ohms, $\frac{1}{2}$ -watt.
- R_2, R_3, R_4, R_5, R_6 — 50,000 ohms, $\frac{1}{2}$ -watt.
- L_1 — Approximately 40 turns No. 22 d.s.c. wire, close-wound on a $1\frac{1}{2}$ -inch coil form tapped at the 5th turn from the grounded end. A few turns more or less may be needed to spread tuning as desired. (See text.)
- L_2 — Depends upon frequency of crystal used.
- R_4 — 25,000 ohms, $\frac{1}{2}$ -watt.
- R_6 — $\frac{1}{2}$ -megohm, $\frac{1}{2}$ -watt.
- R_7 — 3000 ohms, $\frac{1}{2}$ -watt.
- R_9 — $\frac{1}{2}$ -megohm, $\frac{1}{2}$ -watt.
- V_1 — 6J7 metal.
- V_2 — 6A8 glass.
- V_3 — 6K5 metal.

during calibration because when properly made the calibration will last indefinitely. C_1 should be set so that, with C_3 set at maximum capacity, tuning C_2 from maximum to minimum capacity will cover approximately 1715-1895 kc. (It will probably be necessary to remove or add turns to L_1 to accomplish this.) C_1 has no external dial — once its adjustment is made it remains fixed and should be locked in position.

While making calibrations C_4 should be at half capacity. Adjustments are then made only with the calibration dial of C_2 . The apparatus should be allowed to warm up sufficiently to prevent drift during calibration. Immediately after sufficient points have been obtained to permit accurate calibration, open switch Sw_2 and vary C_2 throughout its scale, recording the dial settings corresponding to the strongest of the crystal beats.

Adjust C_2 to maximum capacity, then reduce the capacity of C_3 until approximately 1890 kc. is obtained. Record the setting of C_3 and proceed to calibrate the C_2 scale from maximum to minimum capacity again, which will place the low-capacity reading near 2070 kc. Again check the crystal points as in the paragraph above.

These two calibrations and their harmonics will cover all amateur bands. If it is desired to have an instrument covering any frequency, complete the calibration by re-setting C_2 and C_3 to the next higher frequency bands until 3430 kc. is reached.

After calibration, the crystal points will be used as reference. For example, if it is desired to measure a frequency between 1890 and 2070 kc. set the calibration dial at the calibration reading corresponding to the crystal point nearest the estimated frequency under measurement, set C_3 to proper value for this calibration and adjust C_4 to zero beat with that crystal point. (Checking two adjacent points will tell if the wrong one is being used or if something is in error.) Immediately after this the full-scale calibration 1890 to 2070 kc. will apply with a high degree of accuracy.

It is apparently possible to eliminate C_1 and C_3 by making C_2 and L_1 sufficiently large to cover the entire band 1715-2050 kc. This would be the case in adapting existing electron-coupled frequency meters and would simplify construction and calibration, but would eliminate the all-wave feature and limit the accuracy since there would be less band-spread.

Calibration points may be obtained in a number of different ways. However, rather than plot these on a calibration curve, it is suggested that interpolation be used and a chart prepared similar to that shown above, thus permitting immediate identification of frequency.

A typical log entry would look something like this:

SAMPLE FREQUENCY METER CALIBRATION

C_3 adjustment — 0.0. Crystal check points: 10.1 26.0 55.6 84.2
100.0 (underline strongest crystal beat)

Dial	160 m.	80 m.	40 m.	20 m.	10 m.	5 m.	
10.0	1700.0	3400.0	6800.0	13600.0	27200.0	...	
10.1	1700.1	3400.2	6800.4	13600.8	27201.6	...	xtl point
10.2	1700.2	3400.4	6800.8	13601.6	27203.2	...	

Monthly frequency meter calibration checked against:

WWV (b. c. harmonics, etc.) — C_2 , 98.2 degrees; C_3 , 30 degrees; Dec. 13, 1938

Calibration — C_2 , 98.3 degrees; C_3 , 30 degrees; deviation, 100 cycles

Frequency check of transmitter:

Crystal "A" — 3991 kc.; Deviation, 0

Crystal "B" — 7015 kc.; Deviation, — 2 kc.

We Want a Safety Slogan

\$25 Prize

WE WANT a neat phrase or slogan or catch-line to epitomize our campaign for safety. It must be something that will appeal to the amateur, something he can remember and make his motto, something with which we can campaign. For the best suggestion received during the next month we offer a prize of \$25.

What we want is something of the stop-look-and-listen or safety-first variety but more peculiarly applicable to amateur radio. For instance, "Be careful—death is permanent" doesn't have enough amateur atmosphere. "Dead transmitter, live ham; live transmitter, dead ham" has the amateur touch but is too long, too smart. Can't you make a better suggestion?

All entries must reach our office by noon of March 31st. Separate communications. None returned. The editors of *QST* are the judges, their decision final. Study this article carefully for ideas and then get going! Our check for Bux 25 to the winnah!

★ WHAT THE LEAGUE IS DOING ★

SOME STAFF CHANGES

WE VERY much regret to have to announce the retirement of James J. Lamb as our technical editor, because of his continuing illness. On leave of absence for the past year, he is now making steady progress towards recovery, but his return to active work is still quite a few months away. World-famous as the developer of the single-signal superheterodyne, the noise silencer and the heterotone, his connection with our staff is by no means severed. We hope that he will soon be back with us and pulling new wonders out of the old hat. Pending his return he is listed on our staff as a consultant on leave of absence.

George Grammer, W1DF, becomes our new technical editor, a duty which he has been performing the past year after many years as our assistant technical editor. A clear-thinking, hard-headed amateur possessed of an extremely lucid style of writing, his constructional articles in *QST* have been famous for many years, and he enjoys a wide acquaintance in amateur radio and in the industry. There is no need for a lengthy introduction of him; his work on our staff the past ten years will convince everyone of his admirable qualifications for his new post.

Donald H. Mix, still the Sleepless Wonder of W1TS, becomes now an assistant technical editor — which in his case also is work that he has already been doing the past year. Amongst other things and including regular contributions to *QST*, he will edit most of our departments and will have a heavy hand in the writing of the *Handbook*.

We regret to announce the separation from our staff of Thomas M. Ferrill, Jr., W1LJI, who has spent the past year with us for experience's sake as an interruption of his schooling at M.I.T., and who now returns there to complete his studies. We shall see more of this young man. Author of some valuable *QST* articles and of some of the chapters of the current *Handbook*, he will continue as a contributor and will be a special member of our *Handbook* staff this summer.

A strong new addition to our editorial staff is Byron Goodman, W1JPE, for the past three years one of the assistant secretaries of the League. An excellent technical man, he is transferred now to the editorial department as an assistant technical editor. In his recent work he has tramped the United States and Canada from end to end, speaking before clubs and conventions, and is known from coast to coast. Goodman is a Californian, ex-W6CAL, and gives our staff

that well-known W6 touch. Graduate of the University of California in electrical engineering, he has already had a prominent part in the technical work of *QST* and the *Handbook*, in addition to his other duties. Ardent amateur, DXer and antenna shark, his appointment to the editorial staff will make *QST* more interesting for you. Oh, yes, he will continue to write "How's DX?"

Vernon Chambers, W1JEQ, in recent years our laboratorian, succeeds now to the *QST* technical information service. A member of our staff for some years, he was associated with the late Ross Hull in his u.h.f. gear-building program for the new *Handbook* and, after the latter's death, carried that work to completion. He is also the author of several very popular articles on low-power rigs.

Succeeding Mr. Goodman on our secretarial staff is a brand-new headquarters face, that of John Huntoon, until now W9KJY of Glen Ellyn, Ill. Just completing a term as secretary of the Chicago Area Radio Club Council, he had a big part to play in the success of the recent national convention at Chicago: A crack operator, he took a few minutes out during the convention to win the code-copying contest. Visitors to the convention will remember this yellow-headed ball of fire who was everywhere at once. He has been very active in Chicago affairs, giving up the treasurership of the Chicago Radio Traffic Association when he came east to join us, and he was for many years our S.C.M. for Illinois. He'll be signing headquarters letters now and getting around to visit you at your clubs soon.

— — — — —

ISLAND PREFIXES

F. C. C. HAS circularized all amateur licensees in the Virgin Islands and our various Pacific isles, announcing the availability of the new identifying prefixes requested by A.R.R.L., as we reported in this department in December. So far the gang is very slow in responding, and mighty few of the new prefixes are in use. Island gang, attention: The next move is yours. You can't just use these new prefixes; you have to make formal application to F. C. C. for modification of your station license to change the prefix letters of the call. We urge you to do so without delay, so we can recognize you. It will add to your contacts, and it may come in very handy!

(Continued on page 98)

A Portable Station for A.C. or Battery Operation

A Compact Unit with Crystal-Controlled C.W.-'Phone Transmitter and Superhet Receiver

BY HARLEY E. STEINER,* W7DTJ

YOUR author is a ham with two hobbies, radio and fishing. Strangely enough, the latter was responsible for the evolution of this "portable portable." Invariably, after enjoying two or three days of fly casting in some isolated section of Idaho's more primitive areas, the XYL would start suggesting that maybe we'd better cut our contemplated week or ten days short, as she was wondering whether or not the two junior ops were receiving their spinach on schedule, or maybe they had caught cold, or perhaps the house had burned down, and so on, far, far into the night. After analyzing the situation thoroughly the only courses open were to discontinue the fishing trips, eliminate the juniors, or devise some means of communication so as to put her mind at ease periodically. In spite of the maternal instinct she is a very ardent fisherman (or fisherwoman), so we decided on the communication angle.

Portability and reliability being the primary requirements, the design resulted in a ruggedly-constructed unit including a complete transmitter and receiver, exclusive of power supply, mounted on a 7 by 13½-inch etched aluminum chassis and housed in a substantial hardwood cabinet measuring 11 by 15 by 8 inches outside. The panel is 1/16-inch polished dural measuring 7 by 14 inches. There is adequate room in the removable front cover of the cabinet to house the antenna equipment, power cable, one spare set of coils and a log book and pencil.

Power supply was next considered, and after much thought a 6-volt storage battery was selected as the primary source of power, since the battery in the car was always available and didn't weigh much more than a bunch of dry batteries in

case a camp had to be established via pack horse at a point remote from a road. Another desirable factor is that storage batteries would always be available in case of any disaster which might require a unit for emergency communication. Provision has also been made for operation from the 110-volt a.c. power lines whenever they are available.

The 75-meter band was selected as being best suited for the range desired, and most of the operation has been on 3996.5-ke. 'phone. However, the outfit works equally well on 160, 40 and 20, using crystals ground for the operating frequency. Either 'phone or c.w. may be used. A power input of 18 watts (300 volts at 0.060 amp.) resulted in a signal healthy enough to give adequate coverage under most conditions.

The Circuit

Referring to the schematic, Fig. 1, it will be found that the transmitter section uses a 6N7G as a push-pull crystal-controlled oscillator capacity-coupled to another 6N7G used as a push-pull-neutralized amplifier. It was found that it is not necessary to re-neutralize in changing bands. In fact, the neutralizing adjustments have never been touched since the outfit was originally tuned, and the set has seen lots of very difficult trips over forest-service roads that at times were almost impassable.

The antenna, which is fed from a link winding around the center of the final tank coil, is a half-wave doublet using 119 feet of No. 16 copper wire for the flat-top and a good grade of receiving-type doublet transmission line for a feeder.

A circuit-closing tip jack is connected in the grid return of the final to permit connection of a key for c.w. operation.

* 1011 15th Ave., Lewiston, Idaho.

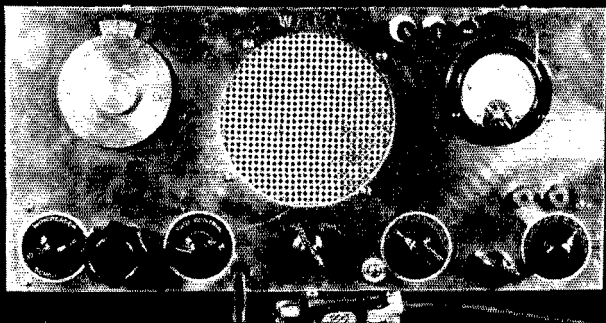

Behind this 7-by-14 panel are a superhet receiver, crystal-controlled transmitter, and speech amplifier-modulator. The set can be used on all bands from 20 to 160 meters, and works from either a.c. or storage-battery supply. A novel feature is the use of the loud speaker as a microphone. The set fits into a wooden case which also carries the antenna and the usual indispensable accessories.

QST for

In this top view of the portable station, the receiver is at the right, transmitter at the left, and the audio amplifier along the front. The large cans cover the receiver plug-in coils.

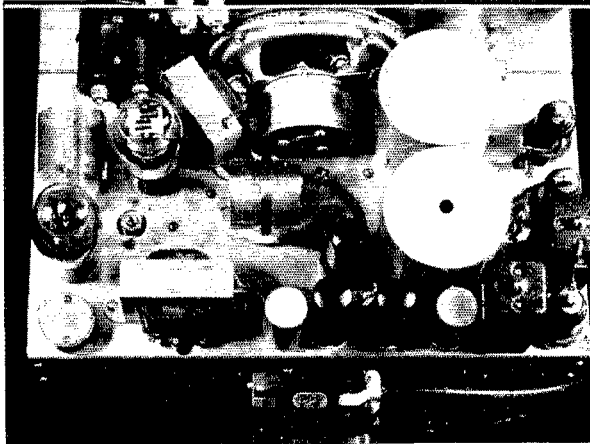

The receiver circuit is adapted from the familiar Jones Super-Gainer, as past experience had indicated its excellent efficiency for a small number of tubes. A 6K7 is used as a triode-connected high-frequency oscillator. A 6L7 functions as a mixer and works into a 465-ke. intermediate-amplifier transformer of the iron-core variety. The i.f. amplifier tube is a 6K7 which feeds one section of a 6N7 as a regenerative grid-leak detector through another of the iron core i.f. units. The audio channel consists of a 6N7, with elements parallel-connected, driving another 6N7 used as a zero-bias Class-B amplifier. A voice-coil winding of 60 turns of No. 28 enameled wire was added to the modulation transformer to drive the 5-inch permanent magnet dynamic speaker for receiving.

In the transmitting position the speaker is used as a dynamic microphone. Its output is fed through a 3-ohm-to-grid transformer to the unused half of the 6N7 detector tube, which is resistance coupled to the driver and modulator. Speaking in a normal tone of voice directly into the speaker will furnish sufficient audio output to modulate 18 watts input 100 per cent. The characteristic boomy sound of such a crude dynamic mike is satisfactorily corrected by the use of a small (250- μ fd.) coupling condenser between the first and second stages and by cementing six cardboard ribs in a radial fashion to the inner side of the speaker cone to stiffen it. This also improves the intelligibility of the speaker when used for receiving. Special attention is called to the use of the Mallory bias cell in series with the speech amplifier grid, as this was an easy solution to the problem of bias on this stage. On first tests a high-frequency parasitic oscillation developed in the speech amplifier, and it refused to respond to any kind of treatment until the polarity of

the mike transformer secondary was accidentally reversed. The parasitic immediately disappeared and has never bothered since. We mention it here in the hope that it will prevent hours of mental anguish for some unfortunate brother ham.

Layout and Construction

The controls, reading from left to right are: sensitivity, receiver tuning, regeneration, send-receive switch, transmitter filament switch (to economize on filament consumption in case the receiver only is being used), amplifier tuning, meter switch, and oscillator tuning. Directly above the last mentioned control is the pin-tip circuit-closing jack for the key. The meter switch permits the 100-ma. meter to be used to read the plate current of either the oscillator, modulator, or final amplifier. The neutralizing condensers are adjusted by means of an insulated screw driver and are fastened in position with compression lock nuts on the split-condenser bearings. Type RSS Amphenol steatite sockets are used throughout because of their unusually small size and excellent mechanical strength and insulating properties. Their rugged terminals proved very helpful in the wiring operation.

The transmitting inductances are factory-wound (Decker Series L) and are very rugged in spite of their extremely light weight. The oscillator coil has no link, but the amplifier coil is equipped with the center-type link winding. The receiver coils are wound on Hammarlund SWF-4 coil forms in accordance with the coil table. They are covered with Hammarlund type CS coil shields, which are rather large for portable equipment, but the space was available and we believe in as large a coil shield as possible. A $\frac{5}{16}$ -inch hole is drilled in the top of the first detector coil shield to permit insertion of a tuning wand, which proved very valuable in making the final adjustment of inductance on this coil to insure tracking without the use of parallel trimmers. This permitted a large enough tuning range so that the coils would overlap when tuned with the 50- μ fd. condensers, and it was found that the broadcast band can be covered with two sets of coils. We found the news broadcasts to be

The outfit described in this article has served its owner well on trips which gave both the mechanical and electrical ends a severe test. So impressed was Assistant Secretary Budlong when, on a Western trip last fall, he encountered it at an outdoor hamfest that he convinced builder, W7DTJ, it ought to be passed on to other hams through the medium of *QST*. So Fisherman W7DTJ is now Author W7DTJ — and maybe we should sub-title this article "How to Keep the XYL Happy Though Camping"!

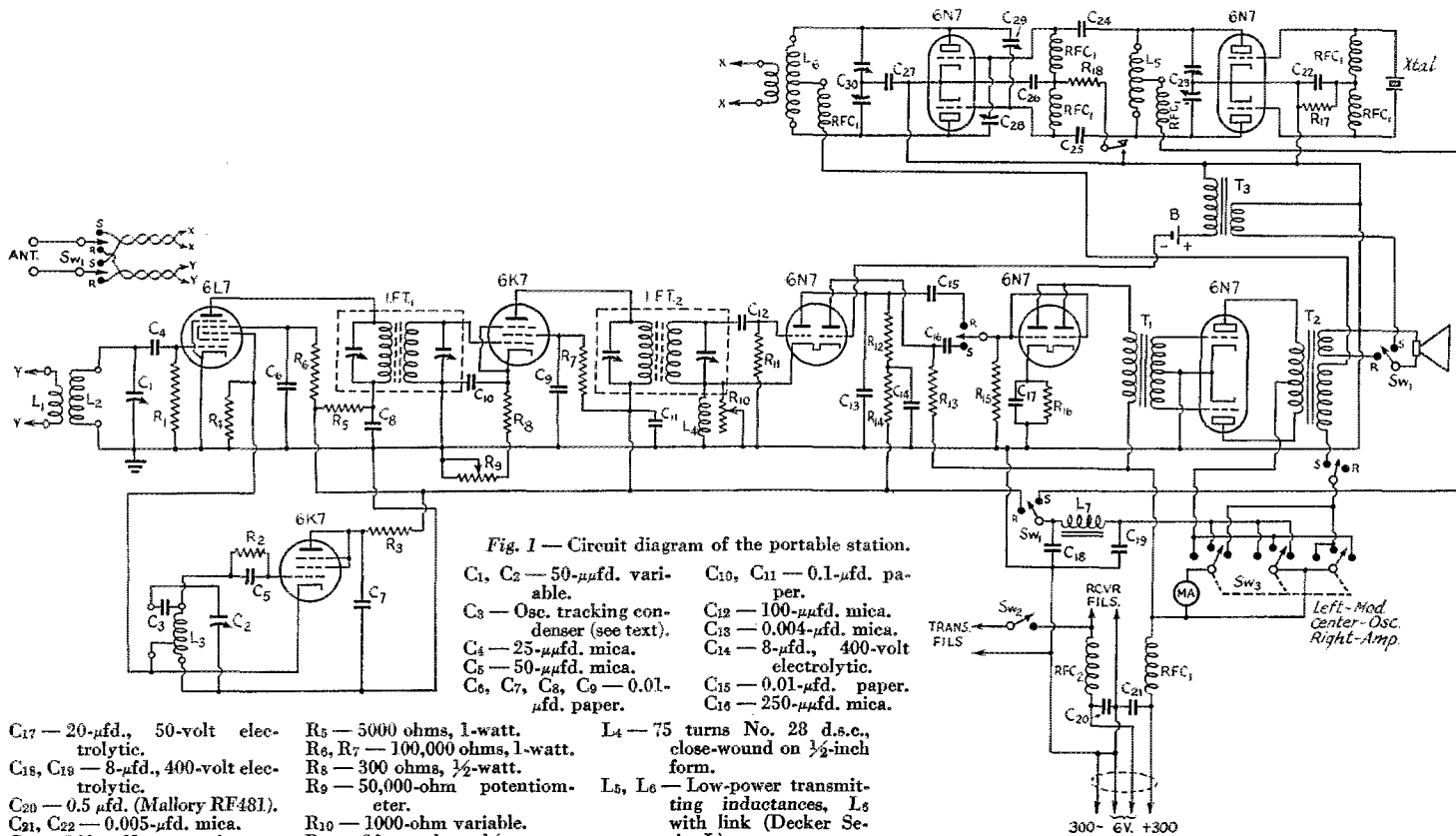

Fig. 1 — Circuit diagram of the portable station.

- C₁₇ — 20- μ fd., 50-volt electrolytic.
- C₁₈, C₁₉ — 8- μ fd., 400-volt electrolytic.
- C₂₀ — 0.5 μ fd. (Mallory RF481).
- C₂₁, C₂₂ — 0.005- μ fd. mica.
- C₂₃ — 100 μ fd. per section.
- C₂₄, C₂₅ — 100- μ fd. mica.
- C₂₆, C₂₇ — 0.005- μ fd. mica.
- C₂₈, C₂₉ — 15- μ fd. variable.
- C₃₀ — 100- μ fd. per section.
- R₁ — 2 megohms, $\frac{1}{2}$ -watt.
- R₂ — 25,000 ohms, $\frac{1}{2}$ -watt.
- R₃ — 15,000 ohms, 10-watt.
- R₄ — 50,000 ohms, $\frac{1}{2}$ -watt.
- R₅ — 5000 ohms, 1-watt.
- R₆, R₇ — 100,000 ohms, 1-watt.
- R₈ — 300 ohms, $\frac{1}{2}$ -watt.
- R₉ — 50,000-ohm potentiometer.
- R₁₀ — 1000-ohm variable.
- R₁₁ — 10 megohms, $\frac{1}{2}$ -watt.
- R₁₂, R₁₃ — 100,000 ohms, 1-watt.
- R₁₄ — 250,000 ohms, 1-watt.
- R₁₅ — 500,000 ohms, $\frac{1}{2}$ -watt.
- R₁₆ — 850 ohms, 1-watt.
- R₁₇ — 10,000 ohms, 2-watt.
- R₁₈ — 1500 ohms, 2-watt.
- L₁, L₂, L₃ — See coil table.

- C₁₀, C₁₁ — 0.1- μ fd. paper.
- C₁₂ — 100- μ fd. mica.
- C₁₃ — 0.004- μ fd. mica.
- C₁₄ — 8- μ fd., 400-volt electrolytic.
- C₁₅ — 0.01- μ fd. paper.
- C₁₆ — 250- μ fd. mica.
- L₄ — 75 turns No. 28 d.s.c., close-wound on $\frac{1}{2}$ -inch form.
- L₅, L₆ — Low-power transmitting inductances, L₅ with link (Decker Series L).
- L₇ — 20 henrys, 85 ma.
- RFC₁ — 2.5-mh. r.f. chokes.
- RFC₂ — Line choke (Mallory 581).
- Sw₁ — Yaxley 1322-L.
- Sw₂ — S.p.s.t. toggle.
- Sw₃ — Yaxley 3243-J.
- MA — 0-100 d.c. milliammeter.

- IFT₁ — 465-kc. iron-core i.f. transformer (Meissner 16-5740).
- IFT₂ — 465-kc. iron-core i.f. transformer (Meissner 16-5742).
- T₁ — Driver transformer, 6N7-6N7 (Inca L-42).
- T₂ — Class-B modulation transformer, 6N7 to 5000-ohm load (Inca No. 41) with extra voice-coil winding of 60 turns of No. 28 enameled wire.

Things are pretty crowded below the chassis, but everything fits. The ganged tuning condenser for the receiver is at the left in this view. The two variables at the right tune the transmitting oscillator and amplifier tank circuits; they are used as split-stator condensers. Note the extension shaft on the receiver regeneration control.

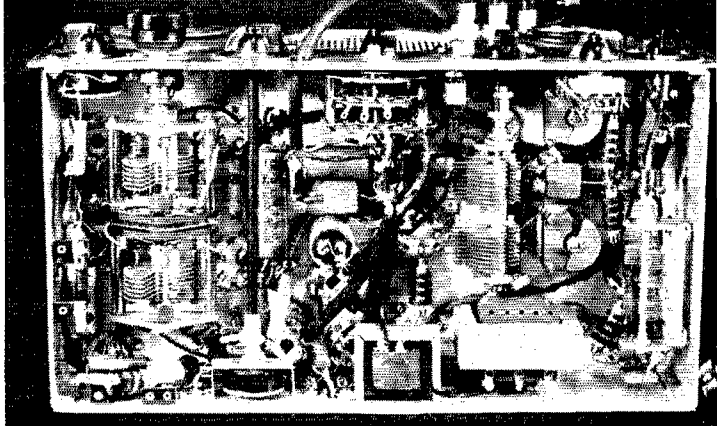

very helpful when we were out of touch with civilization for any great length of time. The oscillator series padding condenser on the 160-meter coil is 0.001- μ fd. capacity and is mounted inside the oscillator coil form for that band. It was not found necessary to use series padders on the 20-, 40- and 80-meter coils as the tracking error was not great enough to cause any noticeable loss of sensitivity. The inductance of the detector coil was adjusted for perfect tracking at the centers of the respective ham bands, with a jumper connected across the proper prongs on the oscillator coil forms on these bands instead of a padding condenser.

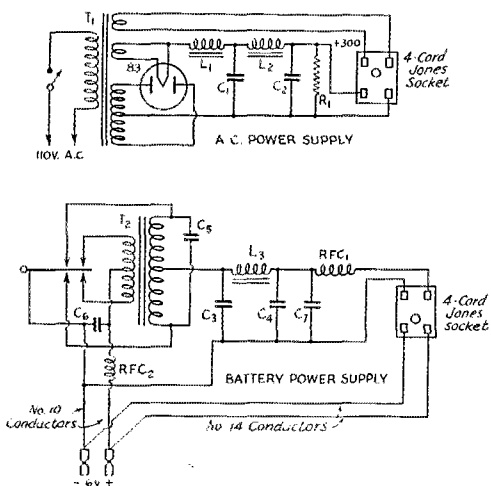

Fig. 2 — Power-supply unit circuit diagram.

- C_1, C_2, C_3, C_4 — 8- μ fd., 450-volt electrolytic.
- C_5 — 0.01 μ fd., 2000-volt.
- C_6 — 1 μ fd. (Mallory RF482).
- C_7 — 0.005- μ fd. mica.
- L_1 — 10 henrys, 150 ma.
- L_2 — 20 henrys, 150 ma.
- L_3 — 30 henrys, 150 ma.
- RFC_1 — 2.5-mh. r.f. choke.
- RFC_2 — Line choke (Mallory RF583).
- V — Synchronous vibrator (Mallory 225).
- R_1 — 20,000 ohms, 25-watt.
- T_1 — A.c. power transformer; 375 volts each side c.t. at 150 ma.; 6.3 volts at 4.9 amp.; 5 volts at 3 amp.
- T_2 — Special 6-volt power transformer (see text).

The receiver tuning condenser is an old model two-gang National (2SE50) having 50- μ fd. capacity per section and 270-degree s.l.f. plates. For some reason not quite clear to us this particular condenser is no longer listed in the current catalogues, but it can no doubt be obtained on special order. It is driven through a Crowe planetary drive unit having a 7-to-1 ratio. The 270-degree tuning dial is driven with a piece of phosphor bronze dial cable used as a belt which is securely anchored to the drums on both ends to prevent slipping. Two small rubber grommets are located in the chassis where the dial cable passed through to prevent a metal-to-metal contact which would result in noisy operation and excessive wear on the belt.

Power is furnished to the outfit through a four-conductor cable which is permanently connected to the set and terminates in a four-prong Jones connector.

Particular attention is called to the r.f. filter unit in which the power cable terminates. It consists of a Mallory RF481 special by-pass condenser and a Mallory RF581 choke in the ungrounded filament lead, and a 0.005- μ fd. mica condenser and a 2.5-mh. r.f. choke in the high-voltage lead. This filter is very essential for the elimination of vibrator hash. The Mallory RF type chokes and condensers are also used to very good advantage in the vibrator power-supply unit.

Constructional details are quite clear in the

(Continued on page 96)

COIL TABLE					
Band	Turns				Wire Size
	L_1	L_2	L_3	Tap	
14 Mc. . . .	2 $\frac{1}{4}$	10 $\frac{3}{4}$	9 $\frac{3}{4}$	1 $\frac{1}{4}$	18
7 Mc. . . .	2 $\frac{1}{4}$	23	20 $\frac{3}{4}$	3 $\frac{1}{4}$	18
3.5 Mc. . . .	2 $\frac{1}{4}$	45	38 $\frac{3}{4}$	7	24
1.75 Mc. . . .	3	82	57	11	30

All coils on 1 $\frac{1}{4}$ -inch diameter forms, turns spaced to make length of winding 1 $\frac{1}{2}$ inches.

A Miniature 100-Watt Amplifier

◆
Although the chassis isn't much bigger than the palm of your hand, it contains the complete r.f. section of a 100-watt output final amplifier. The tubes are the new "baby" Gammatron 24's. The separate meter panel also contains the filament transformer. This model is for capacity-coupling to the grids.

◆

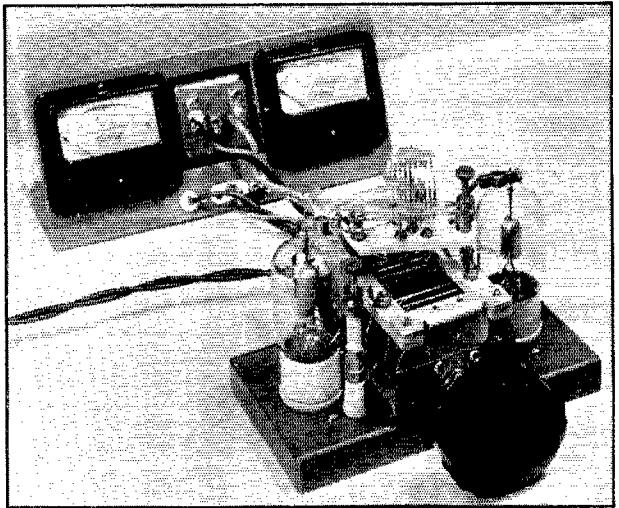

Compact Construction for the 28- and 56-Mc. Bands

BY JAMES MILLEN,* W1HRX

THE amplifier described herewith was originally constructed to satisfy a number of desires, not the least of which was to prove to one of our friends, W9DRD, that we could build a more intriguing piece of ham gear than he! The

* North Reading, Mass.

others involved such things as being fascinated by the new tiny Gammatrons and a consequent desire to see for ourselves just what they would really do. But perhaps the deciding factor in the end was to be able to have a reasonable 10-meter c.w. signal on the air for some Sunday morning schedules during the winter without disturbing the regular 20-meter 'phone "sender" or bringing any more large gear into the house; after all, there are three completely-filled relay racks there now! Consequently, a small unit that was compact and light enough in weight to "hang from the feeders" (actually it is fastened with a small C-clamp to the top crossbar of the relay rack) and which could be fed from the normal 1000-volt modulator power supply and driven by the regular exciter, was designed.

The tank condenser and coils, as well as the Gammatrons, are recently designed parts and tie in together very nicely. With 1000 volts on the plates, the driving power required is but 7 watts and the output about 100.

The Circuit

The circuit is quite conventional in every way, and where the amplifier is to be used close to an exciter with an output circuit that will permit capacity coupling to the final grid circuit, a minimum of parts is required, as shown in Fig. 1. In our case, however, where we were using the NTE exciter, which has link output, it was necessary to provide a grid tank circuit.

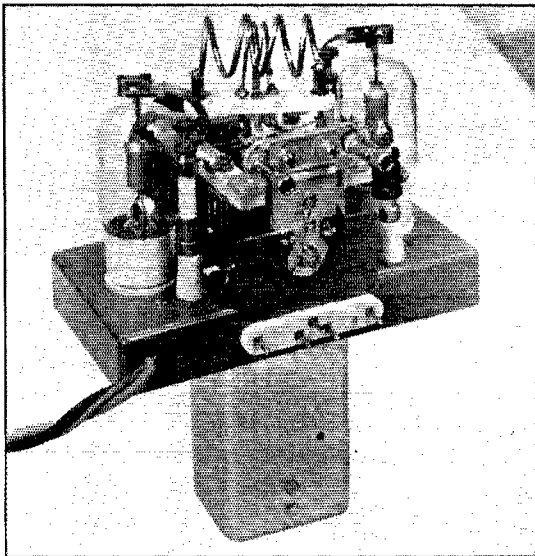

A rear view of the model with link-coupled grid circuit. The grid tank is in the shield can suspended from below the chassis. Except for the coils, this amplifier is identical with that shown in front view in the other photograph.

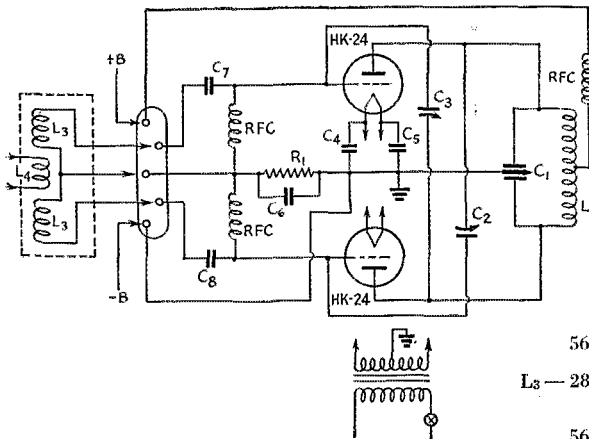

Fig. 1 — Circuit diagram of the compact 100-watt amplifier.

- C₁ — 35–35- μ fd. variable, 3000 v. (National TMH-35D).
- C₂, C₃ — 2 μ fd. (approximately) (National NC-600).
- C₄, C₅ — 0.003- μ fd. mica (Aerovox).
- C₆ — 0.001- μ fd. mica (Aerovox).
- C₇, C₈ — 100- μ fd. mica (Aerovox).
- RFC — 2.1-mh. chokes (National R-100).

- R₁ — 7500 ohms, 10 watts.
- L₁ — 28 Mc.: 8 turns No. 18, diameter 1½ inches, length ¾ inch.
- 56 Mc.: 4 turns No. 10, diameter 1 inch, length 2 inches.
- L₂ — 28 Mc.: 3 turns No. 18, diameter 1½ inches, wound over L₁.
- 56 Mc.: 2 turns No. 14, diameter ¾ inch, wound inside L₁.

- L₃ — 28 Mc.: 8 turns No. 24, diameter 1 inch, spaced 24 turns per inch; wound in two sections with link between.
- 56 Mc.: 6 turns No. 24, diameter ¾ inch, spaced 24 turns per inch; two sections, with link between.

- I₄ — 28 Mc.: 2 turns No. 20 on same form as L₃.
- 56 Mc.: 2 turns No. 20 on same form as L₃.

NOTE. L₁–L₂ for 28 Mc. is a National type AR-16-20C coil with 6 turns removed (3 at each end).

Small tubes naturally suggest the idea of miniature apparatus assemblies to go with them. It's not always possible, though, to keep dimensions small when a reasonable amount of power has to be handled. Here's a cleverly laid out amplifier which fully justifies the term "miniature" — yet it is easily capable of delivering 100 ten-meter watts to an antenna. Adaptable to five, too.

This was mounted underneath the chassis, as shown in one of the photographs, and was constructed from a standard fixed-tune unit. With such an input-tank arrangement, a low-impedance link line of some length can be run from the exciter to the final.

But few comments are believed necessary on the grid tank circuit, as the table gives the winding details for both the 5- and 10-meter bands. Only one section of the double condenser in the grid tank is used, and it is connected directly across the grid coil. The grid coil is split, with the link coil in between the two sections. For the 5-meter band, the coil form is ½ inch in diameter, rather than the 1-inch form normally furnished with the units and used in the 10-meter band model. When mounted on top of a relay rack, the grid tank drops down between the top parallel bars of the rack.

Assembly Details

The illustrations show how well the parts fit together to form an extremely compact, as well as electrically symmetrical, unit. The chassis has a base area of only 3½ by 6½ inches.

Inasmuch as only one-band operation was desired, no attempt was made to use the plug-in bases normally designed to go with the small air-wound tank coils. Instead, the plate coil is directly mounted on the tank condenser by soldering the two outside pins to lugs on diagonally

opposite stator terminals of the condenser. The condenser-coil combination is mounted sufficiently above the socket level to bring the plate leads to the tubes in the most convenient positions. The mounting brackets for the condenser are the pieces of the chassis bent up when making the large cut-out. This arrangement also makes for short leads to the r.f. chokes and neutralizing

(Continued on page 106)

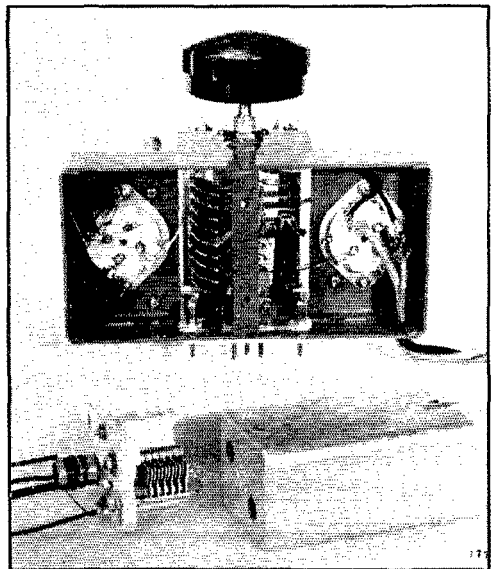

The chassis construction is clearly visible in this photograph. The bridging strip across the center is the support for the grid tank. The 5-meter grid tank, disassembled, is shown below.



ARMY-AMATEUR RADIO SYSTEM ACTIVITIES

THE Ninth Corps Area spreads over eight states and Alaska, has about one fifth of the total Army Amateur Radio System membership on its rolls, and from the southwest corner of California to Nome, Alaska, there is an air-line distance of about thirty-five hundred miles. Headquarters is at the Presidio in San Francisco, and a glance at a map will show that it is far from being centrally located. For this reason the operating and administrative problems are different from those of other Corps Areas in the system. Due to the large size of California, it was found necessary to split it into three State Nets, giving us altogether eleven states, each with its Net Control Station and Alternates.

The main problem was the need for prompt and consistent communication with all parts of the area, and was solved by the establishment of a Corps Area Traffic Net which meets every night during the year at 7:00 P.M. and continues until clear. Each state, except Alaska, has a representative in regular attendance, and we have one station in Oregon to which is assigned the duty of keeping a regular schedule with Alaska on 40 meters, bringing their traffic to the Corps Area Net and taking all messages destined for that state. As the State Nets all use the single-spot frequency plan, there is a local net in each state, in operation practically every night of the week except Saturday and Sunday, thus providing us with a net-work of stations covering the entire Corps Area from 7:00 until 9:30 or 10:00 P.M. every evening. The training in traffic handling and net control gained by all the members who join in this work is invaluable.

The Corps Area and State Nets use c.w., but phone nets are now being organized as Local State Nets and are rapidly proving their worth. Each of these tie into the C.A. Net by means of one of their members who shifts to c.w. and reports for traffic during the evening. A few work on 160 meters, but the majority are operating on 75 and, of course, a Class A ticket as well as a good station is required for membership.

The results of this closely knit organization and thorough training have been well demonstrated in the efficient handling of all emergencies which have developed in the Corps Area. In connection with emergency work we insist strongly on the possession of portable emergency transmitters or, at least, emergency power for the regular station transmitter and, as was shown in the last call from WLM, are well supplied in this regard.

This sounds like "all work and no play," but that is far from the truth. The whole attention of those at the head of the organization is centered on an attempt to give a well-rounded program that will train and interest any amateur. There is an extension course in Elementary Military Cryptography for those who have a liking for the work and, although enrollment is optional, our members lean toward this science and there is always a waiting list. There are frequent intra-state and inter-state contests that give each man a chance to show his operating ability and yet have a good time. From time to time Headquarters springs some unexpected contest or problem in which the entire Corps Area takes part. Practically all the states have selected a frequency separate from but near to that of their state net, which they use for rag-chewing and where they are free to enjoy themselves and yet may be found by their SNCS if need arises. These various activities are planned and managed by the CANC Staff, each member of which is a specialist in his line. One plans and runs contests, another handles all 'phone organization, another is Cryptography Instructor, etc., thus taking the minor details off the shoulders of the Liaison Officer and Radio Aide, leaving them free to plan for the best interests of the Corps Area as a whole. The R.A. is assisted in his work by his "Counselors," men who have been in the organization for a long time and whose advice and experience aids much in shaping the general policies adopted. All this is done, naturally, under the supervision and close coöperation of the Liaison Officer and we are particularly fortunate in having with us Major N. L. Baldwin, the man who took hold of the "baby" A.A.R.S. and started it out on the present path it is following.

While the membership of some states is above their assigned quota and they have closed their rolls, a place can always be found for a man who is really interested in our work and gives promise of making a good A.A.R.S. We are very jealous of our good reputation, and anyone wishing to come in with us must be prepared to undertake the regular training and obey the rules and regulations considered necessary for the proper functioning of the system. We are a "team" and work as a team, not as individuals. To such men who are interested and will play the game, we extend a hearty invitation to join and assure him not only a fine training but plenty of fun and relaxation as well.

(Continued on page 108)

★ WITH THE AFFILIATED CLUBS ★

ATTENTION, CLUB SECRETARIES:

THIS department — With the Affiliated Clubs — is for the purpose of passing along worth-while suggestions for club operation, tested ideas on maintaining interest in meetings and increasing attendance, and general notes on activities of all A.R.R.L.-affiliated clubs. Club secretaries are invited to submit items relative to what is going on in their respective organizations. Don't "hide your light under a bushel" . . . let the other societies know of your experiences and activities.

A.R.R.L. AFFILIATED CLUB HONOR ROLL

JANUARY *QST* listed those societies whose entire membership consists of members of the League. This month we take pleasure in announcing the addition of the *Charlotte (N. C.) Amateur Radio Association* to this 100%-membership group.

AFFILIATED CLUB STATIONS

ADD to list of amateur stations operated by A.R.R.L.-affiliated clubs:

VE1RC — Moncton Amateur Radio Club

W1LRN — Hi-Q Radio Club

W9ZJK — Central Missouri Amateur Radio Club

HAM CALLS ON AUTOMOBILE LICENSE PLATES

DID you notice that photo in January *QST* showing W8NFR's automobile registration plate for 1939? It has long been the dream of many radio amateurs to have their call letters on their license plates. The Great Lakes Amateur Radiophone Association, under the leadership of W8NFR, not being satisfied with dreams, took the bull by the horns, with the result that between 400 and 500 Michigan amateurs have received from the Secretary of State their 1939 automobile license plates carrying their call letters instead of the usual numbers! This was accomplished through the efforts of W8NFR and the coöperation of Mr. Leon D. Case, Secretary of State. The idea was originated as an encouragement for hams in the Detroit area to join the Great Lakes Amateur Radiophone Association. Finding the Secretary of State's office receptive of the idea, W8NFR compiled a list of call letters of interested amateurs. The Secretary of State informed all inquirers to send their requests through W8NFR. In this way a single list of 400 to 500 hams was compiled and sent as one group to the Secretary of State, thus making

the request carry more weight and simplifying the work at the Secretary's office. We have heard of several clubs that are going after the special plates in other states; let us know how you make out.

GOVERNOR ADDRESSES NORTH CAROLINA CLUB

THE North Carolina Floating Club, an organization of hams in the Old North State holding regular bimonthly meetings in the cities throughout the State, met in Raleigh on January 8th. The highlight of the meeting was an address by the Honorable Clyde R. Hoey, Governor of North Carolina, who mentioned the early development of radio, its marvelous growth into one of the big industries of the country, and assigned amateurs an important place in that development. He extolled their worth in cases of



The Honorable Clyde R. Hoey, Governor of North Carolina, addressing The North Carolina Floating Club.

emergencies and in national defense, and urged them to continue their wonderful hobby, letting nothing stand in the way.

Talks were also given by T. B. Smiley, W4EBA, lighting engineer for the Carolina Power and Light Co., on the family of curves of a vacuum tube, using the T-55 as a type; and C. M. Smith, radio engineer for the North Carolina Radio Patrol, who described the radio system. The meeting was attended by approximately 140 persons. At the conclusion of the banquet, at which Director Caveness, W4DW, was toastmaster, the club voted to meet in Fayetteville, N. C., on Sunday afternoon, February 26th.

DISASTER COMMUNICATION TEST

ON BEHALF of the Spokane (Wash.) Chapter, American Red Cross, and under the leadership of W. L. Miller, W7AAN, A.R.R.L. Emergency Coördinator, the Spokane Amateur Radio Association on November 20, 1938, was sponsor of a demonstration of amateur radio as a means of communication in emergencies.

(Continued on page 55)

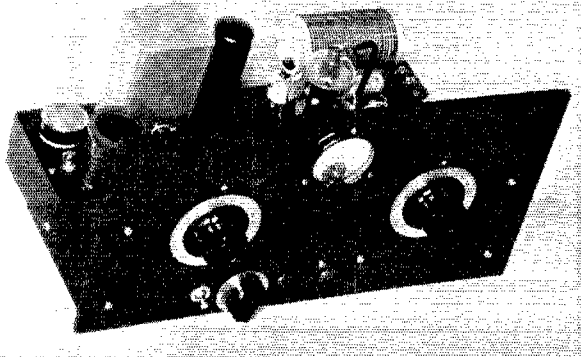

Five-band operation with 160-meter crystals is provided by this two-tube exciter. Comparison of this illustration with Fig. 841 of the 1939 Edition *Radio Amateur's Handbook* shows that this is a revamped version of the *Handbook* exciter. Immediately in front of the crystal is the series lamp, and a portion of a cathode plug-in coil—a newly-added feature—is visible behind the left top corner of the panel. At the bottom of the front panel, left to right, are: toggle switch for choosing between Tri-tet and grid-plate oscillator circuits, variable cathode condenser, oscillator plate current bulb, and "comparison" bulb.

One Crystal—Two Tubes—Five Bands

Odd Harmonics as Well as Even Harmonics are Useful for Amateur Bands

BY T. M. FERRILL, JR.* WILJI

TIME after time, a feeling of keen disappointment is experienced when, after noting in the title of an article the phrase, ". . . Operating on Five Bands," or, "Five-Band Three-Tube Transmitter," the reader finds on closer study that the transmitter or exciter in reality operates with a single crystal on only three bands, and that two or three crystals are required for operation in all of the most-used amateur bands. When it is found that two tubes supply appreciable driving power on four bands with a single crystal, the interest of the amateur is at once aroused, especially if this operation is provided by reliable circuits, and even more if the two tubes are inexpensive. If such four-band operation has been of interest in the past, a two-tube arrangement providing enough output on five bands from one crystal to drive a medium-power triode fully (HF100, T55, HK54, RK51, or 808) should demand much attention. The exciter shown here does just that.

Development of Frequency Multipliers

Although there are in common use two excellent circuits of crystal oscillators giving high harmonic output, little has been done recently to put them to greatest use to hams. At the time of development of the Tri-tet oscillator,¹ it was found that with two tubes, a small amount of power output could be realized on the 14-Mc. band from a crystal in the 1.7-Mc. band. Type 59 tubes became popular for use in the oscillator and amplifier-doubler stage of a "universal exciter" incorporating the Tri-tet oscillator.²

One step in development of efficient frequency multiplying exciters was use of suppressor-grid regeneration in a small transmitting pentode Tri-

tet, which was then followed by a similar pentode requiring only a fraction of a watt of driving power.³ Popularity of this exciter, however, was limited by the unusual regenerative circuit used, since most amateurs become quite wary at the mention of unusual regenerative circuits and locked oscillators.

One of the most recent developments toward high harmonic output from small tubes involved use of an amplifier stage with plate circuit inductively coupled to the plate circuit of the preceding stage. In the simplest form the amplifier was excited by a capacity-coupled crystal oscillator with series cathode capacity for increased harmonic output.⁴ Ten-watt output at 28 Mc. was obtained with a 3.5-Mc. crystal, with an 802 oscillator and 807 amplifier.

Ten to Eighteen Watts on 28 Mc. From 1.75-Mc. Crystal

The tubes which are now available for low-power stages of transmitters make it possible to obtain, without unusual circuits, several watts output on five bands from a single crystal. The high power output and high harmonic output of the 6L6 tube have given it first place in amateur popularity as a crystal oscillator. Capable of delivering about 25 watts crystal-frequency output, this tube is a far cry from the Type 59 tube, which delivered 3 to 5 watts on crystal frequency. Also, the 807 tube is a step nearer the ideal for use in exciters. This tube delivers more than double the output of the low-power transmitting pentode tubes, with less driving power applied to the grid. Another important advantage of the small beam transmitting tube is the tolerance of grid driving power—a very small amount is enough, but

* M. I. T. Dormitories, Cambridge, Mass.

¹ Lamb, "A More Stable Oscillator of High Harmonic Output," *QST*, June, 1933.

² Grammer, "A Simplified Five-Band Exciter Unit," *QST*, Nov., 1933.

³ Goodman, "A High-Performance Three-Stage Transmitter with Improved Tri-tet Exciter," *QST*, June, 1938.

⁴ Reinartz, "A Fundamental-Reinforced Harmonic-Generating Circuit," *QST*, July, 1937; "Putting the Harmonic Generator to Work," *QST*, April, 1938.

Do you make full use of the harmonic frequencies of your crystals?

Do you have difficulty in obtaining sufficient high-frequency excitation?

Do you worry about excessive crystal current, heating and drift?

Even if your answer to the first question above is "yes," and to the other two questions "no," you will find these carefully checked results of oscillator-amplifier tests interesting and instructive.

Anyway, don't fail to glance at this material and to make a mental note of it for the time when you plan new transmitting gear.

satisfactory operation continues when the excitation becomes excessive. The transmitting pentode has narrow limits of driving power for best operation — more or less than this optimum range causes a marked reduction of output.

Although a 6L6 Tri-tet oscillator gives only a small fraction on the eighth harmonic of the large fundamental output obtainable, the 14-Mc. output with a 1.75-Mc. crystal is enough for fair excitation of an 807 doubler, which then gives appreciable output on 28 Mc. This is readily understood when it is realized that the 807 is rated at less than $\frac{1}{4}$ -watt r.f. driving power for 37.5 watts output as a Class-C amplifier, a power amplification of 150!

Odd Harmonics

And now we come to a subject which certainly has not been given the attention which development of harmonic oscillators should have encouraged — odd harmonics. In the past, the first (fundamental), second, fourth, eighth, and sixteenth harmonics have been given attention, while the fifth, seventh, and higher odd harmonics have been carefully avoided. Indeed, search through publications for material previously written on amateur use of odd harmonics disclosed, "The third, fifth, sixth, seventh, and eleventh harmonics just won't do in amateur circles, . . ."! In 1931, it was suggested that 4.75-Mc. crystals be obtained for excitation in the 14-Mc. band, and that tripling be used in a single stage to replace the stages needed for quadrupling from a low-frequency amateur-band crystal.⁵

⁵ Phelps. "Why Not Frequency Tripling?", *QST*, Aug., 1931.

Bottom view of the exciter. The additional cathode tank circuit is clearly shown in this view. Note the mounting of the oscillator plate panel lamps.

Reference to the accompanying table of 1.75-Mc. crystals and harmonics reveals a new group of frequencies produced in the 28-Mc. band by tuning the plate circuit of the oscillator to the fifth harmonic of the 160-meter crystal frequency, and tripling in the 807 amplifier (the beam tube acts as an amplifier as well as a frequency multiplier, since the fifteenth harmonic output is far more powerful than the fifth harmonic input). Since the completion of this unit, each explanation of this odd-harmonic operation has brought forth from the listener a question about the order of output obtainable with this unusual method of operation. The answer is simply that the fifth harmonic of the oscillator is ample to excite fully the 807, and that the latter operates nearly as efficiently when tripling as when doubling. In fact, since the fifth harmonic excitation to the amplifier is much larger than the eighth, more output is obtained from the 807 on the fifteenth than on the sixteenth, though the output is between 10 and 17 watts on each.

Choice of Oscillator Circuits

In experiments with the unit shown in the photographs, and with other oscillators, Tri-tet and grid-plate, it was found that the Tri-tet is superior for most even harmonics, while the grid-plate (an oscillator using a condenser of the order of 100- μ fd. capacity, variable or fixed, in series with the cathode, and thus in series simultaneously with the r.f. grid and plate currents) is superior for most odd harmonics. Therefore, a toggle switch was placed on the panel to switch from a conventional Tri-tet oscillator circuit to a grid-plate oscillator by shorting the crystal (and series indicator bulb) to ground across the Tri-tet cathode coil. Condenser C_1 of the accompanying diagram then becomes the cathode condenser of the G.-P. oscillator, and allows adjustment for maximum output on the desired harmonic. The toggle switch, designated Sw_1 in the diagram, is switched to position "2" for the odd harmonics of the oscillator. This solves not only the odd-harmonic excitation problem, but also that of fundamental operation of the 6L6 oscillator, which preferably should not be operated as a Tri-tet on crystal frequency.

Seventh and Fourteenth Harmonics

With the question of getting enough excitation on the higher odd harmonics settled, some atten-

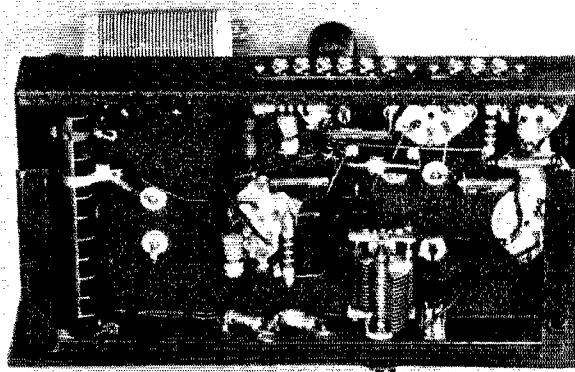

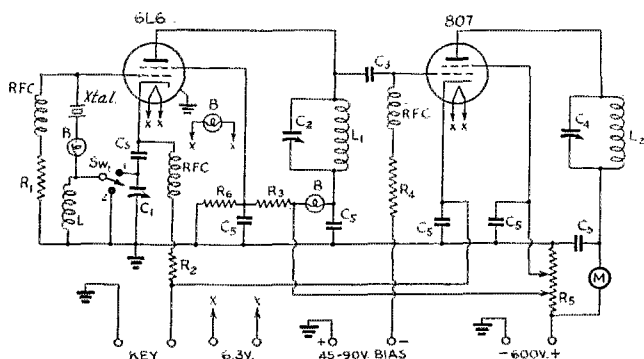

The two-tube exciter used for the tests

In position "1," the single-pole, double-throw switch connects the cathode inductance in operation in the Tri-tet circuit. In position "2," this switch shorts the cathode coil, making a "grid-plate" oscillator, or one which uses a capacity through which grid and plate current must flow.

- C₁ — 150- μ fd. midget variable (National ST-150).
 C₂ — 200- μ fd. midget (Hammarlund MC-200-M), oscillator tuning.
 C₃ — 0.0001- μ fd. mica — coupling condenser.
 C₄ — 150- μ fd. variable (National TMS-150) 0.026" airgap, amplifier tuning.
 C₅ — 0.01 μ fd., 600-volt paper, by-pass.
 RFC — National R 100.

tion should be given to the thought of still more methods of arriving at the high-frequency bands from 1.75-Mc. crystals. The strong fifteenth harmonic output obtained should open up new fields for the Class-C and Class-B licensed amateurs who desire to operate on the 160- and 10-meter 'phone bands — many of these already have crystals in the range of 1900 to 2000 kc. Crystals in the new range of 160-meter band frequencies, which at first sight seemed to offer no opportunity for harmonic operation in other bands, in reality will be quite useful for the 14- and 28-Mc. bands, for seventh and fourteenth harmonics. The table of 160-meter crystals shows the frequencies in the 14-Mc. band covered by the seventh harmonics of the new crystals; and the frequencies in the 28-Mc. band provided by doubling in the 807 from the seventh-harmonic oscillator output are also given. Here again, the Class-B and Class-C licensed 'phone men are given an opportunity to make full use of a single crystal for operation in these widely separated 'phone bands — the crystals for this method of operation should have frequencies between 2036 and 2050 kc., as shown in the table.

The excitation for the seventh and fourteenth harmonic frequencies is easily obtained, since the seventh harmonic output of the grid-plate oscillator is comparable to the eighth harmonic output of the Tri-tet, and the 807 operates quite as well for 14- and 28-Mc. output at the seventh and

- R₁ — 0.1 meg., 1-watt, oscillator grid leak.
 R₂ — 400 ohms, 2-watt, oscillator cathode resistor.
 R₃ — 15,000 ohms, 10-watt, oscillator screen voltage divider.
 R₄ — 50,000 ohms, 2-watt, amplifier grid leak.
 R₅ — 25,000 ohms, 100-watt — main voltage divider.
 R₆ — 50,000 ohms, 2-watt, oscillator screen voltage divider.
 L — 1.7 Mc. crystals — 40 turns No. 22 d.s.c., close-wound, 1½-inch diameter.
 3.5 Mc. crystals — 20 turns No. 20 enameled, 1½-inch length, 1½-inch diameter.
 7 Mc. crystals — 9 turns No. 20 enameled, 1-inch length, 1½-inch diameter.

- L₁ — 1.7-3.5 Mc. — 45 turns No. 26 d.s.c., close-wound, 1" diam.
 3.5-7 Mc. — 24 turns No. 24 d.s.c., 1" diam., 1½" long.
 7-14 Mc. — 11 turns No. 18 d.c.c., 1" diam., 1" long.
 L₂ — All 807 plate coils wound to 3-inch length on 1¼-inch diameter forms, as follows:
 1.7 Mc. — 54 turns No. 16 enameled.
 3.5 Mc. — 33 turns No. 16 enameled.
 7 Mc. — 15 turns No. 14 tinned.
 14 Mc. — 11 turns No. 14 tinned.
 28 Mc. — 6 turns No. 14 tinned.
 R — 6.3-volt, 150-ma. dial lamps.
 M — 0-200 milliammeter.
 Sw₁ — Single-pole, double-throw toggle switch.

fourteenth harmonics as at the eighth and sixteenth.

A Practical, Easily-Built Exciter

The above references to the circuits and operation of the 6L6-807 exciter tell almost all of the essential facts about it. To insure a thorough understanding of the construction and operation of the exciter, however, a few more remarks are justified.

From the illustrations, it is probably already apparent that this unit is the exciter of pages 183 and 184, 1939 edition *The Radio Amateur's Handbook*, with modifications. Construction of the exciter in the original form, using a metal chassis 7 by 13 by 2 inches and a masonite panel 7½ by 14 inches, is described in detail in the above reference. The 807 amplifier of the exciter was retained intact except for substitution of hand-wound coils for the manufactured coils originally specified. The larger plate coils made experimental coil cutting and tapping easier, so that optimum L-C ratio and the best load for each band could quickly be found. If desired, the manufactured coils may be used in such a set with little difference in operation. A parasitic suppression resistor specified for optional connection in series with the 807 plate was not required for proper operation in these tests.

The r.f. plate circuit of the oscillator of the earlier exciter is retained intact — the original shielded plug-in coils are very convenient, since

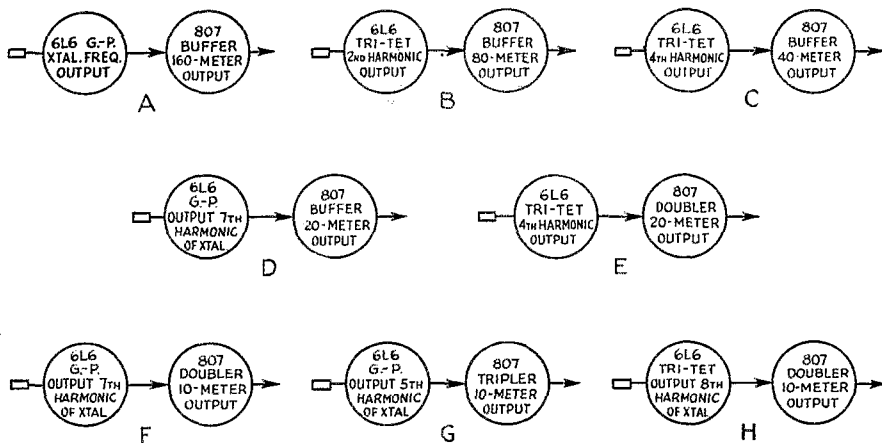

The diagrams above indicate the harmonic of the oscillator and the harmonic of the amplifier used for exciter output on the frequencies in the corresponding columns below.

From the table below, easy selection of 160-meter crystals may be made for harmonic operation in other bands. Crystals in the 80- and 40-meter bands may also be quickly selected by reference to the second and third columns, and to columns E and H following.

the ranges of the coils overlap and thus insure that the plate circuit may be tuned readily to any frequency between 1.7 and 15 Mc. Unshielded plug-in coils may be used at a total saving of about 65¢, but a removable shield should be provided if this is done.

The change in the grid circuit of the oscillator simply amounts to addition of a cathode coil and substitution of a variable condenser for the fixed cathode condenser, C₁. Provision of a toggle switch for choosing between Tri-tet and grid-plate oscillator circuit has already been mentioned.

Whereas two meter jacks formerly were pro-

vided on the oscillator panel for measuring oscillator and amplifier plate currents, a meter and a pair of 6.3-volt pilot lamps are now used. The meter, a 0-200 range 2-inch milliammeter, is connected permanently in series with the 807 plate supply circuit. With the low plate voltage used, the bakelite case and bakelite reset-screw crank protect the operator from shock. The 6.3-volt pilot bulb connected in series with the oscillator plate supply wiring is mounted behind one of the lower panel holes formerly provided for meter jacks, and is positioned so that none of the metal is exposed to the front of the panel. A finger can be

(Continued on page 108)

Crystal Frequency	Easily Obtained Harmonics						
	80 meters	40 meters	20 meters		10 meters		
	Second harmonic	Fourth harmonic	Seventh harmonic	Eighth harmonic	Fourteenth harmonic	Fifteenth harmonic	Sixteenth harmonic
A	B	C	D	E	F	G	H
1750-1768.5 c.w.	3500-3537 c.w.	7000-7074 c.w.		14,000-14,148 c.w.			28,000-28,296 c.w.
1769-1781 c.w.	3538-3582 c.w.	7076-7124 c.w.		14,152-14,248 'phone			28,304-28,496 c.w.
1781.5-1800 c.w.	3583-3600 c.w.	7126-7200 c.w.		14,251-14,400 c.w.			28,504-28,800 'phone
1800-1825 'phone	3600-3650 c.w.	7200-7300 c.w.					28,800-29,200 'phone
1825-1867 'phone	3650-3734 c.w.						29,200-29,872 'phone
1867-1875 'phone	3734-3750 c.w.					28,005-28,125 c.w.	29,872-30,000 'phone
1875-1900 'phone	3750-3800 c.w.					28,125-28,500 c.w.	
1900-1950 'phone	3800-3900 c.w.					28,500-29,250 'phone	
1950-2000 'phone	3900-4000 'phone					29,250-30,000 'phone	
2000-2021 'phone			14,000-14,147 c.w.		28,000-28,294 c.w.		
2022-2035 'phone			14,154-14,245 'phone		28,308-28,490 c.w.		
2036-2050 'phone			14,252-14,350 c.w.		28,504-28,700 'phone		



NAVAL COMMUNICATION RESERVE NOTES

AMATEURS generally, and particularly those of the N.C.R., will be interested in knowing that Lieut. John L. Reinartz, U.S.N.R., ex-WIQP, has succeeded Lieut.-Commander Wm. Justice Lee, U.S.N.R., in charge of the N.C.R. desk in the Office of Naval Communications at Washington. Commander Lee, after organizing the N.C.R. and building it to its present efficiency over ten years of duty, is now transferred to broader duties in the Bureau of Navigation, in charge of the communications organization and training of all the several classes of naval reserves. It is fitting that the N.C.R. should continue to be headed by an amateur reservist on permanent active duty. In selecting Lieutenant Reinartz the Navy Department has chosen one of the best-known amateurs and one of the most versatile experimenters in the whole country.

THE Naval Communication Reserve of the Eleventh Naval District carries a roster of approximately two hundred and fifty officers and men, practically all owning and operating their own amateur stations. Drawn from practically every phase of the civilian radio field, the officer and enlisted personnel of the District truly presents a cross-section of the present-day communications picture.

The Eleventh Naval District Naval Communication Reserve is commanded by a naval reserve officer and is administered by the Commandant through the Director, U. S. Naval Reserve, a regular navy officer of the rank of captain; and the instructor, Naval Communication Reserve, who is the Assistant District Communication Officer. The District is divided into Sections and Units, each with a commander and staff. The Commander, Naval Communication Reserve of the Eleventh Naval District, administers the organization through a staff composed of an executive officer, an operations officer, and an educational officer; in addition, specific duties are assigned the aide for officer instruction, the supply officer, two assistant operations officers and a recruiting officer.

Officers and men of the Eleventh Naval District Communication Reserve feel themselves particularly fortunate in having as the Director, U. S. Naval Reserve, an officer of broad experience whose last previous duty was commanding officer of the U.S.S. *Nevada*. During his present

tour of duty, the activities of the Naval Reserve have been expanded to the end that each individual has an opportunity to enjoy his association with the organization. Instruction in the use of the .45 calibre automatic pistol under a competent instructor has resulted in the qualification of a number of pistol experts, among them members of the Naval Communication Reserve. Official presentation of medals is made at the monthly lectures, another intensely interesting activity. These lectures cover naval subjects and are usually delivered by the director.

The first annual Reserve Church Service and Review was held during the year 1938. Participated in by all officers and men of all branches of the Naval and Marine Corps Reserve, it was held in the Los Angeles Memorial Coliseum on a Sunday morning. Following the church service, all units were reviewed by the senior naval and marine corps officers of the District.

With the United States Fleet based within the District waters for a number of years, officers and men of the Naval Communication Reserve have had a splendid opportunity to become well acquainted with the forces afloat. Numerous group trips to ships, participated in by the entire units in uniform, have done much to give those making the trips a new pride in being an American citizen. Many officers and men observed the Fleet Air Review held recently in San Pedro Harbor in honor of the American Legion National Convention.

Communication duty for the Organized Reserve Summer Cruise aboard the U.S.S. *Cincinnati*, U.S.S. *Perry*, U.S.S. *Zane*, U.S.S. *Wasmuth* and U.S.S. *Trever*, was performed exclusively by Naval Communication Reservists. During the fourteen day cruise, they drew regular pay of their ratings, and the actual operating during maneuvers was interesting and worth-while. Several enlisted men during the past year have requested and have been granted as much as six months active training duty, without pay, aboard ships of the Navy. While not drawing pay, they are furnished with subsistence and invariably they have greatly enjoyed their duty.

One of the most important functions of the Naval Communication Reserve is the perfecting of a communication organization capable of carrying on during a major disaster. Reservists the country over have an enviable record during floods and hurricanes, and the Eleventh Naval District is proud that its Naval Communication

(Continued on page 114)

W5EOW built this rotatable directive system for less than three dollars. He introduces a unique method of construction and a new rotating mechanism. If the cost of a rotary has been worrying you, read this article.

Poor Man's Rotary Beam

An Inexpensive Structure for Bi-Directional Rotaries

BY F. G. SOUTHWORTH,* W5EOW

SOME TIME ago, we at W5EOW were overcome by the urge (and wild claims, too) to partake of the advantages of a rotary beam. So, with a hand on the purse, we looked at catalogues listing such gadgets. Our dismay and surprise at the cost of even the simplest were surpassed only by the realization that our rig, receiver and living-room furniture together had cost less. That first urge was much too great, however, so designs and plans were examined. Disappointment was again our lot, however, for in each case, machined

* 5619 Goodwin, Dallas, Texas.

fittings were necessary and costly. It seemed necessary, therefore, that a rotating device be designed from parts obtainable at the dime store. With this in mind, the arrangement to be described was evolved.

A pair of barn or strap hinges was purchased for 25 cents and mounted on a 20-foot 2-by-2, according to the sketch. In our case, the top hinge is placed so that it mounts on a convenient joist piece of a house gable, while the other hinge is bolted to a short length of 4-by-4 post driven into the ground. It must be understood at this

point that this is not the only possible method of mounting; in fact, this handy little rotator can be mounted in more ways than can be described. For simplicity, the illustration shows another pole as a mounting. We now have a 2-by-2 standard which rotates through an arc of 180 degrees.

To provide control for this rotation, the pin is removed from the bottom hinge and replaced by a machine bolt of longer dimension. This bolt runs through the center hole of a toothed wheel which was bought second-hand from a bicycle shop for 30 cents. In addition to the center hole, another $\frac{1}{8}$ -inch hole is drilled $1\frac{1}{2}$ inches from center for a wood screw which will be screwed into the bottom of the 2-by-2. A bicycle chain is then used to control the rotation from the operating position.

This brings us to the antenna itself. We have said that our pole rotates through an arc 180 degrees. Our antenna, therefore, must be of the bi-directional type. In our own case, the "8JK" type was chosen because of its simplicity and ease of adjustment. Accordingly, one was made up with two 30-foot sections with a break of 2 feet at the center of each and spaced 8 feet 8 inches.

(Continued on page 114)

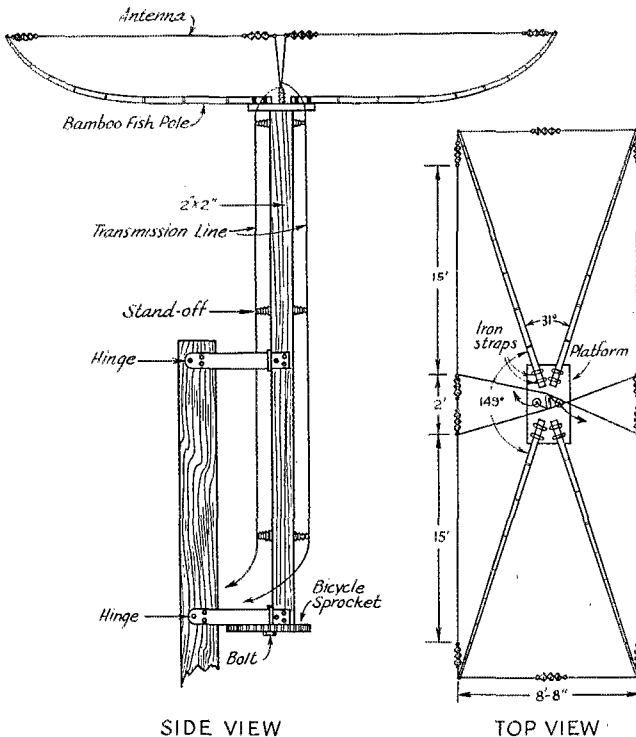

SIDE VIEW

TOP VIEW

The rotatable "8JK" antenna at W5EOW. The four supporting members are bamboo fishing poles. The "barn-door" hinge mounting permits rotation through an arc of 180 degrees by means of a bicycle sprocket and chain at the bottom.

A 15-Watt Crystal-Controlled Five-Meter 'Phone

**Compact Outfit for Generating the Stabilized Signal Required by the
New Regulations**

BY GLENN H. PICKETT,* W2HDV

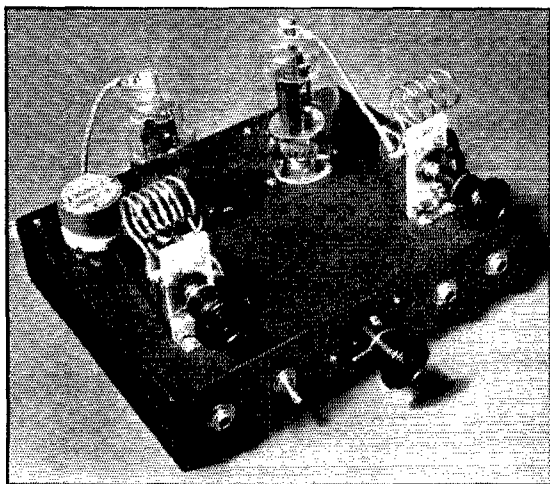

The transmitter is a neatly-built gadget on a small standard chassis. The oscillator cathode circuit is at the left, amplifier plate tank at the right. A ten-meter crystal is used for frequency control, with alternative c.c. control when desired.

THE recent ruling of the Federal Communications Commission prohibiting the use of modulated oscillators in the 56-Mc. band prompted the writer to try his hand at building a simple, stable transmitter of medium-low power that would meet the new regulations and still not bankrupt a meager pocketbook. The results obtained and the fun in building it were highly gratifying, and while it is not startlingly new in principle, it was felt that a description might prove interesting to the 5-meter addict.

The transmitter was designed complete in three units: radio frequency, audio and power

*c/o Harvey Radio, 103 W. 43rd St., New York City.

supply. The separate units are of enough general utility to be used separately or in conjunction with other transmitters. For instance, the r.f. unit can be used to excite a final amplifier of 150-200 watts input; the audio section is an excellent 24- or 32-watt modulator and speech amplifier, or driver for a Class-B modulator; and the power supply will furnish 400 volts d.c. at 250 ma., plus two filament supplies of 6.3 volts at 3 amperes.

The R. F. End

Taking the r.f. section first, it was decided to use an oscillator which could be either crystal-controlled or self-excited, and a single amplifier stage. With the self-excited oscillator connections, the rig still retains the one advantage of a modulated oscillator—that of being able to skip around the band to avoid QRM—and yet be able to stay put once a desirable spot is found. As a crystal-controlled outfit, it leaves little to be desired as a simple means of getting 15 to 18 watts of energy into an antenna on one given frequency. In this case a 10-meter crystal is used.

Switching from one type of oscillator circuit to the other requires but about 20 seconds' time. The oscillator circuit chosen for crystal control is the old stand-by Tri-tet. Using an 89 tube, it was found that there was no trouble of any kind encountered in getting it working from the start. Plenty of excitation was available to drive an HY-61 beam-power tube with about 30 watts input. The crystal runs absolutely cold at all times, thus considerably reducing the drift that seems to be inherent in ultra-high-frequency crystals. When switching from crystal to self-

Five-meter crystal control certainly need not be fearsome when a satisfactory r.f. unit can be constructed as simply as the one described by the author. Nor is it especially expensive. True, the modulator shown here does run a bit higher than a comparable gadget for a single-button mike, but that's a matter of choice. A stable carrier can do justice to higher-quality audio, so better speech equipment might as well be used if it can be afforded. If not—well, any modulator which will put 20 watts or so into a 5000-ohm load will do.

excited, the cathode lead of the oscillator is shifted from the top end of the coil to a tap 1 or 2 turns from the ground, and a grid condenser is plugged in in place of the crystal. This condenser is a small mica type soldered into a 5-prong plug for convenience in inserting it in the circuit.

A standard-size chassis, 7 by 9 by 2 inches, was chosen so that at a later date it could be placed in a standard cabinet, and the parts were placed with this in mind. This meant that the HY-61 had to be mounted with its socket suspended inside the chassis on 1¼-inch pillars. Incidentally, this mounting made for shorter leads and better shielding between grid and plate circuits.

The coils are all self-supporting, of No. 12 bare copper, and are all soldered directly to their respective tuning condensers. It was felt that any attempt to provide for 10-meter operation by means of plug-in coils would possibly make for higher losses. At any rate the low cost of the parts used should not preclude building another similar unit with coils designed for that band.

The cathode (or grid) coil and its tuning condenser are mounted on top of the chassis, making short connections to the crystal grid condenser socket and to the grid of the tube. The oscillator plate coil and its condenser are mounted under the chassis, thus shielding the coil from the plate of the amplifier. The amplifier plate tank occupies the right-hand end of the chassis, on top.

Plenty of by-passing is used and a common ground bus of No. 12 copper wire is run the full length of the chassis. Steel chassis are not exactly the best media for conducting the ground currents to a common point at 56 megacycles.

Power supply is fed to the chassis through a six-wire cable, which plugs into a male chassis plug at the right-rear of the chassis. Two of these

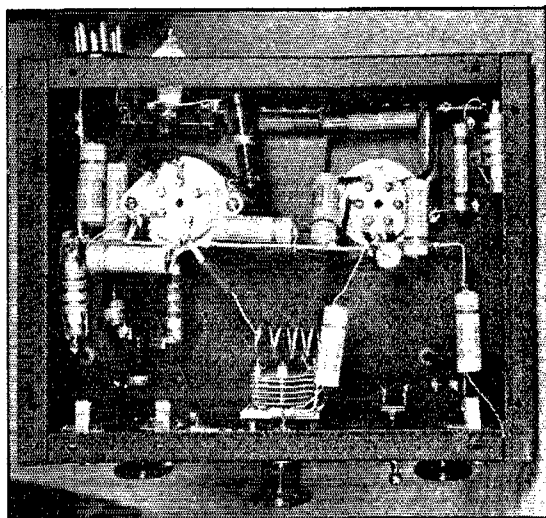

Below the chassis of the r.f. unit. The oscillator plate tank is at the lower center. Note the ground bus running between the two tube sockets.

wires are used to close the negative "B" circuit in the power supply, through the toggle switch on the front of the chassis. These wires are paralleled with a similar switch in the power supply unit. Two of the remaining wires are for filament, one for "B" plus to the oscillator and the sixth is used as a common ground and negative "B" return. A small feed-through insulator serves as a terminal for the "B" plus for the plate and screen of the HY-61. This, of course, connects to the power supply through the modulation transformer secondary, which is mounted on the audio chassis.

Metering is by means of jacks as shown in Fig. 1. It will be noticed that the amplifier grid-current jack does not connect between the grid-leak and

Fig. 1 — Circuit diagram of the r.f. unit.

- C₁ — 75- μ fd. variable.
- C₂ — 35- μ fd. variable.
- C₃ — 4- μ fd., 450-volt electrolytic.
- C₄ — 50- μ fd. mica.
- C₅ — 25- μ fd. variable.
- C₆ — 0.002- μ fd. mica, 1000-volt.
- C₇ — 0.01- μ fd. paper, 600-volt.
- C₈ — 50- μ fd. mica (mounted in plug).
- R₁ — 60,000 ohms, 1-watt.
- R₂ — 10,000 ohms, 2-watt.
- R₃, R₄ — 25,000 ohms, 2-watt.
- R₅ — 3500 ohms, 10-watt.
- R₆ — 10,000 ohms, 1-watt.
- R₇ — 400 ohms, 10-watt.
- R₈ — 20,000 ohms, 10-watt.
- RFC — 2.5-mh. choke, 125 ma.
- J — Single closed-circuit jack.

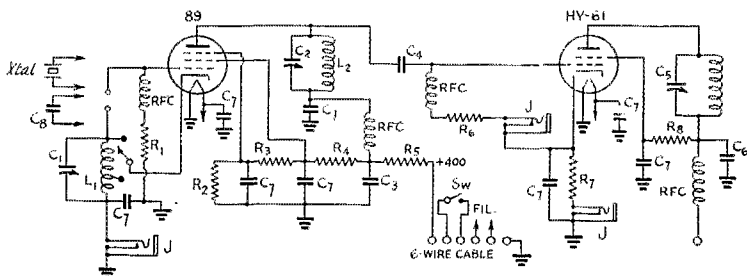

- Sw — S.p.s.t. toggle switch.
- L₁ — 6 turns, inside diameter ¾-inch, spaced to make coil length 1½ inches.
- L₂ — 4 turns, ½-inch inside diameter, spaced to occupy 1¼ inches.
- L₃ — 4 turns, ¾-inch inside diameter, spaced to occupy 1¼ inches.

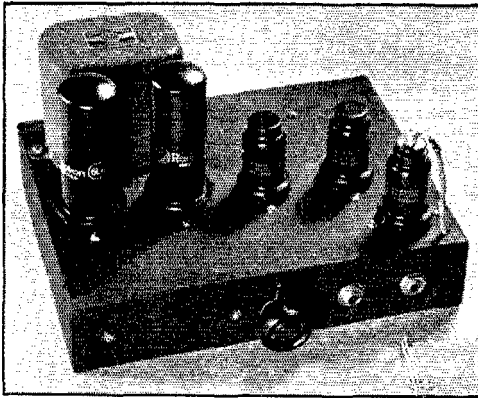

ground, as is usually done, but between grid-leak and cathode, thus permitting the grid current to

The modulator unit has three stages of speech amplification preceding the 6L6 output tubes, providing plenty of amplification for a crystal microphone. A second jack, cutting into the grid circuit of the second stage, allows the use of an audio oscillator for modulated c.w. transmission without overloading the speech amplifier.

tion in the modulators could be tolerated. The power supply was to be 400 volts, so, to avoid the necessity for dropping the plate voltage through a resistor, tubes had to be chosen that would operate safely at that voltage. The available filament supply was 6.3 volts at 3 amperes, so the filament ratings of the speech tubes and modulators had to fall within that limit. Sufficient gain had to be available to operate from a crystal microphone (or other high-impedance microphones), without having to crawl into the mike, and at the same time an input with lower gain should be provided for use out of an audio oscillator for modulated c.w. purposes. The tube line-up shown in Fig. 2

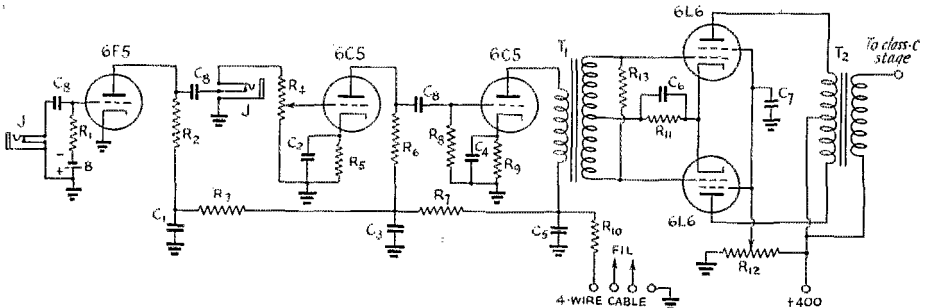

Fig. 2 — Speech amplifier and modulator.

C₁, C₃, C₅, C₇ — 4- μ fd., 450-volt electrolytic.

C₂, C₄, C₆ — 10- μ fd., 25-volt electrolytic.

R₁ — 5 megohms, $\frac{1}{2}$ -watt.

R₂ — 250,000 ohms, $\frac{1}{2}$ -watt.

R₃ — 60,000 ohms, $\frac{1}{2}$ -watt.

R₄ — 500,000-ohm potentiometer.

R₅ — 6000 ohms, $\frac{1}{2}$ -watt.

R₆ — 100,000 ohms, $\frac{1}{2}$ -watt.

R₇ — 60,000 ohms, 1-watt.

R₈ — 500,000 ohms, $\frac{1}{2}$ -watt.

R₉ — 2500 ohms, $\frac{1}{2}$ -watt.

C₈ — 0.01- μ fd., 600-volt paper.

B — Mallory bias cell.

R₁₀ — 5000 ohms, $\frac{1}{2}$ -watt.

R₁₁ — 200 ohms, 10-watt.

R₁₂ — 50,000 ohms, 25-watt.

R₁₃ — 100,000 ohms, $\frac{1}{2}$ -watt.

J — Single closed-circuit jack.

T₁ — Single plate to push-pull grid transformer (Stancor A-73C).

T₂ — 30-watt universal output transformer (UTC S-19)

be read when the cathode circuit is opened by an open plug. This forms an easy method of tuning up without damage to the plate and screen. All jacks are either at ground or at very low d.c. potential, thus preventing those disconcerting moments when one gets a touch of 400 volts or so.

The cathode lead to the oscillator terminates in a small rubber-insulated clip.

Speech Amplifier and Modulator

In choosing the audio system, several conditions had to be fulfilled. Fifteen to eighteen watts of audio power were required. A common power supply was to be used on the r.f. and a.f. units, which meant that very little plate-current varia-

proved to fulfill all the requirements admirably. Class-AB 6L6's are used as modulators; with 400 volts on the plate and 250 volts on the screen,

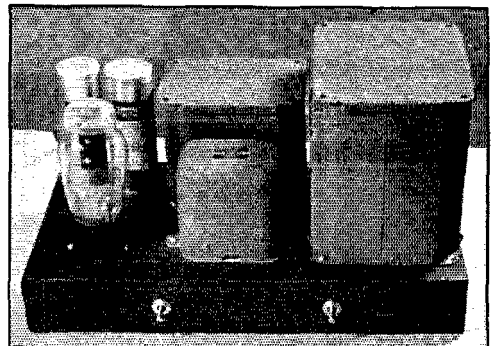

The power-supply unit, conventional in design, handles the plate and filament requirements of both r.f. and audio units. The construction harmonizes with that of the other two sections of the complete transmitter.

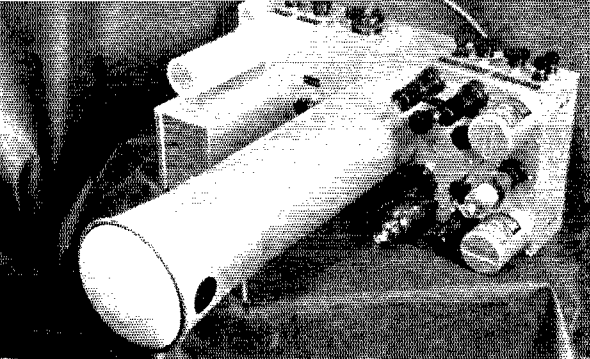

Fig. 2 — Scanning, synchronizing and power-supply circuits are assembled on one chassis with the 1802 cathode-ray tube. This unit may be connected to the receiver described in a previous issue, replacing the electromagnetic-deflection circuits shown in February *QST*.

An Electrostatic-Deflection Kinescope Unit for the Television Receiver

Scanning, Synchronizing and Power Supply Circuits for the New Five-Inch Tubes

BY J. B. SHERMAN*

LAST month's article¹ described Kinescope outfits for electromagnetic deflection, for use with the video receiver described in Mr. C. C. Shumard's articles.² A new 5-inch tube for electrostatic deflection, the Type 1802,³ also lends itself well to use in this receiver. A single, compact unit has been built for the 1802, containing high-voltage supply and synchronizing and scanning equipment.

Fig. 1 shows the circuit of this unit. The composite horizontal and vertical synchronizing signal from the receiver is supplied from the receiver to the post marked "sync input," and the horizontal and vertical impulses are separated and delivered to the respective scanning oscillators in much the same manner as shown previously. Blocking oscillators and discharge circuits are used for generating the sawtooth waves. These are modified somewhat from the form shown for magnetic deflection, in order to suit the electrostatic-deflection requirements. The output circuits, however, are entirely different, since it is necessary in the electrostatic case to supply large voltages rather than the large currents required for magnetic deflection.

It will be observed that push-pull deflection is used for the Kinescope. This makes it possible to obtain sufficient deflecting voltage with a "B"

supply of only 300 volts for operation of the Kinescope at 2000 volts on the second anode. Furthermore, focus and linearity of deflection with this arrangement are much better than can be obtained with the single-ended connection.

A Type 6N7 tube is used for vertical deflection output, push-pull operation being obtained by feeding one grid from the opposite plate circuit. A lower value of plate load resistance is necessary for the horizontal output than for the vertical, in order to maintain an adequate frequency-response characteristic for the high-frequency sawtooth. A Type 6F8G tube is used for horizontal output because it permits a greater plate voltage swing than the 6N7 at the lower load resistance. The push-pull operation is obtained again by driving one grid from the opposite plate.

Fig. 2 shows the appearance of the complete unit. A standard 8" × 17" × 3" chassis is used, turned on its side, with the Kinescope socket mounted in the center. This makes possible

The new electrostatic-deflection tubes are not only appreciably less expensive than the magnetic tubes of equivalent size, but are probably more adaptable to amateur use as well. The circuits for television reception resemble those made familiar by oscilloscope practice; no special deflecting coils are required. And, as proved by the sample photograph in this article, the picture has good detail. An excellent moderate-cost unit for "looking-in" on the transmissions soon to be regularly scheduled.

* Research and Engineering Dept., RCA Manufacturing Co., Harrison, N. J.

¹ J. B. Sherman, "Using Electromagnetic-Deflection Cathode-Ray Tubes in the Television Receiver," *QST*, February, 1939.

² C. C. Shumard, "A Practical Television Receiver for the Amateur," *QST*, December, 1938; "Construction and Alignment of the Television Receiver," *QST*, January, 1939.

³ Type 1802-P1 has the familiar green screen; Type 1802-P4 uses the more recent white screen.

simple, compact construction. With adequate shielding of the Kinescope no effect on either focus or deflection can be observed due to the proximity of the power transformer. The out-

side shield which serves also to support the Kinescope is $\frac{1}{4}$ -inch aluminum tubing, 12 inches long and 4 inches inside diameter. It is fastened to the chassis by four 6-32 bolts tapped into the

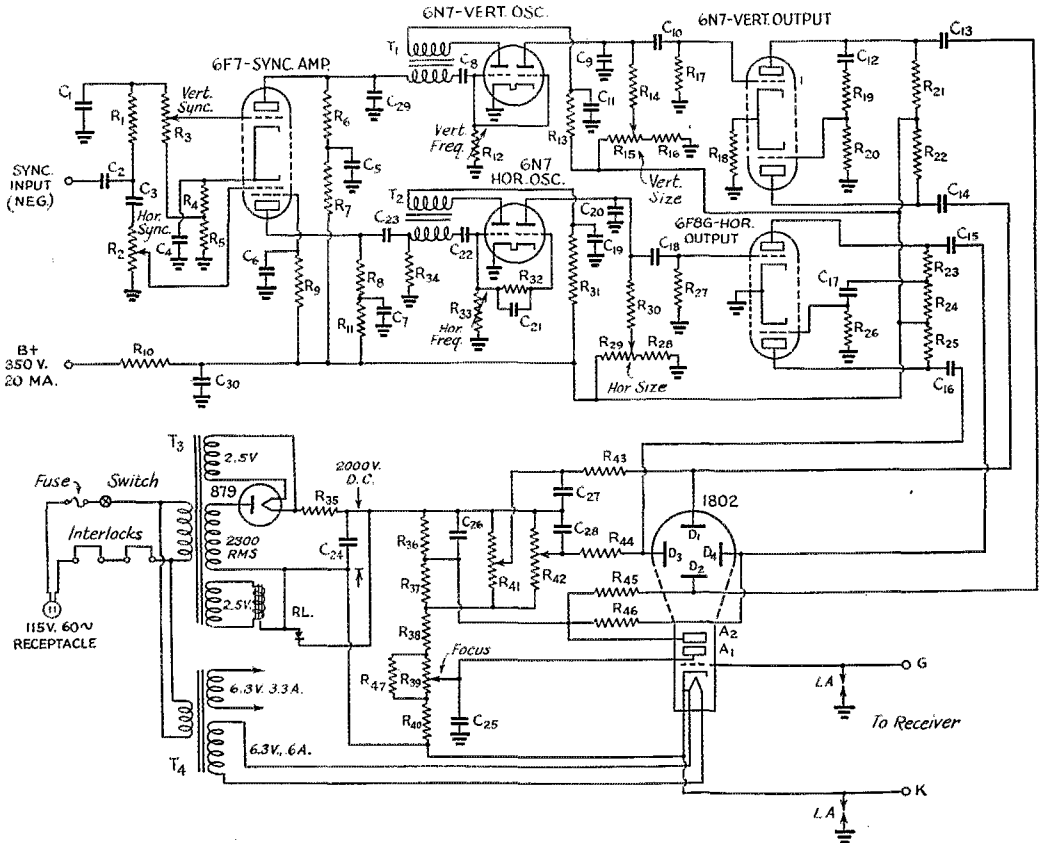

Fig. 1 — Scanning, synchronizing and power supply circuits for the 1802.

- C₁, C₂₀, C₂₂, C₂₉ — 0.001- μ fd., 400-volt.
- C₂, C₅, C₉, C₁₀, C₁₁, C₁₂ — 0.25- μ fd., 400-volt.
- C₃ — 50- μ fd., 400-volt.
- C₄ — 25- μ fd., 25-volt.
- C₆, C₁₉ — 0.05- μ fd., 400-volt.
- C₇, C₈ — 0.1- μ fd., 400-volt.
- C₁₃, C₁₄ — 0.1- μ fd., 2000-volt.
- C₁₅, C₁₆ — 0.005- μ fd., 2000-volt.
- C₁₇, C₁₈ — 0.01- μ fd., 400-volt.
- C₂₁ — 800- μ fd., 200-volt.
- C₂₃ — 0.004- μ fd., 400-volt.
- C₂₄ — 1- μ fd., 2000-volt (Aerovox Type 2005).
- C₂₅ — 0.1- μ fd., 1000-volt.
- C₂₆, C₂₇, C₂₈ — 0.25- μ fd., 200-volt.
- C₃₀ — 16- μ fd., 450-volt.
- R₁, R₇, R₁₁, R₁₃, R₃₁ — 0.1-megohm, $\frac{1}{2}$ -watt.
- R₂ — 10,000-ohm potentiometer.
- R₃, R₁₂, R₃₉, R₄₁, R₄₂ — 0.25-megohm potentiometer.
- R₄ — 900 ohms, $\frac{1}{2}$ -watt.
- R₅ — 1100 ohms, $\frac{1}{2}$ -watt.
- R₆, R₈ — 10,000 ohms, $\frac{1}{2}$ -watt.
- R₉ — 0.4-megohm, $\frac{1}{2}$ -watt.
- R₁₀ — 2000 ohms, 2-watt.
- R₁₄ — 1-megohm, $\frac{1}{2}$ -watt.
- R₁₅, R₂₉, R₃₃ — 0.1-megohm potentiometer.

- R₁₆, R₂₈ — 1000 ohms, $\frac{1}{2}$ -watt.
- R₁₇, R₁₉, R₂₆, R₂₇, R₄₄, R₄₆ — 2 megohms, $\frac{1}{2}$ -watt.
- R₁₈ — 2500 ohms, $\frac{1}{2}$ -watt.
- R₂₀ — 60,000 ohms, $\frac{1}{2}$ -watt.
- R₂₁, R₂₂ — 0.2-megohm, $\frac{1}{2}$ -watt.
- R₂₃, R₂₅ — 50,000 ohms, 1-watt.
- R₂₄ — 3000 ohms, $\frac{1}{2}$ -watt.
- R₃₀ — 0.5-megohm, $\frac{1}{2}$ -watt.
- R₃₂ — 5000 ohms, $\frac{1}{2}$ -watt.
- R₃₄ — 500 ohms, $\frac{1}{2}$ -watt.
- R₃₅ — 50,000 ohms, 2-watt.
- R₃₆, R₃₇ — 30,000 ohms, $\frac{1}{2}$ -watt.
- R₃₈ — 0.6-megohm, 3-watt (3-0.2 meg., 1 watt).
- R₄₀ — 0.15-megohm, 1-watt.
- R₄₃, R₄₅ — 3 megohms, $\frac{1}{2}$ -watt.
- R₄₇ — 0.5-megohm, 1-watt.
- T₁ — Vertical oscillation transformer (RCA No. 9834)
- T₂ — Horizontal oscillation transformer (RCA No. 9835).
- T₃ — Power transformer (see text) (RCA No. 9839).
- T₄ — Filament transformer.
- LA — Lightening arrestors (Brach No. 27A, dismounted).
- RL — Discharge relay — Dunco No. RA-1 (modified as described).

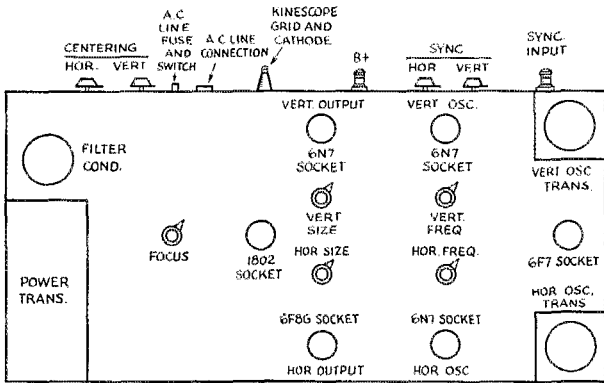

Fig. 3 — Layout drawing of the 1802 unit.

tubing wall. In order to house the tube completely a cone, $4\frac{1}{2}$ inches long and $5\frac{1}{2}$ inches in diameter at the mouth, is cut from No. 20 sheet aluminum and fastened to the end by bolts tapped into the tubing. The inside shield consists of a loosely-wound spiral of 3 layers of No. 22 sheet iron, 11 inches long, which fits inside the aluminum tube. If it is necessary to demagnetize the iron, this can be done in the same manner as described in last month's article.

The 1802 socket is the new standard 11-pin magnal type.

Fig. 3 shows the layout of the panel and Fig. 4 is an inside view of the chassis. Focus, size, and frequency controls are located on the panel so that their shafts can be extended to a cabinet front panel. Centering and sync controls are not often used and are therefore placed on the upper edge of the chassis, where they can be conveniently reached in a cabinet with hinged top.

The usual high-voltage precautions have been taken. Neon lightning arrestors are connected from Kinescope grid and cathode to ground to prevent any possible external appearance of high voltage at these points. Pin jacks fastened to the cover of the rear of the chassis open the 110-volt circuit when the cover is removed, and a relay discharges the high-voltage condenser when the 110-volt circuit is broken, whether by removal of the cover or by operation of the line switch. By promptly removing the high voltage, the discharge relay also prevents the appearance of a stationary spot on the screen after the entire receiver is turned off, for since the Kinescope bias is obtained from the low-voltage receiver supply

which has a shorter time constant than the high-voltage supply, the Kinescope anode voltage would otherwise persist after the scanning and bias voltages have been removed. The discharge relay is a modified Dunco type RA-1, shown in the photograph of Fig. 5. It is mounted upside down in order to obtain gravity operation in the event of failure of the spring, and has an extension contact arm fastened to the armature. This is the low side of the circuit, and the high-voltage connection is made to a contact on a small porcelain standoff insulator mounted directly on the chassis. This relay has a 2.5-volt winding which

is conveniently connected to the unused 2.5-volt secondary of the power transformer.

In connection with the power transformer, it should be mentioned that the high-voltage secondary potential actually required is only about 1700 volts r.m.s. However, high-voltage low-current transformers designed for Kine-

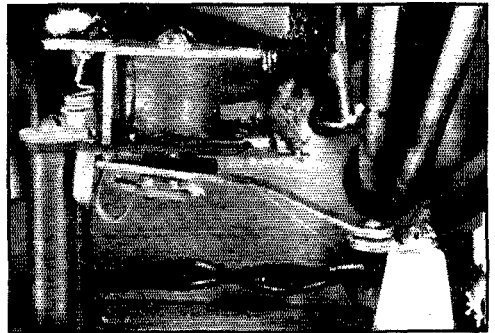

Fig. 5 — The gravity-operated relay is a simple adaptation of an ordinary inexpensive a.c. relay. The extension arm is connected to the low-potential end of the high-voltage supply, thus no special insulation is needed.

scope operation are at present difficult to obtain, and it was necessary to use a standard transformer of higher voltage with a series resistor.

The Kinescope operates at heater voltage of 6.3, as do the rest of the tubes in the unit. However, since the Kinescope cathode and heater are operated above ground, a separate transformer winding is required. The small trans-

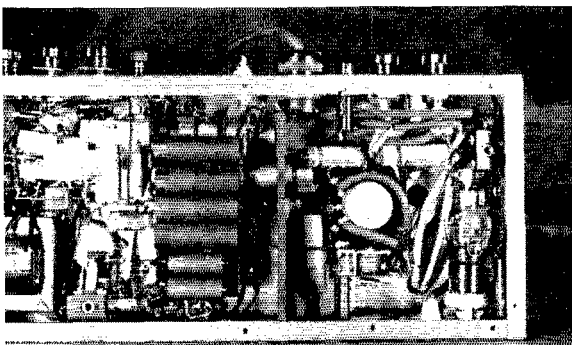

Fig. 4 — Most of the components are below the chassis. The rectifier tube is at the right, filament transformer in the lower left corner.

Affiliated Clubs

(Continued from p. 41)



Fig. 6 — This photograph shows the detail that the five-inch electrostatic tube is capable of giving. The picture originated in an r.f. signal generator and was passed through the entire receiver, not just the video circuits alone.

former mounted inside the chassis near the 6F7 tube has two 6.3-volt windings for supplying all of the heaters. It is perfectly satisfactory, however, to run all but the Kinescope from the same transformer winding which supplies the rest of the tubes in the receiver.

Since the 300-volt current demand of the unit is small (approximately 20 ma.), it is most convenient to use the same "B" supply as shown in Fig. 2 of Mr. Shumard's December article. The negative "B" connection of the scanning unit is ground. The positive "B" lead is run to the output side of the second filter choke. It may be necessary to reduce R_{57} in the "B" supply slightly to maintain the specified 3 volts across it. If necessary, the filter output can be increased by using a small condenser (say 1 μ f.) across the rectifier output before the first choke. The other connections to the receiver are sync input, Kinescope grid, and Kinescope cathode. These are made directly to the terminals thus marked.

After the unit has been built, the linearity of scanning can be checked by the bar-pattern method described previously. It will be noted that the circuit shows no scanning distribution adjustments, nor should any be necessary. If greater deflection is desired, R_{10} may be reduced, which will increase the "B" supply voltage. However, 300 volts is adequate for rated 2000-volt operation of the 1802.

Fig. 6 is a photograph of a received Monoscope picture, using the 1802 unit connected to the receiver described in Mr. Shumard's articles. The Monoscope signal was used to modulate a signal generator tuned to 45 Mc. and connected to the antenna posts of the receiver, and the photograph thus indicates the overall performance of the complete outfit.

Actually a mobilization of emergency facilities, the test was also witnessed by officials of telephone, telegraph and power companies, the American Legion and various public officials. Contact was established with some fifteen cities in Washington, Idaho and Montana on 3.9- and 1.75-Mc. 'phone. Several stations operated on emergency power, one actually having a power failure and handling replacement orders for the power company. Amateurs cooperating in the test included W7BFI (Spokane control station), W7AAN, W7AQK, W7ABK, W7ABT, W7FGZ, W7BOZ, W7CCR, W7BTJ, W7EPS, W7DZX, W7FIJ, W7CRL, W7EPS, W7BYT, W7FON, W7BXN, W7HR, W7EQV, W7EDU, W7ADK, W7DOZ, W7DTJ, W7DYT, W7ASA, W7FOV, W7FOM, W7FVO.

VISIT YOUR LOCAL CLUB

Address the Communications Manager, A.R.R.L. (enclosing 3¢ stamp, please), for data on affiliated clubs in your vicinity. Clubs are excellent places to get acquainted with radio amateurs and to participate in interesting discussions on our hobby. At A.R.R.L. headquarters there are recorded the addresses of several hundred amateur radio clubs affiliated with the League, their places and times of meeting. Why not drop in at your local club and "meet the gang"?

GENERAL CLUB NEWS

THE Mike and Key Club of Baltimore, Md. held a Party and Dance on January 21st to help pay for the complete, emergency-powered station now under construction by the club. A worthy objective! . . . The Iowa-Illinois Amateur Radio Club has adopted a new By-Law whereby every member in good standing receives with payment of his dues a year's membership in the A.R.R.L. This was done to stimulate club membership and insure 100% membership in the League. . . . The Worcester (Mass.) Radio Association is planning a banquet commemorating its 20th anniversary to be held some time in the early spring. A new transmitter is being completed for the club station, WIBKQ, and it is hoped that many contacts will be possible with other affiliated club stations. . . . An enthusiastic code class under the tutorage of Nate Heaton, W9UVU, is a regular feature of the Hamfesters Radio Club (Chicago). In addition to teaching code the need for good operating practices is also stressed in an effort to start out the beginner in the right way. The club's theory class is under the direction of Wynne H. Davies, W9YKJ. . . . W2J1Q, Tu-Boro Radio Club, is operating on 7 Mc. with a 6L6 oscillator-6L6 doubler combination. . . . The Albuquerque Communications Club (New Mexico) is sponsor of a weekly newspaper column, "Picked Up By The Antenna," written by Ted Douglass, club activities manager. . . . The Mid-Hudson Amateur Radio Club (Poughkeepsie, N. Y.) held a very successful Fourth Annual Banquet and Get-Together on December 10, 1938. M.-H.A.R.A. recently conducted a raffle, the proceeds of which are to be used to build a portable emergency-powered transmitter. . . .

— E. L. B.

A New Idea in V.T. Voltmeter Design

Automatic Slide-Back Giving Direct Readings

BY R. E. POLLARD,* W8PCI

THOSE amateurs fortunate enough to own test equipment more elaborate than a d.c. voltmeter are indeed few, and yet the possession of such equipment as an oscilloscope, v.t. voltmeter, signal generator, audio oscillator, field strength meter, etc. would open up many phases of radio for the amateur's investigation which are now closed to him because of the lack of such equipment.

Next to a multi-range voltmeter we consider a v.t. voltmeter the instrument of greatest value around the shack. The varied uses for this instrument, such as r.f. voltage measurement, field strength measurement, checking carrier harmonic content, frequency response measurements, circuit alignment, etc., have been covered in previous *QST* articles. We read them all, but at the time the cost and circuit complications seemed too excessive. Recently, however, when some means of measuring r.f. voltages began to assume more the proportions of a necessity than a mere luxury, everything available concerning v.t. voltmeters was reviewed. One definite shortcoming of all these units seemed to stand out. That is the necessity, once connection is made to the circuit under test, for manually adjusting a "slide-back" or cancelling voltage or else referring to a calibration chart. It seemed that since so many circuit functions such as volume control, frequency control, modulation control and power supply voltage control are being made automatic it should be possible to make the variation in plate current through a d.c. amplifier automatically slide back a bucking voltage to cancel that under test. Then too, as is always the case, we desired to minimize the cost as much as possible by utilizing parts available around the shack.

From the foregoing circumstances, from many graphs run on the performance of various tubes, and from several circuits tried, the arrangement shown in Fig. 1 was finally evolved. Its accuracy and general usefulness have proved more than gratifying. It has a range of approximately $\frac{1}{2}$ to 500 volts on d.c. 60-cycle, audio or r.f. frequencies, with practically no loading of the circuit under test. The input capacity, which must be kept low for use across tuned circuits or at ultra-high frequencies, is not much above that of the better units using acorn tubes in the popular "goose-neck" construction. The unique feature about the unit is that the d.c. voltmeter reads directly the peak value of the voltage under test,

with no need for any manual adjustment or reference to any calibration chart. This is an advantage which to the best of my knowledge is not to be found even in the best of commercial instruments.

It is probably also in order to mention some shortcomings. First is the cost which, exclusive of the voltmeter, approaches \$25 if one were to buy everything. By utilizing parts available this figure can of course be cut down considerably. For instance the parts we needed to buy, not including a cabinet, cost us \$3.78. Secondly, there is an initial reading of about one-half volt, probably caused by stray electrons collecting on the grid of the 75. With a 10-megohm load resistor it doesn't take much current flow to develop a half-volt bias. But at any rate we do not consider this such a serious drawback: it simply renders the unit useless for voltages below one-half volt and necessitates the shorting of the test leads when adjusting the voltmeter to zero. The last shortcoming is that when the unit is first turned on the 81 filament warms up first and practically the full supply voltage is applied across the d.c. voltmeter. This necessitates some precaution, because if the meter should be set on a low-voltage range there will be need for a new 0.1 milliammeter, and they cost money. Some will prefer to protect the meter with a fuse, although we have connected a toggle switch in one meter lead. This switch is mounted right beside the power switch and serves as a reminder to make certain the meter circuit is open until all tubes warm up.

The "slide-back" type of v.t. voltmeter, in which readings are taken by measuring the amount of additional bias needed to restore the plate-current of the voltmeter tube to an arbitrary "zero" setting when a signal is applied, has a record of continued usefulness. This article describes a method of making the slide-back automatic, thereby eliminating the manual adjustment necessary with the voltmeter in its usual form. Like all similar instruments, it reads peak values; if the waveform is pure the r.m.s. can be found by dividing the reading by 1.41. More often the peak voltages are of greatest interest in measurements on amateur radio equipment.

*109 S. 9th St., Olean, N. Y.

Operation of the Circuit

For reasons explained later the entire circuit must be left floating with no direct connection to chassis or ground. This lack of any point such as ground for use as a reference level makes explanation of the operation somewhat difficult. However for the purpose of circuit analysis only, point *A* in Fig. 1 will be considered as "ground." V_1 , a 75 tube, can be considered as a diode rectifier, the grid serving as the anode; V_2 , a 6L6, as

rectified r.f. and pass to the grid of V_2 a negative d.c. voltage equal to the peak value at point *B*.¹ This increase in bias on the 6L6 results in decreased plate current and therefore decreased voltage drop across R_3 and R_4 . Point *C* therefore will be less positive (or in other words more negative) in respect to *E* than previously. The neon bulb N_1 serves simply as a bias battery would, allowing the grid of the second 6L6 to operate negatively below *C*. Since the voltage drop across N_1 is practically constant, point *G* or the grid of V_3 must follow any change in potential at point *C*.

Since point *C* we found is now more negative than previously, *G* must also be more negative than before, resulting in a decrease in plate current in V_3 and reduced voltage drop across R_5 .²

Now R_5 is connected between *A* and *J*; and since *A* is considered as "ground" a reduction in voltage drop across R_5 will make *J* more negative (i.e., less positive) in relation to ground. But it will be noted that through R_6 , R_4 , R_3 and N_2 all electrodes of V_2 except the grid are connected to *J*. It follows that all these points must be more negative with respect to *A* than previously, which is equivalent to making the grid of V_2 more positive or reducing the applied bias. This action continues until the negative bias originally applied from *B* is cancelled and a state of equilibrium is again produced. If

a d.c. voltmeter is connected between *A* and some point *D* which before the test was at "ground" potential, it will read the value of the positive slide-back voltage necessary to cancel the negative bias originally applied to the grid. This will within very close limits equal the ten-volt peak value of the r.f. voltage output from the oscillator under test.³

¹ That is, the voltage developed between *A* and *B* is applied between the grid of V_2 and *D*. Since no current flows in the 6L6 grid circuit, there will be no initial loss of voltage through the meter *M* because the constants are adjusted so that the potential difference between *A* and *D* is zero with *A* and *B* shorted, as described later.—*Editor*.

² It may be of some aid in visualizing the action of the circuit to consider that the voltage drop across R_3R_4 bucks the bias voltage supplied to the neon bulb N_1 from the bleeder section R_5 . Lowered drop through R_3R_4 therefore means smaller positive bucking voltage, consequently higher net negative bias.—*Editor*.

³ The meter actually reads the difference in potential be-

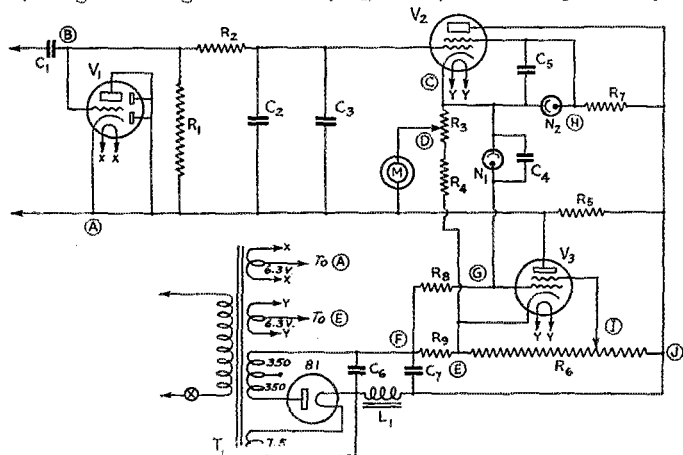

Fig. 1—The v.t. voltmeter circuit used by the author, V_1 is a Type 75 tube, V_2 and V_3 are 6L6's.

C_1 — 0.005- μ fd. mica.
 C_2 — 100- μ fd. mica.
 C_3 — 0.1- μ fd. paper
 C_4, C_5 — 250- μ fd. mica.
 C_6, C_7 — Paper replacement for dual 8-8 μ fd. electrolytic (C-D PE-B6808).
 R_1 — 10 megohms, 1-watt carbon.
 R_2 — 5 megohms, 1-watt carbon.

R_3 — 400-ohm wire-wound potentiometer.
 R_4 — 2500 ohms, 10-watt.
 R_5 — 10,000 ohms, 50-watt.
 R_6 — 25,000 ohms, 50-watt adjustable.
 R_7 — 250,000 ohms, 1-watt.
 R_8 — 100,000 ohms, $\frac{1}{2}$ -watt.

R_9 — 400 ohms, 10-watt.
 N_1, N_2 — 2-watt neon bulbs with base resistor removed.
 T_1 — Power transformer; see text.
 L_1 — 75-ma. filter choke, receiver type.
 M — Multi-range d.c. voltmeter, 1000 ohms per volt.

a d.c. amplifier; and V_3 , another 6L6, as another d.c. amplifier or, if preferred, as a variable resistance. Let us assume that the test leads are applied to a source of r.f. voltage such as the output of a superheterodyne oscillator, the peak value of which is ten volts. Condenser C_1 offers practically no impedance to such r.f. voltage and during the positive portion of the cycle the grid will draw current from the cathode. This current flowing through load resistor R_1 will bias the grid negative until the bias thus developed equals the peak r.f. voltage. At this point the grid is of course swung positive by the applied r.f. voltage only during a very small part of the positive half cycle. The duration of this portion of the cycle is so short that the amount of power actually taken from the oscillator under test is negligible.

Progressing therefrom, R_2 together with C_2 and C_3 form a filter network to smooth out the

Construction

One precaution should be noted before progressing further. That is the necessity for preventing possible contact with any portion of the circuit. This will become evident when the unit's operation while making d.c. measurements is considered. In this case point *B* is connected directly to negative. In most d.c. measurements this will be ground on the circuit under test, and point *A* will be connected to positive. Should *A* be grounded to the chassis and cabinet, the whole unit would assume a voltage above ground equal to the voltage under test. Therefore the chassis and even the tube shells are left floating, and all jacks for test leads are of the insulated type.

The 75 tube is mounted on the end of a 4-wire cable similar to the "goose-neck" construction so it can be placed at the voltage source for r.f. measurements. This cable should preferably be shielded and should have good rubber insulation on each individual wire. A little moisture on cotton-insulated cables would give leakage, and it would take very little leakage from the line leading to the 6L6 grid to affect seriously the unit's accuracy. A standard female 6-prong cable connector on the end of the cable serves as socket for the 75 tube. A rubber grommet in the side of the connector shell allows bringing out a test lead from cathode and also carries the leads to R_1 and R_2 . The resistors themselves run up along side of the tube and are soldered to the grid clip. Condenser C_1 is soldered directly to the grid clip and mounted straight up above the tube, the other lead serving to make connection to the r.f. voltage under test. C_2 is a midget mica mounted within the cable connector to give filtering as close to the cathode as possible for r.f. C_3 is mounted under the chassis at the 6L6 socket. It is needed to give additional filtering on 60 cycles. We are using a paper condenser at this point although it should be a mica unit, in the interest of low leakage.

Complete shielding of the input circuit from the test prod through to the grid of V_2 is desira-

between the plate of V_3 and the point *D*; initially this potential difference is zero (by adjustment). With applied signal, the operation is analogous to that of the regulator tube in a regulated plate supply, in that the voltage drop from plate to cathode of V_3 adjusts itself to restore the original circuit conditions. The change in drop necessary to bring this about is equal to the additional bias developed across *AB*, since only this value will permit the circuit to function as it did without signal.—*Editor*.

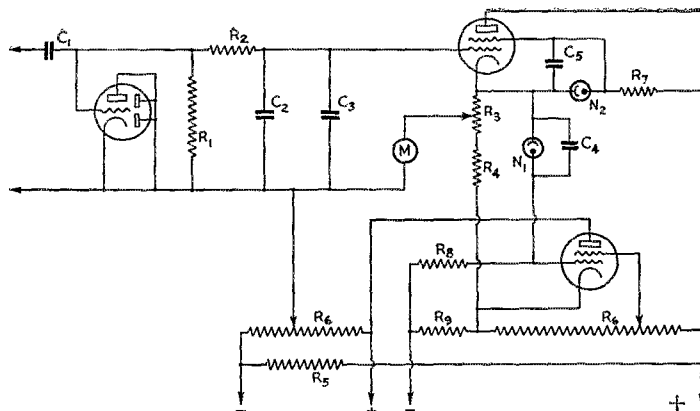

Fig. 2 — Suggested circuit for use with two low-voltage power supplies. Components have the same values as in Fig. 1. Some adjustment of resistors may be necessary to compensate for departures from the author's voltages, as explained in the text.

ble. Without it, when using standard test leads for other than r.f. measurements the lead connected to the grid of the 75 is very susceptible to pick-up from any a.c. or r.f. source, so that if a strong field is present the initial reading will rise considerably above the $\frac{1}{2}$ -volt value previously mentioned. The test lead connected to the 75 cathode need not be shielded.

Our unit is constructed on a 11 by $6\frac{1}{2}$ by $1\frac{1}{2}$ chassis and we plan on housing it in a metal cabinet with hinged cover. For all except r.f. measurements the cable and 75 tube will be placed in the cabinet and the grid connected by a clip directly to a banana jack for d.c. and through a 1- μ f. paper condenser to another jack for audio and 60 cycles. Standard test leads will then be used for these measurements.

The resistors must be removed from the neon bulb bases, and this is most easily done by unsoldering the base lead wires and heating the base in boiling water, after which it can be pulled from the bulb.⁴ Neon bulbs are noted for the interference they set up. The 250- μ fd. condensers shown across the bulbs were sufficient to eliminate this entirely.

A power transformer giving the filament voltages needed may not be available commercially, in which case a separate transformer for the 81 filament will be needed. We used an old b.c.l. transformer by removing the filament windings and installing new ones to give the desired voltages. Some may have parts available for two low-voltage supplies but not for one high-voltage

(Continued on page 116)

⁴ Tubes such as the RCA-991 and Sylvania VR-90 and VR-150 may be used instead. These tubes are made for regulator use and do not have resistors incorporated in the structure.—*Editor*.



H A M D O M



EDITOR'S NOTE: Roth Jones, VK3BG, contributes data for the "Hamdom" feature this month with an account of three of the better-known VK's.

★ ★ ★

There was a time not so many years ago when it was said that Bill Moore, VK2HZ knew more hams personally than any two VK's put together. However, in recent years these personal contacts have fallen off with a YF holding the reins. A radio enthusiast from 1922, he didn't graduate to the ham ranks till 1930, when the

ham career. Although VK6SA was established in 1926, it was 1928 when he made the first interstate QSO on 27 Mc. with 3BQ. Since then he has worked every amateur band — 5, 10, 20, 32, 40, 80, 160. WAC on two bands, his best time for the circuit is 3 hours, 20 minutes. The first VK station to receive a WAS certificate, he was at last reports the only VK6 with WAS and WAC. Over 100 countries have been worked, with confirmation from 81. This was mostly done with the p.p. 46's that have been the station stand-by for the past two years. Married, VK6SA has two junior ops and a YL. He is in charge of the wireless branch of the Perth police — making him just another of those to whom radio is both work and play. That he works hard at the "play" end is attested by the fact that, in addition to general DX contacts, he has worked some 2000 W's and is WAS on all bands except five! Even so, he is perhaps proudest of all of the 3-times-weekly regular sked with W2GTZ which has been running for about two years.

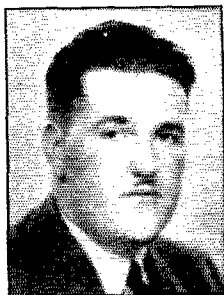

VK2HZ

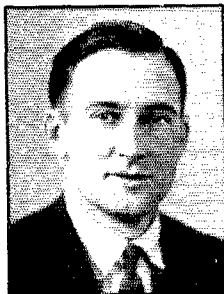

VK6SA

then popular p.p. 45's were used to WAC in two months. The transmitter these days is more civilized C.C. with 125 watts to an 830B. The W.I.A. and various radio clubs have seen him in various offices. A member of the Wireless Institute of Australia since 1928, he represented the N.S.W. Division at the 1935 Hobart Tasmania Convention and landed home as Federal President (No. 1 position in amateur affairs down under), holding this position till he retired in 1938 due to pressure of business. During his stay as Federal President, many new amateur regulations were framed, including the 50-watt power limit and full-time high-power permits for VK's. Interested also in writing on amateur affairs, quite a number of Australian radio journals have borne the brunt of his efforts. VK2HZ is fairly well-known as a station with 97 countries and WAC on 10, 20, and 40 meters to date. QSO's have been made on all bands from 5 to 250 meters. The 10-meter band has been the center of attraction; VK2HZ was one of the very first stations to contact Europe on this band, ON4AU being the earliest QSO.

S. C. Austin, VK6SA, started in radio in 1918 listening to 600-meter sigs with a crystal detector. Following some five years of commercial operating at sea between 1922 and 1928, he settled down to

Amateurs in New South Wales look to Wal Ryan, VK2TI, to show the way, either in the legislative sphere or working DX. There may

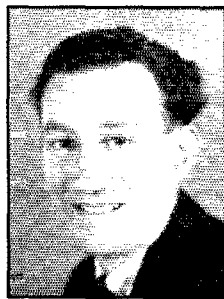

VK2TI

be other stations who have longer lists of stations worked, but 2TI's record per operating hour would take some beating. While most operating is on c.w.; 'phone is also used quite frequently. In the past twelve months Wal has ranked within the first three places for VK in B.E.R.U., D.J.D.C. and A.R.R.L. contests. Some record! As President of the Wireless Institute of Australia, New South Wales Division, following two years as Hon. Sec., he has done much to establish the Institute on a sound basis in this State. He organized the 1938 VK-ZL DX Contest commemorating Australia's 150th anniversary celebrations, held in October, 1938. An enthusiastic worker for the amateur movement — popular with all — "one of the best" — Wal Ryan, VK2TI!

HAM
SHACKS

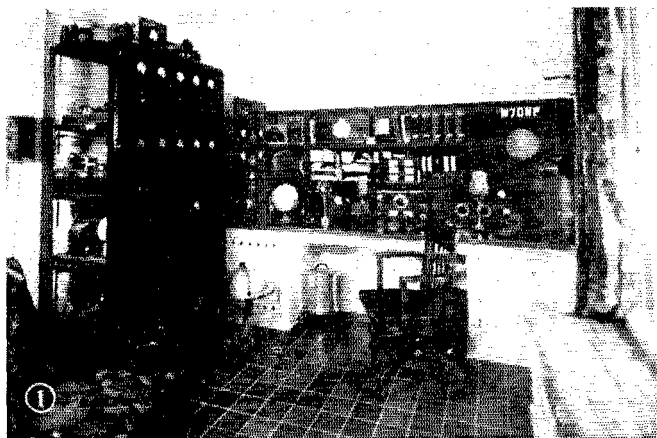

(1) W7DNP
PORTLAND, OREGON



(2) W7FDL
ROSALIA, WASHINGTON



(4) W9KEX
CEDAR RAPIDS, IOWA



(3) W8WV CLEVELAND, OHIO



(6) W3AQN, YORK, PENNA.

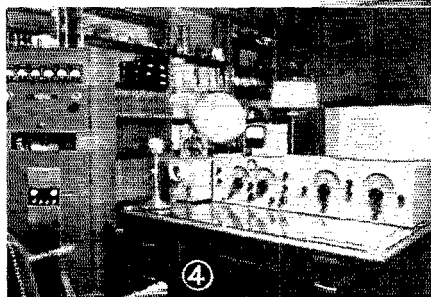

(5) G5ZJ
LETCHWORTH, ENGLAND



W7DNP

OWNED and operated by Dr. John Fitzgibbon, W7DNP will be heard most frequently in the 28-, 14- and 4-Mc. 'phone bands although the Collins 4A transmitter to the right of the HRÖ receiver and the 32B to the extreme right attest to the well-known fact that W7DNP is not a 100 per cent 'phone station. The main transmitter at the left is a home-engineered job with a T-200 in the final modulated by a pair of Class-B 03A's. Parallel 47's in the oscillator, parallel 46's in the doubler stage and an RK20 furnish the required r.f. excitation. The speech-amplifier-driver unit is a five-stage affair ending up with 46's. This transmitter is designed only for 28- and 14-Mc. work.

The smaller rig at the left of the operating position is used for 4- and 1.8-Mc. 'phone work. The S30 final driven by a 47 crystal oscillator and 841 buffer is modulated by Class-B 46's.

The shelf space above the operating table is filled with ultra-high-frequency and monitoring gear, but the thing that takes our eye is that volume of cupboard space for odds and ends which make some ham installations an eyesore.

W7FDL

C. A. LYNCH, owner, is an old-time newspaper man having been in the editorial game for something over fifty years. He now publishes the *Citizen Journal* of Rosalia. Most newspaper men we know seem to be on the job twenty-four hours a day, but "Mike," as he chooses to be called, finds time to have plenty of fun and excitement with his 200-watt Collins transmitter and RME69 receiver with DB20 preselector. He seems to have had no particular difficulty in working all continents on 'phone and while he prefers the closer personality of 'phone contacts, he can and frequently does pound brass with the best of them.

W8WV

HOYT S. SCOTT is a real old-timer having been a ham since 1910 and a member of the A.R.R.L. since its organization. He held the calls of pre-war 8LE and post-war 8JMB before he finally settled down to serious business with W8WV. His chief interest is in construction although he is active in the United States Naval Reserve, in which he holds the commission of lieutenant, and in 'phone work on 75. The operating tables which may be seen in the photograph are of his own design and construction. Besides being extremely attractive in appearance, they show thought in operating convenience. The shelves for receivers and monitoring and testing equipment leave the operating table free for action. Controls for the two transmitters, which unfortunately do not show in the photograph, are conveniently located at each side of the operating table. The

NC100 is the main station receiver. Lt. Scott has also constructed several compact units for portable and emergency work.

The low-frequency transmitter consists of a pair of 6L6's in the oscillator, pair of 211's in the buffer and push-pull 204-A's in the final, which is modulated for 'phone work by four 03A's Class B.

The high-frequency rig for 14- and 28-Mc. work has a 59 in the oscillator, pair of RK20's in the doubler stage and push-pull 852's in the final.

W9KEX

ELEN S. HAHN, signing W9KEX, is one of the relative new-comers to the game of amateur radio. Although the inauguration of the station took place only last October, she has succeeded in working stations in all parts of the world. The transmitter is a Collins 30J delivering an output of 250 watts from 1.7 to 60 Mc. The receiver is the familiar RME69 with DB20 preselector and 510X expander for the higher frequencies. The station is equipped for break-in and push-to-talk operation.

Two antennas are in use. A three-element General rotary beam is used for 14- and 28-Mc. work, while a 133-foot Collins multi-band antenna takes care of the lower frequencies.

G5ZJ

OWNED and operated by Kenneth Jowers, G5ZJ is one of the higher-powered G's. That commercial-looking rack unit at the left-center houses nothing less than a pair of 100TH's with driving and modulating equipment. Over ninety countries have been worked on two-way 'phone which goes to show what a good 'phone transmitter in the right mood can do. The equipment at the left is for speech amplification and monitoring. Two receivers are ready for use. One is a 12-tube superhet covering 28 to 1.7 Mc., while the other is designed for most effective work at the ultra-high frequencies. We seldom find the typical G without his portable gear and 5ZJ is no exception since he has built emergency gear for both low and ultra-high frequencies.

W3AQN

W3AQN is no stranger to the 3.5-Mc. traffic gang. Paul Stumpf has operated this station ever since he started back in 1922 at the age of 12. While traffic work holds his chief interest, he branches out occasionally and works a little DX or engages in rag-chewing.

The transmitter consists of the old reliable combination of 47 oscillator, 10 buffer-doubler and 242A final. He still sticks to the regenerative detector and two-stage audio amplifier he built years ago. Just tune around the 3.5-Mc. c.w. band almost any night — you can't miss him.



HINTS AND KINKS FOR THE EXPERIMENTER

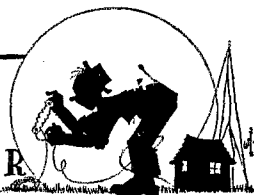

A CONVENIENT and useful application of the unique advantages of the new push-button switches may be made to the problem of measuring current and voltage in several circuits.

Since two buttons may be pressed simultaneously, two meters — two milliammeters, or a milliammeter and a voltmeter — may be used with a single switch, as shown in Fig. 1. In the arrangement shown, a milliammeter is switched to any of five circuits, while a voltmeter is used to measure any of three voltages.

Not only does a switch of this type provide automatic shorting of the current circuits when the meter is removed, so that no additional apparatus is necessary to maintain continuous circuits, but also it provides a convenient means for range multiplication of the meters used. Low-resistance shunts may be permanently connected across the external-circuit connections of any switch section, and thus will be in parallel with the meter when that section is used. In this way, the contact resistance of the switch is placed in series with the meter rather than with the usually lower-resistance shunt, and so the error introduced by the switch is materially reduced. This factor is particularly noticeable when such a meter as a 0-1 milliammeter is used with individual current-multiplier shunts, as the resistance of the meter — in the range between 20 and 100 ohms — is sufficient to make the additional resistance of two meter contacts negligible.

Similarly, series multiplier resistors may be connected in series with the voltage connections, as shown in the amplifier plate voltage section of the switch in Fig. 1. This method may be applied to the use of a single 0-1 milliammeter for current and voltage measurements, but a single meter may of course be used for only one purpose at a time.

Since the voltage applied to the switch must be held to reasonable limits, the meter connections must all be made at points no farther removed from ground than a few hundred volts. All voltmeter sections having large series multiplier resistors should be provided with a shorting connection between the contacts opposite those of the meter, to prevent a high potential existing across the switch. Plate current measurements to high-voltage stages similarly should be made at low-voltage points — either in series with the negative power supply connection, or in series with the cathode of the tube (in the latter case the indicated current is the sum of plate and grid current of the stage).

— Leonard Tulavskas, W9LKV

CURRENT VS. COLOR OF PILOT BULBS

ALTHOUGH charts giving comparisons between percentage of emitted light and bulb current have been published, such charts are of little value without some means of making light intensity measurements. For example, how is one to know the percentage of full brilliancy of a bulb when the filament has just begun to glow with a dull red color?

To provide a means of using the apparent filament colors of pilot bulbs to indicate current values, various pilot bulbs were connected in series with milliammeter

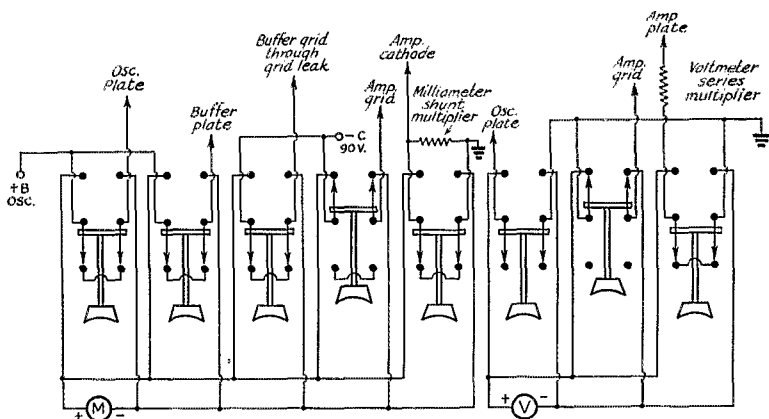

Fig. 1 — An example of push-button meter switching arrangement. The five buttons at left in this layout are used to switch the milliammeter for plate and grid currents, while the three at right are used for plate- and grid-voltage ranges.

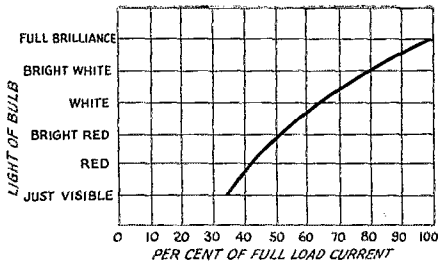

Fig. 2 — Filament colors of pilot bulbs plotted against current.

and batteries, and approximate data were taken for color-current comparisons. The results of the tests are given in Fig. 2.

It will be noted in the chart that when the filament of the bulb becomes just visible, the current is approximately $\frac{1}{3}$ full current rating of the lamp. For a No. 40 bulb this would be $\frac{1}{3}$ of 150, or approximately 50 ma. With a No. 46 bulb the current would be $\frac{1}{3}$ of 250 ma., or about 80.

When the filament of a bulb becomes white, the current is approximately $\frac{2}{3}$ full rating of the lamp — 100 ma. with No. 40, or 160 ma. with No. 46.

It is easy for the eye to distinguish between the various brilliancies from "just visible" to "white," and less easy for those between "white" and "full brilliancy," but the latter range applies only to approximately the maximum-current third of the range. The middle third of the current measuring range is accompanied by the most easily distinguished color changes in the bulb, and thus selection of the type bulb used for a definite purpose should be based on this range. When no light is visible in the bulb, the current is known to be between zero and $\frac{1}{3}$ full rating of the lamp.

— Fred Sutter, W8QBW

SIMPLE CHECKS ON GAS-DRIVEN A.C. GENERATORS

BEING in doubt about the frequency and voltage of the a.c. power generated by a 3-kw. separately excited generator with 5-horsepower single-cylinder gasoline engine, W5EGV has arrived at a simple and economical solution to these problems.

A 60-cycle electric clock was attached to the output of the generator. Frequency checks of fair accuracy were made by comparing the speed of the second hand of the clock with that of a pocket watch. By adjustment of the engine speed to give correct rate of the second hand, the clock may be made to keep fairly accurate time.

Operating the transmitter while varying the speed of the engine, it was found that the transformers operated best in the frequencies between

50 and 60 cycles, the efficiency dropping off with operation outside of this range.

It was further found that a light bulb connected across the output of the generator was a far from reliable check, since the voltage required to produce what seemed normal brilliancy of the bulb on bright sunlight days was in the neighborhood of 150 volts. Accordingly, the light bulb was replaced by a Readrite a.c. voltmeter. This instrument has been found satisfactory for the adjustments required to maintain correct output voltage of the generator.

It should be noted that if a 50-cycle clock is used to check the frequency of a generator used for 60-cycle a.c., one revolution of the second hand should be made in 50 seconds, and the clock should gain 4.8 hours in each 24-hour day.

With this inexpensive equipment for checking the operation of the generator, stable operation with regenerative and superheterodyne receivers is maintained and the 46-47-PP10's transmitter on the 14-Mc. band never needs retuning after long periods of operation or idleness.

— Dan Nightingale, W5EGV

ELIMINATION OF FILAMENT TRANSFORMER FROM NEGATIVE-PEAK OVERMODULATION INDICATOR

USE of modulated-amplifier plate current to heat the filament of the rectifier tube used in overmodulation indicators of the negative peak type, has been proposed by James Fulleylore, Port Washington, N. Y., and by George Woster, W9FHN. With this simplifying step, the apparatus required for the indicator is reduced to a single rectifier tube of low filament current requirement, and a neon-bulb or meter indicating device. An expensive filament transformer with

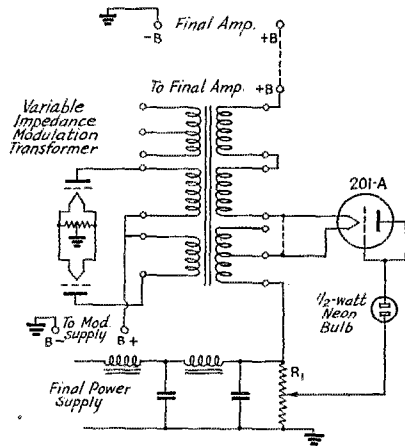

Fig. 3 — Negative-peak overmodulation indicator.

high voltage insulation is eliminated by the use of plate current for filament heating.

The circuit shown in Fig. 3 is designed to operate with high-voltage amplifiers as well as with low-voltage, high-current stages. Since the tubes suitable for use as rectifiers with the low-filament heating current available are not capable of withstanding very high inverse peak voltage, W9FHN places the rectifier filament between series sections of the secondary winding of the modulation transformer. Because this connection of the rectifier makes only a fraction of the audio output voltage available for operation of the modulation indicator, the tap on the resistor across the power supply, R_1 , must be placed a proportionate distance toward ground from the positive supply terminal to cause flashes at 100-per cent modulation. If a modulation transformer with two equal secondary windings designed for series or parallel connection is used, the rectifier filament may be connected in series with the two windings when used for high voltage modulation. With the more recent type of variable-match transformers, where separate winding portions are connected in series to form a secondary matching a desired impedance, the secondary portions should be connected in such a way as to place the rectifier filament only a few turns from the positive power-supply connection.

The voltage divider R_1 for the d.c. voltage to the indicator is made up of carbon or small wire-wound resistors, with total resistance (ohms) equal to about 1000 times the power-supply voltage, and a total power dissipation of approximately 5 watts. A simple refinement for this indicating system is a potentiometer used as a portion of the voltage divider. When calibrated with a borrowed oscilloscope, the potentiometer readily may be set to flash at any desired modulation percentage.

This system, with rectifier tube connected at center of modulation transformer secondary, has been in use several months at W9FHN on a 1500-volt modulated amplifier with entirely satisfactory results.

— . . . —

SAFETY SWITCH FOR POWER SUPPLY

AN INEXPENSIVE kink for power-supply switching which, if properly used, may save the operator from painful shocks is shown in Fig. 4. A double-pole double-throw switch is used in the position normally occupied by a single-throw single-pole switch. One pole performs the function of opening the plate transformer primary circuit, while the other pole, on the opposite throw, shorts the output terminals of the plate supply. This removes the chance of shock by condenser discharge if the bleeder circuit should be opened and, in addition, it reduces the danger of having high voltage appear in the power supply because of

accidental primary circuit closing through a path external of the switch.

Two precautions should be carefully observed in the use of this switch, however, without which it may prove a hazard rather than a safety device. First, the moving part of the section used for out-

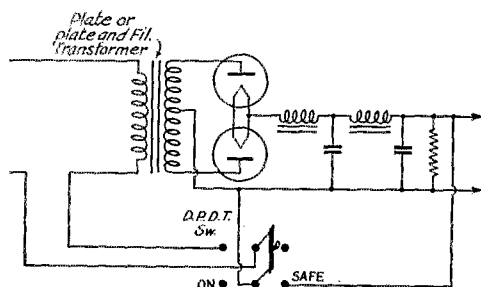

Fig. 4 — Filter discharging switch.

put shorting should be connected to the ground power supply terminal, with the stationary pole connected to the other high-voltage terminal. Second, if an open knife switch is used, the stationary pole of the shorting section should be made inaccessible to accidental contact with the operator's hand or body. The switch should preferably be enclosed completely, or should be a type which may be mounted with the "works" behind a panel or in a control box.

— Everett G. Taylor, W8NAF

Silent Keys

IT is with deep regret that we record the passing of these amateurs:

Walter Everett Best, W6JNG, Bakersfield, Calif.

Robert I. Crowell, W1BLD, Newtonville, Mass.

R. M. Dalton, W9APF, St. Mary's, Kansas
Harold D. Edenfield, W9SJV, Edgerton, Kansas

Anthony M. Malas, W2JBC, Hoboken, N. J.

Yoshihiko Mayeda, W6IED, Belmont, Calif.

Manuel Ernesto Mendoza, W6QC, ex-W6BJF, Phoenix, Ariz.

Archibald Spiller, ex-W8ACR, Cleveland, Ohio

John H. Steffen, W5GSJ, Albuquerque, N. M.

J. Wright Winn, W9AHA, Madison, Ind.

★ I. A. R. U. NEWS ★

Devoted to the interests and activities of the

INTERNATIONAL AMATEUR RADIO UNION

Headquarters Society: THE AMERICAN RADIO RELAY LEAGUE, West Hartford, Conn.

MEMBER SOCIETIES

American Radio Relay League
Asociatia Amatorilor Romani de Unde Scurte
Associazione Radiotecnica Italiana
Canadian Section A.R.R.L.
Ceskoslovenski Amatér Vysilaci
Deutscher Amateur Sende-und-Empfangs Dienst
Eesti Raadio Amatooride Uhing
Experimental Radio Society of Egypt
Experimenterende Danske Radioamatorer
Federation des Emetteurs Belges
Irish Radio Transmitters Society

日本アマチュア無線聯盟 Japan
Liga Colombiana de Radio Aficionados
Liga Mexicana de Radio Experimentadores
Magyar Rövidhullámú Amatőrök Országos Egyesülete
Nederlandsche Vereeniging voor Internationaal Radioamateurisme
Nederlandsch-Indische Vereeniging voor Internationaal Radioamateurisme
Newfoundland Amateur Radio Association
New Zealand Association of Radio Transmitters
Norsk Radio Relæ Liga

Polski Związek Krotkofalowcow
Radio Club de Cuba
Radio Club Venezolano
Radio Society of Great Britain
Rede dos Emissores Portugueses
Reseau des Emetteurs Français
Reseau Luxembourgeois des Amateurs d'Ondes Courtes
South African Radio Relay League
Suomen Radioamatööriyhdistys r.y.
Sveriges Sandareamatörer
Unión de Radiomóviles Españoles
Union Schweiz Kurzwellen Amateurs
Wireless Institute of Australia

CALENDAR

THE December Calendar of the Union customarily contains a brief report by the Headquarters on the affairs of the Union for the past year. The June Calendar carries the reports of individual member-societies.

The outstanding event of the year was of course the Cairo treaty conference, which has already been discussed in detail in *QST*. In general, the Union can claim to have successfully withstood, through its delegation, strong attacks against amateur radio on the part of powerful agencies and administrations and, with certain exceptions in the European region, to have preserved essentially all territory and privileges internationally devoted to amateur radio.

Two new societies were admitted to the Union during 1938: the *Eesti Raadio Amatooride Uhing* (E.R.A.U.), Estonia, and the *Radio Club de Cuba* (R.C.C.), Cuba. One society was deleted, when the O.V.S.V., Austria, was absorbed by the D.A.S.D. The membership of the Union is now 33. Correspondence concerning membership was carried on during the year with societies in Brazil, Lithuania and Mozambique, resulting in the formal proposal for membership of the *Liga dos Radio Emissores de Mocambique* (L.R.E.M.).

The Headquarters has continued its handling

of the normal operating activities of the Union in customary fashion. A considerable volume of correspondence with officials of member-societies has been maintained. A total of 958 WAC certificates was issued during the year.

The Headquarters proposes that the S.S.A. (Sweden) be requested to undertake the representation of the Union at the C.C.I.R. meeting at Stockholm, Sweden, in July, 1940, being charged with the duty of appointing suitable representatives and performing the duties of the Union in connection therewith. It further proposes that the task of preparing and filing appropriate technical studies prior to the meeting be delegated to the A.R.R.L., and finally proposes that the offer of A.R.R.L., to defray the participation expenses of the conference, be accepted. Although the Headquarters society has represented the Union at such affairs in the past, an Inter-American regional conference of vital importance to its own interests will be held in Santiago, Chile, at about the same time and the A.R.R.L. will not be able to provide representatives to both places.

— — — —

HERE AND THERE

THE magazine of the R.E.F., *Radio REF* has recently (January) been dressed up consid-

CNIAF, Jose Sierra, Tangier, International Zone, Africa. Temporarily closed down because of a new law prohibiting amateur radio in the Zone, CNIAF still has hopes of returning to the air.

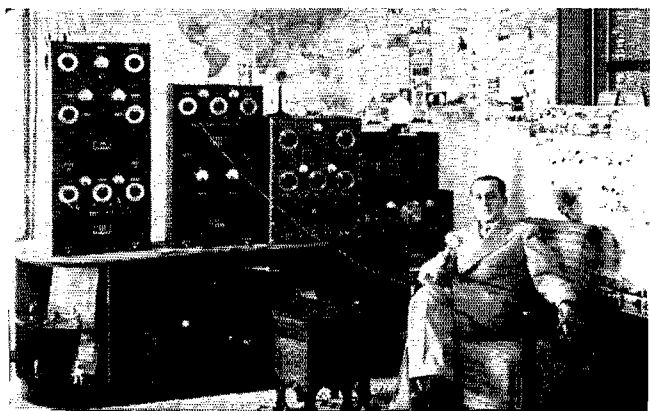

erably and is getting to be quite a sizable affair, running about 80 pages. Amateurs who can read French should enjoy it thoroughly. . . . Another interesting magazine, for readers of French, is *QSO*, the Belgian publication. For the DX-minded, ON4EY suggests a "300 Districts" club, composed of stations working 300 or more districts. By "district" they mean prefix numbers in most of the countries, suffix letters in Germany (the last letter in D calls represents the district), first letters following the numeral in LU calls (same reason), provinces in Canada, states in the United States, numbers and first letters in Brazil and first letters in Uruguay. It looks a little complicated but gives the DX-ers one more thing to shoot at. It's described in the January, 1939, issue. . . . The Experimental Division of the N.V.I.R. suggests a notation for superheterodyne receivers on QSL cards and during QSO's. For example, 1-V-s-2-V-2 means one stage preselection, first detector with separate oscillator, two i.f. stages, second detector and two stages of audio. . . . The first Egyptian radio amateur convention was held by the E.R.S.E. in Cairo on November 26, 1938, and was a marked success, attracting members from Cairo, Alexandria, Mansoura and Heliopolis, as well as two G's who were in Egypt at the time. . . . Apparently the G's are the same as the rest of us. "Uncle Tom," who writes a biting column in the *T & R Bulletin* each month and never pulls punches, suggests a "P" or "platitude" code. Instead of spelling out "GE OM Tnx fer call glad to QSO ur sigs RST 579" you would only send "P1." Some of the "P" signals are for 'phone men as, for example, P4, which means, "Good evening, old man. I suppose I've got to work you but you sound as if you're only using a 6L6 and a carbon mike. You know I only like to work 100-watt stations with Oxford accents, so cut it short and let me get on with it." P6 is also a handy one, meaning "Well, thank goodness I've made enough small talk to say QRU to you now without seeming too rude. Don't bother to call me again — I shan't hear you anyway. QSL if you like, but you'll be lucky if you get one back. Just come back with your final, but I shall have switched off, anyway, or else I'll be calling Test again." However, P6 is only for the truthful. . . .

EARTHQUAKE

SKETCHY advance reports indicate that amateur radio in Chile upheld traditional amateur standards of public service during the January earthquake tragedy.

U. S. press dispatches credited amateur radio with getting out the initial flash and first details of the catastrophe. Later, it was reported that amateurs of the country were being mobilized by the communications ministry for emergency duty. Shortly after this, all licenses for normal inter-

national amateur communication were withdrawn, apparently as part of an official censorship program designed to prevent the circularization of unauthorized bulletins and reports.

This did not mean the abandonment of amateur facilities, however, according to our information. Amateur stations and operators were presumably mobilized in the government net of portable stations sent throughout the stricken area to provide essential relief communications. The actual results of this work will probably not be known until well after the emergency phase has passed.

Change in Problem Contest Dates

TO MAKE it more convenient for the more distant contestants to meet the closing date of the series of monthly Problem Contests in *QST*, we are advancing the date on which future contests will close to the fifth of the following month. In order to make this possible, the solutions to Problem No. 24 will be published in the April issue instead of this issue. Entrants in the contest of Problem No. 25, presented in *QST* for February, will have until March fifth to submit solutions, while solutions to Problem No. 26, which appears in this issue, must arrive at *QST* not later than April fifth.

PROBLEM NO. 26

Our Hero isn't one of those poor unfortunates who have met their Waterloo across the terminals of the high-voltage supply — and he doesn't intend to be. Among other things, he has decided that he wants to do something to reduce the hazard in neutralizing his high-power amplifier. To be sure, he can turn the power off, make an adjustment, turn the power back on and check neutralization by the grid-meter method, but this takes a lot of time and it's all too easy to go into phase with the power switch so that he's "on" when the switch is "on" when a series of tests is to be made. He's looking for a gadget which he can use which will provide plenty of insulation, permit him to stand at a respectable distance from the transmitter and yet adjust neutralizing condensers. He wants something which may be adapted to all types of neutralizing condensers, whether they be vertically or horizontally mounted. He also wants to be able to check neutralization with a neon bulb and yet doesn't want to have to get his hand into the danger zone. In other words, he wants to be able to use any of the usual methods of neutralizing without endangering himself. How would you solve the problem?



CORRESPONDENCE FROM MEMBERS

The Publishers of *QST* assume no responsibility for statements made herein by correspondents. †

SAFETY

141½ Sixth St., Dover, N. H.

Editor, *QST*:

I wish to commend the timely and splendid editorial in the current issue of *QST*, and to say that I know that the majority of your readers will greatly appreciate the program of safety instruction you are about to embark upon, or rather, have already started.

As an instructor in First Aid under the American National Red Cross for the New Hampshire State Highway Department, I would like to offer one suggestion. Although the Artificial Resuscitation instructions were more than complete in the article by Mr. DeSoto, no written instructions can produce the efficiency that personal instruction can. It is quite possible that there are many in the amateur ranks who would like to receive this instruction, along with instruction in the two other vital elements of first aid, namely, serious bleeding and poisoning, who do not know that usually arrangements may easily be made to secure such instruction.

I would suggest that you call to their attention, particularly to the attention of the clubs, that it is usually possible through their local chapters of the Red Cross to arrange for classes in First Aid Instruction. These classes consist of fifteen hours of instruction as a minimum, usually divided into five three-hour sessions, although the arrangements may be made. I also know that any of the instructors would gladly lay emphasis on instruction and practice of resuscitation.

For that matter a widespread knowledge among America's amateurs of what to do when one of the three real serious things mentioned above happen would greatly enhance the excellent work that has already been done by the National Red Cross.

— Homer H. Richardson, *W1AXW*

822 Beatty Ave., Cambridge, Ohio

Editor, *QST*:

Thanks for your excellent article on resuscitation. I hope that *QST* sees fit to devote more space to safety articles.

Here's one point of improvement on the technique of administering artificial respiration as illustrated in your article. The operator should straddle only one leg of the patient, grasping the

patient's knee firmly between his own knees. This is considerably more comfortable to the operator and, more important, this method prevents the patient from sliding forward during the forward stroke of the operator. This also permits a second person to straddle the other knee of the patient in order to closely observe how, and then take over the operation without confusion. Another method is to have a second operator kneel on the floor beside the operator and go through the motions on an imaginary subject until the technique is learned, then a quick side-shift by both causes no pause in the application of respiration. By working in fifteen minute shifts this can be kept up for hours. . . .

— Thomas B. Hedges, *N8BKE-WPHT*

Chicago, Ill.

Editor, *QST*:

. . . This February issue didn't just ring the bell. It sounded a clarion call to amateurs throughout the world — that *safety* is the keynote to a continuation of the pleasure and fun to be derived from operating an amateur station. I believe that the letter incorporated in the February editorial is the most potent spokesman for safety in transmitters I have ever seen. And the explanation of the death-dealing speech amplifier responsible for the listing of W9VYU under "Silent Keys" is something that every amateur should give his most careful attention.

The history of amateur radio is full of such tragedy, but from these tragic episodes we who live should benefit in taking to heart the cause and effect of a lesson learned only when some fellow amateur pays the price of life itself, or of permanent injury. *QST* and the A.R.R.L. cannot be too highly commended for its plans for a safety program. But the success or failure of that program rests solely with the amateurs, and whether or not they support it by spreading the gospel of all types of safety in equipment — and then taking steps to see that individual equipment is subjected to a safety treatment.

Safety in equipment can best be built on one basic principle; clean workmanship coupled with intelligent placing of power equipment, with proper caution applied to the use of adequate insulation, and then elimination of all exposed points of wiring which carry high voltage. . . .

(Continued on page 122)



OPERATING NEWS



F. E. HANDY, WIBDI, Communications Mgr.

E. L. BATTEY, WIUE, Asst. Communications Mgr.

ARL Check. To start a fixed text message, the originator must select one of the texts from a list. The amateur starting the message sends the *number* corresponding to that particular text instead of the text. The letters ARL (short for American-Radio-Relay-League-numbered-text-to-follow) must be placed before the figures of the check to show that the text is from our particular numbered text list. "ARL" identifies this at once as a message that has to be expanded for delivery or relaying to a station that has no list (to have complete understanding and avoid error). In radio handling the number must always be spelled out, for accuracy.

The new list of "A.R.R.L. Numbered Radiograms" has been mailed to every member of the League's Emergency Corps, and to every O.R.S., O.P.S., and field organization official. The list of fixed texts was prepared mainly with possible emergency needs and utility in mind; it is a special tool for special occasions. It may be used *only* when stations at each end of a QSO are equipped with exactly similar lists. Extra precautions to insure accuracy are necessary when using a number for a text; every message delivered or relayed to a station not having a list must be completely expanded.

The new list of sixty texts will be sent free of charge to anyone requesting it by sending a radiogram asking for it. We want the list to be available to anyone active in amateur traffic handling or likely to have a use for it. We shall continue to recommend the use of *individually worded messages* instead of any stereotyped form in every case possible. "Numbered texts" are here; use with caution, only with other operators with experience and similar lists. But all stations might well keep a copy of the new list ready *in the station log*.

Example: NR1 W1AW CK ARL1 Newington Conn March 2 (Address) BT THREE BT John AR

ARL? can readily be understood to mean, "Do you have the list of A.R.R.L.-Numbered Radiograms, and are you ready for such a message," ARL (reply) then means, "I have the A.R.R.L.-Numbered Radiogram list. I am ready for such a message." A list of the texts applicable to possible relief-emergency uses follows:

- | | |
|-------|---|
| ONE | All safe. Do not be concerned about disaster reports. |
| TWO | Coming home as soon as possible. |
| THREE | Am perfectly all right. Don't worry. |
| FOUR | Everyone safe here. Only slight property damage. |

- FIVE
- SIX
- *SEVEN
- EIGHT
- NINE
- TEN

ELEVEN

- *TWELVE
- *THIRTEEN
- *FOURTEEN

- *FIFTEEN
- *SIXTEEN
- *SEVENTEEN
- *EIGHTEEN

All well here. Love to folks. Everyone safe, writing soon. Reply by amateur radio. All safe, writing soon, love. Come home at once. Will be home as soon as conditions permit. Cannot get home. Am perfectly all right. Will be home as soon as conditions permit. Are you safe? Anxious to hear from you. IS safe? Anxious to hear. Anxious to know if everything is OK. Please advise. Advise at once if you need help. Please advise your condition. Kindly get in touch with us. Please contact me as soon as possible (at).

Never forget to put "ARL" in the check — or the delivering station will deliver a "number" instead of the words it stands for. From the table we see that the text in the example must be completely written out as AM PERFECTLY ALL RIGHT. DON'T WORRY. when it is delivered, or transmitted to any station without a list, or that cannot make affirmative response to "ARL?"

A.R.R.L.'s Eleventh International DX Competition marks the beginning of a new decade in these glorious opportunities. The announcement (February *QST*) is a far cry from that in March 1927 *QST*, but we haven't the slightest doubt that it will keep the early promises to "smash previous records" if you give it half a chance. It's still a lot of fun! The *multiplier* and other refinements had not been invented in those earlier days. Scores in October 1927 *QST* were picayune. Less than 200 operators reported. The point in those days was to prove which station was best for work with a *given country*, still interesting provided anyone today wanted to stop hunting countries long enough to "specialize" on one country. Our baby has grown up, developed megalomania, required a quota system, and simplified "exchanges" in place of messages.

The winner of certificates today is the man with the best score for his locality, the principle being recognized clearly that no true comparisons can be made between stations working under widely different geographic circumstances. Our League aim also, is not to create in amateur radio certain selected individuals set up as "tin gods" because of combined operating ability and location, but rather to properly recognize all ability shown with its qualifying location. The way the

* Not to be solicited in emergency. * Not to be handled in first stages of emergency. (In the Ohio flood, refugees were moved about so such traffic could not be delivered.)

man "played the game" is what counts, along with the fun and his score, to judge from things that get around.

There's a big annual turnover in who gets the certificates as winners! Two thirds fail to hang on to the prize two consecutive years, according to the report of our statistician, while 90 percent fall by the wayside in three years time! If we were to bet (he who gambles will lose) we think the '37-'38 winners (*) in the 1938 honor list are worthy of odds if they enter. Look them over:

W1AVJ	W3PC*	W5YJ*	W7FUL	W9GPS*
W1DFQ	W4AH*	W6AHZ	W8BTI	W9FLM*
W1EWD*	W4AJX	W6AJD	W8JMP	W9RXL
W1EZ*	W4CBY*	W6CXW*	W8KVI	W9UBB
W1KIV	W4CDE	W6DTB	W8LEC*	W9USH
W1TW	W4DCK*	W6GCX*	W8LUQ	
W1ZB	W4ELQ*	W6GPB	W9AEH	VE1CO
W2DC	W4FEH	W6KUT*	W9AJA	VE2EW
W2JME	W5ASG	W6LCJ	W9ARL*	VE3QD
W2UK*	W5DN	W6MVQ	W9RBS	VE4GD
W3BEN	W5DNV	W6NGD	W9DWU	VE4JV*
W3BES	W5HAG	W7BYW	W9HFI	VE4RO*
W3EMM	W5KC	W7AMX*	W9LOJ	VE5QP*
	W5VV*	W7EOI	W9NNZ*	

This year our contest does without the low frequency bands, avoiding possible conflict in case it should be necessary for the F.C.C. to invoke the emergency regulations with respect to these bands for just a certain part of the country. From the standpoint that certain frequencies are best for certain distances there is common sense always in using the best suited frequencies for international work in a DX Contest, and not attempting to "stunt" by using those too low, or too high, for consistent signal strength. More WAC's and "new countries" may be got by using the reliable 10-20-40 combination at any time. Many annually find fun and profit in taking part from the *operating sport* angle; each QSO brings pleasure and the score doesn't have to be of box car size. It's QST news if you take part even if you don't aim at top honors, so let's hear what you do in the annual DX scramble, everyone.

— F. E. H.

Major Tragedy

The editor of the Northern Alberta Radio Club's "Ham News" found himself in a real dilemma when, on the eve of the SS Contest, the "eth" mythteriously dithappeared from hith typewriter." CQ Eth Eth!

QMF

To complete the QMH, QML series for indicating where a fellow is going to start listening following a CQ, W9FA and W5GNF suggest "QMF," to mean "Will listen on my own frequency," or, "Will tune in the vicinity of my frequency, plus or minus 50-kc." A good ideal!

VE2EE, Verdun, P. Q., has been maintaining schedules with LDUC, the Lincoln-Ellsworth Expedition, keeping VE2IC in touch with his wife in Montreal.

CONTEST WARNING

The amateur bands offer an inviting prospect to F.C.C. Monitoring Station equipment (as if the F.C.C. needed invitation), especially at the time of the DX Competition. Much checking will occur in both periods. Besides this a larger number of Official Observers are on the job with 100-kc. standards this year. Two members of the Headquarters staff will be operating frequency checking equipment, with reliable checks on a reference standard, and precise General Radio equipment, as a supplementary part of the O.O. lineup. The policy of disqualifications, for either careless or intentional off-frequency operation, will be followed firmly as in the past.

PRIZES FOR BEST ARTICLE

The article by Mr. L. R. Mitchell, W1HIL* wins the C.D. article contest prize this month. Each month we print the most interesting and valuable article received marked "for the C.D. contest." Contributions may be on any phase of amateur operating or communication activity (DX, 'phone, traffic, rag-chewing, clubs, fraternalism, etc.) which adds constructively to amateur organization work. Prize winners may select a 1938 bound *Handbook, QST*, Binder and League Emblem, six logs, eight pads radiogram blanks, DX Map and three pads or any other combination of A.R.R.L. supplies of equivalent value. Try your luck. Send your contribution to-day!

Mumblings of a 'Phone Ham

BY L. R. MITCHELL, W1HIL*

DURING the past few weeks I have been spending a lot of time tuning over the 'phone bands looking for 'phone stations which might be considered as possible candidates for the Official Phone Station appointment. I have been very much surprised to find how many 'phone stations operate exactly opposite of the good operating conditions and practices as set forth for and followed by most of the stations now holding the OPS appointment.

It was most surprising to find that the stations operating in the Class A bands were by far the worst offenders in regard to frequency modulation audio side bands, over modulation, disregard for operating rights of others, monopolization of certain frequencies by certain stations, tuning up of rigs for as long a period as 35 minutes during peak operating hours, even playing phonograph records as short a time ago as Christmas week, in spite of recent FCC rulings. At least 15 per cent of the stations have such a high hum level and audio quality is so poor that their effective voice range is greatly reduced. Then we have the "Hello test" and the long-winded CQ artist helping to make QRM much worse on the crowded 'phone bands. The quality of the signal put out by some stations operating in the Class A 'phone bands would make the average 160-meter 'phone man give up in despair and go back on c.w., where many of these Class A 'phones should go until they can improve their rigs and operating practices. Class A operators are supposed to be tops in mechanical knowledge and operating ability because of years of experience. Many fall far short of this classification.

If the small percentage of 'phones operating with poor mechanical equipment were the only ones to attract our attention, things would not be so bad because in time the F.C.C. would get them and force them to clear up the mechanical troubles. However, we have many operators, on all 'phone bands, who remind me of many auto drivers who are fine people till they get behind the wheel of a car and they then become first-class road hogs. The same thing applies to 'phone operators. Many are fine people in person, but let them get behind a mike and they become road hogs of the air, doing exactly what they want to do with no regard for the rights or wishes of others. Sometimes I think that some operators have no way of tuning over their own frequency before throwing a carrier on the air! When there is a strong signal on your own frequency, why try to get through on that frequency? Why not change or wait, rather than jam up the other fellow's QSO's. In these days of cheap xtals and good e.c.c.'s, it is certainly easy to change frequency and, after all, we operate mostly for fun, so even if one cannot shift frequency certainly we can wait. Many operators seem to need a little education and an injection of a little common sense and a dose of the Amateur Code. It

* Phone Activities Manager, Eastern Mass., 51-A North Ave., Melrose, Mass.

seems to me that some form of education is the only answer to this matter of operator trouble.

It is not necessary to have a lot of high-priced equipment to have good audio quality for example. Some of the highest quality stations on the air use nothing more than a single-button carbon mike and low-gain audio equipment. Here again the matter of common sense comes into play. Every-one operating 'phone should construct a simple diode monitor and modulation indicator, and check every time they go on the air for intelligibility and intelligence of operation! In other words, check both the mechanical equipment and the operator. Take some pride in your signals and operating.

I would suggest that everyone operating on 'phone should memorize the amateur's code and faithfully follow same during the course of operations on the air.

There is a little booklet called "Operating an Amateur Radio Station" published by the A.R.R.L. Communications Department which contains some very good advice. Most A.R.R.L. members, at least, have this booklet though, I feel, many fail to read and follow same. I wish that every 'phone operator would read this fine booklet, and the 'phone men in particular should read and follow the information to be found in the section under the heading of the Official Phone Station appointment. Let's see how we can follow some of the suggestions and remove the air hog from the picture.

"... ham who takes pride in the manner of signal he puts on the air." Certainly many of the signals on the air are nothing of which to be proud. "... live up to the Amateurs code of good fraternalism and operating equality." Stop and think, gang, how many of us do think of the other fellow even 20 per cent of the time? "... avoid frequency modulation and over modulation." How many more fine QSO's could be enjoyed by all of us if this simple yet all-important matter were only followed 100 per cent? "... cooperate with each other and with all amateurs, regardless of power or frequency." How many of us are willing to cooperate with the other fellow if it keeps us from doing what we want to do? "Adjustments—outside operating hours." How many times have you heard some one throw on a carrier with no modulation or send V's on the 'phone bands for hours? Could anything be more selfish? *Use a dummy antenna!* "... Make the operation of your station an example to be looked up to by other amateurs." "Observe frequency bands. Comply with F.C.C. regulations." "Adopt and further common sense effecting voice operating procedure." If only many hams now operating on the 'phone bands would follow the above! What a great improvement it would make in every way and what a *much higher opinion* the average RCL would have of the average 'phone operator! "... This appointment is for every live-wire operator of a first-class 'phone working any 'phone band." Even though a 'phone operator does not wish to belong to the A.R.R.L. or hold the OPS appointment still it would benefit him and amateur radio as a whole if he would read, learn and follow the *aims* of Official Phone Stations. If this were done it would help to clear up a very bad condition now existing in the 'phone bands.

I would like to have all 'phone men, who are interested in cleaning up and improving the 'phone band, get this above mentioned operating booklet, read and learn and follow the material they find there, if possible become Official Phone Stations and *set the pace* for proper 'phone operation. It would surprise everyone to find how quickly many of the worst offenders would see errors in technique, and the way to improvement and become better operators. Let's go, gang, and improve the operating in the 'phone bands.

This station works on 'phone 100 per cent and holds Class A ticket, O.P.S., P.A.M. and A.A.R.S. appointments so we feel free to write as we do since much of it may apply to myself and none of it is personal but all for the good of hams in general and 'phone operators in particular. Think it over, fellows, and do something!!

Speaking of coincidences, W8KF called CQ on 3.9-Mc. 'phone and was answered on the same frequency by W8KB, who was QRM'd by W8KG calling CQ. KG was hailed and a three-way was soon in progress.

WIAW Operating Schedule

OPERATING-VISITING HOURS:

3:00 P.M. — 3:00 A.M. E.S.T. daily except Sat. and Sun.
Saturday — 8:30 P.M. — 2:30 A.M. E.S.T.
Sunday — 7:00 P.M. — 1:00 A.M. E.S.T.

OFFICIAL BROADCAST SCHEDULE (for sending additional information to all radio amateurs):

Frequencies

C.W.: 1760-3800-7150-14,254 kc. (simultaneously)

Starting Times (P.M.)		Speeds (W.P.M.)								
E.S.T.	C.S.T.	M.S.T.	P.S.T.	M	T	W	Th	Fri	Sat	Sun
8:30	7:30	6:30	5:30	20	15	25	15	20	—	20
Midnight	11:00	10:00	9:30	15	25	15	20	15	15	—

'Phone: 1808, 3950, 14,240 kcs.

Each code transmission will be followed in turn by voice transmission on each of the above frequencies.

GENERAL OPERATION:

WIAW devotes the following periods of the 3 P.M.—3 A.M. EST operating day, except for days starting Saturday and Sunday, to GENERAL¹ work with all amateurs in the following bands:

Band	Frequency	Time—Eastern Standard
1.8 Mc.	1808-1760-kc. 'phone/c.w.	11:00-11:59 P.M.
3.5 Mc.	*3800-kc. c.w.	1:30- 2:00 A.M. ² 8:00- 8:30 P.M.
3.9 Mc.	3950-kc. 'phone	9:30-10:00 P.M. 1:00- 1:30 A.M. ²
7 Mc.	*7150-kc. c.w.	2:00- 3:00 A.M. ²
14 Mc.	*14,254-kc. c.w.	6:30- 7:00 P.M.
14 Mc.	14,240-kc. 'phone	10:30-11:00 P.M. 6:00- 6:30 P.M. 10:00-10:30 P.M.

On Saturdays WIAW is operated from 8:30 P.M. to 2:30 A.M. E.S.T., and on Sundays from 7:00 P.M. to 1:00 A.M. E.S.T. On these days operation will be devoted to the most profitable use of bands for general contacts and to participation in special week-end operating activities and contests. The station is not operated on legal national holidays.

¹ Between 7 P.M. E.S.T., March 3rd, and 7 P.M., March 12th, the General Operation periods will be cancelled to permit the operators time for essential Frequency Measurement and monitoring work during the DX Competition. Scheduled daily transmission of Official and Special Messages to amateurs, and scheduled connections with A.R.R.L. Trunk Lines for moving traffic will be maintained, however.

Between 7 P.M. E.S.T., March 17th, and 7 P.M., March 26th, O.B.S. and traffic schedules will be observed, and the parts of the General Operation Schedule marked (*) will be resumed, in addition. There will be *full resumption* of all the above schedule between 7 P.M. E.S.T., March 12th, and 7 P.M., March 15th, and daily following 7 P.M., March 26th. The operation starting on Thursday, March 16th, and Friday, March 17th, will be as indicated, but only 7 P.M. and 1 A.M. of the following days respectively.

² Daily except Sun. and Mon.

New Certificate for All-VE Work

The VE Operators' Association is dedicated to the interests of Canadian amateur operators and publishes a fine printed magazine, "XTAL." The society is offering a new WAVE (or "worked all VE") Certificate, which will be of interest to all United States amateurs.

(1) The applicant shall submit proof of contact with two different stations in each province, contacts being on different bands (total of 18 confirmations). Yukon Territory and Northwest Territories shall be considered as part of British Columbia. (2) All contacts, for which the award is claimed, shall be made on or after January 1, 1939. (3) Applicants residing in territory designated by the prefix VE or W shall make all contacts from within one province or state. (4) The sum of twenty-five cents shall be forwarded with application, to defray costs and return postage on cards. The fee shall be waived if the applicant is a member of the VE Operators' Association. (Address: 106 Jarvis St., Toronto, Ontario.)

Check Your Harmonics

Considerable difficulty from 1.75-Mc. 'phone harmonics is being encountered by c.w. operators in the 3.5-Mc. band. The situation is becoming so serious as to actually interfere with the operation of traffic and other operator-training nets, in some cases forcing nets to cease operations. "160 meter" operators are requested to check the adjustment of their rigs to insure that they have a minimum of harmonic radiation.

The attention of 3.9-Mc. 'phone operators is called to a communication from station CFCY/VE9EH, Charlottetown, P. E. I. VE1GH, operator of that station, writes, "I would like to advise all amateurs in the 1st, 2nd and 3rd districts of the United States to watch radiation of their second harmonics on frequencies of press signals which we copy here at CFCY. We use a directional receiving antenna and even weak harmonics cause us intolerable inconvenience at times, particularly in the early evening."

Airways and Telephone Company representatives report continued cases of interference from amateur harmonics. All amateurs are urged to check for harmonics of improper amplitude from their transmitters, especially in these out-of-band regions: (160) 3430-3500 kc., 5145-6000 kc., 6860-8000 kc., (80) 7300-8000 kc., 10,500-12,000 kc., 14,400-16,000 kc., (40) 14,400-14,600 kc.

2 1/2 Meters

112-Mc. work is beginning to pick up according to reports from W1IJ, W2HNY and W2JBO. More activity is urged on that band, in order to ascertain its full capabilities. On January 31 W1IJ (56-Mc.), Madison, Conn., and W2HNY (112-Mc.), Riverhead, N. Y., a distance of 28 miles, established a successful cross-band contact. W2HNY used an RK-34 resonant line oscillator, tone modulated, with seven watts input. The antenna was a vertical director, antenna, reflector located in the attic, about twenty feet above ground and forty-five feet above sea level. Two-hundred foot cliffs on the Long Island shore prohibit line of sight. W1IJ reported W2HNY's signals S3/4. These operators request schedules with any of the gang in Connecticut or on Long Island. W2JBO, Bronx, N. Y., is now using 112-Mc. and has made two successful contacts, one with W2JRG, Tuckahoe, N. Y. (about 8 miles away), the other with W2JTF, who was working portable-mobile. Constant contact was maintained with W2JTF until he reached Fort Tryon Park, N. Y. C., when a solid QSO of an hour's duration was held. Additional reports on 112-Mc. results will be appreciated.

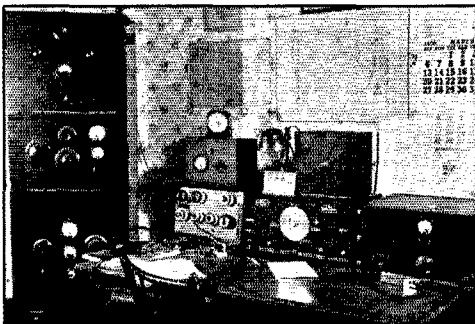

W8AQ, O.R.S./O.P.S., Wadsworth, Ohio

Station of "Ev" H. Gibbs, Ohio Section Communications Manager. "Ev" expects to make a business trip to Europe starting some time in February, to be gone two or three months. He will visit England, France and Poland, and hopes to be able to make some sort of ham contacts with the States from those countries. During his absence W8KNF, O.P.S., will carry on as Acting S.C.M.

Brass Pounders' League

(December 16th-January 15th)

Call	Orig.	Del.	Rel.	Extra Del. Credit	Total
W4PL	31	73	2084	58	2246
W7DUE	0	0	2234	0	2234
W7EBQ	0	0	2156	0	2156
W6FWJ	400	702	20	698	1820
W4TR	56	250	1180	222	1708
W9ZDZ	15	54	1405	50	1524
W6IOX	37	64	1338	63	1502
W4BAQ	21	60	1280	58	1419
W5FDR	158	264	798	187	1407
W8QAN	44	45	1086	152	1327
W2BCX	26	32	1204	0	1262
W3QP	262	469	0	469	1200
W1NUJ	39	78	919	0	1036
W5EOE	24	48	804	34	1010
W5MN	160	157	542	146	1005
W3CIZ	36	84	716	84	920
W2JHB	15	135	630	122	902
W4FX	12	125	682	20	839
W5CEZ	36	159	570	14	789
W2CKG**	156	173	206	206	779
W1H8X	26	19	714	10	769
W9NPL	18	64	610	44	736
W5FRE	24	24	660	17	725
W8BTV	12	41	622	30	705
W5BN	245	44	198	198	688
W3BWT	73	65	496	52	686
W4ETX	259	207	0	200	666
W9ZQW	15	40	566	40	661
W2GVZ	37	164	290	161	652
W818K	4	17	600	15	636
W8DNX	1	27	563	20	611
W8NCS	22	146	360	32	610
W8QGD*	69	108	261	68	606
W2BCX*	8	10	576	0	594
W3GTS	183	67	254	67	571
W8LUV	41	4	518	0	563
W8JTT	14	23	504	16	557
W7WJ	0	0	555	0	555
W5GPV	86	72	332	58	548
W6CZO	10	165	208	161	544
W9EKK	19	31	486	0	536
W9PYF	19	71	406	40	536
W2CGG	52	67	362	27	519
W3ECP	31	57	386	42	516
W4CXY	12	14	488	0	514
W8KWA	16	39	422	30	507
W9ESA	58	193	124	125	500

MORE-THAN-ONE-OPERATOR STATIONS

Call	Orig.	Del.	Rel.	Extra Del. Credit	Total
KA1HR	3033	1608	1064	0	5705
W5OW	385	313	3110	221	4029
W3CXL	9	30	1306	15	1360
W9BNT	60	100	963	27	1150
W7CCF	27	32	700	18	777
W1GQJ	55	101	525	68	749
K5AA	576	90	6	57	729

These stations "make" the B.P.L. with total of 500 or over. One hundred deliveries+ Ex. Del. Credits also rate B.P.L. standing. The following one-operator stations make the B.P.L. on deliveries. Deliveries count.

W7APS, 320	W9ZFC, 154	VE38G, 112
W1JH, 284	W6ZT, 152	W5FSK, 108
W1JSM, 275	W9UHQ, 146	W1KZT, 104
W6LUJ, 215	W6OQH, 142	W2HCO, 103
W3EML, 212	W8ASW, 128	W4DXH, 103
W8QGD, 200	W9YPL, 128	W1KIN, 101
W1GTN, 187	W9EDQ, 127	W2KMI, 101
W1UCK, 177	W1KH, 126	W3AOC, 101
W8JQE, 174	W2KXF, 124	W3BGD, 101
W7CZY, 169	W4ABS, 124	More-than-one-opr.
W2JZC, 165	W9QG, 123	W1AW, 170
W5DWN, 162	W9LCT, 117	

A.A.R.S.

Call	Orig.	Del.	Rel.	Extra Del. Credit	Total
WLMI (W6GXM)	42	70	492	68	672

MORE-THAN-ONE-OPERATOR STATIONS

Call	Orig.	Del.	Rel.	Extra Del. Credit	Total
WLM (W3CXL)	294	304	6241	274	7113

WLMI (W6GXM)*, WLNW (W2DBQ)* and WLHL (W9QG) made the B.P.L. on 224, 220 and 126 deliveries respectively.

A total of 500 or more, or 100 deliveries Ex. D. Cr. will put you in line for a place in the B.P.L.

* November-December.

** All traffic handled on radiophone.

How's DX?

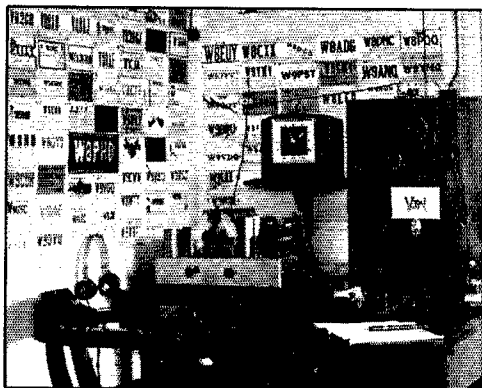

VQ8AI, Vacaos, Mauritius

Although low-powered, this station of Raoul Thomas is well known to DX operators throughout the world. The transmitter is a single 6L6 Tri tet running at 18 watts input, and the receiver is a modified all-wave job.

HOW:

FOR a number of years the Los-Angeles-and-vice-nity DX merchants have tried in vain to top the DX Contest scores of the eastern big guns. Many are of the opinion that the easy multipliers picked up on 80 in the east were responsible for the difference and constitute an advantage for the east that is impossible to overcome from any other part of the country. However, the 160- and 80-meter bands have been eliminated from this year's Contest, and now the odds are so indefinite that several handicappers and bookies we know are refusing all bets on the annual event. But you know we wouldn't think of letting you down, so here's the way we pick 'em in the coming classic, barring scratches before post time, emergencies, and a war or two:

W2UK — An even-money choice to repeat and become the first three-time-high man of the event. A strong finisher, not bothered by a muddy track.

W6GRL — Impossible to overlook the strong showing the W6's will make this year, and we pick GRL as the biggest threat, followed closely by

W6CXW — Smart, clean operating makes Henry a tough one to beat.

W3EMM — Sure to finish close to the top. Virginia can well be proud of her son.

We slow up when we get down to here, but we advise you not to overlook such consistent performers as W9ARL, W2BHW, W4CBBY, W6CUH, W3EVT and W3PC, all of whom we put in the "long shot" class.

WHERE:

ONE of the favorite imaginary locations for phoneys has long been Clipperton Island, the French island 1500 miles south of San Diego. Well, ex-W7PX just returned from there and says that no one lives there, and that the same is true of Cocos. HC2FM is the only station on Galapagos, but only works HCG on 7-Mc. sked Don't get too excited about LZ1AA. G2IO says they hear his 56-Mc. harmonic over there There is still that doubt about XU4XA. He doesn't sound right to a lot of the boys, and W9TJ gets him better on his European beam. On the other hand, some of the XU's have told W's that he's

OK. So? W8DHN/4 worked EA9I (7185 T9), who gave his address as Jose Ortez, Box 25, Ifni, Ifni. It's a honey if OK W9HQH grabbed himself a sweet one when he worked F5MSE on 40 last November. Undercover, he was at Fort Gouraud in the portion of French West Africa called "Mauritania" Don't pass up VU7BR (14,340 T9) for just another VU. He (ex-G5TB) has the first license in Bahrein Island (V88), and is on around 14-15 GMT. No, we don't know why he doesn't sign V88, but it probably has something to do with politics, if you're that interested ST6KR is the only station in Sudan now, ST2CM having gone to SU W2BHW worked someone signing OB2SK (14,360 T9). The fellow said he was reverting to his old call (his present one is VS5AC) because he was operating in North Borneo instead of Sarawak. Oh, sure, but with a bit of salt, please There are no licensed amateurs in the Faroes, if at all W1EH says HP1A gets on c.w. Wednesday nights on 14,335, and sometimes 14,060. He uses 'phone at random times on the lower frequency On the other hand, HP1X is also in Panama but very, very much undercover, and cards should go only to W8DOD, for forwarding. The situation in Panama is such that probably no one but HP1A will ever get a ham ticket down there GI6YM has the dope on the VQ5's. VQ5ELD (14,050) is on c.w. only, but VQ5EJT is on both 'phone and c.w., on 14,050 and 14,140. VQ5KLB is inactive at present. All can be QSL'd care of the Post Office, Entebbe, Uganda. The VQ5AB worked by W1WV was very much a phoney, and the only guy he fooled was the fellow who told us about it, and that wasn't W1WV VK3MR, in his DX column in "Amateur Radio," the VK magazine, voices the opinion that F08AA, YJ1AA and ZK1AB were all phoney — probably all the same fellow, somewhere in VK2 W6PCP got the QTH of ZC3A (7250 T9) as Rene Pelletier, London, North West Point, Christmas Island EA7AV (14,450 T7) says to QSL via the R.E.P. (Portugal), as does EA6BA (7315 T8c), worked by W8JSU W1WV and W2GVZ both forward letters from ZB2A which state that ZB2A's W contacts were with only W2KLL, W1WV, W1FH and W2GT B2LCB is aboard a boat between Argentina and the States, according to W2KAM W6POX hears KD6QLS (7025) around 1 A.M., but weak HB9J says TA1AA gives his address as: Policaj Turk, Ancara, Turkey.

WHEN:

THE 1750-ke. band has been good, as a glance at the separate item on it somewhere among these pages will reveal. And 80 has been no slouch. Best bit we've heard of was W6CMN's reception of PA0AX and an unidentified G, around 11 P.M. W8KWA worked G6RB (3625 T9) and heard HB9W. W81ZJ heard ZL4RY. W1FXB worked

H. H. Prince Mohamed Abd El-Moneim, SU1AM

Patron and Honorary President of the E.R.S.E., SU1AM is a reliable Egyptian contact on 10 and 20 'phone, and was the African end of the recent All-Continent Round Table.





WHENEVER we learn of a way to improve one of our products, we like to incorporate the change in production units as rapidly as possible. Frequently it is not practical to change already released advertisements or printed catalogs so that they do not in their description of the product, conflict with the item itself in its revised form and thus cause a certain amount of confusion.

For instance, in our catalog this year we specified the type 80 rectifier tube in connection with our new type CRR oscilloscope. When these oscilloscopes were put in production, we found that it was more desirable to use the 6X5 rectifier, rather than the 80. Consequently we did so. Still another instance is our TMS condenser — in the original advertisement and catalog listing we showed the condenser as having a long threaded bushing as part of the front bearing assembly. In making these condensers, however, someone showed us that they could be improved by omitting this bushing. Consequently, we did so.

We have been taken to task by a few of our customers on the two above mentioned improvements that we made in production. We mention this now with the hope of forestalling any misunderstanding in connection with an improvement program that we at present have under way for all of our transmitting condensers.

We are in the process of increasing, wherever desirable, the thickness of the plates. This brings up several complications, as the air-gap has to be slightly decreased or else the overall length of the condenser increased. In the case where the overall length is increased, the picture is complicated for the person who has laid out a transmitter around previously published specifications of overall length. On the other hand, a decrease in the air-gap in some models means a slight decrease in breakdown voltage, and thus, too, a deviation from previously published specifications. This latter condition, however, is not necessarily universally true. In many of the condensers, increasing the plate thickness and decreasing the air-gap by a corresponding amount actually raises the breakdown voltage. This, of course, takes place largely in the models with the longer air-gaps.

Changing the air-gap also affects the total capacity and, again, changes the past published specifications. This latter matter of total maximum capacity of condensers, both transmitting and receiving, opens up still another problem. It has been customary to classify and list condensers by maximum capacity in round numbers; thus we refer frequently to a condenser as being "100 mmf.". Actually, such is seldom the case in practice. Using a round number of plates, the capacity is more likely to be anything but 100 mmf. If, on the other hand, the plates are originally designed to have such an area and the air-gap is so selected that the 100 mmf. condenser actually has a total maximum capacity of 100 mmf., then think of what is likely to happen with the 50 mmf., the 75 mmf. or the 150 mmf., or any of the other such values. . . . All of which means that where possible we add an extra plate and run the capacity somewhat over the rated value. There are times, however, when it is more practical, and we feel more desirable from the users point of view, to fall just short of the rated capacity than to run far too much over.

JAMES MILLEN



**"Premium" Quality Without
"Premium" Price**

P. R. MALLORY & CO. Inc.
MALLORY
Transmitting
Condensers

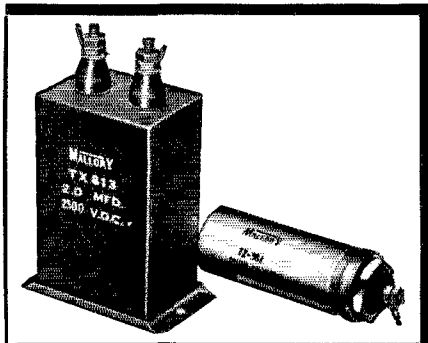

**with Exclusive Impregnating
Compound that Gives Longer
Life—Greater Dependability**

It is false economy to use cheap transmitting condensers in your rig—their failure can result in damage to expensive power supply equipment. Use long-life Mallyory Transmitting Condensers, for dependable service—they cost no more. Both the TX and the TZ types are ideal for radio transmitter and high-power amplifier applications.

Both condensers are impregnated with exclusive Mallyory Compound. It is not a wax and is unlike any special or standard impregnating oil now offered. It positively contains no chlorine, either in free or combined form. High dielectric constant and unusual heat resistance assures that condensers impregnated with Mallyory Compound afford the best power factor and extremely stable DC resistance. See your distributor now for both TX and TZ Mallyory Transmitting Condensers.

P. R. MALLORY & CO., Inc.
INDIANAPOLIS INDIANA
Cable Address—PELMALLO

Use
P. R. MALLORY & CO. Inc.
MALLORY
APPROVED RADIO
PRECISION PRODUCTS

Use
YAXLEY
APPROVED RADIO
PRECISION PRODUCTS

HB9W (3560 T9) and heard ON4HC (3515 T9), and W1HYG worked G6WV, ON4HC and ON4JB. W8RXG worked F3NZ. ON4HC was VE3IG's 10th country on 80. W6DIX and W6POX both worked ZL's.

It takes about six months of gently razzing the 40-meter gang to pull dope out of them, but when it comes it's really something. W5EXR is the fair-haired lad this month, with a swell lot of dope. He and W9YXO got together, and from their logs present the following case for the defense: PK1TT (7170 T9), KF6PMO (7275), XUBNA (7250) at 7 A.M., VQ5KLB (7320 T9) but not on much, HK5JD (7095 T8x) very consistent, VP7NX (7280 T8), HC2CV (7280 T7), YV4AA (7275), CE4AD (7160 T9) and LU9CK (7160 T9), as well as many others in Europe and Asia W2HUG has worked KA1AX as well as VK, ZL and Europe, and W2DSV worked K6MOJ and a flock of Europeans including OZ7OX (7080), SP2PF (7110), E85C (7045), SM5NV (7200) and a bunch of G's W6JBZ worked GM6CM, and W6POX heard ZS6DW W6PCP has heard KG6NVJ and KF6FJG at about 7150 and says that KA1AX has worked several VS5's and U9AB on 40 W1AJ got CT1AZ (7260), ON4IF (7260), UK5KJ (7225) and G8KP (7205) W8JSU practically makes 40 sit up and talk, what with K4AA (7209), HP1X (7115 T9), SP1CF (7175 T9), Europe, VK, ZL, South America and KA1AX W9TJ says TF3C is on 7000 and 7060 these evenings, looking for DX contacts.

Nothing to report on 10, but we'll lay you 3-to-1 it's hot by the time your eyes get down to here. And the DX Contest results will hinge on its performance.

On 20, we have regular customers dropping in, like W2HHF with VP8AD (14,300 T8c), VU2MA (14,320), XU6D (14,400), KA1RP (14,320), PK1VX (14,350), CR7AL (14,040, 14,255) and VU2BG (14,260) and, in the heard column, VU2AN (14,360), CR6AL (14,250), VQ2AG (14,320), VS6AF (14,340) and VU2KK (14,395) W2BHW isn't taking a back seat, and submits such stalwarts as VU2DR (14,055 T8), VU2MA (14,120 T9), PK4KS (14,300 T9), VU2EB (14,360 T9) and XU6AL (14,410 T5), with J9CB (14,360 T8), XZ2JB (14,300 T7), J8CB (14,395 T8) and XU7TH (14,400 T7) in the heard list W9PNE reports the reliables J2NF, J2JJ and J5CC still coming through during the late afternoon on the high end That high end is where VQ3HJP (T7) stays, too. Incidentally, he's ex-SU68W EL2A (14,265 T7) is still to be found, if you listen at about 7:30 P.M., EST We join with W2EQS in suspecting PJ5AA and PJ5CF of being phoneys, but the undercover-but-far-from-phoney PJ1BV (14,410 T7) can be found regularly at the same old stand. His cards that came through the other day made you happy, didn't they? Some day we hope to be able to tell you the whole story of PJ1BV—it's real fun W9GKS has VU2FX (14,340 T9), UK3AH (14,420 T6) and UB1B (14,365 T9) down in the book, with KF6DHW (14,380 T9), HR7WC (14,325 T9) and U9ML (14,420 T9) on the "spotted-but-not-worked" list W8OUK's bid includes CT2BP (14,380 T9), CT2BO (14,410 T8), F8BRY (14,370 T9), CN8AY (14,410 T8), CR7BC (14,335), ZE1JM (14,300 T9) and an eye on VQ4RHL (14,340 T9).

PHONE:

ALTHOUGH our personal experience with 'phone is strictly limited to the, "If a man answers, hang up" type of land-line operation, we have no doubt but what a lot of good DX goes on in the bands reserved for those followers of the tinninnabular technique. So in one fell swoop we dispel all rumors that this column isn't open to 'phone DX and present the dope on hand. So far our contributors have been more outstanding for their faithfulness than their number—we hope the situation is remedied practically at once If we can believe W1HKK, the PK's are as thick as dust on a high-to-low-power switch, what with PK1VY (14,100), PK1VM (14,110), PK2WL (14,130), PK3VL (14,145), PK4KS (14,300) and PK3WI (14,090), with XZ2DX (14,015), LX1AY (14,000), XZ2DY (14,010), VS6AG (14,125), F18AC (14,140), VP8D (14,145) and ZC6EC (14,290) no less accessible W2HHF heard TG5JG (14,020), whose QTH is John Grullen, Box 12, Guatemala City W6ITH is always there with the latest, and this month it includes ZL2BE (28,420, 14,210 and 3900), ZL2BN (3965), VS2AS (28,070), VS6AF (28,650), UK000 (anywhere in 14-Mc. band) around 1 A.M., VK6MU (14,070) and KF6DHW (14,380). Europe and Africa are good from 8-10 A.M., on both 10 and 20.

Approved by ROYALTY

EIMAC TUBES and the
TEMCO Transmitter

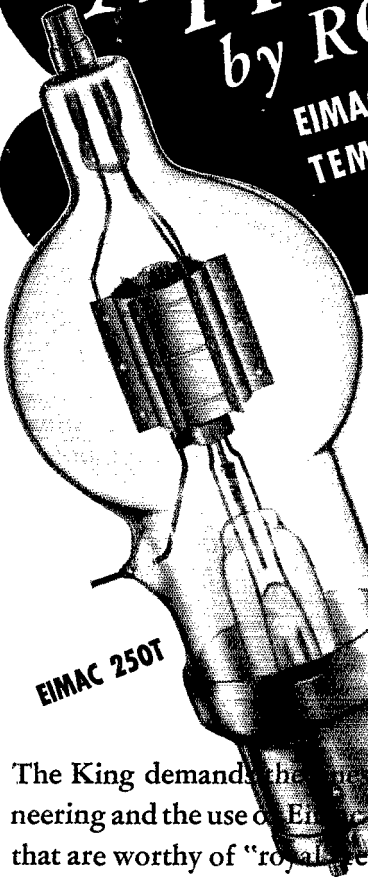

EIMAC 250T

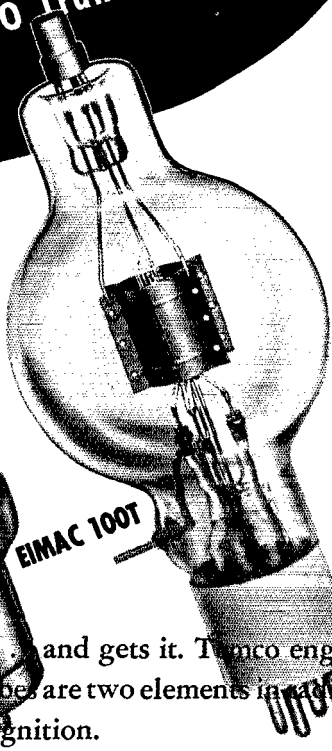

EIMAC 100T

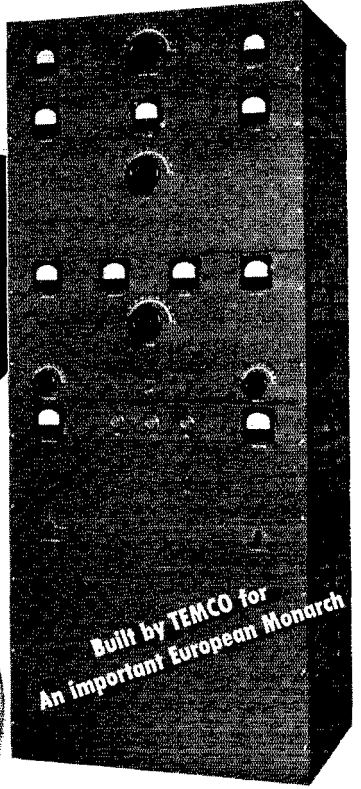

Built by TEMCO for
An important European Monarch

With Eimac tubes in the final and a power supply of 2500 volts, an input of 1500 watts is used. Transmitter operates on a single band—9000 to 10,000 KC—frequency changes are instantaneous. An Eimac 100TH is the intermediate amplifier while two 250TH's in push-pull modulated by two 250TH's in class "B" constitute the final. Facilities are available for direct or remote control. Speech amplifier is separate with provision for two channel mixing.

The King demands the best—and gets it. Temco engineering and the use of Eimac tubes are two elements in a radio that are worthy of "royal" recognition.

This—"By Appointment To His Majesty"—is a fitting testimonial to the superior characteristics and unusual power capabilities of Eimac tubes—and to Temco.

Amateurs who wish to reign supreme—who are ready to move forward in radio—will do well to step into rank with royalty, by adopting Eimac tubes.

We'll be glad to tell you the name of H.R.H. the King who ordered this transmitter—and answer any questions you wish about Eimac tubes.

Eimac TUBES

EITEL-McCULLOUGH, INC., San Bruno, Calif.

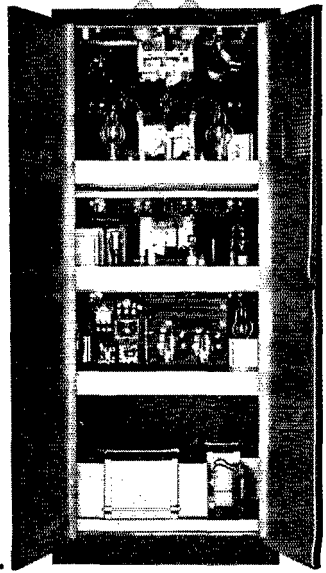

A NEW TREND

Last month we told you about our new 500 and 1000 watt Multi-band condensers and showed you a photo of the XG-70-50-XQ, the 500 watt size.

Now meet the 1 K.W. Multi-band, face to face. The finest quality of material and workmanship, built into the sturdiest of heavy brass frames. Built right for those who insist on the finest.

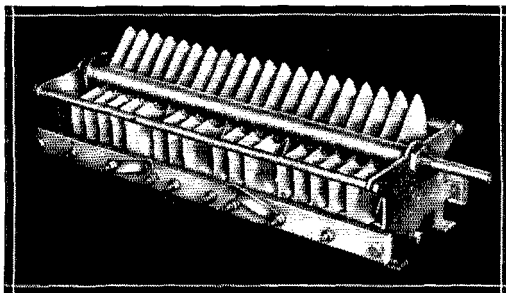

★ **TYPE TL-70-50-UQ** ★
1000 WATT Multi-Band

Frame — "T" type, commercial specifications.
Airgap — .294" (per section).
Plates — .050" thick aluminum — buffed.
Insulation — New G.E. H.F. MYCALEX No. 1364
LIST PRICE . \$40.00 AMATEUR NET PRICE . \$24.00

New BRACKETS for MIDWAYS and "N" Type CARDWELLS

Just a simple, sturdy aluminum bracket for one of Cardwell's most popular series of variable capacitors.

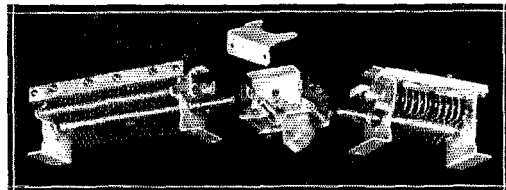

See how they lend themselves to short lead tank circuit layouts, on the NP-35-ND U.H.F. Dual and the MT-100-GD. Some will prefer to use them as illustrated on the MT-50-GS Single Midway, perhaps mounting on insulating pillars. Notice how inductance coil jack bars can be mounted across the inverted mtg. feet on duals. Commercial and amateur designers will realize the fulfillment of a need they have perhaps, long felt.

TYPE M—Mounting Bracket

Of satin finish aluminum, with 3 flister head screws and lock washers.

LIST each20c AMATEUR NET12c

**THE ALLEN D. CARDWELL
MANUFACTURING CORPORATION**
83 PROSPECT STREET, BROOKLYN, NEW YORK

WHO:

IF THAT was the real AC4YN that W9HLF worked on 14,295 the other evening, credit will go to Moore for pulling off the sweetest coup DX of the year. We'll wait until the card comes through before we really rave, but don't say we didn't warn you ZS6AA, who was over here for a short while, regrets he didn't have time to see more of the gang. However, he did manage to visit W8MPX, W9EKD, W2GNQ and W2JYK Gerry Sayre of OX2QY says that some of the cards he sent out came back for better addresses, so if you didn't get yours you might drop a line to Gerry at Milton, Wisc. . . . VQ2GW (14,335) is on at 2145 GT daily looking for W4 and W7. W8OUK skeds him, if you want to make it sure-fire HB9J plans to visit the U. S. in April and May, making W2BHW his headquarters J2MI is going to MX this spring, so maybe we'll hear an MX rolling through the way 2MI did Another 2MI, G2MI this time, offers a new RSGB Handbook to the Delaware and New Mexico stations that make him WAS. Line forms on the right If you worked WCFT's operator when he was on land at one of those places, you'll be pleased to know that Eurich sent in a QSO list which will give you DXCC credit YU7AY will swap stamps for a Call Book or radio magazine W1CC, now W3HXP in Maryland, has a new location — the first six QSO's gave him WAC. And he has made WAC from there in 56 minutes, including two Asians in that time G4's are getting on the air now, so don't let the prefix perturb you You wouldn't think a doublet bent Z-shape (for lack of space) in an attic would be much good, but that's all there is on the end of the 125 watts at W2PLG, and he's nearly ready for the CC list. Latest include VU2FS (14,090 T9), CS2V (14,340 T9) and VS6AO (14,340 T9) CR7AW (14,300) is active every day from 03-05 and 21-24 GMT Asians are good at VO3X, but Nevada is still missing G5QY, well up in the DXCC, just applied for his 'phone WAC, made with 9 watts input HB9X needs New Mexico, Nevada, Arizona, Wyoming and Nebraska for guess what When VK9DK gets on, it's on 7040, T9, according to W7EIA who worked him If you managed to get to the end of all this last month, the following needs no explanation save that we found it on our desk one morning, without a clue to its origin.

Reply

Low grid mills vs. wifey's wishes,
Stone-cold plates vs. dirty dishes,
"Fair" skywires vs. taut clotheslines —
The gentleman who wrote those lines
Should remember that the wives of some
Think weak PK's are chewing gum!

OK, OK! We'll make you a proposition. You stay off 14,400-14,395 and let us have it all to ourselves during the Contest, and we won't print any more poetry. Is it a deal? Seriously, the very best of luck to youse guys. We hope this Contest turns out to be a real honey, and that you all get your share. Good hunting!

— W1JPE

Yacht "Haida," WKDS/W6KVA

J. R. FORAN, W6KVA, is radio operator on the Yacht *Haida*, WKDS. He has a 75-watt ham rig ('phone and c.w.) aboard, using the regular ship's antenna. The *Haida* is a Diesel powered yacht, 217 feet long, owned by Major Max C. Fleischmann, of "yeast" fame, and carrying a crew of thirty men. W6KVA writes, "The next cruise will be to Mexico, on the west coast, and will probably take us as far south as Acapulco. We will be in and out of every Mexican port on the west coast, over to Tres Marias Islands, and up into the head of the Gulf of California. I have received special permission from the Mexican government allowing me to work ham radio in any of their ports, as long as the equipment is kept aboard the *Haida*. In that way we can shift to any ham frequency once the ship is anchored or docked. The rest of the time we will be on 28 Mc., signing 'Mobile at Sea.' Later in the summer we will be north again,

Ultra-Modern

The
NEW

HQ-120

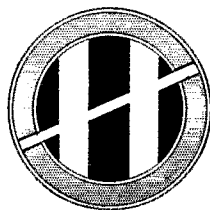
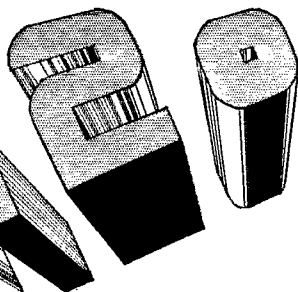
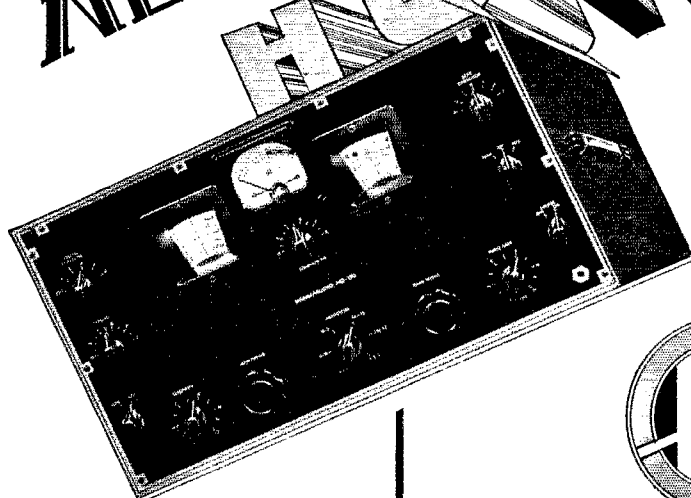

Tuning Range—31—54 MC.

- ★ Full range crystal filter selectivity makes the HQ-120 ideal for either phone or C.W. operation. There are six ranges.
- ★ Over 310 degrees spread for each amateur band. Direct calibration in megacycles for the amateur bands allows the amateur to check frequency with marked accuracy. Main dial also calibrated.
- ★ Due to uniform R.F. gain and constant crystal filter output the calibrated "S" meter provides an accurate check on signal strength.

- ★ Special 15-gang condenser, 6-gang main tuning and 9-gang band-spread, provides uniform spread and high efficiency.
- ★ Efficient noise limiter for reducing automobile ignition QRM and similar disturbances.
- ★ Antenna compensator permits perfect circuit alignment with all types of antennae. Also provides maximum image rejection, maximum signal-to-noise ratio.

WRITE DEPT. Q-3 FOR BOOKLET

HAMMARLUND

424 W 33 ST NYCITY NY

Canadian Office: 41 West Ave. No., Hamilton, Ont.

Again

we call your attention to

The New SIMPSON "HAMMETER" Model 240

3,000 volts self-contained
(no external multipliers necessary)

the first, self-contained pocket-size tester built expressly for your needs

WHY has the Hammer, announced only a month ago, become the fastest selling instrument we ever built?

The answer is that it gives the amateur everything he can want in checking high voltage, checking steps of construction, and running down trouble, and gives it at the remarkably reasonable price of \$14.75.

The heart of the Hammeter is the Simpson D'Arsonval movement with expensive bridge-type construction and soft-iron pole pieces — built for a life time of service. Both A.C. and D.C. voltage ranges have a resistance of 1,000 ohms per volt.

It is shock-proof throughout — test cables are insulated for 5,000 volts; tips are heavily insulated; clips have heavy rubber insulation. Panel is handsome black formica with gold lettering; scale is silver etched as in finest instruments. Modern knife-edge pointer gives accurate readings. It's built like a quality, miniature camera — measures only 5 1/4 x 2 7/8 x 1 3/4" and weighs only 20 ounces. Note the many ranges listed above; make it your testing instrument.

And A NEW HIGH IN PANEL INSTRUMENT VALUES

Simpson Panel Instruments were first to offer the expensive bridge-type construction and soft iron pole pieces at prices no higher than you formerly paid for ordinary instruments. Now these values are made still more sensational by the reduced prices listed below. The quality remains the same — only the price has been changed.

R. F. AMMETERS—Internal thermo-couple radio frequency ammeters (1, 1 1/2, 2, 2 1/2, 3 or 5 Amps.)
Your net price..... **\$4.59**

HIGH RANGE VOLTMETERS—D. C. plate voltmeters, complete with external resistors, (1,000-1,500-2,000-2,500-3,000 or 4,000 volts).
Your net price..... **\$8.90**

(5,000 volt range \$12.00 net)
DECIBEL METERS—Rectifier type volume level indicator [-10 to +6 db (500 ohm line; 6 M.W.)]
Your net price..... **\$7.84**

OTHER OUTSTANDING VALUES ARE:
D.C. plate milliammeters (all popular ranges from 0-5 to 0-1,000 milliamps).
List \$6.35.

Net price to you..... **\$4.15**

A.C. filament voltmeters (0-10 or 0-15 V.)
List \$6.35.

Net price to you..... **\$4.15**

Illuminated dials for all popular ranges, including 6V. lamp, 50c net additional.

SIMPSON ELECTRIC COMPANY
5210 Kinzie Street, Chicago, Ill.

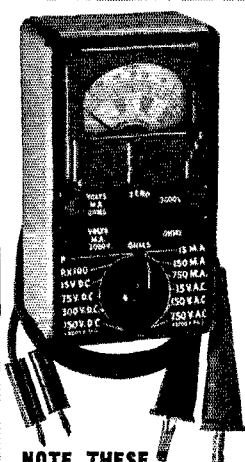
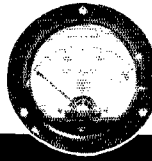
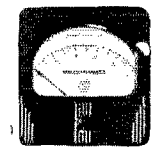

NOTE THESE RANGES:
A. C. volts: 0-15-150-750-3,000. D. C. volts: 0-15-75-300-750-3,000.
D. C. milliamps: 0-15-150-750. Ohms: 0-3,000 (center scale 30) and 0-300,000 (center scale 3,000).
Your net price..... **\$14.75**

in British Columbian and Alaskan waters, working in British Columbia with a special permit, which they were kind enough to grant us. I have quite a lot of time to play around with ham radio and am on 28 Mc. most of the daylight hours. Would appreciate a call from any of the fellows, and will arrange several schedules with some of them. Can't give any set frequencies as I shift around quite a bit, and in addition to phone do quite a bit of work on c.w., especially on 14 Mc." Mailing address for the *Haida* is P. O. Box 1101, San Pedro, California.

High Scores, "A.R.R.L." Party

EARLY reports indicate that the 2nd Annual "A.R.R.L." QSO Party (January 7th-8th) was a grand success. The official report, with list of winners, will appear in July QST. The "claimed scores" of some of the outstanding participants are presented here for the information of those interested. In each case the figures represent score, stations worked and sections worked:

W3BES	36234-275-66	W7CMB	19470-165-59
W8OFN	32364-261-62	W9CWW	18422-151-61
W2GSA	30503-259-59	W1AW (Geo)	18370-168-55
W6KFC	30420-234-65	W3DGM	18040-205-44
W9RQM	29232-232-63	W9AWF	17877-152-59
W2HMJ	28896-258-56	W3ATR	17596-166-53
W8KUN	28497-242-59	W1KQY	17452-179-49
W9VPZ	28210-217-65	W1AVJ	17298-184-47
W9VDY	27648-236-59	W8NUV	17264-166-52
W1TS	26288-212-62	W9ZAR	17256-163-56
W8MOT	24864-222-56	W2ISQ	17172-162-53
W9MUX	24720-206-60	W8NHA	17050-155-55
W9TH	24282-213-57	W4APU	16968-152-56
W9IH	23684-193-62	W5KC	16932-166-51
VE3OI	23320-212-55	W1UE	16848-163-52
W9NST	22500-194-58	W9MGV	16632-150-56
W8DOD	21836-206-53	W2HZY	16422-161-51
W3FPQ	21560-196-55	W6BIP	16302-143-57
W8JTT	21288-185-58	W4AGI	14935-173-43
W9EYH	20764-179-58	W8LCN	14798-151-49
W9ZFT	20474-177-58	W8DZC	14602-149-49
VE3ES	20060-170-59	W4ABT	14498-151-48
W2JKH	20034-189-53	W8LYZ	14450-145-50

Iowa Emergency Net

As an emergency preparedness step the Iowa-Illinois Amateur Radio Club, Burlington, Iowa, together with W0WTD, A.R.R.L. Emergency Coördinator, is sponsor of a 1.75-Mc. c.w. net for the purpose of testing emergency rigs. Some fifteen members of the club now have emergency transmitters and power supplies and meet on the air every Thursday at 7:00 P.M. between 1763 and 1767 kcs. In most cases the rigs consist of a single tube, crystal controlled, running from 5- to 15-watts input. Distances up to 500 miles are covered consistently. A survey is being completed of all available 110-220 a.c. emergency plants in Burlington, and written consent is being secured from all industries and individuals, having independent power plants, to make them available for emergency work.

On Saturday nights (700; P.M.) the tests are extended to include the entire state of Iowa and all amateurs are being urged to build portable-emergency gear and get in on the program. An invitation is also extended to operators in western Illinois and northern Missouri to participate in the drills.

A round table QSO on 3510-ke., including nine stations in five states, took place starting at 11:30 P.M., Jan. 26, and lasting until 1:30 A.M. The rag chews involved were: W2SC, W3AOC, W9PQL, W9DLI, W8FFK, W8J8N, W8OFN, W9IZI and W8DAL.

O.B.S.

The following is a supplement to the list of A.R.R.L. Official Broadcasting Stations in October QST (page 71): W1VF, W2EOA/W2HXQ, W4BDT, W4BQE, W4DLK, W4DQW, W5CXH, W5GHF, W7CJR, W8AHV, W8BOK, W8PJJ, W9JVR, W9ZGR, VE3AJB.

SIMPSON

INSTRUMENTS THAT STAY ACCURATE

AMATEURS—YOUR THOUGHTS MAY BE WORTH MONEY

ZENITH RADIO CORPORATION

— 6001 DICKENS AVENUE —

CHICAGO

OFFICE OF
E. F. McDONALD, JR.
PRESIDENT

February 15, 1939

To Radio Amateurs:

This is an invitation to every "ham" in the world.

Most advertisers in magazines, newspapers, etc., tell you how to spend your money. This is not that type of message.

I have always contended that the credit for most of the major developments we have in radio have been due to the American amateur. The radio industry's enormous laboratories have done little but refine that which the amateur discovered. The Zenith Radio Corporation is always ready to reward amateurs who send us suggestions that we have not before had, if we adopt them.

We haven't an engineer in our laboratory over forty years old - they're all ex-"hams," progressive and very much open-minded. To them nothing is impossible. We have found that it is not always the fellow who knows all the rules of why things won't work that produces real results. As a matter of fact, the contrary is usually true.

If you want to see an example of development, drop into a Zenith dealer's store and examine the Wavemagnet model of radio, just put on the market, using no antenna, ground or battery. This is not a set built for "hams." This job was suggested by an amateur and the improved shielded loop was refined by our laboratory. If you know how to build this loop better, tell us and, if your suggestion is novel and we adopt it, we will reward you.

So, you see this was not an ad telling you how to spend your money. It is just an invitation for more of you to correspond with us on further developments.

Cordially yours,

E. F. McDonald, Jr.

HC

MORE ABOUT TELEVISION

— Sylvania 5-inch cathode-ray picture tube. Amateurs — here's the Sylvania 5-inch-screen television tube for that larger-sized receiver you plan to build. Sylvania is keeping abreast of the rapid developments in television art, and you, too, will want to play your part in the advancement of television science.

In cathode-ray tubes as in audio receiver tubes — you can count on Sylvania for high quality... dependable performance always. Write today to Hygrade Sylvania Corporation, Emporium, Pa., for further technical data on this new television tube.

SYLVANIA

SET-TESTED RADIO TUBES

MEMBERS, DX CENTURY CLUB

G6WY (No. 5).....	143	W9ADN (No. 61)....	108
W6GRL (No. 15)....	134	W2CMY (No. 68)....	108
W1TW (No. 3).....	133	W2DC (No. 79)....	108
W1SZ (No. 7).....	133	W2GVZ (No. 80)....	108
W8DFH (No. 14)....	133	W6HX (No. 21)....	107
W6CXW (No. 4)....	132	G6CL (No. 24)....	107
W2GT (No. 32)....	132	VK5WR (No. 49)....	107
GZQZ (No. 6).....	130	W1JPE (No. 66)....	107
W2GTZ (No. 12)....	130	W3DDM (No. 72)....	107
W8BTI (No. 56)....	129	W2AAL (No. 81)....	107
ON4AU (No. 40)....	128	G5BJ (No. 93)....	106
W8CRA (No. 1)....	127	G5RV (No. 64)....	105
W1TS (No. 9).....	127	PA0XF (No. 43)....	105
W2GW (No. 11)....	125	W6FZL (No. 48)....	105
W1LZ (No. 10)....	123	W4CYU (No. 78)....	105
W9ARL (No. 18)....	122	W4DRD (No. 94)....	105
HB9J (No. 15)....	121	W9TB (No. 95)....	105
W8DHC (No. 27)....	120	W8BKP (No. 65)....	104
W1DF (No. 29)....	120	W2OA (No. 73)....	104
J5CC (No. 46)....	120	W2AX (No. 84)....	104
W3EMM (No. 58)....	119	W2ZK (No. 85)....	104
W1BUX (No. 2)....	118	W3CAU (No. 96)....	104
W9EG (No. 16)....	118	DA4FF (No. 99)....	104
W8OSL (No. 23)....	118	E15F (No. 19)....	103
W5BB (No. 37)....	118	G6PK (No. 45)....	103
W8OQF (No. 30)....	117	W2CJM (No. 47)....	103
W1FH (No. 71)....	117	G2TR (No. 83)....	103
W8DWV (No. 17)....	116	W1CH (No. 91)....	103
W2UK (No. 33)....	116	W3AG (No. 107)....	103
W8ADG (No. 63)....	116	W9UM (No. 108)....	103
W8LEC (No. 25)....	115	W4CBY (No. 20)....	102
W6KIP (No. 28)....	115	W1WV (No. 69)....	102
W9PST (No. 35)....	115	W8NJP (No. 90)....	102
W5VV (No. 38)....	115	W5KC (No. 92)....	102
W4BPD (No. 70)....	115	G2DH (No. 101)....	102
W9EF (No. 44)....	114	W2BYP (No. 102)....	102
W9TJ (No. 67)....	114	G5QY (No. 103)....	102
W8JMP (No. 22)....	113	F8RJ (No. 8)....	101
W3CHE (No. 87)....	113	VK3KX (No. 57)....	101
G6RH (No. 36)....	112	ZL1HY (No. 59)....	101
W9KA (No. 42)....	112	W1ZB (No. 62)....	101
W6GAL (No. 50)....	112	W4AJX (No. 75)....	101
W4CEN (No. 60)....	112	W6DOB (No. 76)....	101
W7AMX (No. 26)....	111	W1DUK (No. 82)....	101
W2BHW (No. 39)....	111	W2CBO (No. 86)....	101
W9FS (No. 77)....	111	SUIWM (No. 89)....	101
ON4AU (No. 31)....	110	F8RR (No. 98)....	101
W6ADP (No. 34)....	110	W1CC (No. 106)....	101
W9GDH (No. 41)....	110	W1ADM (No. 110)....	101
W2CYS (No. 52)....	110	W3FRY (No. 85)....	100
W3EDP (No. 53)....	110	W8UY (No. 97)....	100
W2HHF (No. 54)....	110	W2DSB (No. 100)....	100
W3EUV (No. 55)....	110	W1AXA (No. 104)....	100
W3EPV (No. 74)....	110	G6NF (No. 105)....	100
W3EVT (No. 51)....	108	W8KKG (No. 109)....	100

The following have submitted proof of contact with 75-or-more countries.

PA0QF.....	99	W3EMA.....	87	W3FLH.....	79
W9AJA.....	99	W1HX.....	86	W6LJD.....	79
G6GH.....	97	W2IOP.....	86	W6MVK.....	79
W1GDY.....	97	W3ATU.....	86	W8JPC.....	79
VE2EE.....	96	W3KT.....	86	G6YE.....	78
W1BY.....	96	W8IQB.....	86	VE2GA.....	78
W1FR.....	96	W9FLH.....	86	W1EWD.....	78
W1GX.....	96	W6FKZ.....	85	W4TZ.....	78
W1ZT.....	96	W8LAV.....	85	W8AAT.....	78
W8BOX.....	96	Z3ZX.....	85	W8BFG.....	78
W3BE.....	95	G6GZ.....	84	W8FJN.....	78
W8OXO.....	95	SM6WL.....	84	W8MTY.....	78
G2MI.....	94	VK8SA.....	84	W9BEZ.....	78
W8AU.....	94	W2GRG.....	84	W9MRW.....	78
F8BAB.....	93	W3AGV.....	84	W1CA.....	77
W3BEM.....	93	W3OP.....	84	W4DMB.....	77
W6BAM.....	93	W4CFD.....	84	W6AM.....	77
W6GHU.....	93	W8BSF.....	84	W6KUT.....	77
HB9BG.....	92	W9OVU.....	84	W6TT.....	77
W4CBE.....	92	SPIAR.....	83	W8QDV.....	77
HB9C.....	91	W1BFT.....	83	W8ZK.....	77
W1GNB.....	91	W2BMX.....	83	G6XL.....	76
W3ZX.....	91	W5ASG.....	83	W3AYB.....	76
W8DOD.....	91	W6GPB.....	83	W3BSF.....	76
J2JJ.....	90	W9RBT.....	83	W6DTB.....	76
W1RY.....	90	W2ALO.....	82	W3LZK.....	76
W8KW.....	90	W9RCQ.....	81	ZELJ.....	76
W9CWW.....	90	W2AER.....	80	D3CSC.....	75
G5BD.....	89	W3BVN.....	80	PA0JMW.....	75
W1BXC.....	89	W3EPR.....	80	SPILP.....	75
W6TTE.....	89	W3GEH.....	80	W3CKT.....	75
W8AAJ.....	89	W4EQK.....	80	W6GK.....	75
W8CJ.....	89	W8WB.....	80	W9JDE.....	75
G2DZ.....	88	W8DAE.....	80	Radlotelephone.....	75
PA0QZ.....	88	W8JAE.....	80	W2IXY.....	80
W3JM.....	88	LUTAZ.....	79	W4CYU.....	80
W9AEE.....	87	W3AOO.....	79	W6ITE.....	76
		W3GHD.....	79		

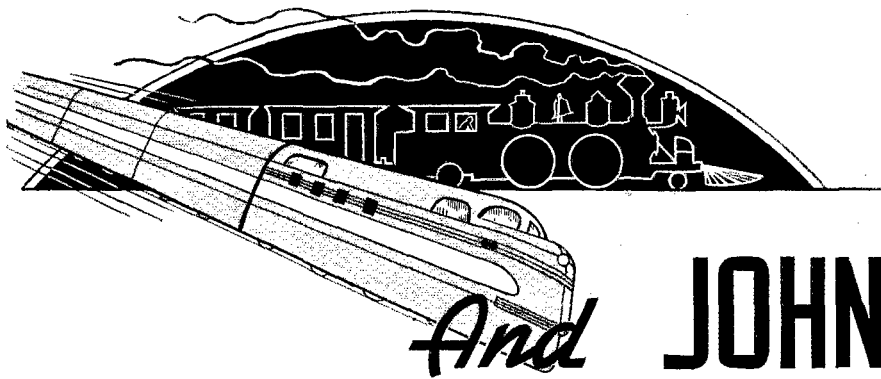

And JOHNSON "HI-Q" INDUCTORS

are also far advanced in their field!

NOTE THESE ADVANTAGES

- ★ Works directly into line without tuning networks of any kind.
- ★ Employs high grade insulation — porcelain and steatite.
- ★ Carefully designed for proper Inductance-Capacity ratio.
- ★ Continuously variable coupling plus ability to couple into high impedance (no other inductor offers this).
- ★ Impervious to ordinary heat and moisture.
- ★ Lower in price than any other inductor of similar power rating.

CUT-AWAY OF THE NEW JOHNSON "HI-Q" INDUCTOR SHOWING LOCATION OF THE ROTATING COUPLING COIL

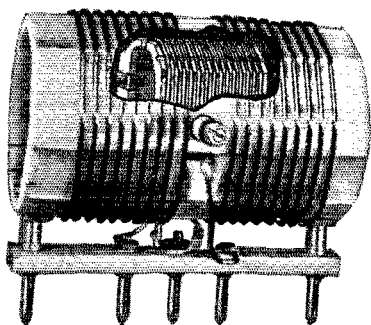

NOTE

Rotating Coupling Coil

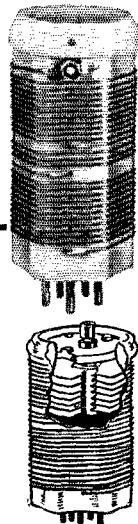

New Tube Socket "HI-Q" Inductors eliminate laborious winding of coils for exciter and low power amplifier stages. Two series, both rated at 75 watts, coupling winding at center or bottom. Note cut-away drawing showing provision for mounting the new Johnson type J Condenser inside — a complete low power tank circuit in one small unit.

Examine the very obvious improvements incorporated into this new line of Johnson "HI-Q" Inductors and observe how well they meet the requirements of an ideal inductor. No antenna tuning networks. Variation of coupling as desired. 10, 20 and 40 meter units work into any impedance up to and including 600 ohms. Units are supplied for all amateur bands, 10 to 160 meters inclusive, and in two sizes, 250 and 750 watt ratings. Infinite patience, exhaustive laboratory study and precision manufacture have gone into this new line to give you improved performance and greater satisfaction.

Available now from your Johnson jobber
or write for Catalog 965J



E. F. JOHNSON CO.

WASECA, MINNESOTA

EXPORT: 25 WARREN ST., NEW YORK, N. Y.

"MANUFACTURERS OF RADIO TRANSMITTING EQUIPMENT"

OHMITE for Maximum Efficiency

Dummy Antenna Helps in 10 Ways

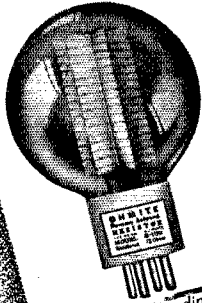

Do You Know how much actual power is delivered at the end of your transmission line? — How much the mismatch exists between your transmission line and antenna? Determine these and many additional facts about your rig and improve its efficiency by using the new Model D-100 Ohmite Dummy Antenna. Available in 75 ohm, 600 ohm and other resistance values. Rated at 100 watts.

List Price..... **\$5.50**

[Send for Bulletin 111!]

(Patents Pending)

Use the Popular "Brown Devils"

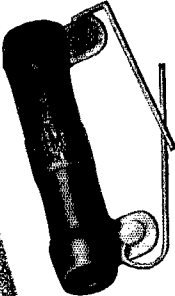

You're sure of the best kind of resistor job when you install the popular Ohmite Brown Devils for voltage dropping, bias units, bleeders, etc. They're extra-sturdy, wire wound, all-porcelain units built right, sealed tight, permanently protected by Ohmite Vitreous Enamel — and they're economical. Available in 10 and 20 watt sizes in resistances from 1 to 100,000 ohms.

Ask Your Jobber also for Ohmite Dioidohm "Adjustable" Resistors, Ohmite Rheostats, R.F. Plate and Power Line Chokes, Band Switches, etc.

WRITE TODAY FOR FREE CATALOG 17

OHMITE MANUFACTURING CO.
4865 Flournoy Street ★ Chicago, Illinois, U. S. A.



A.R.R.L. Trunk Lines

THE A.R.R.L. spot frequency all-O.R.S. Trunk Lines are moving traffic in record time. Route your traffic via these channels for reliable service. Most of the lines operate "as a net," enabling messages to be handled from terminal to terminal within a very few minutes. Each line has a "manager" whose duties are to make sure that each operator keeps schedules, arrange operation to speed message-handling time, recommend changes when needed, etc. Each manager makes a monthly report to Headquarters so that necessary action may be taken and records kept up to date. Each A.R.R.L. Section Net is requested to maintain a connection with the Trunk Lines to facilitate deliveries and provide an outlet for the Section.

National Trunk Line Net: 3670 kc., W8KWA, Manager — 10:30 p.m. EST. This net makes possible the rapid exchange of traffic between the various lines. Stations representing their lines in the N.T.L. Net are W8KWA/W8QAN (A), W4CXY (B), W1IP (C), W4DS (D), W8DNX (E), W9RVW (connects with F), W9RMN/W9MCC (G), W9UEG (H), VE2LC/VE2MV (I), W9BAZ (J), W9FLG (K), W8HCS/W9NFL (L) and W8DDC/W5ENI (M).

Trunk "A": 3565 kc., 10:00 p.m., EST, W8LSF, Manager — W2KTR W8KWA W8LSF W9TUV W9HGF W9HEN W9DM W7CCR W7FCG W7CZY (Alternates: W8QAN W8QGD W9YXH W9LCT W9RZA) — New Jersey to Washington.

Trunk "B": 3795 kc., 10:00 p.m., EST, W9OUD, Manager — W3BZX W8OXO W9EDQ W4HK W9OUD W9KPA W9RVW W6FYR W6CW W6LMD (Alternates: W3EFM W8GBF W9CDA W4CXY W9WIN W9EKQ W6LLH W6BIC W6MGL) — New Jersey to California.

Trunk "C": 3790 kc., 6:45 p.m., EST (Northern end), 7:30 p.m., EST (Southern end), W3AKB, Manager — W1GOJ W1LP W1EPE W1AFB W2JHB W3AKB W3BWT W3HDQ W4DLX W4CZA W4PEI (Alternates: W1EFR W1FFL W2CEK W3EFH W3AKN W4EOP) — Maine to Florida.

Trunk "D": 3620 kc., 7:30 p.m., CST, W4DS, Manager — W4DXF W4DS W5GHF W5FXX W5ANR W5FAJ W5FOM W5ZU W6KOL W6CZO (Alternates: W5DNE/W5FRE W5ZM W6OUU W6OQH) — South Carolina to California.

Trunk "E": 3705 kc., 8:00 p.m., EST (Eastern end), Midnight, EST (Western end), W7GEE, Manager — W4CIZ W8DNX W9UKD W9FWW W7GEE W7FFQ W7FAF W7CWN (Alternates: W4FSP W8DDC W9PKW W7GZG W7GBF) — Maryland to Washington.

Trunk "F": 3790 kc., 6:30 and 8:00 p.m., PST, W7WY, Manager — VE5EP W7APS W7WY W7APF W7GKA W6NQB W6MQM W6GTM (Alternates: VE5ID W7APF W6LMD).

Trunk "G": 3625 kc., 10:00 p.m., EST plus individual schedules, W8BJO, Manager — W1HRE W2GTW W8BJO W8IXJ W9RMN W9DUA W9HFO W7ABO W7NH W7DUE (Alternates: W2KXF W8CSE W9MCC W9SEB W7FFQ) — Massachusetts to Oregon.

Trunk "H": 3605 kc., 9:30 and 5:30 p.m., CST, W9ZCC, Manager — W9RZA W9ZCC W9ZAR W9JAP W9UEG W5GHF W5BN (Alternates: W9WIN W5FXX) — North Dakota to Louisiana.

Trunk "I": 3690 kc., Individual schedules, VE4CM, Manager — VE1MK VE2LC VE3VA VE3HV VE4AAW VE4CM VE4GE VE5SW (Alternates: VE2MV VE3SG VE4GC VE4CQ VE4LX) — Maritimes to British Columbia.

Trunk "J": 3773 kc., 6:00 p.m., EST, W9BAZ, Manager — W9SZL W9HPG W9BAZ W4EDR W4AXP W4COB (Alternates: W4APU) — Wisconsin to Florida.

Trunk "K": 3755 kc., 5:30 p.m., CST plus individual schedules, W5CEZ, Manager — W9FOC W9PYF W9FLG W5CEZ W5MN (Alternates: W9TFA W9XQO W9VQG W5EGP W5OW) — Illinois to Texas.

Trunk "L": 3615 kc., 8:00 and 11:00 p.m., EST, W9FAM, Manager — W2BCX W8MOT W8HCS W9TBM W9NFL W9LCX W9FAM W9EKQ W6FYR (Alternates: W2HY W8GBC W9YWE W9QKJ W9DUA W9KPA W9RVW W6AXN) — New Jersey to California.

Trunk "M": 3585 kc., 8:00 p.m., EST (Eastern end), Midnight, EST (Western end), W5EOE, Manager — W2CGG W3GZK W8DDC VE3TM W8LVU W9QKJ W9KLJ W5EOE W5ENI W6KFC W6MYT (Alternates:

BY Request

the PA 500

for GREATER POWER

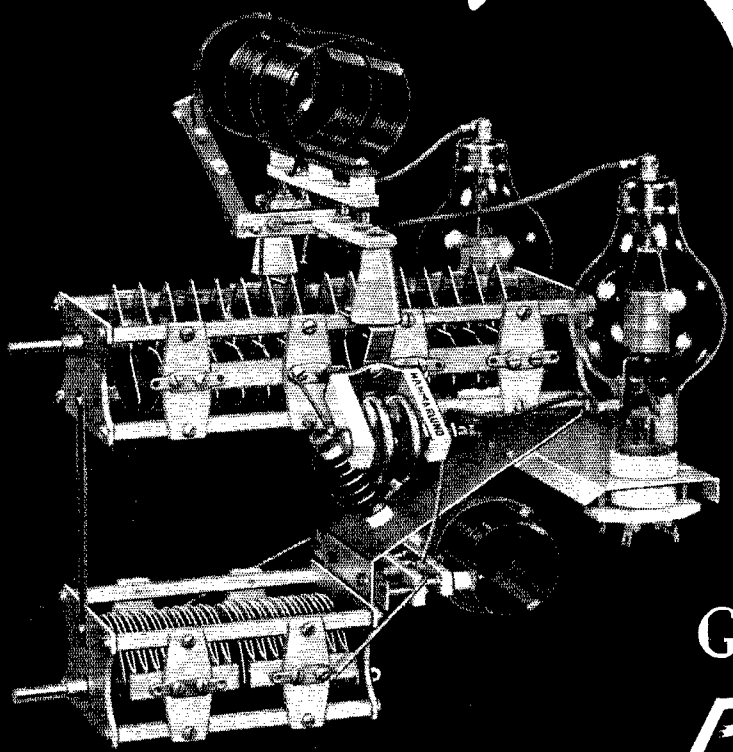

HAMMARLUND'S NEW PA-500, 500 watt final amplifier will meet the requirements of those amateurs who have expressed their desire for greater power output than that obtainable with the PA-300. This new Foundation Unit can be used with outputs up to 500 watts with great efficiency. The same general theme of construction employed in the PA-300 is also used in the PA-500. The PA-500 is designed to use HAMMARLUND "TC" high-voltage transmitting condensers with plate spacing up to .230", thus permitting a wide margin of safety for either phone or C.W. operation. Although RK-38 tubes are shown in the illustration, any popular high efficiency triode of suitable power rating may be used. Provision has been made for

accommodating either fixed or variable-link plate and grid coils. All metal brackets are of aluminum (two coil brackets are brass) and completely drilled and shaped to fit standard Hammarlund parts. The entire amplifier can be assembled and wired by even the most inexperienced person in less than an hour.

WRITE FOR FOLDER!

HAMMARLUND MFG. CO., INC.	Q-3
424-438 W. 33 St., N. Y. City	
() Please send PA-500 Folder	
Name.....
Address.....
City.....	State.....

Canadian Office: 41 West Avenue,
No., Hamilton, Ont.



HAMMARLUND

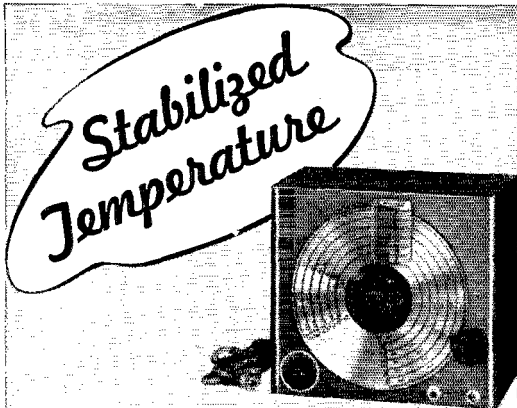

TO be worth its salt a frequency meter must be stable. A peek inside the GUTHMAN U10 FREQUENCY METER-MONITOR shows its mechanical stability. This is obtained through a large, solid frame tuning condenser of wide-spaced plates, a high Q Litz Inductance wound on ceramic form, SILVERCON silver-plated-on-mica fixed condensers, and rigid mounting of parts and wirings.

But this sound mechanical design alone could not contribute precise frequency stability without temperature stabilization. So temperature is triply stabilized. The oscillator tuning circuit is enclosed in an internal closed temperature shield. This shield is in turn enclosed in the closed outer cabinet. Two tubes and a ballast tube, with heaters operated continuously, maintain tuning circuit temperature stable at well above room temperature (and make for long tube life, too).

Through such triple temperature stabilization drift is surprisingly low — has been measured as less than one cycle in a million over 24 hour runs. But despite such stability, we are extra conservative in recommending that even with such a frequency meter as the U10, you never presume it to be more accurate than you can set zero-beat on WWV — 50 parts in 5,000,000 for safety.

The U10 FREQUENCY METER-MONITOR has passed a number of severe tests by outside laboratories. They found it good. We are sure you'll find it good, too. Examine it at your jobbers — or send us a postcard for complete description of this and other new items — including

COMMUNICATION SUPER-HET

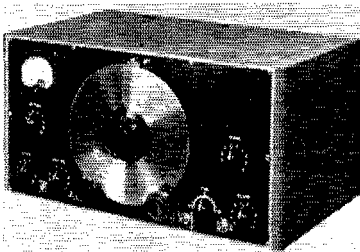

THE new GUTHMAN U17 Communication Super-Het is a strictly communication receiver kit, fully assembled all ready to wire, with complete detailed instructions. It is the first commercial example of the new technique of both r.f. and i.f. regeneration for low cost single-signal super-hets advocated in recent QST, the A.R.R.L. Handbook and other publications. At amazingly low cost, this easily wired 8 tube, 5 thru 550 meter kit is something of a revelation in dx, with selectivity continuously variable up to single-signal c.w., smooth a.v.c. action, tone quality, signal-to-noise ratio . . . and in the effective subduing of ruinous noise crashes by its simple new noise limiter.

WRITE FOR FULL DETAILS

EDWIN I. *Guthman* & CO., INC.
402 S. PEORIA ST. • CHICAGO, U. S. A.
CABLE ADDRESS: GUTHCO CHICAGO

W3GKN W8DNX VE3OI W8GAV W9OUD W5DGP W5GPV) — New Jersey to California.

The A.R.R.L. Trunk Line System provides a means of effectively moving traffic into any State or Canadian province. Connections are also maintained to the various U. S. possessions and traffic to those points will receive the best routing when sent "via the National T.L. Net." The co-operation of all operators in preventing unnecessary QRM on T.L. frequencies at times schedules are in operation will be appreciated by every Trunk Line Station. Route your traffic "via the trunk lines!"

1.75-Mc. DX

FEBRUARY QST (page 69) reported on trans-Atlantic contacts established during the R.S.G.B. 1.75-Mc. Contest on the January 7th-8th week-end. Additional data have now been received, reporting also on contacts made on other January week-ends. VE1EA has been one of the outstanding stations in the "160-meter DX" work, his results shaping up as follows: Jan. 8 — Worked: G5JO, G5RI, G5XH G2RC, G5QY, G2CF, G6GH, G6SQ, G6MK; Heard: G6GM, G6GL, G2PU, G3AH, G5MY. Jan. 15th — Worked: G6GM. Jan. 22nd — Worked: G6GM, G6WY, G2MI, G2PL, G2AO. Jan. 29th — Worked: F8ZF, G5RI, G2PL, G2AO, G6GM; Heard: W8OAN. In connection with the F8ZF contact, VE1EA heard F8ZF near his frequency in QSO with FA8BG. He didn't hear FA8BG, but took a chance and called both F8ZF and FA8BG. F8ZF came back and told VE1EA that FA8BG heard him.

On January 7th-8th G6WY worked W1ERX, W1AW, W1BB and W1DZ. On January 15th G2PU and F8ZF worked FA8BG. G2MI worked an HA. On January 22nd G6WY worked FA8BG, VE1EA and W1DZ; heard W2FJY, W1KUW, W8BQ and W1BKL. G2PL worked W1DZ, W2FJY, W1KUW and VE1EA; heard W1AW, W8QB, W8QLY, W1BKL, W3IQN and W2FQB (?). G2MI worked VE1EA and was heard by W1DZ. G6GM worked VE1EA and W2FJY. G6GL worked VE1EA and FA8BG. G5SFI worked FA8BG. On January 29th G2PL heard W1AW and W1BB, worked VE1EA. FA8BG is reported as hearing W5FQQ and two W8's.

On February 4th-5th week-end, W8KWA worked FA8BG; additional reports for this week-end are not yet available.

Frequencies of several of the active G's are: G6WY, 1766 kc.; G2MI, approximately the same as G6WY; G2PL, 1725 kc.; G6GM, 1780 kc.; G6GL, 1790 kc. Regular tests are being carried out by these stations each Sunday from 0500 to about 0800 GT. The following G's are active on 1.75 Mc. with an input of 10 watts: G6BQ, G5RI, G2AO, G3GH, G5MY, G2AX, while the following have special 100-watt licenses: G6WY, G2MI and G2PL. VU2AN has promised to try "160." F8RJ and other F's will be on for the Sunday morning tests and SM6WL expects to be on during February with 300 watts. FA8BG will continue his 1.75-Mc. operations with his 100-watt rig. VE1MQ is among those hearing 8BG, who reports he will be on 1754 kc.; he has been logged in the vicinity of 1725 kc. Many more reports are expected following the February tests (see Jan. QST, page 90) under the leadership of G6FO, who conducted the first "160 meter DX tests" in 1932 and 1933. Watch "160" and report results to A.R.R.L., please.

— . . . —

Ham Radio Defeats Isolation

"Our community (McCloud, Calif.), as well as several others (Dunsmuir, Weed, Mt. Shasta City, etc.), is located in or just at the edge of the deep snow belt, with an annual snowfall of approximately 20 to 25 feet; the past two winters considerably more. There are numerous interruptions of land line service, and the brunt of this falls on my station (only station with emergency equipment in this part of the district). I have been keeping daily schedules with two isolated mountain districts here in Northern California, providing their only outlet to landline communication during the winter months. One of my scheduled stations, W6OGJ, is located in a small community in the Trinity Alps, Forest Glen. The other, W6NXE, is at Power House Pit No. 3, Dunsmuir."

— V. N. Feldhausen, Sr., W6MDI



ALL'S WELL THAT ENDS WELL

You will remember the old saying, that "Everything has an end except a piece of string and it has two." The ends are important — as you realize when you try to lace a frayed shoe string.

We get our Wire Wound Resistors off to a good start by using high grade ceramic tubes and winding them carefully. The next problem is to complete this winding with a substantial terminal at each end. These terminals are vital, for they are the only means of connecting the external circuit. (The best treatment for a resistor with a broken terminal is to give it a good throwing away.)

It is our opinion that one type of terminal cannot be the best for all the different tube and wire sizes. We make more than ten different types for industrial applications and standardize on three types for general use.

For large resistors and heavy wire sizes the rivetted type of terminal is quite suitable. In this style the terminal band is rivetted in position around the ceramic tube before the winding is put on. After winding, the end of the wire is secured mechanically to small lugs on the terminal band and soldered in place. This makes an extra heavy, stout connection, and this type (our terminal No. 3) is strong enough to

serve as a mounting for the resistor if desired.

While we recommend the rivetted terminal for heavy wire sizes, we have developed a unique die cast construction for small tubes and fine wire sizes. In this construction the wire is wound on the tube first and the wound tube then placed in a mold, where the terminal is die cast around the winding, tube and all. This casting shrinks on cooling and grips the wire and tube with tremendous force. We die cast either wire lead pigtails (our terminal No. 1) or soldering lugs (our terminal No. 2) in position. This process eliminates the need for handling and soldering fine wire sizes on the small resistors, thus keeping the resistance wire always flat against the tube, where it is completely covered and protected.

The above designs would not be possible if it were not for the low temperatures at which we process our cement coating. Our resistors never undergo the extreme firing temperatures which are necessary in putting the glazed finish on some types of units. This explains why our terminals retain their stiffness and strength. These are small details, but they are important in an article which must withstand rough service.

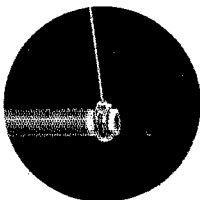

Terminal No. 1
Cast Lead Wire Pigtail

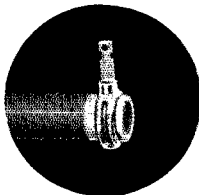

No. 2
Cast Soldering Lug

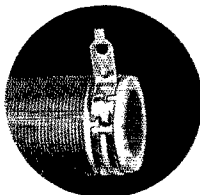

No. 3
Rivetted Terminal

INTERNATIONAL RESISTANCE COMPANY • 401 NORTH BROAD STREET, PHILADELPHIA, PA.

The Most Popular A.C.-D.C. PRECISION Series 842-L 30 RANGE MULTI-TESTER Includes a

2500 VOLT

A.C.-D.C. RANGE

Both at 1000 ohms per volt



COMPARE THESE FEATURES



- ★ Large size 4½ inch square meter
- ★ Wire wound shunts and matched multipliers, both at 1% accuracy
- ★ Five AC Voltage Ranges: 0-10; 0-50; 0-250; 0-1000; 0-2500 volts
- ★ Five DC Voltage Ranges: 0-10; 0-50; 0-250; 0-1000; 0-2500 volts
- ★ Six DC Current Ranges: 0-1; 0-10; 0-50; 0-250 MA; 0-1; 0-10 amps
- ★ Four Resistance Ranges: 0-400 ohms (20 ohms center) SHUNT METHOD
0-100,000 ohms (300 ohms center)
0-1 Megohm (8000 ohms center)
0-10 Megohms (80,000 ohms center)

NOTE: Provisions for mounting ohmmeter power supply (4½ and 45v batteries) on inside of case. No external connections necessary.

- ★ Five Decibel Ranges from 10 to 63 DB: 0DB, 14DB, 28DB, 40DB, 48DB
 - ★ Five Output Ranges: 0-10; 0-50; 0-250; 0-1000; 0-2500 volts
- 842-L** Size 7½ x 8½ x 4. Housed in walnut finished wood case with carrying handle. Less batteries and test leads. Net **\$21.95**
- 842-P** Same specifications as 842-L but housed in walnut finished wood portable case with removable cover. Size 9 x 10 x 6. Less batteries and test leads. Net **\$23.95**

popular HANDI-TESTER PRECISION Series 830



D.C.—VOLT—OHM—MILLIAMMETER SPECIFICATIONS

- ★ Five D.C. Voltage Ranges at 1000 ohms per volt: 0-10; 0-100; 0-250; 0-500; 0-1000 volts
- ★ Four D.C. Current Ranges: 0-1; 0-10; 0-100; 0-250 MA

- ★ Two Resistance Ranges: Low ohms (shunt method) ½ to 500 ohms
High ohms 0-300,000 ohms
- ★ Ohmmeter Ranges are powered by self contained supply
- ★ Other Features: Large 3" square meter, D'Arsonval movement 2% accuracy, adjust ohms compensator; attractive metal etched panel; walnut finished wood case with carrying strap self contained battery included; compact size 7 x 4½ x 2½. Net price **\$10.95**

SEE these two series as well as any of the 12 popular PRECISION Test Equipment models on display at all the leading radio parts jobbers, or write direct for latest "spec" sheets.

Safety Technique

(Continued from page 28)

for some manufacturer to bring out a really useful gadget. In the meantime, a rubber sleeve of the type used with test clips could be slipped on the wire before fastening, and afterward pulled over the terminal to cover all the metal normally exposed. It would afford considerable protection.

Likewise, there's room for improvement in transformer terminal boards in the field of protection from accidental contact. When the transformer is mounted so that the present type of terminal board is within reach in the normal course of operating or routine adjustment, it ought to be covered up. This can be done quite easily by running all the wires through a piece of bakelite the same size as the terminal board and shoving the bakelite piece up quite close to the terminals. It will be rather hard to get your fingers in, and you'll probably be reminded to turn off the power before changing connections.

(12) Layout — In construction of r.f. units, components should be located so that danger of touching high-voltage circuits during adjustments or coil changing is minimized.

In other words, don't lay out a circuit so that you practically have to put your hand against the tank condenser or the plate of the tube when you change coils. Coils which have to be changed always should be on the most accessible part of the chassis.

(13) Parallel Feed — When design considerations permit its use, parallel feed to transmitting tubes is recommended for circuits in which coils must be changed manually.

The dangerous thing about a tank coil is the d.c. voltage — r.f. may cause a bad burn but is not likely to be fatal. So, if there's no d.c. on the coil your chances are much better should you forget "A" of the "ABC's." As a matter of fact, there's a lot of unfounded superstition about parallel feed, dating back to the days when it was hard to get a good choke. But at the present time suitable chokes are certainly available for low- and medium-power transmitters, at least when the set is not intended to cover the whole spectrum. Admittedly, it is asking a lot of a choke to work on all bands from 5 or 10 to 160. We don't say categorically that parallel feed must be used; rather, we say that if it *can* be used in your particular transmitter, it *should* be, and the set will be just that much safer to operate.

(14) Series Feed — With series plate feed in the final stage, coupling to the antenna preferably should be inductive; if direct coupling is used, blocking condensers amply rated to withstand the peak plate voltage should be installed between the plate tank circuit and the antenna system.

CRYSTAL
FILTER

ELECTRIC
BAND
SPREAD

R.F. ON
ALL
BANDS

CERAMIC
COIL
FORMS



Model
438

BUILT
with
Traditional
HOWARD
QUALITY

4 BANDS . . .

8 TUBES . . .

BUILT-IN SPEAKER

\$49.95

less crystal

HOWARD *Performance* IS THE PROOF!

ANNOUNCED only 90 days ago — the 438 has been welcomed with open arms.

A truly quality instrument that will surprise you in its performing abilities. Model 438 embodies professional features never before associated with equipment in this price class . . . real "DX" with R-9 reception: Ceramic Coil Forms . . . R.F. Stage on all Bands . . . Separate Coils for each Band . . . Xtal Filter . . . Complete Coverage 540 KC — 43 MC

. . . Electric Band Spread with vernier control . . . 2-stage Iron Core I.F. . . . Accurately Calibrated Slide Rule Dial . . . 8 Tubes . . . Provision for a 6-volt Power Supply . . . Band-in-use Indicator . . . B.F.O. with Pitch Control . . . 2 Watts Power Output . . . Built-in 6" Dynamic Speaker . . . Head Phone Jack . . . Doublet or Marconi Antennae Connections . . . Provision for External Speaker . . . Provisions for Howard tube type 'R' Meter.

Models to Suit the Individual Tastes of the Most Exacting Amateur and Professional

MODEL 450-A — 12 Tubes — 6 Bands — Frequency Coverage .54 to 65 MC . . . Ceramic Coil Forms . . . Dual I.F. Channels . . . Two S.L.F. Ceramic Insulated Tuning Condensers . . . 47 inches of electric bandspread . . . Crystal Filter . . . Calibrated 'R' Meter . . . Accurately calibrated direct reading dial . . . Price, with Tubes, less Speaker, less Crystal. Net \$87.50

MODEL 430 — 6 Tubes — 4 Bands — Frequency Coverage .54 to 40 MC . . . Ceramic Coil Forms . . . B.F.O. with pitch control . . . Iron Core I.F. transformers . . . Electric bandspread . . . Built-in Dynamic Speaker . . . Headphone jack . . . Accurate direct reading straight line dial . . . Price, Complete with Tubes and Speaker. Net. \$29.95

MODEL 440 — 9 Tubes — 5 Bands — Continuous coverage .54 MC to 40 MC . . . Ceramic Coil Forms . . . S.L.F. Ceramic Insulated Tuning Condensers, Electric bandspread, R.F. on all bands, Iron Core I.F. transformers . . . Electric bandspread . . . Calibrated 'R' Meter, Crystal Filter . . . Price, with Tubes, less Speaker, less Crystal. \$66.50

Pacific Coast and Export Prices Slightly Higher

Howard Radio Company

1731-35 West Belmont Ave., Chicago, Ill.

Please send me more information on

Model 438

Model 430

Model 450-A

Model 440

Cable Address: "Howardco"

Name

Address

City.....State.....

America's Oldest Radio Manufacturer

BROADCASTERS HAVE LEARNED —

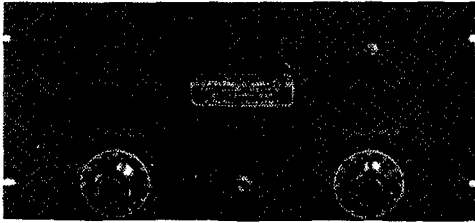

Yes, Broadcasters have learned that the Gates Peak Limiting Amplifier has definitely boosted their modulated signal from 3 to 5 db. Figure this out on your slide rule and you will find this is equal at least to doubling power in voice transmission.

Gates American now offers to the communications industry a new type and moderately priced peak limiting speech amplifier designed for quick action, high gain, to positively prevent over modulation and best of all gives that voice signal a mighty nice boost without over-modulation.

Police radio, airport stations, discriminating amateurs and many other phases of communications will want to investigate this equipment by writing for Bulletin Q44 or inquiring of their jobber.



This hardly needs comment. We certainly don't want the plate voltage to appear without warning at the feeders or on the antenna. Use good blocking condensers, not only rated for the peak plate voltage (including modulation) but also to carry the r.f. current that will have to flow through them.

(15) Breadboards — Breadboard-type transmitters should be provided with panels to prevent accidental contact with live components when controls are operated. Items (2) and (3) should be observed with respect to apparatus mounted on or projecting through the panel.

It is obviously desirable to have a breadboard transmitter arranged so that no danger spots are waiting for unwary fingers when only normal tuning operations are being carried on. If you have a breadboard layout, by all means put a panel in front (wood, presdwood or similar materials will do) and then treat the panel just as though the set were in a rack. Meters can be mounted conveniently at the back of the breadboard where they are easily visible but well out of reach.

(16) Clips — Adjusting clips on tank coils should be provided with insulating sleeves.

Rubber sleeves over clips used to vary antenna coupling in direct- or capacity-coupled circuits may prevent a burn or shock should the operator forget to turn off the power while making adjustments. They're worthwhile protection, inexpensive and can be installed in a few seconds.

(17) Keys — The arm of the telegraph key should be grounded in every case. In keying circuits which do not permit a direct ground on the key, a suitably-insulated relay should always be used. Live parts of the key should be protected from accidental bodily contact by suitable covers or barriers.

Lots of fellows have had jolts from keys, especially those using center-tap keying. *Always* arrange the circuit so that the arm of the key can be connected to an actual ground. This automatically safetyizes most of the exposed metal parts; the remaining hot points should be covered over so they can't be touched. It would not be hard to make a small box of wood or metal to fit over most of the key, leaving only the operating lever in the open. Manufacturers could help out here, too.

Incidentally, the key symbol that appears in diagrams (including those in the *Handbook*) is not to be taken as a literal representation of the method of connecting the respective sides of the key. Convenience usually dictates which way the key is drawn, and although we intend to make the picture and practice conform wherever possible, always remember that in doing the actual wiring the key arm *should go to ground*, no matter how it is represented in the diagram.

The NEW

THROUGH POINT BUSHING

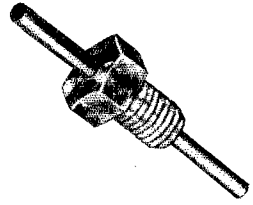

THE NEW NATIONAL Through Point Bushing is one of the handiest gadgets in years. Its body of injection-molded low-loss Victron is compact enough to go in cramped quarters conveniently. It obviously makes an ideal lead-through bushing for low power equipment. It is equally useful as a stand-off insulator, for mounting R-100 Chokes, NC-600 Neutralizing

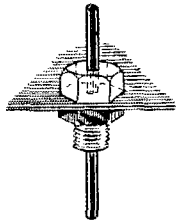

Condensers and the like. The central conductor is .093" in diameter — the same as the pin on an octal tube — so that contacts from the National CIR Octal can be used for clip connections. The central conductor can be removed from the bushing if desired, but it does not come easily, but a good grip and a steady pull with the pliers will do the trick. The hollow bushing can then be threaded over bus wire of any length desired, and fastened in place by heat or coil dope.



Sockets can be used if desired. It does a steady pull



Best of all, the price is so low that you can use them freely. Only \$.45 net, per package of twelve.

NATIONAL COMPANY, INC., MALDEN, MASS.



What —

Is the F.C.C. Regulation Re: ?

- Operation in times of emergency
- Measurement of xmitter frequency
- Operation of 'phone transmitters
- Measurement of transmitter power
- Frequencies for ham television
- New ultra-high-frequency bands
- Stability of signals up to 60 Mc.

THE ANSWERS will be found in
the current (ninth) edition of

THE RADIO AMATEUR'S LICENSE MANUAL

Going after your first ham "ticket"? You need the manual for its instructions on where to apply, how to go about it in the right way — and, most important of all, for the nearly 200 typical license exam questions and answers.

Already licensed? The manual is still necessary for its dope on renewal and modification procedure, the Class A exam (with typical questions and answers), portable procedure, etc.

ALL the dope on every phase of amateur licensing procedure, and, of course, the complete text of the new regulations and pertinent extracts from the basic radio law.

25¢ postpaid

THE AMERICAN RADIO RELAY LEAGUE
West Hartford, Connecticut

(18) Relays — Relays should be provided with covers, or installed in such fashion that accidental closing by mechanical means cannot occur.

A relay is a useful and often indispensable device, but is not always to be trusted. A power or keying relay mounted in the transmitter often can be turned on unintentionally if something (a tool, for instance) should drop on it and close the contacts. Therefore the relay should be so placed in the set that such a contingency cannot occur, or a cover should be installed for the same purpose.

No protection can be afforded against sticking relay contacts without going into our third section of the safety problem, special safety devices. We shall do that later. But Rule 5 of the present series, always remembering "A" of the "ABC's," will take care of such a situation.

There they are. As we said before, none of them represents any particular hardship, either constructionally or on the basis of cost. All have the weight of logic behind them. Naturally we intend to follow them in our own construction, although freely admitting that exceptions to some of them can be quoted to us both from past *QST's* and *Handbooks*.

Accidents still can happen, of course, even though all these constructional precautions are taken; that is why we put primary emphasis on the "ABC's." But following them will do much to reduce the chances of accident; for safety's sake, put them into practice *at once*.

One point brought up by a correspondent deserves mention. Many 110-volt lines have fuses both in the grounded side and the hot side, and a dangerous condition can arise should the fuse in the ground side burn out, leaving the other fuse intact. Such fusing was common practice years ago, but is contrary to the National Electrical Safety Code. Look over your cellar installation, and check to see if there is a good ground connection to one side of the circuit or to the center wire of a three-wire system. If so, and the ground or neutral is fused, bridge the fuse by a good solid connection using wire of the same size as the rest of the circuit. If you have any hesitancy about making this change, get your local building inspector to confirm it.

In closing, we want to repeat here the thought in last month's Editorial. No voltage, including those in the lower hundreds, can be considered non-dangerous to life. Handle *every* circuit with caution — remember that the lowly 110 has more electrocutions to its credit than any other.

Strays

NEW QTH?

All magazine publishers find the change-of-address problem difficult at best. It is necessary to prepare wrappers well in advance of the actual mailing. Prompt advice of your new address, giving your old one at the same time, will be greatly appreciated.

ATTENTION ALL HAM'S

THORDARSON QUALITY AT PRICES YOU WILL APPRECIATE

THE "19" SERIES

- * PLATE TRANSFORMERS
- * CHOKES
- * MODULATION TRANSFORMERS
- * FILAMENT TRANSFORMERS
- * DRIVER TRANSFORMERS

"19" SERIES PLATE SUPPLY TRANSFORMERS
Primary 115 Volts, 50-60 Cycles

Transformers rated in D.C. volts from two section filter
Electrostatic shield between primary and secondary

THORDARSON QUALITY FOR THE
"HAM" IN THE POPULAR-PRICE FIELD!
COMPARE!

Shown at the left is catalog information on the plate transformers and chokes in this new series of transformers. Complete information on the full series in Catalog No. 400-C, from your parts distributor or write factory for *Free* copy.

Type No.	Sec. A.C. Load Volts	D.C. Volts	D.C. M.A.	Your Cost
T-19P55	660-0-660 550-0-550	300* 490	250	\$4.50
T-19P56	900-0-900 800-0-800	750 600	225	4.80
T-19P57	1075-0-1075 507-0-507	1000** 400	125 150	6.00
T-19P58	1200-0-1200 900-0-900	1000** 750	200 150	7.80
T-19P59	1560-0-1560 1250-0-1250	1250 1000	300	9.60
T-19P60	1875-0-1875 1560-0-1560	1500 1250	300	11.10
T-19P61	2125-0-2125 1875-0-1875	1750 1500	300	12.00
T-19P62	2420-0-2420 2125-0-2125	2000 1750	300	12.90
T-19P63	1560-0-1560 1265-0-1265	1250 1000	500	13.80
T-19P64	1875-0-1875 1560-0-1560	1500 1250	500	17.70
T-19P65	3000-0-3000 2420-0-2420	2500 2000	300	17.70
T-19P66	2125-0-2125 1875-0-1875	1750 1500	500	22.50
T-19P67	2450-0-2450 2125-0-2125	2000 1750	500	25.50
T-19P68	3000-0-3000 2450-0-2450	2500 2000	500	30.00

*This transformer has a bias tap at 30V. **These transformers designed for double rectifiers and will deliver both secondary ratings simultaneously.

"19" SERIES SWINGING AND FILTER CHOKES

Inductance listed is that actually measured at rated current

SWINGING CHOKES						
Type No.	Cap. D.C.M.A.	Inductance Henries	D.C. Res. Ohms	Volts Insulation	Your Cost	
T-19C35	200	5-20	130	3000	\$2.85	
T-19C36	300	5-20	105	3000	3.90	
T-19C37	400	5-20	90	4000	5.40	
T-19C38	500	5-20	75	4000	6.90	
SMOOTHING CHOKES						
T-19C42	200	12	130	3000	2.85	
T-19C43	300	12	105	3000	3.90	
T-19C44	400	12	90	4000	5.40	
T-19C45	500	12	75	4000	6.90	

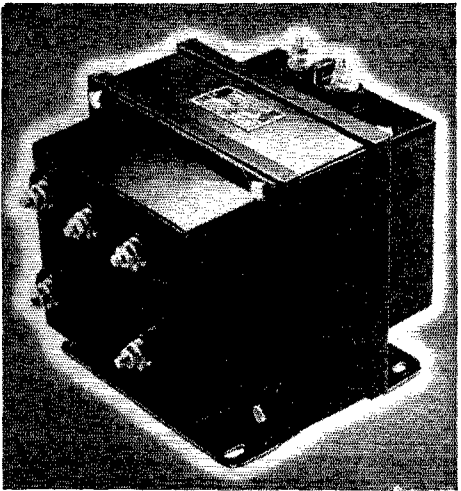

"19" Series Plate Transformer
Mounting Style 2 K
Fully shielded - Air cooled

THORDARSON ELECTRIC MFG. CO.
500 W. HURON ST., CHICAGO, ILL.
Demand "Power by Thordarson"

Low Driving Power

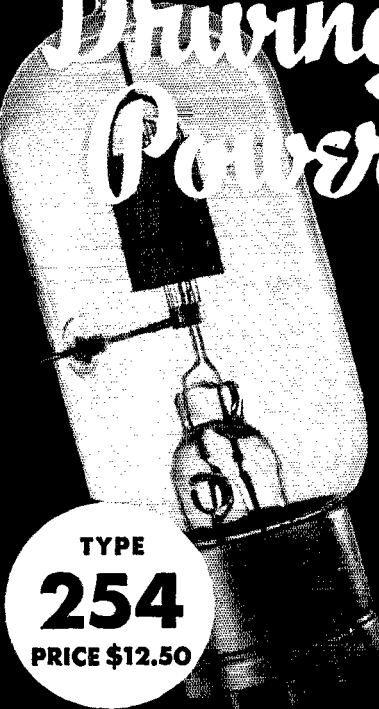

TYPE
254
PRICE \$12.50

HIGH POWER GAIN

Because of their scientific design and the use of a braced vertical bar tantalum grid, the 254 and other GAMMATRONS have a high power gain. This is possible because only tantalum will operate successfully with the close filament to grid spacings employed in GAMMATRON tubes. Other grid materials give rise to secondary emission when placed too close to the filament and thus they cannot successfully give the high power gain that GAMMATRONS afford.

This means that your rig is cheaper to build, requires less stages, the crystal duty is lighter, and it is easier to tune when you use GAMMATRONS.

Write for data Type 24 to 3054.
Heintz & Kaufman, So. San Francisco

 **GAMMATRON**

Modern Band-Switching Super

(Continued from page 29)

only a small capacity of approximately 2 μ fd. to the detector grid. The b.o. output is variable from practically zero to maximum without frequency shift. While this may seem an unnecessary control it really is extremely useful in weak signal reception. There is also a point at which the sensitivity of the second detector is maximum, and more b.o. output greatly reduces the sensitivity of the detector.⁴

Communications Switch

As everyone knows who has used them, acorn tubes will not stand r.f. floating through them during periods of transmission and must be protected. The method used here is to open the cathode circuit, thus preventing grid current from flowing. In addition the plate circuit is broken. An extra set of contacts opens the keying line to the transmitter whenever the switch is in the receive position; this prevents a visitor from playing havoc. Besides protecting the acorn tubes the send-receive switch opens the cathodes of the second detector and 6C5 a.f. stage in order to remove all noise at the output and allow the monitor to be heard. With this method most of the receiver is left on, including all oscillators. As a result there is no mad scramble to find that weak DX station when coming back on the receiver since there is no drift caused by entirely removing the plate voltage, as is so often done. Unfortunately, break-in operation simply is out of the question with acorn tubes near a transmitter of much power, if decent life is to be expected from the tubes.

Power Supplies and Line Filter

The current drawn by the 6L6 stage is approximately 130 ma., while the balance of the receiver draws 85 ma. Either current is a fairly heavy load, so two power supplies were deemed the easiest way out. This increases the overall bulk and weight somewhat but has the advantage of allowing the a.f. to be removed when not being used. Both supplies are arranged so that the heaters of all tubes may be turned on separately before the plate supply. The combination bleeder and series resistor on the supply for the r.f. end of the receiver is for the purpose of adjusting the output to 350 volts, at which value all tubes have the correct voltages. This is necessary because of the drop through the series resistors in each plate lead.

The a.c. line filter is mounted in a completely-shielded aluminum box under the chassis, with the a.c. for the entire receiver coming directly

⁴ It seems likely that the reduced sensitivity occurs when the detector grid is overloaded; that is, when the sum of the b.o. voltage and incoming-signal voltage exceeds the grid bias. The audio beat output will increase with b.o. voltage until its value equals the signal voltage, after which the audio output will remain constant. With strong signals, the detector overload point might readily be reached before the equal-voltage condition, with the result that there will be a definite maximum-sensitivity point on the b.o. output control. —EDRON.

Taylor Tubes Topics



BATHING BEAUTIES WIN ON "LOOK" BUT TAYLOR TUBES WIN ON "PERFORMANCE"!

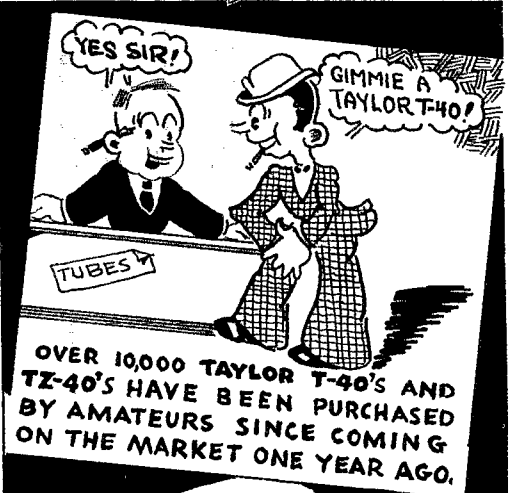

OVER 10,000 TAYLOR T-40'S AND TZ-40'S HAVE BEEN PURCHASED BY AMATEURS SINCE COMING ON THE MARKET ONE YEAR AGO.



FACTS TO REMEMBER

***1939 MANUAL AND CATALOG FREE FOR THE ASKING. GIVES COMPLETE DOPE ON BIG FREE CHASSIS DEAL. * T-55 NOW ONLY \$6.00 * NEW, MIGHTY 249B'S-HI-POWER RECTIFIER FOR KILOWATT RIGS. * KEEP AN EYE OPEN FOR OUR ADVERTISEMENT ON THOSE NEW, SENSATIONAL THIN WALL CARBON ANODE TUBES.**

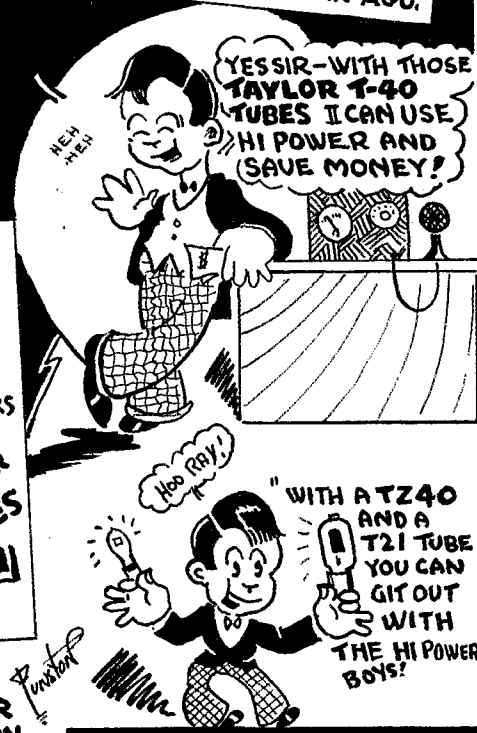

"WITH A TZ40 AND A T21 TUBE YOU CAN GIT OUT WITH THE HI POWER BOYS?"

"More Watts Per Dollar"

TAYLOR TUBES, INC., 2341 WABANSIA AVE., CHICAGO, ILLINOIS

FIRST CHOICE

OF EXPERTS . . . EVERYWHERE!

SELECTED by Temco engineers for the powerful 1000 "water" built for King Ghazzi . . . Standard equipment on the finest jobs of leading transmitter manufacturers . . . Specified by foremost kit makers . . . Favorite of famous rig designers . . . There can be no greater nor more sincere indication of B & W superiority than this widespread acceptance of AIR INDUCTORS by men whom you have recognized as top-notch transmitter experts. These men judge by PERFORMANCE . . . we ask you to do the same. Go to your jobber's and examine AIR INDUCTORS . . . try them! Then you will be the judge!

BARKER & WILLIAMSON
DEPT. A-3
ARDMORE, PA.

B & W "BABIES"
NEW! . . . "Tops"
in 25-watt performance! See them at your jobber's — or write for details.

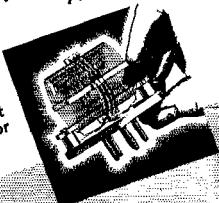

AIR INDUCTORS

into it through the rear of the chassis. The filter consists of a double r.f. choke in each side of the line and a grounded center-tapped condenser. It serves both to prevent r.f. from a transmitter from entering via the power line and to reduce noises such as those caused by electrical apparatus cutting on and off. Naturally, it would also prevent any signal pickup from this direction as well. After trying this filter on a standard receiver in a noisy location we are completely sold on it. All constants are given under Fig. 1 and were figured to cover an r.f. range of 3.5 to 30 Mc.

Mechanical Construction

Everyone has his own ideas as to panel and chassis layouts, so no time will be spent on that subject. The front panel is 30 by 11½ inches and the chassis is 5¾ inches high by 18 inches deep and 29 inches long. The entire assembly exclusive of the coil compartments is made of ¼-inch aluminum. Aluminum of this thickness is very rigid, and while somewhat more expensive than steel it is a pleasure to work. The chassis is made of four separate pieces rather than being bent from a single sheet, as it is difficult to bend aluminum of this thickness and get a nice-looking job. Half-inch brass angle pieces fasten the chassis together and made in this way all edges are absolutely true. The front panel acts as the front edge of the chassis and also completes the shielding on this side of the coil compartments.

As an aid to station operation and to dress up the front panel, a 4-inch electric clock is mounted to the left of the dial where it becomes a permanent part of the station and does not get knocked over.

For frequency spotting two sets of curves were made, one set covering the general-coverage ranges and the other the different amateur bands.

Most ham equipment is turned out without any engraving or finish and as a result the appearance is not all that could be desired. There are a good many different finishes that can be applied to aluminum. In this case we used a steel-wool grained finish with two coats of very thin lacquer which serves to remove all gloss and leave a satin-smooth finish. The lacquer used is called No. 33 bronzing liquid, and while it can be scratched somewhat it prevents dirt from getting directly into the aluminum and it may be washed without damage.

The panel engraving is another home-brewed job and was done with a set of dies and a hammer. It is mighty ticklish work, and one must practice on other things first or a good panel will certainly be ruined. The dies are fairly expensive — our set cost \$7.50 — but they will last a lifetime. The scales were cut in the panel with dies made from tool steel blanks. The scales are first laid out on the panel with a protractor equipped with a 6-inch rule pinned at its center. These little gadgets are mighty handy and are sold in dime stores. The position of all lettering is marked with

Your Inquiries Invited

When you need amateur equipment it is to your advantage to write to me. You get personal attention; 6% terms financed by myself so you buy with less cost and more convenience; fair trade-in value for your equipment; ten day trial of all receivers; and my cooperation in every way to see that you are 100% satisfied. For any equipment, the latest information and technical help, write to W9ARA.

Compare My Terms with Others

Model and Receiver	Cash Price	Down Payment	12 Monthly Payments
The new RME-70	\$138.60	\$27.72	\$9.79
HQ-180X and NC101X	139.00	25.80	9.11
NC100A	130.00	24.00	8.48
NC80X and NC81X	99.00	19.80	6.99
Breting 49 and S16	99.00	19.80	6.99
Howard 438	49.95	9.99	3.53
NC-44 and S-20	49.50	9.90	3.49

Also HRO, Breting 9, Howards, Sargents, all others

Similar terms on Hallicrafters, National, Harvey, RCA, RME, Temco transmitters and Thordarson, National, U.T.C., Utah, Kits.

Bob Henry

W9ARA

BUTLER

MISSOURI

IT'S HERE AT LAST

THE MEISSNER

TELEVISION KIT!!

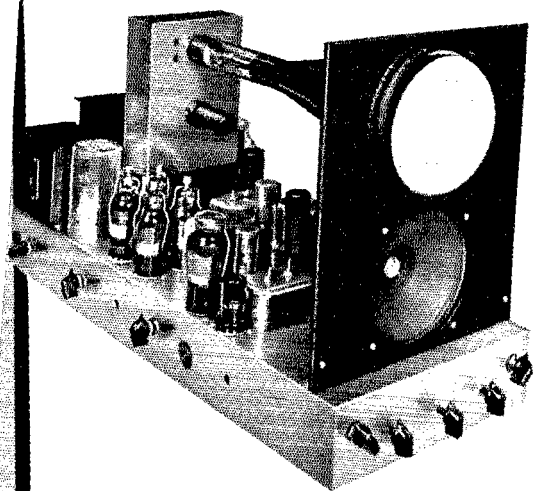

SOUND as well as VIDEO—both in one unit!



The New Shock-proof design!



Meissner quality at a price anyone can afford to pay!



Meissner OFFERS YOU practical TELEVISION because Meissner has put years of time in research to be READY when REAL TELEVISION arrived. It is HERE NOW!



Two models — one with 3-inch and one with 5-inch tube!



The last word in modern TELEVISION!

Get your name in NOW for the first information!

WRITE TODAY FOR FULL DETAILS!

Meissner

DEPT. Q-3, MT. CARMEL, ILL.

"A FAMOUS NAME FOR TWO DECADES"

MAIL COUPON

MEISSNER MFG. CO.
Mt. Carmel, Illinois, Dept. Q-3
Please *rush* me information on
TELEVISION KITS!!

Name

Address

City..... State.....

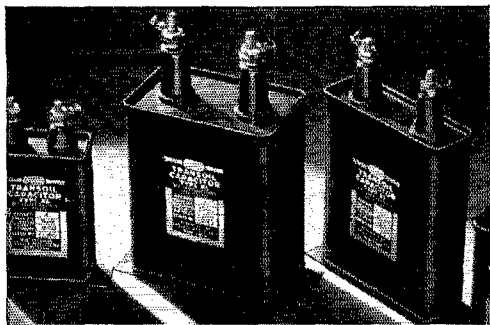

TRANSOIL

for transmitting

**HIGHEST QUALITY
OIL CAPACITORS**

Write for Catalog 2-X
listing complete lines

TRANSOIL—SOLAREX—TRANSMICA

SOLAR
MFG. CORP.



599 BROADWAY
NEW YORK CITY

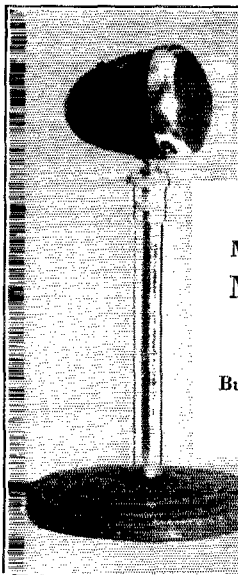

NEW INSIDE NEW OUTSIDE

That's the story
on the

TIBBETTS MONOBAR-CRYSTAL MICROPHONE

NOT AN OLD IDEA
PUT IN A NEW CASE

But a radically different and
advanced type of
Crystal Microphone

High quality
output of .1 volt
at
four inches speaking
distance — think of it
— takes less amplifier.

Order yours direct today — money back guarantee. Complete with base and 7 feet of cable — black and chrome finish. \$10.45 cash — \$11.45, \$5.45 with order and promise to pay \$1.00 monthly until paid in full.

WRITE FOR DESCRIPTIVE BOOKLET TODAY

TIBBETTS LABORATORIES
Camden, Maine

a rule and pencil and equally divided on each side of the center line of the control with which it is associated. All it takes is a steady hand, a good eye and plenty of practice to turn out a nice job.

Results and Comments

The noise suppressor reduces automobile hash about 75 per cent on the 14-Mc. band and somewhat less than this percentage on 28 Mc. Also, any crashing noises such as lightning are reduced to the point where they are not bothersome at all and only produce a soft sound. On the lower-frequency bands automobile hash is completely removed. Just why it doesn't do the same on 14 and 28 Mc. is hard to say except that ignition noise is of course much stronger on those bands. By switching in the network a lot of the ignition noise is reduced still further and the overall noise level is the lowest of any receiver we have ever heard. Although located 17 miles in the country, the station is on a main highway and is a perfect spot to try out such things as noise suppressors. The gain of the two 956 pre-selector stages is so high that the i.f. gain is at a minimum practically all the time. This applies to 28 Mc., too, which we feel is "something."

What the League Is Doing

(Continued from page 35)

ELECTION STATISTICS

IN OUR recent elections 96.8 per cent of the voting by members of the League was done by licensed amateurs. Only 3.2 per cent of the balloting was done by members whose right to vote was based upon the fact that they have been continuously members of the League since May 1, 1934. The figures by divisions are as follows:

	Licensed Amateurs Per Cent	Relying on Prior Membership Per Cent
New England Division.....	96.4	3.6
Northwestern Division.....	97.8	2.2
West Gulf Division.....	96.9	3.1
Rocky Mountain Division....	95.7	4.3
National Average.....	96.8	3.2

The prior-membership figure drops steadily. It was 18 per cent in the 1934 elections, was down to 6.04 per cent in the 1937 elections, and is now not a factor of consequence in our elections.

Portable Station

(Continued from page 37)

photographs of the finished outfit. Note the flexible coupling on the oscillator tuning condenser and the bakelite shaft extension on the amplifier tuning condenser. All parts are located to reduce wiring to a minimum, especially in the r.f. circuits. It is necessary to mount and wire the

"The RADIO SHACK

Hallicrafters leads the field again!

BUY ON
EASY
TERMS



The New
**SKY
BUDDY**

Now 10 METER BAND
with ELECTRICAL BAND SPREAD
IMMEDIATE DELIVERY

Check These Features

- 6 Tubes with 8 Tube Performance
- 4 Bands
- Complete Coverage 44 MC to 545 KC
- Separate Band Spread Dial
- Built-in Speaker
- Beat Frequency Oscillator
- Pitch Control
- Send-Receive Switch
- Phone Jack
- Band Switch
- AVC Switch

Amateur's Net Price

\$29.50
COMPLETE

Write for
FREE
72-page
Catalog



Special Value!

X-CUT 40 METER
UNMOUNTED CRYSTALS
7000 KC TO 7300 KC

We reserve the right to supply within 10
KC of your desired frequency, but due to
our large stock, we can usually supply
them within a few KC.

**SPECIAL
LOW PRICE \$1.35**

MAIL
ORDERS
FILLED
PROMPTLY



New Hammarlund "HQ-120"

Continuous range from 31 to .54 mc — 12
tubes; antenna compensating control; 310°
band spread; noise limiter follows AVC for
quiet reception; variable band width crystal
filter for phone reception; calibrated "S"
meter on all models.

Model	Cash Price	Down Payment	Per Mo. Per 12 Mos.
HQ-120*	\$117.00	\$23.40	\$8.36
HQ-120-X**	129.00	24.00	9.47

*Less crystal filter **With crystal filter

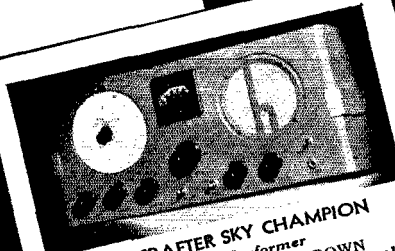

HALLICRAFTER SKY CHAMPION
A Proven Performer

Cash Price **\$49.50** or **\$9.50 DOWN**
and **\$7.33** for 6 months

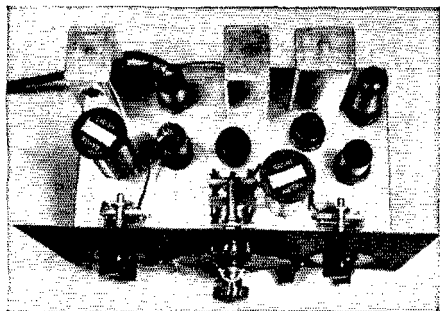

Kit of Parts for

The QST REGENERATIVE SINGLE SIGNAL SUPER

Described in October '38 QST

This single signal super, designed by George Grammer, was described in the October 1938 issue of *QST*. By popular request, we have decided to supply the complete kit with all specified parts, miscellaneous parts, punched chassis, and panel, 8 coil forms and wire to wind them, diagrams, and instructions. Nothing else to buy except tubes and power supply.

A high degree of selectivity is accomplished by using regeneration in the mixer stage; and is equal to a receiver having a stage of pre-selection.

Single signal reception is gained with regeneration used in the I.F. amplifier. The I.F. stage is quite conventional, and it has a marked absence of drifting, due to the permeability tuned I.F. transformers.

Complete kit less tubes and power supply
NET PRICE..... **\$19.56**

Kit of 6 Raytheon tubes for above kit..... \$4.49

Crackle finished, hinged top cabinet, supplied at \$1.95 extra

46 BRATTLE ST. - BOSTON, MASS. - U.S.A.



Professional Performance

FOR AMATEURS

with the

NEW BRUSH MIKES

The Brush High Leveler Series is being greeted with cheers from the ranks of the amateurs. Model HL high level—46 db. comes complete with *Vari-Swiv* mounting and 25 feet of cable. List price \$23.50. The second in the series is the D-1 model which is especially recommended for better quality amateur P.A., recording, and amateur applications. Its level is — 62 db. with a response from 30 to 5,500 c.p.s. ± 3 db. Complete with *Vari-Swiv* mounting \$23.50 list. Above microphones available with socket assembly in place of *Vari-Swiv* when specified.

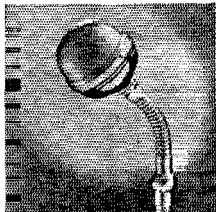

MODEL HL

Write for complete catalog

THE BRUSH DEVELOPMENT COMPANY
3320 Perkins Avenue Cleveland, Ohio

various components in a more or less systematic order, or you may find a connection down inside somewhere that needs soldering and it will be necessary, perhaps, to remove half the parts in order to do the job. Ordinarily we try to build equipment that is easily serviced, but in the interests of compactness we took a lot of liberties with this outfit.

Power Supply

The a.c. power supply is quite conventional and the schematic, Fig. 2, is self-explanatory. Any available power supply furnishing 300 volts d.c. at 130 ma. with good regulation, and 6.3 volts a.c. at 4.9 amperes, will be satisfactory. A four-prong Jones socket is used to take power-supply cable from the portable.

The vibrator supply was home built as there were none on the market at that time with sufficiently high output. They are available from several different manufacturers now. The power transformer was wound on a core of 1½ by 1¾ cross section. The primary consists of 35 turns of No. 10 enameled wire, center-tapped. The secondary is wound with 1950 turns of No. 30 enameled and is also center-tapped. The vibrator used is a Mallory Type 225. The type 725 is also suitable and has the advantage of being reversible in its socket to reverse the polarity of the d.c. output in case of use on a car that has the wrong side of the battery grounded to the frame. It requires a special socket which is available from the vibrator manufacturer.

It is very important that the filament conductors be carried straight through to the battery clips as the hash and hum set up by using one wire to carry both the vibrator and filament circuit from the battery to the d.c. power supply was terrific. The entire d.c. supply is housed in a heavy (16-gauge) iron box with welded corners and a close-fitting lid. It is also equipped with a four-prong Jones connector.

The primary power is removed by disconnecting a battery clip, as the introduction of switches in the 6-volt d.c. circuit caused some difficulty with voltage drop on account of the relatively high current. The total drain from the storage battery is 14 amperes in the transmitting position and 11 amperes for receiving. This can be reduced to less than 10 amperes by turning off the transmitter filaments when they are not needed. A word of caution regarding the buffer condenser: It must have a rating of at least 2000 volts or it is likely to blow up on the extreme peak voltages encountered.

In conclusion, the results obtained from the set have more than justified the work involved in building it. We have never failed to keep a schedule, and have never replaced or repaired any part in the seven months of hard usage the set has had. We have loaned it on different occasions to other amateurs, and it has been all over the states of Idaho, Washington and Montana, under all sorts of weather conditions and over all sorts of roads. We feel that it is truly a portable station in every sense of the word.

The King CHOSE PAR-METAL!

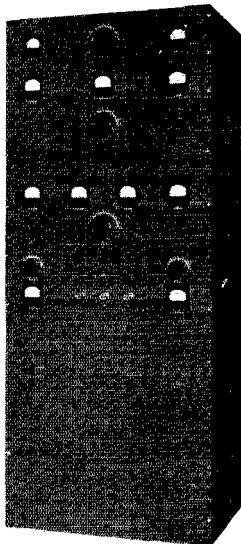

This Temco one KW transmitter, just built for a well known Eastern ruler, was completely housed in a Par-Metal cabinet.

Par-Metal racks, panels and chassis are the standard of the industry both for Amateur and Broadcast stations.

Send today for catalog 39 showing the many combinations possible with Par-Metal Products.

PAR-METAL PRODUCTS CORP.

3521-41st St., LONG ISLAND CITY, N. Y.

TUBES THAT STAY

Gas-free

HAVE HEAT-PROOF ANODES

Properly evacuated tubes with SPEER Graphite Anodes stay gas-free because these heat-proof anodes permit degassing at temperatures far beyond any encountered in practice, and thereafter give off no gas. On the contrary, SPEER Graphite Anodes tend to absorb gas given off by other tube elements.

Being heat-proof at temperatures even beyond the melting point of glass, SPEER Graphite Anodes do not soften, fuse or warp. They can't — no matter what you do.

SPEER Graphite Anodes are sold only to tube manufacturers. A list of these and SPEER Graphite Anode Book 80 sent on request.

SPEER CARBON CO.
ST. MARYS, PA.

Chicago
Cleveland
Detroit

Milwaukee
New York
Pittsburgh



SPEER GRAPHITE ANODES

Station Activities



ATLANTIC DIVISION

EASTERN PENNSYLVANIA — SCM, John B. Morgan, W3QP — Asst. S.C.M. in charge of E.C. W3AKB — R.M.'s: 3AKB, 3AQN, 8ASW. 3FRY did some fine relay work direct with KAIBH and K6BNR. 3EEW copied a message some 400 words long from OY4C for A.R.R.L. 8CIG, Activities Manager of the Susquehanna Valley A.R.A. at Selinsgrove, advises they have applied for League affiliation. They meet every Friday night in the Selinsgrove Community Centre, and invite any interested hams to drop in any time. 8DEC and 8QJP had an all-night party New Year's eve, and worked 4 countries on 3.9-Mc. 'phone. 8RJL was active in last QSO Party. 3ADE is "suppressing" his modulation on 1.75 Mc. 3AKB reports much better operating conditions on Trunk Line "C"'s new frequency. Five Section members made the B.P.L. as a result of the "Christmas rush." 3AQN is very pleased with the cooperation of the members of the Eastern Penn. Traffic Net. 3BGD can work into Europe any time between 3 P.M. and 4 A.M. on 7 Mc. 3DGC moved to 1720 St. Paul St., Baltimore. 3EEW, an O.O., says there can be no excuse for F.C.C. tickets since the new laws have become effective. 3EZ reports that the Main Line Radio Club has inaugurated a weekly roll-call by 'phone; members turn out nicely. 3GYK has the unique set-up of a 6L6G pushing a '52 to 100 watts. 8ATF finally hooked Colorado on 3.5 Mc. and was delighted with 599 report. 8OML now uses an 800.

Traffic: W8ADE 34 3AKB 205 3AOC 228 3AQN 254 3BGD 283 3BES 20 3EDC 263 3ERW 14 3EFH 156 3EML 467 3EJW 2 3EZ 253 3GDI 37 3GMC 225 3GUB 13 3GYK 26 3HCT 2 3HDB 1 3QP 1200 8ASW 440 8ATF 21 8COT 15 8EY 3 8FLA 127 8HKS 22 8OML 4.

MARYLAND-DELAWARE-DISTRICT OF COLUMBIA — SCM, Edgar L. Hudson, W3BAK — 3CXL, 3CQS, R.M.'s. 3BWT, Chief R.M. 3ECP has been rebuilding. GKN is building new exciter. HUM reports T.L. "A-P" very active. HSB has new NC-44. EKZ has new rig with 100TH's and worked 54th country. DRE has worked 19 countries and 5 continents. ETE needs only New Mexico for W.A.S., Asia for W.A.C. WU is QRL QSL Bureau. EZN has new P.P. T125 final.

Traffic: W8CXL 1360 (WLM 7113) CIZ 920 BWT 686 ECP 516 GKN 116 HUM 96 HSB 17 ME 27 CDG 10 FPQ 5 GZK 6 AKR 2 BAK 1.

SOUTHERN NEW JERSEY — SCM, W. W. Filson, W3BEI — The Section is topped in traffic this month by EFM. BZX on Trunk "B" is reaching a commanding position. DNU is N. J. alternate in newly formed "Eastern Owl Net" which GCU is working hard to perfect. HLV is with C.C.C. at Blanding, Utah. ZI made 90 contacts in 30 Sections in A.R.R.L. Party. FFE reports from U. of P. FBW made about 14,000 points in the party. GDW is grinding his own crystals. HPE joined Trenton Radio Society, which is 100 per cent A.R.R.L. The Frankford Radio Club visited T.R.S. 3 BES as M.C. The Greater Camden Radio Club elected officers: Pres., AYZ; vice-pres., C. O'Neill; sec., CZN; treas., BYK; sgt.-at-arms, V. Parker; directors, Burkett, Blair, LuBrant and McCurdy. Club meets 2nd and 4th Wednesdays at Camden Y.M.C.A. HKO is putting finishing touches on new 300-watt rig. GNU gave 7-Mc. DX'ers a treat with 600-watt rig. FTU completed fine 28-Mc. rig. HHZ is trying to make W.A.C. on 28-Mc. 'phone. AYC added a reflector to 14-Mc. antenna. ZI has gone 'phone and is cutting capers on 3.9 Mc. Prospective O.P.S. should communicate with OCO, new P.A.M. South Jersey Radio Ass'n gives a door prize (no charge) each meeting night. Ek-3AN is now 9AQC in Lake Bluff, Ill.

Traffic: W3EFM 367 (WLNJ 38) BZX 240 DNU 212 ZI 169 BYR 75 (WLVN 51) GCU 65 QL 36 BEI 35 FBM 31 GUG 6 ABEJ-BAY 3.

WESTERN NEW YORK — SCM, H. E. Preston, W8CSE — R.M.'s: 8BJO, 8DSS, 8FCG, 8JTT. P.A.M.: 8CGU. E.C.: 8GWY, 8RGA. Section O.R.S. frequency: 3720 kc. RGA, Emergency Coördinator is building strong organization in Monroe County. The Rochester Club is enjoying very active year; on Jan. 15th they held local QSO party with contacts limited to Monroe County; a silver

loving cup was offered the winner. NOI is now on 3.9-Mc. 'phone as well as 28. EBS gave the Rochester Club an FB talk on 28 Mc. DOD was on 1.75-Mc. 'phone during local party. SGX is trying to get on 28 Mc. PPR and RGA are experimenting with 28-Mc. antennas. RRF is running 150 watts to pair of 6L6's on 14 Mc. ABX's vertical blew down. DZF is passing out "seegers." ECM is a "papa," too. BOX moved to Dansville, Ill., and has call 9KVS. HZD is going to 14 and 28 Mc. Thanks to RGA for above dope. KYM has new modulator. QJG is heard occasionally. AXE changed QTH; is electrician at State Hospital, Ogdensburg. RVM applied for O.R.S. DNE is changing QTH to Cortland. CTX is active on 3.5 Mc. PLA has been DXing on 7 and 14 Mc. RMR continues to get real results on 7 Mc. SVQ and SYZ are new hams in Mount Morris. A son was born to NXQ on Dec. 26th. DHU is helping GWY get the gang lined up for A.E.C. NNJ has nice 3.9-Mc. 'phone QSO with VE5OT; R589 both ends for 3½ hours. SFD, RBW, QWA and QIO joined A.E.C. RXG worked F3NZ on 3580 kc. with 15 watts to 6L6 crystal oscillator. QMR left us to spend a few months in Florida. UY resumed operation on 1.8-Mc. 'phone and 14-Mc. c.w. KVVU and SFD have lots of fun on 1.8-Mc. 'phone with little "junk box" rig of March '38 QST. SFD, MPN and RZL are busy on 3.5 Mc. MYQ has nice new rig. Thanks to SFD for dope from northeast corner. PFM is going to give 28-Mc. 'phone a whirl, and suggests more of the boys use 28 Mc. in O.P.S. Contest. QQM reports that there may be another ham station in Nevada in the near future, as 3HLV is moving out that way. Hurrah! We have with us 8SUY, Buffalo, ex-1KJS. Welcome, O.M. KXA is back on. CGU keeps in touch with the world on 3.9- and 14-Mc. 'phone. GWY is building new shack. RRS drills with Susquehanna Emergency Net on 3.9-Mc. 'phone. SEA has 809 final on 7 Mc. SEB with 175 watts to pair of 809's works plenty of foreign DX on 7 Mc. SEI built new final using RK12. SBV handles plenty of traffic. New officers in Elmira Club: SBV, pres.; OCP, vice-pres. and treas.; RZF, secy. KBS is working on transmitter for DX Contest. ABM is on low end of 14 Mc. RZF, ADV, SVB, PQX, KIJ, HQY and GPR are on 7 Mc. IGT and MUQ get together a couple of times each week on 3.9-Mc. 'phone. NOU from Troy, Pa., now resident of Elmira, has pair of T20's on 3.5 Mc. ADV received long-needed card from Nevada. RRS and MRA are working for W.A.S. CHU is getting out on 28 Mc. The above information has been "snitched" from DZC's FB weekly column appearing in one of the Elmira newspapers. Thanks to PQX for sending the clippings. JTT is the "big shot" this month when it comes to traffic. SHC gets in a little brass pounding. SBI is heard frequently on 3.5 Mc. RKM worked a couple Africans with his 809. QUN has shown a lot of activity in both A.A.R.S. and O.R.S. Nets. SMH is in Binghamton on 7 Mc. PCN has nice e.c.o. and gets flattering reports. WATCH FOR ANNOUNCEMENT OF SECTION QSO PARTY IN NEXT MONTH'S QST.

Traffic: W8JTT 557 AQE 44 DHU 38 NNJ 1 CTX 12 QMR 122 ROI 8 RGA 3 KXA 9 GWY 90 RRS 4 SEI 6 CGU 11 PCN 107 PLA 194 BJO 88 FCG 320 DSS 297 SBV 130 CSE 117 JQE 362 QUN 69 RKM 233 SHC 26. (November-December: RXG 62.)

WESTERN PENNSYLVANIA — SCM, Kendall Speer, Jr., W8OFO — Dr. Woodruff, W8CMP, was made an honorary member of the Altoona Horseshoe Radio Club. The Club is holding several interesting contests. The McKean County Club has 100 per cent A.R.R.L. membership. Congrats. The Pittsburgh Area Radio Council is progressing with plans for Atlantic Division Convention in June in Pittsburgh. QAN comes through with terrific traffic total making B.P.L. on both total and deliveries. B.P.L.'s: QAN, DNX, KWA. DNX is busy on three Trunks. KWA is working some DX on 3.5 Mc. QBK says the Code class at Altoona is ready for F.C.C. exams. YA is busy with WLMA. A.A.R.S. station on 3497.5 kc. CKO will operate the Weather Bureau Net on 3590-ke. c.w. RQA says FUW is chasing DX on 3.5 Mc. PX, the Ohio River Regional Coördinator, will control the Weather Bureau Net on 3965-ke. 'phone. QGH is operating 14-Mc. 'phone using HK254 final, 400 watts. NQG uses pair of 35T's on 28 Mc. OUT moved shack to third floor. KXP is on 14 Mc. NCJ says his XYL ragchews on 7256 kc. KOB is on 3.5 Mc. Santa brought RAU a pair of 809's and a T21; RBM got a pair of T55's. RAZ is starting a Hammerlund kit. NUG has complete automatic break-in arrangement; the first touch of the key shuts off the receiver, starts the transmitter and

switches the antenna. A flock of DX is being worked by OBM on 7 Mc. DRO is R.C.C. member. R1Y uses 6L6-6L6G-25 watter on 3.5 and 7 Mc. ROA says ATH is a proud papa. KBJ says HK3CW is in charge of radio communications for the Republic of Colombia. MKF rebuilt for 28-Mc. operation. PJJ rebuilt speech unit. RAT is putting on low power 3.5-Mc. rig. RBD likes TZ40 final with 50 watts. QEJ is putting up a beam antenna for 28 Mc. ASE worked OSI across town with a dummy antenna. RIT passed his Class A. 1VQ got married. KSA is plate modulating a 450-watt rig on 3.9-Mc. 'phone with pair of 203Z's. A B.C.L. cut down IYI's skywire. LO is operating portable from Penn Albert Hotel at Greensburg. QVQ is on 14 Mc. BOZ installed new speech amplifier. NTJ is on 3.9-Mc. 'phone. KYW received an antenna mast for Christmas. 3EUQ is now 8SVT. OUH made W.A.S. with 20 watts input; 42 states were worked on 3.5 Mc. NQO is redesigning his portable emergency equipment.

Traffic: W8QAN 1327 DNX 611 KWA 507 DDC 323 MOT 283 FUW 254 MJK 161 QBK 154 NDE 151 IOH-MOJ 107 YA 88 QFM 51 DYY 38 KNB 36 CNP 35 CKO-RQA 24 OSI 23 PX 22 EFA-KTM-OFO-OUT 21 KTS 15 KXP 14 NCJ 18 KOB 14 FZG 10 EBJ-RAU-AXD 8 NUG 7 OEM 6 DRO 5 R1Y-IZS-ROA 3 KBJ 2 GYB-SHN-SIL 1.

ROANOKE DIVISION

NORTH CAROLINA SECTION — SCM, H. S. Carter, W4OG — I want to thank the Raleigh Club for the fine meeting held there in January. It was a real honor to have the Governor of North Carolina speak to our gathering. FJS is on the Emergency Net that meets each Sunday. DLX is doing a good job with Trunk Line "C," and needs an alternate. Anyone interested please get in touch with DLX or the S.C.M. FCB is handling plenty of traffic on 3.5 and 7 Mc. FUB, new Charlotte ham, works 3.5- and 7-Mc. bands. FQC and FQG are new Brookford hams. ALT is back on A.A.R.S. EIT reports that his brother and EIU are in college at Port Arthur, Texas, and he is keeping a daily schedule with them. ETE plans to move the rig to Wake Forest. BNL is now Class A. FIB is on 1.75- and 28-Mc. 'phone. ATC has a 50-watt rig in final. ESO reports for State College fellows. ATC is rebuilding final. FKU, DOU, CWP, CSC, ESO and CYA had a swell time at the State Meeting. (We all did.) FBD reports his location swell for DX. DGV schedules K4AF each morning. ABT and CFR worked the A.R.R.L. contest. DWB reports from Chapel Hill. WE, the club station, is getting started from new location. 8GES/4 is on at Chapel Hill with T55 final. FCU of Kingsport, Tenn., wants some traffic schedules in North Carolina on 7 Mc. Anyone interested please get in touch with him. 73.

Traffic: W4DLX 132 FCB 58 FBD 25 ALT 20 DGV 18 DW 13 FUS 9 DWB 6 BHR 5 ETE 2 ESO 1.

SOUTH CAROLINA — SCM, Tad Ferguson, W4BQE — BDT has been appointed O.B.S. BRF schedules AOB and CLA daily. CZA is active on T.L. "C" also does a little 40 cw. DXF is taking over T.L. "D." EOP has his O.R.S. and is alternate on T.L. "C." DNR is on 3.5- and 7-Mc. c.w., also 1.75-Mc. 'phone. EDQ is on 7 Mc. as well as 28- and 1.75-Mc. 'phone. EXJ has new antenna and is on 1.75-Mc. 'phone. BZX has new oscilloscope. FMZ likes to handle traffic. CPX operates 1.75-Mc. 'phone. COL has new 150-watt all-band rig and new Sky Challenger. DX has new rig with T-20 final modulated class "B." CQG has new rotatable beam. FFO is using 2A3 with 7½-watts input on 3.9-Mc. 'phone. CKW reports new half wave antenna works FB on 1.75 Mc. ECG has regular schedules with CZA, CZN, and FNT. Santa dropped by EPJ's shack with new NC81X. DRE worked 58 stations without a miss, also worked 88 out of 92 calls. FSL has regular schedules with CZN. EGH has his O.P.S. and is active on 1.75 Mc. CUS has new rig with increase in power. FFH works 3.5- and 7-Mc. c.w. and 1.75-Mc. 'phone. BPD is radiating that usual S9 signal on 1.75-Mc. 'phone. DTU sticks to 28 Mc. DQY is back on 1.75 Mc. BYA has returned to the air. New hams in Lyman: FRX and FRY; FRY is 13 years of age and can send and receive at least 25 words per. Welcome to both you fellows. EOZ changed QTH to Cheraw. EWB takes an active part in the nets. CZN makes FB report on activity of A.A.R.S. net. FDN is active in c.w. nets. Thanks, fellows. Our 1939 aim: More League members and increased activity in this Section 73.

Traffic: W4CZN 273 CZA 174 EOP 77 DXF 48 EWB 38

FDN 36 CQU 32 BRF 27 ECG 24 BPD-CUS 23 DNR 22 FSL 20 FMZ 15 DGD-FFH 12 EGH-EJK 10 FKX-DNQ 9 BDT 7 DRE-EOZ 5 CPX-EZF 3 DQY-EDQ 2 COL 1.

VIRGINIA — SCM, Charles M. Waff, Jr., W3UVA — R.M.: 3GTS — P.A.M.'s 3ALJ, 3GWQ — CSY worked XU4XA on 14 Mc. GTS made B.P.L. for second consecutive month. GWQ is having great success with the Old Dominion Phone Net, with twenty attendants at a recent meeting. GSG is working on modulator. BZE worked G2PU, LY1AD, D4ORT and GM8KR on 7 Mc. in two hours. EZH is a member of a "Service Net" between Army, Navy and Marine amateur stations. ELN has connections through schedules for traffic delivery in the Virgin Island, Guam and points in Asia. BWA has P.P. 211's on 1.75 Mc. HNV would like a schedule with some Virginia station Sunday nights on 3.5 Mc. FQO has 45 countries confirmed now, his latest card being from CR7BT. HEZ schedules 3RR and 9OEB. DZW uses c.c. on 14 Mc. FWT is on 1.75-, 4- and 14-Mc. 'phone. AIJ reports progress with the Virginia Phone Net, with room for others, however. Ex-3PR is now at Mare Island, Calif. ELJ and HYA are radio ops, on Douglas bombers at Langley Field. GRV is 100 per cent experimenting now. HXV is new ham at Lynchburg. GTS made 3120 points in the A.R.R.L. Party. FJ is planning a 56-Mc. crystal job for this summer. CFL took unto himself a XYL Dec. 31st; congrats and good luck, OM! BTR and BSB visited FFC. BTR is building a tower on which to mount a 14-Mc. beam. BSB worked HB, ON, G and K6 on 3.5 Mc. and hears ZL. CYV uses a 14 Mc. ½-wave vertical. GTZ has new Sky Challenger. UVA visited Richmond. GKL has P.P. HF100's with half kw. input. The Zertz Net functions on 7 Mc. Sundays at 2 p.m.; a member is wanted in Roanoke, Petersburg and vicinity of Washington. Write 3BZE, the N.C.S. BIW is using 808's, modulated by Class B T55's. BAD controls rig with relays. GDX worked VS7RA for W.A.C. on 'phone. FMY is rebuilding again "for the exercise." Nets: Virginia Traffic Net, HDQ, N.C.S.; members wanted immediately. Zertz Net, BZE, N.C.S. Virginia Phone Net, AIJ, N.C.S. Old Dominion Phone Net, GWQ, N.C.S. The Richmond Amateur Radio Club has issued an invitation to the Virginia Floating Club to meet with them April 2nd. For further information write GWQ, president, R.A.R.C.

Traffic: W8GTS 571 HDQ 263 ELN 63 BZE 26 GWQ 24 CYV 20 CSY 12 FJ 12 EZH 11 HEZ 9 AIJ 7 FWT 3 GKL 2 DZW-FQO 1.

WEST VIRGINIA — SCM, C. S. Hoffmann, Jr., W8HD — KKG is the first W. Va. member of the DX Century Club. BTV made a record in handling a total of 705 messages! His second month in the B.P.L., and the highest traffic total since GB made over a thousand about nine years ago. BTV worked on 3.5 Mc. G PAO, HB and V06. FB work! But "Hank" has resigned his trunk line schedules and says he's going in for 14 Mc. DX! OXO, new O.R.S., has been appointed to fill the long-vacated post of R.M. for the Northern District of W. Va. The Emergency Coordinators Interchange (stations from Ky., W. Va., Ohio, Ill., Ind. and Mich.) uses 3905 kc. MOL is a member. The Roanoke Division Convention is to be sponsored by the Charleston Radio Club, at Charleston, August 5 and 6. The Atlantic Division Convention will be held at Pittsburgh, Pa., sometime during May. Dr. Friend (8KIU-DSJ), Prof. at W.V.U., during recent illness, attended his regular physics class via radio! PSR has new 100-watt rig. The Mountaineer A.R.A. had a most interesting meeting when KIU gave a technical talk Jan. 6. Visitors at the meeting were FQG and 2CTT. They invite visiting hams. GBF worked G6WY on 3.5 Mc. KXC is back on. KVV finished a 2-year job of rebuilding. Hi! ESQ threw a big Ham New Year Party. HSA has the DX bug. MZD rebuilt. JRL visited Ohio and Indiana, also Wheeling. JTM and BOK have new jr ops. OJI is doing good work as Official Observer. JM, now on 'phone and c.w., wants schedules with Utah and Nevada for W.A.S. BRE's station is located at the WPAR transmitter and all hams are cordially invited to visit them. PQQ has worked 76 countries; 65 confirmed. QFN is experimenting on a loop antenna (for 'phone work) and would appreciate QSL's. 3GCU of Trenton, N. Y., wants a station and an alternate station for W. Va. schedule as part of his organization in an O.R.S. net, to be known as the "Eastern Owl" Net. Plans are for schedule at 12:30 a.m. Wed. and Sat. with a station and an alternate station in each of 21 states covering entire eastern seaboard. It is hoped to get a spot freq. for the Net at 3815 kc. Active O.R.S. are invited to write 3GCU at once. Larry

(Continued on page 104)



FOR
BOTH
AC
AND
DC
TESTING
USE
Model 666
DEALER PRICE
\$1500

Pocket Volt-Ohm Milliammeter

Uses large 3" sq. Triplet Instrument. Has molded case, selector switch and all necessary accessories. A complete instrument for voltage, direct current and resistance analyses. Size — 3 1/16" x 5 7/8" x 2 3/4". See Your Jobber — Write For Catalog.

The Triplet Electrical Instrument Co.
253 Harmon Avenue, Bluffton, Ohio

Please send me more information on Model 666.

Name.....
Address.....
City.....State.....

RADIO ENGINEERING



RCA Institutes offer an intensive course of high standard embracing all phases of Radio and Television. Practical training with modern equipment at New York and Chicago schools. Also specialized courses and Home Study Courses under "No obligation" plan.

Illustrated Catalog on request

RCA INSTITUTES, INC. Dept. ST-39

A Radio Corporation of America Service

75 Varick St., New York 1154 Merchandise Mart, Chicago

PRECISION CRYSTALS

Highest quality crystals carefully prepared for frequency stability and maximum output — rigidly tested to assure you of dependable operation. Be sure of your transmitter frequency — use

PRECISION CRYSTALS

Low frequency drift unit supplied within 5 Kc. of your specified frequency in the 40, 80 or 160 meter bands calibrated to within .03%. Supplied in holder as illustrated to plug into G.R. type jacks or in round holder to plug into a tube socket (See Jan. issue QST). Price \$4.50.

Highest quality 'X' cut crystals supplied within 5 Kc. of your specified frequency in the 40, 80 or 160 meter bands and calibrated to within .03% supplied mounted. Price \$4.00. Please state if holder as illustrated or round holder for tube socket is wanted.

Precision crystals for commercial requirements quoted on at your request. Now in our tenth year of business.

PRECISION PIEZO SERVICE

427 Asia Street

Baton Rouge, La.

102

★ S. F. TRANSMISSIONS ★

Date	Schedule	Station	Date	Schedule	Station
Mar. 3	BB	W6XX	Apr. 1	BX	W6XX
	A	W9XAN	Apr. 2	C	W6XX
Mar. 4	BX	W6XX	Apr. 7	A	W6XX
Mar. 5	C	W6XX	Apr. 14	B	W6XX
Mar. 10	A	W6XX	A	W9XAN	
Mar. 17	A	W9XAN	Apr. 21	A	W9XAN
	B	W6XX	A	W6XX	
Mar. 24	A	W9XAN	Apr. 23	BB	W6XX
	A	W6XX	A	W9XAN	
Mar. 31	BB	W6XX	Apr. 29	BX	W6XX
	A	W9XAN	Apr. 30	C	W6XX

STANDARD FREQUENCY SCHEDULES

Time (p.m.)	Sched. and Freq. (kc.)		Time (p.m.)	Sched. and Freq. (kc.)	
	A	B		BB	C
8:00	3500	7000	4:00	7000	14,000
8:08	3600	7100	4:08	7100	14,100
8:16	3700	7200	4:16	7200	14,200
8:24	3800	7300	4:24	7300	14,300
8:32	3900		4:32		14,400
8:40	4000				

Time (a.m.)	Sched. and Freq. (kc.)
	BX
6:00	7000
6:08	7100
6:16	7200
6:24	7300

The time specified in the schedules is local standard time at the transmitting station. W9XAN uses Central Standard Time, and W6XX, Pacific Standard Time.

TRANSMITTING PROCEDURE

The time allotted to each transmission is 8 minutes divided as follows:

- 2 minutes—QST QST QST de (station call letters).
 - 3 minutes—Characteristic letter of station followed by call letters and statement of frequency. The characteristic letter of W9XAN is "O"; and that of W6XX is "M."
 - 1 minute—Statement of frequency in kilocycles and announcement of next frequency.
 - 2 minutes—Time allowed to change to next frequency.
- W9XAN: Elgin Observatory, Elgin National Watch Company, Elgin, Ill., Frank D. Urie in charge.
W6XX: Don Lee Broadcasting System, Los Angeles, Calif., Frank M. Kennedy in charge.

WWV Schedules

EACH Tuesday, Wednesday and Friday (except legal holidays), the National Bureau of Standards station, WWV, transmits with a power of 20 kw. on three carrier frequencies as follows: 10:00 to 11:30 A.M., E.S.T., on 5000 kc.; noon to 1:30 P.M., E.S.T., on 10,000 kc.; 2:00 to 3:30 P.M., E.S.T., on 20,000 kc. The Tuesday and Friday transmissions are unmodulated c.w. except for 1-second standard-time intervals consisting of short pulses with 1000-cycle modulation. On the Wednesday transmissions, the carrier is modulated 30% with a standard audio frequency of 1000 c.p.s. The standard musical pitch A = M440 c.p.s. is also transmitted from 4:00 P.M. to 2:00 A.M., E.S.T., daily except Saturdays and Sundays, on a carrier frequency of 5000 kc., power 1 kw., 100% modulation. The accuracy of the frequencies of the WWV transmissions is better than 1 part in 5,000,000.

FIT FOR A KING and FIT FOR A 'HAM'

The world's finest

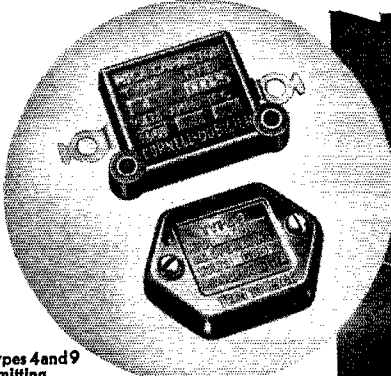
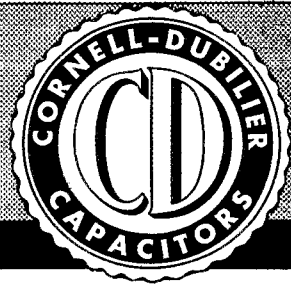

Types 4 and 9
Xmitting
Bypass Capacitors

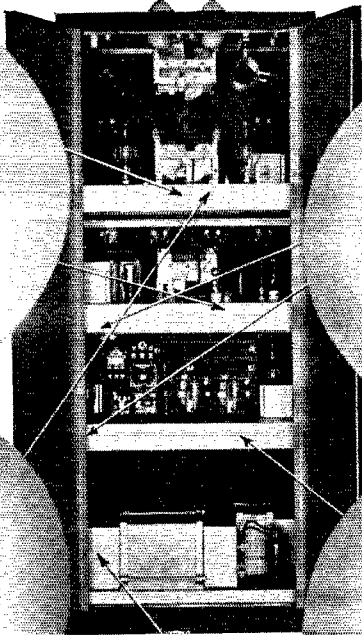

Above illustration of
TEMCO 1,000 Watt
Special Transmitter
(Mfd. Transmitter
Equipment, Mfg. Co.)

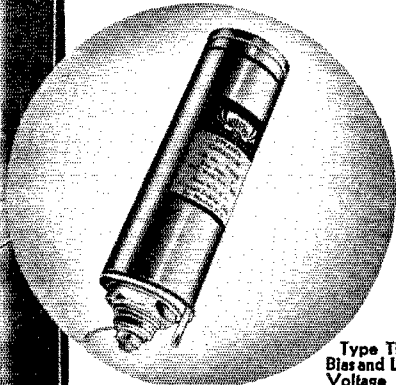

Type TLA
Blas and Low
Voltage Ca-
pacitor



Type 86
R.F. Plate
Blocking Capacitor

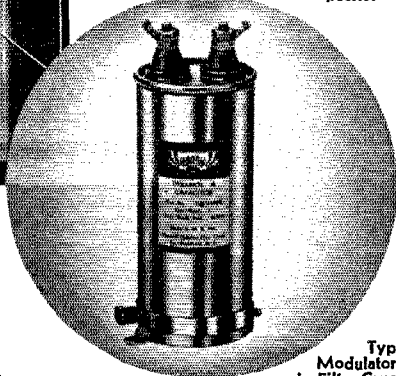

Type TQ
Modulator Sup-
ply Filter Capacitors

WHEN the ruler* of an Eastern domain set out to modernize his communication systems, Cornell-Dubilier capacitors were used in the transmitters. There is significance, we think, in this selection. For here quality alone was the watchword . . . money no object. Yet C-Ds — the capacitors "costing less" in the "long run" because they "live longer" — were chosen. One more impressive step in the march of C-Ds around the world!

You can always rely on the capacitor fit for a king. Catalog No. 161 describes the capacitors used in the TEMCO Transmitter in detail.

Products of the World's Largest Manufacturers of Capacitors

*NAME ON REQUEST

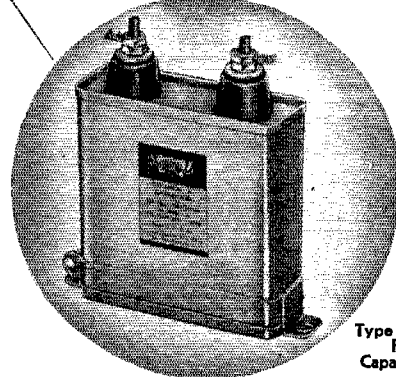

Type TJU
Filter
Capacitor

CORNELL - DUBILIER
ELECTRIC CORPORATION
South Plainfield, New Jersey

MICA • PAPER • DYKANOL
WET and DRY ELECTROLYTICS

(Continued from page 101)

Dunnam, Ex-8EIK, is now 3HR0. EP worked a K4 on 1.75-Mc. 'phone! JRL was control station for a 2 1/2-hr. 1.75-Mc. 'phone single-frequency round table, composed of ILPO, ILGW, 2LMG, 3GUT, 3EFT, 5FIO, 6OND, 8JRL, 8PUA, 9JUY and 9JUI! Each station worked every other station, too! The SCM had a very enjoyable visit with Clarksburg and Fairmont hams.

Traffic: W8BTV 705 PSR 89 HD 11 JM 2.

NEW ENGLAND DIVISION

CONNECTICUT — SCM, Frederick Ellis, Jr., W1CTI — Nutmeg Net, 3640 kc., 6:45 and 9 p.m. daily except Sunday. HSX leads off with a B.P.L. total; schedules with K5AG, K5AF and K5AM helped. JXP is all set with emergency power supplies. KKS works lots of DX with 40 watts to an 809. Ex-1QP is 2LWC. HSX and FMV received confirmation on J2JJ. BIHM received his on J2KG. DDX and JHN joined N.C.R. KDO is ready for the air. AGT and TD are rebuilding. JYE is back with the gang on 3640-ke. Nutmeg Net. JQK has new antenna. TS visited GB with DX cards and a new receiver. KFN is soldering 200 watts into an iron box. FJE and HCU rejoined New Haven Club. IQC moved to new QTH. KQY is designing new transmitter, P.P. 809's with band-switching and tracking. JAK will complete chrome-plated kilowatt rig for March DX Contest. BDI has a new final amplifier under way for 14-28-Mc. set. Testing new emergency power at AW, and N.C.R. meetings keep our Communications Manager busy in the evenings. AOK renewed O.R.S. GB wishes to extend thanks to all radio clubs that sent greetings by radio and card. JEL, HYU and HYF are back on. JEY is building a rig for 28-Mc. 'phone. DUC works swell DX on 14 Mc. KAK took a trip up in New York State and visited with 8NTP. KYQ, E.C. for Willimantic, has been promised cooperation of Red Cross and Police Department in case of emergency. BCG and KWF are building new band-switching, tracking, crystal or e.c.o. exciters. New officers elected at C.B.A.: Pres., BCG; vice-pres., CTI; sec'y., C. Simpson; treas., S. Shepherd; directors, L. Bryan, J. Foster, W2AHI, and L. Henriksen.

Traffic: W1HSX 769 JXP 413 AW 302 UE 230 TS 225 KKS 159 JMY 100 KFN 88 KQY 84 JQD-CTI 83 ES 44 KYQ 24 TD 11 GB 7 EFW 5 BDI 4.

MAINE — SCM, Winfield A. Ramsdell, W1FBJ — The Lincoln County Radio Club held its regular meeting, Jan. 8th, in the form of a hamfest; about 100 present. GM, the R.L., attended unofficially. JJK gave a talk on audio and microphones. IIE was the toastmaster. ATA moved to Buffalo. LIZ is rebuilding. EZR is having swell time on 1.75-Mc. 'phone. HSE has worked ON, G, PA0, GW and D on 3.5 Mc. DHH is on 1.75-Mc. 'phone most of the time. AQL has '47 crystal, RK-11 buffer, '03A final. EMP has new Howard receiver. The Lincoln County Radio Club call is LSP. P.A.W.A. elected officers: ELY, pres.; KAD, vice-pres.; CRP, sec'y.; GVS, treas.; FBI, chief opr. AQB, ATS, AUC, PQ and DAS are forming a Maine Net on 3.9-Mc. 'phone, meeting at 12:30 p.m. EWN has new all-band transmitter for portable work. After an illness of several years, from which there was no hope of recovery, DOZ, E. E. Hardy of Farmington, passed away Jan. 3rd at Brookline, Mass., where he had recently undergone an operation. Ham radio has lost a loyal supporter, ITC, G. Howard Noyes of Stonington, was fatally injured in an automobile accident Jan. 11th. Icy road was the cause of the accident. The loss will be greatly felt by a large circle of friends.

Traffic: W1GOJ 749 INW 435 KOU 324 IIE 292 CFO 282 HSD 109 IST 97 KMM 59 GVS 67 FBJ 41 GMD 34 GKC 33 DHH 30 HSE 29 LER 7.

EASTERN MASSACHUSETTS — SCM, Sam Cross, W1IWC — KH, JSM and JCK make the B.P.L. JJJ has been trying the usual run of crazy circuits. IGN worked ON4HC on 3.5 Mc. LOC received a 589 report from Seattle on 3.5 Mc. KZF has been back on N.C.S. since the first of the year. LBY has new exciter finished. JFS is rebuilding for 56 and 28 Mc. HLL has new rig all set to go. BDU is now using an HRO. JGQ is new O.P.S. GAG has completed work on rig. ALP had fine time in A.R.R.L. Party. The Section extends its sympathy to BVL in the death of his father. JKT has been trying new antennas for new rig. JJZ returned to Fall River. KKO's little 6L6 is knocking them off on 14 Mc. WV says: "14 Mc. is noticeable for the great increase in UNNECESSARY c.w. testing and UNNECESSARY use of the band for local QSO's to the great detriment of the

DX." How about it, guys? GDY put up new mast to replace the tree blown down by the big storm. AAR will be on 28-Mc. 'phone shortly. CWI is trying to get an e.c.o. M.O.P.A. working on 56 Mc. IPB left 56 Mc. for 1.75-Mc. 'phone. IPB left on a shake-down cruise. AFP has new rig under construction for 56 and 28 Mc. FLZ is putting an 808 in the final. PI is doing a nice job organizing the new net. LNN is active on 7-Mc. with '47 crystal and 6L6 with 56 watts. WI applied for O.R.S. Any stations active on 7 Mc. interested in traffic work, contact WI or BDU for schedules. I would like to invite all members of the A.R.R.L. who operate on 'phone here in the Eastern Massachusetts Section of the New England Division to consider the Official Phone Station appointment. It is only necessary to meet a few simple conditions as outlined in the A.R.R.L. operating booklet. Why not investigate this appointment and do your part to help improve operating conditions of the 'phone bands? Write to Larry Mitchell, W1HIL, Phone Activities Manager, 51-A North Ave., Melrose, Mass.

Traffic: W1JBM 309 JCK 357 (W1GW 72) JJJ 258 IGN 227 KH 184 LOC 165 EMG 131 AGX 115 KZT 157 LBY 72 HWE 64 JFS 52 LLX 41 HIL 5 BDU 3. (Nov.-Dec.: W1EPE 531 KCT 146 IGN 135.)

WESTERN MASSACHUSETTS — SCM, William J. Barrett, W1JAH — BIV is now S.N.C.S. 41 in Central Mass. A.A.R.S. IOT keeps his batting average right up. EOB marked his 48th state during RM-Nite. BVR was reappointed First Corps Area Radio Aide for another year. Perce also starts his second term as our A.R.R.L. Director. Congrats! JAH is active in West. Mass. A.A.R.S. when business permits. LNH rebuilt rig and remodelled station. BNL is on 3.5 and 14 Mc. DUZ completed his oscilloscope. GZL reports Holyoke gang DXing on 28 Mc. AJ worked YR5CJ, HA8G, LX1AS and SP1YX on 7 Mc. JMH is at Univ. of Louisiana, 5GIW, LQT is working in Boston. LPC is building 1.75-Mc. rig. COI handled messages from Colombia and Java on 'phone. FOI has emergency equipment. RB, ex-1ASY, is back on. KRX finally ironed out bugs in rig. KJK has '52 final awaiting 3300 volts. Fellows, don't let the next emergency catch us flat-footed. Let's get our emergency rigs built and tested. If interested in traffic handling as A.A.R.S. or O.R.S., drop a line to JAH. 'Phones contact JAH or GZL.

Traffic: W1BIV 281 IOT 267 (W1GN 79) EOB 177 (W1GD 4) BVR 112 (W1G 178) JAH 77 LNH 65 BNL 40 DUZ 38 GZL 28 AJ 20 COI-FOI 4 RB-KRX 3 KJK 1. (Nov. Dec.: W1EOB 164 (W1GD 15).)

NEW HAMPSHIRE — SCM, Carl B. Evans, W1BFT-DMD — The third test mobilization of the N. H. Emergency Network (NHEN) is scheduled for first Sunday in May, the 7th. At this time, weather conditions should permit the operation of portable equipment, and the use of it is strongly recommended on this date. The M.V.A.R.A. and the Nashua Mike and Key Club will have one or more portables in operation. The main idea is to set up a portable in some near-by locality, which has no regular means of radio communication and contact in on the Emergency Net. Let's be ready for any emergency, and know what to do, and how to do it. There are possibilities of a 56-Mc. Emergency Net working on conjunction with the other nets. Anyone interested, please contact your S.C.M. JNO is experimenting with e.c. AVJ replaced T55 with RK47. KLV incorporated band-switching in his new exciter. Mr. and Mrs. KLD announce the arrival of a Jr. op (boy). Many congrats. JDV moved to Nashua and is active on 29- and 2-Mc. 'phone. LTD is new Bristol ham. Mr. and Mrs. CFG report new YL Jr. op. Congrats are again in order! The Southern N. H. gang organized a 29-Mc. 'Phone Net, meeting nightly at 6:30 p.m. Anyone interested in joining, contact GEY in Nashua. CPM needs New Mexico for W.A.S. GNZ is building new receiver. HXJ is chasing harmonics with e.c. oscillator. The Nashua Mike and Key Club held first annual meeting and banquet, with invited guests and door prizes. HOU has new Johnson Q on 29-Mc. 'phone. IJB received S9 report from England on 3.9-Mc. 'phone. LCD is back on from new QTH. EAW has an 808 final on 29-Mc. 'phone.

Traffic: W1IP 307 KIN 280 (W1GR 20) GMM 216 BFT 126 IDY 55 AEF 33 JDP 25 ELL 11 DMD 8.

RHODE ISLAND — SCM, Clayton C. Gordon, W1HRC — JUE is dropping out of ham radio. We are going to miss him. Good luck, Jean. LQG and KLE joined A.A.R.S. Prov. Radio Ass'n elected JXA, pres.; JP, vice-pres.; LDL, sec'y.; DDY, treas.; KCS, HRC and the retiring president,

GTN, were elected to the Board of Directors. GTN has been president for so long and so successfully that he has more than earned a rest. JRY was appointed Technical Committee head for the coming year. Plans have been discussed to have the club station, INM, manned more consistently. At present AQ is the only club station in Rhode Island that is reasonably active. HRC has been bitten by the DX bug. CPV has fifteen Emergency Corps applications executed for 1939. Good work, Bert.

Traffic: W1INU 1036 GTN 450 INT-KWA 219 QR 174 KIV 147 KLR 127 JXQ 104 HCW 99 CPV 92 KTH 80 LAB 65 KYK 50 KKE 48 KOG 48 JDX 44 LDL 27 HRC 15.

VERMONT—SCM, Alvin H. Battison, W1GNF—2JBL is on 7 and 3.5 Mc. at Middlebury. FSV has another nice traffic total. KTB received the last card necessary for W.A.S. KOO received a Mac-Key for Christmas. KZJ is new member of A.A.R.S. DQK and GQJ joined 3.5-Mc. crew. GAE has new super. DPO is a patient at Pittsford Sanatorium. A letter or card would do much to cheer him up. AVP, KTB, GAN, FSV, KJG, JXS and 2JBL-1 participated in the A.R.R.L. Party. AVP is practising with the N. H. Emergency Net. JVS has at last received one card after many Asian contacts. 2BAQ-1 has been transferred to Pittsfield, Mass. EHB is trying an SW3 receiver. GNF added a telescoping matching section to his 3.5-Mc. antenna. FLR has new high-voltage power supply. PXY expects some new operators at Fort Ethan Allen.

Traffic: W1FSV 201 KTB 107 KXY 33 AVP 26 KOO 23 W2JBL-1 27.

HUDSON DIVISION

EASTERN NEW YORK—SCM, Robert E. Haight, W2LU—W2KXF built new super and heads the traffic list. KWG is doing FB job with traffic for West Point. KFB is sticking on 1.75-Mc. 'phone with new rig. HXQ made 7472 points in A.R.R.L. QSO Party. HXQ would like to play checkers by radio. HUB won Mac Key at Poughkeepsie Hamfest. FQG gets out well on 3.9-Mc. 'phone. HLB reports for Albany boys. HCM finished new band-switching transmitter. ACB wants more A.E.C. members in his area. ALP schedules 6NYQ-LHM and 5HGC on 29.7-Mc. 'phone. ALP reports ACB joining him to use same antenna. LLU is keeping in touch with brother in Fla., via ham radio. GFD is on 3941 kc. 'phone. The Mid-Hudson A.R.C. elected officers: Pres., CGT; vice-pres., CDM; secy., BJX; treas., GWY; historian, AGZ. The club had a very successful Fourth Banquet and Get-Together on Dec. 10th, with 40 hams attending from 33 cities and towns along the Hudson Valley, and from as far away as New Haven, Conn. Speakers were 2CVV, 2AMJ and 2DKJ. BJX was Toastmaster and GFD, then club president, extended a welcome to the assembled brethren. M.H.A.R.C. conducted a raffle and raised money to build a portable emergency-powered transmitter, usable on either 6-volt battery, or 110-volts a.c. CGT has a small outfit perking on 28 Mc. AEQ holds forth regularly on 1.75-Mc. 'phone, with T-20's in final. HVS is on 7 Mc., T-55 final. AFI is on 7 and 28 Mc. BJX has 1939 automobile license plates DC-73; the DC stands for Dutchess County. EDT is 7 Mc. hound. GFD is active 3.9-Mc. 'phone. JGQ is now 8BAP in Rochester. HES is on 7 Mc. with 2A5, 46, '10. LUK is new ham in Beacon. CDM is building new exciter, using RK-25, 807, 6J5G. The Poughkeepsie gang gets on the air every Sunday morning at 10:00 a.m. for a round-table rag-chew on 28-Mc. 'phone. HLB, HTN and KLK are at Yale. HLB is chief op of club station 1YU. HYK is senior at state college. AWF works remote control. FBA is bug gun at R.P.I. KEP is thinking of "2½ meters." APT is father of twin sons. KUD and HXL hold open house at their stations for S.A.R.A. members.

Traffic: W2KXF 242 KWG 194 KFB 54 LU 50 BLU 28 EOP HXQ 24 ITK 14 FQG 11 HLB 5 HCM 4 ACB 3.

NEW YORK CITY AND LONG ISLAND—SCM, Ed. L. Baunach, W2AZV—ITX, new O.R.S., is completely battery operated. CWP, LPJ and KMZ are out for O.R.S. JUX is trying for O.B.S. KAM is now located at 156 So. 3rd St., Brooklyn. KKR is living with KOH, 607 W. 190th St., N. Y. C. FF has his 30-FX for sale. KVY visited N. Y. during the holidays; his QTH is Box 728, Ga. Tech., Atlanta. FFV left U. S. A. to again become SM5UU. 2JBL/1 is on 7 and 3.5 Mc. from Middlebury, Vt. IOP put up his 42-foot mast. LSD received his ticket Nov. 21, 1938. LOQ is on 7104 kc. LHP has an eight-watt 'phone rig on 1.75 Mc., for disposing of local traffic. HLI expects to get his rig

going on 1.75 Mc. HNR's pre-selector works FB. KSP has a new "percentage of modulation" indicator. LDB has a swell frequency meter and is checking frequencies for the boys. IUQ expects to be a Kentucky Colonel at the U. of Ky. CEK using pair of '46's on 3.5 Mc. called CQ DX and worked D4TFU. LBF worked D3DRF on 7 Mc. ECLJ is pounding brass at sea between N. Y., Fla., and Texas. JVB is running 500 watts to a T-125 on 7, 14 and 28 Mc. 1ZJ is experimenting with band switching e.c.c. On Christmas eve KYO managed to round up a number of 14-Mc. 'phone stations for a Christmas party on the air. HNR lost his mother. KJT is trying 28-Mc. 'phone. KD gets out on 14-Mc. 'phone. Santa brought KJY a pair of HY40's for 7-Mc. rig. DOG is operating 1.75-Mc. 'phone using from 9- to 15-watts input. FCH, BFA, JRC, LNU and KPB are operating 1.75-Mc. 'phone. IXQ has new secondary frequency standard, incorporating receiver tuned to WWV. DBQ was snow bound at AYE's shack for three days in Flatbush. LBK is using new pre-selector on his SX16. LOK is building 1.75-Mc. 'phone and acting as President of T.R.F. Communications Assn. LQF, chief of AEE, the Columbia U. Radio Club, is looking for schedules. LOE reports for CXN, the Brooklyn Tech H.S. Radio Club; they have eighteen students who help JMQ and KMX, the chief ops, keep the station on the air. CXN operates during school hours on 7 and 14 Mc., putting 500 watts into P.P. T55's. The Sunrise Radio Club station is now on 1979- and 3958-ke. 'phone, using 6C5 Pierce Oscillator, 6L6G final, pair of 42's modulators and 76 speech. Bay Ridge has new Radio Club, known as Kings Amateur Radio Association; meetings are held on the second and fourth Fridays at Ye Olde Cabin, 75th St. and Fifth Ave. Officers are: Pres., JSY; vice-pres., KSG; treas., INT; secy., IBU; sgt. at arms, GIJ. 1939 officers of the 73 Club: Pres., ASF; vice-pres., DXC; secy.-treas., CWP; meetings are held on second and fourth Wednesdays at P.S. 115, 177th St. and St. Nicholas Avenue, N.Y.C., at 8 p.m. JUX is starting a coast-to-coast 1.75-Mc. 'phone net, all stations to be A.E.C. members. Those interested should contact JUX. Stations interested in the Section A.E.C. line-ups should get in touch with their various county E.C.'s: BGO for Bronx, GDF for Queens, JHB for Brooklyn, JZX for Nassau and LR for Suffolk. Effective immediately the N. Y. C. and L. I. Section Net (3710 kc.) operating hours are changed to 8:30 p.m. instead of 7:30 p.m. All stations with traffic should listen for LR, the N.C.S. AHC reports the next Division meeting will be held March 29, 8:00 p.m. at the Army Building, 39 Whitehall St., N.Y.C.

Traffic: W2JZX 210 JEB 902 LR 176 DBQ 169 (WLNB 25) HMJ 162 KI 133 PF 111 AZV 89 ITX 88 LPJ 58 BGO 42 JBL 27 GDF 26 JRE 31 BJO 25 FF 26 HYL 23 KYO 21 LHP 19 LOQ 18 JDG 14 AZM 11 IOP 10 CHK 9 LBL-HYJ 8 AHC 7 LSD 9 BYL 6 FLD-FIP 5 CIT 4 AA 3 CET-KAM-HGO-DOG-AHC-JRC 2 CWP-HSO-AGC 1.

NORTHERN NEW JERSEY—SCM, Fred C. Read, W2GMN—Five N. N. J. stations made B.P.L. for this period. Nice going! GVZ has worked 120 countries. GJJ and GRG are new official observers. John Reinartz, 1QP/2 demonstrated a 100-ke. multivibrator oscillator at the Jan. 25th meeting of North Newark A.R.C. LTI worked ten states, first two weeks on air with 6L6 oscillator. IWY, now Class A, has moved to 14 Mc. KRA is building 28-14-7-Mc. job with 90-watts input. KBS is building 500-watt rig for 28 Mc. LCA is building new high-power rig. HRZ is going in for television. LXD is building M.O.P.A. rig for 56 Mc. and "2½ meters." 2HOZ/9 at college in Michigan is again pounding brass. EPP's new QTH is Hanover. Ek-IJPP is now 2LEP and in North Newark. The February meeting of the Northern New Jersey QSP Club was held on Governor's Island, where the members were guests of JUV. KON and GRG are new O.P.S. HXI is back in Boston attending college. HCO has been doing fine traffic work. KIE and BPK are on 28-Mc. 'phone. IOZ has new 23-Mc. antenna. EKU is active on 'phone on all bands. FSQ is on 1.75-Mc. c.w. DZV moved out of N. N. J. Section. KNN has worked 47 states. IYG has Class A license and new station. CJX's new junior op keeps him busy. LAG has been changing rig for 3.9-Mc. 'phone. GSA gives fair warning to high SS scores of N. N. J. that he is taking this Section next year!

Traffic: W2BCX 594 (Nov.-Dec.) (WLNRF 548) BCX 1262 (WLNRF 970) GYZ 652 (WLNRI 13) CGG 519 HCO 202 KTR 56 (Nov.-Dec.) KTR 129 KMI 121 HXI 90 KHA 84 HQL 69 (WLNRI 134) JUC 30 BZJ 11 CJX 8 CIZ 5 LAG 2.



Parasitic Oscillations

that reduce efficiency and output at desired radio frequency and introduce distortion in phone transmitters, can be eliminated with a Ward Leonard Parasitic Suppressor. For full information send for Circular 507.



WARD LEONARD PARASITIC SUPPRESSORS

WARD LEONARD ELECTRIC COMPANY

41 South Street, Mount Vernon, N. Y.

Please send me FREE "Circular 507".

Name

Address Call Signal

City State

RADIO

ENGINEERING, broadcasting, aviation and police radio, servicing, marine radio telegraphy and telephony, Morse telegraphy and railway accounting taught thoroughly. 48 weeks' engineering course, equivalent to three years of college radio work. School established 1874. All expenses low. Catalog free.

DODGE'S INSTITUTE, Day Street, Valparaiso, Indiana

LEARN CODE

the way you'll be using it
by SOUND

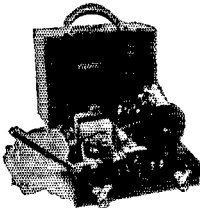

The best way to learn to read code is by listening to code. The best way to learn to send code is by hearing your own sending repeated back to you. With the new All-Electric Master Teleplex Code Teaching Machine, you learn code the natural, easy, fascinating way. Only instrument ever produced which records your sending in visible

dots and dashes—then SENDS BACK your own key work at any speed you desire. That's why practically every school teaching code uses TELEPLEX. We furnish complete course, lend you All-Electric Master Teleplex, give you personal instruction with a MONEY BACK GUARANTEE—all at a surprisingly low cost per month. Write today for FREE catalog Q. 3. No obligation.

"HAM" SPECIAL

Standard Teleplex—a highly efficient code teacher using heavy specially prepared waxed paper tape, having two rows of perforations. Write for Free folder "Q.T.3."

TELEPLEX CO., 67-68 Park Place, N. Y.

In Canada, Write

Canadian Electronic Institute, Toronto, Ontario

A Miniature 100-Watt Amplifier

(Continued from page 39)

condensers when they are mounted vertically as shown.

Both the neutralizing condensers and the chokes are mounted on the stand-offs furnished with the tube sockets and the coil plug-bases. This is done by cutting off the diecast conical point at one end of each of these units and drilling and tapping for a length of 6/32 screw. The antenna link terminals from the plate tank coil are run to one of the new small Victron terminal strips, which is mounted on an angle bracket at the rear of the condenser. The high-voltage supply, as well as the r.f. input connections, are made through a 5-prong coil plug mounted on the rear of the chassis. This plug is held in place with a small backing strip of Victron. The leads from the meter panel terminate in a corresponding socket, which is used with this plug to complete the connection. The filament leads go directly from one of the sockets on the amplifier to the terminals on the filament transformer and not through the plug strip.

A 5-Meter Model

The original unit worked out so well on 10 meters that a second model was made up for 5-meter operation. The only difference, of course, is in the grid and plate tank circuit. Because of the extremely low stray circuit capacities in both of these units, as a result of the short leads and compact layout, it was found that neither the standard 10-meter, nor standard 5-meter small air-wound coils would tune over the respective bands with the 35- μ fd. per section condenser unit used. For 10 meters we used the 20-meter coil and removed six turns (three from each end). For the 5-meter tank coil, the 10-meter coil can be used by removing 2 turns from each end (4 total), or a special coil can be made as in Fig. 1.

'Phone

In order to use this unit as a Class-C modulated amplifier for 'phone work, it must be operated at reduced input, or else larger tank coils and more driving power be employed. For 5-meter 'phone operation, for instance, with 1000 volts on the plate, about 11 watts of driving power are needed. In our case, however, the 7½-odd watt output of the NTE was the limiting factor (they are rated about 5, but generally run as high as 7½), so for 'phone operation we reduced plate voltage, and of course sacrificed output, in the interests of convenience, compactness, and simplicity.

If the standard coils are used, initial tuning should be done at reduced plate voltage, and then the antenna load connected before applying full voltage as, after all, the coils are being used under conditions much in excess of their normal ratings.

A capacity of approximately 2 μ fd., which lies well within the range of the neutralizing

WORTHY FOR A KING

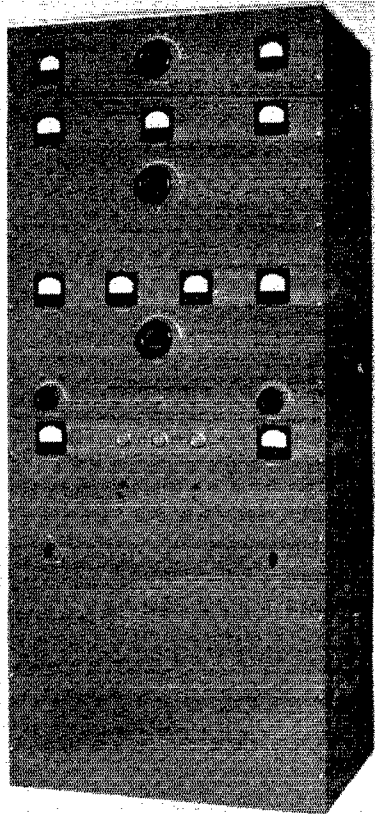
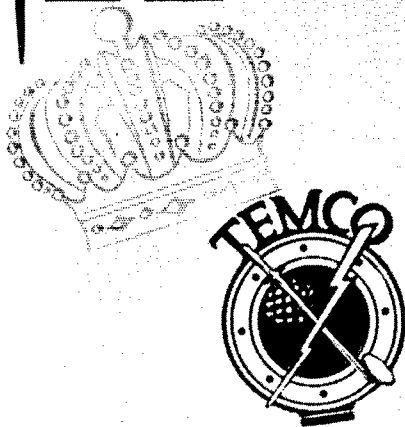

Recently Temco shipped to an Oriental Potentate a Kilowatt Transmitter which represented a fine example of modern design and skillful engineering. To its new owner this transmitter was symbolic—a transmitter for his personal use which was worthy of his station.

That Temco is proud of the recognition shown goes without saying, yet the selection of a Temco transmitter in this instance, as in many others, was *not* a matter of chance. **QUALITY**, like a Beacon, always points the way.

Temco engineers, proud as they are in their own achievements, give full credit to those manufacturers whose parts have been consistently specified because of their proven quality. It is no wonder that Temco transmitters have been the unqualified choice not only of this world famous ruler, but scores of Amateurs, Broadcast stations, the Boston Police and many other municipal police departments throughout the world.

Above: Temco Kilowatt transmitter sold to Eastern Potentate. Among the quality parts used are Kenyon Transformers, Eimac Tubes, B & W coils, United rectifiers, Par-Metal cabinet, etc. Temco equipment is standard through the industry. Send for catalog or consult our engineering department regarding your problem.

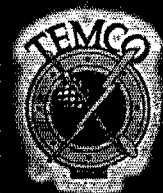

Transmitter Equipment Manufacturing Co., INC.

130 CEDAR STREET • NEW YORK, N. Y.

Designers and Manufacturers of Radio Transmitting and Accessory Equipment

QTH FARM?

No need for highline power. Hundreds of Hams on farms, expeditions, portable and emergency outfits now depend on Wincharger to operate their low power rigs. Sensational new heavy duty model (25 amperes 6 volts — 15 amperes 12 volts) has more than double the current output of ordinary 6-volt chargers. Starts charging battery in a 5½ mile breeze. Equipped with 7½ inch (dia.) 4 pole generator, 49 bar commutator, 7½ foot Albers patented Air-foil propeller, Air brake governor and collector ring with double carbon brushes. Can be mounted on a roof or on Wincharger sectional guyed tower. Order direct or write for complete details.



\$3995

(6 or 12-Volt)
F. O. B.
Sioux City
Iowa

Complete with 10-foot Tower and Instrument Panel

MAIL COUPON FOR COMPLETE DETAILS
WINCHARGER CORPORATION, Sioux City, Iowa

Please send information on the following:

Winchargers
 6-volt
 12-volt
 32-volt

Batteries
 6-volt
 32-volt
 Antenna Tower

Your call please

Name

Address

City..... State.....

condensers chosen, is needed to neutralize the Gammatron 24's.

The Meter Panel

The meter panel unit contains the grid and plate meters and filament transformer. This was made as a separate unit for several reasons, the most important of which was that it could then be used with both our 5- and 10-meter final amplifiers, and with still others should they be constructed in the future. Altogether, such an arrangement permits quick and easy band-changing without the necessity for much re-tuning, especially where a switching exciter is available.

A.A.R.S. Activities

(Continued from page 40)

The following cryptogram is presented for those interested in these problems. Solutions received by the Liaison Officer, A.A.R.S., 3441 Munitions Building, Washington, D. C., will be acknowledged by mail. 09131 92034 44591 43811 09100 50106 36261 80839 31363 40733 69635 91332 61514 31968 64381 12456 14170 11830 03396 30409 44575 51305 42263 66149 23641 23043 22585 51314 38053 46869 39423 73063 19552 90274 51545 90631 09534 51144 04050 33415 08306 76255 13690 13829 47330 56364 13301 75521 59057 21809 38583 44312 59635 41908 30564 27009 44365 56818 05244 03067 34375 51369 43266 11705 51042 41942 59302 90000.

One Crystal—Two Tubes—Five Bands

(Continued from page 45)

accidentally put through the panel to touch the bulb, but only glass is touched. A similar bulb connected across the 6.3-volt filament supply is mounted behind the other panel hole to provide a constant standard of full brilliancy for comparison with the plate-current indicator bulb. This is an easy solution to the problem of judging full brilliancy of the lamps in varying conditions of room light. The current rating of the lamps at 6.3 volts is approximately 150 ma., and the glow — just a visible redness at first — begins at approximately 50 ma. Various oscillator plate current values may be estimated by reference to a chart given elsewhere in this issue.⁶

Another 6.3-volt bulb is connected in series with the crystal. Although this does not serve as a fuse, the value as an indicator of crystal current, and thus of crystal heating and danger of cracking, more than justifies the very small cost and effort of installation.

⁶ Sutter, "Current vs. Color of Pilot Bulbs." See page 62 this issue.

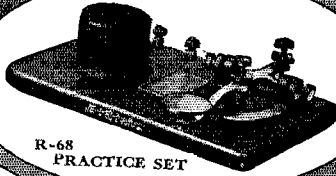

R-68
PRACTICE SET

WIRELESS PRACTICE SETS

Designed for those who want a well made instrument to learn the code. Set consists of a key and high frequency buzzer mounted on a mahogany finished wood base equipped with binding posts. The code is printed on a plate and fastened to the base between the key and buzzer. Buzzer is adjustable. List \$3.40.

SIGNAL's line of Wireless Keys, Telegraph Instruments and Wireless Practice Sets is complete. Send for bulletin.

SIGNAL ELECTRIC MFG. CO.
Menominee, Michigan, U. S. A.

SIGNAL
MANUFACTURERS OF ELECTRICAL PRODUCTS

MEET THE "GANG" at TERMINAL!

These men have made TERMINAL the LEADING HAMRADIO SUPPLY HOUSE in the EAST! Their interest in amateur radio is genuine; you'll find them sincerely friendly, and always at your service.



BILL FILLER, W2AOQ



JACK SIMON



SAM LAINE, W2BKU



FRANK MILLER, W2BUS



PAUL BURKE

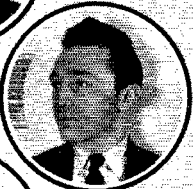

HARRY ADELMAN, W2JYV



STANLEY KOJALA



ADOLPH GROSS

Some Typical TERMINAL Ham Values... while they last!

The following items are but a few of the "buys" to be had at TERMINAL. Each is made by a well-known, reputable manufacturer. Every radio product sold by Terminal is guaranteed to live up to Terminal's high standards in quality—regardless of its low price!

TRANSFORMER SPECIALS!

PLATE TRANSFORMERS

Type	Sec. Lead	A.C. Volts	D.C. Volts	D.C. Ma.	Wt. lbs.	Your Cost
P-1	830/830 660/660		650 500	200	8 3/4	\$3.10
P-2	1565/1565 1265/1265		1250 1000	500	35 1/2	9.95
P-3	2180/2180 1760/1760		1800 1450	300	30 3/4	8.95
P-4	2920/2920 2420/2420		2500 2000	300	42	11.25
P-5	1200/1200 900/900		1000 750	200 150	16	5.95

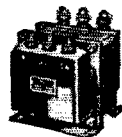

SMOOTHING CHOKES

Type No.	D.C. Ma.	Induct. Henries	D.C. Ohms	Volts Ins.	Wt. lbs.	Your Cost
C-1	200	12	130	2000	4 3/4	\$1.75
C-2	300	12	105	2000	9 1/2	2.35

FILAMENT TRANSFORMERS

Type No.	Sec. Volts	Sec. Amps.	Volts Ins.	Wt. lbs.	Your Cost
F-1	2.5 CT.	10	7500	2 1/4	\$1.30
F-2	5.25 CT.	13	2000	4	1.65
F-3	6.3 CT.	7	2000	1 1/2	.85
F-4	7.5 CT.	8	2000	4	1.55
F-5	10 CT.	8	2000	4	1.90
F-6	6.3 CT.	6	2000	2 3/4	1.30

ANTENNA WIRE — cut to any length

Enameled or Tinned	Enameled Copperweld
No. 12—49c per 100 ft.	No. 12—89c per 100 ft.
No. 14—35c per 100 ft.	No. 14—62c per 100 ft.

TEMCO TRANSMITTERS In Stock

Complete line of Temco transmitters are on display at both Terminal stores in New York City. Write to us for literature!

PORCELAIN FEEDER SPREADERS

2".....6c	4".....7c	6".....10c
-----------	-----------	------------

Complete line of Johnson "Q" antennas in stock



TERMINAL CRYSTALS

X-cut, unmounted quartz crystals. .1% accuracy guaranteed. Large choice of frequencies. Your cost..... \$1.19

For 160, 80 and 40 meters

TERMINAL crystal holder .95

TRANSMITTING CAPACITORS

Best quality all impregnated and filled. Furnished with universal mounting brackets. These units can "take it"!

Type No.	Cap. Mfd.	D.C. Voltage	Wt. lbs.	Your Cost
1M-2	2	1000		\$1.35
1M-4	4	1000		1.85
2M-2	2	2000		2.25
2M-4	4	2000		3.45



TURNER Crystal Mike

A good quality crystal microphone, complete with swivel joint, desk stand and cable. Ideal for amateur phone transmission. Your cost, only \$9.95



Non-Magnetic RELAY RACK PANELS

MASONITE PANELS—Black Crackle Finish, 3/16" thick, can be worked same as wood. Tempered and strong.

Size	Your Cost	Size	Your Cost
3 1/2" x 19"	32c	10 1/2" x 19"	66c
5 1/2" x 19"	43c	12 1/4" x 19"	75c
7" x 19"	48c	14" x 19"	82c
8 3/4" x 19"	56c	15 3/4" x 19"	95c

TERMINAL Radio Corp.

2 STORES IN NEW YORK CITY

80 CORTLANDT ST. • 68 WEST 45th ST.

Cable Address: TERMRADIO

ARE YOU A "LID"?

-- CANDLER Can Speed Up Your Code!

Why keep on with a rotten fist when it's so easy to become a good op? Maybe you've practiced for years without much progress, perhaps you're still having trouble reading fast code. Don't be discouraged! Write Candler! With a few weeks of Candler training, learning the correct fundamentals, acquiring sound consciousness, you'll make more progress than you did with months and years of undirected practice. You'll be able to read whole words without conscious effort as easily as you read them on the printed page! It's not how much you practice but *how* you practice that counts in learning code or gaining speed — and Candler can show you *how* just as he has helped thousands of others.

Candler takes you right through from the very beginning to your amateur or commercial license. Send for your FREE copy of the "Book of Facts" today. You'll be making the first step toward becoming a fast op. There are beginners' and advanced courses, equally inexpensive! Do it now!

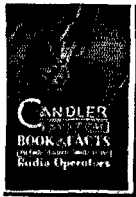

CANDLER SYSTEM CO.

Dept. Q-3, Box 331, ASHEVILLE, NO. CAROLINA
British Address: Room 56, Craven House,
Kingsway, London, W. C. 2.



★ TYPE TR-8 TRANSMITTER-RECEIVER:

- New, modernized, crystal controlled, 5 meter operation
- Many other units in bulletin for 1939 ● Write to RADIO TRANSCIEVER LABS., 8627 115 Street, Richmond Hill, New York City. Cable address "Ratralab."

New Performance Features at Amazing Low Cost!

Two New TURNER Microphones — The Dynamic 88 — Crystal 66

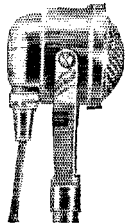

You get new advanced engineering and design — at no increase in cost — in these handsome new Turner mikes. Ruggedness that assures tops in performance under severe operating conditions — weighted frequency response — inertia mounted cartridges — narrow beam pickup of all frequencies — absolute wind and blast proofing, are exclusive features of these matchless new Turner models. Write for free Bulletin **\$25.00 LIST 41-A.**

THE TURNER CO.
CEDAR RAPIDS, IOWA

Licensed Under Patents of the
Brush Development Co.

MODEL 66
Get praise-winning studio quality with this professional mike. Order now.

Tuning

How will the operator know when the exciter is tuned to the desired harmonic, rather than some out-of-band frequency? After the exciter has been operated a few days, this entirely ceases to be a worry, since easily read dials should be used on the oscillator and amplifier plate tuning condensers, and the settings for these dials with operation on each harmonic should be recorded. A good start in determining the harmonic to which the oscillator plate tank circuit is tuned is given by the oscillator plate coils, which, when properly wound, tune through one band at the high-capacity end of the condenser range, and through the next higher-frequency band at the other end of the condenser range. With a 1.75-Mc. crystal in use, the coil for the 7-Mc. to 14.4-Mc. range is used in the plate circuit for tuning to the fifth harmonic, for instance. The fourth harmonic, 7 Mc., is found with the oscillator switched to Tri-tet, and with the plate tuning condenser very near maximum capacity. If the plate condenser is now rotated slowly toward the low-capacity end of the range, the next point at which excitation to the 807 will be shown is the fifth harmonic setting of the condenser. If fifteenth harmonic output from the 807 is desired, the 28-Mc. amplifier plate coil is used and the plate circuit of the 807 is tuned to the third harmonic of the oscillator output. The 28-Mc. setting of the amplifier tuning condenser will be found to be near minimum capacity (the second harmonic of the oscillator output may be found near the middle of the amplifier tuning range, but this harmonic is of course disregarded).

Tuning the oscillator plate circuit still farther toward minimum capacity, the sixth, seventh, and eighth harmonics of the crystal will be found in order, with the eighth harmonic occurring near minimum capacity of C_1 . Of these three last-named harmonics, the seventh and eighth will be most used, and the dial settings for these two should be carefully recorded. Of course, slight allowance toward a smaller capacity for each harmonic must be made for a higher-frequency crystal in the same band as the one from which the settings are recorded, but this will not be found difficult in practice.

The above recommendation of the Tri-tet oscillator for noting the harmonic dial settings is based on the fact that the Tri-tet is more certain to show output on all of the crystal harmonics up to the eighth. Once the plate condenser setting for the fifth harmonic (or for the seventh) has been found, the toggle switch should be changed to the position for the grid-plate oscillator circuit, and the oscillator should be carefully adjusted for maximum output consistent with good keying and note.

The receiver may be used for further assurance of proper harmonic output of the 807 amplifier. Coupling to any following stage should be removed from the 807 plate circuit, and a piece of insulated wire three or four feet long should be clipped to the plate coil a few turns from the end by-passed to ground. Care should be used to keep

New Foreign Order Dept.

Special Attention given to FOREIGN ORDERS in this new Export Department. Hams outside the U. S. be sure to WRITE TODAY for Big New Catalog and full details of Newark's New Foreign Order Dept.

ORDER Direct from NOW
This Ad

Get that NEW RECEIVER on Easy Terms FOR THE D-X CONTEST

National's NEW NC 100XA

Notice the big, new type, illuminated dial with direct reading scales for each band. Calibrated in Megacycles. Also continuous running vernier dial with band spread readings from 0 to 1000 at all frequencies. Equipped with "S" Meter. Cabinet restyled and enlarged. Yet with all these fine improvements the NC 100XA costs no more! Send only \$22.50 with order, pay balance easy terms as listed below. Cash Price \$142.50.

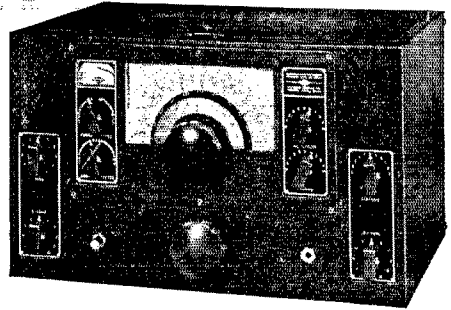

CHOOSE any one of the fine nationally known sets

in this list and RESOLVE TO HAVE IT . . . NOW! Regardless of what set you want, just send Down Payment with your order. Balance in six, nine or twelve months as listed below.

	Cash Price	Down Payment	6 Months Payments	9 Months Payments	12 Months Payments
NATIONAL NC 80X-81X Complete with Tubes and 8" PM Speaker in Cabinet	\$99.00	\$19.00	\$14.30	\$9.66	\$7.30
NATIONAL NC 100XA Complete with Tubes, Crystal and Speaker in Cabinet	\$142.50	\$22.50	\$21.10	\$14.21	\$10.80
NATIONAL NC 101X Complete with Tubes, Crystal and Speaker	\$129.00	\$24.00	\$18.58	\$12.50	\$9.47
NATIONAL HRO DE LUXE Complete with Tubes, Crystal and Coils	\$179.70	\$29.70	\$26.14	\$17.67	\$13.45
NATIONAL NC 44 \$49.50 Complete.	Not Sold on Payment Plan				
HALLICRAFTER SKY CHAMPION — Model S-20 Complete	\$49.50	Not Sold on Payment Plan			
RME 69 Complete with Tubes, Crystal and Speaker	\$152.88	\$27.88	\$21.94	\$14.77	\$11.25
RME 70 Complete with Tubes, Crystal and Speaker	\$138.60	\$28.60	\$19.42	\$13.07	\$9.91
HAMMARLUND SUPER PRO Complete with Tubes and 8" Dynamic Speaker	\$123.00	\$33.00	\$36.35	\$24.61	\$18.75
Model SP 110, 15-560 Meters or Model SP 110S, 7.5-240 Meters	\$243.00	\$33.00	\$36.35	\$24.61	\$18.75
HAMMARLUND SUPER PRO Complete with Tubes, Crystal and 8" Dynamic Speaker	\$261.00	\$41.00	\$38.08	\$25.78	\$19.64
Model SP 110X, 15-560 Meters or Model SP 110SX, 7.5-240 Meters	\$243.00	\$41.00	\$38.08	\$25.78	\$19.64
HALLICRAFTER SKY BUDY — Model S-19 Complete	Not Sold on Payment Plan				
HALLICRAFTER SUPER SKY RIDER SX-17 Complete with Tubes, Crystal and Speaker	\$149.50	\$34.50	\$20.26	\$13.64	\$10.36
HALLICRAFTER SKY RIDER MARINE Complete with Tubes and Speaker	\$64.50	\$14.50	\$9.32	\$6.26	
HALLICRAFTER SKY RIDER 5-10 Complete with Tubes and Speaker	\$69.50	\$19.50	\$9.32	\$6.26	

NEW
Hammarlund
HQ-120
Complete with Tubes, Crystal and Speaker —
Cash Price
\$129.00
\$24 Down
Balance
\$18.68 for 6 months!
\$12.60 for 9 months; or \$9.47 for 12 months.

We will have all the New Receivers as Announced by the Manufacturers

HAMS! LOOK AT THESE BIG NEWARK SPECIALS!

Oil Filled, Oil Impregnated
FILTER CONDENSERS

Only \$1 1500 V. DC. 1 1/2 mfd.

2" Diameter Round Can. 2 3/4" high. Weight 1/2 lb. Well Known Makes. Only a few of each left . . . and they're going fast. Order Now. Guaranteed at rated voltages.

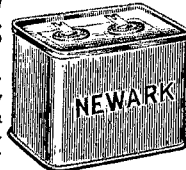

Your CALL LETTERS in GOLD10c

Big shadowed decalcomania letters nearly TWO INCHES high. Put them on your HAM SHACK door, auto window, etc. Send time for yours today. Be sure to give your call letters.

FREE Catalog

Listing Thousands of items, sets, tubes, parts and supplies. Write for this Big 76 page 1939 Catalog Today.

National's NEW 600-WATT TRANSMITTER

Now Yours on NEWARK'S EASY TERMS

Write for Time Payment Details — A modern Transmitter available in kit form built around the new National Co. type "NTE" Combination Exciter and Speech Amplifier. Complete descriptive booklet sent upon request.

2 mfd., 2000 V. DC 4 7/8 x 3 1/2 x 1 3/4, 1 1/4 lbs.	\$1.50
3 mfd., 1250 V. DC 3 1/4 x 3 1/4 x 1 1/4, 1 1/4 lbs.	1.25
3 mfd., 1500 V. DC 5 x 3 3/4 x 1 3/4, 1 1/2 lbs.	1.50
4.4 mfd., 1500 V. DC 5 x 3 3/4 x 1 3/4, 1 1/4 lbs.	1.75
8 mfd., 2000 V. DC 5 x 3 3/8 x 3 3/4, 2 3/4 lbs.	2.75

NEWARK

Electric Company

323 W. MADISON ST.
Dept. Q CHICAGO, ILL.



SPECIAL

For March

HICKOCK THERMOCOUPLE R.F. AMMETERS

0-5 amps..... **\$3.95**
 Dual 0-2 and 0-5 amps.....
 Dual 0-1.2 and 0-5 amps.....
 3¼" Diameter, Front Panel mount

— LIMITED QUANTITY —

NEW! Hallicrafter's Sky Buddy

Now with 10 meters and electrical Band Spread. No extra cost.....\$29.50

Here's an FB Rig Tester

Supreme Model 542 Multitester

Reads D.C. Volts: 0-6, 150, 300, 1500

A.C. Volts: 0-6, 30, 150, 600

OHMS: 4 ranges — 1 ohm to 2 megs.

DB: -6 to +10, +24, +38, +50

D.C. Ma: 0-.3, 6, 30, 150

COMPACT — 3" X 5¼" X 2"

5000 ohms per volt..... **\$15.97**

CORNELL-DUBILIER

Xmitting Capacitors

Oil Impregnated — Oil Filled

2 Mfd — 1000 V..... **\$1.62**

2 Mfd — 1500 V..... **2.21**

2 Mfd — 2000 V..... **2.50**

Complete catalog on request

Punch Your Own Chassis and Panels

Without hammer or anvil. New screw punch requires wrench only. Available in any standard size: ¼" to 1¾"..... **\$1.75**

THORDARSON Universal Modulation Transformers

Tapped to match any audio to any R.F. Load.

60 watts audio..... **\$5.88**

100 watts audio..... **8.82**

250 watts audio..... **14.11**

Write or stop in for complete listing

WASCO E-C Exciter Unit

Instant QSV over entire band with steady T9X signal. NO CHIRPING! Two GL6's provide sufficient output to drive final. Complete kit with coils for one band..... **\$14.45**

FREE INTERESTING CIRCULAR

If you cannot conveniently stop in at our big store, be sure to drop us a post card. Your name will be placed on our active amateur mailing list for FREE copies of all new bulletins and catalogs. Keep up to date with this progressive service.

ALSO SEE OUR AD PAGE 120 OF THIS ISSUE

EXPORT ORDERS SOLICITED

Prompt attention to all inquiries



RADIO CO.

212 Fulton Street, Dept CT New York

Cable Address SUNRADIO NEW YORK

the wire from touching any other wiring or metal parts, or the operator. The receiver should then be tuned to the desired frequency of output, and the amplifier should be tuned through resonance for this harmonic. If the amplifier is on the desired frequency, a marked rise of signal should be noted in the receiver. A further check is provided by tuning the receiver to the next lower frequency band and noting the effect on the signal produced by the plate circuit tuning. If as much signal increase is noted on this band as on the previous one, a second glance should be cast at the 807 output coil and the setting of the tuning condenser! Otherwise, with little effect on the signal in the receiver (tuned to the lower-frequency band) produced by tuning the 807 plate condenser through the setting believed to be the desired harmonic, the operator may feel reasonably sure of his ground.

The time-tried absorption wavemeter is, of course, still very valuable for checking the harmonic of a tank circuit; but if the above procedure is followed, construction and calibration of a wavemeter should not be necessary. The output of the 807 should be heard in the receiver always during tuning adjustments.

Further Notes on Operation

Because of the wide range of harmonic operation made possible by use of 160-meter crystals, mention of operation with 80- and 40-meter crystals has been withheld for these later paragraphs. Nevertheless, operation with crystals in these bands is quite normal. It should be pointed out that sixteenth harmonic output from the 807 is very small — approximately 3 watts — when a 3.5-Mc. crystal is used for 56-Mc. exciter output. Although the exciter was not primarily designed to include 5-meter output, entirely satisfactory operation in this band is provided by use of the 807 as a 56-Mc. doubler, excited by 28-Mc. output of the Tri-tet oscillator with a 7-Mc. crystal. For 56-Mc. output, the plate tank circuit of the 807 should be changed to place the tuning condenser and coil in series between plate and ground, and the plate of the 807 should be fed d.c. through a radio-frequency choke similar to the others used in the exciter. Because of the great reduction in the effective capacity across the plate coil with this circuit, the 28-Mc. plate coil may be used for 56-Mc. operation.

A very wide choice of frequencies in the 56-Mc. band may be obtained by use of a triode doubler driven by the output of the 807.



A tip for the DX contest: "Ohmite News" says: "If you want to hear better, have your head X-rayed. X-ray operators have noted that persons whose heads were X-rayed often showed a temporary improvement in hearing."

HITCH YOUR TRANSMITTER TO A BLILEY LD2

AND WATCH IT GET YOUR SIGNALS THROUGH

Operating conditions in the congested 80- and 160-meter bands place a premium on stable signals. Low frequency drift and a sharp clean signal are necessary characteristics for getting through — especially when operating conditions are difficult.

The LD2 Crystal Unit has a frequency drift of less than 4 cycles/mc./°C., a high activity and is free from spurious frequencies. Manufactured by experienced technicians, this precision unit (for the 80- and 160-meter bands) is your guarantee of stable dependable frequency control.

Install an LD2 in your transmitter — you can get it from your Bliley Distributor for only \$4.80. He will be glad to give you a copy of circular A-6 describing the complete line of Bliley Crystal Units.

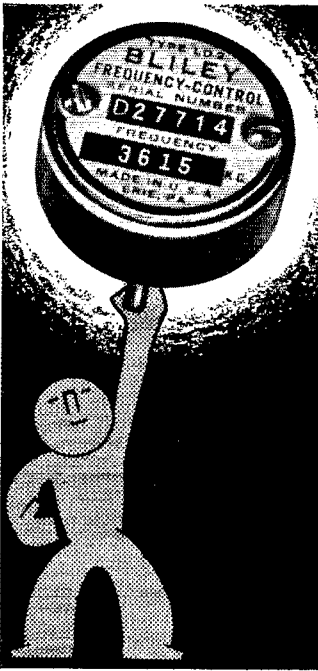

BLILEY LD-2 CRYSTAL UNIT

110 VOLTS AC Anytime, Anywhere! with Katolight Plants

Have special plant for operating radio receivers and transmitters. Close tolerance regulation. Full 350 watts AC and 100 watts at 6 volts. Filtered and Shielded. \$66.00
Amateur's price \$66.00
Other sizes up to 10,000 watts.
Both gasoline and Diesel.
KATOLIGHT, Mankato, Minn., U.S.A.

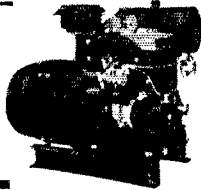

SICKLES COILS

SECURE A COPY OF OUR NO. 939
CATALOG FROM YOUR JOBBER

F. W. SICKLES COMPANY

300 Main Street

Springfield, Mass.

• TELEGRAPHY—TELEVISION—TELEPHONY •

AVIATION
TRANS RADIO
PRESS
TELETYPE
TYPEWRITING



PRACTICAL
EXPERIENCE
STUDIO —
TRANSMITTER —
ANNOUNCING

The major technical training equipment owned by Port Arthur College and in operation on the college campus consists of the 500-Watt Commercial Broadcast Transmitter of Station KPAC; two-way Television Transmitter and Receiver; Latest Type RCA Marine and Airways transmitter installation complete; SOS Automatic Alarm; Marine Direction Finder; Trans-radio Press Receiving Equipment, and Laboratory complete where students assemble composite transmitters, amplifiers, audio amplifiers, R. F. amplifiers, etc.

Port Arthur College pioneered the teaching of Radio with classes in 1909, and for thirty years has maintained an active Employment Bureau for the placement of its graduates.

If interested in details about Radio Course, write for Bulletin R

PORT ARTHUR COLLEGE ■ PORT ARTHUR (World-Known Port), TEXAS

N. C. R. Notes

(Continued from page 46)

Reserve lived up to the high traditions of the service during the disastrous Southern California earthquake of 1933 and the floods of March, 1938. The importance of a disciplined organization was amply proven; numbers of unattached amateurs, capable and willing but helpless due to the confusion, offered their services to the Naval Communication Reserve network and performed splendid work. Civil authorities, awakened to the seriousness of disrupted communications, and educated to the possibilities of organization by contact with smoothly running Naval Communication Reserve circuits operating under stress of a major disaster, are cooperating with the Naval Communication Reserve in every possible way; furnishing city-owned quarters, perfecting liaison between police radio and the Naval Communication Reserve. Major disasters teach that there is a definite job for each and every available communication facility during the emergency period; and lives will be saved if each facility is organized to do the job it is best qualified to handle, with all facilities organized into a flexible communications system for the purpose of eliminating confusion and duplication. The Naval Communication Reserve considers cooperation with other facilities, toward this objective, a very important part of its mission.

The Eleventh Naval District Naval Communication Reserve is on the lookout for those who would be interested in enlisting as signalmen, preferably those who have been honorably discharged from the regular Navy with signalmen ratings. All such men are urged to contact their local Naval Communication Reserve commanding officer.

Poor Man's Rotary Beam

(Continued from page 47)

In the construction, all insulators are attached and the system is laid out upon the ground. The 2 spacing wires, each 8 feet 8 inches long, are fastened at each end as shown in the sketch. These wires should be broken up with strain insulators, since their only purpose is to maintain the spacing at the ends of the antenna; they are not a portion of the radiating system. The center cross-over wires are now put in place using a 6-inch spreader at the center to separate them.

The supports for the antenna proper are four 22-foot fishing poles which we purchased for one dollar. These poles are mounted on a 12-inch by 12-inch piece of 1-inch oak by means of eight metal conduit fasteners. They are arranged so that the angles embracing the antenna wires are each 149 degrees. Obviously the opposite angles are 31 degrees. We now mount our antenna on the tips of the bamboo poles bending each up about 4 feet. A little trial and error will be necessary to find the position at which all corners are level.

We now mount the platform on top of the 2-

Answers YOUR Questions HOW TO PASS Radio License Examinations

By CHARLES E. DREW, I.R.E., A.I.E.E.

This book is more than just a new edition of a famous work. It has been completely rewritten, and will serve as an excellent guide to all radiomen. Important phases of the subject are given thorough treatment, so that the man who understands the content of this book will be well qualified to pass the examination for his commercial license. **\$2.00**

ON APPROVAL COUPON

John Wiley & Sons, Inc.
440 Fourth Avenue, New York, N. Y.

Kindly send me a copy of Drew's HOW TO PASS, on ten days' approval. If I decide to keep it, I will remit \$2.00; otherwise I will return the book postpaid.

Name

Address

City and State

Employed by

QST 3-39

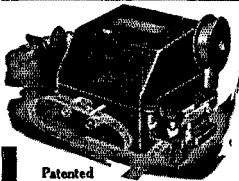

A Perfected AUTOMATIC SENDER

\$13.50 **\$12.50**
West of Denver

Patented

Save your fist. Let the Automatic Sender raise your stations for you. Repeats calls or messages indefinitely. Length of messages practically unlimited. Sends from 2 to 70 words a minute. Motor driven. Entirely automatic. Built-in tape perforator. Absolute uniformity in spacing of characters. Used with buzzer or oscillator, makes excellent code teacher for novice and speed-builder for the advanced amateur. Complete with 6 rolls of tape and full instructions. No extra equipment needed.

Mercury Vapor Keyer

Eliminate clicks. Will handle any keying **\$7**
circuit up to 850 volts at 500 M.A. Less Tube
FULLY GUARANTEED Postpaid in U. S. A.

Haddon Heights
New Jersey, U. S. A.

Gardiner-Levering Co.

ONAN ELECTRIC PLANTS

Supply the "JUICE"
WHEN POWER LINES FAIL
OVER 40 MODELS - 350 TO 50,000 WATTS

COMPLETE—READY TO RUN
HUNDREDS OF ONAN ELECTRIC PLANTS serve Amateur and Commercial operators. When Power Lines fail and Communication is needed most, they supply Power for Lights and Radios—Save Property and even Lives.

Portable—Dependable—Economical
Thousands in use in all parts of the World. Highest Quality Materials—Modern Design. 110 and 220 Volt A.C.—12, 32 and 110 Volt D.C. and Dual Voltage Generators. Manual, Self-Starting and Full Automatic Starting Types. Write for Details.

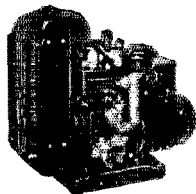

D. W. ONAN & SONS, 342 Royalston Av., Minneapolis, Minn.

ASTATIC

CRYSTAL MICROPHONES

Meet the Modern and Exacting Demands of Professional Broadcasting, Veteran Amateurs and Efficient Public Address Systems

Model T-3, with its unique swivel mount, tilting head and exceptional performance is a general favorite in the P. A. field and among amateurs. It is listed at \$25.00. Astatic's New Multi-Unit Microphones, used extensively with high class P. A. Systems, are made in two models: MU-2 at \$29.50 and MU-4 at \$39.50. Model D-104, that grand old Astatic favorite, continues to serve and delight veteran amateurs the world over. D-104 is listed at \$22.50. All Astatic Microphones come equipped with cable and interchangeable plug and socket connector.

See Your Astatic Jobber or Write for Literature

ASTATIC MICROPHONE LABORATORY, INC.

Pioneer Manufacturers of Quality Crystal Devices, Youngstown, Ohio
 Licensed Under Brush Development Co. Patents—Astatic Patents Pending

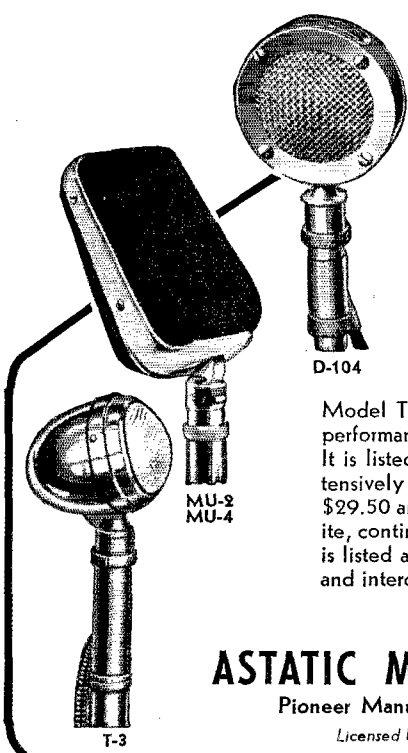

TRIMM HEADSETS COMMERCIAL FEATHERWEIGHT

FOR REAL DX

Own A Pair Of Each For Your Rig

Write Dept. R-43 for Folder

TRIMM RADIO MFG. CO.
 1770 W. Berteau Ave. Chicago, Illinois

FREQUENCY

measurements easily and accurately attained with the new type DFS dual frequency crystal which oscillates at 100 and 1000 Kc.

Small, compact, and attractively mounted in a bakelite holder designed for easy mounting.

It is a valuable aid to radio servicemen for calibrating receivers, oscillators, etc.

Amateurs will find this new low priced unit invaluable for frequency measurements in the amateur bands.

Net Price, mounted — \$7.25

THE VALPEY CRYSTALS

Box 321

Holliston, Mass.

A GOOD NAME GOES A LONG WAY

Ken-Rad Radio Tubes maintain their good name because of a thoroughly sound foundation of engineering skill and unexcelled manufacturing facilities.



Ken-Rad Radio Tubes

KEN-RAD TUBE & LAMP CORPORATION - OWENSBORO, KY.

Manufacturers of all types of radio tubes and Ken-Rad Electric Lamp Bulbs

New WASCO

PRECISION E.C. OSCILLATOR

In the price reach of all amateurs. Laboratory Wired and Tested with one set of coils and moving coil M.A. Meter. Net **\$17.64**
 2 — 6L6 tubes, each **1.22**



Conform with the new F.C.C. Regulations

New GUTHMAN

PRECISION FREQUENCY METER

Laboratory Tested with tubes, net **\$31.26**
 The U-10 Frequency Meter-monitor may also be obtained in kit form.

Complete parts less tubes ready for wiring, net **\$21.75**

CONVERT YOUR PRESENT SET

to a dual diversity receiver with the Guthman Dual diversity coupler available as a kit for only **\$16.46**
 or factory wired and tested, with tubes, net **21.75**



IN STOCK BLILEY

40 METER VARIABLE CRYSTALS



Modernize your rig with an antenna relay and get the advantage of your transmitting antenna for receiving.

WARD-LEONARD

Mycalex Insulated RF-D.P.D.T. Relay, net **\$5.88**

New GORDON

1 KW antenna relay with husky $\frac{3}{8}$ " silver contacts, net..... **\$8.88**

New ADVANCE Type 400 Relay

Mounted on $\frac{1}{4}$ " Isolantite Base, contacts will handle 15 amperes. Net..... **\$5.88**



ONLY A FEW LEFT!

POWER TRANSFORMERS

Made by one of the Country's
Leading Manufacturers

● Hum Bucking Type Coil Structure ● Completely
 Poured with Humidity Proof Compound ● Designed to
 deliver 1500 or 2000 volts D.C. at 500 MA. ● Dimensions
 10 $\frac{1}{2}$ x 8 $\frac{1}{2}$ x 8 ● Gross Weight 85 lbs., net **\$16.95**

OUR *Best* VALUE IS OUR RECORD OF LOYAL SERVICE

HARVEY

Radio Company of New York

103 WEST 43rd STREET • NEW YORK, N. Y.

CABLE ADDRESS: "HARADIO"

by-2, using four angle-iron pieces and machine bolts; wood screws are not satisfactory. Our matching section is attached to the center of the cross-over wires, goes through two feed-through insulators in opposite sides of the square platform and is supported throughout its length by small porcelain stand-off insulators fastened to the sides of the 2-by-2. The shorting bar and feeder may be attached according to the dictates of each builder. Their adjustment has been covered many times in *QST* and the Handbook and will not be repeated.

Due to the low cost, in our case \$2.75, separate rotaries for the 5-, 10- and 20-meter bands are planned at W5EOW. It works so well that we know that the antenna just doesn't realize what a cheap rotator is pushing it around.

A New Idea in V.T. Voltmeter Design

(Continued from page 58)

supply as shown. For them the circuit shown in Fig. 2 is suggested. This has not actually been tried out but should prove as satisfactory as that of Fig. 1.

One change which we plan on making in the circuit of Fig. 1 is the inclusion of voltage regulation in the power supply. The 6L6 plates can be supplied from the unregulated source satisfactorily but the screen supply should be regulated. If this were done the voltage divider consisting of N_2 and R_7 could be eliminated and the screen supplied from a bleeder. The regulation of our supply is very bad, the output being only around 360 volts with full load but rising to nearly 700 with all load except the bleeder removed. We at first tried supplying both screens from the bleeder but the voltage increase due to poor regulation when a test voltage was applied was enough to make the unit's accuracy unsatisfactory. N_2 keeps the screen voltage of V_2 constant with respect to cathode.

Adjustment

We would recommend that anyone duplicating this unit follow the original parts values closely, as they have been found to provide the greatest accuracy. After wiring is completed attention should be directed toward proper bias adjustments. Points *A* and *B* should always be shorted when making adjustments. If after the tubes warm up the bias on V_2 as measured between *A* and *C* is found to be positive instead of negative as desired, the screen voltage on V_3 should be increased. This increases the current through R_5 and makes *A* more negative with respect to the other electrodes of V_2 . The screen voltage, however, should not be made much above 100 volts in order to keep the screen current within safe limits. If a positive bias should be found on V_2 with proper screen voltage on V_3 and neon bulb N_1 should not ignite, cathode resistor R_4 must be replaced with one of higher resistance.

R_7 and R_8 , which are in series with the neon bulbs, serve only to limit current through the

SS39 SIGNAL SQUIRTERS ARE DOING THE JOB

W1HX says:

Dear Mims:

Am certainly pleased with the new Signal Squirter and as you can see from the list, I have worked all continents in less than three weeks' time since installation. It works wonders for transmitting and receiving. I have had four contacts with Asia on c.w. and on fone. I have had R9 plus reports from Europe, Africa, South America and the U. S. A. or Four Continents out of the Six. The power is not doing all that and I feel that the antenna should get all the credit. My installation is only four feet above the peak of the house here and the location is not exceptional although fairly good. Hoping this helps you to know what users of your new antenna are doing, will say best luck and success to you and now I'll sign off.

Cordially yours,

(signed) NORM YOUNG W1HX

DIRECTION INDICATOR

Now Ready! . . . \$24.50

Other components available individually. ROTATOR now improved over early model!

20-meter kit \$59.50

10-meter kit \$49.50

Kit includes low-drain, non-interference producing motors; new coupling system permitting open wire feed; ingenious rotating mechanism; "Inductostub," the new coupling device; self-supporting radiating elements . . . Continuous rotation in either direction, greater transmission gain, easy tuning! WRITE TODAY FOR COMPLETE DATA!

HERE are some of the users of SS39's —

CO2XX	W2JKQ	W6JPW
CO7CX	W2JOA	W6MBD
G5ML	W2ISW	W6MKD
LU4CZ	W2KAP	W6NKK
TC9BA	W2KR	W6NKP
VK2RJ	W3ASG	W6NNR
W1AA	W3BJR	W8AAJ
W1AUR	W3CKY	W8AAN
W1BGA	W3CPE	W8CIR
W1BLO	W3FOP	W8GLY
W1BQN	W3KFC	W8HL
W1CND	W4DJZ	W8KDJ
W1HX	W4DSY	W8MPX
W1IPC	W4DYP	W8NKY
W1JFG	W4FRF	W8ARK
W1KIU	W4FT	W8BHT
W1KKP	W5AFG	W8CBJ
W1ZD	W5BDB	W8CVN
W2AD	W5BEK	W9EIX
W2ARB	W5DUK	W9NA
W2BTP	W5EKF	W9NFA
W2BZ	W5FHJ	W9NMH
W2DQW	W5FPD	W9RFT
W2GAU	W5VY	W9RCH
W2GVZ	W5ZS	W9RGY
W2HWF	W6BXQ	W9WUC
W2IEF	W6DEP	W9ZYB
W2IHX		

Get Ready for the DX Contest—Now

"Put Your Signal Where You Want It When You Want It There"

Write—Right Away

MIMS RADIO COMPANY

M. P. MIMS—W5BDB, P. O. Box 504, Texarkana, Ark.

MORE POWER TO THE KING!

UNITED 972A Rectifiers now supply Royal Power to His Majesty's new TEMCO transmitter. Fine equipment! Our compliments to the king!



972A
\$4.00

966A
\$2.50

Monarchs of the Shack, by the thousands, have shown this same kind of regal discrimination. Amateur and commercial operators alike have learned that mercury rectifier technique is a UNITED ELECTRONICS domain. That's why UNITED rectifiers are used more and more in important places.

UNITED

TRANSMITTING TUBES

—36 types in all—are specimens of the finest craftsmanship. Write us for free bulletin.

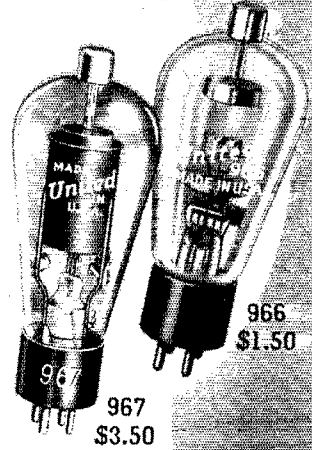

966
\$1.50

967
\$3.50

UNITED ELECTRONICS COMPANY
42 Spring St. Cable "UNELCO" Newark, N. J.



**MR. RADIOMAN: What Are You
Doing About "Tomorrow"?**

**Start Training NOW in Practical
Radio Engineering**

*E. H. Rietske
Pres. CREI*

● Don't sit back and watch the other fellow get ahead. Radio plays no "favorites." The GOOD men get the GOOD jobs. TECHNICAL TRAINING makes it possible for YOU to get ahead to a better job and better pay. Preparing yourself *today* is the best insurance for a better job *tomorrow!* We can help you get ahead as we have helped hundreds of other ambitious men.

**Write for
FREE
Booklet:**
"A Tested Plan
for a Future in
Radio
Engineering"



**CREI Technical Training
Prepares You for a Bright
Future in a Field Where
Training Pays!**

CREI home-study courses are planned for EXPERIENCED radiomen who want to become ENGINEERS. Every phase of practical radio engineering is thoroughly covered. If you combine your own radio experience and knowledge with CREI training you should be equipped to take advantage of every opportunity to improve yourself. Write today for details.

Capitol Radio Engineering Institute
Dept. Q-3, 3224 16th St. N.W., Washington, D. C.

QSL Cards

Individual QSL Cards printed as you want them, at reasonable prices. Samples gladly submitted on request.

HINDS & EDGARTON, INC., W 9 W R
Ex. W9APY
19 South Wells Street, Chicago, Illinois

Enjoy Sending at Its Easiest and Best
with the Great New Easy-Action

VIBROPLEX No. 6 Semi-Automatic Key

Japanese Base **\$17**

Nickel-Plated Base **\$19**

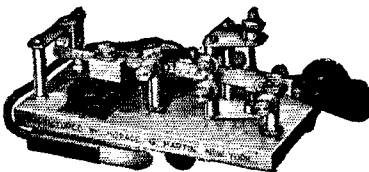

Enjoy the treat of a finer, smoother, more efficient bug than most operators have ever owned. It thrills you with its strong, clear signal, machine speed and ease of operation. Its free easy-action eliminates tiring arm work and enables you to enjoy sending at its easiest and best. Place your order NOW! Money order or registered mail. Liberal allowance on old Vibroplex. Write for catalog.

JUNIOR
Only \$12.50

Slightly smaller base but in all other details similar to the Improved model shown in catalog. All standard features. A low priced key with world-famous Vibroplex quality.



The BUG trade mark identifies the Genuine Vibroplex.

THE VIBROPLEX CO., INC., 832 Broadway, New York, N. Y.

bulbs, and may have to be replaced with other values if the power-supply voltage varies greatly from that of the original unit. The resistance should be as high as possible to keep the current through the neon bulbs at a minimum, but low enough to allow them to ignite readily.

To assist in adjustment of the unit the following operating voltages are given for various points. These are all in relation to point A and are made with no test voltage applied but with A and B shorted.

Point	Voltage in Relation to A
C.....	pos. 2 volts
D.....	zero
E.....	neg. 42 volts
F.....	neg. 65 "
G.....	neg. 45 "
H.....	pos. 48 "
I.....	pos. 35 "
J.....	pos. 320 "

We have found this unit the most welcome addition ever made to our equipment and believe its general usefulness will please anyone duplicating it. Accuracy is excellent on low voltages, gradually decreasing at higher values until at 400 volts the error is around five percent.

Its sensitivity has amazed us. Touching the finger to the 75 grid will give a reading of three to four volts. Touching the hand of another person or any metal object of any size will increase the reading. We couldn't understand this at first but began suspecting it was pick-up from the house wiring and proved it to be so by passing our hand over a wire—not actually touching the conductor—carrying one side of the 110-volt circuit. The voltmeter, which at the time was on the five-volt range, went clear off scale. We found that while touching the 75 grid with one hand even raising the other hand toward a 110-volt-line in the ceiling gave an increased reading. Such sensitivity should have many uses.

Crystal-Controlled 'Phone

(Continued from page 51)

downward, protruding through a 4-inch hole. The chokes are mounted similarly, but with smaller holes. The "B" plus and filament leads terminate in a five- and six-prong female sockets on the rear edge. These correspond to the plugs on the r.f. and a.f. units. Two toggle switches are mounted on the front edge, one controlling the 110-volt a.c. input, and the other serving as a stand-by switch in case the power supply is used on some other rig.

Tuning and Adjustment

After mounting and wiring all parts according to diagrams and photos, the rig is ready for tuning up. Plug in the power cords and interconnecting cables, insert the tubes, and turn on the 110-volt switch, making sure that the stand-by switches on r.f. and power-supply units are both off. If you wish to try it first as a self-excited oscillator, plug the grid condenser into the socket. Place the cathode clip at 1 or 2 turns from the ground end

NOT *for your bookshelf—*

FOR PRACTICAL USE



The

**RADIO AMATEUR'S
HANDBOOK**

\$1 postpaid in Continental U.S.A. — \$1.25 postpaid elsewhere

Buckram bound edition, \$2.50 Spanish edition \$1.50

American Radio Relay League

West Hartford, Conn.

SERVING HIS HIGHNESS

The RADIO Amateur

Democratic as he may be, the Radio Amateur is king in his own world of the short waves. He commands respect, demands the best and will brook no interference with his intention to get what he wants when he wants it. He often asks for — and gets — advice, but he is discriminating in his selection of his counselors.

We, here at Sun Radio, recognize the unique position of the Radio Amateur and realize — even anticipate — his every requirement. To that end we carry the most complete stocks of the finest lines of merchandise. We serve loyally and well, we endeavor to give counsel based upon long, practical experience. It is no wonder that Sun Radio Company is held in such high favor by Radio Amateurs and Technicians who want the best.

Temco Transmitters ARE ALWAYS IN STOCK

Typical of the quality lines which we carry in stock for the discriminating, are TEMCO Transmitters. Skillfully engineered and incorporating quality components in its construction, it represents a finished product "FIT for a KING." Let us give you a demonstration.

We carry the following lines all of which are consistently advertised in the pages of QST.

- | | | |
|--------------|-----------------|-----------------|
| ● Hammarlund | ● U.T.C. | ● R.M.E. |
| ● Taylor | ● Meissner | ● Howard |
| ● Thordarson | ● Hytron | ● Johnson |
| ● Simpson | ● Eimac | ● Biley |
| ● I.R.C. | ● Raytheon | ● Hallicrafters |
| ● National | ● New Sky Buddy | |

SEE PAGE 112 OF THIS ISSUE ON WHICH APPEARS ANOTHER SUN ADVERTISEMENT

SUN RADIO CO.
212 Fulton Street, New York, N. Y.
Cable Address: SUNRADIO NEW YORK

of the oscillator grid coil. Plug in a meter, preferably 0-25 ma. or less, into the final grid jack, and an open plug into the final cathode jack. Set the oscillator grid condenser at about $\frac{1}{2}$ total capacity. Turn the stand-by switch on and rotate the oscillator plate condenser until there is an indication of grid current. This should run in the neighborhood of 3 to 5 ma. If no reading results, perhaps the plate coil is not quite the right size. Try spreading the turns further apart or compressing them a little. Adjust the cathode tap until the grid current reads highest. Now turn off the stand-by switch and connect a meter (0-150 or 0-200 ma.) into the cathode jack of the final. Turn on the stand-by switch and rotate the final tank condenser until minimum cathode current results. This current, which will be in the neighborhood of 30 ma., is the sum of the plate and screen currents. Under loaded conditions it should be about 90 ma. Higher loading can be obtained, but should not be used if linear modulation is expected.

Coupling to the antenna will depend on the type of antenna used. For spaced feeders, 2 or 3 turns of well-insulated wire pushed in between the turns of the tank coil at the "B"-plus end will serve. For twisted-pair feeders, 2 turns probably will suffice. Adjust the coupling by sliding the turns in and out. The oscillator cathode current, measured in the left-hand jack, will be in the neighborhood of 25 to 30 ma. It is best to disregard the actual value here and tune the oscillator plate for maximum grid current to the final, which may not coincide with minimum cathode current of the oscillator.

For crystal control, a 10-meter crystal is plugged into the socket, and the cathode lead is clipped to the top of the coil. Tuning is the same as for self-excited connection, except that the oscillator cathode condenser capacity will be somewhat lower, and the setting will not be critical. In the self-excited circuit this condenser determines the frequency, and a small change in capacity will represent quite a change in frequency. Be careful to tune it so that it is always within the band. This can be determined by listening to the carrier on a receiver on which the band limits are clearly defined. When making this test the open plug can be inserted in the final cathode jack, enough energy being radiated by the oscillator itself to be picked up by a nearby receiver.

Unless the units are enclosed in cabinets, it is best not to place the r.f. section too close to the audio. No trouble was experienced by the author, but r.f. feed-back might occur under certain conditions. The chassis of one of the units should be

AMATEUR RADIO LICENSES

Day and Evening Classes in Code and Theory
HOME STUDY COURSES

Reasonable, Efficient and Thorough, Hundreds of
Licensed Students Now on the Air

American Radio Institute, 1123 Broadway, New York, N. Y.

Where to buy it

A directory of suppliers who carry in stock the products of these dependable manufacturers.



ALBANY, N. Y. Uncle Dave's Radio Shack 356 Broadway
ATLANTA, GEORGIA Wholesale Radio Service Co., Inc. 265 Peachtree Street
BOSTON, MASS. Radio Shack 46 Brattle Street
BOSTON, MASS. Wholesale Radio Service Company, Inc. 110 Federal Street
BRONX, N. Y. Wholesale Radio Service Company, Inc. 542 East Fordham Rd.
BUTLER, MISSOURI Henry Radio Shop 211-215 N. Main Street
CHICAGO, ILL. Allied Radio Corp. 833 W. Jackson Blvd.
CHICAGO, ILL. Wholesale Radio Service Company, Inc. 901-911 W. Jackson Blvd.
CINCINNATI, OHIO United Radio, Inc. 1103 Vine Street
COLUMBUS, OHIO Bell Radio Parts Co. 203 N. Fourth St.
DETROIT, MICH. Radio Specialties Co. 325 E. Jefferson Ave.
DETROIT, MICHIGAN Radio Specialties Co. 11800 Woodward Ave.
HARTFORD, CONNECTICUT Radio Inspection Service Company 227 Asylum Street
HOUSTON, TEXAS R. C. Hall & L. F. Hall Box 2434
JAMAICA, L. I. Wholesale Radio Service Company, Inc. 90-08 166th Street
KANSAS CITY, MO. Burstein-Applebee Company 1012 McGee Street
NEW ORLEANS, LA. Shuler Supply Company 902 Poydras Street
NEW YORK, N. Y. Harrison Radio Co. 12 West Broadway
NEW YORK, N. Y. Wholesale Radio Service Co., Inc. 100 Sixth Ave.
NEWARK, N. J. Wholesale Radio Service Co., Inc. 219 Central Ave.
OAKLAND, CAL. Offenbach's 2085 Broadway
POTTSVILLE, PENN. E. Norwegian & George Sts. Jones Radio Company
READING, PENN. George D. Barbey Company 404 Walnut St.
READING, PENN. Jones Radio Company 104 North Ninth Street
SACRAMENTO, CAL. Offenbach's 1310 K Street
SAN FRANCISCO, CAL. Offenbach's 1452 Market Street
SPRINGFIELD, MASS. T. F. Cushing 349 Worthington St.
WASHINGTON, D. C. Sun Radio & Service Supply Co. 938 F Street, N. W.

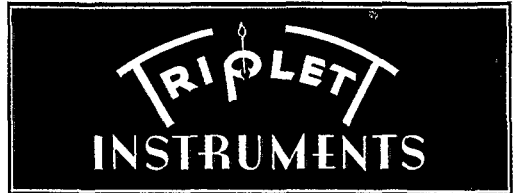

ALBANY, N. Y. Uncle Dave's Radio Shack 356 Broadway
ATLANTA, GEORGIA Wholesale Radio Service Company 69 Forsyth Street, N. W.
ATLANTA, GEORGIA Wholesale Radio Service Company 265 Peachtree Street
BOSTON, MASS. Radio Shack 46 Brattle Street
BOSTON, MASS. Wholesale Radio Service Company, Inc. 110 Federal Street
BRONX, N. Y. Wholesale Radio Service Company, Inc. 542 East Fordham Rd.
BUTLER, MISSOURI Henry Radio Shop 211-215 N. Main Street
CHICAGO, ILLINOIS Allied Radio Corp. 833 W. Jackson Blvd.
CHICAGO, ILLINOIS Electric & Radio Supply Co., Inc. 25 North Franklin Street
CHICAGO, ILL. Wholesale Radio Service Company, Inc. 901-911 W. Jackson Blvd.
CINCINNATI, OHIO United Radio, Inc. 1103 Vine Street
DALLAS, TEXAS Southwest Radio Supply 1905 Commerce Street
JAMAICA, L. I. Wholesale Radio Service Company, Inc. 90-08 166th Street
LITTLE ROCK, ARKANSAS Beem Radio Company 409 W. 3rd St.
MINNEAPOLIS, MINNESOTA Low Bonn Company 1124-26 Harmon Place
MONTREAL, CANADA Canadian Electrical Supply Co., Ltd. 285 Craig Street, West
MUSKOGEE, OKLAHOMA Home Radio Mart 204 No. Twelfth Street
NEW ORLEANS, LA. Shuler Supply Company 902 Poydras Street
NEW YORK, N. Y. Wholesale Radio Service Company 100 Sixth Avenue
NEWARK, N. J. Wholesale Radio Service Company 219 Central Ave.
OAKLAND, CAL. Offenbach's 2085 Broadway
POTTSVILLE, PENN. E. Norwegian & George Sts. Jones Radio Company
READING, PENN. George D. Barbey Co. 404 Walnut Street
READING, PENN. Jones Radio Company 104 North Ninth St.
SACRAMENTO, CAL. Offenbach's 1310 K Street
SAN FRANCISCO, CAL. Offenbach's 1452 Market Street
WASHINGTON, D. C. Sun Radio & Service Supply Co. 938 F Street, N. W.

Listings on this page do not necessarily imply endorsement by QST of the dealers or of other equipment sold by them.

GUTHMAN FREQUENCY METER-MONITOR

★ Designed by McMurdo Silver to conform to new F.C.C. regulation.

★ Accurate frequency check for 5, 10, 20, 40, 80 and 160 meters.

★ A stable, precision instrument.

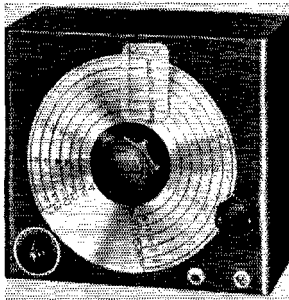

MAIL ORDERS FILLED SAME DAY RECEIVED

W9-LLX, Newark's Harry Harrison, has rigidly tested the new Guthman Frequency Meter-Monitor, and approves it from every angle. Newark therefore offers it to you, in both wired and kit form, with our highest recommendation as to quality, workmanship and accurate performance.

★ U-10, Completely wired Frequency Meter-Monitor, tested with full operating instructions.

Complete Unit, wired, less tubes, net price.....\$28.67

Kit of Raytheon tubes, net price.....\$2.79

★ U-10-K, Frequency Meter-Monitor Kit.

All necessary parts, including cabinet, easy to follow wiring instructions, most parts in position to wire.

Complete kit, less tubes — net price.....\$21.76

Kit of Raytheon tubes, net price.....\$2.79

Write for complete descriptive literature

NEWARK ELECTRIC COMPANY
323 W. Madison, Chicago



NEW HOLDER DESIGN

15 SECONDS TO
INSTALL CRYSTAL

For All Bands

GREATER STABILITY

Plugs in 5 prong tube socket

Beautiful Appearance

MODEL AH HOLDER \$1.00 At your dealer or direct

HIPOWER LOW DRIFT CRYSTALS:
within 10 kc. or Choice of stock

AH-10, 1700-3500 Kc. bands \$2.35

AH-10, 7000-7300 " bands \$3.90

WRITE FOR NEW LITERATURE

Hipower "Low Drift" Broadcast and Commercial Crystals Are Approved by F.C.C.

Hipower Crystal Co., 2035 Charleston St., Chicago

LEARN RADIO — TELEVISION —

500 Licensed graduates placed in past 7 years in shipping, broadcasting, aviation, police, etc., we also teach radio servicing and repairing; new beginners class now forming, day or eve., 52-page catalog free; one of the oldest, largest and best equipped schools.

MASS. RADIO SCHOOL

18 Boylston Street, Boston

G. R. Entwistle, Pres.
Established 1899

R. F. Trop, Treas.
Hancock 8184

connected to a good ground, otherwise a slight hum may be evident on the carrier.

No attempt has been made at the time of this writing to work any great DX with the little outfit, but all reports have been to the effect that it sounded as though a much higher-powered rig was in use, and perfectly stable carrier reports were had with both the crystal and the self-excited oscillator connections. It will certainly outperform a modulated oscillator of much higher power because all the energy is concentrated in a narrow band instead of being spread over 50 to 100 kilocycles.

Correspondence

(Continued from page 67)

I'm sure that the A.R.R.L. affiliated clubs will also support such a program. In fact I know of one that will get behind it wholeheartedly. I give you my assurance that the Tri-Town Radio Amateur Club will back that Safety Program 100 per cent. We won't wait for the A.R.R.L. to request our support. Tomorrow night, January 27th, this organization will start the Safety ball rolling. And we'll follow it up at our next meeting of February 10th by a discussion and actual demonstration of the Schäfer Prone Pressure method of resuscitation. That meeting will be given as much publicity as possible so that all amateurs in the Chicago area, as well as the general public will have an opportunity to attend. And to show that we're really in earnest, we'll submit to the A.R.R.L. a complete report following that demonstration. . . .

— Tri-Town Radio Amateur Club
D. L. Warner, W9IBC, President

660 Scotland Road, Orange, N. J.

Editor, *QST*:

Mr. John M. Orts, Director of Safety Education for the Public Service Corporation of New Jersey, informed me that he would be pleased to arrange a showing of a sound moving picture, followed by a demonstration of the proper method of applying artificial resuscitation.

This offer is open to all radio clubs in all New Jersey and entails no obligations. Simply write to Mr. Orts at the Main Office of the company in Newark, New Jersey.

— Nelson B. Wolf, W2FSQ

410 High St., Cranford, N. J.

Editor, *QST*:

. . . As I look back over nearly nineteen years of amateur radio activity, it suddenly occurs to me that comparatively little has been done to educate the radio amateur in the practice of safety except to warn him that high voltages are dangerous. We have all been too busy trying new circuits and creating rapid band change arrangements etc. to notice how the modern radio apparatus has multiplied the number of accident hazards. . . .

In reading your article concerning the tragedy at W9VYU, two important and much disregarded safety practices occurred to me — one so vividly demonstrated in the diagram accompanying the article. The first is the fusing of our radio equipment. How many amateurs are depending only on the main house fuses for their protection? Breakdowns may occur in our sets and still not blow these fuses. The second, and possibly most important, is the grounding of all exposed metal parts of radio apparatus not an integral part of the circuit. Parts not at ground potential should be enclosed so as not to be easily contacted. All ground connections should have a good electrical bond between them.

The articles in the February issue of *QST* have been the source of very interesting discussions on the NNJ-1 Net here, and the net control stations have originated a safety message to every member. We all will follow your safety campaign with a great deal of interest.

— P. E. Strout, W8KMI

HAM-ADS

(1) Advertising shall pertain to radio and shall be of nature of interest to radio amateurs or experimenters in their pursuit of the art.

(2) No display of any character will be accepted, nor can any special typographical arrangement, such as all or part capital letters be used which would tend to make one advertisement stand out from the others.

(3) The Ham-Ad rate is 15¢ per word, except as noted in paragraph (6) below.

(4) Remittance in full must accompany copy. No cash or contract discount or agency commission will be allowed.

(5) Closing date for Ham-Ads is the 25th of the second month preceding publication date.

(6) A special rate of 7¢ per word will apply to advertising which, in our judgment, is obviously non-commercial in nature and is placed and signed by a member of the American Radio Relay League. Thus, advertising of bona fide surplus equipment owned, used and for sale by an individual or apparatus offered for exchange or advertising inquiring for special equipment, if by a member of the American Radio Relay League takes the 7¢ rate. An attempt to deal in apparatus in quantity for profit, even if by an individual, is commercial and all advertising by him takes the 15¢ rate. Provisions of paragraphs (1), (2), (4) and (5) apply to all advertising in this column regardless of which rate may apply.

Having made no investigation of the advertisers in the classified columns, the publishers of QST are unable to vouch for their integrity or for the grade or character of the products advertised.

QUARTZ—direct importers from Brazil of best quality pure quartz suitable for making piezo-electric crystals.

Diamond Drill Carbon Co., 719 World Bldg., New York City.

RADIO engineering, broadcasting, aviation and police radio, servicing, marine and Morse telegraphy taught thoroughly. All expenses low. Catalog free. Dodge's Institute, Byrd St., Valparaiso, Ind.

USED receivers. Bargains. Cash only. No trades. Price list 3¢. W3DQ, Wilmington, Del.

RADIO control—Send stamp for circulars showing latest equipment. Lightweight, reliable, guaranteed to perform. Radio Control Headquarters, Granby, Conn.

CALLBOOKS—Winter edition now on sale containing complete up-to-date list of radio hams throughout entire world. Also world prefix map, press schedules and new time conversion chart. Single copies \$1.25. Canada and foreign \$1.35. Radio Amateur Call Book, 610 S. Dearborn, Chicago.

QSL'S, Cuts, Cartoons. Free samples. Theodore Porcher, 7708 Navahoe, Philadelphia, Pa.

IPS rubber crystal, QSY remotely, varies completely 160 to 10 meters. Approximately 200 watts output, \$19.50. Radio Apparatus Mfg., 1522 No. Clark, Chicago, W9IFS.

QSL'S—W8NOS.

CRYSTALS, mounted, 80-160 \$1.25, V-cut 40 \$2.25. R9 Crystals, 338 Murray Ave., Arnold, Pa.

QSL'S, Free samples. Printer, Corwith, Iowa.

GENERAL Electric dynamotors 24/750 volts 200 mils, new, \$15. Westinghouse 27½/350, \$10.; 6-15 volt 500 watts with propeller, \$8. 500 cycle 600 watts, \$8. Henry Kieziele, 215 Hart Blvd., Staten Island, N. Y.

QSL'S, 1939 designs. 50¢ to \$2. per hundred. W2FJE, 101 Hanson Place, Brooklyn, N. Y.

CRYSTALS: mounted; 40X, \$1.60; 160-80A, \$1.25; C.O.D.'s accepted. Pacific Labs., 344 Fetterly, Los Angeles.

QSL'S, SWL's. 100-3 color-75¢. Lapco, 344 W. 39th, Indianapolis, Ind.

FREE catalog. Order direct or from dealers. 160-80 meter Y crystals, 75¢. Faberadio, Batavia, Ill.

MUST sell: complete 450 watt fone-CW transmitter, \$125. Details? Write W8RTV, Pittsburgh, Pa.

SELL ACR-155, unconditionally guaranteed, \$35. Aaron Goodhines, W8RXA, Boonville, N. Y.

QSL'S—SWL's. Rainbo effects. Stamp. Fritz, 455 Mason, Joliet, Ill.

SELL: 1938 Clough-Brenkle tube tester, new, \$20. W3BEY.

EASTERN factory service station for Hallicrafters, RME, Howard, Sargent. Remember peak performance requires periodical receiver realignment. Communication Measurements Lab., 136 Liberty St., N. Y. C.

QSL'S, Finest value. Samples. Maleco, 1805 St. Johns Place, Brooklyn, N. Y.

SWAP brand new \$20. accordion for Riders Manuals. Clarence Pate, Samson, Ala.

SW3, latest circuit, power supply, coils, stand-by switch, perfect. \$18. W2EXR.

BRAND new HQ-120X receivers only \$10.52 down payment. Lowest terms on National, Hallicrafters, RME, Howard, etc. Write for free price list before you buy. W3DQ.

LOWEST terms on the latest Harvey transmitters. New model 100-T only \$17.25 down. UHX-10 portable only \$5.25 down. Free price list. W3DQ.

LOWEST terms on all standard parts. Large stock. Easy payment terms on all orders of \$25. and over. Mail me your list now. W3DQ.

12 KVA 487 cycle motor generator set. Burns Automobile, Dayton, Ohio.

200 watt phone, CW, all-band transmitter, rack and panel, 5 Triplet square meters, 4 power supplies, 6A6-807-T55, 6C6-76—pp. 76's, pp. 6A3's, pp. TZ20's Class B. Complete with Shure 705W crystal mike, crystals and all coils; \$150. W9YZT, 1133 Market, DeKalb, Ill.

QSL'S, QSL's. Made-to-order. World's finest. Samples? (Stamp). QST. "Radio" subscriptions appreciated. Bliley crystals. W8DED, Holland, Mich.

HAMMARLUND Super-Pro model SP10 with xtal filter and Jensen 12" speaker, used very little—must sell. Best cash offer takes this receiver. Charles Zeissig, 61 Rathbun Ave., White Plains, N. Y.

HARVEY 80T xmt. Like new. New RK20A. Factory coils 10-20-40-80-160. Shure xtal mike. Cost \$203.51. Sell \$100. W1JZE.

ROTARY beam motors, brushless, instantaneous reversing, low drain, noiseless, small, 110 a.c., \$3. postpaid. W8PKS.

QSL'S. Best, cheap. Radio Printer, Union, N. Y.

SELL: commercially-built 150 watt transmitter RK-47 final, \$80. NC-100XA perfect, \$110. or best offer. W3GKN.

COMPLETE station for sale. Collins oscillator-doubler. 50 watt final. Rack and panel. Custom-built to order. FB7 with National power supply including 20 meter coils. No reasonable offer refused. Last QSO with Holland. W1CV, Prospect Hill, Somerville, Mass.

USE Douglas Universal modulation transformers. Match all tubes. Designed by WSUD. 50 watts audio, \$4.95 pair; 100 watts audio, \$7.75 pair. Postpaid in U. S. One year guarantee. Write W9IXR, Rice Lake, Wis.

RECONDITIONED guaranteed RME69, \$90.; RME pre-selector, \$30.; Hallicrafters SX-11, \$64.; Hallicrafters SX-15, \$49.; Breting 14, \$59.; Patterson PR10, \$39.; Comet-Pro, \$39.; and others. Trade? Genmotors, receivers, see January QST. Walter Ashe Radio Co., St. Louis, Mo.

CRYSTALS—see February QST Hamad for crystal special. William Threm, W8FN, 3071 Moosewood St., Cincinnati, Ohio.

WANTED: McMurdo Silver or Scott receiver. Write details—Sullivan, 39 Chipman St., Medford, Mass.

SELL: National FBXA; 20, 40, 160 coils; \$25. W9OPL.

QSL cards. Samples. Meador, Box 241, Columbus, Miss.

SELLING out W4AG. Transmitters, receivers, vibroplexes, hundreds extra parts. Want cash and pre-cancelled stamps. What do you need? Morgan Gravlee, Kennedy, Ala.

BARGAIN: selling new high quality transmitters, 100% modulation, prices include tubes, etc.; 450W. phone-CW, \$245.; 675W. phone-1,000W. CW, \$365.; for information write: Askenasy, E. E., 274 Sterling Place, Brooklyn, N. Y.

QSL'S, Samples, prices on request. W2AEY, 338 Elmora, Elizabeth, N. J.

RME69; silencer, relay connections. Complete, \$97.50. W8NHQ.

SELL Weston model 476 multirange a.c. voltmeter 0-4, 16, 150, 450, 750 for \$8. 301 multirange d.c. voltmeter 0-10, 100, 250, 500, 750 for \$8. 301 multirange d.c. milliammeter 0-25, 125, 2½ amps. for \$5. All three for \$20. Amperite RBM mike and adjustable stand, \$15. Will accept credit memo from reputable dealer for \$35. for all of above. W5CRQ.

TUBES: Make offer—8 RK18, 1 RK31, 2 RK16, 2 RK15, 1 RK24, 1 Taylor 845, 3 211C, 1 T203A, 6 RCA-842, 3 RCA-867, 1 Sylvania 203A, 2 Sylvania 830. W2ABK.

COLLINS 30FX transmitter, 125 watts CW, 40 watts phone output, completely equipped with all coils, tubes, No. 7-Y speech amplifier, microphone, control unit. Excellent buy for \$165. Talley, W2PFF, 188 Linden Blvd., Brooklyn, N. Y.

BEAM builders—here's just what you need. Motor, worm reduction gearing, thrust ball bearings, hollow shaft, head, all mounted on steel base. Selysynchronous indicators, aluminum beam elements, tilting heads, Bassett cable, steel elements. Rotary Array Service, W8ML.

SELL: QST's, '29 to '38, complete except Dec., '29. Also 21 copies R-9, 47 copies Radio. All for \$14., plus transportation. W9GIV, 707 No. Pine, Chicago.

QSL'S? W8QCC, Frackville, Pa.

ARE you from Missouri, Mass., N. J., W. Va., N. C., S. C., Ga., Fla., Miss., Tenn., Ark., Texas, or Mont.? If so, we have a valuable opening on our staff for the sale of short-wave diathermy units, approved by A.M.A., and other recognized electro-medical specialties. Liberal comm. pd. Est. 60 yrs. McIntosh Elec. Corp., 225 No. Calif. Ave., Chicago.

QSL'S, 100 made to order, 60¢ up. W8BZK, Newark, Ohio.

CRYSTALS: airmailed 160-80M lo-drift 40X, \$1.95; 40 lo-drift, \$2.75; 80M vari-frequency, 100 k.c. bars, 20M crystals, \$4.50 mounted. C.O.D.'s accepted. Commercial crystals quoted. C-W Mfg. Co., 1170 Esperanza, Los Angeles.

ROTARY beams. Used receivers. Transmitter kits. New receivers, all makes. Vertical radiators. Communication headquarters. Transmitters designed and built to order. Receivers serviced. All phases of high frequency communication. Write to Southern Ohio's only amateur owned amateur business. Jos. N. Davies, WBANT, 2767 No. Bend Rd., Sta. A., Cincinnati, Ohio.

CRYSTALS: The ever increasing popularity of T9 crystals definitely show they must be good—they are good. Get wire and T9-ize. Powerful, fracture resisting X-cut, 40 and 80 meter bands, \$1.60; 7300-7500 k.c. range now only \$1.60 also. Post-paid. Improved T9 ceramic holder, \$1. C.O.D.'s accepted. Various types of fine commercial crystals supplied on order—send for folder. Sold by: Espy's, 2223 State St., New Orleans, La.; Frank Anzalone, 375 W. 48th St., N. Y. C.; Casa Edison, Havana, Cuba; Henry Radio Shop, Butler, Mo.; Hieronymus Radio, 88-34 209th St., Queens Village, N. Y.; Pemberton Labs., Ft. Wayne, Ind.; Hamrad Wholesale, Kensington, London, Eng.; and Eidson's, Temple, Texas. Note: Other territory available—inquire.

EIDSON'S crystals, holders, quick service. Hieronymus Radio, 88-34 209th St., Queens Village, N. Y.

QSL'S—free samples—Howe Brothers, Wisner, Neb.

SELL surplus equipment. Write W9ZHO.

BARGAIN: 1 k.w. 20 Meter phone, HF200's final, 212D's mod., 14 meters, rack & panel. 250 watts phone, 160-20, 9 meters, rack & panel. Reg. preselector, DB20, PR15 & misc. parts. W9VOO.

YOUR call in 2 1/2" aluminum letters on forest green panel, 75¢ postpaid. E. Bailey, W. Newton, Pa.

IT pays you to write W9ARA for ham receivers; whether you pay cash, buy on my economical 6% terms, or trade equipment. You get quickest delivery from world's most complete stock and ten-day free trial. Specials: new ACR-175, \$59.75; HRO, Jr. with S meter, \$88.; others. Write, W9ARA, Butler, Mo.

RECONDITIONED guaranteed communications receivers shipped on ten-day trial. Practically all models cheap. For example: RME-69, \$89.; HRO, Jr., \$59.; Breting 12, \$49.; S9 Super-Skyrider, \$29.; FB7, \$19.; Sky-Buddy, \$15.; latest ACSW3, \$12.50. Terms. List free. W9ARA, Butler, Mo.

SELL mounted xtals; Bliley: LD2-7136, 7154—\$3.; BC3-7056—\$1.75; Premier-7005, 7170—\$4.75; odd brand: 7126—\$2.50. W2HFF.

SELL: 170 QST's 1922-1938, \$10.; Radio Eng. Lab. receiver, 5 bands, \$15. W9BSJ.

NATIONAL single signal crystal-filter receiver FB7XA with 2 stage postal preselector. Band-spread coils 10, 20, 40, 80; also broadcast. 10, 20 coils only for preselector. About 125 countries heard last two months—now have HRO. First \$47.50 takes with speaker and power supply—packing extra. Wanted: QST's—Vols. 1 through 9 only in good condition. Will swap on above. W2BNX, 85-12 165th St., Jamaica, N. Y.

QSL cards, 75¢ a 100, two colors. Tubes, Hytrons. W9DGH.

MACAUTO code machines: low monthly rental 50,000 words practice tapes. Write N. C. Ayers, 221 Columbus Ave., Boston, Mass.

QSL'S: new, colorful. Samples free. Brownie, W3CJI, 523 No. Tenth St., Allentown, Pa.

NEW Western Electric dual 78 turntables, \$50. Daven 500 ohm T and H pads, \$7. and \$13.50. W2KTC, 153 Schenck Ave., Brooklyn.

BARGAIN: Modern 675 watts CW in Par-Met cabinet, \$150. Write for details. W2LXT, Patchogue, L. I.

SACRIFICE all or parts 300 watt transmitter. New York City; phone Stillwell 4-2153, evenings.

NEW 25 watt modulator with speech & power supply, \$18.50; 60 watt, \$32.50; 100 watt, \$48.50. New & used transmitters, \$20. up. Write. Frampton Radio, Blackwell, Okla.

ANY radio circuit diagram 25¢. Order mentioning manufacturer's name, model. Catalog free. Supreme Publications 3727 W. 13th, Chicago.

METER repair service—all types. Month special: milliammeters, \$1.75. Braden Engineering Co., 1809 Fifth Ave., Dayton, Ohio.

TELEPLEXES, Instructographs, omnigraphs bought, sold, traded. Ryan's, Hannibal, Mo.

EXCHANGE equipment for film-pack camera. W3AOF

EVEN KINGS

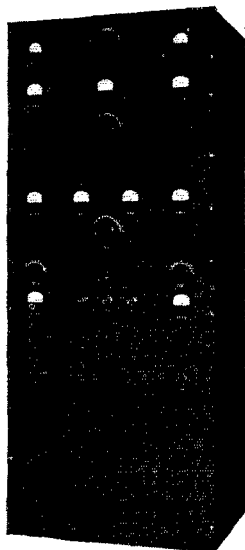

can use short leads and symmetrical circuits.

A & B Tank Condensers

supply these, and more, in

Temco Transmitters

Write for latest bulletin

ATKINS & BROWN
215 FOURTEENTH STREET
OAKLAND • CALIFORNIA

Piezo-Electric Crystals Exclusively

Quality crystals of all practical frequencies supplied SINCE 1925. Prices quoted upon receipt of your specifications.

Our Pledge: **QUALITY FIRST**
SCIENTIFIC RADIO SERVICE

"The Crystal Specialists Since 1925" University Park, Hyattsville, Md.

LEARN CODE RIGHT

Always ready — no weather interference — beats having someone send to you. Speed range 5 to 40 W.P.M. Radio or Morse.

STANDARD with 10 tapes and book of instructions, without oscillator, \$20.25

JUNIOR with 5 tapes and book of instructions (not rented), without oscillator . . \$12.00

Complete oscillator equipment less battery, \$6.50

RENTAL Standard with 10 tapes and book of instructions \$3.00 first month, \$2.25 each additional month.

With transformer and tube socket 25¢ per month more. With key and head phones 50¢ per month extra. \$10 deposit or business references required.

Write for details today

INSTRUCTOGRAPH COMPANY

Dept. Q-3, 912 Lakeside Place, Chicago, Illinois

Representatives for Canada:

Radio College of Canada, 363 Bay Street, Toronto

RADIO COURSES

New Classes Now Starting

RADIO OPERATING • BROADCASTING • CODE
RADIO SERVICING • TELEVISION
• ELECTRONICS — 1 year day course; 2 years eve.
Day and Evening Classes — Booklet upon request

NEW YORK YMCA SCHOOLS

4 West 63rd Street, New York City

Your Nearest Dealer Is Your Best Friend

Your nearest dealer is entitled to your patronage. You can trust him. He is equipped with a knowledge and understanding of amateur radio. He is your logical and safe source of advice and counsel on what equipment you should buy. His stock is complete. He can supply your needs without delay. His prices are fair and consistent with the high quality of the goods he carries. He is responsible to you and interested in you.

Patronize the dealer nearest you—You can have confidence in him

ATLANTA, GEORGIA

Wholesale Radio Service Company, Inc.
265 Peachtree Street
"The World's Largest Radio Supply House"

BALTIMORE, MARYLAND

Radio Electric Service Co.
3 N. Howard St.
Everything for the amateur

BOSTON, MASS.

Wholesale Radio Service Company, Inc.
110 Federal Street
"The World's Largest Radio Supply House"

BRIDGEPORT, CONNECTICUT

Hatry & Young, Inc.
177 Cannon Street
Time Payments On All Types Of Equipment

BRONX, NEW YORK

Wholesale Radio Service Company, Inc.
542 East Fordham Road
"The World's Largest Radio Supply House"

BUFFALO, NEW YORK

Dymac Radio
216 E. Genesee Street
Ham and BCL Equipment W8RRL, W8OLB, W8GJ Cl. 2080

BUFFALO, NEW YORK

Radio Equipment Corp.
326 Elm Street
W8PMC and W8NEL — Ham, service and sound equipment

HARTFORD, CONNECTICUT

Hatry & Young, Inc.
203 Ann Street
Trade Your Old Communication Receiver

JAMAICA, L. I., NEW YORK

Wholesale Radio Service Company, Inc.
90-08 166th Street (Merrick Road)
"The World's Largest Radio Supply House"

MONTREAL, CANADA

Canadian Elec. Supply Co., Ltd.
285 Craig St., W.
Quality parts and equipment for discriminating buyers

NEWARK, N. J.

Wholesale Radio Service Company, Inc.
219 Central Avenue
"The World's Largest Radio Supply House"

NEW HAVEN, CONNECTICUT

Hatry & Young, Inc.
86 Meadow Street
National, Taylor, Triplett, Radiotron, RME, Howard, etc.

NEW YORK, N. Y.

Wholesale Radio Service Company, Inc.
100 Sixth Avenue
"The World's Largest Radio Supply House"

NEW YORK, N. Y.

Harrison Radio Company
12 West Broadway
Harrison Has It! Phone WOrth 2-6276 for information or rush service

PHILADELPHIA, PENNSYLVANIA

Eugene G. Wile
10 S. Tenth Street
Complete Stock of Quality Merchandise

RICHMOND, VIRGINIA

The Arnold Company
Broad at Harrison St.
W3EQQ — "The Virginia Ham Headquarters" — W3FBL

ROCHESTER, NEW YORK

Radio Parts & Equipment Co.
244 Clinton Avenue, North
Complete stock amateur-BCL parts. Standard discounts

TORONTO, CANADA

A & A Radio Service Supply
101 Queen Street, West
Canada's Foremost Radio Supply House

WINNIPEG, CANADA

Electrical Supplies, Ltd.
306-10 Ross Avenue
Western Canadian Amateur Headquarters for Leading Lines

YOU ARE PROTECTED
WHEN YOU BUY FROM

QST

ADVERTISERS

“Advertising for *QST* is accepted only from firms who, in the publisher’s opinion, are of established integrity and whose products secure the approval of the technical staff of the American Radio Relay League.”

Quoted from QST’s advertising rate card.

Every conceivable need of a radio amateur can be supplied by the advertisers in QST. And you will know the product has the approval of the League’s technical staff

Index to Advertisers

American Radio Institute	120
Asatic Microphone Laboratory, Inc.	115
Atkins & Brown	124
Barker & Williamson	94
Bliley Electric Company	113
Brush Development Company, The	98
Candler System Company	110
Capitol Radio Engineering Institute	118
Cardwell Mfg. Corp., Allen D.	76
Centralab	2
Collins Radio Company	Cov. 2
Cornell-Dubilier Electric Corp.	103
Dodge’s Institute	106
Eitel-McCullough, Inc.	75
Electrical Supplies, Ltd.	112
Gardner-Levering Company	114
Gates American Corp.	88
Hallcrafters, Inc., The	4 to 13
Hammarlund Mfg. Company, Inc.	77, 83
Harvey Radio Company	116
Helntz & Kaufman	92
Henry Radio Shop	94
Hinds & Edgarton	118
Hipower Crystal Company	122
Howard Radio Company	87
Hygrade Sylvania Corp.	80
Instructograph Company	124
International Resistance Company	85
Johnson Company, E. F.	81
Kato Engineering Company	113
Ken-Rad Tube & Lamp Corp.	115
Kenyon Transformer Company, Inc.	15
Mallory & Company, Inc., P. R.	74
Massachusetts Radio School	122
Meissner Mfg. Company, Inc.	95
Mims Radio Company	117
National Company, Inc.	Cov. 3, 73, 89
New York YMCA Schools	124
Newark Electric Company	111, 122
Ohmite Mfg. Company	82
Onan & Sons, D. W.	114
Par-Metal Products Corp.	98
Port Arthur College	113
Precision Apparatus Company	86
Precision Piezo Service	102
RCA Institutes, Inc.	102
RCA Mfg. Company, Inc.	Cov. 4
Radio Mfg. Engineers, Inc.	127
Radio Shack, The	97
Radio Transceiver Laboratories	110
Raytheon Production Corp.	1
Scientific Radio Service	124
Sickles Company, F. W.	113
Signal Electric Mfg. Company	108
Simpson Electric Company	78
Solar Mfg. Corp.	96
Speer Carbon Company	99
Sun Radio Company	112, 120
Taylor Tubes, Inc.	93
Teleplex Company	106
Terminal Radio Corp.	109
Thordarson Electric Mfg. Company	91
Tibbetts Laboratories	96
Transmitter Equipment Mfg. Company	107
Trimn Radio Mfg. Company	115
Triplett Elec. Instrument Co., Inc.	102
Turner Company, The	110
United Electronics Company	117
United Transformer Corp.	128
Valpey Crystals, The	115
Vibroplex Company, Inc., The	118
Ward Leonard Electric Company	106
Wiley & Sons, Inc., John	114
Wincharger Corp.	108
Yaxley	74
Zenith Radio Corp.	79

The RME-70

FROM THE INSIDE

(THE SECOND of a SERIES)

Get acquainted with your receiver — acknowledge the fact that *knowing* your set means getting results. This one principle of good radio operation we would like to put over in a big way.

Just the other day an ardent radio listener (an old Morse Operator by the way) sent in a log of radio operation. We wish that all of you could see it. Through the medium of this excellent account in which not only station call-letters, and frequencies, but also control positions, R readings, weather and other pertinent details, were jotted down, the panorama of short wave radio was unfolded in one of the finest analyses we had ever seen. Does this listener know how to operate his receiver? — get the most of it? — he must! The results obtained are splendid evidence of operator and receiver performance. No controls on an RME receiver are superfluous — use them to advantage!

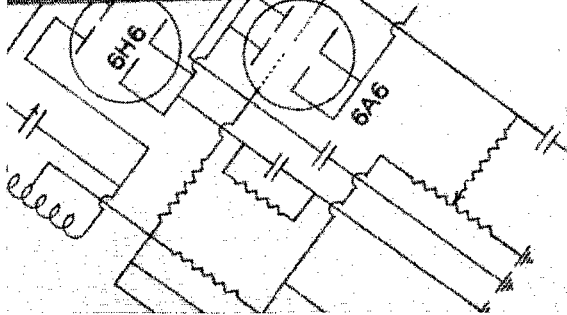
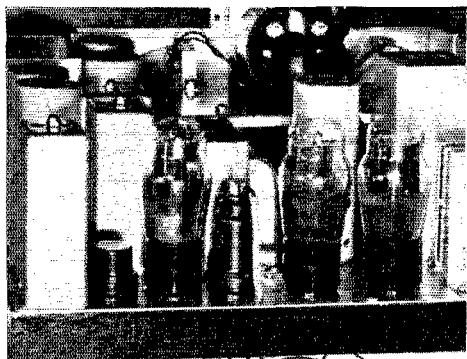

"Automatic Noise Suppression"

The RME-70 noise suppressor is an automatic device. It works on the same general principle as other noise suppressors. However, as an automatic suppressor it is one of the most perfect in operation of any yet designed and placed into a communication receiver. The circuit of the suppressor is designed to permit 100% modulation of signals without affecting the audio quality. On 10 and 20 meters the performance of this automatic device is many times uncanny in its functioning. Only one tube, namely, the 6A6, is used in the suppressor making for simplicity as well as effective-

ness. In actual operation the noise suppressor is left in the circuit. The standby control however permits the removal of the noise suppressor from the circuit and allows normal operation of the receiver. In this way the actual performance of the suppressor may be monitored. More detailed information on this automatic noise limiter is found in the article written by Mr. Dickert in the November issue of *QST*, page 19, reading time 14 minutes — absorption time from 14 minutes to 1 hr. 14 min., more or less!

IF YOU HAVE ANY
QUESTIONS OR DESIRE
DESCRIPTIVE LITERATURE

TRY THE POSTAL ROUTE

RADIO MFG. ENGINEERS, INC.

111 Harrison Street
Peoria, Illinois

ADVERTISEMENT

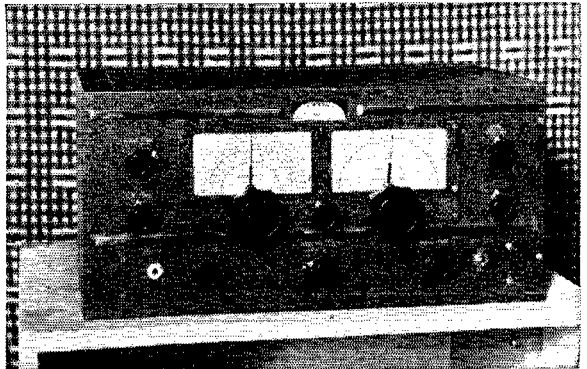



VARIMATCH TRANSFORMERS

for COMMERCIAL and AMATEUR APPLICATIONS

ALL UTC transformers are designed for maximum flexibility. The Vari-match series are noteworthy in that they will match any audio tubes to any RF tubes within their output rating, eliminating the possibility of obsolescence as new tubes are announced. All you have to decide is the DC input to your RF stage. Then just pick the VARIMATCH output transformer that will handle the maximum audio power required. These transformers will also match the line impedance output of PA or similar amplifiers direct to the Class C tubes. ALL VARIMATCH outputs matching RF stages will carry DC in the secondary.

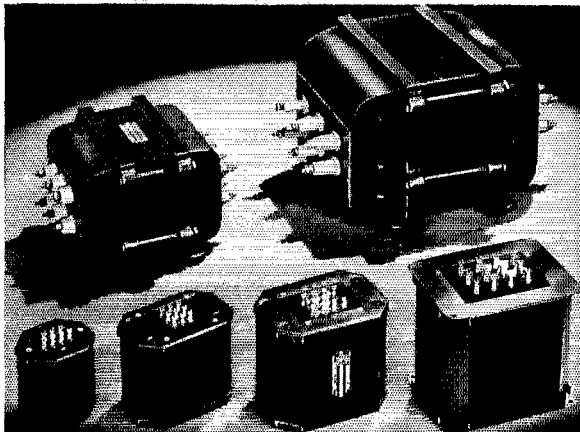

VARIMATCH MODULATION TRANSFORMERS

UTC VARIMATCH Modulation Transformers Will Match ANY Modulator Tubes to ANY RF Load . . .

- VM-0 Maximum audio output 12 watts.....\$3.00
- VM-1 Maximum audio output 30 watts.....\$4.80
- VM-2 Maximum audio output 60 watts.....\$7.50
- VM-3 Maximum audio output 125 watts.....\$12.00
- VM-4 Maximum audio output 300 watts.....\$19.50
- VM-5 Maximum audio output 600 watts.....\$42.00

VARIMATCH INPUT TRANSFORMERS

Varimatch Input Transformers will take care of practically every driver requirement.

- PA-51 AX Single 56, 6C5, 45, 59, 6L6, 2A3, etc. to class B 46, 59, 79, or A prime 42's, 45's, etc.....\$3.30

- PA-53AX Push Pull 45, 59, 2A3, 6L6, etc. to class B 210, 801, 800, 35T, RK-18, 203A, ZB-120, etc.....\$4.50

- PA-59AX 500 ohms line to 805, 838, 203A, 210, 800, ZB-120, etc.....\$4.50

- PA-238AX Push Pull Parallel 45, 2A3, 6L6, etc to push pull parallel 838, 203A, ZB-120, or to class B 204A, HF-300, 849, etc.....\$10.50

- PA-512 500 ohms line to class B, 150T, HF-300, 204A, etc.....\$12.00

PA VARIMATCH TRANSFORMERS

The new UTC PA Varimatch transformers will match practically any tube in their power range to a 200-500 ohm line or to any voice coil.

- PVM-1 For all audio tubes up to 12 watts. \$3.00
- PVM-2 For all audio tubes up to 30 watts. \$4.80
- PVM-3 For all audio tubes up to 60 watts. \$7.50
- PVM-4 For all audio tubes up to 125 watts. \$12.00
- PVM-5 For all audio tubes up to 300 watts. \$19.50

LINE VARIMATCH TRANSFORMERS

The UTC LINE VARIMATCH units will match any single or group of voice coils to a 500 ohm line. Impedance range is from .2 to 75 ohms in 50 combinations . . . UTC LINE VARIMATCH AUTOFORMERS will match one to ten 500 ohms lines or LVM 500 ohm windings to the 500 ohm output of an audio amplifier.

- LVM-1 15 watt Line Varimatch unit.....\$2.70
- LVM-2 40 watt Line Varimatch unit.....\$4.20
- LVM-3 75 watt Line Varimatch unit.....\$6.00
- LVM-10 15 watt Line Varimatch Autoformer 500, 250, 167, 125, 100, 83, 71, 62, 50 ohms.....\$2.70
- LVM-11 30 watt Line Varimatch Autoformer.....\$4.20
- LVM-12 60 watt Line Varimatch Autoformer.....\$6.00
- LVM-13 125 watt Line Varimatch Autoformer.....\$10.80
- LVM-14 300 watt Line Varimatch Autoformer.....\$15.00

ALL PRICES SHOWN ARE NET TO AMATEURS

UNITED TRANSFORMER CORP.

Write: COMMUNICATIONS DIV. ★ 150 VARICK ST. ★ NEW YORK, N. Y.
EXPORT DIVISION: 100 VARICK STREET NEW YORK, N. Y. CABLES: "ARLAB"

QST for March, 1939, EASTERN Edition

COMBINATION

The NSM Modulator unit and NTX-30 transmitter are available as a combination unit in a steel cabinet finished in black wrinkle. Net price for the Combination, with equipment as listed with the single units \$207.00 above.....

SINGLE UNITS

The Type NSM Modulator, complete with tubes and mounted in the table model steel cabinet, finished in black wrinkle, as illustrated below. Net Price..... \$78.00

The Type NSM can be furnished with a 1/8" steel relay rack panel at an additional net of..... \$6.00

The NTX-30 Transmitter, complete with tubes, crystal holder (but less crystals), and four sets of tank coils for 10, 20, 40 and 80 meter operation, in steel cabinet, black wrinkle finish. Net Price..... \$117.00

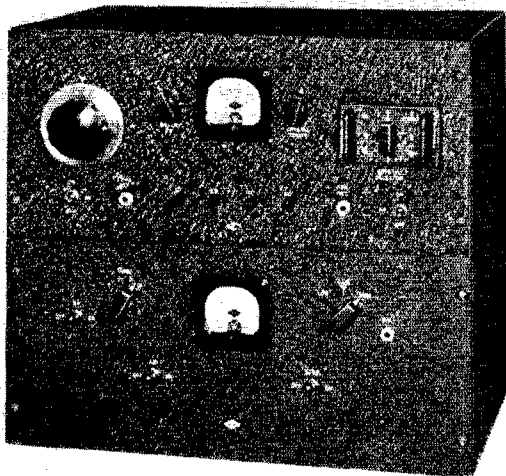

A MODULATOR for the NTX-30 Transmitter

The new Type NSM Modulator Unit is intended particularly for use with the NTX-30 Transmitter, but its many advanced features make it desirable for any modulating job within its 30 watt rating. Typical among its features are Automatic Volume Compression, permitting high modulation levels without danger of overmodulation, its DB meter indicating the amount of compression, its four-position tone control which cuts either highs or lows, or both, or leaves intact the normal range of 50 to 10,000 cycles, and its two separate input circuits. We shall be pleased to have you inspect the new NSM at your dealers. It is thoroughly engineered, and of high quality.

SPECIFICATIONS

Four stages of resistance-coupled amplification with 57 input, 58 second stage, 6F8G phase inverter, and push pull 6L6G output — Power gain approximately 135 db, output 30 watts — 6X5 high voltage rectifier used in Automatic Volume Compression circuit — VR-150 Voltage Regulator. Two separate input circuits, one of which omits the first 57 amplifier tube — Frequency response flat from 50 to 10,000 cycles.

AS A SINGLE UNIT

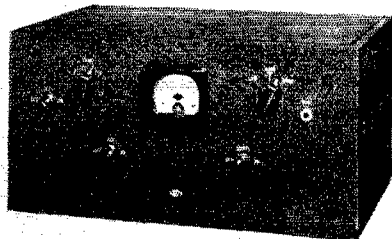

The NSM Modulator is available as a single unit, with either relay rack mounting or a table model cabinet similar in appearance to the NTX-30 Transmitter.

NATIONAL COMPANY, INC., MALDEN, MASS.

A SINGLE TUBE 150 WATT XTAL RIG

WITH THE
RCA 813!
A Beam Power Tetrode

GIVES PHENOMENAL RESULTS
AS A HIGH-POWERED
CRYSTAL OSCILLATOR



AMATEUR N
\$28.50

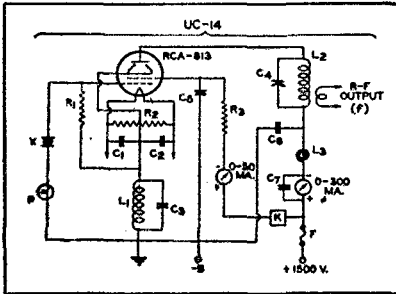

Oscillator can be plate-modulated as well as key

Here's the news you have been waiting for! A one-tube crystal-controlled 'phone or cw transmitter is a reality with the new RCA 813 beam power tetrode! Severe tests made in plate-modulated service*prove that 100% modulation can be obtained with good linearity, low distortion, a plate circuit efficiency of 60% and a carrier output of 100 watts! Equally trying tests in cw telegraphy service with 80 and 40

meter crystals respectively that a power output of 150 watts can be obtained—and excitation keying can be accomplished with a screen circuit! In neither case is the r-f crystal current excessive. The circuit used to achieve these remarkable results is the Reinartz Tetrode Crystal Oscillator arrangement shown in the diagram at left. The same circuit constants can be used for cw or 'phone operation.

- C₁ C₂ C₇ - 0.002 mf, MICA
- C₃ - 0.0001 mf, MICA
- C₄ - 1.5 mmf per METER
- C₅ - 0.001 mf, 2000 V. MICA
- C₆ - 0.002 mf, 5000 V. MICA
- R₁ - 30,000 OHMS, WIRE-WOUND
- R₂ - 50 OHMS, C.T., WIRE-WOUND
- R₃ - 50,000 OHMS, 25 WATTS
- L₁ - 100 TURNS NO. 24 D. C. C. on 1-1/4" Diameter Form
- L₂ - FOR FREQUENCY "f"
- L₃ - R-F CHOKE, 250 MA. D.C.
- F - 1.4 A. HIGH-VOLTAGE FUSE
- K - SEE NOTE
- X - CRYSTAL, FREQUENCY "f"
- P - 2.0-VOLT, 60-MA. PILOT

Note: "K" is a high-voltage keying relay, insulated for 2500 Volts. Do not use an ordinary key in this position under any circumstances.



Refer to December Ham Tips for further information

*Frequency modulation at 80 meters was found to be negligible