

QST

January, 1939
25 cents

devoted entirely to

amateur radio

In this issue—
NEW
EXPERIMENTAL
IN ANTENNAS
WORK ON
REGULATION
TELEVISION
RECEIVERS
CONSTRUCTION



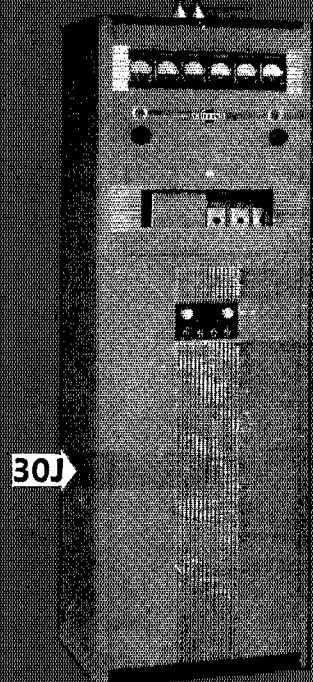
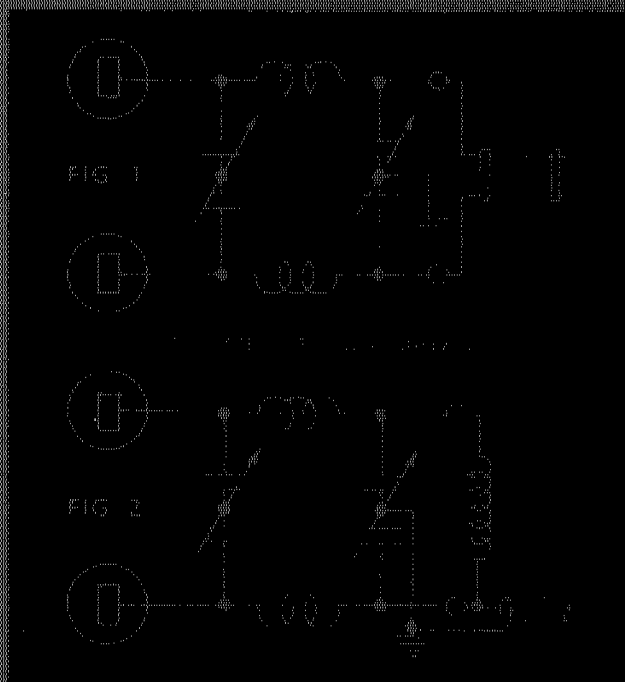

Push Pull To Single Ended

Everyone who has built transmitters has at some time or another contended with the problem of coupling a push pull amplifier to an unbalanced load. Difficulty—preventing one tube from doing all the work. Even inductive coupling is likely to unbalance the tube loads unless great care is taken.

It occurred to us that the simple system used in Collins 30J's and 32G's might be of interest. Fig. 1 shows the usual Collins pi tank connected to a two wire balanced line. Fig. 2 shows the same network connected to an unbalanced load such as a concentric line with no changes except the addition

of a small "phasing coil." Size of phasing coil is not critical except that it should be roughly adjusted to carry 4 to 10 times the current in the transmission line. The circuit is adjusted for resonance and proper loading in exactly the same manner as Fig. 1. Very simple and no trouble at all.

Perhaps, this arrangement would be a suitable subject for a technical article, but is really so simple that no further explanation is needed. We mention the phase inverter in this advertisement as an example of the many useful innovations you find in a Collins transmitter.

COLLINS RADIO COMPANY

CEDAR RAPIDS, IOWA

NEW YORK, N. Y.: 11 WEST 42 STREET

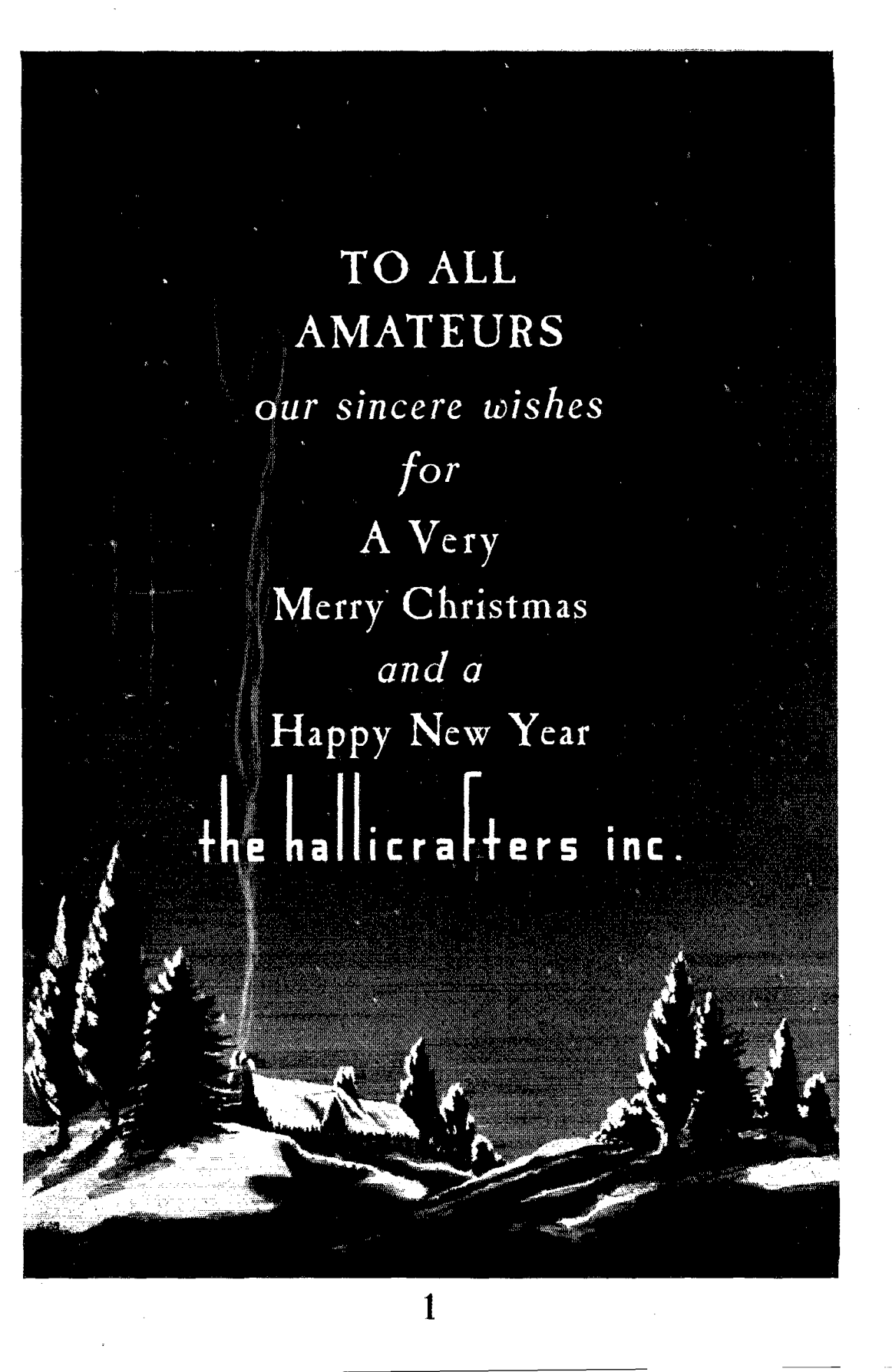

TO ALL
AMATEURS
our sincere wishes
for
A Very
Merry Christmas
and a
Happy New Year
the hallicrafters inc.

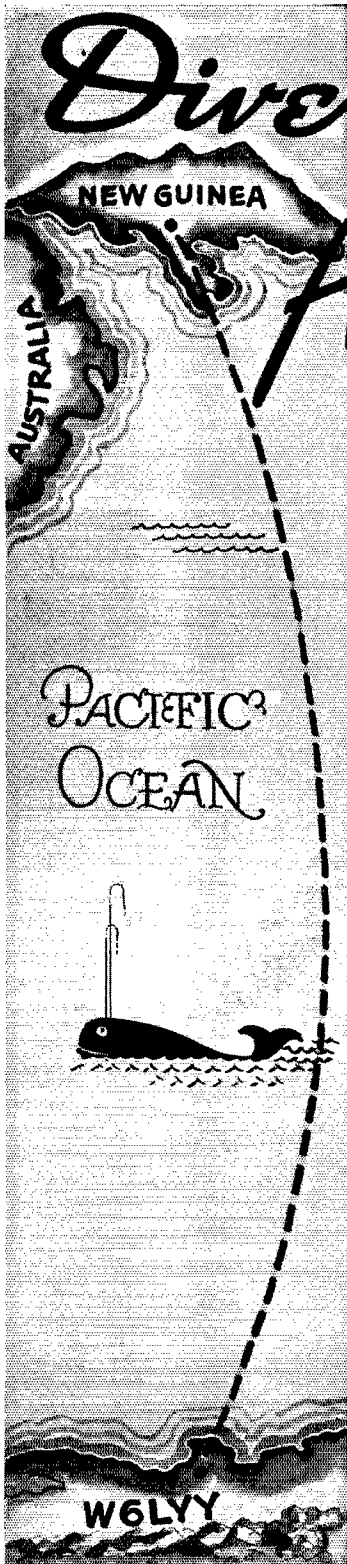

Diversity RECEPTION Across the Pacific!

Hallicrafters Dual Diversity Receivers to Be Used to Maintain Contact with Archbold New Guinea Expedition



Dual Diversity installed in Barney Boyd's shack.

Receiving System with special speaker now on way to New Guinea.

STEAMING across the Pacific to remote Hollandia in Dutch New Guinea, a fast ship is carrying a new Dual Diversity Receiving System to the Archbold Expedition for the American Museum of Natural History. In the shack of W6LYY in San Diego, Calif. Barney Boyd already has installed another Dual Diversity. Soon these two Hallicrafters Diversity receivers will be helping maintain dependable communications across 7000 miles of Pacific Ocean, between the crew of the gigantic \$250,000 Consolidated flying boat "GUBA" of the expedition and their base station, Barney Boyd's shack.

Realizing the importance of regular communications between the expedition and their home base, these two Hallicrafters Dual Diversity Receiving Systems were recently ordered, to provide the most modern and dependable radio reception available today. You will find Hallicrafters Dual Diversity Systems used wherever the finest of Radio Reception is demanded.

Ask your Hallicrafters Dealer about the Hallicrafters Dual Diversity Receiving System, or write for complete information

the hallicrafters inc.

2611 Indiana Ave., Chicago, U.S.A.

Cable Address: HALLICRAFT, Chicago

'WORLD'S LARGEST BUILDERS OF AMATEUR COMMUNICATIONS EQUIPMENT'

JANUARY 1939

VOLUME XXIII

NUMBER 1



STAFF

EDITORIAL

KENNETH B. WARNER
Editor and Business Manager

CLARK C. ROBINSON
Managing Editor

JAMES J. LAMB
Technical Editor
(on leave of absence)

GEORGE GRAMMER
Acting Technical Editor

DONALD H. MIX &
THOMAS M. FERRILL, JR.
Technical Assistants

VERNON C. CHAMBERS
Laboratorian

ADVERTISING

F. CHEYNEY BEEKLEY
Advertising Manager

CHARLES BRUNELLE
Asst. Advertising Manager

CIRCULATION

DAVID H. HOUGHTON
Circulation Manager

RALPH T. BEAUDIN
Asst. Circulation Manager



OFFICES

38 La Salle Road
West Hartford, Connecticut

Subscription rate in United States and Possessions and Canada, \$2.50 per year, postpaid; all other countries, \$3.00 per year, postpaid. Single copies, 25 cents. Foreign remittances should be by international postal or express money order or bank draft negotiable in the U. S. and for an equivalent amount in U. S. funds.

Entered as second-class matter May 29, 1919, at the post office at Hartford, Connecticut, under the Act of March 3, 1879. Acceptance for mailing at special rate of postage provided for in section 1103, Act of October 3, 1917, authorized September 9, 1922. Additional entry at Concord, N. H., authorized February 21, 1929, under the Act of February 26, 1925. Additional second-class entries to cover sectional editions authorized March 20, 1935.

Copyright 1938 by the American Radio Relay League, Inc. Title registered at United States Patent Office.

QST

devoted entirely to

AMATEUR RADIO

PUBLISHED, MONTHLY, AS ITS OFFICIAL ORGAN, BY THE AMERICAN RADIO RELAY LEAGUE, INC., AT WEST HARTFORD, CONN., U. S. A.; OFFICIAL ORGAN OF THE INTERNATIONAL AMATEUR RADIO UNION



CONTENTS

Editorials	7
Calls Heard	8
Bound Volume XXII of QST	8
Ham at 30° Below A. G. ("Gerry") Sayre, W2QY	9
Feeding Vertical Antennas Arthur Lynch, W2DKJ	13
What the League Is Doing	18
New Transmitting Tubes HK24, 810	19
One-Half Cubic Foot of Transmitter	
H. E. Rice, Jr., W9YZH/4	20
A Wide-Range Audio Amplifier T. M. Ferrill, Jr., W1LJI	24
'Phone "Splatter" Douglas Fortune, W9UVC	28
The Cairo Regs Go into Effect Kenneth B. Warner, W1EH	30
Another Method of Keying with Controlled Rectifier Tubes Byron Goodman, W1JPE	31
With the Affiliated Clubs	32
Technical Aspects of the New Regs George Grammer, W1DF	33
Selectivity with the 2-Tube Regenerative Receiver Fred Sutter, W8QBK	36
A Dual-Frequency Crystal Calibrator F. A. Lennberg, W8CQQ	38
The Coaxial Vertical Radiator John J. Long, W8ABX	42
Construction and Alignment of the Television Receiver C. C. Shumard	45
A.A.R.S. Activities	53
2nd Annual "A.R.R.L." QSO Party	54
A Compact Crystal-Controlled 56- & 28-Mc. 'Phone Transmitter D. D. Kahle, W9AUJ	55
Naval Communication Reserve Notes	60
Book Review	61
I.A.R.U. News	62
A Signal-Metering Valve H. O. Talen, W9PYQ	64
How Would You Do It?	67
Silent Keys	68
Hints and Kinks	69
Operating News	72
Correspondence Department	76
Standard Frequency Transmissions	82
A.R.R.L. QSL Bureau	102
New Apparatus	122
Hamads	123
QST's Index of Advertisers	126

Section Communications Managers of the A.R.R.L. Communications Department

All appointments in the League's field organization are made by the proper S.C.M., elected by members in each Section listed. Mail your S.C.M. (on the 10th of each month) a postal covering your radio activities for the previous 30 days. Tell him your DX, plans for experimenting, results in 'phone and traffic. He is interested, whether you are an A.R.R.L. member or get your QST at the newsstands; he wants a report from every active ham. If interested and qualified for O.R.S., O.P.S. or other appointments he can tell you about them, too.

ATLANTIC DIVISION			
Eastern Pennsylvania Maryland-Delaware-District of Columbia Southern New Jersey Western New York Western Pennsylvania	W3QP W3BAK W3BEI W8CSE W8OFO	John B. Morgan Edgar L. Hudson W. W. Filson Ed Preston Kendall Speer, Jr.	Blue Bell Laurel, Delaware Audubon Tully Lowerber
CENTRAL DIVISION			
Illinois Indiana Kentucky Michigan Ohio Wisconsin	W9RMN W9QG W9ARU W8DFE W8AQ W9UIT	Leslie M. Dickson Noble Burkhart Darrell A. Downard Harold C. Bird E. H. Gibbs Aldrich C. Kronos	Edellyn Farms R. 4, Box 1 116 N. Longworth Ave. R.F.D. 2 405 Broad St. 3127-A West Madison St.
DAKOTA DIVISION			
North Dakota South Dakota Northern Minnesota Southern Minnesota	W9RZA W9VOD W9IGZ W9YNQ	Ernest Bloch Dr. A. L. Russell Edwin L. Wicklund Millard L. Bender	Box 202 R.F.D. 3 608 N. Huron Ave.
DELTA DIVISION			
Arkansas Louisiana Mississippi* Tennessee	W5ABI W5DKR W5CHF W4DWS	H. E. Vette Eugene H. Treadaway Robert E. Barr William Harold Walker	4415 West 12th St. 2749 Myrtle St. 301 Boscobel 301 Boscobel
HUDSON DIVISION			
Eastern New York N. Y. C. & Long Island Northern New Jersey	W2LU W2AZV W2GMN	Robert E. Haight E. L. Baumach Fred C. Read	511 South Holmes St. 102 Central Ave. 1014 North Ave.
MIDWEST DIVISION			
Iowa Kansas Missouri Nebraska	W9ARE W9JEG W9OUD W9FAM	Clyde C. Richelieu Melvin D. Kirby Miss Letha Allendorf Samuel C. Wallace	Route 6, c/o U. S. Airway Commun. Sta. 1015 W. 3rd St. Green St.
NEW ENGLAND DIVISION			
Connecticut Maine Eastern Massachusetts Western Massachusetts New Hampshire Rhode Island Vermont	W1CTI W1FBT W1IWC W1IAH W1BFT W1HRC W1GNF	Frederick Ellis, Jr. Winfield A. Ramsdell Sam Gross William J. Barrett Carl B. Evans Clayton C. Gordon Alvin H. Battison	19 Merrill Rd. 1188 Washington Ave. Pleasant St. 239 Columbia St. 80 No. State St. 192 Washington Ave. 1 Central St.
NORTHWESTERN DIVISION			
Alaska Idaho Montana Oregon* Washington	K7ENA W7EMT W7BL W7KV W7FCG	Leo E. Osterman Carl Etchelberger C. A. Woodhouse Ralph J. Gibbons W. Beale	Customhouse Route 2 Halter Dam c/o United Air Lines R. 4, School Ave.
PACIFIC DIVISION			
Hawaii* Nevada Santa Clara Valley East Bay San Francisco Sacramento Valley Philippines San Joaquin Valley*	K6OTH W6BIC W6FBW W6JTV W6SG W6CZY KA1GR W6NJQ	Hugh Cecil Rea Edward W. Heim Elbert Amarantes Harold J. Burchfield Alan D. Whittaker, Jr. J. L. C. Buckenham George L. Rickard Clarence Ramer	1925 Keesaukoku St. 509 Claremont St. 454 Washington St. 2240 106th Ave. 79 Blinnor Ave. 2931 24th St. Box 849 941 Clinton Ave.
ROANOKE DIVISION			
North Carolina South Carolina Virginia West Virginia	W40G W4BQE W3UVA W8HLD	H. S. Carter Ted Ferguson Charles M. Waff, Jr. C. S. Hoffmann, Jr.	P. O. Box 111 1213 College St. 2607 Stuart Ave. 47 Lynwood Ave.
ROCKY MOUNTAIN DIVISION			
Colorado Utah-Wyoming	W9EHC W7CLH	Carl C. Drumeller Ernest E. Parshall	1828 East Kiowa St. Salt Creek Electric Plant
SOUTHEASTERN DIVISION			
Alabama Eastern Florida Western Florida* Georgia West Indies (Cuba-Isle-of-Pines- Porto Rico-Virgin Islands)	W4DGS W4DVO W4AXP W4AGI WA2OP	James F. Thompson L. A. Connolly Oscar Cederstrom Leland W. Smith Mario de la Torre	1203 South Perry St. 719 So. Willow Ave. Second St. & Bruce Ave. 2010 Pennsylvania Ave. Escobar 110 (Altos)
SOUTHWESTERN DIVISION			
Los Angeles Arizona San Diego	W6MQM W6KFC W6JRM	Ralph S. Click Victor C. Clark Howard K. Breedlove	1038 Milwaukee Ave. 747 E. Polk St. R. 2, Box 636
WEST GULF DIVISION			
Northern Texas (Oklahoma) Southern Texas New Mexico	W5DXA W5CEZ W5BHO W5CGJ	Lee Hughes Carter L. Simpson Dave H. Calk Joseph M. Eldott	125 N. Main St. 2010 So. 4th St. 6726 Ave. Q
MARITIME DIVISION			
Maritime	VE1DQ	A. M. Crowell	69 Dublin St. Halifax, N. S.
ONTARIO DIVISION			
Ontario	VE3SG	Fred H. B. Saxon	302 Lee Ave. Toronto, Ont.
QUEBEC DIVISION			
Quebec	VE2CO	Lindsay G. Morris	Apt. 6, 4510 Girouard Ave., N.D.G. Montreal, P. Q.
VANALTA DIVISION			
Alberta British Columbia	VE4GE VE5HP	C. S. Jamieson J. Hepburn, Jr.	581 W. Riverside Drive 335 Foul Bay Road Drumheller, Alta. Victoria
PRAIRIE DIVISION			
Manitoba Saskatchewan	VE4BG VE4SY	A. J. R. Simpson Arthur Chesworth	635 Garfield St. 1071 4th Ave., N. W. Winnipeg Moose Jaw

* Officials appointed to act until the membership of the Section choose permanent S.C.M.s by nomination and election.

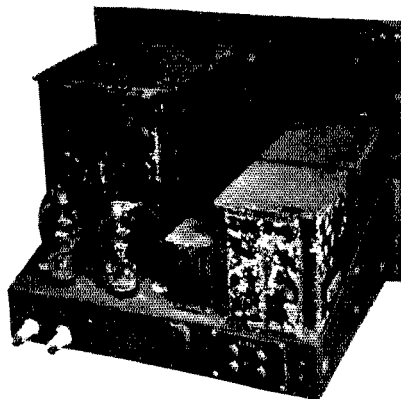

Kandid Ken-O-Talk, No. 13

• BACK FROM THE ARCTIC WITH KENYONS •

THE photo above shows Gerry Sayre (OX2QY, W1OXAB, WAWG) chief operator for the MacGregor Arctic Expedition and one rack of the transmitter which for sixteen months maintained communication with all parts of the world. Several times during the expedition's stay in the north re-broadcasts were made over national chains. The technical staff of the commercial broadcasting company made many favorable comments on the excellent quality of the signal. The wide range frequency response and low distortion of the audio system were praised as being exceptional in a transmitter of this type.

Every transformer used by the MacGregor Arctic Expedition was a KENYON "T"-line type. The transmitter as described in the December 1937 issue (page 27) of *QST* was designed to modulate 500 watts input to the class "C" stage. The main power supply chassis is shown above beside the audio and power rack. A close examination of this un-retouched photograph will show the cases badly corroded and pitted. One interesting thing to note is that the chassis at the bottom of the rack were considerably more affected by this condition than those at the top.

When the transmitter had not been used for some time and a change of temperature occurred so that metal parts were cooler than the air, pools of water would collect. This water of course was salty, and made it necessary to wipe thoroughly all high potential parts before starting a transmission.

For sixteen months the "T"-line transformers and chokes took this rigorous test and NOT ONE UNIT FAILED. No laboratory test could demonstrate in such a positive manner the value of vacuum impregnation FULLY POURED UNITS.

The complete filling of these units with a moisture proof compound is the only thing which prevented the collection of pools of water inside the case. Once this had happened, low resistance leakage paths would be formed and it would not be long before breakdowns would occur.

Gerry Sayre informs us that he considers the transformers as good as ever and intends getting on the air in the near future with the same transmitter.

The "T"-line transformers stood the test and are in condition to deliver many more hours of satisfactory service because they were fully poured.

F. P. Kenyon

THE AMERICAN RADIO RELAY LEAGUE

Directors

<i>President</i>	
EUGENE C. WOODRUFF	W8CMP
234 W. Fairmount Ave., State College, Pa.	
<i>Vice-President</i>	
GEORGE W. BAILEY	WIKH
74 Webster Road, Weston, Mass.	
<i>Canadian General Manager</i>	
ALEX REID	VE2BE
169 Logan Ave., St. Lambert, P. Q.	
<i>Atlantic Division</i>	
WALTER BRADLEY MARTIN	W3QV
Box 612, Roslyn, Pa.	
<i>Central Division</i>	
R. H. G. MATHEWS	ex-W9ZN
100 East Ohio St., Chicago	
<i>Dakota Division</i>	
FRED W. YOUNG	W9MZN
107 Hanover St., Mankato, Minn.	
<i>Delta Division</i>	
E. RAY ARLEDGE	W58I
P.O. Box 286, Pine Bluff, Ark.	
<i>Hudson Division</i>	
KENNETH T. HILL	W2AHC
115 Willow St., Douglaston, L. I., N. Y.	
<i>Midwest Division</i>	
FLOYD E. NORWINE, JR.	W9EFC
120 South Fourth St., St. Louis, Mo.	
<i>New England Division</i>	
PERCY C. NOBLE	W1BVR
37 Broad St., Westfield, Mass.	
<i>Northwestern Division</i>	
RALPH J. GIBBONS	W7KY
c/o United Air Lines, Portland, Ore.	
<i>Pacific Division</i>	
J. L. McCARGAR	W6EY
66 Hamilton Pl., Oakland, Calif.	
<i>Roanoke Division</i>	
H. L. CAVENESS	W4DW
State College Station, Raleigh, N. C.	
<i>Rocky Mountain Division</i>	
EDWARD C. STOCKMAN	W9ESA
618 So. Williams St., Denver	
<i>Southeastern Division</i>	
BENNETT R. ADAMS, JR.	W4APU
1512 Grove Place, Homewood, Ala.	
<i>Southwestern Division</i>	
CHARLES E. BLALACK	W6GG
443 Main St., El Centro, Calif.	
<i>West Gulf Division</i>	
WAYLAND M. GROVES	W6NW
c/o Humble Pipe Line, Mt. Pleasant, Texas	

THE AMERICAN RADIO RELAY LEAGUE, INC., is a non-commercial association of radio amateurs, bonded for the promotion of interest in amateur radio communication and experimentation, for the relaying of messages by radio, for the advancement of the radio art and of the public welfare, for the representation of the radio amateur in legislative matters, and for the maintenance of fraternalism and a high standard of conduct.

It is an incorporated association without capital stock, chartered under the laws of Connecticut. Its affairs are governed by a Board of Directors, elected every two years by the general membership. The officers are elected or appointed by the Directors. The League is non-commercial and no one commercially engaged in the manufacture, sale or rental of radio apparatus is eligible to membership on its board.

"Of, by and for the amateur," it numbers within its ranks practically every worth-while amateur in the nation and has a history of glorious achievement as the standard-bearer in amateur affairs.

Inquiries regarding membership are solicited. A bona fide interest in amateur radio is the only essential qualification; ownership of a transmitting station and knowledge of the code are not prerequisite. Correspondence should be addressed to the Secretary.



HIRAM PERCY MAXIM, FIRST PRESIDENT

Officers

<i>President</i>	EUGENE C. WOODRUFF, W8CMP
	State College, Pa.
<i>Vice-President</i>	GEORGE W. BAILEY, WIKH
	Weston, Mass.
<i>Secretary</i>	KENNETH B. WARNER, WIEH
	West Hartford, Connecticut
<i>Treasurer</i>	ARTHUR A. HEBERT, WIES
	West Hartford, Connecticut
<i>Communications Mgr.</i>	F. EDWARD HANDY, W1BDI
	West Hartford, Connecticut
<i>General Counsel</i>	PAUL M. SEGAL
	1026 Woodward Building, Washington, D. C.
<i>Address all general correspondence to the administrative headquarters at West Hartford, Connecticut.</i>	

"IT SEEMS TO US—"

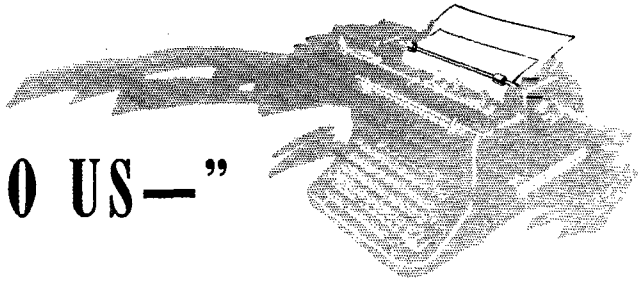

1938 IN REVIEW

AS THE clocks move swiftly onward to the end of an eventful year, it is interesting to cast a reflective eye backward and see where we got in 1938. It should help us in the coming year.

Amateur radio continued its slow and wholesome growth, at a rate just fast enough to be encouraging, slow enough to provide for easy assimilation. In the United States the number of licensed stations reached 50,000 for the first time. Despite immense congestion we have made some improvements in the ease and reliability of communication and are more than holding our own. This is accomplished through no slackening of general amateur spirit and activity but under quite the converse circumstances, for the contests and operating activities of the past year enjoyed more participation than ever before.

Mid-year brought the effective date of the inter-American treaties of Habana and the gradual putting into effect of their amateur provisions by early-acting countries. Here is the Western entente at work, emphasizing the community interest of the Americas in radio problems in a spirit that is a satisfying departure from the stock views of the Old World. The coming year will see us appreciate more and more this solidarity of western viewpoint, will see increasing liberalization of amateur communication. The great Cairo conference was successfully hurdled, amateur frequencies unchanged except in palpitating Europe. Our domestic regulations were revised late in the year in a way that has provided general satisfaction.

In the field of technique there is place for a mild glow of satisfaction over the increasing consciousness of the need for independent thinking by the individual amateur, presaging a return to more intelligent experimenting and development work rather than the blind copying of stereotyped styles. New apparatus appeared in such profusion as to constitute an embarrassment of riches—sturdier tubes, new tubes requiring remarkably low excitation, better and cheaper receivers marked by improved variable selectivity, a considerable trend towards manufactured transmitters both complete and in units, and many interesting auxiliary pieces of gear. Great interest prevailed in improved antenna systems and higher

efficiencies were attained with closer-spaced systems, while amateur ingenuity produced many interesting solutions of the mechanical problems of rotatable systems. In transmitters themselves the trend has been distinctly towards the capacity to shift frequency quickly, involving not only band-switching exciters but ganged tuning of whole transmitters and a notable revival of self-excited and consequently flexible exciters. The latter have struck perhaps the sourest technical note of the year, figuratively as well as literally. Of undeniable value, they are probably here to stay but the average of their performance in 1938 was decidedly less than it should be, indicating the need for more study. And, as with any strange implement, we showed that we have not yet learned how to use them with discretion and courtesy, so that on this score we took a small step backwards which we must hasten to overcome. With commercial television looming, amateurs learned much about the technique of the new art from the triple standpoints of engineering interest, the probable construction of their own receivers and, of most consequence, as preparation for two-way television ultimately finding a place in amateur communication. U.h.f. technique bettered noticeably, while abnormal transmission conditions provided amateur radio an opportunity to contribute substantially to knowledge of the performance of the ionosphere.

Amateur radio as an institution awakened mightily to awareness of its public-service duty in emergencies. The southern California flood and the New England flood and hurricane provided the outstanding examples of organized amateur performance. Phone stations markedly improved their ability to serve in emergencies. Increased consciousness of the duty to be prepared led both to remarkable new government regulations to foster and protect our work and to the building of a prodigious quantity of new portable emergency apparatus, tested in the most successful Field Day event ever held. Administrative organization paralleled equipment building, so that the year-end finds us satisfyingly improved in ability to perform.

Within the A.R.R.L., mention also needs to be made of the holding of the first national convention in over a decade, with the greatest attend-

ance ever recorded at an amateur gathering; and of the commissioning of the new W1AW, model headquarters station of the League. An active membership was increasingly aware of its own responsibility in a democratic self-governing institution; gave intelligent and spirited study to its problems; was not appreciably misled by circus-barkers who, for their own ends, sought to break down the faith of amateurs in their own unique coöperative association. All of which augurs immensely well for the society's future.

Death seemingly selected from our ranks this year an unusual number of the shining marks she loves so well. A considerable number of names famous in our annals were added to the roll of silent keys, including that of our own late editor, Ross A. Hull. Hard-paid tolls exacted by unrelenting Time, they are the sad part of the 1938 story.

With increased verve and improved apprecia-

tion of its circumstances, duties and rights, amateur radio marches into 1939 with torches aloft, knowing that its devotees alone will determine what that year shall be.

MRI XMAS ES HPI NEW YR

It is that glad season of the year again when friend greets friend with warmest wish. It is notably true of the brotherhood of amateur radio, whose raw material is intracommunication. The members of the headquarters staff of the American Radio Relay League send cordial greetings and hearty good wishes for happiness, health and prosperity to the radio amateurs of every land!

Our New Year's present to you all is a new and better-looking *QST* and the promise of a journal constantly increasing in the interest and value of its contents. 73.

K. B. W.

Strays

The other night we heard a chap on about 14,404 kc., calling CQ and asking for a frequency check, explaining to the world that he had a new crystal and wanted to know whether it was in the band or not. Hi! Do you reckon the monitoring stations'll give him the info he wants? And will

Calls Heard

Tel-Aviv, Palestine

(14-Mc. band, Oct. 16th, 5-7:30 p.m. EST)

W1FH, GHK, BFT, LAX, BHM, BA, CCK
 W2GUD, BNK, AGW, AAS, FKE, HSZ, FZI, BWE, AJ,
 RS, AOA, APU, LND, CBL, IYO
 W3CKA, COD, FFH, GAU, GTL, GWL, GYL, GWJ,
 GQC, JN
 W4DWU, FFT, EAK, AOL, FDA, EPL, EYI
 W5BFX
 W6MJK
 W8BTI, DFH, CRA, LBD, LIW, GMZ, JAX
 K4AOP, KD, FCV, FHR
 K5AU
 NY1AB
 CM2GR

Beirut, Syria

(14-Mc. band, Oct. 17th, 5-6:30 p.m. EST)

W1DBS, LAX, AXX, GNE, KHV, DKD, LMO
 W2EDM, KEZ, EGL, IYO, HXT, AOA, FKE, KJY,
 HQX, ISU, BHW, GSA
 W3EUJ, EZN, HJL, US, CRW, BHV, GWJ, FOO, AOO,
 GTL, GTR, QP, WU
 W4DE, FJI, CFJ
 W8GMZ
 W9KFL
 K4KD, FCV
 K5AA
 NY1AB

— Max Buch, W2AMA
 3rd Op., Aboard S.S. *Excalibur*, KGWT

he have to do some fast thinking when the F.C.C. asks him for a description of his frequency-checking equipment!

Use of old half-tone cuts (copper) for Faraday shields is suggested by W2WD. As it is necessary to visit the printer to obtain the material, W2WD suggests further that the printer be persuaded to cut the slots to within half an inch of one edge with his metal saw. The shield is then completed — unless the ambitious ham wishes to rub it on a sheet of sandpaper to make a more finished job!

According to a college paper description of W9ZOL, the station of Synton radio fraternity at the University of Illinois, “. . . the power input to the one-hundredth tube in the final stage of the transmitter is 300 watts.” Apparently, the linotype operator hadn't heard of a 100-TH tube!

Ex-W4HJ, one of the operators at the Asheville, N. C., Police radio station, sends the following: “Our system at WPFS employs ‘two-way’ communication between the cars and headquarters. The cars are identified by various numbers, and it so happens that the county sheriff's car is number 88. Imagine the amusement of visiting amateurs when they hear a decidedly bass and very much businesslike voice calling, ‘88 to headquarters, 88 to headquarters. . . .’”

Bound Volume XXII of QST

WE HAVE a limited number of Bound Volume XXII of *QST*. This volume is made up in two sections, each containing six issues of 1938 *QST*. Handsomely bound and gold imprinted the complete volume is priced at \$6.00, postpaid.

A group of North Greenland Eskimos enjoying the noon-day sun. The polar bear and fox-skin pants still stand guard against chilly nights, even in midsummer. The sport in the left foreground with the "bowl" haircut has evidently blown himself to a white shirt and suspenders at a Danish trading post.



Ham at 30° Below

Being the Musings and Random Comment of an Amateur Radio Operator with an Arctic Expedition Signing OX2QY-W10XAB

BY A. G. ("GERRY") SAYRE,* W2QY

REMEMBER that QSO we had from above the Arctic Circle?

You probably envied me, then, sitting in my snug berth and working the world. To some extent you were right—from the number and variety of the contacts available it was a ham's heaven up there near 80° N.

But there is another side to the story, too—a story of headaches and heartaches, of hardship and downright misery. It is my hope to bring you something of both sides in this story.

Picture a typical night's operation at OX2QY-W10XAB-WAWG: DX'ers calling us by the dozens. I try to answer each of them in turn and complete an FB QSO in the short time at my disposal. But Father Time marches right along—the supply of gasoline is none too large and must be conserved—so we cut it short. Boy! What a thrill to hear the lads calling and what a pity when I am unable to answer each in turn. Stations five deep on various frequencies—try to get a solid QSO out of it all! It really was hard, when the allotted time had been used up and hundreds were still calling, to have to close down and say goodnight.

That characteristic waver you reported on our signals . . . yes, you had it, too. Hollow-sounding, with rapid fluctuations in signal strength. Must be characteristic of the paths over which the signals were travelling . . . there's something worth noting. Looking back over it, we see that almost invariably the stations we contacted best had higher power and, most important of all, they had some form of special antenna to throw

the signal up to us, to enable them to reach out and over the interference.

So it went, night after night. Ah, a new station calling us! We go back, give him a report, and—bang! He is wiped out by QRM from someone else QSY'ing right on his frequency trying to get a new country. Wonder if this bedlam will ever let up? . . . Very little static was experienced, except during winter periods. When dry, hard snow and ice particles drifted down from the plateau above us and struck the antenna and feedline, the discharge brought not only severe bursts but substantial jolts on contact. Frequently it jumped over in the receiver, and even a few times in the final tank condenser. This was our worst trouble. Hash from the three windchargers which operated the 32-volt system, from the radio engine ignition and also the exciter and generator, was minimized by filtering.

It was interesting, too, to note the variations in signal strength, before, during and after magnetic disturbances or storms. Signals are supposed to increase in strength just preceding and just following such storms, and that seemed to check quite well with our log. Complete fadeouts always brought home to us thoughts of other years when men had spent the long Arctic night without radio to furnish them with the latest news, or a world series baseball game or the major football game of the week. Possibly it might be Jack Benny or the Breakfast Clubbers to whom we would turn for our amusement. To miss them and others left our day only partly filled.

Maybe I ought to go back to the beginning, and set the scene a bit, so you can appreciate that.

*Milton, Rock County, Wis.

It started on July 1, 1937. That was the day the MacGregor Arctic Expedition sailed away from Port Newark, N. J. The radio equipment had not been completed or tested. The first day I was assigned the job of installing the 120-volt lighting system throughout the ship. But the fumes from leaky exhausts and seasickness got me. Sick was no word for it—I was out!

The first leg of the trip was completed July 9th when we docked at Lunenburg, N. S. There, Donald Whittemore, W2CUZ of N.B.C. and I got the rigs going after infinite checking and rechecking, building and rebuilding. VE1CD, VE1GC and VE1GH deserve a lot of credit for their aid and thanks for their hospitality. Finally, everything was working on all frequencies. We put up the ship's antennas there, too—a vertical Marconi and a 17-Mc. doublet.

On the 14th we left Lunenburg for Sydney. There we tested with WCC and got to work on the 'phone. VE1CR helped in true amateur fashion. Don Whittemore left us at Sydney, and on July 20th we shoved off again. What a treat it had been to meet such hospitable people! Everyone in Nova Scotia had treated us like brothers. But now we were heading north again, out through the straits of Belle Isle and into the cold Arctic seas. The rig was running 500 watts input on c.w., feeding the vertical Marconi.

The water was warm in the Straits and many codfish could be seen on the surface. We saw a beautiful aurora in color the night of July 24th. What a sight! One of the brightest and most brilliantly colored of the entire trip—never saw anything like it in the States!

But radio conditions were punk. Had an insulator burn up—the first trouble of that sort. Above Battle Harbor, Labrador, it started to get cooler and we sighted our first icebergs. A few days later, at about 55° N., it was appreciably colder—about 42° F.—and we saw lots of growlers and a few bergs. July 31st brought us rough going, with the seas carrying away bowsprit lines and bobstays. We headed across toward Greenland to get favorable currents. Too rough for radio! On August 2nd we sighted the coastline of southern Greenland and the seas began moderating. For days on end the high, snow-capped,

barren, bleak, rough, rocky fiorded coastline was then visible. Sea birds, icebergs, fresh codfish from fishing vessels on the banks—these were the events of our lives.

On August 4th the radio engine began to balk. Valve adjustment was off. Code signals on the broadcast band surprised me; found they were fishing vessels working each other with low power. More engine trouble a couple of days later. I noted a peculiar greenish color to the sky just at the top of the icecap over Greenland—no, I wasn't sick, either! At Fairhaven, headquarters for the Danish fishing fleet where we went to replenish our water supply, we lost our anchor due to the great depth. One of the crew was overcome with exhaust gas, gave us a bad time. . . .

August 7th was a day of troubles. I tried to get through on schedule but a downhaul line was fouling the antenna system. Some fun! Finally we got going, then ran out of gasoline in the middle of a QSO. Boy! Receiver went dead, but new rectifier and output tubes fixed that and we finally got going again.

The next day we crossed the Arctic Circle. The sky was a variety of hues—what a picture! Water black, shaded to green, sky to the west full of variegated tones, to the east covered with a purplish tint. Radio conditions improved that day, too.

On August 13th, following a flock of radio troubles and QSO's with W10XDA and W9BBU, we put in at Idgloorsuit on the east shore of Hare Island. This is the place where Rockwell Kent spent a winter and based the story of *Salamina* on his experiences, you know. Glaciers, icebergs, the Eskimo settlement, flowers still in bloom but no trees—all the color one would want. We delivered Mr. Kent's presents to the natives, and were they happy! Saw our first kyacks, and the accurate harpooning at either birds or seal. These people are unique, having small, dark, squat bodies, plump, round faces, and cheerful smiles. They love to have visitors—had a coffee party and dance for us that night.

We got some dogs there, and then set out for the North again—through the thickest pack of icebergs encountered on the trip. The absence of static is noticeable—in contrast to WHD's plaint that thunderstorms made it hard to read us back in New York. On August 17th, north of 73°, we sent the first messages from the crew to W8ITK. Vibration of the ship's motors shook the final grid coil from its mounting; it broke two RK-20's as it fell. Just another thing to do better next time!

For the next ten days or so we struggled further north. The temperature grew colder, hanging between 32 and 44° F. Then we struck floe ice and freshly-frozen layer ice. It began to look as though we would not reach our destination at 82° N. Finally, unable to get across to Ellesmereland, we turned back and entered Etah fiord. There we

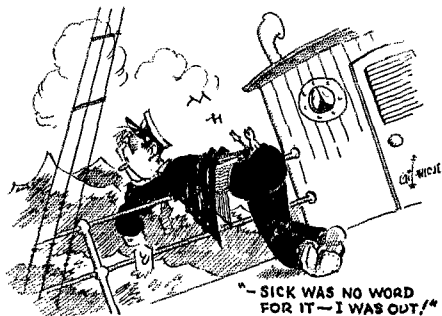

◆
An enlargement from an 8 mm. film which shows in the foreground the rear stick that held up the rhombic. The ship can be seen frozen in the ice.
◆

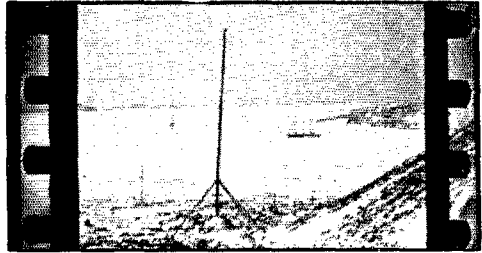

went ashore to stretch our legs for the first time since Sydney!

Etah began to look attractive as a headquarters. It was a large fiord, and there were little flowers still blossoming there. A 14×20-foot cabin left by the British Arctic Expedition would make a good nucleus for the headquarters. So on August 29th we started the tedious, heavy job of unloading ship and ferrying the gear and supplies ashore in boats. After tentatively deciding on a possible location for a rhombic just east of the shack, we lost 4000 feet of antenna wire overboard. I honestly felt like weeping!

Two days later we were blown out of the fiord by strong gales. The anchor was out and one hawser was attached to a deadman ashore, but the hawser broke and the anchor dragged, and out we went. The engines were started, and barely kept us off the rocks. The gales were too strong to permit re-entry and the way to the north was blocked, so we just tacked back and forth until the winds died.

But our troubles were not ended. The next day, on again entering Etah, one propeller fouled with the line. Then the other motor backfired and caught fire. We lay to and all hands fought desperately with water, Pyrene, and sand. We tried not to think of the 3000 gallons of gasoline in the hold! Finally the fire was put out, and an outboard motor on a dory pushed us into the fiord.

Do you begin to see now what I mean, when I say there are two sides to the story? If you don't think it's a lot more fun to sit back home in the comforts of civilization and work the expeditions, you're crazy!

However, whatever our feelings, we had work to do. The remaining stores were unloaded and installations completed. Most of the details of the equipment were given in the yarn I sent down by radio to the boys at QST, which was printed in the December 1937 issue, so I won't go into that again.

But I do have a few observations and explanations I should like to make. First of all, we want to thank all the stations, both commercial and amateur, for their splendid cooperation all the time we were out. Such amateurs as W2CIF, W3DPU and W8CJJ were especially helpful throughout the entire year. QRN, QRM, QSB and skip all caused repeats and delays, but nev-

ertheless we cleared the hook. 'Phone schedules with W3DHM, allowing Mrs. MacGregor and her daughter to talk with the Commander, were usually very successful. W2JKQ was also of great service in piping us through to parents and families. All in all, we appreciate ham radio far more than we did before we went "up North"!

Conditions seemed to be quite different from those good old days when Don Mix took WNP up there in 1923-24. Then, of course, they worked 220 meters from 10 P.M. to 5 A.M. We could hear regular broadcast signals only a few times between Sept. 1st and May 31st, even with the gain of the big rhombic ashore. But the 14-Mc. band was consistently open most all night long and throughout the daytime. In the region between 1500 kc. and 7000 kc., however, no signals were heard at any time day or night, winter or summer—during the time we were ashore. Only rarely did anything come through even on 7 Mc.

Between 9- and 18-Mc. signals were heard practically every day, with variations for time of day, season and fadeouts. Conditions in this region seemed similar to those back home. Ten-meter signals were never good, but on a few days wavered in and out with deep fading. No signals were heard on 56 Mc. This collapse on the part of both the lower and the higher frequencies was a source of considerable surprise to us, since we had expected to use both. Incidentally, two different makes of superhets and an SW-3 were used, so the receiver can't be blamed.

We had anticipated a large amount of work with antennas, but when that 4000 feet of wire went down our good intentions went also. There was barely enough left to erect the diamond. We did put up one doublet, but it blew down and did not give us much service. Of course, the rhombic gave a huge gain on both transmission and reception compared with the ship antennas.

On checking our log with the magnetic conditions as observed by RCA we found substantially complete agreement. (A complete summation of all our findings is not yet available. We are now investigating many angles.) Incidentally, during the April 1938 fadeouts (12th-17th) we are told that our magnetic recorder showed the strongest magnetic storm ever observed at any point on earth to date! Other complete fadeouts occurred on January 16th-17th and February 7th.

There were months when VE1-2-3 and W1 were barely audible. Then, of course, other sections would come through in great style. Sometimes only VE4-5 and W6-7 would be good. Schedules would be arranged only to find conditions such that nothing could be received. It's all in the game!

Input to the Gammatrons varied, but finally we settled on 400 watts input—200 ma. at 2000 volts—with plenty of bias to hold them down. This was equally satisfactory on ham and broadcast work, press and commercial schedules, 'phone and c.w. No trouble was experienced in getting the rhombic to load up on any of the frequencies used, ranging from 8655 to 17,310 kc.

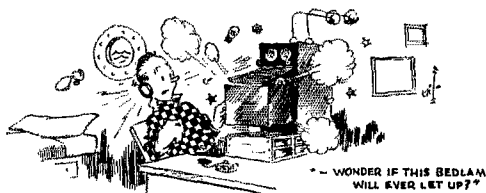

Our main purpose was to report the daily weather summary to the U. S. Weather Bureau in Washington, to send a weekly magnetic summary to the Carnegie Institute of Terrestrial Magnetism in Washington, to deliver at least one NBC broadcast a month, and to furnish press news to the *New York Times*' station, WHD. After all of these were served we might have an hour for amateur schedules and general contacts.

I hope that all of you appreciate just how things go on an expedition. They are not so smooth and rosy as they are painted before you leave port! Hamming is the last thing the expedition proper cares for. On the other hand, we had to rely on amateurs for many of our contacts. Our hats are off to you! We owe all of you much. That applies especially to the gang at W2CIF. We could always depend on you to handle whatever we needed, and all of us grew to know that 2500 miles away there were friends on whom we could rely. Our thanks, too, to W2BCR for his invaluable aid and to W3DHM. Space does not permit the full acknowledgment of our debt to all of you. There are many more who handled lesser amounts of traffic to whom we owe a similar tribute.

A week after the anniversary of our departure from New Jersey we set sail from Etah on the return voyage. The fiord ice had just opened to let us out. The journey home occupied the next three months—months of hard work and slow going and an occasional highlight which I will try to relive for you briefly.

Arriving at Thule on July 12th, we were met by Governor Neilsen and his staff, and by the British Arctic Expedition boys who were waiting for

their ship. A few days after leaving there we were caught in an ice pack, west of Melville Bay. Radio conditions were poor. I got out the portable gear and fitted lifeboats. Finally, on August 1st, after more than ten days of struggle, we were free of the pack near Hare Island. Soon there was fresh codfish again—and mighty welcome, too!

Engine troubles came to a head in early August, with water and spray drenching it continuously. On August 9th we passed southward over the Arctic Circle, having been north of it just a year and a day! Winds were sluggish, radio conditions poor. A few days later I climbed the rigging and secured the concentric feedline which had worn out its lashing in the roll of the ship at sea. A nice job for a landlubber, pitching and rolling around up in the sky! Huge numbers of petrels, kittywakes and gulls around all the fishing banks. . . .

Auroras all the way down. . . . At 61° N. the first regular b.c. stations started to come through. . . . The ship leaked badly, and one man was continuously on the pumps. . . . At 50° N. off Fogo Island, 4-Mc. ham signals started to come through again. . . . On August 30th we landed at St. Johns—and were we happy to be back ashore again! Fifty-four days at sea. . . . I can't tell you of all the hospitality of the St. Johns' ham crew. VO1H, VO1A, VO1G, VO1I, VO1P, VO1S—they all went out of their way to entertain and assist us. Wonderful ham spirit exists there—and wonderful equipment, too, considering the cost of gear up there. . . .

After 18 days in St. Johns, during which the ship was completely overhauled and outfitted, we sailed out of this oldtime fishing port. We rounded Cape Race next day at noon, and then calms and a high pressure area set in. This high-pressure zone apparently held the hurricane which hit Long Island and New England and sent it over land, doing all the damage.

Finally, on October 14th, having lost a main-sail in the meantime, we held our last QSO with W2CIF while entering the Narrows of New York harbor, and then closed the rig down for good.

There are plenty of things that one learns on a 15-month jaunt of this sort. One notable point is to protect all equipment against condensation of moisture. Otherwise every time the switch is turned on, something blows up. We tried chemicals to dry the air, larger tank condensers, and other methods. Finally, we adopted the system of pre-heating the operating shack before each schedule period. The warm air absorbed the condensed moisture and permitted satisfactory operation. Ample safety factors are, of course, essential. It will be hard for you to visualize conditions as they were. When your bunk gets damp and mildews, when your clothes get sticky and clammy as you hang them up, when

(Continued on page 106)

Feeding Vertical Antennas



BY ARTHUR LYNCH,*
W2DKJ

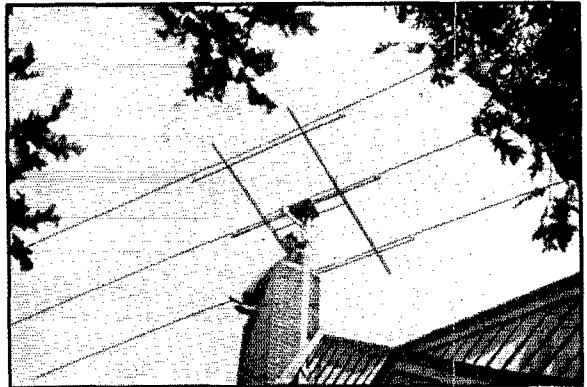

Photo by Ed. Ruth, W2GYL

The author and this chimney have been associated in a good many antenna experiments, which probably accounts for their obvious palishness. This photograph has nothing to do with the subject matter of the article, but shows a new six-element rotary beam which has been giving an excellent account of itself.

Methods of Using Vertical Elements Singly, and in Combination to Form Simple Directive Systems

IT SEEMS strange that there should be any problem regarding the proper method of feeding a vertical radiator, yet that such a problem exists is most certainly true. After all, except for a few comparatively unimportant details, there should be nothing more to feeding a vertical than feeding the more familiar horizontal types.

In giving consideration to the method for feeding any particular antenna, we must give some thought to its physical characteristics. It is well-known that the physical dimensions, for an antenna which is to be used on a certain frequency, will vary somewhat as a result of the proximity and the character of other bodies which may be in the active field of the antenna. The height above ground and the character of the ground have marked effects. The current literature is so full of information covering these

* 136 Liberty St., New York City.

important subjects that we will skip it entirely. It is mentioned only to indicate that it has not been given attention in the following text and that the dimensions given here cannot be set down for rule-of-thumb guidance, but are intended only as guide posts for determining the starting point for the particular antenna and feed system which will best fit into a particular group of conditions.

It is not to be assumed that any of the information given here is especially new; in its fundamental form, most of it is to be found in the *A.R.R.L. Handbook*. Those novel kinks, such as are illustrated in some of the last figures, are but conveniences which make for better operating conditions where it is necessary to make compromises, forced upon us by lack of space or local restrictions of one form or another.

The Quarter-Wave "Marconi"

Several years of operating ultra-high-frequency equipment in airplanes and cars, to say nothing

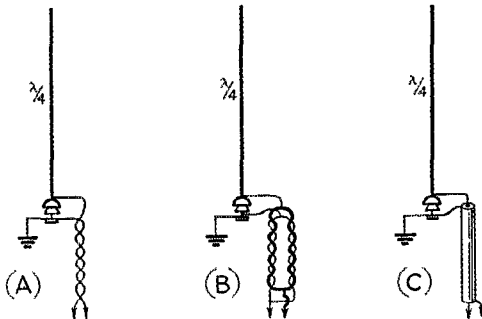

Fig. 1 — Various methods of feed to quarter-wave vertical "Marconi" antennas.

For some mysterious reason the business of supplying power to a vertical antenna assumes the aspect of a Problem to a good many hams. If W2DKJ did nothing more than dispel the fog which seems to surround that region between the transmitter and the vertical radiator, this article would be well worth while. But he goes farther than that, bringing out some points which are decidedly worthy of consideration by the antenna-minded chap who has to worry about space. Good practical dope, tested at many different stations and locations.

of yachts and high buildings, has brought us to the conclusion that too little attention is given to the quarter-wave "Marconi" antenna. For most mobile purposes we have found it to be ideal, and certainly much less trouble to install and use than

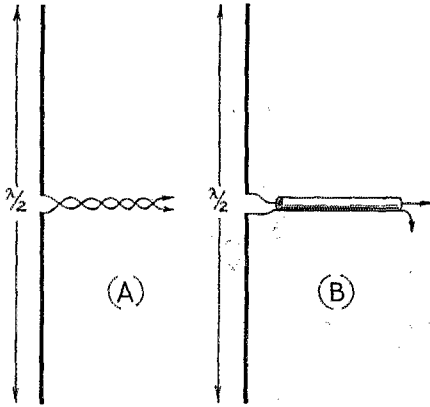

Fig. 2—Center feed through twisted and concentric lines.

any of the more elaborate types. Then, too, we have never found any of the others, except beams, to perform better. A telescopic type of broadcast antenna, extended to approximately 4 feet, was hastily attached to a wooden cross-member of an airplane and the point was pushed up through the skin. It was installed with a view to making a single flight. It stuck with the ship, through all kinds of weather, for more than a hundred thousand miles. Actual tests made later with other types showed no superiority in performance electrically, and all of them were a headache mechanically. Very much the same story can be told of the job on our car.

So, when there is not much room and you want to put up an aerial which is the least conspicuous, give some consideration to one of the arrangements shown in Figs. 1. They are the shortest units possible for good performance on a particular band and, since they are to be current fed, the insulation problem is not a serious one.

Also, the impedance between the base of such an antenna and ground is in the vicinity of 35 ohms.¹ Some of the better twisted-pair transmission lines have an impedance in the vicinity of 75 ohms. If the line is to be short and the power not too high, the mismatch of impedance, when the arrangement shown in Fig. 1-A is used, doesn't really cut much ice. Theo-

¹ W. C. Timus, "Ultra-high Frequency Antenna Terminations," *Electronics*, August, 1935.

retically, yes; practically, no! If you want to run a longer line or want to run more power, or if you're just fussy about efficiency, the arrangement shown in Fig. 1-B will fill the bill nicely for you. Here two twisted-pair lines are run in multiple, making certain that they are of the same polarity,² and you have cut the surge impedance in half and doubled the power-carrying ability of the line. You have not, however, cut down the dielectric loss per foot in the line itself,³ although the temperature rise will be less if the line is being overloaded.

In Fig. 1-B we have indicated the method for feeding a vertical quarter-wave "Marconi" with a concentric or coaxial line. If a line of 30 or 35 ohms is available it will do the trick very nicely, but the mechanical difficulties which are generally encountered in making such a line are seldom justified by the improvement in performance, if any.

In all three of these cases we have shown one side of the transmission line grounded adjacent to the base of the antenna. It doesn't seem to make much difference if this part of the line is permitted to hang in thin air. The line may, of course, be random length.

For most practical purposes, a quarter-wave radiator on 5 meters is 4 feet, 10 meters is 8 feet, 20 meters is 16 feet, 40 meters is 33 feet, 80 meters is 66 feet, and 160 meters is 133 feet.

Half-Wave Dipoles

Where two quarter-waves are used, as in Fig. 2, we have the typical half-wave dipole. In free space, where the antenna is not influenced by the ground or surrounding objects, the impedance at the center is approximately 72 ohms. This is,

² I.e., each wire in one feeder connected to the corresponding wire in the other. The wires usually are coded in a two-conductor cable. — Error.

³ S. W. Seeley, "Match and Mismatch," *QST*, November, 1937.

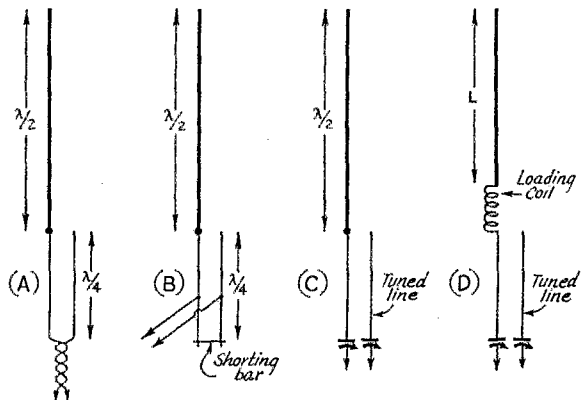

Fig. 3—Representative end-feeding methods. In "D" the inductance of the loading coil should be adjustable.

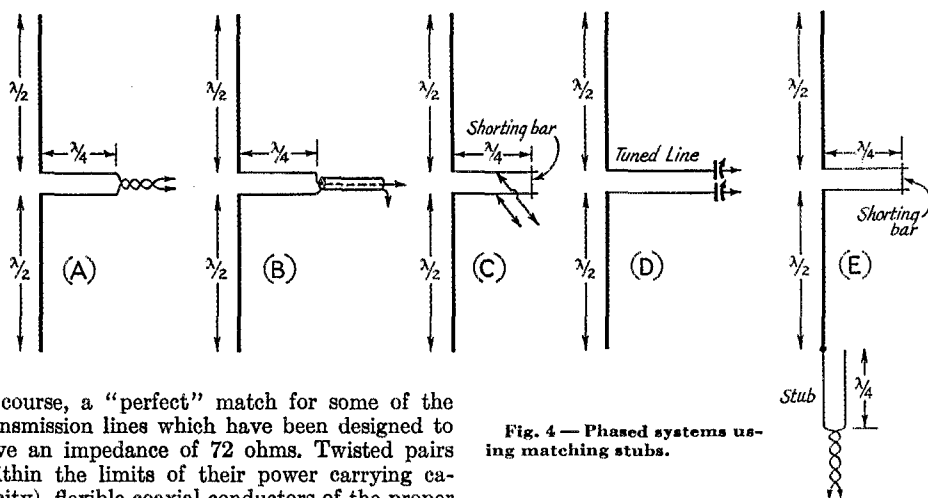

Fig. 4 — Phased systems using matching stubs.

of course, a "perfect" match for some of the transmission lines which have been designed to have an impedance of 72 ohms. Twisted pairs (within the limits of their power carrying capacity), flexible coaxial conductors of the proper impedance, or solid coaxial lines may be used to feed this very simple type of antenna.

It should be remembered that all coaxial lines are not of the same impedance and that the proper line for a given type of antenna feed system should be used. This is equally true of twisted-pair feeders. They will be found to vary from about 65 to 170 ohms. This variation is not very important if the line is not to be too long and is not made to carry a power overload.

The Half-Wave "J"

Because, no doubt, of the popularity of the "J" type of antenna for police high-frequency installations, many amateurs are using this aerial in one form or another. We have played some nasty tricks on this type of antenna, and it seems to have taken the abuse very nicely. A unit of the type shown in Fig. 3-A was made up of rather heavy wire. A rope was fastened to an insulator attached to the top, and the whole business was run up to the top of a yacht's mast, among steel shrouds, etc. The lower end was held in place by winding the twisted-pair transmission line up and down over a belaying pin, which was brass and grounded. The line was run some 20 feet along the deck and into a cabin window. Using only a few watts, we were able to contact other installations of the same character, on 5 meters, up to about 35 miles. On the lower-frequency bands, the results to be obtained are very satisfactory.

The simplest way to get such an antenna started is to make the length $0.97 \times$ a half-wave ($492,000/f$ in kc.) and the matching section can generally be cut a quarter-wave long.⁴ If it is possible to shock-excite the whole system the

point of highest current may be found on the matching stub, and will be the point where a low-impedance transmission line should be attached.

There is little difference between such a simple system and the one shown in Fig. 3-B other than the use of the shorting bar and the open-wire higher-impedance transmission-line. The shorting bar is placed in the stub, at the point of highest current, as indicated by a current-squared galvanometer, and the transmission-line is slid up and down above the shorting bar, with the power on, until a point is found where the standing waves on the line are minimum or disappear altogether.

For a permanent installation, where objection will not be raised to the unsightly appearance of the open wire line, particularly where power above 200 watts is to be used, this arrangement is to be preferred to the simpler system at 3-A.

Of course it is always possible to use "Zepp" feeders with almost any kind of vertical antenna, and the arrangement shown in Fig. 3-C is suggested as a typical case. For full details on the use of this kind of line reference should be made to the *A.R.R.L. Handbook*.

Where operation is desired on more than one band, it is possible to do a fair job by taking advantage of the system shown in Fig. 3-D. A loading coil is inserted between the base of the vertical radiator and one end of the "Zepp" feeders. If the loading coil is of the flat spiral type, the positions for the tuning clips can be marked on the copper strip, for the various frequencies desired, so that the adjustment may be made with the least loss of time.

A new setting of the variable condensers in the feeders will need to be made and they may be marked in a similar fashion. The condensers may be adjacent to the final amplifier or in any other convenient part of the line, depending on the

⁴ More commonly, the factor is taken as 0.95 for the half-wave antenna and 0.97 for a two-wire open feeder. In any event, if exactly the right length is wanted the system had best be adjusted experimentally. — Editor.

length and type of tuning (series or parallel) used. A good arrangement for this type of antenna is to place the loading coil in a weather-proof housing which is set right at the base of the vertical radiator.

Two or More Half-Waves in Phase

A lot of the energy which is shot up at too high an angle to be useful, when one of the foregoing vertical antennas is used, is pulled down and shot out in more desirable directions when half-wave antennas are operated in phase and stacked one above the other. Everything else being equal, the radiation from one of the systems shown in Fig. 4 should be just about 150 per cent that which could be had from any of the other aerials we have considered.

Any former remarks concerning matching stubs and transmission lines may be considered as applying directly to these aerials, in just the same manner. The method of feeding from the end, as shown in Fig. 4-E, may be a mechanical convenience, but it is likely to produce a system which is not as symmetrical as the center-fed methods. Various types of transmission-lines may be used in connection with the matching stub (Fig. 4-E) as outlined previously.⁵ However, it is desirable to leave off the stub and the transmission-line and find the correct position of

⁵ Where a twisted pair or coaxial line is series-fed into the low-impedance point on the stub, the exactness of the match will depend upon the surge impedance of the matching stub. The mismatch with a 600-ohm stub should not be greater than 2:1, which is not serious, under ordinary circumstances. Closer match can be secured by adjusting the conductor spacing of the matching stub to minimize standing waves on the transmission line. — ERRORS.

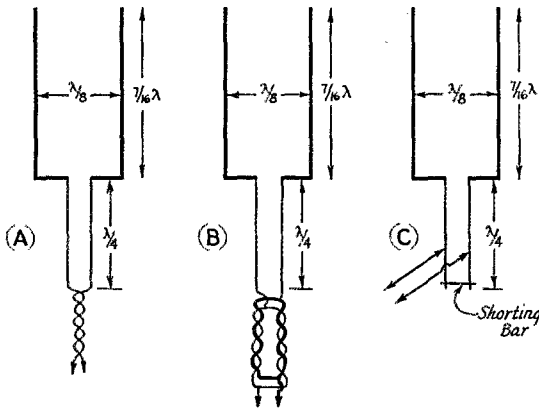

Fig. 5 — "Pitchfork" antennas with stub feed.

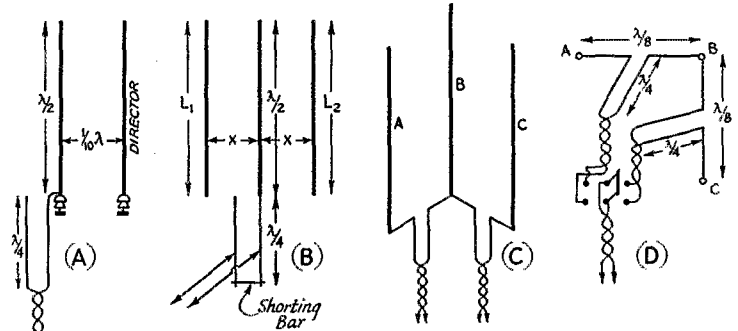

Fig. 6 — Simple directive systems using vertical elements.

the shorting bar on the phasing section, by shock-exciting the antenna and locating the point of highest current in the phasing section with a current squared galvanometer. Then the stub may be attached and fed in the same manner as with any other form of aerial.

Additional half waves may be added, if additional phasing sections are used, but they are not very useful if the entire system is not more than a half wave above ground at its lowest point.

"Pitch-fork" Bi-directional Half-wave Beams

In locations where space is limited, and where a bi-directional antenna may be a convenience, we should not lose sight of the possible gain to be had from the "pitchfork" (Fig. 5) over the ordinary type of vertical antenna. In many cases, it will be an improvement over two half-waves in phase, for the reason that it tends to put the signal where we want it. For receiving, it tends to cut out interference from stations in undesired directions as well as increasing signal strength from those stations in desired directions.

Since the spacing between the two vertical sections is only an eighth wavelength and the matching stub is only a quarter-wave long, it is possible to set such an array above an apartment-house roof, using self-supporting vertical rods. The entire assembly does not become too cumbersome, even though it is used on the 20-meter band, when the vertical elements become about 29 feet high, with a separation of about 8 feet. Some of the more ingenious fellows have made beams of this nature rotary, but where rotation is possible, we prefer the arrangements shown in Figs. 6-A and 6-B, for reasons outlined later.

In locations where rotation is not possible and a single aerial is all that can be used, the pitchfork has its advantages if we choose the two directions with care. If two such beams can be set up a reasonable distance apart, we can cover all directions with a great deal more efficiency than would be

The vertical two-section "W8JK" rotatable beam installed at W2AZ. Self-supporting 20-meter half-wave elements are used. The beam is bi-directional and the antenna need be rotated only 180 degrees for complete horizontal coverage.

possible with any of the single units previously considered.

The use of three vertical elements for making a fixed beam which covers four directions, with fair results, is shown in Figs. 6-C and 6-D. It will be seen that the center unit is used with both systems and we have, in effect, two distinct beams at right angles to each other and having two distinct feed systems. The results which have been produced by this layout have been most encouraging. While they are not so good as those to be had from two similar beams a reasonable distance apart, and while it is possible to find current in the vertical element which is not in use, the performance is distinctly better than we thought it would be. This holds true for both transmitting and receiving.

The double-pole double-throw switch used to make the experiments on the 10- and 20-meter bands was located near the transmitter. It is thought that a suitable switch located at the base of the antenna, and remotely controlled, would bring about even better results.

One marked advantage of this double pitchfork beam was its gain over a single half-wave radiator for use in covering all directions simultaneously. To accomplish that result it was only necessary to feed the two transmission lines in multiple. The advantage of such an arrangement for general calling purposes is obvious.

As outlined before, any desirable transmission-line may be run to the quarter-wave stub, if the conditions for using those lines are met.

Vertical Rotary Beams

It is a bit difficult to know just where to give credit for the various ideas which have been conceived and worked out by so many investigators, and it is likely that much credit is given to some who have not been the first to use various arrangements because those who have actually been first have not made their findings known. In outlining the next two types of arrays, we wish to thank Lawrence M. Cockaday, W2JCY, and Frank Lester, W2AMJ, for much of the electrical and mechanical work which they have done and for the information this work brought to light.

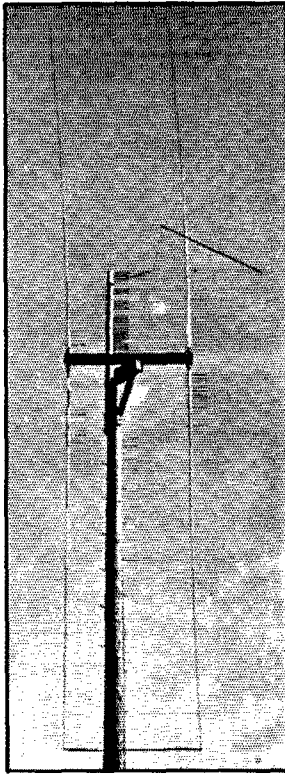

Photo by W. F. Diehl, 6X-2CY

Many investigators have had the impression that Brown's paper before the I.R.E. which so ably covered the subject of half-wave radiators and close-spacing,⁶ was intended to convey the idea that his findings would apply only to the use of a single radiator and a single director or reflector. It has been generally thought that the use of both director and reflector would not be an advantage. We think that what he intended to convey was the thought that the actual results which he described were found to be true under a given set of circumstances and that other sets of circumstances had not been investigated. In any event, there is no doubt now that both the director and the reflector, used with close-spacing and a half-wave radiator, provide better performance than either of them alone.

The mechanical difficulties usually encountered with nearly every type of rotary beam are reduced to a minimum when the arrangements shown in Fig. 6-A and 6-B are employed. In the former, we have shown a half-wave radiator with a director and no reflector, while in the latter we have shown the manner in which both may be used. Again, all the information regarding transmission-lines and matching stubs applies to this case, and two of the simpler methods have been illustrated.

It will be seen that changing the direction of radiation with this type of beam depends entirely upon the location of the director and/or reflector and that the radiator, matching stub and transmission-line remain fixed. The mechanical details for bringing this condition about are obviously simple, even where it is desired to use the three-element array on 20 meters.

Single-Wire Feed

One of the least used and one of the simplest methods of getting energy from a final tank circuit to an antenna is

(Continued on page 108)

⁶ G. H. Brown, Proc. I.R.E., January, 1937.

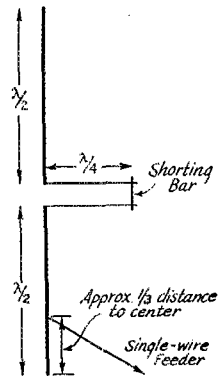

Fig. 7—Half waves in phase with single-wire feed and phasing stub.

★ WHAT THE LEAGUE IS DOING ★

League Activities, Washington Notes, Board Actions—For Your Information

MORE EXAMINATION POINTS

THE Federal Communications Commission has drawn new 125-mile circles around three of its sub-offices: at Savannah, Ga., Tampa, Fla., and San Diego, Calif. The Class C examination is no longer available within these areas. Frequent examinations will be held at these offices for Classes B and A, but by special appointment with the office, not on regular schedule.

Examinations are now also available at the sub-office at Juneau, Alaska, by appointment, but Class C is still available throughout K7. In addition to this, Class A and Class B examinations continue available in Alaska by arrangement with any Army Signal Corps station, and at other points through Coast Guard officers.

— . . . —

THE INTER-AMERICAN ARRANGEMENT

THERE is a rumor going the rounds that Mexico has repudiated the inter-American radio treaty of Habana and that there will be a serious amateur interference situation as a result. The rumor is unfounded. Mexico on October 28th did reject the North American *broadcasting* arrangement but on that same date did approve the Habana Convention and the Inter-American Arrangement Concerning Radio Communications. The latter is the important administrative agreement assigning amateur bands exclusively to amateurs and subdividing them in agreed manner between 'phone and c.w. as reported in last February's *QST*. Thus Mexico, rather than creating an interference situation, has gone the whole way in the support of amateur radio. Incidentally, the other countries that have so far approved the Habana arrangement are the United States, Chile, Haiti and Peru.

— . . . —

THE CENTRAL DIVISION MATTER

A YOUNG tempest has been kicked up in the Central Division by some members who have not understood the reasons for the outcome of the nominations for director this year. There are murmurings of an "unholy alliance" between the incumbent director, Mr. Mathews, and the Executive Committee, with the latter invoking petty technicalities to keep the former improperly in office. The matter seems to need some further discussion.

First off, we call attention to a letter from Director Mathews appearing in this month's "Correspondence." In 1937 the Board of Directors adopted new rules for the eligibility of candidates for directors, included in which was the requirement that all candidates must have been continuously both a licensed amateur operator and a member of the League for at least four years immediately preceding nomination. The Executive Committee received petitions for six nominees: W8JK, W9UZ, W9ZN, W9BAZ, W9BJE, W9PNV. W8JK and W9ZN withdrew their names by written communication. The petition for W9PNV carried the signatures of only nine League members and so could not be regarded—at least ten are required. Neither W9UZ nor W9BAZ satisfied the requirement of four years uninterrupted membership preceding nomination. W9BJE had neither continuous operator license nor continuous League membership for the four years preceding nomination. These rules are adopted by the Board for the control of the Executive Committee and are binding upon the latter. There was simply no candidate eligible under the rules and so there was no election.

The question now is what happens under such circumstances. The answer is that another rule, By-Law 21, comes into play: it provides that directors are elected for a term of two years or until their successors are duly elected and qualified. The division having failed to name a candidate eligible under the rules, the incumbent director automatically remains in office. This is a customary rule in all such organizations as ours, and in our case has for its purpose preventing the division from losing its vote and its representation through failure to name an eligible candidate. It is true that Mr. Mathews was not a candidate, having withdrawn his name, and it is also true that he would not have been eligible under the present rules to stand as a candidate for reelection. But he was eligible when elected, the rules having been changed since, and his automatic retention in office is not only legal but the only possible outcome of the unusual circumstances. The Executive Committee of course would be open to the gravest criticism if it accepted candidates who were ineligible under the rules. There is reason to feel that the rules themselves may be too severe when they disqualify this many otherwise desirable candidates. With-

out doubt that question will be studied carefully by the Board at its next meeting.

— . . . —
FINANCIAL STATEMENT

THE third quarter of the League's operations for 1938 showed increasing gross revenues but naturally continuing expenses, resulting in another substantial operating loss before appropriations. Net result is that the League enters the last quarter of the year about even. It is expected that the last quarter, which sees the appearance of the new Handbook, will yield a substantial gain. Third-quarter figures:

STATEMENT OF REVENUES AND EXPENSES, EXCLUSIVE OF EXPENDITURES CHARGED TO APPROPRIATIONS, FOR THE THREE MONTHS ENDED SEPTEMBER 30, 1938

REVENUES		
Membership dues	\$12,220.38	
Advertising sales, <i>QST</i>	21,548.35	
Advertising sales, booklets	510.00	
Newsdealer sales, <i>QST</i>	10,563.98	
Handbook sales	4,618.94	
Spanish edition Handbook revenues	21.43	
Booklet sales	1,834.62	
Calculator sales	232.19	
Membership supplies sales	1,541.39	
Interest earned	569.53	
Cash discounts received	207.41	
Bad debts recovered	39.32	\$53,907.54
<i>Deduct:</i>		
Returns and allowances	\$3,996.58	
Exchange and collection charges	15.01	
Cash discounts allowed	345.85	
	\$4,357.44	
Less decrease in reserve for newsdealer returns of <i>QST</i>	26.61	4,330.83
Net Revenues		\$49,576.71
EXPENSES		
Publication expenses, <i>QST</i>	\$15,948.07	
Publication expenses, Handbook	3,662.59	
Publication expenses, booklets	833.16	
Publication expenses, calculators	118.64	
Salaries	24,493.32	
Membership supplies expenses	920.76	
Postage	1,748.03	
Office supplies and printing	1,058.02	
Travel expenses, business	699.70	
Travel expenses, contact	1,747.62	
<i>QST</i> forwarding expenses	987.73	
Telephone and telegraph	627.60	
General expenses	1,322.58	
Insurance	208.32	
Rent, light and heat	1,121.47	
General Counsel expenses	255.25	
Communications Dept. field expenses	119.89	
Headquarters station expenses	714.91	
Alterations and repairs expenses	60.00	
Bad debts written off	67.00	
Provision for depreciation of:		
Furniture and equipment	419.97	
Headquarters station	35.49	
Total Expenses		57,168.52
Net loss before expenditures against appropriations		\$7,591.81

New Transmitting Tubes

HK 24

A TUBE in an entirely new size range for transmitting lines is the Gammatron 24. This tube makes use of a tantalum plate with enclosed top to obtain dissipation capability rated at 25 watts.

Maximum height of the tube is 4¾ inches, and maximum diameter is 1½ inches. The measured height of one tube, exclusive of the plate terminal at top, is 3¾ inches, while the bulb diameter of the same tube measures 1¾ inches.

Below are given some of the ratings of this tube:

Plate-grid capacity	1.7 µfd.
Grid-filament capacity	2.5 µfd.
Plate-filament capacity	0.4 µfd.

Operation as r.f. power amplifier, Class-C unmodulated:

D.c. plate voltage (max. value)	1500 volts
D.c. plate current (max. value)	75 ma.
D.c. grid voltage	-120 volts
D.c. grid current	20 ma.
Peak r.f. grid voltage	240 volts
Grid driving power	3.8 watts
Power output	89 watts

For operation as Class-C r.f. amplifier with 100-per cent plate modulation, the plate supply voltage is reduced to 1250 and the plate current is reduced to 60 ma. The tubes are rated at 125 watts output in Class-B audio operation.

The maximum ratings for the 24 apply for frequencies up to 60 megacycles; a slight reduction is necessary for 112-Mc. operation, and data on the performance of the tube at frequencies up to 360 Mc. are given by the manufacturer.

810

A new carbon-plate tube suited for operation at 500 watts input as an unmodulated Class-C amplifier, or for 590 watts output (per pair) in Class-B audio operation, is the RCA 810. This tube, including end shields for the filament in a design for more efficient operation at low voltage (2000 volts maximum), makes possible compact construction of high power transmitters for 375 or 750 watts output using one or two of the new tubes. The maximum ratings of the tube are for frequencies as high as 30 megacycles.

(Continued on page 59)



One-Half Cubic

A Complete Low-Power

◆
One small chassis contains powersupply, speech amplifier and modulator, three r.f. stages—ending in an 807—and an antenna tuner. Despite a lot of apparatus, the set is an exceptionally clean-looking job.
◆

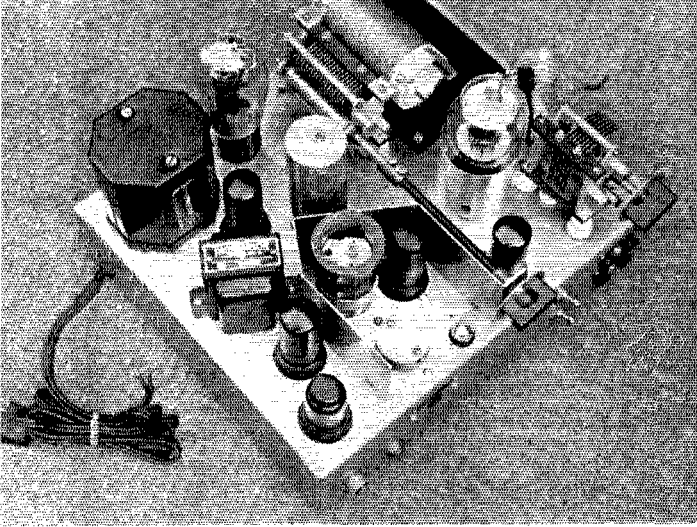

FIRST and foremost, a frank admission is in order: The outfit to be described is not the result of a pre-formulated plan. Its size and shape were determined at the outset by a sheet of aluminum which I had on hand. The rig arrived at its present state in two distinct stages, beginning as a 160-meter 'phone portable without benefit of buffer. It was built rather hurriedly for a vacation trip, and was much in use in New England this past summer. All in all, the results were satisfactory. The 'phone quality was good and DX contacts of a few hundred miles were not uncommon, but it seemed that at every turn some person of non-ham status would ask me, "How far can you talk on your radio sending set?"

Now, to a ham with nothing but 160-meter coils in his duffle bag, that's just plain embarrassing. My attempts at explaining the higher frequency bands were all but futile; the fact remains that we amateurs have the reputation of talking around the world. No amount of mumbling about "skip distance," 10-meter DX, and the like would satisfy them—or me either for that matter—because, quite naturally, I had talked myself into 20 and 10 meters for the small rig. The job is done, and the methods and results are to be described for what they may be worth.

Oscillator and Harmonic Generator

In the circuit diagram of Fig. 1, a 6F6 (metal tubes are a necessity to conserve space) is used in a conventional pentode crystal oscillator circuit. The feed-back capacitor, C_4 , was found necessary when quadrupling to 10 meters in the harmonic generator.¹ The oscillator must be tuned

¹ J. L. Reinartz, *QST*, July, 1937, and April, 1938.

quite near its peak (the oscillator is responsible for a large share of the excitation at the control grid of the final amplifier in this circuit) and therefore cleaner keying resulted from the use of a slight amount of regeneration. The cathode of the oscillator is keyed for break-in. If the oscillator circuit of Fig. 1 is used, the 6F6 shield is grounded at the socket. If the Reinartz circuit is substituted, the shield should be tied to the cathode end of the coil and condenser. Only a 160- and a 40-meter crystal are required for operation in the five lowest frequency amateur bands.

Another 6F6 is utilized in the second stage of the harmonic generator, and is used only when doubling to 20 or quadrupling to 10 meters from a 40-meter crystal. On 160, 80 and 40 meters the Class-C amplifier is driven by the crystal oscillator. The 807 doubles to 80 meters for c.w. operation only at present. If 75-meter 'phone is contemplated, or if the last possible watt of output is desired, a special coil form should be made for L_1 and L_2 and the second stage switched in. It is suggested that this extra long form be made of a length of $1\frac{1}{2}$ -inch diameter bakelite tubing fastened to a tube base. The coil sizes and spacing are included in the list. When driving straight through, the second 6F6 should be removed from its socket, although the circuit will function with it in place. SW_1 is a very small homemade knife switch with a victrol base, and appears between the oscillator tuning condenser and the power supply chokes in the under-chassis view. It is necessary to omit cathode bias in the second stage and to operate the screen grid at the voltage indicated (a round figure of 200 volts is used at all screens for convenience) for best results.

On the New England trip mentioned in the article, Mr. Rice found time to drop in on us at Headquarters last summer, and the gang was greatly impressed by the neat portable job he was carrying around with him. Naturally we inquired as to the possibility of getting a story on it, and here is the result. We think you'll like the outfit as well as we did.

Foot of Transmitter

Phone-C. W. Rig for Five Bands

BY H. E. RICE, JR.,* W9YZH/4

The Final Amplifier

The final amplifier is strictly conventional with the one exception of the connection of screen bypass C_{12} . SW_2 , the 'phone-c.w. switch, cuts in a screen dropping resistor for 'phone operation, and in the c.w. position it does about everything possible to make the most of the available voltage consistent with a clean keyed signal.

Audio

The speech amplifier and modulator are also conventional, and have proved satisfactory. The audio system is, in fact, practically identical to the Class-B amplifier for portable use described in the current RCA "Receiving Tube Manual." A double-button carbon microphone is used.

Antenna Coupler

The antenna coil consists of 36 turns of No. 18 bare copper wire, $1\frac{3}{4}$ inches diameter, winding length $2\frac{3}{4}$ inches, with spring brass slider clips at either end, one to vary the tap and thereby the coupling to the final tank and the other to short out turns from the voltage end. Suffice to say that with the 360- μ fd. condenser connected across the coil the resultant tank circuit will tune to 160, 80 and 40 meters.

Power Supplies

The main power supply uses an 83 rectifier and delivers 300 volts under full load. SW_3 is the send-receive switch.

It is granted that a separate bias supply for a transmitter of this power may, at first glance, seem out of place. In this instance, cathode biasing of the 807 meant a sacrifice of precious power, and it is out of the question in the second stage. I prefer to key the oscillator and I don't like

*Great Smoky Mountains National Park, Gatlinburg, Tenn.

COIL DATA

- L_1 —(a) 1.75-Mc. crystal: 52 turns No. 24 enamel closewound.
(b) 7-Mc. crystal: 14 turns No. 20 d.c.c. closewound.
 L_2 —(c) 3.5 Mc.: 26 turns No. 20 d.c.c. closewound.
(d) 14 Mc.: 7 turns No. 18 enamel, length $\frac{1}{2}$ inch.
(e) 28 Mc.: $3\frac{1}{2}$ turns No. 18 enamel, length $\frac{1}{2}$ inch. (This coil, with a 25- μ fd. condenser, will hit only the 4th harmonic.)

When doubling or quadrupling, coils L_1 and L_2 are wound on the same coil form, spaced as follows: a-c, $2\frac{1}{2}$ inches; b-d, 1 inch; and b-e, $\frac{1}{2}$ inch. All L_1 and L_2 coils are $1\frac{1}{2}$ inches diameter. For output on 1.75 and 7 Mc., separate coils are used at L_1 , i.e. coils with no other winding on the form. The two coils needed for 1.75-Mc. output are shown in one of the photographs. Ten-meter coils are in the sockets.

- L_3 —1.7 Mc.: 44 turns No. 20 d.c.c. closewound on $1\frac{3}{4}$ " dia. form.
3.5 Mc.: 26 turns No. 20 d.c.c. closewound on $1\frac{3}{4}$ " dia. form.
7 Mc.: 40-meter end link Decker coil, 2 turns removed.
14 Mc.: 20-meter end link Decker coil, 2 turns removed.
28 Mc.: 10-meter end link Decker coil, 3 turns removed.

soaring plate current whether or not the plate dissipation rating of a tube is exceeded thereby. The pack shown fills the bill nicely, is quite economical and very compact. With the components specified, the plate current of the last two stages falls to zero when the oscillator circuit is opened.

Construction

The chassis measures 10 by 12 inches and is $2\frac{1}{2}$ inches deep. It is made of $\frac{1}{16}$ -inch half-tempered aluminum, and is equipped with rubber mounting feet at the four corners. The layout of parts is controlled by the chassis, and unless a slightly larger size is used, would have to be followed quite closely if the performance is to be duplicated.

Beginning at the right rear corner, the power transformer is mounted under the chassis with the cover plate on top. This is believed to be the simplest and neatest method of mounting this

This is the complete transmitting layout, ready to be hooked to an antenna and the 110-volt power source. The microphone input circuit, in the aluminum box at the right, contains the mike battery, transformer, and microphone-current control; it could be incorporated in the main unit by making the chassis a little larger. With two crystals, the set can be operated on all bands from 1.75 to 28 Mc.

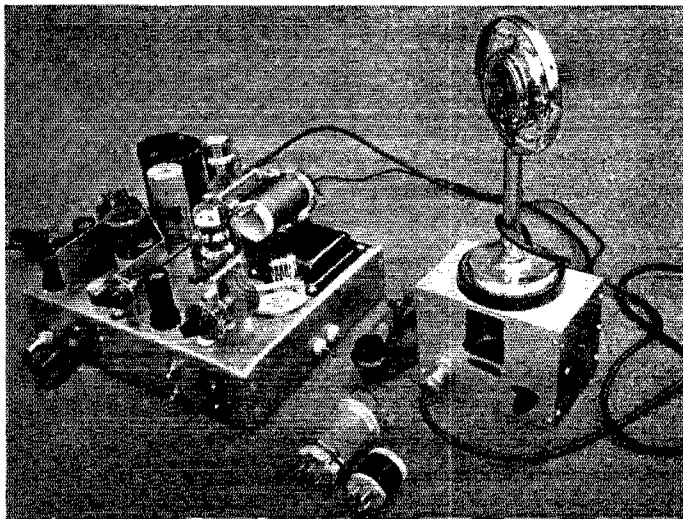

type transformer in all cases since the cut-out edges are hidden and thus do not need to be smooth. The electromagnetic properties are in no way impaired.

The antenna tuning condenser is mounted vertically on small standoffs just to the left of the power transformer, with the coil form suspended from it by aluminum brackets. A National ceramic form, $1\frac{3}{4}$ inches diameter by $3\frac{1}{2}$ inches long, was found suitable for this purpose and is fastened permanently in place. Next in line along the rear is the rectifier tube, with the modulation transformer at the corner. The 6N7 modulator, driver transformer, 6N7 driver, and 6C5 speech amplifier at the left front corner follow in that order in a staggered row along the left-hand edge. The crystal pilot-bulb current indicator, oscillator tube, and oscillator and harmonic generator coil form with C_2 of Fig. 1 mounted inside are grouped in a shield compartment to the right of the 6C5. The right front corner of this shield is folded to the right three quarters of an inch, and serves as a support for a panel bushing to guide the insulating rod which turns the antenna condenser. The socket for the harmonic generator tube is located just outside the shield, with its center $1\frac{1}{4}$ inches from the front and 5 inches from the right-hand edge of the chassis. It was necessary to crowd this socket as far to the left as possible to leave room behind the chassis front for the two d.p.d.t. toggle switches. The center of the socket for the 807 is $3\frac{1}{2}$ inches from the front and $3\frac{1}{2}$ inches from the right-hand edge. The final tank coil socket is to the right and to the rear of the 807, with the condenser at the right front corner.

The power supply chokes are mounted end to end on an aluminum bracket under the chassis. The main filter condenser is bolted through in the usual way directly behind the oscillator shield compartment. The bias pack with its rectifier tube is under the chassis ahead of the transformer. C_1 is also underneath, and tunes with a screwdriver from the front. It will be noted that the screwdriver hole is fitted with a rubber grommet to prevent accidental short circuits. Lock washers are used throughout, and all variable condensers are set reasonably tight.

The microphone input with its battery is in a separate aluminum box 4 by $4\frac{1}{2}$ by 6 inches, the bottom of which extends out from the left side to form a weighted base to which the straight key is bolted. A length of crystal microphone cable connects from R_6 to the grid of the 6C5. These details can be seen in the photograph. The microphone input, complete as shown, was on hand at this station. It would be entirely practicable to mount the transformer under the transmitter chassis, in which case the voltage should be taken from the power pack, and the gain might well be fixed for the normal input to the modulated amplifier.

Operation

No hum troubles were encountered, so it was not found necessary to connect the chassis to an earth ground. In the event of an accidental short circuit to ground, the $1/32$ -ampere fuse in the bias supply will prevent possible damage to the rectifier tube from a grounded power line.

Parasitic chokes were found necessary on 20 and

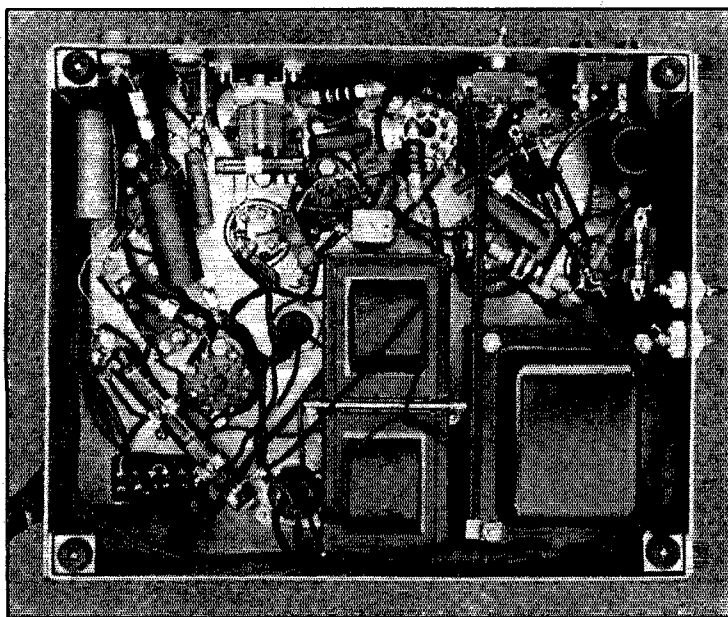

◆
Most of the below-chassis space has been utilized, as this below-chassis view shows. Note the 6H6 bias rectifier in the upper right-hand corner. The chassis is bent from a sheet of semi-hard aluminum.
◆

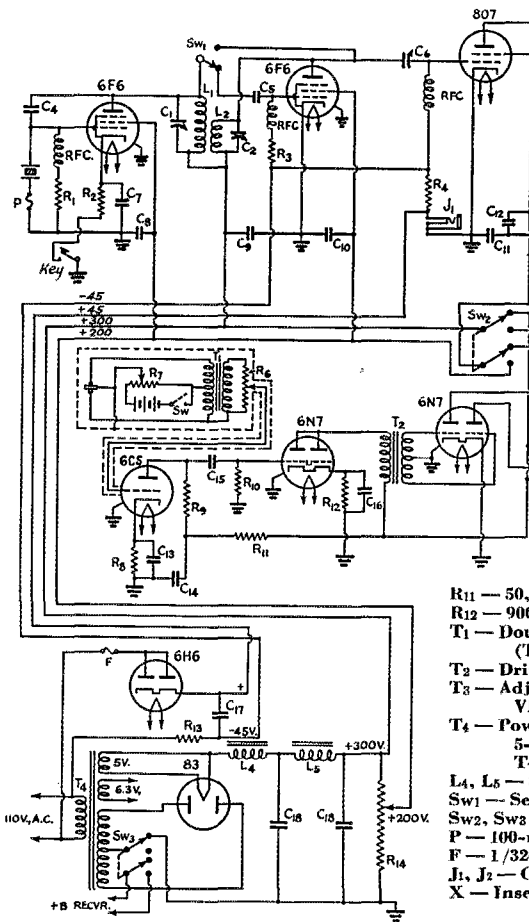

Fig. 1—Circuit diagram of the complete transmitter.

- C₁—140- μ fd. variable (Hammarlund APC-140).
- C₂—14 Mc., 50- μ fd. variable (Hammarlund APC-50).
- C₃—28 Mc., 25- μ fd. variable (Hammarlund APC-25).
- C₃—150- μ fd. variable (Cardwell MR-150-BS).
- C₄—3- μ fd. maximum.
- C₅—100- μ fd. maximum.
- C₆—3-30- μ fd. trimmer (National M-30).
- C₇, C₈, C₉—0.01- μ fd. mica.
- C₁₀—0.1- μ fd. paper. C₁₄—0.5- μ fd. paper.
- C₁₁—0.01- μ fd. mica. C₁₅—0.02- μ fd. paper.
- C₁₂—0.1- μ fd. paper. C₁₆—25- μ fd. electrolyt.
- C₁₃—25- μ fd. electrolytic.
- C₁₇—40- μ fd., 150-volt electrolytic.
- C₁₈—8-8- μ fd., 600-volt electrolytic.
- R₁—20,000 ohms, 1/2-watt.
- R₂—400 ohms, 2-watt.
- R₃—100,000 ohms, 1/2-watt.
- R₄—6000 ohms, 1-watt.
- R₅—10,000 ohms, 10-watt.
- R₆—500,000-ohm gain control.
- R₇—1000-ohm variable, with switch (microphone current control).
- R₈—5000 ohms, 1/2-watt.
- R₉—100,000 ohms, 1/2-watt.
- R₁₀—250,000 ohms, 1/2-watt.
- R₁₁—50,000 ohms, 1/2-watt. R₁₃—4000 ohms, 1-watt.
- R₁₂—900 ohms, 1/2-watt. R₁₄—20,000 ohms, 30-watt.
- T₁—Double-button microphone to grid transformer (Thordarson T-65A73).
- T₂—Driver transformer, 6N7-6N7 (Thordarson T-67D47).
- T₃—Adjustable Class-B output transformer (U.T.C. VMO).
- T₄—Power transformer, 400 v. each side c.t. at 200 ma., with 5-volt and 6.3-volt filament windings (Thordarson T-13R16).
- L₄, L₅—8 henrys, 150-ma. (Thordarson T-13C30).
- Sw₁—See text.
- Sw₂, Sw₃—D.p.d.t. toggle.
- P—100-ma. pilot bulb.
- F—1/32-amp. fuse.
- J₁, J₂—Closed-circuit phone tip jacks (see text).
- X—Insert parasitic choke here (see text).

10 meters. Ten turns of No. 18 enameled wire, 1/4 inch diameter (wound on a test prod) cleared the circuit. The choke was wired in by soldering directly to the 807 plate clip.

Provision for metering is accomplished by the use of shorting type 'phone-tip jacks in the grid and plate circuits of the final amplifier. A test meter is used for this purpose. The antenna coupling is adjusted to draw 65 plate milliamperes for 'phone operation and 85 for c.w. Thus the input varies between 16 and 25 watts. With bias and plate voltage applied, there is enough excitation at the control grid of the 807 to cause 6 to 7 grid milliamperes to flow through 6000 ohms at 10 meters and 10 or more on the lower frequencies. Be that as it may, it is important that excitation be controlled. There is a very definite optimum for each plate current reading for linear operation and greatest output. Between 3 1/2 and 4 milliamperes will be about right. The plate tank of the second 6F6 may be detuned when necessary. However, in most instances, satisfactory control of excitation can be main-

tained by detuning the oscillator, which practice lowers the crystal current and improves the keyed signal.

This transmitter is one solution of a completely self-contained rig, for use away from the home station, in which nothing but power is sacrificed. It has been of very real interest as a proving ground for the harmonic generator operated at a low plate voltage and for the small bias pack. A socket could be wired in readily to provide for convenient connection to an independent power source for field use. My 300-watt transmitter is very much on the shelf for the present.

CHRISTMAS

Greetings

TO ALL HAMS

*from the Crew
at Headquarters*

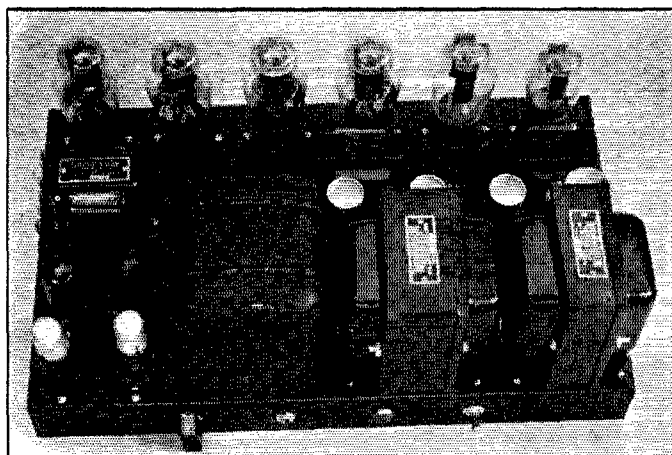

The wide-range 30-watt amplifier complete with power supply. The gain control knob is at the left on the front of the chassis, with microphone jack, pilot light (2.5-volt light in parallel with the 2A3 filaments), and power switch in order toward the right. The two 6J7 tubes are at the left front corner of chassis, with the two 6N7 tubes directly behind. The output transformer is located at the front center of chassis, with power transformer to the right and 250-ma. choke at the right front corner. The four condenser cans are in a row behind the transformers and large choke, and the two small chokes are directly behind the condensers. The input transformer for the 2A3 tubes is directly behind the 6N7 tubes.

A Wide-Range Audio Amplifier

All-Push-Pull Stages Applied to 30-Watt Amplifier-Driver

BY T. M. FERRILL, JR.,* WILJI

IF ALL of the different phases of interest in amateur radiophone work were averaged, it would probably be found that the first interest of the operators in their equipment is quality and fidelity, with power, flexibility, and general utility following closely in some such order as that given. It should be realized, however, that neither an extremely wide frequency response range nor extremely low percentage distortion is necessary for an amateur 'phone station of excellent voice quality. A frequency range with less than 2 db variation between 100 and 4000 cycles is adequate for this purpose. The usual broadcast program has a range of the order of 100 to 5000 cycles, and experience indicates that a frequency range of 80 to 8000 cycles is adequate to give excellent reproduction of all sounds except certain types of noises.¹ Amplitude distortions of 3 to 5 percent are detectable but are not considered objectionable, while 10-percent distortion is quite noticeable.

What characteristics, then, should a 'phone operator "go after" when building a high-quality transmitter? If any of the audio equipment is to be used for other services, such as public address or theatre amplifier work, it would be desirable to include a range of 60 to 15,000 cycles, making possible substantially perfect reproduction of music as well as speech.¹ In modulation of an

amateur 'phone transmitter, however, such a broad range is not only unneeded, but also *very undesirable*. The high-frequency portion of this range would add little to the naturalness of the speech if reproduced in the receiver, and a super-heterodyne with sufficient selectivity for satisfactory reception in the crowded 'phone bands loses this high-frequency part of the transmitted speech. Reference to a typical receiver selectivity curve² shows that even if the transmitter has absolutely no frequency discrimination in the audible range of frequencies, the audio output of the second detector in the receiver will be approximately 25 db lower at 5000 cycles than at 100 to 500 cycles and approximately 50 db lower at 10,000 cycles, so that there is nothing to be gained by transmitting the audio frequencies above 5000 cycles. More important for amateur communication work is the fact that the *high frequencies not received by the station contacted may interfere with reception of the stations 10 to 15 kilocycles from the frequency of the transmitter*.

The amplifier shown and described here is intended not as a compromise between a narrow-range system and one suited for purposes other than amateur 'phone work, but as an excellent amplifier for any audio-frequency application. As shown in Fig. 2 it is provided with a condenser (C_g) which limits the high-frequency response of the system, with the resulting curve shown in dashed line in Fig. 1. This curve coincides with

* Technical Dept., QST.

¹ F. E. Terman, *Fundamentals of Radio*, page 432, McGraw-Hill Book Co., Inc., 1938.

² Page 97, *The Radio Amateur's Handbook*, 16th Edition, 1939.

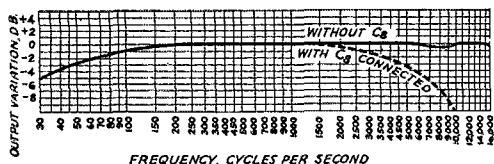

Fig. 1—Frequency response curves taken with limiting condenser connected for voice transmission and omitted for other uses.

the response curve of the amplifier without condenser up to above 1000 cycles, and then gradually begins falling off, being noticeably low past 5000 cycles. At 10,000 cycles the response has decreased more than 10 db, and this, coupled with the fact that the amount of energy in this frequency region produced by the voice is very small, makes for almost complete elimination of interference from broad side-bands sometimes mistakenly attributed to overmodulation in the case of high-power transmitters.

If operation of the amplifier as a wide-range unit is desired, it is only necessary to disconnect C_g , so that the extremely wide response range shown in solid line in Fig. 1 is the result. Actually, the amplifier is built for this range, and the condenser is an accessory for 'phone operation.

There are several factors which take part in determining the frequency range of an amplifier. If the cathode bias resistor of a single-tube amplifier is by-passed by a too-small capacitance, the low-frequency response of the stage will be impaired, particularly if the cathode resistor is small and the amplification is high. Either a large capacity at this point or a bias cell used in the grid circuit of the stage with the cathode grounded, is a simple remedy at this point. A capacitance of 20 to 50 microfarads is usually sufficient for good low-frequency response if a cathode resistor of 2000 ohms or less is used, and smaller capacities are suitable for larger resistors.

Note that the power supply components and wiring are confined to the half of the chassis at left in this view. The input condensers and chokes are located at the microphone jack, and from the ends of the chokes, shielded wires go through the chassis to the grids of the 6J7 tubes. Plate and grid coupling condensers for the voltage amplifier stages are mounted in a compact group behind the 6N7 tubes. The whole layout is planned for simplicity, with placement of parts for the output of one stage to feed right into the input of the next. In the row of 4-prong tubes, first is the 82, second is the 83, and then four 2A3's.

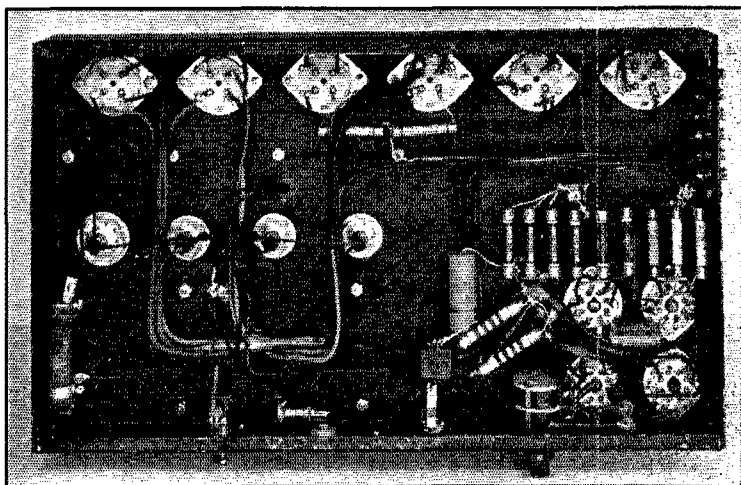

Another factor often found to be the cause of poor low-frequency response is insufficient primary inductance of audio coupling transformers, particularly those used to couple power amplifier stages. Better transformers are at least a partial solution to this difficulty, but sometimes this solution is too expensive to be justified.

Coupling condensers used between voltage amplifier stages must be included in the list of items which might impair the low-frequency response of the amplifier, but tubular paper condensers rated at 600 volts and at 0.01 to 0.1 μ d. are entirely satisfactory.

Causes for loss of high-frequency response in audio amplifiers include decrease of effective plate load impedance of one stage by high effective input capacity of a following stage (most noticeable with high- μ triode types having high plate-to-grid capacity) and decrease of effective plate load impedance of a voltage amplifier stage by high capacity of the plate transformer windings. If the first of these two troubles is experienced, it may be reduced by use of either a lower- μ triode or lower values of plate and grid coupling resistance. If the latter is the offender, a better (and usually more expensive) transformer is the direct solution.

Since it is possible to replace range-limiting condensers with larger capacitances at very little cost relative to the resulting improvement of the frequency range, there is a strong tendency in the design of amplifiers toward use of resistance coupling of voltage amplifier stages in preference to transformer coupling.

A means of improving the frequency range of an amplifier is the introduction of inverse feedback in one stage, or over two or three; this requires provision for more gain than would otherwise be necessary, and requires additional apparatus, although the result usually gives more than justification for the expense and work neces-

sary. Inverse feed-back also tends to reduce the hum and the amplitude distortion in the stages over which it operates.

The amplifier described in these pages is entirely orthodox in all features except one — the use of push-pull stages throughout. As will be seen from the solid line of Fig. 1, inverse feed-back is not needed for extension of the range of this amplifier, since the response at the low- and high-frequency ends of the desirable range is quite high.

This excellent frequency characteristic is made possible primarily by use of push-pull stages throughout so that the current through the bias resistors is almost constant over the audio cycle, and thus the use of cathode by-pass condensers which might cause frequency discrimination is made unnecessary. Use of resistance-coupled voltage amplifier stages with sufficient coupling-

condenser capacity and with coupling resistors chosen with due regard to the high- μ triodes is a further step toward wide-range response. Since the output stage in an amplifier of this power is almost invariably push-pull, and since a push-pull stage is usually considered a desirable driver for the output amplifier (particularly with such an output stage as four small triodes which are likely to have some grid-current flow on audio peaks), the use of push-pull stages from the input of the amplifier simplifies the problem of driving the output stages without a transformer.

Whereas addition of inverse feed-back to an amplifier makes a marked decrease in hum level, the push-pull stages throughout this amplifier perform this function also,³ to a very marked ex-

³ Ferrill, "Refinements in Combination Exciters," *QST* Oct., 1938.

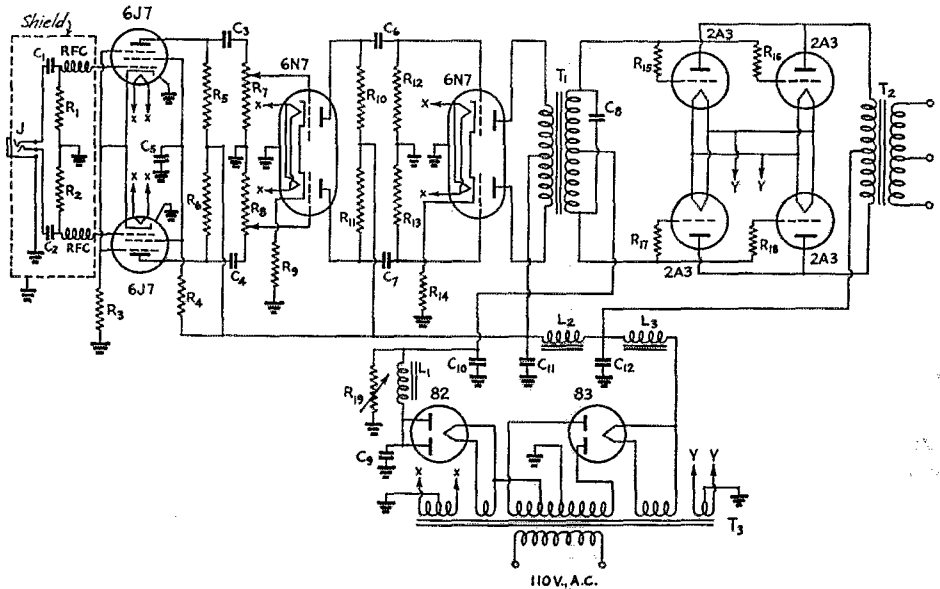

Fig. 2 — Circuit diagram of the amplifier with range limiter

- C₁, C₂ — 0.006- μ fd. mica, 600-volt.
- C₃, C₄, C₆, C₇ — 0.01- μ fd. paper tubular, 600-volt.
- C₅ — 0.1- μ fd. paper tubular, 600-volt.
- C₈ — 0.002- μ fd. mica, 600-volt.
- C₉, C₁₀ — 8- μ fd. sections of dual electrolytic, 250-volt working (two Mallory HD683 connected in parallel).
- C₁₁ — 16- μ fd. electrolytic, 500-volt working (two Mallory HD683 connected in parallel).
- C₁₂ — 8- μ fd. electrolytic, 500-volt working (Mallory HD683).
- J — 3-wire jack.
- R₁, R₂ — 2-megohm, $\frac{1}{2}$ -watt carbon.

- R₃ — 600-ohm, $\frac{1}{2}$ -watt carbon.
- R₄ — 0.6-megohm, 1-watt carbon.
- R₅, R₆, R₁₀, R₁₁ — 0.25-megohm, 1-watt carbon.
- R₇, R₈ — 2-gang, 500,000-ohm potentiometer (Centralab 4-010804).
- R₉ — 2000-ohm, 1-watt carbon.
- R₁₂, R₁₈ — 0.5-megohm, 1-watt carbon.
- R₁₄ — 700-ohm, 1-watt carbon.
- R₁₅, R₁₆, R₁₇, R₁₈ — 100-ohm, 1-watt carbon.
- R₁₉ — 2,500-ohm, 25-watt, semi-variable (see text).
- T₁ — Push-pull driver input transformer (Thordarson 74D32).
- T₂ — Multi-match driver transformer (Thordarson 15D80).

- T₃ — Power transformer to deliver a.c. voltages as follows: 435 volts each side of center-tap at 250-ma. d.c. load; 80 volts (single tap) for bias rectifier; 2.5 volts, center-tapped, at 10 amperes; 2.5 volts at 3 amperes, 5 volts at 3 amperes, 6.3 volts, center-tapped, at 1.5 amperes (Thordarson 75R50).
- L₁ — 7.2-henry, 120-ma. choke (Thordarson 75C49).
- L₂ — 22-henry, 35-ma. choke (Thordarson 18C92).
- L₃ — 13-henry, 250-ma. choke (Thordarson 75C51).
- RFC — 2.5-millihenry, 125-ma. r.f. chokes.

tent when hum in the amplifier would arise from a slight a.c. content in the power supply output voltage.

Since the non-uniformity of 2A3 tubes has been the subject of some comment⁴ in discussions of push-pull power amplifiers, readers may desire an explanation of the reason for use of these tubes in an amplifier designed for better-than-ordinary performance. To meet this demand, measurements were conducted on a small assortment of 2A3 tubes of different makes and ages. Although much variation was noted in the static plate currents of different tubes at maintained grid and plate voltages throughout the operating range of the tubes, it was found that the *change* in plate current with a definite *change* in grid voltage was quite uniform for the assortment of tubes tested. Since the second-harmonic distortion produced in a push-pull amplifier of transformer output is dependent on the non-uniformity of dynamic characteristics of the tubes rather than on differences of static characteristics, the second-harmonic distortion generated in the output stage as a result of non-uniformity of the tubes will be smaller than the distortion contributed by other causes, and thus may be neglected in the choice of tubes.

Construction

The amplifier is built on a steel chassis measuring 17 by 10 by 2 inches. The arrangement of parts is planned for short, direct wiring, more for convenience than for reasons associated with the operation of the amplifier. The only precautions necessary in the wiring are that the input wiring (from microphone jack to grids of 6J7 tubes) be shielded, and that the a.c. leads be kept away from the circuits of the first two stages.

R.f. chokes are used to isolate the input of the 6J7 stage from radio frequency pickup in the microphone cable, which latter should be of the two-wire shielded type. The shielding braid of the cable and the shell of the microphone are grounded, and the two wire conductors of the cable are connected to the crystal element of the microphone (or to the high-impedance transformer winding in a velocity type). Resistors R_1 and R_2 shown in the circuit diagram of Fig. 2 serve as a voltage divider as well as a d.c. connection between grids and ground, so that only two wires are necessary to connect the output of the microphone to the amplifier input.

The two-section gain control, R_7 and R_8 , is provided with two complete separate elements operated by a single shaft, and has three connection lugs on each element. These lugs should be connected as pairs; the pair at the counter-clockwise ends of the resistance strips (viewing the control from the front panel) should be connected to ground, the pair of middle lugs should be con-

nected to the grids of the first 6N7 amplifier, and the pair at the clockwise ends of the strips should be connected to the 6J7 coupling condensers.

The output transformer is provided with taps (only two connections are made to two jacks at bottom of the transformer) connected to jacks on an outside terminal board. Impedances corresponding to turns ratios of 1:1, 1:1.25, 1:1.5., 1:1.75, and 1:2 are made readily available for matching almost any desired pair of Class-B modulator grids. By means of a terminal strip at the side of the chassis, two wires may be run directly to the grids of the Class-B amplifier, while a third wire (from terminal connected to the transformer secondary center-tap) may be used for application of fixed bias to the modulator grids, or may be grounded for zero-bias Class-B tubes. The fourth and fifth terminals on the strip are used as 110-volt a.c. terminals, to facilitate use of the amplifier for various purposes and to suit it to connection of power cables in a transmitter installation.

The 2,500-ohm semi-variable resistor provides for adjustment to -62 volts of the bias voltage applied to the 2A3 grids. In the amplifier shown here, this voltage was obtained with the tap on the resistor set for the full 2500 ohms. This would suggest the use of a resistor of 3000 ohms which might well be obtained at the beginning of construction of the amplifier, so that there is no danger of finding the available range of bias voltage too small. If no voltmeter suitable for measuring the bias voltage is available, the slider tap on this resistor should be set for a no-signal plate current of 40 ma. per tube. With the bias resistor setting determined, a plate milliammeter may be inserted in series with each 2A3 plate (the other three plates should be connected directly to the ends of the transformer primary winding during each measurement) and the no-signal plate currents of the four tubes at this bias may be determined. If it is found that one parallel pair of 2A3 tubes is carrying much higher current than the other pair, the tubes may be interchanged until the total currents to the two pairs are approximately equal. This is not a particularly important operation, however, as the previous remarks regarding unbalance of the tubes indicate, and is only suggested as a step to satisfy the most exacting builder.

Strays

WSQBW writes that it has been called to his attention that a flashlight-lamp antenna current indicator (*QST*, October, 1938) may be the cause of a chirpy signal when used in conjunction with a self-excited oscillator feeding the antenna. Comparatively few of these are in use nowadays, but it's a point worth remembering if a bulb should be used with one of them. It's not likely to occur with a crystal oscillator or m.o.p.a.

⁴ Brown and Hawkins, "Low Z for Linearity," *QST*, Oct., 1938.

'Phone "Splatter"

Not all Broad 'Phone Signals Result from Overmodulation

BY DOUGLAS FORTUNE,* W9UVC

Those crackles extending out beyond the normal side-bands accompanying voice transmission may be caused by overmodulation — and again, they may not. So don't be too sure that your 'phone is "sharp" when the oscilloscope says the modulation peaks are staying below the 100 per cent mark. How come? Well, read what W9UVC has to say about a prevalent, but overlooked, cause of 'phone "splatter."

AT THE present time there is a great deal of discussion concerning the broad signals so prevalent in our 'phone bands. It is a fair estimate to say that 95 per cent of all 'phone stations occupy more space in the band than they should, in spite of the fact that some operators conscientiously try to reduce the band width by

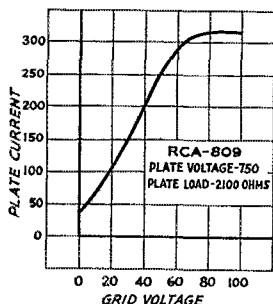

Fig. 1—Dynamic grid-voltage plate-current characteristic of the 809 tube, used by the author as an illustration.

limiting the frequency response of their speech amplifiers. Although this measure does help matters, the "splattering" still continues. This condition, although generally attributed to overmodulation, may be due to a number of causes. In reality overmodulation, by the very nature of the design of the average amateur transmitter, is often an impossibility.

"Splattering" is the result of any condition which causes the 'phone signal to occupy an exceedingly wide channel. Since the channel occupied is equal to twice the highest audio fre-

* Thordarson Elec. Mfg. Co., Chicago.

Fig. 2—Three types of waves having the same peak values but containing different amounts of power. A, the familiar sine wave; B, flat-topped wave typical of an overdriven Class-B stage; C, the extreme case of a square wave.

quency, any audio distortion in the form of harmonics will tend to broaden the signal. Thus a 'phone transmitter modulated by a 400-cycle sine wave occupies a channel width of 800 cycles. However, if the 400-cycle signal should contain an appreciable amount of third-harmonic distortion, the highest audio frequency would be 1200 cycles and the band width 2400 cycles. The addition of the third harmonic has thus trebled the band width. For this reason "splattering" is due not only to overmodulation but also to excessive audio distortion, most frequently introduced in an overdriven Class-B modulator or driver stage. A step in the direction of eliminating "splattering" in the bands is through the use of automatic modulation control. This circuit, if operated in conjunction with a properly designed modulator, actually will increase the average side-band power and eliminate excessive audio distortion.

For a given amount of peak power, speech operation of a Class-B modulator calls for an average plate current of only one-half the sine-wave value as specified by the tube manufacturer. Since the Class-B plate current meter is the usual modulation indicator the amateur, in nine cases out of ten, "kicks up" the average speech plate-current to the sine-wave value. Under these conditions the power represented by the increase in average modulator plate current corresponds to an increase in average power without appreciably increasing the peak power. This in turn corresponds to alteration of the wave shape, or the introduction of distortion in the form of harmonics which broaden the signal.

Average vs. Peak Power

Fig. 1 shows the dynamic characteristics of the RCA 809. It may be seen that the characteristic

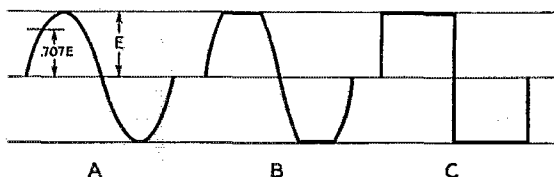

is fairly straight up to a grid voltage of + 65 volts. However, beyond this point the characteristic bends sharply, with the result that above + 65 volts an input signal of any wave shape will become flat-topped. At this point the grid impedance of the Class-B stage changes abruptly, and further flattening of the wave takes place in the driver stage. It should be noted that beyond + 65 grid volts the peak current (from which peak power is determined) does not change appreciably although the average power, which is proportional to the area of the wave, increases rapidly. This may be seen more clearly from Fig. 2, which shows a sine wave, a flat-topped wave, and a square wave, the peak values of which are equal to *E*. The average value of each of the waves is different and is equal to the area under the wave divided by the base. It may be seen that as the wave form approaches the square wave the average power increases. Now it must be remembered that in a Class-B modulator the peak power is the limiting factor and the average power falls where it may, depending entirely upon the wave shape. If distortion is to be avoided in speech operation the average power must be equal to only one-quarter the peak value, and as a result the average power of speech, with peak power the limiting factor, is rather low in comparison to the sine wave or the square wave.

For modulation purposes it is important to have as high a value of average power as possible without distorting the wave by causing it to become flat topped. To this end broadcast operators "ride the gain," increasing the gain for weak signals and decreasing it for strong signals. If the gain is not varied but set so that full output power is obtained with the strong signal, the output will be below normal for the weaker signal. By the same token if the gain is set so that full output is obtained from the weak signal, overload and distortion will result on the strong signal. However, if the gain is varied with the signal, the average power is increased without distortion taking place. The same effect of "riding the gain" may be obtained automatically by means of an automatic modulation control circuit which maintains the speech amplifier output constant for any input signal above a certain level. In this manner the amplifier gain is high for low input signals, and it is decreased proportionally for high inputs, thus increasing the average power.

It is not the purpose of this article to show the automatic modulation control circuit, which has already been described,¹ but a few words on the operation of such a circuit may be in order. For

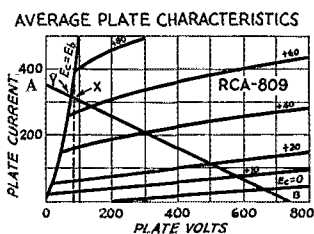

Fig. 3—809 plate-voltage plate-current family, showing load line.

correct operation, the gain control should be advanced slightly beyond the point for normal operation so that on strong signals the rectifier circuit supplying the bias to the control tube will be brought into operation.

In using automatic modulation control, it is quite possible for the Class-B stage to be overdriven without overmodulation taking place, and as a result the amateur who has incorporated

one of these circuits in his transmitter may be unaware of the "splattering" which he is causing. In using the automatic modulation control circuit, it is safe to say that the circuit is not operating properly if the average modulator plate current, on speech, is much greater than one-half the sine wave value. If it is found that this is so, the Class-B plate-to-plate load may be reduced below its original value.

Overmodulation?

The fact that overmodulation is sometimes impossible may be seen from Fig. 3, which shows the familiar plate characteristics of the 809. The normal load line of $\frac{S_{400}}{4}$, or 2100 ohms, is shown at AB. For an average sine-wave power output

of 100 watts, the peak plate current is $\sqrt{\frac{200}{2100}}$ or

0.315 ma. at point X on the load line. The peak voltage developed across the load is 0.315×2100 or 660 volts, and the minimum plate voltage is thus 750-660 or 90 volts. The 660 peak volts across one-half the primary are transferred to the secondary of the modulation transformer to vary the effective voltage of the Class-C stage. If by a wild stretch of the imagination the 809 grids were driven sufficiently hard so that the entire voltage of 750 volts were effectively across the load, the transmitter would be modulated only $\frac{750}{660} \times 100$,

or 114 per cent. In actual practice the minimum plate voltage would not drop much below the value of peak grid voltage (point Y) and the transmitter would be modulated $\frac{750-65}{660} \times 100$ or

104 per cent, so that even under ideal conditions this would not cause a great deal of "splattering." Poor regulation in either the a.c. line or in the power supply will tend to lower the value of minimum plate voltage. The primary resistance of the output transformer also tends to reduce this value since the voltage lost across the primary must be calculated from the value of peak current, which is usually high even for a medium-power modulator.

The tube manufacturer's Class-B rating is based upon theoretical considerations, and does

(Continued on page 68)

¹ Plummer, Waller, "Negative-Peak Automatic Modulation Control for Plate Modulated 'Phone Transmitters," *QST*, October, 1937.

The Cairo Regs Go Into Effect

A Few Changes of Interest to Amateurs, Effective January 1st

BY KENNETH B. WARNER,* W1EH

ON THE first of the New Year the changes in the international radio regulations adopted at the Cairo Conference go into effect except those relating to frequency allocations, which are not effective until September 1st next — and which have no application to amateur radio in the Americas, anyway. There is nothing very important in these other subjects, but there are a few details that we think will interest the active amateur.

We should perhaps first examine the question of the changes in the code characters for punctuation marks. These are not embodied in the new radio regulations, but originated in the telegraph conference held simultaneously in Cairo and were consented to by the radio conference. A.R.R.L. Hq. is having a great deal of difficulty in ascertaining the extent to which these changes will be adopted in radio procedure on January 1st — nobody seems to know. We know that they take effect on the land lines of Europe; it is probable that the international point-to-point radio circuits will adopt them; but it seems very questionable whether they will be put into effect in American domestic work, particularly in the maritime mobile service which is our closest relation in the commercial services. If the domestic commercial and government services adopt the changes, we of course shall want to also, but there is a general reluctance to change and we doubt its happening. So the dope at the moment is that, at least until further notice in *QST*, we of the A.R.R.L. are *not* adopting these punctuation changes.

An interesting change occurs in the Q code. You are all aware of the confusion in QSA meanings because signal strength and readability have been combined in one indication — the situation that impelled amateurs to the adoption of the RST system. The administrations now take a page from our book by separating these functions, assigning the strength indications to QSA on a 1-to-5 scale and the readability indications similarly to QRK. The following new practice is now established:

Strength

- QSA 1 — Barely perceptible
- QSA 2 — Weak
- QSA 3 — Fairly good
- QSA 4 — Good
- QSA 5 — Very good

Readability

- QRK 1 — Unreadable
- QRK 2 — Readable occasionally
- QRK 3 — Readable with difficulty
- QRK 4 — Readable
- QRK 5 — Perfectly readable

Phone men who have retained the practice of making mumbo-jumbo about “QSA 4, R8,” and so on, should find this new nomenclature preferable — if they feel they must use telegraphic abbreviations instead of saying it with words. In voice operating most of us prefer to *talk* about strength and readability, using those terms. For c.w. work, we’ll be sticking to RST as preferable. But we thought you’d like to know the new meanings, to understand practice in the commercial mobile service.

Three uninteresting additions have been made on the end of the Q code:

QUK? means, “Can you tell me the condition of the sea observed at . . . (place or coordinates)?”, while the accompanying meaning for *QUK* is, “The sea at . . . (place or coordinates) is . . .”

In similar fashion, *QUL?* asks, “Can you tell me the swell observed at . . . (place or coordinates)?”, while the companion answer *QUL* means, “The surge at . . . (place or coordinates) is . . .”

QUM? asks, “Is the distress traffic ended?”, and *QUM* itself asserts that “The distress traffic is ended.”

There is one new two-letter abbreviation, a useful one: *TU* means, “Thank you for the cooperation given.” Being shorter, it is now probably preferable to our *TNX* and *TKU*.

Those of you who listen in on the maritime mobile service will be interested to know that, in addition to two forms of CQ, there is now to be a CP call. In amateur radio we use CQ as a general inquiry signal, ending the transmission with a K, but for our broadcasts of general A.R.R.L. information we use the call QST. The mobile service uses the inquiry signal CQ in just the way that we do, but they also use it, omitting the terminal letter K, for their broadcasts of information intended to be used by anyone who can receive it — that is, as a call to all stations without a request for reply. The new call CP is a restricted version of the latter use and is designated as a call to certain receiving stations without request for reply. The call is followed by two or more call

*Managing Secretary, A.R.R.L.

(Continued on page 118)

Fig. 1—The current flowing between the center-tap of a plate transformer and the filter: A, with choke input; B, with condenser input.

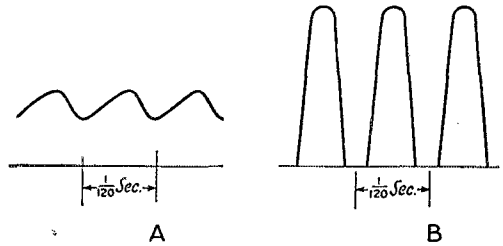

Another Method of Keying With Controlled Rectifier Tubes

BY BYRON GOODMAN,* WIJPE

Those hams whose inclinations are toward pre-filter keying, but who have hesitated to oust a pair of perfectly good 866's in favor of more expensive grid- or magnetically-controlled tubes, will find this article of interest. Only one controlled rectifier tube is needed — and the existing power supply is hardly disturbed.

PRIMARY keying of power supply transformers has enjoyed a certain amount of popularity because, keying through the power supply filter, it gives a "softness" that prevents thumps and eliminates clicks. One of its major disadvantages, especially in high-power circuits, is the bad sparking at the key or relay contacts due to

* Assistant Secretary, A.R.R.L.

inductive surges from the transformer primary. This disadvantage was eliminated by the introduction of grid¹- and magnetically²-controlled mercury-vapor rectifier tubes, to be used in the regular full-wave rectifier circuits. However, there is a fairly simple way to retain the desirable characteristics of rectifier keying with only one controlled rectifier instead of the usual two.

The controlled rectifier tube can be used only in circuits where the anode voltage is reduced to zero during part of the cycle, otherwise when the current has once started flowing the grid can never again regain control. For this reason the tube cannot be used in ordinary keyer-tube applications or other d.c. circuits but it can be used in rectifier circuits. Ordinarily two are used in the usual full-wave rectifier circuit, where the anode voltage is zero during one-half of the

(Continued on page 112)

¹ QST, Feb., 1938, p. 34.

² QST, Sept., 1938, p. 42.

Fig. 2 — One method of applying a single controlled-rectifier to multi-stage keying.

- T₁ — Bias transformer, 300-volt each side, low current, insulated for total plate voltage.
- T₂ — Driver plate transformer.
- T₃ — Final plate transformer.
- T₄ — Keyed-rectifier filament transformer. 2½-volt, 10,000-volt insulation.

KT — Controlled rectifier tube. (Eimac KY-21 or Sheldon KY-866.)

C₁ — .25 μfd., 600-volt paper.

C₂ — 1 μfd. if driver uses high voltage and low current; 2 μfd. if driver takes low voltage and high current.

C₃, C₄, Ch — Final amplifier filter.

R₁ — 50,000-ohm, 2-watt carbon.

R₂ — 1-3 megohm, or high-voltage voltmeter.

R₃ — Driver stage grid leak.

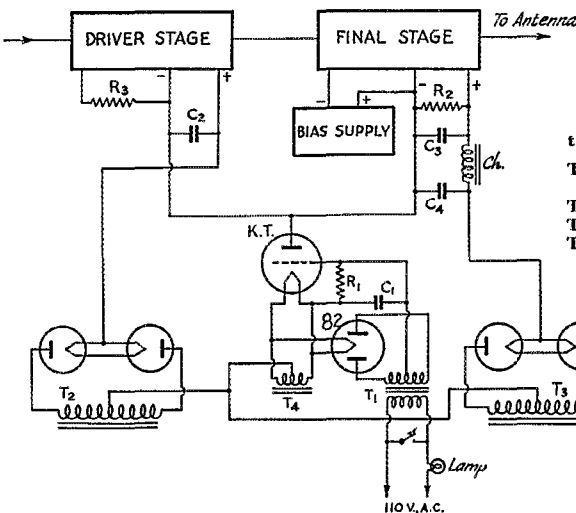

★ WITH THE AFFILIATED CLUBS ★

A.R.R.L. AFFILIATED CLUB HONOR ROLL

All members of these are A.R.R.L. members

Baton Rouge Amateur Radio Club, Baton Rouge, La.
 Bluefield Amateur Radio Club, Bluefield, W. Va.
 Bridgeport Amateur Radio Association, Bridgeport, Conn.
 Chester Radio Club, Chester, Pa.
 Electric City Radio Club, Scranton, Pa.
 Fellsway Radio Club, Medford, Mass.
 Huron Radio Club, Huron, S. Dak.
 Kaw Valley Radio Club, Topeka, Kansas
 Moncton Amateur Radio Club, Moncton, N. B., Canada
 Mound City Radio Amateurs, St. Louis, Mo.
 New Orleans Radio Club, New Orleans, La.
 Norfolk County Radio Association, Norwood, Mass.
 Northern Nassau Wireless Ass'n, Manhasset, L. I., N. Y.
 O.B.P., Chapter No. 1, St. Louis, Mo.
 Pendleton Amateur Radio Club, Pendleton, Oregon
 Santa Clara County Amateur Radio Ass'n., San Jose, Calif.
 The Northwest Amateur Radio Club, Des Plaines, Ill.
 The Portland Sevens, Portland, Oregon
 Trenton Radio Society, Trenton, N. J.
 Valley Radio Club, Eugene, Oregon
 Yakima Amateur Radio Club, Yakima, Wash.
 York Radio Club, Elmhurst, Ill.
 York Road Radio Club, Glenside, Pa.

Affiliated Club Stations

THE August, 1938 issue of *QST* carried a comprehensive list of calls of amateur stations operated by A.R.R.L.-affiliated clubs. Add to that list the following:

W3AQ Delaware Valley Radio Association
 W5DIG Galveston Amateur Radio Club
 W7AQ Yakima Amateur Radio Club
 W9YB Purdue University Radio Club

A Challenge

The Northern Nassau Wireless Association would like to challenge other radio clubs to competition in the game of nine-pins, matches to be played via amateur radio. Clubs interested should communicate with the secretary, R. Weinmann, Hammond Road, Glen Cove, L. I., N. Y. . . . The N.N.W.A. is looking ahead to increased activity and has recently purchased four lots (forming a strip 40 ft. by 250 ft.), upon which the Association hopes to build a club house.

Exhibit Stations

The Delaware Valley Radio Association set up and operated its station, W3AQ, at the Trenton State Fair Grounds (Trenton, N. J.) during the

week September 25th-October 1st. The layout consisted of a 300-watt rack-mounted rig on 1962-ke. 'phone (for demonstration to John Q. Public) and a telegraph rig running 100 watts on 7286 and 3535 kc. (for traffic work). W3AQ tied in with A.R.R.L. and A.A.R.S. Nets, and many messages were handled for all parts of the United States and its possessions. The D.V.R.A. is stressing the Civic Radio Center-Emergency Station idea in Trenton, and a building fund already has been established for the erection of a club house and emergency radio station. The main purpose of the exhibit at the Fair was to acquaint the public with the useful work amateur radio is doing.

The Milwaukee Radio Amateurs' Club had an exhibit station at the Wisconsin Hobby Exp.

Manchester Radio Club

Through the coöperation of the Manchester Chamber of Commerce, the Manchester (Conn.) Radio Club has secured a permanent meeting place in the Hotel Sheriden. This is the result of activities of members during the hurricane and flood. As an expression of appreciation of the community, the Chamber has placed at the club's disposal their Board of Directors' room, which seats about forty, and a banquet hall that will seat about one hundred and twenty.

A combined "house-warming" and farewell party for Mr. and Mrs. J. L. Reinartz, W1QP, who have moved to Union, N. J., was held in the new quarters, November 2d, some 115 amateurs attending. Talent from broadcast station WTIC furnished the entertainment, and R. F. Alford, W1JAM, was toastmaster. ZL2JQ, visiting at A.R.R.L. headquarters, was in attendance, and told those present about amateur radio in New Zealand. A roast beef dinner was enjoyed by all.

Monthly Raffle

The South Jersey Radio Association raffles off a "no charge" door prize each month with the following aims: (1) To check membership and visitors; (2) to aid the membership committee in getting after new members; (3) To advertise A.R.R.L. and what it has done for the amateur — the door prize is always League merchandise.

Emergency Preparedness

The Galveston Amateur Radio Club, W5DIG, is sponsor of the extensive Gulf Coast Storm Net, well known for its excellent performance during the storm season.

The Associated Radio Amateurs of Southern New England, W1AQ, has purchased a 110-volt,

(Continued on page 120)

There's no lack of information on the construction and use of equipment which will make compliance with the new amateur regulations, announced in December *QST*, easy. This article gives a few pointers, tells where to get the more detailed information you'll need if you:

- (1) have a modulated oscillator on five meters;
- (2) try to shoulder up to the last kilocycle in a band;
- (3) are in the 900-watts-input-or-more class.

If you don't qualify in any of these there isn't much to worry about.

Technical Aspects of the New Regs



BY GEORGE GRAMMER,* W1DF



Some Suggestions on Making Equipment and Practices Conform to New Requirements

THE NEW F. C. C. regulations¹ affect the technical operation of amateur stations in three ways: In requiring a check of the transmitting frequency by means independent of the transmitter itself; in providing that the 56-Mc. band come under the same provisions with respect to frequency stability that have been in force for the lower frequencies, and in requiring measurement of input power when power in excess of 900 watts is used. Insofar as measurement of power and frequency are concerned, the new regulations simply constitute a statement of a principle that should have represented universal amateur practice anyhow, since the responsibility for staying within a band and for keeping within the power limit always has been with the individual. The principal difference now lies in the fact that blaming the crystal is not longer a valid excuse (if it ever was) in reply to a pink slip.

Let's take the three divisions separately and see what compliance involves.

Frequency Measurement

The regulation (Sec. 152.44) says that the transmitter frequency must be checked regularly by means independent of the transmitter itself, and of sufficient accuracy to ensure operation inside the band. This works no hardship on the man who does not crowd the edges. The frequency checks can be made readily with the station receiver, provided it is capable of giving a beat note on the transmitting oscillator. The average superhet easily will meet this requirement.

If the receiver is of the type having a general-coverage "band-set" dial with a separate band-spread dial tuning a low-capacity condenser gang, it will be necessary to note quite accurately the band-set dial setting which gives the desired spread. With a "standard" set of conditions, then, a frequency calibration curve can be plotted for the band-spread dial. The handiest thing for

calibrating is a simple 100-kc. oscillator⁴ which can be set on frequency by checking against WWV or a broadcast station. Every ham ought to have—and use regularly—one of these gadgets, and now is a good time to build one if you haven't done it already. Nothing could be more simple or cheap, and it's a bare junk-box indeed which won't furnish most of the parts. It will give to a rather high degree of accuracy all the band edges which are even multiples of 100 kc.—better accuracy, certainly, than the receiver is capable of maintaining.

Now that we have the band edges and enough intermediate points to draw a calibration curve, it's a simple matter to make a frequency check. Turn on the transmitter oscillator, tune it in on the receiver, and note the dial setting. If it is well inside the band there's nothing further to worry about—provided you haven't picked the wrong harmonic somewhere along a string of frequency doublers! That certainly shouldn't be a factor if the transmitter is in regular operation, but is well worth keeping in mind in testing out a new rig.

Now just how much dependable accuracy does this checking method have? It depends upon a number of factors. The oscillator in a superhet is ordinarily a fairly stable job, so that it is quite safe to say that its frequency, if nothing in the receiver is changed, will not vary over 1 per cent from any predetermined value. With a decent dial, reset errors can be included in this figure. With a possible error of 1 per cent, the actual frequency may differ from that given by the calibration curve, for a given band-spread dial setting, by f kilocycles times 0.01, which comes out 35 kc. at 3500 kc., 70 kc. at 7000 kc., and so on. Since we don't know whether the error will be on the high- or low-frequency side, we have to assume the unfavorable case; that is, it is necessary to stay 35 kc. inside the edge at 3500, 70 kc. inside at 7000, 140 kc. at 14,000, and similarly on other bands. If this seems like chopping off a lot of ter-

* Acting Technical Editor.

ritory, remember this—you're depending upon a calibration which must be "safe" even if no signal can be heard in or near the band. Naturally, if a commercial marker station of known frequency, and whose position on the dial at the time of calibration is known, is on the air it can be used as a check on the calibration, and thus indicate the extent of the shift and its direction. Likewise, the 100-kc. oscillator can be brought into play if WWV or the broadcast station against which it is checked is on the air. Under these conditions, of course, the band edges can be approached with a great deal more confidence. But there are lots of times when no guideposts are at hand, and we have to be prepared to accept the resulting limitations when we operate in those hours.

If the transmitter is crystal-controlled and the crystal frequency is 10 kc. or more inside on 3.5 Mc., 20 kc. on 7 Mc., and so on, operation is pretty safe under any conditions if the receiver checks the frequency as being at its usual place in the band. The two independent frequency sources are considerably more reliable than one alone, provided they agree. It is not enough, however, to depend upon the crystal by itself.

With a small amount of preliminary work the dependability of the receiver easily can be determined. For instance, the drift under varying conditions of room temperature can be measured by comparison with a marker station or the 100-kc. oscillator. The reset accuracy can be similarly checked. The effect of disconnecting the antenna or reducing the gain to get a small enough signal can be observed. Adding all these things together (they may vary from band to band) will show the percentage accuracy that can be maintained over a considerable period of time.

In making these checks, don't forget that on cold winter mornings the shack temperature may be as much as 40 degrees below what it hits on a mid-summer day—the receiver won't forget to change its frequency accordingly.

The problem takes on a different aspect if the receiver is of the autodyne type. Here it is difficult, if not impossible, to determine with any reasonable accuracy where the transmitter frequency is in the band because the receiver usually blocks. In that case the transmitter must be tuned in on a separate monitor² which can be calibrated by the means already described, picking up the monitor signal in the receiver for zero-beating against the calibration points. With reasonably good construction, the monitor becomes a quite satisfactory heterodyne frequency meter.

Speaking of heterodyne frequency meters, the average well-constructed instrument of this type will give somewhat higher accuracy than the average receiver, principally because it operates under a fixed set of conditions and hence can be made rather stable. It is not difficult to maintain the accuracy within 0.2 per cent, which will per-

mit operating that much closer to the edges of the bands; up to 7 kc. from the edge at 3500, 14 kc. at 7000, and so on. This presupposes an initial accurate calibration, regular re-checking of the calibration, a readable dial, and use only after a warm-up period to minimize drift from temperature effects. More care, of course—but that is the penalty for the supposed advantage of working near the edge of a band. Information on calibration (the 100-kc. oscillator is best) and use of such a frequency meter will be found in the A.R.R.L. *Handbook*, as well as in the bibliography appended to this article.³

Now for the chaps who shave kilocycles. There's no leeway here, and the highest accuracy that can be obtained is needed. The only apparent solution is the use of a good 100-kc. oscillator,⁴ adjustable to exact frequency by comparison with WWV transmissions and preferably checked against a broadcast station of known frequency stability when the Bureau of standards transmissions are not available. A simple and inexpensive oscillator will suffice with *continuous* checking against a standard; the accuracy then will be nearly as good as that of the source. Without such checking it is no more dependable than the ordinary heterodyne frequency meter. The construction and use of such oscillators has been thoroughly covered in *QST*. Refinements such as a harmonic amplifier and a multivibrator which modulates the amplifier may be added, the latter particularly for measurement of frequency inside a band and for locating band edges, such as the limits of the 14-Mc. 'phone band, which are not exact multiples of 100 kc.

The preferred arrangement of this sort is one which uses a 100-kc. *crystal* oscillator. With reasonably-stable supply voltages, the frequency variation of such an oscillator will be determined almost wholly by the temperature coefficient of the crystal. If the oscillator is operated at low power so that heating from r.f. is not appreciable, the frequency change with normal room-temperature excursions will be much smaller than with a self-excited oscillator. However, the variation should be checked over a period of time against WWV so that the maximum shift can be determined, since in setting the transmitter frequency it is still necessary to allow for the variations in crystal frequency. These may be anywhere from a hundred cycles to over a kilocycle at 3.5 Mc. (or a few hundred cycles to 4 or 5 kc. at 14 Mc.) depending on the temperature range and the temperature-frequency coefficient of the particular crystal. Temperature control of the oscillator will go far to increase the 24-hours-a-day reliability. But even temperature control does not make such an outfit a second WWV, so use caution in sneaking up within a few hundred cycles of the edge.

Some useful information on the construction and use of a crystal calibrator is contained in

another article in this issue. A good deal of the discussion applies to the use of any 100-kc. oscillator, whether or not of the type actually described.

Finally, one more point must be considered when the transmitter frequency is near the edge: If the receiver or freq-meter used for checking is a.c. operated, the frequency of its oscillator is very likely to take a jump when the power goes on the transmitter—just one more factor which limits the accuracy with which measurements can be made, and in turn the distance one can legitimately go toward the edge of the band. When it comes down to a matter of cycles, it is doubtful if a reliable check is possible in the station itself; someone far enough away to get a relatively weak signal, and not affected by the same line-voltage variations, must do the job.

56-Mc. Transmitters

Speaking generally, compliance with the new stability requirements on 56 Mc. is likely to involve the use of crystal control, from preference although not from necessity. At any rate, the construction and operating technique of the lower-frequency bands must be adopted. These are familiar enough at 28 Mc., and their extension to 56 Mc. has been the subject of several *QST* articles.⁵ The chief difference is in greater care in the selection of tubes and in laying out circuits for greatest operating efficiency, both of which have been the subject of considerable discussion.

For those who want simple u.h.f. equipment a shift to the 112-Mc. band is imperative. The new regulation serves a double purpose, in that it gives much needed relief of congestion on 56 Mc. and also provides an incentive for occupancy of the, until now, neglected 2½-meter band. The new *Handbook* contains new data on the construction of more effective transmitters and receivers for this band, and there will be more to come in future *QST*'s. In fact, 112 Mc. should be an ideal band for short-distance communication and emergency work, since interference from man-made static is negligible and the smaller antenna dimensions permit compact construction of effective antenna systems. And, although there has been no indication of it so far, who knows but that one of these days we'll be finding 2½-meter signals coming back from the ionosphere, just as they do now and then on five?

In thinking of u.h.f. work, don't forget that the frequency-measuring requirements apply here just as much as to the lower frequencies. The measurement technique described above can be applied to 56 Mc. quite readily, but on 112 Mc. and higher it would seem that Lecher wires constitute a good-enough check. Their use is explained in the *Handbook*.

BIBLIOGRAPHY

1. "We Have New Regulations," *QST*, December, 1938.
2. A.R.R.L. *Handbook*, Chapter 16. "Improving the Freqmeter-Monitor," *QST*, April, 1934.
3. A.R.R.L. *Handbook*, Chapter 16. "C.W. and 'Phone Station Freq-Meter-Monitor," *QST*, June, 1938. "Freqmeter Calibration from B. C. Stations," *QST*, March, 1934.
4. "A New Type of Frequency-Checking Device," *QST*, June, 1938. "A Dual-Frequency Crystal Calibrator," *QST*, January, 1939. "A 100-Kc. E. C. Oscillator for Frequency Checking," *QST*, May, 1937.
5. A.R.R.L. *Handbook*, 1939 Edition, Chapter 12. "56-Mc. Crystal Control with 28-Mc. Crystals," *QST*, January, 1938. "Portable-Mobile Crystal-Controlled U.H.F. Transmitter," *QST*, May, 1938. "Modernizing the 56-Mc. Transceiver," *QST*, April, 1938. "Crystal-Controlled 5- and 10-Meter Portable," *QST*, April, 1938. "250-Watt Output Crystal-Controlled 28- and 56-Mc. Transmitter," *QST*, August, 1938. "56-Mc. Crystal-Controlled Transmitter with 6L6 Output," *QST*, March, 1937. "Simple Bread-Board Crystal-Controlled Transmitter for 56 Mc.," *QST*, July, 1937. "100-Watt 56-Mc. Crystal Control Output," *QST*, August, 1936. "Licking the Crystal-Control Problem on U.H.F.," *QST*, August, 1936.

Power Measurement

Comparatively few of us are affected by the regulation on measuring power, and since it is a simple thing to do it needs little discussion. However, the purchase of an expensive high-voltage voltmeter is not obligatory. A good milliammeter in series with the plate-supply bleeder, plus Ohm's Law

$$\left(\text{Volts} = \frac{R \text{ (ohms)} \times I \text{ (ma.)}}{1000} \right)$$

will give just as good an answer, provided the bleeder resistance is known to a satisfactory degree of accuracy. Commercial tolerances are too broad for this purpose, so the bleeder and milliammeter should be calibrated against a good borrowed voltmeter, or else the resistance of the bleeder should be measured accurately. If your power supply has no bleeder, this is just one more argument, in addition to the many good ones already existing, for putting one in. The plate milliammeter can be used for the measurement by putting a jack or switching arrangement in series with the bleeder, so that you don't even need an extra meter. Note, however, that the regulation says "accurate," so don't put dependence on dime store meters.

The new regulations should help solve some of our operating problems, not only in cleaning up five meters but in starting a trend, we hope, away from the nonsensical piling-up of stations at the edges of the bands.

Selectivity With the 2-Tube Regenerative Receiver

WHEN *QST* devotees read this story about a two-tube regenerative receiver with selectivity comparable to that of a superhet, I can almost hear the gust of Gargantuan laughter sweeping the ranks. All right, laugh! If I were the reader of this instead of the writer, I, too, would bray as loud as the loudest.

In *QST* for June, 1934, there was described a two-tube regenerative receiver — in my opinion, a receiver which is still “tops” in simplicity, low cost and performance.¹ I believe it also appeared in some of the subsequent *Handbooks*. I made a lot of them. However, there were two drawbacks — lack of selectivity and the difficulty of fitting an antenna free from hum, especially on 20 meters. I recently wondered what would result if this set were made up pee-wee fashion something like the “QSL-Forty” transmitter.² Not being an expert and so lacking that sometimes unfortunate gift of prophecy, the only way to find out was to try it and see.

¹ Grammer, “What About the Simple Receiver?”, *QST*, June, 1934.

² Sutter, “The QSL Forty,” *QST*, February, 1938.

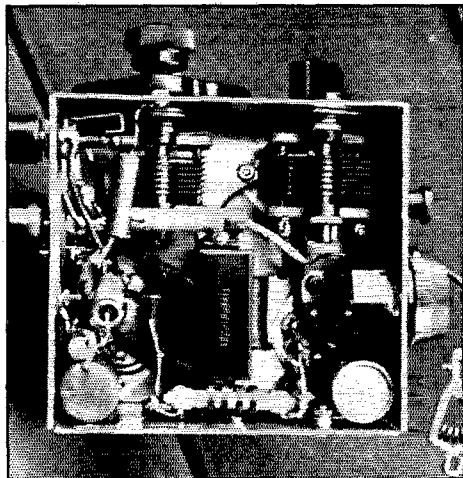

Space is at a premium underneath the chassis, but with a little care all the parts can be fitted in.

The photographs show the set on a chassis $4\frac{3}{4}$ inches by 5 inches and $3\frac{1}{8}$ inches deep, and the thing sticking up from the antenna post is the antenna — a piece of $\frac{3}{16}$ -inch copper tubing 12 inches long. You might make it a couple of feet longer, if it does not project through the dining-room floor and interfere with the Old Man’s ankles as he dunks his morning doughnut.

I don’t like to refer to the set as a nice little portable (even if it be so) because the average rig called by that name is about as “portable” as an 8-hp. outboard motor.

Performance

Let’s get on with a little account of the performance of the set. I have here a list of c.w. stations located from coast to coast and from Florida to the Lakes, heard on this receiver. There isn’t any point in listing the calls; for one thing there is no space to spare, and you will have to take my word for it anyway.

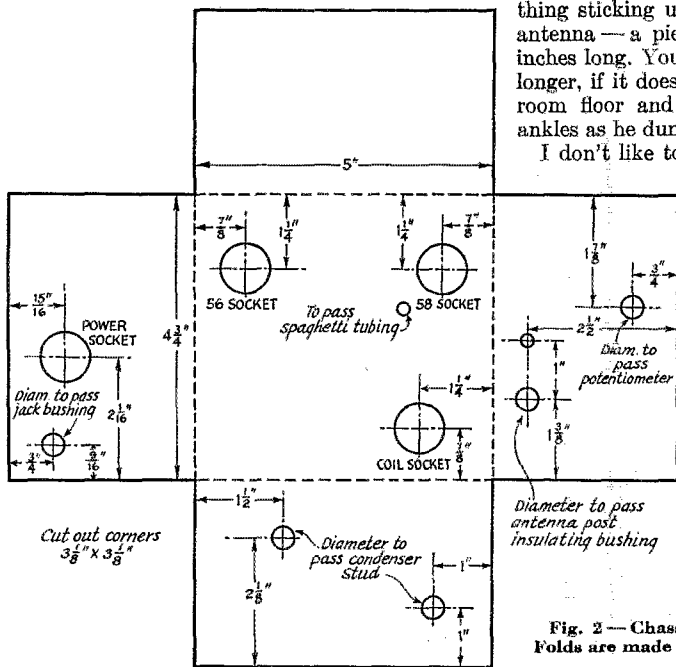
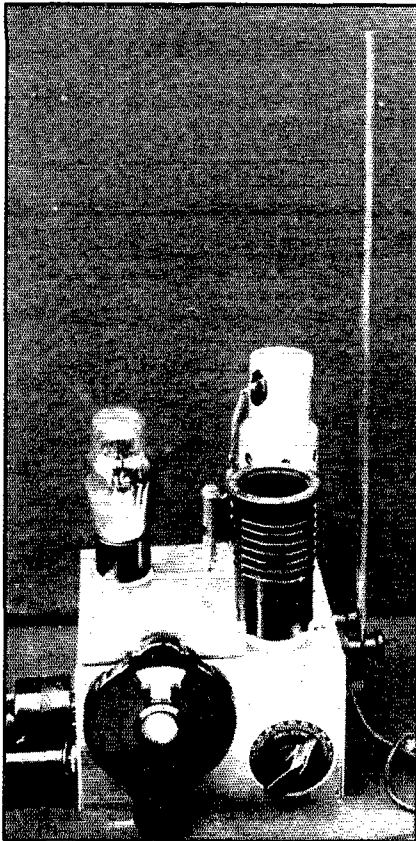

Fig. 2 — Chassis dimensions and drilling data. Folds are made on the dotted lines.

A "Pec-Wee" Version of an Old Favorite

BY FRED SUTTER,* W3QBW-QDK



This little two-tube regenerative receiver is just about the same size as the "OSL Forty" transmitter described by the same author in February, 1938, *QST*. The rod antenna which has given such satisfactory results is visible at the right.

Fig. 1 — Circuit diagram of the compact receiver.

- C₁, C₂ — 100- μ fd. variable (Hammarlund MC-100-S).
- C₃, C₄, C₅ — 100- μ fd. mica.
- C₆ — 5- μ fd. 400-volt electrolytic.
- C₇ — 10- μ fd. 50-volt electrolytic.
- C₈ — 0.01- μ fd. paper, 400-volt.
- C₉, C₁₀ — 0.005- μ fd. paper, 400-volt (capacity not critical).
- R₁ — 0.5 to 5 megohms, 1-watt.
- R₂ — 50,000-ohm potentiometer.
- R₃ — 25,000 ohms, 10-watt.
- R₄ — 2000 ohms, 1-watt.
- R₅ — 1 megohm, 1-watt.
- R₆ — 75 ohms, center-tapped.
- RFC — 2.5-mh. r.f. choke (National R-100).
- L₁ — See coil table.
- L₂ — 1000-henry choke (Thordarson T-29C27).

Note: C₆ and C₇ should not be over two inches long.

Frequency Range	Coil Data		Band-Spread
	Total turns	Cathode Tap	
1450 to 3400 kc. (1.75)	54½	3¼	29¾
3050 to 7100 kc. (3.5)	27½	1¼	11¾
6100 to 14,200 kc. (7)	13½	¾	4¼
10,600 to 24,000 kc. (14)	7½	½	1¼
18,000 to 41,000 kc. (28)	3½	¼	½

The secret of improving the selectivity of a simple regenerative set is even simpler than the receiver itself—use a small antenna. Yes, we know all the arguments for making the antenna as effective a "signal-sucker" as possible—but the fact remains that a regenerative detector quickly overloads on strong signals, and signals that block the detector can't readily be tuned out. Besides, weaker signals are amplified more—a surprisingly small antenna can be used, as the author points out. You don't have to build the set to take advantage of this story, although you'll no doubt be tempted to build it anyhow!

This is not offered as proof of the sensitivity of the two-tube, about which everyone already knows, but to show that this particular set with a 12-inch antenna drags them in from far and near. To me, at least, that was news. Nearly all of them were nice headset volume, but a good many were uncomfortably loud, especially on 20 meters. And by the way, one 20-meter call was 12AL, Italy.

Tuning

The tuning was very sharp; a station would "peak" in about the thickness of a line on the dial, and these look to me a little less than a hundredth of an inch thick. (This dial has a spread of 3½ inches and the 40-meter band covers nearly 180 degrees.) If two stations were very close, the unwanted one would drop out, or into the background, while the other peaked up sharp and loud. Of course, after all, the final test in making a com-

(Continued on page 114)

* 1000 Kensington Road, Grosse Pointe, Mich.

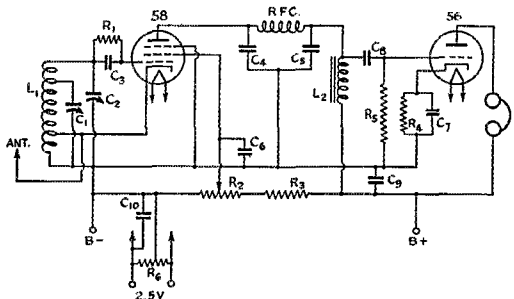

All coils are wound with No. 24 d.s.c. wire on 1½-inch diameter forms, the length of the coil being 1½ inches in all cases. The figure in parentheses after each frequency range indicates the amateur band for which that coil is used. The taps are counted off from the lower or ground terminal.

A Dual-Frequency Crystal Calibrator

An Inexpensive Device for Indicating 100- and 1000-ke. Points in the High-Frequency Spectrum

BY F. A. LENNBERG,* W8CQQ

AMATEUR radio, like other radio communication services, must keep in step with technological development. We amateurs are given a rather free hand in the use of our frequencies, but as our number increases and radio technique advances, higher technical standards of operation are required for our mutual benefit and for the comfort of services outside of our own frequency bands.

The amateur-band limits are definitely stated and are inflexible quantities — they are as precise as frequency can be determined. We are not supposed to work outside the limits specified, but some of us, through zeal for catching elusive DX, in an attempt to obtain an essentially clear channel or just from sheer carelessness, have let our operating frequencies slip “just a little bit” beyond the legal limits. This often causes interference with other radio communication services and results in severe criticism of amateur radio. The new F.C.C. amateur regulations have placed the responsibility for maintenance of correct frequency squarely on our own shoulders. The

particular rule states, in effect, that each amateur station must have some independent means for measurement of the transmitter frequency and must establish a procedure for checking it regularly. This means that an off-frequency citation from now on will really be a serious matter.

The frequency-checking device need not be in the actual possession of the station operator and need only be of sufficient accuracy to insure operation within the band limits. When the transmitter frequency is well within the band limits the station receiver can suffice, but when operation is very close to the band edges a precision frequency standard is necessary. Obviously, it is much better practice for each amateur to have his own checking apparatus rather than to depend on the generosity of a neighbor.

Frequency-Checking Equipment

The problem is, just what type of equipment should be used? Different types of frequency monitors have been described in past issues of *QST*, and each possesses certain advantages. The most accurate and dependable arrangement, however, is a low-frequency secondary standard the harmonics of which can be used to outline and subdivide the bands.¹ Because the frequency of the standard can be checked against transmissions from WWV, it is a reliable device independent of calibration curves, charts, etc. It can be used in conjunction with the regular station receiver, thereby simplifying the equipment and at the same time affording flexibility.

It is usual practice to choose a frequency of 100 kc. for the secondary standard. This value provides adequate calibration points for general application, and is sufficiently high that the harmonics are usable at very high frequencies. One objection to this frequency, however, is the fact that a harmonic spacing of 100 kc. is small in relation to usual receiver dial calibrations at high frequencies. As a result, it is not difficult at the high frequencies to become confused as to which harmonic is which.

The difficulty of identifying harmonics can be

* Sales Engineer, Biley Electric Co., Erie, Pa.

¹ “A New Type of Frequency-Checking Device,” *QST*, June, 1938.

This simple device generates 100-ke. harmonics up to 20,000 kc., and 1000-ke. harmonics up to 60,000 kc. The dual-frequency crystal can be seen in the center between the two tubes. Immediately in front of the crystal is the frequency adjusting condenser. At the left bottom is the 100-ke. inductance, L, and the tuning condenser C₁, for the 1000-ke. tank. The panel controls include R₂ and the three switches shown in Fig. 1.



eliminated through the use of two oscillators, one at 100 kc. and the other at 1000 kc. The procedure then becomes merely a matter of locating the 1000-kc. calibration points and then sub-dividing them with 100-kc. harmonics. This provides the necessary flexibility but complicates the apparatus.

It is a known fact that quartz crystals have two or more frequencies of oscillation. For instance, an X-cut crystal will oscillate at a certain frequency largely determined by its thickness and also at a much lower frequency largely determined by the length of the crystal along its so-called mechanical axis. If we intentionally grind an X-cut crystal to oscillate at 100 kc. on one dimension and at 1000 kc. on another dimension, we have a simple means for constructing a double-frequency calibration oscillator.

The manufacture of a dual-frequency crystal presents somewhat of a problem because the crystal dimensions in relation to frequency are somewhat interdependent. Changing one frequency by grinding will influence the other frequency of oscillation. It is not difficult to imagine the infinite patience and juggling ability which would be required to bring both crystal frequencies to exact specified values. This problem was solved by grinding the 100-kc. mode of oscillation so that the crystal frequency could be adjusted to exactly 100-kc. by means of a small variable condenser placed in parallel with it, and by allowing a grinding tolerance of 0.05 per cent for the 1000-kc. frequency.² After all, the 1000-kc. frequency is largely for the purpose of providing sign posts along the way, and its absolute frequency therefore need not be precisely 1000 kc.

A Practical Calibrator

The crystal calibrator pictured was designed around a dual-frequency crystal. This device is simple, flexible and easy to construct. It is excellent for amateur frequency monitoring and for general calibration purposes. The output is rich in harmonics and either crystal frequency is instantly available by a mere flip of a toggle switch. Usable harmonics can be obtained up to 20,000 kc. from the 100-kc. frequency and through 60,000 kc. from the 1000-kc. frequency. The exact upper limit, of course, depends somewhat on the sensitivity of the receiving equipment employed. The oscillating frequency is practically independent of loading effects because electron coupling is employed.

² At the present time the dual-frequency unit used by the author is manufactured to a tolerance of 0.01 per cent at 100 kc. For adjustment to exactly 100 kc. as described here it is necessary that the crystal frequency be on the high side of 100 kc.; the parallel condenser will be ineffective if the frequency is low. Crystals ground to the high-frequency side, suitable for tuning to exact frequency, will be supplied if so ordered. The suffix "A" on the type number indicates the proper type of crystal. — Editor.

The calibrator described here is a low-cost instrument capable of a rather high order of accuracy in locating the edges of the various amateur bands — at least those whose edges are multiples of 100 kc. The crystal oscillates in two modes to give 100- and 1000-kc. fundamental frequencies, the uses of which are — or should be — well known to the amateur fraternity by this time. Capable of adjustment to zero beat with WWV, the 100-kc. frequency can be maintained to a precision limited only by temperature and voltage effects, the temperature coefficient being approximately 10 cycles/Mc./degree C.

For wider frequency range (extending the 100-kc. harmonics to 28 and even 56 Mc.) and checking at closer frequency intervals, the oscillator output readily can be fed into an amplifier and multivibrator of the type described in June, 1933, *QST*.

Fig. 1 shows the complete wiring diagram of the instrument. Note that only a small number of inexpensive parts is required. Because the current drawn from the power supply is low, a resistance-capacity filter rather than an inductance-capacity filter is used. The filtering action is ample, since a 3-inch oscilloscope (without amplifier) connected to the d.c. output showed no trace of a.c.

A double-pole double-throw toggle switch, Sw_1 , is used to select the proper tank for either crystal frequency. It should be noted that this switch also disconnects condenser C_6 when the crystal oscillates at 1000 kc. In the original model C_6 was permanently connected across the crystal but it was found that the added capacity greatly decreased the activity at 1000 kc., and the crystal became quite sluggish in starting. Disconnecting C_6 by Sw_1 completely cured this difficulty. The leads between C_6 and Sw_1 should be kept reasonably short and placed to keep any stray capacity at a minimum. Since we are dealing with relatively low frequencies, however, it is not necessary to go to exceedingly great pains to keep all leads physically short.

For easy detection of the calibrator harmonics in a receiver, it is often advantageous to modulate the calibrator output. Modulation in this instrument is obtained by connecting the plate of the oscillator tube to the input of the power supply filter. Switch Sw_2 provides instantaneous choice of a modulated or unmodulated output. The screen-grid of the 6F6 tube is always fed with d.c. to prevent frequency modulation which could occur were the screen also connected to the filter input at the same time.

The output control, R_3 , is not essential but is advantageous in preventing receiver overloading, especially when the calibrator output is allowed to beat in the receiver with a weak incoming signal. For simplicity, R_3 and the power switch Sw_1 are combined into one unit. The operation

of the output control did not come up to expectations in the original model due largely to the fact that no shielding of the output leads was used and partly to radiation coupling between the calibrator and the receiver. The use of a shielded lead to the output terminal would undoubtedly have increased the effectiveness of the control several times.

The alternate attenuator diagrammed helps to decrease the effects of radiation coupling because the receiver input sensitivity is reduced at the same time that the calibrator output is attenuated. This arrangement can be used to advantage in amateur practice because it provides a simple means for shorting the receiver r.f. input when the station transmitter is turned on for a frequency check. The disadvantage of the system, however, occurs when low output from the calibrator is desired, since the receiver sensitivity is reduced by the action of the attenuator. Either attenuator has its advantages, but the original arrangement is best for general calibrator purposes.

Switch Sw_3 offers a simple means of disconnecting the calibrator from the receiver without disturbing the attenuator setting. The switch, however, will be highly effective only when the output lead is shielded to prevent stray pick-up from the calibrator itself.

Preliminary Checks

The tuning condenser C_1 for 1000 kc. is not critical and can be adjusted without the use of meters. Connect the calibrator to the receiver and tune the receiver to some frequency at which a 1000-kc. harmonic should appear. Adjust C_1 until the crystal oscillates and leave the adjustment at a point where the crystal starts readily when Sw_1 is thrown to the 1000-kc. position.

To adjust the crystal frequency to 100 kc., tune in WWV on 5000 kc. The standard frequency

schedules for WWV are published in each issue of *QST*. WWV transmits on 5000 kc. (with 440-cycle modulation) daily, except Saturday and Sunday, between 4:00 p.m. and 2:00 a.m., E.S.T. Couple the calibrator to the receiver and set Sw_1 for 100 kc. A beat note will be heard which is the result of the 50th harmonic of the oscillator beating against WWV. Adjust C_6 until the beat frequency reduces to zero. If the receiver is equipped with an S-meter, the meter will follow the beats when the frequency difference becomes a matter of only a few cycles. By watching the meter motion, you can easily determine when the beat is reduced to zero.

If the adjustment is made when WWV is modulated at 440 cycles, be sure that you observe the beat between the carrier and the calibrator harmonic. It is possible to obtain a beat against one of the side bands and this, of course, is incorrect. When the tone-modulation is broken for a station announcement, the beat should remain the same; if incorrect the beat will be 440 cycles.

Don't expect the calibrator to hold zero beat for indefinite periods of time. Temperature changes and oscillator voltage variations will cause small shifts in frequency. This is to be expected and can be eliminated only by temperature control and the use of a voltage regulated supply — refinements which are necessary only if an extremely high degree of precision is wanted.

Calibrating

For calibrating a receiver, simply connect the calibrator to the receiver antenna post and note the dial settings at which the calibrator harmonics

Fig. 1 — Circuit of the 100-1000-kc. crystal calibrator.

- L — 8-mh. r.f. choke (for 100 kc.)
- L_1 — Single section of a 2.1- or 2.5-mh. r.f. choke — remove all but 1 coil from the form (for 1000 kc.).

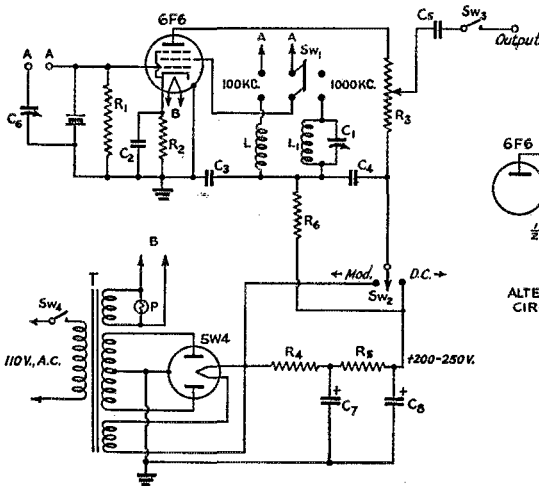

- C_1 — 100- μ fd. mica trimmer condenser.
- C_2, C_3, C_4 , 0.1- μ fd. paper condenser.
- C_5 — 0.001- μ fd. mica.
- C_6 — 25- μ fd. midget air condenser.
- C_7, C_8 — 4- μ fd. dry electrolytic.
- R_1 — 5 megohms, 1/2-watt.
- R_2 — 500 ohms, 1-watt.
- R_3 — 1/2-megohm volume control and power switch (Sw_4).
- R_4 — 10,000 ohms, 1-watt.
- R_5 — 20,000 ohms, 1-watt.
- R_6 — 25,000 ohms, 1-watt.
- Sw_1, Sw_2 — D.p.d.t. snap switch.
- Sw_3 — S.p.s.t. snap switch.
- Sw_4 — (see R_3).
- T — Power transformer 6.3 v., 5 v., and 640 v., c.t. (Kenyon K40MY or similar).
- X — 100-1000-kc. dual-frequency crystal (Bliley type SMC100A).

Note the simplicity of layout and wiring. The power supply is at the left and the r.f. end is at the right. The variable condenser in the center is in parallel with the crystal to provide a frequency adjustment. The r.f. output is fed to the feed-through insulator at the bottom of the picture. The single pie r.f. choke, at the center left, is L₁. Sw₂ is at the left top, Sw₃ at the center, and Sw₁ at the right.

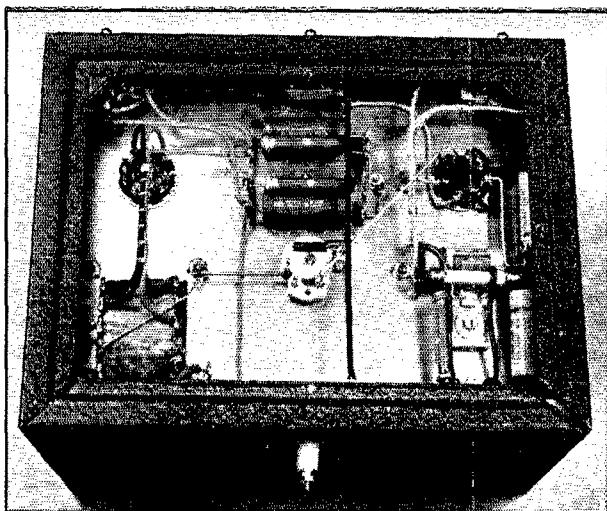

appear. The use of modulation will assist in locating the harmonics. If the receiver has an S-meter, the dial setting for each harmonic can be accurately determined by tuning for maximum reading. It will, of course, be necessary to start from some known frequency in order to determine the frequency of each successive harmonic. This presents no particular problem because there is an ample supply of radio stations which will serve as markers. The frequency of the station need only be known to a degree sufficient for identification of the first calibrator harmonic to be used. All other frequencies, in a series, are then known because each successive harmonic differs from the preceding harmonic by the fundamental oscillator frequency. For instance, if the first harmonic used from the 100-kc. oscillator frequency is 7000 kc., harmonics will appear at 7100 kc., 7200 kc., 7300 kc., etc. Naturally, care must be taken not to skip a single harmonic for that would upset the calibration.

When working at low and medium-high frequencies, only harmonics of the 100-kc. calibrator frequency need be used. At high frequencies, however, it is best first to locate 1000-kc. points and then to subdivide them by harmonics from the 100-kc. frequency. This prevents confusion where the 100-kc. calibration points are close together and it would be easy to miss a count or two. Once the procedure is understood, a complete receiver calibration can be effected in a short space of time.

For calibrating a variable oscillator, feed the output from both the calibrator and the oscillator into a suitable receiver. Tune to each successive calibrator harmonic with the receiver and set the oscillator to zero beat with each harmonic. In this way the calibration can proceed at a rapid rate. Be sure that the fundamental of the oscilla-

tor rather than a harmonic is picked up in the receiver. Of course, harmonics of the oscillator can be used just as well, but calculations to correct for the harmonic order will be required.

The frequency of any signal can be determined with fair accuracy by interpolation in a receiver. Note the dial settings at which the signal and the two adjacent calibrator harmonics appear. Elementary arithmetic will then provide the answer. The final accuracy will depend upon the precision to which the dial readings can be determined and the linearity of the receiver between the measuring points.

For the uninitiated, it may be pointed out that interpolation is a process of determining an unknown by its relation to known values. Let us assume that the frequency to be measured appears at dial setting 26.6 while adjacent 100-kc. harmonics appear at 15.1 and 55.1. From the receiver calibration it is determined that the harmonic at 15.1 must be 3200 kc. while the harmonic at 55.1 must be 3300 kc. This means that the signal frequency must be between 3200 kc. and 3300 kc. There are 55.1 minus 15.1 or 40 dial divisions between the harmonics. The frequency difference is 100 kc., therefore each dial division represents $100 \div 40$ or 2.5 kc. Since the unknown signal is 26.6 minus 15.1 or 11.5 divisions higher than 3200 kc., its frequency must be 3200 kc. plus 11.5×2.5 or 3228.75 kc.

If the signal being measured is very near the edge of the band, it may be difficult to interpolate with reasonable accuracy. In this case, allow the signal and the calibrator harmonic to beat together in the receiver so that an audio-frequency note will be produced. The frequency of the note will then be the frequency difference between the signal and the calibrator harmonic. This fre-

(Continued on page 59)

The Coaxial Vertical Radiator

An Improved Half-wave Antenna System for Low-Angle Radiation

BY JOHN J. LONG,* W8ABX

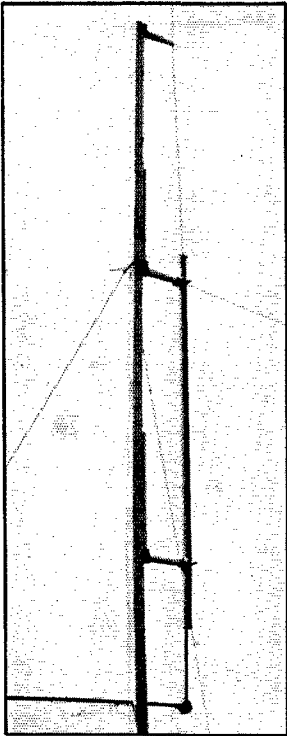

◆
The coaxial antenna installed at W8XAI, mounted on stand-off insulators on a wooden pole. This installation uses a commercial $\frac{1}{2}$ -inch concentric feed line. The lower quarter wave section of the antenna through which the line runs is two-inch tubing. Less expensive arrangements can easily be devised for amateur work. A portion of the ground screen is just visible at the bottom.
◆

THE antenna to be described was first used, so far as the writer knows, by the Western Electric company for their new ultra-high-frequency police transmitters. Although the antenna gives exceptional results, very little information has been available on why it works as well as it does. The explanation to be given later is simply that of the present writer. The results, however, are real — so real that any one wishing to operate on 5 or 10 meters will do well to put up such a rig.

Briefly, the antenna is a simple half-wave vertical dipole with the power fed into the center by running the concentric-line feeder up through the lower quarter-wave section of the dipole. This can be done by any number of mechanical arrangements, and two such arrangements, used experimentally at W8XAI and W8PK, will be described. W8PK operated on five meters and W8XAI on 31.6 Mc.

At W8XAI, a $\frac{3}{8}$ -inch isolantite-insulated coaxial line was used to feed the dipole. A piece of two-inch copper tubing was soldered to the end of the line by placing a disc of copper at the top, as shown in Fig. 1. The upper quarter-wave section was mounted on an insulator, and consisted of a piece of quarter-inch brass tubing. The whole assembly was mounted on insulators as shown in the photograph. The antenna power was 100 watts, and tests were made with different mem-

bers of the WHAM staff and other listeners in Rochester, 16 miles away, to get information on how this antenna compared with a "J" type antenna which was formerly used. The new type of feeder system was so superior to the old that the improvement was very impressive.

The end-fed "J" type antenna is shown in Fig. 2, while the type used at W8XAI is shown in Fig. 3. This antenna feed system was quite unsatisfactory. On one test, the half-wave antenna was disconnected from the feeders and practically the same signal strength was reported as when the antenna was on, showing that the feeders were radiating considerable energy all by themselves! It so happened that the feeders were in a very unfavorable spot for doing much radiating, so most of the power was being wasted in heating the shielding on the building.

Ground Screens

We have been reading about the theoretical half-wave antenna erected over perfectly-conducting earth for so long, and never seeing one in operation, that we were pretty well disgusted with the theoretically-perfect antenna. It looked beautiful on paper but there just didn't seem to be any perfectly-conducting earth on this particular globe. We had some copper screen left over which was used for shielding our transmitter building, and which was supposed to be the last word in conductivity. We said, "Why not set up a piece of synthetic perfectly-conducting earth under our half-wave antenna and see what happens?" A test was made by placing this copper screen directly under the antenna, and reports at once showed that the theory was right, but that the earth as we know it was not so hot.

It is a simple matter to place a good ground screen at least a half wavelength in radius under a five- or ten-meter antenna. We wish it were as simple in the broadcast band!

Five-Meter Results

Before we get to the cracker barrel opinion on what happens with a vertical "J" antenna, let's see what W8PK did with a five-meter antenna built along the same lines.

He did not have a rigid piece of concentric line available so he made up the rig shown in Fig. 4.

* Chief Engineer, WHAM; 63 Sonora Parkway, Brighton, N. Y.

The concentric line consisted of a piece of low-grade No. 14 rubber-covered house wire pulled through a length of quarter-inch brass tubing. A piece of $\frac{7}{8}$ -inch copper tubing was soldered to the end of it, and the top quarter-wave section was an extension of the inner conductor. The whole assembly was suspended from the top by a regular antenna insulator.

The boys on "five" said it was as loud as a beam job that he spent considerable time building — minus the trouble of having to go out and turn it whenever he wanted a different direction. The thing puts an R9 signal into W8ABX, 18 miles away, on five meters. The beam job never did that. Maybe he didn't have the beam operating at maximum efficiency, but that is the point — there are plenty of beams that are not working to the utmost! Just because the signals get weaker when the antenna is turned in the opposite direction is no sign that it is working efficiently in the direction at which it is pointed.

There was some doubt about the length of the lower quarter-wave section, but it was found by using a sliding sleeve on the outer tubing that the length was the same as that of the upper section, and came out exactly as calculated. Forty-eight inches for 56.5 Mc. will give you some idea of the lengths for other bands.

Why It Works

Now for some guessing: Apparently a vertical "J" type antenna with a vertical quarter-wave "Zepp" type matching section at the end of the half-wave antenna has voltage which is out of phase in each side 180 degrees. But looking at it

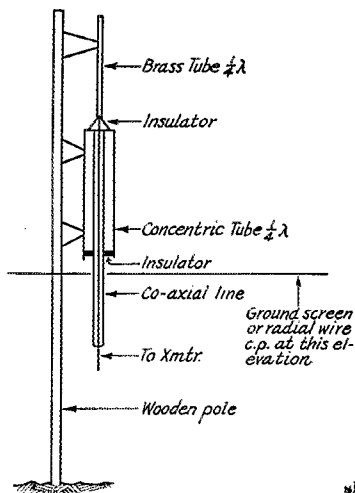

Fig. 1 — The coaxial antenna at W8XAI. Its performance is markedly better than that of the resonant-line fed antenna (Fig. 3) formerly used.

This is a description of the new Western Electric antenna developed for u.h.f. police work. Installed at short-wave broadcasting station W8XAI, its performance was so evidently superior to the old "J" type that the hams on the staff just naturally had to give it a workout on amateur bands, with the results recounted in this article. It should be excellent for 5-meter work, since it is designed to give more intense low-angle radiation than it is possible to achieve with the more conventional forms.

from the antenna's angle, the feeder becomes part of the antenna if it does any radiating itself.¹ If this setup is operated above a ground, it is a $\frac{3}{4}$ -wave antenna. A $\frac{3}{4}$ -wave antenna has a very husky lobe of high-angle radiation and a weak lobe of practically horizontal radiation. This is so when the antenna is above perfectly conducting earth! Wasting all of the main part of the radiation in a high-angle lobe is not good "ham radio" at these frequencies. Anyway this new method of feeding is doing its stuff, so why worry with theory which is only correct when figured over perfectly-conducting earth — of which there is none!

To check the idea, a vertical dipole was supported from a concentric line out of the attic window at W8ABX as shown in Fig. 5, thereby

¹ At 56 Mc. in particular, it is doubtful whether a line with 6-inch spacing can be considered to be at all near the non-radiating condition. This spacing begins to approach the $\frac{1}{40}$ th wave spacing which, with out-of-phase currents, forms an effective radiating system. See p. 18, *QST*, May, 1938.

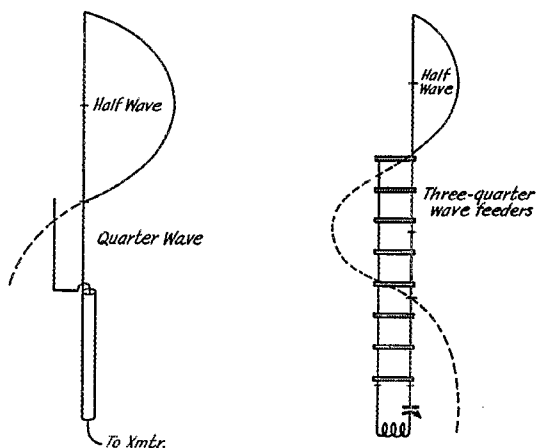

Fig. 2 — The "J" antenna, showing a "net" standing wave on the matching section, because of current or phase unbalance. Radiation from the matching section will tend to raise the angle of radiation.

Fig. 3 — The old W8XAI antenna, used before the coaxial antenna was installed.

eliminating the vertical matching section. This antenna gets better reports than were ever obtained with an end-fed job.

Remember this: An antenna with power being fed into it is not the same as a theoretical antenna in free space. If the feeders radiate any energy which will interfere with the radiation pattern of the antenna itself no one can tell what is happen-

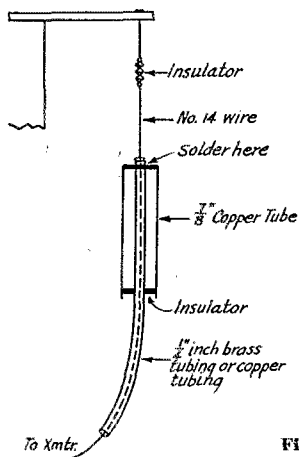

Fig. 4—The 5-meter coaxial antenna built by W8PK, using materials easily available to the average amateur. This antenna gave a good account of itself as compared to a rotary beam.

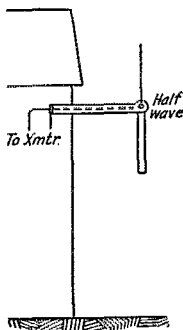

Fig. 5—Vertical antenna with horizontal feed line as installed at W8ABX to check the effect of feeders. Results were definitely superior to those with the same type of antenna but with the feeder system vertical.

ing without making an elaborate field-strength survey. This is not being done by the average ham.

After all this talk you will probably say, "My antenna is the best one I ever tried." OK, but don't say we didn't tell you about the "theoretically-perfect" vertical half-wave antenna!

ERROR'S NOTE.— This article was written before the coaxial antenna had been described in print by its designer, Arnold B. Bailey, of the Bell Telephone Laboratories. Subsequently an article by Mr. Bailey appeared in the September, 1938, issue of *Pick-ups*, monthly publication of the Western Electric Company. The principle of operation is essentially as outlined by W8ABX, the intention being to eliminate radiation from the feeder system and, in the case of the common form of u.h.f. police antenna, from the grounded metal pole of which the top section is usually considered to be the radiating antenna. The inner surface of the quarter-wave tube can be considered to be an extension of the outer surface of the coaxial transmission line and does not carry current (except when power is coupled into it, as in the case of a nearby antenna). The outer surface, however, acts like the lower quarter-wave section of a ver-

tical half-wave antenna; the current does not penetrate below the surface because of skin effect. The quarter-wave tube and the section of coaxial line it encloses can be looked upon as a high-Q circuit, so that a large potential difference appears between the lower end of the tube and the line proper. This is equivalent to placing a wave-trap in series with the lower end of the antenna and the outer surface of the concentric feed line, with the result that practically no power is transferred to the outer surface of the line itself; hence no current flows in it and it does not radiate. Tests carried out by Bell Labs have shown that an average signal-strength increase of 8 db results when the coaxial antenna is substituted for the ordinary "J."

It should be pointed out that, except for reduction of feeder (and pole) radiation the coaxial antenna is not a more "efficient" antenna, in the sense that it radiates more of the power supplied to it than does the ordinary half-wave dipole; it is, in fact, still a half-wave dipole. Its greater effectiveness lies in the fact that it eliminates stray radiation and thus permits the dipole to approach its theoretical performance in concentrating radiation along the horizontal. In other words, more of the radiated power will be pushed along the ground — the place where it is wanted in the case of normal u.h.f. work. Since low-angle radiation is desirable for long-distance 28-Mc. work, the antenna should also be highly effective for DX as well as local work on that band.

Incidentally, W8ABX's suggestion of using a ground screen under the antenna is well worth considering, particularly at these frequencies. Several of the WHAM gang have found such screens to increase materially the effectiveness of the antenna,² and at 56 and 28 Mc. the area to be covered is not large (a circle a wavelength in diameter at most). In a recent conversation, W8ABX suggested that a radius of 0.3 wavelength should be sufficient, since the current tends to concentrate at this point, and that tests had shown that going beyond this distance to a radius of a half-wavelength did not appreciably improve the results.

— G. G.

² W8EBS reports that the use of a chicken-wire ground screen under his 10-meter rotary beam has improved the output very noticeably, making it better than the coaxial antenna, as would be expected. He also reports that the radiation angle could be changed to suit the station he was working, which also is according to the book. The screen should be a half wave below a horizontal antenna for lowest angle of radiation. Under a vertical antenna, the screen should be placed near the bottom of the lowest vertical element.—AUTHOR.

Strays

In your haste to see How's DX did you notice the dope on Regs? One concerns the Cairo Conference and the other clears up the technical difficulties of the FCC Regs.

Construction and Alignment of the Television Receiver

R.F. and I.F. Coupling Units—Test Equipment—Performance Curves

BY C. C. SHUMARD*

IN DECEMBER *QST*¹ the circuit of the superheterodyne television receiver was given, as well as a functional analysis of the various stages. In this article, the construction of the "hand-tailored" parts will be described. The alignment and operating procedure will be explained in detail.

CONSTRUCTION

R.F. Input Stage Assembly

In photo "A," the lower right-hand unit shows the r.f. and antenna coil assembly, with switch S_1 (refer to Fig. 2 of December *QST*) mounted on a 3-legged bracket above the coil form. Design data for the three coils (L_1 , L_2 and L_3) are given in Fig. 4. The coil form is made of thin-walled bakelite tubing. The single-turn antenna coil, wound with No. 14 enameled wire, has its output leads crossed over for a distance of about $\frac{1}{4}$ inch; the leads then go through separate holes in the chassis to the two-lug terminal strip mounted on the opposite side of the chassis. These leads are short enough to make the antenna coil self-supporting — it is not directly fastened to the coil form, except on the ground lug where the center-tap connection is made. Another view of this unit is shown in photo "B" (at left). The various by-pass condensers and resistors are mounted around the coil form, with very short leads.

It may have been noted that the parts list given in the legend of Fig. 2, December *QST*, is quite specific as to the particular parts employed. Many of the parts were carefully chosen for small physical size, so that they would go in the rather limited space available in the shielded units.

* RCA Manufacturing Co., Inc., Harrison, N. J.

¹ C. C. Shumard, "A Practical Television Receiver for the Amateur," *QST*, December, 1938.

Oscillator-Mixer Stage Assembly

Photo "A" (upper unit) shows the oscillator-mixer coil assembly, with switch S_2 mounted at the top. Design data for coils L_4 , L_5 and L_6 (circuit constants are referred to Fig. 2) are given in Fig. 5. The oscillator coils L_5 and L_6 , wound with heavy enameled wire, are held in place by the pressure of the wire on the coil form, assisted by the short, stiff output leads soldered to nearby circuit parts. Coil L_4 is held in place by small soldering lugs riveted to the form at each end of the winding. Collodion, used sparingly, also helps to hold the windings in place. The coil form is of the same material as in the r.f. unit.

As even the most casual reader must know by this time, the design of coupling circuits which will pass the extraordinarily wide frequency band necessary for good picture reception is one of the most critical features of a television receiver. In this article, a continuation of the one by the same author in December *QST*, the construction of these circuits is discussed in detail. The exact dimensions given, as well as the carefully worked out alignment procedure, should enable the constructor to get the receiver into operation with a minimum of trouble. In conjunction with the deflection circuits for small cathode-ray tubes described in October *QST*, it constitutes a complete television receiving system. Data on using electromagnetic-deflection tubes and on the new electrostatically-deflected kinescopes will be given in a subsequent issue.

I.F. Coupling Units

The design of the four i.f. coupling units and of the sound-buffer coil assembly is quite similar, so that it is worth while to make a metal template for the "base plates" used in each of these units. This template, shown in Fig. 6, can also be used to mark the coil forms and shield cans for drilling. The material used for the base plates and coil forms is a special grade of hard rubber, "Radio X2B" compound, made by the American Hard Rubber Company, New York, N. Y. This material is used principally because of its low leakage, which is important in the i.f. coupling units in order to avoid leakage currents through the a.g.c. circuit. The dimensions of the base plates are $3\frac{1}{8}$ by $1\frac{1}{8}$ by $\frac{3}{32}$ inches.

Photo "C" shows an assembled i.f. unit, with the various condensers and resistors mounted around the coil form and on the base plate. Design details of the i.f. coils are given in Fig. 7, and are exactly the same for all four i.f. units. The i.f. coil forms ($3\frac{5}{16}$ " long) are cut from solid, hard-rubber rods $\frac{1}{2}$ inch in diameter, made of the same hard-rubber material as the base plates.

FIG. 3 FRONT VIEW DIMENSIONAL DRAWING - TELEVISION RECEIVER PANEL

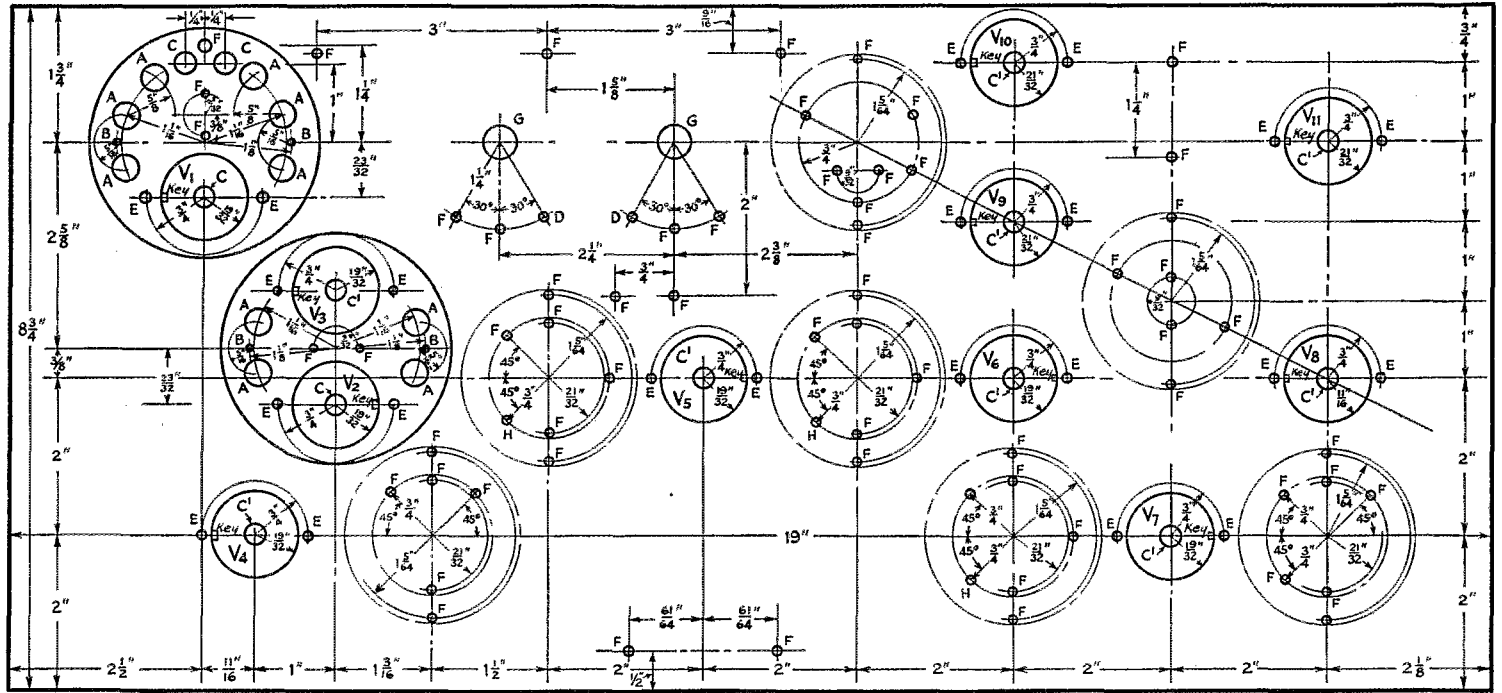

A - $\frac{5}{16}$ " HOLE
 B - No. 44 DRILL
 C - $\frac{1}{4}$ " HOLE

D - No. 6 DRILL
 E - No. 30 DRILL
 F - No. 28 DRILL

G - $\frac{3}{8}$ " HOLE
 H - No. 10 DRILL
 C' - $\frac{1}{4}$ " HOLE FOR $1\frac{3}{16}$ " KNOCKOUT

Sound Buffer Input-Coupling Unit

The input-coupling unit of the sound buffer stage is constructed very much like the i.f. units, as can be seen from photo "D." Coil design data for this unit (L_7 and L_8) are given in Fig. 8. The coil form is made of thin-walled bakelite tubing, as used for the r.f. coils.

Video Input-Coupling Unit

The two coils comprising the input coupling and compensating unit (L_{21} and L_{22}) of the video amplifier stage are shown in photo "E." Design data for the windings are given in Fig. 9. The coil forms are similar to those used in the i.f. units. The inductance values of L_{21} and L_{22} are important. These coils, in conjunction with the circuit and tube capacitances present, compensate the video input circuit so that the desired video characteristics are obtained. No adjustment of the video input circuit should be necessary if the coil and layout specifications are followed closely.

Video Output-Coupling Unit

Photo "F" shows the output coupling and compensating unit of the video amplifier. Design data for inductance L_{23} are given in Fig. 10. The output compensation provided by L_{23} should be satisfactory where the Kinescope grid terminal is placed close to the video output network. Such placement minimizes the Kinescope input-circuit capacitance.

General Circuit and Wiring Considerations

The wiring of the receiver, in general, should follow good practice for ultra-high-frequency equipment. All h.f. grounds should be made direct to the chassis with the shortest possible leads. All leads carrying high frequencies should be kept reasonably clear of other wiring and circuit components.

The "hot" plate and grid leads of the r.f. oscillator, mixer, i.f. sound buffer, and video stages are wired with single strands of No. 30 wire, insulated with spaghetti tubing where necessary; in some cases, no insulation is used except where the leads pass through the chassis or through a shield can. The use of this small wire, carefully spaced from all grounded parts, is important in reducing unwanted capacitive effects.

One side of the common heater winding is grounded; the other side of the heater supply circuit is by-passed to ground directly at the socket of each r.f. and i.f. stage.

Test Equipment and Alignment Procedure

The exact alignment of a receiver is usually a laboratory operation. However, it is believed that if the specifications which have been given are followed closely, the alignment of the i.f. coupling stages will be the only job requiring special test apparatus. A calibrated oscillator covering the

Changes in Receiver Constants

Since publication of the television receiver circuit in December *QST*, further work with the receiver indicates that the following changes in circuit constants are advisable in the interests of better performance from the hum standpoint:

Component	Old Value	New Value
C_{75}	50- μ fd., 25-volt elec.	100- μ fd., 25-volt elec.
C_{66}	0.01- μ fd., 200-v. paper	50- μ fd., 25-volt elec.
C_{70}	0.05- μ fd., 400-v. paper	0.002- μ fd., 400-v. paper

Resistor R_{41} should be eliminated.

i.f. frequency band and a good vacuum-tube voltmeter are required, in addition to the auxiliary short-wave "sound" receiver mentioned in the preceding article.

Test Oscillator

A test oscillator covering a frequency range from about 8 to 14 Mc., and having an output voltage at low impedance adjustable up to about 0.3 volt, is necessary for the i.f. and sound-buffer line-up. It is, of course, also essential that the r.f. output voltage for a given attenuator setting should remain substantially constant throughout the frequency range employed.

An RCA Type 153 test oscillator² was used to align this receiver. In using the Type 153 oscillator, it was considered desirable to make a slight change in its output circuit before starting the alignment procedure. A 40-ohm carbon resistor was inserted between R_{13} and R_{14} (see Figs. 11 and 12). The reason for this will be explained later. Two different methods of coupling the test oscillator to the receiver were employed. For i.f. unit No. 4, next to the detector, a fairly large signal voltage is required because the gain of only this one stage is effective. For the line-up of this stage, the oscillator is coupled to the i.f. tube grid by means of the coupling network C_1 , C_2 , R_2 and R_3 . The lead to C_2 is broken at point "X" (see Fig. 12) and connected with a short lead directly to the oscillator output terminal marked "Medium." The same connection is also used for i.f. unit No. 3, the oscillator signal being suitably reduced by means of the attenuator, R_{12} (Fig. 11). The transmission line shown in Fig. 12 is not used for units 4 and 3, and is left unconnected at both ends during their alignment.

For the line-up of i.f. units Nos. 2 and 1, the transmission line, consisting of a short length of shielded wire having an impedance of about 50 ohms, is connected as shown in Fig. 12. The 40-ohm resistor previously inserted allows both

²This is an inexpensive all-wave (100-30,000 Kc.) test oscillator of the type included in the usual service-man's kit. — Editor.

the input and output terminations of the line to be made 50 ohms, which approximately matches the line impedance. The use of the line for the two high-gain stages permits the signal voltage to be applied directly between the tube grid and ground, and minimizes pick-up and feedback which might exist with direct wire coupling. The magnitude of the oscillator output voltage cannot easily be determined, but this is not essential. It is more important that the oscillator voltage should be substantially constant over the i.f. band.

Vacuum-Tube Voltmeter

Because of the very high frequencies involved, the vacuum-tube voltmeter employed must have a very low input capacitance. A v.t. voltmeter using a 954 Acorn tube was described in *QST* for May, 1935.³ An instrument of this general type is suitable for the alignment work. A sensitive microammeter should be used for the indicating meter. One requiring 200 μ a. for full-scale deflection is suitable. The v.t. voltmeter should be designed and calibrated for at least two ranges. The maximum voltage for these ranges should be about 0.8 volt and 2.5 volts. Space limitations preclude more complete information on the design of tube voltmeters, but good references dealing with this subject are available.

I.F. Alignment

With the test equipment all at hand, the alignment procedure can be started. The last i.f. coupling unit (No. 4) is, of course, first to be aligned. No connections need be made from the receiver to the scanning unit. As a preliminary, it is advisable to short-circuit the plate of the r.f. tube and of each i.f. tube (except V_7) to the + B lead, by means of a direct wire jumper. Oscillator tube V_3 can be left out of its socket. These precautions prevent any possible output from the shorted stages and do not seriously upset the voltages from the power supply unit. The general procedure is as follows:

³ The probe type or "goose-neck"; *QST*, May, 1935, p. 90.

Connect the common a.g.c. bias lead (see Fig. 2, December *QST*) to the - 3 volt end of R_{57} , instead of to R_{54} , so that the tubes will get their bias, temporarily, direct from the power unit. Connect the test oscillator to the grid of V_7 , using the coupling method explained under "Test Oscillator." Remove the i.f. shield can, disconnect the high side of C_{63} (the detector plate-circuit condenser) and substitute the short v.t. voltmeter input leads to the 954, from the detector plate to ground. The 6H6 is left in its socket. Set C_{60} to about $\frac{1}{4}$ maximum capacity and replace the shield can. Adjust the test oscillator for a suitable output and set the v.t. voltmeter on its most sensitive scale. The voltage output or response curve of i.f. unit No. 4 can now be obtained.

For any i.f. stage, the output curve will have two peaks, as in Fig. 13-B, when proper adjustment is made. The frequencies at which the two peaks occur can be used as an "index" of the alignment. Fig. 13-B may be taken as typical of what is desired. The peaks on this curve occur at about 10.6 Mc. and 12.8 Mc., and will show quite plainly as maximum readings on the v.t. voltmeter as the test oscillator is tuned rapidly through the desired frequency range. The frequency range being covered should be mentally correlated with the v.t. voltmeter readings so that the general shape of the curve can be visualized readily without the curve actually being plotted on paper.

For the first trial, some curve such as Fig. 13-A may be obtained. Here, the low-frequency i.f. peak is very large and the high-frequency peak is almost non-existent. This type of curve indicates that the capacitance of C_{60} is too large. Curve 13-C shows the effect of too small a value for C_{60} . Some intermediate setting of C_{60} should give the desired curve, 13-B.

It will be noted that this curve drops more rapidly at the 10.5-Mc. end than at the 13-Mc. end. This is the effect of the series-coupling circuit $L_{19}C_{62}$ (also of $L_{16}C_{54}$, etc.), which should tune to approximately 8.5 Mc. The nominal value of

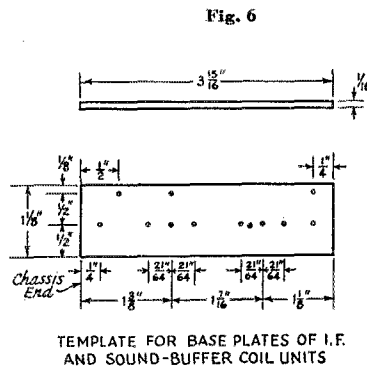
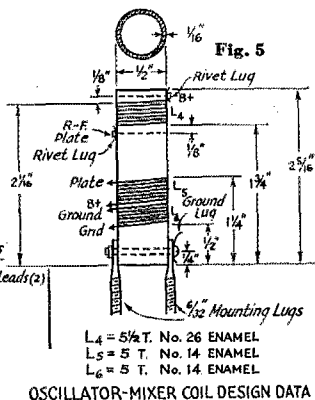
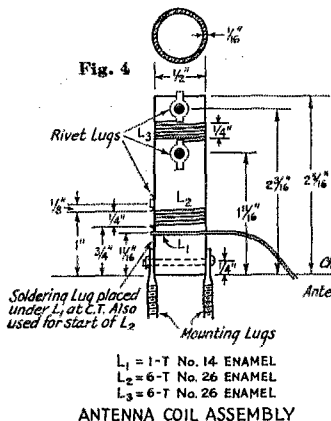

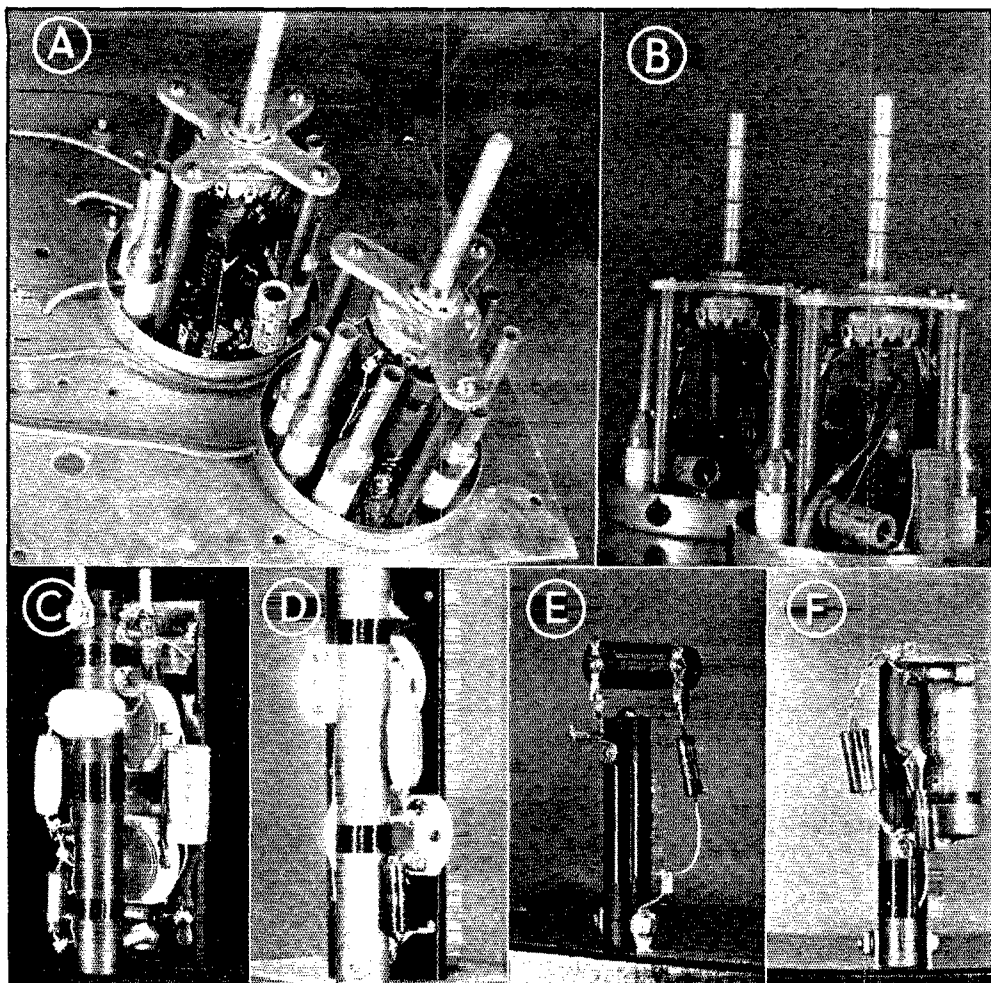

C_{62} (also C_{54} , C_{46} , and C_{30}) is shown in the legend of Fig. 2 as $18 \mu\text{fd}$. If the *actual* value is less than 16.5 to $17 \mu\text{fd}$., the effect is to cut into the 10.5-Mc . end of the i.f. response curve. A value greater than 18.5 to $19 \mu\text{fd}$. will also be detrimental to the band-pass characteristic. Different condensers may be tried if the desired curve cannot otherwise be obtained. The values of the i.f. termination resistors (R_{34} , R_{30} , R_{25} , and R_{20}) are also important, and should not vary from the nominal figure by more than ± 5 per cent.

For the line-up of i.f. coupling unit No. 3, the grid circuit of V_7 is connected normally, the jumper is removed from the plate circuit of V_6 , and the test oscillator is coupled to the grid of V_6 in the same manner as it was to V_7 . The v.t. voltmeter is left connected across the detector input circuit for the entire alignment, inasmuch as only overall response curves ordinarily need be taken.

A representative overall curve of i.f. units Nos. 4 and 3 is shown in Fig. 14. The peaks here occur at about 10.5 and 12.5 Mc . This curve is obtained as for i.f. unit No. 4, except that both plate condenser C_{52} and grid condenser C_{55} are adjusted. C_{52} should be used essentially to adjust the low-frequency peak and C_{55} the high-frequency peak, although some effects on both peaks are produced by either adjustment. These effects may be readily checked by tuning the test oscillator fairly rapidly through the proper range and simultaneously observing the rise and fall of the v.t. voltmeter reading. The coupling units are so designed that only a small amount of the capacitance of either condenser should be required. It will be found that the peaks will become more pronounced and more easily checked on the v.t. voltmeter as more cascaded stages are lined up, because the overall curve represents the product of the gains of all the stages in operation.

I.f. unit No. 2 should next be aligned according to the general procedure just described. The jumper across the plate circuit of V_5 should not be forgotten, and must be removed. The test oscillator is coupled to the grid circuit of V_5 , using the coaxial line connected as shown in Fig. 12, and condensers C_{44} and C_{47} are adjusted. A typical overall curve for i.f. units Nos. 4, 3, and 2 is shown in Fig. 15.

Before i.f. unit No. 1 is adjusted, it is necessary to align the sound-buffer stage. It has been mentioned that the 1853 sound-buffer tube is used to prevent the oscillator of the sound receiver from feeding into the video i.f. stages, inasmuch as the frequency of the oscillator in the sound receiver is usually close to the video i.f. band. The sound buffer tube is not used for amplification of the sound i.f. signal, but it serves as a coupling tube in addition to its other function. For the alignment, proceed as follows:

Connect the antenna and ground terminals of the sound receiver to the 50-ohm termination (R_{16}) of the sound-buffer transmission line, shown in Fig. 2. Disconnect the sound input lead (coming from the plate circuit of the mixer tube) at R_{13} and connect the free end of R_{13} to the test oscillator, using transmission-line coupling. Set the test oscillator at 11.25 Mc. (with 400-cycle modulation now applied) and tune the sound receiver to this frequency. Adjust C_{33} until the modulated 11.25-Mc. signal is a minimum in the sound receiver. This adjustment should be made at a low output level — that is, with a small oscillator signal and a low receiver volume-control setting — after the signal has once been tuned in. Next, set the oscillator at 9.75 Mc. and tune the sound receiver to this signal. Then adjust C_{35} until the signal is a maximum at a low output level. Repeat the entire procedure once more, starting again with the 11.25-Mc. modulated signal. This

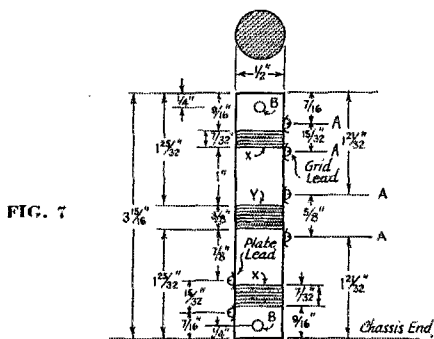

FIG. 7

A = 2-56 × 3/16 BRASS R.H. MACHINE SCREW AND LUG, TAPPED IN
 B = TAP THROUGH FOR 6-32 F.H. BRASS MACHINE SCREW
 X = 23 T. No. 32 ENAMEL, L₉, L₁₁, L₁₂, L₁₄, ETC.
 Y = 46 T. No. 32 ENAMEL, L₁₀, L₁₃, L₁₆, L₁₉

I.F. COIL DESIGN DATA

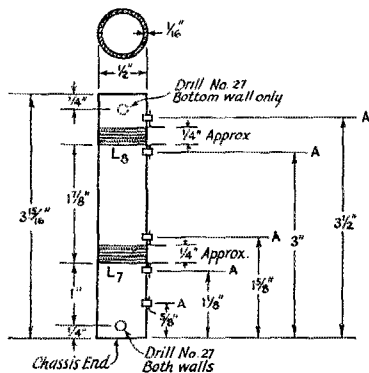

FIG. 8

L₇ = 29 T No. 32 ENAMEL
 L₈ = 26 T No. 32 ENAMEL
 A = RIVET LUGS, DRILL No. 35

SOUND-BUFFER-COIL DESIGN DATA

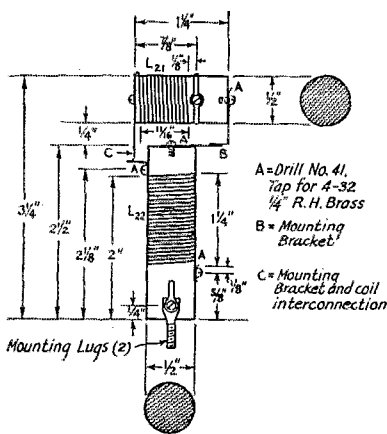

FIG. 9

L₂₂ = 280 1/2 T No. 38 ENAMEL
 L₂₁ = 155 T No. 38 ENAMEL
 VIDEO INPUT-COMPENSATION COIL ASSEMBLY

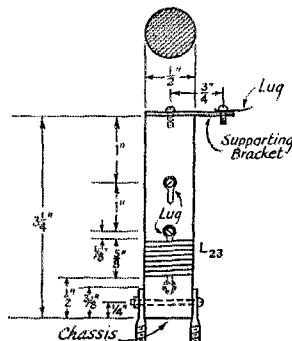

FIG. 10

L₂₃ = 88 T. No. 34 ENAMEL
 VIDEO OUTPUT COMPENSATING COIL & FORM

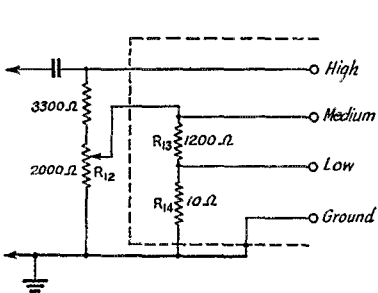

Fig. 11 — Normal output circuit of Type 153 (RCA) test oscillator.

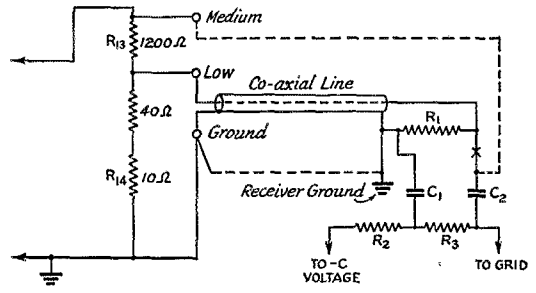
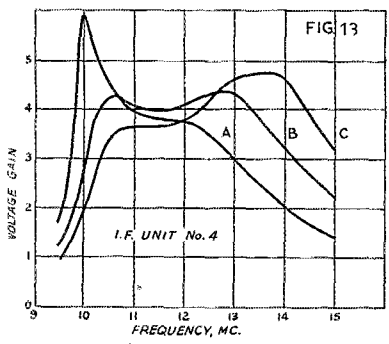

Fig. 12 — Revised oscillator-output circuit and coupling system. The coaxial transmission line is the same material as described for the output of the sound-buffer unit in December QST. Values are as follows: R₁, 50 ohms, 1/2-watt; R₂, R₃, 50,000 ohms, 1/2-watt; C₁, C₂, 50-μfd. mica, midget type.

should complete the adjustment of the sound buffer stage, so that its input lead can be reconnected to the mixer plate circuit.

The test oscillator should now be connected to the mixer input and i.f. unit No. 1 aligned, according to the procedure previously described for i.f. unit No. 2. After the proper adjustment of C₂₃ and C₃₁, an overall i.f. curve similar to Fig. 16-A should be obtained. The mixer is thus used, for this step of the alignment, as an i.f. amplifier under mixer tube conditions.

It will be seen that the curve of Fig. 16-A substantially fulfills the requirements for the desired type of i.f. response, according to the theoretical considerations discussed in the preceding article. An effect of the sound buffer stage is to reduce the response variation over the i.f. band and to reduce the i.f. gain in the neighborhood of 13 Mc. This reduction of gain at the high i.f. (low video)



Figs. 13-17 — I.f. response curves at progressive stages in the alignment procedure. Fig. 17 shows the overall i.f. response (gain control) applied to the i.f. grids.

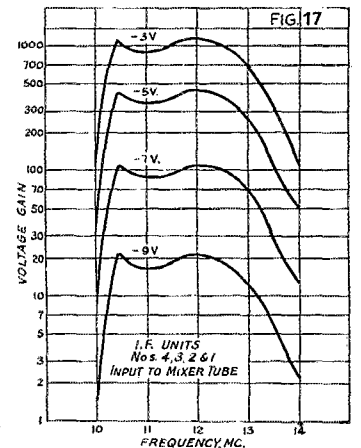
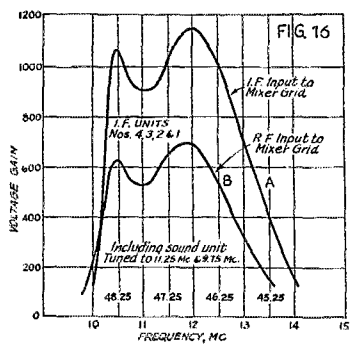
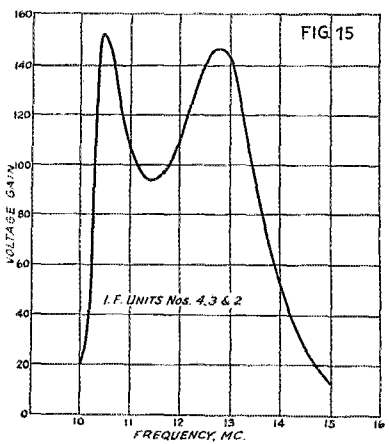
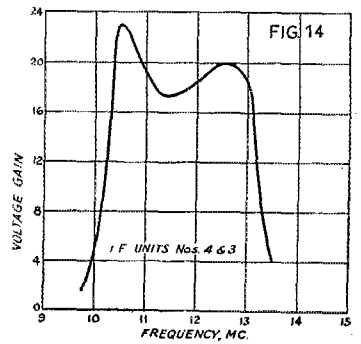

end of the video sideband is desirable in order to minimize overlapping of the low video frequencies, as pointed out in December *QST* (see Fig. 1). The tendency for such overlapping or "doubling up" of the low video frequencies is, of course, due in part to the fact that single-sideband reception is employed in the receiver.

The curve of Fig. 16-B gives the overall gain characteristic of the receiver, exclusive of the r.f. and video stages, with r.f. input to the mixer tube used to beat with the inserted oscillator signal. The oscillator frequency for this curve was set at 58.75 Mc.

When the alignment procedure has been completed and the final i.f. response curve has the desired characteristics, the vacuum-tube voltmeter is removed from the detector input circuit. The detector plate condenser C_{63} is reconnected and its rotor meshed about $\frac{1}{4}$ inch, as measured along the outer edges of the rotor plates. Slight re-settings of C_{63} should be tried after a picture is obtained, to determine if the picture definition can be improved. However, the detector input circuit is sufficiently broad so that the effects of any slight misalignment will be minimized.

The four curves of Fig. 17 show the response of the receiver with different values of grid bias on the r.f. and i.f. tubes. In this receiver, the pass band does not vary appreciably with grid bias changes. It will be observed (Fig. 2) that the cathode resistors of the r.f. and i.f. stages are *not* bypassed. The omission of the cathode by-pass condensers tends to minimize input-capacitance variations in the a.g.c. controlled tubes and is an important factor in obtaining the operating characteristics desired of the receiver. The overall i.f. response is practically flat from 10.5 Mc. to 13 Mc., as is shown by the logarithmic gain curves of Fig. 17.

Operation

With the i.f. alignment completed, the picture receiver is ready to be connected to the scanning and Kinescope units. It is important to note that this receiver is especially designed to "tie in" with the electromagnetic Kinescope and scanning units to be described in a subsequent article by Mr. J. B. Sherman. The output terminals shown in Fig. 2 can be directly connected to the electromagnetic units, and the various receiver controls and circuits function just as described.

If, however, one of the electrostatic Kinescope and scanning units shown earlier⁴ is to be employed, some variations in procedure are required. In Figs. 3 and 4 (October *QST*) the external connection to the Kinescope grid is marked "Video Input." A 0.5- μ fd. d.c. blocking condenser must be inserted in this lead before it is connected to the output terminal of the video amplifier in the picture receiver. With this capacitive coupling, the Kinescope receives its d.c. background-control bias from the Kinescope power pack, as shown in October *QST*, and not from the picture receiver.

The receiver terminal marked "To cathode of Kinescope" and bias potentiometer R_{55} (Fig. 2, December *QST*) are thus not used with the electrostatic units. This means, of course, that the automatic background-control circuit in the picture receiver is not put to use, because of the "a.c. coupling" of the video input signal.

After the 0.5- μ fd. condenser has been inserted in the Kinescope grid circuit, the picture receiver is connected to the other units as shown in the circuit diagrams,

omitting the Kinescope cathode connection at the receiver. The chassis of the various units which go to make up the complete receiver should all be tied together with a good, low-resistance ground strap.

The antenna feeders, assuming a half-wave doublet antenna is used, consist of a twisted pair. The feeder leads are connected to the two antenna terminals provided on the picture receiver chassis. Switches S_1 and S_2 are set in the maximum-capacitance position (on C_3 , C_8 , C_9 and C_{12}), for a station in the 44-49 Mc. range.

The scanning circuits are put into operation as described in October *QST*, so that the rectangular picture area is scanned.

For locations where a strong signal from the transmitter is available, no particular difficulty should be encountered in tuning in the signal. Usually, an adjustment of the oscillator frequency (by means of C_{12}) will bring in some signal. Once a signal is obtained, the effects of tuning, synchronizing, and the background control will readily be noticed on the Kinescope screen. One of the first steps is to tune the pre-selector and mixer controls until the signal is strong enough to obtain proper synchronization of the scanning oscillators with the transmitter. The background

(Continued on page 116)

⁴J. B. Sherman, "Building Television Receivers with Standard Cathode-Ray Tubes," *QST*, October, 1938.



G — Photograph of test pattern from an r.f. signal generator on the screen of a Type 1800 Kinescope used with the receiver described.



ARMY-AMATEUR RADIO SYSTEM ACTIVITIES

THE Eighth Corps Area of the Army Amateur Radio System is comprised of the states of Texas, Oklahoma, Colorado, New Mexico, Arizona and a small corner of Wyoming in which is located Fort Francis E. Warren. This is, roughly, a little more than 22 per cent of the entire area of the United States, to be covered by the Corps Area Nets. Headquarters and the Net Control Station are located at Fort Sam Houston, Texas, near San Antonio.

The Eighth has had its share of disastrous emergencies. Hurricanes, floods and even ice storms as late as the winter of 1937-38 have tested the efficiency of the A.A.R.S. and its organization.

The reason so many good amateurs are in favor of traffic handling systems and nets is because these systems provide the necessary training to make an amateur operator an efficient operator. Traffic handling and drill periods make good operators better. Good operators are essential in an emergency because they know what to do more quickly and efficiently than those without training. For the benefit of everyone, amateur radio must be prepared to operate immediately at any given time.

Some good amateur operators hesitate to enroll in the A.A.R.S. for fear they will not have time to fulfill the drill period requirements. While there is no limit to the amount of time a member may devote to A.A.R.S. work, the Eighth Corps Area has defined for its members the minimum weekly requirements. These requirements are as follows:

1. Copy a broadcast from the Army Net Control station, WLM, Washington, D. C., once weekly on Monday nights.
2. Copy a broadcast from the Corps Area Net Control Station, W5OW, Fort Sam Houston, Texas.
3. Prepare a message to the State Net Control Station stating that the two above broadcasts have been copied.
4. Contact by radio the State NCS or his alternate and send him the message that has been prepared.

These four weekly requirements constitute a basis for scoring members under a system similar to baseball batting averages. Each item is a time at bat. Four hits each week give a member a batting average of 1,000. Members not having an abundance of time will find that the minimum may be held to as little as an hour each week if all goes well.

When a member has enrolled he is furnished with a copy of Circular No. 6. This circular is a combination of five pamphlets covering all the details found in drill practice, cryptography, etc. After a two months' probationary period, a member is issued a certificate of membership and enrolled in the active files of his particular State Net.

Normally, all stations in a state operate on the State Net frequency. This is usually in the 80-meter band on c.w., although some nets use phone and the 160-meter band. Drills are normally conducted on Monday nights but may be authorized at other periods of the week. In fact, several nets meet nightly for the exchange of traffic and ideas. The Corps Area Net, conducted by WLJ on 6990 kcs. is open each evening except Sunday and traffic reaching WLJ is expeditiously handled through the Army Net.

The Net Calls and Spot Frequencies of the different states in the Eighth Corps Area are as follows: Colorado (CO) 3840 kc.; New Mexico (NM) 3702.5 kc.; Arizona (AZ) 3597.5 kc.; Oklahoma (OL) 3682.5 kc. and Texas (TX) 3657.5 kc.

The Army Net and Corps Area Net Broadcasts are made on Monday nights at the following times: WLM at 7:00 P.M. and 10:00 P.M. E.S.T., simultaneously on 3497.5 and 6990 kc. W5OW at 6:30 P.M. C.S.T. on 3790 kc. The Corps Area Broadcast is made twice, at 6:30 P.M. and 8:30 P.M. C.S.T. on 3790 kc.

Beginning with the April 1938 issue of *QST*, a cryptogram has appeared at the close of the A.A.R.S. activities article. Several of these have been quite difficult to solve. Eighty persons have submitted solutions as follows: April, 49; May, 23; June, 43; July, 27; August, 10; September, 3 and October, 1.

Following is this month's problem: UABUW WFUZN DUABY DAOZC ATAPT Efvvf EOGDG SDWIH QQWHP IGWIM KUVOA EIKFF JEAOJ MQQGJ JPGBH IZDMP IGXGU WFGCA UMDZW SSOFK EXXXX

Correct solutions submitted to the Liaison Officer, A.A.R.S., 3441 Munitions Bldg., Washington, D. C., will be acknowledged.

~~2~~ Strays ~~3~~

W2KSF has finally found a use for his old variable condensers — he uses them as slicers for hard-boiled eggs!

2nd Annual "A.R.R.L." QSO Party!

Fun and Fraternalism for Members—January 7th-8th (Sat.-Sun.)—Distinctive Membership Charms with Calls to be Awarded in each Section—Try Your Luck in Get-Acquainted Party for All Members—Start a QSO List, Call "ARRL de . . .," Use Phone or Telegraph. Any Bands in This Activity

MEMBERS in each Section are invited to chat with as many other A.R.R.L. members (anywhere) as they can. The leading member station in each Section will receive *his own call* on the attractive watch charm medallions (illustrated) as soon as results have been analyzed.

Only A.R.R.L. Members are eligible. It is a family party for all of us members, a chance to see who our fraternity brothers are. CQ's are out! The way to get contacts in this will be to send "ARRL de . . ." In the course of a contact members will tell each other two things, the *name* of their Section¹ and the *date* their membership expires, month and year.

Log forms (not necessary) will be sent free on request to Hq., or rule your own, just three columns listing *calls, Sections, dates*. In radiotelephone contacts the Section, membership month and year will be named. No special order is required. The exchange can be a small part of the conversation. Radiotelegraph members will abbreviate Section names and use four numerals to show membership dates. "Conn 0343" will mean "Connecticut Section, my membership good until *March 1943*" for example. Information to be exchanged in every case comes right off your own *League membership certificate or pocket card*. Members will not enter in either a radiotelegraph or radiotelephone classification. Many use both. Scores can be all by one mode, or part telegraph and part voice—and any combination of frequencies you like. Advance entry is unnecessary. Just take part and send in the list of members you worked with claimed score.

Starting Time: Saturday, January 7th, 2300 11 P.M. Greenwich; 3 P.M. PST; 4 P.M. MST; 5 P.M. CST; 6 P.M. EST or the equivalent at any point.

¹ See complete list of 71 A.R.R.L. field organization Sections, in this issue of *QST*. An insignia award is also available to the leading member in each continent (outside field organization territory). All members outside the field organization use the name of their continent instead of a section abbreviation. Note that CO-CM, K4-6-7, KA, and VO as well as W-VE members are in the field organization and cannot be also counted under a continental status. Hq. staff stations and W1AW will participate but are not eligible for awards.

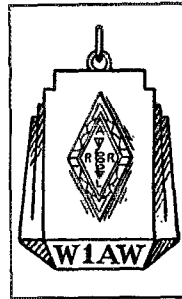

◆
Gold-Bronze-Enamelled Medallions with personal calls in the style shown will be awarded in each of the 71 A.R.R.L. sections and to the member leading each of the six continental areas.
◆

Ending Time: Monday, January 9th, 0801 8:01 A.M. Greenwich; 12:01 A.M. PST; 1:01 A.M. MST; 2:01 A.M. CST; 3:01 A.M. EST or equivalent.

Operate *any 20* hours of the 33-hour party. State contest hours you did *not* operate if your score is over 10,000.

Scoring: 1 point for each complete set of information sent; 1 point for each set of data received and logged. No member can be worked to get more than one complete exchange for 2 points. The sum of points will be multiplied by the number of *different Sections* (and continents² outside field organization territory) in which at least one member has been worked and exchange effected. A convenient way to keep record of new and different Sections as you work them is to circle and number the name of the Section the first time it is written in your list.

A lot of fun assured. See how many members you can work on this January Saturday-Sunday weekend. And if you work anybody not a member, ask him "Why not?" It's one of the big annual events. See you there.

—F. E. H.

² The multiplier is the sum of the number of Sections and continents outside the field organization territory in which at least one A.R.R.L. member is contacted. But a single multiplier times the sum of points gives the score. Example: W6XXX has completed two-way exchanges with 57 different stations located in 31 different A.R.R.L. Sections and Europe and Oceania. His multiplier is 33. Score? $2 \times 57 = 114$. $114 \times 33 = 3762$.

A Compact Crystal-Controlled 56-28-Mc. Phone Transmitter

A 25-Watt Input Band-Switching Unit Adaptable to Fixed-Station or Portable-Mobile Use

BY D. D. KAHLE,* W9AUJ

WITH the ever increasing activity on the 5- and 10-meter bands, the writer felt that a small transmitter, suitable for both portable mobile and fixed station use and designed for quick changing between 5 and 10 meters, would be welcome to the ultra-high-frequency minded amateur. This unit has been designed with several unusual features, among which are a unique system of band-switching, a high-quality audio system, and a minimum number of parts consistent with good design and compact construction.

R.F. Section

The transmitter is built on a chassis measuring 7 by 7 by 2¾ inches. The r.f. system consists of a 6V6 metal tube as a Tri-tet oscillator, operating from a 20-meter crystal, and an 807 final amplifier. The Tri-tet oscillator is conventional, and the only precaution necessary is that the cathode and output tanks should be well shielded from each other, since the cathode circuit tunes to a frequency fairly close to the output circuit. In the transmitter described, the cathode tuned circuit is mounted above the chassis while the output circuit is underneath. This is advantageous since the fact that the grid of the 807 comes out underneath the chassis makes an extremely short grid lead possible. A 250-milliamperere (6.3-volt) pilot lamp in series with the crystal barely glows, showing a low value of crystal current. The plate current of the oscillator is about 25 ma. loaded.

The 807 is used as a straight amplifier on 10 meters or as a doubler for operation on 5 meters. The grid current is about 4 milliamperes, which is slightly more than needed on 10 but is just about the correct value to drive the 807 as a doubler to 5. It is important that an I.R.C. old-style resistor with the metal ends be used in the grid circuit of the 807. Resistors of the new insulated type, both 1- and 2-watt sizes, were tried but apparently the insulation loss at 10 meters is very high, because both heated so badly that the insulation cracked, even with no tube in the final amplifier. Only 2 milliamperes of excitation were ob-

*571 Lafayette St., Denver, Colo.

tained with the insulated type whereas 4 milliamperes are obtained with the old metal-ended type. Ceramic material is used for insulation in the old type but the material in the new insulated type is evidently very poor for high-frequency use. Any resistor using ceramic insulation should operate satisfactorily.¹

The "5 and 10" outfit described in this article has some interesting circuit features, both r.f. and audio, besides its physical compactness. With "B" consumption approximately 150 ma. at 350 volts, it can be used with either the familiar a.c. power pack or the battery-operated vibrator-type supply.

The 807 socket is extended below the top of the chassis so that the overall height of the unit with the 807 in the socket is 6¾ inches. This allows the transmitter to be mounted in a standard 7-by-8-by-8 cabinet. A large hole is cut in the chassis to enable the shield, which is mounted on the socket, to extend

above the chassis.

A novel system of band-switching was designed for simplicity. As shown in the diagram, a single coil, condenser and 2-gang isolantite-insulated

¹ A good r.f. choke in series with the leak would prevent loss of this sort, since without the choke the resistor must carry r.f. as well as d.c. The insulated-type resistors have larger capacity in addition to the bakelite casing; both factors contribute to the greater loss as compared to the older type.—EDITOR.

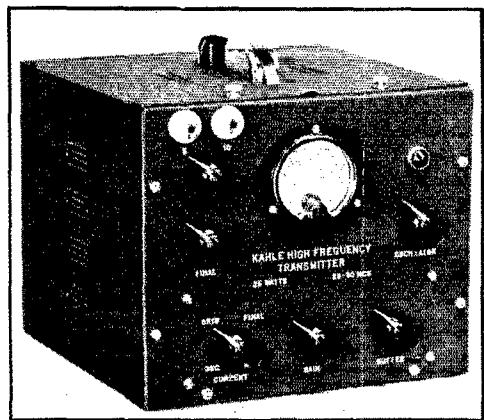

Compact construction features this crystal-controlled 28-56-Mc. transmitter. The case contains two-stage r.f. and three-stage audio systems. The r.f. output tube is an 807.

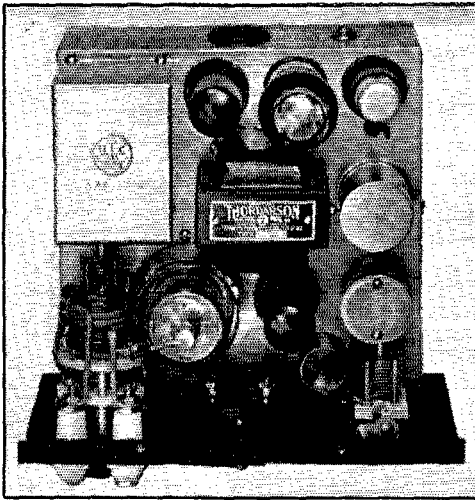

switch are used in the tank circuit. In an attempt to improve the efficiency of the 56-megacycle tank circuit, series tuning was chosen. Since the output capacity of the tube and capacity of wiring, etc., is practically all the capacity needed for a tank circuit of proper LC ratio for 5 meters, the addition of any external parallel capacity results in high circulating current. Because of skin effect and higher resistance at ultra-high frequencies, this high current results in reduced power output. With series tuning, we eliminate the disadvantage of additional parallel capacity and allow the circulating current to flow through the plate and screen leads of the tube. Since the 807 is designed for maximum input at 60 megacycles, it is able to withstand these circulating currents through

The top-of-chassis layout. The final tank circuit is at the left, next to the 807 tube. Oscillator and cathode tank circuit occupy the right foreground. The small can just behind the crystal is the microphone battery case. Audio section is along the rear edge.

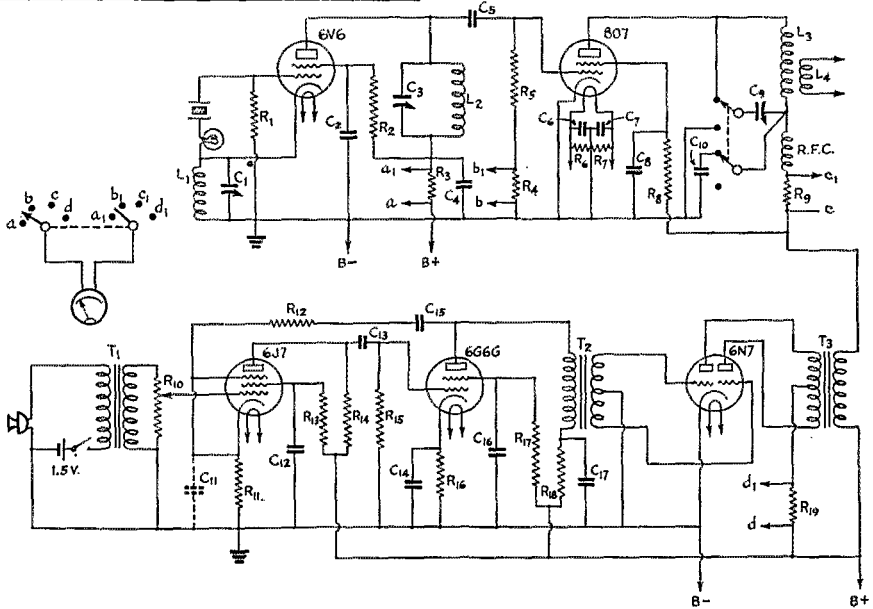

Fig. 1 — Circuit diagram of the r.f. and audio sections.

- R₁ — 100,000-ohm, ½-watt.
- R₂ — 30,000-ohm, 1-watt.
- R₃ — Meter shunt.
- R₄ — 600 ohms (meter shunt).
- R₅ — 50,000-ohm, 1-watt (I.R.C. Type F).
- R₆, R₇ — 50-ohm, ½-watt.
- R₈ — 10,000-ohm, 10-watt.
- R₉ — Meter shunt.
- R₁₀ — 500,000-ohm potentiometer.
- R₁₁ — 600-ohm, ½-watt.
- R₁₂ — 50,000-ohm, ½-watt.
- R₁₃ — 500,000-ohm, ½-watt.
- R₁₄ — 100,000-ohm, ½-watt.
- R₁₅ — 500,000-ohm, ½-watt.
- R₁₆ — 600-ohm, ½-watt.
- R₁₇ — 75,000-ohm, 1-watt.
- R₁₈ — 12,500-ohm, 2-watt.
- R₁₉ — Meter shunt.
- C₁ — 75- μ fd. midget variable (National UM-75).
- C₂ — 0.002- μ fd. mica.
- C₃ — 35- μ fd. midget variable (National UM-35).
- C₄ — 0.001- μ fd. mica.
- C₅ — 75- μ fd. mica.
- C₆, C₇ — 0.001- μ fd. mica.
- C₈ — 0.002- μ fd. mica.
- C₉ — 25- μ fd. midget, double spaced (National UM-100 rebuilt; alternate plates removed).

- C₁₀ — 0.002- μ fd. mica.
- C₁₁ — See text.
- C₁₂, C₁₃ — 0.1- μ fd. paper, 450-volt.
- C₁₄ — 25- μ fd. electrolytic, 25-volt.
- C₁₅, C₁₆ — 0.1- μ fd. paper, 450-volt.
- C₁₇ — 0.5- μ fd., 450-volt.
- T₁ — S.B. microphone transformer (Thordarson T-86A02).
- T₂ — Class-B input transformer for 6N7 (Thordarson T-67D89).
- T₃ — Class-B output transformer, 10,000 to 3500/5000 ohms (U.T.C. CS-33).
- RFC — 2.5-mh. r.f. choke.
- L₁ — 9 turns No. 12, inside diameter ¾ inch, turns spaced slightly less than wire diameter.
- L₂ — 8 turns same as L₁.
- L₃ — Same as L₁.
- L₄ — 3 turns No. 16, covered with spaghetti tubing.

the leads.² Although the tube efficiency may not be increased, the actual tank efficiency is undoubtedly increased.

For 10-meter operation, the condenser is switched in parallel with the coil, and a by-pass condenser is switched in from the "B"-plus side of the tank coil to ground. This arrangement results in a tank circuit of proper LC ratio for 10 meters. It is now seen that 5- to 10-meter band-switching is accomplished without any loss of efficiency, and it is highly probable that some efficiency is gained through the use of series tuning on 5 meters.

The tank condenser, 25- μ fd. maximum capacity, tunes about three-fourths of the way in on 10 and one-fourth in on 5, using the same crystal. The plate current of the 807 at resonance, unloaded, on 10 meters is 8 ma. with 360 volts on the plate. On 56 Mc. it is about 22 ma. with the same plate voltage. The minimum plate current unloaded, however, is not a true indication of efficiency; the figures are given simply as a comparative value on which the amateur can base his own findings.

Audio Equipment

The speech amplifier and modulator were designed with the idea in mind of obtaining the best quality possible with standard parts. Two stages of speech amplification were used so that sufficient gain would be available for fixed station operation. The 6J7 pentode feeds a 6G6G pentode driver for a 6N7 modulator. A large amount of negative feed-back is used from the plate of the 6G6G to the cathode of the 6J7 to reduce distortion which develops in the pentode driver stage. The use of negative feed-back also cancels most of the hum in the first two stages and reduces the overall gain to a usable value for carbon-microphone operation. No decoupling filter is necessary in the 6J7 plate circuit. A 50- or 100- μ fd. fixed condenser from cathode to ground in the 6J7 stage may be necessary to prevent r.f. feedback in the audio system, although it was not used in the original model. The 12,500-ohm 2-watt resistor is used to drop the plate voltage of

² At least at the plate voltage used by the author. A good by-pass condenser must be used from screen to ground, and the lead from the switch to the ground side of the condenser made direct and short.—*ERROR.*

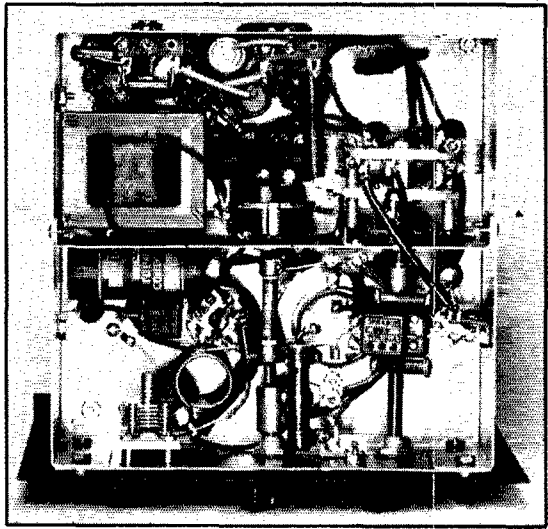

Bottom view, showing the division between r.f. and audio. In the lower (r.f.) section, the oscillator output tank circuit is at the left; 807 socket at the right. The meter switch and gain control are in the audio section, mounted on the shield partition. They are operated by extension shafts from the panel.

the 6G6G to 180 volts. The 6G6G was chosen as a driver principally because of its better driving capabilities and lower heater current.

With the assistance of W9CJJ of KFEL, a complete test was made on the audio system. The results were surprising indeed. The unweighted noise level measured — 44 db. The overall response from the grid of the 6J7 to the secondary of the modulation transformer, measured from zero level at 1000 cycles, was found to be flat within 2 db from 50 to 12,000 cycles. The total harmonic distortion measured 9 per cent at 20 watts input to the final amplifier with 100 per cent modulation.

It may seem strange that a single-button microphone is used after all the talk about the high-quality audio system, but the microphone used is a telephone type F-1 which has excellent quality for a carbon microphone. However, the idea in mind in giving information on response, noise level and distortion is to show what can be obtained from standard low-priced components, negative feed-back and proper design. The type F-1 microphone, however, sounds very good on

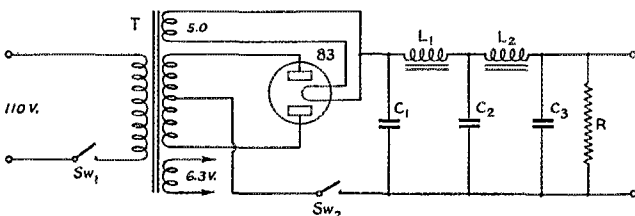

Fig. 2 — Power supply circuit.
 T — Power transformer, 350v. each side c.t., 145 ma., with 5- and 6.3-volt filament windings (Thordarson T-70R62.)
 C₁, C₂, C₃ — 8- μ fd. electrolytic, 500-volt.
 L₁, L₂ — 8-henry, 150-ma. (Thordarson T-13C30).
 R — 25,000-ohm, 25-watt.
 Sw₁, Sw₂ — S.p.s.t. toggle switches.

the air. A used button will not sound nearly as good as a new one, as those which have been in telephone service have been operated above 1.5 volts and in a good many cases the carbon is "frozen." Operating these buttons at 1.5 volts improves the frequency response because of the reduced current (about 10 milliamperes) through the primary of the input transformer. These buttons are now available from the Western Electric Company at a cost of \$4.50. Since they operate at such low current, a standard 1.5-volt flashlight cell can be used to supply current to them.

The round object next to the Thordarson modulator-input transformer is the microphone battery case. It was made of two pieces of $\frac{1}{16}$ -inch wall brass tubing. The plug-in part consists of a piece of $1\frac{1}{4}$ -inch inside diameter by $2\frac{1}{2}$ -inch long tubing, with a spiral flashlight spring soldered to a piece of brass plate and the plate in turn soldered to the tubing; after soldering, the excess material is turned off in a lathe. A hole is cut in the chassis, and a piece of bakelite with a brass machine screw filed off flat and inserted in it is mounted underneath the chassis. This screw acts as the positive terminal for the battery. A piece of $1\frac{3}{8}$ -inch inside diameter tubing is cut three-fourths of an inch long and two spade lugs for mounting are soldered on the inside. This piece of tubing is drilled and tapped for a $\frac{5}{32}$ screw and the case countersunk for this screw. The battery is inserted in the case and then slipped into the larger ring which is mounted on the chassis and the screw tightened, holding the battery and case firmly in place. The case can be chromium-plated for about 50 cents. The head of the holding screw comes out on the side of the chassis, and a hole is drilled in the cabinet so the battery can be removed without taking the chassis from the cabinet.

The microphone "on-off" switch is incorporated on the gain control.

For crystal microphone operation, it is necessary that a pentode stage of preamplification such as a 6J7 be added. The microphone battery case and transformer should be removed to make room for the tube, resistors and condensers. The rest of the amplifier need not be changed. Negative feed-back is not necessary on the preamplifier stage as distortion should be very low. The additional parts for a preamplifier stage will not cost any more than the battery case and transformer and it would probably be well worth

while to use a crystal microphone if the transmitter is to be used for fixed station operation most of the time.

Power Supply and Metering

The entire unit is operated from a 150-milliampere 350-volt supply for fixed station operation. Although most amateurs have such a power supply or the parts for one lying around, the circuit diagram and list of parts is given in Fig. 2 for those who would have to purchase one. The regulation is excellent considering that at 25 watts input to the final, 100 per cent speech modulation does not kick the plate-current meter downward. At 22 watts input, the plate voltage drops to 330 volts and the plate current is about 66 ma. This input presents a load impedance of 5000 ohms to the modulator.

A vibrator supply can be made up for portable-mobile operation by using two 75-milliampere 300-volt units in parallel. The heater drain of the transmitter is 2.6 amperes.

The oscillator plate, final grid, final plate, and modulator plate currents are measured by means of a 10-milliampere meter and a 2-circuit 4-position switch. The shunts are made by buying one Mallory-Electrad 10-watt, 2-ohm wire wound resistor and 4 extra clips. Three 100-milliampere shunts can be made from one resistor and soldered across the switch terminals. It is very easy to make these shunts. The ceramic tubing on which the resistance wire is wound can be broken very easily with a pair of side cutters and the clips put on and adjusted with a standard 100-ma. meter so that the 10-mil meter will read about 95 ma. with the standard reading full scale. Then the resistance wire can be filed off until 100-milliampere full scale reading is obtained. This system is practically as cheap as the plug and jack system and is much more convenient.

A 500-ohm resistor is connected across the switch terminals measuring the grid current. This resistor across the 10-milliampere movement does not affect the meter reading and, of course, the meter being shunted across it does not affect the grid current to the final.

Antenna Coupling

For fixed station operation, link coupling is used to an antenna coupling system. Fig. 3 shows the diagram. This coupling system is very simple and allows either tuned or untuned feeders of any impedance to be matched to the transmitter. Voltage-fed feeders are usually connected near the ends of the coil while current-fed feeders are connected closer to the center. By adjusting the position of the clips on the twisted-pair line, any degree of coupling can be accomplished. This system is usually correctly tuned when the final tank condenser tunes to resonance in the same place loaded as it does unloaded. Care must be taken to keep the clips in the same electrical

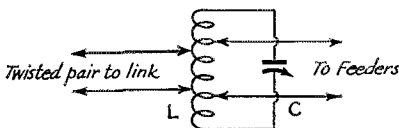

Fig. 3 — Antenna tuning unit.

L — 4 turns No. 12, diameter $1\frac{3}{4}$ inches, spaced $\frac{1}{2}$ inch.
C — 50- μ fd. variable.

position on each side of the center of the coil. If tuned feeders are used on an antenna for 5 and 10 meters, and if they are voltage fed on both bands, then it is possible that no change in the adjustment of the clips will be necessary and only the condenser need be retuned. For portable mobile operation, a better coupling arrangement would be had by tapping on the tank coil with a single-wire feeder.

The pictures show fairly well the parts placement and it is suggested that the constructional design be followed closely to insure efficient operation. No trouble should be experienced provided the circuit constants are duplicated. This unit operated exactly like the preceding "haywire" model with the exception of the r.f. feed-back as mentioned above. All ground and by-pass connections should be as short as possible, and in the r.f. stages should be made to the same point in each stage wherever convenient. It will be a simple, foolproof transmitter and with a reasonably good antenna will provide many reliable contacts.

Dual-Frequency Calibrator

(Continued from page 41)

quency can be estimated or, if desired, compared with some standard such as an audio-frequency oscillator, a piano or a mouth-organ.

The edges of the new 160-meter band and the 20-meter 'phone band are not multiples of 100 kc. They can be determined closely by interpolation, however, or with a strong signal, by performing the measurement at the second harmonic (1750 kc. $\times 2 = 3500$ kc., 2050 kc. $\times 2 = 4100$ kc.).

Images in Superhet Receivers

Other than the necessity for always starting with some known harmonic, there is an additional precaution which must be observed when the calibrator is used in conjunction with a superheterodyne receiver. Misleading calibrations or measurements can result from the presence of images. Unless the images are recognized and ignored, the calibration or measurement will be in error. Suppose we want to locate 7000 kc. with a 1000-kc. harmonic and the receiver i.f. is 465 kc. If the selectivity of the receiver is not extremely high, the 7000-kc. frequency will apparently occur at two points close together. One is correct, the other is an image of 8000 kc.

When the receiver is tuned to 7000 kc. the local oscillator is at 7465 kc. Now if the receiver is tuned to 6070 kc., the 7000-kc. signal may beat with the oscillator to produce the i.f. at 465 kc. and the same signal will be heard again at 6070 kc. (7000 kc. - (6070 kc. + 465 kc.) = 465 kc.). Similarly, the image of the 8000-kc. harmonic will appear at 7070 kc. Therefore, signals may be heard at 7000 kc. and 7070 kc., with 7070 kc., the

image, being the weaker of the two. This is not too confusing with 1000-kc. harmonics but could be quite difficult with 100-kc. harmonics because of their closer spacing. With a 465-kc. i.f. and 100-kc. harmonics there would be an image 70 kc. above (or 30 kc. below) each calibration point. Fortunately, however, the natural attenuation of the 100-kc. harmonics with increasing frequency is sufficiently great so that, in most cases, the images are barely discernible.

The problem of images becomes more serious as the frequency is increased because the frequency difference between the image and the correct frequency becomes a smaller percentage and, therefore, the receiver selectivity to images becomes less. By careful observation, with the knowledge that images may be present, incorrect measurements will be avoided. Once the images are recognized, their presence will cause no great concern.

The various controls for the crystal calibrator were designed to provide flexibility so that the instrument can be placed on the operating table and permanently connected to the station receiver. In addition to its application for frequency measurement and checking, the calibrator can be used to indicate dead spots or low sensitivity areas in any one tuning range or seriously decreased sensitivity from one range to another. After the mechanics and technique of using the calibrator have been learned, the instrument will prove to be a valuable adjunct to any amateur station.

810

(Continued on page 19)

Below are given some of the manufacturer's data: Direct interelectrode capacities:

Grid-plate.....	4.8 μ fd.
Grid-filament.....	8.7 μ fd.
Plate-filament.....	12 μ fd.

Class-C telegraphy at maximum plate voltage:

D.c. plate voltage.....	2000 volts
D.c. grid voltage.....	-160 volts
Peak r.f. grid voltage.....	330 volts
D.c. plate current.....	250 ma.
D.c. grid current.....	40 ma.
Driving power, approximate.....	12 watts
Power output, approximate.....	375 watts

— T. M. F.

Strays

A lady to whom W2GVZ recently delivered a ham message wrote a note of thanks and included, "I have a son in California who was an amateur once, but now is earning a nice salary and has his own home."

Cheer up, hams!!



NAVAL COMMUNICATION RESERVE NOTES

Twelfth Naval District, U. S. Naval Communication Reserve

BY LIEUT. (JG) RALPH A. JACK,
N6FPW

THE U. S. Naval Communication Reserve of the Twelfth Naval District, commanded by Lieutenant-Commander Henry U. Linkins C-V(S) USNR, has headquarters at 105 Market Street, San Francisco, Calif. Naval Reserve Radio Control station NDH is at NCR headquarters. NDO, the Reserve alternate control station, is located at Fresno, Calif. The District is divided into ten Communication Reserve Sections and 32 units. Sections average about 20,000 square miles and contain several units. The distances between Section District and Unit headquarters are on an average about 60 miles. The distance makes the radio work more interesting and simulates real communication situations where contacts must be solely by radio. NCR Section headquarters are at San Francisco, Oakland, San Mateo, Fresno, Berkeley, Santa Rosa, and Marysville, Calif., and Elko, Nev., Salt Lake, Utah, and Denver, Colo.

Section Three, the San Joaquin Valley Section, has been selected as a typical example of the NCR sections and is described in this article. Headquarters are in the Naval Reserve Building at the Fresno Municipal Airport. The Section contains four units located respectively at Turlock, Fresno, Lindsay and Bakersfield, as well as the Section headquarters at Fresno. Units One, Four and Five are respectively 90, 65 and 100 miles from the Section headquarters. The diagram shows the radio circuits operating into and out of the Naval Reserve Building in Fresno. The arrows show direction of command, although traffic is handled both directions on all circuits. The Western Net, controlled by NPG, San Fran-

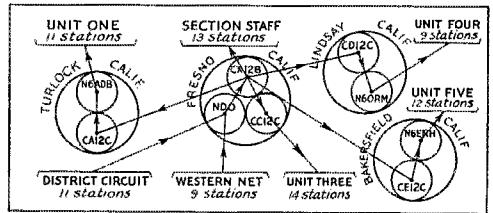

The circuits of Section Three NCR. The large circle in the center indicating Fresno is the same as the picture of the radio stations.

cisco, extends from Honolulu to Seattle and San Diego. The District Circuit, controlled by NDH, San Francisco, reaches from San Francisco to the four states, California, Nevada, Utah, and Colorado. Section Three participates in these circuits through NDO on the Western Net and CX12B on the District Circuit. Circuits confined to Section Three are the Section Circuit from Fresno to the four-unit headquarters at Turlock, Fresno, Lindsay and Bakersfield, and the unit circuits. The units each maintain two control or guard transmitters. One of these is on the Section circuit and the other is the unit control station. The unit control station contacts the individual radio stations of the members of the unit. Each unit conducts its own drill on its own frequency. Drills usually last two hours and are held weekly. For approximately 30 minutes Navy Radio NPG broadcasts naval reserve information to all members of the District. By means of the circuit plan it is possible to send information or dispatches from the District headquarters to any reservist at his own radio station in his home and receive answers via the other circuits in a short time. All communication is done on c.w.

The references made to stations and radiomen are made in their amateur station calls, although each radioman also has a Naval Reserve call assigned him for use on Navy frequencies. Each unit has several men enlisted as seamen who are training to become either radiomen or signalmen. This offers an excellent chance for young men who want to develop into radiomen or signalmen. They are given free training. Qualified radiomen are enlisted in rates as radiomen. Inquiries should be addressed to U. S. Naval Communication Reserve Commander, 105 Market Street, San Francisco, Calif.

Two interesting phases of the NCR work are the training duty at sea and at the Naval Reserve Aviation Bases, and the Emergency Com-

The site of emergency communications by N6DXG, N6ENA, N6FPW and N6GBT during snow disasters marooning several hundred people in the Sierra Mountains.

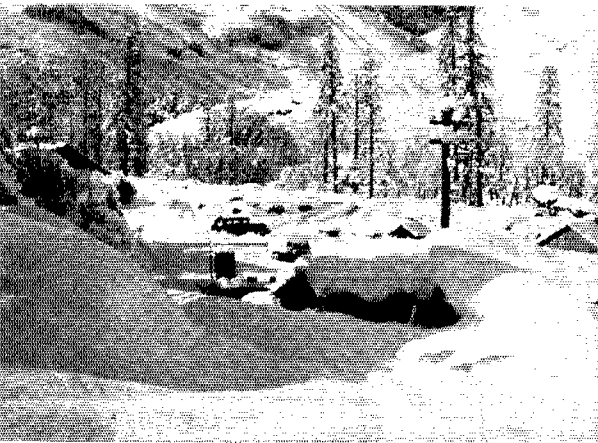

communication services rendered in cases of local disasters. Many radiomen train annually as radiomen on ships of the U. S. Navy at sea, or as radiomen in planes of the U. S. Navy operating out of Naval Reserve Aviation Bases. Section Three radiomen have cruised to Alaska, China, Hawaii, Panama, Mexico, South America, as well as the coastwise cruises. As this is being written, a Unit Three yeoman is on his way to Honolulu on NCR training duty.

One of the most fascinating branches of the work is the emergency communication service which is performed whenever disaster strikes. Many articles have appeared in *QST* about this type of service, so only a summary is given here of the emergency services performed by Section Three during the last few years. Unit Five, Bakersfield, furnished the emergency communications needed for six days when a cloudburst derailed and buried a portion of a train in the Tehachapi Mountains. Unit Three provided emergency communications when a California State Prison Camp was cut off from the outside world for weeks by exceptionally heavy snows. Radiomen N6DXG, N6ENA, N6GBT, N6CLB and N6FPW furnished communications continuously until roads were reopened and 'phone lines up again. The same combination handled emergency communication service when it was necessary to relay word back to snowplow crews to open a little used road, covered with 12 feet of snow at Hume Lake, so a woman could be removed to a hospital in Fresno, 70 miles away, for an emergency appendicitis operation. By use of NCR radio circuits, word reached the California State Highway Camp, isolated by snow and with 'phone lines down. Roads were opened and the woman was brought out and the operation performed successfully all within eight hours.

All units have aided in Flood Emergency communication work. Unit Three and the Section Staff were called upon twice last winter for such service. Members of Section Three Staff and of Unit Three spent 82 hours in the air in searching planes last spring, flying over snow-covered



This shows the Section Three headquarters radio room at the Fresno Airport. Transmitters operating on district, section and unit circuits are shown: Left to right, CX12B, NDO, CC12C, Supervisor N6CXM, Radiomen. Back row: N6NWN, N6IBU, N6GUR; Front row: N6JDU, N6JHM, N6BRU.

mountains, searching for a lost airliner, passengers and crew.

The U. S. Naval Communication Reserve offers amateurs an opportunity to communicate on circuits that really perform, an opportunity to become proficient in radio communication work, training duty as radiomen at sea with the U. S. Fleet, training duty in the air as radiomen in the planes of the Naval Air Bases, a chance to be a part of an efficient emergency disaster communication system and a rating in the Naval Reserve that is recognized by the U. S. Navy. The Naval Communication Reserve serves the amateur as a large Radio Club with a local chapter in his home town and chapters in most of the cities of the United States. The Club is the amateur's dream of the "Club with its own radio station, circuits, club house and real operators as members."

Book Review

Electrolytic Capacitors, by Paul McKnight Deeley; 276 pages, profusely illustrated. Cornell-Dubilier Electric Corp., South Plainfield, N. J.

Written in a most readable manner by the chief engineer of the Electrolytic Division of Cornell-Dubilier Electric Corp., *Electrolytic Capacitors* constitutes the first treatment of the subject which may be called complete.

While it does not divulge details of processing which might be termed "trade secrets," it is, nevertheless, an excellent source of technical information on the theory, construction, characteristics, testing and application of electrolytic capacitors of all types. Numerous block drawings and charts are used to illustrate the various steps in fabrication and to demonstrate the influence of each of the many factors involved.

The book concludes with an appendix describing the construction of simplified measuring and testing equipment.

—D. H. M.

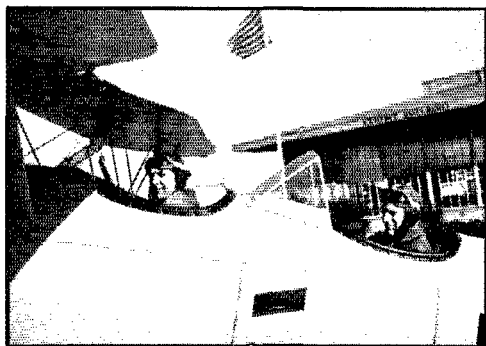

N6GBT in rear cockpit ready for flight as radioman in U. S. Navy plane.

★ I. A. R. U. NEWS ★

Devoted to the interests and activities of the

INTERNATIONAL AMATEUR RADIO UNION

Headquarters Society: THE AMERICAN RADIO RELAY LEAGUE, West Hartford, Conn.

MEMBER SOCIETIES

American Radio Relay League
 Asociația Amatorilor Romani de Unde
 Scurte
 Associazione Radiotecnica Italiana
 Canadian Section A.R.R.L.
 Českoslovenští Amatéri Vysílači
 Deutscher Amateur Sende-und-Empfangs
 Dienst
 Eesti Raadio Amatooride Ühing
 Experimental Radio Society of Egypt
 Experimenterende Danske Radioamatorer
 Federation des Emetteurs Belges
 Irish Radio Transmitters Society

日本アマチュア無線聯盟 Japan
 Liga Colombiana de Radio Aficionados
 Liga Mexicana de Radio Experimentadores
 Magyar Rövidhullámú Amatőrök Országos
 Egyletete
 Nederlandsche Vereeniging voor Interna-
 tionaal Radioamateurisme
 Nederlandsch-Indische Vereeniging voor
 Internationaal Radioamateurisme
 Newfoundland Amateur Radio Association
 New Zealand Association of Radio Trans-
 mitters
 Norsk Radio Relæ Liga

Polski Związek Krotkofalowcow
 Radio Club de Cuba
 Radio Club Venezolano
 Radio Society of Great Britain
 Rede dos Emissores Portugueses
 Réseau des Emetteurs Français
 Réseau Luxembourgeois des Ama-
 teurs d'Ondes Courtes
 South African Radio Relay League
 Suomen Radioamatööriliitto r.y.
 Sveriges Radioramatorer
 Unión de Radioemissores Españoles
 UnionSchweiz Kurzwellen Amateure
 Wireless Institute of Australia

COUNTRIES

WE ARE again running the list of countries used in computing the DX Century Club standings. The changes have been few and minor, amounting to the addition of several Pacific island groups (see last month's "How's DX?"), the consolidation of the British New Hebrides and French New Hebrides under one head (after it was determined that whether a French or English call is signed depends solely on the nationality of the operator!), and the deletion of Austria. Austria still counts, of course, under Rule 6 of the Club rules.

Country	Prefix
Aden	
Aegean Islands	
Afghanistan	YA
Alaska	K7
Albania	ZA
Aldabra Islands	
Algeria	FA
Andaman Islands	
Andorra	
Anglo-Egyptian Sudan	ST
Angola	CR8
Argentina	LU
Ascension Island	ZD8
Australia	VK
Azores Islands	CT2
Bahama Islands	VP7
Bahrain Islands	VS8
Baker Island, Howland Island, Am. Phoenix Islands	KF6
Balearic Islands	EA6
Baluchistan	
Barbados	VP6
Bechuanaland	
Belgian Congo	OQ
Belgium	ON
Bermuda Islands	VP9
Bhutan	
Bolivia	CP
Borneo, Netherlands	PK5
Brazil	PY
British Honduras	VP1

Country	Prefix
British North Borneo	VS4
Brunei	
Bulgaria	LZ
Burma	XZ
Cameroons, French	FE8
Canada	VE
Canal Zone	(K5)
Canary Islands	EA8
Cape Verde Islands	CR4
Caroline Islands	
Cayman Islands	VP5
Celebes and Molucca Islands	PK6
Ceylon	VS7
Chagos Islands	VQ8
Channel Islands	G
Chile	CE
China	XU
Chosen (Korea)	J8
Christmas Island	ZC3
Clipperton Island	
Cocos Island	TI
Cocos Islands	ZC2
Colombia	HJ
Comoro Islands	
Cook Islands	ZK1
Corsica	
Costa Rica	TI
Crete	SV
Cuba	CM-CO
Cyprus	ZC4
Czechoslovakia	OK
Danzig	YM
Denmark	OZ
Dominican Republic	HI
Easter Island	
Ecuador	HC
Egypt	SU
England	G
Eritrea	
Estonia	ES
Ethiopia	ET
Faeroes, The	OY
Falkland Islands	VP8
Fanning Island	VR3
Federated Malay States	VS2
Fiji Islands	VR2
Finland	OH
France	F
French Equatorial Africa	FQ8
French India	FN
French Indochina	FI8
French Oceania	FO8
French West Africa	FF8

<i>Country</i>	<i>Prefix</i>	<i>Country</i>	<i>Prefix</i>
Fridtjof Nansen Land (Franz Josef Land)		Oman	
Galapagos Islands		Palau (Pelew) Islands	
Gambia	ZD3	Palestine	ZC6
Germany	D	Panama	HP
Gibraltar	ZB2	Papua Territory	VK4
Gilbert & Ellice Islands and Ocean Island	VR1	Paraguay	ZP
Goa (Portuguese India)	CR8	Peru	OA
Gold Coast (and British Togoland)	ZD4	Philippine Islands	KA
Gough Island		Phoenix Islands	
Greece	SV	Pitcairn Island	VR6
Greenland	OX	Poland	SP
Guadeloupe	FG8	Portugal	CT
Guam	KB6	Principe and Sao Thome Islands	
Guatemala	TG	Puerto Rico	K4
Guiana, British	VP3	Reunion Island	FR8
Guiana, Netherlands (Surinam)	PZ	Rhodesia, Northern	VQ2
Guiana, French, and Inini	FY8	Rhodesia, Southern	ZE
Guinea, Portuguese	CR5	Rio de Oro	
Guinea, Spanish		Roumania	YR
Haiti	HH	St. Helena	ZD7
Hawaiian Islands	K6	Salvador	YS
Hejaz	HZ	Sardinia	
Honduras	HR	Samoa, American	KH
Hong Kong	VS6	Samoa, Western	ZM
Hungary	HA	Sarawak	VS5
Iceland	TF	Saudi Arabia	
Ifni		Scotland	GM
India	VU	Seychelles	VQ9
Iran (Persia)	EP	Siam	HS
Iraq (Mesopotamia)	YI	Sierra Leone	ZD1
Ireland, Northern	GI	Socotra	
Irish Free State	EI	Solomon Islands	VR4
Isle of Man	G	Somaliland, British	VQ6
Italy	I	Somaliland, French	FL8
Jamaica	VP5	Somaliland, Italian	
Jan Mayen Island	OY	South Georgia	VP8
Japan	J	South Orkney Islands	VP8
Jarvis Island, Palmyra group	KG6	South Shetland Islands	VP8
Java	PK	Southwest Africa	ZS3
Johnston Island	KE6	Soviet Union:	
Kenya	VQ4	European Russian Socialist Federated Soviet Republic	U1-3-4 7
Kerguelen Islands		White Russian Soviet Socialist Republic	U2
Kuweit		Ukranian Soviet Socialist Republic	U5
Laccadive Islands		Transcaucasian Socialist Federal Soviet Republic	U6
Latvia	YL	Uzbek Soviet Socialist Republic (Uzbekistan)	U8
Leeward Islands	VP2	Turkoman Soviet Socialist Republic	U8
Liberia	EL	Asiatic Russian S.F.S.R.	U9-0
Libya		Spain	EA
Liechtenstein		Straits Settlements	VS1
Lithuania	LY	Sumatra	PK4
Luxembourg	LX	Svalbard (Spitzbergen)	
Macau	CR9	Sweden	SM
Madagascar	FB8	Switzerland	HB
Madeira Islands	CT3	Syria	
Maldive Islands	VS9	Taiwan (Formosa)	J9
Malta	ZB1	Tanganyika Territory	VQ3
Manchukuo	(MX)	Tangier Zone	
Marianas Islands		Tannu Tuva	
Marshall Islands	J9	Tasmania	VK7
Martinique	FM8	Tibet	
Mauritius	VQ8	Timor, Portuguese	CR10
Mexico	XE	Togoland, French	FD8
Midway Island	KD6	Tokelau (Union) Islands	
Miquelon and St. Pierre Islands	FP8	Tonga (Friendly) Islands	VR5
Monaco		Transjordan	ZC1
Mongolia		Trinidad and Tobago	VP4
Morocco, French	CN	Tristan da Cunha	ZU9
Morocco, Spanish	EA9	Tunisia	FT4
Mozambique	CR7	Turkey	TA
Nepal		Turks and Caicos Islands	VP5
Netherlands	PA	Uganda	VQ5
Netherlands West Indies (Curacao)	PJ	Union of South Africa	ZS
New Caledonia	FK8	United States	W [N]
Newfoundland and Labrador	VO	Uruguay	CX
New Guinea, Netherlands	PK6	Venezuela	YV
New Guinea, Territory of	VK9	Virgin Islands	KB4
New Hebrides	FU8, YJ	Wake group	KC6
New Zealand	ZL	Wales	GW
Nicaragua	YN	Windward Islands	VP2
Nicarbar Islands		Wrangel Island	
Nigeria (British Cameroons)	ZD2	Yemen	
Niue	ZK2	Yugoslavia	YT-YU
Non-Federated Malay States	VS3	Zanzibar	VQ1
Norway	LA		
Nyasaland	ZD6		

A Signal-Metering Valve

A Different Approach to the Limitation of Signals and Noise Peaks in Receivers

BY H. O. TALEN,* W9PYQ

A VARIETY of methods has been developed for limiting the signal and noise peaks which blare out of our loudspeakers and earphones so unexpectedly at times. Some of the devices are applicable to the intermediate frequency channel in a superheterodyne receiver, others to the detector or audio channel, but very few to the high-frequency circuits in the receiver.

The circuit arrangement to be described is one which was evolved during a series of experiments with a 14-Mc. receiver of the tuned r.f.-regenerative detector type. It has not been tried out here in a superheterodyne line-up as yet.

The Problem

Automobile sparks, static and heavily modulated carriers have a natural but disconcerting way of getting into and through the first tuned circuits of the receiver. Fading signals, especially those which "fade in" to an R9++ are equally distressing with a receiver which has little or no automatic gain control action.

It has previously been pointed out by J. J. Lamb that the limitation of signal and noise peaks should take place in the earlier circuits in the receiver, before the high-Q tuned circuits are reached.¹ The difficulty involved depends primarily upon the insensitivity and relatively slow response of the majority of limiting devices available. The usual methods involving additional bias on the grids of the r.f. or i.f. tubes appear inadequate and difficult to apply at high frequencies, as numerous attempts have shown.

The Approach

An r.f. amplifier is usually operated as a Class-A amplifier designed to permit signal-voltage excursions somewhat in excess of those required to handle the signal levels ordinarily encountered. For this reason noise peaks, etc., come through

without much hindrance. If the grid voltage range of the input circuits is too limited, cross modulation effects and partial demodulation may be expected.

In spite of these threatened disadvantages, it was decided to experiment with an r.f. stage with severely limited grid voltage range, and if possible, to make use of any rectification which occurred on voltage peaks to reduce the amplifier gain with a minimum of time lag. In any event, the control tube, or "signal metering valve" was to be followed by a regenerative detector and audio channel (or i.f. amplifier) to bring the signal up to the required level.

A little attention to the radio textbooks brought out the fact that opposite changes in plate current are produced by grid-leak detectors and plate or grid-bias detectors, i.e., strong signals cause a decrease of average plate current in the former, but an increase with the latter type. It was learned also that a grid leak detector may be expected to produce about three times as much change in average plate current as a grid-bias detector.

Bridge Circuit Possibilities

In order to make use of the characteristics mentioned a bridge circuit, in which the opposite effects would tend to balance the branches, suggested itself. A double triode was chosen for the first trial, even though feedback troubles could be expected. Accordingly, the circuit shown in Fig. 1 was set up, using one of the triodes as a grid-leak biased amplifier and the other as a cathode-resistor biased amplifier, both expected to operate at times as rectifiers.

It will be noted that the grids are driven in phase and that the two plates are connected to opposite ends of a unidirectional center-tapped winding in such a manner that the fields produced by the two plate currents will cancel each

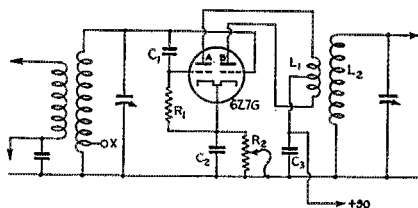

Fig. 1—Circuit arrangement of the signal-metering valve, using a double triode. In the author's receiver this circuit is inserted between a tuned r.f. stage and a regenerative detector. The coils have the usual constants for interstage applications; in the output circuit, L₁ has three turns each side of center-tap, L₂ 14 turns total, for operation in the 14-Mc. band. Other constants are as follows:

- | | |
|------------------------------------|--|
| C ₁ —100 μ fd. | C ₃ —0.005 μ fd. |
| C ₂ —250 μ fd. | R ₁ —1 megohm. |
| R ₂ —5000-ohm variable. | X—tap for negative feed-back (see text). |

The man with an autodyne receiver ought to turn out to be a pretty good operator—he has to cope with so many things, such as noise and interference, which the superhet owner has a chance to overcome. Except for audio limiters, practically all noise-reducing circuits have been aimed at owners and builders of superhets. The experimental circuit described here, however, is an exception—it can be used with either type of receiver, and it should not be hard to add it to a plug-in coil t.r.f. set. Certainly worth a trial if you're in a noisy location.

other, more or less. Assuming that the characteristics of the triodes are identical, and that they are operated at the same grid and plate voltages, the cancellation of the fields should be substantially complete, which is borne out fairly well in practice. By shifting the operating point of either triode with respect to the other, signals will be passed through because of the unbalanced condition.

Demodulation and Cross-Modulation

A milliammeter in the cathode lead of the signal valve shows a tendency to follow the modulation on strong signals, indicating demodulation of the peaks. For this reason and others, it is to be expected that the individual plate circuits carry harmonic currents, portions of which do not balance out in the common return to the cathode. However, the resultant signals, judged by the loudspeaker output, have not suffered sufficient distortion to make them any less acceptable, without being hyper-critical about them. Part of the explanation may lie in the fact that the "knee" of the resultant curves *C* in Fig. 2 becomes decreasingly sharp as minimum gain is approached. The least demodulation will occur when operating midway between the knee and plate current cut-off, a point dependent more or less on the operating conditions otherwise chosen.

During the time that the signal valve has been in use, no moderate cases of cross-modulation have been observed which could be attributed directly to this part of the receiver. As usual, the very powerful local 'phone signals effectively blanket any weak signals in their vicinity on the band.

Choice of Tubes

The experiments with the signal metering valve conducted to date have been confined to the use of the double triode, admittedly to save the work of installing an extra socket and the wiring for a pair of r.f. pentodes. The latter tubes should cause less trouble from feed-back between the plates and control grids. In the triode set-up, the plate coils must be

kept reasonably small, should be close wound and placed near the ground end of the following grid coil.

As a further means of controlling oscillation in the triode signal valve, the by-pass condenser, C_a , from the center tap of the plate coil was disconnected from ground and connected about $\frac{3}{4}$ of a turn from the ground end of the triode grid coil (point *X* in Fig. 1). This is an application of the circuit trick discussed in an article in *QST* for March, 1938,² giving negative feed-back of currents in the plate return lead. With this arrangement, which may or may not give exact neutralization, the triodes become stable enough to work between a regenerative r.f. pentode and a regenerative detector without interlocking of the two except when the regenerative gain in the first circuit is materially advanced.

The grid circuit of the signal valve tunes rather broadly due to the loading effect of the grid-cathode resistances. In a superheterodyne or other receiver with automatic gain control voltage provided by means other than that described here, the signal valve circuit with both grids biased directly, instead of having one of them biased by grid leak, could be incorporated either as an r.f. or an i.f. amplifier. In the latter application, the need for providing a center-tapped plate coil would not present the same difficulties as in the high-frequency end, particularly in a multi-band receiver.

In Fig. 2 are shown some grid voltage-plate current curves to illustrate the effects which may be expected from the arrangement in Fig. 1. For the sake of simplicity, no consideration is given to the fact that the plate current of the grid-leak triode (*A*) depends upon the combined effect of the signal voltage and the bias developed across the leak by the grid current.

In Fig. 2 (b), the triodes have equal bias and
²H. O. Talen, "A Feed-Back Compensator for R.F. Circuits," *QST*, March, 1938.

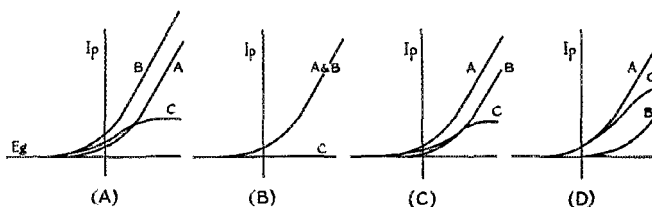

Fig. 2—Illustrative grid-voltage plate-current curves for the double triode. *A* is the grid-leak section; *B* the cathode-biased section. Curves marked "C" are obtained by subtraction, for the condition of equal bias in (b) and for various differences in bias in (a), (c) and (d). The vertical line does not represent zero bias but instead is intended to show the point of operation, or no-signal plate-current point, of triode *A*. For practical tubes, the "C" curves will slope upward at the right instead of being exactly horizontal.

the "gain curve" is a horizontal line, *C*. In Figs. 2(c) and 2(d), the curves have been separated by increasing the cathode bias on triode *B*. The grid leak of triode *A* is returned directly to the common cathode connection and the bias developed on grid *A* is substantially independent of the change in voltage drop across the cathode resistor R_2 , within limits.

As the difference in bias is increased, the resultant curves (*C*) begin to have sufficient slope to indicate amplification through the signal valve. Strong signals and noise peaks can be amplified to the full extent of the slope, but beyond that they can cause little change in the net voltage fed to the next stage, and accordingly the peaks are cut off or suppressed so far as the following circuits are concerned. In practice, the limitation of the peaks is readily appreciated, and the absence of noise crashes and blaring signals is a pleasant relief for which the price paid is a loss of part of the overall gain otherwise available from the r.f. stage devoted to control purposes.

If the bias on triode *B* is gradually made less negative than that on grid *A*, a similar series of effects would be obtained, as in Fig. 2(a). It may be necessary to apply an actual positive bias to the grid of triode *B* to obtain a sufficient separation of the characteristic curves.

Automatic Gain Control

As mentioned, the triode *A*, with grid-leak bias, tends to shift its operating point to a lower plate current, which is equivalent to moving its operating curve to the right. The decreased current should have the effect of lowering the voltage drop across the cathode resistor, thereby reducing the bias on triode *B*. The latter triode, on the other hand, will tend to draw a higher current, equivalent to moving its curve to the left by a relatively small amount. The net effect (when the bias on *B* exceeds the bias on *A*) is to reduce the slope of the resultant curve *C*, and therefore to reduce the effective gain of the signal valve. The length of the "linear" portion of the slope also decreases to a certain minimum which is a function of the curvature of the E_p-I_p characteristic of the triodes near plate current cut-off.

The net decrease in plate current caused by a strong carrier can be observed on a milliammeter in the cathode or plate lead, and amounts to as much as 10 per cent of a total current of from one to two milliamperes. The a.g.c. action, if any, on weak signals is important only as it concerns fading, and no experimental proof of such action has been attempted.

The proper setting of the adjustable cathode resistor, R_2 , can be found readily enough by observing the point at which minimum signals are obtained, and then increasing the resistance until a satisfactory signal level, or the maximum tolerable noise level, is reached. The "minimum" setting depends upon the value of grid leak R_1

and the plate voltage used. In the experimental set-up, a one-megohm leak worked more satisfactorily than a half megohm or two megohms. The plate voltage was kept at about 90 volts, which may or may not be the optimum value.

Volume Expansion

From the foregoing discussion, it is apparent that a limited degree of "volume expansion" could be obtained by operating grid *B* at a more positive potential than grid *A*. It may also be noted that, when the biases are adjusted for low output with a.g.c. action, a strong carrier will reverse the relation of the biases and volume expansion will occur, particularly on modulation peaks. Under these conditions, the louder signals on the hand come through with very little background and heterodyne noise. Transient peak voltages continue to be limited by the signal-valve action.

"Phone "Splatter"

(Continued from page 29)

not take into account practical limitations usually encountered in actual practice. As a matter of fact, it is safe to say that because of the above considerations most amateur stations cannot be modulated 100 per cent.² The remedy for the above condition lies in decreasing the Class-B plate-to-plate load, thus increasing both the peak current of the tubes and the value of minimum plate voltage. Although this procedure will cause overload for a sine-wave signal, for speech purposes the tubes are operating well within their average-current and plate-dissipation limits. In fact, it is possible to obtain a considerable amount of speech power by decreasing the plate-to-plate load to the correct value.³ In conclusion, the intelligent use of the automatic modulation control circuit and the correct adjustment of the Class-B modulator will result in a clear-cut understandable signal which requires a minimum of band width and which causes a minimum of interference to adjacent channels.

² Provided good design principles are followed, however, the well-known tendency to use more than rated plate voltage, plus "conservatism" in providing more than enough audio power, account for the fact that there is a good deal of actual overmodulation.—EDIRON.

³ For design information, see Anderson, "Speech versus Sine Waves," *QST*, March, 1938.—EDIRON.

Strays

When W1TS sent his msg nr 73 in the recent SS Contest, W7CMB replied with his nr 88. When 1TS sent his msg nr 88, VE3GT answered with his msg nr 73.

W2QY says, "The wiring arrangements of too many ham transmitters are not so well suited for the label 'Underwriter's Approved' as for the version 'Undertaker's Approved!'"

HOW WOULD YOU DO IT?



During the past year or two, Our Hero has uncovered many worth-while kinks of general interest in his search for solutions to his various problems. He feels, however, that the purpose of the Problem Contest would be better served if others brought their problems out into the open. He believes there are many knotty problems of general interest which pop up from time to time in the experiences of other amateurs.

If you have a problem of general interest, or know of someone who has such a problem, why not jot it down on a card and mail it to the Problem Contest Editor, *QST*, West Hartford, Conn., and see what the gang can do with it? Even if you already have a solution, perhaps a better one can be found.

We shall endeavor to use as many as possible of the problems submitted. How about it?

ANTENNA SWITCHING WITH CONSTANT LOADING

IT WILL be remembered that Problem No. 22 (see *QST* for October) involved switching the transmitter to any one of several antennas of various types and, at the same time, maintaining constant transmitter loading so that the transmitter might be switched quickly from one system to another without adjustments of any kind.

All solutions received run along similar lines. A separate antenna tuner is provided for each antenna system. Low-impedance lines lead from the antenna couplers to the switching arrangement, and thence to a link, coupled to the output-amplifier tank circuit. Some means, such as a variable link, is provided for each antenna tuner so that coupling may be adjusted to the desired degree.

Fig. 1 shows various antenna-coupler arrangements. The arrangement at A is especially suitable for 400-, 600- or 800-ohm lines although it is sometimes used with tuned lines. The system at B will be recognized as the series-parallel tuner used commonly with tuned lines feeding Zepp or center-fed antennas. At C is shown the method of coupling to a simple voltage-fed antenna or to a single-wire transmission line. An antenna fed with a low-impedance cable line needs no adjusting coupler as indicated

at D. W80MM suggests the arrangement shown at E in which variable condensers are eliminated by the use of a variable-inductance coupler.

In A and C, the tank circuit should be capable of tuning to resonance at the operating frequency. At B, the size of the coil will have to be adjusted experimentally for the feeder length and frequency at which it is to be used. The size of the variable inductance coil at E will also depend upon the characteristics of the line with which it is to be used. The inductance should vary from 0.25 to 1 microhenry per meter for medium low-impedance lines. For tuned lines, the inductance should vary from about 5 microhenrys per meter to zero, depending upon feeder length.

The various schemes for switching the low-impedance link lines from one antenna coupler to another are shown in Fig. 2. At A, a pair of ganged rotary switches selects the proper link line while the d.p.d.t. switch or relay switches the particular antenna in use from transmitter to receiver. The arrangement at B, suggested by W1FHH and W1KFN, is the same except that one side of each link line is common so that a single rotary switch unit may be employed.

At C, a system of two d.p.d.t. switches by W3HDI is used to take care of as many as four antenna systems. At D, is the system of plugs and jacks used by W2JQM.

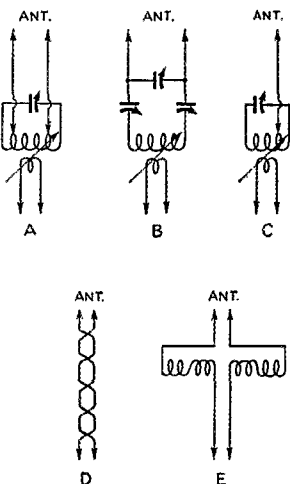

Fig. 1 — Antenna coupling systems. A — For medium impedance transmission lines. B — For tuned lines. C — For voltage-fed antennas or single-wire transmission lines. D — Low-impedance line. E — Variable-inductance coupler.

Adjustment

As mentioned previously, some means of adjusting the coupling between the link line and the antenna coupler should be provided in each case. This may be accomplished by providing a swinging link winding or by tapping the link line on the antenna tank coil. The output amplifier tank coil should also be provided with a variable link to permit adjustment of coupling and to remove d.c. voltage from the link line. If one of the antenna systems in use employs a low-impedance line of 70 ohms or thereabouts, the transmitter should be first tuned and adjusted for proper loading with this antenna system. The output tank circuit coupling should be fixed for this antenna system and the coupling for the other antenna systems should be adjusted at the antenna coupler rather than at the final amplifier.

The coupling for each of the other antenna systems is adjusted to duplicate the loading of the first.

Most communications-type receivers will work satisfactorily, even though most input circuits are designed for somewhat higher impedances, if the low-impedance line is fed directly into the input terminals, unless the connecting link lines must be of appreciable length. In this case, a circuit tuning to resonance may be placed near the receiver, and the receiver input and low-impedance transmission line coupled to this tuned circuit by means of separate link windings, preferably one of which may be varied for best matching. W8BYU uses 300-ohm lines to provide a better match for the receiver input. This line may consist of a pair of No. 12 wires spaced one-half inch. Once set, it should not be necessary to change the receiver coupler adjustment when switching from one antenna to another.

With each of the antennas adjusted as described, it should be possible to switch quickly from one antenna to another, when the occasion arises, without the necessity for further adjustments.

Prize Winners

First Prize — Kenneth V. Curtis, W1FHH.

Second Prize — Floyd L. Rittman, W8BYU.

Rules under which the contest is conducted are as follows:

1. Solutions must be mailed to reach West Hartford before the 20th of the publication month of the issue in which the problem has appeared. (For instance, solutions of problem given in the January issue must arrive at *QST* before January 20th.) They must be addressed to the Problem Contest Editor, *QST*, West Hartford, Conn.

2. Manuscripts must not be longer than 1000 words, written in ink or typewritten, with double spacing, on one side of the sheet. Diagrams must be neat and legible.

3. All solutions submitted become the property

PROBLEM NO. 24

Our Hero is in a quandary. He put off replacing the halyards on his sixty-footer just a bit too long. The other day a stiff breeze put enough strain on the rope to break it. This leaves Our Hero gazing skyward, with one end of his antenna on the ground, wondering how he is going to replace the halyards without taking down the mast. The mast has two sets of guy wires, one set about half-way up and the other set at the top. How would you go about replacing the halyards?

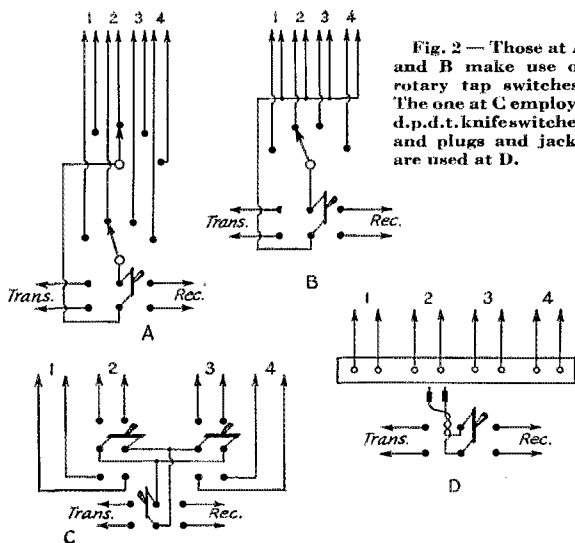

Fig. 2 — Those at A and B make use of rotary tap switches. The one at C employs d.p.d.t. kniveswitches and plugs and jacks are used at D.

of *QST*, available for publication in the magazine.

4. The editors of *QST* will serve as judges. Their decision will be final.

Prizes of five dollars' worth of A.R.R.L. station supplies or publications will be given to the author of the solution considered best each month, two dollars and fifty cents' worth of supplies or publications to the author of the solution adjudged second best. The winners are requested to specify the supplies preferred.

Silent Keys

It is with deep regret that we record the passing of these amateurs:

- Frank B. Arup, EI3M, Sandycove, Dublin, I. F. S.
- Henry R. Chetham, W1HC, Somerville, Mass.
- Robert S. Connavaile, W3KFM, Springfield, N. Y.
- Edward Germeroth, W2CHT, Ridgewood, L. I., N. Y.
- Robert M. Henderson, W8LQO, Cedar Springs, Mich.
- Lt. Allen Moore Howerly, U.S.A.A.C., W4EJO, Knoxville, Tenn.
- Arthur Kammer, W2PH, Lynbrook, L. I., N. Y.
- Melford Sewalson, W7BDZ, Butte, Montana
- George L. Steen, W3AYQ, Bordentown, N. J.



HINTS AND KINKS

FOR THE EXPERIMENTER



AN OSCILLATOR WHICH COMBINES MANY FEATURES

AFTER four years of experimenting with oscillators, crystal and e.c., and using almost every oscillator tube from a '99 to my big 803, I have at last hit upon a solution to my woes.

Ideal oscillator requirements include the following conclusions:

1. The oscillator must key readily, even with cranky crystals.
2. There must be no chirp in the note.
3. Key clicks must be absent to permit easy break-in operation and also to avoid broadcast interference.
4. The oscillator must permit key leads of any length without resort to a relay.
5. The current keyed must be small to save keying contacts.
6. There must be no possibility of getting shocked when the hand is put across the key.
7. The base of the key or bug must be grounded to prevent shocks between receiver and key.
8. Crystal current must be less than 30 ma. at all times.
9. When operated as an e.c. oscillator the

stability must be comparable with that of an X-cut crystal.

10. The oscillator must not require a special high-regulation power supply.

11. It must not require any outside power, or entail a loss in available voltage. (Vacuum tube keyer is thus unsuitable because of drop in voltage and because of need for extra equipment.)

Does your oscillator meet these requirements? If not, try the circuit of Fig. 1. I do not claim high power output for this oscillator, but it has high stability and good keying.

With a 7½-watt lamp as load, I experimented with various voltages and circuits, and found that the Tri-tet circuit with the 802 was the best suited to my purpose. Using a 60-ma. lamp to indicate crystal current, and variable resistors for obtaining proper voltage for screen and suppressor, I found that the output remained nearly constant down to 35 volts on the screen and 30 volts on the suppressor. The plate voltage was 450. With this potential, things did not heat up, and the crystal current dropped off so low that it did not light up the 60-ma. bulb at all; this was with a VF-1 80-meter crystal and output on 40 meters. After getting that part of the problem settled, keying was taken up. Keying the negative connection produced clicks, and besides one could easily get a shock when touching the key. Keying the ground lead of the cathode coil works very well with crystal control but not so well for e.c. operation as it causes variation of the frequency. Positive keying produced clicks and a chirp with e.c. Screen or suppressor keying failed to cut the output to zero, with the additional disadvantage of putting high voltage on the key. Finally, after studying the *Handbook* in search of ideas, I noted that grid block keying (illustrated for an amplifier stage) might have possibilities. No sooner said than done, so I installed a 45-volt battery to try it out temporarily. It worked so nicely that I haven't bothered to obtain the blocking voltage from a bleeder. Anyway, the battery is used to bias the 803 final, so why not use it if available? If a little more crystal current is not objectionable, the grid resistor might be increased, but I found by using a variable one that 10,000 ohms was best for crystal and about 2000 ohms for e.c.o. I left it at 10,000 ohms, however, since undoubtedly many crystals would cause keying difficulties with only 2000 ohms. However, the lower the better from the

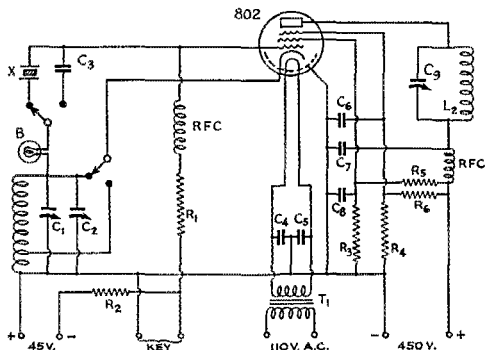

Fig. 1 — Circuit of the high-stability oscillator.

- C₁ — 325- μ fd. receiving-type variable.
- C₂ — 35- μ fd. midjet variable.
- C₃ — 250- μ fd. fixed mica.
- C₄, C₅ — 0.01- μ fd. fixed tubular paper.
- C₆, C₇, C₈ — 0.002- μ fd. fixed mica.
- C₉ — 100- μ fd. midjet variable.
- R₁ — 10,000-ohm, 2-watt carbon.
- R₂ — 50,000-ohm, 1-watt carbon.
- R₃ — 10,000-ohm, 10-watt.
- R₄ — 10,000-ohm, 1-watt carbon.
- R₅ — 40,000-ohm, 10-watt.
- R₆ — 150,000-ohm, 2-watt carbon.

standpoint of crystal current. I might mention that this VF-1 crystal has a minimum frequency of 3500 kc., and it is often operated for output on 7000.2 kc., so crystal current is especially important with a negative temperature coefficient of the crystal.

Using the e.c.o., the only difference I can detect is the fact that a ripple is slightly noticeable. This is as expected, for the present filter is inadequate for an e.c.o. More is to be added later. The crystal tone is quite pure.

No shock is possible, and the key leads are over 50 feet long. The keyed current is exceedingly small.

Although I have not had a chance to use it very much since I built it, all reports have been crystal, and most of the fellows are very much surprised to know that I use e.c.o. It is very stable and the drift is negligible. The low screen voltage plays an important part in reducing drift. The accompanying circuit is that of the resulting oscillator (Fig. 1). It could be simplified somewhat by use of a single low-resistance bleeder with taps, using the power supply itself for the blocking voltage (which is between $22\frac{1}{2}$ and 45 volts).

—Alan Buffington, W3EEW

TROUBLE GOING TO TEN METERS?

AFTER much difficulty had been experienced in attempting to drive a push-pull amplifier on ten meters with an 814 buffer stage, it was found that rearrangement of the amplifier parts and wiring made possible an increase of excitation grid current from 50 to 70 ma. The layout which resulted from experiments with the ten-meter amplifier is shown in the accompanying illustrations.

The grid coil is mounted directly on the Cardwell MT70GD tuning condenser (equipped with

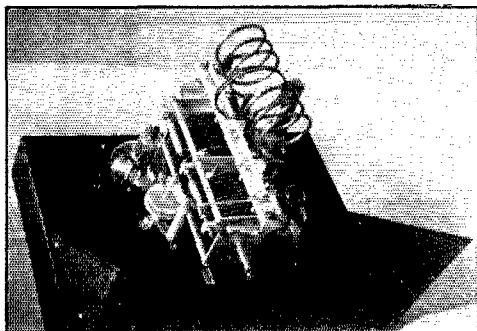

Views above and below the improved amplifier arrangement.

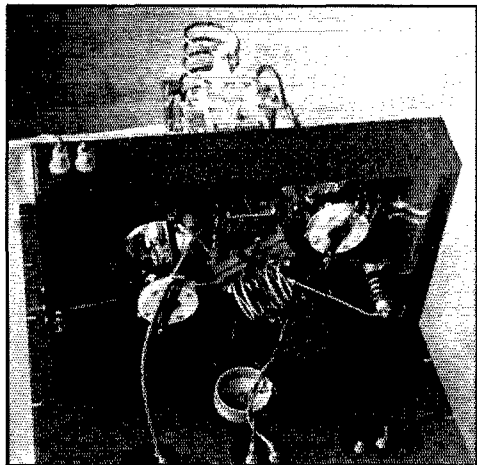

high-frequency dielectric strips) which is mounted beneath the chassis with rotor plates almost touching the chassis when open.

Feed-through insulators directly in line with the bottom plate connections of the neutralizing condensers make possible extremely short leads, while the top plate connections of the neutralizing condensers extend almost directly to the stator connections on the plate tuning condenser.

The Johnson 70DD70 plate condenser was chosen for several reasons: Reversing the end angles and extending them by using the panel mounting pillars (supplied with the condenser) permitted mounting the B. & W. high-power coil directly on the condenser. The construction of the condenser (with stator plates flaring out to greatest over-all width at what is normally the base of the condenser) makes it possible to have the tops of the amplifier tubes come almost to the stator terminals.

It is particularly important on ten meters if

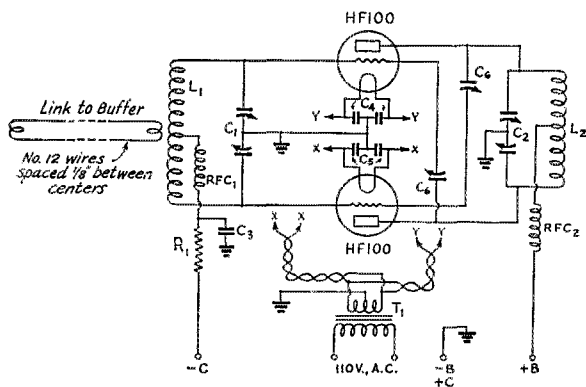

Fig. 2 — Circuit of the revised ten-meter amplifier. The circuit and parts used are conventional in every respect, and suitable constants may be taken from Fig. 859, 1939 Edition of the Radio Amateur's Handbook.

the r.f.-carrying links between stages are long and are likely to have fairly high r.f. voltage across them, that a line using good high-frequency dielectric be used rather than the more common twisted-pair line. The latter type became quite hot when used to couple the grid circuit of the ten-meter amplifier to the plate circuit of the buffer, and since the total power output of the buffer is small compared to the output of the transmitter, noticeable heat at this point represents a relatively large loss of driving power. The link used here consists of two No. 12 wires spaced $\frac{1}{8}$ inch between centers. The wires are held in this spacing by tight-fitting holes drilled through small blocks of Victron.

Four filament by-pass condensers are used; two are connected directly to the filament terminals of each socket, and the four ground ends of the condensers are connected to a ground point on the chassis. Separate heavy twisted pairs are then run to the filament transformer, which is placed in an inconspicuous position beneath the front of the chassis.

Although no circuit change was made when the final amplifier was rebuilt for ten-meter operation, and although the circuit used (see Fig. 2) is quite conventional, the rearrangement of the parts from the former layout which required longer connecting wires and longer ground return paths has made it possible to more than adequately drive the amplifier with an 814 buffer which, previously, had insufficient output.

—W. K. Thomas, W8QAN

EMERGENCY GRID TANK

ALTHOUGH crystal frequency control alone may be used during normal operation of an amateur station, provision for readily converting the oscillator from crystal control to self-excited operation may be of value for several reasons. For instance, it is sometimes desirable to make measurements on an antenna system for a wide

range of frequencies, or to determine whether certain tuned circuits in the transmitter are capable of covering entire bands. Unless the operator is so fortunate as to possess several crystals of suitable frequencies, self-excited operation of the transmitter is the logical solution for these purposes. Probably a greater reason for providing some means for self-excited operation is the possibility that some unforeseen condition might make it very important that the transmitter be operated on some frequency for which no crystal is readily available, with the stability of the oscillator a secondary consideration in this case.

The simple and effective coil-and-condenser tank shown in Fig. 3 is the outcome of such thoughts on the part of Walter S. Rogers, W1DFS.

A 5-prong coil with tuning condenser internally mounted is used for the complete gadget, with one end of the winding and one connecting wire from the condenser connected to one of the base pins ordinarily used for crystal connection, and the

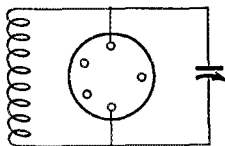

Fig. 4

other condenser connection and coil end connected to the other crystal pin, as shown in Fig. 4. The coil form is a Hammarlund SWF-5, and the condenser is a Hammarlund APC-100 midget designed especially for mounting in the form. The condenser shaft at W1DFS is provided with a bushing-type shaft extender, and a bakelite knob is used for convenient tuning of the tank. Alternatively, screwdriver adjustment of the condenser may be used—the shaft is made with slot provision for this purpose.

Tanks for the 160-, 80-, and 40-meter bands are made by closewinding 60 turns, 23 turns, and 12 turns, respectively, of No. 22 d.c.c. wire on the $1\frac{1}{2}$ -inch diameter coil forms. These inductances allow tuning on all three bands in the maximum capacity range of the condenser.

~~Strays~~

James Dickert ("A New Automatic Noise Limiter," *QST*, November, 1938) drops us a note to say that the 6Y7G or 6Z7G can be substituted for the 6M7, 6A6, etc. in the noise limiter with equally satisfactory results. The advantage is that these tubes have smaller envelopes and therefore probably can be fitted more readily into existing receivers. Another point of interest to builders of the circuit is that hum caused by heater-cathode leakage can be cured by reducing the heater voltage: $3\frac{1}{2}$ to 4 volts on the heater is sufficient for good circuit operation, and eliminates hum from this source.

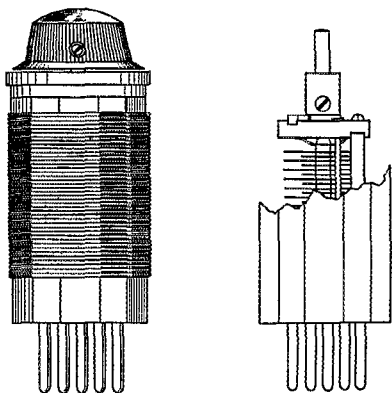

Fig. 3—Simple frequency-control unit for self-excited operation.



OPERATING NEWS



F. E. HANDY, Communications Manager

E. L. BATTEY, Asst. Communications Manager

The Member Party. The biggest event in operating, to start the year off right, is the special activity dedicated to all League Members, to be held January 7th and 8th . . . call-emblem-insignia prizes . . . only League members eligible. See the announcement back a few pages and get in on the fun!

Use MH-ML-HM-LM Sub-Band Tuning. We repeat below the tuning definitions¹ discussed last month with suggestions from outside this country on how-to-work-DX. The point was that to make good QSO's easier, results better, all of us amateurs should use *all* our frequency bands, not just pile up on the edges ineffectively with only a few brute power radiators able to get through.

It is now suggested, with due thanks to W1AVB, that the QMH signals be described more completely, as applying to specific sub-bands rather than to entire amateur bands. At 20 meters, for example, we have in the U. S. A. a 400-kc. band which is (in operating effect) two "outside" sub-bands in which c.w. is predominant, separated by a central portion in which voice work predominates. It is logical that the QMH-QLM operating signals should *not* be used in cross-band operation, but should always apply with respect to *each sub-band segment*² *alone!*

All stations outside the United States are asked to make liberal use of the QMH, QML, etc. abbreviations or their equivalents in accord with example² below. In this manner more satisfactory contacts, much more free of interference, may readily obtain.

Emergency Readiness. OM Winter came early this year with extra-heavy snowfall. It is timely then to call attention to the fact that we

¹ From "Operating an Amateur Radio Station:

- QHM — Will start to listen at high frequency end of band and tune towards middle of band.
- QMH — Will start to listen in the middle of the band and tune toward the high freq. end.
- QLM — Will start to listen at the low frequency end of band and tune towards middle of band.
- QML — Will start to listen in the middle of the band and tune toward the low frequency end.

² For example, 14,000-14,150, 14,150-14,250, 14,250-14,400 kc., 28-28.5 and 28.5-30 Mc., are typical sub-bands. The low and HIGH designations should refer to the extremities of each of these sub-bands in practical work.

If a DX station working at 14375 kc. uses "LM" or QLM after he signs, you may be sure he is tuning for stations working between 14,250 (the low end), back to his own frequency, about in the middle of the particular band segment. A radiotelephone specification of TUNING HIGH to LOW (for QHL) would indicate tuning was to be 14,250 to 14,150 kcs., likewise.

should be prepared for the hazards of winter, and the likelihood of a flood season to follow. Amateur radio communication must be ready to function on short notice to replace disrupted or overloaded wire circuits in either isolated or general-relief-type emergencies. Preparedness is the prime need of the whole amateur service.

Have you equipped so you could go self-powered in a hurry should you find yourself the only skilled "radio" person in your community? Are you all lined up with the League's Emergency Corps (whether self-powered or not) so you know the practice and policy thoroughly? Are you lined up with your Coördinator so you know "just" where you would fit into the picture best in emergency?

Every amateur with a license should "register" in the A.E.C. Qualified men to represent the amateur service as EMERGENCY COÖRDINATORS are needed in scores of communities. These appointments are made by S.C.M.'s. E.C.'s have the responsibility of framing plans for almost any contingency for their locality, of forming local amateur-planning committees, and of maintaining contact with local officials, keeping the community aware of what we amateurs are prepared to do. As an individual amateur, maintain annual registration in the A.E.C. To those now registered: Be sure you return (filled out) the colored survey form that will reach you direct from Hq. after the turn of the year. It will be the "annual round-up" or roll call to insure activity and readiness, and we are obliged to drop those *not* responding in order to know just where we stand from a preparedness standpoint from year to year.

The new F.C.C. Emergency Regulations for the amateur service are explained (pages 405-407 and 420) in the new Radio Amateur's Handbook. Refer to those sections, or ask your local A.R.R.L. Coördinator what you must do, should a communications emergency condition arise. When F.C.C. "declares" a communications emergency these F.C.C. restrictions on 1.8 and 3.5-4-Mc. work become mandatory. More on Emergency Work next month.

— F. E. H.

BRIEFS

When you're out on your New Year's Eve celebration, try a CQ on your horn or other noise maker . . . you might be surprised — like W2KZQ was when he tooted a CQ while ushering in 1938, and raised W2JKN on the other side of the dance floor!

If you need Arizona for W.A.S., look for the following stations: 28 Mc. — W6KMM OIF IXC NGJ FZQ OJK OWX NGG MAE ORX GFQ KMG PNN NEL LSK JFO. 14-Mc. 'phone — W6IMR KTJ KVE; c.w. — PFL PEO CVW QAP PJP KMM. 7 Mc. — W6IYZ NXO PNN LYU NEL PUM QBX PFL 5GDT/8. 3.5-Mc. c.w. — W6NRP NVC BMC GBN NXO JJO QNJ KMM. 3.9-Mc. 'phone — W6KMM L3N HVY LKE POM OFE. 1.75-Mc. 'phone — W6LYG J1W PQQ OWX.

— . . . —

An amateur radio station was displayed and operated at the DeKalb County Fair, Auburn, Ind., during the first week of October, '38. The rig was set up in a special booth in the county courthouse. Much interest was shown by the fair-goers. The transmitter used was the property of W9IWN, whose call was used. W9YZJ furnished the receiver, W9YCF the modulation meter and additional equipment.

— . . . —

Attention is called to the fact that W hams too often do not put enough postage on QSL's addressed to Canada. Cards should carry a 2¢ stamp, letters 3¢.

— . . . —

Flood Traffic

BY THERON E. TAPPAN, W8AVD

PRIZES FOR BEST ARTICLE

The article by Mr. Theron E. Tappan, W8AVD* wins the C.D. article contest prize this month. Each month we print the most interesting and valuable article received marked "for the C.D. contest." Contributions may be on any phase of amateur operating or communication activity (DX, 'phone, traffic, rag-chewing, clubs, fraternalism, etc.) which adds constructively to amateur organization work. Prize winners may select a 1938 bound *Handbook*, *QST*, Binder and League Emblem, six logs, eight pads radiogram blanks, DX Map and three pads or any other combination of A.R.R.L. supplies of equivalent value. Try your luck. Send your contribution to-day!

We've got a pile of work to do
We short-wave hams, you know
When rivers rise to flood stage
Their banks to overflow.
Each tiny mountain rivulet
Swells to amazing size
As it feeds the roaring river
With the downpour from the skies.

Whole towns are swept like matches
In the rush of raging tide
And families gaze in terror
As they watch their homes subside.
Why can't we pull together
When disasters like this come;
Not fill the air with nonsense.
Making QSO's quite bum.

For in some tiny hamlet,
Or a city, dark and bleak
With no electric power,
No means by which to speak
Upon a friendly telephone.
Some ham, in grim despair
Works desperately with batteries
To put him on the air.

* 547 Clark St., Waverly, N. Y.

Don't heckle him with messages,
Don't make him leave his mike
To seek your friends and relatives,
For he can't take a hike
Through flooded streets and byways
To find some homeless soul
Who's likely fled for refuge
And found some dry, safe goal.

The poor guy's trying vainly
His QRR to send,
To tell of needy families.
To ask that help we lend;
For they need food and clothing,
And maybe serum too;
Upon the heels of floods you know
Disease is nothing new.

The Red Cross wants to hear his needs
So just stand by and wait.
And make efficient QSO's
Until the floods abate;
No time for wild hysteria;
Far better, don't you think
To keep the airways clear for him —
His one remaining link.

You wouldn't want your mike or key
To QRM his call
By booming out a signal
When there's no need to at all.
So forget your pride and power,
Keep the ether clear for him.
Give him help — for boy, he needs it;
Don't you know his power's dim?

— . . . —

BRIEFS

Didja notice W1AW's advertised amateur transmissions on 8001 kc. (page 20, Dec. *QST*)? It should have been 1800 kc., of course. We're going to make the proof reader answer the pink ticket!

— . . . —

In connection with 1.75-Mc. Trans-Atlantic work G2PL reports logging W1AW (R5 S2) on 1808-kc. 'phone at 11:30 p.m., EST, November 12th, and on 1800-kc. c.w. (RST 459) at midnight EST, December 3rd.

— . . . —

W1CPV reports the following: The Leichardt Expedition in the Simpson Desert, Central Australia, is operating two transmitters on 187, 56.6 and 34 meters under calls VK8WA and VK8WB. Very low power is used, two to four watts from a pedal-driven generator.



The Casper Radio Amateurs Club entered this distinctive float in the "Wyoming on Parade" celebration. At the operating position is Stacy K. Anderson, W7FWM, club president. H. McFarlane, W7CBL, is driver of the truck, which was donated by Charles Burdick, W7EOT, and decorated by club members.

How's DX?

How:

THERE'S no doubt but what it's a fine thing to believe in Santa Claus. We do, especially when we call someone the whole band's calling. And no doubt a lot of other folks do, if the letters we get are any indication. Lots of people write in asking us to check our QSO lists from EL2A, HH4AS, PJ1BV, etc. Sorry, but no have got. The only lists we do have, which we use *only* for checking for the Century Club (or WAC) are from PK6XX, OX2QY, K6NVJ, YV2CU, IYAA, YA5XX and YS2LR (through Nov. 17th). These lists were obtained as a convenience in helping fellows get confirmation from some of the hard-to-get-cards-from countries. We don't send out QSL's for the above stations. The only other way we can help you get confirmation on some of the tough ones is from the DX Contest log of the station, if he sent in one. You can check that by taking a look at the results of the Contest — if your DX station has a score listed, he sent in a log.

One more ray of sunshine: the SARRL returned ZS3F's SARRL DX Contest log to him (his cards, records and stuff had been destroyed in a fire), and if you write to ZS3F direct you can probably get a card from him, if you worked him in the Contest.

Where:

There isn't any doubt now about VS3OL, in case you were holding out hope. VS2AG, the BERU rep in Malaya, says there ain't no Cerabanga, and suggests that the guy was operating somewhere in W4 or W5, from an examination of the cards sent for QSP ILLD worked ZC4EB (14,320 T6), who said he was the operator of the radio station at Nicosia, Cyprus W2CMY, who asks XU4XA (14,290 T9), says the guy is quite OK, that he uses an HRO and 180 watts to an 803, and *may* go Tibet in the near future Yes, there was an EP5SO actually on the air for a short while. He was quite legit, but got scared and quit before he worked any W's. Some BL took up the cause and signed the call, and the purpose of these rambling lines is to tell you, if you're a W, that you didn't work the real EP5SO but the phoney W6OFD grabbed a nice one in ZC3D (14,370 T9) at Christmas Island, whose home station and the place to send your card is ZD1D at Sierra Leone It just doesn't pay to brand screwy calls "phoney" until you have some evidence. For example, who'd think that ZK2AG, worked by W8JSU some time back, would have turned up legit? But

he did, and the sad part is that he left Niue on Dec. 8th Maybe CR8AF (14,415), worked by W3EYV and W9RRT, is good, but it takes a lot of Pollyanna to go for UH1AA (7195 T3), worked by W2GSA and claiming to be in Hejaz Choicest among the Asians that have been popping through to the east coast during the past month was J9CA (14,310 T9), worked by W2BHW, W4CBY and W8CRA, and known to be quite legit. Also choice but not so certain is VS5AG (14,415 T8), worked by W8JMP and W1FH W4BPD heard FO8AR (14,410 T7) one evening New countries, for a lot of folks, can be had in PK4KO (14,120 and 14,360 T9) and CN1AA (14,360 T9) No dope on PJ6AR (14,420 T6), but PJ1BV (14,425 T6) is quite good One of the reasons you haven't received a card from CX2AJ may be that you sent your card to the wrong address. Try one to Jose Enzo Sommaruga, Marco Bruto 1168, Montevideo, Uruguay, says W8NBK, and you may have better luck. NBK did Panama is a tough place to find a signal from these days, and W8AU suggests looking around 14,355 for a T8 signal signing HP1G. He's undercover, so take it easy with the card W4ERD grabbed some cream for himself when he worked VQ5KLB (7350) one night. That's the only station in Uganda, you know W8DHU scared up G3QF (14,320) for an Isle of Man contact CN8MI says that all CN cards should be sent via the A.A.E.M., Box 50, Casablanca, Morocco Good bets, picked at random: HS1BJ (14,035 T9), VS1AA (14,030 T9), VS1AL (14,350 T9), LZ1ID (14,380 T7) QSL via HB9CE, U81B (14,320 T9x), U9AB (14,410 T9) and CR6AI (14,170 T7) who, by the way, QSL's if you hear any "D" calls ending in "W", they'll be ex-OE stations.

When:

G2PL is still pounding away on 1730 kc. Sundays from 0430-0600 GT. So far W1BB and VE1EA are the only ones trying to work him, but they tell us there's room for one or two more on the band.

The 3.5-Mc. band isn't as good yet as we thought it would be, or else our ears need overhauling, but there's a gang on every Saturday night trying to get across. W8PWU, who did some swell work there last year, made up a time table for 80, which shows that 04-08 GT should be the best time for Europe, and 08-12 GT the best for Oceania W6AM raised ZL2BN on 75 phone during the SS The USKA advises that several HB stations are active daily on the low end of 80, between 05 and 07 GT.

On 40, J2PJ (7140 T8x) is on regularly from 12-14 GT, and was S8 when W5AVF in Mississippi worked him W7GZN reports TI6RR (7100 T5) and ZP2AY (7100 T9) around midnight PST.

Ten looks fair, what with W3CBT reporting VQ4CRE (28,040), VQ3TOM, SU1MW (28,360), SU1AM (28,260) and U9BE There are a lot of ZL and CN 'phones on 10, in case you're interested.

There seems to be a difference of opinion on 20 — some argue that conditions are swell and others say punko. We'll present the evidence and you can be the judge The rotary at W8OPB accounted for J8CG (14,420 T8), J2JJ (14,390 T9), VQ3HJP (14,410 T8), VQ2PL (14,410 T9) and VQ2MI (14,330 T9) Among the chere at

The antenna system at VS2AE, Perak, F.M.S., is a rotatable half-wave W8JK flat-top directional job on top of an 80-foot tower. Four hundred quarter-wave radials are buried 6 inches underground at the base of the tower, and the node point of the antenna link is grounded to the center of the radial system.

The transmitter runs 100 watts to the final pair of suppressor-modulated RK20's; the receiver is an HRO.

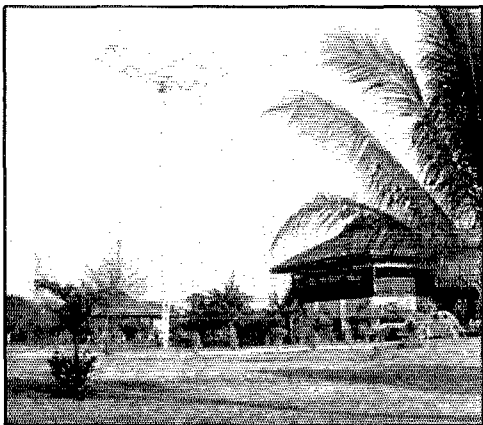

The transmitter line-up at J9CA is 59x-59-210, running 20 watts to the final. The receiver is a L-V-2 a.c. homemade affair, the antenna a full-wave Zepp. Look for J9CA on 14,310, T9, from 13-15 GT.

W2HHF are CR7AF (14,275), VU2LK (14,020), VU2FX (14,330 T8), ZE1JT (14,310), VU2EU (14,340), VS4JS (14,050), XU7CK (14,360 T8), V87AR (14,380 T8), XU8CM (14,300), XU8DI (14,410), VU2FO (14,350 T8), VK9BW (14,430), TF3C (14,380 T7), UK8IA (14,335 T7) and J8CA (14,350 T8) At W9WJD it's ZD2H (14,300 T9x), F18AC (14,405 T9), K6DSF (14,398 T9x), YS2LR (14,410 T9) and VP2AB (14,410 T8) W1FVF adds HC1PZ (28,065 T9), VP1DM (14,270 T9) and NY1AB (14,260 T9) G6RH gives us the British slant with VP8AD (14,390 T8) at about 22 GT on Saturdays, K6TE (14,300 T9), NY1AA (14,300 T9), HR7WC (14,410 T9) and VP2AT (14,415 T9) From W9AIW's log: ZE1JS (14,370), CR7AG (14,300 T9), HR2ON (14,410) and XSV1SM (14,420 T9) The new lazy H at W2BHW is really laying down a smack in the tough places, what with J3CG (14,310 T9), PK1BO (14,395 T9), XU7CW (14,405 T7), XU6D (14,165 T9) and J4CP (14,335 T9) W4BPD grabbed off CR7AL (14,235 T9), CR7AY (14,005 T9), CR7BT (14,115 T9), VK9VG (14,420 T9) and OY4C (14,405 T9) in the late evening, and J3FK (14,440 T9), XU2JN (14,395 T8) and J2NF (14,425 T9) in the early yawning W8JDB added PK1TM (14,190 T9), ZB1R (14,300 T9) and FA8DA (14,355 T8).

What:

If, like the poor, e.c.o.'s are going to be with us, we might as well give you a few tips on how to get a half-way decent note with them. The sweetest sounding one we've heard (and, unfortunately, we've heard plenty) is the one W6CUH finished recently. Instead of just slapping the thing together and sliding it into the band the same evening, he went to the trouble of completely shielding it, filtered all power leads into it, removed it some distance from the transmitter (to minimize the r.f. pickup) and included the stabilizing part of a stabilized power supply in the cabinet. A 6L7 tube is used for the oscillator. Listening to it, it's hard to believe that it isn't crystal. Too bad that pride doesn't enter into the construction of more of them.

Who:

It's nice to know that some of the HH stations have friends at court. Some time back we cracked that HH2B and HH4AS were the only QSL'ing-HH's, with the result that the more fair-minded lads took up the cause and inform us that HH2MC, HH2LD and HH2X also send the pasteboards. OK, we'll start impeaching W5EWZ says that TG9BA has permission to operate and cards don't have to go under cover. 9BA will be on c.w. in the very near future Just when we figured that W4CBBY was pining away because his side-kick W4DZH got hitched, along comes a letter telling of the latest DX down there. It reads like the Call Book, including some prime slices as FN1C, FG8AB, J9CA, ZB2A, VS1AI, CR6AI, PK4KO, HS1BJ, CN1AA, LZ1ID, Y12BA, and a whole mess of J, XU, V86, V87, VU, XZ, PK and VK9, for a new total of 140 countries worked. Yeah, guess he hasn't given up DX yet EI6M, who has the most westerly QTH in Europe (outside of TF), is QRP but quite anxious to work W's W2GMM worked XIIER and received a card from IIER, with no explanation for the "X." Which leaves us right where we started Speaking of Italian stations, W1KH was told by I1KN that "I had to pass judgment" for having a radio because some "dumb ham wrote me a letter." So, once again, take it easy with those ticklish countries, and don't mention radio on the envelope VE5HR, the QSL Manager out that way, takes issue with the claimed record of W9RSU and W9WWL that theirs was the best DX QSO in the same call area. VE5HR worked VE5ACS on Resolution Island, the distance being a mere 2385 miles W9EF tells us

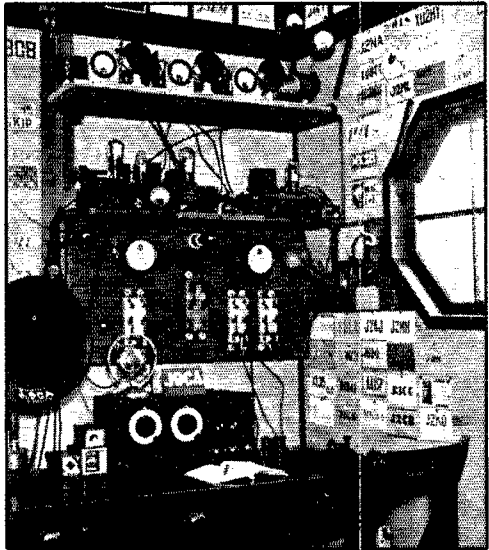

that ZD4AB has gone up the coast to Takoradi but will be back on from Accra about Dec. 20th. He's going back to England in March, so you'd better grab him before then DX stations on the prowl for Mississippi will do well to look for W5AVF (14,300) and W5AUB (14,050, 14,295, 23,100) W9HLF skeds VU2FX (14,350 T9x) daily, and will be glad to help anyone get a VU QSO F18AC needs Nevada, R. I., S. D., N. M., Alabama and Arkansas for WAS. Incidentally, F18AC deserves an orchid or something for the swell way he keeps up with his QSL's, which sort of disproves any moans that "it can't be done." He has warmed many a cockle by his prompt cards OQ5AE, back in the States for a short vacation, says the most consistent W's over in the Congo are W8JK on c.w. and W4HX on 'phone This darn town of Ridgewood, N. J., has three C Clubbers: W2BHW, W2CMY and W2GVZ W6ITH, who skeds PK6XX, says that the expedition will have a good 28-Mc. signal soon, via a rotary beam, and that they're boosting their 14-Mc. input to a KW. If they'd only get on c.w. more, all would be peachy W1COI has been grabbing some nice ones on both phone and c.w. Some of the phones include SV1CA, ZB1L, CN1AF, HC2HP, I1NQ, PK4KS, CX2AK and VU2BG W2AZ grabbed his 100th country the other day, which may not sound so amazing until you know that all 100 have been worked on phone! VO3X has been giving a first VO to a number of the Asians during the recent good Asian spell W1HX has a new rotary and added 10 new countries with it right off the bat HK5JD (7095) still needs S.D. for his WAS. He's on around midnight EST ZS1CN (14,340 phone or c.w.) wants Nevada for the usual reason. W3HKY can arrange a sked for you Things aren't so bad in W7, according to W7FMX. PK4KS ZE1JI, J8CD, HB9J, HC1PZ and YS2LR are some of the latest The season's best, me hearties; may all your neighbors use straight razors instead of those #*&# electric ones!

PJ3CO:

It was mighty pleasant to learn from PJ1BV the other eve that PJ3CO got off with only a \$40 fine. An agent from the N.V.I.R. intervened for him.

— W1JPE

Further Operating News on Page 84

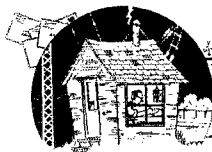

CORRESPONDENCE FROM MEMBERS

The Publishers of *QST* assume no responsibility for statements made herein by correspondents.

SAFETY CAMPAIGN



Rapid City, S. Dak.

Editor, *QST*:

. . . I wish to tell you about a safety campaign which our club has decided to launch here in the Black Hills territory, for better fused and shielded power supplies, and in so doing hope to eliminate the possibility of such an accident as Ross Hull had a short time ago. His death has been truly a great lesson to all of us, and we think it would be a great benefit to all amateurs to become more conscious of such a danger.

We have worked out a seal and have named it the "Hull Safety Seal" in memory of him, which we are planning on using in our club. A committee has been appointed whose duty it is to inspect all equipment of each amateur who is a member of our club, and when such equipment has been passed upon as being satisfactorily safe according to the rules set up by the club, the member is then entitled to use the "Hull Safety Seal" on his QSL cards and on other correspondence with amateurs.

After we had our own plan worked out it was suggested that we submit it to the League, hoping that they would be interested in our project and perhaps turn it into a nationwide campaign. The seal has been copyrighted, as you will notice. We did this to prevent anyone from commercializing it, and in case the League should wish to adopt our plan as a national project we should be very glad to turn over the copyright to them. . . .

— Gerald F. Lee, W9YKY
Pres., Black Hills Amateur Radio Club

EDITOR'S NOTE. — This is an admirable project. Its success necessarily depends on local inspection and control, and it seems therefore to be a matter best handled by the individual local affiliated clubs. *QST* heartily endorses the application of this idea on the part of amateur groups generally, and will welcome reaction and response.

A LETTER FROM DIRECTOR MATHEWS

100 E. Ohio St., Chicago, Ill.

Editor, *QST*:

As you know, I have not been a candidate for re-election to the office of director of the Central Division of the League. The reason for this, as you also know, is that, prior to my original election two years ago, I had allowed my operator's license to lapse. At the first meeting of the Board which I attended, the constitutional provisions covering directors' eligibility were changed to provide that a candidate for this office must have held an operator's license continuously for a period of four years prior to his candidacy. Obviously this was impossible in my case, as it is physically impossible to do something in two years that requires four for its accomplishment.

I was amazed to receive the notification that, due to the ineligibility of all the other candidates nominated in the Central Division, the by-laws provide that I should serve another term as director for the next two years. While it certainly was not my intention to occupy this position again, I want to assure the members of the League in the Central Division that I will do my best to continue to represent them to the best of my ability and to try to accomplish through the Board the things which they tell me they wish done.

I believe the situation brought about by the present wording of the by-laws covering eligibility is a most unfortunate one. It is my understanding that there were five candidates for the office of director, all ineligible for various technical reasons and any one of whom, I am sure, would have made an excellent director for the division. (While I myself voted for the eligibility rules mentioned, I did so in the belief that they were satisfied by any continuous term of four years as a licensed amateur operator and not necessarily the four years immediately preceding nomination.) It will be my first concern at the next Board meeting to do my best to see to it that the Board alters these provisions in such manner that this situation can never occur again. Our League is, and must continue to be, a democratic institution whose directors are elected by the members. I do not consider it proper to have restrictions so severe that mem-

(Continued on page 78)



IN SPITE of the commercial air lines and high-speed streamlined trains, it is still quite impractical for anyone to make much of a dent in the job of getting around this country of ours and personally contacting, even with a fleeting greeting, an appreciable percentage of our customers, friends and "over-the-air" acquaintances. Even so, we do make the attempt as frequently as possible. In addition to making new friends, renewing old friendships and, of course, doing a little business, we inevitably in our travels learn of many interesting and, to us, unthought of applications for our products as well as changes and improvements that can be made to them. Of course, many of our friends also write to us when they feel that they have an interesting idea. Many of these items have been presented in this page in the past.

Thus, just recently Jack Thorpe, W8IDG, suggested a jack to fit the top of our GS-3 and 4 insulators. It is similar to the one now used in the GS-8 but designed to screw into the tapped hole on the Isolantite body. When ordering, just add the symbol "J" to the stand-off type number. The net cost is but six cents more.

Then, just a few days ago, we received a letter from Willard Minton, W5FVE, calling to our attention the fact that the new line of "air-wound" buffer coils could be easily mounted on the back of the TMS type condensers. Just enlarge the two small holes in the condenser end-plate and mount one of the PB-16 sockets. The holes in the condenser end-plate don't quite line up with the coil socket mounting holes but the "enlarging act" takes care of that situation in a quite practical way.

Herb Hollister, W9DRD, has been after us for quite some time to change the electrodes of the "4-in-1" crystal holder from the straight pressure type to the fixed air-gap type, by providing three small raised points on each plate. The activity of the crystal when thus mounted is increased considerably and of course the necessity for having spotlessly clean plates is eliminated. When the crystal is so mounted, however, it is likely to have a slightly different operating frequency than when mounted between flat plates or in a different type holder. Therefore, whether the holder be one of our new "4-in-1" or of some other make, frequency checks should be made under normal operating conditions. Of course, the new regulations also make this compulsory.

Incidentally, Herb also had some other ideas on crystals, particularly on extremely simple and practical methods of using them for fixed frequency reception in connection with the control of the high frequency oscillator of standard communications receivers. The whole thing is a little involved to present on this page, however, and we hope *QST* will want to describe the affair in more expansive editorial space in the near future — and in the meantime,

Merry Christmas and Happy New Year!

JAMES MILLEN



Transmitter Band Switching Made Easy

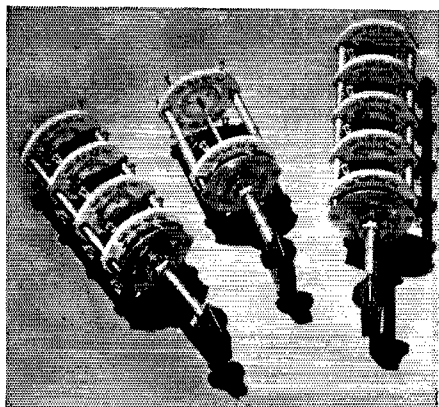

with MALLORY-YAXLEY "HamBand" Switches

Convenient terminal arrangements, wide spacing of current carrying parts, heavy silver-plating on contacts, and low-loss magnesium silicate ceramic insulation especially designed for high frequency application... make band switching a reality for every amateur... and almost as easy as changing bands on a modern communications receiver. Mallory-Yaxley 160C HamBand Switches are rated for use in transmitter plate circuits using up to 1000 Volts DC with power up to 100 watts inclusive. Your Mallory-Yaxley distributor can give you complete information.

P. R. MALLORY & CO., Inc.
INDIANAPOLIS INDIANA

Cable Address — PELMALLO

Use
MALLORY
APPROVED RADIO
PRECISION PRODUCTS

Use
YAXLEY
APPROVED RADIO
PRECISION PRODUCTS

Correspondence Dept.

(Continued from page 76)

bers in the Central Division are deprived of their opportunity to cast ballots, as they were this year. Insofar as my personal feelings are concerned I want to promise them here and now, as I said earlier in this letter, that it will be my first concern to remedy the conditions which brought this situation about.

— R. H. G. Mathews
Central Division Director

EDITOR'S NOTE. — A League by-law provides that a director is elected for a term of two years, "or until his successor is duly elected and qualified." This is a customary provision and is deliberately made to prevent a situation wherein a division, through failure to name eligible candidates, would be left without a vote and representation at Board meetings. Because not one of the Central Division nominees complied with the new eligibility requirements, there was no election in the Central this year and Mr. Mathews remains in office, so that the division is not deprived of its vote. See By-Law 21. As to the eligibility provisions themselves, members will be interested in knowing that the Executive Committee is recommending to the Board that it make a further study of its rules so as to prevent the disqualifying of so many otherwise desirable candidates.

HQ SALARIES

230 Cleghorn, Honolulu, Hawaii

Editor, *QST*:

The quarterly statement of revenues and expenses for the three months ended June 30, 1938, is worthy of our notice. It is even interesting as compared to similar statements published in *QST* during the years of 1935 and 1936.

A casual comparison of such statements will show net revenues taken in by A.R.R.L. are remaining comparatively constant. It will also show salaries paid to officers and employees are steadily mounting. To-day \$24,091.76 is paid out every three months in salaries. In 1934-35 that total was \$19,252.08, or a net difference of \$4,839.68. We see an increase in salary expenditures by 25 per cent.

As a struggling A.R.R.L. member I would like to know what has necessitated this handsome increase. How is the increase made up — more employees?

Do you in Hq. hold up your hands in horror at the thought of affecting every possible economy with the point in mind of eventually lowering membership dues? The nearly \$5000 used for increases in salaries every three months would go a long way toward making possible the reduction in price of *QST* to 15¢ per copy (remember, there would then be some increase in circulation).

Perhaps I am all wrong, but I do not find the idea of \$1.50 per year for A.R.R.L. dues an appalling aversion. A.R.R.L. publications to-day are not essentially bigger or better than in 1935. May I ask why the great increase in salaries?

— Stanley L. Grimes, K6PTY, ex-W7CQB-W3GRH

EDITOR'S NOTE. — Three factors contribute toward the apparent disparity in the figures cited by Mr. Grimes: The League's pay-roll at the end of 1934 totaled 29 full-time employees, as against 37 in mid-1938; a general pay-cut of approximately 10 per cent was in effect in 1934 as a result of depression conditions; the purely clerical employees of the League (stenographers, shipping clerks, etc.) receive overtime wages for extra work evenings during busy seasons. With the growth of amateur radio the business affairs of the League have increased also, necessitating more clerical overtime and so raising this content of the pay-roll as well.

When these corrective factors are applied, the average salary paid employees is slightly less in 1938 than in 1934.

Incidentally, the percentage of total salaries to total expenses has been reduced slightly each year for the past several years. At the same time the proportion paid out for the production of *QST* (now in excess of \$5.00 per member) and for general membership services (Communications De-

*For more R9 in '39
Choose Raytheon!*

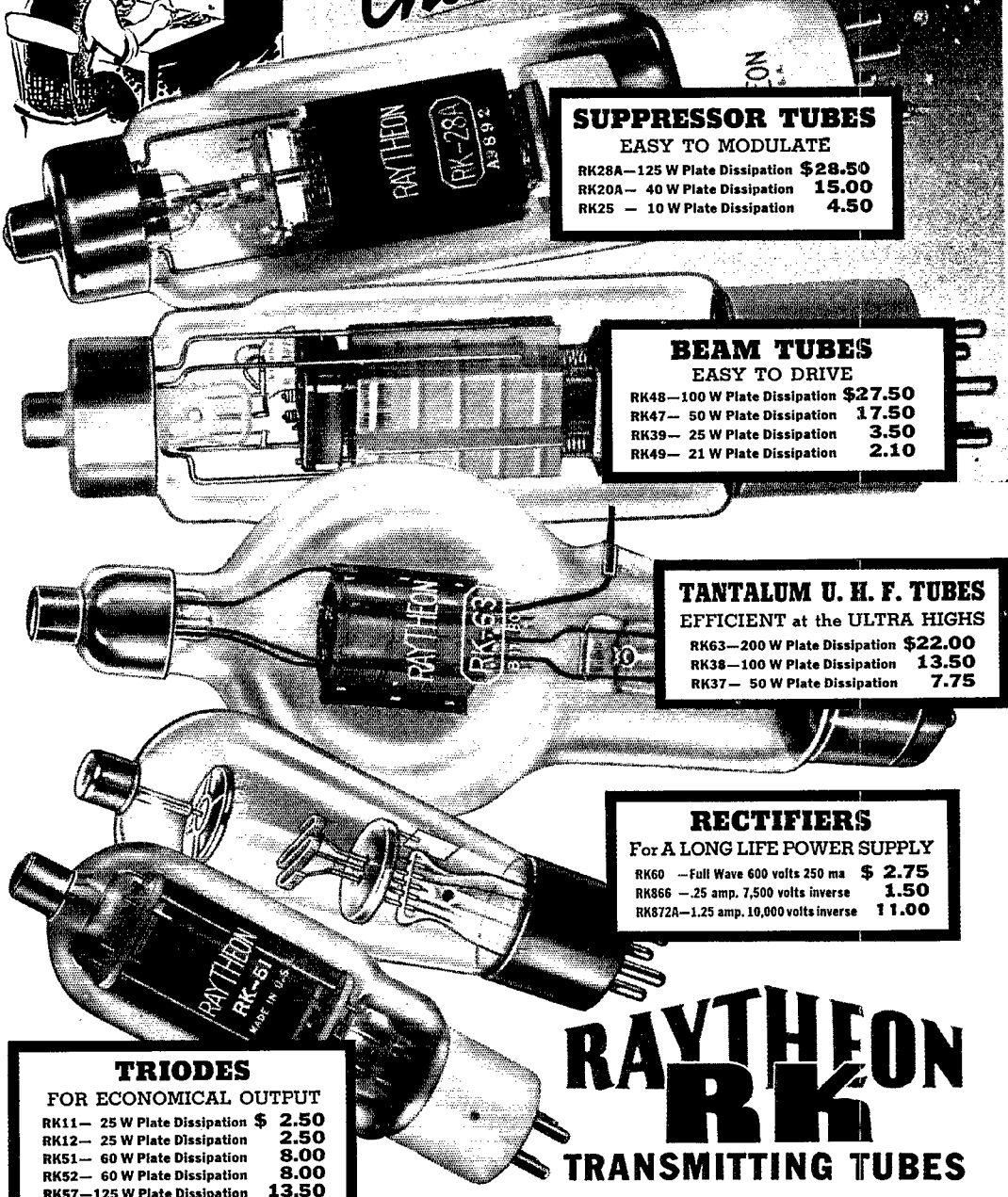
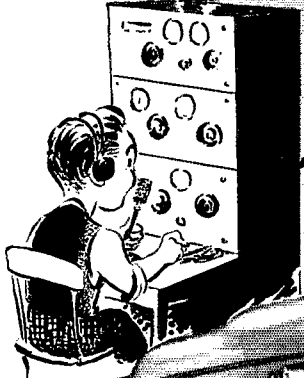

SUPPRESSOR TUBES

EASY TO MODULATE

- RK28A—125 W Plate Dissipation \$28.50
- RK20A— 40 W Plate Dissipation 15.00
- RK25 — 10 W Plate Dissipation 4.50

BEAM TUBES

EASY TO DRIVE

- RK48—100 W Plate Dissipation \$27.50
- RK47— 50 W Plate Dissipation 17.50
- RK39— 25 W Plate Dissipation 3.50
- RK49— 21 W Plate Dissipation 2.10

TANTALUM U. H. F. TUBES

EFFICIENT at the ULTRA HIGHS

- RK63—200 W Plate Dissipation \$22.00
- RK38—100 W Plate Dissipation 13.50
- RK37— 50 W Plate Dissipation 7.75

RECTIFIERS

For A LONG LIFE POWER SUPPLY

- RK60 —Full Wave 600 volts 250 ma \$ 2.75
- RK866 —.25 amp. 7,500 volts inverse 1.50
- RK872A—1.25 amp. 10,000 volts inverse 11.00

TRIODES

FOR ECONOMICAL OUTPUT

- RK11— 25 W Plate Dissipation \$ 2.50
- RK12— 25 W Plate Dissipation 2.50
- RK51— 60 W Plate Dissipation 8.00
- RK52— 60 W Plate Dissipation 8.00
- RK57—125 W Plate Dissipation 13.50

**RAYTHEON
RK
TRANSMITTING TUBES**

NEWTON, MASS. • NEW YORK • CHICAGO • SAN FRANCISCO • ATLANTA

"WORLD'S LARGEST EXCLUSIVE RADIO TUBE MANUFACTURERS"

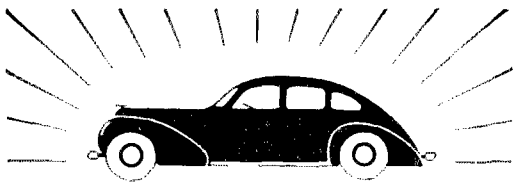

As up-to-date as a NEW CAR

A new 1939 model, the Harvey 75-T Transmitter combines dependability, power and low cost in a convenient table model. A powerful CW signal on 5 bands plus sufficient Phone output to work great distances make this the "buy of the year."

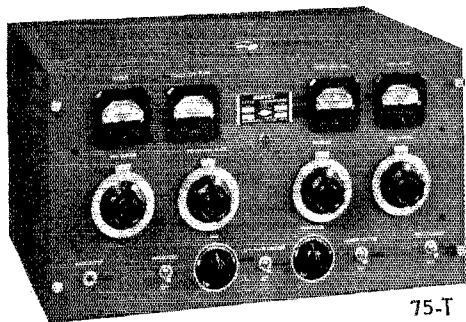

75-T

Coil changing for the 3 simplified circuits is made easy by the hinged cover cabinet. The main power supply is external to the transmitter itself and may be installed in any convenient position where space is available. The power chassis is housed under a grille cover for safety as well as ventilation. Our new catalogue, which contains complete information on the 75-T as well as other NEW transmitting units, is now ready. Information on HARVEY Police 2-way Radio and HARVEY Marine Radio-Telephone equipment is also available if you write to **Harvey Radio Laboratories, Inc., 25 Thorndike Street, Cambridge, Massachusetts.** Export: 25 Warren Street, New York City. Cable: "Simontrice."

partment, Washington and international representation, Board expenses, etc., totaling about \$4.00 per member annually) has been increased.

Concerning the size of publications, the average size of *QST* during the last quarter of 1938 was 123 pages as against 109 for the same period of 1934. The 1939 *Handbook* has a total of 560 pages, compared with the 1935 *Handbook's* 282.

THE AMATEUR IS BALANCED

West Middletown, Ohio

Editor, *QST*:

I don't know when I have read an editorial that touched me more than yours in October *QST*.

I am an old Morse telegrapher and have seen some hard service in my time, but in the past twenty years I have been in the grocery business where I spend about seventy-five hours every week, so you see most of my time is spent with my business. Outside of several hours in the evenings and Sundays, I haven't much time for amateur radio, but I have been abusing myself by staying up too late at night and spending too many hours at it on Sundays. Therefore I haven't been getting the proper amount of sunshine and exercise needed by a man of my age, and I am not rugged physically.

I have caused blinking of the lights, key clicks in our h.c. receiver and maybe am not always in the best of humor when told about it, so have been a general nuisance around the house for the past three years — but, say, it's hard to stop when those VK's and ZL's are coming through about 589x! But when I read that creed of the amateur I feel awful guilty.

That editorial of yours sure did set me to thinking and I want to thank you from the bottom of my heart for it, and I hope it has the same effect on thousands of hams and may be the cause of saving them their health and much money in doctor bills in later life. . . .

— John G. Hunt, W3QIE

ABOUT CORRESPONDENCE

4450 N. Mozart St., Chicago, Ill.

Editor, *QST*:

Found this poem in a magazine and I think that if some of the hot air fiends who release their steam through this column read it they might think first before they let loose.

Here it is:

ANOTHER'S FAULTS

In speaking of a person's faults,
Pray don't forget your own;
Remember, those in a house of glass
Should never throw a stone.
If you have nothing else to do
But talk of those who sin,
'Tis better you should look at home
And from that point begin.

— J. H. Grigg, W9ZQT

53 East 7th St., Holland, Mich.

Editor, *QST*:

The Correspondence Section should be doubled in space allotment in *QST*. Some of the articles are very long and drawn out and there should be a minimum length of two or three inches per article.

I think the Correspondence Section should include progressive thoughts for increasing the enjoyment we amateurs have in our most interesting hobby or at least one of the most interesting of all hobbies.

I also suggest that the fellows all get together and urge *QST* to publish a full page or even two full pages of nothing but photographs of some of the most active "hams" in the country. This should include station pictures as well as ops' pictures. Foreign stations also should be included. Also antenna systems that deserve publication.

This will greatly increase the average ham's interest in the magazine we all like, *QST*.

— Rus Sakkers, W8DED

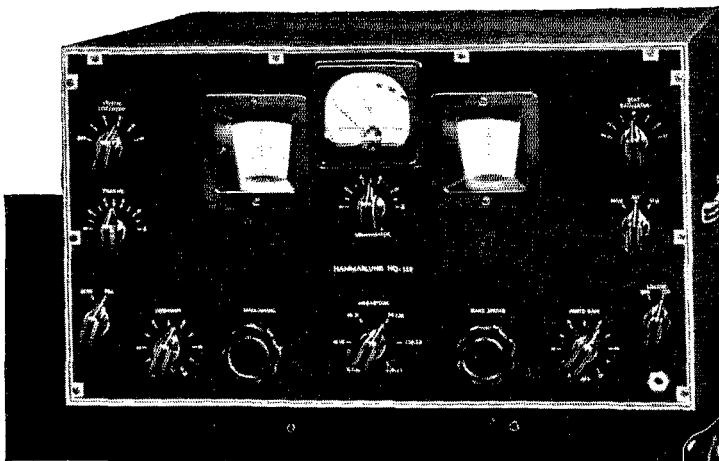

LIST PRICE

\$215.00

Complete with tubes,
crystal, speaker

HQ-120 with Full Range CRYSTAL FILTER

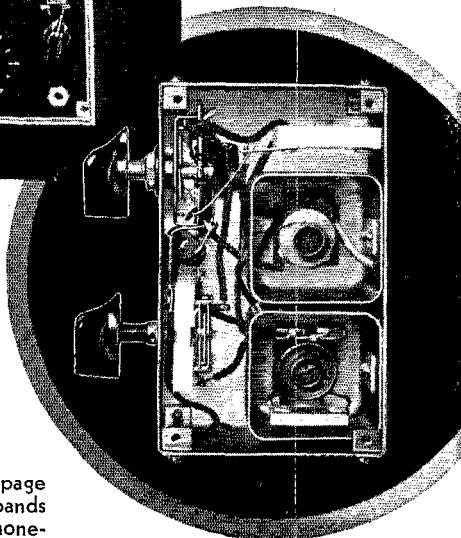

THE NEW "HQ-120" with its "full range" crystal filter (see page 33 of December QST) splits crowded amateur phone bands wide open. This exclusive Hammarlund feature solves the phone-man's age-old problem of QRM from heterodynes and side-band splashover. The selectivity curves shown in the drawing were taken on a production model receiver. Labeling of these curves corresponds to the markings of the selectivity switch on the panel. In practice, curve No. 1 is not only wide enough to permit excellent voice reception, but fairly good quality music as well. Curve No. 2 is intended for voice reception where quality is a consideration even though QRM may be very heavy. Number 3 is for extreme conditions of interference where "getting the message through" is more important than quality. Positions 4 and 5 are for CW code reception. Unlike most crystal filters, the output of this one is uniform throughout its selectivity range, and there is no interlocking of controls.

Special consideration has been given to the R.F. gain of the receiver in order that it will not require a stronger signal on 20 meters than on 80, for example, to read "S-9" on the meter. The "HQ-120" is also equipped with a noise limiter which follows the strength of the incoming signal and suppresses automobile ignition interference and similar disturbances. In order to maintain high efficiency with various types of antennas, the "HQ-120" has an antenna compensating control which assures maximum image rejection, maximum signal-to-noise ratio, and perfect circuit alignment at all times. There is a spread of 310 degrees for each amateur band from 80 to 10 meters, and the dial is calibrated in megacycles for these amateur bands. This means you no longer have to guess at the frequency of your own transmitter or of the one at the other end of the QSO. Write Dept. Q-1 for complete descriptive literature.

Curves for Crystal Filter

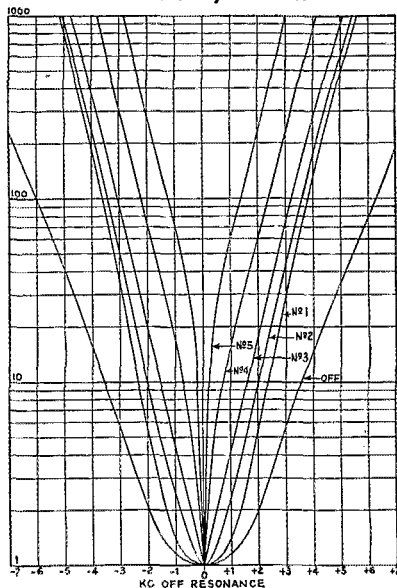

SEND FOR 16-PAGE BOOKLET!



HAMMARLUND MFG. CO., INC.

424-438 WEST 33rd ST., NEW YORK

CANADIAN OFFICE: 41 WEST AVE., NO., HAMILTON, ONT.



A NEW TREND

Ganged Neutralizers for Single Control Neutralization of Push Pull Amplifiers

Long in use by commercial designers, ganged neutralizing capacitors are becoming more and more widely used by progressive amateur designers. Essentially conventional in natural layout, the push pull triode class "C" amplifier lends itself most fittingly to further simplicity achieved by use of Cardwell ganged neutralizing condensers.

Medium power amplifiers in particular are readily adapted to their use. We illustrate two new units, the ES-7-SDI Trim-air dual neutralizer, and the ET-15-ADI, which have been requested by numerous progressive amateur designers.

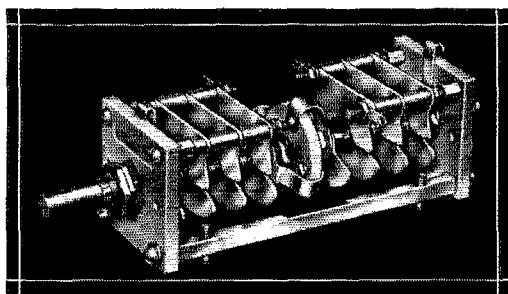

NEW Type ES-7-SDI — Dual Neutralizer

For push-pull T-40's, HY-40, HY-57, RK-18's etc. Maximum Capacity each section 7 mmfd. Minimum Capacity each section 4 mmfd. Airgap — .140". Peak V_p — 5000 V, at 7 M.C. Plates — .040" thick, buffed and polished aluminum. Size — $4\frac{3}{8}'' \times 1\frac{1}{2}'' \times 1\frac{1}{2}''$. Insulation — Isolantite end plates with Alsimag 196 insulated coupling between rotor sections. LIST PRICE \$4.50

Type ES-4-SDI — Dual Neutralizer

Similar to ES-7-SDI except maximum capacity per section is 4 mmfd. and minimum 1.5 mmfds. For push pull amplifiers using tubes such as 316-A, UH-35, 800, RK-30, 834, RK-32, 304-A and UH-50. LIST PRICE, \$4.10

NEW Type ET-15-ADI — Dual Neutralizer

For push pull RK-59, 841, 10, 801, T-20, 809, RK-11, RK-12, 825, 756, 830, 316-A. Maximum Capacity — each section — 15 mmfd. Minimum Capacity — each section — 1.5 mmfd. Airgap — .070". Peak Volt — 2500. Plates — .020" thick aluminum — unbuffed. Size — $3\frac{3}{4}'' \times 1\frac{1}{2}'' \times 1\frac{1}{2}''$. Insulation — Isolantite end plates, with Alsimag 196 insulated coupling between rotor sections. LIST PRICE, \$3.50

Type ET-30-ADI — A Dual Neutralizing Unit

Similar to ET-15-ADI except for push pull tubes with grid to plate capacities higher than the capacity range of the ET-15-ADI. If plate modulation is used, plate voltages in excess of 600 V. should not be used. Maximum Capacity per section is 30 mmfd. Minimum Capacity per section is 4 mmfd. LIST PRICE, \$4.10

Type NA-12-NDI — Dual Neutralizer

Similar in construction to the well known NP-35-ND H.F. dual except with greater plate spacing and lower capacity, with 10,000 V. LO-FLEX couplings between rotor sections. For neutralizing push pull amplifiers using such tubes as RK-31, 841-A, 835, 838, 261-A, RK-57 and 805. Maximum Capacity each section — 12 mmfds. Minimum Capacity each section — 6 mmfds. Airgap — .218". Peak Voltage — 6500 volts (conservative). Plates — .040" thick buffed and polished aluminum. Size — $2\frac{1}{2}''$ wide $\times 2\frac{1}{16}''$ high $\times 5\frac{25}{32}''$ long. Insulation — Isolantite and General Electric Mycalex. LIST PRICE, \$15.00

THE ALLEN D. CARDWELL
MANUFACTURING CORPORATION

83 PROSPECT STREET, BROOKLYN, NEW YORK

Standard Frequency Transmissions

Date	Schedule	Station	Date	Schedule	Station
Jan. 6	BB	W6XX	Feb. 3	BB	W6XX
	A	W9XAN		A	W9XAN
Jan. 7	BX	W6XX	Feb. 4	BX	W6XX
Jan. 8	C	W6XX	Feb. 5	C	W6XX
Jan. 13	A	W6XX	Feb. 10	A	W6XX
Jan. 20	A	W9XAN	Feb. 17	A	W9XAN
	B	W6XX		B	W6XX
Jan. 27	A	W9XAN	Feb. 24	A	W9XAN
	A	W6XX		A	W6XX

STANDARD FREQUENCY SCHEDULES

Time (p.m.)	Sched. and Freq. (kc.)		Time (p.m.)	Sched. and Freq. (kc.)	
	A	B		BB	C
8:00	3500	7100	4:00	7000	14,000
8:08	3600	7100	4:08	7100	14,100
8:16	3700	7200	4:16	7200	14,200
8:24	3800	7300	4:24	7300	14,300
8:32	3900		4:32		14,400
8:40	4000				

Time (a.m.) Sched. and Freq. (kc.) BX

6:00	7000
6:08	7100
6:16	7200
6:24	7300

The time specified in the schedules is local standard time at the transmitting station. W9XAN uses Central Standard Time, and W6XX, Pacific Standard Time.

TRANSMITTING PROCEDURE

The time allotted to each transmission is 8 minutes divided as follows:

- 2 minutes—QST QST QST de (station call letters).
- 3 minutes—Characteristic letter of station followed by call letters and statement of frequency. The characteristic letter of W9XAN is "O"; and that of W6XX is "M."
- 1 minute—Statement of frequency in kilocycles and announcement of next frequency.
- 2 minutes—Time allowed to change to next frequency.

W9XAN: Elgin Observatory, Elgin National Watch Company, Elgin, Ill., Frank D. Urie in charge.

W6XX: Don Lee Broadcasting System, Los Angeles, Calif., Frank M. Kennedy in charge.

WWV Schedules

EACH Tuesday, Wednesday and Friday (except legal holidays), the National Bureau of Standards station, WWV, transmits with a power of 20 kw. on three carrier frequencies as follows: 10:00 to 11:30 A.M., E.S.T., on 5000 kc.; noon to 1:30 P.M., E.S.T., on 10,000 kc.; 2:00 to 3:30 P.M., E.S.T., on 20,000 kc. The Tuesday and Friday transmissions are unmodulated c.w. except for 1-second standard-time intervals consisting of short pulses with 1000-cycle modulation. On the Wednesday transmissions, the carrier is modulated 30% with a standard audio frequency of 1000 c.p.s. The standard musical pitch A = M440 c.p.s. is also transmitted from 4:00 P.M. to 2:00 A.M., E.S.T., daily except Saturdays and Sundays, on a carrier frequency of 5000 kc., power 1 kw., 100% modulation. The accuracy of the frequencies of the WWV transmissions is better than 1 part in 5,000,000.

An Eimac Tube is an improvement for any transmitter.

POWER CONVERTERS

not power dissipators

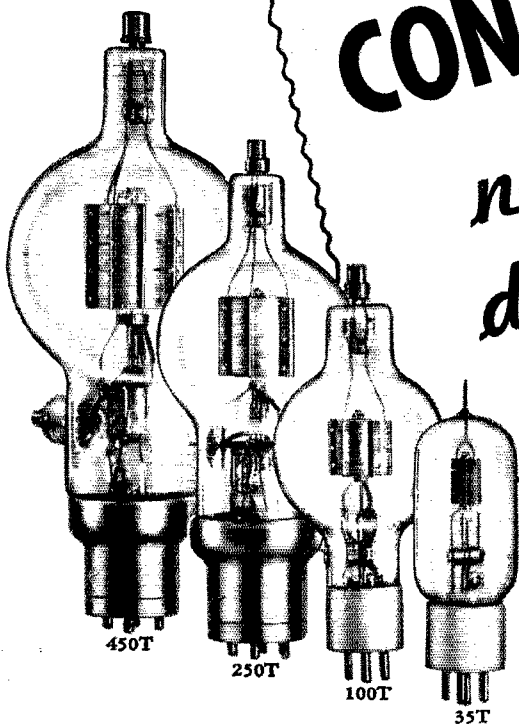

From the very beginning it has been the purpose of the makers of Eimac tubes to produce and make practical a vacuum tube having unlimited capabilities and extremely high efficiencies. Their ultimate goal (not yet achieved) being to get 5 KW output from a small tube like the 35T. How far they have succeeded is evidenced by the outstanding performance to be gained from Eimac tubes today.

Eimac is not "just another good tube." It represents a great step forward for the entire field of radio communications. Progressive radio engineers who refuse to cling to precedent . . . who wish to obtain outstanding results . . . to be ahead of the crowd . . . have found Eimac tubes to be a requisite. Even those who are satisfied with the old way of doing things find definite improvement when they change to Eimac. The point is: Eimac tubes are capable of far greater performance than the average equipment in use today is capable of producing.

With Eimac tubes, emission failure is almost a thing of the past. High voltages; high temperatures; gas will never affect an Eimac tube. That is why it is possible to get such extremely high power output from a comparatively small Eimac tube.

An example of Eimac's super performance is to be found in a group of new transmitters recently completed by the Thos. L. Siebenthaler Mfg. Co. to the design and specifications of TWA and Eastern Air Lines. In these transmitters, a pair of Eimac 450T tubes give an output of 4 KW while being operated well within their ratings. This kind of performance can easily be yours.

Eimac
TUBES

EITEL-McCULLOUGH, INC.
SAN BRUNO, CALIFORNIA

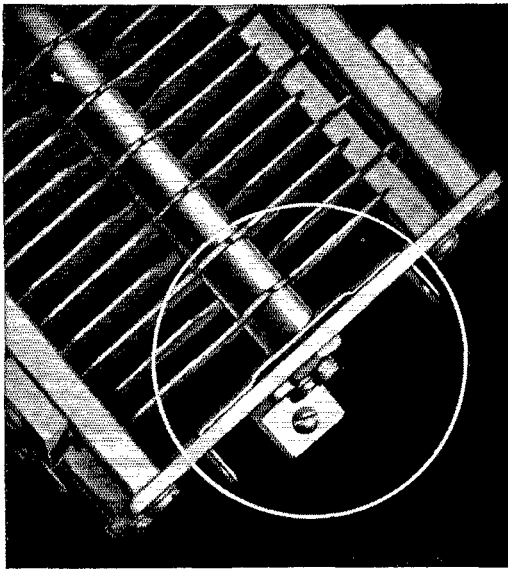

No THROUGH-FRAME CONTACTS

GOOD CONTACTS are one of the most important features of transmitting condenser design. Hammarlund engineers have paid particular attention to this point in designing the new "TC". The illustration shows the one piece, direct-to-rotor contact of the new "TC". Notice that metal-to-metal contact through the frame is not depended upon to carry the high current usually associated with tank condensers. The contact is of silver plated Beryllium, noted for its low resistivity and great physical strength. This contact is bent so that it passes through the end plate forming two soldering lugs so the connection will be short and direct. This is only one of the many features of the new "TC" which also embodies the non-magnetic principle of rotor assembly. See these outstanding condensers at your dealer's or write for complete details.

Send for "39" catalog containing further details on the "TC".

HAMMARLUND MFG. CO., INC.
424-438 W. 33rd St., N. Y. C. Q-1-39

Please send me 1939 catalog



Name.....
Address.....
City.....State.....



HAMMARLUND

Canadian Office: 41 West Ave. No., Hamilton, Ont.

Operating News

(Continued from page 76)

October '38 O.R.S.-O.P.S. Parties

THE October O.R.S. and O.P.S. get-togethers were "humdingers," with splendid turn-outs and scores of unprecedented magnitude. New highs were established in both parties. Active qualified operators should get in on these enjoyable activities by lining up their stations with the O.R.S. or O.P.S. group. Write your S.C.M. *to-day*, if interested.

W3BES leads the O.R.S. gang for the second consecutive time and W8MBW "ditto's" in the O.P.S. group—take a look at their records! W2JZX moved up into second place among O.P.S., with W1COI third. W8KUN, second high O.R.S., gave W3BES a close race, followed by W4NC with W4ABT operating. The next O.R.S. and O.P.S. Parties will be on January 28th-29th. Make your plans accordingly!

Official Relay Station Scores

Station	Score	Def. Stat.	Def. Sect.	No. Heard	Power	Section
W3BES	16,279,922	203	54	16	150-200	E. Pa.
W8KUN	16,115,042	210	57	41	100	W. Pa.
W4NC	(4ABT, opr.)	13,585,500	194	56	22	800 N. C.
W6KFC	13,233,671	153	56	18	50-100	Ariz.
W1TS	12,757,525	200	53	-	350	Conn.
W8JTT	10,180,884	175	53	43	250	W. N. Y.
W2HMJ	8,990,980	163	47	8	250	N. Y. C. & L. I.
W4AGI	7,791,538	158	48	5	500	Georgia
W2HZY	7,546,922	151	51	26	100	N. N. J.
W1LLX	6,715,812	159	42	22	200	E. Mass.

Station	Score	Stat.	Sect.	Station	Score	Stat.	Sect.
W3GDI	6,251,265	146	43	W9ARE	4,835,922	131	4
W8CMH	5,971,158	142	44	W8LCN	4,592,820	118	51
W9KJY	5,708,968	134	50	W7FFQ	4,483,794	102	41
W1KQY	5,701,220	149	44	W7GEE	4,073,067	95	45
W3CHH	5,544,211	141	40	W3FPQ	3,907,464	127	36
W9VES	5,368,641	134	47	W3NFB	3,868,805	118	41
W5EOE	5,336,988	125	47	W1EOB	3,391,704	115	35
W3DGM	5,233,943	147	40	W3ADE	3,169,026	108	38
W8MOT	5,130,876	132	45	W2GVZ	3,112,159	120	49
W9NFL	4,834,720	117	47	W2KXF	2,999,716	108	33
				VE3EF	2,996,448	110	37

The score of W1AW, not competitive with any of the above, is recounted for the information of Members: W1AW (W1JTD opr.); 16,878,980; 210; 58; 31; 1,000.

Official Phone Station Scores

Station	Score	QSO's	Sections	Heard	Power Input	Section
W8MBW	9180	60	27	20	800	W. N. Y.
W2JZX	7100	50	25	17	700	N. Y. C. & L. I.
W1COI	6944*	49	26	13	40/400	W. Mass.
W9WXL	6288	42	24	26	85/200	Ky.
W1BNO	6118	48	23	13	500	W. Mass.
W3FGJ	5880	43	24	15	500	Va.
W4CYB	5880	48	21	20	500/250	N. C.
W1GZL	5094	35	13	54	50/300	W. Mass.
W8DSJ	4920	40	20	22	100/300	W. Va.
W8ICQ	4864	48	19	8	125/150	Ohio

Station	Score	QSO's	Sect.	Station	Score	QSO's	Sect.
W4DCQ/2	4370	38	19	W2DC	3675	31	21
W4CVQ	4360	26	20	W2DVC	3328	30	16
W8BHN	4340	43	20	W8PFM	3162	30	17
W9TTA	4087	41	17	W1DWP	3040	26	20
W8NNJ	3819	35	19	W5CXH	2924	20	17
W1EAO	3686	34	19	W3BRZ	2772	26	18
				VE3KM	2736	31	16

* 8 hours, 25 mins. Score of 7306 corrected to 8 hours.

Charting a future course

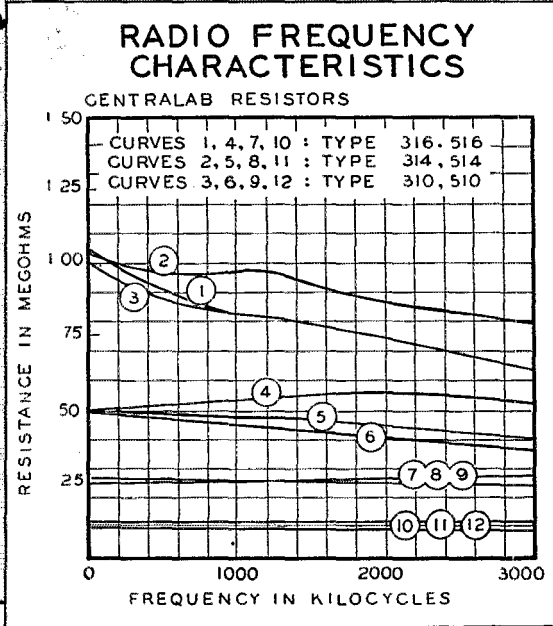
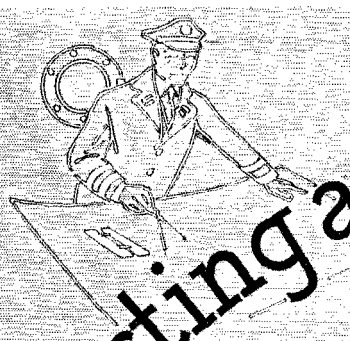

Cross-sectional sketch of Centralab Resistor

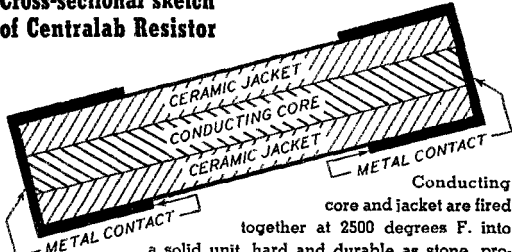

Conducting core and jacket are fired together at 2500 degrees F. into a solid unit, hard and durable as stone, providing mechanical strength and protection against humidity. Copper contact to the resistance material at the extreme ends only provides uniform resistance and load distribution over ENTIRE length. End contacts do not short circuit part of the resistance as in other types.

Because resistance is small in diameter and uniformly distributed for entire length, Centralab's specific resistance per unit length is low. The result is low noise level and constant value over a wide range of frequency and voltage.

CENTRALAB • Division of Globe-Union Inc., Milwaukee

TELEVISION CIRCUITS

frequently require fixed resistors whose values remain uniform at high frequencies. Centralab Fixed Resistors because of their relatively small cross section conductor area plot a comparatively flat resistance-frequency curve . . . as shown in the graph above.

In charting the future — in Television broadcast and reception, Centralab will continue to give satisfactory service . . . just as it is now doing with its performance record of more than 80,000,000 units in all parts of the world.

Engineers send for Resistor Data Bulletin 647.
SPECIFY CENTRALAB

Centralab

★ FIXED RESISTORS ★

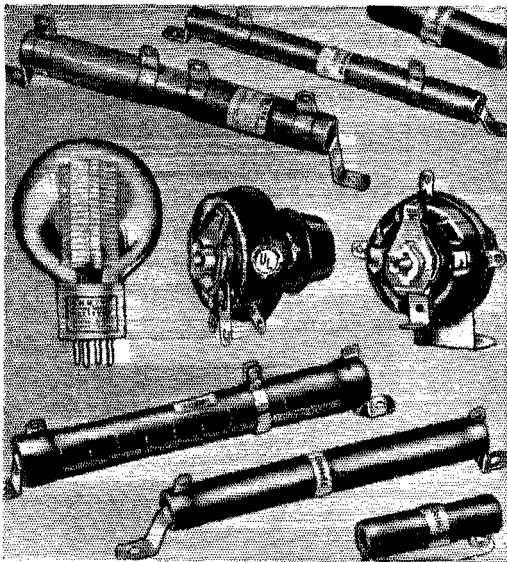

From Power Line to Antenna

OHMITE

parts improve your Rig!

DUMMY ANTENNA New Ohmite Vacuum-Type. Used to easily, accurately measure actual transmitter output, for tuning up to peak efficiency, and for many other purposes.

RHEOSTATS Time-proved Ohmite all-porcelain vitreous-enamelled Rheostats keep power tube filaments at exact rated value for best efficiency — Increase tube life.

BAND SWITCH Provides instant, easy change from one frequency to another with really low-loss efficiency. For all transmitter stages.

BROWN DEVILS Popular, economical, dependable Resistors for voltage dropping, bias units, bleeders, etc. 10 and 20 watt sizes.

DIVIDOHMS Handy vitreous-enamelled Adjustable Resistors for quick, accurate change of resistance value or replacement. 10 to 200 watts.

FIXED RESISTORS Ohmite vitreous-enamelled Resistors used by eminent designers and manufacturers of amateur and commercial transmitters and receivers.

R.F. PLATE CHOKES High frequency solenoid chokes designed to avoid either fundamental or harmonic resonance in the amateur bands.

POWER LINE CHOKES Keep R.F. currents from going out over the power line — lessen interference with BCL receivers.

Available from Your Jobber. Write today for free Catalog 17 and Dummy Antenna Bulletin 111.

OHMITE MANUFACTURING CO.
4831 West Floumoy Street ★ Chicago, U.S.A.

OHMITE

RHEOSTATS RESISTORS TAP SWITCHES

MEMBERS, DX CENTURY CLUB

G6WY (No. 5)...	141	W9GDH (No. 41)...	109
W1WY (No. 7)...	133	W9EF (No. 44)...	109
W1SZ (No. 7)...	132	W4CEN (No. 60)...	109
W8DFH (No. 14)...	131	W3EDP (No. 53)...	108
W6CXW (No. 4)...	130	W6HY (No. 21)...	107
W6GRL (No. 15)...	129	G6CL (No. 24)...	107
W2GT (No. 32)...	128	W2HHF (No. 54)...	106
G2ZQ (No. 6)...	127	W3EVW (No. 55)...	106
W2GTZ (No. 12)...	127	PAØXF (No. 49)...	105
W8CRA (No. 1)...	126	VK5WR (No. 61)...	105
W1TS (No. 9)...	125	W9ADN (No. 61)...	105
W2GW (No. 11)...	125	W1JPE (No. 66)...	105
ON4AU (No. 40)...	125	W9KA (No. 42)...	104
W1LZ (No. 10)...	121	W6FZL (No. 48)...	104
W1BUX (No. 2)...	118	W3EVT (No. 51)...	104
W9KG (No. 16)...	118	W8BKP (No. 55)...	104
W8DHC (No. 27)...	118	W3CHE (No. 87)...	104
H8J (No. 13)...	117	E1SF (No. 19)...	103
W9ARL (No. 18)...	117	G6KP (No. 45)...	103
W8OSL (No. 23)...	116	W4CYU (No. 79)...	103
W5BB (No. 37)...	116	W2DC (No. 78)...	103
W3EMM (No. 58)...	116	W2GVZ (No. 80)...	103
W6KIP (No. 28)...	115	G2TR (No. 83)...	103
W8BTI (No. 56)...	114	W4CBY (No. 20)...	102
W8DWV (No. 17)...	113	W2CMY (No. 68)...	102
W8JMP (No. 22)...	113	W1WV (No. 69)...	102
W2UK (No. 33)...	113	W2AAL (No. 81)...	102
W8LEC (No. 25)...	112	F8RJ (No. 9)...	101
W1DF (No. 29)...	112	W2CJM (No. 57)...	101
W8OQF (No. 30)...	112	W2CYS (No. 52)...	101
W9PST (No. 35)...	112	VK3KX (No. 59)...	101
G6RH (No. 36)...	112	ZL1HY (No. 73)...	101
W6GAL (No. 50)...	112	W1ZB (No. 62)...	101
W4BFD (No. 70)...	112	W3DDM (No. 75)...	101
W1FH (No. 71)...	112	W2OA (No. 73)...	101
W7AMX (No. 26)...	111	W3EPV (No. 74)...	101
W2BHW (No. 39)...	111	W4AJX (No. 75)...	101
W8ADG (No. 63)...	111	W6DOB (No. 76)...	101
ON4AU (No. 31)...	110	W9ES (No. 77)...	101
W6ADP (No. 34)...	110	W1DUK (No. 82)...	101
J5CC (No. 46)...	110	G5RV (No. 84)...	100
W9TJ (No. 67)...	110	VE2AX (No. 84)...	100
W5VV (No. 38)...	109	W3FRY (No. 85)...	100
		W2CBO (No. 86)...	100

The following have submitted proof of contacts with 75-or-more countries.

W2DSB.....	99	H89X.....	89	Radiotelephone	
W8EUY.....	99	VE2EE.....	89	W2IXY.....	77
PAØQF.....	98	FAØQZ.....	88	W4CYU.....	75
W2AA.....	98	W3JM.....	88	W5BLA.....	81
W3AG.....	98	W8DOD.....	88	W6LH.....	81
W3GAU.....	98	W8NJP.....	88	W9RCQ.....	81
F8RR.....	97	G2DZ.....	88	W8BVN.....	80
W1CC.....	96	G2ML.....	88	W3EPR.....	80
W4BDD.....	95	W1GOK.....	87	W3GEH.....	80
W2DXY.....	94	W4CJH.....	87	W8DFG.....	78
W1ZL.....	93	W6TH.....	87	LU7AZ.....	79
W6BAM.....	93	W8AAJ.....	87	SM6WL.....	79
W6GJU.....	93	W9AEH.....	87	W1BWD.....	78
W8BOX.....	93	W1HX.....	86	W2AER.....	78
G6GEL.....	93	W3AIU.....	86	W8AAI.....	78
W1FT.....	92	W3CW.....	86	W8DFG.....	78
W2BYP.....	92	W1GNE.....	85	W8JTN.....	78
W8OXO.....	92	W2IOP.....	85	W8MTY.....	78
W1BGY.....	91	W4MR.....	85	W9UIM.....	78
W3BES.....	91	W6FKZ.....	85	GØYR.....	78
F88AB.....	91	W2GRG.....	84	VE2GA.....	78
G8NP.....	91	W3AGV.....	84	W1ICA.....	77
H89BG.....	91	W3KT.....	84	W8KUT.....	77
W1BY.....	90	W4CFD.....	84	W8TT.....	77
W8KTV.....	90	W8BSE.....	84	W6LDJ.....	76
J3JJ.....	90	G5QY.....	84	W8LZK.....	76
SUIWM.....	90	VK6SA.....	84	G8KX.....	76
W1ADM.....	89	W8ASG.....	83	ZS2X.....	76
W3ZX.....	89	G8ZO.....	83	W3CKT.....	75
W5KC.....	89	SP1AR.....	83	W3FLH.....	75
W8AU.....	89	W2ALO.....	82	W4TZ.....	75
W8CJJ.....	89	W3OP.....	82	W8AM.....	75
W8KCG.....	89	W6GPB.....	82	W8DAE.....	75
G5BD.....	89	W9OV.....	82	PAØJMW.....	75
		W1BFT.....	81		

Emergency Preparation Demonstrations

T. J. De Lasaux, A.R.R.L. Emergency Coördinator, San Francisco Section, is sponsoring demonstrations of the availability of amateur radio for emergency communication. On Sept. 24, 1938, in connection with the celebration of the opening of a new strip of highway, a fixed station was set up in the office of Marvelous Marin, Inc., and a portable emergency-powered transmitter and receiver was at the scene of the celebration. This made it possible for state and other civic officials to participate with full assurance that they could be reached at any time. In addition, the State Police Highway Patrol had its receiver tuned to the frequency used

TAYLOR TUBES ARE CUSTOM BUILT

to bring **YOU**

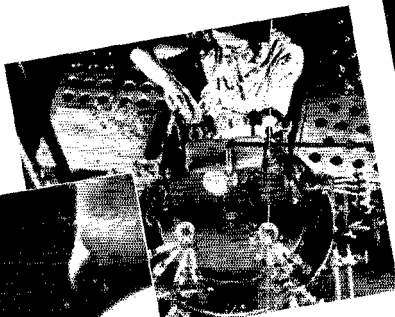

The difficult job of shaping the envelopes of 866jr's and other small tubes requires the same expert individual care as exercised in larger tube building.

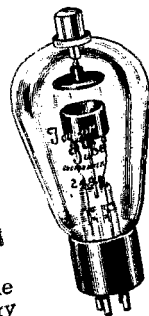

One of the world's finest glass-blowers is pictured here as he shapes the envelope of a T-200. Careful **CUSTOM BUILT** manufacture of every TAYLOR Tube makes them your favorites.

Photographs courtesy RADIO NEWS

MORE WATTS PER DOLLAR

The words "CUSTOM BUILT" which are printed on each TAYLOR TUBES carton, guarantee YOU better all around tube performance. Longer hours of efficient operating service can only come as a result of *individualized* and *skillful* "CUSTOM BUILT" tube manufacture. Every Taylor Tube, from the smallest to the largest, is individually built. The slogan, "MORE WATTS PER DOLLAR," is more than a boast — it is the true performance standard by which all Amateur Transmitting Tubes are gauged. Yes, with TAYLOR TUBES it's "How Many" AND "How Good."

NEW 1939 TAYLOR TUBES MANUAL AND CATALOG NOW READY

TAYLOR TUBES, INC., 2341 Wabansia Ave., CHICAGO, ILLINOIS

No. 842 L A.C.—D.C.—VOLT—OHM—DECIBEL—MILLIAMMETER—AMMETER

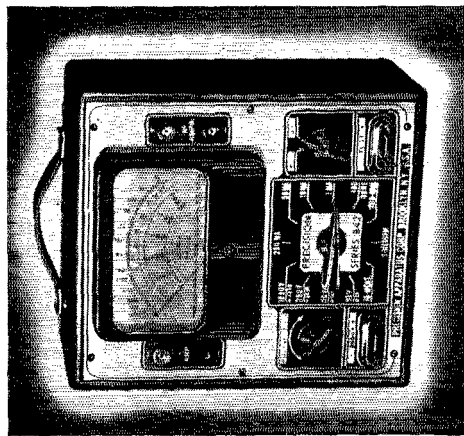

Two Popular "PRECISION" Testers

SPECIFICATIONS

Five A.C. and D.C. Voltage Ranges at 1000 ohms per volt: 0-10, 0-250/1000 VOLTS

Six D.C. Current Ranges: 0-1, 0-10, 0-100, 0-1000, 0-10000, 0-100000

Four Resistance Ranges: 0-10, 0-100, 0-1000, 0-10000

Five Decibel Ranges from -10 to +140dB

Five Output Ranges (Same as A.C. Ranges)

Large 4 1/2 inch square meter. Wire wound shunts and metalized multipliers, both of 1% accuracy.

Five A.C. Voltage Ranges at 1000 ohms per volt: 0-10, 0-100, 0-250, 0-500, 0-1000 volts

Four D.C. Current Ranges: 0-1, 0-10, 0-100, 0-1000

Two Resistance Ranges: Low ohms (shunt method) 1/2 to 500 ohms. High ohms 0-300,000 ohms.

Ohmmeter Ranges are powered by self contained supply.

Other Features: Large 3" square meter, 1/2% accuracy; adjust ohms compensator; attractive metal etched panel; walnut finished wood case with carrying strap self contained battery included; compact size 7 x 4 1/2 x 2 1/2".

Available at leading Parts Jobbers

NET PRICE \$21.95

NET PRICE \$10.95

Less Batteries and test leads

Less Batteries and test leads

PRECISION APPARATUS COMPANY
 321 EAST NEW YORK AVENUE • BROOKLYN, NEW YORK
 EXPORT DIVISION: 458 BROADWAY, NEW YORK, U. S. A.—CABLE ADDRESS: MORHANEX

No. 830 D.C.—VOLT—OHM—MILLIAMMETER



by the amateurs (in the 1.75-Mc. band) in the event additional men were needed to handle the traffic situation. Those participating were W6SG, W6LQW, W6OMC, W6QGN and W6OBK.

On Oct. 24th another demonstration was given for the disaster committee of the American Legion in Marin County. Portable equipment was set up in the three A. L. posts, one at Mill Valley, Ross and San Anselmo. The three posts held a joint meeting by means of the hook-up. 1804 kc. was used and, with the cooperation of the Mission Trails Net, which monitored the frequency, there was little QRM. The demonstration was a success and there is a probability that the A. L. group will underwrite the securing of an emergency power supply, transmitter and receiver for each section of the county having a population of from 5000 to 10,000 inhabitants. Participating in this demonstration were W6FVK, W6HVX, W6KNZ, W6LQW, W6PAZ, W6QGN and W6SG. Also present and assisting were W6OBJ, Emergency Coördinator, East Bay Section, together with his two assistants, W6BF and W6OMIC.

Wisconsin-Minnesota Sleet Storm

A sleet storm beginning the night of Oct. 21, 1938, and lasting through the 22d, turning to heavy slush snow, left sections of western and northern Wisconsin and southeastern Minnesota without power and communication facilities. Again amateur radio filled the breach. At 10:00 a.m. on the 22d, the Northern States Power Company asked W9DCM, Minneapolis, to contact Eau Claire, Wis., W9DCM made contact with W9IXR, Rice Lake, Wis., who made a long-distance telephone call on the last line that was standing, notifying the power company at Eau Claire to secure the aid of local amateurs. In a short time W9OKS and W9SKX of Eau Claire were in communication with W9BN and W9DCM of Minneapolis. W9AN, St. Croix, Wis., was also on the air giving service to the power company, contacting W9SKX, W9OSB and W9UVA to handle traffic in that area. Red Wing, Minn., was entirely out of communication and power service. W9DCM raised W9ORL of Red Wing and furnished that city with its sole contact through the 22d and 23d until regular service was restored. W9ORL was using a 7-watt battery-powered rig. W9FWN assisted at ORL. Through this contact, men and supplies were sent to Red Wing to assist in restoring power service. W9SYX was on hand throughout the emergency requesting non-participating stations to remain off the air to lessen the QRM, and assisting in relaying information. All of these stations, with the exception of W9BN, W9OKS and W9SKX were on 3.9-Mc. phone with W9DCM as the central station for clearing information to the power company office in Minneapolis.

On the 23d, W9JNU of Eau Claire took a portable out with a line crew to patrol ninety miles of transmission lines which were down in the stricken area, reporting breaks as they came to them. W9OKS acted as key station to keep the dispatcher at Eau Claire advised of the progress of the crew. On the morning of the 24th, W9DIT went into action with a line crew to patrol another section of line, approximately one hundred miles in length. The two portables were on the job with the crews until the repairs were completed and the crews sent home. W9JNU was powered with a Mallory power pack, and W9DIT with a genemotor, each using a storage battery for primary power. Each portable had an output of about 7 watts, crystal-controlled and operated 3.5-Mc. c.w., as did the key station, W9OKS. These operators are all members of the Northern Wisconsin Radio Club and welcomed the opportunity to be of service and demonstrate the effectiveness and reliability of amateur radio in emergencies.

With Cannon Falls, Minn., still without telephone service on the 23d, W9DH and W9DCM took portable equipment from W9BN, Minneapolis, to that city. Enroute over poor roads their receiver went bad and they called upon W9BQJ, Cannon Falls, who assisted them in locating another set. With the cooperation of W9BQJ, W9DH-portable was set up about twelve miles out of the city on the power company's line to Red Wing. Two 56-Mc. transceivers were used from the base station out on the line and information relayed into Cannon Falls to the power company's dispatcher. The c.c. portable transmitter consisting of a single 6A6 on 3890 kc. was powered by a six volt storage battery and a 350-volt generator.

W9GBL, La Crosse, Wis., was also on the job. The Michigan QMN Net on 3663 kc. was active throughout the emergency period, ready to assist in every way possible.

— W9DCM, W9BN and W9OKS.



EARTHWORM SIGHS to 20 K.W.

WE ARE only human, fall in love, have grouches, and are bitten by bugs like anyone else. At the moment it's Q. and A. with us, so read on:

Q. What is a Metallized Resistor?

A. A Metallized Resistor consists of a very thin film of fine conducting particles bonded together on the surface of an insulating base.

Q. How thick is this film?

A. About as thick as the seat of our 2nd-best pants — one to three thousandths of an inch.

Q. How fine are these particles?

A. Of colloidal size — they are ground fine enough to float in air.

Q. Of what are these conducting particles made?

A. Carbon and other conducting materials.

Q. How are they bonded to this insulating base?

A. The conducting particles are deposited in a controlled film on the surface of the insulator. Successive treatments in high temperature conveyor ovens bond the particles together and to the insulating base. This stabilizes the film to prevent changes in resistance after the unit is completed. Needless to say, these processes have been continually improved and refined during the fifteen years we have made resistors.

Q. What is the insulating material on which this film is applied?

A. Glass, Isolantite or Steatite, and Bakelite. A special glass rod or tube, about the diameter of a pencil lead, is used in the High Frequency "F" Type and the Insulated "BT" Type Low-Power Resistors. The same is also used in the Types "FH" and "MG" Ultra High Range Resistors (up to 100,000 megohms). Isolantite or Steatite tubes are used as the base material for the Type "MP" High Frequency Power and the "MV" High Voltage Resistors.

A high grade bakelite is the material to which the metallized film is applied for volume controls.

Q. Wherein do these Metallized Resistors differ from the common carbon units?

A. The Metallized Resistor has a conducting

film of minute cross-section compared to the solid body of the molded or extruded carbon resistor.

Q. And so . . . ?

A. The Metallized Resistor uses a conducting element of much lower specific resistance, or; *the proportion of conducting to non-conducting material is much greater.* This is the direct reason for the low noise level, and low voltage and temperature coefficients noted here in November.

Q. Will such a thin film carry power?

A. This is a matter of design. We manufacture Metallized Resistors that will handle anything from an earthworm's sigh up to 20 K.W. of R.F. (These latter units are water cooled, of course, and are about 3" diameter x 20" long.) Other low range Type "MP's" handle momentary surges of several thousand amperes.

Q. Will it handle voltage?

A. The standard rating on the Type "MVR" Resistor is 100,000 volts. There are high voltage generators in various Universities using multiple units at a million volts upwards.

Q. How about the frequency characteristic? Does the impedance stay constant from D.C. up to ultra high frequencies?

A. The "MP" Resistors are a close approach to a pure resistance. They are used up to a hundred megacycles. As a dummy antenna load they may be coupled to the final tank in your transmitter without requiring re-tuning. This same characteristic makes them most suitable for terminating Rhombic antennas, measuring non-resonant lines, etc.

Q. Why do you have so many types?

A. There are six different types of Metallized Resistors, each designed for maximum performance in certain characteristics. One of the virtues of the metallized process is this flexibility in design.

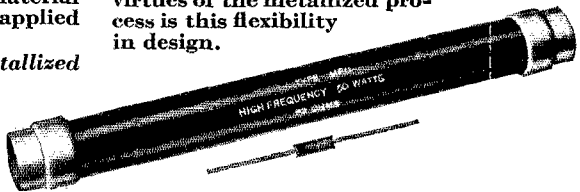

INTERNATIONAL RESISTANCE COMPANY • 401 NORTH BROAD STREET, PHILADELPHIA, PA.

Another B & W ACHIEVEMENT IN COIL DESIGN!

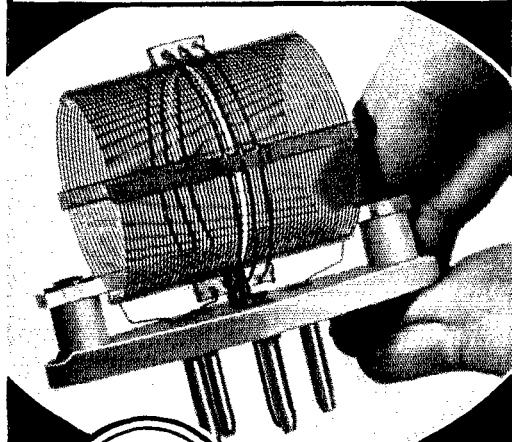

B & W THE NEW "BABY" (25 WATT) AIR INDUCTORS

B & W BABIES have all the strength, the vastly superior efficiency, the unmatched good looks that have made AIR INDUCTORS the standard of coil performance throughout the World.

Yet, BABIES are smaller than any other air-spaced coils ever made! They are burdened with less insulating material than was ever practical before! Turns are perfectly air-spaced, absolutely symmetrical, amazingly rugged — even when the finest wire is used! And their 25 Watt rating is very conservative!

An entirely new winding method* — conceived and perfected by B & W — is the secret of such fine appearance and ultra-high efficiency in a coil only 1 1/2" long x 1 1/4" in diameter! The secret, too, of the finer, more dependable performance they give in all

25 Watt applications. BABIES are available in five types, from 10 to 160 meters. Universal 5-prong Alsimex 196 bases permit quick, easy band changing.

Amateur
Net Price, **\$1.00**

Patent Applied for

AND REMEMBER:
There is an AIR
INDUCTOR for
every inductance
application . . .
any coil you need
from 10 to 160
meters — from 25
Watts to 1 K.W.

**AT YOUR
JOBBER'S**
or write for details

BARKER & WILLIAMSON

Radio Manufacturing Engineers • ANDMORE, PENNSYLVANIA

W1AW Operating Schedule

(Effective Dec. 27, 1938)

OPERATING-VISITING HOURS:

3:00 P.M.—3:00 A.M. daily, except Sat. & Sun.

Saturday — 8:30 P.M.—2:30 A.M.

Sunday — 7:00 P.M.—1:00 A.M.

GENERAL OPERATION:

W1AW devotes the following periods daily, except Saturday and Sunday, to *GENERAL work* with all amateurs in the following bands:

Band	Frequency	Time — Eastern Standard
1.5 Mc.	1808-1800-kc.	3:00- 3:30 P.M. 11:00-11:30 P.M.
	'phone/c.w.	
3.5 Mc.	3800-kc. c.w.	3:30- 4:00 P.M. 8:00- 8:30 P.M.
3.9 Mc.	3950-kc. 'phone	10:00-11:00 P.M.
7 Mc.	7150-kc. c.w.	1:00- 2:00 A.M.*
14 Mc.	14,254-kc. c.w.	6:00- 7:00 P.M.
14 Mc.	14,240-kc. 'phone	4:00- 5:00 P.M.

* Daily except Sun. & Mon.

On Saturdays W1AW is operated from 8:30 P.M. to 2:30 A.M. E.S.T., and on Sundays from 7:00 P.M. to 1:00 A.M. E.S.T. On these days operation will be devoted to the most profitable use of bands for general contacts and to participation in special week-end operating activities and contests. The station is not operated on legal national holidays.

OFFICIAL BROADCAST SCHEDULE (for sending addressed information to all radio amateurs):

Frequencies

C.W.: 1800-3800-7150-14,254 kcs. (simultaneously)

Starting Times (P.M.) Speeds (W.P.M.)

E.S.T.	C.S.T.	M.S.T.	P.S.T.	M	T	W	Th	Fri	Sat	Sun
8:30	7:30	6:30	5:30	20	15	25	15	20	—	—
Midnight	11:00	10:00	9:00	15	25	15	20	15	15	—

'PHONE: 1808, 3950, 14240 kcs.

Each code transmission will be followed in turn by voice transmission on each of the above frequencies.

BRIEFS

1.75-Mc. Trans-Atlantic Tests, February 1939

The Annual 1.75-Mc. Trans-Atlantic Tests will be held this year in February under the guidance of G6FO. The object of the tests is to continue the observations and tests originally started in 1934 by G2II (now GW6AA), to endeavor to effect G-W QSO's on 1.75 Mc., to observe conditions obtaining on the band at the time and during the period which previous experience shows to be the best for contacts between U. S. A. and Europe, and to focus interest on the DX possibilities of our lowest frequency band.

A number of G stations, as well as many listeners, are interested in these tests. It is hoped that W operators using 1.75 Mc. will participate and keep the following schedule: 0430 to 0730 G.T. on each of these dates — February 4th, 6th, 8th, 10th, 12th, 14th and 16th. Calling and Listening Schedule: 0430-0440, W calls, G listens; 0440-0450, G calls, W listens; 0450-0500, W calls, G listens; and so on at ten-minute intervals until 0730 G.T. Accurate time-keeping is essential. All G stations will operate in the region 1720-1800 kcs., listening for W c.w. and 'phone stations in the complete "160-meter" band. Any QSO established should be kept short to give other stations an opportunity to make contact. All American participants are asked to send a log and report as soon as possible after the Tests to G6FO, 84-86, Tabernacle St., London, E. C. 2, England. Reports should also be sent to A.R.R.L. headquarters.

— S. S. Perry, W1BB.

Addenda, Field Day Results

Received too late to make the December QST story on the 1938 A.R.R.L. Field Day was the report of the Jacksonville (Fla.) Radio Club. Operating W4DIQ-4 on 7 and 14-Mc. c.w. and 28- and 3.9-Mc. 'phone, the "Jax" gang made 501 points (33 QSO's). Operators were W4CRZ, W4BNK, W4EEM-W9QBU, W4EOE, W4EOS and W4DIQ.

The call of the Saskatoon Amateur Radio Club was erroneously listed in the F.D. scores as VE4AAW. The correct



ATTENTION ALL HAM'S

THORDARSON QUALITY AT PRICES YOU WILL APPRECIATE

THE "19" SERIES

- * PLATE TRANSFORMERS
- * CHOKES
- * MODULATION TRANSFORMERS
- * FILAMENT TRANSFORMERS
- * DRIVER TRANSFORMERS

"19" SERIES PLATE SUPPLY TRANSFORMERS
Primary 115 Volts, 50-60 Cycles

Transformers rated in D.C. volts from two section filter
Electrostatic shield between primary and secondary

THORDARSON QUALITY FOR THE
"HAM" IN THE POPULAR-PRICE FIELD!
COMPARE!

Type No.	Sec. A.G. Load Volts	D.C. Volts	D.C. M.A.	Your Cost
T-19P55	660-0-660 550-0-550	500* 400	250	\$4.50
T-19P56	900-0-900 800-0-800	750 600	225	4.80
T-19P57	1075-0-1075 507-0-507	1000** 400	125 150	6.00
T-19P58	1200-0-1200 900-0-900	1000** 750	200 150	7.80
T-19P59	1560-0-1560 1250-0-1250	1250 1000	300	9.60
T-19P60	1875-0-1875 1560-0-1560	1500 1250	300	11.10
T-19P61	2125-0-2125 1875-0-1875	1750 1500	300	12.00
T-19P62	2420-0-2420 2125-0-2125	2000 1750	300	12.90
T-19P63	1560-0-1560 1265-0-1265	1250 1000	500	13.80
T-19P64	1875-0-1875 1560-0-1560	1500 1250	500	17.70
T-19P65	3000-0-3000 2420-0-2420	2500 2000	300	17.70
T-19P66	2125-0-2125 1875-0-1875	1750 1500	500	22.50
T-19P67	2450-0-2450 2125-0-2125	2000 1750	500	25.50
T-19P68	3000-0-3000 2450-0-2450	2500 2000	500	30.00

*This transformer has a bias tap at 30V. **These transformers designed for double rectifiers and will deliver both secondary ratings simultaneously.

"19" SERIES SWINGING AND FILTER CHOKES

Inductance listed is that actually measured at rated current
All adequately insulated

Type No.	Cap. D.C.M.A.	Inductance Henries	D.C. Res. Ohms	Volts Insulation	Your Cost
T-19C35	200	5-20	130	3000	\$2.85
T-19C36	300	5-20	105	3000	3.90
T-19C37	400	5-20	90	4000	5.40
T-19C38	500	5-20	75	4000	6.90

Type No.	Cap. D.C.M.A.	Inductance Henries	D.C. Res. Ohms	Volts Insulation	Your Cost
T-19C42	200	12	130	3000	2.85
T-19C43	300	12	105	3000	3.90
T-19C44	400	12	90	4000	5.40
T-19C45	500	12	75	4000	6.90

Shown at the left is catalog information on the plate transformers and chokes in this new series of transformers. Complete information on the full series in Catalog No. 400-C, from your parts distributor or write factory for Free copy.

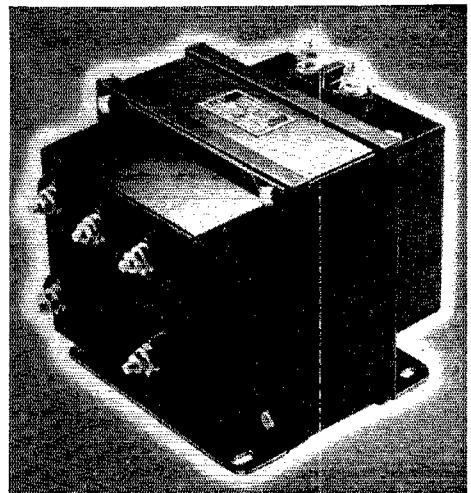

"19" Series Plate Transformer
Mounting Style 2 K
Fully shielded - Air cooled

THORDARSON ELECTRIC MFG. CO.

500 W. HURON ST., CHICAGO, ILL.

Demand "Power by Thordarson"

TO OUR READERS

who are not

A.R.R.L. MEMBERS

WOULDN'T you like to become a member of the American Radio Relay League? We need you in this big organization of radio amateurs, the only amateur association that does things. From your reading of *QST* you have gained a knowledge of the nature of the League and what it does, and you have read its purposes as set forth on page 6 of this issue. We should like to have you become a full-fledged member and add your strength to ours in the things we are undertaking for Amateur Radio. You will have the membership edition of *QST* delivered at your door each month. A convenient application form is printed below — clip it out and mail it today.



A bona fide interest in amateur radio is the only essential qualification for membership

AMERICAN RADIO RELAY LEAGUE Hartford, Connecticut, U. S. A.

I hereby apply for membership in the American Radio Relay League, and enclose \$2.50 (\$3 in foreign countries) in payment of one year's dues, \$1.25 of which is for a subscription to *QST* for the same period. Please begin my subscription with the issue. Mail my Certificate of Membership and send *QST* to the following name and address.

.....

.....

.....

Do you know a friend who is also interested in Amateur Radio, whose name you might give us so we may send him a sample copy of *QST*?

.....

.....

Thanks

call is VE4AAA. Through an oversight the Jersey Shore Amateur Radio Association failed to mention W2HWX as a member of its F.D. party; HWX played an important part in W2AIW-2 operations.

Brass Pounders' League

(October 16th–November 15th)

Call	Orig.	Del.	Rel.	Extra Del. Credit	Total
W2CGG	29	318	1654	303	2304
W2JHB	391	490	703	473	2057
W4PL	21	64	1627	48	1760
W6IOX	15	15	782	11	823
W8KWA	32	63	642	0	737
W3CJZ	19	47	587	47	700
W6DE	61	112	364	112	649
W3EML	63	86	420	74	643
W1KZT	21	314	48	254	637
W8LKJ	138	21	472	2	633
W8QGD	88	137	282	99	606
W3BWT	51	82	359	63	555
W1KCI	541	13	0	0	554
W5FDR	42	122	278	108	550
W5MN	29	73	366	56	524
W5EOE	23	142	338	18	521
W9NPL	18	35	442	16	511
W1ENU	66	35	408	0	509
W6LLW	9	40	434	22	505

MORE-THAN-ONE-OPERATOR STATIONS

Call	Orig.	Del.	Rel.	Extra Del. Credit	Total
K1IHR	709	480	890	0	2079
W5OW	154	166	1340	83	1743
W4CXY	941	10	0	0	951
W9BNT	54	147	368	17	586
W1GOF	68	63	401	41	573

These stations "make" the B.P.L. with total of 500 or over. One hundred deliveries + Ex. Del. Credits also rate B.P.L. standing. The following one-operator stations make the B.P.L. on deliveries. Deliveries count!

W8CMI, 294	W6IMI, 161	W8FUW, 121
W6JTV, 229	W9TFA, 159	W5DAQ, 115
W9GSA, 224	W8ZX, 152	W8DKS, 114
W2CQ, 217	W3CF, 151	W8RO, 108
W5DKR, 191	W1KIN, 148	W5GUK, 100
W7APS, 190	W5CEZ, 147	More-than-one-opr.
W6EJA, 186	W5BN, 135	W1AW, 372
W2BC, 178	W6MDI, 132	K5AA, 151
W9URB, 166	W1AKS, 129	

A.A.R.S.

WLN (W2SC) made the B.P.L. on 297 deliveries.

MORE-THAN-ONE-OPERATOR STATIONS

Call	Orig.	Del.	Rel.	Extra Del. Credit	Total
WLM (W3CXL)	130	348	2857	74	3409

A total of 500 or more, or 100 deliveries Ex. D. Cr. will put you in line for a place in the B.P.L.

Third Annual South African DX Contest

AMATEURS throughout the world are invited to participate in the third S.A.R.R.L. International DX Contest to be held on the first and second week ends of January, 1939.

Dates: January 7th (1600 GMT) to January 8th (2200 GMT) and January 14th (1600 GMT) to January 15th (2200 GMT).

Bands: Any or all bands can be used. A station can be worked but once per band, per week end. Stations worked on the first week end can be worked on the second week end.

Exchanges: As usual, a six-figure group will be exchanged. The first three numbers will be the signal report; the last three numbers will be a self-assigned figure used throughout the contest.

Points: Two points may be claimed for "two-way" exchanges, one point for "one-way" exchange.

Zones: Stations outside the "Africas" will base their multipliers on the following zones: ZS1, ZS2, ZS3, ZS4, ZS5, ZS6, ZE, VQ2, VQ3, CR7, FB8, FR8, OQ5, ZN1, VQ8.

Scoring: DX stations outside of the African zone will compute their scores by multiplying the total number of contacts by the total number of African zones by the total number of points. For example: W9ARL contacts 38 sta-

25 watt output at one meter!

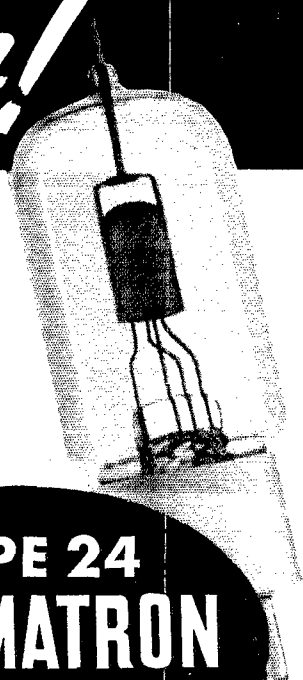
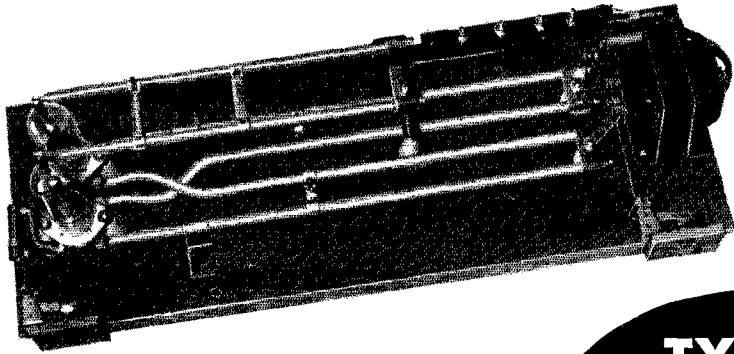

Shown above is a one-meter parallel rod oscillator which is capable of delivering more than 25 watts of radio frequency power to its load. Constructional information on this transmitter will be forwarded on request.

**TYPE 24
GAMMATRON
\$350**

HOW IT WORKS

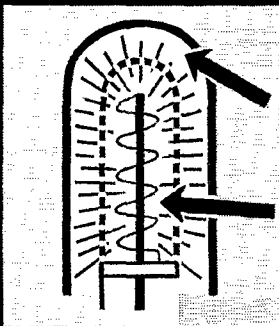

The phenomenal power output of the Type 24 Gammatron at ultra high frequencies is due to its scientific design.

The use of a long, capped Tantalum plate prevents the escape of stray electrons from the ends of the plate structure which greatly reduces the efficiency in ordinary U. H. F. tubes.

The use of a tantalum grid permits very close spacing to the filament, thus providing a very short time of electron flight and resultant high efficiency at very short wave lengths. Write for the U. H. F. data on the Type 24 Gammatron.

HEINTZ AND KAUFMAN
SOUTH CALIFORNIA
SAN FRANCISCO LTD U. S. A.



THE law requires that every amateur station shall regularly check and measure transmitter frequency. Frequency measuring apparatus is required to be external to transmitter frequency control. For precise frequency measurement a stable and dependable frequency meter-monitor is indicated.

GUTHMAN is proud to offer the precision frequency meter and amplified monitor illustrated above and parts for its construction.

This instrument provides features heretofore available only in precision laboratory equipment. Designed for precise measurement, it offers a 7 3/4", 324 degree dial, accurately calibrated for 5 to 160 meter bands; zero adjuster for use with 20 precision calibration frequencies available; A.C. or D.C. operation with voltage and temperature stabilization of electron coupled oscillator and amplified monitoring.

It is styled to "dress up" any station; priced extraordinarily low; designed for precision work.

See your jobber or write for full details on this and an outstanding line of quality r.f. and i.f. transformers, fixed and variable condensers and other parts.

EDWIN I. Guthman & CO., INC.
402 S. PEORIA ST. CHICAGO, U. S. A.

PRECISION CRYSTALS

Highest quality crystals carefully prepared for frequency stability and maximum output. Rigidly tested to assure you of dependable operation. Be sure of your transmitter frequency — use PRECISION CRYSTALS.

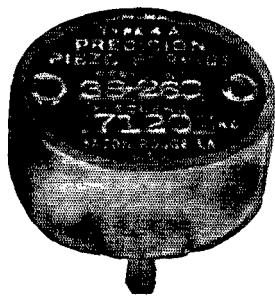

Type 4-A low drift unit plugs into a tube socket. Supplied within 5 Kc. of your specified frequency in the 40, 80 or 160 meter bands. Calibration accurate to within 0.03%. Price, \$4.50.

X cut crystals supplied in type 4 holder for tube socket within 5 Kc. of your specified frequency in the 40, 80 or 160 meter bands. Price, \$4.00.

Either the low drift crystals or the *X* cut type can be supplied in square holders to plug into G.R. type jacks at the above prices.

Crystals for commercial requirements quoted on at your request. Now in our ninth year of business.

PRECISION PIEZO SERVICE
427 Asia Street Baton Rouge, La.

tions in 10 African zones for 76 points. His score = $38 \times 10 \times 76 = 28,880$ points.

Awards: The highest DX scorer will receive a miniature trophy and a certificate. The highest in each country (each district in U.S.A.) will receive a certificate.

Returns: Logs showing Date, Station, Time, Freq., Zone, Nr. Sent, Nr. Received, Points and Total should reach the S.A.R.R.L., P. O. Box 7028, Johannesburg, South Africa, not later than March 15, 1939.

High Sweepstakes Scores

As this issue goes to press logs for the 1938 Sweepstakes Contest are arriving by the dozens each day . . . and some 700 have already been received. It is as yet impossible to give any official results, but we're passing along the "claimed results" of some of the higher scorers, since we know that all participants are anxious to receive this information. So far there has been no report of anyone working all Sections in the contest. The complete official results are scheduled for April QST. The tabulation following shows score, stations worked and section worked in each case:

C. W. T.		W3FMY	41856-328-64
W3BES	84000-502-67	VE3ES	41456-304-55
W6KFC	76500-450-68	VE2DR	40800-273-60
W3CHH	74080-463-64	W9AET	40031-263-61
W2IOP	71998-482-62	W9MGN	38964-257-61
W5KC	69500-422-67	W1KFE	38480-300-65
W9RSO	69020-406-68	W6MEK	38132-256-62
W9VKF	67235-397-68	W8AVB	37818-291-66
W8OFN	66430-514-65	W9WTW	37620-316-60
W2HMJ	65000-400-65	W2JJE	36600-246-60
W1TS	62531-363-69	W9YXO	36409-304-59
W7CMB	61556-369-67	W3GKL	35409-304-59
W8OKC	60795-389-63		
W1AW (Hal)	60720-460-66	'Phone	
W4APU	60095-357-68	W6ITH	45126-327-69
W9WFS	57840-303-64	W2JUL	17820-168-54
W2HZY	57165-368-62	W9YQN	17280-160-54
W9MUX	57120-359-64	W9TTS	13888-125-56
W8JTT	56695-333-68	YE3AIB	13475-123-44
W3ATR	56050-380-59	W9TQL	12960-152-36
W8DOD	54019-325-67	W9UYD	12584-123-62
W9ZAR	53156-338-63	VE5FZ	12514-110-47
W9AWP	52053-331-63	W9ZTO	11040-115-48
W8CMH	49995-303-66	W6EJC	10608-102-52
VE2EP	49300-290-68	W4CDG	10368-97-54
W1AVJ	49115-312-65	W9GDB	10125-91-50
W3GAU	48669-301-65	W6AM	9447-100-47
W6QAP	48100-304-65	W9WXL	7898-81-39
W9CWW	46398-277-67	VE4WJ	7556-79-39
W1KQY	46116-366-63	W8JAH	7490-85-44
W5CWW	44000-277-64	W5FDQ	7264-75-39
W3FPQ	43710-354-62	W1GKI	6865-63-43
W9ZMG	42319-310-55	W4BQE	5719-67-43
W5ELE	41920-267-64		

S. C. Tornado Emergency

A tornado hit Charleston, S. C., about 8:20 A.M., September 29, 1938, leaving the city without power and with but one telephone line that was highly overtaxed by folks who were trying to communicate with their loved ones, friends or places of business.

The city being without power naturally handicapped the amateurs who were without the necessary emergency equipment. (A lesson on why we should all have auxiliary equipment!) However, the power company did restore power to the rural districts near the edge of the city, and that enabled W4FFH to put his 7-Mc. rig on the air around 11:00 A.M. As soon as the flying debris had settled, the amateurs of Charleston set about doing the best they could to start an emergency circuit. A portable battery-powered rig owned by W4CUS was loaned to the City Police department so that they could keep in contact with the police force and direct rescue work. CUS aided by FFH then returned to Pollet Beach to bring CUS' rig to the city, that it might be set up at the car barn sub station where an attempt was being made to secure a line from the power plant which would give 110 volts a.c. This rig was turned over to the N.C.R. members, W4DHT, W4DBK, W4EOR,

FOR AMATEUR RADIO

HY25 \$1.45 Net

R.F. Power Amplifier, Oscillator, Class "B" Modulator, Frequency-Doubler, Ceramic Base and Insulation.

Plate Dissipation..... 25 watts max.
 Plate Voltage (D.C.)..... 800 max.
 Filament Voltage..... 7.5
 Filament Current..... 2.25 amp.
 Average Amp. Factor..... .55
 Grid to Plate Cap..... 4.6 μ f

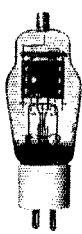

HY40 \$2.75 Net

R.F. Power Amplifier, Oscillator, Class "B" Modulator, General Purpose High-Efficiency Triode, Graphite Anode, Lava Insulation, Ceramic Base.

Plate Dissipation..... 40 watts max.
 Plate Voltage (D.C.)..... 1000 max.
 Filament Voltage..... 7.5
 Filament Current..... 2.25 amp.
 Average Amp. Factor..... .25
 Grid to Plate Cap..... 6.3 μ f



HY51A-HY51B \$5.00 Net

R.F. Power Amplifier, Oscillator, Class "B" Modulator, Frequency-Doubler, Graphite Anode, Lava Insulation, Ceramic Base.

Plate Dissipation..... .65 watts max.
 Plate Voltage (D.C.)..... 1000 max.
 Filament Voltage..... 7.5 on HY51A, 10.0 on HY51B
 Filament Current... 3.5 amp. on HY51A, 2.25 amp. on HY51B
 Average Amp. Factor..... .25
 Grid to Plate Cap..... 7.5 μ f



HY57 \$3.50 Net

R.F. Power Amplifier, Oscillator, Class "B" Modulator, Frequency-Doubler, Graphite Anode, Lava Insulation, Ceramic Base.

Plate Dissipation..... 40 watts max.
 Plate Voltage (D.C.)..... 800 max.
 Filament Voltage..... 6.3
 Filament Current..... 2.25 amp.
 Average Amp. Factor..... .50
 Grid to Plate Cap..... 5.1 μ f



HY60 \$2.50 Net

Beam-Tetrode, R.F. Amplifier, Oscillator, Class AB1 Audio Amplifier, Frequency-Doubler, Ceramic Base. NO NEUTRALIZATION REQUIRED FOR USE AT RADIO FREQUENCIES.

Heater Voltage (A.C. or D.C.)..... 6.3
 Heater Current..... 0.5 amp.
 D.C. Plate Voltage..... 425 max.
 Plate Current..... 60 ma. max.
 Grid Current..... 4 ma. max.
 R.F. Output (Class "C")... 16 watts approx.



HY61 \$3.00 Net

Beam-Tetrode, R.F. Amplifier, Oscillator, Class AB2 Audio Amplifier, Frequency-Doubler, Ceramic Base. NO NEUTRALIZATION REQUIRED FOR USE AT RADIO FREQUENCIES.

Heater Voltage (A.C. or D.C.)..... 6.3
 Heater Current..... 0.9 amp.
 D.C. Plate Voltage..... 600 max.
 Plate Current..... 100 ma. max.
 Grid Current..... .5 ma. max.
 R.F. Output (Class "C")... 37.5 watts approx.



6L6GX \$1.55 Net

Beam-Tetrode, Power Amplifier. (LOW-LOSS REPLACEMENT FOR 6L6 AND 6L6G.) Ceramic Base.

Heater Voltage..... 6.3
 Heater Current..... 0.9 amp.
 Plate Voltage..... 500 max. volts
 Screen Voltage..... 300 max. volts
 Plate Resistance..... 22500 ohms
 Mutual Conductance..... 6000 umhos
 Amplification Factor..... 135
 Plate Dissipation..... 25 watts max.
 Plate Current..... 90 max. ma.
 Screen Current..... 6 max. ma.



HY615 TRIODE \$2.00 Net

Ultra-High Frequency Oscillator, R. F. Amplifier, Detector, Plate and Grid leads are brought out to caps in the dome of the bulb. The HY615 features short connection leads, small internal elements and low inter-electrode capacities resulting in efficient operation at ultra-high frequencies. Ceramic Base.

Heater Voltage (A.C. or D.C.)..... 6.3
 Heater Current..... 0.15 amp.
 Plate Voltage..... 250 max.
 Plate Dissipation..... 3.5 watts max.



866 JR. \$1.05 Net

Half-Wave, Mercury Vapor Rectifier, Ceramic Base.

Filament Voltage..... 2.5
 Filament Current... 2.5 amp.



866 \$1.50 Net

Half-Wave, Mercury Vapor Rectifier, Heavy Duty.

Filament Voltage..... 2.5
 Filament Current... 5 amp.



HYTRON LABORATORIES

SALEM

MASS.

A DIVISION OF THE HYTRON CORP.

Fits YOUR RIG and POCKETBOOK

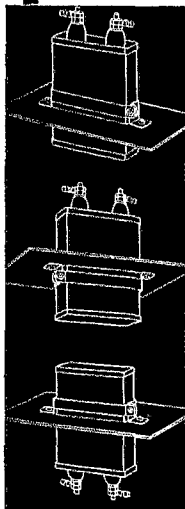

● HYVOL high-voltage capacitors are now obtainable in oil-filled (heavy-duty) and wax-filled (normal-duty) types. Adjustable mounting bracket. High-tension pillar terminals. Steel cases. Conservative ratings. And at prices that will please you.

CATALOG . . .

Ask local supplier for latest AEROVOX catalog. Ask to see HYVOL capacitors. Or write us direct.



No Matter What Type Beam You Want

- HORIZONTAL
- VERTICAL
- FIXED
- ROTARY
- 10-METER
- 20-METER

You can make it best with PREMEX Elements, employing the special Corulite and Adjust-a-Rod Units. Send for diagrams or see your jobber.

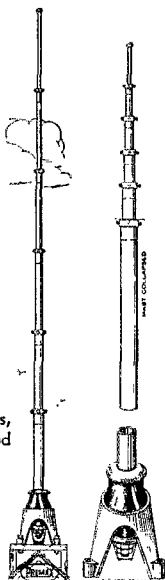

Premax Products

Division of Chisholm-Ryder Co., Inc.
3919 HIGHLAND—NIAGARA FALLS, N. Y.

SEND
FOR
SPECIAL
ANTENNA
BULLETIN

W4DFC, W4EXP and W4FND. CUS then went to the home of FFH and, with W4CYT, aided FFH in the delivery of messages and collection of those to be transmitted. W4CUS later took control of his station which he had left with the N.C.E. group. At about 10:30 P.M. contact had been made and traffic started moving over the South Carolina 1.75-Mc. 'Phone Net. This work continued until 3:30 A.M., when time was taken out for a little shut-eye and a return to the air early in the day to complete the job of delivering and transmitting the rest of the traffic. CUS was aided by FFH and CYT in his late hour operation.

South Carolina amateurs taking part in the 1.75-Mc. circuit were W4EOZ, W4EDQ, W4BZX, W4DQY, W4ETF, W4EGH, W4EZF and W4EJK. These 1.75-Mc. fellows had been guarding the frequency of W4CUS in Charleston a long time before he was able to get his station on the air, keeping the channel clear.

3.5-Mc. operations: As soon as the fact that the tornado had almost isolated Charleston was known the 3.5-Mc. c.w. gang began a movement to construct an emergency circuit. Efforts to contact the Charleston fellows on 3.5 Mc. proved futile until about 7:00 P.M., when W4CWN at Fort Moultrie came on and was immediately contacted by W4BQE (with W4DNR, E.C.) at the key. CWN was aided by W4BNB and the following fellows about the Fort who aided in the deliveries, etc.: George C. Monts, Erwin Cathcart, R. E. Wentz, Jr., Paul McMichen, J. D. Bradley, Jake Lee Garbade, Robert E. Haring and J. A. B. Wentz. CWN is a government operator and, after about two or three hours of operation, it was necessary for him to return to the government frequency. W4BRF set about to secure the necessary batteries to enable W4CZN to put his portable rig on the air and continue the good work of CWN. CZN was aided in his operation by W4CZA. South Carolina fellows known to have taken part in the emergency work on 3.5 Mc. were W4BDT, W4CQU, W4EWB, W4BQE, W4EXJ and W4DNR. W4IR of College Park, Ga., also assisted. W5DAQ of New Orleans, Louisiana Emergency Coordinator, put some traffic into Charleston via W4CZN and made deliveries of replies within a few hours.

— Ted Ferguson, W4BQE.
S.C.M., S. C.

O.B.S.

The following is a supplement to the list of A.R.R.L. Official Broadcasting Stations in October QST (page 71): W2CHK, W2JZX, W4BMM, W5FDR, W5GDU, W6IGO, W6KEO, VE4AA.

BRIEFS

Flea Power Defined

"A new type of high power is now becoming prevalent in the Chicago and nearby town areas. Kilowatt stations are becoming numerous, and a new club has been formed. It is called 'The Flea Power Club' and at this writing there are twenty-one members, each of whom operates a rig at an input of five watts or less. Perhaps you have wondered about the high power heretofore mentioned. Well, you have it . . . one watt is the equivalent of 200 flea-power watts; therefore, five watts makes a kilowatt flea-power station!"

— "The Oscillator," official publication, Tri-Town Radio Club.

W6USA

W6USA, amateur station at the Golden Gate International Exposition, on Treasure Island, San Francisco Bay, will be in operation soon. A very attractive souvenir QSL card will be sent for each QSO.

Broadcast station KPAB, Laredo, Texas, plans a series of DX programs directed to radio amateurs, running from January 15th to February 7th at around 2:00 to 3:00 A.M. CST. In addition to the usual acknowledgments KPAB will send to each individual reporting reception a souvenir of the Mexican border. These souvenirs will consist of such items as Mexican Sombreros, Mexican Sarapes, pottery, dressed fleas, jumping beans, feather pictures, miniature figures and many other characteristic Mexican handiwork pieces.

One of the
**GREATEST 'HAM' KITS
 EVER ASSEMBLED!**

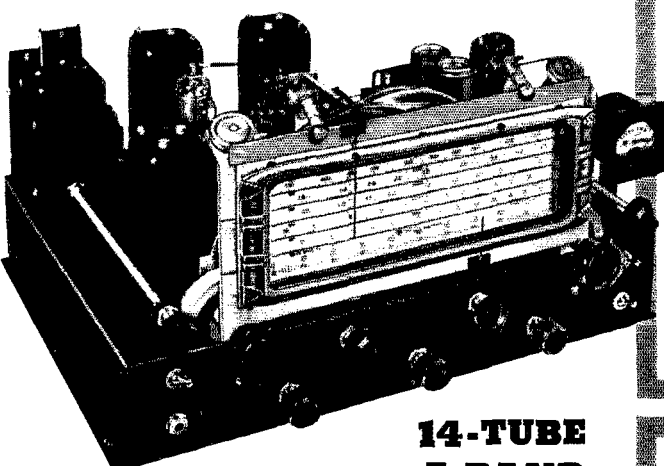

**14-TUBE
 5 BAND
 TRAFFIC MASTER
 COMMUNICATIONS RECEIVER**

Man! Here is a 14-tube, 5-band communications receiver that has practically every major circuit improvement known to radio engineers! In sensitivity, selectivity and signal-to-noise ratio on the amateur bands it is outstanding — and one of the greatest 'ham' kits ever assembled!

The TRAFFIC MASTER comes to you in complete, easily-assembled form — everything except tubes and speaker — with completely assembled all-wave Tuning Unit ready for mounting.

A built-in Noise Silencer — and a dozen other excellent features make it an outstanding receiver in amateur radio. Your Parts Jobber has this and other Meissner Kits. If not, write Dept. Q-1 at the factory. Ask for FREE 44-page catalog.

\$81.90 LESS TUBES AND SPEAKER
 PANEL AND CABINET AVAILABLE

FEATURES

14 Tubes • 5 Band Pre-Aligned Tuning Unit covering 9.25 to 565 meters • Better than 1 M.V. Sensitivity on all Ham Bands • Large 9" Linear Scale Dial accurately calibrated • Flywheel Tuning on main and Band Spread Dials • "Align-Aire" (Air-Tuned) Coils • Built-in Noise Silencer Circuit • B.F.O. with Pitch Control • 3 Gang Precision Tuning Condenser—Ceramic-Insulated • Mono-Unit-Crystal Filter Assembly with Phasing Control and Shorting Switch • Electrical Band Spread Condenser.

**NEW! 120-PAGE
 COMPLETE INSTRUCTION
 BOOK**

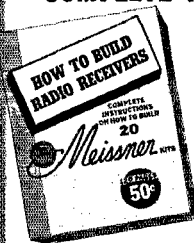

Packed with theory and technical data. Easy-to-understand graphs, charts, pictorial and schematic diagrams, alignment data, constructional

data and operating instructions for 20 new Meissner receiver kits. Also information on adapters, converters. At your Parts Jobber—or order direct. Address Dept. Q-1.

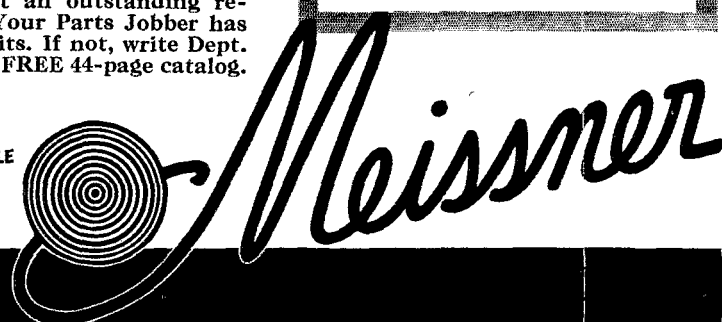

MT. CARMEL, ILLINOIS

"A FAMOUS NAME FOR TWO DECADES"

push-to-talk RELAY

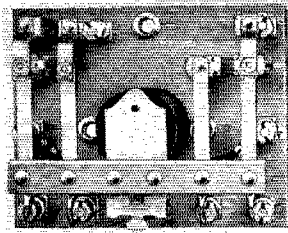

Ward Leonard Break-In Relays are especially suitable on phone transmitters where the operator merely presses a button while transmitting and releases it while receiving. For full details and prices get Circular 507B.

WARD LEONARD RADIO SPECIALTIES

WARD LEONARD ELECTRIC COMPANY

41 South St., Mount Vernon, N. Y.

Please send FREE Bulletin 507B.

Name

Street

City and State

Call Signal

The South Florida Radio Association of Miami held its annual Portable Field Contest on October 16th. Winners were W4AIL, W4PEP and W4DUW. Operation was in the 3.9-, 3.5- and 1.75-Mc. bands, c.w. and 'phone, with portable-emergency equipment. Scoring was based upon points received for contacts at no less than one mile distance and exchange of number groups with other portables and the two base stations, W4EDD and W4DRD. Power inputs ranged from 3 to 50 watts, and net scores were obtained by the division of the gross score by the square root of the input power.

The first meeting (in person) of the Susquehanna Emergency Net was held at the Safe Harbor Power Plant of the Pennsylvania Water & Power Co., on Labor Day, 1938. Arrangements were in charge of A.R.R.L. Emergency Coordinator Charles Landis, W3UA, Mrs. Landis acting as host for the ladies. The gathering was addressed by Mr. Walter Wesseliuss, Asst. Director Relief, American Red Cross (Washington, D. C.), and Mr. Francis Farquhar of York, Pa., Chapter of the Red Cross on the necessity for communications, accuracy, etc., during emergencies. Other speakers were Mr. C. P. Merriam of Pennsylvania Water & Power, and A.R.R.L. Atlantic Division Director "Brad" Martin, W3QV. W3ZD and W8AYD demonstrated emergency equipment and told of their experiences in operating A.E.C. gear. An open forum discussion of net matters led to a better understanding of problems. Dinner was served, and a trip through the power plant made for an enjoyable and instructive day for all present.

Amateurs again were called upon to provide communication in the North Park Boat Races, Pittsburgh, in connection with the Allegheny County Sesqui-Centennial Celebration. The number of entrants and drivers being doubled over the previous year, more time was necessary and more work for the radio crew. To eliminate some difficulties of previous experiences, the bulk of the work between the judges' stand and the boat house was carried on cross-band on 3.9- and 14-Mc. 'phone. The races covered two days, September 3rd-4th, 1938, with an attendance of over 250,000 people. 56-Mc. 'phone was used to provide communication between the crash boats and the judges' stand and boat house. This frequency was also kept as an emergency stand-by channel. Amateurs participating were W8OLW, OC, FTY, ONW, OFO, CUG, UK, BSO, CFR, AMP and NDP.



CONTROL WHEELS

The Choice Throughout the World of the Discriminate in Both the Amateur and Commercial Fields.

2 1/4" Complete with Scale & Indicator Plate \$1.20 net

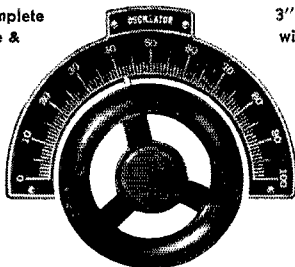

3" Complete with Scale & Indicator Plate \$1.50 net

COVERED BY U. S. DESIGN PATENT NO. 110995

RADIO



PRODUCTS

COTO-COIL CO., INC.

71 Willard Ave.

Providence, R. I.



Lloyd M. Demrick, W6HJX, in charge of radio with the Andean Anthropological Expedition, Inc. The small unit pictured is one of two portable rigs to be used for contact between field parties and the base station. The transmitter runs 35 watts input on c.w. and uses a 6C5 for grid-leak modulation; oscillator is an 802 e.c.o. The receiver is a two-tube regenerative using a 6J7 and 6C5. Plug-in coils are used throughout. For further details on the Expedition see page 46, December *QST*. Call letters probably will not be issued until the preliminary party arrives in Ecuador. Frequencies applied for include all the amateur bands and three channels for 'phone, one each in the neighborhood of 19, 35 and 50 meters. Further information will be presented in *QST* as available.

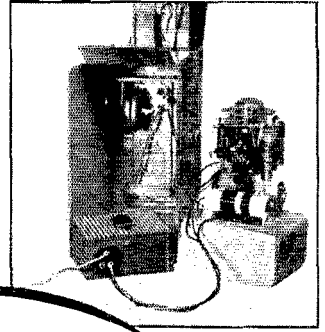

The WEATHER SCIENTIST Uses BURGESS *Portable Power*

"How's the weather up there?" ask scientists working with the Weather Bureau and M.I.T.

And out of the ether comes a faint signal. It is the voice of the "RaySonde" or radiometeorograph. "Up there" perhaps three, six, twelve, fifteen miles into the stratosphere where a thin latex balloon has taken this sensitive instrument.

Thus we have a new and more efficient means of foretelling weather conditions. The small broadcasting station in the

RaySonde carries its power right with it in the form of a small Burgess battery. Its famous manufacturer, J. P. Friez & Sons, has found that Burgess batteries have proved themselves utterly dependable again in this, another unusual service.

The same quality and dependability that make Burgess the choice of leaders are built into all Burgess batteries. They are available to you in standard and special purpose types for all your radio and experimental work.

BURGESS BATTERY COMPANY
FREEPORT, ILL.

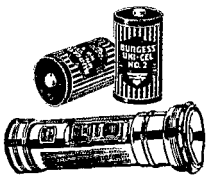

BURGESS



Station Activities



ROANOKE DIVISION

NORTH CAROLINA — SCM, H. S. Carter, W4OG — The Charlotte gang put on a swell meeting for the Floating Club, and a good time was had by all. Thanks, fellows. BX is on regularly using c.w. DLX leads the State in traffic this month. FB. BXF is doing a good job with the Emergency Corps in Charlotte. BHR got on long enough to handle some traffic. FJS has his rig on 1.75-Mc. 'phone. BRT spends most of his time rag chewing on 3.5 and 7 Mc. DW copied the Navy and Armistice Day messages, and gets on for A.A.R.S. drills. The Raleigh gang is busy on plans for the Floating Club meeting to be held there in January, and promises a big time for all that attend. ALT, back at his old location, is active in A.A.R.S. The University Radio Club is active again with the following members: DVV, FKS, DWB, FQV, FAL, EPH, CZC, CXM, LJBW and 2HZS. The station call is WE, and they will be operating on 14-Mc. 'phone soon. EYA, EXX and DSM passed Class A exam. DSM is putting a pair of 35T's on 14 and 3.9-Mc. 'phone. A unit of the N.C.R. is being organized at Salisbury-Spencer. DCQ is working portable in N. J. with a pair of 809's on 3.9-Mc. 'phone. DGV is working 28 Mc. mostly. CFR is heard regularly on 7 Mc. ABT is active in A.A.R.S. AHF continues to add countries to his list. OG has a pair of 52's to replace the ones that went west. There is a vacancy on Trunk Line "C" in North Carolina, due to the resignation of DWB, who is attending school. Anyone interested in filling this vacancy, please get in touch with the S.C.M. BMR has returned to the air on 14 Mc. after six months of rebuilding; he has 1-kw. 'phone on 14 Mc., 150 watts on 28 Mc.

Traffic: W4DLX 49 FCB 33 FJS 13 ALT 12 DGV 9 DW-ABT 5 BHR-BX-BRT 4 DCQ/3-EYA-OG 3.

SOUTH CAROLINA — SCM, Ted Ferguson, W4BQE — BRF on 3.5 Mc. carries a number of schedules. FFO on 3.9-Mc. 'phone schedules DMX, COL and TJ. COL is operating portable at Clemson. EPJ is working 3.9-Mc. 'phone. BMN will soon have new rig on 28 Mc. CQG has three new antennas with 4 half waves in phase. EZF is working 7-Mc. c.w. and 1.75-Mc. 'phone. EXJ is working 28 and 1.75-Mc. 'phone and has been appointed E.C. for the Palmetto Club. ETF schedules CUS. FMZ is operating 3.5 Mc. CO's "QSL 40" works FB. MN is back on 3.5 Mc. ECG schedules CZA and FNT. FEH likes his new beam antenna; he and AUW are working on emergency equipment. EJK has worked all states on 1.75 Mc. 'phone with his vertical and 75 watts. BPD is 1.75-Mc. 'phone net control station, assisted by FNC. DTU hopes to be on 1.75 Mc. soon. DRE and BDT are active on 3.5 Mc. EHF has 250 watts on 3.5 Mc. 8TP is coaching football at Mullins. DGD will soon be on 3.5-Mc. c.w. and 1.75-Mc. 'phone. FSL is active in various nets on 3.5 Mc. FEH operates 7 and 3.5 Mc., and is E.C. for Charleston. CQU likes his 3.5 Mc. and keeps several schedules. CZA and his 3.5-Mc. S.C. Net are working FB. BPD invites more of the fellows to meet the 1.75-Mc. 'Phone Net each Sunday, 5:00 p.m., 1960 kc. If you are a c.w. fellow, both the A.A.R.S. and S.C. Net would be glad to have you in their nets, frequency 3832 kc. Call CZN or CZA. Let's have more reports, fellows.

Traffic: W4CZN 158 CZA 87 CQU 44 DXF 35 EWB-FFH 25 BDT 22 BRF 16 FDN 13 ETF 11 EMB 10 DRE 6 FSL-BPD 3 EZF 2.

VIRGINIA — SCM, Charles M. Waff, Jr., W3UVA — R.M., 3GTS — P.A.M.'s 3ALJ, 3GWQ — EMX moved to Roanoke and is rebuilding main rig; in the meantime, Ed and Dot are using an 807 modulated by a 6L6 Class A. GDK, who operates 1.75 Mc., welcomes new laws. FMY finished new low-power rig. BIG, GOQ and several officers at Marine Base at Quantico send thanks for the new "Virginia Ham," replacing "QRX," which is now being published by the Richmond Amateur Radio Club. Your contributions, factual, fictional, and financial, will be appreciated. Address C. A. Rudloff, W3FMY, 2914 Parkwood Ave., Richmond, Va., Chairman of the Editorial Committee. All became W.A.S. No. 495; congrats! HBH is at C.C.C. Camp Mormans River, Va., their call is HSF, which schedules FJO and ELN. HBB schedules his brothers, 9CHN and 9JMY. HAS is changing QTH; he also operates HEA, N.G. Station. NT is rebuilding with pair of 860's final. CA is re-

building and moving. GWP worked Arizona for his 45th state. FBL put in 800's final. APT uses 300 watts to a 100T1L BSY/6 schedules AVR weekly on 28-Mc. 'phone. HVT worked Y82LR for country No. 127; other good DX worked in past month included KA1FG, J2NF, VU2FO, PK1BO, J3FK, YT3R, KA1AP, UK8IA, XU4XA, FI8AC, J2MI, PK1TT, U8TB, VU2FX and PK1TM. GSG schedules GIC at V.P.I. CSY is hearing good DX including PK4KS. GGI is preparing to invade 7 Mc. FQO worked 75 stations in 40 sections in the first week-end of SS. HCQ is looking for DX on 28 Mc.; he got a good start with VQ4CRE. HDP spends his time rag-chewing. CNY has new pole and rotary beam. FBX has new transmitter on 28-Mc. 'phone. GRV has P.P. 805's ready to start as soon as he moves from QRN infested downtown apartment. FWT is on 1.75, 4 and 14-Mc. 'phone. CYV has been on vacation in W9 territory. FQP worked XU8NC, XU4XA, J2KG and OY3A for new countries, making 96. JG is using '10 final with 30 watts and 2-tube regenerative receiver. FHF is using P.P. T40's final. FHO is still blurring on 4-Mc. 'phone. GTQ is on 41 Mc. with P.P. T'Z40's. CYM, now in Hope-well, is building RK-20 for 14 and 4-Mc. 'phone and 7-Mc. c.w. BZ operates daily on 29,148 kc. BRA uses P.P. 801's final and modulates with '10's. GOQ is Alternate Net Control. A.A.R.S. GWQ informs us the Old Dominion Net will meet Sundays at 9:00 p.m. on 1895 kc. However, call the gang even if your frequency is not on or near the net frequency. Members so far are AHC, BKG, AKN, GON, EFO, HOY, GGP, GWH, GRU and GWQ, the N.C. Station. GON is alternate N.C.S. DQD, having been off nearly two years, is back on with 6L6G on 3601, 3809 and 7148 kc. GTS has rig working FB with 150 watts. BFW is rebuilding for 1 kw. on c.w. DZW is looking for DX and Nevada on 'phone with 100 watts. AJJ keeps the Virginia 'Phone Net going regularly. UVA finished new rig with P.P. 100TH's final. GGI is rag chewing on 1.75 Mc. with '46 modulated by '50's. ELN schedules K4AAN, Virgin Islands, daily on 7 Mc. and would like schedules with Virginia stations. Thanks, fellows, for swell report this month. Especially thanks to the new reporters.

Traffic: W3GOQ 269 GTS 242 HDQ 94 HBH 23 GSG 15 KVT 14 CSY 12 FMY 10 FBL-AJJ 4 GWQ-HDP 2.

WEST VIRGINIA — SCM, C. S. Hoffman, Jr., W8FD/W8NS — KKG worked FI8AC and VS2AE, making 127 countries worked; he now has 98 verified! Other noteworthy scores: JRL 112, 72 verified; MZD 78, 54 verified; KWI 119, 85 verified. New O.P.S.: JM and RJG. JM is an old-timer. RJG is a shut-in. BTV made the highest traffic total for many a year in W. Va., 453! PTJ has second highest, 216. The S.C.M. again visited Clarksburg and Elkins. Hunting-ton Radio Club officers were re-elected; their new directors: MOL and AFB. MOL moved and is putting up 67-ft. high antenna. KIU was on in O.R.S. Contest and DSJ in O.P.S. Contest from W.V.U. MIP is teaching at W.V.U., EYV coaching athletics at Paw Paw High School. RFP got his Radio Telephone First. RDC reports 81E new Romney station. KLP took Class A. exam. PAJ is Treasurer of Antioch College Club; his dad, MIP, is Treasurer of Mountaineer A.R.A. NEU lost his 804's and is back to the old '03's. New Fairmont station: SWV. The Mountaineer A.R.A. had a fish fry, Dec. 9th. New officers: OXO, pres.; ESQ, v.-pres.; MIP, treas.; Chas. Handy, secy.; GBF, activities mgr. Hams dug basement for ESQ's new home! MIP got Class A and is on 3.9-Mc. 'phone. PZT has new Sky-rider. FEW moved to Kentucky. BDP is working with television. HSA is building 14-Mc. rotary beam. BOK has new Junior opr! PHY says the 'round-table on 7040 kc. is going well. MLW is putting a pair of '03A's in P.A. RFP has new 260-ft. flat top! Bluefield is represented by a report from MOP. PTJ schedules PIH, 4DD and 6LLW, besides the State Net. 2BXR/8 and YF visited Washington, D. C. JRL, QFN and JTM are on 1.75-Mc. 'phone. New Hunting-ton stations: SDU and SNT.

Traffic: W8BTV 453 PTJ 216 KIU/DSJ 24 PSR 18 JM 6 RFP 8 EYV 1.

ATLANTIC DIVISION

EASTERN PENNSYLVANIA — SCM, John B. Morgan, W3QP — Asst. SCM in charge of E. C., W3AKB. R.M.'s: 3AKB, 3AQN, 8ASW. Twice during October several members of the Ultra High Frequency Club of Phila. visited Hawk Mtn., a spot in the Blue Mtns. of Penna. well-known to ornithologists and meteorologists for its peculiar air currents which are a part of a sky pathway used annually by countless thousands of migrating birds. The club mem-

bers established 56 Mc. stations on Hawk Mtn. and Lookout Mtn., one mile apart, and assisted a survey group in measuring the speed of various species of birds. 3AQN has been handling traffic exclusively for eleven years. 3BES was at the top in the O.R.S. party again. New e.c.o. rigs have been installed at 3AOC, 3EEW, 3QP and 8OML, 100-cc. osc. and multivibrators are in use at 3DXC and 8ASW. 3FXZ installed an 803 final for some 14-Mc. DX. 3GQU is covering Europe well with 100-watt 'phone on 14 and 28 Mc. 3GYG has worked all but the sixth district on 3.5 Mc. with 6L6G crystal osc. 8FLA has been appointed Radio Aide, Third Corps Area A.A.R.S. Traffic totals continue healthy with 334 originals against 463 deliveries, total points 3133. There have been comments that the revised regulations will handicap the portability of 56-Mc. equipment, but a little study will show that there are tubes available which will meet the situation with no increase in the weight of the transmitters and receivers. Those who feel the desire will find a fertile field for super-regenerators still available on 112 and 224 Mc.

Traffic: W8ADE 14 3AKB 205 3AOC 138 3AQN 170 3BES 9 3BGD 200 3DGC 188 3DXC 15 3EDC 253 3EFH 4 3FML 643 3EWJ 127 3FXZ 56 3GDI 20 3GHW 2 2GYV 8 3HCT 4 3NF 226 3QP 241 3QV 56 3UA 28 8ASW 38 5 8ATF 8 8FLA 104 8NPQ 16 8OML 23.

MARYLAND-DELAWARE-DISTRICT OF COLUMBIA — SCM, Edgar L. Hudson, W3BAK — 3CXL, 3CQS, R.M.'s 3BWT, Chief R.M. CIZ operates on T.L. "E" and has many fine schedules. BWT has nine traffic schedules. HUM reports T.L. A-P on 3630 kc. working fine to West Coast. K6 and K7. GKN entered Oct. O.R.S. contest with Hartley rig of 1922 vintage with 100 watts; made fine score and got T9 reports. FEG is trying stainless steel antenna. GZK is using new e.c.o. which works fine. CAB is consistently on 7 and 3.5 Mc. GXO reports the Mike and Key Club organizing emergency corps with portable rig. CDG is back on 3.5 Mc. meeting old friends. WU has been made 3rd Dist. QSL Manager. AKR is doing a complete rebuilding job. DRE has new 101X. ME has been ill; we wish you a speedy recovery. Bob. ER is on with new rig with 808's P.P. final. BAK is still working schedule with AXP-3, his son Roland, who is located at Penna. Military College. AED is planning new portable emergency rig, using 110-volt generator and gasoline motor. BHE is getting lots of fun on low power 'phone. CDQ visited 8CMP Nov. 12-13 and had grand time. We have a report from Washington's youngest ham, HTW, 15 years old. His QTH: Bill Taubersmidt, 1706 Kearny St., N. E., Washington, D. C. Radio Chess games are being resumed at CAB and he reports that on Nov. 8 Dr. G. W. Hervey at CAB, played Mr. B. H. Sexton at 8OKL. OKL won. On Nov. 15 Mr. D. S. Burch was guest player at CAB, playing Saxton in Pittsburgh. The game was recessed on the 31st move to be finished at a later date. DGC moved to Baltimore from Phila. HVC is new call of N.C.R. station at Rehoboth, Del. EUK has new field strength meter and a 260-foot antenna. DTO is leaving for three year stay in Puerto Rico. FKT of Rehoboth, Del., is stationed at Exmore, Va., for a time, and is working portable from there, on c.w.

Traffic: W3CXL 312 (WLM 3409) CIZ 700 BWT 555 ECP 150 HUM 87 GKN 85 FEG 58 GZK 47 HSB 18 CAB-GXO 8 FPQ 6 CDG 5 WU-AKR 2.

SOUTHERN NEW JERSEY — SCM, W. Walter Filson, W3BEI—BZX replaces BYR as eastern terminus of "Trunk B." BYR sends high total for the section. FFE will try to get in a little operating at the U. of P. station, ABT. ZI is proud to make it known that Mrs. ZI has received her call, HVO. DNU is building new receiver and code practice set for the Jr. op. GCU is busy organizing an "Eastern Owl Net," which will meet after midnight. Regret to have to record the passing of AYQ of Bordentown. Believe GLY joined the order of Benedicts. FBT has new rig on 7 Mc. with T740 final. HGS has nice shiny NC 101X and is building rig for 7, 14 and 28 Mc. AXU is rebuilding his rig trying to make the new regs on 56 Mc. The S.C.M. and a former S.C.M., QL, attended the Oct. meeting of Trenton Radio Society and among other things were treated to a motion picture record of their recent field day. Ex-3AN recently returned from the Virgin Islands where he was K4ENY and is now stationed at the Great Lakes Training Station at Chicago. Two new hams in Delair are CFH and GHF. GAI is on the air with 125 watts.

Traffic: W3BYR 265 (WLVN 52) ZI 141 BZX 122 EFM 98 (WLNJ 20) DNU 80 QI, 48 BEI 34 AEJ 10 GCU 6 FDF 2.

WESTERN NEW YORK — SCM, H. E. Preston,

W8CSE — R.M.'s: BJO, DSS, FCG, JTT. Section O.R.S. Net Frequency; 3720 kc. The Finger Lakes Transmitting Society held annual hamfest Nov. 12th. This "get-together" is one of the finest in this part of the state and many of the section's most prominent hams were present. "Doc" Simpson, 8CPC presided as toastmaster. After dinner speeches were made by Radio Inspector Grinnell, Division Director Brad Martin, 3QV, John Long 8ABX of WHAM, the S.C.M. 8CSE and several others. A large assortment of prizes were given out and everyone had a good time. Make your plans NOW to attend next year. AQE is active after a silence of nearly two years. RXG is back on 3586 kc. handling traffic. IWV has nice luck with DX on 14 Mc. JQE keeps traffic schedules on 3505 kc. BFG hopes to work about ten more countries for his Century Club membership. GWT is getting under way after summer "lay off." QQM is on 3630 kc. and gets a kick out of playing checkers via radio with 3HLV. RKA is on 3560 kc. regularly. OAP has new skywire up and with help of FCM and RKA is back on the air. NNJ entertained Mr. and Mrs. CGU, Mr. and Mrs. FFN, Mr. and Mrs. O. Anderson of Lowville and Bob Reynolds of Oneida at a private hamfest on Nov. 9th. DHU took time out to work D4ORT, PA0QQ and F3CW on 3.5 Mc. with 50 watts to final. EIJ handles a little traffic. RBW has new rig going strong. QMR on 3742.5 kc. has been appointed net control for Eastern N. Y. State A.A.R.S. Net. RTX schedules 5FSU daily on 28-Mc. 'phone. RGA will be Emergency Coördinator for Monroe County as well as new O.P.S. GWY is Emergency Coördinator in Washington, Warren, Saratoga and Essex Counties. All amateurs in this territory, possessing emergency equipment of any kind, are urged to get in touch with Ray. IIO, Buffalo, 3730; NUA, Utica, 3520; and QUN, Sacketts Harbor, 3650 kc. are new O.R.S. PCN, Buffalo, 3534 kc., is also taking traffic for that vicinity. IIO is running 350 watts to final and uses ACR111 receiver. SEI won a 905 in raffle at Auburn Hamfest. Our apologies to RZX. The statement was made that he was attending the St. Lawrence Univ. He is attending Clarkson Tech at Potsdam. SPA is also in Potsdam. RKJ is on 1890 kc. 'phone with suppressor modulated 802. ORU is moving to Syracuse. NMH is now operating on 7007 kc. SEF and SED are on 1.8-Mc. 'phone. Ex-8BAL is back in Syracuse. SHC is working his way up to top place in traffic game. BDV wishes to thank everyone who helped make the Auburn Hamfest so successful. IY is now located in Marathon. FCG and RKM are consistent reporters in O.R.S. net. PLA has e.c.o. and roams around 3.5-Mc. band. JTT made a big 88 score. Ex-6LUF is now located in Wellsville when he is 8OQU; he has a pair of HF-300's in final and operates mainly on Class A 'phone bands. 4ABV is operating portable in Belmont with pair of '46's on 3.9-Mc. 'phone; it is rumored that twin YL's came to his shack! The Buffalo Mike and Key Club has resumed its meetings on the first and third Saturdays of each month, in the Westminster Hall, 421 Monroe St., Buffalo. The Central New York Radio Club meets every Thursday night at its new clubroom in the Griffin Building, 135 West Onondago St., Syracuse. Your Radio Club is what YOU as an individual make it. The interest and effort that each member displays combines to make the club an organization of real value to all. SUPPORT YOUR RADIO CLUB.

Traffic: W8IIO 18 PCN 66 RTX 11 QMR 158 DHU 50 RKA 4 QQM 1 JQE 55 RXG 6 CSE 186 BJO 47 DSS 166 GWY 51 RKM 123 JTT 238 SHC 50 FCG 247 PLA 208.

WESTERN PENNSYLVANIA — SCM, Kendall Speer, Jr., W8OFO — Horseshoe Radio Club (Altoona) is now A.A.R.L. affiliated. Congratulations. The Greensburg Amateur Radio Club has been newly organized with intense interest shown; they have joined the Pittsburgh Area Radio Council. R.M. KWA leads the Section in traffic with a nice total. QAN was re-elected chairman of the Radio Council. DDC is regular member now on T.L. "M." MOT is active. T.L. "E" is represented in W. Pa. by DNX. FUV says SIL and HBG enlisted in N.C.R. NDE again schedules into the Nutmeg Net. KXS is operating YA this season with George Hart now at Hq's. PFW is using pair of 6L6's with 150 watts. MJK has been appointed D.N.C.S. for Pa. A.A.R.S. QBK is one of the Assistant Emergency Coördinators for Altoona. IZS had a nice total for the O.R.S. Party. NCJ and XYL are working nice DX. HBG is still rebuilding that final. QEM has new Class B modulation. BJJ says RAT has been heard in Cuba on 1.75-Mc. 'phone. MKF has installed a.v.c. in transmitter and it's working splendidly. RBI has new antenna, a half wave with reflector. SHN is using a

(Continued on page 104)

ASTATIC

MODEL D-104 MICROPHONE

Time has proven the merits of this crystal microphone for "speech range" performance under all conditions. "Hams" still think of it as "tops."

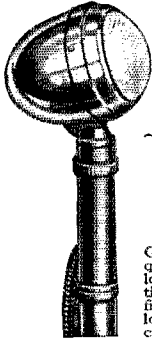

Complete with interchangeable locking connector and 8-ft. cable.

List Price **\$22.50**

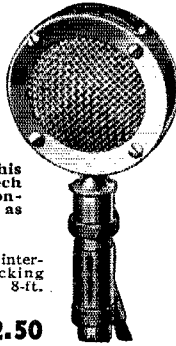

MODEL T-3 Another Favorite

General purpose microphone with high quality performance. Designed with self-locking, tilting head, adjustable to directional or non-directional position. Chrome finish. Equipped with interchangeable locking connector and 25-ft. cable. List Price..... **\$25.00**

*** * * * * * * * * * *

ASTATIC

Microphone Laboratory, Inc.
Youngstown, Ohio

Licensed Under Brush Development Co. Patents

A.R.R.L. QSL Bureau

For the convenience of its members, the League maintains a QSL-card forwarding system which operates through volunteer "District QSL Managers" in each of the nine United States and five Canadian districts. In order to secure such foreign cards as may be received for you, send your district manager a standard No. 10 stamped envelope. If you have reason to expect a considerable number of cards, put on an extra stamp so that it has a total of six-cents postage. Your own name and address go in the customary place on the face, and *your station call should be printed prominently in the upper left-hand corner.*

- W1—J. T. Steiger, W1BGY, 35 Call Street, Willimansett, Mass.
- W2—H. W. Yahnel, W2SN, Lake Ave., Helmetta, N. J.
- W3—Maurice Downs, W3WU, 1311 Sheridan St., N. W., Washington, D. C.
- W4—G. W. Hoke, W4DYB, 328 Mell Ave., N. E., Atlanta, Ga.
- W5—E. H. Treadaway, W5DKR, 2749 Myrtle St., New Orleans, La.
- W6—Horace Greer, W6TI, 414 Fairmount Ave., Oakland, Calif.
- W7—Frank E. Pratt, W7DXZ, 5023 So. Ferry St., Tacoma, Wash.
- W8—F. W. Allen, W8GER, 324 Richmond Ave., Dayton, Ohio.
- W9—Roy W. McCarty, W9KA, 11 South Michigan Ave., Villa Park, Ill.
- VE1—L. J. Fader, VE1FQ, 125 Henry St., Halifax, N. S.
- VE2—C. W. Skarstedt, VE2DR, 236 Elm Ave., Westmount, P. Q.
- VE3—Bert Knowles, VE3QB, Lanark, Ont.
- VE4—George Behrends, VE4RO, 186 Oakdean Blvd., St. James, Winnipeg, Manitoba.
- VE5—H. R. Hough, VE5HR, 1785 First St., Victoria, B. C.
- K4—F. McCown, K4RJ, Family Court 7, San-turce, Puerto Rico.
- K5—Norman F. Miller, K5AF, 15th Air Base Squadron, Albrook Field, Canal Zone.
- K6—James F. Pa, K6LBH, 1416D Lunalilo St., Honolulu, T. H.
- K7—Dean Williams, K7ELM, Box 2373, Juneau, Alaska.
- KA—George L. Rickard, KA1GR, P. O. Box 849, Manila, P. I.

NEW!

GORDON

HEAVY DUTY RF RELAY

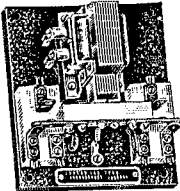

- Takes 1 Kw. Easily
- Husky 3/8" Silver Contacts
- 1/2" Contact Spacing
- Alesmag 196 RF Ins.
- Especially suited for Beam Antennas

This sturdy RF relay is designed for Antenna Change-over, Multi-band Transmitter Tank Switching and 60 cycle Power Switching. No chatter. For 110 volt AC. Very reasonably priced at \$9 net.

See Your Jobber or Write for Details

GORDON HAND WHEELS

FOUR SIZES

(3 1/4", 2 1/4", 1 3/4", 1 1/4" dia.)

Here is a sweet line of tuning controls. Be sure to see all sizes and combinations at your jobber's. Available with chrome metal pointers, with scales or dial plates. Give your panels that professional touch by standardizing on GORDON Hand Wheels and Name Plates.

★ Write for listing of 126 GORDON Name Plates. Also data on World DX Clock and other GORDON accessories.

WRITE DEPT. Q FOR GORDON CATALOG



GORDON SPECIALTIES COMPANY

1104 SOUTH WABASH AVENUE CHICAGO, ILLINOIS

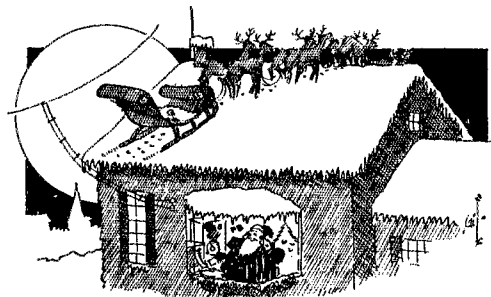

U. S. Auto Alarms
Approved by F.C.C.
 Mackay type 101-A and Radiomarine Model AR-8600 are described in minute detail with complete operating instructions. Circuit diagrams and photographs.

ELECTRON TUBE
 Various types, characteristics and applications, explained by Robt. Kruse, internationally known expert and radio engineering and technical editor.

Vacuum Tube Amplifiers and Oscillators
 Class A and B audio amplifiers; Class B and C radio frequency amplifiers; Oscillator circuits; etc., etc.

Modulation and Modulation Analysis
 Classification of systems and full explanation of each. Analysis by component method and by use of Cathode ray oscilloscope.

Latest Broadcast Transmitters
 R C A types 100-H, 250-D, 5 KW type 5-D. Installations, adjustments, operation, and maintenance. High Fidelity and new equalized feedback circuits.

Marine Radio — Telegraph Transmitters
 and receivers — latest types. R M C A type 8003, 8006, 9007 transmitters and 8503 and 8504 receivers. Mackay type 131-A and 142 transmitters.

F.C.C. RULES and REGULATIONS
 covering broadcast, ship, aviation, and police services. All important radio provisions of Communications Act.

DUTIES of the Radio Operator
 at ground stations of commercial transport companies. Operation, adjustment, maintenance of transmitters and receivers and radio beacon receivers.

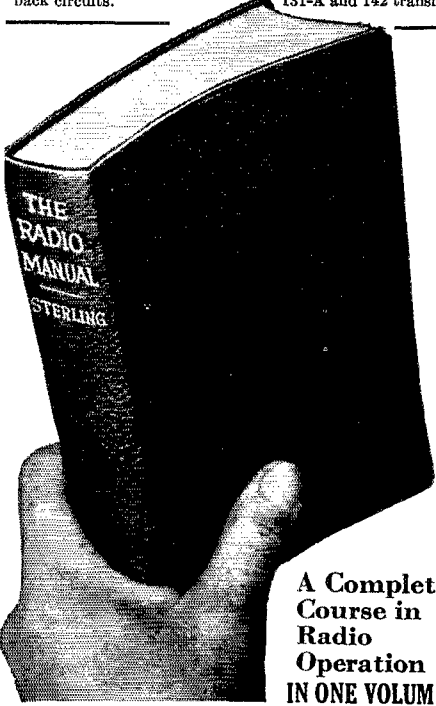

A Complete Course in Radio Operation IN ONE VOLUME

Enables You to Qualify for Gov't License as Operator or Inspector

20 Big Chapters Cover:

Microphones of all types — Radio and Audio Frequency Measurements — Antenna Resistance Measurements — Theory, Operation and Use of Radio Range and Marker Beacons (localizers) — Landing Beams including Lorenz System of Instrument Landing — System of Blind Landing developed by the U. S. Bureau of Standards experts — Radio Direction Finders (RCA and Kolster types with description of apparatus, maintenance, and service instructions) — Bellini-Tosi System — Ultra-high Frequency Police Transmitters and Receivers and Details of police communication systems — All Important Radio Provisions of the Communications Act of 1934 as amended effective 1937 — General Radio Regulations Governing Distress Signals.

This is just a hint of the vast amount of information packed into this great book. It is essential to every student, operator, and inspector.

EXAMINE IT FREE!

This is the Revised 1938 Edition of "The Radio Manual," 1000 pages, hundreds of illustrations. Bound in Flexible Fabrikoid. The coupon brings the volume for free examination. If you do not agree that it is the best Radio book you have seen, return it and owe nothing. If you keep it, pay the price of \$6.00 in easy installments.

Latest 1938 Data!

A complete revision, of this standard handbook, greatly enlarged, up to the minute. Complete information covering the entire field of Radio — all arranged for ready reference.

THE RADIO MANUAL

A Handbook for Students, Amateurs, Operators and Inspectors

Here's the only complete Handbook for students, amateurs, operators, and inspectors. It covers the entire field of radio in 1,000 pages with hundreds of illustrations and diagrams. It is actually a complete course of training in radio operation and a complete reference book for everyone in the field. It gives instantly the answer to every question about principles, methods, and apparatus of radio transmitting and receiving.

New Information Never Before Available

This new edition is packed with up-to-the-minute information much of which is available in no other book and all of which is essential to any man whose work or hobby is radio in any of its branches.

Prepared by F.C.C. Expert

The author, G. E. Sterling, is Assistant Chief, Field Section, Engineering Dept., Federal Communications Commission and nationally known as an outstanding authority.

Sent on Approval Mail This Coupon Today!

D. VAN NOSTRAND CO., 250 Fourth Avenue, New York
 Send me on approval THE RADIO MANUAL. Within 5 days after I receive the book, I can return it and owe nothing. If I keep it, I will send you \$2.00 as first payment and I will pay \$2.00 monthly thereafter for 2 months — \$6.00 in all. (5% discount for cash.) (QST 1-39)

Name.....
 Address.....
 City..... State.....
 Reference.....
 Address.....

FOR FREE CATALOG of best books of practical instruction and technical information, check here. If you do not want The Radio Manual cross out paragraph above.

(Continued from page 101)

"QSL 40" on 7 Mc. ROA is building T40 final and 809's modulators. PDP is working 28-Mc. 'phone. OSI is using his prize, a HY25, to drive P.P. 809's. RBD uses an RK37 final, but is installing a TZ40. RYN has new rig, 300 watts to 6L6-T20-P.P. 35T's. New amateurs: Greensburg — SMX and SNA. SMX operates 7 and 3.5 Mc. with 9 watts input. ASE uses 350 watts on 7 Mc. RYD works nice DX with only six watts. RYO is building new rig. QVQ is working nice DX on 14 Mc. with rotary beam. RAU is building emergency transmitter and receiver. Blessed events at homes of NWW, OKY, IFY and RUL. Congrats, fellers, PX has been appointed Ohio River Region Emergency Coordinator to work with the U. S. Weather Bureau.

Traffic: W8KWA 737 QAN 266 DDC 251 OFO 239 MOT 236 DNX 226 FUW 203 NDE 95 IOH 53 YA 42 PFW 38 CMP 37 MJK 34 KUN 164 BQK 145 ZD 144 RQA 124 IZS 21 KXP 30 NCJ 17 HBG 16 QEM 13 PJJ-RBI 5 ROA 3 OSI-RRD 2.

HUDSON DIVISION

EASTERN NEW YORK — SCM, Robert E. Haight, W2LU — KXF, high traffic man for the month, reports FB line-up of schedules. LU handled traffic for Scarsdale Business Men's Show. LLU keeps Feura Bush on the air. ITK reports for Kingston's boys. GTW is doing a good job on T.L. "G." KOI enjoyed the SS. DVC entered Oct. O.P.S. party, making score of 3328. BNR is on 7 Mc. with pair of 809's. HUB sports and FB homemade super. 1KVB reports GSB (Union College Radio Club) all set for lots of traffic. KKK, JQP, HKP, 8BHS and 1KVB keep the air hot from GSB on 3548 kc. ISJ reports the following N.C.R. hams from his Section made cruises this past summer: CUA to Guantanamo Bay, Cuba on U.S.S. *Fairfax*; LDS to Guantanamo Bay on U.S.S. *J. Fred Talbot*; ISJ to Havana and Key West on U.S.S. *J. Fred Talbot*; and FAR to Charleston, S. C., on a battleship. ISJ would like to contact any ham interested in the N.C.R. KUD joined the O.R.S. and O.P.S. boys. AMM is perking out nicely on 28 Mc. Your S.C.M. extends to all hands his best wishes for a Merry Christmas and Happy and Prosperous New Year.

Traffic: W2KXF 80 LU 50 LLU 54 ITK 16 GTW 14 KOI 5.

NEW YORK CITY AND LONG ISLAND — SCM, Ed L. Baunach, W2AZV — Appointments this month: GDF, E.C. for Queens County; KUY, JDG, HYJ, O.P.S.; CHK, O.B.S. on 14 Mc. and JDG, O.B.S. on 3.9-Mc. 'phone. JRE and JUX are working for O.P.S. appointments. DVU is moving to Montclair. BVG is back on 7250 kc. after being off since 1930. ELK vacationed in Florida. JVK passed the 1st Class Telephone and 2nd Class Telegraph exams. IXQ is studying for 1st Class Telephone ticket. JHB's YL and IXQ's XYL are practicing code. LHP had a swell time in his first SS. LBI also entered the SS for first time. KYO works G8T (a blind World War Veteran) for hours at a time on 14-Mc. 'phone. AOY schedules 6NAE, handling traffic for his mother who arrived from Europe. One night HGO took a message on 7 Mc. from CJP in Schenectady for Rockville Centre. He then called CQ R.C. on 56 Mc. DMM, who was traveling east in his car, copied HGO, told him to give him the message and he would deliver when he reached R.C. DMM always carries message blanks along with him in his car! LEA reports that CHT passed away at the Boulevard Hospital, Queens, Nov. 13th. FF has new vertical up 68 feet. JZX has two new Howard receivers, 430 and 450A. DBQ is State Radio Aide of S.N.Y. and OQ State N.C.S. of C.W. A.A.R.S. PF is trying out new radio procedure for A.A.R.S. 'phone nets, same as used in Army Air Corps. JHB, SC and OQ made the B.P.L. Only operating time that SC has for rag chews is Saturday nights. BGO is helping a new ham in the 8th district. EC reports the A.-P. trunk line one hundred per cent in operation to west coast, KA, K6 and K7. EVA spends most of his time rag chewing. HYJ says DX on 28 Mc. is FB. KI schedules 1GOJ daily on 3674 kc. HPB won a Mac-Key at Tu-Boro R.C. fourth annual dinner. Election results at Tu-Boro R.C.: BMW, pres.; AVI, vice-pres.; HBO, sec.-treas. CLE, the Stuyvesant H.S.R.C. is on 7 and 14 Mc. with 6L6 and 809; new club officers: KLF, pres.; LKE, vice-pres. KXB is adding P.P. 809's to final. A YL op arrived at CET's. Congrats. AZV operates the N.C.R. drills on Saturday mornings at 10 a.m. ESO can be heard on 3.9-Mc. 'phone. HMJ, R.M. for Staten Island, requests the S.I. gang to get in touch with him for traffic outlets on the island. ITX is operating completely on battery power. KJY's emergency outfit is 6L6 osc., 6L6 final, 6-volt

genemotor. All stations desiring to deliver traffic into N.Y.C. should look for LK on 3710 kc. at 7:30 p.m.; he is on every night with the N.Y.C. and L.I. Section Net. Those interested in emergency operation should get in touch with AZV for registration in the Emergency Corps. We need many more A.E.C. stations in this Section.

Traffic: W2JHB 2087 OQ 375 SC 278 (WLN 415) DBQ 144 (WLN 479) JZX 143 AZV 140 EC 126 PF 69 LR 36 LOQ 36 BGO 19 KI 16 FF-LBI 15 LHP-KYO 14 AZM-BYL 13 HYL-CIT 12 AA-DLR 11 GDF-AHG 10 FID-OT 9 FIP 8 LFN-HYJ 7 BFA 6 ELK-BDR 5 GRJ 4 HGO 3 DMM-HJT 3 IRC-KXB 2 DOG-JRC 1 HMJ 62.

NORTHERN NEW JERSEY — SCM, Fred C. Read, W2GMN — GVZ received DX Century Club certificate. He is new E.C. for Ridgewood, and has been assigned WLN1 in A.A.R.S. October meeting of QSP Club was held at home of BCX. HQL is looking for more morning traffic schedules. CGG turned out fine traffic total for this period. LNB and LRB are new stations in Bayonne, Bayonne's High School station, GYO, has been active. KMI is new O.R.S. JUC is looking for more schedules in early evening. DSV is after an R.C.C. membership. IJD, one of original ops at 4ABS, has new QTH at New Brunswick. KEG has new antenna. HDD, HDM and IZF are becoming active again. KMN needs two more states for W.A.S. Ex-20Y is again active ham with call LQI. IWY is increasing power. North Newark Amateur Radio Club is now affiliated with A.A.R.L. KON is doing nicely on 1.8-Mc. 'phone. JIX completed his new rig. Mr. W. J. Howell, F.C.C. inspector, spoke at the first Annual Dinner of the N.N.A.R.C., Dec. 14th. The club held its first "Open House" of the season Oct. 26th.

Traffic: W2CGG 2304 BCX 213 (WLN 316) GVZ 207 (WLN 18) KHA 146 HQL 73 (WLN 68) KMI 46 JUC 24 DSV 5 CIZ 3 IZV 2. W2JMX (Sept.-Oct.)

NEW ENGLAND DIVISION

CONNECTICUT — SCM, Frederiek Ells, Jr., W1CTI — The Nutmeg Net is operating smoothly on 3640 kc. at 6:45 p.m. Following is a list of the N.C.S.: Mon. and Tues., 1TS; Wed., 1AMQ; Thurs., 1KFN; Fri., 1AMQ; Sat., 1JXP. Due to a change in his working hours, KQY gave up his position of N.C.S., but will be on hand as often as possible. Any Connecticut station interested in working in a spot frequency net with a bunch of real traffic handlers should communicate with any of the above or the S.C.M. AW B.P.L.'s on deliveries. CTI and BCG are members of the Norwalk Chapter, American Red Cross Committee for Disaster Preparedness and Relief. APW has been appointed E.C. for Milford. DBI is planning a new rig for his home station. UE moved into West Hartford and is busy with N.C.R. TD has new 50-footer ready to plant. JBI has six more states to go for W.A.S. Officers of the recently formed Willimantic Amateur Radio Club are DUC, pres.; KAK, sec'y and treas. The Manchester Radio Club held a combination housewarming and farewell party to WIGP, who has moved to Union, N. J. Talks were made by AVK, ES, DF, SZ, BDI, UE and others. IJAM was Master of Ceremonies. KKS suggests that clubs without a meeting place of their own contact their Chamber of Commerce, which might offer them suitable quarters. CTT attended A.A.R.S. meeting at the home of AJB. Various A.A.R.S. activities were talked over, including plans for emergency preparedness and cooperation with the Nutmeg Neg. which operates on the A.A.R.S. 3640-kc. state frequency. The New Haven Amateur Radio Association boasts of having the most traffic men and, judging by the number of New Haven stations in the net, they are right. The Connecticut Brass Pounders Association purchased an air-cooled gas engine to drive its a.c. generator, and plans to have a permanent emergency power supply.

Traffic: W1AW 485 KFN 298 JXP 250 KQY 153 JQD 107 TS 91 CTI 83 HSK 35 KKS 36 APW 12 BDI 8 TD 3 JTD-JHM 2 JMY 242 KDK 26 KXM 13 AYF-FVI-CNF 2 AMQ 172 AJB 222 FAJ 57 GMR 79 ITI 83 KV 111 UR 16. (Sept.-Oct.): W1ITI 394.

MAINE, SCM — Winfield A. Ramsdell, W1FBJ — GOJ starts the season off with a bang making B.P.L. the first month . . . he has ten daily schedules beside Trunk Line "C" and the P.T.N. KOH is his very able assistant. DFQ finally made W.A.C. by working F18AC. DHH lost four '66's, so now uses the buffer stage for final with only 150 watts input. LCM is working 1.74-Mc. 'phone. About 25 hams from towns nearby Damariscotta attended the ham-fest at the regular meeting of the Lincoln County Radio

Club, Nov. 6th. A cordial invitation is given to come and sit in with the gang. HIE joined the P.T.N. HYK is new O.P.S. The boys at the U. of M. have reorganized the Amateur Radio Club. JCP was elected pres., ISM sec'y. Monthly meetings in the form of small hamfests will be held throughout the year, and every Tuesday afternoon it is planned to have the club station, W1YA, on the air. LER applied for O.R.S. GMD is new O.P.S. TE, Emergency Coördinator for the Portland area, is putting one of the net drills on the air over the local broadcast station WGAN. More about this later. Best wishes to all of you for a Very Happy and Prosperous New Year.

Traffic: WILMQ 7 DFQ 12 GVS 16 DHH 17 EWN 21 FBJ 40 KCO 42 KMM 54 LJP 57 ILE 60 CPT 80 BTA 69 HSE 76 HSD 111 CFO 155 KOU 221 IWN 394 GOJ 573.

EASTERN MASSACHUSETTS — SCM, Sam D. Gross, W1IWC — P.A.M., L.R. Mitchell, W1HIL. KZT finds WX reports make deliveries count. AKS and the S.C.M. ran neck and neck this month. AKS leads by a nose! HRE is building e.c.o. JSM has e.c.o. all finished, and finds it works FB. JYJ is trying remote control. Sorry business is keeping BEF off the air in E. Mass. We'll miss you like the Dickens, Ev, but hope to work you when you get the rig moved. KH was elected life member, Eastern Mass. Amateur Radio Ass'n. LOC and LBY are new O.R.S. LBY is building new exciter. AGX has new crystal rig on 56 Mc. BMW got mast up at new QTH. BDU was active in SS. JGQ is spending his spare time on new transmitter. JKT rebuilt from power supply to antenna. GAG put regenerative preselector ahead of receiver, and says it works FB. WV attended Bridgeport (Ct.) DX meeting. HKK is back from European trip; he visited G2TR, PV, BY, CL, HA8N, JP and D3MP. The S.C.M. would be glad to hear from A.R.R.L. members interested in Official Observer appointment. If you have accurate means of determining frequencies and the time to do some monitoring of the amateur bands and harmonic frequencies, you can do your share in preventing interference by amateurs and possibly save many stations from notices from the F.C.C.

Traffic: WIKZT 637 AKS 362 IWC 351 EPE 261 LLX 171 HRE 153 LHI 150 JCK 134 (WLG 26) JSM 131 KCT 124 HWE 108 JYJ 101 BEF 88 KH 84 LOC 70 EMG 66 LBY 62 AGX 60 IUQ 47 IGN 39 BMW 25 BDU 7.

WESTERN MASSACHUSETTS — SCM, William J. Barrett, W1JAH — IOT leads the parade this month. All active c.w. men in Worcester County, who are interested in strengthening the Central Mass. A.A.R.S. set-up, are urged to get in touch with IOR or IOT. Those in the counties west of Worcester County contact DVW or the S.C.M. for details. Now is the time to get our emergency set-up polished for next time; may it be far away! EOB is now C.A.N.C. 7 in A.A.R.S. HNE has new receiver; Bart is giving 'phone a whirl once in awhile. BIV is keeping nice bunch of traffic schedules. JAH finally replaced the pole blown down by ye hurricane. AUN is new Emergency Coördinator in Gardner. IOR had visit from VE3ALN. BKQ has new rig on 3.5 Mc. BNL has 6L6-860 on 7 and 3.5 Mc. with Reinartz exciter. KJK put up new full-wave end-fed antenna for 3.5 Mc. AJ is back in Turners Falls; Ralph is installing crystal filter and noise silencer in receiver. LQT is new ham in Montague City. LPC in Greenfield. KRX and KTX visited Vermont hams over Armistice Day, including BJP, DQK, KTB, CUN, KOO and LII. FOI sends in first report since moving to our Section. KOJ has new second-class commercial ticket. COI's new antennae are perking fine on 14 Mc. IEI reports on club activities in recent storm — nice going, fellows. AJD moved to Nashua. N. H. ISL moved to N. C. JJO is almost back to normal after losing antennae and power lines in wind. BNO has temporarily deserted 'phone for c.w. LBR has new Breting 9, DG a new Sky Champ. KIG and HQN have new 14-Mc. rotaries. Let's get going, gang, and perfect our emergency rigs and our whole set-up — when the storm strikes it is too late.

Traffic: W1IOT 252 (WLG 136) FOB 214 HNE 102 BIV 64 JAH 62 DUZ 53 IOR 25 BVR 20 (WLG 102) BNL 14 KJK 13 AJ 9 KRX 6 FOI 1.

NEW HAMPSHIRE — SCM, Carl B. Evans, W1BFT-W1DMD — The second test emergency mobilization of the N.H.E.N. (New Hampshire Emergency Network) will be held the first Sunday in February. Test on the 7-Mc. channel will be made at 4:00 p.m. Controlled net on 7200 kc., but will cover the entire band on QRZ's. Test on 3.5 Mc. will be at 6:00 p.m. Control station BFT-DMD will be on the State Net frequency of 3600 kc. After stations on 3600 have checked in, the entire c.w. band will be covered by

QRZ's. A.A.R.S. check in on their own 3735 kc. net. APK on 3920 kc. will contact 3.9 Mc. 'phones at 5:00 p.m., 2-Mc. 'phones at 6 p.m. from 1900 kc. A general bulletin will be sent out the latter part of January with further details. CME has been appointed Emergency Coördinator for Manchester, TA for Nashua, DUK for Rochester. If anyone in other communities is interested in an E.C. appointment, please get in touch with your S.C.M. JNO is getting the bugs out of his final. KLN has a long list of schedules, as his FB traffic total shows. EAk is on the air in Derry after a two-year lay-off. ADR built a portable gas-engine-driven generator from an old Dodge generator; AXL has one under construction. Highest N. H. SS score reported to date, 49,000 points, was made by AVJ, using his new Meissner Signal Shifter. FB!! JSL is on 56 Mc. with high power from his new QTH. ASQ-1 is on from Manchester. LLD has a new 56 and 28-Mc. crystal-controlled rig. KLD is active on 28 Mc. The Nashua Mike and Key Club is working for a permanent meeting place and an emergency power unit. The M.V.A.R.A. has authorized construction of a vibrapak emergency power unit. APK is putting A.R.R.L. Official Broadcasts on 3920 and 1900 kc. simultaneously. DUK is all set with complete emergency outfit that gets out fine. JNC and HQE have new Breting 9 receivers.

Traffic: WIKIN 336 GMM 144 IP 132 BFT 59 AP 39 AEF 21 DMD-EAL 11 JDP 1.

RHODE ISLAND — SCM, Clayton C. Gordon, W1HRC — KIV (radio sergeant at Fort Adams) joined the A.A.R.S. KRQ (ex-op at WUC), now in Westerly, is on 7 Mc. with RK-20 final; he hopes to be in A.A.R.S. by the time this reaches you. BES gave a talk accompanied by three reels of movies of his expedition to Pitecairn Island to a crowd of hams, their YL's, XYL's and friends, to the tune of about 250 people in Providence on the 17th of November. It was held under the auspices of the P.R.A. The lecture was well received, and those attending report it an evening well spent. GTN opened with remarks explaining to the friends present the difference between our kind of amateurs and Major Bowes' type! A Rhode Island Field Day was held during October in which JDX obtained the use of two National Guard radio stations which the gang used, and were thus able to get some familiarity with this type of equipment. This was in line with better preparedness for emergency. The Field Day was said to have been the most successful so far held in this state. GTN has built a box to house his emergency equipment, with compartments for a receiver, a transmitter using a 6F6 crystal, 6 blocks of 45-volt "B's," 4 dry cells, a 110-v. a.c. power supply to be used when the 110 a.c. is available and save the batteries, a space for antenna and insulators, etc., and space for headset. The cover opens down in the correct manner to furnish a writing desk or operating table, if you wish, when required in a field location. DDY has erected a skywire after a long period of attempting to recuperate from whatever it is that happens to a fellow when matrimony rings the bell on him. JXA assisted at the raising. Those beautiful towers you used to see out at AQ haven't been seen above ground since the hurricane.

Traffic: WIKTH 554 INU 509 GTN 179 INT 151 CPV 94 JUE 56 KYK 81 QR 48 LAB 42 IQF 39 KWA 35 LDL 34 HCW-KKE 31 HRC 26 JXQ 18 KOG 14 JDX 13 KIV 4 FTD 1.

VERMONT — SCM, Alvin H. Battison, W1GNF — KJG is operating by remote control. KRX, KTX, KOO, BJP, LII and KTB enjoyed a small hamfest. LJJ is the newly assigned call of Miss Marion E. Field, Newport. GNF is undergoing extensive rebuilding. JVT is back in his winter quarters. EHB is all enthused about 28 Mc. JRU-IQG rebuilt their Gross outfit. KTB is now an O.R.S. GAN applied for O.P.S. and O.R.S. The Twin State Radio Club had a party to open the winter season. KVB is operating from 2GSB, Schenectady, and will be pleased to schedule any of the gang. 2BAQ-1 has been appointed Asst. Coördinator for the St. Albans area. CBW signs WLGX in the A.A.R.S. JRU has charge of the 1.9-Mc. 'Phone Net. KJG has charge of the 3.5-Mc. Net. The St. Albans Radio Club's November meeting was attended by twenty-five enthusiasts. JNE is giving code practice to the fellows at the St. Albans C.C. Camp. JVS reports fine performance from his emergency generator unit. AHN renewed his O.P.S. KUV is installing an HF100. LPL is sending tape code practice on 3500 kc. nightly. AAJ has new receiver. BNS is back in St. Johnsbury for the winter. The Green Mountain Radio Club is making a survey for a station and club house.

Traffic: WIKTB 50 KJG 69 FSV 6.



E. H. Riethus
Pres. CREI

Here is
How-



You can step ahead into a
better radio job!

You can make more money—and get ahead
faster with CREI technical training

● Don't say you never had the opportunity to get ahead — for *here it is!* Radio wants you — and needs you — for those important jobs that new equipment and methods have created. But, you must have *training first*. CREI courses in Practical Radio Engineering will give you the ability to qualify for a better job. Today's your chance to send for our important story.

TEAR OUT COUPON AND MAIL FOR FREE BOOK

<p>FREE! Please send me your new illustrated book, "A Tested Plan for a Future in Radio"</p> <p>Name.....</p> <p>Address.....</p> <p>City.....</p>	<p>Write for the "CREI Tested Plan"</p> <p>Write today for your copy of this interesting illustrated booklet. Just off the press! You'll thank us many times after you read its 48 pages.</p>
---	---

Capitol Radio Engineering Institute
Dept. Q1, 3224 16th St., N.W., Washington, D. C.

BRAZILIAN QUARTZ CRYSTAL

Largest and most varied stock of Brazilian quartz crystals in the United States. Finest quality suitable for manufacturing piezo-electric crystals, lenses, and prisms. Shipments received regularly from our Brazilian Branch. Also in stock tourmalines for making crystals to control the higher frequencies and quartz for fusing purposes.

BRAZILIAN TRADING CO., INC.

377 Fourth Ave., New York City Murray Hill 4-2891

The New TURNER Model 99 Dynamic Microphone

Gives You Dependable Performance
Regardless of Climate or Temperature

Indoors or Out!

MODEL 99 gives you sure-fire operation under even toughest conditions. Crisp reproduction, no low frequency boom. The 99 has trustworthy response range, 60 to 9000 cycles; high level, -57 DB. Not sensitive to mechanical shock, or affected by dampness or salt air. Cable connector insures quick easy cable changes. Saddle is adjustable. Available in all impedances. **\$29.50 LIST** HIGH IMPEDANCE

Weights 2½ lbs. Professional style. Write for free literature now!

THE TURNER CO.
CEDAR RAPIDS, IOWA
U. S. A.

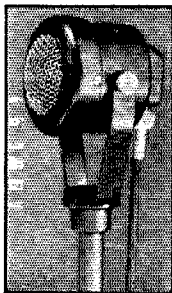

MODEL 99 — EXPENSIVE LOOKS AT LOW COST

Furnished in rich, durable gunmetal. Decidedly semi-directional, reducing feedback problems. 8 ft. cable included.

Ham at 30° Below

(Continued from page 12)

even your duffle bag of clean clothes mildews through, when the tubes collect "blizzard blankets" and the cartons become moist and damp, when your tools and other metallic objects rust in the damp salt air—then you begin to appreciate the precautions required.

Then, too, you must have power to operate. We used a gasoline engine for generating our power. One after another, replacement coils and condensers would go out. We finally had to revert to old Model "T" spark coils, reducing the primary power to lessen burning. Another point is to make sure that your lubricants will function at the temperatures you will encounter. Ours would not, and it was some chore to drain the coil and water immediately after each run, and then reheat it on the stove before starting up again!

Yes, there are two sides to the picture, all right. I certainly had plenty of illusions shattered on this trip. Don't you believe all the bunk they paint about the glory and glamour of expedition life! Just salt it down that expeditions are about nine-tenths good, hard work and about one-tenth bunk. My private opinion, after having spent a little time "up North," is that it is not worth while for an amateur to want to waste a year of his life out in the great unknown, away from the warmth of his family fireside, from clean rooms and hot baths and three square meals a day, from friends and companions, from all that one has come to enjoy and appreciate of civilization. True, it will be different from the humdrum of everyday life. You can be sure of that! You have to rough it and take life as it comes. Whether it be in the tropical heat with insects and jungle fever and vegetation impeding your progress and endless rain to soak up your cheery disposition, or whether it be in the chill of the Arctic with winds biting your serene self and freezing this and that part of your anatomy, snow blowing into your eyes and freezing out visibility so that you cannot help but stumble and fall—wherever it may be, remember that it simply means long, discouraging hours of hard labor under conditions that would be intolerable at home.

Think of having to put up an antenna that has blown down, when it is pitch dark twenty-four hours a day and the temperature is from 10° to 30° below zero, with a howling Arctic wind so strong it almost bowls you over—or think of starting an engine so cold you can barely turn it over every time you have a schedule to keep—or of living closely confined with a group of men with whom you continually rub elbows all day and night for months on end, or of monotonous meals providing the same scanty fare every day, day after day. Think of having to do with and put up with things that are far worse than anything you could expect at home, of doing everything the "hard way"—and then, if you still want to go, this is all I have to say:

More power to you!

CRYSTAL FILTER

ELECTRIC BAND SPREAD

R.F. ON ALL BANDS
CERAMIC COIL FORMS



Model 438
Only
\$49.95
less crystal

**4 BANDS—8 TUBES
BUILT-IN SPEAKER**

HOWARD DOES IT AGAIN!

● With the advent of the world famous 430 many have asked for a larger receiver—here it is.

Model 438 embodies professional features never before associated with equipment in this price class . . . real "DX" with R-9 reception: Ceramic Coil Forms . . . R. F. Stage on all Bands . . . Separate Coils for each Band . . . Xtal Filter . . . Complete Coverage 540 KC—

43 mc . . . Electric Band Spread with vernier control . . . 2-stage Iron Core I. F. . . . Accurately Calibrated Slide Rule Dial . . . 8 Tubes . . . Provisions for a 6-volt Power Supply . . . Band in use Indicator . . . B. F. O. with Pitch Control . . . 2 Watts Power Output . . . Built-in 6" Dynamic Speaker . . . Head Phone Jack . . . Doublet or Marconi Antenna Connections . . . Provision for External Speaker . . . Provisions for Howard tube type 'R' Meter.

Models to Suit the Individual Tastes of the Most Exacting Amateur and Professional

Model 450A—12 Tubes—6 Bands—Frequency Coverage .54 to 65 MC . . . Ceramic Coil Forms . . . Dual I. F. Channels . . . Two S. L. F. Ceramic Insulated Tuning Condensers . . . 47 inches of electric bandspread . . . crystal filter . . . Calibrated 'R' Meter . . . Accurately calibrated direct reading dial . . . Price, with Tubes, less Speaker, less crystal **\$87.50 Net**

Model 430—6 Tubes—4 Bands—Frequency Coverage .54 to 40 MC . . . Ceramic Coil forms . . . B. F. O. with pitch control . . . Iron Core I. F. transformers . . . Electric band spread . . . Built-in Dynamic Speaker . . . Headphone jack . . . Accurate direct reading straight line dial . . . Price, Complete with tubes and speaker **\$29.95 Net**

Model 440—9 Tubes—5 Bands—Continuous coverage .54 MC to 40 MC . . . Ceramic Coil forms, S. L. F. Ceramic Insulated Tuning Condensers, Electric Bandspread, R. F. on all bands, Iron Core I. F. transformers . . . Electric band spread. Calibrated 'R' Meter, Crystal Filter . . . Price with tubes less Speaker, less Crystal **\$66.50**

HOWARD RADIO COMPANY
1731-35 West Belmont Ave., Chicago, Ill.
Please send me more information on
Model 438 Model 430
Model 450-A Model 440
CABLE ADDRESS: "Howardco" Q

Name _____
Address _____
City _____ State _____

America's Oldest Radio Manufacturer

CORNELL-DUBILIER

Star Hit ★ ★ ★
OF THE MONTH

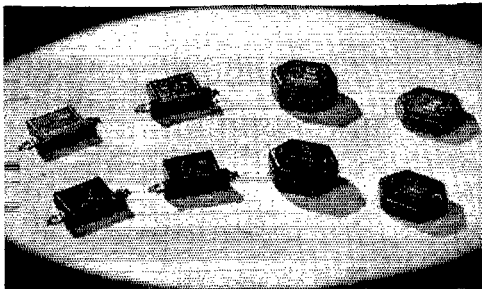

FEATURES OF TYPES 4 and 9

- 1 — India Ruby Mica Dielectric — Low power factor; high Q; long life.
 - 2 — Mica of Stepped Uniform Thickness — Provides high factor of safety.
 - 3 — Specially-Treated Stack Assembly — Affords higher voltage breakdown.
 - 4 — Vacuum Dried Stack Treatment — Low loss; high insulation resistance.
 - 5 — Moulded in Bakelite — Minimum leakage; moisture-proof.
 - 6 — Short Heavy Terminals — Insures good anchorage; mounting accuracy.
 - 7 — Excellent Temperature Coefficient — Practically constant capacity at all temperatures.
- For a complete listing of the entire CORNELL-DUBILIER line, send for Catalog No. 161, FREE ON REQUEST
MICA • PAPER • DYKANOL
WET AND DRY ELECTROLYTICS



CORNELL-DUBILIER
ELECTRIC CORPORATION
South Plainfield, New Jersey

Piezo-Electric Crystals Exclusively

- Quality crystals of all practical frequencies supplied SINCE 1925. Prices quoted upon receipt of your specifications.

Our Pledge: **QUALITY FIRST**

SCIENTIFIC RADIO SERVICE

"The Crystal Specialists Since 1925" University Park, Hyattsville, Md.

If you can use the regulation key—

You Can **Better--Faster--Easier**
Send with the Easy-action

VIBROPLEX No. 6

Great
New No. 6

Japanned Base \$17
Nickel-Plated Base \$19

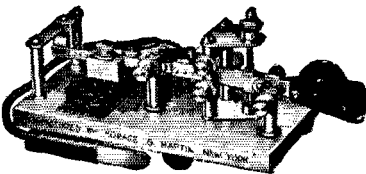

Liberal Allowance on Old Vibroplex

New design. You'll like its many special features that make it so efficient and easy to use.

JUNIOR

Smaller and more compact, but in all other details the same as large model.
Only \$12.50

Its simplicity, mechanical perfection, machine speed and sending ease eliminates tiring arm work and helps you to send with the skill of an expert. Easy to learn. Simply press lever — Vibroplex does the rest. **ORDER NOW!** Prompt shipment. Money order or registered mail. Write for catalog.



The **BUG** trade mark identifies the Genuine Vibroplex.

THE VIBROPLEX CO., INC., 832 Broadway, New York, N. Y.

Vertical Antennas

(Continued from page 17)

the old single-wire feed method. The information covering this form of feed which is given in the *A.R.R.L. Handbook* may be applied to almost any of the foregoing antenna systems and will bring about a certain amount of simplification of the mechanical details. It would be hard to think of a simpler way of feeding almost any of the vertical systems which are made up of single or stacked half-wave units. More or less as an added starter and just to show how easy it is, we have added Fig. 7, which will be recognized as a simplification of Fig. 4-E. As a rule, single-wire feed is not suitable for rotary systems, for reasons which are strictly mechanical, so we have omitted previous mention of it.

Almost any of the quarter-wave Marconi aerials described in the first part of this text may be single-wire fed. Theoretically each of the quarter-wave units has for its other quarter-wave section either the building on which it has been erected or the ground. Many of those that we have used have been on high buildings, and possibly that is the reason for our having secured almost as good results with quarter-wave aerials as with center-fed half-wave units.

The quarter-wave antenna may be single-wire fed by considering the vertical portion as only half the antenna, and the feed line may be attached at a point approximately two-thirds the distance down from the top. It is sometimes thought that it is impossible to use single-wire feed without having standing waves on the transmission line. This need not be true because single-wire feed may be considered in exactly the same light as two-wire feed, the ground itself forming the other half of the line. Therefore the single-wire line may be used as a resonant feed system having standing waves⁷ or a non-resonant system without standing waves. Where vertical aerials are to be used in apartment houses in localities where a great many broadcast receivers are in use, it is desirable to use the non-resonant line to avoid interference.

In the quarter-wave vertical, the point of highest current is at the base of the antenna. The point of lowest voltage is also at the base. This means that there is no need for an insulator at the base at all, and if care is taken in the selection of the feed system there is no reason why a vertical quarter-wave radiator cannot be mounted directly on the steel frame of a building without using insulation of any kind.

Combinations of Vertical Antennas

In all the antennas considered up to now, simplicity has been the keynote. It is perfectly possible to make combinations of vertical ele-

⁷ Resonant operation is inadvisable in practically all cases because under such circumstances the line radiates practically as well as the antenna and is not, therefore, really a transmission line in the usual sense of the term. With non-resonant operation the radiation is low because the line current is low, but the excitation effect of the two-conductor line is lacking.—EDITOR.

NEW YEAR'S GREETINGS *From* The **RADIO SHACK**



5-10 HALLICRAFTER

SKYRIDER

Cash Price **\$69.50** or **\$12.50 Down**
and **5.23** for 12 mos.

Better signals on 5-10 meters calls for the outstanding ultra high frequency receiver.

MAIL ORDERS
PROMPTLY
FILLED

•

Write for Free
72 page
Catalog

•

BUY ON EASY
TERMS

S-17 HALLICRAFTER

SUPER SKYRIDER

Cash Price **\$125.50** or **\$25.50 Down**
& **9.00** for 12 mos.

Designed for the amateur who wants exacting performance and superior reception.

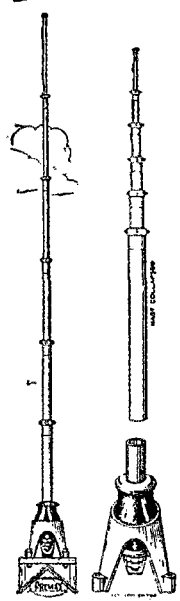

PREMAX VERTICAL RADIATORS

Fully telescoping and adjustable; quick, easy to install; no long pipes to handle; simply erect 6 ft. unit and extend to height desired; special design 25,000 volt insulator to 800-foot Tower type.

10 meter, adj. 7 to 17 ft. Net. \$ 6.17
20 meter, adj. 7 to 34 ft. Net. \$16.76

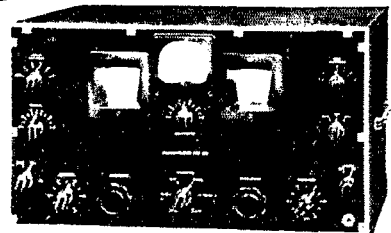

NEW HAMMARLUND "HQ 120"

Continuous range from 31 to .54 mc—12 tubes; antenna compensating control; 310° band spread; noise limiter follows A.V.C. for quiet reception; variable band width crystal filter for phone reception; calibrated "S" meter on all models.

CASH PRICE
\$117.00 \$23.40 down
less crystal filter and \$8.41 for 12 mos.

STANDARD RACK PANELS

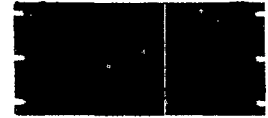

Made in accordance with standard specifications. Constructed of 1/8" steel, finished in fine black crackle.

1 1/8"	\$.39	12 1/4"	.79
3 1/8"	.44	14"	.89
6 1/8"	.49	15 1/2"	.99
7"	.54	17 1/2"	1.09
8 1/2"	.59	19 1/2"	1.19
10 1/2"	.69	21"	1.29

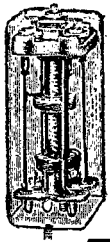

SICKLES IRON CORE PERMEABILITY TUNED I. F. TRANSFORMER

As specified in low cost single signal receiver by George Grammer, on page 14 October QST. Permeability tuned, 456 KC.

I.F. Transformer 6504. Net. \$1.18
Beat Frequency Oscillator 6577. Net. \$1.18

Steel Brackets

Black crackle finish, "S" steel.



3" base (per pair) 44c
11" base (per pair) 59c
13" base (per pair) 69c

Special TRANSMITTING CONDENSER

2 Mfd. **\$1.49**
2000 volts
Guaranteed
Oil treated. Excellent power factor and capacitance characteristics. Tested at 6000 volts DC.



Crackle Finished and Electro Zinc Plated Chassis

*5 1/2"	9 x 1 1/2	35c	10 x 14 x 3	69c
5"	10 x 3	39c	10 x 23 x 3	89c
6"	14 x 3	49c	7 x 17 x 2	63c
*7"	7 x 2	39c	7 x 17 x 3	66c
7"	9 x 2	42c	10 x 17 x 2	69c
7"	11 x 2	45c	10 x 17 x 3	75c
7"	13 x 2	49c	12 x 17 x 2	79c
7"	15 x 3	59c	12 x 17 x 3	85c
10"	12 x 3	65c	13 x 17 x 3	89c

*Available in Zinc Plated only

THE RADIO SHACK 46 Brattle St., Boston, Mass.

DOES FAST CODE GET YOU DOWN?

Write for CANDLER'S
FREE Book of facts!

THERE'S no need to let fast code lick you! If you are having trouble learning code, if you can't develop the speed you need, if you can't get your license — call on Candler! He has trained thousands of operators with the unique Candler System, fellows who were stuck, who couldn't get over the "hump."



In a few weeks with Candler, learning sound-consciousness, getting the proper mental training, you will be able to read code as easily as you read print, without strain or effort. Ask any skilled operator!

Learn about the Candler System! Send for Candler's FREE "Book of Facts" today!

CANDLER SYSTEM CO.

BOX 331, DEPT. Q-1
ASHEVILLE, NO. CAROLINA
BRITISH ADDRESS: ROOM 56, CRAVEN HOUSE,
KINGSWAY, LONDON, W. C. 2.

SICKLES COILS

SECURE A COPY OF OUR NO. 939
CATALOG FROM YOUR JOBBER

F. W. SICKLES COMPANY

300 Main Street

Springfield, Mass.

TYPE HFM TRANSMITTER

"THE TRANSMITTER OF THE FUTURE"

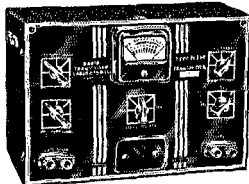

- Six Bands 1715 — 60,000 K.C. on two crystals
- All Frequencies Crystal Controlled
- Instantly Changeable Mobile or Portable
- Final Tube Input 21 to 36 Watts

Net to Amateurs. . \$57.60
Write for bulletins listing our complete, new and approved line for amateurs.

RADIO TRANSCEIVER LABS.

8627 115 Street · Richmond Hill, New York City
CABLE ADDRESS: "RATRALAB"

RADIO COURSES

New Classes Now Starting

- RADIO OPERATING ● BROADCASTING ● CODE
RADIO SERVICING ● TELEVISION
● ELECTRONICS — 1 year day course; 2 years eve.
Day and Evening Classes — Booklet upon request

NEW YORK YMCA SCHOOLS

4 West 63rd Street, New York City

ments to provide some very interesting effects. An outstanding example of the use of two half-wave verticals which could be made to transmit end-fire or broadside by the simple expedient of altering the connection between the transmission line and the feeding stubs was described by Dana Griffin, W2AOE, in *QST* for October, 1935.⁸ The spacing which Griffin used between the vertical elements was quite different from the close spacing which is now so popular, and the advantages of the close spacing will be immediately recognized. A more recent outline of what is essentially the same idea will be found in *QST* for May 1938, under the title "Simple Directional Arrays using Half-Wave Elements," by Nicholas C. Stavrou, W2DFN.

Some very interesting information on the application of three vertical elements for use on 10 meters, as shown diagrammatically in our Fig. 6-B, will be found in an article entitled "A Continuously Rotatable 28-Mc. Beam," by A. F. Neuenhaus, W2BSF, and M. E. Schreiner, W2AJF, which appeared in *QST* for March, 1938.

The most outstanding example that we have seen of the way in which verticals can be used in a rotary beam is now in operation at the station owned by Frank Carter, W2AZ, at East Rockaway, Long Island. On top of a 60-foot telephone pole, which is unguyed, he has set up a pivoted crossarm made of two 2 x 10 planks mounted edgewise. On the top side of this crossarm are mounted two of the new Premax self-supporting 36-foot vertical telescopic radiators. Two similar radiators extend downward from the bottom. The four units have been worked into a vertical two-section "SJK" beam. Since the beam is bi-directional it is only necessary to provide 180 degrees of rotation for 360-degree coverage.

Using about 900 watts input, W2AZ has worked 100 countries on 'phone, using a single frequency in the 20-meter band. Some indication of the superiority of his vertical beam over the three similar horizontal beams that he has been using may be gleaned from the fact that VU2CQ in Bombay, India, can be received SS on the vertical, when he is just audible on the horizontal beam. On a recent weekend W2AZ made WAC on 20-meter 'phone, and he now reports PK6XX in Dutch New Guinea S7 on the vertical beam, when he could not be heard on the horizontal beams at all. VQ3HJP in Tanganyika and TF5C in Iceland have been workable with this new vertical, after they had faded out completely on the horizontal beams.⁹

⁸ D. A. Griffin, "Shifting Antenna Directivity by Phase Switching," *QST*, October, 1935.

⁹ These results are interesting in view of the fact that the only obvious explanation is that the signals were arriving with vertical polarization, since antenna systems having practically the same gain were used. Long-time observations on high-frequency waves have shown that on the average the polarization at the receiving point is horizontal although, of course, there are frequent exceptions. A possible alternative explanation is the difference in vertical characteristics of the systems; the vertical array is broader in the vertical plane than the horizontal array, so that the vertical might show large gain if the signals were arriving at relatively high angles.—EDITOR.

Bassett CONCENTRIC FEEDER

★ NEWARK OFFERS THE LATEST IN ANTENNA EQUIPMENT - - - -

Neither snow, nor rain, nor ice, nor sunshine, nor the gloom of the "XYL" can stay these husky cables from the efficient transfer of radio frequency power from transmitter to antenna.

Newark has a **BASSETT CONCENTRIC FEEDER** or **BASSETT CONCENTRIC TRANSFORMER** for every type antenna and for every power requirement. Order today direct from this ad.

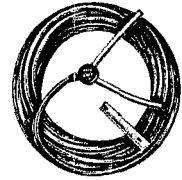

Bassett Concentric Feeder



Bassett Concentric Transformer

Type	Power Rating	Surge Impedance	Price Per Ft.
BCF-64-5000	5000 Watts	64 Ohms	40c
BCF-64-1000	1000 Watts	64 Ohms	17c
BCF-64-500	500 Watts	64 Ohms	10c
BCF-64-200	200 Watts	64 Ohms	5c
BCF-34-1000	1000 Watts	34 Ohms	16c
BCF-28-1000	1000 Watts	28 Ohms	11c
BCF-13-1000	1000 Watts	13 Ohms	7c

Factory moulded and attached end seal, any length.....\$1.50

50-75-100 ft. lengths with end seal on above carried in stock. All other lengths to order only.

Bassett Concentric Transformers

For feeding 3-element rotary beams. Both ends sealed at the factory. One end connects direct to center of antenna and other end direct to open wire line consisting of pair of No. 12 wires spaced four inches apart. Open wire line to transmitter may be any length desired. BCT-10 for 10-meter band. BCT-20 for 20-meter band. Three power ratings as indicated.

BCT-10-1000.....	\$4.15	BCT-20-1000.....	\$5.00
BCT-10-500.....	3.75	BCT-20-500.....	4.25
BCT-10-200.....	3.45	BCT-20-200.....	3.75

Prices include factory attached seals at both ends.

All Items Carried in Stock

Write for the latest Bassett Handbook of Rotary Beam Design.

FREE CATALOG

Illustrations, prices and full details on thousands of separate items, sets, tubes, parts and supplies! **MAKE UP A \$60 ORDER** and Buy All the supplies you need at present low prices. **AND PAY ON EASY TERMS.** Write for this Big 76-page Catalog Today.

BCF-8-1000—Special 8-Ohm, 1000-Watt line for direct feeding of 3 element rotary beam antennae.

BCF-8-1000—50-ft. line with seals, compt. . . \$ 7.40

BCF-8-1000—75-ft. line with seals, compt. . . 10.15

BCF-8-1000—100-ft. line with seals, compt. . . 12.90

Any desired length custom built to order.

Bassett Rotary Beam Antenna Elements

3-Element, 20-Meter Antenna.....\$22.50

3-Element, 10-Meter Antenna..... 15.50

2-Element, 20-Meter Antenna..... 15.50

2-Element, 10-Meter Antenna..... 10.50

These elements are of self-supporting, reinforced lightweight steel, factory cut to correct length, 1" in diameter, and are copper-plated both inside and outside and heavily lacquered. Weight is approximately two ounces per foot.

The above prices include necessary elements, white lacquered wood supporting members, factory mounted insulators, and all necessary hardware.

Your Call Letters in Gold

Hams look at this! Your Call letters in impressive three dimensional style. Big shadowed deca-cornania letters nearly TWO INCHES high. Put them on your HAM SHACK door, auto window, etc. Send dime for yours today. Be sure to give your call letters.

★FLASH: Watch NEWARK'S ad in next month's QST for details of the Beam Antenna Rotator you have been waiting for. Something entirely new in a coupling system. No inefficient slip-rings—no loose swinging feed line. Watch NEWARK'S ad in the next issue.

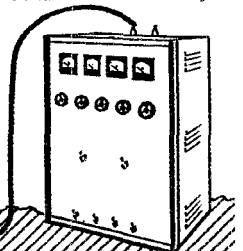

NEWARK ELECTRIC COMPANY

323 W. MADISON ST.

CHICAGO, ILL.

"TWIN" SERVICE



POPULAR PRICES plus HELPFUL SUGGESTIONS

If you want more than the usual "counter service" or mailed "catalog" . . . if you want sincere and helpful suggestions and the benefit of whatever experience we may have . . . you'll always get it at HARVEY'S . . .

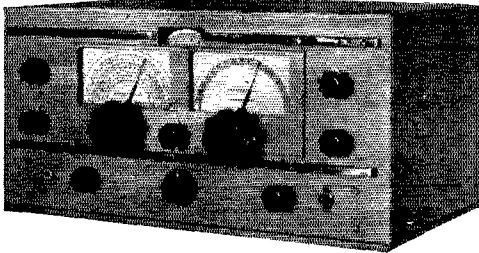

THE NEW RME-70 IS IN STOCK
Come in and see it on display

SPECIAL!

EXCEPTIONAL VALUE! LIMITED QUANTITY!
POWER TRANSFORMER

Made by one of the Country's Leading Manufacturers

● Hum Bucking Type Coil Structure ● Completely Poured with Humidity Proof Compound ● Designed to deliver 1500 or 2000 volts D.C. at 500 MA. ● Dimensions 10½ x 8½ x 8 ● Gross Weight 85 lbs. **\$16.95**

OUR *Best* VALUE IS OUR RECORD OF LOYAL SERVICE

HARVEY

Radio Company of New York

103 WEST 43rd STREET • NEW YORK, N. Y.

CABLE ADDRESS: "HARADIO"

The Cairo Regs

(Continued from page 30)

signals or a code word, and will be used for the transmission of information that may be used only by persons so authorized, such as the subscribers to a press service.

Remember the scheme for classifying types of emissions, wherein A3 is telephony, etc.? There are a few changes there worth noting. The basic uninterrupted carrier, of course used only in special cases such as standard-frequency emissions, is now spoken of as a Type AO continuous wave. Type A1 remains c.w. telegraphy, Type A2 modulated telegraphy, Type A3 telephony. Facsimile is now to be designated Type A4 and television becomes Type A5 emission.

There are a few changes in the prefix letters assigned nations for their calls, but these have been reported as current news as they went into effect, and they appear in detail in the periodical revisions of the I.A.R.U. country list, the prefix listings in the *Handbook*, etc.

That's the works, as far as things interesting to us are concerned.

Another Method of Keying

(Continued from page 31)

cycle and the grid can regain control. If a controlled rectifier is placed between the center-tap of the plate transformer and the filter, the current through the tube will look like Fig. 1-A if choke input is used, but it will look like Fig. 1-B if condenser is used. Thus with condenser input the current from the transformer center-tap flows in only one direction but is reduced to zero 120 times every second, and a single controlled rectifier can be used to key the circuit. The keying will still be through the filter and will retain the characteristics of rectifier keying with a saving of one special rectifier tube. Since condenser input and a minimum of filter are normally used with primary or rectifier keying, no changes are necessary in the circuit other than the introduction of the keyed rectifier tube and its control circuit.

In Fig. 2, an adaptation of the primary-keyed system described by W6CUH,³ the driver and final amplifier are both keyed, and no bleeder is used on the final power supply (except a voltmeter or very high resistance so that the filter will gradually discharge and prevent accidental shock). This system has the advantage that with the key up the voltage on the final amplifier is a little below what it is with the key down, and no thumps are introduced by regulation of the final amplifier power supply. If the keyed driver stage put no "tails" on the characters the final amplifier supply voltage would always remain exactly the same, key up or key down, but with the keying described the voltage will drop somewhat in the "key up" position, depending on the storage in the driver stage supply. Any of the usual methods can be used to control the rectifier

³ QST, March, 1937, p. 31.

Play Safe!

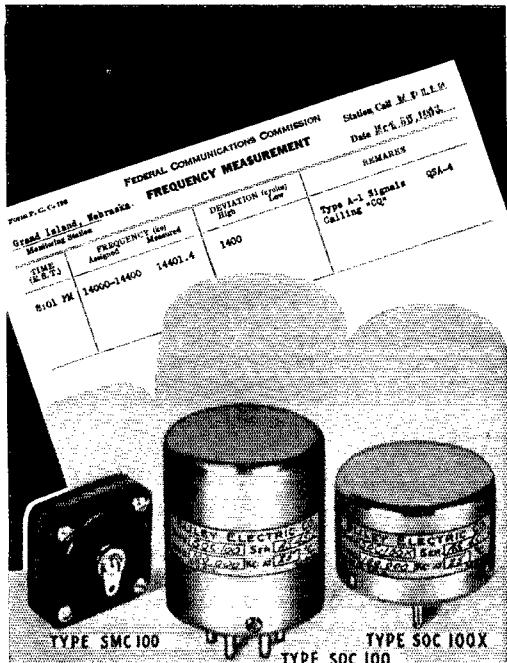

Improper adjustments or incorrect operating conditions can bring about off-frequency radiation in any type of transmitter. The new F.C.C. regulation which requires every amateur station to incorporate an independent means for measurement of the transmitter frequency now places full responsibility squarely on each operator. Play safe—use a standard frequency oscillator in conjunction with your station receiver. You then will have a reliable monitor at low cost.

Where high precision is essential, the type SOC100 low-drift 100kc. Standard Frequency Crystal Unit priced at \$15.50 should be used. The SOC100X, X-cut, mounted 100kc. bar offers economical accuracy at \$9.50. When operation is well within the band limits, a flexible inexpensive frequency standard can be constructed with the type SMC100 Dual-Frequency Crystal Unit (100kc. and 1000kc.) priced at only \$7.75.

Ask your Bliley distributor for a copy of Bulletin A-6, which describes these and other Bliley Crystal Units.

BLILEY SF CRYSTAL UNITS

QSL Cards

Individual QSL Cards printed as you want them, at reasonable prices. Samples gladly submitted on request.

HINDS & EDGARTON, INC., W 9 W R
19 South Wells Street, Chicago, Illinois Ex. W9APY

VERTICAL RADIATORS

BEAM AND MOBILE ANTENNAS

The original self-supporting Vertical Radiator that stands up in all kinds of weather. Fully adjustable from 28 to 34 ft. Order Direct.
Type H F 20. 33-ft. Radiator. (20-40-80-160 Bands).....\$19.50
Type H F 10. 16 ft. Radiator. (10-20-40-80 Bands).....\$13.50
Remit with order or C. O. D. on receipt of \$5.00 deposit

ACE PRODUCTS CO.
2605 2nd Avenue, Seattle, Wash.

● TELEGRAPHY—TELEVISION—TELEPHONY ●

AVIATION
TRANS RADIO
PRESS
TELETYPE
TYPEWRITING



PRACTICAL
EXPERIENCE
STUDIO —
TRANSMITTER —
ANNOUNCING

The major technical training equipment owned by Port Arthur College and in operation on the college campus consists of the 500-Watt Commercial Broadcast Transmitter of Station KPAC; two-way Television Transmitter and Receiver; Latest Type RCA Marine and Airways transmitter installation complete; SOS Automatic Alarm; Marine Direction Finder; Trans-radio Press Receiving Equipment, and Laboratory complete where students assemble composite transmitters, amplifiers, audio amplifiers, R. F. amplifiers, etc.

Port Arthur College pioneered the teaching of Radio with classes in 1909, and for thirty years has maintained an active Employment Bureau for the placement of its graduates.

If interested in details about Radio Course, write for Bulletin R

PORT ARTHUR COLLEGE ■ PORT ARTHUR (World-Known Port), TEXAS

GOOD RESULTS DEMAND

Good Instruments!

- ★ 3" and 4" Sizes Stocked
- ★ Other Sizes Available
- ★ Round or Square
- ★ Attractively Priced

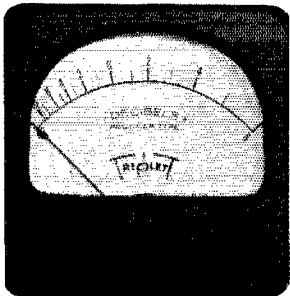

MODEL 327-A DECIBEL METER

Standard range reads up 6 and down 10 decibels, zero decibel at 1.73 volts, 500 ohm line, 6 milliwatts, standard damping furnished unless highly damped is specified.

3" Instrument in New Style Molded Case. **\$12.00**

ALSO 4" MODELS

Model 321 — 3" Round **\$12.00**

Model 421 — 4" Square **\$13.17**

Decibel Meter Kit — Model 150 Kit complete with Decibel Meter, necessary multipliers, switch and other accessories **\$20.00**

== THE TRIPPLETT ELECTRICAL INSTRUMENT CO. ==
 == 251 Harmon Ave. Bluffton, Ohio ==

RADIO ENGINEERING



RCA Institutes offer an intensive course of high standard embracing all phases of Radio and Television. Practical training with modern equipment at New York and Chicago schools. Also, specialized courses and Home Study Courses under "No obligation" plan.

Illustrated Catalog on request

RCA INSTITUTES, INC. Dept. ST-39

A Radio Corporation of America Service

75 Varick St., New York 1154 Merchandise Mart, Chicago

Learn to Send and Receive **CODE**

Learn to send and receive code signals, like operators on ships at sea and at commercial and amateur land stations. Intercept distress signals, news flashes, bulletins, and dozens of other kinds of interesting radio communications.



MASTER TELEPLEX teaches you to receive code exactly the way the world's best operators do — by sound. A heavy waxed paper tape, running through a machine, operates an automatic key which sends messages to you, at any speed you desire. As you improve in

speed, the machine sends faster, gradually preparing you for top-speed amateur and commercial signals. With the new All Electric **MASTER TELEPLEX** you learn to send by sending, and the signals you send are repeated back to you, exactly as you sent them, thus enabling you to correct your own errors. We furnish a complete course, lend you the All Electric **MASTER TELEPLEX** and give you personal instruction with a **MONEY BACK GUARANTEE**. Send for our new **TELEPLEX FOLDER Q1** today. **IT'S FREE!**

THE "HAM" SPECIAL Standard Teleplex — a highly efficient code teacher using heavy specially prepared waxed paper tape, having two rows of perforations. Write for Free folder "Q.T.-1."

TELEPLEX CO. 67-69 PARK PLACE
NEW YORK, N. Y.

In Canada write: CANADIAN ELECTRONIC INSTITUTE, TORONTO, ONTARIO

tube^{1,2}—the one shown is used because the well-insulated bias-supply transformer was on hand.

The system is in use at W1JPE, and the 150-ma., 1700-volt, driver supply and 350-ma., 2800-volt, final supply are handled easily by any of the control tubes available.

¹ QST, Feb., 1938, p. 34.

² QST, Sept., 1938, p. 42.

Selectivity With the 2-Tube Regenerative Receiver

(Continued from page 87)

parison between receivers is to take a case when two incoming signals are so close in frequency that the difference is well down in the audio range, then to see which receiver makes copy of one of them possible. This comparison was made between the pee-wee and a well-known superhet with a crystal filter and repeated day after day. It is still uncertain whether the super shows much, if any, superiority. This would indicate rather unexpected selectivity.³

W8QBW, located in a suburb of Detroit, is in the basement, practically underground. The "ground" is a galvanized pipe passing through the floor into permanently damp earth. To this pipe is bolted a piece of half-inch brass pipe which runs along the edge of the shelf so that ground is brought right up to the receiver. The ground wire from the set is only a few inches long. This may be an important point, but the set was also tested on the second floor, with a steam radiator ground, and they came rolling in just the same.

The power supply for a regenerative receiver needs some attention. The one here has three chokes and three condensers and is satisfactorily quiet.

Referring to the photographs, on the left side are the power-supply and 'phone plugs, in front are the band-spread and band-set dials and on the right side are the antenna and ground posts and the potentiometer knob. On top the arrangement is self-explanatory. In the underside view, with the condenser dials at the left, will be seen the two midget variables; in the center is the audio choke, in the corners condensers C₆ and C₇ (with R₄), at

³ This particular superhet is of the type without a selectivity control, and depends upon the phasing control for variation of effective selectivity. The crystal input circuit is normally factory-adjusted to a relatively broad setting, so that the audio peak on a c.w. signal is not nearly so sharp as it would be on a set having the crystal selectivity adjusted to a high value. Under these conditions the comparison is not so far-fetched as it might seem at first glance, since with both receivers separation of signals having nearly the same beat note is mostly a job for the selectivity of the ear rather than that of the receiver. The regenerative set's selectivity is higher than usual because it is dealing with signals of small amplitude compared with those furnished by the conventional antenna. It is therefore working under considerably more favorable conditions than it would be with a large antenna, or if it had been preceded by an r.f. amplifier. Of course, the "other side of zero beat" is not eliminated, as it is in the crystal super. — Editor.

The Radio Amateur's Handbook

The new 1939 edition of the "Radio Amateur's Handbook" is a thorough revision of the standard manual of amateur communication. A tremendous quantity of new equipment was constructed exclusively for this Edition. The important transmitter chapter has been enlarged and has complete constructional data for units now described for the first time. It includes new diagrams with particular attention to determination of optimum L/C ratios and tank-condenser plate-spacings. Unit designs permit the construction of complete transmitters of any power up to the maximum allowed by amateur regulations. The radiotelephony section was rewritten with the thought of increasing its value to the practical amateur who wants to know more about the adjustment and operation of 'phone transmitters. Modulator data (particularly for the grid-bias and plate systems) will be found for each of the lay-outs featured in the transmitting chapter. Power supplies are of course fully covered so that you may pick the most suitable one. The antenna chapter has been expanded to give complete dope on all varieties from the simpler types to the more elaborate arrays. New treatment of feeder systems and the various antennas will make the operation of these more readily understood. Multi-band operation, antennas for restricted space, as well as complete information on rotary beams, is also to be found in this chapter. Other chapters have received equally thorough treatment. The fundamentals chapter has been simplified. The tube chapter has five pages of new tables to make this complete and up-to-date. New kinks will be found in the chapter on workshop practice. Four receivers have been added to the receiver section, including simple regenerative sets as well as superhets. As in the rest of the book, the emphasis is on proven circuits, with performance and economy foremost. Simple pre-selector and antenna-tuning units are described, together with material on tuning and signal-strength indicators. The transmitters to be found in the ultra-high-frequency chapters are of course designed to comply with the new regulations regarding stability; and the receivers to take advantage of this new set-up on 56 Mc. The still higher u.h.f. bands have not been forgotten, both receiving and transmitting gear having been built and described for the first time in this edition. Apparatus designed and constructed and actually used for the purpose, is included in the chapter on emergency and portable equipment. More effective laboratory equipment, practical for the amateur, is included in the instruments and measurements chapter. Of course the new amateur regulations are to be found in that ever useful source of information, the Appendix. With the extensive index, the reader can locate easily and quickly the information on the subject in which he is interested. Following the form of the previous Editions, putting in all information that is pertinent to the design, construction and operation of proven equipment, the 1939 "Handbook" is the most complete and comprehensive yet. Packed with practical information helpful to the old-timer and youngest beginner alike, concisely written in simple, understandable style, it is more than ever before the greatest dollar's worth in radio.

\$1 postpaid in Continental U.S.A. — \$1.25 postpaid elsewhere

Buckram bound edition, \$2.50

American Radio Relay League

West Hartford, Conn.

Merry Christmas and a Happy New Year

Make This Christmas
a More Joyous One!
Don't wait, but get the radio
equipment you need — now!
Prices are lowest, quality is
highest, always, at **TERMI-
NAL!** You can obtain all
your radio requirements at
either of Terminal's com-
pletely stocked radio supply
houses!

Enjoy the "hamfest" at-
mosphere at the **TERMINAL**
store most conveniently lo-
cated to you — both stores
open evenings until 8:00
P. M.

VISIT THE
TERMINAL STORE
NEAREST YOU!

TERMINAL
Radio Corporation

2 STORES IN NEW YORK CITY
80 CORTLANDT ST. • 68 WEST 45th ST.

Cable Address: **TERMRADIO**

the right is RFC and below this, not visible, are C_4 and C_5 . At the top of the photo is the potentiometer, R_2 , and at the bottom are the power socket and 'phone jack. R_6 is across the 2.5-volt prongs of the power socket and cannot be seen. You cannot install the parts and then connect up — there isn't a chance to get at some of them. Leads should be soldered to the hard-to-get-at points and some of the parts made up into little "assemblies" so that after installation there is not much left to do. In fact this method is really easier than the usual way. Grounds are made right on the spot; for example R_4 , R_5 and R_6 , and the end of L_1 are grounded on the socket screws.

Anyone who builds this set is urged to make the chassis from the illustrated template and follow the placement of parts exactly. You can't tell just what may happen if a rig is made up differently from the original; it might be an improvement but frequently is otherwise.

What has been said applies entirely to c.w. performance. I would not offer the set for 'phone although I did hear some Florida, Texas and West Coast 'phones on 10 meters during the day, with the 12-inch antenna.

Television Receiver

(Continued from page 52)

control is set to give a suitable average illumination of the entire picture. Further adjustments of the tuned circuits, a.g.c. control, and focusing controls will aid in bringing up the picture detail, until optimum settings are found for all adjustments and controls.

For locations where the signal level from the antenna is apt to be low, the final steps in the alignment of the picture receiver can be helped along by means of a calibrated "5-meter" oscillator, provided with sound modulation. The oscillator, tuned to 46.5 Mc., is loosely coupled to the receiver, which can be tuned to the oscillator frequency by observing the moving, unsynchronized band pattern on the Kinescope. The number of dark (or light) bands observed corresponds to the ratio of the sound modulation frequency (of the test oscillator) to the vertical scanning frequency. The set is tuned by adjusting C_{12} , C_9 , C_3 , and C_8 , in the order named. Maximum sensitivity for a specific setting of the a.g.c. and background controls will be indicated by the least average illumination of the Kinescope screen. The oscillator signal, however, should be kept small enough so that the Kinescope pattern never becomes excessively dark. When the picture signal is applied, the settings of C_3 and C_8 may have to be readjusted for best picture definition. Maximum sensitivity and optimum definition are not ordinarily obtained simultaneously, because the pass band may not be wide enough at maximum sensitivity to pass the full video band — that is, to give best picture definition.

The modulated test oscillator may also be used in the tuning of the sound receiver. If, after the picture receiver is aligned for maximum sensitiv-



THE A.R.R.L. EMBLEM



Insignia of the Radio Amateur

IN the January, 1920, issue of *QST* there appeared an editorial requesting suggestions for the design of an A.R.R.L. emblem—a device whereby every amateur could know his brother amateur when they met, an insignia he could wear proudly wherever he went. There was need for such a device. The post-war boom of amateur radio brought thousands of new amateurs on the air, many of whom were neighbors but did not know each other. In the July, 1920, issue the design was announced—the familiar diamond that greets you at the top of this page—adopted by the Board of Directors at its annual meeting. It met with universal acceptance and use. For years it has been the unchallenged emblem of amateur radio, found wherever amateurs gathered, a symbol of the traditional greatness of that thing which we call Amateur Spirit—treasured, revered, idealized.

Do You Wear the A.R.R.L. Pin?

THE LEAGUE EMBLEM, in heavy rolled-gold and black enamel, is available in either pin or button type.

In addition, there are three special colors for Communications Department appointees.

- Red background for the SCM
- Blue background for the ORS
- Green background for the RM and PAM

(Red and green available in pin type only. Blue may be had in either pin or button style.)

THE EMBLEM CUT: A mounted printing electrotpe, $\frac{3}{4}$ " high, for use by members on amateur printed matter, letterheads, cards, etc.

All Emblems Priced the Same . . . Fifty Cents Postpaid

AMERICAN RADIO RELAY LEAGUE, WEST HARTFORD, CONNECTICUT

RELIABLE FREQUENCY CONTROL WITH VALPEY CRYSTALS

Commercial ■ Amateur ■ Special Applications

Types CMA, CBC, LCH, VCH, V5, VM2, LW20, and others described in our catalog, obtainable from your dealer or by writing direct.

Box 321, Holliston, Mass.

AMATEUR RADIO LICENSES

Day and evening classes in code and theory. Home study courses. **THERE IS NO QRM IN THE INSPECTOR'S PHONES!** When you go up for your exam you will hear a clean, clear note without any interference, from a punched tape prepared by an expert. Study for your license the same way; by listening to a clean, clear note in our classrooms sent to you by a commercial operator and instructor of twenty years' experience, or through code machines at home with tapes prepared by an expert. Hundreds of licensed students now on the air. Results guaranteed.

AMERICAN RADIO INSTITUTE

1123 Broadway

New York, N. Y.

A GOOD NAME GOES A LONG WAY

Ken-Rad Tubes have earned their good name through the use of honest materials, skilful precision workmanship and advanced technical knowledge.



Ken-Rad Radio Tubes
KEN-RAD TUBE & LAMP CORPORATION - OWENSBORO, KY.

Manufacturers of all types of radio tubes and Ken-Rad Electric Lamp Bulbs

SOLAR
gives you **MORE** for your money

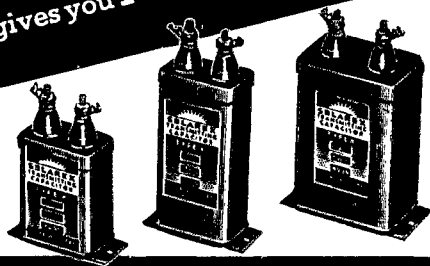

SOLAREX Oil Impregnated TRANSMITTING CAPACITORS

Catalog upon request

SOLAR MFG. CORP.,
599-601 BROADWAY, NEW YORK

NEW HAMMARLUND MODEL HQ-120

Described on Page 81

Down Payment Only \$9.55

COMPARE THESE LOW TERMS
And Send Your Order Direct to W3DQ

Receiver and Model	*Net Cash Price	*Down Payment & 12 Mo. Pay'ts
New NC-44	\$49.50	\$4.04
New RME-70	138.60	11.30
New NC100XA	142.50	11.70
Super Skyrider	99.00	8.08
Sky Challenger II	77.00	6.28
NC101X	129.00	10.52
New HQ-120 complete	117.00	9.55

Also Super Pro, HRO, Patterson, Breting, Sargent and Others
Lowest Terms on Harvey—RCA—Temco—National—
Thordarson—Transmitters & Kits

DELAWARE RADIO SALES COMPANY
WILLARD S. WILSON

405 Del. Ave. — W3DQ — Wilmington, Del.

*For U. S. A. only. Subject to change without notice.

USE B-L RECTIFIERS

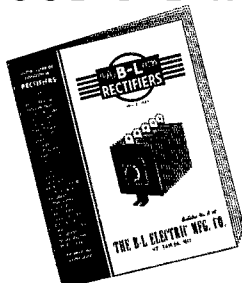

In your rig wherever you need low voltage direct current, as for relays, filaments, and similar applications.

The new B-L Rectifier Manual gives helpful information about circuits, filters, output capacities, etc.

Write today for your free copy of Bulletin No. R-38

The B-L ELECTRIC MFG. CO., St. Louis, Mo.

ity, the test oscillator is tuned 3.25 Mc. higher in frequency, the sound modulation should be quite audible on the sound receiver at a dial setting of about 9.75 Mc. The spacing of 3.25 Mc. between the video carrier and the sound carrier is shown in Fig. 1 in the preceding article. The tuning of the audio signal will be very sharp, due to the selectivity of both the sound receiver and the soundbuffer input circuit. If a tendency for the sound signal to drift is encountered, this may be due to frequency shift in either the sound-receiver oscillator or the picture-receiver oscillator. This effect can be minimized, provided the sound receiver is sufficiently sensitive at 9.75 Mc., by shunting a resistance across the sound-buffer input circuit. This resistance tends to broaden the tuning of the sound buffer stage.

In photograph "G" is shown a picture taken directly from the screen of the type 1800 Kinescope. The video signal, obtained from a Monoscope, was used to modulate a television signal generator, the output of which was fed into the r.f. stage of the picture receiver. Thus, the received picture illustrates the fidelity of which the receiver is capable. In the laboratory model of the receiver built as described, a resolution of better than 350 lines has been obtained with Kinescope Type 1800. This means that the receiver is capable of much better resolution than it is possible to obtain with small Kinescopes such as the 913, 902, and 906 (see page 22, *QST*, October, 1938). However, these smaller tubes will give quite acceptable pictures and will serve nicely the television amateur who is desirous of getting started with the minimum of expense. The picture receiver will justify, at a later date, the use of one of the larger Kinescopes.

The electromagnetic Kinescope and scanning units using Type 1800 Kinescope and shown in the complete receiver photographs in December *QST*, will be described by Mr. Sherman in a subsequent issue.

Bibliography

- "The 954 as a Vacuum-Tube Voltmeter," *QST*, May, 1935, pp. 90-92.
- "Type 726-A Vacuum-Tube Voltmeter," *The General Radio Experimenter*, May, 1937.

Strays

After reading this, 'phone ops with difficult call letters should end their complaining: W9YVZ and W9YZV, both in Chicago, recently had a 160-meter 'phone QSO!



My Creed

To give you specialized personal service of genuine value that is not available from other jobbers.

To sell all equipment on terms financed by myself so you can buy with less cost and more convenience.

To take your equipment in trade at a fair value on other equipment.

To allow you to try any receiver for ten days without obligation and to cooperate with you in every way I can, to see that you are entirely satisfied.

Compare Bob Henry's Terms with others

Model of Receiver	Cash Price	Down Payment	12-Month Payments
The NEW RME-70	\$138.60	\$27.72	\$9.79
Hammarlund HQ-120	117.00	23.40	8.26
Howard 450A	87.50	17.50	6.18
NC80X and NC81X	99.00	19.80	6.99
Improved NC101X	129.00	25.80	9.11
The NEW NC100A	120.00	24.00	8.48
Latest RME-69	152.88	30.57	10.80
Sky Champion and NC-44	49.50	9.90	3.49
Breting 49 and Super Skyrider	99.00	19.80	6.99

Similar terms on Super Pro, Howard, HRO, PR-15, Breting 9, Sargents, others. And on Hallicrafter, National, Harvey, RME, Temco, RCA transmitters and National, Thordarson, UTC, Utah kits.

You can reach me by letter, telegram, phone, or visit nearly 24 hours a day, 365 days a year. Write me for any information and for help in getting the best receiver or transmitter for your use. Your inquiries invited. Foreign orders solicited.

HENRY RADIO SHOP

211 North Main St.

Butler, Missouri

Bob Henry
W9ARA



NEW HOLDER DESIGN 15 SECONDS TO INSTALL CRYSTAL

For All Bands
GREATER STABILITY
Plugs in 5 prong tube socket

Beautiful Appearance

MODEL AH HOLDER \$1.00 At your dealer or direct

HIPOWER LOW DRIFT CRYSTALS:
within 10 kc. or Choice of stock

AH-10, 1700-3500 Kc. bands \$2.35
AH-10, 7000-7300 " bands 3.90

WRITE FOR NEW LITERATURE

Hipower "Low Drift" Broadcast and Commercial
Crystals Are Approved by F.C.C.

Hipower Crystal Co., 2035 Charleston St., Chicago

Eliminate KEY CLICKS without Loss of Power

Gardiner-Levering Mercury Vapor Keyer gives perfect keying on all CW transmitters — hand key, "bug," or machine sender — at all speeds, without loss of power output. Practically no voltage drop. Uses only one type 83 mercury vapor tube. Separate filament supply built in unit. Only 4½" long and 3¾" wide. Merely insert in keying line and plug cord into AC outlet.



\$7

Less tube
POSTPAID
IN U. S. A.

FULLY GUARANTEED

If your dealer can't supply you, write us

GARDINER-LEVERING CO. Haddon Heights
New Jersey, U.S.A.

LOW COST STEEL ANTENNA TOWER

Used and Endorsed by
FEDERAL, STATE, COUNTY, CITY GOV'TS.,
FORESTRY, HIGHWAY PATROLS
and HAMS everywhere!

ONLY 60¢ PER FOOT Complete!

This remarkable low price is possible only because we produce many thousands of these towers each year for use with our Wincharger. Price includes necessary guy wires and tower sections of 10 or 20 ft. lengths with 5 ft. tapered stub top.

LIGHT, STURDY, RIGID

Thousands in use as vertical radiators and horizontal antenna supports. Scientifically braced. No points of undue strain. Both vertical angles and cross braces now hot dip galvanized.

SAFELY ERECTS TO 200 FT.

Quickly and easily erected, without skilled assistance, to heights of from 25 ft. to 200 ft. Enthusiastically used and recommended by police and broadcasters for thoroughly satisfactory service.

READ U. S. FORESTRY LETTER!

"Your tower was installed on Signal Peak, a Lookout Station on the Yakima Indian Reservation, at an elevation of 5,111 ft. above sea level. We have found the Wincharger tower 100% satisfactory and it has stood up under 70 mile winds, snow and ice which are severe at almost a mile up from sea level." Thomas L. Carter, Forest Supervisor, Office of Indian Affairs, U. S. Department of the Interior, Tappanish, Wash.

Order Direct From
WINCHARGER CORPORATION
Sioux City, Iowa

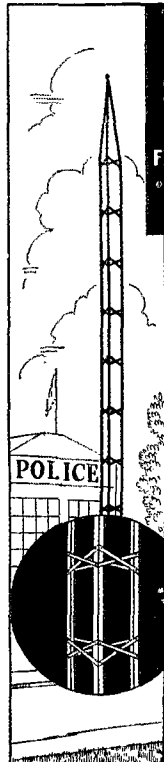

Affiliated Clubs

(Continued from page 52)

300-watt gasoline-driven a.c. generator for emergency use.

The Connecticut Brass Pounders Association, WICBA, has obtained an air-cooled gas engine to drive its a.c. generator, and plans to have a permanent emergency power supply.

In recognition of the service rendered the city of Hartford, Conn., during the hurricane and flood, the Hartford County Amateur Radio Association now has a permanent meeting place in the Chamber of Commerce Rooms, 805 Main Street, Hartford, through the cooperation of the C. of C. and support of the local amateur parts distributors. Plans are under way for a permanent club house on the outskirts of the city. A 300-watt 'phone and c.w. transmitter is about to be constructed for all-band operation and suitable receivers purchased. A drive is to be made for the construction of many emergency transmitters and receivers, operating independently of the 110-volt a.c. mains. A suitable emergency power unit is to be obtained to furnish power for the club station. When all plans materialize, H.C.A.R.A. will have its own club house with plenty of room for beam antennas, etc., the 300-watt rig on all bands, emergency power, and a radio link with the club rooms in downtown Hartford.

Visit Your Local Club

Clubs are excellent places to get acquainted with radio amateurs and to participate in interesting discussions on our hobby. At A.R.R.L. headquarters there are recorded the addresses of several hundred amateur radio clubs affiliated with the League, their places and times of meeting. Why not drop in at your local club and "meet the gang"? Address the Communications Manager (enclosing 3¢ stamp, please) for data on affiliated clubs in your vicinity.

General Club News

June 19, 1938, was an outstanding day for hams of Eastern Ontario and adjoining districts. Under the auspices of the Ottawa Amateur Radio Transmitting Association, a hamfest was held on Shiek's Island in the St. Lawrence River. Over sixty hams from VE2, VE3 and W8 districts, together with YL's, YF's and Jr. ops, spent an enjoyable day. Among the events were hidden transmitter hunts on the 3.9- and 56-Mc. bands, relay race, rag-chewing contest, spelling bee in which DX prefixes had to be identified, nail-driving contest for the ladies, left-foot sending contest, treasure hunt, etc. The A.R.R.L. Canadian General Manager, VE2BE, was in attendance. The usual prize drawing brought activities to a close. The success of the affair was due to the efforts of the committee: VE3MX, VE3ABH, VE3AJB, VE2GP and VE3BY. . . . The Westlake Amateur Radio Association is now meeting at the Harding Junior High School, Lakewood, Ohio, every other Thursday, 8:00 P.M., and invites nearby hams to drop in. . . . At the October 28th meeting the Olney Amateur Radio Club, Philadelphia, enjoyed a talk on radium by Dr. Henny of the Temple University Hospital. . . . The 56-Megacycle Minutemen officers are now as follows: G. R. Cogswell, W1AJW, president; R. E. Burditt, W1MJ, vice-president; A. H. Downer, W1DMS, secretary. Correspondence should be addressed to the secretary at 60 Willow Ave., Somerville, Mass. . . . VE3QB sends an interesting item which appeared

GREETINGS 1939!

● *We take this occasion to thank the thousands of Radio Amateurs, technicians, broadcast station engineers and experimenters who have contributed to the continued success of our business.*

We like to feel that you have come to us not only because we stretch our ingenuity in an endeavor to give you the finest possible service but because you like us, because we understand your most intimate technical requirements and are able to assist you ably and well.

We greet the New Year, confident that we will be in a position to better serve your needs than ever before. May we have the opportunity to serve you?

SUN RADIO CO.

SAMUEL SCHWARTZ
Pres.

SUN RADIO CO.
212 Fulton Street, New York, N. Y.
Cable Address SUNRADIO NEW YORK

Where to buy it

A directory of suppliers who carry in stock the products of these dependable manufacturers.



ALBANY, N. Y. Uncle Dave's Radio Shack 356 Broadway
 ATLANTA, GEORGIA Wholesale Radio Service Co., Inc. 265 Peachtree Street
 BOSTON, MASS. Radio Shack 46 Brattle Street
 BOSTON, MASS. Wholesale Radio Service Company, Inc. 110 Federal Street
 BRONX, N. Y. Wholesale Radio Service Company, Inc. 542 East Fordham Rd.
 BUTLER, MISSOURI Henry Radio Shop 211-215 N. Main Street
 CHICAGO, ILL. Allied Radio Corp. 833 W. Jackson Blvd.
 CHICAGO, ILL. Wholesale Radio Service Company, Inc. 901-911 W. Jackson Blvd.
 COLUMBUS, OHIO Bell Radio Parts Co. 203 N. Fourth St.
 DETROIT, MICH. Radio Specialties Co. 325 E. Jefferson Ave.
 DETROIT, MICHIGAN Radio Specialties Co. 11800 Woodward Ave.
 HARTFORD, CONNECTICUT Radio Inspection Service Company 227 Asylum Street
 HOUSTON, TEXAS R. C. Hall & L. F. Hall 625 East 14th Street
 JAMAICA, L. I. Wholesale Radio Service Company, Inc. 90-08 166th Street
 KANSAS CITY, MO. Burstein-Applebee Company 1012 McGee Street
 NEW ORLEANS, LA. Shuler Supply Company 902 Poydras Street
 NEW YORK, N. Y. Harrison Radio Co. 12 West Broadway
 NEW YORK, N. Y. Wholesale Radio Service Co., Inc. 100 Sixth Ave.
 NEWARK, N. J. Wholesale Radio Service Co., Inc. 219 Central Ave.
 OAKLAND, CAL. Offenbach Electric Co. 2085 Broadway
 POTTSVILLE, PENN. E. Norwegian & George Sts. Jones Radio Company
 READING, PENN. George D. Barbey Company 404 Walnut St.
 READING, PENN. Jones Radio Company 104 North Ninth Street
 SAN FRANCISCO, CAL. Offenbach Electric Company 1452 Market Street
 SPRINGFIELD, MASS. T. F. Cushing 349 Worthington St.
 WASHINGTON, D. C. Sun Radio & Service Supply Co. 938 F Street, N. W.

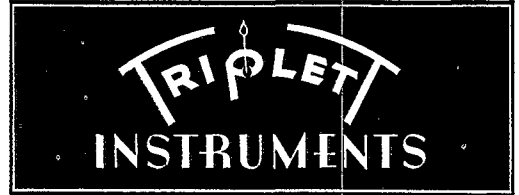

ALBANY, N. Y. Uncle Dave's Radio Shack 356 Broadway
 ATLANTA, GEORGIA Garvin Electric Company 69 Forsyth Street, N. W.
 ATLANTA, GEORGIA Wholesale Radio Service Company 265 Peachtree Street
 BOSTON, MASS. Radio Shack 46 Brattle Street
 BOSTON, MASS. Wholesale Radio Service Company, Inc. 110 Federal Street
 BRONX, N. Y. Wholesale Radio Service Company, Inc. 542 East Fordham Rd.
 BUTLER, MISSOURI Henry Radio Shop 211-215 N. Main Street
 CHICAGO, ILLINOIS Allied Radio Corp. 833 W. Jackson Blvd.
 CHICAGO, ILLINOIS Electric & Radio Supply Co., Inc. 25 North Franklin Street
 CHICAGO, ILL. Wholesale Radio Service Company, Inc. 901-911 W. Jackson Blvd.
 DALLAS, TEXAS Southwest Radio Supply 1905 Commerce Street
 JAMAICA, L. I. Wholesale Radio Service Company, Inc. 90-08 166th Street
 LITTLE ROCK, ARKANSAS Beem Radio Company 409 W. 3rd St.
 MIAMI, FLORIDA Tropical Camera Stores, Inc. 123 Second Street, N. E.
 MINNEAPOLIS, MINNESOTA Lew Bonn Company 1124-26 Harmon Place
 MONTREAL, CANADA Canadian Electrical Supply Co., Ltd. 285 Craig Street, West
 NEW ORLEANS, LA. Shuler Supply Company 902 Poydras Street
 NEW YORK, N. Y. Wholesale Radio Service Company 100 Sixth Avenue
 NEWARK, N. J. Wholesale Radio Service Company 219 Central Ave.
 OAKLAND, CAL. Offenbach Electric Co. 2085 Broadway
 POTTSVILLE, PENN. E. Norwegian & George Sts. Jones Radio Company
 READING, PENN. George D. Barbey Co. 404 Walnut Street
 READING, PENN. Jones Radio Company 104 North Ninth St.
 SAN FRANCISCO, CAL. Offenbach Electric Company 1452 Market Street
 WASHINGTON, D. C. Sun Radio & Service Supply Co. 938 F Street, N. W.

Listings on this page do not necessarily imply endorsement by QST of the dealers or of other equipment sold by them.

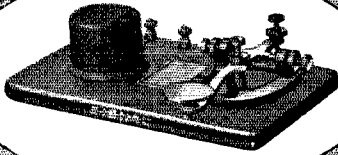

WIRELESS PRACTICE SETS

R-68 PRACTICE SET

Designed for those who want a well made instrument to learn the code. Set consists of a key and high frequency buzzer mounted on a mahogany finished wood base equipped with binding posts. The code is printed on a plate and fastened to the base between the key and buzzer. Buzzer is adjustable. List \$3.40.

SIGNAL's line of Wireless Keys, Telegraph Instruments and Wireless Practice Sets is complete. Send for our bulletin.

SIGNAL ELECTRIC MFG. CO.
Menominee, Michigan, U. S. A.

SIGNAL
MANUFACTURERS OF ELECTRICAL PRODUCTS

in the *Ottawa Journal* of May 23, 1912: "The Dominion Amateur Wireless Association of Ottawa was organized 'to promote interest in wireless telegraphy and to encourage the installation of amateur wireless stations.' . . ." Do any amateur clubs now in existence date back that far? . . . The Tenth Annual Michigan Hamfest (May, 1938), under the auspices of the Detroit Amateur Radio Association, met with the customary success, attendance being well over 600. Besides staging the Michigan Hamfest each year, the D.A.R.A. is justly proud of its record of the issuance of the D.A.R.A. Bulletin, published monthly for more than seven years without missing a single edition. This bulletin is mailed free to all operators reporting to the Michigan S.C.M. D.A.R.A. has also aided in the organization and maintenance of the well known Michigan (QMN) Traffic Net on 3663 kc. . . .
— E. L. B.

New Apparatus

Concentric Cable Kit

KITS for assembly of 1/2-inch diameter coaxial cable for lengths of 10, 25, or 50 feet, including inner conductor, outer shield, clips, screws, nuts, eyelets, and assembly instructions are now available from the Transducer Corporation, 30 Rockefeller Plaza, New York City. Ceramic spacers are used to maintain a flexible wire centrally located in a braid outer covering. Different wire sizes may be substituted to obtain various impedances, the size of the wire being limited only by the diameter of the spacer openings.

In the assembly process, the spacers are first strung on the length of inner conductor to be used. The braid is then opened in just the same manner as used for putting flexible braid shielding on hook-up wire, and the inner conductor and spacer assembly is pulled through the outer shield. After the outer conductor is tightened firmly on the spacers, screw clamps are used to secure the ends and complete the assembly.

Dummy Load Resistor

A new 100-watt constant-resistance dummy load resistor is now made available for amateurs by the Ohmite Manufacturing Company. Available in either 73 ohms or 600 ohms resistance, this unit is practically non-inductive for frequencies as high as 15 megacycles. The two resistances in which the resistor is made available match it to standard concentric, twisted-pair, and open transmission lines. Because the resistance of the unit remains almost constant at varying power up to 100 watts load dissipation, the resistors are well suited to use in series with r.f. ammeters for approximate measurement of r.f. output power of stages in the transmitter and of the power actually delivered to the antenna through the feed line.

The resistance element is enclosed within a glass globe which is evacuated and gas filled. The assembly is finished by addition of a ceramic 4-prong tube base, with the resistance element connected between the filament pins, so that a single dummy resistor may be made readily useful for a variety of applications by inclusion of 4-prong sockets at desired points in the transmitter.
— T. M. F.

LEARN CODE RIGHT

Always ready — no weather interference — beats having someone send to you. Speed range 5 to 40 W.P.M. Radio or Morse.

STANDARD with 10 tapes and book of instructions . . . \$20.25
JUNIOR with 5 tapes and book of instructions (not rented) . . . \$12.00
Complete oscillator equipment less battery, \$6.50

RENTAL Standard with 10 tapes and book of instructions \$3.00 first month, \$2.25 each additional month.

With transformer and tube socket 25¢ per month more. With key and head phones 50¢ per month extra. \$10 deposit or business references required.

Write for details today

INSTRUCTOGRAPH COMPANY

Dept. Q-1, 912 Lakeside Place, Chicago, Illinois

Representatives for Canada:

Radio College of Canada, 863 Bay Street, Toronto

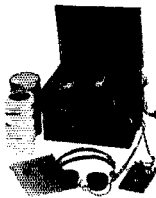

LEARN RADIO

— TELEVISION —

500 Licensed graduates placed in past 7 years in shippings, broadcasting, aviation, police, etc., we also teach radio servicing and repairing; new term Sept. 12th, Nov. 7th day or eve.; 52-page catalog free; oldest, largest and best equipped.

MASS. RADIO SCHOOL

18 Boylston Street, Boston

G. R. Entwistle, Pres.
Established 1899

R. F. Trop, Treas.
Hancock 8184

HAM-ADS

(1) Advertising shall pertain to radio and shall be of nature of interest to radio amateurs or experimenters in their pursuit of the art.

(2) No display of any character will be accepted, nor can any special typographical arrangement, such as all or part capital letters be used which would tend to make one advertisement stand out from the others.

(3) The Ham-Ad rate is 15c per word, except as noted in paragraph (6) below.

(4) Remittance in full must accompany copy. No cash or contract discount or agency commission will be allowed.

(5) Closing date for Ham-Ads is the 25th of the second month preceding publication date.

(6) A special rate of 7c per word will apply to advertising which, in our judgment, is obviously non-commercial in nature and is placed and signed by a member of the American Radio Relay League. Thus, advertising of bona fide surplus equipment owned, used and for sale by an individual or apparatus offered for exchange or advertising inquiring for special equipment, if by a member of the American Radio Relay League takes the 7c rate. An attempt to deal in apparatus in quantity for profit, even if by an individual, is commercial and all advertising by him takes the 15c rate. Provisions of paragraphs (1), (2), (4) and (5) apply to all advertising in this column regardless of which rate may apply.

Having made no investigation of the advertisers in the classified columns, the publishers of *QST* are unable to vouch for their integrity or for the grade or character of the products advertised.

QUARTZ—direct importers from Brazil of best quality pure quartz suitable for making piezo-electric crystals. Diamond Drill Carbon Co., 719 World Bldg., New York City.

RADIO engineering, broadcasting, aviation and police radio, servicing, marine and Morse telegraphy taught thoroughly. All expenses low. Catalog free. Dodge's Institute, Byrd St., Valparaiso, Ind.

USED receivers. Bargains. Cash only. No trades. Price list 3¢. W3DQ, Wilmington, Del.

QSL's, all colors, cartoons, snappy service. Write for free samples today. W1BEF, 16 Stockbridge Ave., Lowell, Mass.

CALLBOOKS—Winter edition now on sale containing complete up-to-date list of radio hams throughout entire world. Also world prefix map, press schedules and new time conversion chart. Single copies \$1.25. Canada and foreign \$1.35. Radio Amateur Call Book, 610 B. Dearborn, Chicago.

FREE catalog. Y-cut crystals, 75¢. Other cuts reasonable. Also commercial crystals. Faberadio, Batavia, Ill.

QSL's, samples. Meador, Box 1534, Savannah, Ga.

CRYSTALS, mounted, 80-160 \$1.25, V-cut 40 \$2.25. R9 Crystals, 388 Murray Ave., Arnold, Pa.

BASSETT buys for cash Collins, Harvey, Temco transmitters, National, Hammarlund, RME receivers, etc. Send data and desired price. Sell Bassett HF-1000-W commercial 1000-watt telephone transmitter, serial No. 1. T-200's. Final modulated by 822's, complete with all tubes, speech equipment, and accessories. Cost \$2000—first check \$975. takes complete. W9ZDO.

QSL's, SWL's: one color 45¢, two color 60¢ hundred, postpaid. Samples. W1FTM, 268 Piedmont, Waterbury, Conn.

RCA ACT-40 phone transmitter with tubes in metal rack with antenna tuning unit, \$145. Ideal for small municipal police transmitter. W9KJF.

QSL's, SWL's. 100—3 color—75¢. Lapeco, 344 W. 39th, Indianapolis, Ind.

CRYSTALS: X-cut 1" sq. 80—160, \$1.40; mounted, \$2.25; 40, \$2.50; mounted, \$3.25. =3 kilocycles. Guaranteed the best. The Ransom Lab., No. Syracuse, N. Y.

QSL's. Free samples. Printer, Corwith, Iowa.

SELLING out. Stamp for list of used parts. W9LVO, 415 Oak St., Brazil, Ind.

QSL's, SWL's—Original, outstandingly different. Fritz's, 455 Mason, Joliet, Ill.

EARN \$56. per unit, selling nationally advertised shortwave diathermy unit to physicians. Reliable firm. Estab. 60 years. Valuable territories now open. McIntosh Electrical Corp., 225 No. California Ave., Chicago.

QSL's, **QSL's**, **QSL's**. World's finest. Samples? W8DED Holland, Mich. (Bibley crystal sales, QST subscriptions accepted.)

BARGAINS in parts you need; power transformers; speakers of all kinds; resistors; audio transformers; condensers, all types; chokes and tubes; everything at give-away prices. Write for complete list. W9SEK, 2505 Johnson Ave., Cedar Rapids, Iowa.

IPS rubber crystal, QSY remotely, varies completely 160 to 10 meters. Approximately 20 watts output, \$19.80. Radio Apparatus Mfg., 1522 No. Clark, Chicago, W9IFS.

FOR sale, cheap. (14) 5 k.w., 3750 volt Crocker Wheeler ball-bearing generators. (4) 5 k.w. 1000/2000 volt Gen. Elec. double commutator type generators with motors. All equipment practically new. Write Motor Repair & Mfg., 1561 Hamilton Ave., Cleveland, Ohio.

YOUR call spin in chain tie clip. Gold filled. Beautifully hand made. 60¢ coin. W9SZB, Lake Bluff, Ill.

TUNGAR—used 15 ampere with bulb, in good condition. Will ship C.O.D. best offer. W2KOO, 418 Conrad Rd., Englewood, N. J.

RECONDITIONED guaranteed Sky-Buddies, \$16.; Sky-Chiefs, \$25.; FBX's, \$21.; FB7's, \$18.; coils, \$2.50; SW3's—SW5's, \$9.; coils, \$1. Walter Ashe Radio Co., 1100 Pine St., St. Louis, Mo.

WANTED: Acme-Delta transformers, AD-26, AD-35, AD-46. WDSU, 5017 Mission, Dallas, Texas.

CALIFORNIA kilowatt. Phone and c.w. 80 to 10 meters. Parts cost over \$1,300. Sell for \$500. cash or trade for Temco 600 or new Collins 80J. W8QBQ, Carbon, W. Va.

RECEIVER ACR111 used less than one month—unconditionally guaranteed. First \$95. takes it. W3ARR.

WANTED: used RME-69's, NC-100's, NC-101's, Super-Pro's. Generous trades toward other equipment. Write in full detail. State price wanted. Hatry & Young, Inc., Hartford, Conn.

BARGAIN 6F6—RK49 xmttr 3 bands complete less crystals, \$18. W9CFB, Moulton, Iowa.

SELL Super Gainer, 7 tubes, coils 10-200, Jensen dynamic, complete. \$25. cash. W9ZNV.

SELLING OUT—Set Riders Manuals, analyzer, tube tester, 350 watt fone & c.w. transmitter, 50 watt fone & c.w. transmitter. W5FSS, Tylertown, Miss.

BARGAINS in transmitters, 75 watts only \$25. Modulators with speech and power 30 watts, \$18. Frampton Radio, Blackwell, Okla.

50 watt phone transmitter for sale. Owner deceased. Rcese Schultz, 2241 Melrose St., Chicago.

QSL's of the better kind. W2AEY, 338 Elmora, Elizabeth, N. J.

DOUGLAS transformers of quality. Universal modulation type. Designed by W8UD. 50 watts audio, \$4.95 pair; 100 watts audio, \$7.75 pair. Postpaid in U. S. One year guarantee. Write W9IXR, Rice Lake, Wis.

WANTED: Index 1933 QST, old-fashioned tubes, first ten editions of "Handbook". W9EWH.

QSL's. Swell new styles. Samples. Maleco, 1805 St. Johns Place, Brooklyn, N. Y.

CALL letters for station mounting. Beautifully finished. On modern base. 10" x 2 1/2". Postpaid, 50¢. W9ZJF.

QSL's. Samples free. W8RCF, 76 Colorado, Detroit, Mich.

TELEPLEX BS, instructographs, omnigraphs, receivers, meters bought, sold. Ryan's, Hannibal, Mo.

CRYSTAL bargains. See December issue. Pacific Labs., W6JEB.

HIGH gain rotaries. 20 DB increase. Variable speed worm drives, telescoping aluminum tapered beam elements. Selsyn-chronous direction indicators, tilting heads for radiation angle control. Everything for beam builders. Rotary Array Service. W8ML.

QSL's, W8QCC, Frackville, Pa.

CRYSTAL bargains—see December issue. C-W Mfg. Co.

MAGNET wire. Correct lengths and gauge for emergency generators. W8DT.

LISTEN for high-frequency broadcast station W9XA, 26,450 kilocycles, Kansas City. Programs of interest to short-wave listeners and radio amateurs.

QSL's—W8NOS.

CRYSTAL buyers, bear this in mind: when you buy an Eidson T9 crystal you get a quality product absolutely guaranteed. There are no seconds for sale at any price. 40 and 80 meter bands, \$1.60, 7301-7500 kc. range, \$2. postpaid. Improved T9 ceramic holders, \$1. C.O.D.'s accepted. Commercial crystal users send for literature. These and other reputable dealers sell and vouch for Eidson crystals: Henry Radio Shop, Butler, Mo.; Frank Anzalone, 375 W. 46th St., N. Y. C.; Southwest Radio Supply, Dallas, Texas; Van Radio, 464 E. 117th, No. 7, Cleveland, Ohio; Espy's, 2223 State St., New Orleans, La.; Casa Edison, Havana, Cuba; and Eidson's, Temple, Texas.

BARGAIN Emerson dynamotors 6 volt input, average output 180 volts 40 milliampers. Forty brand new at \$4. each; forty reconditioned, \$3. each. Walter Ashe Radio Co., St. Louis, Mo.

QSL's, high quality, postpaid 100—50¢; 500—\$2. Samples free. Howe Brothers, Wisner, Neb.

SPEAKERS—hifidelity, 12" and 15", card brings list. W9UUN, 2610 1/2 Bowser St., Ft. Wayne, Ind.

SPECIAL: Ur sigs revd hr, phone, CQ's, etc., on guaranteed phonograph records, 35¢. Bargains: mikes, revs., a.c. converters, etc. Brown's Radio Lab., Dolgeville, N. Y.

QSL'S: W8BZK, Newark, Ohio.

TUBING for your beam. Anything, your price, particulars 3 cents. Dr. M. Redman, W9ENK, Fargo, N. D.

TRY us first for radio supplies. Loughnane & Co., Decatur, Ill.

QSL'S. Wide range of new ideas. Lowest prices. Free samples to hams. W2FJE, 101 Hanson Place, Brooklyn, N. Y.

WANTED: 2000 plate transformer, 300 ma. W1KRRK.

ATTENTION ex-ship operators: navy receivers SE 143 1220 1420 at bargain prices. W7AJM, 3017 N. E. 31st Ave., Portland, Ore.

SELL SX-11 Skyrider; 100 watt phone—c.w., xtal-ec, 160-10 meters, xtal mike, extra equipment. Send for details. Best offer \$100. or over. W2JVD, Norfolk Ave., Maplewood, N. J.

RADIO control—Send stamp for circulars showing latest equipment. Lightweight, reliable, guaranteed to perform. Radio Control Headquarters, Granby, Conn.

MARINE radiotelephone sales representatives, also first or second class phone men for installation & service in their localities. Marinephone, Inc., 591 Broadway, N. Y. C.

LINCOLN R9 with twelve inch Jensen speaker, \$15. QSL printing press, \$8. W9VOV, Luxemburg, Wis.

ALL-band fifty watt transmitter, with tubes, \$30. W8GDC, 320 Seventeenth Ave., Columbus, Ohio.

FLASH: brand new RCA ACR111 receivers in factory-sealed cartons, \$99.50 cash. No swaps or trades. Temco 100 transmitter complete. Best cash offer takes it. W3DQ.

ROTARY beams. Used receivers. Transmitter kits. New receivers, all makes. New RME-70's. Communication headquarters. Transmitters designed and built to order. Receivers serviced. All phases of high frequency communication. Write to Southern Ohio's only amateur owned amateur business. Jos. N. Davies, W8ANT, 2767 No. Bend Rd., Sta. A, Cincinnati, Ohio.

QSL'S. Cuts. Cartoons. Free samples. Theodore Forcher, 7708 Navahoe, Philadelphia, Pa.

FOR sale: W. E. tubes: 2-228A's, one new—4-212D—1-212E. Reasonable offer for any will be accepted. Part of W. E. I k.w. transmitter available. Write for list to W8BY, Inc., Green Bay, Wis.

BARGAINS: reconditioned guaranteed communications receivers shipped on ten-day trial. Practically all models at big savings. Terms. List free. W9ARA, Butler, Mo.

BEST place to get communications receivers is from W9ARA. Best trades, best terms, ten-day trial. Brand-new ACR-111's factory-sealed cartons, \$99., new 25 cycle model ACR-175, \$79. Code machines rented. W9ARA.

SELL thirty watt, three stage exciter-transmitter. Choice forty, twenty, or ten coils. Self-contained power supply. Tubes, less xtal. Built September this year. Larger rig makes this surplus. Standard Bud chassis black wrinkle. Thirty dollars. W5GKB.

PRECISION transformers: 3000 volt center-tapped at 250 mils, \$6. 5000 volt center-tapped at 250 mils, \$9. W8ADU.

LOOK hams: Set—desk pad, 15 x 22, waste basket 11" high, frame for license, log book cover, call book cover, all wid ur call letters stamped in gold; genuine leather morocco grain, black, mahogany, tan; \$17. complete, plus postage, in U. S. A. Specialist in bookbinding. Handicraft Center, Inc., 369 E. 62 St., N. Y. C., Leather Dept.

RADIO

ENGINEERING, broadcasting, aviation and police radio, servicing, marine radio telegraphy and telephony, Morse telegraphy and railway accounting taught thoroughly. 48 weeks' engineering course, equivalent to three years of college radio work. School established 1874. All expenses low. Catalog free.

DODGE'S INSTITUTE, Day Street, Valparaiso, Indiana

MEMORANDUM

✓ You need a copy of the new best-yet 1939 Handbook.

✓ You need a binder for your 1938 *QST's*—and another for 1939.

JANUARY, 1939

Building An Amateur Radio Telephone Transmitter

Absolutely the first requisite in either building or operating a 'phone transmitter is a solid understanding of what we are attempting to do when we accomplish voice transmission. Understanding the functions of the various parts, we shall avoid difficulties. The saddest thing in amateur radio is a 'phone amateur who does not understand the operation of his apparatus. The book begins, therefore, with a discussion of the principles involved and makes every effort to make this discussion perfectly clear so that the reader can easily make it a part of his own knowledge. It then goes on to the actual construction and operation of an inexpensive but efficient 'phone transmitter.

PRICED AT
25 CENTS PER COPY
POSTPAID

**American
Radio Relay League**

West Hartford
Connecticut

Your Nearest Dealer Is Your Best Friend

Your nearest dealer is entitled to your patronage. You can trust him. He is equipped with a knowledge and understanding of amateur radio. He is your logical and safe source of advice and counsel on what equipment you should buy. His stock is complete. He can supply your needs without delay. His prices are fair and consistent with the high quality of the goods he carries. He is responsible to you and interested in you.

Patronize the dealer nearest you—You can have confidence in him

<p>ATLANTA, GEORGIA Wholesale Radio Service Company, Inc. 265 Peachtree Street "The World's Largest Radio Supply House"</p>	<p>NEWARK, N. J. Wholesale Radio Service Company, Inc. 219 Central Avenue "The World's Largest Radio Supply House"</p>
<p>BALTIMORE, MARYLAND Radio Electric Service Co. 3 N. Howard St. Everything for the amateur</p>	<p>NEW HAVEN, CONNECTICUT Hatry & Young, Inc. 86 Meadow Street National, Taylor, Triplett, Radiotron, RME, Howard, etc.</p>
<p>BOSTON, MASS. Wholesale Radio Service Company, Inc. 110 Federal Street "The World's Largest Radio Supply House"</p>	<p>NEW YORK, N. Y. Wholesale Radio Service Company, Inc. 100 Sixth Avenue "The World's Largest Radio Supply House"</p>
<p>BRIDGEPORT, CONNECTICUT Hatry & Young, Inc. 177 Hannon Street Time Payments On All Types Of Equipment</p>	<p>NEW YORK, N. Y. Harrison Radio Company 12 West Broadway Harrison Has It! Phone WOrth 2-6276 for information or rush service</p>
<p>BRONX, NEW YORK Wholesale Radio Service Company, Inc. 542 East Fordham Road "The World's Largest Radio Supply House"</p>	<p>PHILADELPHIA, PENNSYLVANIA Eugene G. Wile 10 S. Tenth Street Complete Stock of Quality Merchandise</p>
<p>BUFFALO, NEW YORK Dymac Radio 216 E. Genesee Street Ham and BCL Equipment W8RRL, W8OLB, W8GJ Cl. 2080</p>	<p>RICHMOND, VIRGINIA The Arnold Company Broad at Harrison St. W3EQQ—"The Virginia Ham Headquarters"—W3FBL</p>
<p>BUFFALO, NEW YORK Radio Equipment Corp. 326 Elm Street W80BK—Ham, service and sound equipment</p>	<p>ROCHESTER, NEW YORK Radio Parts & Equipment Co. 244 Clinton Avenue, North Complete stock amateur-BCL parts. Standard discounts</p>
<p>HARTFORD, CONNECTICUT Hatry & Young, Inc. 203 Ann Street Trade Your Old Communication Receiver</p>	<p>TORONTO, CANADA A & A Radio Service Supply 101 Queen Street, West Canada's Foremost Radio Supply House</p>
<p>JAMAICA, L. I. Wholesale Radio Service Company, Inc. 90-08 166th Street (Merrick Road) "The World's Largest Radio Supply House"</p>	<p>TORONTO, ONTARIO, CANADA Wholesale Radio Company, Ltd. 1133-37 Bay Street Canada's Largest Radio Parts Distributor—VE-3XB</p>
<p>MONTREAL, CANADA Canadian Elec. Supply Co., Ltd. 285 Craig St., W. Quality parts and equipment for discriminating buyers</p>	<p>WINNIPEG, CANADA Electrical Supplies, Ltd. 306-10 Ross Avenue Western Canadian Amateur Headquarters for Leading Lines</p>

YOU ARE PROTECTED
WHEN YOU BUY FROM

QST

ADVERTISERS

“Advertising for *QST* is accepted only from firms who, in the publisher’s opinion, are of established integrity and whose products secure the approval of the technical staff of the American Radio Relay League.”

Quoted from QST’s advertising rate card.

Every conceivable need of a radio amateur can be supplied by the advertisers in QST. And you will know the product has the approval of the League’s technical staff

Index to Advertisers

Ace Products Company	113
Aerovox Corp.	96
American Radio Institute	117
Astatic Microphone Laboratory, Inc.	102
B-I Electric Mfg. Company, The	118
Barker & Williamson	90
Billey Electric Company	113
Brazilian Trading Company	106
Burgess Battery Company	99
Candler System Company	110
Capitol Radio Engineering Institute	106
Cardwell Mfg. Corp., Allen D.	83
Centralab	85
Cullins Radio Company	Cov. 2
Cornell-Dubilier Electric Corp.	108
Coto-Coil Company, Inc.	98
Delaware Radio Sales Company	118
Dodge’s Institute	124
Eitel-McCullough, Inc.	83
Gardiner-Levering Company	119
Gordon Specialties Company	102
Guthman & Company, Edwin I.	94
Hallcrafters, Inc., The	1, 2
Hammarlund Mfg. Company, Inc.	81, 84
Harvey Radio Company	112
Harvey Radio Laboratories	80
Heintz & Kaufman, Ltd.	93
Henry Radio Shop	119
Hinds & Edgerton	113
Hipower Crystal Company	119
Howard Radio Company	107
Hytronic Laboratories	95
Instructograph Company	122
International Resistance Company	89
Ken-Rad Tube & Lamp Corp.	117
Kenyon Transformer Company, Inc.	5
Mallory & Company, Inc., P. R.	78
Massachusetts Radio School	122
Meissner Manufacturing Company	97
National Company, Inc.	Cov. 3, 77
New York YMCA Schools	110
Newark Electric Company	111
Ohmite Manufacturing Company	86
Port Arthur College	113
Precision Apparatus Company	88
Precision Piezo Service	94
Premax Products	96
RCA Institutes, Inc.	114
RCA Manufacturing Company, Inc.	Cov. 4
Radio Mfg. Engineers, Inc.	127
Radio Shack, The	109
Radio Transceiver Laboratories	110
Raytheon Production Corp.	79
Scientific Radio Service	108
Sickles Company, F. W.	110
Signal Electric Mfg. Company	122
Solar Manufacturing Corp.	118
Sun Radio Company	120
Taylor Tubes, Inc.	87
Telex Company	114
Terminal Radio Corp.	116
Thordarson Electric Mfg. Company	91
Triplett Elec. Instrument Co., Inc.	114
Turner Company, The	106
United Transformer Corp.	128
Valpey Crystals, The	117
Van Nostrand Company, D.	103
Vibroplex Company, Inc., The	108
Ward Leonard Electric Company	98
Wilson, Willard S.	118
Wincharger Corporation	119
Vaxley	78

RME Precision

RME precision in manufacture, test and assembly has been instrumental in building a reputation, known the world over.

When RME receivers were recently specified by a foreign Army Department, as the only sets which would meet their rigorous requirements of stability and performance in field maneuvers, RME was "put on the spot" in also building some special equipment for direction-finding purposes. We built the direction-finders — and with them went the RME-69's.

RME receivers are *performers*, yet are moderate in cost.



The new 70's are on display. After you've seen one, heard one perform, and if you've ever hankered to own one — well, we know you'll not wait much longer.

WRITE
for RME-70
BULLETIN

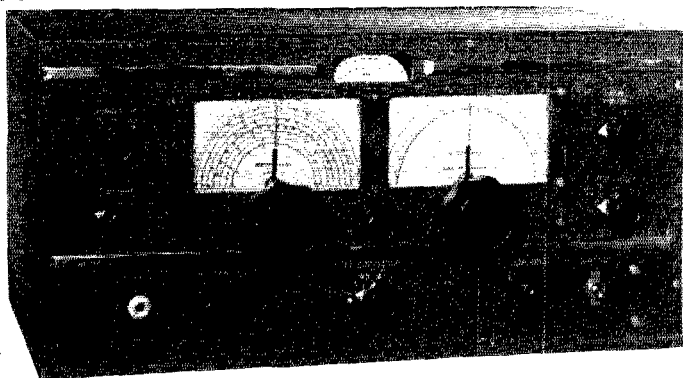

RADIO MFG. ENGINEERS, INC.

One Eleven Harrison St.

Peoria, Illinois



TRANSFORMERS For Every Application



Television — audio, power, filter ■ Aircraft — ouncer audios ■ Audio equalizers and filters ■ Varimatch Modulation transformers ■ Varitran voltage controls ■ Commercial plate and distribution transformers ■ Linear Standard, Hiperm Alloy transformers ■ Amplifier and transmitter kits.

Ask your local distributor for the new PS403 UTC bulletin.

UNITED TRANSFORMER CORP.

72 SPRING STREET

NEW YORK, N. Y.

EXPORT DIVISION 100 VARICK STREET NEW YORK, N. Y. CABLES "ARLAB"

QST for January, 1939, EASTERN Edition



NC-81X

ESPECIALLY EFFECTIVE on 28 mc!

Such features as the high frequency I.F. (1560 kc.) and the continuously variable wide range (200 c. to 7 kc.) crystal filter circuit used in the NC-81X amateur band receiver, contribute much to its excellent performance on all amateur bands. Among the many other outstanding features of this unusual receiver are the cast aluminum inductance catacomb and the sturdy, specially designed, straight frequency line tuning condenser that, in combination, result in an unusually high degree of stability, permanence of calibration, and freedom from tuning backlash.

Net Price — Complete with Speaker and Cabinet.....\$99.00



NATIONAL COMPANY, INC.

RCA Introduces

New WHITE SCREEN

TELEVISION TUBES

906-P4—WHITE SCREEN... \$15.00

Introducing the new RCA-906-P4, a 3-inch television Kinescope. Similar to the present RCA-906 Cathode-Ray Tube, this new tube features a white fluorescent screen—and an unusually low cost! In addition to its low initial cost, this new tube provides low circuit cost because of its low voltage operation. Has conductive coating which minimizes deflecting-plate loading and prevents drifting of the pattern with changes in bias.

1802-P4—WHITE SCREEN... \$27.50

Introducing the 1802-P4, a 5-inch television Kinescope having electrostatic deflection and white screen. This tube provides excellent quality television pictures. *The deflection sensitivity is such that the beam may be deflected across the entire screen with no more voltage than is required for full deflection on 3-inch tube.* Separate terminals are provided in the new Magnal 11-pin base for each deflecting plate.

1802-P1—GREEN SCREEN... \$24.75

Introducing the 1802-P1, a new 5-inch oscillograph tube which is similar to the 1802-P4 except for its green screen. In oscillographic application the 1802-P1 represents extremely high quality because it is capable of providing excellent television pictures. For television purposes the 1802-P1 operates well with an anode potential of only 1200 volts.

RCA presents the Magic Key every Sunday, 2 to 3 P.M., E.S.T., on the NBC Blue Network

RCA Radio Tubes—first in metal, foremost in glass, finest in performance



for

TELEVISION