

QST

November, 1937

25 cents

devoted entirely to

amateur radio

In this Issue—

**A New
L. F. Amplifier
System**

**More on
Directive
Antennas**

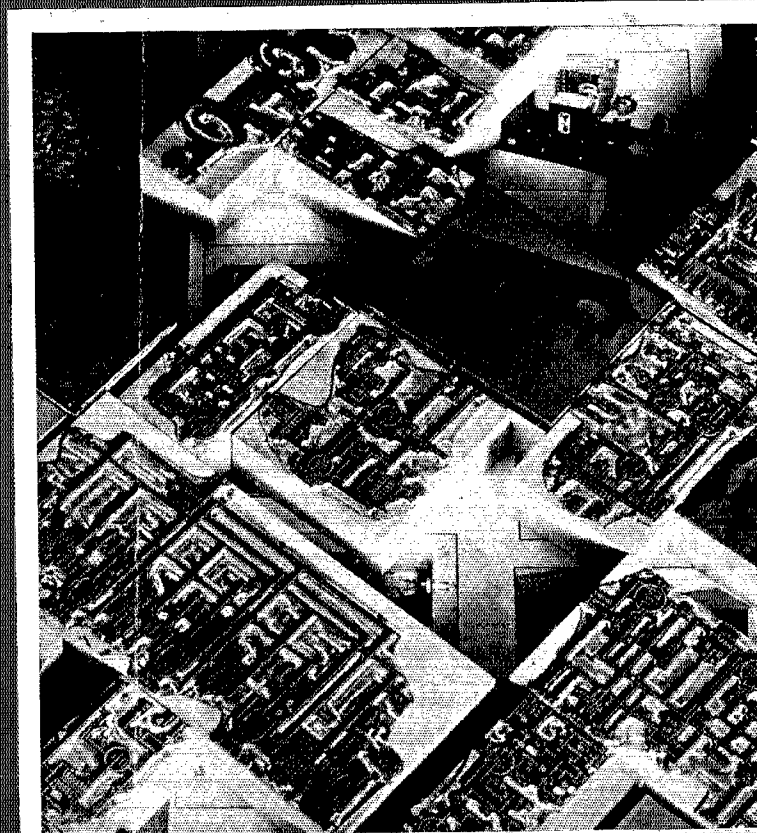

It's Our Baby and We Love It

If you haven't already heard, we are talking about Collins' newest arrival, the 30J 250 watt Transmitter. With a power increase of 40% over the 30FXC, the 30J remains in the 30FXC price class. New styling and new mechanical features are a pleasure to the eye and an aid to better operating. Simplified tuning has been the key note of the design. Like all proud parents, we could go on and on, but a glance at the specifications will show you that we are not unjustly proud.

SPECIFICATIONS

POWER OUTPUT: 250 watts Phone and CW.
FREQUENCY RANGE: 1.5 to 30 megacycles (.5 mc. to 60 mc. on special order).

FREQUENCY CHANGE: Plug-in coils.

POWER SOURCE: 110 volt, 50-60 cycle, single phase A.C., 1200 V.A.

TUBE COMPLEMENT: 1 — C100D Oscillator.

1 — 807 First Doubler-Amplifier.

1 — 807 Second Doubler-Amplifier.

3 — 807 Third Doubler-Amplifiers.

2 — C101 Final Amplifiers.

2 — 6J5G Audio Amplifiers.

2 — 6F6G Audio Drivers.

2 — C120 Modulators.

2 — C249B Mercury Vapor Rectifiers.

2 — C866A Mercury Vapor Rectifiers.

1 — 5Z3 Low Voltage Rectifier.

MODULATION: High level, Class "B".

CRYSTAL: "A" cut in 294 or 1A holder.

AUDIO FREQUENCY INPUT: From microphone — 40 db at 50,000 ohms.

AUDIO FREQUENCY RESPONSE: Plus or minus 1.5 db from 100 to 5000 cycles.

CARRIER NOISE: More than 40 db below 100% modulation.

OUTPUT CIRCUIT: Pi tank circuit for operation with balanced transmission line or feeder.

CABINET DIMENSIONS: 60" x 20" x 13"

WEIGHT: 300 pounds.

NEW MECHANICAL FEATURES: "Streamlined" cabinet. Hinged rear door. Tube access window. Rectangular instruments behind glass window. Pretuned excitation tank circuits adjustable through access window. Further refinements in workmanship.

NEW ELECTRICAL FEATURES: Simplified output circuit. Link coupling to pushpull final amplifier. Fixed grid bias. Stage by stage metering and switching. Three power supplies. Negative resistance oscillator. Beam excitation tubes. Convenient control circuits.

30J

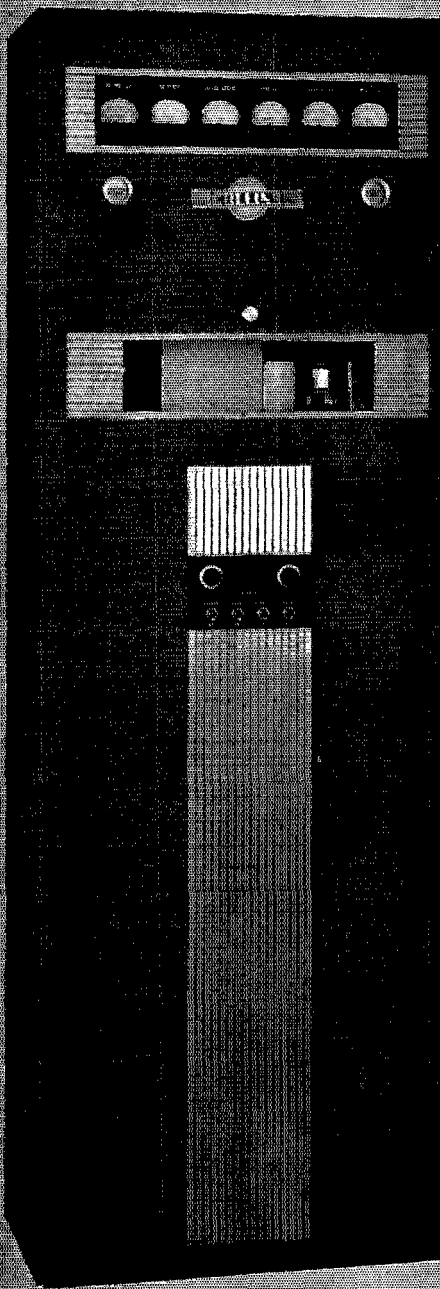

COLLINS RADIO COMPANY

CEDAR RAPIDS, IOWA — NEW YORK, N. Y.; 11 WEST 42 ST.

There are a

Thousand Years of
RESEARCH and EXPERIENCE

back of Every

**hallicrafters
receiver**

THE Hallicrafters occupy a unique place in the communications receiver field. Alone among the exclusive manufacturers of this type of equipment, they hold both RCA and Hazeltine licenses.

What does this mean to the purchaser of a Hallicrafters receiver?

First, it is an indication of the stability and integrity of the manufacturer. In the entire radio industry there are but a few of the more substantial organizations who are privileged to hold such licenses.

Second, it means that the manufacturer of this equipment has at his disposal the fruits of a life time of intensive radio research, by the finest engineering brains in the radio industry. A thousand is a ridiculously modest estimate of the years upon years of brilliant experiment by hundreds of engineers and scientists, through which radio science has been brought to its present state of perfection, and which is all available to the Hallicrafters through their patent licenses.

No wonder the Hallicrafters can produce so advanced a receiver as the New 1938 Super Skyrider—no wonder the Sky Challenger is so outstanding among receivers in the \$80.00 price bracket, a challenge in itself. There's more in a Hallicrafters receiver than meets the eye—a background of brilliant, revolutionary engineering. See these receivers at your dealers. Try them out. Compare them. And remember, look for the license label on any receiver.

Write for illustrated booklet describing the complete Hallicrafters Line

The SKY CHALLENGER



ALL HALLICRAFTERS RECEIVERS SOLD ON LIBERAL TIME PAYMENTS

the hallicrafters inc.

INDIANA AVE. CHICAGO, U.S.A. • CABLE ADDRESS: "HALLICRAFT" CHICAGO

World's Leading Manufacturers of Amateur Communications Equipment

OUR CHIEF ENGINEER *wrote this advertisement!*

Believing that specific technical information about the New 1938 Super Skyrider would be welcomed by most amateurs, we are submitting the following composite summary of reports by three independent, impartial laboratories. The reports were submitted in considerable detail but our limited space permits inclusion only of figures on the amateur bands.

OVERALL SENSITIVITY -- Taken at 50 milliwatts output, measured in microvolts with IF's in sharp position

1800 kc	-- .5 mv	14,000 kc	-- .75 mv
3500 kc	-- .8 mv	28,000 kc	-- 1.00 mv
7000 kc	-- .25 mv	60,000 kc	-- 11.00 mv

IMAGE RATIO -- Taken at 3 spots

4000 kc	-- 200 to 1
7000 kc	-- 290 to 1
14000 kc	-- 35 to 1

The laboratories all commented that image ratio was very good on this receiver.

SIGNAL TO NOISE RATIO -- Described as Equivalent Noise Sideband In-put (E.N.S.I.) is reported at great length but is summarized in 2 reports in the following statements:

(1) "The values of the E.N.S.I. are somewhat better than usual".
 (2) "Short Wave reception should be unusually good on this receiver".

SELECTIVITY -- This important set of tests was summarized in one report by the statement "The selectivity in the sharp position is considerably greater than the average for receivers of this type".

(a) Selectivity "sharp"	(b) Selectivity "broad"
<u>Times Down</u>	<u>Times Down</u>
2	2
10	10
100	100
1000	1000
<u>Total Band Width</u>	<u>Total Band Width</u>
2.2 kc	7.3 kc
5.21 kc	14.5 kc
8.7 kc	20.0 kc
12.8 kc	26.1 kc

This last series of figures demonstrates a high order of selectivity, which, combined with the new and improved Band Spread, makes the New 1938 Super Skyrider a receiver capable of true communications performance.

Karl W. Miles
 Chief Engineer
 The Hallicrafters, Inc.

The NEW 1938
**SUPER
 SKYRIDER**

WRITE FOR
 ILLUSTRATED
 CIRCULAR



For the engineering-minded amateur interested in technical details, Mr. Karl W. Miles, Chief Engineer of the Hallicrafters, Inc., has prepared the above statement.

the hallicrafters inc.

2611 INDIANA AVE., CHICAGO, U.S.A. ■ CABLE ADDRESS "HALLICRAFT" CHICAGO

World's Leading Manufacturers of Amateur Communications Receivers
 Say You Saw It in QST — It Identifies You and Helps QST

QST

devoted entirely to

AMATEUR RADIO

PUBLISHED, MONTHLY, AS ITS OFFICIAL ORGAN, BY THE AMERICAN RADIO RELAY LEAGUE, INC., AT WEST HARTFORD, CONN., U. S. A.; OFFICIAL ORGAN OF THE INTERNATIONAL AMATEUR RADIO UNION

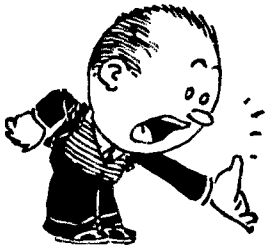

NOVEMBER 1937

Volume XXI Number 11



Kenneth B. Warner (Secretary, A.R.R.L.), *Editor-in-Chief and Business Manager*; Ross A. Hull, *Associate Editor*; James J. Lamb, *Technical Editor*; George Grammer, *Assistant Technical Editor*; Clark C. Rodimon, *Managing Editor*; David H. Houghton, *Circulation Manager*; Ralph T. Beaudin, *Assistant Circulation Manager*; F. Cheyney Beekley, *Advertising Manager*; Charles Brunelle, *Assistant Advertising Manager*.

*Editorial and
Advertising Offices*

38 La Salle Road

West Hartford, Connecticut

Subscription rate in United States and Possessions and Canada, \$2.50 per year, postpaid; all other countries, \$4.00 per year, postpaid. Single copies, 25 cents. Foreign remittances should be by international postal or express money order or bank draft negotiable in the U. S. and for an equivalent amount in U. S. funds.

Entered as second-class matter May 29, 1919, at the post office at Hartford, Connecticut, under the Act of March 3, 1879. Acceptance for mailing at special rate of postage provided for in section 1103, Act of October 3, 1917, authorized September 9, 1922. Additional entry at Concord, N. H., authorized February 21, 1929, under the Act of February 28, 1925.

Additional second-class entries to cover sectional editions authorized March 20, 1935. Copyright 1937 by the American Radio Relay League, Inc. Title registered at United States Patent Office.

The Contents

Editorials	9
New Cathode Ray Tubes for Television	10
The Maritime Division Convention	10
1937 A.R.R.L. Field Day Results	11
A 10-Watt Speech Amplifier with Voltage-Regulated Plate Supply <i>George Grammer</i>	15
What the League Is Doing	18
A New I.F. Amplifier System with Infinite Off-Frequency Rejection . . . <i>Karl W. Miles and J. L. A. McLaughlin</i>	19
Match and Mis-Match . . . <i>Stuart W. Seeley, W2JOA</i>	24
Rewinding an Auto Generator for 110-Volt A.C. Supply . . . <i>H. J. Burchfield, W6JTV</i>	26
Naval Communication Reserve Notes	30
Army-Amateur Radio System Activities	31
How Long Is a Quarter Wavelength? <i>J. N. A. Hawkins, W6AAR</i>	32
Notes on Steatite-Type High-Frequency Insulation <i>Hans Thurnauer</i>	33
Making the Most of Directive Antennas <i>Don C. Wallace, W6AM</i>	35
A DeLuxe 100-Watt C.W.-Phone Transmitter with Band-Switching Exciter . . . <i>George F. Wunderlich, W6DUW</i>	38
How Would You Do It?	42
Announcing — Eighth A.R.R.L. Sweepstakes <i>F. E. Handy, W1BDI</i>	43
Hints and Kinks	46
I.A.R.U. News	48
Operating News	49
A New High-Power Triode 833	90
A.R.R.L. QSL Bureau	94
Standard Frequency Transmissions	110
Silent Keys	112
Hamads	123
QST's Index of Advertisers	126

H
E
R
E
S
H
E
C
O
M
E
S!

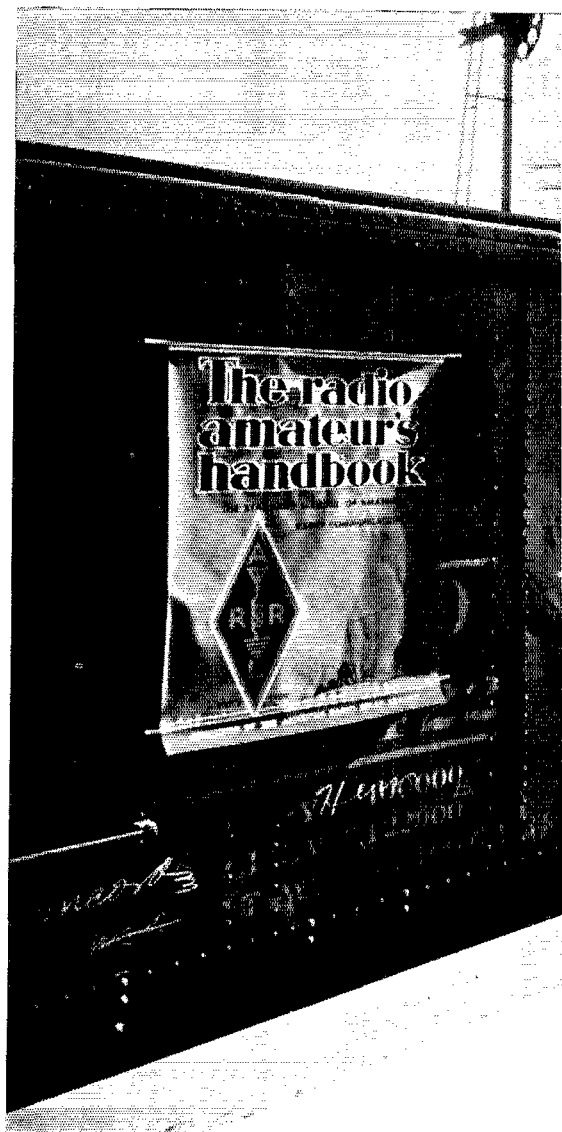



The
Radio Amateur's
HANDBOOK

1938 Edition

IN YOUR STATION

NOVEMBER 1

\$1 POSTPAID
\$1.25 OUTSIDE OF
CONTINENTAL U. S. A.

AMERICAN RADIO RELAY LEAGUE, WEST HARTFORD, CONN., U. S. A.

Say You Saw It in *QST* — It Identifies You and Helps *QST*

STANDARD 'SUPER-PRO'
RECEIVER CHASSIS

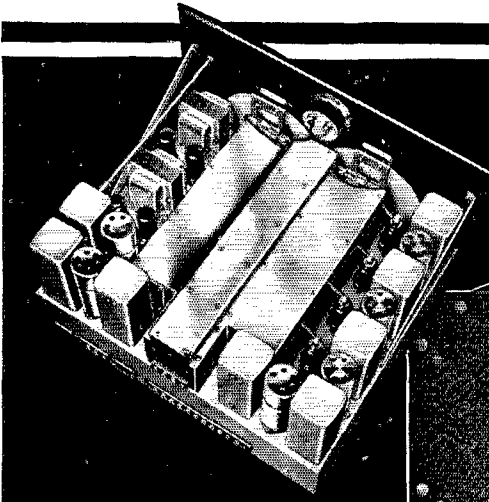

STANDARD 'SUPER-PRO'
IN METAL CABINET

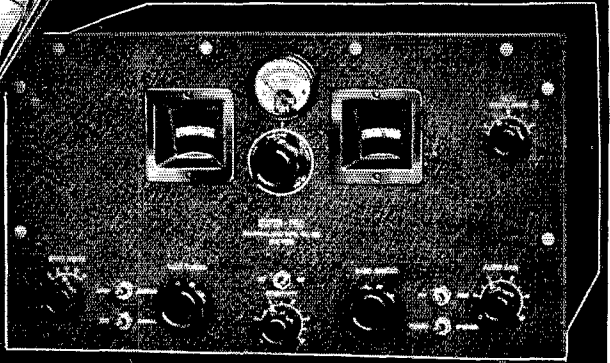

For Dependable Service

THE new "Super-Pro" with its distinctive design and rugged construction, provides trouble-free "dependable service" so essential to the critical amateur and professional for his important and exacting air activities. Among the "Super-Pro" features that contribute to this superior efficiency is the husky, self-contained tuning unit, with its unique noiseless band-change cam knife switch. Silver plated knives and contacts insure low resistance contact for each circuit. No moving part carries current to cause noise or provide stray coupling. In addition, the tuning unit has 20 separate coil assemblies, with coils wound on highest grade bakelite and mounted on Isolantite bases. All coils have copper disc inductance adjusters and variable trimming capacitors permitting precision alignment at low and high frequency ends of the bands. The tuning unit also has a shielded 4-gang tuning condenser and 12-gang band spread condenser with soldered brass Midline plates, stainless steel rotor shaft, and steel ball bearings affording smooth and accurate tuning.

Other features of the "Super-Pro" are — two R.F. stages on all bands; calibrated band width (3 to 16 kc.), beat oscillator, audio, and sensitivity controls; direct tuning; high fidelity; variable crystal filter; C.W.-Mod. Standby, A.V.C.-Man.,

Speaker-Phone switches; relay strip; 8 metal and 8 glass tubes. Crystal or standard types available in table model, rack panel, or console for 7½ to 240 or 15 to 560 meters. Console model has a bass reflex sealed sound chamber and a 15" high fidelity speaker.

See and hear this outstanding receiver today! If you haven't the name of your local authorized Hammarlund dealer, mail coupon below for these data and complete details on the new "Super-Pro."

MAIL THIS COUPON!

HAMMARLUND MFG. CO., INC.
424-438 W. 33rd St., N. Y. City

- Please send me "Super-Pro" bulletin
- Please send me "Super-Pro" Console bulletin
- Please send me dealer listing



Name.....

Address.....

City.....State.....Q-11



HAMMARLUND

Say You Saw It in QST — It Identifies You and Helps QST

Section Communications Managers of the A.R.R.L. Communications Department

All appointments in the League's field organization are made by the proper S.C.M., elected by members in each Section listed. Mail your S.C.M. (on the 16th of each month) a postal covering your radio activities for the previous 30 days. Tell him your DX, plans for experimenting, results in phone and traffic. He is interested, whether you are an A.R.R.L. member or get your QST at the newsstands; he wants a report from every active ham. If interested and qualified for O.R.S., O.P.S. or other appointments he can tell you about them, too.

Eastern Pennsylvania	W3QP	ATLANTIC DIVISION John Buck Morgan	8527 Germantown Ave.	Chestnut Hill, Philadelphia
Maryland-Delaware-District of Columbia	W3BAK W3BEI W4DSS W8OFO	Edgar L. Hudson W. W. Filson Charles Smith Kendall Speer, Jr.	247 E. Atlantic Ave. 310 E. Walnut St.	Laurel, Delaware Audubon Onedia Lower
Southern New Jersey		CENTRAL DIVISION L. John Huntoon	327 Brandon Ave.	Glen Ellyn
Western New York	W9KJY	Noble Burkhart	R. 4, Box 1	Indianapolis
Western Pennsylvania	W9QCG W9AUIH W8DPE W8AQ W9AKT	G. W. Mossbarger Harold C. Bird E. H. Gibbs Karl R. Medrow	Box 177 R.F.D. 2 405 Broad St. 2201 Winnebago St.	Camp Taylor Pontiac Wadsworth Madison
Illinois		DAKOTA DIVISION Ernest Bloch	Box 202	Thompson
Indiana	W9RZA	Andrew J. Kiar	271 West Prospect Ave.	Pierr
Kentucky	W8SER	Edwin L. Wicklund	R.F.D. 3	Kensington
Michigan	W9IGZ	Webster F. Soules	3549 36th Ave., So.	Minneapolis
Ohio	W9DCM			
Wisconsin*		DELTA DIVISION H. E. Velte	4415 West 12th St.	Little Rock
		Eugene H. Treadaway	3749 Myrtle St.	New Orleans
		J. H. Weems, Jr.	P. O. Box 244	State College
		B. G. Lowrey Smith	673 Hillcrest St.	Memphis
North Dakota		HUDSON DIVISION Robert E. Haight	511 South Holmes St.	Scotia
North Dakota	W5ABI W5DKR W5CWO W4DEF	E. L. Baunach Fred C. Read	102 Central Ave. 1014 North Ave.	Massapequa, L. I. Elizabeth
Northern Minnesota		MIDWEST DIVISION Owen Williams	108 No. Johnson St.	Iowa City
Southern Minnesota	W2LU W2AZV W2GMN	Harry E. Legler	304 Miami St.	Hiawatha
		J. Dewey Mills	Box 205	Mount Vernon
		Samuels C. Wallace	Green St.	Clark
Arkansas		NEW ENGLAND DIVISION Frederick Ellis, Jr.	19 Merrill Rd.	Norwalk
Louisiana	W9NNM	Winfield A. Ramsdell	1188 Washington Ave.	Burland
Louisiana	W9PBB	Sam Grant	Pleasant St.	Marsfield Hills
Mississippi	W9CIR	William J. Barrett	239 Columbia St.	Adams
Tennessee	W9FAM	Carl B. Evans	80 No. State St.	Concord
		Clayton C. Gordon	192 Washington Ave.	Providence
		Alvin H. Battison	1 Central St.	Windsor
Eastern New York		NORTHWESTERN DIVISION Richard J. Fox	Box 301	Ketchikan
N. Y. C. & Long Island		Carl Eichelberger	2810 North 26th St.	Boise
Northern New Jersey		Russell U. Richmond	5013 N. E. Clackamas	Somers
		Eugene E. Loveloy	Route 1, Box 398	Portland
		Robert H. Votaw		Vancouver
Iowa		PACIFIC DIVISION Otis Hill	Box 952	Hilo
Kansas	W6AIA	Edward W. Heim	509 Claremont St.	Reno
Kansas	W6BIC	Elbert Amarantes	454 Washington St.	San Jose
Missouri	W6FBW	Harold T. Burchfield	2240 106th Ave.	Oakland
Nebraska	W6TIV W6SG W6GZY KAIGR W6LPE	Alan D. Whittaker, Jr. J. L. C. Buckenham George L. Rickard Angelo V. Astone	79 Elinor Ave. 2931-24th St. Box 849 729 Safford	Mill Valley Sacramento Manila Fresno
Connecticut		ROANOKE DIVISION H. S. Carter	P. O. Box 111	Winston-Salem
Maine	W1CTI W1FB W1WVC	Ted Ferguson	1213 College St.	Columbia
Eastern Massachusetts	W1JAH	Charles M. Waff, Jr.	2914 Monument Ave.	Richmond
Western Massachusetts	W1BFT	C. S. Hoffmann, Jr.	47 Lynwood Ave.	Wheeling
New Hampshire	W1HRK			
Rhode Island	W1GNF			
Vermont		ROCKY MOUNTAIN DIVISION Glen Glasscock	2164 So. Corona St.	Denver
		Townsend J. Rigby		Midwest Wyoming
Alaska	K7PO			
Idaho	W7EMT			
Montana	W7CRH			
Oregon	W7AJV			
Washington	W7WY			
Hawaii		SOUTHEASTERN DIVISION James F. Thompson	102 Narrow Lane Rd.	Montgomery
Nevada	K6ATA	L. A. Connolly	712 S. Edison Ave.	Tampa
Nevada	W6BIC	Ellis R. Curry	Box 425	Madison
Santa Clara Valley	W6FBW	Charles W. Davis	2136 N. E. Boulevard Dr.	Atlanta, Ga.
East Bay	W6TIV			
San Francisco	W6SG			
Sacramento Valley	W6GZY			
Philippines	KAIGR			
San Joaquin Valley	W6LPE			
North Carolina	W4OG			
South Carolina	W4BOE			
Virginia	W3UVA			
West Virginia	W8HD			
Colorado		SOUTHWESTERN DIVISION Don M. Draper	4421 West 63 St.	Los Angeles
Utah-Wyoming	W9FA W7COH	Victor C. Clark	747 E. Polk St.	Phoenix
		Harry A. Ambler	731 York St.	Mission Beach
Alabama	W4DGS			
Eastern Florida*	W4DVO			
Western Florida	W4BSJ			
Georgia-Cuba-Isle-of-Pines- Porto Rico-Virgin Islands	*W4PM			
Los Angeles	W6GXM			
Arizona	W6KFC			
San Diego	W6EOP			
Northern Texas	W5DNA			
Oklahoma	W5CEZ			
Southern Texas	W5BDJ			
New Mexico	W5CGJ			
Maritime	VE1DQ	MARITIME DIVISION A. M. Crowll	69 Dublin St.	Halifax, N. S.
Ontario	VE3SG	ONTARIO DIVISION Fred H. B. Saxon	392 Lee Ave.	Toronto, Ont.
Quebec	VE2EE	QUEBEC DIVISION Stan Comach	780 Brault Ave.	Verdun, P. Q.
Alberta	VE4LX	VANALTA DIVISION Alfred D. Kettenbach	1221 Burnaby St.	Rockyford
British Columbia	VE5EP	D. R. Vaughan-Smith		Vancouver
Manitoba	VE4BG	PRAIRIE DIVISION A. J. R. Simpson	635 Garfield St.	Winnipeg
Saskatchewan	VE4EL	Wilfred Skaife	2040 McTavish St.	Regina

* Officials appointed to act until the membership of the Section choose permanent S.C.M.'s by nomination and election.

The American Radio Relay League



THE AMERICAN RADIO RELAY LEAGUE, INC., is a non-commercial association of radio amateurs, bonded for the promotion of interest in amateur radio communication and experimentation, for the relaying of messages by radio, for the advancement of the radio art and of the public welfare, for the representation of the radio amateur in legislative matters, and for the maintenance of fraternalism and a high standard of conduct.

It is an incorporated association without capital stock, chartered under the laws of Connecticut. Its affairs are governed by a Board of Directors, elected every two years by the general membership. The officers are elected or appointed by the Directors. The League is non-commercial and no one commercially engaged in the manufacture, sale or rental of radio apparatus is eligible to membership on its board.

"Of, by and for the amateur," it numbers within its ranks practically every worth-while amateur in the nation and has a history of glorious achievement as the standard-bearer in amateur affairs.

Inquiries regarding membership are solicited. A bona fide interest in amateur radio is the only essential qualification; ownership of a transmitting station and knowledge of the code are not prerequisite. Correspondence should be addressed to the Secretary.

HIRAM PERCY MAXIM, FIRST PRESIDENT

OFFICERS

President.....EUGENE C. WOODRUFF, W8CMP
State College, Pa.

Vice-President.....GEORGE W. BAILEY, W1KH
Weston, Mass.

Secretary.....KENNETH B. WARNER, W1EH
West Hartford, Connecticut

Treasurer.....ARTHUR A. HEBERT, W1ES
West Hartford, Connecticut

Communications Mgr....F. EDWARD HANDY, W1BDI
West Hartford, Connecticut

General Counsel.....PAUL M. SEGAL
1010 Shoreham Building, Washington, D. C.

DIRECTORS

President
EUGENE C. WOODRUFF.....W8CMP
234 W. Fairmount Ave., State College, Pa.

Vice-President
GEORGE W. BAILEY.....W1KH
74 Webster Road, Weston, Mass.

Canadian General Manager
ALEX REID.....VE2BE
169 Logan Ave., St. Lambert, P. Q.

Atlantic Division
WALTER BRADLEY MARTIN.....W3QV
Box 612, Roslyn, Pa.

Central Division
R. H. G. MATHEWS.....W9ZN
100 East Ohio St., Chicago

Dakota Division
CARL L. JABS.....W9BVH
1822 James St., St. Paul, Minn.

Delta Division
E. RAY ARLEDGE.....W5SI
P. O. Box 286, Pine Bluff, Ark.

Hudson Division
KENNETH T. HILL.....W2AHC
115 Willow St., Douglaston, L. I., N. Y.

Midwest Division
FLOYD E. NORWINE, JR.....W9EFC
120 South Fourth St., St. Louis, Mo.

New England Division
PERCY C. NOBLE.....W1BVR
37 Broad St., Westfield, Mass.

Northwestern Division
RALPH J. GIBBONS.....W7KV
c/o United Air Lines, Pendleton, Ore.

Pacific Division
S. G. CULVER.....W6AN
2962 Russell St., Berkeley, Calif.

Roanoke Division
H. L. CAVENESS.....W4DW
State College Station, Raleigh, N. C.

Rocky Mountain Division
EDWARD C. STOCKMAN.....W9ESA
618 So. Williams St., Denver

Southeastern Division
BENNETT R. ADAMS, JR.....W4APU
1512 Grove Place, Homewood, Ala.

Southwestern Division
CHARLES E. BLALACK.....W6GG
443 Main St., El Centro, Calif.

West Gulf Division
WAYLAND M. GROVES.....W5NW
c/o Humble Pipe Line, Talco, Texas

Address all general correspondence to the administrative headquarters at West Hartford, Connecticut



THE EDITOR'S MILL

WE'VE sat here a half an hour with a sheet of blank paper in the editorial mill, ruminating on a line of thought that has possessed us the past several days, wondering whether it's worth talking about and how to get started doing so. We've decided to sound off. We hope no one will take us too seriously. We'll probably say a number of things that we don't quite mean, just for the purpose of exciting a line of thought and illustrating what's been on our mind.

We wonder if this old game isn't getting a great deal too complicated. We also wonder if we don't make much of this complication for ourselves by hanging onto dead things and dead practices long after they should have received decent burial. Do we amateurs sometimes develop mild cases of muscle-binding of the brain? It seems to us that we don't forget easily enough, nor discard and throw away painlessly enough. And we're thinking both of apparatus and of ideas themselves.

Just as an example, consider the average amateur's attic, generally containing what was once many dollars worth of radio apparatus, now outgrown and stowed away. Stowed away why? Well, in the hope that there will be use for it later. Yet, ten to one, every one of us in his heart knows that we'll never drag that old gear into use again. It just sits there, collecting dust. And distracting us with memories of the days when it was prime. That's it—distracting us. We hang too much onto our dead past. We're not nimble enough to take the mental plunge and get it over with, once and for all. Isn't it possible that we'd be better off if we threw that old junk away and, with it, the very memories of it and everything it stood for, so as to leave mental houseroom for new ideas, new developments, progress? Isn't it probably symbolic of something, this way we hang on to decrepit gear in the attic? Most of mental hygiene is about on a par with this, we often think. Our operating ideas, our social ideas within the amateur picture, are largely those of years that are gone. We do things and think things a certain way because we used to, because we remember so well the successive steps that led to our present practices—and in the process all these separate components of our thoughts and actions take on a certain sanctity and we are prone not to disturb them. So, ask we, what of our vaunted flexibility and mental agility and wideawakeness, this terrific resourcefulness of the amateur?

Here we are, just for another example, engaging in terrible mental gymnastics whenever a group of hams meet, on the simple question of antennas and ways of feeding them. We wind ourselves into the darndest knots over matched impedances and various other aspects of what ought to be a simple problem. Simple because, when it's all said and done, and the job is working, it can be seen to be simple. Yet the way we torture ourselves in the interim proves that the old bean is still loaded down with ancient concepts, the old and clumsy way of looking at things, to an extent that has precluded simplification and easy-does-it. We're the same way about transmitters. So a crystal will give stability at a low power level, will it, and other stages can double frequency and multiply power, and a final can give the power a big boost? Hmmm. And rather difficult neutralization will make the many stages behave, provided they are accompanied by a maze of by-passes and r.f. grounds and resistors serving many purposes, you say? Well, sonny boy, we have to point out that the net result is a monster of many stages, of dozens of dials and meters, and of a positively fiendish complexity. It puts out a grand signal, the swellest we know about, but at what a price in complication, hard work and headaches—and dollars! We suppose we put up with it only because we haven't yet thought out a more rational way of doing the job. But it seems to us that we ought to positively surge with impatience over still compounding the old ideas of a little crystal stage here in the southwest corner, followed by another stage to do this and another to do that, all requiring separate adjustment, until the result is an electrician's nightmare. It's too much of a good thing. We ought to be restlessly seeking some means of kicking the whole kaboodle overboard and doing these things in a new and refreshingly simpler manner. Probably we ought to feel the same way about receivers but most of us buy ours ready-made from a factory and our sense of outrage is somewhat lulled by the fact that somebody else has done the dirty work. Perhaps some day some manufacturer will bring out a factory-built dingbat for transmitters, containing all the generating and doubling and exciting stages and 95% of the soldered connections and headaches, and if that happens we'll probably take it and like it.

But ought we to? Shouldn't we still be sick of

such hellish complications, of getting present-day results by compounding little bits of ancient information on top of one another? That genius is an infinite capacity for taking pains is, in this case, sheer rubbish, we think. Outspoken impatience with outworn claptrap is also a virtue. We'd be better off if we were all just seething with a fine indignation at the humiliation of not knowing how to do these jobs in any more effective fashion, and if there burned in us an almost reckless determination to find means to junk these moth-eaten procedures, both in technique and in operating, and to develop modern short-cuts to better results. The whole structure of our technical practices could stand reexamination, searching reexamination in a bitter mood. We need some forthright intensive thinking on how to cut away the débris of the past twenty years; realistic, objective thinking-out of how to accomplish our results in direct fashion. And to this end we need first to denude our minds of their burden of outworn physical concepts and moss-covered theory, of complacent acceptance of rust-encrusted prac-

tices, of unwillingness to be impatient! And, of all these, the mental housecleaning is the most important.

Do we hear a call for a psychiatrist? Is it suggested that we are flying in the face of all scientific history, in that improvements are to be had only at the expense of complications, with occasional consolidations of new ground gained? And that we forget that man never learns anything except painfully, little bit by little? Well, buddy, our answer is that it's just too long between consolidations, and as for the rest, by heavens we're amateurs and we don't have to content ourselves with orthodox modes of thinking. More power, we say, to the spirit of impatience in this field!

And so we suggest that it is in that direction that will be found the next great increment of amateur progress. We call now for serious thought-taking on this subject. Is there a chance or are we nuts? We'd be glad to have letters from members for our correspondence column. If you're still with us, hop on your megacycle and let's go places!

K. B. W.

The Cover

THE dizzy pattern up front this month is the result of popping a camera near the managing editor's desk as this issue was under construction. The gadgets will be recognized as "cuts"—the engravings with which the illustrations in the magazine are printed. Some of the engravers' proofs can be seen under the cuts themselves.

New Cathode-Ray Tubes for Television Reception

WHEN tubes labeled "television" are made available for amateur and experimental use, it does seem as though that long-awaited type of transmission is coming close to the well-known corner around which it has been these many years. RCA has brought out two new cathode-ray tubes designed for experimental television

reception, one having a 5-inch screen and the other a 9-inch; they are shown in the accompanying photograph. They will be known as Types 1800 (9-inch) and 1801 (5-inch), and have been named "Kinescopes."

Both tubes are of the electromagnetic-deflection type. A medium-persistence fluorescent material with which pictures have a yellowish hue is used for the screens. Heater voltage in both cases is 2.5 volts. The 1800 operates with Anode No. 2 voltages up to 7000, Anode No. 1 up to 2000; similar maximum ratings for the 1801 are 3000 and 1000 volts, respectively.

Kinescopes are being released on a purely experimental basis, with no present intention of marketing complete equipment with which they can be used.

The Maritime Division Convention

THE annual Maritime Convention sponsored by the Halifax Amateur Radio Club was a great success. It was well attended and everyone had a good time. The ball started rolling on Saturday afternoon, September 4th, with registration at the Nova Scotia Hotel. The person attending from the greatest distance was W. H. Lord of Chattanooga, Tenn. Another welcome guest was WIVE, a rather appropriate call for the occasion. The total number in attendance was one hundred and sixteen.

The first meeting was addressed by Professor G. H. Burchell, of the Department of Electrical Engineering of the Nova Scotia Technical Col-

(Continued on page 90)

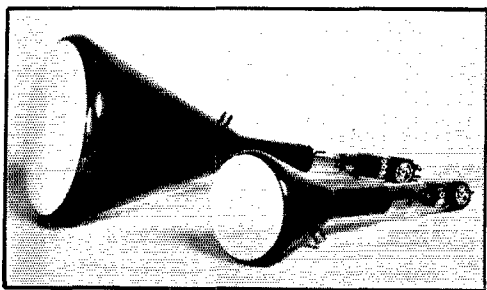

1937 A.R.R.L. Field Day Results

THE Fifth Annual A.R.R.L. Field Day (June, 1937) was by far the most successful outdoor operating activity ever held. 642 individuals participated! Practically all of these were licensed radio amateurs, a comparative few S.W.L.'s and hams-to-be assisting in station installations, in rustling grub, etc. 60 club-groups totalling 465 individuals took advantage of the opportunity for a real radio outing. The remaining 177 participants went out alone, or in most cases in small groups. An activity such as the "F.D." lends itself best to group-participation, although it was fun for all, "lone wolves" and "large gangs" alike.

Interest in portable work and the emergency-preparedness that it encourages is increasing by leaps and bounds. The fact that some 550 different "portable stations" were worked or logged on the Field Day week-end indicates the widespread activity along these lines. Once bitten by the "portable" bug and once experiencing the surprising work that can be done with low power rigs "in the field" there is nothing to do but come back for more—and how the gang comes back each time a Field Day is announced! In some instances "portable-to-portable" contacts on the F.D. ran 30% or higher of all contacts made.

1937 F.D. rules were practically the same as in previous years. However, this year contacts between two stations in the field (portable-to-portable) counted "2 points" rather than the usual 1 point for general QSO's. An extra credit of 10 points was also given for

originating not more than one message addressed to A.R.R.L. Headquarters reporting the numbers of operators, the location, conditions and power, all of which data would normally be needed in actual emergency. A good number of these messages reached West Hartford and proved of considerable interest to all parties handling them. Aside from these two features the scoring was unchanged. Multipliers of 2 or 3 depending on whether either or both transmitter and receiver were independent of commercial power sources and "power multipliers" were again used.

We have said it was the most successful F.D. ever. The scores confirm this statement! The Egyptian Radio Club, with twelve operators manning the club station W9AIU-9 at Alton,



WATCHING THE WHEELS GO 'ROUND

Two hams-to-be investigate the mysteries of the gasoline engine-generator in use at W4BSJ-4, West Florida Shortwave Club.

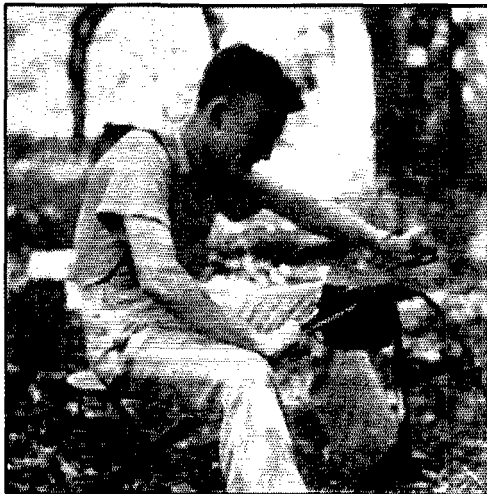

W9SHW BEARS DOWN ON THE HAND-DRIVEN GENERATOR USED TO POWER ONE OF THE RIGS AT W9AWC-9, SEDALIA RADIO CLUB

Illinois, on a 200 foot bluff overlooking the Mississippi River, made a new Field Day record, leading all other contestants—204 QSO's (168 c.w., 36 'phone) . . . 2268 points! Operation was on 3.5, 7 and 14 Mc. C.W. and 1.75 Mc. 'phone, the majority of contacts being made on 7 Mc. Five separate transmitters and four receivers were used. Two transmitters consisted only of an 802 oscillator. Other rigs were 2A5 crystal, 802 final, suppressor grid modulated by 56-2A5; 42 crystal, 802 final, supp. grid modulated by 76-42; 53 crystal, RK23 final, supp. grid modulated by Breting speech amplifier. A single button carbon mike was used on all 'phone rigs. Antennas were a 132 foot end fed Hertz for 3.5, 7 and 14 Mc., 250 foot end fed Hertz for 1.75 Mc., and a doublet for 14 Mc. 'phone. Power supplies were a 110 volt a.c. 300 watt gas driven generator and two 350 volt dynamotors. Input on all transmitters was kept at 20 watts. The results tell a story of good planning and excellent operating on the part of the Egyptian gang. The whole F.C. contingent will join us in extending to them *heartly congratulations!*

A two-man crew placed second with 1923 points—165 contacts! W6MVK-6, operated on C.W. by T. S. Chow, W6MVK, and on 'phone

by George Chow, W6OFD, made this very creditable showing "on location" 8 miles south of Modesto, California. The C.W. rig was 6L6-6L6 with not over 20 watts input, making 102 QSO's on 3.5, 7 and 14 Mc. The 'phone set was 6L6-6L6-100TH running 55 watts input on the 1.75-



COLD? NO! MOSQUITOES!

Members of the Jacksonville Radio Club group (W4EOS-4) shield themselves against the well-known pests.

and 3.9-Mc. bands. Power was generated with a 3-horse gas engine driving a 1-kw. 110-volt a.c. generator. Antennas were a doublet for 3.9 Mc., $\frac{1}{2}$ wave single wire for 1.75 Mc. and $\frac{1}{2}$ wave 7 Mc. for c.w. work. Although these chaps are members of the 100 What Club of Modesto, they worked independently, the club not going out "en-body." However, "statistics prove" that very few club groups anywhere near equalled the accomplishments of these two operators. Well done!

The York Road Radio Club, leader in the '36 Field Day, was again in the doings, fighting hard and considerably bettered its previous performance, but this year we find them in third place—1917 points, 156 QSO's. At that, the gang at W3QV-3 gave W6MVK-6 a mighty close race! Ringing Rocks, near Pottstown, Pa., was again chosen by Y.R.R.C. for its F.D. headquarters. The set-up included five transmitters working on the 3.5-, 7-, 14- and 56-Mc. bands. Most contacts were on 3.5 Mc. with 7 Mc. second. Power supplies consisted of several dynamotors and two 100-volt a.c. generators. Top input used was 18 watts. The W3QV-3 staff was comprised of 21 operators.

Third high among club groups (fourth high among all participating stations) is W2DUA-2, the Northern Nassau Wireless Association. This club was represented by sixteen amateurs, twelve doing the operating, the others acting as "aides-de-camp." 7-, 3.5-, 14- and 56-Mc. bands were used, producing points in the order named for a

total of 1791 . . . 154 QSO's. Separate transmitters were used on each band, power input never exceeding 20 watts. Power for the several receivers was supplied by a 300 watt gas driven a.c. 110 volt generator. For the transmitting equipment, camp lighting, etc., a similar unit of 1800 watts capacity was employed. These two supplies ran continuously for 27 hours on approximately 15 gallons of gas and three quarts of oil. Veterans of Field Days, the N.N.W.A. gang set up again at Pound Ridge Reservation, Cross River, N. Y.

The South Cleveland Radio Club, operating W8ICS-8 at Hudson, Ohio, placed fourth among the clubs with a score of 1638 from 130 QSO's on 3.5-, 7- and 14-Mc. c.w. and 1.75-Mc. 'phone. Separate transmitters were used on each band and were manned by fifteen operators. Power was from genemotors and gas driven generators. This club has bettered its position over previous years so watch out, Future!

There are so many excellent scores it is not possible to detail the layout at each station. The complete list of scores gives the essential facts for each participant. However, particularly worthy of note are the results of the Charleston Amateur Radio Club, W8NCD-8, and the Ithaca Mike and Key Club, W8QLU-8, tied at 1584; the Glendale Amateur Radio Club, W6NOI-6 . . . 1548; The Northwest Amateur Radio Club, W9CA-9 . . . 1515. Scores of over 1000 were submitted by twenty stations!

56 Mc. was again used to quite an extent. W2DKJ's work was exclusively 56 Mc. and his



1937 FIELD DAY WINNERS—EGYPTIAN RADIO CLUB GANG, W9AIU-9, 2268 POINTS, 204 QSO'S!

Front row (left to right): W9ZYP, W9EBX, W9RCQ, W9OWD, W9TYJ. Standing: W9DZU, W9THB, W9EKY, W9BLL, W9PXN, W9KEH, W9VMV, W9DJG.

score represents an all-time high for "five meter" Field Day Work. He made 74 contacts for a total of 909 points! It should be remembered that this was a one-man expedition, including lugging the gear to the tower at 40 Wall Street, New York City, setting it up and operating! Transmitter was a '45 oscillator modulated by a 2A5. Receiver was a three-tube super regenerative. The Tri-

State Radio Club operated W3GKI-2 on 56 Mc. exclusively at High Point Park, N. J., about 1850 feet above sea level. Four operators made 62 contacts, 846 points, a score that is well up the list. Power was 15 to 18 watts. WIEFN operated 56 Mc. portable atop Mt. Greylock, Adams, Mass., making 513 points, 33 QSO's. Power was obtained from 130 volts of B battery. W6AM's contacts also were all on 56 Mc.—46 QSO's, a score of 468. W1HDQ-1, champion of 56-Mc. in previous Field Days, was handicapped by social engagements, being able to operate only part of the week-end, but even so he made 38 contacts, 432 points. The work at W1BKG-1, W1CLI-1 and W9WJW-9 was exclusively 56 Mc.

Highest Canadian station was again VE3KM, operated by the Hamilton Amateur Radio Club . . . 1341 points, 113 QSO's. Second high VE was VE3GT, 59 QSO's, 936 points.

Field Days are in a class by themselves among amateur operating activities. The source of unexcelled good operating fun, at the same time providing the joy of outdoor companionship with brother amateurs, they provide the stimulus to perfect our portable/emergency gear against the time we may be called upon to put it to serious use. Like other activities, there is always the planning ahead for the "next time," but this is even more prevalent among F.D. groups since so many combinations of gear are possible and since one experience in the affairs teaches us so much about the requirements of reliable apparatus. It was great sport—the 1937 Field Day . . . and the ones to come will be the same! See you there!!

E. L. B.

Some of the locations chosen for operation have a decided Field Day "flavor." For example: Signal Hill (W6AM-6); Pionic Hill (W3BHE-3); Cow Pasture Hill (W9KWP-9); High Point Park (W3GKI-2); Sunset Peak (W6HIT-6); Hilltown (W9CFB); Crystal Lake (W9AWC-9)!

Here are some of the things we (The Northwest A.R.C.) learned from our field day experience: (1) . . . have at least three transmitters operating practically continuously. (2) . . . operate on different bands to take advantage of the best operating conditions. (3) . . . it is difficult to operate more than one transmitter in a group because of QRM; if transmitters can be separated by a distance of 600 or 700 feet and operated from separate power supplies QRM will not be had. (4) . . . if several transmitters are to be operated from one power supply, the smart thing to do would be to provide a receiving station some distance away and use 56 Mc. transceivers to relay the signals to the transmitters. (5) . . . in order to get away from commutator "hash" on the generator it was necessary to park the

generator at a distance of 150 to 200 feet from the scene of operations. We tried filters with no results. (6) . . . it is always necessary to prepare for rain! This is the third field day for the club and we have had a rain storm each time. . . . Field days are lots of work but are lots of fun and valuable experience is gained.—G. E. Hart, W9LBP, Secy.



PORTABLE VE3GT WAS A BUSY STATION

Five transmitters and three receivers did duty for this crew. Left to right; seated—VE3ADO, VE3GT, VE3JL, VE3SG; standing—VE3WK, VE3ZE, VE3IX.

We were fortunate in getting the use of a cabin on Connecticut Hill, elevation 2096 feet; it is about 16 miles from Ithaca. With the experience gained in all departments—including culinary—and the interest created, we expect to go to town in the next contest.—Ithaca Mike and Key Club, W8QLU-8.

We operated on Mt. San Rafael. This location was secured by the Los Angeles County Fire Department, who gave the society permission to use the territory for the duration of the contest. The boys were about bowled over when they found that the Fire Ranger, Mr. Knoph, was number 78, and he wore a badge with that number on it. At 2:30 A.M., when everyone was feeling high (altitude 1888 ft. above sea level), the ranger was made an honorary member of the society.—Glendale Amateur Radio Society, W6NOI-6.

The masts for the antennas were put up the Saturday preceding the Field Day, the transmitters installed on June 18th, the "kinks" being ironed out on the next day. Everything worked to perfection with no interference experienced between transmitters. Most contacts were on 7 Mc. Prizes were offered for the operator making the most contacts during his "watch." These were won by W8ATT (first) and W8NLT. The club furnished the eats and the members, when off duty, participated in baseball games, pitched horseshoes and played checkers. A swimming hole was used extensively.—Charleston Amateur Radio Club, W8NCD-8.

Our location was 3 miles northeast of Waterdown, the same old spot. It overlooks Lake Ontario and the Niagara Peninsula. The rig was 42 crystal osc. and 802 or RK25 amp. with 16 watts input. A good time was had by all.—Hamilton Amateur Radio Club, VE3KM.

The equipment was erected just south of the St. Paul City limits on State Highway 13 at a cabin camp located on a high bluff. Two of the portable transmitters and receivers were operated in W9FUZ's trailer coach and two other portable installations were operated from one of the



329 POUNDS OF COOK!

W9TLQ did a bang-up job for the Northwest Amateur Radio Club (W9CA-9), and no one went hungry.

cabins. The source of power used on three of the transmitters was a gas driven a.c. generator while the fourth operated off the power lines. In spite of the low power used all districts in the U.S.A. and two in Canada were worked. Our greatest handicap was QRN due to a violent wind, rain and electrical storm.—*St. Paul Radio Club, W9FUZ.*

The Manteca Radio Club operated atop Pilot Peak, 6100 ft. elevation, Mt. Diablo, 130 miles distant, was worked with a 56 Mc. transceiver! Mosquitoes were bigger and hungrier than ever!—*W6EXH.*



THE ST. PAUL RADIO CLUB OPERATED W9FUZ-9, INSTALLED IN FUZ'S TRAILER COACH

These fellows ran up 1256 points. Left to right: W9JIE, W9ZOV, W9RYJ, W9IBD, W9GIB, W9FUZ, W9ORA.

We were located in an ideal receiving spot, at least a mile from even a dirt road for automobiles. Two kerosene lamps and lots of flashlights kept up the illumination during the night. We were going to use a.c. lines but the electric company said they would charge us \$750.00 to install it! No a.c. for miles.—*Beacon Radio Amateurs, W3BGD-8.*

The transmitter and receiver were located in an 8 x 10 wall tent. Battery and generator for the receiver were also in the tent, as was the battery used for lighting the filaments in the transmitting unit. The gas driven generator was located 40 feet from the tent, the engine muffled, and well insulated wire run to the tent.—*So. Hills Brasspounders and Modulators, W8PX-8.*

An old 135 foot oil derrick was the headquarters of the United Radio Amateurs Club this field day. All bands, including 56 Mc. portable-mobile were worked with the scoring on each band tabulated for reference during future FD's. The club owes everything to the splendid cooperation and earnest help of every member.—*W6IVG-6.*

38.5% of all stations worked were operating portable.—*W8AVH-8.*

The club decided at its last regular meeting before the Field Day to give the operator having the highest number of contacts a year's free membership. VE3MY and VE3AHK tied for honors with 15 each.—*Frontier Radio Club, VE3AJV.*

We obtained our power from a 3 kw. 60 cycle 110 volt generator driven by an Austin gasoline engine. Since we were about three miles from the nearest power line and kept about 1000 watts of lights burning all night, the farmers from the countryside came up to see what was going on in "them thar hills." In fact we had visitors all day Sunday. Those not operating pitched horseshoes, played croquet, bridge, and as usual there were many "candid camera" enthusiasts.—*Winston-Salem Amateur Radio Club, W4NC-4.*

Operators were paired by drawing lots and worked in two hour shifts, one man at the key, one logging. Target shooting, fishing, arrow head hunting, tree climbing and other sports were indulged in.—*Starved Rock Radio Club, W9NGG-9.*

While our score is nothing to get excited about it is higher than in previous years, and the gang certainly broke camp with a more satisfied feeling than ever-before. Two departures from previous practice seem to account for the improvement—the use of the 7 Mc. band instead of 3.5; and the use of nearly 60 watts instead of 20. Those long, depressing stretches with no QSO's were eliminated and that was worth the difference in multiplier. Good weather, good radio conditions, a congenial gang, and—well, "eatable" grub, made the 1937 F.D. a pleasure throughout.—*Bluefield Amateur Radio Club, W8MCL-8.*

The site for our set-up was on a very high bluff on the Ouachita River. A rowboat was hired to carry everyone, and equipment, across the river. Then the fun began. With a motor generator weighing about 140 pounds to take up a steep bluff, at an angle of about 80 degrees—well, just imagine! Everything that one could imagine went wrong with the rig, but we finally got on the air. It was decided to work in one hour shifts through the night. It would have been worth your while to have seen the fun in trying to awaken some of the lads to take their tricks at the key. It was necessary to use calling, shaking, pulling of hair, pouring on of ice water and sundry other things calculated to drag one from the arms of Morpheus. We departed for home, no sadder and no richer, but much the wiser—especially as to how to set up a portable for a Field Day contest and how to pick a place for it.—*Monroe Amateur Radio Club, W5EGK-5.*

The Northern Wisconsin Radio Club participated in the F.D. on Mount Tom in the city of Eau Claire. The peak elevation is 1934 feet. The cleverly arranged transmitter of W9JNU, capable of working all bands, 56 to 3.5 Mc., was used. The complete set-up was housed in two tents.—*W9JNU-9.*

Cows, cows and some more cows. It was awful. They persisted in being curious, almost to the point of stopping our field day activities. For all the chasing we did, we'll bet that farmer got buttermilk when he milked his cows that morning!—*Peoria Amateur Radio Association, W9LWB-9.*

The big feature was stringing up the Zepp aerial at 1 A.M. with the aid of two small flashlights. Try it some time!—*W9VTB-9.*

Minneapolis Radio Club was located on ski tower in Glenwood Park, operating all bands 3.5 to 56 Mc. Wind, rain, flood and famine only obstacles.—*W9PAT-9.*

The truck which we took on Field Day has a 30 foot body and has the generator mounted under it permanently. In the cab are places for the Collins 45A, the FB7 and a transceiver. Also there are sockets built on the truck to put in antenna masts. The masts are removable and are taken down when the truck is moving. This truck is used to carry the famous Roebing "Alligator," which is a 20 foot caterpillar amphibian capable of carrying

40 people either on land, water or through the worst kind of swamp. It is built entirely of duraluminum.—*Clear Water Radio Club, W4EQK-4.*

The station of the Newark Amateur Radio Club was set up on top of a high hill overlooking the town. The equipment was in the back end of a truck, while the antenna was hooked to the top of an oil well derrick.—*W8LTI-8.*

W4CUE-4 was operated at Avondale Park Villa. This Villa is a huge stone affair on a very high hill overlooking Birmingham. The location was as good as one can imagine with no buildings or wire near and nothing as high as the antenna.—*Birmingham Amateur Radio Club.*

(Continued on page 88)

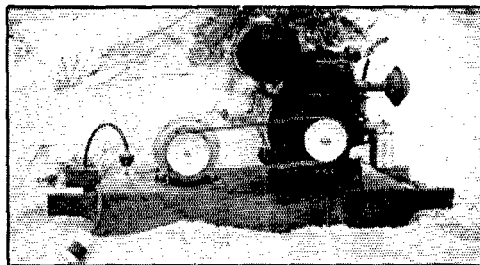

THE JUICE PRODUCER AT W6MGJ-6, HELIX AMATEUR RADIO CLUB

600-watt, 110-volt, 60-cycle a.c. generator run by a 3/4 h.p. Briggs-Stratton gasoline engine.

A 10-Watt Speech Amplifier With Voltage-Regulated Plate Supply

High-Gain Unit for Use with Crystal or Carbon Microphones

By George Grammer*

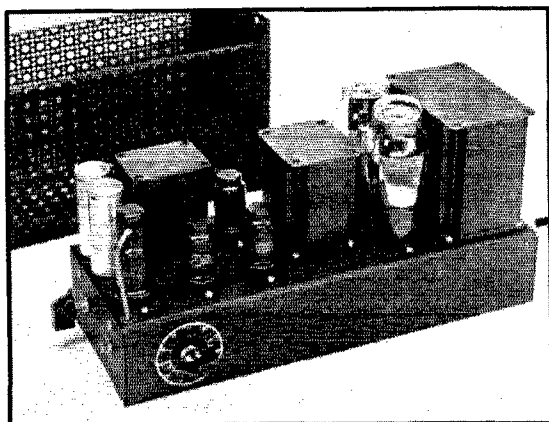

THE 10-WATT SPEECH AMPLIFIER WITH COVER REMOVED

This four-stage amplifier can be used with either crystal or double-button carbon microphones. The output stage uses Class-AB 2A3's.

In the article on voltage-regulated plate supplies in our August issue¹ it was pointed out that because of the regulating action the effective output impedance of such a supply is extremely low, being comparable to that of "B" batteries. When applied to audio amplifier systems, the effect of low output impedance or low internal resistance in the plate supply is to reduce the possibility of oscillation arising as the result of a common impedance in the plate circuits of several stages. In other words, motorboating is less likely to occur when a low-resistance supply is used.

This factor, together with low ripple content in the output, make the voltage-regulated supply an especially desirable unit for use in conjunction with high-gain speech amplifiers. It is the purpose of this article to describe the practical application of such a supply to a universal speech amplifier or driver capable of developing an audio output of ten watts, suitable for working into a Class-B modulator or as a public-address amplifier.

* Assistant Technical Editor.

¹ "Battery Performance from the R.A.C. Power Supply," *QST*, August, 1937.

² Lund and Howe, "Considerations in Speech Amplifier Design," *QST*, January, 1936.

THE SPEECH AMPLIFIER

The speech amplifier, the circuit of which is given in Fig. 1, is designed to have ample gain for diaphragm-type crystal microphones. The input circuit also is arranged so that a double-button carbon microphone can be used, working into a resistance load.² The switching arrangement permits using either type of microphone without cutting a stage in or out to handle the widely different output levels of the two types.

Aside from the microphone input, the tube and circuit line-up is quite conventional. The first tube is a 6J7 pentode, resistance-coupled to a 6C5, with the gain control in the grid circuit of the latter tube. The 6C5 is resistance-coupled into a single-ended to push-pull audio transformer which feeds the grids of a pair of 6C5's. These in turn are transformer-coupled to the power output tubes, a pair of 2A3's which operate Class-AB with self-bias. With this type of operation the tubes are rated at 10 watts output; substitution of fixed bias will raise this figure to 15 watts if the increase in output is desirable. Straight transformer coupling out of the second

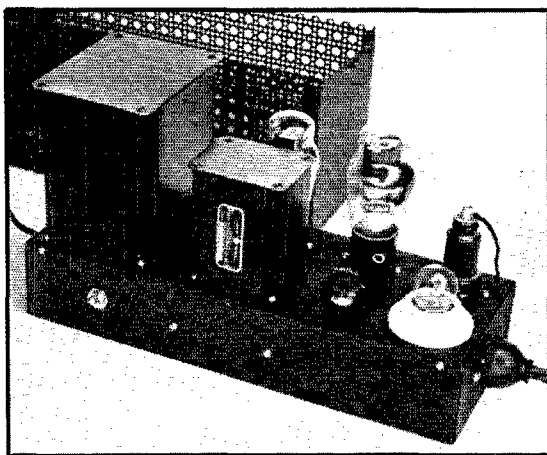

THE POWER SUPPLY, EQUIPPED WITH A VOLTAGE REGULATOR FOR THE LOW-LEVEL STAGES

With the cover on, this unit matches the amplifier. It would also make an excellent power supply for receivers, especially those having Class-AB output.

stage will raise the overall voltage gain somewhat, but simultaneously reduces the low-frequency response. In view of the fact that there is plenty of gain with the resistance coupling as shown in the diagram, we preferred to keep the d.c. out of the transformer primary. In the plate circuits of the first two tubes are RC circuits (R_6C_7 and $R_{10}C_8$) which serve both as decoupling circuits and as additional power-supply filter for the low-level stages. The cathode bias resistor for the 2A3's is contained in the power-supply unit.

Top and bottom views of the speech-amplifier unit are given in two of the photographs. The chassis is 5 by $13\frac{1}{2}$ by $2\frac{1}{2}$ inches, made of black-cracked steel and provided with a perforated metal cover which fits over all the equipment. The 6J7, with a shield cap fitting over the top, is at the left front. Directly behind it are the condensers C_7 and C_8 . Next along the front is the first 6C5 with T_1 behind it; then the push-pull 6C5's, T_2 , the 2A3's, and the output transformer, T_3 . The latter is a plate-to-line transformer designed for coupling out of Class-AB 2A3's, with taps for lines of various standard impedances. On the primary, the 5000-ohm (plate-to-plate) terminals should be used with self-bias operation. The input transformer, T_2 , preferably should be of the type designed to carry grid current with 2A3's, although grid current does not actually flow except at nearly full output.

The gain control, R_7 , is mounted on the front edge of the chassis between the 6J7 and first 6C5. On the left edge in the front view are the jack for a crystal microphone and the switch, S . Carbon microphone and battery connections are made to a five-terminal connection strip mounted on the

rear chassis edge, at the bottom left in the below-chassis view. No particular precautions need be observed in placing parts and wiring below the chassis except to make sure that all ground connections actually break through the paint to the metal of the chassis.

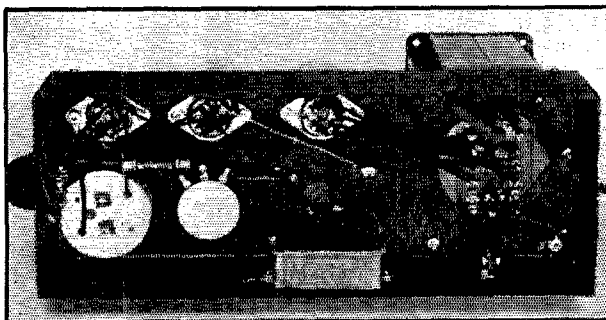

BOTTOM VIEW OF THE POWER SUPPLY UNIT

No special arrangement of parts is necessary. The filter condenser is mounted on one edge of the chassis.

A 7-prong socket at the lower right in the bottom-view photograph brings in all supply voltages. These are marked in Fig. 1. The shielded three-way cable outlet and plug at the right are for the audio-frequency line. A shielded two-wire cable is used, the shield being connected through one pin in the plug to the chassis.

POWER-SUPPLY UNIT

Construction of the power supply is similar to that of the amplifier; the same type and size of chassis is used. The circuit diagram is given in Fig. 2. An ordinary condenser-input filter is used, with the tap for the 2A3's taken off ahead of the regulator section to reduce the load on the latter. The first four tubes in the speech amplifier, however, are fed regulated voltage. The circuit will be

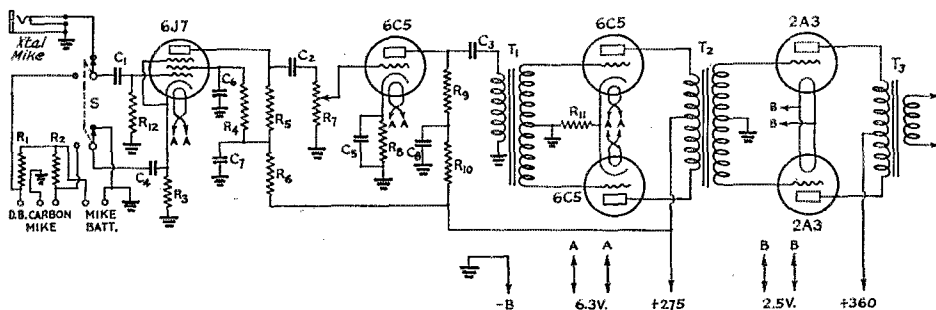
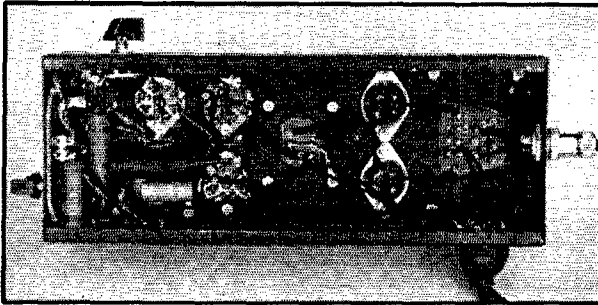

FIG. 1—CIRCUIT DIAGRAM OF THE SPEECH AMPLIFIER

- | | | | |
|---|--|--|--|
| C_1, C_2, C_3 —0.1- μ fd. paper, 400-volt. | R_3 —1000-ohm, $\frac{1}{2}$ -watt. | R_{10} —10,000-ohm, $\frac{1}{2}$ -watt. | T_2 —Audio transformer, push-pull plates to Class-AB grids (Kenyon T-256). |
| C_4, C_5 —5- μ fd. 25-volt electrolytic. | R_4 —1-megohm, 1-watt. | R_{11} —500-ohm, 1-watt. | T_3 —Output transformer, 2A3 plates (5000 ohms) to line (Kenyon T-301). |
| C_6 —0.1- μ fd. paper, 400-volt. | R_5 —0.25-megohm, $\frac{1}{2}$ -watt. | R_{12} —5-megohm, $\frac{1}{2}$ -watt. | |
| C_7, C_8 —8- μ fd. electrolytic, 450-volt (miniature round can type). | R_6 —50,000-ohm, $\frac{1}{2}$ -watt. | R_7 —0.25-megohm volume control. | |
| R_1, R_2 —200-ohm, $\frac{1}{2}$ -watt. | R_8 —2000-ohm, $\frac{1}{2}$ -watt. | T_1 —Audio transformer, single plate to push-pull grids, total ratio 1:4 (Kenyon T-52) | |
| | R_9 —50,000-ohm, 1-watt. | | |

recognized as being the same as that in August *QST*. R_3 is the output voltage control; this should be set by means of a voltmeter to give about 275 volts output. R_6 is the cathode resistor for the 2A3's.



BELOW-CHASSIS VIEW OF THE SPEECH AMPLIFIER
Grid-circuit leads to the 6J7 should be shielded. In operation, the chassis of the amplifier should be connected to a good ground.

With the components specified, the output voltages are as given on the diagram. The terminals marked "360" on the transformer should be connected to the 83-V plates. The cathode current flowing through R_6 develops about 60 volts of bias, leaving 300 for the plates.

The physical layout is shown in the two views of the power supply unit. In the front view, the power transformer is at the left, with the choke next to it. The knob on the top of the chassis operates the volume control, R_3 ; this need not be touched after having been set for the proper output voltage. The neon lamp is mounted in a 110-volt socket in the near right-hand corner. The 6J7, 2A3 and 83-V are along the rear edge. The on-off switch in the 110-volt line is mounted on the front edge of the chassis.

All output connections are brought to a 7-prong socket shown on the left edge in the bottom view. This is wired identically with the socket in the amplifier. A 5-wire cable, plus two heavy wires for the 2A3 filament leads, are wired into 7-prong plugs, one at each end, using corresponding pins for each wire. This permits removing the cord from either or both of the units. The reason for using separate wires for the 2A3 filament power is simply that the wire in the ordinary cable is too small to carry the current without excessive drop, when a length of six feet or so is used. It is highly important to measure the

actual voltage at the sockets to be sure it is within 5% of 2.5 volts; low filament voltage is sure to result in a drastic reduction in the power output that can be obtained without distortion.

The neon bulb (1-watt size) should have its base resistor removed. The gas-flame method of softening the cement is about the simplest.

OPERATING DATA

Provided the constructor follows the circuit faithfully and makes good connections, no troubles need be anticipated in getting the two units to working properly. The one difficulty we encountered in trying them out was that of low filament voltage on the 2A3's, mentioned above, which was corrected by installing leads of ample cross-section. If an audio oscillator of good waveform³ and an oscilloscope are available, the amplifier may readily be checked for distortion, and the power output likewise can be checked by connecting a resistor of the same value as the output impedance chosen across the output terminals. Measurement of the a.c. voltage

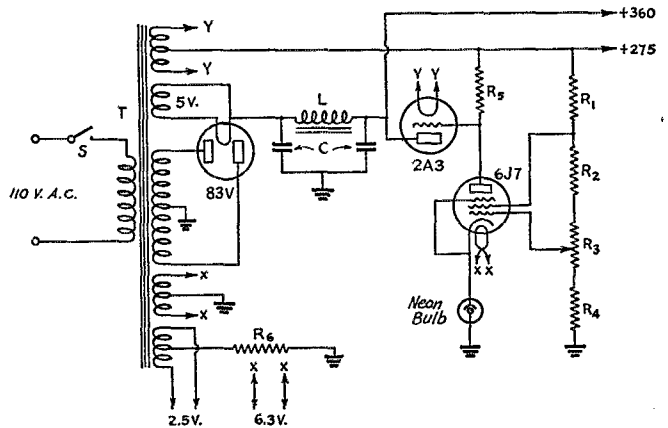

FIG. 2—POWER SUPPLY DIAGRAM

- L—15-henry, 165-ma. filter choke (Kenyon T-154).
- C—8-8- μ fd., 450-volt electrolytic (cardboard box type).
- R_1 —10,000-ohm, 1-watt.
- R_2 —20,000-ohm, 1-watt.
- R_3 —10,000-ohm volume control.
- R_4 —5000-ohm, 1-watt.
- R_5 —0.5-megohm, 1-watt.
- R_6 —800-ohm, 10-watt.
- S—S.p.s.t. toggle switch.
- T—Power transformer; h.v. winding, 360 volts each side c.t., 150 ma.
- 5 volts, 3 amp. (rectifier filament)
- 2.5 volts, 3 amp. (2A3 regulator tube)
- 2.5 volts, 5 amp. (2A3 output tubes)
- 6.3 volts, 3 amp. (6J7 control tube and s.a. tubes) (Kenyon T-214)

developed (a rectifier-type meter should be used) will give the power output ($P = \frac{E^2}{R}$) using the

(Continued on page 116)

³ Waller, "Amateur Applications of the 'Magic Eye,'" *QST*, October, 1936.

● What the League Is Doing ●

League Activities, Washington Notes, Board Actions—For Your Information

Conferences This is a winter of international conferences on radio, and a considerable part of the energy of A.R.R.L. headquarters for many months to come is going into the representation of amateur radio at these affairs.

November sees a meeting at Habana to which are invited all the countries of the Americas, and it may be desirable to review again here the functions of this conference as they may affect us. While broadcasting holds the center of the stage, the intention is to negotiate an agreement for the American region concerning all of the spectrum. Of course above about 4000 kc. this agreement must and will follow the Madrid table faithfully, but in the lower frequencies there is room for some departure from Madrid if there is agreement throughout the American region. We are chiefly interested in seeing the reaffirmation of all the amateur bands as exclusively amateur in the Americas, and we expect it, while at the same time it is probable that this conference will change our 1715-2000 band to 1750-2050, a proposal to which we have given our consent. There is the question of 7-Mc. 'phone in Latin America, and it will be a real difficult one. It is also at this conference that we have proposed the concluding of a uniform agreement between the American nations permitting the free interchange of amateur third-party messages of a type that would not normally go by a paid service. The conference is expected to last all of November. Warner and Segal are representing us.

Meanwhile preparatory meetings are going on all over the world for the Cairo Conference, which opens in February. The United States government has had four committees at work at a series of meetings, examining the proposals of foreign governments. All of the American interests are participating in these conferences, including ourselves. One by one the proposals are examined and classified. At this writing the work has not been finished but we think it safe to say that the U. S. A. will oppose all the hostile proposals towards our bands. What will happen on the other side is a different story, for it is apparent that a large number of nations are espousing proposals to increase the allocations of short-wave broadcasting and of the aeronautical services, and the old squeeze is going to be felt somewhere. That is the reason A.R.R.L. has been working so hard on this subject the past several years, and we think we're now well prepared to take care of ourselves.

Washington Notes

Nothing doing yet on new regulations for emergency communication or concerning portable operation. . . . The new allocation of ultra-high frequencies up to 300 Mc. is expected soon and awaited with great interest everywhere. . . . A.R.R.L. has asked F.C.C. for special identifying prefixes for U. S. A. possessions in K6 and K4, and favorable consideration is expected. . . . The number of amateur stations at the end of the fiscal year on June 30, 1937, was 47,444, comparing with 46,850 one year previous, a growth during the year of only 594. Raising the code speed has made serious inroads on the number of new amateurs. During the fiscal year 1935, only 22% of applicants failed the code test (and 22% additional failed the written examination). During the year ended June 30th, 34% of all applicants failed the code test (and 28% failed the written examination). Failures of the written examination, by classes, were: Class A, 28%; Class B, 28%; Class C, 26%.

Visiting With the coming of cool weather, the League got going promptly on its fall travel program, and many sections of the country are being visited by representatives from headquarters. The three assistant secretaries make most of the long trips, visiting hundreds of clubs and conventions each year, but many of the shorter trips have been made by other members of the gang here. Assistant Secretary A. L. (Bud) Budlong was all the way across the country on a month's tour in September. Assistant Secretary Byron H. (By) Goodman is ditto at this writing. Assistant Secretary C. B. (Clint) DeSoto will follow a little later in the winter. Meanwhile both President Woodruff and Vice-President Bailey are certainly getting around, and are frequent visitors at conventions.

Speaking of visitors, we have 'em here too, particularly since we're in our new quarters, and whenever you're around this way you're invited to call and see what your headquarters outfit looks like. The address is still 38 LaSalle.

Spanish Handbook

We have pleasure in announcing the completion of arrangements whereunder Señor Domingo Arbo, publisher of the well-known Argentine radio journal "Revista Telegrafica," in Buenos Aires, will publish an authorized Spanish translation of the A.R.R.L. manual, "The Radio Amateur's

(Continued on page 76)

A New I.F. Amplifier System with Infinite Off-Frequency Rejection

By Karl W. Miles* and J. L. A. McLaughlin*

BYOND a doubt the trend of basic developments in amateur receiving equipment is towards the reduction of extraneous noises (improved signal-to-noise ratio) as well as the elimination of off-frequency interference. At the present time our receivers are certainly sensitive

intelligibility. However, the skirts at 1000 times down may be so wide as to permit a signal five kilocycles off resonance to produce serious interference with the desired signal. It is obvious that there is something lacking the shape of our selectivity characteristics.

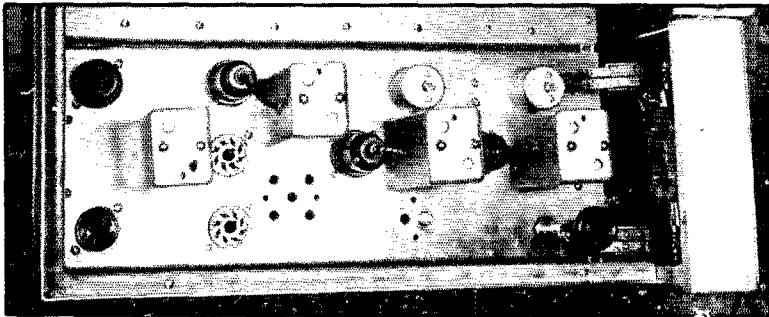

TOP VIEW OF THE INFINITE REJECTION I.F. AMPLIFIER MOUNTED IN THE CHASSIS OF AN EXPERIMENTAL SUPERHET RECEIVER

Our present method of obtaining extreme high i.f. selectivity with transformer coupling consists fundamentally of cascading resonant circuits using high-Q coils in sufficient number to achieve reduction of unwanted signals at some predetermined number of kilocycles either side of the resonance frequency. The resultant selectivity curve is roughly triangular in shape, the apex occurring at resonance frequency.

However, signals within 10 kc. or so of the resonance frequency undergo proportionately less attenuation than those farther from resonance, and the only way which we

enough and in the Single-Signal type, selectivity has reached a higher order for c.w. reception. However, for 'phone reception the selectivity characteristics of our receivers still leave much room for improvement. With a crystal filter adjusted to the "sharp" position, the selectivity characteristic is much too peaked at the nose to be useful for good, intelligible 'phone reception. In the broad crystal position the nose of the curve may be about 1500 cycles wide at 2 times down, which is suitable for obtaining the minimum of interference with fair

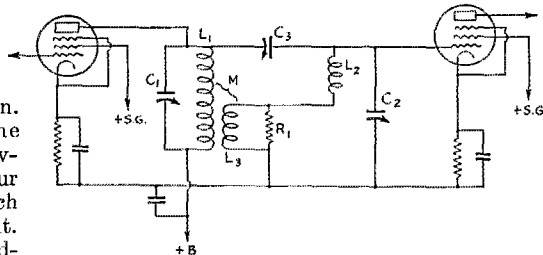
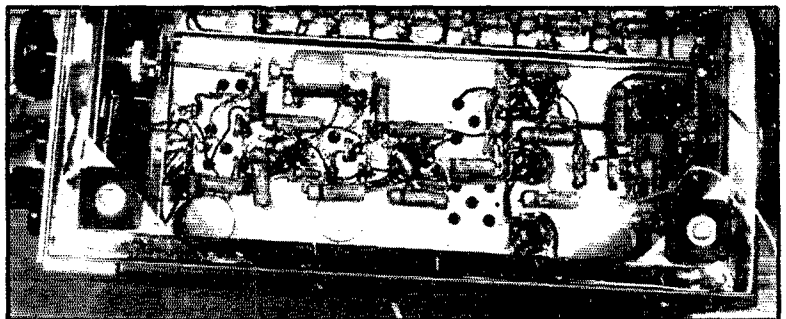

FIG. 1—THE ESSENTIAL ELEMENTS OF THE INFINITE REJECTION I.F. COUPLING SYSTEM
Practical circuit values are given in Fig. 2.



THE SHIELDED TWO-PLATE CONDENSER C_3 (WITH EXTENSION SHAFT) IS MOUNTED UNDERNEATH THE CHASSIS

*The Hallcrafters, Inc., 2511 Indiana Avenue, Chicago, Ill.

can achieve sufficient attenuation of signals in the region closer to resonance is by making the slope of our selectivity curve so steep at the nose that intelligible 'phone reception is impracticable. It is obvious, then, that if we are going to achieve noteworthy improvement in the elimination of unwanted interference by means of extreme selectivity and yet retain a band width at the nose adequate for intelligible 'phone reception, we must attack the problem of providing a selectivity characteristic radically different from the ones we are now using. The ideal shape, of course, would be rectangular rather than triangular. To achieve this desired rectangular shape, we will have to go to some other method than the one of cascading resonant circuits using high-Q coils with present conventional couplers.

We have recently been working on an i.f. amplifier using a system which we believe is a step in the right direction; one which is a radical departure from the conventional coupling circuit. This system was originally developed by Garrard Mountjoy, License Division Laboratory, R.C.A., New York City. In this system couplings are used which are individually infinitely selective in rejecting off-frequency interference.

THE INFINITE ATTENUATION CIRCUIT

Fig. 1 shows the essential circuit diagram of one form of this infinite adjacent-channel attenuation

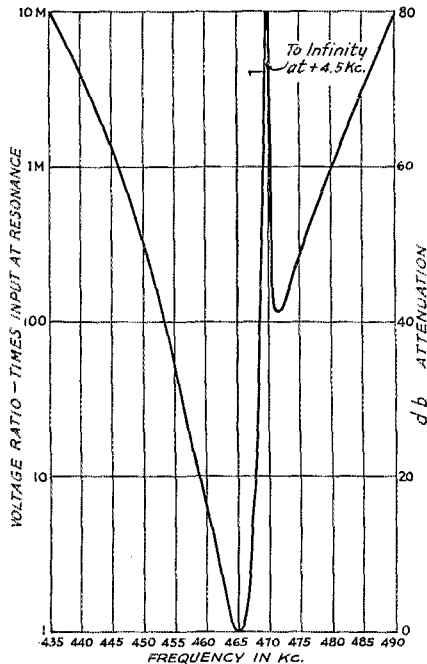
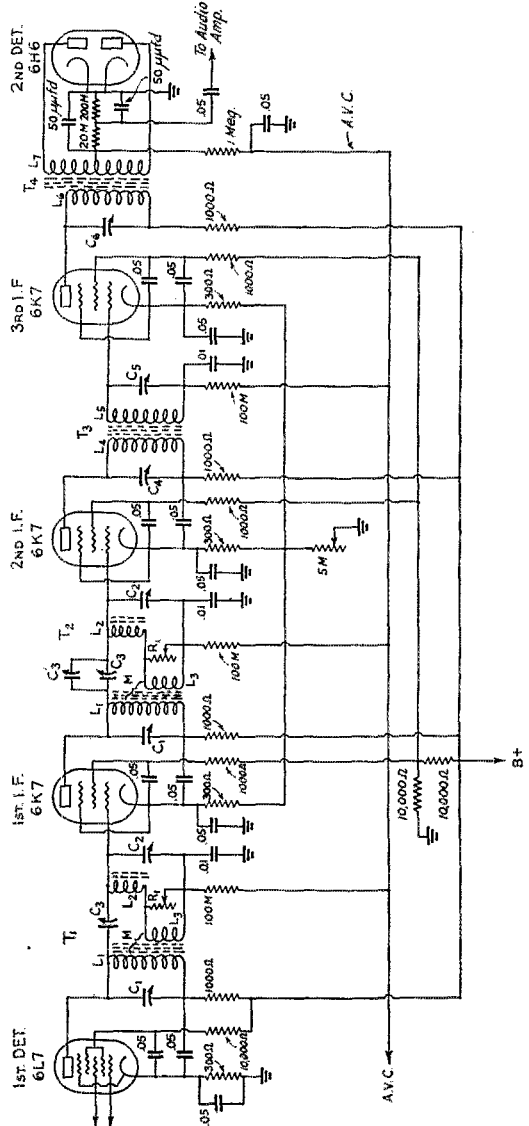

FIG. 3—SELECTIVITY CHARACTERISTIC WITH A SINGLE REJECTOR CIRCUIT SET FOR INFINITE ATTENUATION AT 4.5 KC. ABOVE RESONANCE FREQUENCY

FIG. 2—CIRCUIT OF THE EXPERIMENTAL I.F. AMPLIFIER UNIT

- L₁—1.05 mh.
- L₂—0.9 mh.
- Q of L₁ and L₂ = 150.
- L₃—0.21mh. (200 μh.).
- Mutual coupling, M₁ between L₁ and L₂—0.14 mh. (140 μh.).
- C₁—70—105 μfd. primary tuning air condenser.
- C₂—70—105 μfd. secondary tuning air condenser.
- (The above components are contained in T₁ and T₂, which are special Aladdin Polytron 465-kc. transformers.)
- C₃—25-μfd. shielded midgets (Hammarlund).
- C₃'—1-μfd. shielded midget variable. (See text.)
- R₁—50,000-ohm variable resistor.
- T₃—465-kc. inter-stage i.f. transformer (Aladdin).
- T₄—465-kc. full-wave diode transformer (Aladdin).



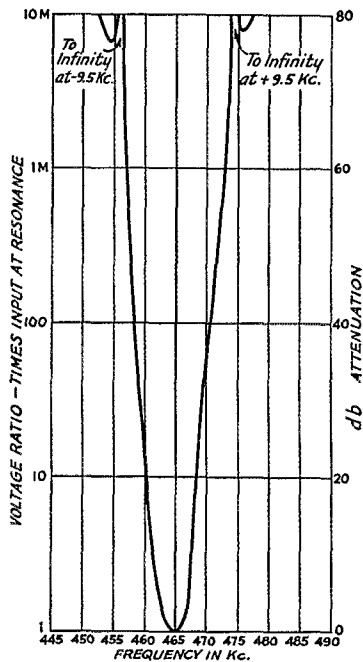

FIG. 4—SELECTIVITY OF THE EXPERIMENTAL 465-KC. I.F. UNIT WITH REJECTOR CIRCUITS 9.5 KC. ABOVE AND BELOW RESONANCE

coupling system. It will be observed that coupling is provided by the mutual inductance, M , between L_1 and L_3 and the capacitive coupling, C_3 . The circuit in itself does not look very startling but the operation of it is.

Mutual inductance M and the capacity coupling C_3 are so chosen that at some determined frequency off resonance, the voltage induced through M is opposite in sign to the voltage induced in C_3 and will therefore cancel out. In other words, no coupling exists at this particular frequency. In order to achieve infinite rejection at this undesired frequency, correction for power factor in the circuit must be made. Resistor R_1 in the diagram is the power factor corrector. The retractor control C_3 can be made variable and tuned over a fairly wide frequency range of rejection without noticeable interlocking effect on the i.f. frequency. For proper operation, resistor R_1 should be variable; but once the infinite rejection point has been found, it need not be touched again.

In the experimental i.f. amplifier diagrammed in Fig. 2 we make use of two of these infinite attenuator couplers (T_1 and T_2) so that the retractor "slots" can be placed either side of the carrier frequency. The graphs and the oscilloscope tracings illustrate graphically just what happens when the two rejectors are set at different frequencies off resonance.

Fig. 3 shows a single retractor circuit set to reject a frequency 4.5 kc. off resonance. The retractor

slot, as is apparent, goes to infinity at this frequency and its action is very similar to the rejection in a crystal filter. Fig. 4 shows two rejectors in use, placed 9.5 kc. plus and minus the resonant frequency, while Fig. 5 is for rejection at plus and minus 5 kc. Some especially interesting effects obtainable with this rejection system are illustrated by Figs. 6 and 7. In Fig. 6, one retractor is set at 5.5 kc. above resonance and the other is set at 10 kc. above resonance. As will be noted, in all of these graphs the slope of the resonance curve is entirely different from that obtained in a single crystal filter circuit. The nose of the resonance curve is well rounded and the slope of the curve on the rejection side varies only approximately 2 kc. from ten times down to infinity. In Fig. 7 we have brought one of the rejectors to plus 3 kc. off resonance, leaving the other one still at plus 10 kc. This gives us an even steeper slope on the retractor side although it also brings the skirt "hump" on this side to 140 times down.

In a three-stage i.f. amplifier it is entirely possible to use four infinite attenuator couplers. Placing two on either side of the resonance frequency (each as in Fig. 6) would give us a curve 10 kc. wide at approximately 5000 times down, and 6 kc. wide at ten times down—plus the virtue of a well-rounded nose. If three of these rejectors are left fixed, two at plus and minus ten kilocycles off resonance and the other one at say plus 5 kc. with the fourth retractor variable, we should have

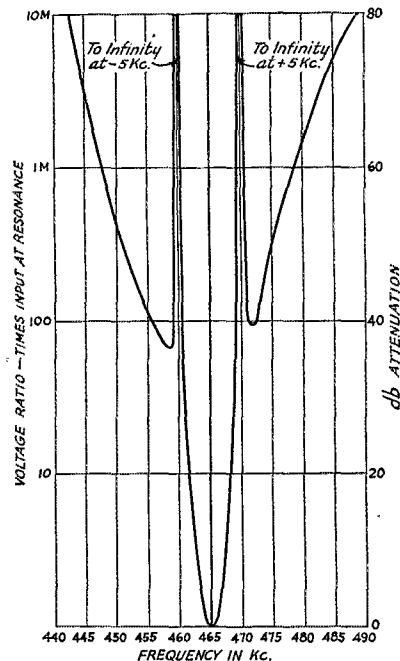
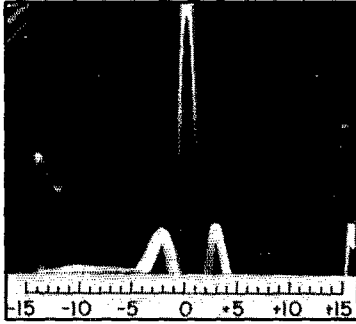

FIG. 5—REJECTION AT 5 KC. ABOVE AND BELOW RESONANCE

UN-RETOUCHED FREQUENCY-SWEEP CATHODE-RAY RESONANCE

curves illustrating the qualitative behavior of the i.f. rejector system for infinite attenuation adjustments close to resonance. It should be noted that the i.f. tube gain was adjusted to give nearly full-screen amplitude for each curve, since the resonance response is considerably reduced with close-in rejection. The scale on each illustration is in kc.



(a) REJECTION AT APPROXIMATELY -1 KC. AND +2 KC.

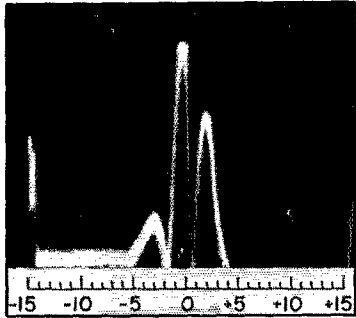

(b) REJECTION AT -2 KC. AND SLIGHTLY LESS THAN +1 KC.

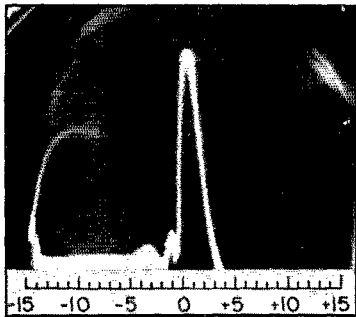

(c) REJECTION AT -0.5 KC. AND -1.5 KC.

an i.f. system practically ideal for present-day amateur 'phone operation. With two stages of pre-selection ahead of such an i.f. system, it can be safely stated that the over-all selectivity curve will be less than 10 kc. wide at ten thousand times down, and still retain a band-width near the nose

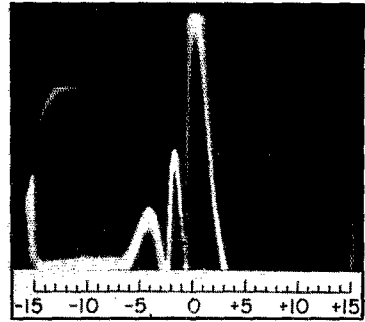

(d) REJECTION AT -0.5 KC. AND -2.5 KC.

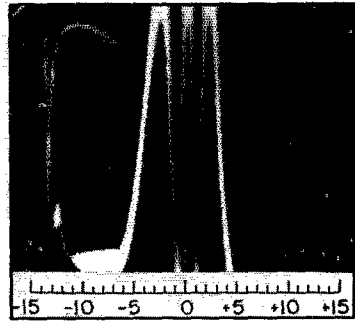

(e) REJECTION AT -1 KC. AND +1 KC.

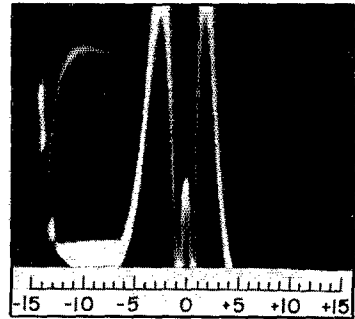

(f) REJECTION AT -0.5 KC. AND +0.5 KC.

of approximately three kilocycles—and, still further, provide the benefits of a variable rejector of infinite attenuation for removing heterodyne carriers within this band width.

ADJUSTMENT

Getting the circuit to work, is fairly simple. C_1 and C_2 are adjusted to 465 kc. as is done in conventional superheterodyne practice. Next, C_3 is adjusted to the frequency of desired rejection and then resistor R_1 is adjusted, together with slight readjustments of C_3 , until infinite rejection takes place at this frequency. It is best to make these adjustments with a sensitive microammeter in the diode load circuit and no modulation on the

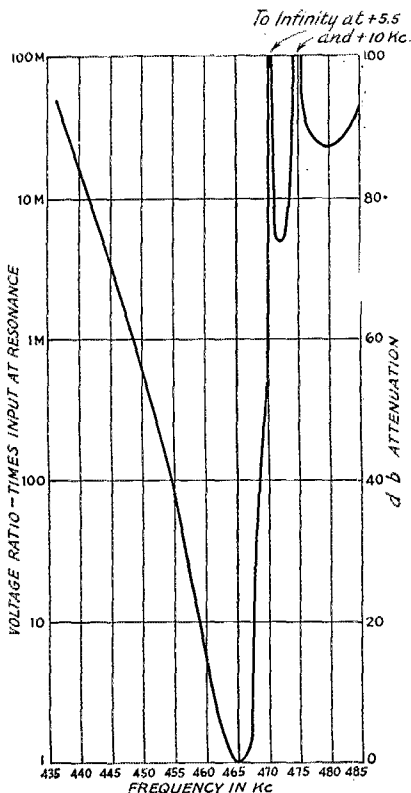

FIG. 6—ONE REJECTION AT 5.5 KC. AND THE OTHER AT 10 KC. ABOVE RESONANCE

signal generator carrier. For infinite rejection, R_1 is quite critical. Inasmuch as the rejection notch is only a few hundred cycles wide, it takes very precise adjustments of C_3 and R_1 to achieve this. To find this infinite rejection point satisfactorily, a microammeter with a range of zero to fifty microamperes is found necessary. Once the best rejection setting for R_1 is found, it stays constant for fairly wide changes of C_3 .

The fixed rejectors (C_3) are small Hammarlund 25- μ fd. variable condensers. For the variable rejector control, C_3 , a condenser of the same type was stripped of all its plates with the exception of one rotor and one stator to give a measured capacitance of 1 μ fd. This was connected across C_3 of the second coupler and was found to have sufficient range to vary the rejector notch from plus 10 kc. to minus 10 kc.

The two fixed rejector controls are shown in the top view of the i.f. amplifier. They are in the two small round cans alongside the two i.f. transformers. The two variable resistors R_1 are on the other side of the same two i.f. transformers, one resistor having an extended shaft with a knob on it. In the bottom view, the condenser mounted on the bracket with the insulated coupling to the

control shaft is the small two-plate variable C'_3 which is across C_3 in the second i.f. coupler.

It should be noted that the skirts of the resonance frequency curve of this three-stage i.f. amplifier *without rejection* are somewhat broader than we normally use in amateur communications receivers. By reducing the inductive coupling between stages, these skirts can be appreciably cut down with noticeable improvement over the curves shown. However, as stated in the opening of this article, this is simply an experimental set-up of a new and certainly interesting attack on the problem of achieving more nearly rectangular selectivity characteristics in our amateur communications receiving equipment. We believe

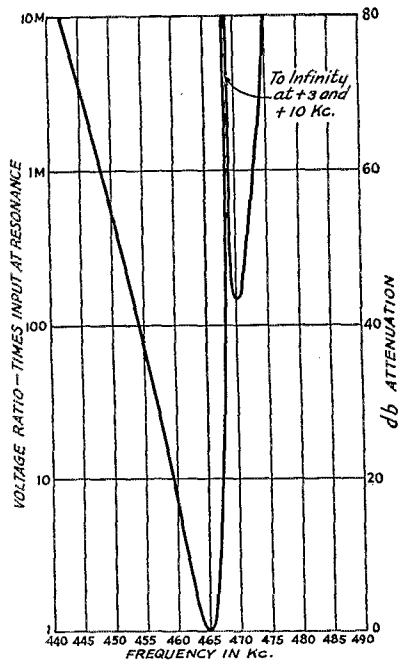

FIG. 7—REJECTION AT 3 KC. AND 10 KC. ABOVE RESONANCE

we are not too optimistic in stating that with more work on this system and further refinement, it will be quite possible to arrive at a curve shape which is rectangular to all practical purposes and of but a few kilocycles width from the nose of the resonance curve to better than ten thousand times down. The result may well be a receiving system of improved signal-to-noise ratio and freedom from off-frequency interference.

Strays

Picked up somewhere by W1IKC:
 "You're so dumb I wouldn't call you a ham."
 "Why not?"
 "A ham can be cured."
 We doubt it!

Match and Mis-Match

Some Pertinent Pointers on Transmitter Loading and Antenna Feed Systems in General

By Stuart W. Seeley,* W2JOA

OH, boy! Have I got my line matched up swell? I've got my pick-up coil a good six inches from the tank and does she 'draw'? Just about all the 'soup' is gone from the tank coil. And boy! does the plate meter walk up scale. Have I got a match or have I got a match?"

Such was the gist of a gleeful burst of exuberance that bubbled forth from the depths of the 20-meter 'phone band a short time ago. Who it was we have no idea for he was soon drowned in the QRM. But it had touched a sore spot with us—this idea of wanting to get all the "soup" out of the final. It also indicated very plainly that a "match" had not been effected in any sense of the word. This article was conceived at that moment.

"EFFICIENT" TANK LOADING

The final tank circuit of a transmitter must be considered as a source of power, in many respects equivalent to a generator or even a battery. If a six-volt storage battery were "loaded" with a 1-inch copper bar across its terminals all the "soup" would be gone from the battery; the voltage across those terminals would be practically zero; but—the power *output* and the *efficiency* would also be practically zero. If we wanted to get the last possible watt *out* of that battery we would load it with a resistor of such a size that it took just half the "soup" away—in other words dropped its terminal voltage to just 3 volts. Under these conditions the power *output* (in the form of heat) would be at an absolute maximum—and the efficiency would be just 50 per cent. How long the poor battery would last under these conditions is, however, problematical. Undoubtedly it would soon have buckled plates and be completely worn out.

If a final tank is loaded until the voltage across it has dropped to half its unloaded value (usually determined roughly by the length of arc which can be drawn), the final stage efficiency will be less than 50 per cent and the tubes may groan and give up the ghost. The output load of a transmitter should *not* be "matched" to the final tank, in the sense that the load resistance is made equal to the driver resistance, any more than the six-volt storage battery should be loaded with a resistance equal to its internal resistance, which results in the half-voltage condition mentioned above.

How then can we determine when a "match,"

* 40-01 221st St., Bayside, Flushing, L. I., N. Y.

as we commonly understand it, has been effected at the transmitter end of the antenna system? If the grid, or grids, of the final stage are being properly driven and if the plate current, with the antenna load removed and tank condenser tuned for minimum, dips to one-quarter or less of the loaded value, the plate milliammeter can be made to tell the story.

First, however, it is necessary to determine what the loaded value should be. The plate voltage times the plate current is equal to the input power to the final. In a well-designed transmitter 55 per cent to 65 per cent of this power will be delivered to the antenna, 10 per cent to 20 per cent will be lost in the combined tank circuit and feed system, and 25 per cent to 30 per cent will be dissipated as plate loss in the tube. Manufacturers usually specify the allowable plate dissipation, so if the above division of power holds good we may safely operate with an input of from $3\frac{1}{2}$ to 4 times the rated plate loss for the tube.

In a 'phone transmitter the lost power must be modulated as well as that which is delivered to the load, so the available modulating power may limit the total input to something less than would otherwise be the case. The simple rule still holds—the input plate power which can be 100 per cent modulated in a Class-C amplifier is equal to twice the available undistorted audio power, arguments to the contrary notwithstanding. Furthermore it is a mistaken notion to believe that an excess of Class-C input power, over and above a value which can be modulated 100 per cent, will prevent side-band spreading. Whether the distortion, which results in the high-frequency (wide side-band) components, comes from an over-loaded modulating stage, or an over-modulated stage, the result is the same.

Having determined what the final input power should be, it should be divided by the plate voltage and the result will be the plate current, in amperes, at which the final should operate. Then it becomes a simple matter to adjust the antenna load coupling until this value of plate current results, bearing in mind that the tank tuning condenser may have to be readjusted slightly for each value of coupling to dip the plate current to its minimum value. Having done this we may rest assured that the maximum *permissible* amount of power is leaving the final tank and entering the load circuit and that an output "match," in the

only applicable sense of the word, has been obtained.

It is probably well to mention here that a slight change in setting of the plate tank condenser may be necessary to maintain "dip" current when the load is applied. This change is perfectly normal and is not necessarily a sign that the feed system or the antenna are out of tune or "mismatched." If a pure resistance was connected across the pick-up coil or across a portion of the tank, to act as a load, it would be found that the total tank capacity would have to be increased from its no-load dip position in order to minimize the plate current. It is only when the required change amounts to 25 per cent or more of the total capacity that it can be considered as a probable indication of an "out-of-tune" antenna system. Even this will not be serious if an open-wire feed system is used, since with these it matters little where reactances in the combined tank and antenna system are "tuned out" as long as the tubes work into a pure resistance (as indicated by minimum plate current) and the final tank capacity is of about the right value to satisfy tank circuit L/C requirements.

FEEDER BEHAVIOR AND LINE LOSS

But suppose the coupling has been tightened up as much as possible and still the plate current has not reached the predetermined operating value. What is the next move? If neither lack of grid excitation nor exceedingly poor plate supply regulation are contributing factors, it is a pretty safe bet that the load circuit either presents an extremely high resistance at the point where it connects across the pick-up coil, or tank, or that it has a lot of "left over" reactance in series with its resistive (load) component. Furthermore, it is also a pretty safe bet that either a single- or double-wire (open) feed system is being used, for the characteristics of twisted pairs and other types of rubber dielectric lines are such that it is almost impossible to run into such a situation with them. More about that later.

To correct this difficulty either the length of the antenna or of the line, or the connection of the line to the antenna, may be altered. Or if it happens to be a pet all-band antenna, or one that cannot be changed for some other reason, one of the well known "impedance-matching networks" may be used. Whether or not such networks are operating efficiently may be determined very easily (if they are handling one hundred watts or more) by whether they become warm during long periods of operation.

Having remedied this difficulty it is a safe assumption that, if open wire lines are used, at least 90% of all the power entering the feed system is being radiated *regardless of whether or not standing waves are present on the feeders or transmission line*. The only possible exception to this is in the case of a two-wire spaced line of extreme

length when operated at 28 Mc. or above.

With single-wire feeders a large amount of the energy may be radiated directly from the feed system, in which case it may be desirable to eliminate standing waves on that part of the load. This may require altering the point of connection between line and antenna, and may also necessitate some change in the antenna length. The question then is how to tell when the standing waves have been eliminated. Of course an r.f. current meter may be inserted successively at three points along the line, one-eighth wave apart; but unless three like meters are available the job becomes laborious and necessitates cutting and splicing the line a great many times. A better way is to take a piece of wire of the same diameter as the feeder, cut a piece about one-quarter wave long and add it in series with the line. This will necessitate running the feeder by a more circuitous route to the transmitter (for the test) and care must be exercised to see that its exposure to grounded objects is approximately the same with the piece in or out. When the length of the antenna and the point of connection between line and antenna have been properly adjusted, insertion or removal of the additional quarter-wave of line will make little or no difference in the final plate current or tank tuning. Under these conditions there will be no standing waves on the feeder and radiation from it will be at a minimum.

It is well to point out here a fact which a good many amateurs overlook. The power input to a transmission line or feeder system which is totally devoid of standing waves is equal to the square of the current flowing into that line times its surge impedance. If that current happens to be, say, 2 amperes and it is flowing into a 500-ohm line, the *apparent* power would be $2 \times 2 \times 500$, or 2000 watts. If the input power to the final is only 150 watts, obviously there must be standing waves on the line. However, if the current were only 0.45 ampere the apparent power would be $0.45 \times 0.45 \times 500$ or 101 watts, which is more in line with the actual value. This latter condition must not, however, be taken as a sure indication that there are no standing waves on the feeders for there may still be a point a quarter-wave or so further out toward the antenna where the current is many times higher than that measured at the transmitter. If this is the case, it was just happenstance that the average value of that standing wave showed up at the transmitter.

HOW IMPORTANT ARE STANDING WAVES?

But radiation and losses in open double-wire lines are usually negligible in any event, regardless of whether standing waves are present or whether the lines are transposed or not, unless the currents in the two wires are not equal—which *will* allow the line to radiate appreciably. If the center of the pick-up coil is grounded, or the two wires are

(Continued on page 76)

Rewinding an Auto Generator for Portable-Emergency 110-volt A.C. Supply

By H. J. Burchfield,* W6JTV

Following the article Practical Organization and Equipment for Emergency Operation, by the S.A.R.O., February 1937 QST, we are now pleased to present practical details on modification of automobile generators to obtain 110 v.a.c. There is nothing better than a full-fledged self-powered supply to keep your whole station on the air "as is" in emergency. Read the previous information; then Section Manager Burchfield's excellent account of how to build an inexpensive first class portable-emergency supply; then make one so you are properly emergency equipped (and ready for the next Field Day)!

As this appears in print Section Managers are extending the A.R.R.L. Emergency Corps, appointing Emergency Coordinators in the larger centers. Throughout the Emergency Corps registrations of all amateur facilities will be conducted. Station schedules for emergency will be planned. Important places will be held by all those self-powered and really prepared. Read on, and build or secure self-powered power supply to-day. Prepare now. Register promptly in the League's Emergency Corps.—EDITOR

WITH a separately-excited automobile generator rebuilt for a.c., it is entirely possible, by pushing a little, to get a full 1000 watts. On the self-excited jobs, it is entirely possible to get 350 watts of good 110 volts at 60 cycles. This article will deal entirely with the separately-excited rewinding job, as we have found need for more than this output for other uses than emergency transmitters and receivers.

I should like to give my sincere thanks to S. W. Duncan, who has so graciously let me use extracts

Babcock, W6ZA, for their wholehearted co-operation.

The photograph of the completed unit shows the six-volt d.c. generator used to provide the field excitation. The whole unit is immediately transportable by two men, weighing somewhere in the vicinity of eighty pounds including the 1-h.p. gasoline engine, the rebuilt generator and the six-volt field-exciter. This set-up will provide dependable, economical, a.c. power for emergencies, field-days—or even to heat up an electric

iron to press your trousers while camping. Its uses are manifold.

But to get down to business. The first thing is to beg, borrow, steal, or otherwise obtain one old Dodge 12-volt generator. These generators were made by the Northeast Manufacturing Company and are known as Type "Ga." They operated as a combination starter and generator. Whether found open-circuited, burned-out or in good shape, they are equally useful for our purpose, since all the original windings, both field and armature, must be "stripped." First remove the armature, being careful to keep all parts such as bearings,



THE SLIP-RINGS, A STRIPPED ARMATURE, AND A REWOUND ONE, SHOWING HOW THE 1/4-INCH DOWELING IS USED TO HOLD WINDINGS IN PLACE, AS WELL AS THE INSULATING PAPER BEFORE BEING TUCKED DOWN AND THE SECURING FIBER STRIPS DRIVEN OVER THEM

Also a finished flywheel, and the four rewound field-coils. The instrument in back is a remote control unit. The two switch blades are used for receiver and transmitter. Voltage is set by means of the tapped field rheostat. Receiver and transmitter plugs are on the base of this unit.

from his book, *Auto Power*. To fellow hams who contemplate building one of these generators, it represents a dollar well invested. Also my appreciation to Mr. O. L. Day, W6OBJ, and Mr. J. W.

* 2240 106th Ave., Oakland, Calif.

nuts, bolts, etc. We found that the easiest way to strip the armature was to use a hacksaw on the windings, sawing carefully up close to the laminations, and in towards the shaft. A pair of pliers is used to pull the old wire from the slots. The

first two or three top wires are the toughest. Once these are removed, the rest of the windings literally fall out.

If it is intended to use the old commutator for one side of the a.c. output, be careful not to mar or damage the bars. If slip-rings are to be installed, it is not necessary to be so careful. Merely use a small chisel to work the old bars away from the shaft, and strip them clean. We used the slip-rings, finding they gave us a better output wave-shape, without a troublesome ripple that develops when using the commutator and the shaft for the terminals. Mr. Duncan explains in his book how the commutator is used. If it is intended to use slip-rings, make a transverse cut with a hacksaw along the shaft. This will cut through the retaining rings holding the commutator bars in place, and they then clean up easily.

A small quantity of 0.010-inch insulating paper is required for re-insulating the slots. Strips are cut the width of the slot and long enough to give a slight overlap when pushed into the slots. This overlap will, to a large extent, protect the windings on the armature from being cut through by the abrupt turns into the succeeding slots. Twenty-four of these pieces are needed.

The field coils require 4 pounds of No. 17 s.c.c. enameled wire. The armature for the separately-excited job needs 3 pounds of No. 15 s.c.c. wire. This ordinarily can be bought from a local armature or motor rewinding company, as can also the insulating paper. Also required are a couple of pieces of horn fiber, $\frac{1}{8}$ - or $\frac{3}{16}$ -inch thick and as long as the slots. These pieces are to be used for tamping the windings into a compact mass in the slots. (At the same time, if it is explained to the company from which you obtain the wire and insulating paper, they can give invaluable aid in construction hints.) About the last of the supplies needed will be insulating varnish (approximately a gallon will be more than sufficient), and a piece of $\frac{1}{4}$ -inch wooden dowel rod. This can be obtained from a local carpenter or cabinet-making shop. The insulating varnish is on the completed fields and armature windings. Also needed is about twenty feet of $\frac{3}{8}$ - or $\frac{1}{2}$ -inch cotton tape. The tape is used to wind around the completed field coils, to bind each into one whole and to keep the windings from separating.

WINDING THE ARMATURE

The armature winding is started from the side from which the commutator was stripped. (If the roll of wire can be placed above your head and

to the right, it will unroll easily and still be out of the way.) You may start with a piece of twine, so as to get the winding sequence straight in your head. The string can be removed when you get the general idea of the winding sequence. First, insert the 24 pieces of insulating paper, one in each slot. This will leave one extra slot to be taken care of later. Leave a piece of wire about eight inches long for one end of the a.c. output. Coil it up so the end will not be in the way while the turns are being laid. Start in any slot, figuring it as

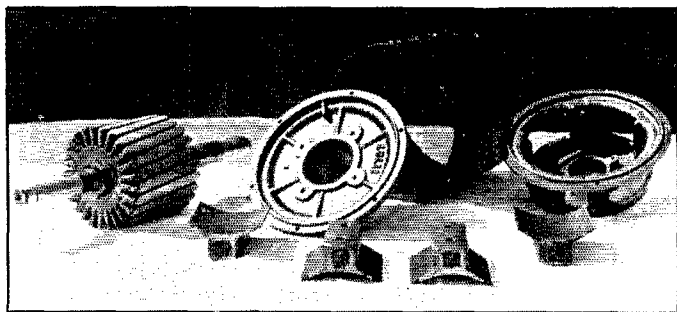

THE STRIPPED GENERATOR READY FOR WINDING AND EQUIPMENT WITH SLIP-RINGS

The frame is crackle-lacquered and baked. The four pieces in front are the field poles as removed from the frame.

No. 1. In the next slot put a piece of the $\frac{1}{4}$ -inch dowel. This is shown in the photo of the completed winding of the armature. It serves to hold each section of the winding in place. The slot occupied by the dowel is No. 2. From No. 1 slot go around No. 2, *under* the dowel, and come back out No. 3 slot. In this winding put 21 turns, using the piece of fiber to tamp the turns down about every six or seven turns. These slots fill up surprisingly fast, so the tamping must be faithfully carried out, or the last two or three turns won't lie in place.

The sequence of these windings is shown in Fig. 1. After the first pair of slots is filled, bring the wire around in the same direction as though to continue. This winding is started up through what is No. 25 slot, the last of the slots if you count around the armature. Continue the same winding direction, through No. 25 slot, around *under* the first winding and the dowel, and back towards yourself through No. 4 slot. Continue winding and tamping this winding for twenty-four turns. After completing this section, bring the lead around in the same direction as in the two preceding coils, in No. 24 slot, through it, around *under* the dowel, then through the first two windings, and back towards yourself through No. 5. Twelve turns go in here—and be careful to tamp these 12 turns down as carefully as the preceding windings, because there are twelve more turns to go in the same slot. When this winding is completed, one pole of the armature is done. Since these three

windings are all in the same direction, remember to start the windings *away* from you; that is, with the long part of the armature shaft pointed toward you.

Now the next pole must be reversed, and this is simplicity itself. The end of the last coil is toward you. From No. 5 slot go to slot No. 9, through this slot, *away from you*, around No. 8 and back towards *yourself* through slot No. 7. Then, back around slot No. 8 and up through slot No. 9 again. There are 21 turns in this pair of slots. Don't forget to use your piece of dowel in slot No. 8, winding your turns *under* it. After 21 turns are completed here, run the next winding (still away from you) up through slot No. 10, around and under the first coil and the dowel, and back through slot No. 6. There are 24 turns in this winding. After this is wound, proceed in the same winding direction up through slot No. 11, and back through slot No. 5.

You already have 12 turns in this slot, and 12 more go in on top, the only difference being that you have now *reversed* the winding direction. This leaves 12 turns in slot No. 11, which is right and proper. Make the last turn of the preceding windings *away* from you, back through slot No. 11. Then bring this winding back toward yourself through slot No. 15, around under the piece of dowel in slot No. 14, and away from yourself through slot No. 13. There are 21 turns in this group. The end of the turns here starts back toward you through slot No. 16. There are 24 turns here, the windings continuing up through slot No. 12 for 24 turns. Then there are 12 turns in the same direction through slot No. 17 and back up over the 12 turns already laid in slot No. 11. Next bring the winding back towards you through slot No. 17 and over to slot No. 21, through slot No. 21 *away* from you, around slot

No. 20, and back towards you through slot No. 19. Lay 21 turns in this section. Continue in the same winding direction through slot No. 22 and back through slot No. 18, for 24 turns.

Now, we have one odd slot. This is slot No. 24. Disregard it entirely. Put the last 12 turns through slot No. 25 and back through and over the turns in slot No. 17. Cut off the remaining wire so that the ending lead is about 12 inches long. This should complete your armature winding.

It is a good plan now to test the winding for ground to the core of the armature, using an ohmmeter. If you have cut through the windings, find the spot and a piece of tape will do for insulation. If you have been moderately careful, though, the continuous winding should be ground-free.

If it is intended to use the old commutator for one side of the a.c. output, solder one piece of the winding to a commutator segment. It is a good idea to go all around all the bars with a soldered jumper so as to short the bars together. The other lead will go direct to the shaft of the armature. Drilling through the shaft and tapping for a 10-32 screw to hold a soldering lug will do the trick for the a.c. return. This means that the frame of the completed job is "hot" on one side—remember that when playing around.

If slip-rings are to be used, this trouble will not be encountered, of course, because both rings may be insulated. This is up to your own inclination. The slip-rings will take some machine work, requiring equipment that may not be available to some of the boys. To complete the armature it is best to cut enough narrow strips of fiber to slip just under the edge of each slot and over the windings, tamping the coils down and the strips of fiber through carefully to keep the cotton insulation from being damaged. These

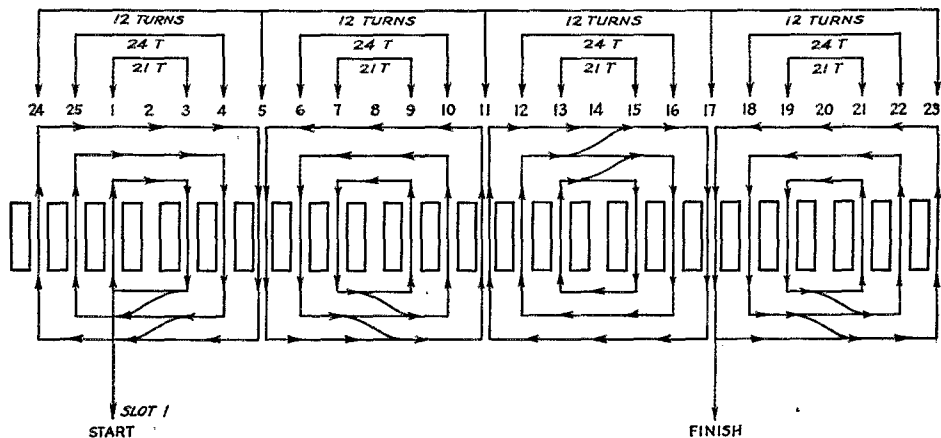

FIG. 1—SHOWING START AND WINDING SEQUENCE OF EACH POLE OF THE ARMATURE
The $\frac{1}{4}$ -inch dowel goes in slots 2, 8, 14 and 20. No windings in these slots on the separately-excited job. Reproduced by permission of Mr. Duncan from his "Auto Power" booklet.

strips will serve a two-fold purpose, to keep the windings from falling out when the machine is "revving," and for extra tightness in the windings themselves. Although not absolutely necessary they are a definite refinement. If a lathe or some other means of balancing the armature in a free-turning jig is available, a free running job with but little vibration will result. These things are supposed to turn over at 1800 r.p.m., and while this is not excessively fast, still things are liable to happen. Inserting pieces of brass $\frac{1}{4}$ -inch round stock in the odd slot will bring the armature to a fairly good balance, so that no part of the whole thing will be heavier on one side than the other. That's just another refinement. Use your own judgment. Possibly other ways of balancing will suggest themselves; if so, all well and good.

THE FIELD COILS

Four field coils are necessary, and while the winding isn't so critical as that of the armature, still some care must be exercised to get a finished coil that is flat and compact. First it is necessary to make a form that will have the same dimension as the core of the old field coils. The field poles removed from the old field coils must fit snugly into the new field coils. This form is very simple to make, as described fully by Mr. Duncan on page 19 of his booklet, "Auto Power." First the wooden block that will serve as a center is cut to fit loosely in the old field form. This center is long enough so that it can be used as a spacer for the exact thickness of the old coil. Drill through this in the *exact* center with a $\frac{1}{4}$ -inch drill. Then two blocks of wood are cut to about 6 inches by 4 inches, and these in turn are drilled through the exact center with a $\frac{1}{4}$ -inch drill. A $\frac{1}{4}$ -inch stove bolt is run through one block, through the center form spacer, and through the other block. A plain washer is put on next, then a lock washer, and the whole thing drawn tightly together with a nut. The projecting end of the $\frac{1}{4}$ -inch bolt can be gripped in the chuck of a breast-drill held in a vise, or in a lathe, to make the turns.

The field coils are wound with No. 17 s.c.e.

wire. In starting the winding, leave a good length of wire over the edge of the form to serve as a lead. It would be a good idea to put a piece of sleeving over this lead. Start the turns slowly, for a few turns, keeping the turns as uniform as possi-

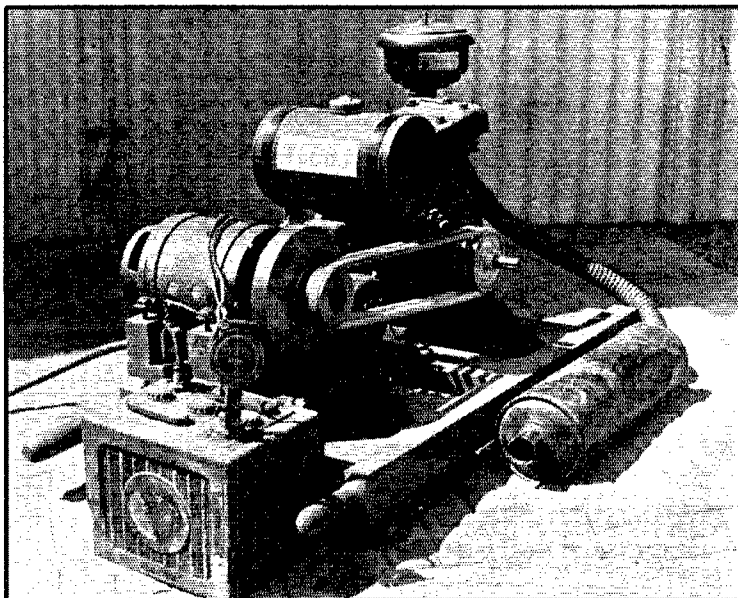

ILLUSTRATING THE GENERAL CONSTRUCTION OF THE CARRY-ALL FRAME AND MOUNTING OF THE PARTS

The 6-volt d.c. generator is in center, driven from a pulley that does not show. The battery makes for a little better a.c. regulation, but is not necessary. The cable shown in back is made up of 4 lengths of rubber covered No. 14 wire, one pair for a.c. output, the other pair for remote voltage adjustment.

ble. 200 turns go on each coil. After each of the four coils is completed, put a piece of sleeving over the No. 17 s.c.e. finish lead, and cut off to a length of about 12 inches. Here is where the tape comes in. In taping each coil, be sure that the inside "start" and outside "finish" leads are readily distinguishable. Tape the coils tightly with $\frac{3}{8}$ - or $\frac{1}{2}$ -inch tape, making each winding overlap the preceding one by about half of the width. The finishing end of the tape is tucked under the last two or three turns and pulled taut. Cut the end of the tape off clean. This completes the field coils.

BAKING

Some ingenuity is called for in baking the coils and armature. Complete instructions for heats, etc., are on each can of insulating varnish, and should be followed as closely as possible for best results. There are also several good air-drying varnishes on the market. (We have been lucky in having a regular baking oven, thermostatically controlled, for our own use.) Be sure to cover up with friction tape any parts of the armature that are to be bearing surfaces, or if the old commuta-

(Continued on page 84)

● NAVAL COMMUNICATION RESERVE NOTES ●

NAVAL Communication Reserve radio drill activities are now underway for the current season. These drill activities are divided into four networks classified as A, B, C and D. The first network is the national net which consists of Naval Radio Arlington in charge, and includes the master and alternate control stations in every Naval District in the United States, Canal Zone and the Hawaiian Islands. The next classification is known as the District or B network, which includes the training stations in the Districts plus the various section control stations of which there are several in every Naval District. The next step is within the section, these C drills being conducted by the section headquarters radio stations for the benefit of their unit stations located in armories, post office buildings and other government quarters. The last group, known as the D net, is made up of the unit stations located in armories and includes the individual amateur station owned by each Reservist.

Heretofore there has been considerable interference in congested localities between amateur stations engaged in purely amateur communication and the various radio drill nets of the Naval Communication Reserve. In spite of the very best of coöperation between individuals and the Communication Reserve there has always been a certain amount of unavoidable interference, particularly on the 3500-ke. band. Some years ago the master and alternate control stations were assigned government frequencies for their training circuits and for the past eight years have operated on 4045 and 3475 kcs. About a year ago the section control stations and the B network were placed on government frequencies between 2000 and 3000 kcs., but the unit stations and individually owned amateur stations remained on amateur frequencies. As there are several thousands of these stations belonging to the Communication Reserve, there still continued to be some unavoidable interference.

This year, for the first time, Navy frequencies have been assigned to the C and D networks. This means that every Naval Reserve-amateur radio station will be assigned a government frequency for official use on drill circuits. A number of years ago the Navy also worked out a system of special Naval Reserve call signs which has been in effect, and these calls will also be used on these government frequencies. Of course this plan will have to be operated for nearly a full season before its benefits will be felt. It will require some time for Reserve-amateurs to convert their equipment to operate on the new channels between 2000 and 3000 kcs. Some will wish to buy crystals and some

will wish to use electron-coupled or master-oscillator power-amplifier circuits. Because of the fact that United States ships use some of these frequencies, it is important that the transmitters be carefully calibrated and that their frequency stability be very good.

The Naval Communication Reserve has never made any attempt to handle a great amount of traffic over the training circuits. It has always taken the position that its mission was to train operators for service with the Navy in case of national emergency and that its primary object was to give radio operators the opportunity to learn naval procedure and methods. In order to do this its radio training circuits are operated in accordance with the requirements of the Naval Communication Service. Many interesting problems are carried out on these circuits and instruction is given in practical navigation, handling charts and other similar exercises. It is interesting to learn that some of the personnel who received instruction of this kind during the past year were able, when assigned to a Navy ship for training duty, to assist in the navigation of the ship and were able to plot positions from radio bearings.

The national competition last year was won by the Communication Reserve of the District of Columbia which is under the command of Lieutenant James H. Nicholson, C-V(S), U.S.N.R. This officer is well known to amateurs in New England and many parts of the United States, as he is connected with the Bureau of Air Commerce in the Department of Commerce and in his capacity as radio engineer for the Airways System, he travels all over the United States.

During the summer Lieutenant Commander W. J. Lee, U.S.N.R., who is on duty in Washington in connection with the administration of the Communication Reserve, traveled through the North Atlantic States and visited many communication organizations in Maine, Massachusetts, New York, New Jersey, Pennsylvania and Delaware.

Commandants of all Naval Districts have recently been authorized to form a Merchant Marine Unit in each Naval District to be composed exclusively of Communication Reserve officers and radiomen who are actually employed at sea in the capacity of commercial operators. Any members of the Communication Reserve who are so employed will eventually be attached to such a unit in their home District.

Recruiting has started up again after the summer lull, and anyone who is interested in joining the Communication Reserve can easily make arrangements to apply by communicating with a

(Continued on page 94)

● ARMY-AMATEUR RADIO SYSTEM ACTIVITIES ●

AT 7 P.M. and 10 P.M. on Thursday, November 11th, a message from the Chief Signal Officer to all Army Amateurs will be broadcast. As has been customary in the past, the broadcast will be made the subject of a competition among Corps Area Army Amateurs. The Corps Area having the largest number of members copying will be announced as the winner. Handicap factors based on quota membership will be applied.

ALL AMATEURS are invited to copy this message which will be broadcast by WLM on 3497.5 and 6990 kc. and by W3CXL on 14,030 kc.

- - - - -

Since the announcement by N.C.R. that drills would be held outside the amateur bands, the question has been raised as to why the A.A.R.S. does not do the same. A few words of explanation may answer this question.

Members of the A.A.R.S. are not part of the Army. They are affiliated voluntarily with the Signal Corps, U. S. Army, for training in handling traffic using Army procedure and for disaster relief communications.

Two special frequencies, 3497.5 and 6990 kc., are assigned to the A.A.R.S. These are obviously not sufficient for 1500 stations. Under present regulations the A.A.R.S., not being a part of the Army, cannot be assigned the use of War Department frequencies for drills.

- - - - -

Last season the office of the Chief Signal Officer sent out a memorandum outlining the change in net organization of the A.A.R.S.

The old organization provided for the Army net, Corps Area nets, state nets, district nets and local nets. The new plan calls for the abolition of the district and local nets whenever practicable and having all stations within a state operate on the state-net frequency. States with large memberships such as New York, Massachusetts, Pennsylvania and California are divided into two or three sub-state nets. The memorandum states in part as follows:

"For some time the organization of local and district nets and the assignment of frequencies in the amateur band has been a problem. The idea that all stations drill on a certain night has contributed largely to the demand for numerous nets and frequencies. The necessity for drill on a certain night also has kept many amateurs from joining the A.A.R.S., due to the fact that certain individuals are not able to drill on the night decided upon. The following plan will eliminate some of these difficulties and provide a more flexible organization in time of emergency. The effi-

ciency of state net organizations has been proved by the operation of nets of the V Corps Area in handling flood traffic.

"Most states do not have a membership so large that it is impossible to work on a spot frequency. In these few large states, district nets can be used.

1. All stations in a state will work on the state net frequency.
2. Hours of operation of the net will be decided upon by the Corps Area.
3. Nets will operate each night in the week.
4. Sufficient alternate state NCS will be appointed to handle the net, during the week, these alternates to work under the SNCS who will designate the station to take his place when he is unable to be present.
5. Local stations in the net will be divided up to operate on certain nights in the week so that all stations will not be on the air together. A definite schedule of locals or net periods can be maintained. This would not prevent locals from coming into the net on nights, other than when he is scheduled, to get rid of traffic."

Local stations of a state should be divided so as to schedule a group of stations to operate a certain hour each night instead of certain nights of the week. This will allow a station to come on the air any night on schedule and will do away with the former necessity of reporting Monday nights for drill to obtain credit for attendance.

The advantages of having stations within a state on a spot frequency are obvious. In an emergency the local station has a much greater chance of contacting his net control station or at least another station within the net, and the net can be quickly put on the alert. Cutting down the number of nets also releases numerous frequencies in the amateur bands. This will also tend to keep the state-net frequencies clear, due to the number of stations using that frequency.

Although the change has not been completed in all Corps Areas, considerable progress is being made. The advantages of this system have already been proven. The Fifth Corps Area which comprises the states of Ohio, West Virginia, Indiana and Kentucky was already set up for state-net spot-frequency operation and used it with excellent results in the flood of January, 1937.

- - - - -

Several references have been made to the nine Corps Areas into which the United States is divided. For the information of all concerned the following shows the states comprising each Corps Area and the headquarters of each:

I. C.A.—W1SC, Army Base, Boston, Mass.—Maine,

(Continued on page 96)

How Long Is a Quarter Wavelength?

Some Practical Figures for the Velocity of Wave Propagation in Antennas and Transmission Lines

By J. N. A. Hawkins,* W6AAR

THE growth in the use of quarter-wave and half-wave matching sections in modern transmission-line fed matched-impedance antenna systems requires an answer to that perennial problem, "How long is a quarter wave?"

Experience with "end effects" in radiating antennas indicates that electrical length and physical length of a conductor are not necessarily the same thing. Although resonant matching lines are ordinarily free from "end effects" they still are subject to a shortening effect which reduces their mechanical or physical length below the electrical fraction of a wavelength which they simulate.

The cause of this shortening is the reduced velocity of propagation of radio frequency energy through a conductor. Radio-frequency energy ordinarily travels through free space with the speed of light, close to 300,000 kilometers or 186,000 miles per second. If the velocity of the energy were the same in copper wire that it is in free space, a half-wave resonant line cut for exactly 7000 kc. would be slightly over 70 feet long. But the actual velocity of propagation through a typical half-wave section consisting of No. 12 wires spaced six inches (600 ohms characteristic surge impedance) is only about 97.5 per

cent of the velocity in free space, so that 7000-kc. energy will only travel 97.5 per cent of 70 feet during one-half cycle of oscillation. Thus the 7000-kc. half-wave section would only be about 68.5 feet long.

TABLE I

Line A (Parallel Open Wire).....	V = 0.975
Line B (Parallel Tubing).....	V = 0.95
Line C (Concentric Tube).....	V = 0.85
Line D (Twisted Pair).....	V = 0.56-0.65

cent of the velocity in free space, so that 7000-kc. energy will only travel 97.5 per cent of 70 feet during one-half cycle of oscillation. Thus the 7000-kc. half-wave section would only be about 68.5 feet long.

In a half-wave radiating antenna operating at 7000 kc. the "end effect" takes about 2.5 per cent off each end of the antenna so that it becomes about 95 per cent of 70 feet long, or about 66.5 feet in length.

It must particularly be noted that the "end effect," which shortens a radiating antenna, only affects the "outer" quarter-waves on the ends of the antenna; the shortening effect is not evenly distributed throughout the length of the antenna.

*2807 Eighth Ave., Los Angeles, Calif.

Thus for antennas greater than one-half wave long, the standard antenna length formula becomes

$$L_{\text{feet}} = \frac{492(K-0.05)}{F_{\text{Mc.}}}$$

Where L is the length in feet; K is the number of half wavelengths in the antenna and F is the frequency of operation in megacycles. Some experiments have shown a constant of 0.04 instead of 0.05; but 0.05 appears to fit most practical cases.¹

RESONANT TRANSMISSION LINES

Now the effect which causes a somewhat similar shortening effect in transmission lines and resonant matching sections differs from the above effect in that the effect is evenly distributed throughout the length of the line or matching section. Thus a half-wave resonant matching section is always exactly half as long as a full-wave section of the same construction. This differs from a radiating antenna since a half-wave antenna may be something less than half as long as a full-wave antenna resonant at the same frequency.

The only point about which care must be taken, in determining the physical length of a matching section, is to make the proper correction for reduced velocity of propagation. This varies with the nature of the conductor and the dielectric surrounding it.

Another point about the velocity of propagation is that it varies somewhat with frequency, and increases slightly as the frequency increases. However, for typical amateur use this variation with frequency can be neglected between 3 and 15 megacycles. Table I shows the average velocity of propagation of r.f. energy through lines of typical construction. The velocities are shown as percentages of free space propagation and are termed the factor V in the length formula shown below.

Line A is a conventional two-wire open line using wire sizes between No. 10 and No. 16 with spacings between two and six inches. It is also

(Continued on page 96)

¹ The correction factor 0.05 gives the same length in feet for a half-wave antenna as the $1.58 \times$ wavelength-in-meters and the $468,000/F_{\text{Mc.}}$ formulas for average length given in the A.R.R.L. Handbook for a number of years. See J. J. Lamb, "What Length Antenna?" QST, Oct., 1928—Editor.

Notes on Steatite-Type High-Frequency Insulation

By Hans Thurnauer*

Contrary to a more or less general impression, "steatite" is not a registered trade name for the products of any particular manufacturer, but is simply a good dictionary word meaning (according to Webster) "A massive variety of talc . . . —called also soapstone." In the United States, a number of organizations, including American Lava, General Ceramics and Isolantite, manufacture what are called "true steatite bodies" containing at least 80 per cent, and usually 85 per cent to 90 per cent, steatite. There is considerable difference of opinion in trade circles as to the relative high-frequency efficiency of products sold under the different brands of the various manufacturers, resulting in confusion to the amateur consumer and a general headache all around. Part of this confusion seems to be traceable to the fact that quantitative figures on loss factor vary widely, even for the same material, apparently because the methods and conditions of measurement are not uniformly the same. Moreover, the fact that loss factor alone is not the sole criterion of insulator loss is generally overlooked. The total power lost in the dielectric is also dependent on the total volume of insulation in the high-frequency field—which brings the mechanical properties of the insulation into the picture. A small piece of higher loss-factor insulation which has adequate mechanical strength for a given job may be preferable to a lower loss factor material which must be of greater volume because it has less mechanical strength. In an effort to cast some light on the situation, we have sought information as free from bias as possible and have obtained the following article on the general subject of steatite-type insulation. Further information and comments of practical interest to amateurs will be welcomed.—EDITOR

WELL-CONSTRUCTED high-frequency apparatus, transmitting as well as receiving, must fulfill at least two requirements. The dielectric losses of the apparatus have to be as low as possible, to assure high efficiency, and the construction has to be absolutely rigid to maintain constancy under any operating conditions.

To have a high- Q tuned circuit, the low-loss coil and condenser are of first importance; but all other components must be considered also to get satisfactory results. As a matter of fact, the better the coil and condenser, the more noticeable are losses introduced through additional components, such as terminal strips, insulating supports, tube bases, sockets, etc.

The other day we read an editorial in one of the radio magazines and found the following thoughts, which illustrate the point: "Engineers give plenty of thought to the Q 's of the component parts of circuits, but how many times have you ever seen anything on the resultant of hanging a good coil across a fairly good condenser, then hooking the whole works to a 'molded-mud' socket. Obviously something happens to the otherwise excellent Q exhibited by the coil—by itself."

We know what happens to our circuit if we use unsuitable insulators; dielectric losses are introduced which cut down selectivity of receivers and cause heating in transmitters.

Let us consider briefly what is understood by dielectric loss. Take a condenser consisting of two metal plates and a dielectric medium between the plates. If this condenser is subjected to the potential of a r.f. field, a current will flow through it; and if the dielectric is ideal, the phase difference

between current and potential will be exactly 90° . There is, therefore, no energy loss. A perfect insulating material is vacuum; and also perfect for all practical purposes is air.

If a liquid, or solid, dielectric is used, however, the case is different. Some of the energy is consumed by the insulating material. The phase difference between current and potential is not 90° but $90^\circ - \sigma$, where σ is called the *loss angle*. The tangent of σ ($\tan \sigma$) is called the *power factor*, usually represented in per cent.

The power factor is not the only material constant that has to do with the dielectric absorption of power. The power loss per unit volume of a material is proportional to the frequency, the square of the voltage gradient, and the product of the power factor and the dielectric constant of the material. This shows that not only the power factor, but also the product of power factor and dielectric constant should be used as a measure of the dielectric loss of a material. This product is called the *loss factor*.

If a condenser with a high capacity is needed, a material with a high dielectric constant will give the desired capacity with a small condenser volume; but the power loss per unit of volume is increased in proportion to the dielectric constant. For insulation of high-frequency circuits, especially where voltage and frequency conditions are severe, a material with low dielectric constant and low power factor should be selected to provide low energy absorption per unit volume.

In high-power short-wave transmitters it is absolutely necessary to use low-loss insulators, because otherwise heating from the high frequency currents due to dielectric losses may result in actual explosion of the insulator.

Air with a dielectric constant of 1 and a power

* American Lava Corp., Chattanooga, Tenn.

factor of 0 is the ideal insulator from the electrical point of view. Air, however, is not so easy to use as an insulator. Insulators not only serve as dielectrics; they also have to support or space metallic conductors and therefore have to be of a solid nature.

What the radio engineer needs, therefore, is an insulating material with these properties:

High mechanical strength and rigidity.

High electrical resistance (ohmic resistance).

Low dielectric loss over the whole frequency range of its application.

Among the natural minerals we only know of one possessing all these properties. That is quartz. Quartz has been regarded as the ideal material for radio insulation and insulators made of clear quartz glass (which is obtained by melting quartz crystals in the electric arc) have unsurpassed electrical properties. But quartz glass insulators are very limited as to sizes and shapes and their cost of manufacture eliminates quartz or quartz glass as a practical high-frequency insulator.

There are some low-loss materials among organic resins, especially in the polystyrol group. They lack, however, one important property—rigidity.

To find an "all-around" high-frequency insulating material we have to look among the ceramic materials and here we find the steatite bodies. They combine the desired mechanical and electrical properties and can be manufactured in quantities at economical prices.

What is understood by the term "steatite bodies"? So much confusion exists about these materials that it may be well worth while to give a brief description.

A steatite body is a high quality ceramic mate-

rial made chiefly of the minerals, steatite, talc or soapstone. These minerals, identical in chemical composition, but different in crystalline structure, are hydrous magnesium silicates of the formula

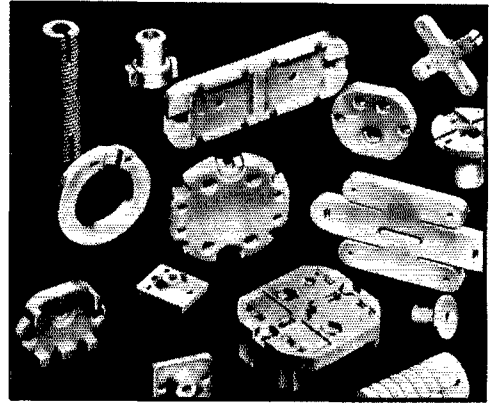

VARIOUS INSULATING PARTS MADE OF "LOW-LOSS" STEATITE AND USED FOR HIGH-FREQUENCY APPLICATIONS

$3 \text{ MgO} \cdot 4 \text{ SiO}_2 \cdot 1 \text{ H}_2\text{O}$. Talc, as used in face powders, is practically the same substance, with the only difference that face-powder talc is usually not pure enough to go into steatite insulation manufacture.

A true steatite body has to be made of at least 80 per cent talc or soapstone.

For making steatite insulators, the raw materials are finely powdered and carefully mixed with certain fluxes. Despite the fact that these fluxes

(Continued on page 98)

COMPARATIVE PROPERTIES OF SOME MATERIALS USED FOR HIGH FREQUENCY INSULATION
(These data represent average values and vary according to composition, size, shape, method of manufacturing and firing)

Type	Porosity (Percentage of water absorption)	Tensile Strength lbs. per sq. in.	Compressive Strength lbs. per sq. in.	Modulus of Rupture lbs. per sq. in.	Softening Temperature (Degrees F)	Dielectric Strength volts/mil	Volume Resistivity ohms/cm.—cube (AC 200 volts) at 75° F.	Dielectric Constant between 1 and 10 Mc.	Power Factor per cent between 1 and 10 Mc.	Loss Factor per cent between 1 and 10 Mc.
"Commercial" Steatite	.07-nil	6500-10,000	80,000-100,000	18,000-22,000	2600	200	Over 10^{14}	6.5-6.2	0.20-0.18	1.24-1.08
"Low-Loss" Steatite	.07-nil	8000-10,000	80,000-100,000	19,000-22,000	2550	200	Over 10^{15}	6.5-6.0	0.06-0.04	0.36-0.23
Dry Process Porcelain	Up to .25	1000-2000	30,000-50,000	8000	2100	40-100	Over 10^{14}	7	0.7-15	5.2-105
Quartz Glass	Nil	Above 10,000	282,000	10,200	2700	100	10^{18}	4.2	0.026-0.028	0.11-0.118
Glass-Bound Mica	.035	25,000	20,000	60	8.5	0.19	1.62

Making the Most of Directive Antennas

Practical Pointers on Operating a Number of Antennas in Limited Space

By Don C. Wallace,* W6AM

DIRECTIVE antennas have been used consistently at W6AM for a number of years. The present lay-out has been up for approximately three, and although other antennas are planned for the near future we shall confine the present description to those now in use. As to what can be done with them:

Often five continents will be worked on 'phone during the course of a single evening, sometimes in as short a period as two hours; all six continents were worked on three different nights during the 'phone portion of the last DX contest. Schedules have been maintained with CE1BC at Chafaral, Chile, for over a year without a miss, except for three times when he had to be absent for business reasons. Over a period of five months, weekly schedules were maintained with Manila on 20-meter 'phone without a break. Europe was worked on 'phone every night the station was in operation for a period of three weeks, and over a period of four months there were only three misses on any night Europe was called on 'phone. For two and one-half years schedules have been maintained with W2NB in New Jersey with never a complete miss during that time. These things are mentioned to show that with effective antennas 20-meter 'phone becomes more than a hit-or-miss skip proposition but takes on the characteristics of a consistent communication circuit—and we are all interested in two-way communication.

The beam antennas are universally used for reception as well as for transmission; to do this a changeover relay transfers the antenna in use (the various antennas are selected by manual switches) from the transmitter to the receiver. This gives an equivalent power gain on the other fellow in receiving and eliminates the necessity for requesting checks on various antennas when the direction of the station contacted is doubtful. It is surprising how accurate the operator can become in determining just where a station is long before it signs off. A quick trial of the various antennas soon indicates the direction, and the characteristics and frequency of the station usually will furnish the balance of the data necessary. On an average, the direction from which the station comes and its approximate location can be guessed nine out of ten times and often as high as nineteen out of twenty times. This is always interesting to visitors at the station.

14-MC. ANTENNAS

The 20-meter 'phone antennas number five. Four of these come off one pole like the spokes of a wheel and the fifth originates at another pole. Two poles only are used for the entire seven antennas (two are on 7 Mc.). Trees, swings and any other convenient points of attachment are used for the far ends of the arrays.

The first honest-to-goodness 20-meter beam was designed by W2NB when he was visiting here and it was put up so that W2NB and W6AM could have a weekly schedule at some time convenient to both of us. The antenna is an adaptation of the Sterba curtain, mounted horizontally to get the benefit of horizontal polarization in reducing local-noise pickup. It consists basically of eight half-waves in two tiers of four each. The radiating elements are all 95% of a half wave in space¹ and the feed-line portions are all an actual half-wave long. The total impedance at the feed point appears to be something like the total of all of the half-wave sections; that is, considering each half-wave section as having a resistance of seventy-two ohms, the termination at the end is something like 8 times 72, or 576 ohms. It happens that No. 14 wire spaced four inches (a standard spreader length) has a computed impedance of 576 ohms, which to all intents and purposes is a natural match and makes matching transformers unnecessary.

If the feed lines are properly terminated it will be found that there is little if any inter-action between the various antennas. Once in a while a little inter-action creeps in, which is not surprising since four are attached to one pole and at the other end of the lot there are three more. This means a lot of antennas in a small space, some of them crossing over others. In addition, the feed lines converge to one spot and for the most part go through the same window.

In order to check the results obtained by using different types of feed lines, a line of approximately 800 ohms was used on the same antenna with noticeably poorer results.

THE COMPLETE ANTENNA SYSTEM

Using this antenna as a basis, the construction of other antennas followed whenever an opportunity offered. They are all bi-directional, and we have gradually come to entitle them:

14 Mc.:

1. New York, Australia

* 4214 Country Club Drive, Long Beach, Calif.

¹ I.e., length in feet = 468/freq. (Mc.).

2. London, New Zealand
3. South Africa, Cuba, Hawaii, South Africa
4. Alaska, Seattle
5. Buenos Aires, Chile—Japan, China, Manila

7 Mc.:

1. Manila, Orient—Mexico, South America
2. New York, Chicago—Australia

In addition, the forty-meter Manila antenna (two half-waves in phase) is used as a half-wave antenna on eighty meters. For ten-meter operation, a vertical antenna consisting of two half-waves in phase is used. And on top of one of the 90-foot telephone poles (there are two on the lot) is a Johnson Q antenna used for five-meter work. This makes nine antennas in use, all of which have their lead-ins brought directly into the station. Sometimes two or three antennas are used at once, although this procedure usually pulls energy out of the direction

desired so it is not done except on rare occasions.

Each 14-Mc. antenna covers at its best point a region varying from $3\frac{1}{2}$ to 5 degrees either side of the direction toward which it is pointed. This gives a strong ten-degree beam in two directions. Each antenna is approximately thirty degrees from the next adjacent one, so in between is an area of reduced utility, although these areas are given a signal about equivalent to that from an ordinary half-wave antenna. Having ten directions at one's disposal, however, is productive of some interesting operation, as can well be imagined. Since putting up the complete layout there has only been a single $1\frac{1}{2}$ -hour period when the twenty-meter band was not good for DX—by which we mean something three thousand miles or over.

All of the antennas are not of the type described above; the drawings show seven in use.

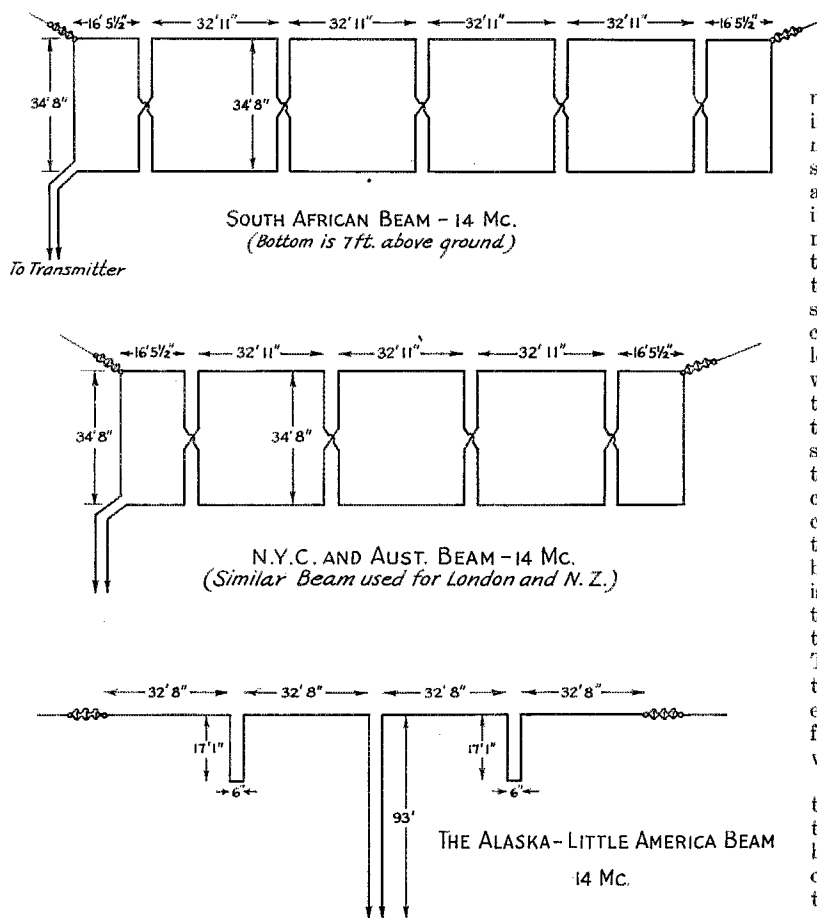

REDUCING INTERFERENCE

Directive antennas have several interesting features not ordinarily considered by the average amateur. For instance, QRM is minimized. With ten separate directions available, strong QRM becomes considerably less than what it would be on one antenna. Although the antennas respond in two directions, usually, because of the characteristics of the twenty-meter band, one direction is skipping out while the opposite direction is at its best. This is not always true, but it is true enough of the time for us to take advantage of it.

It is far quicker to switch from antenna to antenna by means of switches over the receiver than it would be to rotate an antenna, consequently more stations can be spotted and called.

FIG. 1—THREE DIRECTIVE ANTENNA ARRANGEMENTS USED FOR 14-MC. WORK AT W6AM

All consist of phased elements, the line of maximum propagation being broadside to the line of the antenna.

All stations naturally cannot be in the strongest part of the beam, but even at an angle of about fifteen degrees from the optimum direction the signal strength is comparable to that obtained with a half-wave antenna—and beyond that there is another antenna to switch in. Sometimes two antennas are used simultaneously when the

population of the United States—and likewise probably 70% of the amateur stations. This is a busy region, and QRM conditions are almost as bad on that antenna as on a half wave.

GETTING DIRECTIONS RIGHT

Many amateurs who have put up directive antennas try them out

and say, disgustedly, "Oh, it doesn't work as well as my old antenna." In every case that I have personally run down I have found that the particular amateur did not know the real direction in which the antenna was pointed. He laid it out by

guess and by gosh, and simply had not gone to the

trouble to determine his directions exactly. This was very strongly brought home at the time the first European antenna was put up here. It happens that the two poles on the lot are so placed that if a broadside antenna is strung up between them it appears to be directed toward Europe. I put up four half-waves in phase between the two poles, thinking I would get Europe. Sweden, Denmark and Finland were very easy to work on this particular antenna—countries that ordinarily were not heard on any other antenna on the place—but after a week's listening it was found that no London signals had been heard, nor any French nor German. A correction was made by running a long guy wire from the pole over to a

tree so that one end of the antenna could be swung around approximately seven degrees, upon which it was found that London amateurs were plentiful, as well as French, German, and even some Italians and Swiss. However, since the antenna has been moved out no more Swedish or Danish stations have been heard. A seven-degree correction changed the European situation entirely. The present set-up is used because there are many more twenty-meter 'phones in the London area than in any other part of Europe.

(Continued on page 106)

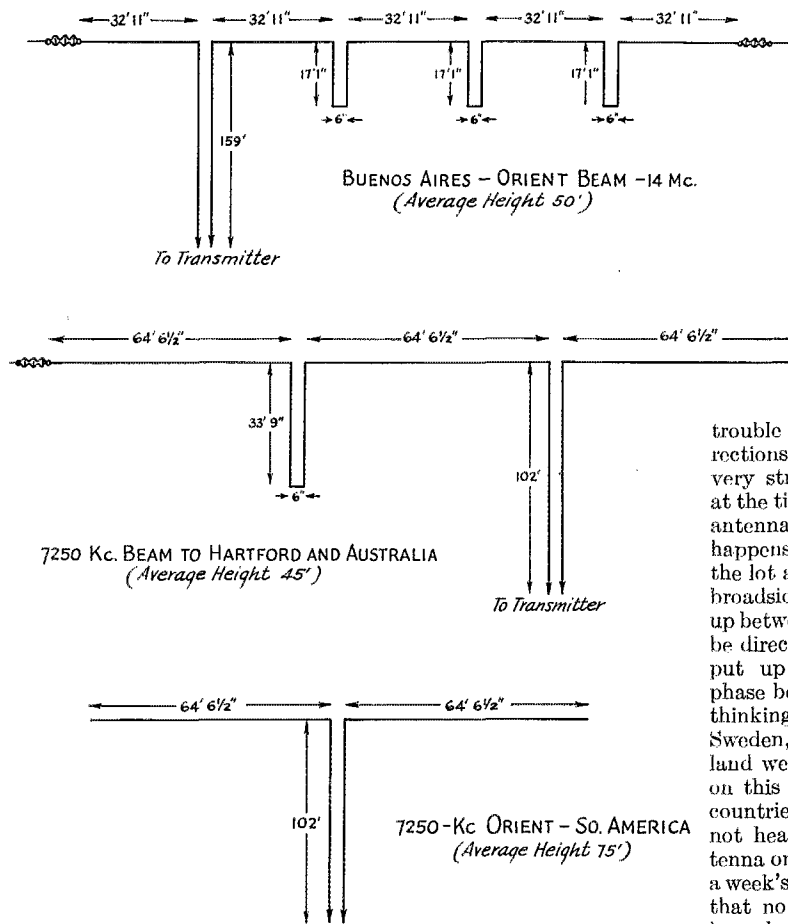

FIG. 2—14- AND 7-MC. ANTENNAS

The antenna in the lower drawing is also used for 3.5-Mc. work as a center-fed half wave.

desired station lies midway between the two, or one of the two will be chosen because of excessive QRM on the other. For instance, in working stations in South Carolina or Florida (one of the directions not optimum at W6AM), it is much more satisfactory to use the Cuban antenna for, although this antenna does not deliver a stronger signal to this area than does the New York antenna, it has relatively smaller QRM in reception. The New York line from Long Beach goes through such cities as Denver, Kansas City and Chicago, taking in about seventy percent of the

A Deluxe 100-Watt C.W.-'Phone Transmitter With Band-Switching Exciter

By George F. Wunderlich,* W6DUW

W6CLT came to us recently with an order for a transmitter involving some features which he believed would make for convenience of operation. The requirements were as follows:

1. Band switching from 1.75 to 30 Mc., including all stages up to the final plate tank coil.
2. Fixed neutralization.
3. Simplicity of operation.
4. Completely self-contained and semi-portable.

Believing that the resulting transmitter has features which may be of general interest to the

*Kaar Engineering Company, Palo Alto, California.

amateur fraternity, the constructional features are described in this article.

R. F. SECTION

A glance at the tube line-up of the radio-frequency portion of transmitter (Fig. 1) will disclose a quite conventional choice of tubes. Starting with the crystal oscillator, we have the 6A6 serving as oscillator and doubler. Provision is made for selecting any one of five crystals by means of a Centralab bakelite five-point switch. Plate coils in the oscillator circuit are switched at the "hot" ends, using the new Centralab isolantite wafer switches. L_1 covers the 1.75- and

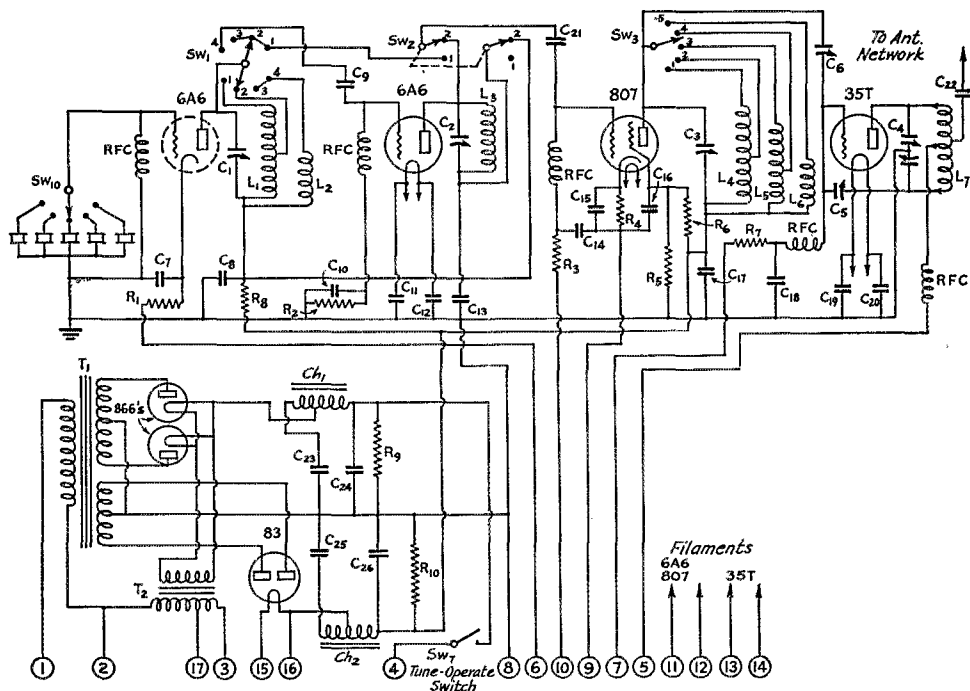
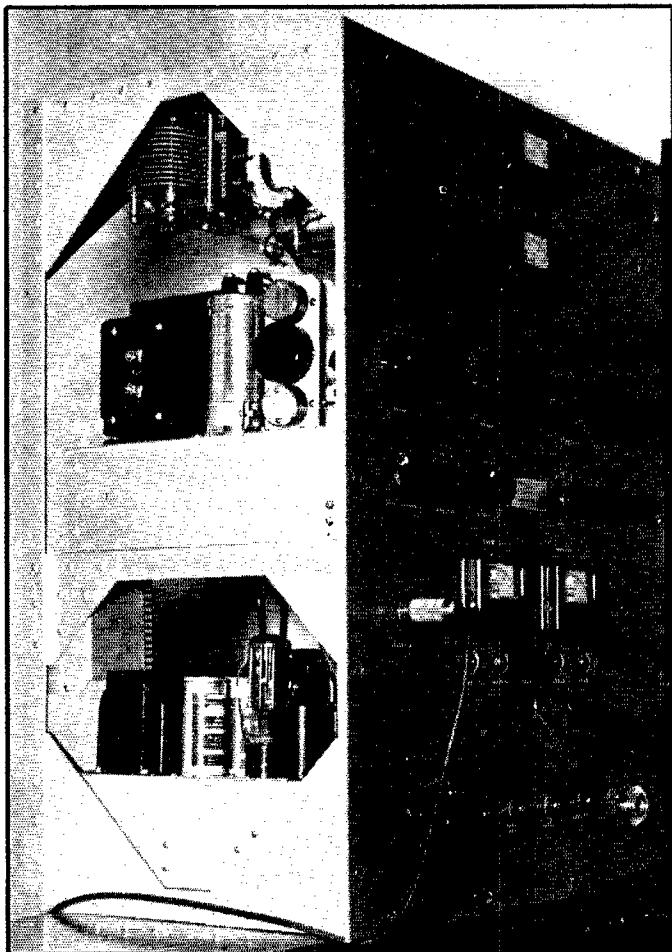

FIG. 1—CIRCUIT OF THE R.F. SECTION

$L_1, L_2, L_3, L_4, L_5, L_6, L_7$ —See text.
 C_1 —200- μ fd. midget variable.
 C_2 —50- μ fd. midget variable.
 C_3, C_6 —100- μ fd. midget variable.
 C_4 —100- μ fd. per section, 3000-volt.
 C_5 —2-plate midget variable, triple-spaced.
 $C_7, C_8, C_{10}, C_{13}, C_{14}, C_{15}, C_{16}, C_{18}$ —0.01- μ fd. 600-volt tubular.
 C_9 —100- μ fd. 500-volt mica.
 C_{11}, C_{12} —0.006- μ fd. 600-volt mica.

$C_{17}, C_{18}, C_{19}, C_{20}$ —0.002- μ fd. 1000-volt mica.
 C_{21} —0.001- μ fd. 1000-volt mica.
 C_{22} —0.002- μ fd. 5000-volt mica.
 C_{23}, C_{24} —2- μ fd. 1500-volt oil condenser.
 C_{25}, C_{26} —2- μ fd. 700-volt oil condenser.
 R_1, R_4 —450-ohm 10-watt.
 R_2 —50,000-ohm 1-watt.
 R_3 —15,000-ohm 10-watt.
 R_5 —50,000-ohm 10-watt.

R_6 —20,000-ohm 10-watt.
 R_7 —2000-ohm 10-watt.
 R_8 —500-ohm 10-watt.
 R_9 —75,000-ohm 100-watt.
 R_{10} —25,000-ohm 25-watt.
 T_1 —2400 v.c.t., 150 ma. 1000 v.c.t., 150 ma.
 T_2 —2½ v.c.t., 12-amp.
 Ch_1 —20-h. 250-ma. choke.
 Ch_2 —15-h. 150-ma. choke.



Because of stray capacities attendant to band switching, it was found inadvisable to operate the 807 as a "straight-through" amplifier on 14 and 28 Mc., since excessive regeneration was encountered. This arrangement does not result in a lack of excitation, however, because the 807 operates so well as a harmonic generator, plate efficiencies of 50% being obtained from the tube in doubling. Actually, it was found that the 35T amplifier could be over-driven with excitation on all bands; hence the excitation control condenser C_6 was included in the set-up.

The band-switch arrangement in the plate circuit of the 807 is quite conventional, and switching here is again accomplished with a Centralab isolantite wafer-type switch. Positions 1, 2, 3, 4 and 5 cover

THE COMPLETE TRANSMITTER READY FOR OPERATION

Controls, reading from left to right, are as follows: Top Row—Crystal plate, doubler plate, buffer plate, amplifier plate. Second Row—Crystal selector switch (SW_1), doubler plate coil switch (SW_2), Buffer plate coil switch (SW_3), excitation control (C_6), tune-operate switch (SW_7). Bottom Row—Audio gain, CW-Phone (SW_9), filament supply (SW_4), plate supply (SW_5), modulator (SW_6), 110-120 volt line switch (SW_8), 6E5 overmodulation indicator.

3.5-Mc. bands, and L_2 7 Mc. SW_1 is a single-section 2-pole 5-position switch. With SW_1 in Position 1, 2 or 3, 1.75-Mc., 3.5-Mc. or 7-Mc. excitation, respectively, is furnished to the grid of the 807 stage. For operation on 1.75, 3.5, 7.0 and 14-Mc., SW_2 is left on Position 1. It will be noted that for 14-Mc. operation the 807 functions as a doubler, working from the 7-Mc. crystal. For 28-Mc. operation, SW_1 is turned to Position 5 and SW_2 to Position 2. This puts excitation on the second triode portion of the 6A6, applies plate voltage to that circuit, and switches the grid of the 807 from the oscillator plate circuit to the 6A6 doubler plate circuit. Thus on 28 Mc. we have a 7-Mc. crystal oscillator, 14-Mc. 6A6 doubler, and the 807 doubling 28 Mc.

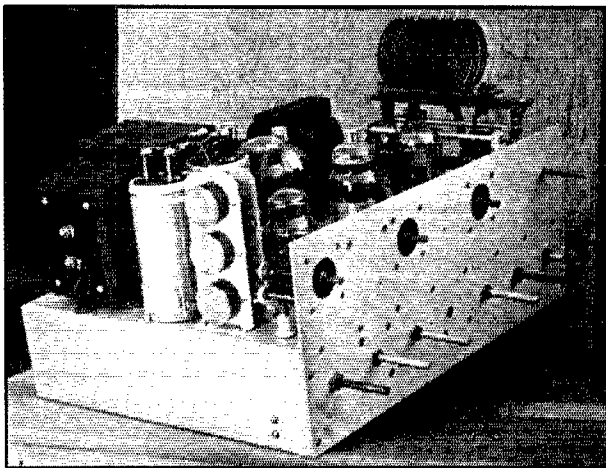

THE R.F. UNIT REMOVED FROM THE FRAME

the 1.75-, 3.5-, 7-, 14- and 28-Mc. bands, respectively.

No coil data are specified in this article, since different layouts will affect stray capacitance and inductance a quite appreciable amount. To the constructor who contemplates duplicating an exciter of this type, let me point out that the strays are quite high, resulting in what may look like too high a ratio of C to L . Actually, despite this necessary compromise, 15 to 25 watts of excitation are available; so let us not allow purist arguments to overrule expediency or convenience, since we accomplish our purpose finally.

A word as to coil forms. Ordinary moulded or ceramic forms of the 1-inch of $1\frac{1}{2}$ -inch diameter variety are quite satisfactory anywhere in the exciter, excepting in the 28-Mc. coil position. At this frequency we cannot recommend too highly the use of an "air-supported" coil. Even coils wound on good-grade ceramic forms were found to be inferior to "air-supported" coils.

The final amplifier, using plug-in coils in the

interest of highest efficiency and space-saving, contains nothing unorthodox. Requirements called for 100 watts of carrier power on all bands, and this was met easily by the 35T used here. Its low interelectrode capacity aids materially in maintaining "fixed neutralization," besides insuring an efficient L - C ratio at 28 Mc. Power input to this tube runs around 150 watts.

AUDIO SYSTEM

Referring to Fig. 2, it will be seen that the audio system consists of a 6F5 speech amplifier, 6N7 phase inverter, push-pull 6C5 drivers, and a pair of 6L6G Class-AB modulators. By raising the plate voltage slightly and increasing the bias and load impedance on the 6L6 stage, it is possible to realize 70 watts of good clean audio with sine-wave input.

R.f. feedback evidenced itself in the audio portion, particularly on 14 and 28 Mc. A small cast dural box housing the microphone jack and its associated r.f. choke removed this difficulty.

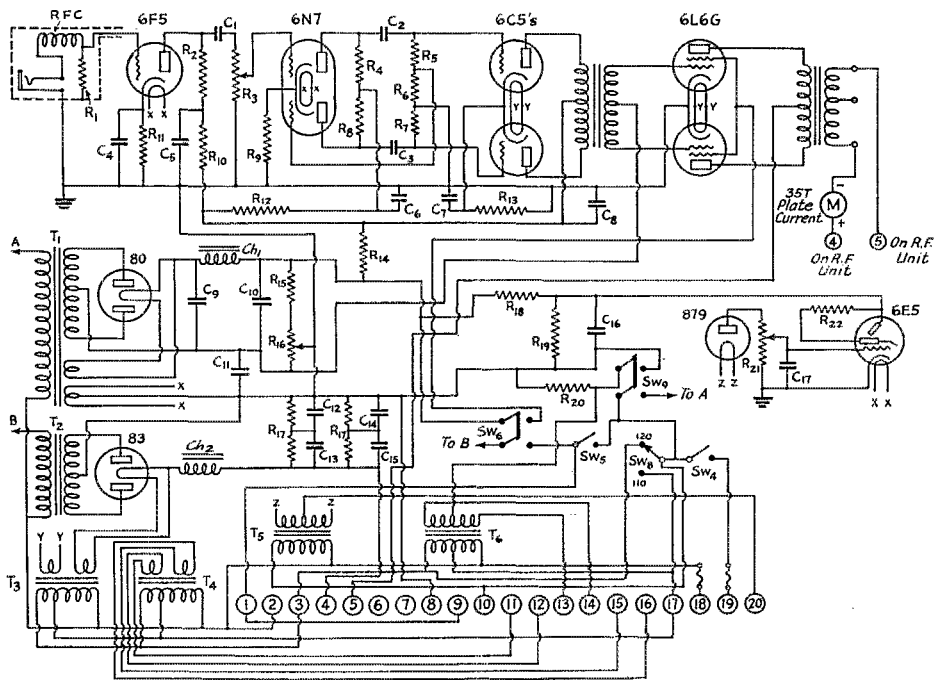
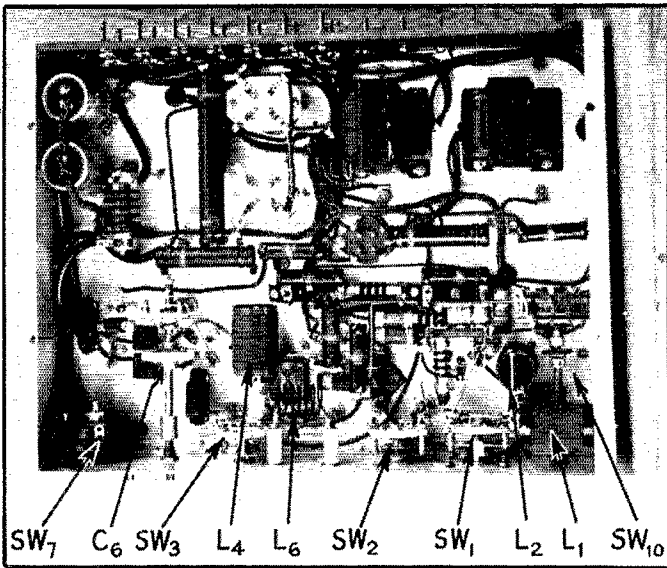

FIG. 2—THE AUDIO SECTION

- C1, C2, C3—0.05 μ fd. 600-volt.
- C4, C7—5 μ fd. 25-volt.
- C5, C16—4 μ fd. 450-volt.
- C6, C8, C9, C10—8 μ fd. 450-volt.
- C11, C12, C13, C14, C15—25 μ fd. 25-volt.
- C17—0.5 μ fd. 600-volt.
- R1—5-meg. $\frac{1}{2}$ -watt.
- R2—250,000-ohm $\frac{1}{2}$ -watt.
- R3—1000-ohm potentiometer.
- R4, R8, R19—100,000-ohm 1-watt.
- R5, R7—500,000-ohm $\frac{1}{2}$ -watt.
- R6—20,000-ohm $\frac{1}{2}$ -watt.
- R9—2000-ohm 1-watt.

- R10, R12—50,000-ohm 1-watt.
- R11—4000-ohm $\frac{1}{2}$ -watt.
- R13—500-ohm 1-watt.
- R14—2500-ohm 10-watt.
- R15—15,000-ohm 10-watt.
- R16—1500-ohm 25-watt variable.
- R17—500,000-ohm 1-watt.
- R18—5000-ohm 2-watt.
- R20—300-ohm 10-watt.
- R21—500,000-ohm potentiometer.
- R22—1-meg. $\frac{1}{2}$ -watt.
- T1—700 v. c.t., 50-ma.—5 v. 2 amp.—6.3 v. 2 amp.

- T2—1200-v. c.t., 250 ma.
- T3, T4—5 v. 3 amp.—6.3 V., c.t., 3 amp.
- T5—2 $\frac{1}{2}$ v. c.t., 4 amp.
- T6—5 v., c.t., 12 amp.
- Ch1—20-h. 85-ma. choke.
- Ch2—30 to 5 h., 25 to 250 ma.
- Sw4—Fil. supply switch.
- Sw5—Plate supply switch.
- Sw6—Modulator "on-off."
- Sw8—110-120 v. line switch.
- Sw9—"Phone-C.W. switch.



BOTTOM VIEW OF THE R.F. UNIT
The symbols refer to Fig. 1.

The negative-peak overmodulation indicator, comprising the 879 and 6E5 tubes, is the one described by Mr. L. C. Waller in Nov., 1936, *QST*. It is a remarkably sensitive device and a little juggling of C_{17} will produce quite a variety of time constants in the action of the 6E5 indicator. It has proved to be far superior to an oscilloscope for overmodulation monitoring, since a transient peak shows up for about a second, where it would be of too short duration on the oscilloscope to be perceptible to the eye.

MECHANICAL CONSIDERATIONS

Weight being a consideration in the design of this transmitter, dural has been used throughout in all the metal work. At this point allow me to digress to one of my pet subjects. The majority of amateurs use either a cadmium-plated steel or half-hard aluminum chassis. Both have their objectionable features. Those who do not have access to drill presses find it a tough job to machine a steel chassis, particularly where a number of socket holes are needed. Then, too, after machining the chassis a number of unplated areas are left exposed, with rust spots sure to set in. Aluminum, while easy to machine, does not work "cleanly"; that is, it has a tendency to be gummy and to raise burs. In my opinion the use of dural overcomes all these difficulties. The so-called "52S-1/2 hard" sheet dural machines cleanly and easily, is stiffer than aluminum, and is readily bent at angles without cracking. For panels, gusset plates and angle stock for racks, the 17ST (heat-treated) grade is the metal to use, since it is one of the hardest of the aluminum alloys. In

addition, 17ST dural is available in square, round, hexagonal and rectangular bar stock and can be used in place of brass for those shaft couplings, neutralizing condensers and similar gadgets which we usually "home-brew." Any of the above materials take on a very nice appearance when bright-dipped and coated with clear lacquer. This operation can be performed quite cheaply by your local plating works.

So, to get back to our story, all chassis were made from 52S dural. As may be seen from the photographs, only the two ends of the chassis are bent down. Half-inch dural angle has been riveted all around the front and back, inside of the chassis, and a sheet of dural riveted on the front face of the chassis. On the back side, a piece of 1/4-inch natural sheet bakelite has been screwed, to form the back side and terminal strip in one. The framework was made from 1 by 1 by 1/8-inch 17ST dural

(Continued on page 110)

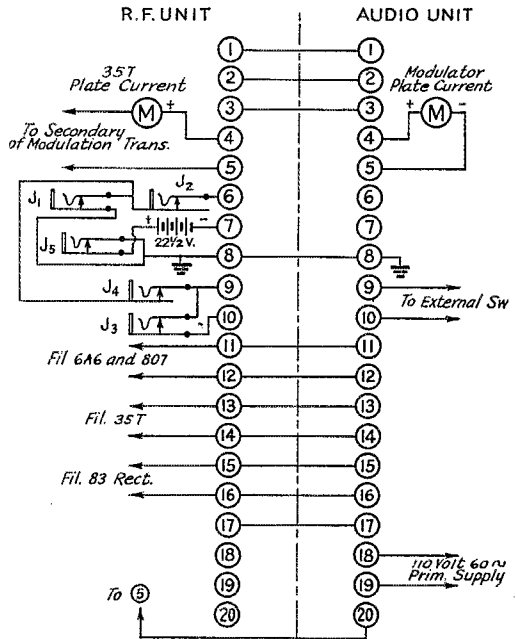

FIG. 3—TERMINAL CONNECTIONS

- J_1 —Key jack.
- J_2 —Oscillator plate current meter.
- J_3 —807 buffer grid meter.
- J_4 —Buffer plate current.
- J_5 —35-T final grid current.

How Would You Do It?

What to Do About Filing Spare Parts: Announcing Problem Number 11

THE various solutions submitted in response to Problem Number 9 differed only slightly in theme. As you may remember, the problem was to find a simple, yet effective system for arranging spare parts and workshop materials so each could be located quickly without the necessity for turning the workshop upside down.

The general idea submitted by most of the contestants is a system of boxes or compartments, suitably labeled, into which spare parts and materials are consigned according to their classifications. The arrangements vary from a collection

ing to the name of the article. Every piece of spare material and the quantity of each is listed in the file. The file card indicates in which box the desired part will be found. Whenever a part is taken out for use or sale, it is taken off the list and the date of the removal and the purpose for which it was removed are recorded. Similarly, when parts are added, they are added to the file. Thus, a continuous record of parts on hand is available, so that, when a new piece of construction is contemplated, it takes but a few moments to determine what new parts must be purchased.

Second prize is awarded to E. N. Fuertes, K4EDS for his sketch of a novel portable hinged box arrangement, shown in the drawing of Fig. 1. The box may be placed on the work bench where it will not occupy much space and where everything for the job will be at hand. When not in use, it can be folded closed and kept in any out-of-the-way corner of the shack, attic, basement or closet.

As will be noted, the completed job is formed by two boxes approximately 6" by 18" by 30", hinged together to form one unit. The sides, top and bottom of each individual box are cut from $\frac{1}{2}$ " by 6" stock of any light wood. The backs, shelves, stops and partitions are cut from $\frac{3}{16}$ " or $\frac{1}{4}$ " plywood. The sides, top and bottom pieces

(Continued on page 118)

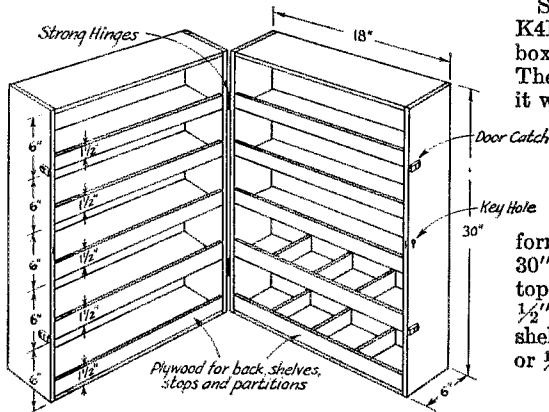

FIG. 1—A COLLAPSIBLE, PORTABLE RACK FOR SMALL AND MEDIUM-SIZE PARTS

of lowly shoe boxes and orange crates to a manufactured steel cabinet, which may be purchased, built to desired specifications, at prices up to sixty or seventy dollars.

Five-pound package-cheese boxes, measuring 4" by 4" by 12", and cigar boxes seem to be the most often suggested as containers of small parts. Coffee cans, mayonnaise jars, fruit jars and cake tins are also suggested. These are lined up on a series of shelves, varying widely in degree of elaborateness, located near the work bench.

Owen Dowd, W2JHB, wins first prize, principally because he was the only one to suggest a card-indexing system for keeping a continual record of parts available for use. His arrangement consists of a series of shelves containing six rows of cigar boxes for small and medium-size parts, a row of home-made boxes about four times the size of the ordinary cigar box for larger parts and two or three widely spaced shelves for the bulkiest items. Instead of labeling each box with its contents, each is given a number.

The card file is arranged alphabetically accord-

Problem No. 11

O. H. is now looking for an honest-to-goodness signal and keying monitor. He has seen many descriptions of systems for continually monitoring the transmitted code signal, but unfortunately most of them have been more or less involved. Specifically, what he wants is an arrangement with which he can listen to his own transmitted signal without the necessity for switching over the headset. Means must be provided for varying the volume and pitch of the beat note to suit his taste. The monitoring system must be completely stable so as to give him a true indication of his signal characteristics and must be capable of monitoring overall frequencies between 1700 and 30,000 Mc. with a minimum of circuit change between bands. If possible, he would like to do away with relays. He wonders if some simple system hasn't been worked out by someone.

Announcing—Eighth A.R.R.L. Sweepstakes

Contest for W, VE, K, KA, CM and VO Hams—Nov. 13th–14th, 20th–21st—
'Phone or C.W. Any Ham Band(s)—Test Stations—Proves Operating Supremacy—Medallion Awards to the C.W. and 'Phone Leaders in Each Section¹—Certificates in Each Club—Gavel Trophy to Winning Club

F. E. Handy* WIBDI

TELEGRAPHING operators will work and compete with other telegraphing operators. 'Phone hams will compete with other 'phone hams. The event is the annual "SS"! Don't miss it.

New medallion awards will be made by the League to the winners in each group in each A.R.R.L. Section. The illustration hardly does this bronze medallion (likeness of T.O.M., Maxim) full justice. Winner's call will be engraved on each award. They're beauties.

Many will also complete their QSL-card record and achieve "WAS" honors through this year's SS. Whether you wish to "work all states" or all A.R.R.L. Sections (even tougher) this is the prime chance of the year to progress toward that objective. The basic idea of the contest is to see how many stations can be worked in such a brief time. The points derived from this will be multiplied by the number of different A.R.R.L. Sections² worked with at least a complete one-way exchange in the contest. Message swaps are *not* required in proof of QSO this year. All essential contest information is sent in the form of a standard preamble. Exchanges are for the record sent to Hq. New hams may also add to their knowledge of the way preambles to A.R.R.L. messages are sent and acknowledged, and fills requested, accuracy of 'phone communication assured, etc., if they take part and follow the standard practices set forth for these things in the new edition of *The Radio Amateur's Handbook*. Some emergencies of late years have found amateurs unfamiliar with good operating practices resulting in delays, garbles, and inability to write or take a

message in standard form. We hope that the "SS" will help both new and old timers to improve and perfect operating technique at the same time all make new station records.

All contest exchanges can be logged directly on the sheet that you send Hq. for a report. Paper work will be completed as you go along with nothing to do but total and summarize points and send it in. *Mimeographed contest forms will be sent gratis to anyone who sends a radiogram or drops a card for the same.* Use of our sheets is not required nor is advance entry necessary. The purpose is to help participants keep a uniform log. It is necessary that the arrangement or form shown with this announcement be followed. Draw your own columns on your own paper if you like . . . or ask us for the prepared sheet.

The "S" schedules operating in two week-ends with a time limit; 33 hours of two week-ends have been specified. You can work more than 20 hours on *one* of the two week-ends, but in no case will

any entry of more than *40 hours' total operating* in the two contest periods be accepted. Use any amateur frequency bands you choose. This timing plan permits the average ham to plan for his time for meals, for 8 hours' daily sleep, etc. Cross examination of logs makes it possible to check operating time.

Effective choice of and use of the available operating hours, the different amateur bands, and operating proficiency will take one a long way toward success. Single-signal selectivity and high sensitivity will win and bring in the stations at distant points calling you. However, results mainly depend on the man behind the station!



* Communications Manager, A.R.R.L.

¹ Including Cuba, Porto Rico, Hawaii, Alaska, P. I., etc. Amateurs in Newfoundland are included in the Maritime Section of the A.R.R.L. field organization.

² See the complete list of the 70 Sections in the A.R.R.L. organization page 7 of this issue of *QST*.

THE GENERAL CALL

"CQ SS CQ SS CQ SS de W . . . W . . . W . . ." is used by stations looking for contacts in the Sweepstakes. A single, snappy CQ SS will bring good results! You will test station perform-

THE CONTEST PERIOD

Time	Starts	Ends
A.S.T.	Nov. 13 & 20, 7:00 P.M.	Nov. 15 & 22, 4:01 A.M.
E.S.T.	Nov. 13 & 20, 6:00 P.M.	Nov. 15 & 22, 3:01 A.M.
C.S.T.	Nov. 13 & 20, 5:00 P.M.	Nov. 15 & 22, 2:01 A.M.
M.S.T.	Nov. 13 & 20, 4:00 P.M.	Nov. 15 & 22, 1:01 A.M.
P.S.T.	Nov. 13 & 20, 3:00 P.M.	Nov. 15 & 22, 12:01 A.M.

ance, work new states and Sections, improve operating efficiency and ability, and meet old and new friends, in the '37 SS.

PROOF OF QSO

At least a *one* way complete six part exchange must be completed and acknowledged between two stations as "proof of QSO"⁴ before points or Sections can be claimed.

It is not essential that each station worked be taking part in the contest to make your points count. Any operator who needs information can be referred to this announcement. First, ask the operator to take your preamble and come through with like information in preamble form.

POWER FACTOR AND SCORES

If the power input to the final stage (plate current times plate voltage— $E \times I$) is:

- (a) Up to and including 100 watts—multiply score by 1.5.
- (b) Over 100 watts—multiply score by 1.

Operating in both low- and high-power classes at different times is still permitted, but scoring rules do not permit Sections worked on high power to be used in the low-power classification. Points of some kind are credited for every QSO with a *bona fide* exchange, whether the station worked is a leading "SS" man or a ham outside the contest. If one breaks his power class, however, the Total Score is the *sum of scores separately computed* for each power class and added.

Scoring system in brief:

All contacts:

One point for each QSO when "receipt" is completed for an exchange one way.

Two points for each QSO when the required information is exchanged both ways.

For final score:

Multiply totaled points by the number of different A.R.R.L. Sections² worked, that is, the

³ Send the letters CK and just the three number RST report. In 'phone exchanges only two numerals need be used in the report, the first always "readability," the second "strength."

Instead of just the state (which is the same as the Section in many cases), identify your A.R.R.L. Section as, for example, Salem, Eastern Mass.; Prov., R. I.; Buffalo, W. N. Y.; Omaha, Neb.; Oakland, E. Bay, etc.

⁴ There is no point in working the same station more than once in the contest period if two points have been earned by an exchange. If but one point is made the first time, you can add a point by working this station again for exchange in the opposite direction. Underline all such exchange entries in your "list," identify them by showing parenthetically the call of the correspondent station. Leave right or left report columns blank so that other pairs of exchanges completed in *one* contact are side by side.

⁵ The highest individually-attained score of any *one* of the operators of amateur stations having more than one operator is the official score for such a station. The summary of score must show *all* stations worked by *all* operators however, circling the entries of stations and/or Sections that cannot count in the official total. Awards will be based on the official total and will be made to the individual operator accredited with this total. To show the possible scores that can be built up by several operators at one station, such scores (all Sections listed by all points listed) may be shown parenthetically after the "official" score that counts toward a possible award.

EXPLAINING CONTEST EXCHANGES

Send Like Std. Msg. Preamble	NR	Call	CK	Place	Time	Date
In the "SS" Exchanges	Number contest info. sent consecutively, 1, 2, 3 etc., a new nr. for each station worked	Send your own call	CK is RST report ³ of station worked	Your city and section ^{1, 2}	Send time of transmitting this "NR"	Send date of QSO
Purpose.....	The QSO-nr tells how you are doing; aids Hq. checking	Identifica-tion	All stations exchange complete reports	The A.R.R.L. Section is vital contest data	Time and Date must check in both logs and fall within the contest period to prove each point claimed	

number in which at least one *bona fide* S.S. point or exchange has been made.

Multiply this ⁶ by 1.5 if you used 100 watts or less for transmitter input.

ADDITIONAL RULES

1. Information in contest exchanges (six parts) must be sent in the order indicated, that of the A.R.R.L. message preamble. Incomplete exchanges or wrong order of sending justifies disqualification.

2. Entries should be (a) in the low-power class, or (b) high-power class, or submitted as the sum of separately computed work at one station falling in each class. Sections worked on high power do not count in the multiplier for low-power-score and vice versa. Logs must show the power used for each QSO or for groups of QSOs.

⁶ If the power was changed between (a) or (b) during the contest, separate scores must be kept for each power class, and the two added together for the total.

3. Reports must show operating time for each period spent on the air in the "SS," and the total of such operating time.

4. Logs must be marked for "Phone" or "C.W." entry, grouping all work by either method together as one score.

5. All work must fall in the contest period.

6. Decisions of the award committee of C.D. staff members shall be accepted as final.

7. Reports must be received at A.R.R.L. Hdq. from all stations except those in Alaska, Hawaii, and P. I. on or before noon, Dec. 24, 1937, to be considered for certificate awards. From outlying points, reports must similarly be received on or before Jan. 20, 1938.

CLUB PARTICIPATION

Certificate awards (besides the 'phone and telegraph Section awards) will be made through each club where *three or more* individual club members,

(Continued on page 118)

STATION W/VE ¹ . . . SUMMARY OF EXCHANGES 8TH A.R.R.L. ALL-SECTION SWEEPSTAKES															
Freq. Band (mc.)	Time On or Off Air	NR	SENT (1 point)				RECEIVED (1 point)				Time (Nov.)	Date (Nov.)	Number of each Different New Section as W'd	Points	
			Stn.	CK-RST	Place	Time	NR	Stn.	CK-RST	Place					
3.5	On 6:10 P.M.	1	W1AW	579	W. Hartford, Conn.	6:15 P.M.	13	3	W1GME	589	Middlebury, Conn.	6:18 P.M.	13	1	2
		2	"	439	W. Hartford, Conn.	6:25 P.M.	13	7	W1BHM	479	New Haven, Conn.	6:30 P.M.	13	..	2
		3	"	587	W. Hartford, Conn.	6:40 P.M.	13	2	W3BKZ	389	Chevy Chase, M.D., D.C.	6:45 P.M.	13	2	2
		4	"	498	W. Hartford, Conn.	10:18 P.M.	13	3	W8BEN	569	Rochester, W. N. Y.	10:24 P.M.	13	3	2
		5	"	578	W. Hartford, Conn.	1:25 A.M.	13	7	W9TSV	589	Chicago, Ill.	1:15 A.M.	13	4	2
		6	"	549	W. Hartford, Conn.	2:50 A.M.	13	15	W9VKF	479	Minneapolis, So. Minn.	2:55 A.M.	14	5	2
14	Off 3:00 A.M. 8 hours 50 min. On 1:00 P.M.	7	W1AW	479	W. Hartford, Conn.	2:15 P.M.	20	14	W5WG	339	Ruston, La.	1:05 P.M.	20	6	1
		8	"	588	W. Hartford, Conn.	3:00 P.M.	20	17	W5BDI	459	Houston, So. Tex.	2:20 P.M.	20	7	2
7	"	9	"	578	W. Hartford, Conn.	4:06 P.M.	20	11	W1EWD	589	New Britain, Conn.	2:55 P.M.	20	..	2
		10	(W5WG) ⁴		Conn.	P.M.									
"	"	10	W1AW	347	W. Hartford, Conn.	4:30 P.M.	20	16	W6MVK	439	Modesto, S. J. V.	4:31 P.M.	20	8	2
		11	"	479	W. Hartford, Conn.	5:10 P.M.	20	9	W9LPT	579	Wheaton, Ill.	5:15 P.M.	20	..	2
4 h. 20 m. 13 h. 10 m.												8 Sec. 22 pts.			
3.5, 7 and 14 mc. used. 85 watts Input Power															

Number and name of operators having a share in above work.
 Claimed score: 22 points x 8 Sections = 176 x 1.5 (85 watts input) = 264
 I hereby state that in this contest I have not operated my transmitter outside any of the frequency bands specified on my station license, and also that the score and points set forth in the above summary are correct and true.

Signature
 My Tube Line up
 Number Different Stations Worked
 Address

HINTS and KINKS for the Experimenter



Regulated Plate Supplies

A GREAT deal of interest has been shown in the subject of voltage-regulated plate supplies of the type described in our August issue.¹ Since amateurs are indefatigable experimenters, it is only natural that several suggestions for changes and improvements have been forthcoming. Here are some from B. P. Hansen, W9KNZ, who has contributed a good many items to these columns:

"The regulated power supply described on page 17 of the August issue has proved thoroughly satisfactory here. Built up exactly to specifications, its performance is nothing short of remarkable. I'm using it on my receiver and the improvement in stability and reduction of hum over the

through excessive line surges that would otherwise extinguish it. With the resistor installed, the only effect of such a surge is a momentary hum that fades right out. By using this resistor it is possible to maintain regulation and still draw a little more current from the unit before regulation is lost. Loss of regulation manifests itself by the appearance of the hum mentioned in the article.

"Third, if the last audio stage is tapped into the supply at the point shown—that is, ahead of the regulator tube—the current drain on the regulator will be greatly reduced. Picking up the supply for the power audio this way does several things: it allows the application of higher voltage to the plate of the power stage; it reduces hum, contrary to expectations, because it reduces the load on the regulator unit; regulation is improved, perhaps due to the bleeder action of the power audio stage ahead of the regulator.

"Fourth, I frequently use headphones, and the first time I used headphones with this supply, I noticed a hiss that wasn't present on the old supply. An 8- μ f. condenser across the output reduced it but it could be completely eliminated by connecting a 0.1- μ f. tubular, C_5 , across the neon tube. Investigation with the oscilloscope bore out the guess that the neon tube with its associated resistors was oscillating at some high frequency. The by-pass condenser stopped this and the audio quality cleared up.

"Fifth, while working on the hiss, I decided that the hum level was too high for comfortable headphone operation, quiet though it was on the speaker. Installation of C_4 (0.25- μ f. tubular), across the junction of R_1 and R_2 to the grid of the control tube took the hum down several db. A further slight but worth-while improvement was effected when C_3 was connected from one side of the 2A3 filament to ground. It is essential that this condenser be connected to the proper side of the filament—on one side the hum is increased, on the other it is reduced.

"The above suggestions are simply gadget improvements, but taken all together, they do accomplish a substantial improvement in the opera-

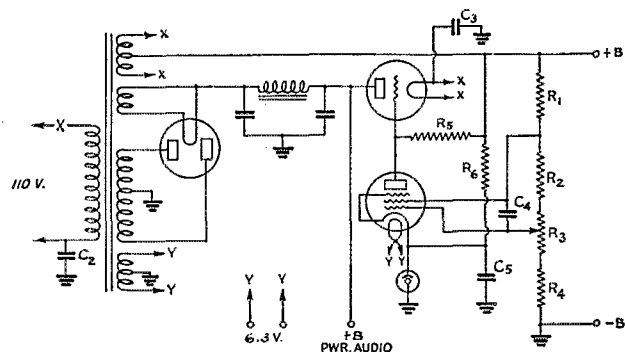

FIG. 1.—REGULATED PLATE SUPPLY WITH CHANGES SUGGESTED BY W9KNZ

C_2, C_5 —0.1- μ f. tubular paper.
 C_3, C_4 —0.25- μ f. tubular paper.
 R_6 —3 megohms, 1-watt.

Other constants are the same as in Fig. 5, page 17, August QST.

old elaborately-filtered supply is something to crow about. However, there are a few small improvements which could well be used to advantage in it.

"First, in this location there is a sharp 120-cycle buzz that comes from any sort of power supply. It can be eliminated by connecting one side of the incoming 115-volt supply to ground (chassis) through a 0.1- μ f. tubular condenser, C_2 in Fig. 1. The condenser also will reduce many line noises.

"Second, R_6 will keep the neon tube ignited

¹"Battery Performance from the R.A.C. Power Supply," August, 1937, QST.

tion of the supply. I also installed another double 8- μ d. filter condenser, just doubling up on the filter already installed, and I feel that this improvement was worth the extra expense and trouble."

In connection with W9KNZ's fourth point,

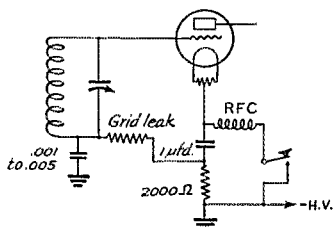

FIG. 2—KEY-CLICK FILTER FOR CENTER-TAP KEYING

oscillation of the neon tube may either be stopped or made worse by the installation of the condenser C_5 , depending upon the conditions existing. In one case where a supply of this type was used for a speech amplifier, the condenser was responsible for motor-boating. The oscillation frequency no doubt varies with different supplies; we encountered one case where the neon tube was responsible for a "hash" which located itself in the broadcast band and could be picked up in nearby receivers, although it could not be heard in the s.w. receiver with which the supply was used. Radiated interference of this type usually can be cured by installing C_2 .

Another experimenter recommends the use of a 1- μ d. condenser connected between the filament of the 2A3 and the grid of the control tube (as shown in Fig. 1 of the August article) as a further means of reducing hum. A good paper condenser should be used.

Neon bulbs without resistors in the bases can be obtained from G.E., although few dealers carry

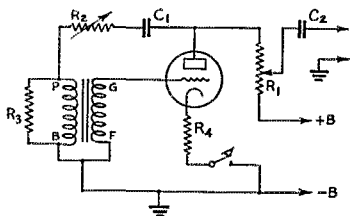

FIG. 3—AUDIO OSCILLATOR WITH RESISTANCE STABILIZATION

- R_1 —50,000-ohm potentiometer (volume control).
- R_1 —500,000-ohm variable (feedback control).
- R_2 —20,000 ohms.
- R_4 —1500-ohm cathode resistor.
- C_1, C_2 —0.1- μ d.
- T—Audio transformer (Thordarson R-100).

them in stock. They are provided with bayonet-type bases such as are used with auto headlights, to distinguish them from the regular type. The

$\frac{1}{2}$ -watt neon tube, without the resistor and with a head-light-bulb base, is also included in RCA's special types and is known as the 991. It should be large enough, since the actual current through the neon tube is quite small.

Key-Click Filter

FIG. 2 is a variation of the usual resistance-capacity key-thump filter as applied to center-tap keying. In ordinary practice the grid leak or bias supply return is to ground; in this case it is made to the junction of the resistor and condense. nected in series across the key. The probable effect of the change is to slow down the cutting off and building up of grid bias, thus helping to smooth off the sharp break which results in clicks.

This suggestion, which comes from W8EWM, no doubt also can be applied to circuits having parallel grid feed as well as the series arrangement shown.

Stabilized Audio Oscillator

THE circuit of Fig. 3 is a resistance-stabilized audio-frequency oscillator, which is simple to construct and so far as can be judged by ear, has a good waveform. It is used here for code practice, but since quite respectable volume can be obtained, it probably could also be used for i.c.w. on the ultra-high frequencies.

The circuit is one that has been used extensively by the telephone companies to test their circuits, and has been analyzed by F. E. Terman in *Electronics*, July, 1933. The distinguishing feature is that it has a feedback resistor connected between the plate of the oscillator tube and the primary of the audio-frequency transformer (through a coupling condenser), which increases the effective resistance of the tuned circuit and thereby stabilizes the circuit. Since the feedback can be adjusted for any tube or voltage, the excitation can be regulated so as to produce a good waveform in the output of the oscillator.

Because the 500,000-ohm stabilizing resistor did not limit the oscillation amplitude sufficiently, a 20,000-ohm resistor was shunted across the primary of the transformer. Also, the note was higher in pitch and the resistor stabilizing the circuit could be adjusted until the note was pure. At too low a value of stabilizing resistor the oscillator motorboats, and at too high a value the tube refused to oscillate. Condensers were left out of the circuit because with them in the pitch was not high enough.

The volume control limits the output of the oscillator, although some "interlocking" is experienced when either of the controls is varied. When constructing the oscillator some experimenting might be necessary so as to obtain the desired pitch and intensity of sound. If the note

(Continued on page 114)

● I. A. R. U. NEWS ●

Devoted to the interests and activities of the

INTERNATIONAL AMATEUR RADIO UNION

Headquarters Society: THE AMERICAN RADIO RELAY LEAGUE, West Hartford, Conn.

MEMBER SOCIETIES

American Radio Relay League
Associazione Radiotecnica Italiana
Canadian Section A.R.R.L.
Ceskoslovenski Amatérni Vysilací
Deutscher Amateur Sende-und-Empfangs
Dienst
Experimenterende Danske Radioamatører
Irish Radio Transmitters Society
日本アマチュア無線聯盟 Japan
Liga Colombiana de Radio Aficionados
Liga Mexicana de Radio Experimentadores

Magyar Kövidhullámu Amatőrök Országos
Egyesülete
Nederlandsche Vereeniging voor Internationaal Radioamateurisme
Nederlandsch-Indische Vereeniging voor
International Radioamateurisme
Newfoundland Amateur Radio Association
New Zealand Association of Radio Transmitters
Norsk Radio Relæ Liga
Österreichischer Versuchssenderverband
Polski Związek Krotkofalowców

Radio Club Venezolano
Radio Society of Great Britain
Rede dos Emissores Portugueses
Reseau Belge
Reseau des Emetteurs Français
South African Radio Relay League
Suomen Radioamatööriilitto r.y.
Sveriges Sandreamatörer
Unión de Radioemisores Españoles
Union Schweiz Kurzwellen Amateure
Wireless Institute of Australia

Conducted by Byron Goodman

WAC Rules:

You would think that everyone in the world knew about WAC by now—close to 5000 certificates having been issued. Maybe they do know about WAC, but nevertheless every once in a while we receive a letter demanding to know why the rules for the issuance of WAC certificates aren't given in *QST*.

It might be a good idea, therefore, to reproduce the detailed set of rules recently adopted by the I.A.R.U. and incorporated in the Miscellaneous Rules appended to the Constitution, at the same time that we list the names of those to whom certificates have been issued in the half-year ended June 30th. This list will appear at the end of the department next month. The rules follow:

"4. (a) In recognition of outstanding achievement in international two-way amateur radio communication there shall be issued by the Union, under the auspices and at the expense of the Headquarters society, certificates to be known as 'WAC' ('Worked-All-Continents') certificates, commemorating the establishing of two-way communication between an amateur station and other amateur stations in each of the six recognized continental areas of the world.

"(b) Applications for the issuance of such certificates shall be transmitted by the applicant, accompanied by adequate proof, to the headquarters of the member-society for the country in which he resides. The headquarters of the member-society shall then examine the proofs and, if they are found satisfactory, shall so attest to the Headquarters society, which shall thereupon issue the certificate and deliver it directly to the applicant. If applicant resides in a country not represented in the Union by a member-society

thereof, the application shall be transmitted direct to the Headquarters society of the Union.

"(c) Where the applicant resides in a country which is represented in the Union by a member-society thereof, it shall be necessary for him to hold membership in such member-society in order to be eligible for the award. Where applicant resides in a country not represented in the Union by a member-society thereof, it shall be necessary for him to pay to the Headquarters society the sum of fifty cents (\$0.50, U. S. funds) in order to receive the award.

"(1) Member-societies shall acquaint the Headquarters with the precise geographical boundaries of the areas in respect of which they are organized, so that the Headquarters may be reliably guided as to the right of non-resident applicants to obtain certificates upon payment of the stipulated fee.

"(d) Proof of the essential qualification for the issuance of WAC certificates, i.e., two-way amateur radio communication with the six recognized continental areas, shall be in the form of QSL cards or equivalent written evidence clearly indicating the fact of two-way communication, or by an examination by competent authority of the log of the station claimed to have been worked. Such an authority can ordinarily be regarded as an official of another member-society of the Union.

"(e) By international agreement, the following boundaries have been adopted as officially indicating the six recognized continental sub-divisions of the world:

North Pole along 180° West—Wrangel Island—

(Continued on page 114)



OPERATING NEWS



Conducted by the Communications Department

F. E. Handy, Communications Manager

E. L. Battey, Asst. Communications Manager

Intelligent handling of a station, not only in emergencies, but all the time, is a vital essential that ought to be required of all amateurs on the air in our crowded bands today. The year 'round we receive communications about improper operating. Sometimes the complaints relate to simple lack of common courtesy to a brother ham. One story is about the W1 ham who holds the record "for sending 148 CQs without signing, for transmitting VP6, then 14 more CQ's, his call *once*, and back to CQ's to a total of 412 before the sign!" There are complaints about the pest who always gives his QTH and expects to swap and give complete addresses each time regardless of whether you are way ahead with use of a well thumbed call book or not! Another relates to the chaps so superior they take a message only if a matter of life and death—the spirit of selfishness and irresponsibility replacing normal amateur display of friendship, fraternalism, and coöperation. But why add to this list. We know them well enough.

Listening on 56 Mc. recently we heard one operator apologize for a newcomer—explain how he would be able to talk at *length* after a while. The "newcomer" made a better impression on us than the speaker. It seemed to us that far better communicating ability might be developed by learning to state thoughts clearly and concisely, and in a manner to avoid phonetic misunderstandings. We should be proud of *what* we have to say, and the impressions that can be given others, rather than striving to create monologues or talk at undue length. Certainly wordiness is not the objective. Our stations are prohibited from "broadcasting" or "entertaining" as an objective. Efficient two-way communicating ability is the thing to develop.

It is *not* intelligent handling of a station or coöperation with an operator advertising that he has "bk in" with his calls, to sit idly by for minute after minute of a properly sent call after the first invitation to "break" has been given. It is not necessary that *you* have complete break-in facilities in your station, to take advantage of the time saving of your correspondent-station's superior facilities. When the operator is looking for you, his receiver parked on your frequency, and he has true break-in (as advertised) just a tap of your key, and he will hear you in the intervals

when his key is up. A "break" from you (which may be less than a complete call) and the chap calling can start his conversation or business. If you miss something in QRM it should be safe to assume that your transmitter has more than a fair chance of halting the signals that have become uncopyable until you direct your station to proceed. Break-in is synonymous with time saving when properly and intelligently used. If you are a good operator you will improve the efficiency of your operation by taking advantage of the other fellows break-in, whether your arrangement permits two-way break-in or not.

Another common fault for which operators of telegraph and voice-equipped stations have been indicted in equal numbers is the "OK but please repeat" foolishness. The "OK" under these circumstances is 90 per cent deception, and the skilled operator instantly labels it as such, so the first words are a dead loss. With the danger that interference gums up the transmission so that the acknowledgment may be taken for a complete receipt of perfect transmission, such expressions are worse than wasted. There is perhaps too great a tendency for the average amateur to spend all his time on his equipment and adjustments and to utterly neglect the matter of *how to operate*. Good examples of snappy 'phone procedure may be found on the Airways and police circuits and for the telegraph operator the clean cut examples on government and commercial channels are recommended. In addition, standard operating practices are set forth in the A.R.R.L. Handbook, the only complete manual for amateur reference.

Let us make the 1938 season one noted for intelligent handling of stations, and new highs in coöperative station endeavor. Make worthwhile progress in the operating effectiveness of our hobby-station an aim!

1937 PA DX Contest

THE N.V.I.R., Dutch I.A.R.U. Society, announces a DX contest to be held on the week-ends November 20th-21st and November 27th-28th, from 1500 G.T., Saturday to 2400 G.T., Sunday. Code-system: First QSO, RST report followed by 001; second QSO, RST followed by 002; and so on. Only PA stations will transmit a code. Stations in other countries are requested to please confirm these codes by cards or by logs. Only one contact per week-end is permitted with the same PA station, unless additional contacts are established on different bands. The highest scorer in each country will receive an award.

PRIZES FOR BEST ARTICLES

The article by Mr. Sam K. Brown, Jr., W8NWZ wins the C.D. article contest prize this month. Each month we print the most interesting and valuable article received marked "for the C.D. contest." Contributions may be on any phase of amateur operating or communication activity (DX, 'phone, traffic, rag-chewing, clubs, fraternalism, etc.) which adds constructively to amateur organization work. Prize winners may select a 1937 bound *Handbook*, *QST* Binder and League Emblem, six logs, eight pads radiogram blanks, DX Map and three pads, or any other combination of A.R.R.L. supplies of equivalent value. Try your luck. Send your contribution to-day!

The Amateur Is Balanced

By Sam K. Brown, Jr., W8NWZ*

THE time has come, I believe, when we as radio amateurs should try to present ourselves before the public with a little more dignity and self-respect than has been done in the past. The old saying, "Oh, so you're one of those radio maniacs," should be done away with. In onesense, we cannot blame John Public for saying this. After all, to many, radio is still a scientific mystery only vaguely understood. However, on the other hand, we as amateurs are partly to blame for the opinion. With the hope that we might better our prestige, let's read the following paragraphs:

"Our Hero," after receiving his ticket, naturally starts in radio with a tremendous bang, and, of course, much midnight oil is wasted away. For three consecutive nights the ether is warm with the incessant brass pounding of our hero's rig. Mother, somewhat worried, decides to permit this indulgence, in hopes that the lure would gradually die down.

Months pass, our hero now both experimenter and operator is still spending his entire leisure time with radio. His mind is crammed full of everything from soup to nuts pertaining to radio. You meet him on the street and ask him some question concerning the present strike situation and he looks at you entirely blank. The conversation turns, and you find he can tell you to the kilocycle where GSB can be found or what frequency Trunk Line X operates on. You ask him about the sunspot situation and his knowledge seems infinite, but it remains to be said that other than radio he is as intelligent as—well, you know. Now, of course, you know as well as I that this type of individual is found only once in a while, but you will agree with me that all too many of us are quite similar. Can you wonder at the public opinion that is predominate in many localities? After all, we all have a social duty to perform. It is a part of life itself and without it we are not far from useless to mankind.

While we are on this topic of over-indulgence, let us look at it from another standpoint. Fortunately our hero is somewhat balanced within the realm of radio and doesn't come under this category. It is my firm opinion that one can spend too much time on some one thing, even though it be his major work. For example, when working algebraic equations (or any math. problem), one finds that there comes a time when the mind is slow to function and solutions seem as far off as the moon. However, if one takes a rest by diverting his mental energy to some other thing, he finds that upon returning to his math., he is fresher and a solution seems at hand. Therelaxation has been worthwhile. Why, then, would not this practice benefit the experimenter who is confronted with some large problem? Should one become steeped in experimentation or should one use good common sense in his indulgence?

Psychologists say that one should drop his favorite line of work, mental or otherwise, for a while and try something

* 30 South Street, McGraw, N. Y.

else. Cases show that one returns to his favorite line with new visions, and some have returned with ideas of great importance to their own interest. In other words, let's allow our mental processes to take a vacation from radio more often, use them for some new purpose. Then, after a time, return to our old work. We may find something in our "vacation's" work of real value to our regular line. Let's all try hard to balance, intelligently, the twenty-four hours of the day and use discretion in regard to radio as a hobby. Thus, I believe, public opinion as well as ourselves will be better off. The fifth law in our code is "The Amateur Is Balanced."

BRASS POUNDERS' LEAGUE

(August 16th-September 15th)

Call	Orig.	Del.	Rel.	Extra Del.	Total
W6ITL	240	419	80	380	1119
W6LLW	50	66	786	49	951
W6CII	25	39	610	50	735
W6NSN	17	73	604	29	723
W6IOX	26	45	552	40	663
W6JTV	104	291	110	112	617
W4PL	11	30	504	23	568
W9WWE	551	3	14	—	568
VE5IL**	153	179	4	175	511

MORE-THAN-ONE-OPERATOR STATIONS

Call	Orig.	Del.	Rel.	Extra Del.	Total
K6OGD	189	204	2002	110	2505
W5OW	81	134	634	117	966
K6NXD	316	68	74	43	501

These stations "make" the B.P.L. with total of 500 or over. One hundred deliveries+Ex. Del. Credits also rate B.P.L. standing. The following one-operator stations make the B.P.L. on deliveries. Deliveries count!

W8BWA, 292	W8IMI, 181	W7EBQ, 110
W3CIZ, 256	W3QE, 133	VE5IL*, 108
W4TR, 212	W5DKE, 131	W2FF, 107
W6OBJ, 208	WIKH, 122	W6LBB, 107
W6BQC, 188	W5FOJ, 110	W6PBA, 100

A.A.R.S.

Call	Orig.	Del.	Rel.	Extra Del.	Total
WLMC (W3DQN)	68	72	773	53	971
WLMI (W6GXM)	107	135	430	—	672
WLML (W3NF)	8	21	483	21	533

WLTK (W9KJY) made the B.P.L. on 518 message deliveries.

MORE-THAN-ONE-OPERATOR STATIONS

Call	Orig.	Del.	Rel.	Extra Del.	Total
WLWM (W3CXL)	130	76	904	—	1110

A total of 500 or more, or 100 deliveries Ex. D. Cr. will put you in line for a place in the B.P.L.

* June-July.

** July-August.

Navy Day Receiving Competition

The annual Navy Day message to Radio Amateurs from the Secretary of the Navy will be transmitted October 27th on the following schedules:

From NAA, Washington: 9:00 P.M., E.S.T., simultaneously on 4045 and 8090 kc.
From NPG, San Francisco: 7:30 P.M., P.S.T., simultaneously on 4045 and 9090 kc.

It is expected that letters of commendation signed by the Secretary of the Navy will be sent to all amateurs submitting perfect copy of the text of the message, as sent from NAA or NPG. It is not necessary to submit copies of both stations. A list of all operators submitting copies will appear in *QST*. Copy what you hear and send what you get to A.R.R.L., Communications Dept., West Hartford, Conn., for grading. Don't guess or recopy! Simply send what you're able to copy as you copied it!

DX Century Club

WE TAKE pleasure this month in announcing the first members of the A.R.R.L. DX Century Club. Membership in this club represents the highest honor in DX circles to-day. Complete details may be found on pages 59 and 60, September *QST*. The award is made to amateur operators who submit satisfactory proof that their amateur stations

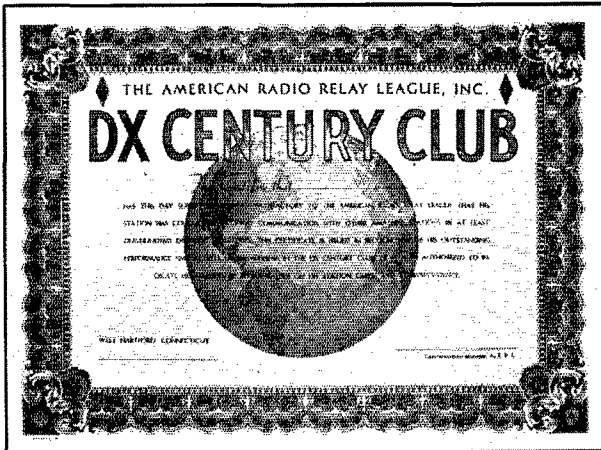

ONLY FIVE OF THESE HANDSOME THREE-COLOR CERTIFICATES HAVE BEEN AWARDED

have been in communication with at least 100 different countries. To date but five amateurs have qualified. Several others are well on the way to the "Century" mark with 75-or-more "confirmed countries." In presenting the first list we extend hearty congratulations to all who have made the grade. One fact is outstanding—of the scores of operators who *claim* contacts with 80, 90, 100 countries, etc., only a comparative few have proven their accomplishments! We again invite all amateurs to read the rules and submit 75-or-more confirmations for *QST* listing, or 100-or-more for Century Club membership. The list will be brought up to date from month to month as new countries are worked by those already in the line-up and as new stations are added to the roster.

MEMBERS, DX CENTURY CLUB

Frank Lucas, W8CRA—112 different countries
Douglas H. Borden, W1BUX—105
Jefferson Borden IV, W1TW/W1CMX—104
Henry Y. Sasaki, W6CXW—101
H. A. Maxwell Whyte, G6WY—100

The following are on the road to membership, having submitted proof of contacts with 75-or-more different countries:

W1SZ	92	W8KKG	78
W1TS	89	G2DZ	78
W2GTZ	88	W3BES	77
W2GW	88	W9ADN	76
W9KA	84	VE2EE	75
W1DUK	79		

IMPORTANT! PLEASE NOTE WELL!

In view of the difficulty of getting other forms of confirmation from certain countries, No. 5 in the list of rules for the DX Century Club (pages 59 and 60, September, 1937, *QST*) is amended to permit acceptance of confirmations from foreign logs for the A.R.R.L. International DX Com-

petitions only. Confirmations of this type will be checked under the following conditions:

(1) Sufficient confirmations of other types must be submitted so that these, plus the DX Contest confirmations, will total 75 or more. Those who have already qualified for monthly listing in *QST* need only request check of the additional confirmations.

(2) Look up the contest results as published in *QST* to see if your man is listed in the foreign scores. If he isn't, he did not send in a log and no confirmation is possible. Logs for the 1935, 1936 and 1937 contests only are available. Results of these contests appear in the September, 1935, September, 1936, and October, 1937, issues of *QST*.

(3) Give year of contest, date and time of QSO.

(4) In future DX Contests, do not request confirmations until after the final results have been published, usually in one of the early Fall issues. Requests before this time must be ignored.

If the contact is checked, your total of countries worked will be increased accordingly in the next available issue of *QST*. Please don't ask us about stations not listed in the contest results, and don't expect replies to letters requesting DX competition confirmations. The *QST* listing will give the answer.

Briefs

After eight hours of brasspounding on commercial marine waves, nine of the twenty-three operators at WCC-WIM go home to the following ham calls (the sines of the ops are also given): LZ W2DIE-1; SF W1FJS; SU W1RZ; SM W1GBD; CB W1IXT; XD W1FZT; DL W1JNI; MI W1VL; TG W1GCQ. After pumping several 40-kw. transmitters for eight hours they still like it. Speaks well for ham radio!

Code classes for beginners and advanced amateurs and those interested in commercial operating are conducted from 7:30 to 9:30 P.M., Monday to Thursday, at Harlem Evening Trade School, 138th St. and 5th Ave., N. Y. C., under the Board of Education.

W7AOL, Salem, Oregon, was tenth high W participant in the 1937 Canada-U. S. A. Contest. In September *QST* W6EJT was erroneously listed in tenth place. W7AOL's score was 9828.

Inadvertently omitted from the DX Contest Results (Oct. *QST*), W4CPZ, Gaffney, S. C., made a score of 5775.

Suggestions for "an amateur radio course of study" suitable for club work, a "sample constitution" containing many useful suggestions and helps for newly formed groups, and "how to organize and maintain interest in the radio club" are all available to any amateur group on request. Also already organized clubs that may be interested in establishing an affiliation with the American Radio Relay League are invited to write for the suggested "resolution" to be considered by their organizations as a first step in bringing the subject before the A.R.R.L.'s Executive Committee for action.

Hamfest: The Finger Lakes Transmitting Society will hold its 10th Annual Banquet and Hamfest at the Osborne Hotel, Auburn, N. Y., on Saturday, November 6th. Registration, 5 P.M.; Banquet, 6:30 P.M. sharp. The committee is working on what it hopes will be something new and original in the hamfest line. Program will include speakers, an auction of ham gear, contests and some real entertainment. Entire cost including feed and all—\$1.50. In keeping with the custom of the Society the affair will be strictly stag. Make reservations with the chairman, W8BDV, 39 Mattie St., Auburn, N. Y.

How's DX?

How:

With the whole world organizing and reorganizing, it's not surprising that the DX boys have eventually come around to a little combine of their own. At least that's what it will amount to, if the plan evolved at the Hudson Division Convention works out. You have, of course, been dummed-up-on from time to time by the local lads who get hold of a choice station and then pass him around until everyone but you has added him to the list. Legitimate stuff, of course, and nice coöperation, but not exactly open competition, which is what DX should be. Well, the boys down at the Hudson affair had a real swell DX rag-chew, led by W2IOP, and one of the suggestions that came out of it was that some station act as a general clearing house for DX information.

The plan would work like this: As a member of the group, you have on file with the central office a number of self-addressed penny post cards. When you, or another member of the group, hear a rare piece of DX you whip a card into the central office with all the pertinent dope—call, frequency, time, and tone—and the central office immediately mails out this dope on the cards that are filed with him. You then have a crack at the DX the next night or so, depending on how long it takes you to get the card and warm up the rig. No guarantee that you'll work him of course, but a nice way to know what's going on. Like most things in ham radio though, its success will depend upon the full coöperation of the whole group.

Far from being in the nebulous stage, it has been arranged for W2JXH, Harry Whiting, 125 East 74 Street, New York City, to act as the central office. There's the arrangement. It will work with your coöperation. (And drop us a line at HQ, too. We like to have the latest dope we can get.)

Where:

Because but few stations have been active in Greenland, it has long been on the hard-to-get list. However, the MacGregor Expedition, now stationed near Etah, is responsible for OX2QY (14,375 kc., T9) being on the air, and a mad scramble has been apparent on the band with everyone lining up to work him. Gerry Sayre, W2QY, is the operator, and the signal gets down here beautifully via a rhombic and a 400-watt push. The evening around 8 p.m. is the time to look for him. W2WC, W8ISK, W1EH, W2PP, W1SZ, W1AQT and W2CYS were some of the first to raise him. However, he'll be up there for a year or so, so everyone should get a crack at him. . . . Here's a nice one, reported by W6GPB who, incidentally, is up to the 81-countries mark: F18AC (14,255 kc., T9x). Send your card to R. R. Lebon, P. O. Box 13, Hanoi, French Indo-China. . . . If you need Mozambique, look around for CR7AW (14,295 kc., T9x), worked by W3DMQ, W3AGV, and W3BES. Another is CR7AP (14,425 kc., T9x) HS1BJ (14,070 kc., T9x) is back on, and has been using 'phone to good advantage. W6TT was the first to work him on 'phone, followed by W6PB, W6OCH, and W6ITH. Reg reports him the loudest Asian 'phone ever heard there. His c.w. is good on the east coast, but try and raise him from W1! W3EVT scored up a good one during the DJDC: LX1AO (T7, self-excited on the 14-Mc. band) W3GHB, who seems to specialize in working the screwcook calls, says that K2BR is a fishing vessel off the coast of Venezuela. . . . Don't spend too much time calling VU2CV. By this time the Canadian authorities should have him well in hand. He was up around Toronto. . . . According to W8OSL who worked him, W6QL is now operating KA1YL (14,350 kc., T9x) And just in case we haven't yet sold you on taking a crack at 7 Mc., you're missing a bet if you don't keep an ear peeled for UT3AC (7028 kc., T9) at Barkol, Outer Mongolia, reported by W7ENW, who also adds J8CH (7065 kc., T9) The QRA of ZS3F, via

W2HMJ is G. W. Dehaas, Box 358, Windhoek, Southwest Africa. . . . W2GTZ reports XZ1S (14,260 kc., T8), supposed to be at Tsiengtao, China, but it's the wrong prefix so we're a little suspicious. W2HGO worked EA7PZ, and W4EPV worked EA3GA (14,400 kc.), so the boys are still on over in Spain. The PA0AA working on 14 Mc. is a phoney, so ignore the blighter. If you hear him on 3.5 Mc. he'll be the real one—maybe!

When:

The 28-Mc. band is back, and although signals haven't yet reached their peak, the band has some choice bits worthy of your consideration. The nicest one we've heard of is FQ8A (28,050 kc., T5), worked by W2DTB and the rest of the gang around noon, E.S.T. . . . W2LXY, on 'phone and W6GPB on c.w., both report good DX coming through, including LU, OA, HK, VK, ZL, and many Europeans. . . . W6NLZ thinks that the time is ripe for some of the Asians to get back on ten, if the way JN's harmonic raps through is any indication of conditions. It is usually S7-8 and occasionally up to S9. . . . W1EWD reports U9ML (28,150 kc.), SV1RX (28,175 kc.), and VU2CQ (28,250 kc.).

If we can't sell you on ten, how about 40? W6NSK, who coasts along with 25 watts to a 6L6 oscillator, has been working such tidbits as VR1AM (7150 kc.), MX2J (7150 kc.), K6OVN (7100 kc. T9) in Guam, and numerous VK, ZL, XU and stuff. Not bad for a California deeiwatt!

All right, all right! If you must be on 20, look for ZC6AQ (14,275 kc., T7) during the evenings. W2BHW, W2CMY, and W2GVZ worked him. It brought GVZ's total up to 93 countries. . . . Or TG2F (14,318 kc.) in Gustemala is good if you can get the rig on 'phone. W3JGF reports him, as well as HA8N (14,125 kc.), CN8AJ (14,104 kc.), and YL2BC (14,070 kc.), all on 'phone. . . . W2DTB, who should be a member of the "How-Does-He-Do-It?" C ub, sends in a swell list of the latest DX worked there. It includes XU8RL (14,305 kc., T9x), FQ8AB (14,280 kc., T9x), V87JW (14,345 kc., T9x), V87RF (14,340 kc., T9x), UX6AE (14,415 kc., T8), YS1B (14,415 kc., T9x), PK1RI (14,375 kc., T9x), VU2FH (14,080 kc., T9x) and V86AG (14,075 kc., T8x). Heard were ST2LR and ST2CM (14,345 kc., T8x), PK1MF (14,310 kc., T9x), and XU3MA and V86AZ (14,070 kc.) In case you're a W7 and think it poor country for DX, look at W7ENW's stuff. It includes a number of Europeans and Asians, and ZE1JI, ZT5Y, CE4AD, LU6AF, and CX2BK. Heard were CR9AC, V84CS, FA8RY, FA8BG, FT4AG, HR2AM, and a flock of South Africans and Asians. . . . VE3AU, who skeds Y12BA (14,280 kc.) among other things, tuned up the rig and has been working FY8E (14,415 kc., T9c), J5CC (14,350 kc., T7), CN8MS (14,415 kc., T6), OH3NQP (14,005 kc., T9), a ship in the Gulf of Bothria (?) and HK3AL (14,410 kc., T8). A good one heard (that W8CRA got) was UK8LA. . . . W6KIP goes right after 'em, and comes up with VK4KC (14,380 kc., T9) in Papua, V88JS (anywhere in the band), J9PA (14,450 kc., T9) in the Marshall Islands, and PK6XH and PK6HR, T8 at various frequencies. Incidentally, KIP and VK2NO are going to take a try at 56 Mc. shortly, in an effort to get across the drink. The 500 watts on c.w. might do the trick. . . . CE7AA (14,260 kc., T9), at the very tip of South America, is back on, around 6 p.m. E.S.T., and was worked by W3OP. . . . For a new country on 'phone, try HC1JB (14,120 or 14,435 kc.). W6ITH reports him.

Who:

Anytime we can give one of the QRP gang a plug we like to do it. G8SD for example, goes merrily along with 1 watt input (100 volts at 10 mills), but he works across the pond pretty well, according to W1ESN. . . . Of course 48

watts isn't low power, but W8LED's story is interesting because after 3½ years of going after Oceania, his first contact there is with VK6SA, just about the toughest VK district. The 48 watts have accounted for 45 countries, but unless OS1BR kicks through he still needs Asia for WAC Of course 95 watts starts to put you up in the power class, but that's just what W9ALV has been using for the past 18

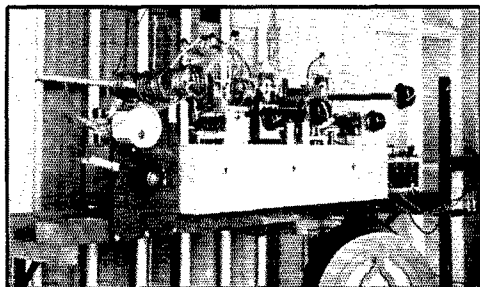

THE 28-MC. RIG OF VU2CQ, BOMBAY, INDIA.

Well-known on 14 Mc., VU2CQ is now on 28 Mc., and may give many their first chance at a ten-meter WAC. The rig uses p-p. 800's in the final.

months, during which time he has worked 101 countries. Some of us here at HQ have been thinking of passing a law against him—he took HS1BJ away the other morning. But on a countries per watt basis, we think that's a pretty sweet piece of work W6IES says that VO1Y (14,040 kc.) would like to work a few more W6's and that PK4MK (14,110 kc., T9) is now the only PK4 on the band, 4KO having gone to Europe for a time W2IXY has the toughest luck. The electric light company put in a new pole and rather than bother to cart away the old pole they left it in her back yard. So now she's the owner of a 40-foot cedar pole which will no doubt be cut up for firewood. Oh, yeah? The first returns from this years DJDC indicate that W9TB will be winner for the U. S., with W3GVX second. W9TB was high W last year, you know. And 13BXK had about 500 QSO's to make him high German station From several sources we hear rumors of a "YU" DX contest now going on. Having received no official word, we can only suggest that you send in your scores, via the QSL Bureau for Yugoslavia W1ZB has been doing nicely on his sked with WCFT, now over near Singapore, but also finds time to work XU8AZ (14,240 kc.), HZ5NI (14,420 kc.), and YS2B (14,420 kc.) W2IOP says he got a QSL from AC4YN, but gives no dope as to whether it was the Tibet station's first W QSO, or his frequency.

WAC:

Latest 'phone WAC's are to W1AAK (28 Mc.), YV5AK, W7DNP, G5CV, VS2AG, G5VM, PA0DS, W3FAM, VE2HG, W1COJ, W4DRD, W3CHE and G6CL, secretary of the R.S.G.B.

—W1JPE

Father Hubbard Arctic Expedition

Amateur station K7GIJ started operation the first of October on King Island, Alaska, for the Father Hubbard Arctic Expedition. K7GIJ operates daily between 2:30 and 10:00 P.M. P.S.T. Schedules with west coast amateur stations are desired, also cooperation in handling traffic and press. Special expedition QSL cards will be sent to stations worked. Frequencies used: 1885, 1905 and 28,700 kc., c.w. and voice; 3650, 7205, 7175 and 14,350 kc., c.w. Please watch for K7GIJ and report work with this and other expeditions to A.R.R.L.

The Schooner *General A. W. Greely*, WAWG, of the MacGregor Arctic Expedition, may be heard daily on schedule with WCC giving position reports, traffic, etc., WAWG on 16,580 kc., WCC on 16,900 kc., at 11:00 A.M. E.S.T.

— —

Members of the Amateur Transmitters' Association of Western Pa. and the Mon-Yough Amateur's Transmitting Association maintained communications at the Sun-Telegraph's outboard motorboat regatta in North Park, Pittsburgh, on August 28th-29th, keeping officials informed on developments in the judges' stand, at the pits, in the police boat and at the far end of the course. W8OFO, W8ONW, W8FTY, W8OC and W8NDP, alternating at the controls of the 56-Mc. 'phone installation at the judges' stand, flashed the official results of each heat to W8CUG and W8UK located at the clubhouse. The information was then relayed by telephone (also installed by the amateurs) to the two pits for the guidance of the pit masters and inspectors and the edification of the drivers. An installation on the police patrol boat manned by W8BSO enabled the officials at the judges' stand to direct the movements of the boat in picking up overturned or stalled boats and transporting officials and notables from the clubhouse or pits to the stand. At the far end of the course a portable 56-Mc. outfit operated by W8AMP did service in notifying the judges' stand of spills and stalls. W8OLW supervised and directed installation and operation of the system.

— —

The papers said that Fislors Comet could be seen with a good pair of glasses. So armed with a good glass a ham gazed skyward and beheld the Comet in all its glory. It seemed large enough to see with the naked eye. He tried it and found that he had gazed rapturously at the long white insulator in his antenna reflecting street lights!

— —

A movie outfit moved on location in Northern California with its stars and sound equipment. A curious amateur scenting the possibility of meeting another amateur among the sound equipment went up to the sound truck and asked, "Are there any hams up here with you?" "Wise guy," shot back the sound technician.

(P.S.—Both of these actually happened.)

—W6SG

General Traffic Period

For moving traffic without schedules we recommend the period 6:30 to 8:00 P.M. (your local time). Use this period to move your traffic through reliable stations. Operators who sign "ORS," "TLS" or "RM" after their call are keenly interested in traffic and are sure to be reliable. The use of directional CQ's will help in routing traffic during the "traffic hour." Also watch for stations calling "CQ Tfc," which indicates that they are looking for radio-gams to handle. USE THE TRAFFIC HOUR—6:30-8:00 P.M.

The Sacramento Valley Amateur Radio Club was fortunate in securing space for an exhibit at the California State Fair, September 3rd-12th. W6QT-6 was operated on 3.5 and 7-Mc. c.w. and 1.75-Mc. 'phone. Equipment of various local amateurs and old-time spark equipment loaned by the Western College of Radio of San Francisco went into the making of a very attractive exhibit, which drew hundreds to the booth daily. Message blanks were furnished through the courtesy of the Sacramento Chamber of Commerce; 391 messages were handled. Amateurs on duty at W6QT-6 were W6AYZ, BVK, ESZ, EWB, GZY, IBH, IMJ, KME, KQQ, NRZ, NSL, MGC, OBX, W7FEN-6 and W6KKL. The State Fair presented the club with an exhibitor's plaque in recognition of the exhibit. The S.V.A.R.C. extends thanks to all who cooperated in handling traffic.

20-Year Club

THE following are new members of the A.R.R.L. 20-Year Club: **W1AHY** **W1BB** **W2EMV** **W2HTU** **W2IP** **W3GLH** **W3WS/3AAJ** **W5CVQ** **W6EA** **W6IX** **K6ONM** **W9AB** **W9DHM** **W9ESA** **W9ZN**. Membership in this club is open to any amateur who held a license 20-or-more years ago and holds a call to-day. If you can qualify as one of the real "old timers," send in a brief chronology of your ham career, particularly the date you started in amateur radio, date of your first amateur license, calls you have held during the years and the call you hold to-day. The write-ups submitted will be used from month to month as space permits.

Rudolph W. Ackerman, W2EMV: "Learned Morse Code in 1904. Set up auto coherer outfit in 1909 with no results except microphonic QRM. Heard first real signals from ships with electrolytic detector antenna and phones in 1911. Copied press from the *New York Herald* Wireless station at the Battery, New York, in 1911 sent in Morse and repeated in Continental. Used Electro Importing Company catalog as a bible and registered my first call RWA with E. I. Co. in 1911. Set up my first transmitter in 1912 using E. I. Co. 100-mile spark coils and electrolytic interrupter with best DX out of the back yard. First Government license 2AMA issued in 1915. Dismantled during the beginning of the World War. Second license issued in 1920 was 2BJO, which expired in 1928. Third license W2EMV—1932 to date operating 'phone and C.W. on the 28 and 14-Mc. bands." . . . **Ivan H. Anderson, W9DGM:** "First call IA in 1912 at Minneapolis, Minn., then 9HZ until the War. After War was assigned 9DGM and then W9DGM, which I still hold. 1918 to 1930 in Minneapolis and from 1930 to date at Anoka, Minn. Have held Commercial ticket since 1923." . . . **W. A. Beasley, W9FRC:** "9DJ issued in 1914—spark coil, DX 30 miles on batteries collected from garages. Then Packard ¼ kw., Rotary gap, Murdock condensers, E. I. Co. osc. trans., 6-wire flat-top ant. Station closed during War while opr. was radioing in A.E.F. Opened up as soon as possible with 9RQ, then NU9ECU and W9FRC since the War. Operation has been on 200, 40, 80, 20 and 10 meters. Final amplifier of present sender contained in rack originally containing whole transmitter in 1928." . . . **Bernard J. Bisciotti, W3FLH:** "Held calls 3FT in 1915—SAPE in 1920. Would like to know how many, if any, of my former buddies of the 321st and 102nd Field Signal Btms. of the late War hold ham tickets." . . . **Howard Blower, W2AX:** "First on the air about 1913 with the call HB. Later got license and call 2AX—original license number 24, which I have held since it was issued. After the War was assigned same call. Have been active more or less ever since. Present transmitter Collins 50 watts input and ACR-136 receiver. Mostly on 14-Mc. band, C.W. Have been member of A.R.R.L. since early 1920's." . . . **Thos. W. Braidwood, W3GLH:** "Started with a spark coil and single slide tuner, plus a carborundum detector in 1912 at Anglesa, N. J. . . . used the call letters 'ZZ' . . . later used a larger spark coil on 110 volts with electrolytic interrupter (this caused all the lights in town to blink!) . . . 1913 obtained license and call 3UZ . . . operated on second class license and in 1914 received first class . . . graduated to loose coupler and ¼-kw. Thordarson with rotary gap and got out 900 miles . . . operated station until closed down with entrance of U. S. in World War . . . resumed operating after War under call 3BA, in meantime had obtained Commercial License in 1918 and became ship operator . . . operated 3BA between trips and then finally got away from ham radio . . . kept in touch through QST and in 1936 returned to hamdom with call W3GLH, which I now operate when I get home between trips. Was pre-war member of A.R.R.L." . . . **A. L. Budlong, W1JFN:** "First receiver in the winter of 1911-12; first transmitter, a Ford spark coil, in 1914, call AB in Washington, D. C.; took amateur exam in 1917 and got the operator ticket, but missed a station call to go with it by a few days, account of the War; after the War, receiver experimentation, and a joint station with 'Stu' Seaton in Washington, call now forgotten; then 1ASN in 1924; 1BUD about 1930; W1JFN in 1935." . . . **C. Harold Campbell, W2IP:** "Started 1916 at Bridgeport, Conn. Received an

Amateur License, Feb. 16, 1917, and the call IABW for my spark coil transmitter. Had to close down several weeks later when the United States entered the World War, and was QRT until the ban lifted. In November 1919, the call 1IV was issued to me and the transmitter grew to ¼ kw. Built my first C.W.-'phone in 1921 using a VT-1 tube and Loop Modulation. Appointed O.R.S. on Jan. 21, 1922. 1IV (later W1IV) remained an active C.W. DX and traffic station until November 1931, when I moved to the Second District and became W2IP. At present most operating is done on 14 and 28-Mc. 'phone and C.W., and 56-Mc. 'phone." . . . **Otis R. Dickinson, W2HTU:** "During 1914 I built a spark transmitter using a Ford spark coil, and operated the transmitter with self-assigned call OD. This transmitter and also several subsequent spark transmitters were used at Hyde Park, N. Y. During 1915 received my first license with call 2SD. My last spark transmitter consisted of an Acme transformer, Murdock condensers, Amrad quenched gap, rotary gap, r.f. hot wire ammeter, edgewound oscillation transformer, aerial change-over switch with third blade on transmitting side arranged to start rotary gap and close 110 a.c. circuit to key and primary. The aerial used was an eight-wire flat top of the T type. Aluminum aerial wire was used, and spreaders were made of bamboo. This transmitter was used until 1926 when license expired and was not renewed, mostly due to the unsatisfactory experiences which I had when I tried C.W. The first vacuum tube I used for receiving was a DeForest Audion which was arranged with two filaments. I still have this tube with one filament in operating condition. During 1934 I built a short-wave receiver, and the bug got me again after listening to ham stations a few evenings. Without much delay I took the Class B exam and was assigned my present call W2HTU. The present rig operates with an input of 450 watts C.W. and 250 watts 'phone." . . . **R. N. Eubank, W3WS (W3AAJ):** "Remember when Navy man came around to put seal on rig, which was under call 3CEB using 2-inch 'Bull Dog' spark coil purchased from Wm. B. Duck catalog. Family would let no lead come to house so had rig in wood shed, using crystal; detector made by Tierney, with Murdock (hair puller) 'phones. Six blocks was DX." . . . **Geo. W. Ewing, W6GM:** "My first QSO was with pre-War 6AOC in the fall of 1916 at which time my call was 6ACD. That was in Highland, Calif. 6GM was assigned to me right after the War and I have had it ever since." . . . **Leon A. Faber, W9DAX:** "Interested in receiving in 1910, '11 and '12. On the air 1913—call QW, then 9EH. After the War, 9AMK. Later W9DAX—held at present." . . . **W. T. Gravelly, W3BZ:** "I started in the amateur game prior to 1914—with no other amateur anywhere around—so—the work and study was alone for a long time. The old pre-War call was 3RO. 3BZ was, and is, the post-War call. The first license, I think, issued in Virginia when the ban was lifted. Station and operator active all during the entire period, except when closed down during the War. Experiences plenty—to-day, as active as at any time during existence—always something new coming up in the 'dog house' (shack). Have held some various jobs with the A.R.R.L. during the years—have received every copy of QST from No. 1—Hi. (Everybody can't say that.)" . . . **Stephen A. Griffin, W1AHY:** "Started in 1910 with single slide tuner wound on a Christmas tree butt, silicon detector, 75-ohm telephone receiver, 1-inch spark coil, photo-plate condenser and helix. The first call used was SG. Started in Portland, Me. Continued with crystal receivers and spark rigs; first license and call of 1FX received in 1915. Closed up in 1917 on account of the War. After the War was over college took care of four years. In 1926 back in the game with call 1AHY, which is the one held at the present time. Also held 1FVY when portable calls were needed." . . . **W. J. Halligan, W9WZE:** "I became interested in 'wireless' around 1915, getting my ham ticket around January or February of 1916. The first call given to me was 1AEH. I continued until the War, serving in the Naval Reserve, and after the War I had the call 1UL. After the War, around 1923 or 1924, I served as New England Division Publicity Manager for the League, and kept about 10 watts of C.W., working in my kitchen for a couple of years until I moved out of the first District." . . . **Joseph E. Hamilton, W4IZ:** "Started in 1911 at Port Chester, N. Y. Spark

coil transmitter, using call letters JH. Took exam at Brooklyn Navy Yard when licenses were first required. Received call 2EW in Jan. 1913. Graduated to $\frac{1}{2}$ -kw. rotary. Closed down for War period and served in Army as radio opr. overseas and at Fort Hancock, N. J., radio station WUB. A way from amateur radio after War for 5 yrs. Held Commercial ticket 1923. Back in the game again 1925 with call 2IZ. Have been active since on 7 and 14-Mc. bands, maintaining the same call which is now W2IZ. Have always been a C.W. man, I have complete file of QST for past 15 yrs. and many previous copies dating back to the second issue of QST, which is my prized possession." . . . **David Harrell, Jr., W5CVQ**: "My first ticket, 1916, SDD. Have held the following licenses: 5DD 1916, 5ABK 1920, 1CTZ 1921-22, 5EN 1923, W5BHN 1931-32. Present call—W5CVQ." . . . **E. H. Hartnell, W9WTE**: "First became interested in radio in 1913; erected first station in spring of 1914, consisting of $\frac{1}{2}$ -inch spark coil and double slide tuner with silicon detector, operating under call of EH. Secured license in fall of 1914 and operated under call of 9KY. Installed 4-inch spark coil, glass plate condenser and helix in 1915 which operated until about time of War. After the War operated a 1-kw. spark transmitter with rotary gap, etc., for several years under the call 9DP. After that gave up radio until April 1936, when the old bug bit again. Secured license and have been operating a 60-watt 'phone on 1875 kc. since, under call of W9WTE. Started taking QST the first issue. Wrote an article which was published in QST, I think some time in 1915. Once a ham, always a ham. Hi!" . . . **Gordon Kressel, W8BO**: "First began winding two slide tuners with a buddy of mine in fall of 1913. Built Spark coil transmitter and tuners during 1914. First license in Sept. 1914. Old WSL and WCC great aid in code practice. First call 3WU good until 1917. Then NIL, QRX for War. Spring of 1919 assigned call 3BO, and it's been 3BO ever since. That's now over 18 years ago and still on the air. Commercial license 1919 to 1923 and again 1934. Two years total commercial service. A.R.R.L. member about 10 years. The first $\frac{1}{4}$ -inch spark coil of 1914 is still here and could be put in service on short notice. $\frac{1}{4}$ -KW Blitzen and the Chambers Sprocket wheel rotary gap also still around the shack." . . . **Wallace H. Leland, W7GCO**: "I started in the summer of 1912, in Berkeley, Calif., under the call 6WL. The outfit was one of those awesome things consisting of spark coil, glass plate condenser, straight gap, etc., and under good DX conditions I could work all of three miles. I naturally graduated, as time went on, to transformer, rotary gap, and all the trimmings, until it was necessary to go off the air in 1917. In the meantime I had put in some time as marine operator with the old Marconi Co., running on one of the old stand-bys, a steam schooner, between Portland, Ore., and San Pedro, Calif. When it was necessary to shut down, I decided that I couldn't get along without my operating, so shipped out in the Navy, putting in my time in transport service in the Atlantic, and in shore stations in France. After the War I stayed off the air until 1923, when I went back again, still in Berkeley, under the call of 6CEG. This lasted until 1927, when the XYL decided that I had better put in less time on the air, and more time at bringing in the sheekels. My next venture started in November 1936, at Cheyenne, Wyo., under the call of W7GCO, and I am still going strong. I am now using a 6L6 tri-tet, driving a pair of 6L6's in parallel, with about 95 watts input, and seem to be getting out very nicely on 7135 kc." . . . **R. H. G. Mathews, W9ZN, Central Div. A.R.R.L. Director**: "My first transmitter consisted of a $\frac{1}{2}$ -inch spark coil rig with a coherer for receiving, and was set up in Springfield in the latter part of 1909. In 1912 I was licensed as 9IK, and in about 1915 or 1916 had the 9ZN call issued, which I have had ever since." . . . **Howard F. McIntosh, K6ONM**: "Started somewhere between 1911 and 1913 with the usual spark coil rig for transmitting and coherer, etc., for receiving. Amateur license with call 3SJ in 1916 and 1917. Naval service 1917 to 1919. Marine operating 1919 to 1929. Been ashore with Mackay Radio since 1929; at present connected with their transmitting station at Kailua, Oahu, T. H. Just recently reentered the amateur game—present call letters, K6ONM, station located at Lanikai, about 15 miles from Honolulu." . . . **H. B. Miller, W9AB and Vern S. Gouker, W9DHM**:

"We started in together, and still chew the fat together when we can get away from the XYL's and second ops. for a few minutes. Our first tickets graced the walls at 9ACM, 1 kw. (?) spark at Goshen (Ind.) High School in 1915. After the War, Gouker became 9DHM, and has held that call ever since, while I have gone thru 9BYG, 9DUZ, 9CVZ, W9HOL, W9AB. Nothing spectacular anywhere along the line—but lots of pleasant memories—such as that snowy night I actually heard 2AGJ! And 5BV. And 8AEZ. A 'KA' right this evening wouldn't hold the same thrill. And I see Fred Hanes is still W9FBH. Wonder if he'll check in for the 20-Year Club? And Glen Decker is W9IGB now. There must be many of the old gang still in the game. I'll be checking the list." . . . **A. R. Montgomery, W6MMB**: "Started in 1913, licensed in '15, Alameda, Calif. 6MA until War came along, then to sea until '20. Various Commercial land jobs, then down to L. A. with call 6QG. Away again until '27; came up with 6DFU until '31. This was the year of the flood, or rather my marriage, etc. Finally overcame all objections to the contrary, got W6MMB in May '35 but didn't get on air until May this year. How's that for optimism? Can look back at the GOOD OLD DAYS of the spark sets, rotary with juice to burn. We kicked then just like we kick now, but the game has gone ahead so much from the old days it isn't even close. I'll take 'em as they are now, or as they are going to be. I hope to have 6MMB in operation for a long time to come. What's a little QRM when there're continents to span." . . . **E. B. Redington, W3GPA**: "Built first ham rig about 1911 after plans published in a most peculiar magazine for amateur radio—*The Delinicator* or one of those ladies' periodicals having a page for boys called 'The Knights of King Arthur's Round Table.' Anyway, there was the dope for a spark coil transmitter, helix and all, and a receiver with two-slide tuner, et cetera. Followed by subscription to Modern Electrics, Electrical Experimenter, and QST—remember the six months for 50 cents offer in the William B. Duck catalogue, I think. Licensed in 1915 (or 1916) as 8AQM. In 1917 I sailed away in the U.S.N. Licensed in October 1919 as 8AJ and have held that call until about a year ago, when Mr. Beadletookitforsafe-keeping until I move to 8th call area again and issued 3rd call area call as W3GPA (watacall). Holding but three calls may be some kind of a record, for all I know." . . . **Lester Reis, W2BR**: "Obtained my first license Jan. 26, 1914 with the call 2RH. Started with $\frac{1}{4}$ -inch spark coil, then 1 inch, using an Electrolytic Interrupter. Ruined one good bedroom rug, then graduated to a 1 kw. Acme transformer with Murdoch Rotary Gap, Clapp Eastman motor. DX 75 miles. Several different receivers from a 3-slide tuner loose coupler Marconi with two crystal detectors, and finally De Forest Audion with 1 filament shot that cost me 6 bucks. In the Signal Corps short time during War. Received license in 1919, but dropped out, and bit by the bug again in 1928 to find quite a change. Received license and call 2BR and still hamming on 56 Mc." . . . **Howard Seeford, W6EA**: "Started amateur wireless in fall of 1908 with iron pyrites detector and telephone receiver. First call used was KM with $\frac{3}{4}$ -inch auto spark coil from 1909 to 1911. Worked ten miles. Wavelength from 300 to 800 meters. Made first home-made quarter kw. spark transformer in 1912. Licensed as 6EA in February of 1913. Worked first DX—100 miles—in February 1914. Talked 25 miles on arc wireless telephone in 1915. Worked 400 miles on half kw. spark in 1916. Became member of A.R.R.L. in June 1916. Got second grade commercial license in fall of 1916. Audiotron was first receiving tube in 1917. Sent first relay message to Atlantic Coast and return in one night of February 1917. Worked nightly message traffic 850 miles on $\frac{3}{4}$ -kw. spark. Was Pacific Coast A.R.R.L. Division Manager before and after the World War. 6EA reissued by R. I. after the War. Worked 1300 miles and was heard 3000 miles on 1-kw. spark. First C.W. transmitter in 1922. W6EA on 80 meters in 1925. NU6EA on 40 meters in 1927. Worked England and New Zealand on 20 meters and worked Chicago on 10 meters of same year. W.A.C. in 1928 on 40 and 20 meters put together. At present on 14 Mc., crystal 100-watt input transmitter with W6EA on 66-foot vertical antenna from top of 101-foot pole." . . . **John H. Stenger, Jr., W8ZS**: "Wound the first coil in 1910. Used a spark coil and SG as call letters. The first

license that I can locate in my files is dated 1914 and call is 8NR. In 1915 I was granted 8ZS with 2500 watts spark outfit. In 1917 I enlisted in the U. S. Navy and went aboard the U. S. Mail Ship *St. Louis* to England. Attached to the Royal Naval Academy for considerable time and then to the Destroyer U.S.S. *Aylwin*. When the Destroyer *Shaw* was rammed by the *Quitania* with a loss of 36 lives, I was sent to Portsmouth, England, to rebuild the radio outfit. Brought the *Shaw* back and joined the U.S.S. *Shawmut* (replaced by the *Langley*) in the Aviation Unit and spent a year in Cuba aviation experimental. Then to NSS (Annapolis), then to NAH (New York Harbor). Then to Sandy Hook, N. J., where I rebuilt the radio station there. Came home in 1921 for a rest. On April 29, 1922, I was granted broadcast station license WBAX and renewed the W8ZS. While I rarely operate W8ZS, you will find one of the staff on 20 meters with about 350-watt 'phone. Forty-one years old, wife and three children. I know quite a few old Navy men and would be delighted to see what happened to them." . . . **E. C. Stockman, W9ESA, Rocky Mtn. Div. A.R.R.L. Director:** "The bug first bit in July 1909 when I was twelve years old, after visiting a friend who had a 'wireless station' occupying part of the hay loft of an old barn. A month or two later when I was able to distinguish 'A' from 'Z,' I gathered up an old one-inch spark coil, some batteries and a key for the transmitter; made up a crystal detector using silicon, a single slide tuning coil and a single telephone receiver, and went on the air using the call ES. When the Colorado Wireless Association was organized in 1912 the members decided to add the letter C to their calls to indicate they were members, so my call for the next few years was CES. Improvements were made to my station from time to time and power increased. In 1914 I was using a 1-kw. rotary spark transmitter and a single Audiotron detector in the receiver, nearly every piece of equipment being home-made. In August 1915 received my first license, call 9ZD which was used until the amateurs were closed on account of the War. This call was reissued to me for two years after the War and then I dropped out of the game for a few years. In September 1926 I was assigned 9ESA, later W9ESA which I hold at the present time. Was enlisted in the Signal Corps of the Army during the War as radio operator and have virtually grown up with amateur radio right here in Denver." . . . **Jack Taft, W6IT:** "In 1909 at Woodburn, Oregon, I built a crystal detector from an article in a dime 'How to build it,' by Paul M. Janke (?). This consisted of two sharpened carbon blocks nailed to a piece of wood, across which a darning needle was placed. The phone was connected to the carbon blocks, the aerial being connected to one side and the ground to the other. I listened patiently for hours without end, but could hear nothing in the way of wireless signals even after connecting 25 or 30 worn-out auto ignitor cells in series, so promptly started experimenting with arc lights. Wireless was dropped for a few months until I moved to Salem, Oregon, where I became acquainted with Adair Lockwood signing CD and Charles Holdiman signing ES. I graduated to silicon detectors and Etheric 'phones and a Ford spark coil. In 1912 I obtained a 3/4-kilowatt Packard transformer and really went to town. My greatest distance with the Packard was to work Charley Austin, C2, at Portland, Oregon, a distance of about 40 miles air line. In 1914 the radio inspector caught up with the Salem gang and my first license was issued to me under call 7JD. In 1915 I moved to Los Angeles and operated for a year and a half under 6JU. In 1917 at Corvallis, Oregon, I operated for a few months under 7JT. The War closed us down and in the meantime I moved to Portland, Oregon, and opened up there under 7JW and also did some experimental work under the call of 7XBD. In 1924 I moved to California and operated spasmodically under the call of 6IT, which I am still using." . . . **Ferd. C. W. Thiede, W2EC:** "1911: Started building coherers and reading E. I. Co. catalogues. Installed 1-inch 'bull dog' spark coil, call letters NX. 1913: Call letters 2EC issued to me and held continuously since then. 1914: Joined A.R.R.L.—have copy of original application still in my files. U.S.N. 1917-1919 radio opr." . . . **James D. Wiley, W1DMF:** "Started 1913, Quaker Oats tuning coil and silicon receiver. 1914, call 1GW at Waban, Mass.; Ford coil and dry battery terminal spark gap. Heard England's Declaration of War

from WCC press. Joined Navy in May 1917 as radio operator and served until end of War, then dropped radio until 1931 when received present call. Where are all the Harvard Radio School graduates and especially the 80 May and June boys of 1917?" . . . **J. F. Wohlford, W3CA:** "Started in ham radio April 14, 1912, or rather got the bug that date and assembled a lot of junk, including a spark coil and a mineral detector. Secured license under call 3WE on or about June of that year. The call today is 3CA and has been that since reopening just after World War. No other calls have been assigned this station." . . . **R. W. Woodward, W1EAO:** "Started in ham radio in 1908. First call was RW followed by SNS (all members of the original Hartford Radio Club used calls beginning with SN-). After licenses were necessary call was 1VW. Charter member of A.R.R.L. Off air from 1915 to 1921 while in Washington at Bureau of Standards. Winner 1923 Trans-Atlantic receiving contest. Certificate in 1931 Freq.-Measuring Contest. At present O.O., O.P.S., P.A.M. and active on all bands, 'phone and C.W."

1937-38 1.75-Mc. DX Tests

By S. S. Perry, WIBB

FOR all amateurs interested in working DX on 160 meters, the 1.75-Mc. tests which have been conducted for the past five years will be repeated again this year under a slightly different schedule. Two tests will be held each week-end during December 1937 and January 1938.

First Test—each Saturday morning, 0430-0730 G.T. (11:30 P.M., Friday to 2:30 A.M., Saturday, E.S.T.); divided into ten-minute transmitting and receiving periods, as follows:

(a) All W/VE stations call "CQ DX" (signing call frequently), starting at 0430 G.T., stopping at 0440. Listen for DX stations 0440-0450. Transmit 0450-0500. Listen 0500-0510, etc., repeating this same schedule sequence each hour until 0730 G.T.

(b) All "DX" stations (other than W/VE) will listen during W/VE transmitting periods, and transmit "Test DX" (signing call frequently) during W/VE listening periods; i.e., Listen 0430-0440 G.T.; Transmit 0440-0450, etc., repeating the schedule sequence each hour until 0730 G.T.

DX and W (or VE) stations may work each other, instead of calling "CQ DX" or "Test DX" during their proper transmitting periods, provided no local sending occurs in a local listening period. Be sure to set your clock accurately Friday evening before the tests and adhere carefully to the schedules above!

Second Test—each Sunday morning, 0430-0730 G.T. (11:30 P.M., Saturday to 2:30 A.M., Sunday, E.S.T.).

This will be a "free for all" three-hour period to call and work DX as one chooses without the fixed ten-minute schedules of the previous night. Stations that "contacted" on Saturday can, of course, make schedules to "work" each other on Sunday.

W/VE stations should remember the suggestion issued each year with the "International DX Contest" to the effect that the way to work more DX is to listen for DX and then call the specific DX station heard. Don't CQ DX in the Second Period. In this way local QRM will be kept at a minimum and on the whole much better results will be obtained.

DX C.W. stations are advised that the best portion of the band to be heard and worked by W/VE stations is between 1725 and 1775 kc. However, 1715-1800 kc. will be scanned carefully by W/VE C.W. listeners. Previously, participants in these tests have been 100% C.W. 'Phone amateurs are also welcome and should work on exactly the same schedule as announced above.

At the conclusion of the test, please make a summary of DX heard and DX worked and forward to WIBB, who will prepare a composite report of the results for QST. Any unusual condition observed or results obtained should especially be noted and reported. Comments, suggestions, criticism of the tests and advice as to whether or not they are desired again for the next year are also requested.

In the past, "G" stations using powers in the neighborhood of 15-25 watts have been successfully worked in these tests. With an ever-increasing interest and use of the 1.75-Mc. band this year additional noteworthy accomplishments are expected.

O.B.S.

The following is a supplement to the list of A.R.R.L. Official Broadcasting Stations in October QST (page 50): W1EAW, W1JSK, W2BJP, W2IXY, W3BIG, W3BIW, W4QL, W5DWW, W5FLU, W5FUM, W6EQM, W7CJR, W8DED, W8FZE, W9AUH, W9AXH, W9FB, W9SDQ, W9TBF, W9TE, VE4EO.

— * * * —

The Marion Amateur Radio Association furnished communications for the Mississinewa Valley Regatta outboard motor-boat races, held on the river at Marion, Ind., on October 3d. Three 56-Mc. units were used, two mobile, one fixed. The race course was 3000 feet, extending upstream from the new W.P.A. dam, and around one bend. W9HBD was set up out on the dam, power being obtained from the control box for the flood gates. This location was also used for a P.A. system, W9HBD supplying the information for announcements. W9MTZ, operating mobile, was stationed at the starting/finish line. Most of the traffic originated at this point via a 200-odd foot messenger service to the judges' stand. W9MTZ picked up general announcements via the P.A. system at the "line," and results and messages via the messengers, and relayed to W9HBD. W9ZDH was stationed at the other end of the course. The purpose of this station was to watch for spills, dead motors, etc., and to report them to W9MTZ, who was in touch with the tow boat. In general the affair was a success, with the exception of a few minor difficulties over which the club had no control. With the experience gained this year the M.A.R.A. will be ready to do an even better job "next time."

— * * * —

While Mrs. Dan MacKaskill of Glace Bay, Nova Scotia, was touring in the New England states, her husband met with a serious accident. Relatives unable to communicate with her immediately thought of amateur radio. VE1JA got on the air and made contact with VE1GR, Halifax, who lined up several amateurs in Boston and vicinity. Through their efforts and the State Police, Mrs. MacKaskill was located and by plane and rail arrived at Glace Bay within forty-eight hours. The Glace Bay and Halifax amateurs thank W1ILM, W1AXE, W1AUJ and W1FBF for their kind assistance in this emergency.

—VF2BE

— * * * —

For the Ham with the Systematic Mind

When I started in Amateur Radio I realized that it would not be long before I was going to need some kind of running record besides a log to keep track of stations worked. So I started a system which has worked out excellently. I make out a 3 x 5 card for each station worked, and keep these filed alphabetically by calls and countries so that I can refer to them instantly. Each card has the QTH, the date of each QSO, record of QSL, rig, reports, QSO number and a short line on the conversation of each QSO. It is very simple to make these entries during the QSO, it takes very little time and gives a permanent record, quickly available, which would be impracticable to obtain by hunting back through the log. Each additional time a station is worked, I merely slip the card out of the file, note the contents of our previous encounter, and add the data to cover the new contact. It helps in rag-chewing to be able to find what we talked about before, etc. I supplement this indexing system by other lists such as a card for each country worked showing the stations in that country in the order worked. I keep various other records on "countries worked," "states worked on different bands," "countries worked on 28 Mc. and on 'phone," etc., just to keep track of things. One "big" sheet lists all the "Q's" worked in alphabetical order.

—W1WV

Hamfesters Hold Huge Picnic

Sixteen hundred hams and their friends gathered together August 8, 1937, at Justice Park Gardens, just southwest of Chicago, for one of the biggest hamfests ever staged in those parts. The Hamfesters Radio Club, Inc., was the host and lived up to its name (Hamfesters!) in grand style. Activity started with a soft ball game in the morning, and at one o'clock the program got under way in earnest. Among the various events was an amateur show divided into two parts, one for the youngsters and one for the oldsters. Numerous races designed to bring out the athletic powers of the participants were staged. The pie-eating contest was a classic. W9OTY displayed unsurpassed technique in this, and was his face "blue"! The grand prize, an RME-69, was won by A. Ballik, stooge at the shack of W9SLB. (W9SLB won the RME-69 at the Central Div. Conv.!) Second prize, a Sky Buddy receiver, was won by W9ROQ. Other grand prizes were an Electro-Voice mike and a 15-inch self-starting electric clock, won by W9MHQ and W9WQI respectively. Among those present were W9TSN, Asst. Director, Central Division, A.R.R.L.; W9KJY, S.C.M. Illinois; and that genial pair of Al's, Cox and Knodell, W9UAG and W9TLQ, business manager and editor of *Harmonics*. After dancing to a nine-piece orchestra until late evening, the last of the tired but happy throng left for home. It was a great day and everyone is looking forward to the Hamfesters' Fifth Annual Picnic, August 7, 1938.

— * * * —

Amateur radio assisted the English Public Schools Exploration Society (G8XY) during its visit to Newfoundland when a member of the party met with an accident. VO3X heard G8XY calling "CQ VO Urgent." Making contact he was advised that a student had fallen over a cliff, that they could not reach him and help was needed. There was no means of communication other than amateur radio. VO3X took a message for the Game Warden at Trout River asking him to come at once and put it on the G.P.O. lines. The Warden arrived at the scene of the accident and, although the student met his death in the fall, amateur radio did its part in summoning aid. VO4Y also participated in the work, keeping in daily touch with G8XY and finally making funeral arrangements.

— * * * —

Chess by Radio

A series of chess games by radio was inaugurated on July 14th between Washington, D. C., and Arlington, Va. The purpose of the series is to develop a procedure and methods which will insure the successful and satisfactory playing of games by radio this fall when players in and near Washington will engage in games with players located in Boston, New York, Philadelphia and elsewhere.

Four players met at W3CAB (3591 kc.), Washington, D. C., and four players at W3EEN (3790 kc.), Arlington, Va. Two games were played, which allowed two players in consultation playing each side in each game. The results were highly satisfactory. In the past, chess matches have been played by radio but in many cases they dragged, difficulties arose and interest did not continue. The present tryouts, in which a careful study will be made of the environment of the games, it is believed will lead to methods and handling which will result in continued success of chess via radio and the sustained interest of all participants. By early October it is expected that regular matches between clubs and players in distant cities can be reliably scheduled and carried out on a fully tested basis.

—W3CAB.

— * * * —

The Monterey Peninsula Radio Club participated in the open house festivities at Pacific Grove, Calif. A lighted boat parade was staged from Monterey to Pacific Grove. The boats were all beautifully decorated and lighted. There were also fireworks from some of the boats. On board the *Albacore*, which is the Fish and Game Commission boat, W6COO operated a 56-Mc. transmitter through which various officials of the affair described what was going on. W6NTU operated a receiver at the Pacific Grove pier. The received signals were amplified by a P.A. system so that the immense audience could hear everything from the boat.

Alberta Hamfest

The Northern Alberta Radio Club Hamfest held at Edmonton, July 10th and 11th was favored with one of the largest registrations ever recorded in Alberta. A good number of Saskatchewan fellows put in an appearance as well as a quite general representation from all of Alberta—although there was an almost complete absence of Calgary hams, with only one who was holidaying in the district putting in an appearance. The program got under way with the technical session held at the University of Alberta. Lectures by Dr. Cornish of the University faculty and Roy Usher, VE4EA, were well received, as well as a humorous lecture by VE4HT. A demonstration of radio and electrical equipment and a visit to the Electrical Engineering Dept. of the University concluded the session.

The banquet was attended by 85. The evening program included a talk by Cyril Waites, Vice-President of the Astronomical Society of Canada; reminiscences of early days as a ship operator by W. G. D. Allen, local R. I.; a playlet, "Amateur Radio Marches On," by local hams; Prevaricators' Club yarns; and the highlight of the evening, an enlightening demonstration and lecture on "Splitting of the Atom" by Professor Buzzoff. The program wound up with presentation of a film loaned by the National Carbon Co., Ltd. Visits to the Edmonton Steam Power Plant, hamshacks, CJCA, Canada's largest inland seaplane base, etc., started off the Sunday program. Picnic headquarters were later established and the assembly indulged in games, races, etc. An excellent picnic lunch marked the official close of the hamfest. It is generally conceded that the 1937 Alberta Hamfest will go down in Ham History as one of the finest ever staged.

—VE4LQ

56-Mc. Notes

Scattering reports of good DX work on 56 Mc. during August and September, when conditions were excellent on that band, continue to come in. W1DUJ, Warren, Maine, heard W9CLH, Elgin, Ill., several times on the evening of August 9th, strength 7-8. W8KAY, Akron, reports receiving W9CLH between 7 and 9 p.m., Sept. 6. W3DZR, Philadelphia, reports the band open the night of September 10th, with first and second district stations coming through S5 to S8. W3AC, portable at High Point Park, N. J., came through S7 while using 18 watts input to 112's. W1BCR, Providence, R. I., was heard S7-8. On Sept. 6 at 2:05 p.m., while on the Skyline Blvd., about 25 miles south of San Francisco, at an elevation of 2300 feet, W6JOF worked W6IDF (Los Angeles), an airline distance of about 350 miles. W6JOF was using two 42's in transceiver, portable-mobile rig, about 3 watts into an ordinary fish-pole antenna. Not at all bad! W8IPD sends a photo of his installation at W8IPD-1, Mt. Washington, N. H., where he and VE3AP conducted a

"Five-Meter Expedition" between August 16th-21st; results are not given in detail. "Ultra High Frequency News" is a bulletin published by W3AUY, W3FOD and W3DJ, all of Philadelphia. It is chock-full of data of interest to 56-Mc. enthusiasts, particularly those in and around Philadelphia. All "five meter" men within normal range of Philadelphia will find it worth investigating. On the eventful night of Sept. 10th, W3AUY worked W2HF, W2HVK, W1AVV and W2GHV; he heard a score of W2's and several W1's.

When Case Company dealers of the San Joaquin Valley went to a meeting in Racine, Wis., they were kept in constant contact with home through W6NJP, installed on the special train which transported the party.

The "service message" is a useful implement in improving amateur message handling. The service message may be used to test various routes, it may refer to non-deliveries, to delayed transmission, errors, or to any phase of traffic work. Should a message you originate receive poor service and you are interested to know what happened to it, start a service message along the original route making inquiry. Rather than condemn everybody concerned, make an actual check-up and find out what really happened and where to place the blame.



THE ADVANCE PARTY OF THE AMERICAN MUSEUM OF NATURAL HISTORY EXPEDITION TO NEW GUINEA LEFT OCTOBER 15TH BY STEAMER; THE REST OF THE PARTY WILL FOLLOW BY PLANE IN JANUARY

In accordance with the Museum's plans, made in cooperation with Mr. Richard Archbold, Research Associate, the scientists expect to be there for a full year from January 1st. Harold G. Ramm, W2BVB, is pictured here with the gear he will use as radio operator at the expedition's base station at Hollandria. Raymond Booth, W3—, will man the aircraft station, KHAHX, which operates on aircraft frequencies 500, 3105, 6210 and 12,420 kcs. The base station consists of a 500-watt transmitter (837 crystal, RK46 buffer-doubler, 805's output-805's mod.). Phone will be used as much as possible with a shift to c.w. as necessary to get through tropical QRN; 26 amateur band crystals are being taken along. More news on the expedition is expected from time to time from W2BVB. Amateur contacts for the expedition personnel from this country will be valued, although there will be but a modest traffic load. Report all work with this expedition to A.R.R.L.

and transmitting his own, it was suddenly apparent to K5AA that both messages were of the same Check, and that while one originated in Rochester, N. Y., the other was destined for the same city!

Station Activities

See Pages 100, 101, 104, 105

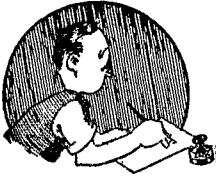

CORRESPONDENCE

The Publishers of QST assume no responsibility for statements made herein by correspondents

Little White (?) Lies

151 Tiffany Place, Irvington, N. J.

Editor, QST:

. . . I have always been strict in giving reports—indeed, I have sometimes been accused of being a crank because of the strictness with which I gave my tone reports. On the other hand, there were probably many times when I was careless in giving reports. But when I read this letter (QST, March, 1937, "I Cannot tell A Lie," by W9RSE) I resolved to paste a copy of the RST system on the front of my call book and use it before giving a single report. . . . Now let me tell you what happened as a result of my resolution.

One evening W1— came back to my CQ, and after carefully consulting the RST scale I gave him a tone report of T4. W1— came back, indignantly demanding the meaning of the T4 report. "Why," he said, "I've been working boys right along who gave T8 and T9. There must be something wrong with your receiver."

Just to make sure my receiver was O.K., I tuned around the band and heard some T9x notes—you know the kind, clear, pure ringing tones—then I tuned back to W1—'s frequency and heard his sig with a pronounced ripple. Let me say that my receiver pack is well filtered and by-passed for tunable hums, etc., so that the chances for a.c. at my end were very slim indeed. And not only that, there were plenty of other sigs which were T9 in my opinion. But to continue, I went back to W1— and smoothed things over as much as possible, saying the trouble might well be with me, but that for his benefit I suggested that he check his rig over. Finally W1— proposed that I stand by and listen to the report he got in answer to his CQ. And here is the pay-off—some other W1 came back and reported him 599x! Well, W1— told his contact that he was talking to W2FXV who reported a T4 but, since the report was *really* T9, everything was FB. How do you like that?

I suppose this is just another case of human nature and hams being human will listen to what they really want to hear, not what is actually the truth! I don't know what can be done about this situation and I can't suggest a cure, because heaven only knows you have pleaded enough. If I am hardboiled and read 'em off the sheet I am sure to arouse resentment. On the other hand, I want my reports to mean something. Maybe what I should do is be strict and then apologize for it.

The only thing I can hope to accomplish by this letter besides letting off steam is to wake up some of the boys and hope they will get wise to themselves. So, gang, why not pull out March QST and read what W9RSE has to say—once, twice, three times if necessary. Make every report mean something and be honest when giving 'em out.

—Wm. Nastuk, W2FXV

Canadian QSL's

Box 705, Yarmouth, N. S.

Editor, QST:

I wonder if you would drop a word of advice through your magazine to those hams sending QSL cards.

Cards to Canada call for a two-cent stamp. If sent with a one-cent stamp we have to pay two cents before we even get a look at them. This doesn't make us any too keen about spending two more cents to send a return card.

—Clyde L. Robbins, VE1DW

Lightning Doesn't Need to Strike Twice

147 Canton Ave., Milton, Mass.

Editor, QST:

Direct lightning strokes on amateur aerials are perhaps sufficiently unusual so that you would be interested in an experience I have just had along that line.

I have a Johnson "Q" ten-meter long-wire antenna which I use for receiving purposes. One end of the antenna is made fast to a chimney of the house; the other end is supported by a rope rove through a pulley made fast to a branch of a big elm with a counterweight on the other end of the rope.

Last Thursday, lightning struck the elm. The bolt struck in the uppermost branches, came down the tree to the limb (which is about forty feet off the ground) to which the antenna is made fast, and then jumped horizontally about ten feet to the antenna. The antenna, which is of No. 12 hard-drawn wire, was burned off at the strain insulator. As a matter of fact, there are two insulators in series, a cheap porcelain one and one of National's Isolantite 4" insulators. The former was pretty well shattered; the latter

showed no signs of grief except that there is a liberal deposit of copper burned into the glaze at each end where the holes go through.

The bolt travelled the length of the antenna wire to the aluminum-tube matching transformer. At that point, it flashed over from one side to the other and came in on both feeder wires. These are of No. 14 wire spaced with porcelain insulators. The feeders were protected by two glass broadcast receiver-type lightning arrestors. Both of these flashed over, one of them sufficiently violently to crack the glass and burn off the clips inside for about a quarter of an inch. This discharge took most of the "sock" out of the bolt, but some of it came on into the house. I have four receiving antennas arranged with jacks into any one of which I can plug a receiver. The bottom jack connects to a long wire receiver on one leg and to ground on the other. This jack is two inches removed from the Johnson jack. These jacks flashed over heavily, indicating a voltage of at least 20,000 at this point. The flash reached some curtains, which were heavily charred but not actually set on fire. The ground wire from the aerial goes through the floor into the basement where it is tied to a 2/0 house lighting ground. The point of connection of the house fuse box was sufficiently "above ground" to burn out most of the fuses.

There were several interesting collaterals.

For example, the connection between the Johnson transformer and the antenna was made with tinned copper braid. These 4" links provided such a high r.f. resistance that the lightning jumped from wire to wire rather than follow the tortuous path involved in the braiding. I have always heard that braid has a high r.f. resistance and this experience certainly proved it. The second point that impressed me was the fierce heat involved at any point where an arc occurred. Witness the burning off of lightning arrestor prongs and the burning in two of No. 12 wire.

The third significant point is that a ground wire may be at zero potential for ordinary uses, but when a bolt of lightning is trying to find its way home the voltage is far, far removed from ground, even a few feet from the low end.

Finally, I can now ponder on what would have happened if any instruments, such as receiving sets, had been connected to the antenna, or if there hadn't been lightning arrestors in good working order in the system. As it was, I missed a fire by the narrowest of margins.

You can get some idea of the currents that flowed on the house side of the arrestors when I tell you that two small meters hooked into various pieces of apparatus on my desk were wrecked although neither had any direct connection to the aerial. Further, the steel case of an oscilloscope, which was located about a foot from the ground wire, was sufficiently magnetized to give a permanent deflection to the beam of nearly an inch.

All in all, I have come out of the experience with a pretty wholesome respect for a bolt of lightning and a determination to be sure that things are "cut clear" when a thunder storm is in progress. . . .

—Theodore Clark

Plea for 1.7-Mc. DX

2 Highland Ct., Far Rockaway, L. I.

Editor, *QST*:

. . . It seems to me, if I can recall F.C.C. regulations correctly, there is from 1715 kc. to 1800 kc. a band with great possibilities but no activity. DX tests in past years have proved the possibilities of this band, but the lure of the higher frequencies has diverted the interests of many who may have operated here to the other bands. This leaves a nice empty space occupied only by a few Canadian 'phones. True, we cannot expect what we get on ten, twenty, or forty as far as consistency in DX goes, but we can, by increasing the activity in the right section, have some real enjoyable and novel contacts for this band.

Let me explain what I mean by "increasing activity in the right places." Due to the fact that it is possible to work, from the east coast, consistently out to the middle west and as far as Florida, just after sunset, with a few good signals operating night after night scattered around the country

anyone would obtain some pleasure out of operating this band. As it is now, you have to wait hours and sometimes days before there is much activity simply because everybody thinks nothing is coming through when actually there is no one operating. In other words, we need someone to make a start and this can be done by renewing interest in the band. Just let some of those fellows up in Newfoundland, Mexico, Cuba, the West Indies or Bermuda (if their local regulations permit) put some good equipment on the 1.75-Mc. band with suitable antennas and I'll wager that they will put swell signals in here. Don't forget that with the band in its present condition we do not have to contend with QRM. Also, why not continue the DX tests that used to prove so interesting in years gone by? Let some of those European countries cook up interest and watch the way transatlantic reports will be exchanged as in days of old. . . .

—Martin Kronenberg

W9 Calls

W & J College, Washington, Pa.

Editor, *QST*:

I'd like to see this query answered in *QST*.

After W9ZZZ is reached will the F.C.C. start licenses with W9AAAA?

—Raymond M. Bell, W3RFG

EDITOR'S NOTE.—No.

Fighting Galoots

Scottville, Mich.

Editor, *QST*:

I am a new ham. In fact I have only had my ticket about two months. I have worked several years to gain enough "wisdom" so I wouldn't be too much of a lid when I went on the air.

Before I got my ticket, the *Handbook*, the *License Manual*, and all the rest kept telling me what an unselfish and swell bunch of fellows were in amateur radio. So, I got my license.

Yes, I got my license—and what do I find? I find a mess of fighting galoots, some who do not appreciate the advantage of a kilowatt, some who think the low-powered fellow the scum of the crop, others who like nothing better than to yell about QRM, and so-called "rotten" sigs.

Are we going to have 40,000 hams peacefully ragchewing or are we going to have this same number QR'ing our bands with fighting over who's who and what's what? I agree with W8JRG—"It was here before a lot of you were in it and it is going to be here when you're making a feast for the worms."

—Forest J. Pinkerton, W3QVL

A Professional Comment

P. O. Box 503, Drummondville, Que.

Editor, *QST*:

With reference to your editorial in the August number of *QST*, your second item regarding the transmission of the international code and the straightforward criticism you make regarding its awful mutilation by a large number of amateurs is very opportune and, if I may say so, much delayed.

Now why is it such conditions exist? How on earth do these men ever pass their code examination? The regulations must be very, very elastic and the examiners very lax and indifferent.

Admitted there are stations being handled in a very exemplary manner, but these are in the minority.

I have considered going "on the air" for some time, but when I listen to the awful telegraphy on the amateur bands I wonder if it is worth the time and expense.

Perhaps a little advice to those of you amateurs who

(Continued on page 68)

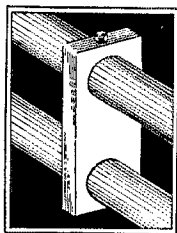

There are two commonly used methods of matching the impedance of a transmission line to that of an antenna system: the concentrated transformer network and the quarter-wave section. The latter is most popular in amateur installations and is usually either a quarter-wave matching stub (in which the transmission line is tapped off some distance from one end) or a linear transformer, alias "Q-bar." Of the two, the Q-bar type seems to be the most favored by wide usage. It is an extremely effective and practical method, and kits of parts have long been available from practically all dealers.

Our own objection to the Q-bar system has been a mechanical one. Namely, that the coils of soft tubing and adjustable insulators supplied in the usual kit have been somewhat haywire. It is almost impossible to get the coiled tubing straight, and the feat is scarcely worth the trouble in any case since the tubing is not stiff enough to support its own weight and immediately kinks again. The adjustable insulators are likewise subject to involuntary adjustments.

For our use at W1HRX, we decided to design a rigid, non-adjustable assembly. This has proved so entirely satisfactory that arrangements have been made to sell the parts commercially. Thus does history repeat itself, for the original disk-type neutralizing condensers too were first built as a private folly at W1HRX, using disks left as scrap when socket holes were punched in aluminum chassis. These have been widely copied, even to the use of a socket-sized disk.

However, to get back to the Q-bar. The particular dimensions which we chose were designed to match 72 Ohms to 600 Ohms, or in other words they matched a center-fed half-wave antenna to a feeder using No. 12 B&S wire and 6-inch spreaders (such as National AA-3 spreaders). It obviously will not match other sizes of wire, etc., but in our experience it is a lot easier to buy No. 12 wire than it is to adjust an adjustable Q-bar.

Once a system of fixed dimensions is decided on, it becomes very easy to build a rugged assembly. Stiff, thin-walled, seamless duralumin tubing is made in exactly straight lengths up to fifty feet long, though for ease in shipping it usually is not handled in lengths more than fourteen feet long. Most radio dealers will carry some of this tubing in stock in the near future, together with fittings for splicing lengths of tubing end to end.

The spacers become the simple Isolantite blocks pictured above. They are simply slipped over the duralumin tube to the position desired. To hold them in place, a small hole is drilled through the tubing opposite the small hole in the Isolantite block and a screw is driven home, holding both together. Preferably this screw should be a 6 x 32 machine screw, which will require tapping the duralumin tube. A wood screw can be used however. Connections to the system can be conveniently made with ground clamps.

JAMES MILLEN



Use
YAXLEY
APPROVED RADIO
PRECISION PRODUCTS

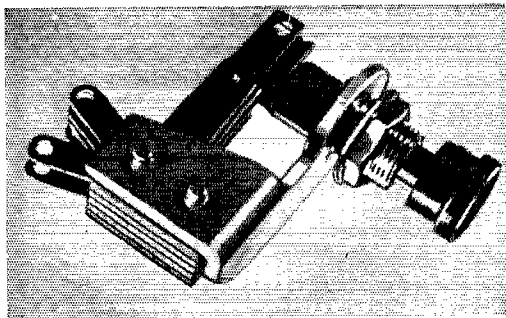

YAXLEY

Push-Button Switches

We haven't said much about them but you will find Yaxley Push-Button Switches in almost every station. They are ideal for meter shunt service, as well as for set analyzers, tube checkers and other test equipment.

Mallory Push-Button Switches have numerous outstanding features, such as:

1. Accurate workmanship.
2. Nickel-plated phosphor bronze springs.
3. Coin silver contacts.
4. Heavy cadmium-plated frame.
5. Self-wiping contact action.
6. Hot tinned soldering lugs.

Available in both locking and non-locking types with a large variety of spring contact arrangements. See Yaxley Push-Button Switches at your distributor's.

P. R. MALLORY & CO., Inc.
INDIANAPOLIS INDIANA
Cable Address—PELMALLO

Use
P. R. MALLORY & CO. Inc.
MALLORY
APPROVED RADIO
PRECISION PRODUCTS

(Continued from page 60)

"know" the code but cannot "handle" it will not come amiss. In the many years that I have been reading *QST* very polite "digs" have often been made at the commercials from the pens of your members, but if you chaps want to hear the code as it ought to be sent, listen to some of the commercials who take a pride in their sending. There are many "styles," but the delivery is good, sensible and readable. Readability is the first thing and speed the last.

A few minutes ago I heard two "bugs" going at it hammer and tongs, and I marvel at the ability of these two to understand each other. Of course there is a "bk" about every 4th word, but what do they care—look at the speed!

Now my suggestions are these. Forget the "bug" type of key for about five years; by that time you will have mastered the "straight" key. When I say "mastered" I mean *mastered*, not a mere burst at 20 w.p.m. for a couple of minutes but, say, for an hour and with no erasures. Listen to a good commercial station. I don't mean auto stations, but honest to goodness key punchers such as PCH, GKT, EAL, GLD and to your own two splendid stations WCC and WSC. Time is dimming my memory as to others but these will suffice. Listen to their style and copy them. You will then be in a position to call yourselves Operators. You will say, "But they are commercials, we are amateurs." Don't let that worry you, for imitation is the highest form of flattery and the commercials don't mind you copying them. . . .

I think amateur operating is the ideal hobby. It can be done from one's own fireside. It is instructive and entertaining. The urge to get back on the air is very strong, but until I feel that I am not going to get a headache trying to decipher what someone sends to me when I tell him to "shoot" and he goes and "squirts" or another has to be told to "Please repeat all the dashes have received only the dots," I think I will get more satisfaction by continuing to be just another observer.

—John K. Holland

"Our Hero's" Dilemma

Bradner, Ohio

Dere Eddy:

I yam settin hr bitin mi fingernails and wishing I dared say sompin I dont dare say on acct of the mikes open an I dont want FCC hopin all over me fer brakin regulashuns. But I'm tellin ye sompins gotta be dun abt it. Hr wuz me a law abidin, peace lovin, brass pounder that wuz havg a FB time chewin the rag on 80 & 40 and liken it. Then all of a sudden a weezel pops oute the board pile and landed rit on my op table. It scared me so bad I passd out a minnut and wen I wok up I yad a new ham shak all dekd out and rite wher the majestik ole sideswiper used to set wuz a bran new xtl mik, and tt wondr of wondrs the ole either chopper had ben all turned inside out an rit ther in front of mi eys wuz a full one tent kw on 160. I didden mine it 4 a while but its gitten undr mi hid. I never will forgive the guy wot tore up my cw rig and put this dude affair in its place. I'm gettin homesik for tt beloved dah dit dah dit an brothur U kin luk fer some mity lonesum CQs in cw. Ther is howevr anothur ant in the pant 4 sum gi haild me tothr da an ses Y don ya jin up wid t OFS. Ten I tole D gui tt I wud an an now I dunno wot 2 do. So wil U pleze take it up wid the othr brainstormers and see wut can be dun. I woodden min but the QRm on 160 fone is so bad tonit tt I cannot even here a kw sig. Oh its turrible an I got a hedake so wot will I dew? urs respectively

—Paul R. Smith, W8FHB

P.S.—I wan you shud no 2 tt thos fones call me Four Hungry Bachlors an now I cant get no YL.

Ham Silencer

2543 S. Avers Ave., Chicago, Ill.

Editor, *QST*:

Well, here it is September, 1937, the second anniversary since you published my article, "Hormones vs. Restriction," and the trend is still the same to the present day.

The hams are still crying about "High Power," "Flea

(Continued on page 66)

Dependable!



Cement Coated
**TRANSMITTING
POWER WIRE WOUND
RESISTORS**

**THEY'LL STAND
THE OVERLOADS...**

*Because of the Proven
Superiority of the IRC
Cement Coating*

A coating that withstands temperatures beyond 250° C. . . .

. . . A coating that stands up under all kinds of moisture and humidity—even salt water immersion . . .

. . . A coating applied to the resistor without the intense and oftentimes damaging heat which weakens the construction of old style wire wound resistors.

That is the story behind the famous IRC Transmitting Power Wire Wound Resistors with their exclusive IRC Cement Coating. That is why, throughout the world, you'll find them specified for those exacting jobs where there **MUST** be no failure.

*Fixed and adjustable
types for every
requirement*

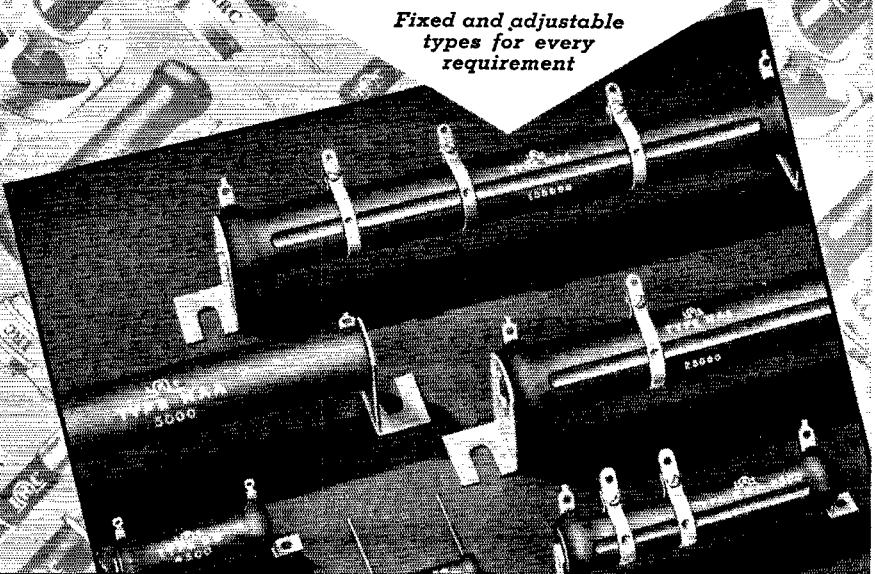

INTERNATIONAL RESISTANCE COMPANY

401 NORTH BROAD STREET, PHILADELPHIA, PA.

Factories or Licensees in Canada, England, France, Germany, Italy, Denmark and Australia

**MAKERS OF RESISTANCE UNITS OF MORE TYPES, IN MORE SHAPES, FOR
MORE APPLICATIONS THAN ANY OTHER MANUFACTURER IN THE WORLD**

Say You Saw It in *QST* — It Identifies You and Helps *QST*

EXTRA

Newark News

EXTRA

TIME PAYMENTS!

BIGGER VALUES!

4-HOUR SERVICE!

Everything You Need
Always in Stock!
No "Back-Orders!"
Faster Service!

ORDER NOW

Easy terms on orders for parts, sets and tubes, \$60.00 or more. We have all the new amateur sets as soon as released by manufacturers, on our convenient 6% Credit Plan. No matter what set you want, we can furnish it. All the standard makes in stock for immediate delivery. Before you buy, WRITE Us. You'll SAVE MONEY!

All Standard Sets
and Parts Available
on Time Payments.
Buy Now.. Pay Later!

**ONLY A FEW OF THESE LEFT
VERY SPECIAL**

Oil Filled
and Oil Impregnated

**FILTER
CONDENSERS**

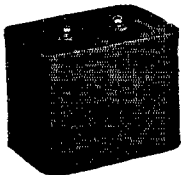

Lucky purchase of 10,000 all well known makes enables us to offer astonishing low prices. All Guaranteed at rated voltages. Already sold down to limited supply and going fast.

Order Now

2 mid., 2000 V. DC, 4 3/4" x 3 3/4" x 1 1/2", 1 1/2 lbs.	\$1.50
3 mid., 1250 V. DC, 3 3/4" x 3 3/4" x 1 1/2", 1 1/2 lbs.	1.25
8 mid., 2000 V. DC, 5 x 3 3/4" x 3 3/4", 2 3/4 lbs.	2.75
9 mid., 3000 V. DC, 5 3/4" x 3 3/4" x 1 1/2", 9 lbs.	7.25
(Including 2 3/8" Bakelite Standoffs)	
4.4 mid., 1500 V. DC, 5 x 3 3/4" x 1 1/2", 1 1/2 lbs.	1.75

**A COMPLETE STOCK OF ALL
X'M'TING TUBES ALWAYS ON HAND**

Newark SPECIALIZES in supplying Transmuting Tubes. A complete stock of ALL BRANDS and ALL TYPES is always kept on hand. No matter what Tube you want, you can get them from Newark, IMMEDIATELY!

RCA		RAYTHEON		TAYLOR	
Type	Net Price	Type	Net Price	Type	Net Price
800	\$10.00	RK20A	\$15.00	T-20	\$2.45
801	3.45	RK23	4.50	TZ-20	2.45
802	3.50	RK25	4.50	T-55	8.00
805	13.50	RK37	8.00	T-125	13.50
806	22.00	RK38	14.50	203Z	8.50
807	3.50	RK39	3.50	866	1.50
808	4.75	RK47	17.50	866JR	1.00
838	16.00	RK48	27.50		
954	5.00	RK49	2.10		
955	3.00				
956	5.00				
806	1.50				
906	13.50				
913	4.00				

EIMAC		GAMMATRON		AMPEREX	
Type	Net Price	Type	Net Price	Type	Net Price
		HK-354	24.50	ZB120	10.00
		HK-254C	24.50	HF100	12.50
		HK-154	12.50		

EIMAC	
Type	Net Price
35T	8.00
100TH	13.50
250TH	24.50
250TL	24.50
100TL	13.50

EIMAC CLOSE OUT
New EIMAC 150T
SPECIAL \$18.50

Other Lines Always Carried in Stock . . .

- A Complete Line of National Products
- New Aerovox Transmuting Condensers
- Complete Stock of Cardwell Condensers
- Full Stock of Barker-Williamson Coils
- The Complete New Johnson Line

**SENSATIONAL VALUES
1938 "THORDARSONS"**

**PLATE TRANSFORMERS
for Amateurs**

Fully shielded — air cooled construction — tapped primaries — porcelain terminals.

No.	DC. Volts	DC. Volts	Size	Net Price
T-16P00	500/600	200	3 3/4" x 4" x 5"	\$3.88
T-16P01	1000/1250	300	5 1/4" x 7" x 7 1/2"	7.64
T-16P02	1000/1250	500	6 3/4" x 7 1/4" x 8"	12.35
T-16P03	1450/1800	300	6 3/4" x 6 3/4" x 8"	11.17
T-16P04	2000/2500	300	6 3/4" x 8" x 8"	13.67

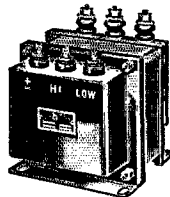

FILAMENT TRANSFORMERS

T-16F08	— 2.5 volts C.T. @ 5.25 Amps.	Insulation volts 2,000 \$1.88
T-16F09	— 2.5 volts C.T. @ 10 Amps.	Insulation volts 2,000 \$1.03
T-16F10	— 2.5 volts C.T. @ 10 Amps.	Insulation volts 7,500 \$1.62
T-16F11	— 5.25 volts C.T. @ 4 Amps.	Insulation volts 2,000 \$1.18
T-16F12	— 5.25 volts C.T. @ 13 Amps.	Insulation volts 2,000 \$2.06
T-16F17	— 6.3 volts C.T. @ 3 Amps.	Insulation volts 2,000 \$1.03
T-16F13	— 7.5 volts C.T. @ 4 Amps.	Insulation volts 2,000 \$1.18
T-16F14	— 7.5 volts C.T. @ 8 Amps.	Insulation volts 2,000 \$1.91
T-16F15	— 10 volts C.T. @ 4 Amps.	Insulation volts 2,000 \$1.79
T-16F16	— 10 volts C.T. @ 8 Amps.	Insulation volts 2,000 \$2.35

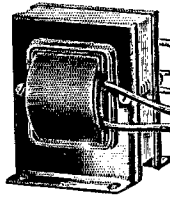

Open style sub or top panel mounting — 115 volt, 60 cycle primaries.

CHOKES—Input

T-16C20	— 5-20h — 200 ma — 2000 v.	Ins. \$2.20
T-16C21	— 5-20h — 300 ma — 3000v.	Ins. \$2.94
T-16C22	— 5-20h — 500 ma — 3000 v.	Ins. \$5.29

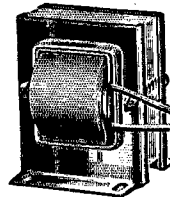

SMOOTHING

T-16C25	— 12h — 200 ma — 2000 v.	Ins. \$2.20
T-16C26	— 12h — 300 ma — 3000 v.	Ins. \$2.94
T-16C27	— 12h — 500 ma — 3000 v.	Ins. \$5.29

FREE 1938 Newark Catalog! Just off the Press. Hundreds of New Items! Bigger Values! Lower Prices! Write for your copy NOW!

NEWARK ELECTRIC COMPANY
226 W. MADISON ST. Dept. Q CHICAGO, ILL.

EXTRA

Newark News

EXTRA

CROWN NEW CHAMPS!

Championship won by latest NATIONAL NC 80X
and NC 81X Communication Receivers!



A FEW months ago these two NATIONAL receivers were unknown. Today they are considered to be the CHAMPIONS of the field by amateur owners everywhere. Their many amazing new features plus stability of signal and ease of operation are the sterling qualities which caused NEWARK to take pride in being the first NATIONAL FRANCHISED dealer to offer these CHAMPION **\$88.00** RECEIVERS at the sensational price of only (Cash Price)

or — \$18.00 down — \$12.68 a month for six months or \$8.53 a month for nine months, or \$6.44 a month for twelve months. (Complete with Tubes, Crystal Filter, 8" PM Speaker Chassis.)

Newark quick service and unexcelled time payment plan is known the world over. AVOID DELAY — Order these new receivers from NEWARK. Send for the free NEWARK PARTS CATALOG.

Other National Champion Receivers Available On Time

	Cash Price	Down Payment	6-Months Payments	9-Months Payments	12-Months Payments
NATIONAL NC-100X, Complete with tubes, crystal and speaker in cabinet.	\$147.60	\$27.60	\$21.10	\$14.21	\$10.80
NATIONAL NC-100, Complete with tubes and speaker in cabinet.	\$125.10	\$20.10	\$18.58	\$12.50	\$9.47
NATIONAL NC-101X, Complete with tubes, crystal and speaker in cabinet.	\$129.00	\$24.00	\$18.58	\$12.50	\$9.47
NATIONAL HRO, With tubes and coils.	\$179.70	\$29.70	\$26.14	\$17.67	\$13.45
NATIONAL HRO, With tubes, coils and power supply.	\$195.60	\$35.60	\$27.84	\$18.83	\$14.33

NEWARK ELECTRIC COMPANY

226 W. MADISON ST. Dept. Q CHICAGO, ILL.

NOW THAT CONVENTIONS ARE OVER



AND WE ARE THROUGH WORRYING whether we're one of those unfortunates who go home empty handed — or one of the "lucky" bunch who gets some prize we don't need — let's settle down and see whether we can get a little more out of our rig than the other fellow claimed he got. Of course this may require some new equipment and that hurts, but "Old Doc LEEDS" prices will sure ease the pain.

RAYTHEON BEAM Power Tubes

Less than two watts will drive them

RK-47. 100 watt output. Net. \$17.50
 RK-48. 230 watt output. Net. 27.50
 Raytheon improved Pentode RK-20A. No neutralization required. 0.9 watt excitation required; 80 watt class "C" power output. Net. \$15.00

CARDWELL CONDENSERS

Now with G.E. Mycalex as standard insulation on all type "T" — "X" and midway condensers

XG-110 KD. 110-110 mfd. 6000 v. for p.p. tanks \$10.58
 MT-150-GS midway 16-150 mfd. 3000 v. peak 3.53
 NA-6 NS — H.F. neutralizer for low capacity tubes 4-6 mfd. \$2.12
 We carry a complete stock of CARDWELL condensers

LEEDS LD-5 CRYSTALS

Mounted in metal holder to fit standard 5 prong socket, cut to your specified frequency, at no extra cost, in the 40-80 and 160 meter bands. Unconditionally guaranteed. Net. \$3.50

The New TAYLOR
 T-125 low C — low
 impedance 400 watts
 \$13.50

The improved RCA 807;
 higher ratings, 600 v.
 class C telegraph \$3.50

LEEDS CONDENSERS

Oil impregnated: Non Inductive: Hermetically sealed

2 mfd. 1000 v. Net. . \$1.50 4 mfd. 2000 v. Net. . \$4.65
 4 mfd. 1000 v. Net. . 2.00 1 mfd. 3000 v. Net. . 2.50
 2 mfd. 2000 v. Net. . 2.45 2 mfd. 3000 v. Net. . 4.95
 Unconditionally guaranteed.

LEEDS TRANSFORMERS

COMPLETELY SHIELDED — HIGH VOLTAGE
 1500-1000-1250 each side C.T. at 300 ma. Net. . \$6.75
 2500-2000-1500 each side C.T. at 300 ma. Net. . 10.95
 500-425 each side C.T. at 250 ma. 5 v. at 3 amp; 2-6.3 v. at 3 amp. \$2.95
 2.5 v. C.T. at 10 amps; 5000 v. insulation for 2-866 tubes. \$1.65

LEEDS SHIELDED CHOKES

to match the above transformers.

20 H. 200 MA 115 ohm \$1.45 5/25 H. 200 MA 115 ohm
 20 H. 300 MA 95 ohm 2.85 5/25 H. 300 MA 95 ohm
 20 H. 400 MA 85 ohm 3.45 5/25 H. 400 MA 85 ohm
 20 H. 550 MA 55 ohm 4.95 5/25 H. 550 MA 55 ohm



LEADS THE FIELD

World Wide Service to Amateurs

45 Vesey Street
 New York City

Tel. COrtland 7-2612
 Cable Address: "RADLEEDS"

(Continued from page 64)

Power," "More Bands," "Lids," "160 Band For Class A Operators" and ever on in this manner.

After surveying the correspondence sections of QST in regard to the above subject, I have drawn the following conclusion:

The amateurs (those who are in the above-mentioned categories) are working on the principle of the noise silencer. In the noise silencer, the noise kills itself out. The more noise, the bigger the killing, with the end result that you have nothing. Thus: The hams are making so much noise (introspectively, in their own hobby) that they will some day kill themselves out with the end result that none of us will have the good old hobby of ham radio. . . .

—(Dr.) Emil S. Burger, W9CIIH

Adding Ideas to Ham Radio

P. O. Box 600, Madera, Calif.

Editor, QST:

. . . I'm another guy who has been silent a long time and am now ready to say my piece. I don't know but what I agree nearly 100% with W9RQS's letter in September QST. In my business [ranching] I have the opportunity to make non-ham acquaintances from all over the country. Cattle buyers travel considerably and come here from many different states. A number of them have seen my shack. They all have complaints about our amateur stations. "What good are they?" "What are they talking about?" "How come the government doesn't do something about it?" Those are the kind of questions they ask me about it.

Why should hams spend so much time in QSO's where nothing is said but "Ur sig rst 579 hr om hi hi wl gess nm hr so 73"? What good does that do for anybody? When this is carried on 'phone, what is the public going to think about us? As for the technical side, anyone can experiment with circuits and construction with dummy antennas and accomplish just as much as if they try experiments on the air. Electrical engineers are constantly doing research far beyond the average ham. When something is developed off the air, it could be tested and proven on the air while doing something useful such as handling traffic. I see no reason why a ham should have college education to get his license. Such things as a T report on your signal can be found by listening on a simple monitor. Why clutter the air up asking a fellow "QRK" and when he says "RST597x," saying, "QRX while I see if I can improve my note," followed by holding the key down and making QRM all the time you are retuning or testing your outfit. If your note isn't T9, you should know it before you get on the air by listening to your monitor when using a dummy antenna. If it isn't T9 you shouldn't be on the air—it is against the law.

W9RQS's letter exposed the asinine, silly activities of hams so I won't list any more here. They are like a bunch of little kids playing in the mud, making mud pies. Their "RST 559 hr wl gru" transmissions and their continual rebuilding, staying up all night, fussing with deep theory is costing them money, not helping anyone but manufacturers, and giving the public a bad opinion. Let them build their big rigs, S.S. Supers, etc. I've got a pair of 46's in push-pull with 45 watts input and a 3-tube receiver of the t.r.f. type. My antenna is just a straight wire 132 feet long, 15 feet high, and runs through trees, power lines, telephone wire, and near buildings. With my station I have got S9 reports in Asia, Australia, Africa, and all over the Americas, have worked WAC on 40 meters and twice on 20, have kept skeds with KA, K6, K7 and handled traffic with them successfully over a long period of time, and I have only changed my rig once in over 3 years. Let them have their k.w. inputs, and let them build their big masts and fuss with their transmitters.

I would like to see amateur radio work towards international peace, emergency relief, traffic handling, and world wide friendship—and they could do it, too. A few are doing it now, but I never have been able to make friends with a DX station because they won't talk about anything except QSL and QRU and theory. I haven't been able to make many real friends in this country, because all they will talk about is RST, DX they worked, their xmit or revr, and QRU. Usually they want to QRT as soon as they are contacted.

A NEW DEVELOPMENT

BLILEY B5 CRYSTAL UNIT



For the 40-METER BAND 35% MORE POWER*

Here is another outstanding development by Bliley—a mounted 40-meter crystal that is really superior. All time-worn ideas concerning crystal design were thrown aside in the design of this new dependable 40-meter crystal.

The B5 unit for 40 meters is a better crystal **safely carrying 35% more current* than the popular Bliley LD2 40-meter unit which it now replaces at no increase in cost. Compare the performance of this new crystal unit—your distributor has them in stock for \$4.80.

For the 20-METER BAND NEW LOW DRIFT

Bliley, the pioneer in the development of high frequency quartz crystals, now brings new standards to 20-meter crystal control with the B5 20-meter crystal unit. This crystal has a drift of less than 4 cycles/MC./°C. and possesses a high activity. It can be used in conventional crystal oscillator circuits and is directly interchangeable

with the lower priced, medium drift Bliley HF2 20-meter unit.

The B5 unit is available in the complete range from 14.0 to 15.0 MC. for use in the 20-meter band and for multiplying to 10 and 5 meters—your distributor has them in stock for \$7.50.

New Low BLILEY PRICES

TYPE BC3	\$3.35
40-80 METER BANDS	
TYPE LD2	\$4.80
80-160 METER BANDS	
TYPE B5	\$4.80
40 METER BAND	
TYPE HF2	\$5.75
10-20 METER BANDS	
TYPE B5	\$7.50
20 METER BAND	
TYPE VF1	\$7.50
80 METERS VARIABLE FREQ.	

BLILEY CRYSTAL UNITS

SPEER ANODES GIVE

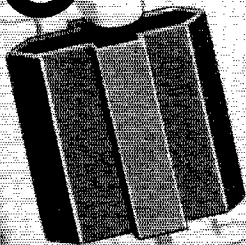

"MORE WATTS PER DOLLAR"

Speer Graphite Anodes help tube makers give you more for your money. Speer Processed Graphite Anodes cannot soften, melt, warp or distort at any temperature whatever. Speer Anodes are supplied only to manufacturers. For booklet on Graphite Anodes and list of tube makers who supply them, address:

**SPEER CARBON CO.
ST. MARYS, PA.**



7729

The club in general certainly enjoyed the Field Day and Traffic skeds are hard to get too, considering the number of hams on the air. . . .

Sure, some guy is going to have a letter in next month's QST saying I overlooked the great action of the amateurs in the flood relief, the great amount of traffic handled, and other accomplishments. You can't kid me. I listen on all the bands and, out of hundreds of signals on the air, a few are doing something useful or something sensible, while the others are all foolishness. Ragchews are OK if ideas are exchanged and friendships are made, and if they are sensible ragchews, not just "hi hi" and "73" and "QRU." Experimenting has its place too, if it isn't "QRX while I change a gadget in my set," followed by holding a key down for 5 minutes, or saying "123456789" in the mike or whistling on a 'phone station.

I'd like to have a sked with some guy in a foreign country every day and talk about things other than radio part of the time. In that way international friendship would be boosted and likelihood of war reduced. Both me and the other fellow would learn something from each other about the other country. Ideas would be exchanged. Also, performance of apparatus could be checked over a long period of time, day after day, season after season. Ideas on radio would add to each other's knowledge some and become a good thing too, if not made the sole topic of discussion. But no, they all just want to say "Ur sigs rst blah blah wl qru 73 CUL sk cq cq dx de—etc." Where does that get anybody? . . . Talking won't do any good. I'd like to see somebody do something about it. No regulations, but conscientious effort on the part of all hams. Let's hear some ideas to kill the old "wl QRU hr 73" holoney.

—Keith C. Daulton, W6EPQ

Field Day Results

(Continued from page 14)

although we did not score very high, that is of secondary importance compared to the kilowatts of fun we derived. —Butte Amateur Radio Club, W7GDB-7.

We used a 53, 802 rig running 8 watts input on 'phone and 15 watts on c.w. Power was from an a.c. generator run from the car fan belt. And what a gas bill! We were located on Saddle Peak Road up in the Malibu Mts.—W6KSSX, W6NSC, W6OKL.

We set up at Hilltown, Iowa, on the highest hill we could find. In the wee hours of the morning had to move the rig inside the truck due to a heavy dew. Transmitter: 12A crystal, 41 amp., 315 volts B batteries.—W9CFB, W9YWF.

Transmitter was 6L6, e.o. or c.c. Receiver, t.r.f. using 8 volt tubes. 56 Mc. rig: 6A6 and 6L6 mod. Of 72 QSO's, 33 were with other portables.—W3FRB, W3EHW, W3FQZ, W3GAC.

W6HJT-6 was located on the side of a mountain near Wildwood, Calif. The antennas were a vertical 66 foot Zepp and a 132 foot end fed wound around trees. Operation was on 7, 14 and 3.5 Mc.—W6HJT, W6IES, W6JPE.

We learned a great deal on our field day test. Most important points are (1) keep equipment in convenient units, easily carried and using plug-in connections; (2) necessity for rapid band changing; (3) proved to our satisfaction that 110 volt 60 cycle a.c. makes best emergency power supply. —W8FBC, W8JNJ, W8LEV.

The rig was set up on top of a mountain about 4½ miles south of Ola, Ark. The transmitter was a 71A TNT osc. and a pair of 71A's in parallel as amp. Power supply consisted of four B batteries and car battery. Receiver used 32, 32 and 33.—W6FJR-5.

This surely was a popular field day, at least in this section, and we're looking forward to the next.—W6GEZ, W6JRZ.

We operated W6UF-6 from Copernicus Peak. It goes up at an angle of 45 degrees and the distance from our cars to the "lookout" was about 400 feet by the trail. We hauled by the "sweat of our brow" nine storage batteries, twelve heavy duty B batteries, gas engine, HRO receiver, Sargent receiver, 'phone transmitter for 3.9 and 1.75 Mc., 'phone transmitter for 28 Mc., 56 Mc. transmitter and receiver, tubes, speakers, tools, junk, blankets, food, gas stove, antennas, etc.—W6CEO, W6CHE, W6LUS, W6UF.

The second day of operation at the Connecticut location revealed the 244th Field Artillery, New York Nat'l Guard, testing in the neighborhood of 56 Mc. A call and QSO brought to EIC's location one Army Radio truck, one car



High lights of Jean Piccard's unusual stratosphere flight, Rochester, Minnesota, July 17, 1937. Burgess Batteries were used.

As Up-to-Date As the Newest Idea— Burgess Portable Power

New ideas may come and go. But there remains an unflinching source of dependable portable power—Burgess Batteries.

In this case, it's a radically new type of stratosphere balloon. In another, it may be revolutionary communication systems, television, or exploration techniques. Whatever the requirements, they have usually been anticipated by Burgess.

Burgess is an old name in this ever progressing scientific world—kept young and virile by constant development—unfaltering research.

Burgess Battery Company
Freeport, Illinois

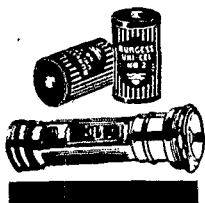

BURGESS



Say You Saw It in QST — It Identifies You and Helps QST

Say . . . RADIO AMATEUR!

Remember the time you were ready to put up that new Radio Tower?

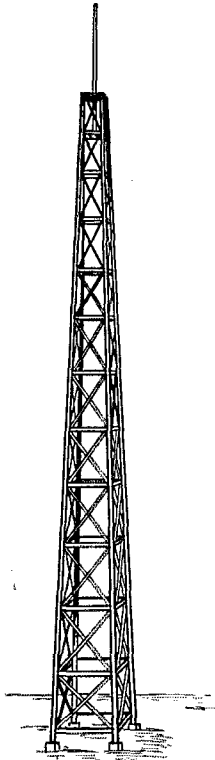

You could not do it by yourself — Your first turn for help was to your Fellow Radio Amateurs — They were glad to give you a lift — Together you raised the tower, and had a good time doing it.

YOUR MEMBERSHIP IN

YOUR A.R.R.L. helps raise the towers of AMATEUR RADIO

**THE BOARD OF DIRECTORS
A. R. R. L.**

and one field set. They very kindly cooperated in constructing a 14 Mc. antenna, using the Army portable antenna masts.—W2EIC-1.

Our antenna mast was made from three clothes props and "C" clamps. It worked out very FB.—W8OPX-8.

The rig was set up in a tent on a small mountain about five miles from our home station in Nutley, N. J.—W2DEN-2.

From 8:30 p.m. Saturday to about 3:00 a.m. Sunday a terrific electrical storm raged, causing the lean-to shack in which we were operating to leak like a worn-out sieve. Lightning struck a giant oak about a hundred feet from the shack and split it to pieces.—W9WGP-9.

The location was in a "little red school house" built back in the early 1800's. It sure was swell, on the side of the Watching mountains.—W2GLH-2.

We were located in a house trailer on top of a hill 7½ miles northwest of Pinedale, Wyo., approximately 110 miles from a railroad. The only sign of civilization was the highway to Yellowstone Park.—W7EMQ-7.

For antenna supports we used our portable transmitters towers, which are composed of three sections of 2 x 2 bolted together, about twelve foot lengths so can carry on car.—W5SP-5.

Field Day Participation

Club Station	QSOs	Score*
W9AIU-9 Egyptian Radio Club ¹	204-A	2368
W3QV-3 York Road Radio Club ²	156-A	1917
W2DUA-2 Northern Nassau Wireless Association ³	154-A	1791
W8ICS-8 South Cleveland Radio Club ⁴	130-A	1638
W8NCD-8 Charleston Amateur Radio Club ⁵	125-AB	1584
W8QLU-8 Ithaca Mike and Key Club ⁶	114-A	1584
W6NOI-6 Glendale Amateur Radio Society ⁷	121-AB	1548
W9CA-9 The Northwest Amateur Radio Club ⁸	131-AB	1515
VE3KM Hamilton Amateur Radio Club ⁹	113-A	1341
W9FUZ-9 St. Paul Radio Club ¹⁰	94-AB	1256 rt
W4CDC-4 Chattanooga Amateur Radio Club ¹¹	115-A	1125
W3GAG-3 Philadelphia Wireless Association Radio Club ¹²	81-A	1071
W9AWC-9 Sedalia Radio Club ¹³	72-A	1054
W3BGD-3 Beacon Radio Amateurs ¹⁴	74-A	1044
W8PX-8 The South Hills Brasspounders and Modulators ¹⁵	99-A	990
W6IVG-6 United Radio Amateur Club ¹⁶	83-A	951
W4DJP-4 Chattahoochee Radio Club ¹⁷	72-A	945
W6KX-6 Los Angeles Amateur Radio Club ¹⁸	177-AC	907 rt
W8AVH-8 The Westlake Amateur Radio Club ¹⁹	75-A	900
W8NQW-8 Utica Amateur Radio Club ²⁰	64-A	882
W3GKI-2 Tri-State Radio Club ²¹	62-A	846
W8MDU-8 The Cambridge Radio Club ²²	72-A	846
VE3AJV Frontier Radio Club ²³	97-AB	840
W6GJP-6 Burbank Radio Club ²⁴	82-A	819
W3BKQ-3 Chester Radio Club ²⁵	60-A	801
W8MLV-8 Aerial Radio Club ²⁶	58-A	801
W4NC-4 Winston-Salem Amateur Radio Club Inc. ²⁷	97-A	762
W9SUJ-9 The Hot Stove Radio Club ²⁸	78-A	747
W8DSO-8 Amateur Transmitter's Association of Western Pa. ²⁹	56-A	738
W4EOS-4 Jax Radio Club ³⁰	44-A	639
W9NGG-9 Starved Rock Radio Club ³¹	67-A	624
W8MCL-8 Bluefield Amateur Radio Club ³²	74-B	618
W6NHH-6 Palomar Amateur Radio Club ³³	50-A	600
W9YKK-9 The Monument City Radio Club ³⁴	55-A	585
W8EGK-5 Monroe Amateur Radio Club ³⁵	69-A	567
W6NXV-6 Orange County Amateur Radio Club ³⁶	74-B	546
W6MGJ-6 Helix Amateur Radio Club ³⁷	71-B	540
W9ADJ-9 Black Hills Amateur Radio Club ³⁸	46-A	513
W8MQX-8 Kenmore Buffalo and Tonawanda Radio Club ³⁹	33-A	465
W9JNU-9 Northern Wisconsin Radio Club ⁴⁰	52-B	438
W8LWB-9 Peoria Amateur Radio Association ⁴¹	25-A	432
W4CFD-4 Southside Amateur Radio Association ⁴²	26-A	414
W9VTE-9 Central Colorado Radio Association ⁴³	27-A	378
W9PAT-9 Minneapolis Radio Club ⁴⁴	30-AC	351
W9OKY-9 Pike's Peak Amateur Radio Association ⁴⁵	39-A	351



"Centralab is the difference between a satisfied customer and a dissatisfied one."

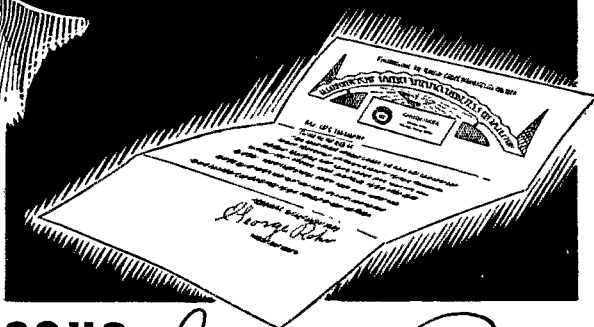

says

George Rohr.

Mr. George Rohr of 67 Thorne St., Jersey City, N. J. hands us the above bouquet along with some other very flattering statements in a recent letter! Thanks Mr. Rohr . . . thousands of other servicemen feel the same way about Centralab.

In fact, set manufacturers and experimenters as well as servicemen have for years shown their preference for Centralab . . . and they have said it with generous orders. We suggest, you too specify CENTRALAB.

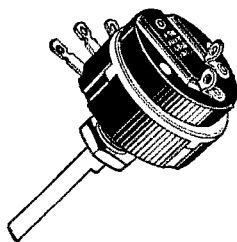

The smooth Centralab Control offers maximum resistor length for case diameter . . . close uniformity between resistors . . . accurate tapers . . . uniform current distribution . . . better power dissipation and longer life.

Centralab

DIV. OF GLOBE-UNION INC., MILWAUKEE, WISC.

Canterbury Rd., Kilbourn
London N.W. England

118 Avenue Ledru-Rollin
Paris

WIN NEW RCA
APPARATUS FOR
YOUR STATION!

200 PRIZES WORTH \$1,300!

Offered FREE in Easy Contest!

**LOOK
AT THESE
PRIZES!**

Just tell us in your own way what you think
of RCA Tubes! Nothing for you to buy!

HERE'S ALL YOU DO TO ENTER!

(1) Get contest entry form and letter of instructions from your nearest distributor of RCA transmitting tubes.

(2) Fill out entry form. Then write a letter (500 words or less) telling (a) "Why I Use RCA Tubes in My Transmitter", or (b) "Why I Don't Use RCA Tubes in My

Transmitter". A duplicate set of prizes will be awarded on each subject. You have an equal chance to win a prize whether you use RCA Tubes or not.

(3) Mail entry form together with letter to RCA at the address below. Envelopes will be provided. No postage required.

Identical prizes will be awarded winners in each of the two groups in this contest. 100 prizes will be awarded for the best answers on "Why I Use RCA Tubes in My Transmitter", 100 prizes will be awarded for the best answers on "Why I Don't Use RCA Tubes in My Transmitter".

Winners may choose other RCA products as substitute prizes if they wish. List Prices of the RCA products they select, however, must not exceed that of the "official" prize. Official prizes in this contest are as follows:

Contest Closes December 15, 1937

All entries must be post-marked
not later than that date!

Prizes will be awarded as quickly as contest judges determine winners. Contest open only to licensed amateurs in continental United States. Employees of the RCA Manufacturing Company, Inc., are not eligible. Judges' decisions will be final.

Here's a great chance for you to win valuable apparatus for your station! It's an easy contest—doesn't cost a cent to enter. There's nothing for you to buy—no box tops or labels to send in. We even pay the postage!

RCA is offering 200 prizes—worth \$1,300—because RCA is always looking ahead, always planning products that will further the enjoyment and widen the scope of amateur radio. From your contest answers will come ideas. They will enable RCA to make products even more suited to your requirements. They will help RCA create tubes to step up the performance, increase the pleasure of amateur radio.

Get in this contest today! You've got just as good a chance to win as the next fellow.

PRIZES

	Value
1—ACR-111	\$189.50
(16-Tube Receiver)	
2—ACT-20	129.50
(less accessories) (20-Watt Trans.)	
3—ACR-155	74.50
(9-Tube Receiver)	
4—Two RCA-806	44.00
(450-Watt Triode)	
5—One RCA-803	34.50
(210-Watt Pentode)	
6—Two RCA-805	27.00
(215-Watt Triode)	
7—Two RCA-808	15.50
(140-Watt Triode)	
8—One RCA-906	13.50
(3-inch C-R Tube)	
9—One RCA-834	12.50
(75-Watt u.h.f. Triode)	
10—One RCA-808	7.75
(140-Watt Triode)	
11-20—One RCA-802 or 807	3.50
21-50—Pair RCA-866	3.00
51-100—RCA Metal Tube .	
Cigarette Lighter	1.00



for Amateur Radio

RCA MANUFACTURING CO., INC., CAMDEN, N. J. • A Service of the Radio Corporation of America

See You Saw It in QST — It Identifies You and Helps QST

INDISPENSABLES

✓ your receiver

✓ your transmitter

✓ your F.C.C. licenses

✓ your LICENSE MANUAL!

It's against the law to operate an amateur radio station without the required federal licenses for station and operator. The maximum penalty for so doing is a \$10,000 fine and two years in a federal penitentiary.

That's the broad basic picture. But within the scope of the federal licensing machinery are many detailed regulations, the violation of any one of which can lead to suspension, cancellation of licenses, or even fines or imprisonment. These regulations change frequently, in step with the rapidly developing art of radio.

There is only one way for the amateur to keep at his finger tips these changing legal requirements—short of maintaining his own Washington legal bureau. That is to keep the latest edition of the Radio Amateurs License Manual in the shack at all times. New editions always contain the latest regulations—and when a new edition appears it means that changes in federal regulations have made its predecessor obsolete.

WE ARE NOW SUPPLYING THE EIGHTH EDITION

TAKE A LOOK AT YOUR COPY!

25 cents postpaid

AMERICAN RADIO RELAY LEAGUE

West Hartford, Connecticut, U. S. A.

W8KYC-8	Marietta Radio Society	44-C	162
W7GDB-7	Butte Amateur Radio Club	21-A	111

INDIVIDUAL AND GROUP SCORES

W6MVK	W6MVK-W6OFD	165-AB	1923
W1BDI	W1AFB-W1BDI-W1GKM-W1JTD-W1IUE	103-A	1350
W6KSS-6	W6KSS-W6NSC-W6OKL	77-A	1152
W9CFB-9	W9CFB-W9YWW	37-A	1134
W3FRB-3	W3EHW-W3FQZ-W3FRB-W3GAC	72-A	1035
W6HJT-6	W6HJT-W6IES-W6JPE	38-AB	1002
VE3GT	VE3ADO-VE3IX-VE3WK-VE3ZE-VE3JI-VE3GT-VE3SG	59-A	936
W8JNJ-8	W8FBC-W8JNJ-W8LEV	74-A	928
W2DKJ-2	W2DKJ	74-A	909
W9TEW-9	W9AEM-W9FT-W9LBN-W9TEW-W9WNG	61-A	801
W6NIK-6	W6JQX-W6KBD-W6NIK-W6NYA	59-A	774
W1JPE-1	W1CBD-W1EH-W1JFN-W1JPE	57-A	738
W5FJR-5	W5EVX-W5FJR-W5GLB-Jack Dowden (SWL)	41-A	675
W9VTO-9	W9IAG-W9VFI-W9VTO		645
W8LYP-8	W8LYP	101-B	640 T
VE1GH	VE1CD-VE1GH-VE1JK	50-A	621
W6LMD-6	W6LMD-W6MGL	41-A	612
W6OOZ-6	W6GEZ-W6JRZ-W6OOZ	37-A	603
W6UF-6	W6CEO-W6CHE-W6LUS-W6UF	33-AB	591
W1EFN-1	W1EFN	33-A	513
W3FCC-3	W3FFC-W3FUT-W3FVJ-W3GOA-W3GOB	33-A	513
W9MMU-9	W9K GK-W9MMU-W9MSX-W9TGB-W9YZL	38-A	504
W2EIC-1	W2EIC	26-A	495
W9WGP-9	W9WWD-W9YXH-W9ZBO-W9ZBY-E. Wright (SWL)	28-A	495
VE3SY	VE3ANE-VE3SY-Ed Ottney	39-A	486
W6AM-6	W6AM	46-B	468
W8OPX-8	W8OPX-W8OYY-W8PMB	24-A	468
W2DEN-2	W2DEN-W2FQW-W2HGX	32-A	450
VE3BY	VE3AJB-VE3BY	29-A	432
W1HDQ-1	W1HDQ	38-A	432
W8FYH-8	W8DLU-W8FYH-W8MEV	35-A	414
W8BJB-8	W8BJB	26-A	414
VE3GI	VE3GI	32-A	403
W2IXJ-2	W2ECL-W2HLI-W2IZL	21-A	333
W8KWP-9	W8KJY-W8KWP	23-A	324
W2FUQ-2	W2FUQ-W2KIR	18-A	324
W8HMJ-8	W8HMJ	21-A	315
W6GCM-6	W6GCM-W6MNR	22-A	306
W6HIT-6	W6KNF-W6MJU-W6NJA-W6HIT	27-AB	282
W9LBV-9	W9LBV-W9RFQ-W9RLT-W9SWI	22-A	243
W1FGO-1	W1FGO	18-A	234
VE3SD	VE3AAT-VE3ABB-VE3AFS-VE3AJZ-VE3SD	46-A	229 RT
VE4ACS	VE4ABM-VE4ACS-VE4EO-VE4OF	24-B	198
W9AB-9	W9AB-W9CRZ	27-AB	186
W1BKG-1	W1AMS-W1AZW-W1BKG-W1HNE	12-A	171
W3BHE-3	W3BHE-W3GUT	16-A	162
W2GLE-2	W2GLE	38-A	153
W7AEC-Q-7	W7AEC-W7BFC-W7DIE	12-B	150
W8TS-9	W8TS-W9YSA-W. J. Monka	8-A	144
W9WOK-9	W9WOK	12-A	126
VE4AFT	VE4ABC-VE4AFG-VE4NF-VE4TY-VE4AFT	11-A	126
W1CTW-1	W1CTW	28-A	123
W9BOP-9	W9BOP	8-A	117
W1DKD-1	W1DKD	8-A	108
W5FH-5	W5AQR-W5FH	8-A	108
W9WJW-9	W9WJW-W9WYB	10-A	103
W5FJM-5	W5EYB-W5FJM	12-B	96
W5FDS-5	W5FDS-W5GKV-W5GLS	37-B	94 RT
W8OFO-8	W8OFO	14-A	81
W9KXJ-9	W9FND-W9KXJ-W9SPZ	47-A	79
W5SP-5	W5QA-W5SP	12-B	72
W9ALO-9	W9ALO	6-A	72
W9OKZ-9	W9OKZ	17-AC	49 RT
W6MVFH-6	W6MVFH-Ben Bauman	3-A	45
W1CLI-1	W1CLI	7-A	36

IT'S IN HERE, O. M.!



The **STANCOR HAMANUAL**

New... complete... practical! 16 complete circuits from microphone to antenna post... transformers for *all* tubes.... Don't build or re-build until you have seen the Stancor Hamanual. . . . It has all the latest dope!

Ask Your Jobber for Your Copy!

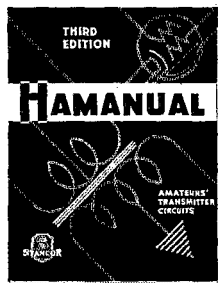

STANDARD TRANSFORMER CORPORATION

850 BLACKHAWK STREET CHICAGO

Say You Saw It in QST — It Identifies You and Helps QST

NEW PORTABLE "EVEREADY" RADIO BATTERIES



No. 722

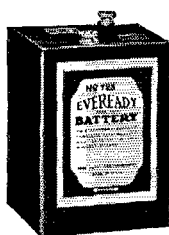

No. 723



No. 733

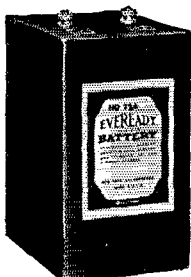

No. 724



No. 738



No. 744

No. 722—2-cell, 3-volt "A" Battery. Length 2 11/16 in., Width 1 1/2 in., Height 4 1/2 in., Weight 11 oz.

No. 723—4-cell, 3-volt "A" Battery. Length 2 3/4 in., Width 2 3/4 in., Height 4 3/8 in., Weight 1 lb. 5 oz.

No. 724—8-cell, 3-volt "A" Battery. Length 4 in., Width 2 3/4 in., Height 6 in., Weight 2 lbs. 4 oz.

No. 733—45-volt "B" Battery. Tap at +22 1/2 volts. Length 3 1/8 in., Width 1 3/8 in., Height 4 1/2 in., Weight 12 oz.

No. 738—45-volt "B" Battery. Tap at +22 1/2 volts. Length 3 1/8 in., Width 2 3/8 in., Height 4 1/2 in., Weight 1 lb. 4 oz.

No. 744—7 1/2-volt "C" Battery. Tap at -4 1/2 volts. Length 2 15/16 in., Width 1 1/16 in., Height 1 3/8 in., Weight 2 oz.

Descriptive sheet mailed on request to:

BATTERY HEADQUARTERS

NATIONAL CARBON COMPANY, INC.

30 East 42nd Street, New York, N. Y.

Unit of Union Carbide  and Carbon Corporation

VE8LI	VE8LI	2-A	27
WIJBJ-1	WIJBJ	6-A	24 RT
W9RSL-9	W9RSL-W9RST-W9SNU- W9VNN	2-A	18

What the League Is Doing

(Continued from page 18)

Handbook." This question has been brewing for some years, being marked last year by a pirated Spanish edition of our 1935 *Handbook*. This work was unauthorized by the League and was a poor translation and wretchedly produced. The "Revista Telegrafica" people are so favorably known to Spanish readers that no further assurance is necessary as to the goodness and reliability of the job that will now be done with the League's approval. The Spanish edition is expected to be ready about the first of the year. While of course the main distribution will be made from Argentina, U. S. readers will be able to obtain it from Hq.

Match and Mis-Match

(Continued from page 25)

tapped to points equidistant from the "cold" center of a double-ended tank, and the antenna is symmetrical, the currents will be equal. The only exception to this is in the case of an excessively high-inductance pick-up coil with one end exposed to a "hot" part of the tank in such manner as to allow considerable "capacity pick-up."

To say that standing waves on an open double line are generally of no consequence as far as efficiency and radiation are concerned is directly to contradict an old and generally accepted belief to the contrary. But such is the case. The average open double-wire line as used by the amateur is so nearly loss free that seldom will more than 0.5 db loss result when it is sufficiently mis-matched at the antenna to cause 60% of the power flowing out from the transmitter to be reflected back down the line instead of entering the antenna, a condition which results in standing waves of about 8-to-1 ratio in maximum to minimum currents. Of course, if the line is several hundred feet long and is operated at either 28 Mc. or 56 Mc. the losses will run up. Recently a 200-foot 2-inch spaced line was measured at 50 Mc and was found to have an attenuation due to loss and radiation combined of 1.1 db. Had this line been operated at that frequency with severe standing waves the attenuation would have amounted to several db.

Energy reflected back down the line from the antenna can be said to change the apparent input impedance of the line at the transmitter so that more power flows out toward the antenna. Thus some of the energy actually makes several round trips up and down the line; but still the line losses are usually low enough so that practically all of it eventually gets into the antenna and is radiated. Consider the case of the so-called Zepp feeders. Here the transmission line is deliberately "mis-matched" at the antenna so that at least 85

Your transmitter is no better than its tubes

**"A CHAIN IS AS STRONG
AS ITS WEAKEST LINK"**

You know the old adage about the chain and its weakest link. It's easy to see how that fits here.

A "sour" tube will destroy all possibility of maximum results, even though your equipment is the finest obtainable. Your transmitter, regardless of how it is constructed, will deliver better performance with Eimac tubes.

They defy their own ratings and welcome an extra heavy overload. RED HOT yes... WHITE HOT; they'll take it. Completely degassed tantalum electrodes, a new type thoriated filament, no internal insulators, elimination of "getter". These and other Eimac features—applied the Eimac way—explain why these transmitter tubes are far ahead of all others.

*Eimac Tubes for every transmitter from
50 watts to 5000 watts*

35T 100T 250T 450T 750T

*See Your Dealer or Write
for Information*

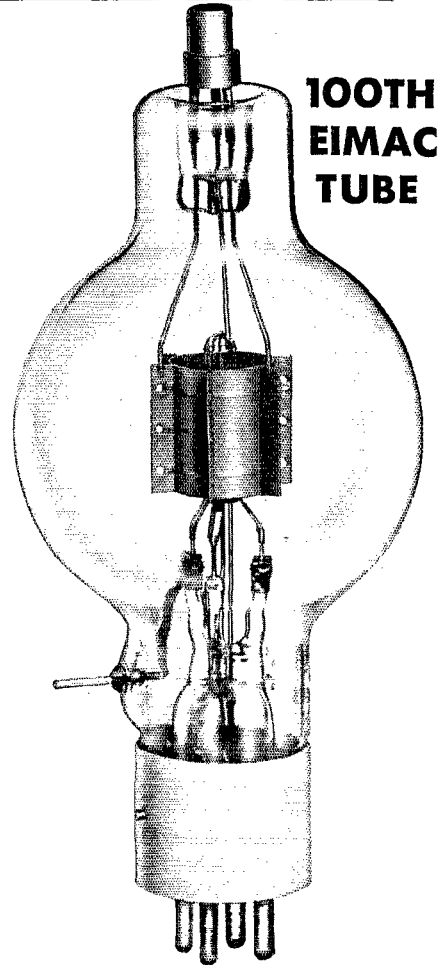

PLAY SAFE... INSIST ON

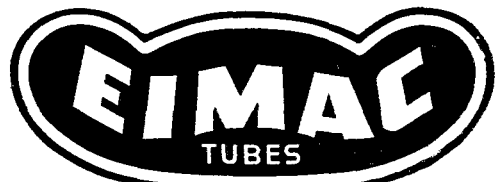

EITEL & McCULLOUGH, INC. • San Bruno, California

The "THOUSAND WATTERS"

USE THEM

Exclusively

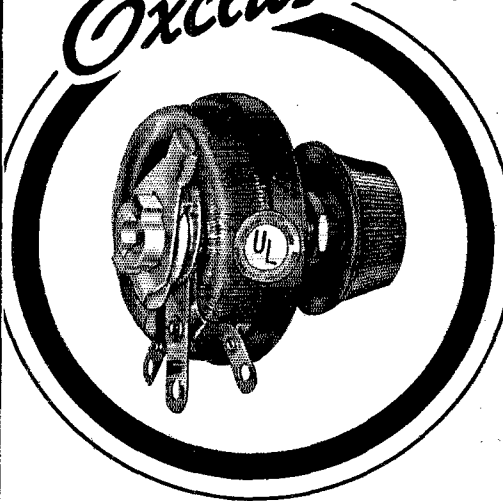

Whether or not you use OHMITE rheostats to control the filaments of your transmitting tubes depends upon whether you have a "commercial style" rig or a haywire job. Almost invariably you will find them in the transmitters of the "thousand watters" for the same reasons that the broadcasting stations use them—they are the utmost in dependability and fine control.

Special alloy wire is wound over porcelain, and all but the contact surface vitreous enameled. The turns are permanently held in place, and the metal-graphite contact, touching each of the many turns, provides smooth, close adjustment. And yet you can buy an OHMITE power rheostat for surprisingly little. Your parts jobber stocks them.

OHMITE

MANUFACTURING CO.

4831 FLOURNOY STREET, CHICAGO

per cent of all the power starting out toward the antenna is reflected back down the feeders from the antenna junction point toward the transmitter. This results in standing waves often as high as 50 to 1 in ratio between maximum and minimum currents; and yet Zepp feeders too may be made to operate with good efficiency.

If it has not already been inferred, it is probably well to mention here that standing waves on the line cannot be altered by changes in the so-called "match" at the transmitter end of the line; also that they cannot be eliminated unless the antenna and line are actually matched, in the sense that the impedance of one is made exactly equal to the impedance of the other at the junction point of the two.

It would be a mistake to take the foregoing as an invitation to throw together most any type of poorly constructed open-wire line with a feeling of, "Well, what's the difference?" Good workmanship and attention to detail have not ceased to pay dividends even though they may not always be in the form of more miles per watt.

It so happens that losses in most all types of lines used by the amateur are almost exactly proportional to frequency. This means that they may be rated in terms of "db per wave length" and such rating will hold good for any frequency of operation. The average of several open two-wire lines which were measured was 0.12 db per wave length. This means the average 66-foot air-spaced pair (if no standing waves were present) would produce a loss of about 0.12 db at 14 Mc., 0.06 db at 7 Mc. and only 0.03 at 3.5 Mc. Twisted pairs and other types of rubber-dielectric lines have considerably more attenuation, but they also have other electrical and mechanical characteristics which make them preferable to open-wire lines in some installations, particularly where the distance between transmitter and antenna feed point is not over one wavelength.

RUBBER-INSULATED PAIRS

The best of such low-impedance lines have an attenuation of about 1 db per wavelength. The loss in the very poorest ones is about twice that amount. Ordinary twisted lamp cord has a surge impedance of 140 ohms and shows a loss of approximately 1.4 db per wavelength when dry. Of course it will not stand the weather; the losses increase tremendously when it is soaking wet; but it may be useful, if properly handled, for inside work. Two pairs of such wires, each of exactly the same length, connected in parallel will form a line of about 70 ohms impedance. Unfortunately the loss in such a combination is not halved but remains at the same value as for a single pair. Needless to say the "polarity" of connection of such a combination must be the same on both ends. In other words, if the coded conductor of one pair is joined to the coded conductor of the other at one end, the same must be true at the opposite end. Ordinary parallel moulded rubber lamp cord has a surge impedance of 120 ohms and produces somewhat less loss than the fabric covered twisted type. It may stand weather conditions

IN DEFENSE OF LAW AND ORDER

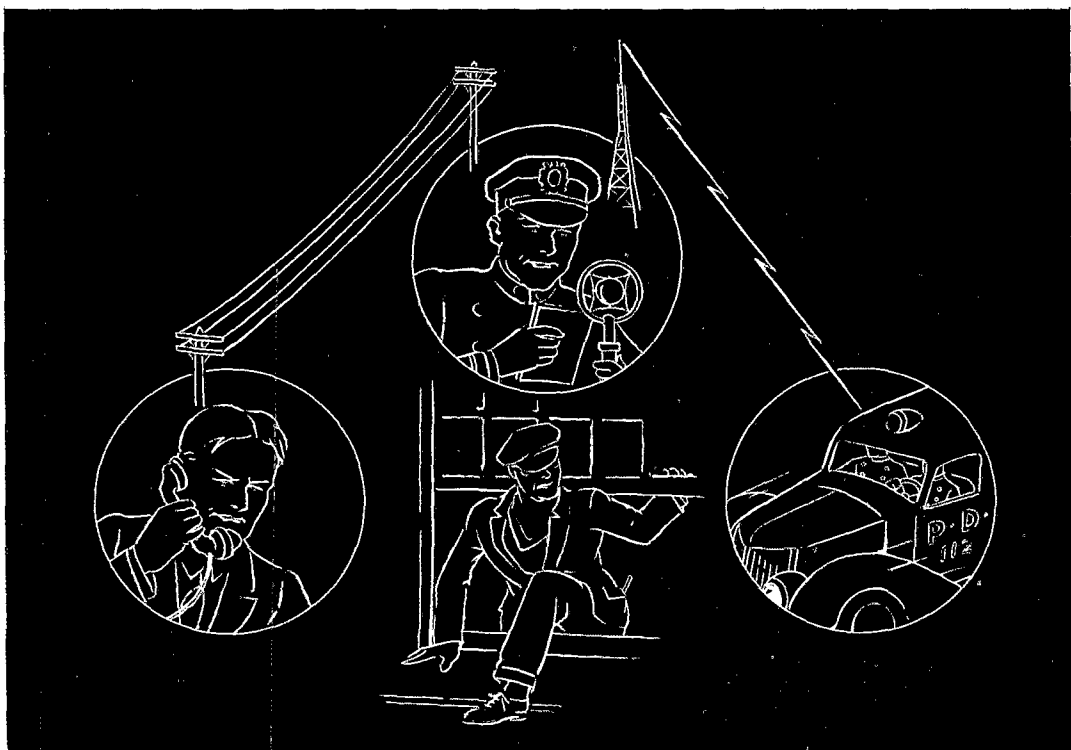

A CRIME may be imminent . . . Life and property may be endangered! A telephone call to police headquarters will speed a radio cruiser to the scene . . . in defense of law and order.

In such crises, radio messages must be sent quickly and received clearly. Isolantite* ceramic insulators are important factors in keeping radio equipment operating efficiently.

In police radio transmitting equipment, Isolantite insulators increase output by reducing dielectric losses. Isolantite co-axial transmission line delivers power efficiently to the Isolantite-insulated antenna, from which the

voice is carried to the remotest cruiser. Police receivers insulated with Isolantite hold their tuning accurately, and never fail, because of drift, to hear the command to action.

Long experience in the manufacture of ceramic insulators for radio equipment enables Isolantite engineers to offer valuable assistance in the formulation of economical insulator designs. This experience is at your service for the asking.

*Reg. Trade-name for products of Isolantite, Inc.

ISOLANTITE INC.

CERAMIC INSULATORS

Factory: Belleville, New Jersey • Sales Office: 233 Broadway, New York, N. Y.

Say You Saw It in *QST* — It Identifies You and Helps *QST*

**For 5 Meters,
this tube is
a knockout!**

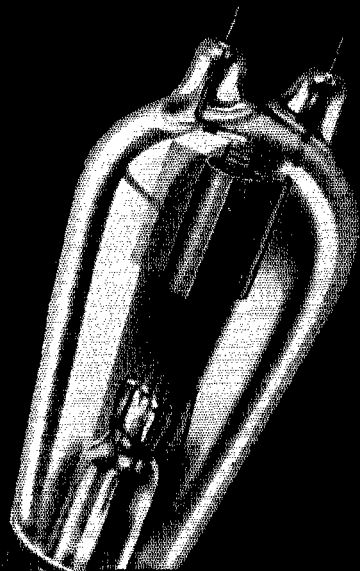

**Western Electric
304 B
TRIODE**

More and more amateurs are recognizing that the Western Electric 304B is the greatest thing on the market for 5 meter work. Next time you design an ultra high frequency transmitter consider these features—

Upper frequency limit: 400 megacycles; Maximum voltage: 1250 volts; Nominal power output, Class C, unmodulated: 85 watts at 60 megacycles, 60 watts at 100 megacycles.

The 304B gives outstanding performance as oscillator, buffer, doubler or final amplifier. For full information on this and other Western Electric tubes for amateur use, consult your dealer—or write Graybar Electric Co., Graybar Building, New York.

Western Electric
BROADCASTING EQUIPMENT
Distributed by **GRAYBAR Electric Company**

somewhat better than other types of lamp cord although no data in this respect are available at the moment.

It must be remembered that the above figures for attenuation are those which apply when the power travels but once along the line. If there is reflection from the load end (which produces standing waves) the loss increases. Naturally the more round trips the energy makes before entering the antenna (load) the greater the loss. That is a rather "loose" statement but serves to stress the point.

Because of the fact that twisted pairs and other rubber dielectric lines inherently waste more of the power as loss than do open wire lines, it is somewhat more necessary to operate them in such manner that the energy traverses them but once; in other words, without standing waves. However even with these a two-to-one mis-match in resistance at the antenna end causes a barely perceptible increase in line losses. To give an example, one type of widely used twisted pair was measured recently and found to have an attenuation constant equivalent to 1 db per wavelength. Thus a 66-foot piece operating at 14 Mc. without standing waves would put 1 db less power into the antenna than the transmitter put into the line. If 250 watts entered the line, 199 watts would be fed into the antenna. The power lost would be 0.87 watt per foot at the near end, gradually decreasing to 0.69 watt per foot at the outer end. The total loss is, of course, 250 minus 199 or 51 watts. However, that particular transmission line has a surge impedance of just 100 ohms and had the 66-foot piece been inserted directly into the center of a half-wave doublet whose resistance was 50 ohms (a not uncommon value) there would have been a 2-to-1 mis-match at the outer end. Under these conditions the total loss would have increased to 60 watts with a maximum of 1.49 watts per foot near the transmitter. There would be several points along the line at which the loss per foot would be less than when perfectly matched, since with standing waves on a "dielectric loss" line the losses are greatest at points of highest voltage and least where the voltage is low and the current high. This accounts for the fact that the total dissipation only increased 18 per cent but the loss per foot at some point near the transmitter increased 58 per cent.

It is readily apparent, then, why "hot" lines are encountered in amateur practice. If mis-match had been 3-to-1 (meaning the load would be either $33\frac{1}{3}$ ohms or 300 ohms) the loss would have increased to 72.5 watts or to 1.5 db and maximum head loss per foot at some point near the transmitter would have increased to slightly over 2 watts. If the line were handling the output of a kilowatt rig under such a condition it would become more than just luke warm, but still would be operating with fair efficiency.

In the above examples the mis-match is assumed to be the result of incorrect resistance only. If the antenna length is not reasonably close to resonance, or harmonic resonance, a certain amount of reactance is introduced which will



Announces a complete line of

TRANSMITTING CAPACITORS

OIL — PAPER

and

MICA TYPES



Write for Complete Catalog

SOLAR MANUFACTURING CORP.

599-601 Broadway, New York, N. Y.

ANOTHER NEW CARDWELL

TYPE ADN DISC TYPE NEUTRALIZER for LOW CAPACITY TUBES

Such as T-20, T-55, 100-TH, 35-T, 50-T, HF-100, 800,
834, 852, RK-34, RK-35, RK-18, etc. . . .

CAPACITY RANGE: .5Mmfd. to 4Mmfd.

Alsimag No. 196 pillars; metal parts are satin finish aluminum except for the nickel silver extra long bearing with fine screw adjustment to eliminate wobble. "Easy to get at" double lugs of husky proportions and knurled thumb nut for easy locking.

NET PRICE **\$1.80** TO AMATEURS

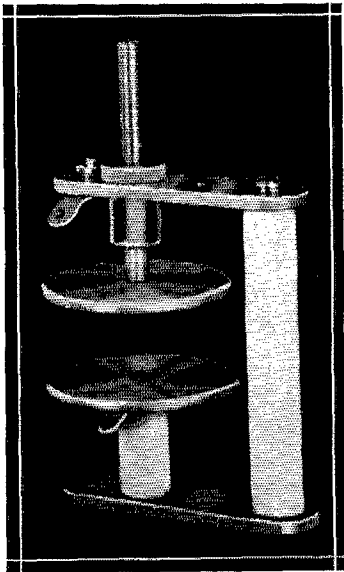

It's Another NEW "CARDWELL"

Yes sir, those are strong words . . . enthusiastic endorsement for a new unit that must measure up to as rigid a standard as that imposed by the many Cardwell condensers that have preceded it . . . condensers that have set a standard for quality throughout the world for almost a decade.

And . . . there will be ANOTHER new Cardwell announced next month.

**THE ALLEN D. CARDWELL
MANUFACTURING CORPORATION**
83 PROSPECT STREET, BROOKLYN, NEW YORK

cause standing waves on a line even though the resistance is correct. With our harmonically related bands and wide-spread information as to correct lengths for antennas there is little excuse for anyone attempting to feed a non-resonant antenna with a low impedance transmission line. The Q or sharpness of resonance of a good antenna is low enough, however, so that the operating frequency can usually depart by several percent before the reactance at the feed point becomes comparable to the resistance. Thus the term "reasonably close to resonance" should not be taken as substantiation of the too prevalent belief that antennas must be cut to the exact inch or that departure from the exact frequency of resonance by a few kilocycles will alter the radiation capabilities of the radiating system.

One interesting fact about low-impedance lines is that a wave travels along them more slowly than it would on an open-wire line.¹ Actually the velocity is equal to the speed of light divided by the square-root of the effective dielectric constant of whatever material is between the two wires. This constant is one for air, so, if it were not for spacers in open-wire lines, the energy would travel along them at almost exactly 300,000,000 meters per second. The dielectric constants of the different insulating materials used in several types of low impedance lines which were measured were apparently all very nearly the same for in every case the "velocity of propagation" was between 57 per cent and 63 per cent of the speed of light.

This is important to know if we wish to add an additional quarter-wave of line to our feeders to check for standing waves (by the method outlined above in the case of the single-wire feeder), because the "electrical length" rather than the physical length of the added piece should be $\frac{1}{4}$ -wave. Thus the piece we would cut would be only 60 per cent as long as would otherwise be the case. For instance, at 14 Mc. it should be about 10 feet long rather than 17 feet or so. It is also interesting to note that the "electrical length" of the 66-foot line operating at 14 Mc., used in the examples above to illustrate the effect of mis-match at the antenna, was approximately one and three-quarters wavelengths. The figures for attenuation are given in terms of physical or "tape measure" length.

A year or so ago some data were widely published indicating the "loss" due to mis-match between a line and its load. These did not apply to antenna feed systems, however, for one simple reason; the input to a transmission line, at the transmitter will change as the load on the outer end is varied; but the coupling to the final tank can always be readjusted so as to absorb the same power from the transmitter regardless of the load impedance. Some of the assumed "loss" in the published data was actually a decrease in power input to the final stage which would result if the coupling had not been readjusted as the load was altered.

¹ For further data on line wave velocities, see "How Long Is a Quarter Wavelength," by J. N. A. Hawkins, elsewhere in this issue.—EDRROR.

Increase Transmitter Efficiency

with New



ILLUMINATED THERMO-AMMETERS

Model 446 with Front Illumination. New Four Inch Square Modernistic Instrument featuring extra long scale. Available also in ammeters, milliammeters, microammeters, voltmeters, millivoltmeters, etc., A.C. and D.C.

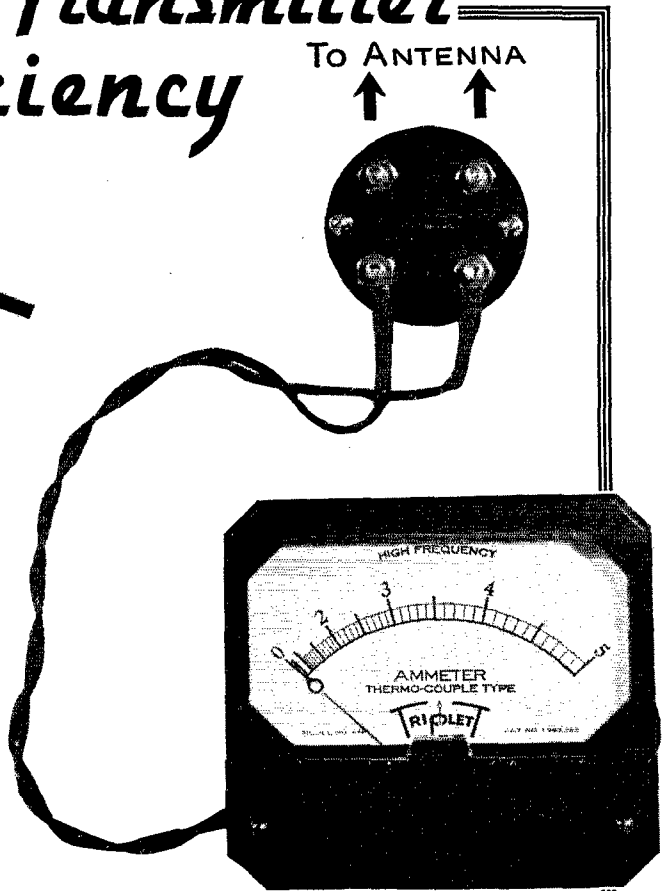

PRICES GREATLY REDUCED

All amateurs know that the sure way to get the most out of your rig is to install a Thermo Ammeter in your antennae circuit. Now you can get a Thermo Ammeter with front illumination. Illumination attachment is extra. Does not affect meter and light bulb can be easily replaced. Perfect distribution of light.

Triplet Thermo Ammeters are sturdily built to

carry high overload capacity and to give long life. The thermo couples are external to the meter and connected to it by 2 ft. leads. The thermo couple can be located where convenient while the ammeter is placed on the panel.

All Thermo couples are designed to work on any size Triplet Thermo Ammeters.

2" Model No. 241 complete with Thermo Couple, not illuminated. **\$5.83**

4" Model No. 446 (as illustrated) illuminated, with thermo couple. **\$7.83**

Thermo Couple for all sizes. Each **\$2.67**

Thermo Ammeters are available in the following ranges:— 0.5, 0-1, 0-1.5, 0-2.5, 0-5.



The Triplet Electrical Instrument Co.
2511 Harmon Ave., Bluffton, Ohio
Please send me more information on Model 426,
I am also interested in

Name.....
Address.....
City.....State.....

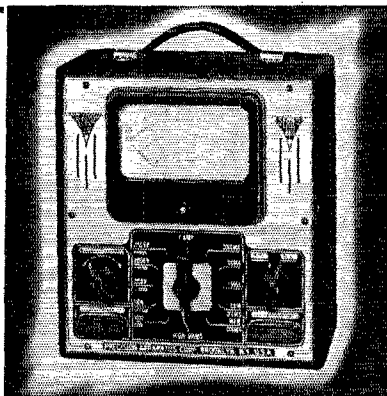

New "PRECISION"

SERIES 840L A.C.—D.C.

VOLT-OHM-DECIBEL-MILLIAMMETER
including a

2500 VOLT A.C. and D.C. RANGE

SPECIFICATIONS

- 5 Output Ranges.
- 5 A.C.-D.C. Voltage Ranges from 0 to 2500 volts.
- 4 D.C. Current Ranges from 0 to 1 amp.
- 3 Resistance Ranges from 0 to 10 megs. (provision for self-contained batteries).
- 5 Decibel Ranges from -10 to plus 63DB.

Net price **\$19.95** Less batteries and test leads to amateurs



"PRECISION"

SERIES 830

D.C. VOLT-OHM-MILLIAMMETER

SPECIFICATIONS

- Five D.C. voltage ranges at 1000 ohms per volt: 0-10; 0-100; 0-250; 0-500; 0-1000 volts.
- Two resistance ranges: Low ohms (shunt method) M to 500 ohms. High ohms 0-300,000 ohms.
- Four D.C. current ranges: 0-1; 0-10; 0-100; U-250 MA.
- Ohmmeter ranges are powered by self contained supply.

Net price **\$10.95** Furnished with self contained battery to amateurs

Write for our new No. 38 Catalog

PRECISION APPARATUS CORP.

821 EAST NEW YORK AVENUE
BROOKLYN, NEW YORK

The ratio of maximum to minimum currents or voltages on a low-loss transmission line is equal to the mis-match ratio between antenna and line if the antenna load is resonant (pure resistance). Thus if we find the maximum current in an open two-wire 600-ohm line feeding a resonant antenna is just 4 times the minimum current, we know the antenna load is either 150 ohms or 2400 ohms. The position of the "nodes" and "loops" and a little common sense would tell us which of these two values is the correct one.

For those who may be mathematically inclined the following expression is given for the efficiency of a transmission line operating with a resistance mis-match at its load (antenna) end in terms of the efficiency of the same line when operating without standing waves.

Let K = efficiency of line when perfectly matched at the antenna end.

M = ratio of line surge impedance to load (antenna) resistance.

Then the line efficiency for any ratio of resistance

$$\text{mis-match} = \frac{4K}{M + \frac{1}{M} + 2 - \left(+ \frac{1}{M} - 2 \right) K^2}$$

Let there be any mistake it should be stated that throughout this article wherever the term efficiency is used it means the ratio of power output to power input. For convenience a table of db loss and per cent efficiency is given herewith.

db Loss	Efficiency	db Loss	Frequency
0	100%	3.0	50%
.25	94.5	3.5	44.5
.5	89	4.0	40
.75	84	4.5	35.5
1.0	79.5	5.0	31.5
1.25	75	6.0	25
1.50	71	7.0	19.5
1.75	67	8.0	18
2.0	63	9.0	12.7
2.5	56	10.0	10

Rewinding an Auto Generator

(Continued from page 29)

tor is to be used for one a.c. return, be sure and tape it too. Then the coils and armature are dipped in the varnish. Afterward, let them drip for a half-hour or so, so as to remove the excess varnish. Then either bake them, or let them air-dry, as may be required by the particular varnish used.

FINAL ASSEMBLY

For final assembly, lay the completed field coils in a line with the end wires toward you. To connect them for proper polarity, assume that the first "finish" is to be a field lead. Then the four will be connected, "start" to "start," "finish" to "finish," and "start" to "start," leaving the remaining "finish" as the other field lead. In other words, they will be connected inside to inside, outside to outside, and inside to inside.

Next, the completed fields are placed in the

Demand

FACTS

To hams everywhere, the name Taylor Tubes stands for the tops in fully guaranteed ace-high quality transmitting tubes. Actual tube performance, long tube life and a *complete line* are the reasons for this record. Specific tubes for each class of radio service means better performance because each service requires different tube characteristics for efficient results. Get the actual facts, not fancy promises, when you buy transmitting tubes. Compare — and you, like thousands of other amateurs, will buy Taylor Tubes.

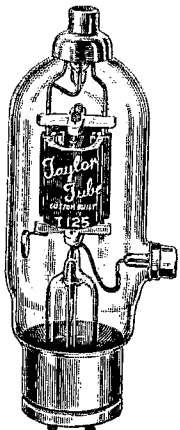

T-125

Carbon Tantalum Anode

125 watts plate dissipation. Amateur Radio's new sensation. Over 800 sold in three months. Conservatively rated 400 watts input plate modulated on all amateur frequencies.

\$13.50 *Easy to Drive*
COMPARE

203-Z

Zero Bias

Up to 300 watts class "B" audio output at plate voltage of 1,250. Extremely easy driver requirements. Use with any standard type 203-A class B transformer. Nonex glass. The tube value that has set the pace in its class. It's wise to buy the Taylor Way. **\$8.50**

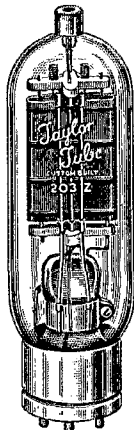

T-55

The sales champion. The most widely used medium power transmitting tube ever produced. Now after only 17 months 8,000 T-55s are in operation. No testimonial is needed to prove the tremendous popularity of this outstanding performer. Ease of operation certain on all frequencies. **\$8.00**

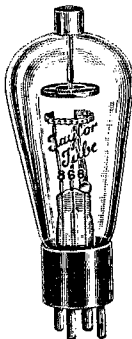
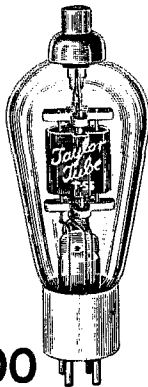

866

The world's fastest selling 866. The absolute tops in quality. Sales talk is unnecessary when you mention these tubes. Over 25,000 Taylor 866's in daily service, do their own talking by giving highest performance and long operating life. **\$1.50 New Low Price**

FREE Big Taylor Tubes Manual and catalog. Get your copy today from your Taylor Tubes distributor or write us. It's a complete amateur handbook in one big volume.

FREE LABEL PIN FREE Ask your distributor for details about the Taylor Tubes Distributor celebration offer. Beautiful WIDNF Label Pin with your own call letters free. Every ham should own one.

"More Watts Per Dollar"

Taylor HEAVY **CUSTOM BUILT** DUTY **Tubes**

TAYLOR TUBES, INC., 2341 WABANSIA AVE., CHICAGO, ILLINOIS

AVIATION RADIO JOBS for HAMS



W9DFY — George Osborn,
Emporia, Kans.
Now employed with a
major U. S. airline.

Rapid expansion on the part of the nation's airlines has made it imperative that they employ more and more radio operators who are well-versed in Airline radio operating procedure. The supply of qualified men is virtually exhausted.

With the cooperation of experienced, actively employed Airline radio operators and communications personnel, we have established and developed our highly specialized, thoroughly practical course in Airline radio operating.

RESULT: Many more calls for our men than we are now able to supply!

As an amateur you have an invaluable advantage in favor of early employment. But we have found from experience that the average "ham" is inclined to be skeptical of such optimism. **WE WELCOME THE STRICTEST INVESTIGATION.** This "checking" has rewarded several "hams" and it can be to *your* advantage, too.

Some of the more active and widely known "ham" operators who have joined their radio experience with Midland training include:

**W9LHQ
W9YCT
W9HON
W9IQI
W9DFY**

These hams, together with many others, are **ALREADY EMPLOYED** in fine, highly respected, responsible positions with leading U. S. airlines.

If *you* are between 18 and 30, have a high school education, are free of uncorrected physical defects, and really like radio operating, it will be to your advantage to get in touch with Norm G. Souther immediately. Write or wire

NORM G. SOUTHER
MIDLAND TELEVISION, INC.
(Midland Broadcasting Company Affiliate)
Dept. 130, 29th Floor Power and Light Building
KANSAS CITY, MISSOURI



W9IQI
Rollie Terrill,
Robinson, Kans.
Now employed
with a major
U. S. airline.

frame, with the leads toward the armature end of the shaft. Insert the field poles in position and draw them up snugly with a good-sized screw-driver. Now connect each field winding as outlined above, remembering the proper sequence of connections. This is vitally important. After they are connected temporarily, run current through them from a six-volt battery and check with a magnetized piece of steel for polarity. One field should attract, the next repel, etc. After making sure that the polarity is correct, make permanent connections with a good soldered splice and wrap with friction tape thoroughly. The loops are daubed with some more of the insulating varnish and tucked snugly away between the fields, so that no "Irish pennants" will get in the way of the revolving armature. The two leads are brought up through a piece of bakelite ($\frac{1}{2}$ -inch is FB), to a pair of binding posts. These will be for the external field connections to a 6-volt battery or d.c. generator, as the case may be.

Now put the old bearings in place, remembering to put the sealed side of the bearing in toward the winding except on the pulley end. On the pulley end, put the sealed side out to keep dust and grit from the bearing. If the old bearings show wear, it would be best to replace them with new. The Fafnir No. 203 "One" and No. 205 "One" are the proper replacement bearings for the Dodge generator. The old-type tapered bearings can be taken up by pushing the outer race in toward the armature; but if they are badly pitted, they should be replaced. After everything is shipshape and the unit is assembled to your satisfaction, turn it over with a motor to a speed of 1800 r.p.m. This is the proper speed for 110-volt output, and good a.c. should be obtained from the slips, or the commutator and shaft combination, with the field excited. For voltage adjustment, a 5-ohm 10-ampere rheostat may be connected in series with one field lead.

In our own case we were bothered to some degree with a flicker in the lights, but this was entirely eliminated by the use of a four-pound fly-wheel. The flicker was noticeable with the slips, and quite troublesome with the old commutator. At the time the fly-wheel was turned on the lathe, two grooves for "V" belts were also machined in. This gives positive drive from the 1-h.p. gasoline motor, the size motor recommended because of the power reserve available. Although these motors are rated at 1 h.p., we have been drawing 800 and 900 watts from them — while, as you know, a horse is 746 watts. The engines are very conservatively rated. Both Montgomery Ward and Sears Roebuck sell 1-h.p. jobs. Some fellows like one, others are impressed with the other. Any one of various makes of 1-h.p. engines can be bolted to the "carry-all" frame easily, are light, and readily portable. They will run a good four hours on one gallon of gasoline. The V-belts used for drives are standard fan-belts. The pulleys on the gas engine are standard, and can be obtained from almost any well-supplied hardware store.

The six-volt generator used for field-excitation

NEW!! GROSS CB-350 RADIOPHONE TRANSMITTER

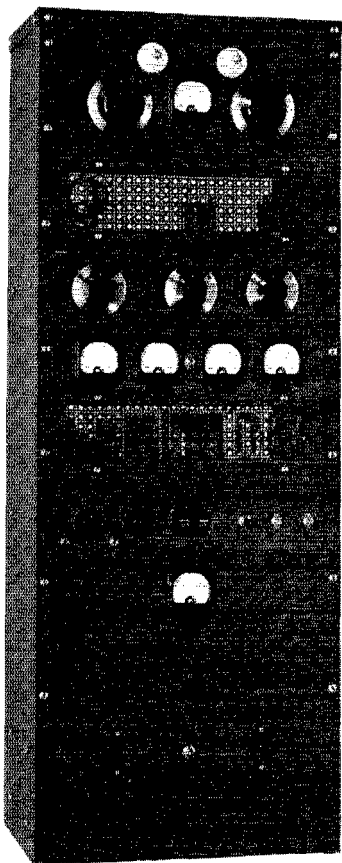

Bulletin upon Request Giving Full
Details and Amazingly Low Price

More and more operators are realizing that only in a GROSS Transmitter can they obtain APPEARANCE, QUALITY, PERFORMANCE and VALUE such as they receive in the CB-350. A really high power phone at an *Amazingly low price*. Truly the "more watts per dollar" slogan takes on a new significance.

- R.F. TUBE LINE UP — 6L6G crystal oscillator, buffer or doubler one T55, class C amplifier two T55s
- POWER SUPPLIES — 1400-1500 volts at 300 M.A. 700 volts at 200 M.A.
- SPEECH AMPLIFIER — Four stage high gain for use with high impedance microphones, self contained power supply
- MODULATOR — Two RK31s are used in the class B modulator. 100% modulation, separate heavy duty power supply
- ANTENNA UNIT — Self contained antenna tuning unit included
- FREQUENCY COVERAGE — 1.7 Mc. 3.5, 7, 14 and 30 M.A.
- POWER — 350 to 400 watts input
- CABINET — Beautifully finished in battleship gray wrinkle lacquer

NEW! BM-100 CLASS B 100 WATT MODULATOR

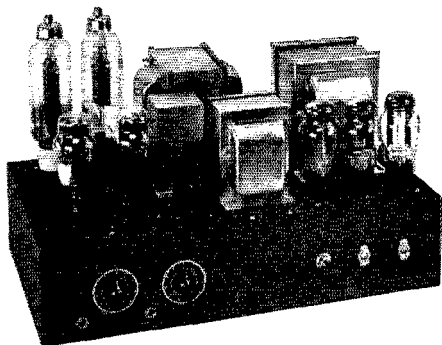

TUBE LINEUP: 3-6C5, 1-6N7, 2-6A3, 2-TZ20, 3-83.

INPUTS: One High and One Low Level High Impedance Input.

The BM-100 Class B Modulator Speech Amplifier will modulate 100% transmitters with inputs up to and including 230 watts input. ■ The unit is completely self contained on the one chassis and includes high gain Speech Amplifier and Dual heavy duty Power Supply. ■ The class B output transformer will match R.F. loads of 3300, 4400, 5000, 5880 ohms. ■ Chassis size: 19" x 11 x 4½. Weight 70 lbs. ■ BM-200 Modulator used in CB-350 Radiophone Transmitter is here illustrated, the BM-100 is very similar in appearance.

Completely wired and tested in our laboratory, less tubes..... **\$59.00**

Matched set of tubes..... **\$12.50**

WRITE FOR FREE NEW CATALOG ON HAM
AND P. A. EQUIPMENT

20% DEPOSIT WITH ALL C. O. D. ORDERS

REMIT BY M. O. INCLUDE POSTAGE

Cable Address: GROSSINC

GROSS RADIO, INC., 51 VESEY STREET, NEW YORK CITY

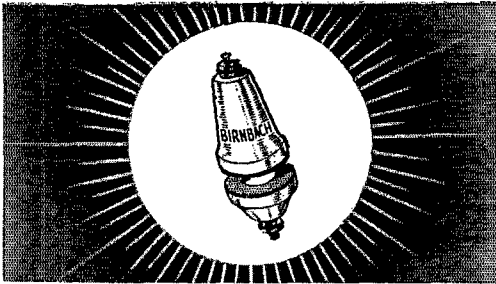

BIRNBACH IMPROVED STANDOFF INSULATORS

Are the Favorites of the Experts

Because they are made of better ceramic. Come in a complete range of heights, for condenser, coils, tube sockets, etc. Can be mounted with a minimum of labor. White glaze.



No. 430..... 5/8" 10c list	No. 432..... 1 1/4" 20c list
No. 431..... 1" 15c list	No. 432J..... 1 1/4" 25c list
No. 431J..... 1" 20c list	No. 433..... 2 1/4" 25c list
No. 433J..... 2 1/4" 50c list	



NEW LOW PRICES ON TRANSMITTING SOCKETS

It pays to buy the best so specify "Birnbach"
 No. 434. 50 watt, list ea... \$1.25
 No. 435. 10 watt, list ea... \$.85

*Special Low Prices in Large Quantities
 Ask your jobber*

BIRNBACH RADIO CO. INC.
 145 HUDSON ST. BIRCO NEW YORK, N. Y.

INTRODUCING

Glassmike

"A FIXED CONDENSER THAT STAYS FIXED"

KEEP that rig of yours on the air! Don't let condenser breakdown interrupt an important Q S O! Here's a "glass walled" by-pass condenser that's absolutely impervious to moisture, *guaranteed* for a year, that will free your rig of condenser trouble from now on. It's absolutely new and different in construction, and costs no more than an ordinary condenser. Ask for Glassmike!

ASK YOUR JOBBER TO SHOW YOU "GLASSMIKE"

CONDENSER PRODUCTS CO.
 1369 NORTH BRANCH STREET
 CHICAGO ILLINOIS

may be of any type you can pick up in the junk yards. Be sure that the direction of rotation is the same as that of the engine used to drive the a.c. generator and exciter.

The "carry-all" frame is about forty inches long and 30 inches wide. The handles on each end make it possible for two men to handle the whole thing easily. The weight is fairly well distributed.

The six-volt generator is mounted between the a.c. generator and the gas engine, and is driven from a third and shorter V-belt. Two V-belts are used to drive the a.c. generator, although one will do the trick. Two seem to give a little better traction, however, as well as a little better safety factor. If one breaks, the other will still run the generator. If desired, the d.c. generator may be eliminated, and the field excitation may be taken from a 6-volt car battery. The field current is on the order of 2 1/2 amperes, not a great deal to worry about.

Some of the fellows around here have used the idea of jacking up one wheel of the car, putting a pulley on the wheel, and driving the generator from that. Another has mounted his under the hood of the car, and drives it from the fan-belt. Another fellow, up country, has made himself a hydraulic drive using a water-ram.

The actual frequency is somewhat higher than 60 cycles, really measuring about 75 cycles. The frequency can be easily checked, using an ordinary electric clock for the purpose. Adjust the field excitation for the desired voltage, put on the clock and let the job run for fifteen minutes or a half-hour. If, in a half-hour stretch, the clock shows a gain of seven and one-half minutes, then the generated frequency is 75 cycles. As all our a.c. receivers and transmitters are made for 60-cycle supply, this higher frequency is really to be desired. The extra 15 cycles gives a peculiar note on a c.w. signal, unlike anything ordinarily heard on the air. The receivers seem to work a little better, too, on the higher supply frequency.

Various makeshifts and schemes will occur to you as you go along, even as with us. If you do run into any difficulty, a little common sense will help you out. I advise getting a copy of Mr. Duncan's book, "Auto Power." There are a lot more jobs in there besides this one, and it is all practically worked out.

The whole thing represents quite a few hours of work, and probably a few well-chosen cuss words, but the results obtained more than justify the expenditure of time and money. Off-hand, I should say that using the best of parts, the whole thing should not run into more than seven dollars and a half at the most.

Strays

W2JVC and W2IJC have exactly the same name, each being Wm. J. Schoenberger. Despite the fact that the name is uncommon, JVC doesn't know IJC.

For Stamina Demand

THORDARSON TRANSFORMERS

Guaranteed performance every hour of the day and every day of the year, is yours when you specify Thordarson transformers for your "Rig"! Precision manufacture and a strict adherence to high engineering ideals builds stamina into every Thordarson Transformer. Demand the best. Use Thordarson Transformers. They can take it and then some.

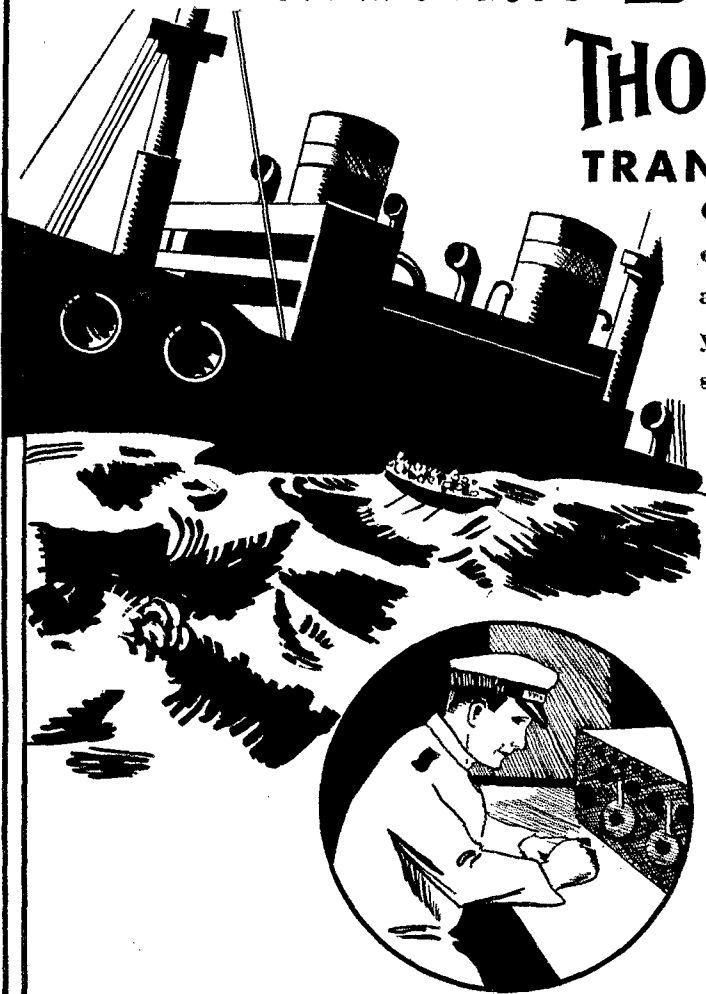

A ship down at the head—A giant airliner lost in heavy fog—these make sensational moments when transmission must go through. Amateurs need the same assurance of dependable performance that is demanded by Air lines, Governments, Broadcast stations, Laboratories, and Communication Systems. Equip your Rig 100% Thordarson for peak operation—at all times—under all conditions.

FREE See your parts distributor, or write us today for catalog No. 400A.

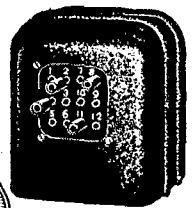

THORDARSON ELECTRIC MFG. CO.

500 W. HURON ST., CHICAGO, ILL.

Demand "Power by Thordarson"

WHY WAIT!

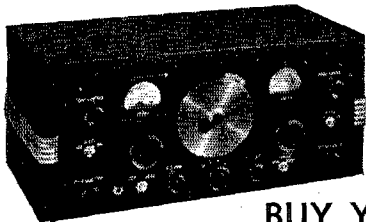

The New
1938
SUPER
SKY
RIDER

**BUY YOUR
New Receiver NOW on
Easy Time Payments!**

YOU can enjoy fine reception by an improved modern receiver while you are paying for it on Hinds and Edgarton "Easy Payment Plan" — the lowest terms you can obtain anywhere. We guarantee satisfaction and you'll get the kind of personal service that has made friends for us everywhere in the country. Here's what one amateur says about Hinds and Edgarton service: — "It is indeed a pleasure trading with you. Your interest in seeing that one gets satisfaction is surely appreciated."

10 DAY
TRIAL

MAIL THIS COUPON TODAY!

HINDS & EDGARTON

19 So. Wells St. (Est. 1914) Chicago, Ill.

Please send me catalog and complete details on time payment plan.

Name.....

Address..... W9APY W9WR

GULF RADIO SCHOOL

Radiotelegraphy

Radiotelephony

Radio Servicing

SECOND PORT } 1007 Carondelet Street
U. S. A. } NEW ORLEANS, LA.

UNIVERSAL MICROPHONES

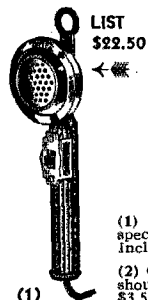

LIST
\$22.50

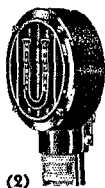

LIST
\$22.50

LIST
\$22.50
or \$24.25
With Plug



(3)

(1) Hand Model Crystal for amateurs, p.a., special events, etc. [Desk holder \$2.50 extra]. Incl. 25 ft. cord. Output — 65 db.

(2) Crystal Stand Model. For use where mike should be mounted on desk or floor. [Desk mount \$3.50 extra]. Inc. 25 ft. cable. All crystal models under patent of Brush Development Co.

(3) Ribbon Microphones. Plug in and use. Self energizing. No polarizing voltage. Semi-directional. High impedance direct to grid and all other impedances. Use on amplifiers of not less than 85 db. gain. Incl. 10 ft. two-conductor cable.

Microphone Division

UNIVERSAL MICROPHONE CO., LTD.

424 Warren Lane

Inglewood, Calif., U. S. A.

A New High-Power Triode

AN unconventional type of construction is utilized in a new power tube just released by RCA. To be known as the 833, the new tube is of the high- μ type and is intended for use as an oscillator, amplifier, or Class-B modulator. The tube structure is intended to minimize internal

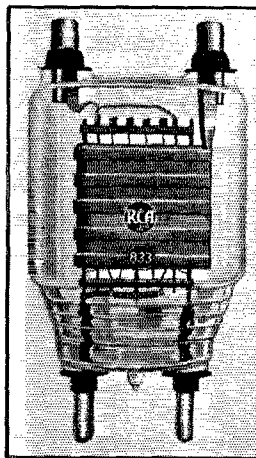

lead inductance and reduce the amount of internal insulation required, and is said to provide high-efficiency operation at moderate plate voltages.

Filament leads are brought out to heavy rod-type connectors, one of which has one side flattened so that the tube can be inserted in the socket in only one way. This prevents reversing the grid and plate terminals, which are at the top of the tube. The overall

length of the tube is about $8\frac{1}{2}$ inches. In Class-C service, the tube is rated at a maximum input of 1250 watts at all frequencies up to 30 megacycles, and may be used with reduced input up to 100 megacycles. Characteristics and maximum ratings are as follows:

Filament voltage	10 volts
Filament current	10 amperes
Amplification factor	35
Grid-plate capacitance	6.3 $\mu\text{f.d.}$
Grid-filament capacitance	12.3 $\mu\text{f.d.}$
Plate-filament capacitance	8.5 $\mu\text{f.d.}$
Max. plate voltage	3000 volts
Max. plate current	500 ma.
Max. grid current	75 ma.
Max. plate dissipation	300 watts
Max. plate input	1250 watts

At ordinary frequencies, a plate efficiency of 80% can be obtained with rather low driving power. For example, one set of typical operating conditions shows the driving power required as 25 watts for an output of 925 watts with 2500 volts and 475 ma. on the plate. The tube should run easily at a kilowatt input.

The Maritime Convention

(Continued from page 10)

lege. He spoke briefly on impedance matching to antennas, and an interesting period of discussion and questions followed.

At eight o'clock the banquet got under way in the Georgian ballroom of the Nova Scotian Hotel. A. A. Stephens, VE1EC, President of the

THE "WANTED" KIND OF HIGH QUALITY LOUD SPEAKER PERFORMANCE

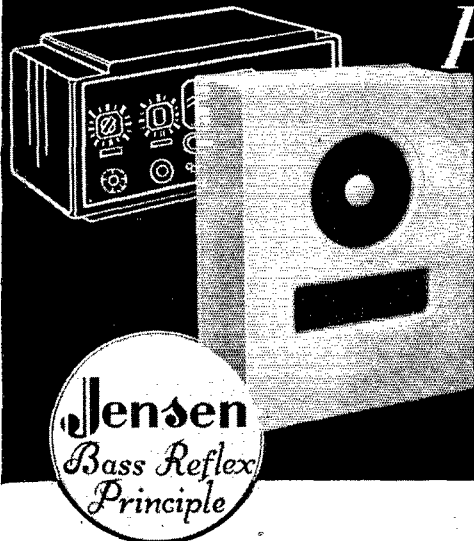

Jensen PERI-DYNAMIC REPRODUCERS

... Perfect for use with the amateur's radio receiver.

THE PERFECT SPEAKER NO BAFFLE REQUIRED

Available in Kits

Model KM is shipped in knock-down kits. Each kit consists of speaker and knock-down enclosure, packed in separate corrugated box containers, shipped together. All necessary screws, bolts, grilles, brackets, etc., included for assembling. Assembly instructions are complete. No tools necessary except an ordinary screw driver. Enclosures are finished with two coats of French Gray. Model KM with 8-inch speaker has a list price of only \$22.00.

There is a Jensen *Peri-dynamic* Reproducer for all known loud speaker applications. Model KM as described above is ideal for general public address use; Model KV is recommended where speech reinforcement is the chief requirement.



Acoustic networks and particularly the Jensen *Bass Reflex Principle* Now conceded by leading engineers to be the feature of 1938 Radio Receivers.

Says a recent engineering publication in effect: "The really new thing for 1938 is the Jensen *Bass Reflex System*."

And so 1938 Receivers will generally establish new high standards of acoustic performance.

Jensen *Peri-dynamic* Reproducers Models KM, with either 8, 10, 12 or 15 inch speaker, all incorporate *Bass Reflex* and are ready now. Ready for the owner who has been dissatisfied with ordinary loud speaker performance; who wanted brilliant highs and middle highs and a low frequency range extended in range and improved in quality. Low frequency response where the fundamentals predominate — not the harmonics.

Model KM-15 with 15" speaker as illustrated, is ideal for those who have high quality radio receivers and want real improvement in loud speaker performance. The receiver can easily be set on top of the Reproducer.

ASK YOUR JOBBER WRITE FOR MORE INFORMATION

Jensen

"The Name Insures
the Quality"

JENSEN RADIO MFG. COMPANY
6601 S. Laramie Avenue, Chicago, Ill.

QST-1137

Please send me more information on Jensen Models KM and KV *Peri-dynamic* Reproducers.

Name.....

Address.....

City.....State.....

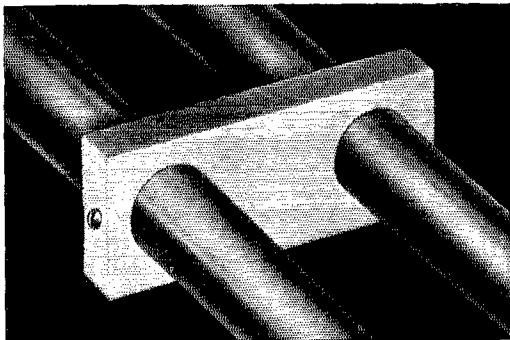

Q-BAR INSULATOR

National offers a new Isolantite insulator for a fixed-ratio Q-bar transformer to match a center-fed half-wave antenna to a feeder using No. 12 B & S wire and six-inch spreaders (72 ohms to 600 ohms). They are designed for use with rigid duralumin tubing with an outside diameter of $\frac{3}{4}$ inches, and are simply slipped over the tubes. The complete assembly is rigid, efficient and tidy as well as convenient to handle.

Q-Bar Insulator, Type QB, Net Price \$.21

NATIONAL COMPANY, INC.
MALDEN, MASS.

Save Time and Costly Experimentation

Build the PROGRESSIVE III

450 WATT INPUT, C.W.,
AND PHONE ON 10—
20—40—80—160 METER
BANDS.

THE radio amateurs—
our country's reserve
communications system—
right now should be given
every cooperation towards
obtaining high power at low
cost.

"PROGRESSIVE III"—
Build it yourself—and you'll
be ready when DX weather
comes. Ingenious design has
kept circuit capacities ex-
tremely low, permitting full
power input either CW or
phone—even on the 10
meter band. The circuit
remains neutralized, permit-
ting fast, easy band chang-
ing with plug-in coils.

It's easy to build, "step-by-
step" if you wish, from
standard parts on panels
and chassis completely drilled
with sockets installed. Cir-
cuit diagrams, directions,
etc. in AMATEUR TRANS-
MITTER MANUAL, 25c
from your jobber or Ama-
teur Press, 333 S. Throop
St., Chicago.

**GENERAL
TRANSFORMER CORP.**
1288 W. Van Buren Street
CHICAGO

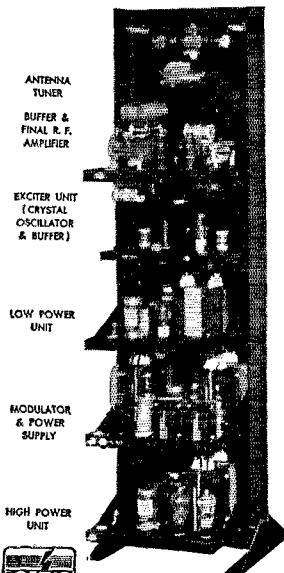

The chassis mount on rack
or in metal cabinets

ASK YOUR JOBBER OR WRITE FOR FREE BULLETIN 44

Halifax Amateur Radio Club, handed the controls over to Major Borrett, VE1DD, who acted as master of ceremonies. The convention was officially welcomed to Halifax by Alderman Dr. S. H. Keshen, representing the Mayor. Alex Reid, VE2BE, of Montreal, Canadian General Manager, spoke briefly on the Bucharest and Cairo conventions. Joe Fassett, the grand old man of amateur radio in eastern Canada, formerly VE1AR, recalled some amusing anecdotes of the early days of radio.

After the brief speeches were over the ballroom was cleared for the contests. The code copying was won by VE1EC and the code sending was won by VE1HK. The silver cup for the VE1 who worked the largest number of foreign countries during the past year was again won by VE1CR. The humorous contests brought many laughs and were enjoyed by everyone. The convention adjourned after the presentation of prizes for the contests.

Sunday morning a large party of the convention were taken on board the *Berengaria*, which was in Halifax on a Labor Day cruise from New York. In the afternoon a picnic, with outdoor sports, was held at St. Margaret's Bay. The weather was rather cool, but three of the picnickers went in swimming and reported the water warmer than the air. During the afternoon the five-meter band was very active since many of the cars were equipped with transceivers.

Early Sunday evening the crowd returned to Halifax and scattered to visit the shacks of the local amateurs, but reassembled to attend the midnight show at the Capitol Theatre. After the show an opportunity was provided to visit the projection rooms and examine the sound equipment through the kindness of SCM VE1DQ.

After a very few hours sleep (for some) the hams again assembled in front of the Nova Scotian Hotel on Monday morning for the five-meter contests. These proved to be one of the best features of the whole convention, and hunt after hunt followed in succession. VE1HJ was in charge of the hidden transmitter and put out a good signal, in fact so good that he was found too quickly by VE1MA the first time. The second hunt lasted longer because the hidden transmitter was located in the centre of a large cemetery. In the afternoon different ones acted as the hidden transmitter and were located by the fleet of mobile five-meter stations cruising the narrow streets of old Halifax.

This concluded the convention, and the VE1's returned to their various QTH's. They all feel that the Halifax Club deserves to be thanked and congratulated for sponsoring such a successful and enjoyable hamfest. Orchids are specially due VE1 EC, AW, EF, FQ, FO, HJ, EK, Ed McLaughlin and, last but not least, the ladies' committee.

J. M. Morton, VE1JM/VE3ALK

A.C. RELAYS

Made by

Allen-Bradley

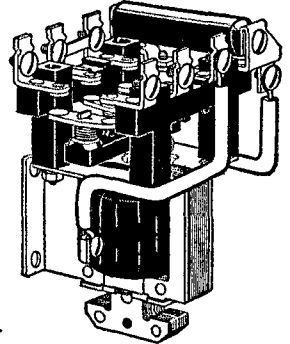
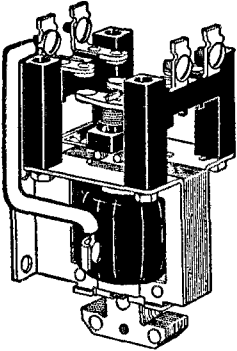

These A. C. solenoid relays are ideal for remote control of transmitters, for control of crystal ovens, and for any general remote control application except for keying. THESE RELAYS WILL NOT OPERATE IN KEYING SERVICE. Silver-to-silver double-break contacts are used throughout.

The maximum contact rating is 10 amp. at 220 v. or 3 amp. at 550 v. The relay coils are wound for 115 volts 60 cycle alternating current. Relays for other voltages can be supplied on special order. Use coupon below.

Type No.	Poles	Nor- mally	Action	Circuit Diagram	Price		Type No.	Poles	Nor- mally	Action	Circuit Diagram	Price	
					Open	In Cab.						Open	In Cab.
A107	1	Open	SP ST		\$3.50	\$4.50	A177	1	Closed	SP ST		\$7.50	\$8.50
A117	1	Closed	SP ST		4.50	5.50	A207	2	Open	DP ST		4.00	5.00
A127	1	Open and Closed	SP DT		5.00	6.00	A217	2	Closed	DP ST		6.00	7.00
A137	1	Open	SP ST		4.00	5.00	A227	2	Open and Closed	DP DT		7.00	8.00
A147	1	Closed	SP ST		5.00	6.00	A237	2	Open	DP ST		4.50	5.50
A157	1	Open and Closed	SP DT		5.50	6.50	A247	2	Closed	DP ST		6.50	7.50
A167	1	Open	SP ST		6.50	7.50						Radiostat —A stepless graphite compression rheostat for primary of 550 watt filament or plate supply transformer. Range 4 to 150 ohms. Price \$6.50	

ORDER BLANK—MAIL WITH REMITTANCE TO

Allen-Bradley Co., 108 W. Greenfield Ave., Milwaukee, Wis.

Enclosed find money order for \$..... for which please send me, shipping charges prepaid, the following items:

..... for..... Volts..... Cycles

Name.....

Address.....



600 V.

Metal-can inverted-mounted type.

Cardboard-case type with Adjustmount metal flanges.

Choice of popular capacities.

Color-coded pigtail leads.

Precisely so. 600 v. D.C. working. The added margin of safety makes these handy electrolytics great favorites among "hams" and experimenters who build rigs to last.

● Write for new 32-page catalog.



?

Want to Read Something Truly Interesting?

Get a copy of "TWO HUNDRED METERS AND DOWN" and thrill to the story of amateur radio. Puff up a bit, if you will, as the story unfolds and shows the important part we amateurs have played in the development of the whole radio field. If you are an old-timer, you will read with interest the accounts of activities you yourself may have taken part in. The interest is still there for those who are comparatively newcomers as the book carries us through to modern times. If you are a beginner, read it to learn to appreciate all that you are now a part of.

► But . . . old-timer, beginner, new-comer, or just one interested in amateur radio — beg, borrow or buy — or steal a copy at the local library and read this inspiring saga of amateur radio . . . "TWO HUNDRED METERS AND DOWN."

\$1.00 postpaid

BUCKRAM BOUND — \$2.00

American Radio Relay League, Inc.
West Hartford, Connecticut, U. S. A.

A.R.R.L. QSL Bureau

FOR the convenience of its members, the League maintains a QSL-card forwarding system which operates through volunteer "District QSL Managers" in each of the nine United States and five Canadian districts. In order to secure such foreign cards as may be received for you, send your district manager a standard No. 8 stamped envelope. If you have reason to expect a considerable number of cards, put on an extra stamp so that it has a total of six-cents postage. Your own name and address go in the customary place on the face, and your station call should be printed prominently in the upper left-hand corner.

- W1—J. T. Steiger, W1BGY, 35 Call Street, Willimansett, Mass.
- W2—H. W. Yahnel, W2SN, Lake Ave., Helmetta, N. J.
- W3—R. E. Macomber, W3CZE, 418 10th St., N. W., Washington, D. C.
- W4—B. W. Benning, W4CBY, 520 Whiteford Ave., Atlanta, Ga.
- W5—E. H. Treadaway, W5DKR, 2749 Myrtle St., New Orleans, La.
- W6—D. Cason Mast, W6KHV, 423 East E St., Ontario, Calif.
- W7—Frank E. Pratt, W7DXZ, 5023 So. Ferry St., Tacoma, Wash.
- W8—F. W. Allen, W8GER, 324 Richmond Ave., Dayton, Ohio.
- W9—Roy W. McCarty, W9KA, 11 South Michigan Ave., Villa Park, Ill.
- VE1—J. E. Roue, VE1FB, 84 Spring Garden Rd., Halifax, N. S.
- VE2—C. W. Skarstedt, VE2DR, 236 Elm Ave., Westmount, P. Q.
- VE3—Bert Knowles, VE3QB, Lanark, Ont.
- VE4—George Behrends, VE4RO, 186 Oakdean Blvd., St. James, Winnipeg, Manitoba.
- VE5—E. H. Cooper, VE5EC, 2024 Carnarvon St., Victoria, B. C.
- K4—F. McCown, K4RJ, Family Court 7, San-turce, Puerto Rico.
- K5—John J. Carr, K5AV, 78th Pursuit Squadron, Albrook Field, Canal Zone.
- K6—James F. Pa, K6LBH, 1416D Lunalilo St., Honolulu, T. H.
- K7—Leo E. Osterman, K7ENA, Customhouse, Wrangell, Alaska.
- KA—George L. Rickard, KA1GR, P. O. Box 849, Manila, P. I.

Naval Communication Reserve Notes

(Continued from page 30)

friend who is in the Communication Reserve, or by communicating with the Commandant of the Naval District in which he may be located. The addresses of the Commandants are as follows:

- | | |
|--|--|
| Commandant,
First Naval District,
Navy Yard,
Boston, Massachusetts. | Commandant,
Ninth Naval District,
Naval Training Station,
Great Lakes, Illinois. |
| Commandant,
Third Naval District,
Navy Yard,
New York, N. Y. | Commandant,
Eleventh Naval District,
Naval Operating Base,
San Diego, California. |

HAMMARLUND "MTC" CONDENSERS

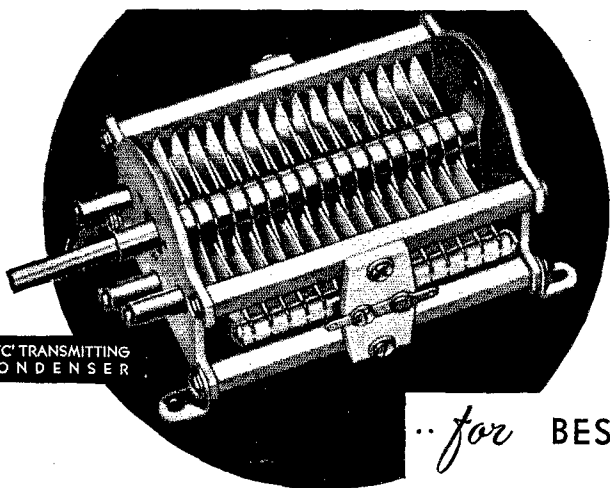

"MTC" TRANSMITTING
CONDENSER

.. for BEST RESULTS!

A low-priced transmitting condenser with every feature necessary in quality transmitters of all kinds — that's the new "MTC" condenser by Hammarlund! Here are some "MTC" features — maximum rigidity, light weight, Isolantite insulation, table or shelf mounting, Beryllium cushion-disc front bearing, rear ball bearing, silver plated wiping contact, heavy wide spaced aluminum plates, round edges

for higher voltages, 19 sizes, 20 to 500 mmf., voltages from 1000 to 10,000, and prices range from \$2.40 to \$8.50! Use the MTC transmitting condensers and watch the QSL's come in!

For best results use Hammarlund, and to be sure you get a genuine Hammarlund product, look for the name — it's stamped on every product. Send for MTC bulletin for further details

HAMMARLUND MANUFACTURING CO.

424-438 West 33rd Street, New York

Radio Operator's
Course
Telegraphy—
Telephony
Aviation

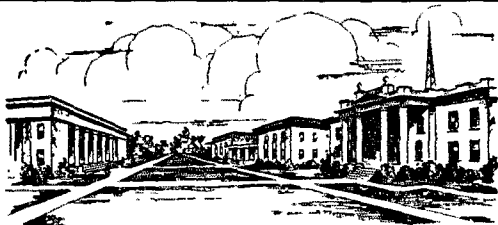

Practical
Experience
Studio—
Transmitter—
Announcing

PORT ARTHUR COLLEGE has been teaching Radio for twenty-eight years, and during this time it has never been our policy to guarantee positions to prospective students, directly or indirectly. We believe it wisdom at this time, however, to go on record in our *QST* advertising to say that it is impossible for us to even come near to supplying the demand for Radio Operators received by our Employment Department. We do not mean by this that all students who enroll will automatically secure positions. The demand is for graduates — good men who deserve and are qualified to hold positions. The graduates of our Radio School, so far as we know or can learn, are employed 100%.

It is possible for every student who enters the P. A. C. Radio School and completes the course in keeping with our standards to receive employment as a Radio Operator for our station

K P A C at the transmitter, in the control room, as trans-radio press operator, or announcer, and not only earn more money than he pays for the training but to also continue his training as a post-graduate student in advanced work and prepare himself to secure and hold operating positions in the upper bracket of broadcasting, marine work, announcing, or airways.

Port Arthur College advertises primarily to Radio Amateurs, and the training is too technical for the average student who has not selected Radio as his life's work. We know the opportunities for positions and advancement are unlimited for men who are interested in Radio and who plan to make this their career and are willing to make the sacrifice and effort necessary to master our training. P. A. C. maintains strict collegiate rank — only high school or college graduates are eligible for enrollment.

If interested in details about Radio Course, write for bulletin R

PORT ARTHUR COLLEGE ■ PORT ARTHUR (World-known port) TEXAS

CORNELL-DUBILIER

Announces

A CAPACITOR THAT IS DIFFERENT

Universal Mounting
A GREAT STEP FORWARD
IN CAPACITOR DESIGN

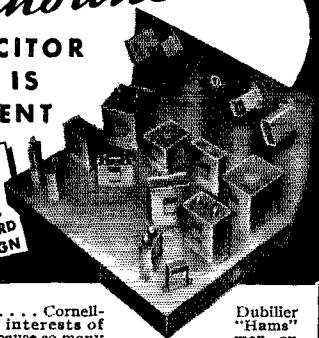

This Much is Certain. . . . Cornell-Engineers have the interests of at heart. It may be because so many the C-D staff are "Hams" themselves. At any rate, they know the problems of the "ham."

Dubilier "Hams" men on they know

It seems to us, that C-D engineers have uncovered "a real one" this time. You know of course, the sometimes lethal effects of a charged condenser. FOR YOUR SAFETY the C-D staff designed Universal Mounting Brackets for all Type T-J-U DYKANOL Capacitors. These brackets are supplied at no extra cost.

For complete details send for catalog No. 151-A
Cornell-Dubilier Electric Corporation 1013 Hamilton Blvd.
South Plainfield, New Jersey

CORNELL - DUBILIER



ELECTRIC CORPORATION

South Plainfield, New Jersey

MATCH TIPS

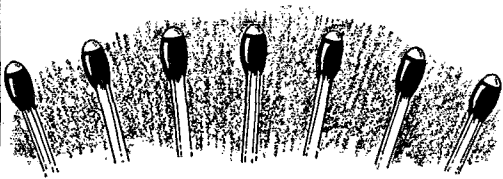

Yes, but just as "hot" tips and far more profitable ones are to be found in Volume Two of

HINTS & KINKS

50¢ postpaid from

AMERICAN RADIO RELAY LEAGUE, INC.

West Hartford, Connecticut

Commandant,
Fourth Naval District,
Navy Yard,
Philadelphia, Pa.

Commandant,
Twelfth Naval District,
Naval Operating Base,
San Francisco, California.

Commandant,
Fifth Naval District,
Naval Operating Base,
Norfolk, Virginia.

Commandant,
Thirteenth Naval District
Headquarters,
Seattle, Washington.

Commandant,
Sixth Naval District,
Navy Yard,
Charleston, S. C.

Commandant,
Fourteenth Naval District
Headquarters,
Pearl Harbor, T. H.

Commandant,
Seventh Naval District,
Navy Yard,
Charleston, S. C.

Commandant,
Fifteenth Naval District
Headquarters,
Balboa, Canal Zone.

Commandant,
Eighth Naval District,
Navy Yard,
Charleston, S. C.

Commandant,
Sixteenth Naval District,
Navy Yard,
Cavite, P. I.

Army-Amateur Radio System Activities

(Continued from page 31)

New Hampshire, Vermont, Massachusetts, Rhode Island, Connecticut.

II. C.A.—W2SC-WLN, Governor's Island, N. Y.—New York, New Jersey, Delaware and Puerto Rico.

III. C.A.—W3SN-WLQ, Baltimore, Md.—Pennsylvania, Maryland, District of Columbia, and Virginia.

IV. C.A.—W4IR-WLR, Atlanta, Ga.—North Carolina, South Carolina, Georgia, Florida, Tennessee, Alabama, Mississippi and Louisiana.

V. C.A.—W5ZG-WLH, Columbus, Ohio.—Ohio, West Virginia, Indiana and Kentucky.

VI. C.A.—W9ANR-WLT, Chicago, Ill.—Illinois, Wisconsin, Michigan.

VII. C.A.—W9BNT-WLU, Omaha, Nebraska.—North Dakota, South Dakota, Minnesota, Iowa, Nebraska, Kansas, Missouri and Arkansas.

VIII. C.A.—W5OW-WLJ, Fort Sam Houston, Texas.—Colorado, Arizona, New Mexico, Oklahoma and Texas.

IX. C.A.—W6NLL-WLV, Presidio of San Francisco, Calif.—Washington, Oregon, Idaho, Montana, Wyoming, Utah, Nevada, California.

Anyone desiring information on the Army Amateur Radio System can obtain it from the Signal Officer of the Area in which he lives. This list will also be helpful to A.A.R.S. members in competitions.

How Long Is a Quarter Wavelength?

(Continued from page 32)

assumed that this line is held several feet away from large conducting or dielectric bodies.

Line B consists of a two-conductor parallel tubing line using copper or aluminum tubing of diameters between $\frac{3}{16}$ - and $\frac{3}{8}$ -inch and tubing spacings between $\frac{3}{4}$ inch and 2 inches. This group includes the Collins "Multiband" and Johnson "Q" sections.

Line C consists of a concentric transmission line using No. 12 copper wire inside of a $\frac{3}{8}$ -inch copper tube with Isolantite spacers every few inches along the line. Incidentally, the measured surge impedance of this line was considerably less than the calculated value of approximately 75 ohms.

Line D is the conventional twisted pair of the "low-loss" type. This type of line should never

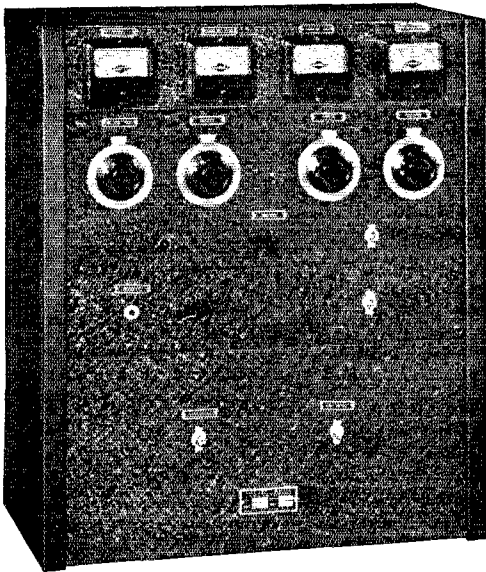

80-T TRANSMITTER

- Covers all bands from 10-160 meters on phone and cw.
- Has all necessary controls and meters, yet is simple to operate.
- Compact in size and well proportioned for restricted space.
- Reasonably priced and may be purchased on easy payments through your dealer.

YOU PROTECT YOUR INVESTMENT

when you buy an 80-T transmitter because it becomes the foundation unit for our 700-R transmitter when higher power is later desired. We allow you the full purchase price of your 80-T when the larger transmitter is acquired, thereby eliminating any depreciation on your initial investment. This feature alone is well worthy of your consideration.

Write for Information and Prices

HARVEY RADIO LABORATORIES, INC.

25 Thorndike St., Cambridge, Mass.

DOWN PAYMENT ON 80T ONLY **\$7.75** ON OUR 20 PAYMENT PLAN.

ORDER NOW

IMMEDIATE DELIVERY

DELAWARE RADIO SALES COMPANY

405 DELAWARE AVENUE — W3DQ — WILMINGTON, DELAWARE

Press Lever — SEMI-AUTOMATIC KEY DOES THE REST

MAKES
SENDING
EASIER

Cuts
Effort
in Half

Insist on the Genuine Martin

VIBROPLEX

Semi-Automatic Key

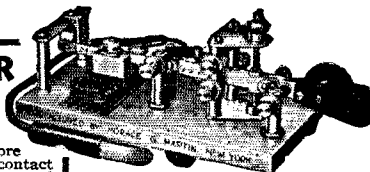

**JUNIOR
ONLY
\$12.50**

Smaller and more compact. Large contact points. Black japanned base. A low priced key with world famous Vibroplex Quality.

Other models — \$17 and \$19

hand sender — less than half the effort. Easy to learn. Easy to use. Easy to own. Order to-day. Insist on the Genuine Martin Vibroplex key. Accept no substitute. Only the Genuine has "THE BUG" trade mark. Your old Vibroplex accepted as part payment. Money order or registered mail. Write for FREE catalog.

Free
Illustrated
Catalog

THE VIBROPLEX CO., Inc.

832 Broadway

New York, N. Y.

PRECISION CRYSTALS



Crystal Holder

Highest quality crystals, one inch square, carefully ground for frequency stability and maximum output. Be sure of your transmitter frequency — use PRECISION CRYSTALS.

Low frequency drift crystals (Type L F C) supplied within 0.1% of your specified frequency and calibrated to within 0.03% are priced as follows: 1750 and 3500 kc. bands — \$3.50 each. 7000 kc. band \$4.00 each. Holder \$1.00.

(Holder as illustrated to fit G.R. jacks or round holder to plug into a tube socket can be furnished. G.R. jacks to plug illustrated holder into — \$1.50 pair.)

'X' cut PRECISION Crystals carefully ground for maximum power supplied within 0.1% of your specified frequency and calibrated to within 0.03% are priced as follows: 1750, 3500 and 7000 kc. bands — \$3.00 each. Add \$1.00 if holder is desired.

'AT' cut crystals for commercial use quoted on at your request. When ordering our product you are assured of the finest obtainable. Now in our seventh year of business.

PRECISION PIEZO SERVICE

427 Asia Street

Baton Rouge, La.

TWO "ALADDINS"

One had a lamp—



... remember the story of Aladdin and how he could work miracles by just rubbing his magic lamp? Well, today there's another "Aladdin" that works miracles, too, but not with a lamp...

The Other Has
POLYIRON!

Like a modern genie, Aladdin "Polyiron" I.F. Transformers bring you an almost unbelievably higher degree of SELECTIVITY and SENSITIVITY — INCREASED GAIN — LOWER NOISE LEVEL — LESS LOSS — BAND EXPANSION. If you haven't a magic lamp to rub, see your jobber or write us for FREE TECHNICAL BOOKLET showing how and why Aladdin components greatly improve reception.

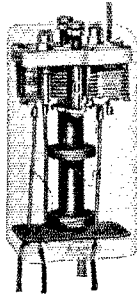

ALADDIN RADIO INDUSTRIES, INC.
466q W. Superior Street, Chicago, Illinois
Licensee of Johnson Laboratories, Inc.

These devices manufactured under one or more of the following U. S. Letters Patents:

1,887,380	1,940,228	1,978,568	1,978,599	1,978,600	1,982,689
1,982,690	1,997,453	2,002,500	2,082,590	2,005,203	2,018,626
2,028,534	2,032,580	2,032,914	2,035,430	2,051,012	2,059,393
2,082,587	2,082,589	2,082,595.	Other patents pending.		

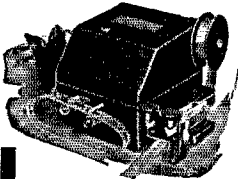

At Last!
A Perfected
**AUTOMATIC
SENDER**

Save your fist. Let the Automatic Sender raise your stations for you. Repeats calls or messages indefinitely. Length of messages unlimited. Sends from 2 to 70 words a minute. Motor driven. Entirely automatic. Built-in tape perforator. Absolute uniformity in spacing of characters. Used with buzzer or oscillator, makes excellent code teacher for novice and speed-builder for the advanced amateur. Complete with 4 rolls of tape and full instructions. No extra equipment needed. If your dealer can't supply you, write us.

only
\$12.50

Postpaid
in U. S. A.
Patent
Pending

MONEY-BACK GUARANTEE

Gardiner-Levering Co. Haddon Heights
New Jersey, U. S. A.

EVERY RADIO OPERATOR

Wishes He'd Bought His **MACKEY** Long Ago!

Find out for yourself! You, too, will send faster, smoother code. Every **MAC KEY** designed, balanced and tested by Champion McElroy himself. Beginners and advanced operators everywhere are improving their speed and technique. Here are the most amazing values in telegraph history. See them at your jobbers. Get your **MACKEY** now. You'll always be glad you did!

New 1938 DeLuxe Semi-Automatic MAC KEY ...	\$9.50
New 1938 Standard Model Semi-Auto. MAC KEY ..	7.50
MAC STRAIGHT KEY , Best Ever. Real Balance...	1.50
MAC OSCILLATOR , Tone and Frequency Control.	4.50
MAC PRACTICE SET , \$2.95. MAC HUMMER ...	1.50
MAC AUTO , Finest Electrical Transmitter — Only	69.00

T. R. McELROY—175 Congress St., Boston, Mass.
WORLD'S CHAMPION TELEGRAPHER

be used as a resonant matching section due to its higher losses as compared to Lines A, B and C. It is also to be noted that there are several different makes of "EO1" cable now offered for sale, which differ somewhat in characteristics. It was also found that six months exposure to the weather affected the losses, characteristic impedance and the velocity of propagation of this type of line so that the factor V shown for Line D is merely an average.²

The length formula for resonant, but non-radiating, lines and matching sections which are electrically a quarter-wavelength long is

$$L_{feet} = \frac{246V}{F_{Mc.}}$$

Where L is the length of the quarter-wave section in feet; V is the velocity correction factor shown in Table I; and F is the frequency of operation in megacycles.

To obtain a half-wave or full-wave section, multiply L by 2 or 4, respectively.

Table II shows some typical lengths for various constructions.

² See also, "Match And Mis-match," by S. W. Seeley, elsewhere in this issue.—Edrron.

TABLE II

Frequency	Quarter Wavelength in Feet			
	Line A	Line B	Line C	Line D
3.5 Mc.	68 ft. 6 in.	66 ft. 9 in.	59 ft. 8 in.	45 ft. 8 in.
3.75	64 ft.	62 ft. 4 in.	55 ft. 11 in.	42 ft. 10 in.
4.0	60 ft.	58 ft. 5 in.	52 ft. 3 in.	40 ft.
7.0	34 ft. 3 in.	33 ft. 5 in.	29 ft. 10 in.	22 ft. 10 in.
7.15	33 ft. 7 in.	32 ft. 9 in.	29 ft. 3 in.	22 ft. 4 in.
7.3	32 ft. 10 in.	32 ft.	28 ft. 7 in.	21 ft. 11 in.
14.0	17 ft. 2 in.	16 ft. 9 in.	14 ft. 11 in.	11 ft. 5 in.
14.2	16 ft. 11 in.	16 ft. 6 in.	14 ft. 9 in.	11 ft. 3 in.
14.4	16 ft. 8 in.	16 ft. 3 in.	14 ft. 6 in.	11 ft. 1 in.

Physical length of electrical quarter-wavelength lines using four different types of construction. See text for specifications of the four types of lines.

Notes on Steatite-Type High-Frequency Insulation

(Continued from page 34)

constitute only a very small portion of the steatite body, they are the determining factors for the properties of the finished article and, by varying these fluxes, the ceramic engineer can produce specific properties in the finished body.

The mixture of tale and fluxes is plastic enough to be pressed by steel dies into desired shapes. By adding some water to the dry mixture, higher plasticity is obtained which makes it possible to extrude the body into tubular shapes or rods, through high pressure extrusion presses. After drying, these extruded pieces are just hard enough so that they can be machined similar to steel, brass or wood; and it is possible to drill holes or cut threads before the pieces are fired, or, as the ceramist says, "while the pieces are green".

The firing process, which takes place at very high temperatures in specially designed kilns,



NEW CANDLER COURSE!

Always the Short-Cut to Code Skill—
NOW IMPROVED 50%

If you REALLY want to be a speedy, accurate code operator, you have the most amazing opportunity in all code history! Walter Candler, maker of champions, will teach you everything you need to know to get your amateur or commercial license — and teach you in *half the usual time!* Don't go on just wishing to be a code expert when Candler training is so easy and so inexpensive. *Today* can be the turning point in your radio career. All you have to do is mail the coupon below. Why delay! *Mail it now!*

World's champion McElroy says, "You can't learn code by practice alone — with any kind of practice set. Automatic Sound Consciousness is the foundation every operator must have. The Candler System in this respect is exclusive, scientific, exact."

Don't stand in the way of your own success. Tear out the coupon and mail it today! You'll always be glad you did.

Walter Candler will train you personally, at home, to qualify as an expert operator. His phenomenal success with thousands, of others, guarantees your own proficiency. Candler knows the short-cuts. He'll save you months of laborious practice. Mail the coupon for proof.



CANDLER SYSTEM CO.

Dept. Q-11, ASHEVILLE, N. CAROLINA, U. S. A.

MAIL COUPON TODAY FOR FREE BOOK

CANDLER SYSTEM CO.
 Dept. Q-11, Asheville, North Carolina, U.S.A.
 Send me your FREE book right away! My present speed is... w.p.m.

NAME.....
 Address.....
 City.....State.....

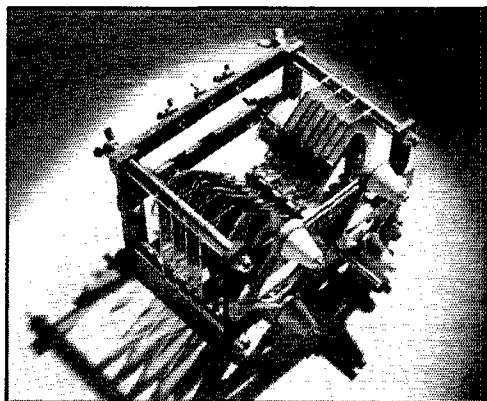

Neutralizer Model ABC 6025-N2

CONDENSERS THAT FEATURE:

- HALF-LENGTH ROTOR SHAFT — *putting inductance where it belongs, in the coil.*
- LOWER MINIMUM CAPACITIES — *giving a greater tuning range.*
- BUILT-IN COIL MOUNTING — *stator, link, and center tap terminals.*
- BUILT-IN NEUTRALIZING CONDENSERS — *optional. No mounting problems.*
- SHORTER OVERALL LENGTHS FOR GIVEN PLATE SPACINGS AND CAPACITIES.
- IMPORTED LEADLESS MYCALEX RF INSULATION — *strength and low losses.*
- HUSKY CONSTRUCTION THROUGHOUT — *clean appearance.*

CERAMIC STANDOFF INSULATORS—*for ungrounded, grounded, or bypassed-to-ground rotor assembly.*

BEAUTIFULLY POLISHED PLATES — $\frac{1}{16}$ inch thick, with rounded edges.

You get all this, and more, in an ATKINS & BROWN condenser. The lower distributed inductance and lower minimum capacity enable a well designed ten or twenty meter transmitter to work on five meters — an added band. For any band — from 5 to 160 — there is nothing better.

Get the Best!

ATKINS & BROWN

W6VX

215 Fourteenth Street, Oakland, California

W6HB

Briefs

W9KMN, Woodstock, Ill., would like to arrange daily schedules with stations near Minneapolis, Minn., Sioux City, Iowa, and in the western part of Nebraska and southern part of Kansas, for the purpose of obtaining amateur meteorological measurements. Operators in the places mentioned who have access to complete amateur meteorological measurements should get in touch with Bruce E. Steinke, W9KMN, Woodstock, Ill.

— — —

Tuning across the 7-Mc. band in the wee small hours of August 8th, W5CWW, El Paso, Texas, heard a creeping rough signal calling "Qrr," the first of a decidedly excited nature and signing XE2DC. Making contact, W5CWW received the following message: "This town is being consumed by fire. Please notify Mexico City." He phoned the police in Ciudad Juarez (just across the border) and passed along the information. The police relayed the message to Mexico City and a relief train was promptly dispatched. The town, El Salto, suffered considerable damage, some fifty houses being destroyed.

Station Activities CANADA MARITIME DIVISION

MARITIME—SCM, A. M. Crowell, VE1DQ—Nova Scotia: FQ has become an RME convert. KY is active on 3.5 Mc. using a new Sky Buddy receiver. ME, a new Halifax ham, has a 6L6 going on 3.5 Mc. KG is awaiting membership in the R.C.C. A very FB bit of portable field work was reported by FQ, who, with a party, recently motored with his 6L6 crystal osc. to Ship Harbor and without benefit of power lines spent a very busy day on 3.5 Mc. getting S8 reports from W1's using only 135 volts of "B." DQ is revamping the final and working on the antenna. MK, the H.A.R.C. station, is now in operation. BV, BC and OW have been active on 14-Mc. 'phone. BV is now located in Halifax. GL has been swatting 14-Mc. 'phone from Moncton. AX has been getting the kinks out of the fist with a new rig on 14 Mc. GR is thinking of adding another big bottle—a T125. LR is piling up the DX contacts on 14-Mc. 'phone. St. John News (by EE); MB has made a fine start for a new ham. BM's new transmitter and receiver are nearly ready. GQ likes the rebuilding idea of amateur radio, and he sure can tell you what will work and what won't. GP and XYL had a fine time at hamfest, as did FL and his YL. LS was the only other ham from St. John to attend the big event. EI's signal sounds much better lately. KZ believes in low power. JN has a pair of T20's—FB, Mac. The L.C.A.R.C. has started its winter activities, and it looks as though there will not be enough old members to initiate the ones coming in. IF keeps the higher frequency bands busy.

ONTARIO DIVISION

ONTARIO—SCM, Fred H. B. Saxon, VE3SS—R.M.'s: ABW, DU, GT, MB, QK, TM, WK. P.A.M.: NX. The Route Manager located nearest to you will be pleased to assist you in getting started in traffic handling. VA has new rig with P.P. T55's in the final, time delay relay on power supplies and an overload relay in every stage; receiver is an HRO. WK had trouble with strain insulators in guy wires on new mast. GN from Rat Rapids visited in Toronto. GG is back as O.R.S., but his QTH is now Toronto. PE is new O.R.S. The Toronto gang enjoyed themselves at Detroit. AJB and BB are qualifying for O.R.S. BB is putting an '03A in final. CN had a visit from MJ and directed him to the summer cottage via 28-Mc. 'phone; he also works ADA (mobile in plane) cross-band 3.9 to 28 Mc. when flying within range, giving ADA WX and landing conditions on Lake Simcoe. AU's 14-Mc. VK score is now 155; on Sept. 14th he worked J5CC, which made him W.A.C. three times in two weeks, the other Asians being U9AV and U9AW. AEV has rebuilt with a '47, 802 and T55; he had a visit from VE4NI. The Lakehead Wireless Club again had a rig at the Fort William Fair and reports much interest from the public. The Lakehead Club's annual picnic was held at Pass Lake; two W hams from Duluth were unexpected but very welcome guests. PE, using T20's in the final on 3.5 Mc., has been heard in Holland this summer. Watch your notes, fellows; the R.I. won't take a very lenient view of persistent raw a.c. signals.

QUEBEC DIVISION

QUEBEC—SCM, Stan Comach, VE2EE—The Montreal Amateur Radio Club has started its meetings again, and all interested are welcome to meet every third Thursday. JK is leaving the district for a sojourn up at North West River, Labrador and LU returns to town from that location. IN has been summering in the bush operating a station for the Forestry, as were also DO and KD. Two new W.A.C. 'phone tickets will adorn the shacks of GA and DQ; the latter has also erected a vertical half wave on 14 Mc. JG is a newcomer in Verdun. JJ has sold his station, lock, stock and barrel. FG is now W.A.C. on c.w. working YI2BA for his Asian. AM worked his first VK 'phone recently; DC, one of our outstanding DX men, has moved from New Carlisle to Montreal. IX is using a '47, 2A3 with 30 watts and has 34 states toward W.A.S. ID has purchased an HF-100. LI is using a T-55 final. KM has rebuilt to a pair of 211's in the final and AG has done likewise. IP is using a T-125. LV has laid his hands on a Class B modulator. W81CM visited DR recently with his YL2B. Hebert from Hartford was also in Montreal. II is now working at the R.C.A.—Victor with EX. CR is changing QTH. BO was on vacation with the W2's. W2BNX has gone back home after the season at Belmont Park. BN is working quite a slice of DX. With 28 Mc. opened up we have heard CA, ID, KX and EW down there with LV somewhere in between 14 and 28. HI. DZ is leaving CKAC to work for C.B.C. NI is running a pair of 150-T's in a swell rig. The trunk line will begin operation soon with LC in charge and LU doing his bit as alternate. We expect that the Tri-Colour Net also will be operating with renewed vigor under the supervision of AB and HT. The election for Canadian General Manager will soon require your attention. Let's pull for our nominee solidly again. I would be pleased to hear some word from the following before November 16th: AA, BN, CW, DH, EQ, FJ, GX, HX, IG, JL, KY, LX, MA, MD, NB . . . drop me a line, tell the gang of your activities.

Traffic: VE2LC 3 DR 17 LI 1.

VANALTA DIVISION

ALBERTA—SCM, Alfred D. Kettenbach, VE4LX—LQ is back with KK on 1.75-Mc. 'phone schedule. EA is working DX on 14-Mc. 'phone; he is the newly elected president of the N.A.R.C. QX moved rig to Varsity for new Varsity Ham Club, which boasts membership of 25, and will be working 3.5-, 7- and 14-Mc. bands, 'phone and c.w. AH has new receiver finished and has started on the new rig. FR is making FB progress with his new 14-Mc. rig. HJ was reflected secretary of N.A.R.C. by acclamation. JO of Cadogan is going North to Fort St. John as radio op for air line company. ADD is preparing for 28-Mc. 'phone. AHY, a new N.A.R.C. member, uses a single '45. VJ will be on with pair of tens in the final of rebuilt rig. AEA tried 28-Mc. 'phone. AGZ put up new skywire. HM was heard working his YF from a Chicago station recently. AJJ, new Edmonton ham, sports nifty-looking rig. UY has gone to Grand Prairie as chief engineer for CFGP. HF is getting out very well with his 2 watts. LQ works lots of VK's, ZL's and G's in a month. ZW of Grand Prairie "went and got himself married." NS has the new rig ready for testing. GM and BW have very interesting discussions about governmental policies, and if you want a real treat just listen to them on 3.9 Mc. these nights. The Alberta Net is back in action for the winter and looking forward to a fine season. AFT leads the traffic handlers this month.

Traffic: VE4AFT 43 GE 31 LX 16 QK 3.

PRAIRIE DIVISION

MANITOBA—SCM, A. J. R. Simpson, VE4BG—AAW lost little time after his trip to Minneapolis. GC, who looked after Trunk Line traffic last year, doing an FB job of it, will be turning this detail over to AAW for the coming winter and will relieve in an alternate capacity. Other stations desiring to hook in with these stations are requested to communicate with them. IP is turning his attention to transmitter alterations. GL recently acquired a new receiver. EK is looking over microphones. ZK keeps busy on 14- and 7-Mc. c.w. QC now uses his RK23 as a buffer-amplifier and finds it much better. QO finds 28-Mc. conditions much better than 14 Mc. RO, by the use of a T720 doubler, has been able to put one of the rigs on 28 Mc. with output about equivalent to 14 Mc. SS is rebuilding bread-board style. KX is heard on 14 and 28 Mc. with a Collins rig. SR finds 14 Mc. good for DX. EJ has an RME69 re-

ceiver and has decided to move the rig to 14 Mc. OK has left Winnipeg for an operating post at The Pas in the North country. We wish him the best of luck. NI will be rebuilding with a T125 Class B modulated. The Winnipeg Radio Club has resumed fall activity with the election of officers for the coming year. The M.W.E.A. and St. James Radio Clubs are also getting under way.

Traffic: VEAAW 13.

SASKATCHEWAN—SCM, Wilfred Skaife, VE4EL—AAA, operated by members of the S.A.R.C., has been on 14 and 56 Mc. the past summer. "T9X" has resumed publication. IQ is running a pair of T20's in final of new rig. LI is working on 56-Mc. portable for the new buggy. MB, TN, PQ, UD have been fooling around with 56-Mc. equipment. QZ now has relay rack using 6L6G crystal osc. and '10 doubler-amp. with about 20 watts input. The S.A.R.C. staged a very successful weiner roast for its members as a preliminary to the club's program of entertainment for the coming season. RJ has been operating 28-Mc. phone. TW had a visit from his brother, W8PKX. UC is working 14-Mc. phone with a T55 final. UD heard VU2CQ on 28-Mc. phone one noon. XY is now located in Saskatoon. XB got bitten by the phone bug and is now operating on 14 Mc. XM is going crystal control and plans to own a Haines "R.S.R." receiver soon. VB reports the presence of a junior op. at his shack. KJ went over his rig to clean up a little haywire here and there. UL is going to Harvard (Cruft Lab.) for his M.Sc. in Communication Engineering. He has done some very steady and reliable monitoring as our Official Observer, and the Section will miss him. UK has nice rig with 59 Tri-tet crystal osc., '46 buffer and two T20's in final; he's modulating with D.B. mike into 56 into two '45's into two '10's in Class B and getting fine results on 14-Mc. phone.

Traffic: VE4QZ 8 El 5.

NEW ENGLAND DIVISION

CONNECTICUT—SCM, Frederick Ellis, Jr., W1CTI—JXP reports that the Humdinger Net will have augmented outlets and contacts this season. APW had a portable 7-watt rig at summer camp. BDI resumed schedule with 3BWT. BIH moved. IMV looks for Conn. stations on 1971 kc. every Sunday at 8:30 a.m. DWP is building a c.w. rig for 3.5-7-14 Mcs. Any Conn. stations desiring to join the Nutmeg Net should get in touch with the S.C.M. The net resumed operations Oct. 4th. ES schedules IDMF and 8CMP.

Traffic: W1JMY 60 JXP 44 AJB 42 DMP 39 ITI 32 KFN 28 EAO 8 APW 7 JYJ 5 BDI 4 KV (WLGJ 38).

MAINE—SCM, Winfield A. Ramsdell, W1FBJ—CFO is on A.A.R.S. 3.5-Mc. C.W. Net using a.c. RK25 and '10 with 60 watts input. GOJ has resumed schedules on Pine Tree Net and Trunk Line "C." HSE would like some traffic schedules. EF is with the Pan Am. Airways at Port Washington, N. Y. KJJ is working out FB on 28 Mc. as well as 1.75-Mc. phone. DMX is working in Lynn, Mass. IST is all set to go with 802 crystal and 802 final. HWY is DXing on 7 Mc. IBR has moved from Mars Hill to Easton. FQU moved to Caribou. JUV is building new Class B modulator. CPS has fine new rig working 7 Mc. mostly, although can switch quickly to 3.5 and 14 Mc. EFX is building new 1.75-Mc. phone. BX is teaching in the Crosby High School at Belfast and has organized a radio club with about twenty members at the school. KKB is building FB 1.75-Mc. phone. AXJ is with Western Union. DOZ, back on the air with the '52's, has erected a mast 60 feet high. IMD is getting ready to go on 3.9-Mc. phone. JPP is working in New Jersey. FZD is on 3.5 Mc. The traffic season has started, and we hope it will be a successful one for all concerned. Anyone who would like to take part in this activity and has difficulty making schedules in any part of the state, please drop a line to the S.C.M. We would like to increase the number of O.P.S. and O.R.S. in this Section, so let the applications come along. Thanks for the cards and letters received this month. Would like to hear from more of the gang.

Traffic: W1FBJ 55 GOJ 24 CFO 12 HZJ 6.

EASTERN MASSACHUSETTS—SCM, Albert N. Giddis, W1ABG—KH attended Central and Hudson Division Conventions. JCK is now O.R.S. JNF reduced power to 45 watts. IIN reports hearing ES5D at noontime on 14 Mc. JTM challenges ABG for high score in Oct. O.R.S. Party. HKY has new 59-T20-HF100 rig completed. IUQ is now on 7 Mc. WV works 'em while rebuilding. JWT has ANR for a teacher at school. IZL has been on a bicycling trip all summer. JID is melting the plates of a pair of '10's. KTI is working out FB on 3.5 Mc. with 6L6 crystal osc. RE is pur-

chasing an RK-20. KMY is rebuilding in a big way. JZU has gone to Kansas City. FRO is giving up radio. We shall feel the loss keenly. QW is trying to move, stay on the air, install U.S.N.R. rig and work all at the same time! The Merrimack Valley Amateur Radio Club elected officers for the coming year as follows: Pres., BEF; vice-pres., JMW; secy., JJE; treas., HXE; act. mgr., ABG. Well, gang, from now on we will have a new "boss" in the Eastern Massachusetts Section, Sam D. Gross, W1WVC, of Marshfield Hills. I feel that the leadership of our Section has fallen into capable hands. However, all his efforts will go for naught if you do not "pitch in" and do your part. Send him your reports regularly and on time. He will do more than his share . . . it's up to you to do yours. 88 fm "AL."

Traffic: W1AKS 217 (WLG0 223) KH 154 INA 143 EMG 100 JCK 40 HWE 38 JNF 34 (WLG1 14) IIN 11 ASI 19 ABG 11 JTM 6 HKY 2.

WESTERN MASSACHUSETTS—SCM, William J. Barrett, W1JAH—ZB raised total countries worked to 110, the new ones being HZ5NI, YS2B, XU8AZ and VQ8AE. IOT is active on A.A.R.S. Net. AJ is building 3.5-Mc. rig for local traffic, using 7 Mc. for schedule with NY1AA. 3FXZ/1 keeps daily schedule with K6NXD and offers to QSP any K6 traffic direct. IOR has 350 watts input now. Ex-W1IDG now signs 3GZH at new QTH in Wilmington, Del. JAH visited S.C.M.'s BFT and ABG. IEI reports KOS new ham in Willimansett. ISN is revamping rig and shack. COI had visit from BGY. KJK is new O.R.S. How about some more of you fellows applying for appointments? BVR is giving his UHX-10 a workout these days. BKG and HNE say that traffic will move this year in Berkshire County. Remember, gang, one station or a dozen stations doesn't make a Section—it takes a little help from everyone, so how about doing your share? KRY is ex-W2KIS and will be on 7 Mc. soon.

Traffic: W1WZ 103 IOT 89 (WLG3 36) AJ 75 IOR 56 JAH 12 DUZ-IZW 6 IEL-AJD 2 W3FXZ/1 58.

NEW HAMPSHIRE—SCM, Carl B. Evans, W1BFT—The N. H. State Traffic Net is now functioning at 6:30 to 7:00 p.m. with BFT as control on Mon., Wed., Fri.; GMM as control on Tues., Thurs., Sat.; on 3840 kc. Any and all stations are invited to get in on this. 3800 to 3900 kc. are covered on QRZ's each night. The N. H. Emergency Net functions the first and third Sundays of each month on 3840 kc. at 11:00 a.m. The M.V.A.R.A. held its annual hot-dog and corn roast at Riverhill, and AWU took his initiation into the club. BCT has moved to Leominster, Mass. BGL now has a junior op. Congrats, OM. IIN is operating from N.H.U. this winter. KKT, a newcomer in Milton, is operating on 7086 kc. with 20 watts input. AXL is now located in Claremont and is on 1.7-Mc. phone. FFL has the Army Net going in great style. IDQ has moved to Massachusetts. JKH finally got on 3.5 Mc. with a T-20 final. FCI is looking for schedules beginning Dec. 1st for WX-ski reports. CNX is working for W.A.S. on 'phone and only lacks four states. EDN, IMB, JEH and KBR are all operating at the State Sanatorium and keeping Glendiff on the map.

Traffic: W1FFL 48 (WLG6 30) KIN 44 GHT 17 HGV 13 IDY 12 CME 11 FCI 6 ITF 3 KBU 2 BFT 1.

RHODE ISLAND—SCM, Clayton C. Gordon, W1HRC—GTN has new transmitter with 36 e.c. oscillator and 50-watt final. ETD with the NC101X is working foreigners on 14 Mc. something terrific. BJA tried a doublet for receiving and wonders why he didn't do it years ago. IAV has left Rhode Island for Harvard—there goes an O.R.S. and O.P.S. that reported regularly as a clock. IZO mentions that the N.C.R. is in new quarters and ready for FB season, JNO writes in for an O.R.S./O.P.S. application form. EZW took the Class "A" exam some weeks ago. KTH visited the P.R.A. and met a lot of the boys personally. The P.R.A.'s fall season is well under way, with something doing every Friday night; BIT talked on transformer winding Sept. 24th. HRC vacationed mountain climbing in Presidential Range again this year from 25th to Oct. 2nd.

Traffic: W1LEG 15 GTN 18 HRC 3 ETD 1.

VERMONT—SCM, Alvin H. Battison, W1GNF—AAK and ELR are back on 28-Mc. phone and c.w. AVF feels better after a three-week stay in the hospital. EMQ has returned to Northeastern Univ. DPO reports DQK, GAN, HXC, IDM, JMO, JLF and KNC active on the 1.7-Mc. phone net. DEX is located in Fall River now. BJP, we are happy to report, is once again numbered amongst the O.R.S. CIL has moved from Rutland. AHN's movies of the Hamfest Group came out quite well. ATZ has another new transmitter on 1.7-Mc. phone. IDW worked several DX stations

(Continued on page 104)

Coto

R. F. CHOKES

PERFORMANCE PLUS LOW COST!

10 METERS?
AND HOW!



CI-11 125 m.a. 36¢ net
CI-12 250 m.a. 45¢ net

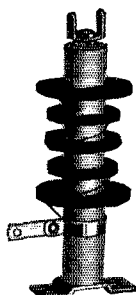

CI-21 75¢ net

See Them at Your Jobber

RADIO



PRODUCTS

COTO-COIL COMPANY Inc.

229 Chapman St., Providence, R. I.

Export address—100 Varick Street, N. Y. C.

American's New DYNAMIC

(High or Low Impedance)

D-5 50 Ohms
List \$27.50

(Both include 25' Cable and Plug)

D-5-T 10,000 Ohms
List \$32.50

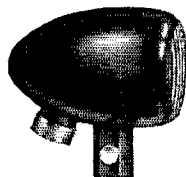

- Rugged
- Excellent Frequency Response
- High Output ● Low Price
- MULTI-PURPOSE

Write for Catalogue on DYNAMIC, CRYSTAL, CARBON, and CONDENSER MICROPHONES, STANDS and ACCESSORIES

AMERICAN MICROPHONE CO., Inc., Ltd.
1915 S. Western, Los Angeles, Cal.

LEARN RADIO

— TELEVISION —

New Beginners' Class Jan. 17th. Send for 48-page catalogue, explains fully, 500 licensed graduates placed in last six years in broadcasting, shipping, police radio, aviation, etc. Oldest, largest and best equipped school in N. E. We teach all branches of radio. Tel. HAN. 8184.

Ten operators placed with Pan-American Airways in one week.

Radio Service Instructions Given

MASS. RADIO SCHOOL
18 Boylston Street, Boston

changes the soft and fragile article into a stone-like and well vitrified mass. Under the microscope tiny crystals of magnesium silicate can be detected in a fired steatite body. These crystals are known as clineonstatite by the mineralogist. These crystals interlock each other and give the high mechanical strength to the body, for which it is so well known. They are also responsible for the high electrical resistance and low dielectric losses of steatite materials.

With the thought in mind that a ceramic material with uniform crystalline structure has the lowest dielectric loss, special steatite materials have been developed with an extremely low power factor over the whole frequency range of the short and ultra-short wave spectrum. Such materials are obtained by carefully selecting the purest raw materials available and by employing unusually high firing temperatures to produce a perfectly uniform crystalline structure.

The great progress which has recently been made through the development of low-loss steatite bodies can be best realized by looking over the property table. These figures show, better than words, why low-loss steatite materials are suitable for radio insulation. Of special advantage is the fact that dielectric losses of steatite materials decrease with increasing frequencies, in contrast to organic insulators.

The softening point of these ceramic materials is way above the temperature range at which the material is used. No cold-flow is, therefore, possible and constancy can be maintained.

One of the very important characteristics of an insulating material is its behavior under humid conditions. One of the most difficult problems is to prevent moisture from affecting the insulating resistance and the dielectric losses of an insulating material. Many well known materials, good under dry conditions, become conductors and, therefore, useless if exposed to the moisture of the air.

If the insulator is porous, moisture penetration will take place through the material. The amount of moisture taken up naturally depends upon the porosity of the material, and the humidity and temperature of the surrounding air. To regain the former insulating qualities, it is necessary to dry out the insulator. This is a very slow process and usually it takes a considerable rise in temperature to dry out a porous insulator which has absorbed moisture. Moreover, some insulators, such as mica and organic resins, do not regain their original qualities, even after thorough drying.

Steatite materials which are completely vitrified cannot absorb moisture. It is, however, possible that moisture may condense on the surface of the insulator, forming a continuous moisture film which reduces the surface resistance if it is not broken up into small globules, separated and insulated from each other. Surface leakage through moisture can be overcome by glazing the insulator with a smooth and brilliant glaze. In some cases, and especially where the insulator cannot be glazed all over, it is better to impregnate with a water-repellant wax or varnish. The

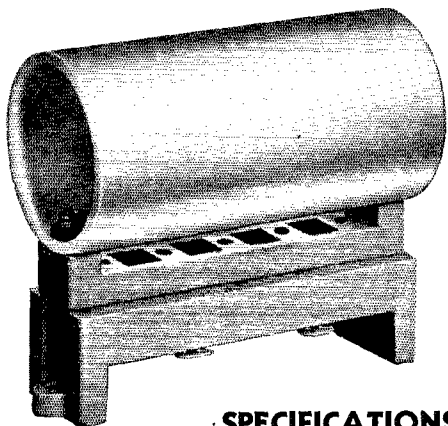

BUFFER COIL FORM

The Buffer Coil Form Assembly illustrated at the left is both versatile and efficient. The Coil Form is drilled for leads and may be used alone, mounted on stand-off insulators. The Coil Plug also may be used alone as a base for self-supported coils. Construction throughout is of low-loss material, and contacts are rugged and positive.

SPECIFICATIONS

The Isolantite Coil Form is 1 3/4" diameter x 3 1/2" long. The base shown at the right is of R-39, and has five prongs with heavy side-wipe contacts.

UR-13, Assembly complete, **\$1.50** PB-5, Plug only **\$.45**

XR-13, Coil Form only **\$.66** XB-5, Socket only **\$.45**

Prices shown above are net prices

NATIONAL COMPANY, INC., MALDEN, MASS.

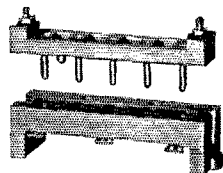

TEMCO

100-WATT TRANSMITTER IDEAL FOR HAM OR BEGINNER

1. High power, Design, Engineering, Parts, Construction and operation at Low Power Cost.
2. The identical superlative skill in design, care in construction and the same quality parts which have made famous the Temco High Powered transmitters now operating in the field, are embodied in the Temco 100 Watts.
3. Extremely liberal dealer time payment plans bring this x'mtr within the purchase power of your pocketbook . . . the initial payment, in fact, is as low as the price of most cheap, unassembled, low power kits.

● A post card will bring you a detailed description of the "100", our unusual finance plan and the name of your nearest dealer.

- 100 Watts output.
- Band Switching exciter from 10-200 meters.
- Remote and panel control with simplified tuning.

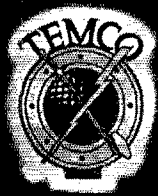
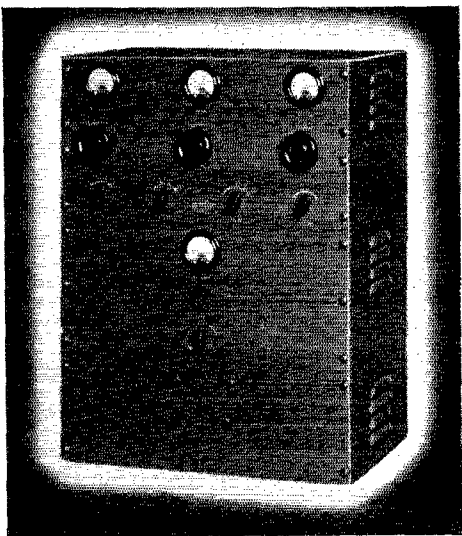

Transmitter Equipment Manufacturing Co., INC.

130 CEDAR STREET • NEW YORK, N. Y.

Designers and Manufacturers of Radio Transmitting and Accessory Equipment

(Continued from page 101)

on 14-Mc. 'phone. GAN is banded up from a recent automobile crash. AHN is a new O.P.S. HOW has again succumbed to the radio fever. JHK operated two weeks for the R.R. at Windsor. FSV has a new Deluxe MacKey. KJG is rebuilding. IZM is building a log cabin "radio shack." N2JBL is attending Middlebury College.

Traffic: W1AVP 14 FSV 8 GNF 5 AHN-DPO 4 KJG 3.

HUDSON DIVISION

EASTERN NEW YORK—SCM, Robert E. Haight, W2LU—LU is on with new rack job: 59-10, 211 final. UL and CL plan trip to visit VE1DC and VE1JD. CC keeps Scarsdale covered. BLU reports GTW home from sea. GXM is trying for DX on 56 Mc. BLU is pushing 100 watts into a T20. HCM attended Hudson Div. Convention. HNH is rebuilding for "click click" band switching, 14, 7, 3.5 Mcs. ACB is building crystalizer 100 kc. and 2000 kc. for checking frequencies for the boys. IJT and KMC are active on 56 Mc. FQH and CYW attended Horsestraders meeting. JRX is using crystal on 56 Mc. KLW, KMC and CYW contacted 1DGS portable on Lebanon Mt. KQO, a new ham, reports for local gang. DPM has new RME-69. JKA puts out nice signal on 56 Mc. with pair of '45's P.P. final. AJE and DVS plan QRM for 3.9-Mc. 'phone boys. KFB is using 6A6 osc.-doubler on 3723 kc. with 20 watts input. KOI is new ham on 1.75-Mc. 'phone. Flash! HUM brings to Ham Radio a new member, Mrs. Henry Osterhoudt. Congratulations and may all the little ones be HUM's. ISQ, now at Military Academy, Culver, Ind., would like to hear from the boys.

Traffic: W2LU 51 UL 34 BLL 11 CC 7.

NEW YORK CITY AND LONG ISLAND—SCM, Ed. L. Baunach, W2AZV—IXY is O.P.S. and O.B.S. on 14, 176 kcs. IYR is out for O.R.S. appointment. JBL is going to Middlebury College. HMJ has his Class "A" ticket. ECL is working the VK's plenty. IOP is trying 'phone. LG says he is going to get a "G" call if he keeps on going to England any more. FZ is building a rig for HXT using band switching. ELK can be heard on all bands. JGF is on 14-Mc. 'phone with a 35T, 100 watts input. OQ is using 89 tri-tet, 802 buffer, 211 final on 3710 kcs. JWE is rebuilding for 14 and 28 Mcs. HKY is going to R.C.A. Institute. ITX is looking for stations in N.Y.C. to schedule from Lehigh University. JXX is experimenting with the reflection of ultra-high frequencies. DOG schedules 8CQA. PF is busy recruiting new A.A.R.S. members. FF is erecting new beam antenna. KRG is new call of 3DQO at Jericho. EYS is on 3710 kcs. JHB is building a one tuning dial transmitter using 6L6 e.c. and RK48. IXQ has given up DX for 1.75-Mc. 'phone. IUD and ION have 14-Mc. beam antennas. JDF rebuilt the r.f. part of his transmitter. Portable 1AA in Brooklyn is having trouble getting enough drive for his 100TH's on 28 Mc. AZV works all night and spends all day in the shack. KIX is using 6L6 tri-tet, 6L6 doubler, pair of tens final on 3.5 Mc. APJ keeps the 56-Mc. band hot. DBQ handled some FB traffic from Shanghai for people in N.Y.C. HGO held a 4-hour-13-minute QSO with 1KVP, Sept. 1st, on 7096 kcs. IHT worked 17 countries in one month using P.P. 6L6's with 100 watts input, Johnson Q antenna on 14 Mc. VG operates on 3567 kcs.

Traffic: W2PF 130 AZV 40 DBQ 29 OQ 28 FF 25 IHT 19 HGO 15 INF 14 JHB 10 IOP-CHK 5 JBL-HYL-BYL-HMJ 4 DQW 3 JXX-AA-CIT 2 VG-DOG 1.

NORTHERN NEW JERSEY—SCM, Fred C. Read, W2GMN—BCX has new rig with about 400 watts input, and is all set for big traffic season; he can work 'phone now, too. IOZ is a new member of the Rag Chewers Club. IVJ is back on 3.5 Mc. JGO has new QTH. EDI and IGR made trip to Wyoming. CHH will be on 3.5-Mc. c.w. during the winter. FXE hopes to be back with 14-Mc. 'phone soon. GVZ has contacted 92 countries to date. KKO and HFB visited Headquarters. JVC dropped a pair of pliers into his rig and blew it up. JMX visited several fellows in Western Mass. JUC is anxious to work DX on 3.5-Mc. c.w. KON is new 1.7-Mc. 'phone at Nutley. BPK is back on 1.7 Mc. with new rig. KDO has been building new transmitter. JKG needs only four states for W.A.S. HNA is prospective O.P.S. 4CXF, member of the Winston-Salem Radio Club, spent several days visiting GMN and seeing New York. IYG is attending Brooklyn Poly. Tech. HNP is studying at Newark College of Engineering. SUICH of Cairo, Egypt, and his XYL were visitors of GIZ in Elizabeth. GDB will be on soon with new rack and panel outfit. ICD is gathering parts for new rig.

Traffic: W2BCX 33 CGG 9 JUC 7 IZV-ICJ 4 GVZ-JMX 2.

ROANOKE DIVISION

NORTH CAROLINA—SCM, H. S. Carter, W4OG—I want to take this opportunity to thank the Richmond gang for a swell time at the convention. The Salisbury Club is looking for a large crowd for the hamfest the first Sunday in November. EXX and EYA are new hams. EXU is the call of the radio club. DSM has a 5-band All-Star transmitter. DOU has entered N. C. State College. VN is working for the N. C. State Highway Patrol installing transmitters and receivers. One of BHR's 100TH's "burstled." CXO has a T55 going swell on 14 Mc.; he has two new 50-foot poles. ENH is putting up two new poles. ESO has a new receiver and is going on 3.5 Mc. with increased power. ESB rebuilt his rig. CEL moved to Greenville, S. C. Sorry to see you go, OM. EG is rebuilding in rack and panel, and has a kw. power amplifier for sale. FT says 28 Mc. is FB now. BQZ applied for O.P.S.; he is running 500 watts input on 14 Mc. BJV is installing the N.C.R. rig in the new Post Office Building. BRK is able to be out again after his operation. FB, OM. EWP is an ex-9 and will be on with about 400 watts input to a pair of '03A's. CPT has loaned his RK-20 rig to the N.C.R. for use to guard an additional frequency. 4NC has a new NC100X receiver; all but four of the club members attended the Richmond Convention. DVU purchased a complete 'phone rig and will be on 1.75 Mc. soon. DGV worked K6CMC, also his first W7 on 'phone. BYA had as visitors DQ and AGF who did some experimenting with 56-Mc. rigs they brought along; they were able to contact as far as Walkertown and Kernersville with ease. 3PM is now located in Winston-Salem. BYA reports some nice traffic for ANU, also for DXW who is working 3.9-Mc. 'phone with fine results. DZZ has Class A ticket and is getting ready for 3.9-Mc. work. EYH received a brand-new ticket and expects to be on 7 Mc. soon. Fellows, don't forget your reports each month. The P.A.M.'s or R.M.'s will be glad to report for you if you don't report direct to me. 73.

Traffic: W4ANU 18 ABT 10 NC 5 BHR 4 QI 2 CXO-DGV 1.

SOUTH CAROLINA—SCM, Ted Ferguson, W4BQE—I am proud to be your new S.C.M. and I assure you I will do my best. BDT, working 3.5 Mc. 7 to 8 p.m. each night, is looking for S. C. stations. ECG has new Sky Challenger. DYC reports that BCN, COL, CZP, DYC, MJ have changed QTH to Clemson College, that EPU and EQH are new hams, and new club officers are COL, pres., and BCN, v.-pres. EOP has new transmitter and wants 7-Mc. schedules. CZA reports schedules Mon., Wed. and Fri. with IR. EPJ is back on the air. DQY is rebuilding using 100TH. EDQ is working 14-Mc. c.w. DX. CL is ready for 28, 14 and 3.5-Mc. 'phone. DLP is back on the air with his '52's. EOG works 7-Mc. c.w. and 1.75-Mc. 'phone. ENR is back in Anderson. The South Carolina hams attending the Roanoke Division Convention were DQY "Stag," CE, CUS and BQE with their XYLs; all had a nice time.

Traffic: W4EOP 5 CZA 3.

VIRGINIA—SCM Charles M. Waff, Jr., W3UVA—FQQ passed Radiophone First Class exam. BTR is using P.P. T-20's with 80 watts. GBK is experimenting with a T-55. CFV is on 1.7 and 7 Mc. CZJ is rebuilding. BLE is active on 7 and 14 Mc. BRD uses 1987 kc. GJP won RME-69 at Roanoke Convention. FGJ is putting in a new Modulation transformer. BWA went with Va. Nat. Guard to Indian Town Gap, Penna. BFW got his receiver going again. FMY schedules AIJ weekly. BZE, who has been on 14 Mc. exclusively, is now expanding to include 7 and 3.5 Mc. ENR will attend V.P.I. GGI works some DX over the week-ends; he'll be on 14 and 56-Mc. 'phone soon. ASK has been working some nice DX and experimenting with 14-Mc. antennas. UVA will have a 2nd op. in a few months in the form of an XYL. DWE is building masts for 3.5 and 14-Mc. 'phone operation this winter. GWN is the call of the Staunton Amateur Radio Club. BAD has one FB outfit, what with P.P. 805's final modulated by 838's Class B (500 watts 'phone and 750 watts c.w.), an oscilloscope, an HRO, and a Johnson Q antenna. BZ has a new 28-Mc. rig and has five antennas at his disposal. EVT was visited by 6KRI. AMB is modulating an RK-20 final on 3.7-Mc. 'phone. Richmond Short Wave Club meets every other Friday at Y.M.C.A. What city will extend an invitation to entertain the next meeting of the VIRGINIA FLOATING RADIO CLUB? Write the S.C.M. GPC is new Trunk Line "C" appointee. The Roanoke Division Convention had an attendance of over 300, which broke all records for this Division. The Richmond gang deserves many thanks for putting on such a fine convention. With the approach of winter activity increases. Will

your reports also increase? Your cooperation will be appreciated. Thanks.

Traffic: W3BWA 345 CFV 26 FMY 6 GJP 4 GGI 1 GTS 49 (WLMG 79) (WLQE 41).

WEST VIRGINIA—SCM C. S. Hoffmann, Jr., W8HD-W8NS—I was very sorry to see W8KKG leave the SCMSHIP, and wish to congratulate him for his splendid work. Thanks to the Radio Clubs for their flattering letters and nominations to the post, and I hope my fifth term as S.C.M. will be successful and that in it the A.R.R.L. spirit will grow. Now for the news: Director W4DW made a trip through the State, visiting clubs in Bluefield, Huntington, Charleston and Wheeling. The gang were enthusiastic in their reception and very proud to have him. New R.M. for Northern District: 8OLV; he will assist 8MCL, Southern District R.M., in organizing an A.R.R.L. West Virginia Net on 3700 kcs. Your applications solicited. BOW got a job in Greensburg. AAO moved to Canton. ELO and OSU married. Congrats, OM's. REP is new station in Mounts-ville. RDC is new Romney station. REH is new Fairmont ham. NEU has new Skyrider and Johnson Q antenna. GBF has two 250TH's in final. The Mountaineer Amateur Radio Assn. had picnic Aug. 15th. New O.R.S. applicants: BWK, LCN, NAU. New W.A.S.: LCN. BWK is back on 3.5 Mc. after three years' absence. KLP and 9CEE are at BC station WBLK. Ex-SALG-8IB, George Meek, back home from operating on New York-Shanghai and Ceylon steamer, reports being able to hear KKG all over the world, and AZD second in consistency! KSJ ("Sr") is building new 28-56 Mc. transmitter. KIU schedules VO11 and WIOXDA. ONP plans schedule with QBS at C.C.C. Camp. MOL has new Patterson receiver. QOZ and KEB live next door to each other. Hil QOZ visited ATT and 3GCD. Black Diamond Radio Club (Logan) has a log cabin in the mountains for club house; they are building a 1-kw. transmitter; PNE is pres., QOZ secy., LGB treas. NLE, OHW and REP returned from course at Naval Training Base. MCL is now Ensign in N.C.R. KCB has new vertical radiator on 7 Mc.

Traffic: W8LCN 7 BWK 2 KIU 20 PHY 5 KSJ 1 MOL 4 NAU 2.

ATLANTIC DIVISION

EASTERN PENNSYLVANIA—SCM, John Buck Morgan, W3QP—R.M.'s: 3AKB, 3AQN, 3EOP, 3ASW. P.A.M.: 3EOZ. 3EZ won the Main Line Radio Club's hidden transmitter hunt. 3AKB is delivering one-day-old traffic from XU, KA and K5. The A.A.R.S. lines are doing a swell job soothing worried relatives and friends in the Far East. 3PCL is now both N.C.R. and A.A.R.S. 3EWW has rebuilt his receiver. 8EU has a new 3.5-Mc. full-wave zep with one end in a graveyard for raising DX Spirits around midnight! 3ECA visited a flock of W2's over the summer. 3FPW has completely rebuilt. 3BGD is working lots of VK and ZL stations, and 3BRZ is 'phoning them with excellent results on his new Vee Beam. 8DHT returns to the ranks after 5 years, and 8OML, 3GUD and 2ITX/3 are back. 3IU says he was "hostess" to the York Road Radio Club recently at a very interesting combined meeting and doggie roast held at his "Hams Paradise." Hams in this Section who want to see how it can be done, stop in to see 3IU's layout. 3GJX is now on high power—Cal-kil, eh-what? 3GXX is goin' to town on 28 Mc. 3GKF has a pair of new HF-100's. 8PTE, 8MAH, 8EOH, 8CPL and 8NWV went to Binghamton Hamfest and heard some fine talks on A.A.R.S. work. 8NWV won the HRO Jr. door prize. 8BFF works everything with his new 14-Mc. rig. 8OHT blew his power transformer, and the \$28 bottle of Eight-mike Miller (8MFD to you) went west when an air bubble in the glass popped. 8PTE, who helps the S. & N. Y. R. R. to prevent its snorting monsters from charging each other, sent us a fine write-up of the up-state doings of the Section.

Traffic: W8EDC 6 NF 101 (WLML 533) EZ 2 QP 206 AKB 18 EHZ 7 AGK 4 AQN 4 ETA 3 ETM 25 ECA 27 FPW 18 BGD 3 GLQ 1 W8AXH 3 PCL 10 ASW 4 FLA 2 DHT 15 OML 5.

MARYLAND-DELAWARE-DISTRICT OF COLUMBIA—SCM, E. L. Hudson, W3BAK—3CQS, 3CXL; R.M.'s. 3BWT: Chief R.M. After a couple months of well-earned vacation BWT, Washington's foremost traffic station, is back on the air after rebuilding and remodeling his shack. Washington's hams turned out in grand style at the Roanoke Convention in Richmond. DLC is back on the air.

The Washington Radio Club resumed business Sept. 11th. EZN wishes to serve notice to all hams in the vicinity of Wash'n that all their friends will be found at the club on meeting nights. EZN is back on the air. BWT has been rebuilding. BHE is working 3.9-Mc. 'phone. BAK is doing some rebuilding. DRE is building another amplifier stage. DOG is testing out new receivers. AXP has returned to the Penna. Military College, and will resume his schedules with the OM, BAK, at home. DQN/WLMC handled about half of CXL/WLM schedules during the Aug.-Sept. month.

Traffic: W3DQN 294 (WLMC 971) CXL 85 (WLM 1010) SN 316 CIZ 276 GKZ 4 GXO 3 FSP 2.

SOUTHERN NEW JERSEY—SCM, W. Walter Filson, W3BEI—There is room for more good traffic men in the So. N. J. Section in order to give sufficient coverage for the net in the Section. EKL of Pitman breaks out with a brand-new rig on all bands, both 'phone and c.w., a 242B final. HAV is newly licensed ham in Runnemede. ZX is having mast trouble with a 50-foot-er. BEI, along with ZX, is still keeping schedules with K4ENY. The So. Jersey Net got under way again on Sept. 25th. Regular net sessions on 3700 kc. Tues., Thurs. and Sat. at 7:15 p.m. Net control station 3BEI and later 3QL and 3BYR.

Traffic: W3AEJ 7 BEI 4.

WESTERN NEW YORK—SCM, Chas. F. Smith, W8DSS—R.M.'s: 8JTT, 8BJO, 8CSE, 8AQE. P.A.M.: 8CGU. PLA starts the season in fine style by leading the traffic gang. LIUQ spends a lot of time rag-chewing. DHC, QDP and LGH have joined the W. N. Y.-1 Net. PFM, CSE, LGH, DPPZ, CGU, QHX and NWZ had a fine time at Binghamton Hamfest. GWT, after experimenting for many weeks, is now ready to get on consistently. BFG and KXA want to get in on the 7-Mc. Net suggested by CSE. All interested, please drop him a line at once. JQE is on with increased power. KXA reports EOP has gone to Gowanda State Hospital, and JSR moved to Geneva. QHX was visited by W3GBC. QMR (Zeh Bouck) passed O.R.S. test and also was appointed Official Observer. LGH, PWU and QXS, Oswego, Avon and Seneca Castle respectively, have applied for O.R.S. MMV and NA passed O.P.S. test. QDP and ABN are lining up some nice schedules. The former also expects to make daily broadcasts to MJV and JFF, who will be away at college. All O.R.S. and O.P.S. are obligated to report monthly. Failure to do this is going to cause a lot of cancellations in the near future. Let's get going. FCG sends best wishes to ye S.C.M. and promises full cooperation during the coming season. 73.

Traffic: W8PLA 44 LUQ 3 QHX 2 DHU-QDP 1.

WESTERN PENNSYLVANIA—SCM, Kendall Speer, Jr., W8OFO—R.M.'s: 8KUN, 8KWA, 8MOT. P.A.M.: 8QNQ. A.A.R.S. Liaison R.M.: 8UK. N.C.R. Liaison R.M.: 8KOB. New O.R.S.: GSH, OKS, 4BOU-8. Prospective O.R.S.: 8DFY; O.P.S.: CQE. The two O.R.S. Section Nets are going strong. The Northwest Net consists of: MOT, KUN, IOH, DDC, AXD, KOB and KNB. The Southwest Net consists of: OFO, KWA, MJK, GUF, MIW, UK, CUG, GSH and OKS. R.M. KUN acts as link between both nets. DON'T FAIL TO TAKE PART IN THE W. PA. QSO CONTEST. See September QST for details. Prizes are rolling in, and it looks like they will exceed the Sixty Dollars worth awarded last season. OFO worked his first ZT, ON and HK. KOB made the R.C.C. OKS usés his O.R.S. crystal in a trick lock circuit which works FB. KWA will be active on National Trunk Net as well as regular Trunk Line "A." NDE says the Humdinger Net is going strong again. DDC is teletype operator at the Butler State Police Barracks. IOH alternates operating nights with his brother, IOI, who uses an RK-20 suppressor grid modulated. MIW was with the American Legion at the New York Convention. MWV has a new rig. The N.C.R. Unit at Farrell is all steamed up for another big year. OAJ is on 28 Mc. 'phone. IYQ wants to sell his oscilloscope. MUT is pleased with Skyrider he won at the S.H.B.P. & M. Hamfest. FRC is now on the Engineering Staff of KDKA. QAN received a fine promotion with his firm which may limit some of his radio activities. CMP made two round trips to the West Coast this summer with many side trips; quite a few conventions and gatherings were attended. UK is building a complete new rig using a pair of T55's in final.

Traffic: W8MOT 391 OFO 108 (WLQU 11) KOB 77 (BD4C 7) PFW 59 GBC 42 KUN 41 OKS 40 KWA 18 NDE 16 DDC 10 UK 8 IOH-MJK 7 GSH-QVQ 3 AXD 2.

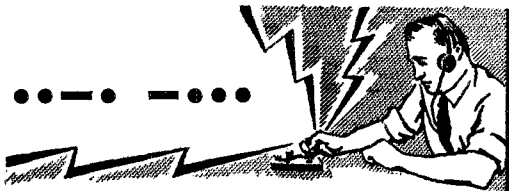

WE STAND ON YOUR RECORD!

Our record isn't as important as YOURS with your present or future employer. If you had enrolled with us two years ago *69% of you would have been promoted to better jobs after graduation . . . more than 260 radio stations would now be employing you and other CREI men in important positions. TODAY — even greater opportunities await the man with adequate MODERN training. If you've been wondering what it's all about — get the answer in our interesting "Tested Plan."

* From graduate surveys



E. H. Rietzke, Pres.

Write Today for our Free 48-page Booklet "A Tested Plan for a Future in Practical Radio Engineering."

CAPITOL RADIO ENGINEERING INSTITUTE

WASHINGTON, D. C. Dept. NEW YORK CITY
14th and Park Road Q-11 29 Broadway



AMERICAN CODE READER

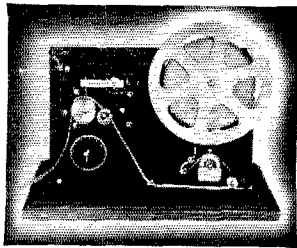

A THREE-PURPOSE DEVICE EVERY HAM AND BEGINNER NEEDS

The American Code Reader does three things and does them well! 1. Connected to voice coil leads in the receiver it will catch code as fast as it is thrown at you. No need to depend upon the ear alone. 2. Used with the American Audio Oscillator the beginner can see and hear his fist at the same time thus correcting and improving it as he goes along. 3. A telegraph key connected in series with a 4.5 v. dry cell may be connected to the input of the Code Reader for personal tape recordings, a boon to the beginner who does not want to be limited to 10 wpm in his sending.

Get all the facts thru your jobber or direct from us. List price, less tube (1-76) \$20

AMERICAN COMMUNICATIONS CORP.
1650 Broadway, Dept. Q-11, New York, N.Y.

most effective waxes are mineral waxes of low acidity. Waxes with low dielectric losses are available which do not change the good dielectric properties of the insulator. Ceresin wax is widely used for this purpose. The insulator is heated up to the melting point of the wax, dipped into the molten wax and the superfluous wax thrown off by centrifuging. This gives an even and thin coating which is not noticeable to the eye, but an impregnated insulator can be easily distinguished from an unimpregnated one by putting a drop of water on the surface. The water spreads over the surface of the unimpregnated material.

Steatite insulators, and especially those of the low-loss type, have found wide application and are used to advantage in many receivers and transmitters. The introduction of low-loss steatite materials has led to the improved construction of coaxial cables, bases of trimmer condensers, high-quality tube sockets, crystal holders, end plates for air tuning condensers, bases for air inductors and a variety of coil forms. There is hardly any insulating part in a radio set which cannot be made out of these low-loss materials. They are applicable wherever rigid construction is essential and where high electrical resistivity and low dielectric losses are important requirements.

Making the Most of Directive Antennas

(Continued from page 87)

When first putting up these antennas the lot plot was used to determine true north; without correction, a compass is practically valueless.² With this as a basis, and using long straight sticks and protractors laid on the ground, the original antennas were put up. Although they were working satisfactorily, after about a year a registered civil engineer was employed to locate the poles with respect to true north and also to locate the trees, swing and other places where the antennas were fastened. A sight on the sun was also taken so that an exact base line could be established on the side of the lot. When the work was finished it was discovered that the New York antenna was 1½ degrees out of line. Originally intended to hit two degrees north of New York so it would also be effective in southern New England, it was actually 3½ degrees north of New York, so that the 5-degree part of the beam cut out some of the twenty-meter 'phones in the greater New York area. They simply were not as good as they were when the antenna was corrected for this degree and a half. Ever since it has functioned exactly as planned, and the survey was well worth while.

CROSSTALK

There are nine feed lines coming into the radio rooms—eighteen wires in all—accordingly there would be some coupling into the wrong antenna if certain precautions were not taken. These precau-

² Alternatively, a bearing may be taken on the Pole Star, or from the sun at noon as described elsewhere in this issue.

DON'T KICK AND HOLLER Be Wise — KENYONIZE

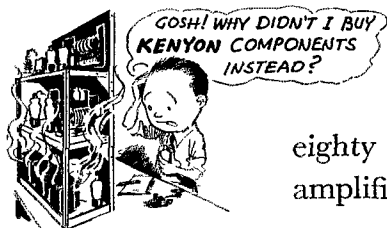

Ask your local jobber to show you the new Amateur line of audio and power components. One hundred and eighty different items ranging from small pre-amplifiers to 1 KW audio components.

Our Universal line of transformers entirely eliminates obsolescence.

KENYON TRANSFORMER CO., INC.

840 Barry Street, New York, N. Y.

Export Department: 25 Warren Street

Cable Address: Simontrice, New York

SPECIAL TO AMATEURS

Piezo-Electric Crystals — \$2.50 EACH POSTPAID

Until supply is exhausted . . . we offer 80 meter band crystals unmounted; accurate calibration, excellent oscillators. Limited quantity.

SCIENTIFIC RADIO SERVICE

"The Crystal Specialists Since 1925." University Park, Hyattsville, Md.

110 VOLTS AC

Anytime! Anywhere! With **KATOLIGHT PLANTS**

850 Watts AC and 6 Volts DC . . . \$ 89.60

550 Watts AC and 6 Volts DC . . . 220.00

1000 Watts AC and 18-32 Volts DC . . . 234.00

Portable—Self-Cranking

Ask for Special Discount to Amateurs

800 watt 110 v. AC Generator only \$19.95

6, 12, 22 and 110 volt Rotary Converters.

AC/DC and DC Generators, Etc., etc.

Write for Details

KATO ENGINEERING COMPANY

Mankato, Minnesota, U.S.A.

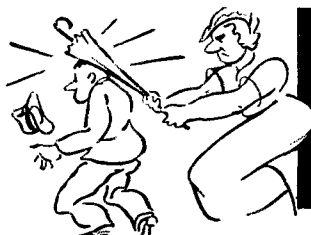
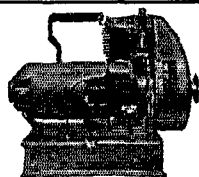

reduce
or increase
resistance
with
**ADJUSTOHM
RESISTORS**

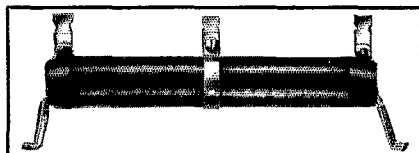

THE adjustable band permits connection to include only the number of turns desired to obtain the correct resistance. Simple and convenient. Gives unlimited scope in balancing circuits. Described in circular 507. Send for it.

WARD LEONARD ELECTRIC COMPANY

41 South Street, Mount Vernon, New York
Please send me FREE copy of 507 and 507B.

Name

Address

City State

Call Signal

LEARN CODE RIGHT

Tapes for Every Need — Even Airways — Send You Typical Messages by **INSTRUCTOGRAPH**

It's easy and practical to learn or improve your Radio or Morse Code, any speed. Senior model with 10 tapes and Book of Instructions — \$20.25. (Rented at low cost) Junior model with 5 tapes and Book of Instructions — \$12.00. (Not rented). Complete oscillator equipment, less battery, \$6.50. Write for details today.

INSTRUCTOGRAPH CO., Dept. Q-11
912 Lakeside Place Chicago, Ill.
Radio College of Canada
853 Bay St., Toronto



BUY ON CASH OR TERMS: HALLICRAFTER AND R.M. E. SHORT WAVE RECEIVERS, SPEED-X AND VIBRO-PLEXES, Telegraph Instruments and Hand Books.

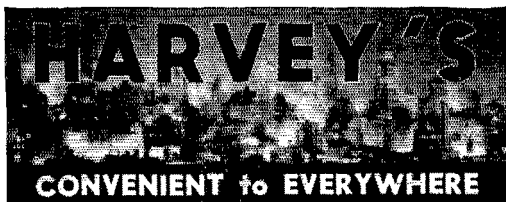

TAYLOR T-20, T-55 TRANSMITTER KITS

This very fine transmitter is the first medium power rig that will work as efficiently on 160 meters as on 10. This is made possible through a unique arrangement used by Earl Anderson, whereby the split stator condenser is used in a parallel arrangement on 160 meters and in series on the high frequency bands. All this is accomplished in the base arrangement of the plugs. Since insulation plays an important part in high frequency operation, only the best quality parts are used in this transmitter.

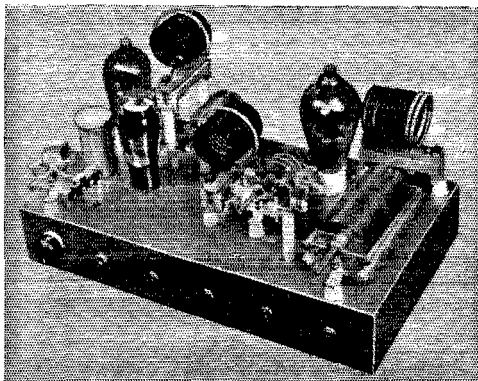

We furnish CARDWELL condensers, NATIONAL coil forms and sockets, UTC transformers, IRC insulated resistors, SANGAMO and CORNELL-DUBILIER condensers, a drilled and punched black crackle chassis (so that all the hard work is finished, and all that remains is a few hours of simple wiring.)

We also furnish a complete kit of coil forms and wire, exactly as shown on page 23 of the June, 1937, issue of QST. The power supply for the T-55 stage is made to deliver as high as 1300 volts at 300 ma. This allows for the addition of another T-55 at some future time. The power supply has a tapped arrangement for 850 volts, 1060 volts or 1300 volts. The smaller supply will deliver 500 volts at 200 ma.

NET PRICES

Transmitter kit...	\$39.95	Taylor T-55.....	\$8.00
Power supply kit..	18.95	Taylor 866 Jr.....	1.00
Low voltage kit...	9.95	RCA 6L6.....	1.35
Taylor T-20.....	2.45	RCA 83.....	.96

OUR *Best* VALUE IS OUR RECORD OF LOYAL SERVICE

HARVEY

Radio Company of New York

103 WEST 43rd STREET • NEW YORK, N. Y.

CABLE ADDRESS: "HARADIO"

tions were lightly touched in the first part of this article and consist mainly of lengthening or shortening the feed line going to an antenna which continues to function when not connected. It is easy to tell whether an antenna is working or not because signals from that direction come in on the receiver, even though the antenna is not connected. In other words, if when listening on the New York antenna unduly strong signals are heard from Cuba, the length of the feed line going to the Cuban antenna is altered until the antenna resumes its normal oblivion. The slight interaction which no doubt exists is just enough so that when listening on one antenna the most prominent amateurs in the other directions can be heard.

We pointed out above that eighteen wires come in, and this naturally brings up the question of what to do about lightning protection. A gap from each feed line to ground is placed at the window entrance. When lightning comes along the energy is drained through the gaps to ground and the antenna system acts as a lightning arrester for the entire neighborhood. In an open field within two miles of the house a man was killed last year while hoeing in his garden, yet during a lightning storm W6AM keeps right on operating and the little gaps jump and look like a Christmas tree in the window. If it were necessary to throw eighteen lightning switches I am afraid the lightning would hit before we could get around to finishing the job.

The little gaps can be set up pretty close—about a sixteenth of an inch—since the feed lines have very little voltage on them at 600 ohms impedance. The ground wires are large—larger than the antenna lead-ins themselves.

We sincerely hope that this little story will encourage other amateurs to put up as many directive antennas as they possibly can. The single-wire feed-line type should not be used because of interaction between antennas, but aside from this precaution we have come to the conclusion that just about as many antennas as a fellow cares to use can be put up on one lot. Several years ago there were fourteen originating from this one station. They were spread out a little more in those days, but made a very satisfactory array.

The more directive antennas that are put up the greater the enjoyment of amateur radio, the more reliable the communication and the less interference caused to stations not in the line of transmission. This means that the amateur with beam antennas is trying to be just as courteous as possible, for in addition to using only one frequency, he uses just the particular slice of air in which he is most interested at the moment.

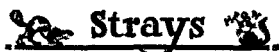

We neglected to mention, in the story on page 45 of the September issue, that the 888 is an RCA tube. No doubt most readers guessed it from the number. Incidentally, the now-released operating data rate the tube at 550 watts output at 200 megacycles.

The RADIO SHACK

46 Brattle St Boston

MORE GOOD HAM NEWS ★ ★ ★ ★ ★

MORE good ham news means further savings and better hamgear. The supply of 40 M xtals at 99 cents is running low. Our offer of Kenco still holds. Remember we also carry the latest standard radio material in stock.

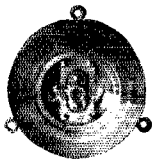

Broadcast Quality DB Mike and Trans. for \$4.95 ★

This Kellogg 501 microphone and transformer was formerly sold to broadcast stations at \$90.00. It's a stretched diaphragm, chamber damped, heavy machined job advertised by Kellogg "practically an equal amplitude from 50 cycles to 5000 cycles." The Kellogg 900 transformer is added for your convenience.

Guaranteed Tobe Micranol 2000 volt, 2 mfd. for \$2.45 ★

We apologize for holding out on the new Tobe Micranols. This Tobe 2 mfd. condenser has been tested and held at 17,000 volts so we feel that an unconditional guarantee is warranted for ham use. We will replace or make a refund on any Tobe Micranol 2 mfd. condenser we sell that has failed in a ham set.

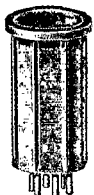

Coto Coil Forms 13c ★

Real receiver and buffer coil forms:

- 4 prong standard
- 5 prong standard
- 6 prong standard

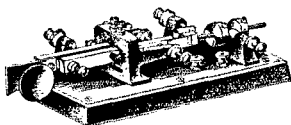

Your opportunity to secure an automatic key still holds—with your money back if you don't like it after one week.....\$3.45 ★

40 Meter X cut 99c ★ 7200 to 7500 kc

Orders from near and far for these fb unmounted xtals made by nationally known mfr. — will exhaust our supply by Xmas.

TAYLOR MORE WATTS PER \$\$\$

T20	\$2.45	TZ20.....	\$2.45
T55	\$8.00	203Z.....	\$8.50
T125	\$13.50	866 Jr.'s..	\$1.00
T200	\$21.50	866.....	\$1.50

BLILEY POWER CRYSTALS

LD2.....	\$4.80	VF1.....	\$7.50
BC3. Now.....	\$3.35		
HF2 — 10 & 20M.....	\$5.75		

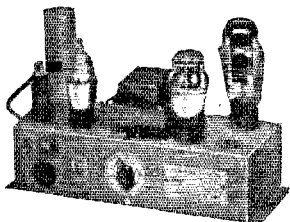

CD

WET ELECTROLYTICS

8 mfd. 475 V.....	30c
16 mfd. 475 V.....	49c

Bassett Concentric

50, 75 and 100 ft. 1 kw cable. Also new low power cable 16c per ft.

OHMITE

RESISTORS & BAND SWITCHES

From the 1 watt to the 200 watt, with slider taps and the famous band switches for 3 and 5 bands in stock.

ALADDIN POLYRON INDUCTANCES

You know those if's that are made for 1,600 Kc and 5,000 Kc as well as standard 175 Kc and 465 Kc types.

See the new HALLICRAFTER SX-16

This is an unusual receiver capable of chasing out those hibernating DX signals. We are told that the SX-16 has "IT" over any other receiver yet produced and it costs less. We'd rather have you decide. You can be sure of factory sharp alignment when buying from The Radio Shack. Allowances on standard receivers and most favorable time payments may be arranged.

Coto Coil Inductors

Have you seen the two sizes, (B and T) which come plain, link, or variable link? The link is in the inside center of the coil where the pickup is best. The mounting material is a slow burning, low loss material — not celluloid.

Special Speech Amplifier (DRIVE OR LOW POWER) MODULATOR

This high gain speech amplifier with 110 volt AC supply tone and mixer controls, will operate from a high impedance microphone including Velotron, crystal or velocity microphone or phonograph pickup, to 500 ohm load at a good 10 watt level. The quality does credit to phonograph records. Its small size makes it convenient to install. Complete, wired, less tubes..... \$19.50

MAIL ORDERS PROMPTLY FILLED—SAVE TIME AT THE SHACK



GORDON NAME PLATES

ANTENNA TUNING

A complete line of 106 beautiful, chromium plated name plates, available in two sizes. Write for listing and low prices on these ever-lasting name plates for Transmitters, Sound and Test equipment.

You're there ON TIME with a World-Wide clock! One quick glance gives you Standard or GMT time, accurately—instantly—for any one of the twenty-four time zones around the world.

This 24 hour time-piece, has a genuine Waltham movement. Attractively colored dials plainly marked for direct reading. Self-starting. Operates on 110 volt, 60 cycle, AC.

Here is a beautiful, practical instrument you'll be mighty proud to own! Black stippled metal base, removable for flush-mounting in your panel. (Hole size 3.11 16"). Only \$9 net to licensed hams. Get yours today! See your jobber. Inquiries invited.

GORDON SPECIALTIES COMPANY

440 SOUTH DEARBORN STREET • CHICAGO, ILLINOIS

NEW PHONES FOR THE RIG

Amateurs! Check your requirements and don't forget the importance of your phones. Get new ones—get better ones—get FEATHERWEIGHTS.

For information, write Dept. R-4

TRIMM RADIO MFG. CO.

1770 Berteau Ave. Chicago, Illinois



THAT PERSONAL TOUCH—by W9ANZ

"The Pioneer 14 Mc. Phone Amateur of the World"

RECEIVERS — XTALS — TUBES

1938 Sky rider.....\$99.00	Taylor T55.....\$8.00
RME69.....151.20	Taylor T20, T220.....2.45
Patterson PR15.....109.50	Taylor T125.....13.50
Billey BC xtals... 3.35	Taylor 866.....1.50
Billey LD xtals... 4.80	Taylor T200.....21.50

A card brings catalogue and information.

LEUCK ELECTRIC SERVICE, LINCOLN, NEBR.

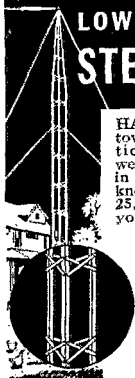

LOW PRICED! EASY TO ERECT! STEEL ANTENNA TOWER

HAMS!—Here's the ideal antenna tower—can also be used as a vertical radiator. Strong! Light weight! Extremely rigid! Comes in 20 ft. sections, with 5 ft. tip, knocked down, for building towers 25, 45, 65, 85, or 105 ft. high, as you wish. Easy to erect. Easy to climb.

Tower Legs— $\frac{1}{2}$ " x $1\frac{1}{2}$ " x $1\frac{1}{2}$ " x 20 ft. Low carbon mild steel angle. Galvanized after fabrication.
Cross Bars— $\frac{1}{2}$ " x $3\frac{1}{2}$ " x 12 $\frac{1}{2}$ " mild steel, spot welded to form X brace. Baked black enamel.
Bolts— $\frac{1}{2}$ " USS x $\frac{3}{4}$ "—1035 steel, cadmium plated. **Guy Wire**—300 ft. No. 9 galvanized with each 20 ft. section. Tower weighs 4 $\frac{1}{2}$ lbs. per foot when assembled.

Order Direct From
WINCHARGER CORPORATION
Dept. QST-11 Sioux City, Iowa

60^c
FT.

i. e. b. Sioux City, Iowa

Standard Frequency Transmissions

Date	Schedule	Station	Date	Schedule	Station
Nov. 5	A	W6XK	Dec. 3	A	W6XK
Nov. 12	B	W9XAN	Dec. 10	B	W9XAN
	B	W6XK		B	W6XK
Nov. 17	C	W9XAN	Dec. 15	C	W9XAN
Nov. 19	B	W9XA	Dec. 17	B	W9XAN
	A	W6XK		A	W6XK
Nov. 24	BB	W9XAN	Dec. 22	BB	W9XAN
Nov. 26	BB	W6XK	Dec. 24	BB	W6XK
	A	W9XAN		A	W9XAN
Nov. 27	BX	W6XK	Dec. 26	C	W6XK
Nov. 28	C	W6XK	Dec. 31	A	W6XK

STANDARD FREQUENCY SCHEDULES

Time (p.m.)	Sched. and Freq. (kc.)		Time (p.m.)	Sched. and Freq. (kc.)	
	A	B		BB	C
8:00	3500	7000	4:00	7000	14,100
8:08	3600	7100	4:08	7100	14,100
8:16	3700	7200	4:16	7200	14,200
8:24	3800	7300	4:24	7300	14,300
8:32	3900		4:32		14,400
8:40	4000				

Time (a.m.)	Sched. and Freq. (kc.)
	BX
6:00	7000
6:08	7100
6:16	7200
6:24	7300

The time specified in the schedules is local standard time at the transmitting station. W9XAN uses Central Standard Time, and W6XK, Pacific Standard Time.

TRANSMITTING PROCEDURE

The time allotted to each transmission is 3 minutes divided as follows:

2 minutes—QST QST de (station call letters).

3 minutes—Characteristic letter of station followed by call letters and statement of frequency. The characteristic letter of W9XAN is "O"; and that of W6XK is "M."

1 minute—Statement of frequency in kilocycles and announcement of next frequency.

2 minutes—Time allowed to change to next frequency.

W9XAN: Elgin Observatory, Elgin National Watch Company, Elgin, Ill., Frank D. Urie in charge.

W6XK: Don Lee Broadcasting System, Los Angeles, Calif., Harold Perry in charge.

Schedules for WWV

FOR transmissions and schedules of standard time intervals and ionosphere bulletins see "WWV Services Again Expanded," June, 1937, QST.

Each Tuesday, Wednesday and Friday (except legal holidays), the National Bureau of Standards station WWV will transmit on three frequencies as follows: 10:00 to 11:30 A.M., E.S.T., 5000 kc., noon to 1:30 P.M., E.S.T., 10,000 kc., 2:00 to 3:30 P.M., E.S.T., 20,000 kc.

A Deluxe 100-Watt Transmitter

(Continued from page 41)

angle, held together with dural gusset plates and rivets.

The front panel is a single sheet of $\frac{1}{8}$ -inch 17ST dural, with the back side bright-dipped and the front finished in a dark grey lacquer. The designations and dial scales were then engraved through the paint and into the metal. This imparts a commercial appearance to the transmitter and avoids cluttering up the panel with a multiplicity of etched plates, which tend to cheapen the looks of an otherwise high quality panel.

Since finishing this transmitter, a wider variety of isolantite wafer-switch parts has been made

My Creed

To give you **SPECIALIZED PERSONAL SERVICE** of genuine value that is not available from other jobbers.

To sell receivers, transmitters, and parts on **TERMS** arranged to suit you with less interest than heretofore charged.

To take your equipment in **TRADE** on other equipment at a fair value.

To have the most **COMPLETE** stock of amateur equipment and give you quicker **SERVICE**, better **TECHNICAL HELP**, and more complete **INFORMATION** about equipment.

To allow you to **TRY** all receivers for **TEN DAYS** without obligation and to **COOPERATE** with you in every way I can to see that you are entirely satisfied.

COMPARE BOB HENRY'S TERMS WITH OTHERS

Model of Receiver	Cash Price	Down Payment	12-month Payments
RME-69	\$151.20	\$30.24	\$10.81
Sky Buddy	29.50	5.90	2.20
Sky Challenger	69.50	13.90	4.15
Super Skyrider	99.00	19.80	7.11
PR-15	109.50	21.90	7.86
Bretting 14	108.00	21.60	7.75
ACR-155	74.50	14.90	5.38
ACR-111	189.50	37.90	13.51
Super Pro	238.14	47.62	16.95

Similar terms on all Harvey, RCA, RME transmitters and Stancor, Progressive, All Star kits.

You can reach me by letter, telegram, phone, or visit nearly 24 hours a day, 365 days a year. Write for any information. Your inquiries are invited.

HENRY RADIO SHOP
211 North Main St., Butler, Missouri

Robert Henry
W9ARA

RADIO ENGINEERING



RCA Institutes offer an intensive course of high standard embracing all phases of Radio. Practical training with modern equipment at New York and Chicago schools. Also specialized courses and Home Study Courses under "No obligation" plan.

Illustrated Catalog on request

RCA INSTITUTES, INC. Dept. ST-37

A Radio Corporation of America Service

75 Varick St., New York 1154 Merchandise Mart, Chicago

FASTEST WAY TO LEARN CODE

Easy, Fascinating — LEARN BY EAR to be a GOOD OP.



The New All Electric Master Teleplex Code Teacher is exactly what thousands are looking for. No experience needed. Ideal for beginners — steps up WPM for ALL Ops. There is no guesswork with Master Teleplex, because it records your sending in visible dots and dashes. You SEE and HEAR exactly how you are making your signals. You learn code the way you'll be using it — by SOUND. Complete course included at no extra charge. Used by many schools and several governments for teaching code. Low cost, easy terms. **MONEY BACK GUARANTEE.** Send now for booklet Q-11, no obligation. Post card will do.

The "Ham" Standard Teleplex — a highly efficient code teacher using heavy specially prepared waxed paper tape, having two rows of perforations. Write for Free folder Q1-11

We are the originators of this type instrument

TELEPLEX CO. 72-76 CORTLANDT ST. NEW YORK, N. Y.

NEW! MODEL T9 CRYSTAL MICROPHONE

For Ham use. Excellent for music pickup too. Very directional — less feedback. Interior floats in case — eliminates breakage and mechanical noise.

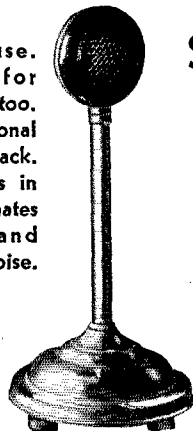

\$19.50 LIST

With Stand As Shown **\$22.50**

NEW SHOCK PROOF INTERIOR

Frequency Response Extended **18%**

Write for Bulletin 100

THE TURNER CO.
Cedar Rapids, Iowa

Licensed Under Patents of the Brush Development Co.

SEASON'S STARS

RECEIVERS

**NATIONAL
HALLICRAFTER
RME—RCA**

TUBES

TAYLOR 866.....	\$1.50
Taylor T20-T220.....	2.45
Taylor T55.....	8.00
Taylor T125.....	13.50
RCA 866.....	1.50
RCA 807.....	3.50
RCA 808.....	8.00

PARTS

Thor. 16P00. 650/500 @ 200 ma...	\$3.88
Thor. 16P01. 1250/1000 @ 300 ma.	7.64
Thor. 16P02. 1250/1000 @ 500 ma.	12.35
Thor. 16F10. 866 Fil. Tr.....	1.62
Thor. 16C20. 5/20 hy. ck. 200 ma..	2.20
Thor. 16C21. 5/20 hy. ck. 300 ma..	2.94
Thor. 16C22. 5/20 hy. ck. 500 ma..	5.28
Thor. 16C25. 12 hy. 200 ma.....	2.20
Thor. 16C26. 12 hy. 300 ma.....	2.94
Thor. 16C27. 12 hy. 500 ma.....	5.28
U.T.C. 20462A. 1000/750 @ 300 ma.....	5.20
U.T.C. 20462F. 20 hy. 200 ma....	1.45
U.T.C. 20462FS. 5/25 hy. 200 ma.	1.45

Triplett Meters, National, Hammarlund, Mallory, Shure, Aerovox, Bliley, I.R.C., Yaxley, Coto-Coil, Raytheon.

OUR \$11.00 RACK IS A PEACH

Time Payments for Conn. Hams

HATRY & YOUNG

HARTFORD.....203 ANN STREET
NEW HAVEN.....36 MEADOW STREET
BRIDGEPORT.....177 CANNON STREET

Radio Since 1912

available, so by changing SW_1 and SW_2 to 2-pole 5-point switches, and wiring to retain proper switching sequence, it is possible to gang these two with SW_3 and so reduce the number of controls.

Silent Keys

It is with deep regret that we record the passing of these amateurs:

Raymond L. Barbur, W7EJK, Bremerton, Wash.

Bernard E. Beatty, W9YTU, Sibley, Iowa

George F. Corey, W1CMZ, New Bedford, Mass.

Engle Ellis, W5BWY, Fort Worth, Texas
George T. Gillogly, W7EJH, Spokane, Wash.

William Greiger, W8JAS, Lansing, Ohio
Ruth Jerrett, XYL VO2Z, Brigus, Newfoundland

John LaValle, W2GWH, Bronx, N. Y. C.
Sergio Levi, I1SL, Firenze, Italy
Carleton W. Moore, W1HOY, Hampton, N. H.

Max Mousty, ON4MX, Menin, Belgium
Thomas L. Pettigrew, W6KLF, Compton, Calif.

Frank W. Paulus, Jr., W9PVW, Sedalia, Mo.

J. Kenneth Reed, W8BRH, Newark, N. Y.
Floyd S. Scobee, W7FBC, Blaine, Wash.

Willard B. Wall, W5ABL, Little Rock, Ark.

Dr. O. E. Wall, K6DB, Honolulu, T. H.
Kenneth D. Wilson, W7AGK, Spokane, Wash.

The 8th A.R.R.L. Sweepstakes

(Continued from page 46)

or new hams invited and reported by such a club, in addition to sending a contest report have their club secretary write Hq. listing their individual calls and scores, and the total of such scores. If there are both club 'phone and c.w. entries, A.R.R.L. will provide two certificate awards for the club to give its leading members. Besides this, the sum of the scores of all club participants ('phone and c.w.) will be added by the secretary, to count for the club!

A genuine gavel, with engraved sterling silver band, is offered as an award to that club whose officers or activities manager submits the greatest collective score of "SS" reports when he adds figures reported by individual members. Club members must send in full reports either direct or through the secretary to substantiate the club's claim on the gavel award! A chance to win honors

BUY FROM THE WORLD'S LARGEST RETAIL RADIO CHAIN!

Famous for
Value
Since 1879

DAVEGA

Amateur
Headquarters
63
CORTLANDT ST.
New York, N. Y.

Famous HALLICRAFTER
SX11
Super Sky Rider
Special

\$74.50

Never before
sold under **\$99.50**

Complete with Crystal and
I.F. Expansion. Plenty in
stock.

Since the earliest days of radio we have
specialized in short wave apparatus.
Today at our 63 Cortlandt St. store we
have the largest communications re-
ceiver department in New York City,
with more than 3,000 sq. ft. of floor
space devoted exclusively to com-
munications receivers and transmitters.
Also, the finest equipped service
department for short wave apparatus.

SMALL DOWN PAYMENT
Easy terms arranged on everything. No
co-makers.

**LIBERAL TRADE-IN
ALLOWANCE**



RME-69

Davega offers the very latest
in short wave apparatus.
Don't fail to see and hear
this RME-69.

Also see the RME-DB20
preselector.

Complete line of HAMMARLUND ■ RME ■ HALLICRAFTER ■ RCA 111
RCA 155 ■ PATTERSON ■ NATIONAL RCA TRANSMITTERS

Get Our EASY TERMS on Hallicrafters 1938 SUPER SKY RIDER

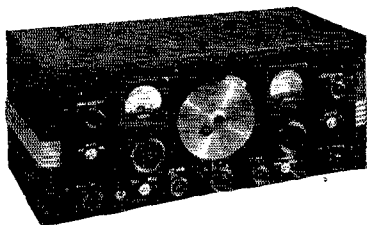

The 1938 Super Sky Rider has everything in its
favor in performance, appearance and low
price. That explains its tremendous popularity
with short wave fans everywhere. Come to
Davega and acquaint yourself with its many
desirable features.

LIBERAL TERMS

Time sales arranged to suit your convenience. Pay for your
Sky Rider in easy instalments.

TRADE-IN ALLOWANCE

Trade in your present apparatus and equipment. We give a
generous allowance.

FULL GUARANTEE

Every Sky Rider we sell bears both the guarantee of the
Hallicrafters and of Davega.

N. Y. Amateur
Headquarters
DAVEGA

63 CORTLANDT ST.

Largest Communications Receiver Department in New York

REBUILDING?

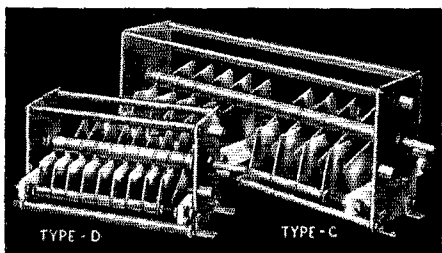

Then you'll find Johnson Condensers ideal for the new rig. The Types "C" and "D" shown above, already famous for their dependability and low cost, have been still further reduced in price!

Made of the finest materials throughout, including such features as buffed and rounded aluminum plates .051" thick and the exceptional insulation of Alsimag 196. Available in spacings up to 1/2" and in a wide range of capacities, these condensers offer maximum performance at extremely low cost.

See September QST for other Johnson condensers.

Ask your Jobber or write for Catalog 964J

E-F-JOHNSON COMPANY 
 MANUFACTURERS OF *Radio Transmitting Equipment*
 WASECA, MINNESOTA, U.S.A.
 Export Office: 25 Warren St., New York, Cable: "SIMONTRICE"

THE VALPEY CRYSTALS

Step by Step Precision Made

Type LMA unit consists of an accurately cut crystal of the low drift type. The frequency drift will not exceed 4 c/m°C. The mounting is of low loss moulded bakelite, employing tube pins for tube socket mounting. The embossed cover has the frequency accurate to within 0.3% stamped on it. Within 5 kc. of specified frequency in the 1.7, 3.5, 7 Mc. bands \$4.50

Type VM2 Crystals — Standard X cut mounted — supplied within 5 kc's specified freq. in the 1.7, 3.5, 7 Mc. bands \$3.00

Type VC2 — Standard X cut crystal, supplied in the 1.7, 3.5, 7 Mc. bands, within 5 kc. of freq. specified \$2.25

Complete illustrations and descriptions in our new catalogue. Order direct or see your local dealer.

THE VALPEY CRYSTALS
 P. O. Box 321, Holliston, Mass.

MODULATION METER



Approved by
 Leading Transmitter
 Kit Manufacturers

**BASED ON F. C. C.
 BC SPECIFICATIONS**

SEE YOUR JOBBER
 QSL FOR CIRCULAR

J-M-P MANUFACTURING CO.

\$19.75 f. o. b.
3042 No. 34th Street - Milwaukee, Wisc.

for your club and a valuable trophy for the club's presiding officer to use at meetings!

Competition comes only from operators in one's immediate Section. Awards are for the operator running up the best communication record for each Section (as indicated by the score). Operators thus have equal DX conditions and operating opportunity. Fullest operating enjoyment is assured. See May QST for full details on the last SS or ask any amateur who took part last year!

REPORTING RESULTS

Report ⁷ to A.R.R.L., West Hartford, Conn., as soon as the contest is over. Use the log form shown in the example. List all operators ⁶ whose work at your station is responsible for any part of the score.

All active ham operators are invited to take part and report. You will work a new bunch of stations, make new records for your station, get QSL cards (be sure to send one for each QSO), have a lot of fun, meet new friends, and perhaps rate an A.R.R.L. award at the conclusion. Do your best operating. Send A.R.R.L. the results for QST mention. MAIL YOUR REPORT IMMEDIATELY AT THE END OF THE CONTEST TO AVOID DELAY AND INSURE THAT YOUR RESULTS ARE CREDITED AND KNOWN THROUGH QST.

⁷ All hams are requested to submit lists, even if they only show a small score, on a postal. By doing this they help support claims made in logs from other stations and receive credit in QST.

Hints and Kinks

(Continued from page 47)

can be cleared up without a resistor shunted across the primary of the transformer, it should be omitted. The plate current was 3.5 ma. at a supply voltage of 270. This produced a grid bias of -5 volts and a plate voltage of about 150. According to the article cited above, the output should correspond to that of a Class-A amplifier operating under the same conditions.

—Theo Stoecke, 3323 Telegraph Ave., Berkeley, Cal.

I.A.R.U. News

(Continued from page 48)

Cape Prince of Wales—Alaska—170° East, 50° North—120° W. Equator—South Pole along 120° West.

North Pole along Greenwich meridian—latitude of Boar I—40° West, 60° North, 40° West, 20° North—20° W. Equator—South Pole along 20° West.

North Pole along 80° East—80° North—Boundary between Russia and Siberia—along boundary between Russia and Siberia—Caspian Sea—round west coast Caspian Sea to Persian boundary—along northern boundary of Persia and Asia Minor to Black Sea—across Mediter-

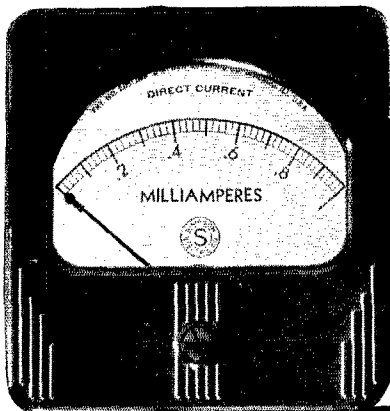

PREMIUM QUALITY

(Bridge-type construction and soft iron pole pieces)

without the PREMIUM PRICE

If you know meters, you know that bridge-type construction with soft iron pole pieces is the first essential of lasting accuracy. And if you know prices, you know that such instruments have always been far more expensive than the ordinary kind. But now, incredible though it may seem, this finer type of construction that hitherto has been confined to the most expensive laboratory instruments, is available in a line of meters that are priced no higher than the ordinary run of instruments. The ingenuity of foremost instrument designers, backed by modern large-scale production methods, has made it possible to produce these meters that are undeniably the finest in the world in their class.

When you buy Simpson Panel Meters, you buy the type that already have become the first choice of prominent concerns whose engineers have made exhaustive tests in choosing meters that represent the greatest possible value in accuracy and ability to stand up in service. Send the coupon for circular showing the ultra-modern designs that will add lustre to the finest panel board.

SIMPSON ELECTRIC CO.
5216 W. Kinzie Street, Chicago

This year's sensation—

the Simpson illuminated dial panel instrument

Picture a panel with these beautiful, stream-lined instruments which have a translucent dial evenly illuminated by a built-in, 6-volt lamp. Net price to amateurs of most A. C. and D. C. ranges (including lamp and **\$5.24** socket) is only.....

Thermo-couple types at new low prices.

The instrument above mounts in a round, 2 3/4" diameter hole. Round case, non-illuminated instruments with identical movement are available in most A. C. and D. C. ranges at net price of \$4.15.

Mail This Coupon For Facts

Simpson Electric Co., 5216 W. Kinzie St., Chicago

Send facts about Simpson Instruments.

Name _____ Call _____

Address _____

SIMPSON *Instruments that*
STAY accurate

TEMCO TRANSMITTER

The Famous Temco "100"
Now Available for the First
Time Under a Most Liberal

TIME PAYMENT
PLAN

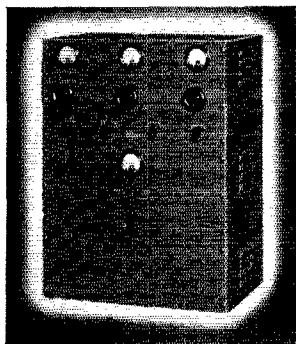

- 100 Watts output
- Band Switching Exciter from 10-200 meters
- Remote and Panel Control with simplified tuning.

SPECIAL TERMS

DOWN PAYMENT AND INSTALLMENTS
ON THIS ULTRA MODERN TRANSMITTER

ONLY
\$16⁵⁰

UNDER OUR 20-PAYMENT PLAN
PLACE YOUR ORDER NOW FOR
PROMPT DELIVERY

DELAWARE RADIO SALES COMPANY

WILLARD S. WILSON — W3DQ

405 Delaware Ave.

ESTAB. 1920

Wilmington, Delaware

YOU BUY RADIO PRODUCTS ON REPUTATION — WHY NOT CHOOSE YOUR JOBBER ON EXACTLY THE SAME BASIS?

Yes sir, when you are looking for amateur radio supplies, an amateur Receiver, X'mtr; Tubes or accessories you first assure yourself of the reliability of the manufacturer. Why not choose your jobber on reputation too? For 15 years Sun Radio has built an enviable reputation for fast, reliable service . . . the kind of service that is built upon a keen understanding of your requirements.

THIS MONTH THE SUN SHINES ON:

● The NEW NATIONAL NC80X complete with Tubes, Speaker and Crystal. Net. . . . **\$88**

● HALLICRAFTERS NEW SUPER SKY-RIDER complete with Tubes, Speaker and Crystal. **\$123**

Write for information on our time payment plan.

- NATIONAL RECEIVERS CARRIED IN STOCK for immediate delivery. NC100, NC101, NC80X, HRO, HRO JR., SW3. Write for Free Catalog and net prices.
- PREMIER CRYSTAL complete with sealed Holder. 40, 80, 160 Meter. **\$4.35**
- STANCOR PLATE TRANSFORMER, 1000 volts, 300 ma, 500 and 750 volt taps. Net. **\$5.75**
- JEWEL PORTABLE METER. 1000 ohms per volt. Ranges 7½-300 and 750 volts. Each. **\$4.25**
- TAYLOR'S LATEST DEVELOPMENT T-125. . . **\$13.50**
All other types in stock.
- SYLVANIA 211 C. Brand New and Guaranteed. Will replace 203A-242A-211 and others. Net. **\$6.45**
EIMAC, RAYTHEON, RCA, AMPEREX TRANSMITTING TUBES IN STOCK.
- We are distributors for Western Electric Amateur Equipment, Tubes, Phones and Mikes in stock.
- BREAK-IN D.P. DT 110 Volt AC Relay. Net. . . . **\$2.75**

Fall Bargain Bulletin Now Ready

Contains many "unadvertised specials," items you may need, new developments plus editorial matter by Sam Schwartz, Ed Berliant and Jack Grand. Get copy at once. It's FREE. Simply send Post card to Dept. Q-12.



reanean to boundary between Palestine and Egypt (i.e., a point on the coast about 25 miles east of El Arish), along boundary to Gulf of Akaba—west coast of Red Sea to Cape Gardafui—just north of Sokotra and straight on to 60° East, 18° North—60° E. Equator, 90° E. Equator—South Pole along 90° East.

90° East Equator—Northern point of Sumatra and straight on to mainland—along coast to Singapore—120° East, 20° North—140° East, 20° North—170° East, 30° North.

40° West latitude of Cape Spartel (Africa), approximately 36° North Cape Spartol—along coast of Africa—boundary between Palestine and Egypt.

120° West Equator—100° West on Equator—boundary between North and South America, along this boundary to Caribbean Sea, round coast to Pia Gallinas—Northern point of Curacao—Northern point of Tortuga to Northern point of Tobago—50° West latitude of Northern point of Tobago—40° West, 20° North.

"(f) In order to be eligible for the award, all contacts made by the applicant must be from one station (in terms of license and call letters, but not necessarily of apparatus) operated at one location. The term 'location' shall be construed as representing one metropolitan area, or, alternatively, an area not exceeding 25 miles (approximately 40 km.) in diameter.

"(g) Holders of WAC certificates are entitled to use the letters 'WAC,' signifying that fact, on their station cards and correspondence."

A 10-Watt Speech Amplifier

(Continued from page 17)

r.m.s. value of voltage, provided the output wave-shape is substantially sinusoidal.

Measurements made on the amplifier showed that at the 10-watt output level distortion was negligible. With the gain fully open, the noise level is approximately 43 db below full output (0.5 milliwatts) most of the noise being tube "rush." Power-supply hum is hardly detectable under these conditions, using a loud speaker for monitoring. With full gain, a peak signal of 0.0017 volt at the grid of the 6J7 will develop 10 watts output. Since the average crystal microphone output is several times higher than this, the actual signal-noise ratio is considerably higher than the minimum figure given above. With normal gain-control setting, noise is practically inaudible, and when any hum is present it usually can be traced to external pickup in the microphone circuit rather than to the amplifier itself.

Frequency response with the components and circuit constants shown is adequate for voice reproduction, dropping between 2 and 3 db below the 1000-cycle figure at 100 and 5000 cycles. There are no humps anywhere in the curve. The frequency range could be considerably extended by using suitable transformers (those specified are

5 Meter Hams Attention!

NOW YOU CAN HAVE CRYSTAL CONTROL ON 5 METERS WITH ONLY TWO STAGES!!

Bliley 10 Meter Mounted Xtals Type HF2 are, Net. **\$5.75**
 Type BC3. Mounted 40, 80 Meter Xtals. Now. \$3.35
 Type LD2. Mounted 40, 80, 160 Meter Xtals. 4.80
 Type HF2. Mounted 20 Meter Crystals. Now. 5.75

"X" Cut Unmounted 40 Meter Crystals

Made by nationally known manufacturer. Your choice from our stock, only \$1.95. These are 1/2" square and have high output. Calibration is accurate to .1%.
 Special Bliley 40 meter crystal holders. \$.95

DO you want a good used receiver? Stop in or write. We usually have some on hand.

Transducer Bullet Dynamic Mikes, either high or low impedance, only \$16.17
 Complete Stocks of Gardwell, Triplett, Thordarson, etc. The New RK49, A 6L6G with 6P Isolantite Base only \$2.10

TAYLOR T20 TZ20 \$2.45
 TAYLOR T125 13.50
 TAYLOR 203Z 8.50
 EIMAG 100TH 13.50
 EIMAG 250TH 24.50
 RAYTHEON RK39 3.50
 AMPEREX HF100 12.50

THE FINISHING TOUCH!

Gordon World-Wide GMT and Standard Time Clock

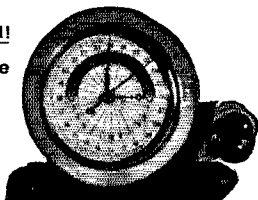

60-Cycle Self-Starting Genuine Waltham 24-Hour Movement. Base removable for panel mounting (Hole size 3M"). Satin Black Finished Base holds clock in reclining position for easy reading. Tells at a glance GMT and Local Standard Time in 24 principal countries around the globe. Tells the time in each of the 24 time zones around the world. And your net cost is only \$9.00

THE NEW 1938 SUPER SKYRIDER

Net Price Complete. Less Speaker and Crystal, \$99.00
 Extra for Crystal, \$12.00 Extra for Speaker, \$12.00
Time Payments on All Hallicrafters Receivers

RME-69. Complete with Crystal and Speaker Net \$151.20

Thordarson Specials

T-16P00. 810 and 640 V.A.C. Ea. side at 200 mls. . . \$3.88
 T-16P01. 1510 and 1220 V.A.C. Ea. side at 300 mls. . . 7.64
 T-16P02. 1540 and 1250 V.A.C. Ea. side at 500 mls. . . 12.35
 T-16P03. 2140 and 1740 V.A.C. Ea. side at 300 mls. . . 11.17
 T-16P04. 2950 and 2370 V.A.C. Ea. side at 300 mls. . . 13.67
See Our Ad in October QST for Kenyon Specials

W3AHR

MAIL ORDERS PROMPTLY FILLED

W3BMS

CONSOLIDATED RADIO CORP., 612 Arch St., Philadelphia, Pa.

TUBES! TUBES! TUBES!

They're all at Terminal!

Taylor		Raytheon	
T20	\$ 2.45	RK39	\$ 3.50
TZ20	2.45	RK20A	15.00
866	1.50	RK47	17.50
866 Jr.	1.00	RK48	27.50
T55	8.00	RK49	2.10
T125	13.50		
203Z	8.50	RCA	
T200	21.50	866	\$ 1.50
822	18.50	802	3.50
Eimac		805	13.50
35T	\$ 8.00	806	22.00
100TH	13.50	807	3.50
100TL	13.50	808	7.75
250TH	24.50		
250TL	24.50		

Not only have we one of the largest stocks of amateur transmitting tubes, but we have EVERYTHING IN RADIO FOR THE AMATEUR!

TERMINAL *Radio Corporation*

BILL FILLER ★ ADOLPH GROSS 80 CORTLANDT ST. NEW YORK, N. Y.

Type HFM

Portable Crystal Control

7000 — 60,000 Kc.

PHONE — CW — MCW

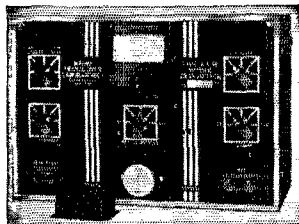

- Single 40 Meter Crystal for All Bands
 - A.C. or Battery Operation
 - Complete With Coils for 5-10-20 and 40 Meters
- H-F-M
TRANSMITTER
\$57.60

5 METER DUPLEX TRANSMITTER-RECEIVER

- T.R.F. and Super-Regeneration
 - 7 Tubes — 5" Dyn. Speaker
 - 6E6 Unity Coupled
 - 10 watt Carrier
 - 100% Modulation
 - Duplex Operation — PHONE ● MCW
- TRANSMITTER —
RECEIVER

\$47.70

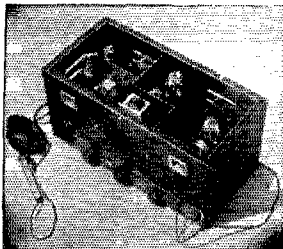

RADIO TRANSCIVER LABORATORIES

8627 — 115 Street, Richmond Hill, New York

HAYNES RIG CHECKER

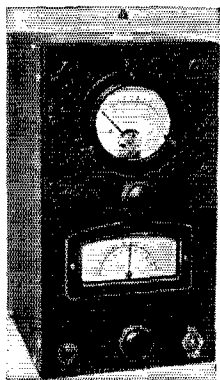

Hams all over the world are telling us that these two instruments are the biggest values in radio today. Your station is not complete without one. Circular and instructions for using sent free on request.

BIG RIG CHECKER **\$17.90** LITTLE RIG CHECKER **\$9.85**

RADIO CONSTRUCTORS LABORATORIES

Dept. Q-1 136 LIBERTY ST., NEW YORK, N. Y.

RADIO

ENGINEERING, broadcasting, aviation and radio telegraphy and telephony, police radio, servicing, marine Morse telegraphy and railway accounting taught thoroughly Engineering course of nine months duration equivalent to three years of college radio work. School established 1874. All expenses low. Catalog free. DODGE'S INSTITUTE, Day Street, Valparaiso, Indiana

particularly intended for voice work) and by increasing the capacities of the various coupling and bypass condensers in the resistance-coupled stages. The added expense does not seem economically justifiable in view of receiver selectivity, the frequency response characteristics of the microphones used by amateurs, and the requirements for satisfactory transmission of speech. As a matter of fact, even though the response drops rapidly below 100 cycles and fairly rapidly above 5000, in an air test there is little difference between this amplifier and one having a considerably wider response range, using the same good-quality microphone in both cases.

The power-supply unit, incidentally, has ample capacity for running the ordinary amateur superhet. By operating all tubes except the power stage from the regulated part of the supply, a marked increase in stability will be obtained, especially when the operating voltage varies with the signal. This is the case with a.v.c. when the plate current of the controlled tubes varies with the gain, and also happens when Class-AB output stages draw more current with large grid excitation.

How Would You Do It?

(Continued from page 48)

are held together with good glue and long, thin wood screws. The shelves are mounted over $\frac{3}{4}$ " by $\frac{3}{4}$ " cleats with headless finishing nails. The hinges should be strong enough to support the weight without sagging. They are fastened to the box with bolts and nuts.

Door catches and a lock are provided. A pair of handles fitted at the top end makes it easy to carry from place to place. The box may be either mounted permanently on the wall or provided with rubber feet. The cost need not exceed three dollars.

Two or three others submitted kinks which are worth mentioning.

W2KJY uses quart-size mayonnaise jars with screw tops for screws and small parts. The screw tops are fastened on the under side of a shelf or the work bench. The jars are removed by simply unscrewing from the permanently-mounted top.

W1ALJ finds a piece of heavy duck, about two feet square, handy when hunting for some particular screw or other item in a miscellaneous lot. The cloth is simply spread on the bench or floor while the contents of the box are spread over the cloth. When the desired item has been found, the remainder is easily poured back into the box.

W3GGE finds a fisherman's tackle box just the trick for screws and small parts as well as tools.

W3GZW suggest the use of a utility closet, sold in department stores for the storage of linen, brooms, etc. His is 5 feet high, 26 inches wide and 12 inches deep, has five shelves and cost approximately four dollars.

W8SOMM obtained sectional cardboard boxes from his grocer for storing tubes. The boxes are

(Continued on page 122)

You TRI-STATE Amateur's

MAKE THE

CAMERADIO CO.

603 GRANT STREET
PITTSBURGH, PA.

YOUR SOURCE
FOR



and UTAH
"NO BACK TALK"
TRANSFORMERS

UTAH RADIO PRODUCTS COMPANY

TORONTO
ONTARIO, CANADA

CHICAGO, U. S. A.
16 YEARS OF LEADERSHIP

BUENOS AIRES
(UCOA RADIO PRODUCTS CO.)

No. 3—\$13.95

Antenna
Coupling Kit

No. 4—\$49.75

500 Watt RF
amplifier

No. 1—\$49.75

A complete
80 Watt CW
transmitter

No. 2—\$44.50

50 Watt
modulator

No. 5—\$49.75

250 Watt
class B mod-
ulator

Prices do not
include tubes,
meters or
crystal.

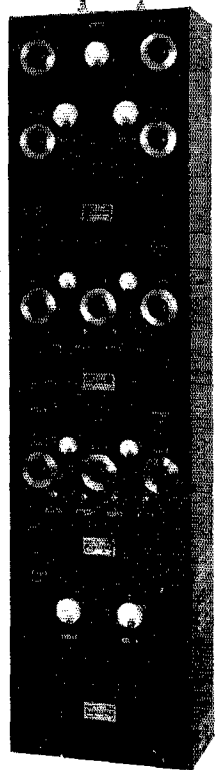

QST-40-11B

WANTED

Mechanical draftsman with sufficient knowledge of Electrical Engineering to assist in Laboratory of Electrical Manufacturer. Location, Chicago.

Address Box 24, Adv. Dept., QST
West Hartford, Conn.

RADIO COURSES

RADIO OPERATING: Prepare for Gov't License Exam. ●
RADIO SERVICING: Including Short Wave ● **AMATEUR**
CODE ● ELECTRONICS ● TELEVISION ●

Day and Evening classes—Booklet upon request

NEW YORK YMCA SCHOOLS

4 West 63rd Street, New York City



NEW HOLDER DESIGN

15 SECONDS TO
INSTALL CRYSTAL

For All Bands
GREATER STABILITY
Plugs in 5 prong tube socket

Beautiful Appearance

MODEL AH HOLDER \$1.00 At your dealer or direct

HIPower LOW DRIFT CRYSTALS:
within 10 kc. or Choice of stock

AH-10, 1700-3500 Kc. bands \$2.35
AH-10, 7000-7300 " band 3.90

WRITE FOR NEW LITERATURE

Hipower "Low Drift" Broadcast and Commercial
Crystals Are Approved by F.C.C.

Hipower Crystal Co., 2035 Charleston St., Chicago

ASTATIC

MODEL T-3 MICROPHONE PRAISED for FLEXIBILITY

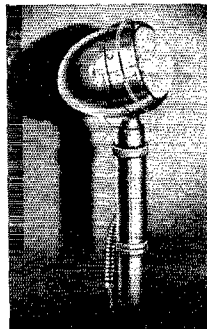

Unique tilting mount permits uni- or non-directional pickup without disturbing frequency response. No yoke and no annoying cable entanglements or breakage. Single diaphragm type for high class public address, broadcast, recording or amateur use. Exceptional directional characteristics. Acoustic feedback definitely reduced. Attractively shaped. Beautiful polished chromium finish. Complete with Astatic exclusive interchangeable plug and socket cable connector, 8-ft. cable and spring cable protector. Fully guaranteed.

LIST PRICE **\$25.00**

SEND FOR LITERATURE on other new Astatic Microphones including unique "GRIP-TO-TALK" Model CD-104, for air-way ground stations, inter-office, inter-factory, amateur and other similar communicating systems.

Licensed under Brush Development Co. Patents

ASTATIC MICROPHONE LABORATORY, INC.
DEPT. G-3, YOUNGSTOWN, OHIO, U. S. A.

Pioneer Manufacturers of Quality Crystal Devices

Where to buy it

A directory of suppliers who carry in stock the products of these dependable manufacturers.



ALBANY, N. Y. Uncle Dave's Radio Shack 356 Broadway
 BALTIMORE, MD. Radio Electric Service Company 3 North Howard St.
 BOSTON, MASS. Radio Shack 46 Brattle Street
 BOSTON, MASS. Wholesale Radio Service Company, Inc. 110 Federal Street
 BRONX, N. Y. Wholesale Radio Service Company, Inc. 542 East Fordham Rd.
 JAMAICA, L. I. Wholesale Radio Service Company, Inc. 90-08 166th Street
 NEWARK, N. J. Wholesale Radio Service Co., Inc. 219 Central Ave.
 NEW YORK, N. Y. Gross Radio, Inc. 51 Vesey St.
 NEW YORK, N. Y. Harrison Radio Co. 12 West Broadway
 NEW YORK, N. Y. Wholesale Radio Service Co., Inc. 100 Sixth Ave.
 NEW YORK, N. Y. Terminal Radio Corp. 80 Cortlandt Street
 POTTSVILLE, PENN. E. Norwegian & George Sts. Sylvester Radio & Supply Co., Inc.
 READING, PENN. George D. Barbey Company 404 Walnut St.
 READING, PENN. Sylvester Radio & Supply Co., Inc. 104 North Ninth Street
 SPRINGFIELD, MASS. T. F. Cushing 349 Worthington St.
 WASHINGTON, D. C. Sun Radio & Service Supply Co. 938 F Street, N. W.

BALTIMORE, MD. Radio Electric Service Company 3 North Howard St.
 BOSTON, MASS. H. Jappe Company 46 Cornhill
 BOSTON, MASS. Radio Shack 46 Brattle Street
 BOSTON, MASS. Wholesale Radio Service Company, Inc. 110 Federal Street
 BRONX, N. Y. Wholesale Radio Service Company, Inc. 542 East Fordham Rd.
 BURLINGTON, VERMONT Vermont Hardware Co., Inc.
 GREENWICH, CONN. Mead Stationery Company 252 Greenwich Ave.
 JAMAICA, L. I. Wholesale Radio Service Company, Inc. 90-08 166th Street
 MONTREAL, CANADA Canadian Electrical Supply Co., Ltd. 285 Craig Street, West
 NEWARK, N. J. Wholesale Radio Service Co. 219 Central Avenue
 NEW YORK, N. Y. Bruno-New York, Inc. 460 W. 34th St.
 NEW YORK, N. Y. Sanford Samuel Corp. 136 Liberty St.
 NEW YORK, N. Y. Wholesale Radio Service Co. 100 Sixth Avenue
 NEW YORK, N. Y. Harrison Radio Company 12 West Broadway
 NEW YORK, N. Y. Grand Central Radio, Inc. 124 E. 44th Street
 PHILADELPHIA, PENN. Eugene G. Wile 10 S. 10th Street
 PHILADELPHIA, PENN. Raymond Rosen & Company 117 North 7th St.
 PHILADELPHIA, PENN. M & H Sporting Goods Company 512 Market Street



POTTSVILLE, PENN. E. Norwegian & George Sts. Sylvester Radio & Supply Co., Inc.
 READING, PENN. Bright & Company 8th & Elm Streets
 READING, PENN. Sylvester Radio & Supply Co., Inc. 104 North Ninth Street
 SPRINGFIELD, MASS. T. F. Cushing 349 Worthington Street

ALBANY, N. Y. Uncle Dave's Radio Shack 356 Broadway

Where to buy it

A directory of suppliers who carry in stock the products of these dependable manufacturers.

WASHINGTON, D. C. 938 F Street, N. W.
Sun Radio & Service Supply Co.

CONCORD, NEW HAMPSHIRE 80 N. State Street
Carl B. Evans

RME
RECEIVERS -- PRE SELECTORS
AMATEUR RADIO EQUIPMENT
RADIO MFG. ENGINEERS, Inc.
PEORIA ILLINOIS

JAMAICA, L. I. 90-08 166th Street
Wholesale Radio Service Company, Inc.

NEWARK, NEW JERSEY 219 Central Street
Wholesale Radio Service Co.

NEW YORK, N. Y. 12 West Broadway
Harrison Radio Company

NEW YORK, N. Y. 100 Sixth Avenue
Wholesale Radio Service Co.

ALBANY, NEW YORK 356 Broadway
Uncle Dave's Radio Shack

WASHINGTON, D. C. 938 F Street, N. W.
Sun Radio & Service Supply Co.

BINGHAMTON, NEW YORK 25-27 Sturges Street
Radio Testing Station

BUFFALO, NEW YORK 216 E. Genessee Street
Dymac Radio

HARTFORD, CONNECTICUT 210 Chapel Street
Stern Wholesale Parts Company

NEW YORK, N. Y. 12 West Broadway
Harrison Radio Company

NEW YORK, N. Y. 80 Cortlandt Street
Terminal Radio Corp.

ROCHESTER, NEW YORK 244 Clinton Ave., N.
Radio Parts & Equipment Co.

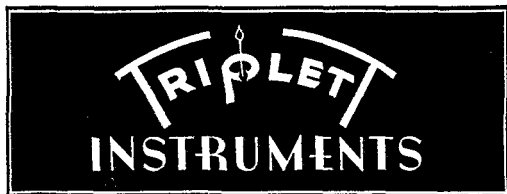

ALBANY, N. Y. 356 Broadway
Uncle Dave's Radio Shack

BOSTON, MASS. 46 Brattle Street
Radio Shack

BOSTON, MASS. 28 Brattle St.
Selden Radio Company

BOSTON, MASS. 110 Federal Street
Wholesale Radio Service Company, Inc.

BRONX, N. Y. 542 East Fordham Rd.
Wholesale Radio Service Company, Inc.

JAMAICA, L. I. 90-08 166th Street
Wholesale Radio Service Company, Inc.

MONTREAL, CANADA 285 Craig Street, West
Canadian Electrical Supply Co., Ltd

NEWARK, N. J. 219 Central Ave.
Wholesale Radio Service Company

NEW YORK, N. Y. 100 Sixth Avenue
Wholesale Radio Service Company

POTTSVILLE, PENN. E. Norwegian & George Sts.
Sylvester Radio & Supply Co., Inc.

READING, PENN. 404 Walnut Street
George D. Barbey Company

READING, PENN. 104 North Ninth St.
Sylvester Radio & Supply Co., Inc.

WASHINGTON, D. C. 938 F Street, N. W.
Sun Radio & Service Supply Co.

RAYTHEON
TRADE MARK
AMATEUR TUBES

ALBANY, NEW YORK 356 Broadway
Uncle Dave's Radio Shack

BOSTON, MASS. 46 Brattle Street
The Radio Shack

BOSTON, MASS. 28 Brattle Street
Selden Radio Company

BOSTON, MASS. 110 Federal Street
Wholesale Radio Service Company, Inc.

BRONX, N. Y. 542 East Fordham Rd.
Wholesale Radio Service Company, Inc.

BUFFALO, NEW YORK 326 Elm Street
Radio Equipment Corp.

DO YOU WANT TO LEARN WIRELESS and TELEGRAPHY?

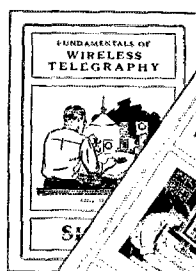

TWO BOOKS EVERY AMATEUR
SHOULD HAVE —

Send Now!



**10¢
Each**
POSTPAID
COIN, OR
STAMPS

Hundreds of amateurs have learned from these books, so can you.

These books give you the fundamentals of wireless and telegraphy. They contain the codes and how to learn them. Mail your order now to:

SIGNAL ELECTRIC MFG. CO., Menominee, Michigan

ESTABLISHED
1892



They're Rolling NOW!



See Pages 4-5

How Would You Do It?

(Continued from page 118)

apparently similar to egg crates, providing separate compartments for each tube which he stores upside down in the compartments.

O. H. thanks, in addition, the host of others, too numerous to mention individually, who came to his rescue.
D. H. M.

And again the contest rules:

1. Solutions must be mailed to reach West Hartford before the 20th of the publication month of the issue in which the problem has appeared. (For instance, solutions of problem given in the March issue must arrive at *QST* before March 20th.) They must be addressed to the Problem Contest Editor, *QST*, West Hartford, Conn.

2. Manuscripts must not be longer than 1000 words, written in ink or typewritten, with double spacing, on one side of the sheet. Diagrams and sketches may be in pencil, must be neat.

3. All solutions submitted become the property of *QST*, available for publication in the magazine.

4. The editors of *QST* will serve as judges. Their decision will be final.

Prizes of \$5 worth of A.R.R.L. station supplies or publications will be given to the author of the solution considered best each month, \$2.50 worth of supplies to the author of the solution adjudged second best. The winners should, of course, state the supplies preferred.

Strays

New 2-Inch Cathode Ray Tube

A new cathode-ray tube for low-voltage operation has been announced by National Union. This tube, which will be known as the Type 2002, has a two-inch flat screen coated with highly-sensitive fine-grain fluorescent material. The overall length is 6¾ inches, and the tube has a small octal base. Deflection plates are of non-magnetic material.

Following are typical operating conditions for the 2002:

Anode No. 2 voltage....	400	500	600
Anode No. 1 voltage....	80	100	120
Grid voltage.....	never positive		
Deflection sensitivity....	.24	.18	.16 mm. per volt
	.26	.20	.17 " " "
Heater voltage.....	6.3 volts		
Heater current.....	0.6 amp.		

From W1JEP comes another story of amateur radio jumping into the breach. A large instrument manufacturer needed several amperes of 14-Mc. juice for testing some t.c. ammeters. None being available in the plant, a member of the organization, W1JEA, was contacted and agreed to lend his rig for the test, which was a rush job. A new kind of service!

Vermont and New Hampshire come near to being desert isles for the many VK's who these days are shooting for WAS. Any ham in those states who wants to QSO Aussies can do a rushing business on 20 in the mornings, simply by sending out a few CQ's and signing "VT" or "NH" after the call.

HAM-ADS

(1) Advertising shall pertain to radio and shall be of nature of interest to radio amateurs or experimenters in their pursuit of the art.

(2) No display of any character will be accepted, nor can any special typographical arrangement, such as all or part capital letters be used which would tend to make one advertisement stand out from the others.

(3) The Ham-Ad rate is 15c per word, except as noted in paragraph (6) below.

(4) Remittance in full must accompany copy. No cash or contract discount or agency commission will be allowed.

(5) Closing date for Ham-Ads is the 25th of the second month preceding publication date.

(6) A special rate of 7c per word will apply to advertising which, in our judgment, is obviously non-commercial in nature and is placed and signed by a member of the American Radio Relay League. Thus, advertising of bona fide surplus equipment owned, used and for sale by an individual or apparatus offered for exchange or advertising inquiring for special equipment, if by a member of the American Radio Relay League, takes the 7c rate. An attempt to deal in apparatus in quantity for profit, even if by an individual, is commercial and takes the 15c rate. Provisions of paragraphs (1), (2), (4) and (5) apply to all advertising in this column regardless of which rate may apply.

Having made no investigation of the advertisers in the classified columns, the publishers of *QST* are unable to vouch for their integrity or for the grade or character of the products advertised.

QUARTZ—direct importers from Brazil of best quality pure quartz suitable for making piezo-electric crystals. Diamond Drill Carbon Co., 719 World Bldg., New York City.

RADIO engineering, broadcasting, aviation and police radio, servicing, marine and Morse telegraphy taught thoroughly. All expenses low. Catalog free. Dodge's Institute, Byrd St., Valparaiso, Ind.

QSL'S, W2SN, Helmetta, N. J.

CALLBOOKS—new DX calls, new prefixes, thousands of new W and VE calls, in the Fall, 1937 Radio Amateur Call Book. Sent postpaid \$1.25, or a whole year (four issues) for \$4. (In foreign countries \$1.35 and \$4.35.) Your call and QRA printed in large type \$1 per year. Radio Amateur Call Book, 610 S. Dearborn, Chicago.

QSL'S, all colors, cartoons, snappy service. Write for free samples today. WIBEF, 16 Stockbridge Ave., Lowell, Mass.

COMPLETE training for all amateur and professional radio licenses. New York Wireless School, 1123 Broadway, N. Y.

QSL'S—Entirely new printing process makes more beautiful cards at lower cost—Send 10¢ in stamps for elaborate kit with which you can design your own card—Astonishingly inexpensive. QSL Company, Box 481, Hartford, Conn.

USED receivers. Bargains. Price list 3¢. W3DQ, 405 Delaware Ave., Wilmington, Del.

CENTRAL Illinois hams—RME equipment. See, write W9ARN.

W2CNL selling out.

QSL'S. Highest quality. Lowest prices. Radio Headquarters, Ft. Wayne, Ind.

RADIO materials. Bankrupt jobber stock. Everything service-men, Hams use. Quality Radio, Richmond, Ind.

QSL'S—2 color—\$1. hundred. Samples. Stamp. W8NOS.

GET an R9 crystal in our new air gap holder near your frequency in the 80 and 160 meter bands. \$1.25. R9 Crystals, 338 Murray Ave., Arnold, Pa.

SELL or trade large oil-filled Westinghouse condensers, \$12, weight 50 lbs., handles 3000 v. O.K. One sufficient for transmitter. W5KD, 215 W. 19, Oklahoma City.

500 watt transmitter complete, \$100; also 7 1/2 kva alternator, 2000 v., 750 watt plate supply. List for stamp. Sell everything too large for house trailer. W5EFV, Alva, Okla.

QSL'S. Cartoons. Free samples. Theodore Porcher, 7708 Navajo St., Philadelphia, Pa.

RADIO, electrical measuring instruments repaired, calibrated, built to order. Measurements made on component radio parts. Peldyne Co., Engineering Bldg., Chicago, Ill.

WANTED: complete amateur fone transmitter 100 watt output. Write full details and lowest cash price. VE4AL, Mossbank, Sask., Canada.

VARIABLE condensers calibrated: ten point calibration against General Radio precision standard. For a limited time, \$1.25. W8MYB, Kiamasha, N. Y.

SELL: Master teleplex. New condition. Copper tapes, blanks. Cotton, 1235 Trenton, Seattle.

CLEARING shack-rack & panel xmitter 47, 46, PR-10's and 2 pwr supplies self contained, with xtal, 40 mtr coils, \$25. Rack & panel 616 tritosc., 616G buffer, 211, like new, final with 200 watts input; complete, \$55. Complete PA system, misc. equipment. F.O.B. W3GES, Red Lion, Pa.

QST'S: Sell 28 copies 1920 to 1933. Fred Elser, 78 Grenada Terr., Springfield, Mass.

QSL'S. Free samples. Printer, Corwith, Iowa.

SAVE 50% on any type transmitting tubes or rebuilt, trade-in accepted. New 203-A, \$12.50. General Electronics, Dobbs Ferry, N. Y.

SELL All-Star 400 watt fone transmitter with 20 and 80 meter coils, new tubes, crystal mike, relay rack, \$300. Lincoln R9 super, 8 to 200 meters with Jensen 12" dynamic, \$50. Barr five meter transceiver \$10, with new tubes. W8KSC, 404 Highland, Turtle Creek, Pa.

SELL—books on commercial radio operating, cheap. VE4AB, LaRiviere, Man.

QSL'S. W8DED QSL's, Glossy white stock. Samples? (stamp). W8DED, Holland, Mich.

CRYSTALS? Order Bliley from W8DED. (Guaranteed).

SELL: Esco Motor-generator 1000 volt 400 milliamperes, 110-220 volt, \$50. Acme filament transformer 110 to 10 or 12 volts 300 watts, \$10. QST and IRE Proceedings from 1926, offer. SW3 with 20-40-80 amateur coils a.c. power pack, \$20. Complete transmitter from 110 volt to antenna terminals operating condition, all crystal controlled with crystal one band. Phone or c.w., 160-80-40 coils, 211 final 212-D modulator velocity mike, panel 21 inches wide by 5 feet high, \$150. Push-Pull RK20 final suppressor modulation crystal microphone, \$100. Portable station, SW4 receiver, 10-2000 meters, speaker, 801 final, Push-Pull 6-L-6 modulator, crystal mike, 160-80-40-20, mounted in carry case, \$100. 802, RK25, 211, 210, Cardwell T183 and National DX 350 and 150 condensers A and N dials, offer. W2AOJ.

QSL cards, neat, attractive, reasonably priced. Samples free. Miller, Printer, Ambler, Pa.

GENERAL Electric dynamotors 24/750 volts 200 mills, \$20. On twelve volts deliver 375. Westinghouse 27 1/2/350, \$10; 200 watts 900 cycles, \$15; 6-15 volts 500 watts Aircraft, \$10. Simon 500 watt 500 cycles with exciters, \$8. Slightly used, \$6. List. Henry Kienle, 215 Hart Blvd., Staten Island, N. Y.

WANTED: Good used 8 to 16 tube short-wave receiver. State make; cash price. Merlin Atkins, Sumner, Ill.

TRANSFORMERS wound to your specifications; special types, etc. Larco Labs., 1616 Hoge Ave., Zanesville, Ohio.

QSL'S, SWL's, 100 3 color 75¢. Lapco, 344 W. 39, Indianapolis, Ind.

TRANSFORMERS, plate 2 1/4 KVA, \$46.80. Chokes, 30H 180 ohms 500 ma. 82 pounds \$10. 10H 30 ohms 1 ampere 75 lb. \$10. Send for circular. Hilet Engineering Co., W. Orange, N. J.

HICKOK instruments. Ham surplus. We trade. Cannady, 38 W. Anderson, Aurora, Mo.

FOR Sale—100-250 watt broadcast transmitter—high fidelity, 100% modulation approved under F.C.C. rule 132. Send for photo and detailed description. Radio Station WHBI, 100 Shipman St., Newark, N. J.

QST'S year 1916 wanted. Sell or trade issues 1919-1933. W9BWH.

SELL: Lafayette 19 transceiver in new condition, complete with tubes, telescope antenna and Universal transceiver set. \$20. W2HCZ, Millerton, N. Y.

SELL or swap for ham gear. Supreme 89-D tester, Weston 665-2 Analyzer, Riders Manuals, Clough-Brengle OC oscillator. Details WALZ, Clarkston, Wash.

MEET the gang on 5. Bulletin describing efficient, stable, and inexpensive long lines oscillator is yours. Write Paradio Sales Co., 124 Garrison Ave., Jersey City, N. Y.

NEW 300 watt all band custom built transmitter 6A6 802 838 five meters, finest parts, complete—\$100. Description. W7IV, 205 Blaine, Missoula, Mont.

QSL'S by Maleco. None better. Free samples. Maleco, 1512 Eastern Parkway, Brooklyn, N. Y.

STATION surplus meters: Westinghouse portable a.c. voltmeter, two ranges, 0-15 and 0-300 \$3; Westinghouse portable d.c. ammeter-voltmeter, eight ranges 0-1.5, 15, 15, 30 amperes, 0-150, 300, 600, 1200 volts \$5; Weston Model 301 500 volt d.c.; 100 milliamperes; ten milliamperes; and five milliamperes, Model 476 10 volt a.c.; 250 volt a.c.; all single range \$2, each; tubes, type 852 \$3.; 203A, 211, 845, 872A \$5, each; 217 \$3; 204A \$20. Melody saxophone \$10. Derrick, Erlton, N. J.

CRYSTALS: Unconditionally guaranteed. Supplied within 5 kilocycles of frequency you specify in 160, 80, or 40 meter band. These are X-cut carefully ground to deliver maximum output and to resist fracture. Exact frequency of crystal written on box. 160 and 80 meter crystals \$1.50, 40 meter crystals \$1.85. For crystals supplied to exact frequency add \$1. to above prices. Try these crystals in your transmitter for thirty days. If not fully satisfied you may return them and your purchase price will be immediately and cheerfully refunded. Wright Radio Labs., 5859 Glenwood Ave., Chicago, Ill. Telephone Sunnyside 6168.

QSL's—printed by an ole timer. W2ABY, 338 Elmors, Elizabeth, N. J.

CRYSTALS: Request descriptive catalog—price list. All amateur types, mounted—unmounted. Unconditionally guaranteed. Ham Crystals, 1104 Lincoln Place, Brooklyn, New York.

NEWEST QSL's—SWL's. Something different. Fritz, 455 Mason, Joliet, Ill.

TRANSMITTER: Improved Lafayette PB46A, 90 watts phone or c.w. all bands including 10, complete with coils, tubes, crystals, antenna coupling unit—\$115. or best offer. W1AA.

QSL'S. 300 one-color cards, \$1. Samples. 2143 Indiana Ave., Columbus, Ohio.

SELL—best offer—Collins 3B xmitr, 204A xmitr or parts, 1 k.w. power supply, W8CMJ.

SELL: New and used transmitting tubes, used 849 carbon plate \$20, two RCA 211's @ \$7. each. New and in original carton. Other bargains. Filter condensers, Weston meters at less than half price. Write for list. D. C. Akers, W2FL, 181 Greenwood Ave., E. Orange, N. J.

SELLING out. Send for list of equipment. W3DQB, Norfolk, Va.

WANTED: Good long-wave receiver covering 600–3000 meters. Miller, Box 20, Lawrenceville, N. J.

FOR sale: Gardiner-Levering automatic sender with 12 rolls of tape, \$6; General Radio test signal generator with tubes type 404, \$5; noise silencer, complete, \$4. W2BCB.

CRYSTALS X 80-160, \$1.50. W9IPD, Iola, Kansas.

SELL out real bargain. Complete new 20–40–80 meter 25 watt fone 80 watt c.w. portable transmitter, never used, best meters, new spare tubes, new 500 watt a.c. generator, type '30 receiver, etc., all \$175. Request list. W1AYG

THREE LD 3500 volt 3 mfd. oil-filled Westinghouse filter condensers, \$20. Fifteen disc omnigraph, 52 records, \$8. Universal DB carbon mike type LL, \$8. W1AYG.

CRYSTALS: Eidson T9 dependable—powerful X cut, 40 and 80 meters \$1.60, fully guaranteed. High harmonic output, our special grinding process resists fracture. Compare the activity or output of T9 crystals with any crystal at any price—judge for yourself. T9 ceramic plug-in holders, \$1.10 postpaid. C.O.D.'s accepted. Eidson's, Temple, Texas or Hieronymus Radio, 88-34 209 St., Queens Village, N. Y.

TEN day trial: RME-69's, \$99; NC100X's, \$99; NC100's, \$89; Breting 14's, \$79; ACR-175's, \$69; ACR-165's, \$49; PR-10's, \$39; Silver 5 B's, \$29; Sky Buddies, \$19; FB7's, \$19; or other sets. List free. Bob Henry, W9ARA, Butler, Mo.

ALL new receivers, transmitters, parts on my 6% plan. Trade in your equipment. Receivers shipped on trial. Write. Bob Henry, Butler, Mo.

SELL—transmitter, 120 watts output; 4 bands; 5 stages; 3 meters; Collins coupler; two power supplies. Nestly mounted on metal chassis for rack mounting. Complete with tubes and coils, \$75. Howard, 5514 Lake St., Chicago.

CRYSTALS, ground to order, 160–80, X cut, ± five kilocycles, \$1.50. Spot frequency, \$2.50. Three semi-finished, 80 meter blanks, including carborundum, \$1.20. Speedy delivery. William Threm, W8FN, 4021 Davis Ave., Cheviot, Ohio.

SELL or swap complete portable station. UHX-10 transmitter, power supply, coils 80, 20 meters xtals, microphone. Zenith 7 tube all-wave 1937 6 volt receiver. Kato 110 volt 300 watt gas generator. Interested cameras or 200 watt phone transmitter. W2EDW.

CRYSTALS unconditionally guaranteed, X cut 7000 k.c.'s, \$1.85, 3500 or 1750, \$1.65, low drift 40–80–160, \$2.20, close frequency supplied. A. E. Rydberg, W9AED, Mitchellville, Iowa.

CABINET for operating table: place for QSL cards, neon bulb, coils, log, call book, message blanks, etc. Only \$1. plus postage. Ask for picture and description. C.O.D. orders O.K. W4DDF, Stratford Ave., Nashville, Tenn.

NEW economical custom-built oscillographs. W8ANT.

ECONOMICAL transmitter kits. W8ANT.

RME-69's and DB-20's in stock. W8ANT.

HALICRAFTER receivers in stock. W8ANT.

RECEIVER headquarters. New and used. W8ANT.

TRANSMITTING tubes. New and used. W8ANT.

ALL lines of new and used amateur equipment bought, sold, exchanged. Write to Southern Ohio's only amateur owned amateur business. Joe. N. Davies, W8ANT, 2767 N. Bend Rd., Sta. A, Cincinnati, Ohio.

SELL Triplett, Universal volt-ohm-milliammeter and free point set tester Model 1167, brand new, \$17. Joseph Rando, 663 Crescent Ave., N. Y. C.

DOLL up your rig with swanky call letter plate. Gives the final touch. See illustrated adv. page 107, September issue QST.

WANTED: used transmitting parts in exchange for 5 X 8 Kelsey hand press and equipment, prints QSL's, etc., W8PTE, Towanda, Pa.

TELEPLEXES, instructographs, omnigraphs, vibroplexes bought, sold. Ryan's, Monroe City, Mo.

211 output, Bliley oven, tubes, phone and c.w., supply, \$40. Want Breting-12. W3ARA, 236 Landis Ave., Vineland, N. J.

QSL'S. Better designs; better stock; better workmanship. Free samples to hams only. W2FJE, 101 Hanson Place, Brooklyn, N. Y.

QST'S—Sell Dec. 1915, buy June 1916. W9ZT, 1623 N. Irving, Minneapolis, Minn.

FOR sale: 115 volt d.c. to 115 volt a.c. 500 watt Esco rotary converter. New condition. \$35. W9CSY, 4923 Newton South, Minneapolis.

TRADE—sell—150-T, RK-20, 872-A's sockets filament xfors, 8UD Class B's, 282-A. Want 852's, 50-T's, xtals. W7EMQ.

FOR sale: Complete NR1 radio and television course, \$25. F. R. Herr, 437 4th Ave., New Kensington, Pa.

SELL: 15 watt 160 c.w. rig. Complete—\$11. W8JGM.

FOR sale: SW5 complete—full coverage coils 10 meters to 120, \$25, cash—30 volt 500 amp. generator. Sell or swap for 110 volt a.c. generator. W1HRR.

WESTINGHOUSE three unit motor generator set, 7.5 H.P. motor, 2,000 volt, 1.5 ampere and 1,000 volt 0.5 ampere generators. Condition perfect. Cost \$1450, sell \$200. Also Westinghouse 75 k.w. rectifier unit. Miller Watkins, Murfreesboro Rd., Nashville.



The Complete Line of Telegraph Keys
 "HI-SPEED"
 Semi-Automatic
 Key

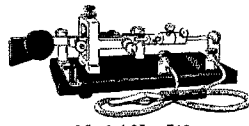

Model No. 510
 Complete with switch cord and plug. List price \$10.75.
 Other models from \$9.25 to \$17.50. Available at leading jobbers everywhere. Write for new literature and Amateur Discounts.

LES LOGAN COMPANY

646 Jessie Street San Francisco

ORIGINAL W8UD CLASS B

UNIVERSAL TRANSFORMERS—Now Improved
 MATCH ALL TUBES

50 WATTS AUDIO, PER PAIR . . . \$4.95 POST
 100 WATTS AUDIO, PER PAIR . . . 7.75 POST
 ONE YEAR GUARANTEE—Write for Data Sheets

Now Sold Exclusively By
 C. R. MALMGREN, W9JXR, WEYERHAEUSER, WIS.

Douglas Radio Products

Unconditionally Guaranteed	PR CRYSTALS	Powerful Reliable
----------------------------	--------------------	-------------------

X cut 7000 KC ± 5 KC . . . \$1.85	3500 or 1750 . . . \$1.65
Low Drift ± 5KC 40-80-160	2.20

PETERSEN RADIO CO. Ex

W9JRY COUNCIL BLUFFS, IOWA W7AHE
 Formerly Omaha Crystal Labs.

BRAZILIAN QUARTZ CRYSTAL

Largest and most varied stock of Brazilian quartz crystals in the United States. Finest quality suitable for manufacturing piezo-electric crystals, lenses, and prisms. Shipments received regularly from our Brazilian Branch. Also in stock tourmalines for making crystals to control the higher frequencies and quartz for fusing purposes.

BRAZILIAN TRADING CO., INC.

377 Fourth Ave., New York City Murray Hill 4-2891

Your Nearest Dealer Is Your Best Friend

Your nearest dealer is entitled to your patronage. You can trust him. He is equipped with a knowledge and understanding of amateur radio. He is your logical and safe source of advice and counsel on what equipment you should buy. His stock is complete. He can supply your needs without delay. His prices are fair and consistent with the high quality of the goods he carries. He is responsible to you and interested in you.

Patronize the dealer nearest you—You can have confidence in him

ATLANTA, GEORGIA

Wholesale Radio Service Company, Inc.
430 West Peachtree Street, N.W.
"Investigate Our Easy Payment Plan"

BALTIMORE, MARYLAND

Radio Electric Service Co.
3 N. Howard St.
Everything for the amateur

BOSTON, MASS.

Wholesale Radio Service Company, Inc.
110 Federal Street
"Investigate Our Easy Time Payment Plan"

BRONX, NEW YORK

Wholesale Radio Service Company, Inc.
542 East Fordham Road
"Investigate Our Easy Payment Plan"

BUFFALO, NEW YORK

Radio Equipment Corp.
326 Elm Street
W80BK — Ham, service and sound equipment — W80LB

BUFFALO, NEW YORK

Dymac Radio
216 E. Genesee Street
Complete Line Ham and BCL Equipment Cl. 2080

JAMAICA, L. I.

Wholesale Radio Service Company, Inc.
90-08 166th Street (Merrick Road)
"Investigate Our Easy Payment Plan"

MONTREAL, CANADA

Canadian Elec. Supply Co., Ltd.
285 Craig St., W.
Quality parts and equipment for discriminating buyers

NEWARK, N. J.

Wholesale Radio Service Company, Inc.
219 Central Avenue
"Investigate Our Easy Payment Plan"

NEW YORK, N. Y.

Gross Radio, Inc.
51 Vesey Street
Fair dealings plus fair prices. Anything in radio

NEW YORK, N. Y.

Wholesale Radio Service Company, Inc.
100 Sixth Avenue
"Investigate Our Easy Payment Plan"

NEW YORK, N. Y.

Harrison Radio Company
12 West Broadway
"The Friendly Ham Supply House"

PHILADELPHIA, PENNSYLVANIA

Eugene G. Wile
10 S. Tenth Street

Complete Stock of Quality Merchandise

PROVIDENCE, RHODE ISLAND

W. H. Edwards Co.
32 Broadway
National, Taylor Tubes, Hallicrafters. Complete amateur supply house

PROVIDENCE, RHODE ISLAND

Kraus & Company
89 Broadway
Everything for the amateur and serviceman

RICHMOND, VIRGINIA

The Arnold Company
527 W. Broad Street
W3EHL—"The Virginia Ham Headquarters"—W3FBL

ROCHESTER, NEW YORK

Radio Parts & Equipment Co.
244 Clinton Avenue, North
Complete stock amateur-BCL parts. Standard discounts

SPRINGFIELD, MASS.

S. S. Kresge Company
1540 Main Street
Standard discounts, standard lines. Advisory service: W1JQ, W1FOF

You Are Protected When You Buy From QST Advertisers

“Advertising for QST is accepted only from firms who, in the publisher’s opinion, are of established integrity and whose products secure the approval of the technical staff of the American Radio Relay League.”

Quoted from QST’s advertising rate card.

Every conceivable need of a radio amateur can be supplied by the advertisers in QST. And you will know the product has the approval of the League’s technical staff.

The Advertisers

Aerovox Corporation	page 94
Aladdin Radio Industries, Inc.	98
Allen-Bradley Company	93
American Communications Company	106
American Microphone Co., Inc., Ltd.	102
Astatic Microphone Laboratory, Inc.	119
Atkins & Brown	99
Birnbach Radio Company, Inc.	88
Billey Electric Company	67
Brazilian Trading Company, Inc.	124
Burgess Battery Company	69
Candler System Company	99
Capitol Radio Engineering Institute	106
Cardwell Mfg. Corp., Allen D.	82
Centralab	71
Cohen’s Sons, Ltd., I. S.	109
Collins Radio Company	Cov. 2
Condenser Products Company	88
Consolidated Radio Corp.	117
Cornell-Dubilier Corp.	96
Coto-Coil Company, Inc.	102
Davega	113
Delaware Radio Sales Company	97, 115
Dodge’s Institute	118
Douglas Radio Products	124
Eitel & McCullough, Inc.	77
Freck Radio & Supply Company	109
Gardiner-Levering Company	98
General Transformer Corp.	92
Gordon Specialties Company	110
Gross Radio, Inc.	87
Gulf Radio School	90
Hallcrafters, Inc., The	1, 2
Hammarlund Manufacturing Co., Inc.	6, 95
Harvey Radio Company	108
Harvey Radio Laboratories, Inc.	97
Hatry & Young	112
Henry Radio Store	111
Hinds & Edgerton	90
Hipower Crystal Company	119
Instructograph Company	107
International Resistance Company	63
Isolantite, Inc.	79
J-M-P Manufacturing Company	114
Jensen Radio Mfg. Company	91
Johnson Company, E. F.	114
Kato Engineering Company	107
Kenyon Transformer Company, Inc.	107
Leeds	66
Leuck Electric	110
Logan Company, Les	124
Mallory & Company, Inc., P. R.	62
Massachusetts Radio School	102
McElroy, T. R.	98
McGraw-Hill Book Company	72
Midland Television, Inc.	86
National Carbon Company, Inc.	Cov. 3, 61, 92, 76
National Company, Inc.	103
Newark Electric Company	64, 65
New York Y. M. C. A. Schools	119
Ohmite Manufacturing Company	78
Petersen Radio Company	124
Port Arthur College	95
Precision Apparatus Corp.	84
Precision Piezo Service	97
RCA Institutes, Inc.	111
RCA Manufacturing Company	Cov. 4, 73
Radio Constructors Laboratories	118
Radio Mfg. Engineers, Inc.	127
Radio Shack, The	109
Radio Supply Company	113
Radio Transceiver Laboratories	118
Scientific Radio Service	107
Signal Electric Mfg. Company	122
Simpson Electric Company	115
Solar Manufacturing Corp.	81
Special Carbon Company	68
Standard Transformer Corp.	75
Sun Radio Company	116
Taylor Tubes, Inc.	85
Teleplex Company	111
Terminal Radio Corp.	117
Thordarson Electric Mfg. Company	89
Transmitter Equipment Mfg. Company	103
Trim Radio Mfg. Company	110
Triplet Electrical Instrument Co., The	83
Turner Company, The	111
United Transformer Corp.	128
Universal Microphone Company, Ltd.	90
Utah Radio Products Corp.	119
Valpey Crystals, The	114
Vibroplex Company, The	97
Ward-Leonard Electric Company	107
Western Electric Company	80
Wilson, Willard S.	97
Wincharger Corporation	110
Yaxley	62

WINNING DX CONTESTS

with
RME Equipment

*has now become
"standard practice"*

Winners *must* have apparatus that they can depend upon . . . it *must* be able to perform under all conditions . . . it *must* be good for 24-hour service . . . and it *must* have all of the features built in that make possible contact under the most severe operating conditions.

We could think of no better testimony than the fact that these recent winners have used RME-69 receivers in showing the world what can be done . . .

The RME-69 does the job — whether for phone or CW contacts. Full information will be sent on request

RADIO MFG. ENGINEERS, INC., PEORIA, ILLINOIS

RME - 69

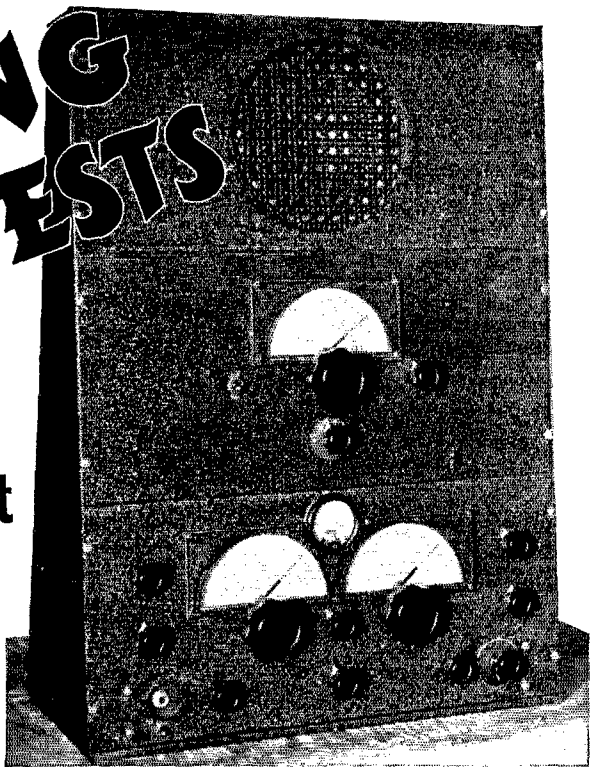

INTERNATIONAL TELEPHONE

Contest Winners

K6MVB Kenneth C. Bryan
First Place International "Leader in QSOs"

W9ARA Robert Henry
First Place W/VE

INTERNATIONAL TELEGRAPH

Contest Winners

W2UK Ralph E. Thomas
First Place W/VE

W2AIW C. W. Rogers
Fourth Place W/VE

UTC BEAM POWER AMPLIFIERS

The UTC PAK kits are now acknowledged by the PA field as ideal Universal amplifiers. PAK power amplifier kits are available with outputs of 8, 15, 35, 55, 70, 110 and 250 watts. Stabilized feedback can be used in the PAK-1, PAK-2, PAK-3 and the PA output transformers have special feedback windings for this purpose. There is provision for mixing of two high impedance inputs. An etched panel providing a dual gain, two position mixer with gain links for high or low gain on each position and a VARITONE equalizer control are now standard equipment on these kits.

PAK-1XM Self bias 35 watt output. Audio and power on separate chassis for rack or cabinet mounting. High impedance input 110 to 120 DB gain. Provision for immediate switch-over to 95 DB gain with connections either for triode plate or 500-200 ohm input line. VARIMATCH modulation output transformer. Impedances available are 220, 408, 1180, 2350, 2400, 3000, 4000, 4670, 5560, 7000, 9150, 9470 ohms. Includes all components and accessories such as resistors, condensers, sockets, calibration plates, etched mixer panel, controls and accessories for a dual gain, two position high impedance mixer, chassis, dust covers with handles, hardware — except tubes — all fully mounted. List Price \$80.00. Your Cost..... **\$48.00**

PAK-2XM Same chassis layout as PAK-1XM but has output of 55 watts in fixed bias. VARIMATCH modulation output transformer. Impedances on 3800 ohms plate to plate 380, 660, 2050, 3740, 4100, 7000, 7500, 8200, 12,000, 15,000, 16,400, 21,500, 29,800. On 4000 ohm plate to plate 237, 1300, 1750, 2700, 3270, 5200. List Price \$85.00. Your Cost..... **\$51.00**

Tubes required for PAK-1M and PAK-2M kits are 1-6J7, 3-6C5's, 2-6L6's, 1-83.

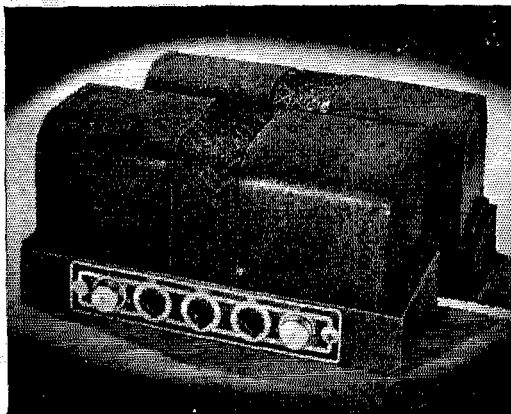

VARITRAN ★ VOLTAGE CONTROL UNITS

- | APPLICATIONS | FEATURES |
|------------------------|------------------------|
| ★ Line voltage control | ★ Smooth control |
| ★ Rectifier control | ★ High efficiency |
| ★ Motor control | ★ Excellent regulation |
| ★ Heat control | ★ Low cost |
| ★ Light control | |

The UTC VARITRAN makes possible continuously variable output voltage, using a sliding contact riding over the turns of an auto-transformer.

Standard units are designed for 115 volts input, 0-130 continuously variable output.

- Model V-1.** 570 Watts — 5 amp. maximum rating, complete with cord, plug and switch, net..... **\$10.00**
- Model V-2.** Same as V-1, but uncased, with terminal strip for rack or panel mounting, net..... **\$9.00**
- Model V-3.** 850 watts maximum rating, 7.5 amps., uncased, with terminal board and provisions for mounting, net..... **\$14.00**
- Model V-4.** 1250 watts — 11 amps. maximum rating, uncased, net..... **\$20.00**
- Model V-5.** 2000 watts maximum rating, 17.5 amps., uncased, net..... **\$32.00**



UTC CATHODE RAY OSCILLOSCOPE

The UTC OSCILLOSCOPE Incorporating the new 2" cathode ray tube has every feature required for application in the radio field. It includes linear sweep, audio amplification, brilliance, focus, beam centering and amplitude controls. Grouping of the controls on the simple control panel is such that rapid and simple adjustment is possible. The entire unit is housed in a black crystal finished carrying case with etched aluminum front panel. The size of this unit is extremely small considering the 2" cathode ray tube and multiplicity of **\$30.00** applications. Net price, complete, less tubes.....

TYPICAL FEATURES ARE

- Large Tube..... 2" screen
- Linear sweep..... 15 to 25,000 cycles
- Amplifier response..... 30 to 20,000 cycles
- High sensitivity..... .2 volts per inch (amplified)
- All controls including beam centering on main panel
- Small size..... 6½ x 10 x 9½ inches overall
- A.C. Power Supply..... 115 volts — 60 cycles
- Tubes used..... 8B5, 80, 6J7, 6K7, 24-XH
- Low hum pickup..... choke filtered plate supply

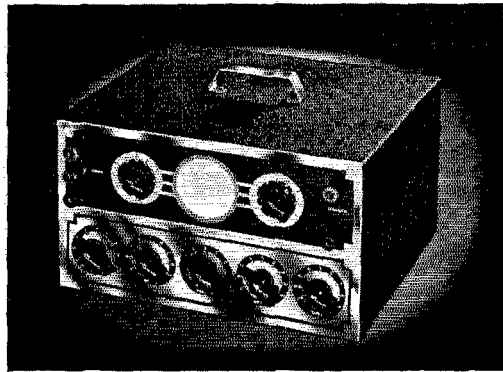

UNITED TRANSFORMER CORP.

72 SPRING STREET

NEW YORK, N. Y.

EXPORT DIVISION 100 VARICK STREET NEW YORK, N. Y. CABLES: "ARLAB"

IT would have been nice if such an outstanding new development as the wide-range crystal filter had been introduced on a high-priced "Super-De Luxe-Ultra" Receiver. But it was too good to keep just for that, because for the first time it has made it possible to build a really fine receiver at a low price.

THE crystal circuit provides selectivity continuously variable from 400 cycles to 5 kilocycles, and has wide range phasing control. By its use, interference and noise are so reduced that a favorable signal-to-noise ratio can be obtained without the signal gain of a preselector. The high IF frequency (1560 KC.) makes it possible to reject image-frequencies without the extra selectivity of a preselector.

THIS is the basic idea back of the NC-81X. To it have been added other new developments, such as the new beam tubes, that take AC-DC sets out of the "midget" class. And to it, also, have been added older time-proven developments such as the "Movable Coil Tuning Unit" of the NC-100, and the Amateur-Band-Spread of the HRO.

THE new NC-81X is in many ways the most extraordinary receiver National has ever built. Do not judge it by its very low price. Test it — where the going is toughest.

NC-81X

Get "Broadcast Quality"

WITH THE NEW RCA Model ACT-150 Transmitter

RCA offers in this new design many worthwhile features that will appeal to the advanced amateur radio operator. Look these outstanding features over and carefully consider all the engineering features RCA Engineers have put into this—the most efficient—most economical 150-watt transmitter ever offered by anyone.

- 150 watts output C.W. and Phone from 10 to 160 meters
- Special Speech Amplifier with Inverse Feedback for high quality voice reproduction
- R.F. feedback practically impossible
- Modulation indicator
- Coils and crystal easily accessible
- Conservative ratings on all parts
- Transformers given special impregnation
- Circuits fully metered
- Attractive cabinets and panel layout
- "Tune-up" protection
- Low tube and accessory cost.

R-F—RCA-807 crystal oscillator, RCA-802 buffer/doubler, 2 RCA-807 drivers, 2 RCA-808 final amplifiers.

Audio—RCA-6J7 input, RCA-6C5 amplifier, 2 RCA-2A3 drivers, 2 RCA-808 modulators.

Power Supply—RCA-80 for speech amplifier, RCA-83 for exciter, RCA-5Z3 for bias and driver plate, 2 RCA-866 for high voltage.

AMATEUR'S NET PRICE

f.o.b. factory with speech amplifier and one set of coils but less tubes, microphone, crystal and other minor accessories. **\$625⁰⁰**

See your supplier or write for descriptive literature

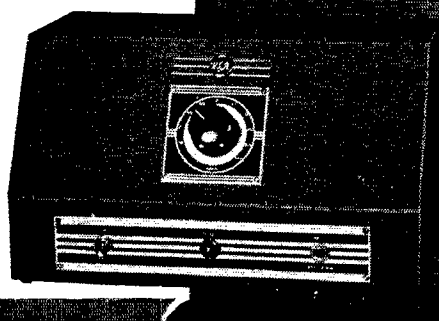
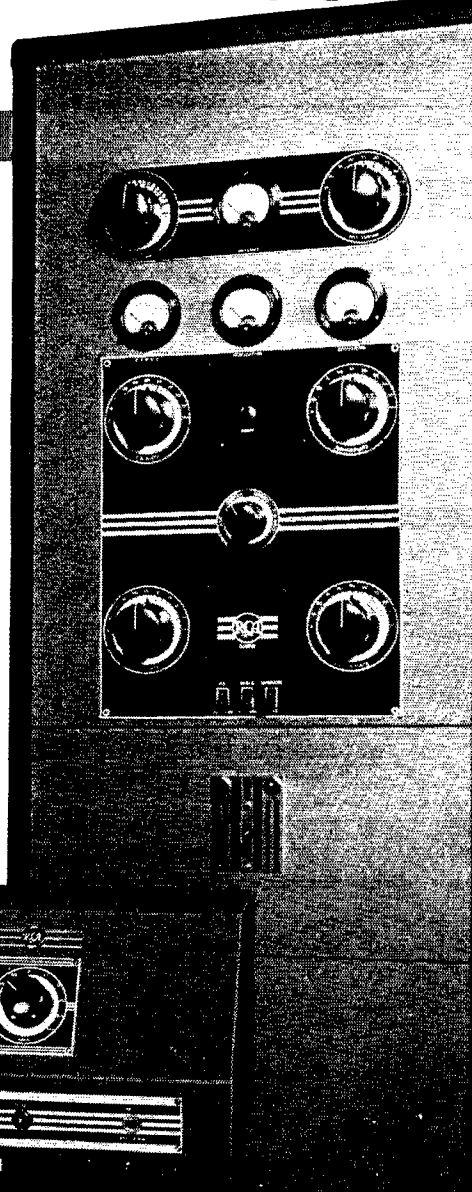

for Amateur Radio

AMATEUR RADIO SECTION

RCA MANUFACTURING CO., INC., Camden, N. J. - A Service of the Radio Corporation of America