

# QST

October, 1938

25 CENTS

devoted entirely to

# amateur radio

In this issue—

New  
Developments  
in  
Transmitter  
Design



# A *New* GENERAL PURPOSE TRANSMITTER

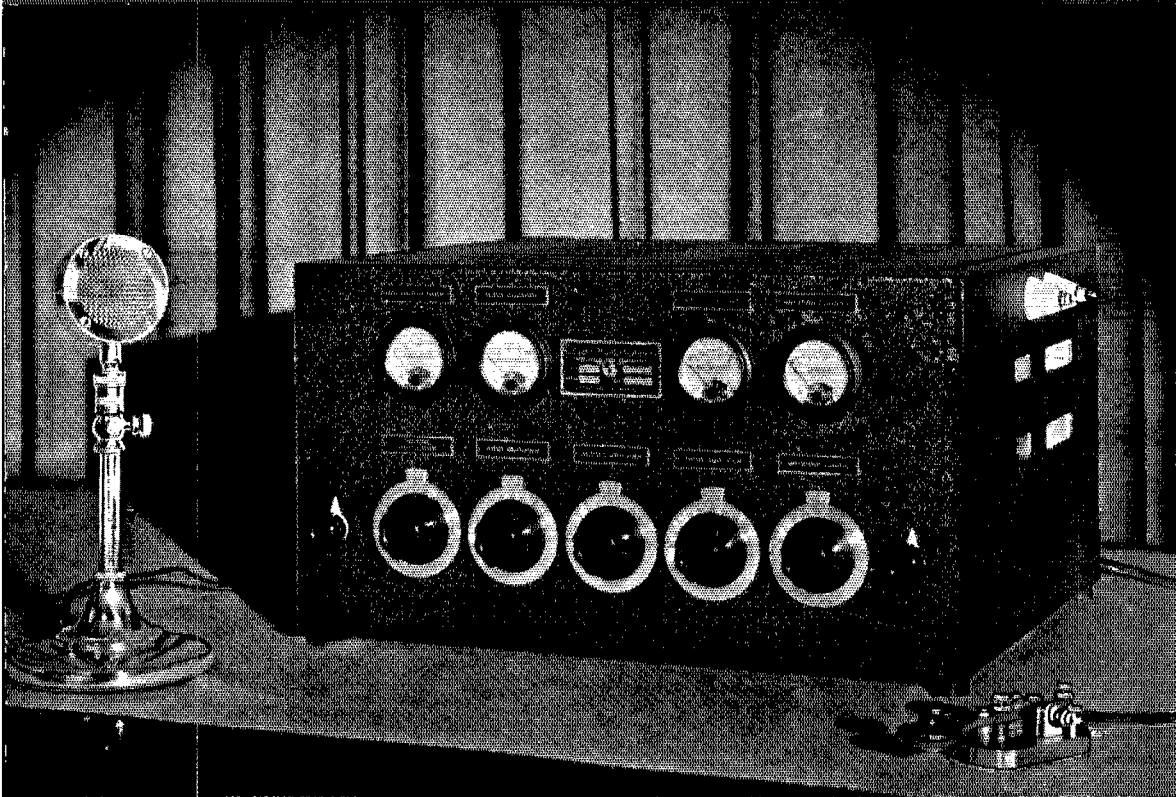

■ THE NEW 32G fully exploits the possibilities of the 6L6 tubes to provide an efficient, low cost, thoroughly modern 25 watt transmitter. R-F tubes are C-100A oscillator, 6L6 first doubler, 6L6 second doubler, 2—6L6 final amplifiers. Frequency range with plug in coils and self contained antenna network is 1500—15,000 kc. The 32G can be operated on frequencies as high as 30,000 kc. with slightly reduced output. Dimensions: 20 x 16 x 10½ inches. Weight: 78 pounds.

The 32G is ideally suited to many applications in amateur, mobile, portable, marine military and police work. Details of the basic design can be modified for special requirements. In short, the 32G is a general purpose low-powered transmitter built in accordance with Collins standards of quality.

Correspondence is invited and the adaptation of the 32G to your problem will be given careful consideration.

## Collins Radio Company

CEDAR RAPIDS  
New York  
11 West 42nd St.



IOWA, U. S. A.  
Mexico City  
Edificio "La Nacional"

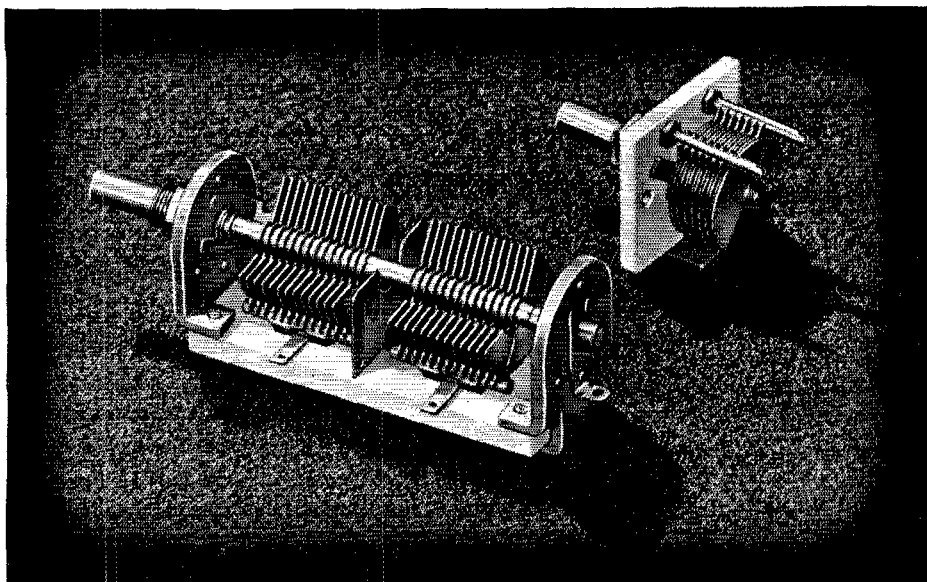

## THE NEW "HF" VARIABLE CONDENSERS

**T**HIS new series of ultra-high frequency variable condensers by Hammarlund, has a score of advanced, exclusive features that will afford highest efficiency as tuning or trimmer condensers for critical ultra-high frequency work.

Single and dual types have cadmium plated, soldered brass plates, and B-100 Isolantite for insulation to insure lowest losses, rigidity, and stability.

In the single unit any one of three different mounting methods may be used. One is a bracket or base mounting; another is a single hole panel mount, and the third is a panel mounting employing spacer bushings which permit complete insulation of both rotor and stator sections. The dual model has single hole panel mounting and base mounting features.

Absolutely noiseless operation is another feature of these new condensers. For example, the dual model has a split rear bearing with individual noiseless

wiping contacts for each section. Rotor contacts can be shifted to several positions via special pins to facilitate wiring with shortest possible leads. Dual model has a special shield with provisions for ground connection.

Single models available in sizes from 15 mmf. to 140 mmf. and a double-spaced 30 mmf. model. Dual sizes range from 50 mmf. to 140 mmf. with also a 30 mmf. double spaced model.

The 140 mmf. single style is only  $1\frac{9}{32}$ " high,  $1\frac{5}{16}$ " wide, and  $1\frac{13}{16}$ " long (behind panel), while the 140 mmf. dual is only  $1\frac{1}{2}$ " high, 1" wide, and  $3\frac{3}{4}$ " long (behind panel). Both models have  $\frac{1}{4}$ " shafts.

The new "HF" condensers are the perfect condensers for your most important work!

Send for a copy of the special "HF" condenser bulletin with further details of these new units. Mail the coupon below.



**FOR FULL  
DETAILS**

Hammarlund Manufacturing Co., Inc.  
424-438 W. 33rd St., New York

Q-10

Check here for new "HF"  
condenser bulletin

Check here for the 1936  
Hammarlund catalog

Name.....Address.....

**MAIL  
TODAY**

**HAMMARLUND'S 25<sup>TH</sup> YEAR**

# "MARINE" 270-B Transmitter

350 Watt—Phone and C.W.

- 1. Ideal tube line-up. 802 Crystal oscillator — 802 buffer — 804 inter-amplifier — pair of 203-H's in push-pull. Two 838s as modulators.
- 2. Built-in oscilloscope for visual monitoring of modulation.
- 3. Self-contained power supply built for continuous full-load operation. No auxiliary batteries needed. Front of panel and remote controls. Safety door interlocks. Complete overload protection.
- 4. Adequately metered in all stages to insure precision tuning and efficient operation.
- 5. Working frequency range 1500 to 30,000 kcs., phone or C.W.
- 6. Built-in universal antenna impedance matching network.
- 7. Husky and rigid double-wall all-metal steel cabinet with each component chassis easily removable as a unit.
- 8. Attractively finished to resist corrosion in all climates. Exterior black wrinkle finish, interior in duco aluminum. All chassis cadmium plated.

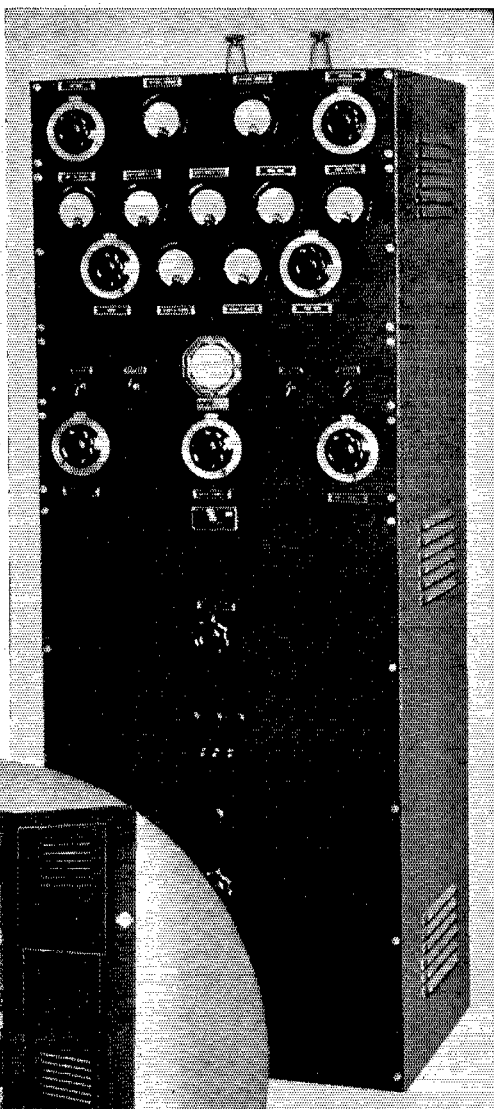

## MARINE RADIO COMPANY

60 Lispenard St.  
New York, N. Y.

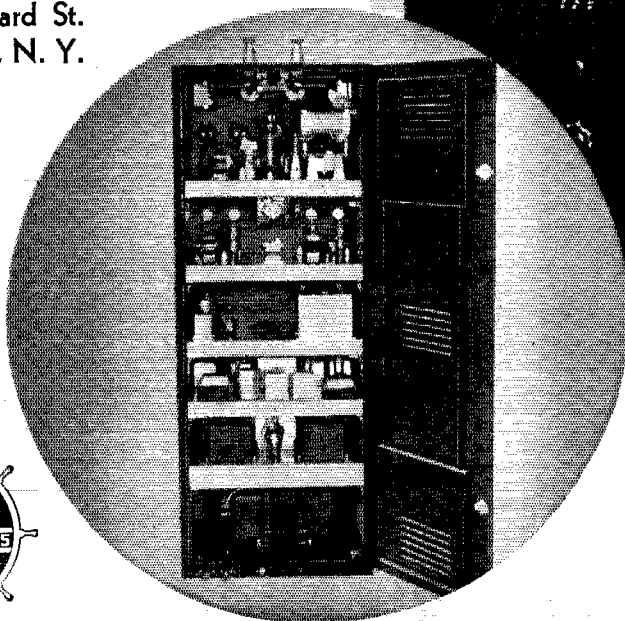

● Get the whole story of this and other ultra-modern transmitters by writing for Bulletin No. 1036. ●

# QST

devoted entirely to

# AMATEUR RADIO

PUBLISHED, MONTHLY, AS ITS OFFICIAL ORGAN, BY THE AMERICAN RADIO RELAY LEAGUE, INC., AT WEST HARTFORD, CONN., U. S. A.; OFFICIAL ORGAN OF THE INTERNATIONAL AMATEUR RADIO UNION

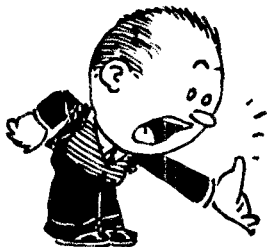

OCTOBER  
1936

Volume XX  
Number 10



Kenneth B. Warner (Secretary, A.R.R.L.), *Editor-in-Chief and Business Manager*; Ross A. Hull, *Associate Editor*; James J. Lamb, *Technical Editor*; George Grammer, *Assistant Technical Editor*; Clark C. Rodimon, *Managing Editor*; David H. Houghton, *Circulation Manager*; F. Cheyney Beekley, *Advertising Manager*; Ursula M. Chamberlain, *Assistant Advertising Manager*.

*Editorial and Advertising Offices*

38 La Salle Road  
West Hartford, Connecticut

Subscription rate in United States and Possessions and Canada, \$2.50 per year, postpaid; all other countries, \$3.00 per year, postpaid. Single copies, 25 cents. Foreign remittances should be by international postal or express money order or bank draft negotiable in the U. S. and for an equivalent amount in U. S. funds.

Entered as second-class matter May 29, 1919, at the post office at Hartford, Connecticut, under the Act of March 3, 1879. Acceptance for mailing at special rate of postage provided for in section 1103, Act of October 3, 1917, authorized September 9, 1923. Additional entry at Concord, N. H., authorized February 21, 1929, under the Act of February 28, 1925.

Additional second-class entries to cover sectional editions authorized March 20, 1935. Copyright 1936 by the American Radio Relay League, Inc. Title registered at United States Patent Office.

## The Contents

Editorials . . . . .	9
Navy Day Receiving Competition . . . . .	10
A Medium-Power Transmitter for 7-, 14- and 28-mc. Bands . . . . . <i>George Grammer, W1DF</i>	11
A Cheap and Efficient Vertical Antenna for 7- and 14-mc. Operation <i>O. S. Keay, W9SJK and Joe L. Pebousbek, Jr., W9EFK</i>	18
1936 VK-ZL International DX Contest . . . . .	20
Multi-tube Oscillators for the Ultra-High Frequencies <i>Paul Zottu</i>	21
Five-Meter Crystal-Controlled Push-Pull 800 Output <i>John L. Reinartz, W1QP</i>	24
A Crystal Filter and Noise Silencer for the "High-Performance" Super . . . . . <i>George Grammer, W1DF</i>	28
A Novel All-Band Transmitter of One-Kilowatt Capacity <i>William W. Eitel, W6UF and Jack A. McCullough, W6CHE</i>	31
Amateur Application of the Magic Eye, Part I <i>L. C. Waller, W2BRO</i>	35
W9ERU Wins Code Speed Contest . . . . .	39
Hamdom . . . . .	40
Laboratory-Type Beat Frequency Audio Oscillator and R.F. Signal Generator, Part II, Signal Generator <i>Clinton B. DeSoto, W1CBD</i>	41
Dixie Jones' Owl Juice . . . . .	45
Watt a Chirp from Dominica <i>John M. Murray, W2AMD</i>	46
Results, June '36 A.R.R.L. "F.D." . . . . .	47
Class-B "Squirt" Modulation With a Pentode Class-C Stage . . . . . <i>E. S. Young, W9AEN</i>	51
Hints and Kinks	
The Class C Audio Amplifier Applied to Regenerative Receivers — Automatic Tone Control — Single Control of Transmitter, Receiver and Monitor — Measuring Power with the Watthour Meter — Calibrating the Receiver for General Coverage — Switching 53 Sections — A Handy Alcohol Lamp from the Junk Box — A Method of Measuring Frequency Drift . . . . .	54
Calls Heard . . . . .	58
Amateur Radio Stations . . . . . <i>VK4DO, W6ETX</i>	59
I.A.R.U. News . . . . .	60
Operating News . . . . .	62
Correspondence Department . . . . .	69
Atlantic Division Convention . . . . .	88
North Dakota State A.R.R.L. Convention . . . . .	90
South Dakota State Convention . . . . .	92
Moncton Hamfest . . . . .	94
Standard Frequency Transmissions . . . . .	96
Ham-ads . . . . .	123
QST's Index of Advertisers . . . . .	126

# NEW 1937 hallicrafter SUPER SKYRIDER

## A FINER AMATEUR RECEIVER

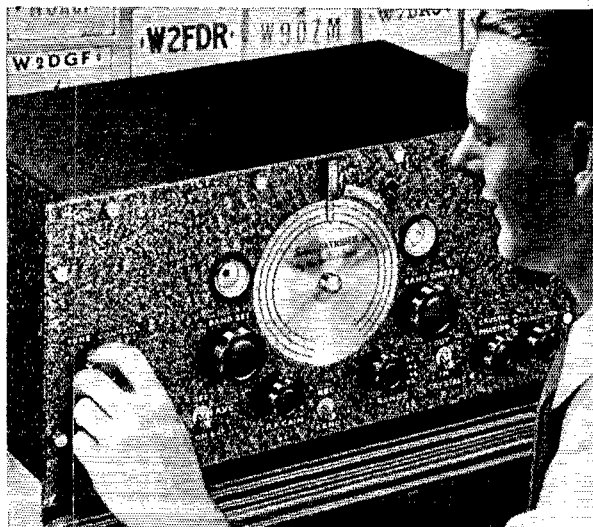

### HERE ARE A FEW OF THE MANY NEW 1937 SUPER SKYRIDER FEATURES:

- 11 Tubes, 10 of them metal.
- 40 M.C. to 535 K.C. in 5 bands.
- 338 Degrees main tuning dial.
- Electro-Mechanical Band Spread
- 14 Watts Undistorted Output
- Direct Calibration Tuning — No Charts or Tables.
- Field Strength Indicator.
- Improved 10 meter performance.
- Single Signal Crystal Action.
- 465 K.C. Iron Core I.F. for improved selectivity.
- Ceramic Insulation.

THE NEW 1937 11-tube Super Skyrider is outstanding! There are many exclusive new features of engineering—design—construction, not to be found on any other communication receivers.

No charts or graphs are needed to read the new Super Skyrider Dial — station frequencies at a glance! That is only one feature of this most conveniently operated set. Higher sensitivity—new and improved phone reception—and 30 other features. And, best of all, you can buy it on TIME PAYMENTS from your radio jobber.

*There Are Many Other New Hallicrafters Communication Receivers to Choose From!*

**THE SKY BUDDY**—A real 5-tube Hallicrafters engineered communication receiver at an astonishingly low price. **THE SKY CHIEF**—This new 7-tube superheterodyne is designed with all the latest features usually found only on much higher priced sets. **THE ULTRA SKYRIDER**—The receiver for the Ultra-High Frequency operator. **THE SKYRIDER COMMERCIAL**—An 11-tube superheterodyne especially fitted for commercial service.

the hallicrafters inc.

Laboratories and Communications Division

2611 Indiana Ave. Chicago, U. S. A.

**NOW YOU CAN BUY ANY NEW 1937  
HALLICRAFTERS COMMUNICATION RECEIVER ON TIME  
PAYMENTS FROM YOUR LOCAL RADIO JOBBER**

NOW YOU CAN BUY  
ANY OF THE NEW

# 1937 hallicrafters

COMMUNICATION RECEIVERS

## ON TIME PAYMENTS!

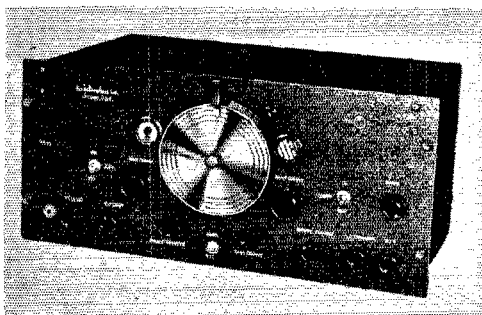

**THE NEW 1937 SKYRIDER** is better than ever before, with greater sensitivity and selectivity, more features and is now offered with 11 tubes — amateur radio's popular receiver and one of its greatest values.

**WE ARE PROUD** to present the amazing new 1937 Hallicrafters Line. We have seen these marvelous new receivers, listened to them, and are glad to extend them our fullest endorsement.

We can say with authority that this 1937 Hallicrafters Line is the most complete of fine amateur radio receivers. Mail the coupon below for complete specifications and details of our time payment plan today.

## MAIL THIS COUPON!

### HINDS & EDGERTON

ESTABLISHED 1914

19 South Wells St., Chicago, Illinois

Gentlemen:

Please send me complete details of the New 1937 Hallicrafters Line and the Hinds & Edgerton Time Payment Plan.

NAME.....

ADDRESS.....

CITY.....STATE.....

#### TIME PAYMENTS

Buy your new Hallicrafters receiver on Hinds & Edgerton's Time Payment Plan — small down payment and easy monthly payments — write at once for details!

**OPERATED BY W9APY AND W9WR**

# Get Your New SUPER SKYRIDER on TIME PAYMENTS

TIME PAYMENTS  
available

On the Entire  
1937  
Hallicrafter  
Line



WE ARE delighted to present the finest line of communications receivers ever built—the New 1937 Hallicrafters! Each dial is completely calibrated the way all precision receivers should be—so that you know instantly what frequency you are on and where every other signal will be found. Then, too, the Hallicrafters are fully licensed by all the important patent holding companies and unlike other manufacturers, are not handicapped by working under patent restrictions.

## TIME PAYMENTS

We have arranged TIME PAYMENTS on all of the New 1937 Hallicrafters Skyriders! There's only a small down payment when you buy—the balance is spread out over the months you are enjoying your New Hallicrafter Skyrider! Don't use obsolete equipment another week! Send us the coupon TODAY—find out how easy it is for you to own the LATEST SKYRIDER!

## MAIL THIS COUPON!

### THE RADIO SHACK

46 BRATTLE STREET

BOSTON, MASS.

Please send me complete technical data on new Hallicrafters Receivers.

Name.....Address.....

City.....State.....



## Section Communications Managers of the A.R.R.L. Communications Department

All appointments in the League's field organization are made by the proper S.C.M., elected by members in each Section listed. Mail your S.C.M. (on the 16th of each month) a postal covering your radio activities for the previous 30 days. Tell him your DX, plans for experimenting, results in 'phone and traffic. He is interested, whether you are an A.R.R.L. member or get your QST at the newsstands; he wants a report from every active ham. If interested and qualified for O.R.S., O.P.S. or other appointments he can tell you about them, too.

Eastern Pennsylvania Maryland-Delaware-District of Columbia Southern New Jersey Western New York Western Pennsylvania	W3EZ  W3BAK W3ZY W8DSS W8OFO	<b>ATLANTIC DIVISION</b> James M. Bruning	339 W. Lancaster Ave.  1107 Park Ave. 310 E. Walnut St.	Haverford  Laurel, Delaware Collingswood Onedia Lowber
Illinois Indiana Kentucky Michigan* Ohio Wisconsin	W9KJY W9TE W9AUH W8DPE W8AQ W9ATO	<b>CENTRAL DIVISION</b> L. John Huntoon Arthur L. Bram G. W. Mossbarger Harold C. Bird E. H. Gibbs E. A. Cary	327 Brandon Ave. 530 East Morris St. Box 177 R.F.D. 2 300 High St. 3922 No. 19th Pl.	Glen Ellyn Indianapolis Camp Taylor Pontiac Wadsworth Milwaukee
North Dakota South Dakota Northern Minnesota Southern Minnesota	W9OEL W9SEB W9OWU W9DCM	<b>DAKOTA DIVISION</b> Hartwell B. Burner Andrew J. Kiar Leonard Hofstad Webster F. Soules	257 Prospect Ave.  3549 36th Ave., So.	Hope Pierre Elbow Lake Minneapolis
Arkansas Louisiana Mississippi Tennessee	W5ABI W5DWW W5CWO W4BBT	<b>DELTA DIVISION</b> H. E. Vette W. J. Wilkinson, Jr. J. H. Weems, Jr. Merrill B. Parker, Jr.	2918 West 15th St. 1523 Laurel St. P. O. Box 244 1912 Oak St.	Little Rock Shreveport State College Chattanooga
Eastern New York N. Y. C. & Long Island Northern New Jersey	W2LU W2AZV W2FOP	<b>HUDSON DIVISION</b> Robert E. Haight E. L. Baunach Charles J. Hammersen	511 South Holmes St. 7823 10th Ave. 92 Claremont Ave.	Scotia Brooklyn Verona
Iowa Kansas Missouri Nebraska	W9LEZ W9FLG W9CJR W9FAM	<b>MIDWEST DIVISION</b> Phil D. Boardman O. J. Snetter J. Dewey Mills Samuel C. Wallace	325 Kirkwood Blvd. 305 Western Ave. Box 205 Green St.	Davenport Topeka Mount Vernon Clarke
Connecticut Maine Eastern Massachusetts Western Massachusetts New Hampshire* Rhode Island Vermont	W1CTI W1CDX W1ABG W1JAH W1BFT W1HRC W1GNF	<b>NEW ENGLAND DIVISION</b> Frederick Ellis, Jr. John W. Singleton Albert N. Giddis William J. Barrett Carl E. Evans Clayton C. Gordon Alvin H. Battison	19 Merrill Rd. 73 Allen St. 128 Crawford St. 239 Columbia St. 80 No. State St. 206 California Ave. 1 Central St.	Norwalk Wilton Lowell Adams Concord Providence Windsor
Alaska Idaho Montana Oregon Washington	K7PO W7NH W7CRH W7AJV W7WY	<b>NORTHWESTERN DIVISION</b> Richard J. Fox Nellie H. Hart Russell U. Richmond Eugene E. Lovejoy Robert H. Votaw	Box 301 Box 6 3435 N. E. 21st Ave. Route 1, Box 398	Ketchikan Twin Falls Somers Portland Vancouver
Hawaii Nevada Santa Clara Valley East Bay San Francisco Sacramento Valley Philippines* San Joaquin Valley*	K6EWQ W6BIC W6FBW W6JFV W6SG W6DVE KA1GR W6LPE	<b>PACIFIC DIVISION</b> Atlas O. Adams Edward W. Heim Fibert Amarantes Harold J. Birchfield Alan D. Whittaker, Jr. Geo. L. Woodington George L. Rickard Angelo V. Astone	21st Infantry Brigade 509 Claremont St. 475 So. 11th St. 2240 106th Ave. 79 Elinor Ave. 716 Redwood Ave. Box 849 729 Safford	Schofield Barracks Reno San Jose Oakland Mill Valley North Sacramento Manila Presto
North Carolina Virginia West Virginia	W4OG W3UVA W8KKG	<b>ROANOKE DIVISION</b> H. S. Carter Charles M. Waff, Jr. Dr. Wm. H. Rihelddaffer	115 Crafton St. P. O. Box 1212	Winston-Salem Univ., Charlottesville Lost Creek
Colorado Utah-Wyoming	W9FA W7COH	<b>ROCKY MOUNTAIN DIVISION</b> Glen Glasscock Townsend J. Rigby	2164 So. Corona St.	Denver Midwest, Wyoming
Alabama Eastern Florida Western Florida Georgia-So. Carolina-Cuba- Isle-of-Pines-Porto Rico- Virgin Islands	W4DGS W4ASR W4MS  W4CE	<b>SOUTHEASTERN DIVISION</b> James F. Thompson William C. Shelton Edward J. Collins  Bannie L. Stewart	2248 S. Arlington Ave. 556 Westmoreland Drive 1517 East Brainard St.  C.C.C. Co. 4466	Birmingham Daytona Beach Pensacola  York, S. C.
Los Angeles Arizona San Diego	W6GNM W6LVG W6EOP	<b>SOUTHWESTERN DIVISION</b> Don M. Draper C. C. Day Harry A. Ambler	4421 West 63 St. "La Posta Quemada" 4101 Hamilton St.	Los Angeles Vail San Diego
Northern Texas Oklahoma Southern Texas New Mexico	W5BII W5CEZ W5BDI W5CGJ	<b>WEST GULF DIVISION</b> Richard M. Cobb Carter L. Simpson Ammon O. Young Joseph M. Eldodt	Box 185 2010 So. 4th St. 4803 Eli St.	Dodd City Ponca City Houston Chamita
Maritime	VE1DQ	<b>MARITIME DIVISION</b> A. M. Crowell	69 Dublin St.	Halifax, N. S.
Ontario	VE3QK	<b>ONTARIO DIVISION</b> John Perdue	229 Askin Boulevard	Windsor, Ont.
Quebec	VE2EE	<b>QUEBEC DIVISION</b> Stan Comach	780 Brault Ave.	Verdun, P. Q.
Alberta British Columbia	VE4X VE5EP	<b>VANALTA DIVISION</b> Alfred D. Kettenbach D. R. Vaughan-Smith	1221 Burnaby St.	Rockyford Vancouver
Manitoba Saskatchewan	VE4BG VE4EL	<b>PRAIRIE DIVISION</b> A. J. R. Simpson Wilfred Skafte	71 Thelmo Mansions 2040 McTavish St.	Winnipeg Regina

\* Officials appointed to act until the membership of the Section choose permanent S.C.M.'s by nomination and election.

# The American Radio Relay League



• **T**HE AMERICAN RADIO RELAY LEAGUE, INC., is a non-commercial association of radio amateurs, bonded for the promotion of interest in amateur radio communication and experimentation, for the relaying of messages by radio, for the advancement of the radio art and of the public welfare, for the representation of the radio amateur in legislative matters, and for the maintenance of fraternalism and a high standard of conduct.

It is an incorporated association without capital stock, chartered under the laws of Connecticut. Its affairs are governed by a Board of Directors, elected every two years by the general membership. The officers are elected or appointed by the Directors. The League is non-commercial and no one commercially engaged in the manufacture, sale or rental of radio apparatus is eligible to membership on its board.

"Of, by and for the amateur," it numbers within its ranks practically every worth-while amateur in the nation and has a history of glorious achievement as the standard-bearer in amateur affairs.

Inquiries regarding membership are solicited. A bona fide interest in amateur radio is the only essential qualification; ownership of a transmitting station and knowledge of the code are not prerequisite. Correspondence should be addressed to the Secretary.

HIRAM PERCY MAXIM, FOUNDER

## OFFICERS

- President**.....EUGENE C. WOODRUFF, W8CMP  
State College, Pa.
- Vice-President**.....GEORGE W. BAILEY, W1KH  
Weston, Mass.
- Secretary**.....KENNETH B. WARNER, W1EH  
West Hartford, Connecticut
- Treasurer**.....ARTHUR A. HEBERT, W1ES  
West Hartford, Connecticut
- Communications Mgr.**...F. EDWARD HANDY, W1BDI  
West Hartford, Connecticut
- ◆
- General Counsel**.....PAUL M. SEGAL  
1010 Shoreham Building, Washington, D. C.
- ◆

Address all general correspondence to the executive headquarters at West Hartford, Connecticut

## DIRECTORS

- President*  
EUGENE C. WOODRUFF.....W8CMP  
234 W. Fairmount Ave., State College, Pa.
- Vice-President*  
GEORGE W. BAILEY.....W1KH  
74 Webster Road, Weston, Mass.
- Canadian General Manager*  
ALEX REID.....VE2BE  
169 Logan Ave., St. Lambert, P. Q.
- Atlantic Division*  
WALTER BRADLEY MARTIN.....W3QV  
Box 612, Roslyn, Pa.
- Central Division*  
EDWARD A. ROBERTS.....W8HC  
2699 Endicott Rd., Shaker Heights, Cleveland
- Dakota Division*  
CARL L. IABS.....W9BVH  
1822 James St., St. Paul, Minn.
- Delta Division*  
E. RAY ARLEDGE.....W5SI  
P. O. Box 286, Pine Bluff, Ark.
- Hudson Division*  
KENNETH T. HILL.....W2AHC  
115 Willow St., Douglaston, L. I., N. Y.
- Midwest Division*  
FLOYD E. NORWINE, JR.....W9EFC  
120 South Fourth St., St. Louis, Mo.
- New England Division*  
PERCY C. NOBLE.....W1BVR  
37 Broad St., Westfield, Mass.
- Northwestern Division*  
RALPH J. GIBBONS.....W7KV  
c/o United Air Lines, Pendleton, Ore.
- Pacific Division*  
S. G. CULVER.....W6AN  
2962 Russell St., Berkeley, Calif.
- Roanoke Division*  
H. L. CAVENESS.....W4DW  
State College Station, Raleigh, N. C.
- Rocky Mountain Division*  
RUSSELL J. ANDREWS.....W9AAB  
1867 So. Lafayette St., Denver, Colo.
- Southeastern Division*  
BENNETT R. ADAMS, JR.....W4APU  
1512 Grove Place, Homewood, Ala.
- Southwestern Division*  
CHARLES E. BLALACK.....W6GG  
443 Main St., El Centro, Calif.
- West Gulf Division*  
WAYLAND M. GROVES.....W5NW  
c/o Humble Pipe Line Co., Neches, Texas



# THE EDITOR'S MILL

TO us it is an encouraging sign that an increasing number of intelligent amateurs are to be heard discussing the possibility of a planned use of our bands. It is an idea that we have whooped up from time to time but we have not yet been able to sell the idea generally and make the sale stick. We are of course reminded of our earlier experiences in putting forward the ideas of c.w. transmission instead of spark, of higher frequencies instead of 200 meters. In both those cases we turned out to be right, although we started talking ahead of our time and in both cases some years were to elapse before amateur radio generally was prepared to adopt the newer ideas. We feel, then, just a little encouraged that others are to be heard discussing this same idea which we have from time to time advocated in our columns.

So long as every radio amateur is free to use any frequency for any purpose, we can almost say that each of our bands ought to be wide enough to accommodate all amateurs doing the same thing at the same time. Obviously our bands will never be this wide; in fact, it should go without saying that they are distinctly too narrow to provide any comfort at all. In such circumstances one is naturally impelled to examine the possibility of improving our operating position by a more intelligent use of different bands for varying ranges or purposes. Straightway, of course, one runs afoul of the fact that any such idea is contrary to the traditions of amateur radio, one of the beauties of which has been the perfect freedom to do anything that regulations permit. It is that aspect of the game which has caused us so often to characterize amateur radio as the many-mooded mistress, all things to all men. If we commence to bind ourselves by rules, restricting our freedom of motion, some of us will be unable to do some of the things we wish, simply because at the moment we will not have the equipment available for the proper band. But on the other hand, any careful examination of our problem must show that we are not doing a good engineering job in the use of our frequencies, that we do not employ thought-out plans that would increase their possibilities, and that the very freedom of action upon which we have always insisted is largely responsible for our interference and con-

gestion. Suppose for a moment that we could find a plan for the use of our different bands that would result in much more comfortable operating by everybody, giving the practical effect of widened bands. Should we not, under those circumstances, be willing to invite a few restrictions upon our liberty, simply in the name of the improvement that we would experience? It seems to us that we should, and that is why we are interested in the possibilities of planning our future along engineering lines.

Some of the fundamentals of any such plan can readily be sketched in bold outline: Most of the slow and unskillful operation, and a terrific percentage of the unnecessary interference, comes from beginning amateurs. Instead of being free to operate anywhere, they might well be obliged to confine their activities to certain portions of our bands during a probationary period of say a year. Within extremely broad limits, we ought to have some restriction on the distances over which we employ different bands of frequencies, particularly at night. Of course certain portions of our bands should always be available for experimental work, for the chap who is trying to cross the Pacific on 1800 kc., for the lad who wants to prove to himself that 14 mc. is no good for working 100 miles at night. But because, by and large, these are the things that cause the unnecessary interference, we might very well recognize the principle that frequency bands should be used for the distances for which they are best suited. It might prove a pious idea to have a regulation obliging every station to possess an arrangement for reducing power. Certainly all of our 'cross-town work ought to be on ultra-high frequencies. 'Phone allocations, instead of "just growing" like Topsy, might more logically be located in accordance with engineering principles.

Increasingly nowadays in ham conversations one of the fellows will be seen to produce a sheet of paper and say, "Now here is how I would propose dividing up the bands. I would employ the 160-meter band for so and so. I would put beginners here. I would divide the 3500 kc. band this way." It's a good sign. That way lies freedom. If anybody would half-way encourage us, we'd feel strongly tempted to put on an essay contest, with prizes for the soundest-appearing

proposals. At least we would then have something concrete to look at, and we could subsequently decide whether we would care to live under those conditions. Does it sound worth trying?

**F**OR years there has been talk of the eventual writing of the history of amateur radio. It has now been done, at least the story up to date, as is announced elsewhere in this issue. It is perhaps surprising that it has never been done before, considering that amateur radio started near the beginning of this century. Perhaps the deterrent lay in the very fact that the story had become so big that a prodigious amount of work would be necessary to cover it. We are happy to say that we think a very satisfying job is done by Mr. De Soto's new book.

Our League itself has been in existence for more years than the age of many of to-day's amateurs. Obviously much has happened in those years that is wholly unknown to any save the old-timers who have been continuously active in amateur radio for twenty years or more. The annual "turn-over" in amateur radio is perhaps as high as 40%. The bulk of the faces in amateur radio are completely new every three years.

To-day's amateurs familiarize themselves with the technique of the moment, they know vaguely that our movement had a past and even a beginning, as they hear old-timers talk of spark transmitters and loose-couplers. But the perfectly fascinating story of our early days and the unfolding tale of the evolution of amateur radio has never been told to them. Here at last we have it.

We believe it interesting to mention here that, although the League is the publisher of this new book, it was not originally written for us or with that thought in view. Although the author is a member of our headquarters staff, the major portion of the writing of the first draft was accomplished before he joined us, and in fact it was his researches in that field that first brought us into contact. The book aims to be a readable but completely impartial recountal of the whole magnificent and absorbing story of amateur radio. Our accomplishments and our disappointments, the whole of our legislative and regulatory experience, our successful emergence from constant vicissitudes, and a keen analysis of where we stand now—all combine to make a thrilling and invaluable record which we believe every amateur will be glad he read.

K. B. W.

## Navy Day Receiving Competition— October 27th

**A**LL amateurs are invited to copy the telegraphic transmissions addressed to radio amateurs from NAA and NPG on Navy Day, October 27th. Messages from the Secretary of the Navy will be sent from these stations. The texts will be substantially the same in thought, but will vary as to wording. A letter of commendation signed by the Secretary of the Navy will be awarded to *every amateur* who makes perfect copy of the text of one message. Both messages may be copied, but only the best copy should be submitted in the competition. It is not necessary to copy both stations, but please mention if both stations were copied when submitting your *best* copy. Only the text of each message will count (not the preamble, break signs, and the like). Mail copies for grading to the A.R.R.L. Communications Department, West Hartford, Conn. Send your original copies—recopying invites errors. The relative standings of the various Naval Districts will be ascertained by comparing the number of letters awarded with the number of copies submitted from each District. Transmissions will be at approximately 15 words per minute and will be preceded by a five-minute CQ call on the following schedule:

From Washington: NAA, 9:00 P.M., E.S.T., simultaneously on 4075, 8150 and 12,225 kcs.

From San Francisco: NPG, 7:05 P.M., P.S.T., simultaneously on 4010 and 8770 kcs.

### Coming—Heterotone Reception

A real improvement in c.w. telegraph reception, giving to pure d.c. signals all the tone quality and other advantages of tone-modulated transmission

but without m.c.w.'s disadvantages, will be described by Jim Lamb in November *QST*. The new "heterotone" system is easily applied to any good ham superhet, especially to crystal-filter types.

# A Medium-Power Transmitter for 7, 14 and 28 mc.

Economical C.W. Operation plus Adaptability to Grid-Bias Modulation

By George Grammer,\* W1DF

**E**VERY amateur who builds a transmitter has his own reasons for choice of tubes, circuits and layout. Because individual requirements often are conflicting, it is unreasonable to expect that, given a level of output power to be obtained, one transmitter arrangement will satisfy everyone. Therefore in describing the transmitter pictured here, it is necessary to point out the various factors which influenced its design.

achievement of a suitable compromise between cost and signal strength. Now this question is complicated in a great many ways, and consideration of all factors involved is a separate story by itself. Suffice to say that we came to the conclusion that the optimum balance was reached with inputs in the neighborhood of 200 or 250 watts. There are a great many tubes which, either singly or in pairs, will handle this input, but in this case

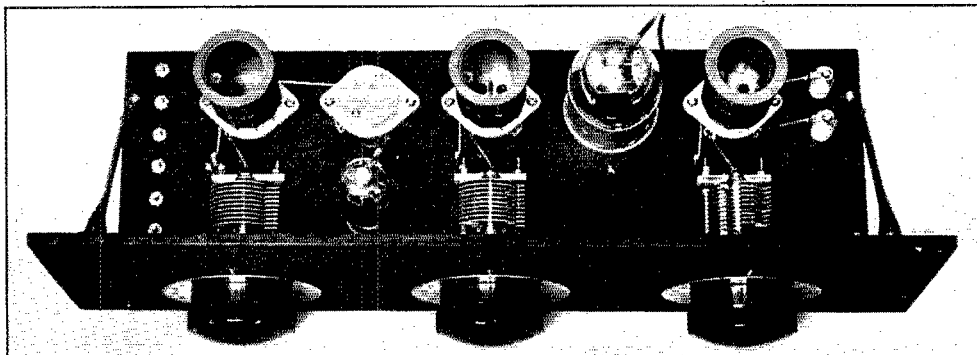

A PLAN VIEW OF THE EXCITER UNIT

*The 89 oscillator is between the cathode and oscillator-plate tuning condensers. The oscillator plate coil (center) should be shielded, as explained in the text. In this photo the shield has been removed to show the coil socket and wiring.*

On the average, the requirements to which it was built probably correspond quite closely with those of many amateurs.

Primarily what was wanted was a rig which would give enough output on 40 and 20 meters so that reasonably consistent work could be done, given a decent antenna; plus a fair amount of power on 10 meters for experimental work and communication when conditions were good; plus the possibility of working 'phone on 20 and 10 occasionally without the necessity for expensive modulating equipment. Further desirable features were simplicity of design and reliability of operation, with enough flexibility so that should the necessity arise for operation on other bands than those specified, the adaptation could be made without reconstruction.

Some of these objectives do not exactly dovetail with the others. However, taking them in order, the decision on the first point rested on the

\* Assistant Technical Editor.

the choice was further influenced by the necessity for meeting the 'phone requirement. Since the amount of 'phone work contemplated did not justify the expense of generating a lot of audio power for plate modulation, the grid-bias system seemed a logical arrangement. With this system the efficiency of the output stage on 'phone would necessarily be low, so to get at least a usable 'phone carrier, the tube or tubes used would have to have a fairly large plate-dissipation rating. Here arose the necessity for compromise between sufficient power capacity for low-efficiency 'phone and unnecessarily large capacity for higher-efficiency c.w. A tube having a plate dissipation rating in the vicinity of 100 watts seemed to us to strike about the right balance, since it would give a 'phone carrier of about 50 watts, and on c.w. would be working rather easily at the input already determined.

There are many tubes in the 100-watt dissipation class, but since this transmitter was being

built chiefly for the higher frequencies, the low-capacity type designed especially for high-frequency work appeared more desirable than the older types, not only because of presumably greater efficiency, especially at ten meters, but

has two advantages not possessed by triodes: excitation requirements are very low, and the suppressor-grid offers a keying means which can hardly be surpassed for key-click elimination. And the Tri-tet oscillator, besides giving second-

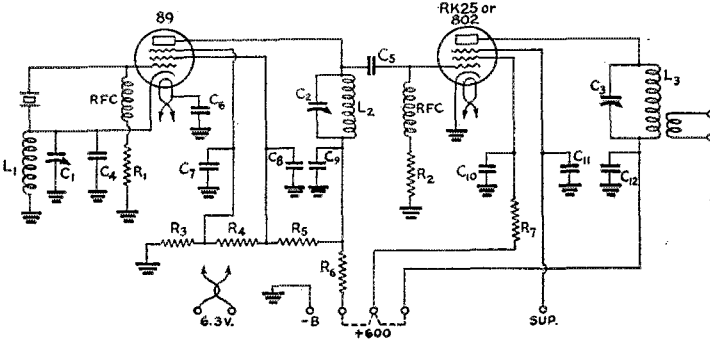

FIG. 1—CIRCUIT DIAGRAM OF THE EXCITER UNIT

The three connections marked "600 volts" can be tied together. Oscillator plate, buffer plate and screen leads are brought out separately to facilitate metering.

- $C_1, C_2, C_3$ —100- $\mu\text{f}$ d. variable.  $C_{10}, C_{12}$ —0.002  $\mu\text{f}$ d. paper, 1500-volt transmitting type, non-inductive.  
 $C_4$ —100  $\mu\text{f}$ d. fixed mica.  $C_8$ —50  $\mu\text{f}$ d. fixed mica.  $C_5$  to  $C_9$  inc.—0.01- $\mu\text{f}$ d. paper, non-inductive.  
 $C_{11}$ —0.001  $\mu\text{f}$ d. fixed mica.  
 $R_1$ —50,000 ohms, 1 watt.  $R_2$ —50,000 ohms, 2 watt.  $R_3$ —10,000 ohms, 1 watt.  $R_4, R_5$ —10,000 ohms, 10 watt.  $R_6$ —10,000 ohms, 25 watt.  $R_7$ —25,000 ohms, 25 watt.

- $L_1$ —For 7-mc. crystal; 7 turns, winding length 1 inch.  
 $L_2$ — 7 mc.: 16 turns, winding length 1 inch.  
 14 mc.: 8 " " " " "  
 $L_3$ — 7 mc.: 18 " " " " "  
 14 mc.: 10 " " " " "  
 28 mc.: 5 " " " " "

All coils wound on Hammarlund forms (diameter  $1\frac{1}{4}$  inches) with No. 18 enameled wire. Link coils on  $L_3$  consist of one or two turns, closely coupled to  $L_3$  at the bottom (cold) end.

also because their low interelectrode capacities make them easier to handle in neutralized circuits. The tube actually used is the RK-36, which aside from capacities is a good deal like the 211. The similarity in ratings encourages the idea of operating the tube as one would a 211, i.e., moderate voltage and fairly high plate current, since for our 200–250 watts this seemed likely to be the least expensive way to do it.

Came next the question of the exciter. Rather than search for new ways of doing old things a step was taken in the opposite direction—to use something time-tried and of known performance. The 89–802 ten-meter exciter described in January *QST*<sup>1</sup> had been doing a good job in regular service, and the idea of not having to neutralize any tubes in the exciter was appealing. The output of 10 watts or so on ten meters was deemed enough for excitation purposes in view of the rather limited use of this band, while two or more times this output should be available on both 14 and 7 mc.

Besides giving the necessary power output, this particular combination has other points to recommend it. A pentode of the 802 or RK23–25 type, in addition to requiring no neutralization,

<sup>1</sup> "Transmitters for Ten Meters", *QST*, January, 1936.

harmonic as well as fundamental output, is far from being "cranky" with regard to crystals—a plate with any oscillation possibilities at all will "go" at the close of the switch, day in and day out. In addition, the circuit gives a buffer effect which is particularly desirable when the following tube is to be keyed.

Thus the final line-up: 7-mc. crystal, 89 Tri-tet oscillator, 802 or RK25 buffer-doubler, and RK36 final amplifier. Three units were built: exciter, final, and antenna coupler.

#### THE EXCITER UNIT

The circuit diagram of the exciter is given in Fig. 1. The general idea is the same as in the exciter already mentioned,<sup>1</sup> but with some differences in details to permit working on several bands. Top-and

bottom-view photographs show how the apparatus is laid out. Panel and base are of Lamtex, the panel measuring 19 by 7 inches, the base 17 by 5. The panel is cut and drilled to standard relay-rack dimensions, as are also the panels for the other units. A strip of aluminum 3 inches wide runs the length of the base, underneath, to take all ground connections. All grounds, incidentally, are made directly to this strip by the shortest possible path. The front part of the base is left uncovered so that the tuning condensers, two of which are at high d.c. potential, need not be separately insulated from the ground strip. All parts are mounted on the base; the condenser shafts simply project through the panel far enough to take the dials. This is also true of the construction of the other units; each is really a breadboard with a panel tacked on the front; the panel can be removed without disturbing any of the apparatus. Power connections are made to a row of machine screws mounted along the left edge of the base; on the right side, output to a link is taken from the pair of standoff insulators.

Progression is from left to right in the top view. The oscillator cathode coil is at the left; the center coil is for the oscillator plate, and that at the right for the buffer plate. The two tubes are

capacity-coupled, the coupling condenser being underneath the base. By-passes in the oscillator circuit are all .01- $\mu$ fd. non-inductive paper condensers; in the buffer circuit, the screen and plate by-pass condensers also are of the non-inductive paper type, but of higher voltage rating. The sup-

In the oscillator cathode circuit, the tuning capacity consists of  $C_1$  and  $C_4$  in parallel, this system being adopted to avoid the necessity for a large variable condenser at  $C_1$  to give the high- $C$  the Tri-tet cathode circuit demands for best operation.

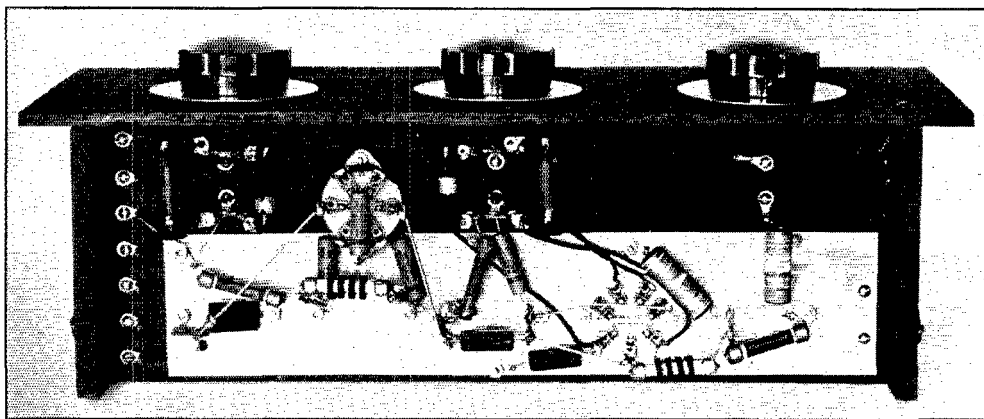

#### SUB-BASE WIRING OF THE EXCITER UNIT

Power-supply connection terminals are at the left in this photograph. The voltage divider and dropping resistors are mounted on lug strips; they can be seen below the center and left-hand dials. Ground connections are made to the aluminum strip running the length of the base; the shortest possible connections should be used. The small fixed condenser at the left end of the ground strip is  $C_4$ , Fig. 1. Connections which must be insulated from the ground strip are made to insulating mounting lugs.

pressor by-pass in the buffer circuit is a 0.001- $\mu$ fd. mica condenser; for keying purposes—and likewise should it be desired to try suppressor modulation on the buffer—it is desirable that this condenser not be too large.

The oscillator plate coil must be shielded to prevent the buffer from self-oscillating. In the space available for the tubes and coils, there is some capacity coupling between the tube plate and the oscillator plate coil, which also tunes the buffer grid circuit, and there is likewise the possibility of magnetic coupling between this coil and the buffer plate coil. The shield is a Hammarlund coil shield of the type used in the Pro receiver. The base is held to the top of the oscillator plate coil socket by the socket mounting screws, the shield itself fitting down over the coil when the latter is in place in the socket. The shield assembly was removed in order to show the parts clearly when the top-view photograph of the exciter unit was taken.

Resistors  $R_3$  to  $R_6$ , inclusive, provide a voltage divider for the oscillator plate, screen and suppressor. The value of 10,000 ohms for  $R_5$  can be reduced if the power supply voltage is 500 rather than 600; the power supply built to go with this unit, of which more will be said later, delivered a bit better than 600 volts under the full load of the two tubes, and a fairly large value of oscillator dropping resistor was necessary to keep the oscillator plate voltage in the vicinity of 300, which is about right for the 89.

Screen voltage for the buffer is obtained through a series dropping resistor,  $R_7$ . The value of the grid leak,  $R_2$ , was determined after a series of tests to be the optimum value for doubling, and is not critical for straight amplification.

The oscillator, buffer screen and buffer plate leads are brought out in the fashion indicated so that meters can be inserted in any of the three circuits.

In view of the fact that most amateurs are familiar with the operation of Tri-tets and pentode amplifiers, it should not be necessary to say much about tuning procedure. The general method for both circuits has been described many times in *QST* and in the *Handbook*. For 7-mc. operation, 7-mc. coils are used at all three positions,  $L_1$ ,  $L_2$  and  $L_3$ ; for 14-mc. work, the same cathode coil is used at  $L_1$ , the 14-mc. coil at  $L_2$ , and the 14-mc. coil at  $L_3$ . On 28 mc. the lineup is the same as for 14 except that a 28-mc. coil is used at  $L_3$ . The total current to the oscillator, including the screen divider, should be in the vicinity of 25 to 30 ma. Minimum buffer plate current will be 10 to 15 ma. on 7 and 14 mc., depending upon the no-load plate supply voltage, and about 30 ma. on 28 mc. Loading to 50 or 60 ma. will give 20 to 25 watts output on 7 and 14 mc. and a bit better than 10 watts on 28 mc., using a 600-volt supply. The suppressor should be operated at about 50 volts positive, although it can be grounded with a small reduction in output. On 28 mc., the buffer plate input should

not exceed 30 to 35 watts, since the lower efficiency will cause more heating and may result in climbing plate current after a short period of continuous operation.

With the 89 operating as a Tri-tet with 7-mc. output, the preferable tuning procedure is to set  $C_1$  at minimum and tune  $C_2$  on the high-frequency side of resonance. The plate tuning is quite broad; oscillations will cease only when  $C_2$  is

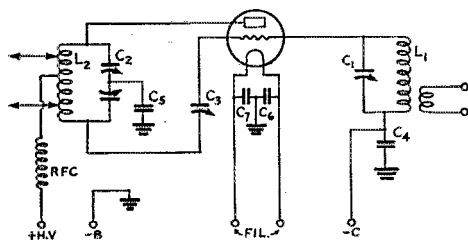

FIG. 2—THE AMPLIFIER DIAGRAM

- $C_1$ —50- $\mu$ fd. variable.
- $C_2$ —Split-stator transmitting type, 100  $\mu$ fd. per section, 3000 volt breakdown per section.
- $C_3$ —Neutralizing condenser (National NC-800).
- $C_4$ —0.001- $\mu$ fd. mica, receiving type.
- $C_5$ —0.002- $\mu$ fd. mica, 5000-volt rating.
- $C_6, C_7$ —0.01- $\mu$ fd. paper, non-inductive.
- RFC—Receiving-type pie-wound choke.
- $L_1$ —28 mc.—4 turns No. 18, diam.  $1\frac{3}{4}$ " , length  $3\frac{1}{4}$ " .  
14 mc.—9 turns No. 18, diam.  $1\frac{3}{4}$ " , length 1" .  
7 mc.—15 turns No. 18, diam.  $1\frac{3}{4}$ " , length 1" .
- All link windings consist of two turns, wound close to the low-potential end of  $L_1$ . (Coil forms are National XR-13).
- $L_2$ —28 mc.—4 turns No. 14, diam.  $2\frac{1}{4}$ " ,  $3\frac{1}{2}$  turns per inch.  
14 mc.—12 turns No. 14, diam.  $2\frac{1}{4}$ " ,  $3\frac{1}{2}$  turns per inch.  
7 mc.—18 turns No. 14, diam.  $2\frac{1}{4}$ " , 7 turns per inch.
- Each coil tapped at center for feed connection. (Forms are National XR-10A.)

tuned to resonance. With the coils specified, any 7-mc. crystal will operate with both  $C_1$  and  $C_2$  at minimum capacity, no special tuning for different frequencies being necessary.

#### THE FINAL AMPLIFIER

The amplifier construction is uniform with that of the exciter. The panel measures 19 by  $10\frac{1}{2}$  inches, the baseboard 17 by  $7\frac{1}{2}$  inches. Although considerations of good layout might dictate more space between the tank condenser and coil, compromise was necessary here to fit the various components in the available width and to have the grid and plate tuning controls come out symmetrically. The socket for the RK36 projects through the base, the purpose being to bring the plate and grid caps closer to their respective circuits, and to put the filament wiring below the base where it is convenient to make connections.

The circuit is a familiar one and needs no special

comment aside from the grounding arrangements. Aluminum plates, similar to that for the exciter ground, are mounted on the bottom side of the base. One of these serves as the actual ground, while the other, connected only to the tank condenser rotor, is by-passed to the first through a high-voltage mica condenser. This was done as a precautionary measure, to take the d.c. voltage off the tank condenser plates so that with a 2000-volt plate supply there would be less tendency toward flashover. With a 1500-volt supply it should not be necessary, and a single ground plate could be used. It should be pointed out, however, that if the amplifier is to be plate-modulated, even at 1500 volts, a tank condenser with a higher voltage rating should be used. A condenser of the type shown fitted nicely into the present design because plate modulation was not intended, and because grid-bias modulation called for comparatively low plate voltage for a tube of this type. A saving of cost and space thereby resulted.

The plate and filament terminals are brought out through porcelain feed-through insulators, the purpose being to insulate them from the tank condenser ground plate. Terminals for grid bias are taken off at the left hand side of the base, looking at the top view. The two feed-throughs at the left are the link terminals. These provide more than adequate insulation for the link, and form convenient connection terminals.

The amplifier grid coils are wound on tubular Isolantite forms, the plate coils on the larger notched ceramic forms. Specifications are given under Fig. 2. In connection with the plate coils, a reasonable amount of tank condenser capacity should be used so that the neutralization will stay put on the different bands. With the bands tuning with  $C_2$  set at one-third scale or more, neutralization will be fixed for all three bands. A small

capacity shunted across the neutralizing section of  $C_2$  to compensate for the plate-filament capacity of the tube should eliminate the tendency to go out of neutralization at the low-capacity end of the scale.<sup>2</sup>

Coupling between exciter and amplifier to give optimum excitation can be adjusted by means of the links. At the exciter end, one or two turns, closely coupled to the cold end of the buffer tank, will be sufficient.

Two or three turns at the amplifier grid end should provide optimum coupling. It is advisable to make the final adjustment by moving the link at the amplifier grid end back and forth slightly to provide the right load on the exciter. Grid current values will depend on the bias and link

<sup>2</sup> "Simplifying Split-Stator Final Amplifiers," June, 1934, QST.

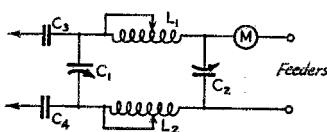

FIG. 3—ANTENNA COUPLER

- $C_1, C_2$ —150- $\mu$ fd. transmitting condensers.
- $C_3, C_4$ —0.002- $\mu$ fd. mica, 5000-volt rating.
- $L_1, L_2$ —12 turns No. 14, diameter  $2\frac{1}{4}$  inches, spacing to give  $3\frac{1}{2}$  turns per inch (coil length  $3\frac{1}{2}$  inches, app.).
- M—Thermo-ammeter (2.5 amp. size suggested).



adjustment. On 7 and 14 mc., the optimum adjustment is that which causes the buffer to draw 50 ma. plate current approximately. With bias of the order of 200 to 250 volts, the grid current should be around 25 ma. under load. On 28 mc., where the excitation is lower, the RK36 should be biased to cut-off (about 100 volts with the plate supply used), in which case the grid current should be approximately 15 ma. under load.

The amplifier can easily be loaded to the rated plate current of 165 ma. At plate voltages in the vicinity of 1200 to 1500 it is probable that the plate current can be increased somewhat over the rating without damage to the tube, although increasing it within any reasonable limits (to 200 ma., perhaps) above the rating will cause no perceptible increase in signal strength.

#### ANTENNA COUPLER

The pi-section antenna coupler used with the rig is shown in one of the photographs. The diagram is given in Fig. 3. The coupler proper is insulated from the series-fed plate tank of the final amplifier

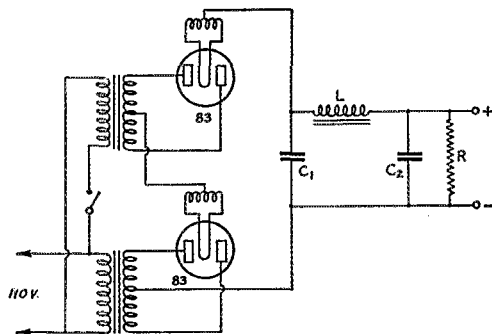
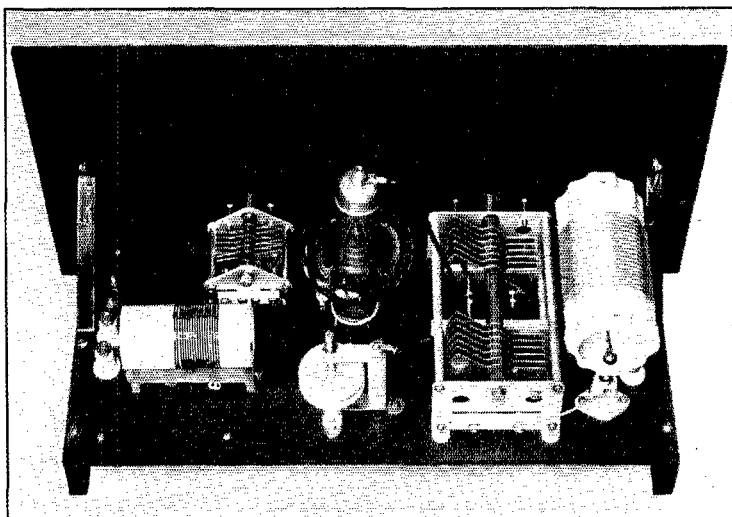

FIG. 4—THE "SERIES" POWER SUPPLY DIAGRAM  
Constants are discussed in the text.

by a pair of high-voltage mica blocking condensers. The coils are wound on ceramic forms separated from each other as much as the space available will permit. The condensers  $C_1$  and  $C_2$  are mounted on stand-off insulators, this being done because both sides of the condensers are at high r.f. potential. In none of the units is the panel and baseboard material used as an

insulator for r.f.; although it is a satisfactory insulator for moderate d.c. voltages, it was deemed better not to depend on it for r.f., stand-off insulators being used instead where necessary. It was not considered necessary to insulate the r.f. ammeter from the panel, since none of the



A REAR VIEW OF THE AMPLIFIER

Grid circuit to the left, plate circuit to the right. The coils shown are for 7-mc. operation.

meter parts are connected to the meter case.

Of course any sort of antenna coupling arrangement could be used. The pi-section filter is often convenient and will work with almost any antenna system. Provided care is used in the preliminary adjustments to find the correct number of turns to use in the coupler coils  $L_1$  and  $L_2$ —and likewise the optimum number of turns across which to tap the coupler on the final tank coil—there should be no great difficulty in getting it to work according to the book. Unless this is done, however, the tuning may be sluggish and it may not be possible to make the tube take load properly. Since the job need be done only once for each band, the time required is inconsequential.

Before the rig is connected to an antenna, it is a good plan to hook a lamp dummy antenna to the feeder terminals of the coupler and go through the adjustment and loading process, noting the amplifier grid current when the amplifier is loaded to the desired degree. When the antenna is substituted for the lamp it will probably be necessary to change the taps from those used with the lamp, but the adjustments should be made with the idea of duplicating as closely as possible the grid current reading (under full load) obtained with the lamp load. This helps eliminate the tendency of the system to throw the amplifier slightly out of neutralization, which

may happen if the tap adjustments are not right. It is especially likely to occur when the coupler is used to work into an unbalanced antenna system, such as a Zepp.

transformer and generally runs lower under load. The outstanding advantage of the condenser-input filter is the fact that the d.c. output voltage always is higher than the r.m.s. transformer

voltage at light loads, and generally is somewhat higher than or at least equal to the r.m.s. voltage at full output current. Its disadvantages are poor voltage regulation and relatively high peak current.

Now peak current is something to consider when expensive rectifier tubes are used, but with inexpensive 83's becomes less of a factor, especially since 83's are built to deliver 200 ma. into a condenser-input filter. Voltage regulation is not much of a factor here because for 'phone the plate current is constant, and on c.w. any tendency

toward key clicks can be taken out in the keying system which will be described later. The one point where poor voltage regulation is felt is in the fact that the filter condensers must be rated to stand the peak voltage under no load conditions; with two 600-volt transformers in series

the peak voltage is in the neighborhood of 1700 volts. Incidentally, for a given product of inductance and capacity, a condenser-input filter gives more smoothing than one with choke input, so something is gained on that score.

A curve showing the voltage variation with load current for this power supply is given in Fig. 5. Voltage across the transformer primaries was 115. The power at different plate currents is

indicated by the dotted curve. The power curve, as a matter of fact, is probably more useful than the voltage curve, since we think in terms of input. It is of particular value in setting up the conditions for grid-bias modulation.<sup>3</sup>

The use of two transformers as indicated in Fig. 4, besides permitting the use of inexpensive rectifier tubes without resort to a bridge circuit, also offers a ready means for reducing power for testing or local work. The switch in series with one transformer primary cuts the voltage in half,

<sup>3</sup> "Grid-Bias Modulation for the General-Purpose Transmitter", *QST*, March, 1935.

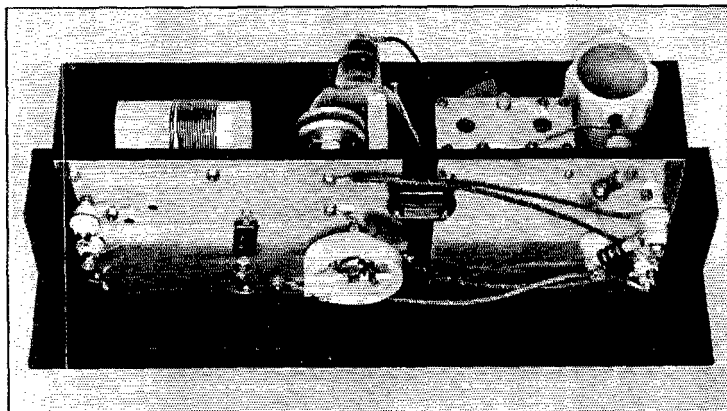

THIS VIEW FROM BELOW THE AMPLIFIER UNIT SHOWS THE TWO GROUND PLATES WITH THE BLOCKING CONDENSER BETWEEN THEM

For operation at 1500 volts or less a single ground plate may be used, the condenser being omitted.

#### POWER SUPPLY

Power supply design and construction usually is quite straightforward and for that reason is left to the preferences of the reader when a transmitter is described. In this case, however, a few remarks may not be out of place, because the possibility of getting a relatively inexpensive power supply had its influence on the transmitter design. In building up a power supply for the amplifier we made use of an idea described some time ago in the Experimenter's Section, using two low-voltage transformers in series. The circuit diagram is shown in Fig. 4. The particular transformers used are rated at 600 volts r.m.s. each side of the center-tap, and can deliver up to 200 ma. An 83 rectifier is used with each one. A departure from non-standard practice is the use of a condenser input filter.

To explain this layout it is necessary to review briefly the various advantages and disadvantages of choke- and condenser-input filters. As is well known, the properly-designed choke-input filter can be made to give excellent voltage regulation, and the input choke prolongs the life of rectifier tubes by keeping down the peak current. Its chief disadvantage is the fact that the maximum obtainable d.c. voltage is only equal to approximately 90% of the r.m.s. output voltage of the

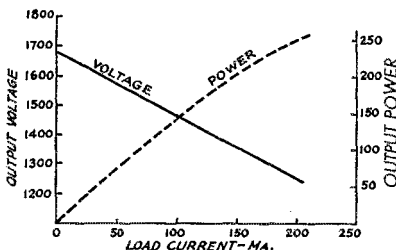

FIG. 5—VOLTAGE AND POWER OUTPUT VS. LOAD CURRENT FOR THE POWER SUPPLY DIAGRAMMED IN FIG. 5

approximately. This is an appreciated feature when tuning adjustments likely to run the amplifier off resonance are made, and should prolong the tube life.

The power supply for the exciter uses a 550-volt transformer of the familiar broadcast-replacement type, with an 83 rectifier. A condenser-input filter also is used with this unit, the condensers being double 8- $\mu$ fd. electrolytics with the two sections connected in series to give 4- $\mu$ fd. condensers with a rating of about 900 volts. The actual power supply has three such condensers and two "commercial-rating" 30-henry chokes. The plate voltage for the buffer is taken off the second condenser, the last choke and condenser providing additional filter for the oscillator alone. This last refinement is to eliminate any possibility of power-supply hum when working 'phone, since the grid-bias system amplifiers any hum existing on the output of the exciter stages. It is unnecessary for c.w. work.

At full load—50–60 ma. on the buffer plate, plus the buffer screen and the oscillator current, a total of something over 100 ma.—the exciter power supply delivers approximately 600 volts. The tube will stand this small excess over the rating without complaining so long as the plate current is kept in the vicinity of the rated value.

#### KEYING

The keying system is shown in Fig. 6. The bias supply indicated should give 250 volts or more; it may be a bank of batteries or a regular "B" type supply. The ground point should be made about 50 volts from the positive end of the bleeder so that a small positive voltage can be applied to the suppressor when the key is closed. The tap for the final amplifier preferably is variable so that the bias can be adjusted in operation to give optimum output.

The general arrangement has been described previously in both *QST* and the *Handbook*. Resistor  $R_1$  is simply to keep the current in the key circuit at a low value; it may be anything from

50,000 ohms up.  $R_2$  and  $C$  determine the time constant, or duration of the building-up and dying-down of the keyed characters. The values of 5000 ohms and 1  $\mu$ fd., respectively, will give sufficient lag—perhaps more than necessary. By varying the value of  $R_2$  it is possible to get almost any lag desired—50,000 ohms at  $R_2$ , for instance, will give so much that it is impossible to key at more than a few words per minute. If  $R_2$  is made variable, the lag can quickly be adjusted to the desired value with the aid of a monitor.

Since the thing that counts is the product of the values of  $R_2$  and  $C$ , a smaller condenser and larger resistor can be used to give the same effect as the values specified. However, if positive voltage

is to be applied to the suppressor with the key down,  $R_2$  should not be too large, since under these conditions current flows to the suppressor and the actual voltage between suppressor and cathode will be less than that furnished by the "C" supply. If the suppressor

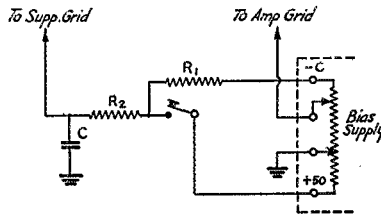
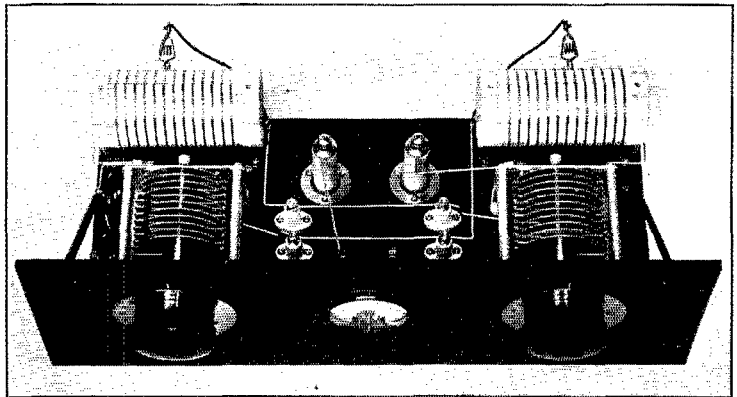

FIG. 6—BIAS AND CLICKLESS KEYING CIRCUIT

$R_1$  should be approximately 50,000 ohms; its value is not critical since it serves only to limit the current in the key circuit.  $C$  and  $R_2$  should be proportioned to give a suitable time constant for clickless keying; 1  $\mu$ fd. and 5000 ohms is satisfactory.



THE PI-SECTION ANTENNA COUPLING FILTER

The two large standoffs at the rear center are the feeder terminals. Input condenser, at left, output at right. The insulating condensers  $C_2$  and  $C_4$ , Fig. 3, are mounted along the left side of the input tuning condenser.

is operated at zero potential under key-down conditions, this consideration disappears and any reasonable values can be used at  $R_2$  and  $C$ . Positive suppressor gives somewhat more output, however, and is therefore worth while.

This method, besides giving positive keying (and incidentally requiring fixed-bias protection for the amplifier tube) also is very successful in eliminating key clicks, not only from nearby b.c. receivers but also locally on the operating

(Continued on page 72)

# A Cheap and Efficient Vertical Antenna for 7- and 14-Mc. Operation

By O. S. Keay,\* W9SJK and Joe Pehoushek,\*\* W9EFK

**O**F LATE there have been few articles written on antenna masts and we feel that the one we constructed last fall merits the time and effort to put it in print. It has several, not new, but unique features, that we feel are worth considering.

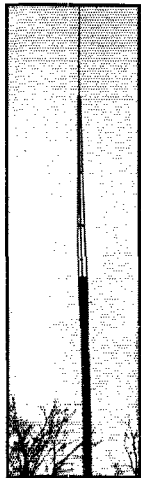

FIG. 1

We wish to pass these along to the rest of the fraternity for their review and use, if they see fit. We have done some experimenting and our work has shown that one dollar spent in the antenna is worth several spent on the rig in the shack. After using several different types of sky hooks in different locations, we came to the conclusion that for all around coverage here in the mid-west, a vertical antenna would suit our purpose to the best advantage. We therefore gave the matter considerable thought and read all of the available material that was at hand. Out of this we evolved the 40-meter half-wave vertical antenna that we will try to describe by word and picture. We sincerely hope that

some of our readers will be able to use advantageously the results of our efforts.

Now to get down to the meat of this attempt at authorship, and briefly explain our brain-child. We were fortunate in having the power company come through our neighborhood replacing some 40-foot 8-inch top poles about the time our ideas of a good antenna began to take concrete form. With a little persuasion we convinced the crew foreman that we could make very good use of a couple of the replaced poles that had deteriorated too much for their use in power service. These poles were rotted some at the ground-line but not too much to support their own weight and some more. As Fig. 1 will indicate, one of these poles became the base structure of our 69-foot vertical mast. After setting this 40-foot cedar pole in the ground 7 feet, we had 33 feet towards our half-wave 40-meter vertical antenna.

This pole remained in the ground without any use for some weeks before we could definitely decide on a practical way to obtain the remaining 33 or more feet we needed for our antenna. After

many plans for the extension were laid to one side, we decided upon the tripod and bamboo fishpole arrangement visible in Fig. 1. The tripod was constructed of three 22-foot fir "two-by-twos" and four cross-members made of 2-inch planking. The bamboo fishpole was obtained after considerable search in the various local hardware stores, for the sum of 35 cents. It also was 22 feet long and was about 1¼ inches in diameter at the base.

The tripod was formed by lag-bolting three uprights to four cross-members that were sized and shaped to give the tripod the proper taper. The cross-members can be seen fairly well in Fig. 1. The points at which the lagbolts passed through the uprights were reinforced by placing a short section of channel iron, of proper size to fit snugly over the uprights, under each bolt. The upper cross-member was placed far enough down from the top of the uprights to serve as a support and form a cradle for the bottom of the fishpole. A hole was bored in this member to just admit

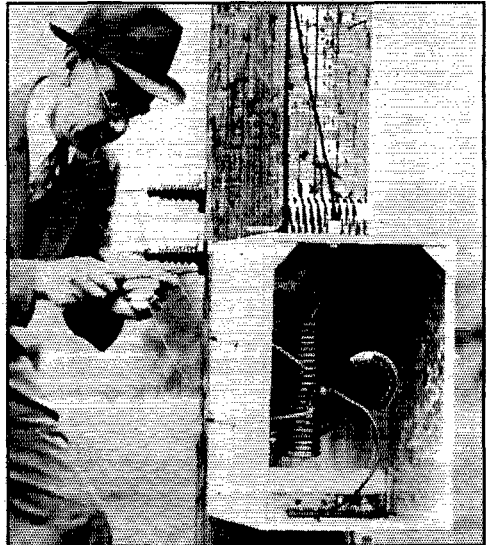

FIG. 2—TUNED FOR 7 MC.

the base of the pole. The lower cross-member was so placed that after allowing for a 4-foot lap it just missed the top of the cedar pole. The other two cross-members were evenly spaced in between these pieces. One other thing that required some thought was the size of the bottom cross-member.

\*169 SE Seymour Ave., Minneapolis, Minn.

\*\*79 SE Melbourne Ave., Minneapolis, Minn.

This was so sized that when the tripod was all assembled it would properly and snugly fit down over the cedar pole.

The base of the fishpole was placed in the hole in the top cross-member and the pole secured by means of a strap iron clamp at the ends of the uprights. A padding of crepe rubber was placed between the ends of the uprights and the pole before applying and tightening the clamp.

It should perhaps be made clear that the fishpole and the tripod were completely constructed and assembled as one unit on the ground before placing it in position on top of the cedar pole. It will be advisable to give the fishpole some treatment, such as one does a bamboo flyrod, to strengthen it and protect it from weather. The tripod should also be weather-proofed with outside paint.

The standoff insulators which were to support

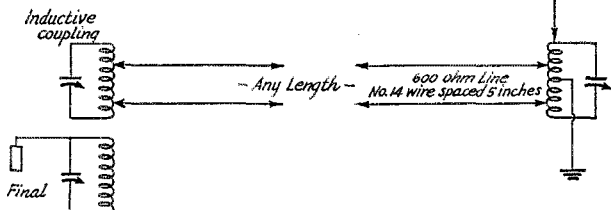

FIG. 3—ANTENNA TUNING SYSTEM

On 7 mc. the antenna operates as a voltage fed Hertz. For 14 mc. work it will be necessary to insert a phasing tank at "X."

the radiating wire were next attached to the assembly and the wire secured in place. These insulators should not be screwed directly to the fishpole, as this will materially weaken the pole, but should be attached by arranging some sort of a clamping device for each insulator and padding it with rubber or some other resilient material. On the tripod and the cedar pole the insulators may, of course, be screwed directly in place.

When all of this preliminary work had been done we were ready to hoist the completed assembly into place on top of the cedar pole. It was raised vertically beside the cedar pole. With the aid of three steadying lines, and a short gin-pole and pulley temporarily anchored to the top of the cedar pole, the extension was guided and hoisted into position and fastened there with six lagbolts. Channel iron reinforcements were again used under each lagbolt.

The remainder of the radiating wire was then uncoiled, from its temporary position at the base of the tripod, and strung down the cedar pole to the impedance matching device, shown in the box in Fig. 2, and cut to the proper length for the frequency to be used.

A 600-ohm matched impedance transmission line was decided on because of the 215 feet from the transmitter to the radiator. This line was

made up of two No. 14 wires spaced 5 inches apart and supported with insulators on various available objects. An impedance-matching device, consisting of a coil and a variable condenser, was located at each end of the line and tuned to the operating frequency the usual methods. Fig. 2 shows the tank at the antenna end of the line, enclosed in a sheet metal housing, and its connections. The procedure for balancing this line and attaching it to the tanks was obtained from a

Westinghouse booklet entitled "Two Wire Untuned Transmission Lines." The antenna was passed through the housing by means of a bushing insulator shown at the top of the box and attached to the end of the tank coil, where the impedance of the radiator matches that of the tank.

It will be noted in Fig. 2 that the center of this coil was grounded. This was done to maintain a balanced condition in the tank, and was found to give a slight increase in antenna current. The coil shown lying on the top of the housing is used in the circuit when working on 20 meters and the coil shown in the circuit resonates at 40 meters. The tank at the transmitter end of the line is of similar construction, inductively coupled to the final, and resonant at the operating frequency.

Fig. 3 shows a schematic diagram of the entire transmission circuit. This arrangement gave a very efficient means of transmitting the energy from the rig to the antenna and seemed to help in reducing BCL interference. The two resonant

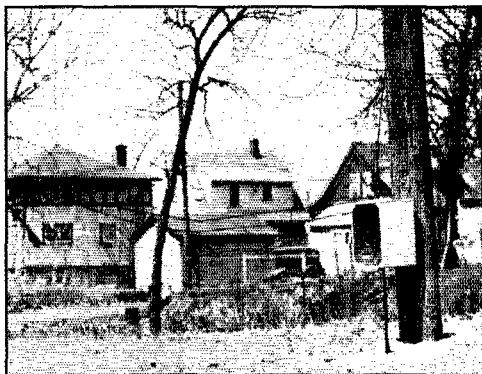

FIG. 4

tanks in the circuit help to reduce harmonic output.

Fig. 4 shows a view of the entire transmission line and also includes the base of the mast. The line and other wires were traced in ink so they would show more clearly. The arrow on the house

(Continued on page 78)

# 1936 VK/ZL International DX Contest

1200 GT, Saturdays, to 1400 GT, Sundays—Oct. 3rd—4th; Oct. 10th—11th;  
Oct. 17th—18th; Oct. 24th—25th; Oct. 31st—Nov. 1st

**T**HE South Australian Division, Wireless Institute of Australia, announces another Centenary Contest for 1936. Several changes in scoring will be noted in the rules, which have been drawn up by G. B. Ragless, VK5GR. Serial numbers will not be used as proof of contact this year. All signal reports exchanged must include Readability, Strength and Tone, and must be so shown in the log. The contest is open to all amateurs of the world. Competitors outside Australia and New Zealand will multiply total QSO points by the number of VK/ZL districts worked (a possible multiplier of 12). Attractive certificates will be awarded to the operator submitting the highest score in each country and in each G, W and VE licensing area. The Contest will be in three sections: (a) Open Section, (b) Handicap Section (for VK/ZL only), (c) Receiving Section. Here are the complete rules and stipulations:

1. The W.I.A. Contest Committee will be the sole judge and its rulings and interpretations will be binding in the case of any dispute.

2. The nature of the Contest requires contacts between the World and VK-ZL.

3. The Contest is open to all Licensed transmitting and receiving stations in any part of the world. Unlicensed, ship and expedition stations are not permitted to enter. Financial Members of W.I.A. and N.Z.A.R.L. only will be eligible for awards in VK-ZL.

4. Only one licensed operator is permitted to operate any particular station. Should two or more operators operate at the same station each will be considered a competitor and must enter under his own call sign, and submit in his log contacts established by him. This debar persons entering who have no amateur license.

5. All amateur frequency bands may be used.

6. No prior entry is required, but each contestant is to submit a log at the conclusion of the Contest showing date, time (GT), band, station worked, signal reports exchanged, and points claimed for each QSO. Signal reports must include Readability, Strength and Tone. *NOTE.—No serial numbers are to be exchanged.*

7. The Contest will be held from 1200 GT, Saturday, October 3 to 1400 GT, Sunday, October 4, and will be continued between the same times on each of the four following week-ends: October 10-11; October 17-18; October 24-25; and October 31—November 1, 1936.

8. **SCORING FOR VK-ZL COMPETITORS.**—Twelve points will be scored for the first contact with a station in a country other than VK-ZL, eleven points for the second, ten for the third and so on until the twelfth, which will score one point. In all cases contacts are irrespective of the band used. This will apply to all countries except England and the United States of America; in these two countries 12 or more (as above) contacts will be permitted with stations having the following prefixes: G2, G5, G6 and W1-2-3-4-5-6-7-8-9. The points scored by contacts in the above manner will be added together and multiplied by the number of countries worked which will give the final score, except in the handicap section, where the grand total will be divided by the input (PA to Aerial in Watts) which will give the final score.

9. **SCORING FOR COMPETITORS OUTSIDE VK-ZL.**—

Twelve points will be scored for the first contact with a VK-ZL prefix zone, eleven for the second, ten for the third and so on to the twelfth contact which will count one point. The first 12 contacts with a particular prefix zone will, therefore, score 78 points. Each additional contact after the twelfth will count one point. This will apply to each VK-ZL prefix zone worked. The points scored in the above manner will be added, and the total multiplied by the number of VK-ZL prefix zones worked which will give the final score. The prefix zones are VK2-3-4-5-6-7-8-9 and ZL1-2-3-4.

10. Only one contact with a specific station on each of the bands will be permitted to count during the whole of the Contest except on the 28-mc. bands where one contact each week-end will be permitted to count.

11. **HANDICAP SECTION.**—All VK-ZL stations entering in the handicap section must state their desire to do so and give the power input to valve feeding the aerial. Input in the handicap section must not exceed 25 watts. Only VK-ZL competitors may enter the handicap section.

12. Entries from VK stations must reach the W.I.A. Contest Committee, Box 284-D, G.P.O., Adelaide, not later than December 1st. All overseas logs must reach the same address not later than December 31, 1936. Entries from ZL stations must be sent to the N.Z.A.R.L., Box 489, G.P.O., Wellington, not later than November 25, 1936.

**AWARDS:** Attractive Certificates will be awarded to the operator returning the highest total in each country and to the highest scorer in each of the G, W and VE prefix districts. For awards for VK-ZL highest scorers see official organs of W.I.A. and N.Z.A.R.L.

**RECEIVING CONTEST:** 1. The general rules for the Receiving Contest are the same as for the transmitting contests. It is open to any short-wave listener in the world except in New Zealand, where only members of the N.Z.A.R.L. can compete in receiving.

2. Only one operator is permitted and only one receiver can be used.

3. The dates, times, scoring of points and logging of stations on one band for the duration of the Contest are the same as for the transmitting contests. **NOTE.**—Reception of 28-mc. stations will be permitted to count for once on a week-end, and not once only for the duration of the Contest.

4. To score points the call sign of the station being called and the readability, strength and tone of the calling station must be entered in the log together with band, date and time. Logging of CQ or TEST calls will not count. **NOTE.**—Overseas stations must be logged by Australian or New Zealand listeners when either calling ZL or VK stations. Overseas listening stations must log VK-ZL stations when they are calling overseas stations.

5. Australian and New Zealand operators will count their scores as in Rule No. 8 of transmitting contests.

6. Overseas listening operators will count their scores as per Rule No. 9 of the transmitting contests.

7. Entries must be sent as per Rule No. 12 of the transmitting contests.

## Strays

Base connections for the 6L6 seem to be bothering some of the fraternity. Sockets should be connected the same as for the 6F6: Pin 1, shield; pin 2, heater; pin 3, plate; pin 4, screen; pin 5, grid; pin 6, no connection; pin 7, heater; pin 8, cathode.

# Multi-Tube Oscillators for the Ultra-High Frequencies\*

By Paul D. Zottu\*\*

**A**N IMPORTANT limitation on the effective use of the ultra-high frequencies is the fact that with present methods the output power that can be developed is small. With the feedback type of oscillator, output decreases approximately inversely as the square of the frequency. Although the use of two tubes in push-pull permits doubling the output of a single-tube oscillator, in the region of 300 mc. this increase amounts to only a few watts with commercially-available tubes. Paralleling of tubes is out of the question because this method causes tube capacities to add and therefore requires reduction of inductance to maintain

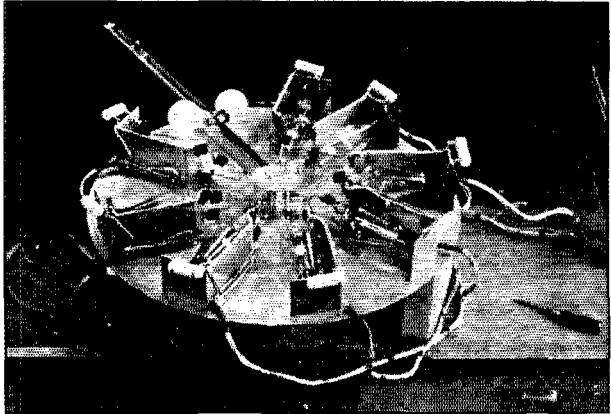

FIG. 2—AN EIGHT-UNIT 120-CM. OSCILLATOR OF THE TYPE DESCRIBED IN THE TEXT

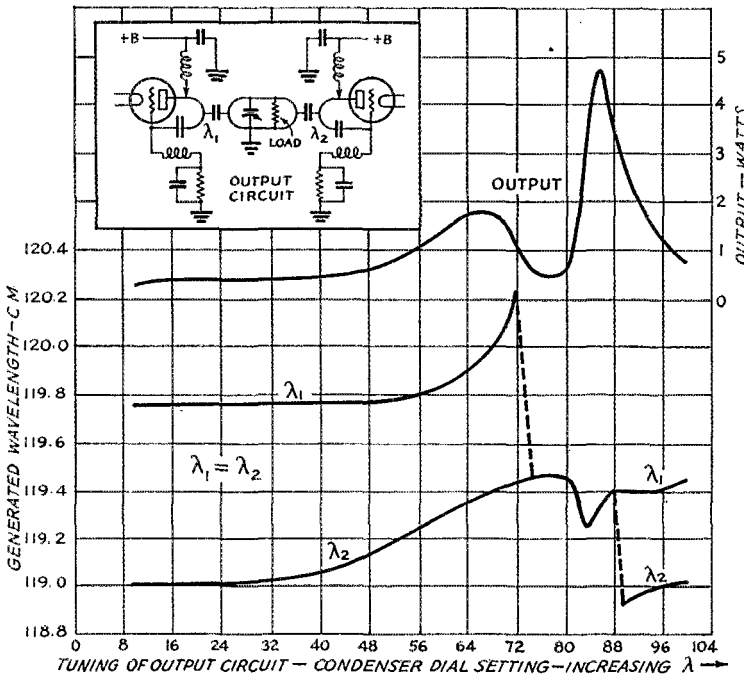

FIG. 1—VARIATION IN FREQUENCY AND POWER OUTPUT WITH TUNING, TWO OSCILLATORS COUPLED TO A COMMON TANK

\* Abstract from a paper presented by the author at the 1936 I.R.E. convention and submitted for publication in full in the *Proceedings of the Institute*.

\*\* Research and Development Lab., RCA Manufacturing Co., RCA Radiotron Division, Harrison, N. J.

A brass plate, on which the whole assembly is mounted, serves as an effective ground.

the same frequency. At the frequencies considered, inductance is already at a premium and further reduction necessitates making the oscillatory circuit inside the tube. Another disadvantage of the direct-parallel system is that the generated frequency changes with the addition or subtraction of a unit. It is evident, therefore, that a means of combining the output of two or more independent oscillators in such a way that these disadvantages are overcome would be highly desirable.

By proper utilization of two well-known effects in the operation of oscillators, a method for combining several oscillators in the desired manner becomes possi-

ble. Consider first a simple oscillator coupled to a tuned circuit which will be termed the secondary circuit. If the coupling is very loose, the secondary tuning will have negligible effect on the oscillator frequency, except in a small region near the point where the two cir-

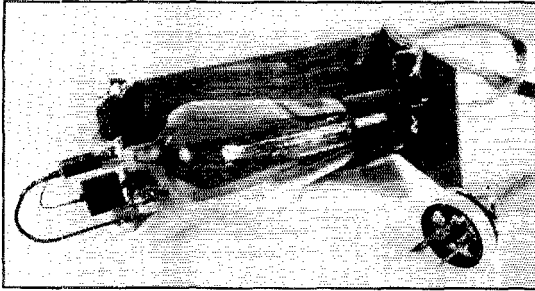

FIG. 3—ONE OF THE 834 OSCILLATOR UNITS MOUNTED IN ITS BRASS FRAME

cuits are in resonance, where a slight change in oscillator frequency will occur. With closer coupling, a considerably greater change in frequency results; as the coupling is still further increased, a "jump" in frequency as the secondary is tuned through resonance will occur. The behavior is modified somewhat by the presence of a load on the secondary, although the general effect is the same. The interesting point is that, depending upon the coupling and load, the oscillator frequency is seriously affected by the tuning of the secondary circuit.

The power output to the secondary circuit depends upon the coupling and tuning; with small values of coupling the output rises as the secondary is tuned into resonance, decreases on tuning away. With coupling values greater than the critical, two points of maximum power output will appear, with a minimum point occurring at resonance. The important thing is that maximum

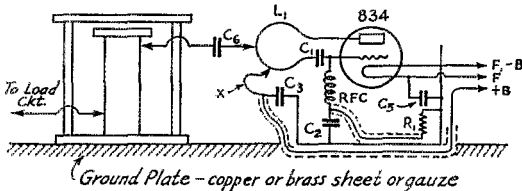

FIG. 4—CIRCUIT DIAGRAM OF THE UNIT OSCILLATOR

- L<sub>1</sub>—"Hairpin" tank of No. 12 wire, dimensions to give the desired frequency. For 120 cm. the loop is approximately 1 1/4 inches across and 2 inches long.
- C<sub>1</sub> to C<sub>6</sub>, inc.—200- $\mu$ fd. "postage-stamp" molded mica condensers.
- R<sub>1</sub>—3000 to 5000 ohms, wire-wound (grid leak).
- RFC—5 to 10 turns of No. 24 enamelled, coil diameter 1/4 inch (not critical).
- X—Lead to condenser C<sub>3</sub> acts as a small impedance; a small choke, as at the grid, might be used instead. Leads from grid choke to leak at base of tube, and from plate tank to plus "B", are shielded wire with shield soldered to brass frame.

output of the oscillator can be obtained with coupling values equal to or greater than critical.

Now suppose we have two oscillators of approximately the same frequency, one being variable a few percent within the region of the other. The two circuits are loosely coupled. As the wavelength of the variable oscillator approaches that of the fixed oscillator, the difference in frequency suddenly disappears, the oscillators having pulled each other in step. This is the common "pulling-in" effect. As the variable oscillator is further varied in the same direction, the generated frequency varies linearly with it until a value is reached where the two oscillators again operate independently. The range over which the two oscillators are synchronized depends, among other variables, upon the ratio of the impressed and the locally generated voltages. This effect provides a method for synchronizing independent oscillators over a limited range.

These two effects may be combined so that two or more independent oscillators can be loaded

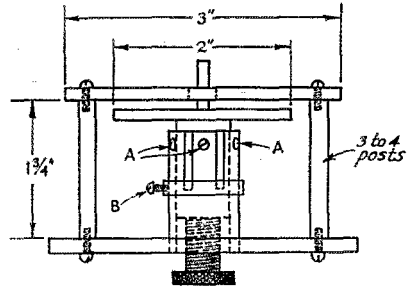

FIG. 5—ESSENTIALS OF THE TANK CIRCUIT  
A—Set screws to which the unit oscillators are connected.  
B—Movable ring, with set screw, for connecting to load circuit.  
The load coupling can be adjusted by moving the ring up and down the inner conductor.

adequately with a common oscillatory circuit. Furthermore, variations in the common oscillatory circuit will affect all of the independent oscillators alike, and through this circuit sufficient coupling will exist to synchronize the oscillators. The curves of Fig. 1 answer the practical question as to what happens when two oscillators differing in wavelength by about one per cent are coupled together through a common output circuit. With the output circuit appreciably detuned both below and above the generated wavelengths two oscillations appear. As the tuning of the output circuit approaches the wavelengths of the oscillators, a point is reached where the two oscillators pull in step and only one wavelength is generated. The two oscillations appear again as the output circuit is detuned in the opposite direction. The output goes through a maximum and a minimum in the in-



terval that the oscillators are synchronized. Within the "silent-interval" the phase between the two oscillators goes through a change of slightly greater than 180 degrees. The in-phase condition is shown by the condition of maximum output and the out-phase condition by minimum output.

#### A PRACTICAL MULTI-TUBE OSCILLATOR

A complete multi-tube oscillator embodying the principles discussed is shown in Fig. 2. In the center is shown a specially designed low-loss short-wave circuit which will be described later. Grouped about this circuit, in more or less radial fashion, are a number of unit oscillators. These are coupled to the tank circuit through by-pass condensers. The unit oscillators are separately tuned to approximately plus or minus one per cent of each other and are then coupled to the main tank circuit. In general, coupling between oscillators other than through the main tank circuit is to be avoided. The load is also coupled to this main circuit. In the present

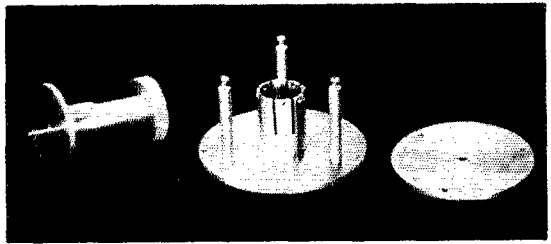

FIG. 6—THE TANK CIRCUIT DISASSEMBLED

mounted on a brass frame. The grid, plate, and filament supply leads are by-passed to the frame. In the multi-tube oscillator, the frame rests on a large brass plate which is essentially at ground potential for radio frequencies.

The tube capacity with an inductance consisting of a short loop of wire between the grid and plate completed through a by-pass condenser makes up the oscillatory circuit. Connections for grid and plate supply are made to the loop through suitable radio-frequency chokes. A shielded cable terminated by a plug connects the unit to the power supply. This has proven a convenient method for placing or removing a unit from service.

A drawing of the low-loss short-wave tank circuit previously mentioned is shown in Fig. 5. Essentially, it is a modified quarter-wave concentric line. If the outer conductor of such a line is replaced by rods, the line will, in many respects, still operate as if the conductor were solid. If such a line is terminated at its open end by a small capacity in order to obtain a condition of resonance, its length will have to be reduced. The amount that the line will be shortened as compared to the length of a quarter of the operating wavelength depends upon the characteristic constants of the line and the value of the terminating capacity. In the present case the ratio of diameters of the outer and inner conductors is approximately three to one and the terminating capacity about 25  $\mu\text{mfd}$ . The line length is approximately 4 cm. The entire circuit is made of copper. Judged by the sharpness of its resonance curve when it is not loaded, the circuit appears remarkably free from losses. Constructing the outer conductor with only a few rods makes the inner conductor readily accessible. Terminating the line with such a large capacity proved very beneficial, because if slight capacity changes take place at insertion or removal of a unit from the system, the changes are only a small fraction of the total capacity of the circuit and will affect the tuning of the line but slightly.

The component parts of this circuit are shown in Fig. 6. The left-hand piece screws into the center piece. The top surface of this piece is one plate of the condenser while the plate at the right of the figure screwed on top of the rods forms the

(Continued on page 74)

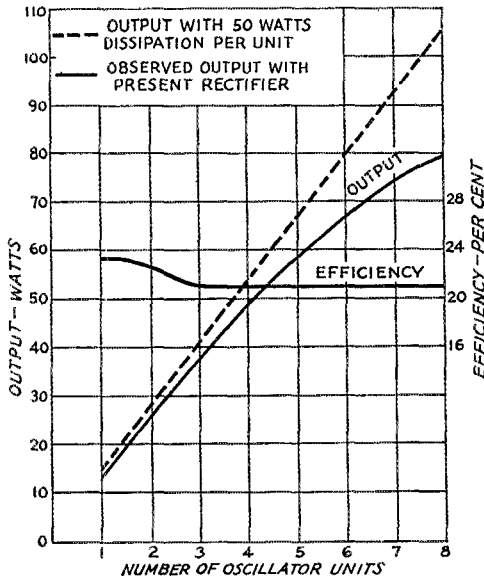

FIG. 7—VARIATION IN OUTPUT AND EFFICIENCY WITH NUMBER OF UNIT OSCILLATORS

As explained in the text, the dropping off in output is occasioned by power supply regulation. With perfect regulation, the curve should be as shown by the dotted line, since the efficiency is constant.

instance the load consists of a lamp connected to a half-wave line which in turn is coupled to the main tank circuit. As the tank circuit is tuned, the output varies in much the same manner as when only one oscillator unit is present, but is magnified by the number of units present.

A unit oscillator is shown in Fig. 2 and its circuit diagram in Fig. 4. It consists of an 834 tube

# 5-Meter Crystal-Control With Push-Pull 800 Output

By John L. Reinartz,\* W1QP

WITH the advent of the superhet receiver into the realm of 5 meters, it became necessary to look about for a means to improve the transmitter and to simulate crystal-control. While resonant-line control has done

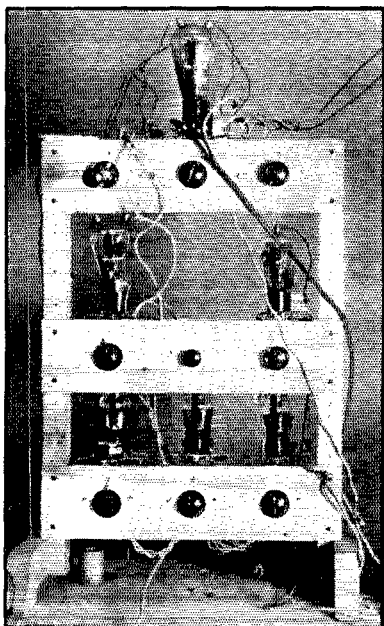

FRONT VIEW OF COMPLETE TRANSMITTER

wonders to improve the stability of the 5-meter signal, it was felt that crystal control was not beyond the possibility of the amateur and therefore it became an interesting problem here at W1QP, resulting in putting on the air a 200-watt input transmitter that is actually crystal-controlled and having in the previous stages nothing that would be a deterrent to any other amateur.

There are two possible ways to start such a transmitter, depending on the desires of the individual. Should he wish to operate in some of the other amateur bands as well as in the 5-meter band, it will entail one method of procedure; but if he builds for the 5-meter band only, it will be even simpler. Because the 5-meter transmitter built here at W1QP was for the 5-meter band only, and since the problems encountered will

have to be met to a lesser degree for any of the lower frequencies, it may be best to show how these problems were overcome in the transmitter built.

With one eye always on the pocketbook, a list was made of all the desirable tubes that could be used, starting with the crystal-control tube at 40 meters. There was to be no doubling at the crystal stage and the last tube in the low-power line-up

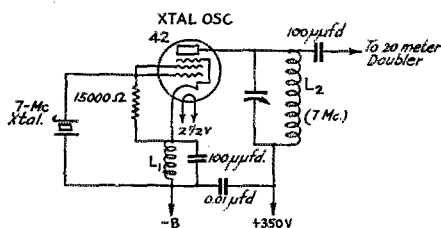

FIG. 1

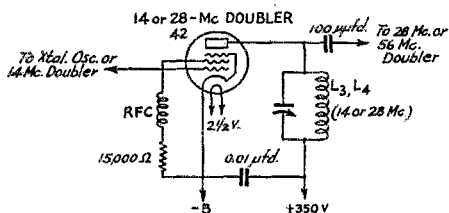

FIG. 2

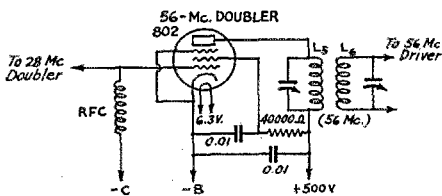

FIG. 3

FIGS. 1, 2, 3, THE CRYSTAL OSCILLATOR AND DOUBLER CIRCUITS FOR GOING FROM 7 MC. TO 56 MC. IN FOUR STAGES

L1—Oscillator cathode coil, 100 microhenrys. (60 turns of No. 24 d.s.c. or s.c.c. on a 1 1/2-inches diameter form is suggested.)

L2—Oscillator plate coil, 7 mc.; 8 turns No. 16 d.c.c., 3/4 inches diameter, basket-wound.

L3—14-mc. doubler plate coil; 4 turns same as L2.

L4—28-mc. doubler plate coil; 4 turns, diameter 1 1/4 inches, 1/4 inch between turns.

L5—56-mc. doubler plate coil; same as L4.

L6—56-mc. buffer grid coil; same as L4.

Tuning condensers for first three stages are 100- $\mu$ fd. Cardwells. The condenser across L5 is a midget 50  $\mu$ fd.

\*176 Wadsworth St., Manchester, Conn.

was to be an 802, chosen for its low driving power requirements. It was finally decided that the line-up would consist of 42 crystal-oscillator tube, 42 doubler to 20 meters, another 42 doubler to 10 meters, and then the 802 as a doubler from 10 to 5 meters. The 802 was to take the burden of exciting a single 800 driver, followed by a pair of 800's in the final stage. It was felt that this 6-stage line-up would keep the expense down and still have power enough in each of the stages to excite properly the following stage.

You may decide that a single 801 is sufficient as the final in the rig you wish to build up. However, here it was more a question of "will it work." Also, there were a number of 200-watt input 5-meter stations on the air and it was desirable to see how a crystal-control rig of like power would act and if the results would be worth the trouble, should any be encountered. Now that the station has been on the air a number of months and all the tubes have had a good try-out

can be found, you feel that you have done your part to clean up the 5-meter band.

Fig. 1 shows the crystal-oscillator circuit. When the 42 is thus used as a triode, the tube does not

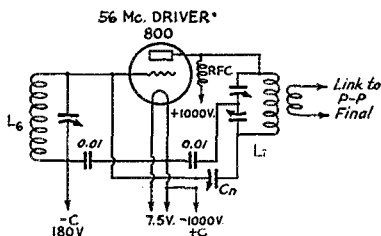

FIG. 4

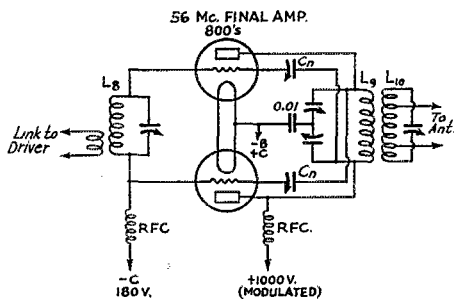

FIG. 5

FIGS. 4 AND 5—56-MC. BUFFER AND PUSH-PULL FINAL

L<sub>6</sub>—See Fig. 3.

L<sub>7</sub>—Buffer plate coil, 5 turns, diameter 1 1/4 inches, 1/4 inch between turns.

L<sub>8</sub>—Final amplifier grid coil; 3 turns same as L<sub>7</sub>.

L<sub>9</sub>, L<sub>10</sub>—Final plate and antenna coils; same as L<sub>8</sub>.

with not a tube failure to date, we can truly say that building this rig has given us more real enjoyment with less worry than some of the transmitters that have been built during the last 27 years. When the lad at the other station tells you that he can use an autodyne receiver on your signal and nary a wiggle of the frequency

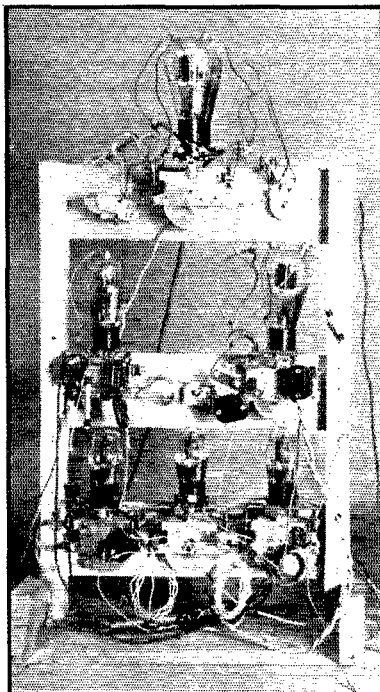

REAR VIEW OF W1QP 56-MC. RIG

draw plate current when excitation is absent, resulting in a safe and sane sort of arrangement. The output as a crystal-controlled tube is approximately 3 watts with 30 ma. plate current at 350 volts. In Fig. 2 we have the same tube used as a doubler and again have the automatic control feature that puts the plate current to zero if it is not excited from the previous stage. The same is true in the 10-meter stage, which has the same circuit as Fig. 2. Fig. 3 shows the circuit arrangement for the 802. This is quite normal and results in the tube acting pretty much as it would at a lower frequency. The plate current is normal and the power output approximately 6 watts at 5 meters. A little more power output can be obtained if the suppressor grid is operated at 22 1/2 volts positive.

No difficulty will be experienced with the 800 driver or the two 800's in the final stage if proper attention to neutralization has been paid. Link coupling will be found advantageous in driving the final stage. It will be much easier to determine and control the proper amount of excitation by this means. Link coupling is also used on the single 800 driver and is especially desirable when it

(Continued on page 76)

# What the League Is Doing

League Activities, Washington Notes, Board Actions—For Your Information

**Election Notice** To all members of the American Radio Relay League residing in the Central, Hudson, New England, Northwestern, Roanoke, Rocky Mountain, Southwestern, and West Gulf Divisions:

You are hereby notified that, in accordance with the constitution, an election is about to be held in each of the above-mentioned divisions to elect both a member of the A.R.R.L. Board of Directors and an alternate thereto, for the 1937-1938 term. Your attention is invited to Sec. 1 of Article IV of the constitution, providing for the government of A.R.R.L. by a board of directors; Sec. 2 of Article IV, defining their eligibility; By-Laws 11 to 21, providing for the nomination and election of directors; and By-Law 12, providing for the simultaneous election of an alternate director.

Voting will take place between November 1 and December 20, 1936, on ballots that will be mailed from the headquarters office in the first week of November. The ballots for each election will list, in one column, the names of all eligible candidates nominated for the office of director by A.R.R.L. members residing in that division; and, in another column, all those similarly named for the office of alternate. Each member will indicate his choice for each office.

Nomination is by petition. Nominating petitions are hereby solicited. Ten or more A.R.R.L. members residing in any one of the above-named divisions may join in nominating any member of the League residing in that division as a candidate for director therefrom, or as a candidate for alternate director therefrom. No person may simultaneously be a candidate for the offices of both director and alternate. A separate petition must be filed for the nomination of each candidate, whether for director or for alternate director. The following form for nomination is suggested:

(Place and date)

Executive Committee  
The American Radio Relay League  
West Hartford, Conn.

Gentlemen:

We, the undersigned members of the A.R.R.L. residing in the . . . . . Division, hereby nominate . . . . ., of . . . . ., as a candidate for director [or for alternate director] from this division for the 1937-1938 term.

(Signatures and addresses)

The signers must be League members in good standing. The nominee must be a League member

in good standing and must be without commercial radio connections: he may not be commercially engaged in the manufacture, selling or rental of radio apparatus or literature. His complete name and address should be given. All such petitions must be filed at the headquarters office of the League in West Hartford, Conn., by noon E.S.T. of the first day of November, 1936. There is no limit to the number of petitions that may be filed, but no member shall append his signature to more than one petition for the office of director and one petition for the office of alternate director. To be valid, a petition must have the signatures of at least ten members in good standing; that is to say, ten or more members must join in executing a single document; a candidate is not nominated by one petition bearing six signatures and another bearing four signatures. Petitioners are urged to have an ample number of signatures, since nominators are frequently found not to be members in good standing.

Present directors from these divisions are as follows: Central, Mr. Edward A. Roberts, W8HC, Cleveland, Ohio; Hudson, Mr. Kenneth T. Hill, W2AHC, Douglaston, N. Y.; New England, Percy C. Noble, W1BVR, Westfield, Mass.; Northwestern, Mr. Ralph J. Gibbons, W7KV, Pendleton, Ore.; Roanoke, Prof. H. L. Caveness, W4DW, Raleigh, N. C.; Rocky Mountain, Mr. Russell J. Andrews, W9AAB, Denver, Colo.; Southwestern, Mr. Charles E. Blalack, W6GG, El Centro, Calif.; West Gulf, Mr. Wayland M. Groves, W5NW, Neches, Texas.

These elections constitute an important part of the machinery of self-government in A.R.R.L. They provide the constitutional opportunity for members to put the direction of their society in the hands of representatives of their own choice. Members are urged to take the initiative and file nominating petitions immediately.

For the Board of Directors:

K. B. WARNER,  
Secretary.

August 10, 1936.

**Ratifications** Uruguay on April 27th ratified the Madrid Convention and its radio regulations. The Free City of Danzig announces its adherence to the convention.

**Financial Statement** The League experienced a small loss from business operations during the second quarter of the year, as is normal at that season. For the information of

members, the operating statement is here published:

STATEMENT OF REVENUES AND EXPENSES,  
EXCLUSIVE OF EXPENDITURES CHARGED  
TO APPROPRIATIONS, FOR THE THREE  
MONTHS ENDED JUNE 30, 1936

REVENUES	
Membership dues . . . . .	\$ 9,312.31
Advertising sales, QST . . . . .	18,316.51
Advertising sales, booklets . . . . .	425.00
Newsdealer sales, QST . . . . .	11,232.32
Handbook sales . . . . .	7,350.07
Booklet sales . . . . .	2,415.03
Calculator sales . . . . .	593.57
Membership supplies sales . . . . .	1,974.60
Interest earned . . . . .	303.48
Cash discounts received . . . . .	324.41
Bad debts recovered . . . . .	5.33
	\$52,252.63
<i>Deduct:</i>	
Returns and allowances . . . . .	4,012.49
Cash discounts allowed . . . . .	394.42
Collection and exchange . . . . .	10.33
	\$ 4,417.24
Less decrease in provision for newsdealer returns of QST . . . . .	734.47
	3,682.77
Net Revenues . . . . .	\$48,569.86

EXPENSES	
Publication expenses, QST . . . . .	\$14,393.40
Publication expenses, Handbook . . . . .	4,299.70
Publication expenses, booklets . . . . .	727.07
Publication expenses, calculators . . . . .	339.89
Salaries . . . . .	21,094.41
Membership supplies expenses . . . . .	1,161.70
Postage . . . . .	1,546.65
Office supplies and printing . . . . .	877.31
Traveling expenses . . . . .	1,705.15
QST forwarding expenses . . . . .	783.53
Telephone and telegraph . . . . .	568.06
General expenses . . . . .	1,438.39
Insurance . . . . .	45.07
Rent, light and heat . . . . .	828.82
Provision for depreciation of furni- ture and equipment . . . . .	261.85
General Counsel expenses . . . . .	10.75
Communications Dept. field ex- penses . . . . .	68.09
Headquarters station expenses . . . . .	112.52
Bad debts written off . . . . .	56.69
	50,309.05
Total Expenses . . . . .	50,309.05
Net Loss before Expenditures against Appropriations . . . . .	\$ 1,739.19

**'Phone  
Frequencies**

Annually the question of more 'phone frequencies comes up at the meetings of the League's Board. This year a small majority of the directors thought that 'phone ought to be increased, and so the F.C.C. was requested to extend the 80-meter Class A subband to read 3850-4000 kc.

Several thousand members of the League, and other licensed amateurs as well, have signed and filed petitions with the F.C.C., to a total of over 6000 signatures, protesting this expansion of the 'phone band of 50 kc. The Commission, not knowing what to make of such an apparently disorganized situation, decided to hold a formal public

hearing on October 20th on the general subject of further allocations for 'phone, where the A.R.R.L. Board's request would be formally examined. Meanwhile it became evident that 'phone amateurs were getting up petitions for the F.C.C.'s eye in favor of the increase, while it was rumored that the c.w. gang was employing counsel to fight the change.

In this unpleasant situation the A.R.R.L. Board has reviewed its request. It has taken the only action it could: it has withdrawn the request. The League cannot be a party to a dogfight of conflicting amateur jealousies before the Commission; it must not permit a request of its to cause such a situation. More than that, making a request is one thing but going to the expense of a formal appearance is another, and our members will doubtless agree that it would be in very questionable taste for the League to stage a fight against several thousand of its own members with money that belongs to them as much as to anybody else. This consideration alone was enough to make necessary the withdrawal of the request. The whole affair shows most clearly that the subject requires more study by the Board, and the cancellation of the request now makes this possible. The hearing is now to be washed out and the directors will make a new study of the whole problem.

We cannot pass by this affair without some comment on its sadder aspect. If individual amateurs are going to plague the Commission with petitions of protest and of support upon our various matters, it takes no clairvoyance to foresee something unpleasant happening to amateur radio. The Commission can't hope to deal with 40,000 individual amateurs. Amateur radio in its present dimensions is possible in this country only because we have a great national society to collect and unify our views—to provide a mechanism within which we have always heretofore acted in concert. *We must not break down that system if we are to survive.* We must wash our dirty linen in private, do our quarreling within our own walls, compose our differences within our own Board, present our position to Washington in one dignified voice, one way or the other. These petitions and these objections belong before the A.R.R.L. Board, not before the F.C.C. That's why we have our present system of government in the League. Amateurs who petition the F.C.C. individually are injuring our status there as nothing else could do. Please, fellows, let's have no more of it!

**Preparations  
for Cairo**

The government of the United States has virtually completed its preparations for the Cairo Conference, as we write, and without putting forward any proposals for the widening of our bands.

It will be remembered that at the June hearings

*(Continued on page 78)*

# A Crystal Filter and Noise-Silencer for the "High-Performance" Super

A Modernizing Unit Which Can Be Adapted to Many  
Non-Single-Signal Receivers

By George Grammer, W1DF\*

IT IS hardly necessary to recount the advantages of the crystal filter and noise-silencing circuits for superhet receivers; both speak for themselves. No "sales talk" being needed, therefore, we shall confine ourselves to a description of the construction and operation of a combination unit built to work with the receiver described in April *QST*.<sup>1</sup> The same circuit and possibly the

receiver to which it is attached; the set can be restored to its original condition in a second or two simply by replacing a grid grip.

The circuit diagram, given in Fig. 1, is practically identical with that given on page 17 of April *QST*.<sup>2</sup> The 6L7 is an extra i.f. amplifier tube, preceding the crystal filter; the silencing voltage is applied to its No. 3 injection grid. The 6J7 and 6H6 are the noise amplifier and rectifier. Silencing, therefore, takes place before the signal reaches the crystal, thereby preventing shock excitation of the crystal by the noise voltages.<sup>2</sup>

The paralleled control grids of the 6L7 and 6J7 pick up their i.f. exciting voltages from the grid cap which normally goes to the i.f. tube in the receiver. After passing through the unit, the i.f. signal goes to the grid of the same receiver i.f. tube. In other words, everything takes place between the grid cap and grid of the i.f. tube.

## CIRCUIT DETAILS

A short résumé of the circuit functions will be of help to those not especially familiar with crystal filter and noise-silencing circuits. The electrode voltages on the 6L7 i.f. amplifier-noise-silencing tube are adjusted primarily to give most effective noise silencing and not particularly to give additional i.f. gain. Nevertheless, there is some gain; rough measurement shows that the stage gives an amplification of two, approximately. The value of the cathode resistor,  $R_1$ , as well as those of the resistors in the screen voltage divider,  $R_2$  and  $R_3$ , are chosen to put a few volts of bias on the control grid and about 30 or 40 volts on the screen; this to make the No. 3 grid, to which the silencing voltage is applied, give more effective control than is possible with normal bias and screen voltages.

The primary of the crystal input transformer,  $T_1$ , connected in the plate circuit of the 6L7, is untuned. The particular transformer used has its secondary tuned by an air trimmer of the usual type; to get the balanced circuit needed for the crystal filter, and also to provide a selectivity control, a split-stator condenser,  $C_1$ , is connected across the secondary circuit.  $C_2$  is the phasing condenser or rejection control. The crystal output

<sup>2</sup> Lamb, "More Developments in the Noise-Silencing I.F. Circuit," *QST*, April, 1936.

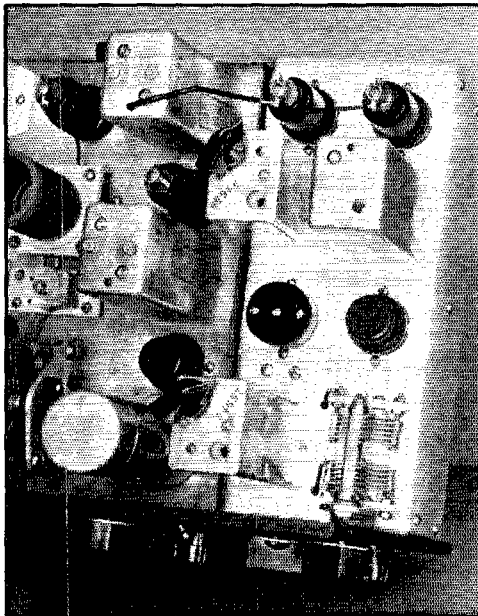

THE CRYSTAL FILTER AND NOISE-SILENCER UNIT ATTACHED TO THE HIGH-PERFORMANCE SUPER

The unit bolts to the right-hand side of the receiver chassis. As explained in the text, no receiver wiring changes are necessary. The various components are identified in the text.

same arrangement of parts can be used with other types of supers now without crystal filters and silencers. It is worth pointing out that the unit as pictured requires no changes in the wiring of the

\* Assistant Technical Editor.

<sup>1</sup> "Building a Simplified High-Performance Superhet," *QST*, April, 1936.

transformer,  $T_2$ , is a single-winding affair, also air-tuned, tapped to give a suitable match for the crystal impedance. The tap is coupled to the crystal through a 50- $\mu$ fd. fixed condenser. This condenser may be made variable, if desired, to give fine adjustment of the coupling between the crystal and output transformer, although the fixed condenser usually will be found satisfactory. (The ground terminal of  $T_2$  is indicated in the diagram as going to the a.v.c. line in the receiver. In case the unit is applied to another type of receiver which does not have a.v.c., this lead can be connected directly to the chassis, in which case  $C_{11}$  may be omitted.)

In the silencer circuit, the 6J7 noise amplifier is biased for normal operation, but its cathode is connected to the rotor arm of a variable resistor,  $R_8$ , so that the bias applied to its grid can be varied between a minimum of three volts (resulting from the use of the cathode resistor  $R_5$ ) and a maximum of about 20 volts.  $R_8$ , by setting the point at which the noise circuit starts to operate, acts as a threshold control. The cathode of the 6H6 noise rectifier also is connected to the movable arm of  $R_8$  to bias the diode plates so that rectification will not take place until the incoming signal or noise reaches the desired level. The switch  $Sw_2$  opens the cathode circuits of both tubes to disable the noise-silencing circuit when desired.

Only the primary of the diode input transformer is tuned. Its secondary is center-tapped so that the diode can be used as a full-wave rectifier. This helps prevent r.f. from getting into the line to the No. 3 grid of the 6L7, where it might upset the action of the silencer. Additional filtering is provided by  $C_3$ ,  $C_4$ , and  $RFC$ .

#### CONSTRUCTION

The photographs show the unit. The chassis is made of aluminum, 4 inches wide, 10 inches deep and 3 inches high, to line up with the receiver chassis. The layout permits getting quite short leads from the first i.f. transformer in the receiver and back again into the grid of the i.f. amplifier tube; this, in fact, was the primary consideration. Secondly, it was of course desirable that the controls be placed so that they could conveniently be brought out to the front where they can most easily be reached.

Looking at the top view, the crystal filter occupies the left-hand section and the noise silencer the right, with the exception of  $C_1$ , the selectivity control. The 6L7 is in the left rear

corner. In front of it is the output transformer,  $T_2$ , then the crystal socket, and finally, right at the front, the input transformer,  $T_1$ . While this makes a fairly long plate lead from the 6L7 to the input transformer necessary, it was considered

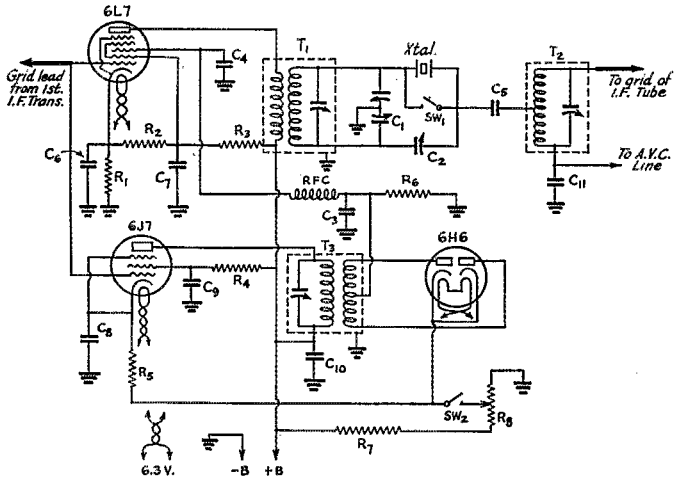

FIG. 1—CIRCUIT DIAGRAM OF THE CRYSTAL FILTER AND NOISE-SILENCER UNIT

The only r.f. connection disturbed in the receiver is the grid-cap connection to the i.f. tube.

$C_1$ —Split-stator condenser (selectivity control), 50  $\mu$ fd. per section (National STD-50).

$C_2$ —15- $\mu$ fd. variable (phasing condenser) (National UM-15).

$C_3$ —100- $\mu$ fd. mica.

$C_4$ ,  $C_8$ —50- $\mu$ fd. mica.

$C_6$  to  $C_{10}$ , inc.—0.1 paper.

$C_{11}$ —0.01 paper.

$R_1$ —2000 ohms,  $\frac{1}{2}$  watt.

$R_2$ —50,000 ohms, 1 watt.

$R_3$ ,  $R_4$ —100,000 ohms, 1 watt.

$R_5$ —300 ohms,  $\frac{1}{2}$  watt.

$R_6$ —100,000 ohms,  $\frac{1}{2}$  watt.

$R_7$ —30,000 ohms, 2 watt.

$R_8$ —30,000-ohm wire-wound volume control (noise suppression or threshold control) (Yaxley).

RFC—20 millihenry r.f. choke (Sickles).

$T_1$ —Crystal filter input transformer, 465 kc. (Sickles).

$T_2$ —Crystal filter output autotransformer, 465 kc. (Sickles)

$T_3$ —Diode transformer for noise circuit, 465 kc. (Aladdin)

$Sw_1$ —S. p. s. t. switch; see text for description.

$Sw_2$ —S. p. s. t. toggle switch mounted on  $R_8$ .

XTAL—Bliley BC-3, 465 kc.

better to have the plate lead long rather than one of the grid leads. The plate lead is run through shield braid to prevent coupling to the other wiring. On the right-hand side, the 6J7 is at the rear right, next is the diode transformer  $T_3$ , next the 6H6, and finally  $C_1$ , the crystal selectivity control.

By-pass condensers underneath the chassis are placed chiefly so that short connections to the chassis can be made. The phasing condenser,  $C_4$ , is mounted below deck by one of the brackets, furnished for that purpose. An insulating coupling between the condenser rotor and an extension shaft (this shaft, complete with bearing, is a Bud Type 531 sawed off to fit) brings the control out to the front.

A condenser with an insulating mounting is

essential here, since neither side of  $C_2$  can be grounded. The crystal on-off switch,  $S_1$  in Fig. 1, is simply a piece of thin brass cut so that when  $C_2$  is set at minimum its rotary plates touch the brass and short-circuit the crystal. The "switch" is mounted on a spare hole in the isolantite mounting plate of the condenser.

The r.f. choke in the silencing circuit is mounted

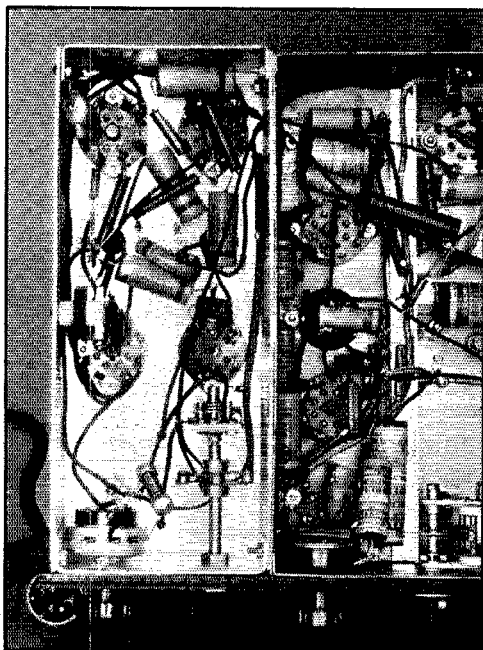

#### SUB-BASE WIRING OF THE FILTER-SILENCER

In most cases, parts are simply placed in convenient locations, using short r.f. leads. The d.c. and filament supply connections to the receiver go through the grommet in the side of the unit.

on the side of the chassis near the 6H6 socket. The whole unit is fastened to the receiver chassis with machine screws; a hole through both furnishes an inlet for filament, B plus, and a.v.c. leads. These are simply soldered to convenient corresponding leads in the receiver itself; the length is unimportant.

#### ADJUSTMENTS AND HANDLING

As we have already explained, the grid caps for the 6L7 and 6J7 are connected to the grid lead coming from the first i.f. transformer in the receiver. The grid lead from  $T_2$  goes back to the receiver i.f. tube. The extra capacity of the two tubes in parallel will require retuning of the secondary winding of the i.f. transformer in the receiver to bring the circuit back to resonance.

To line up the crystal and i.f. it is advisable to make use of a test oscillator of the type used for checking b.c. receiver i.f. circuits. Since the i.f. in the receiver is 465 kc., the crystal likewise is of

this frequency. The first step is to find the main peak of the crystal.

Remove the grid cap from the first detector in the receiver and connect the appropriate leads from the test oscillator. Using headphones, with the beat oscillator off,  $Sw_2$  open and  $Sw_1$  open, vary the oscillator frequency slowly while listening closely for the characteristic "plop" or chirp as the oscillator frequency goes through a crystal peak. If more than one peak shows up (usually there are more than one, but not closer than seven or eight, kilocycles to the main peak), it will be necessary to go through the tuning procedure on each in order to determine which is the main peak. The latter will give the greatest response.

With the test oscillator peaked on the crystal frequency, tune all circuits for maximum deflection of the 6E5. It may be necessary to back off the r.f. gain as the circuits come into line, to keep the deflection within the right operating range. Readjust the test oscillator occasionally to keep the frequency on the crystal peak. To adjust  $T_1$ , set  $C_1$  near maximum capacity and line up with the trimmer in  $T_1$ . When the selectivity control,  $C_1$ , is set to give maximum response with the crystal "in," the 6E5 deflection should be the same with  $Sw_1$  either closed or open; in other words, *switching in the crystal does not cause a decrease in signal strength*, although the QRM and background noise are greatly reduced.

To adjust the noise silencer, close  $Sw_2$  and advance  $R_8$  to about four-fifths maximum. Again using the test oscillator, adjust the condenser in  $T_3$  to block off the signal. The point at which blocking occurs will depend upon the signal strength and the setting of  $R_8$ ; use a signal which will deflect the 6E5 to about half scale and keep retarding  $R_8$  until the signal just blocks off when  $T_3$  is tuned to resonance. The blocking is very easily seen on the "eye." If there is any local noise the adjustment of  $T_3$  can be made equally well without a signal—possibly better—by adjusting for greatest noise suppression.

If no test oscillator is available, an incoming signal may be used for lining-up purposes. It should, however, be perfectly steady. A local broadcast harmonic or signal from the frequency-monitor is best.

A few words about operating the unit: With the crystal switch,  $Sw_1$ , closed (this occurs with the phasing condenser,  $C_2$ , set at minimum, as already described), the crystal is cut out of the circuit and the receiver is simply the same as before except that there is more i.f. gain.  $C_1$  should in that case be set for maximum signal strength. With the switch open, and  $C_1$  set at the same point, the selectivity is greatly increased and the signal strength unchanged. Tune in a signal to maximum strength, using the 6E5 as an indicator, and set the beat oscillator to the desired

(Continued on page 84)



# A Novel All-Band Transmitter of One-Kilowatt Capability

A Three-Stage Design Incorporating High-Power Crystal Oscillator, High-Efficiency Doubler and Triode Rectifier Keying

By William W. Eitel,\* W6UF, and Jack A. McCullough,\*\* W6CHE

**T**HE design of a transmitter, whether for ultimate use on c.w. or 'phone, is usually dictated by the builder's personal preferences and ambitions. Activities of the amateur fraternity are diversified on six different frequency bands, but often the requirements for operating on the 28- and 56-mc. bands have been too severe to permit a single transmitter to be designed for effective operation on all amateur frequencies. It is considered very good practice to design a transmitter for the most efficient operation on the highest frequency to be employed. Then it automatically follows that the best possible results will be realized at the lower frequencies; provided, of course, that a reasonable effort is made to maintain the proper values of capacity to inductance ratio in the tank circuits.

That the transmitter must be crystal-controlled immediately place certain limitations upon our design if the utmost in flexibility is desired. At the present time crystals of fundamental frequency above 14.4 megacycles have not been produced too successfully commercially so we are, of necessity, forced to use some method for frequency multiplication to get to the highest frequencies. The design of the crystal oscillators and frequency multipliers in use probably has as many variations as there are stations in existence. These variations range from all types of receiving tubes to very expensive pentode transmitting tubes. Much can be said in favor of the low first-cost of receiving tubes, but their performance leaves much to be desired.

Reduced to the barest necessities, we find our transmitter must consist of an oscillator, a frequency multiplier, and an amplifier. This transmitter consists of just that, with only three tuned circuits taking care of everything. For the proper operation of our transmitter, a high degree of efficiency is obtained in each stage, which makes impossible the use of tapped coils for frequency changing. The tube lineup is as follows: 35T crys-

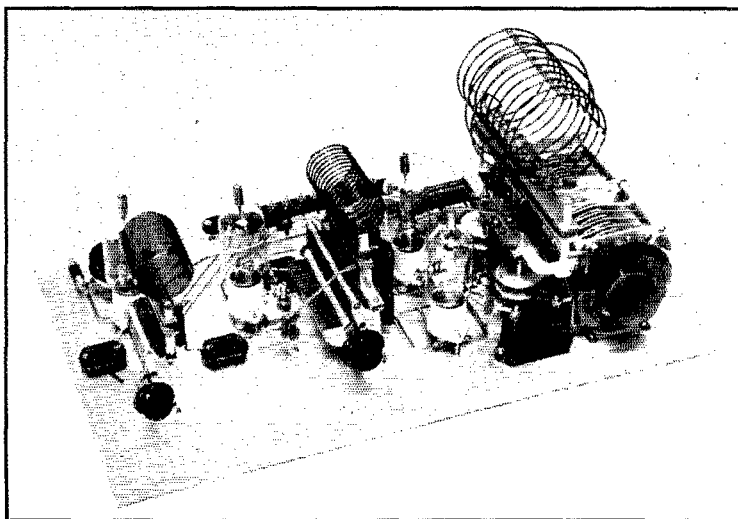

**ONLY THREE STAGES BUT ADAPTABLE TO OPERATION ON ANY AMATEUR BAND FROM 60 MC. DOWN, WITH FINAL PLATE INPUT UP TO A KILOWATT ON THE LOWER FREQUENCIES**

*35T's are used in all stages—and in the power supply rectifier as well.*

tal oscillator, 35T frequency multiplier, and two 35T's in the final connected in push-pull. A single 1500-volt power supply takes care of all 3 stages.

## THE HIGH-POWER OSCILLATOR

The crystal oscillator employs a conventional triode circuit. The only unusual feature is the use of a 500-ohm cathode bias resistor and the elimination of the grid leak. The value of 500 ohms is fairly critical and was chosen because its use greatly minimizes the r.f. crystal current. The extremely low interelectrode capacitance of the 35T reduces the feedback to a minimum and thus

\* 592 San Mateo Ave., San Bruno, Calif.

\*\* 340 Hazel Ave., Millbrae, Calif.

makes possible the use of comparatively high values of plate voltage. With 1500 volts on the plate of the 35T, using a 3.5-megacycle crystal, the r.f. crystal current measures only 65 milliamperes. However, a plate voltage of 1000 on the oscillator is sufficient for normal 1500-volt operation of the final. It is interesting to note that less strain is placed upon the crystal than with a 53 connected in push-pull with 400 volts on the plate. The 35T output is in the neighborhood of

crystal tube requires a separate filament winding in order to obtain the necessary automatic bias. This separate filament winding greatly facilitates the metering of the various circuits, permitting the plate milliammeter to be inserted in the negative lead from the power supply. Separate filament windings are also used for both the doubler and final. Link coupling is unnecessary between the crystal tank and the doubler because the plate voltage is high enough to develop sufficient r.f.

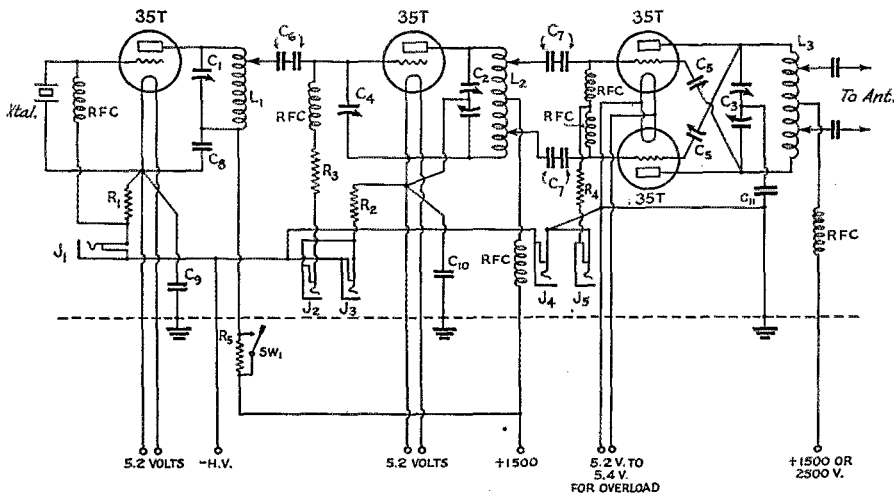

FIG. 1—CIRCUIT OF THE HIGH-POWER THREE-STAGE TRANSMITTER

- |  |  |  |
|--|--|--|
| <p><math>L_1, L_2, L_3</math>—“Air-wound” coils to suit frequency combination. (See table of coil specifications, No. 12 wire windings, Chapter Eight of A.R.R.L. Handbook.)</p> <p><math>C_1</math>—100-<math>\mu</math>fd. oscillator plate tuning (Cardwell MT 100 GS).</p> <p><math>C_2</math>—50-<math>\mu</math>fd. (double 100-<math>\mu</math>fd.) buffer tank tuning (Cardwell MT 100 GD).</p> <p><math>C_3</math>—35-<math>\mu</math>fd. (double 70-<math>\mu</math>fd.) final tank tuning (Johnson 70DD70).</p> <p><math>C_4</math>—Buffer neutralizing condensers. (See text.)</p> <p><math>C_5</math>—Final neutralizing condensers (National NC800. See text).</p> | <p><math>C_6</math>—0.001-<math>\mu</math>fd. mica, doubler grid coupling condensers.</p> <p><math>C_7</math>—0.002-<math>\mu</math>fd. mica, final grid coupling condensers.</p> <p><math>C_8</math>—0.002-<math>\mu</math>fd. 5000-volt mica, oscillator plate by-pass.</p> <p><math>C_9</math>—0.01-<math>\mu</math>fd. oscillator cathode by-pass.</p> <p><math>C_{10}</math>—0.01-<math>\mu</math>fd. doubler cathode by-pass.</p> <p><math>C_{11}</math>—0.002-<math>\mu</math>fd. 5000-volt final plate center-tap by-pass.</p> <p><math>R_1</math>—500-ohm 10-watt oscillator cathode resistor.</p> <p><math>R_2</math>—2500-ohm 25-watt doubler cathode resistor.</p> | <p><math>R_3</math>—50,000-ohm 25-watt doubler grid leak.</p> <p><math>R_4</math>—2500-ohm 10-watt final grid leak.</p> <p><math>R_5</math>—10,000-ohm 50-watt oscillator plate dropping resistor (used only with 40- and 20-meter crystals).</p> <p>RFC—Transmitting-type radio-frequency chokes.</p> <p><math>J_1</math>—Oscillator plate meter jack.</p> <p><math>J_2</math>—Doubler grid meter jack.</p> <p><math>J_3</math>—Doubler plate meter jack.</p> <p><math>J_4</math>—Final plate meter jack.</p> <p><math>J_5</math>—Final grid meter jack.</p> <p><math>SW_1</math>—S.p.s.t. switch to cut in <math>R_5</math> for 40- and 20-meter crystals.</p> |
|--|--|--|

50 watts—more than sufficient to drive the final directly. The interelectrode capacity of the 35T is so low that additional feedback is necessary if maximum output is desired with plate voltages in the neighborhood of 600 volts. But the output at the lower voltages, with increased feedback, is much less and the crystal current is just as high as with high-voltage operation.

The fact that high plate voltages can be used to a decided advantage on the oscillator greatly simplifies our power supply requirements, since an additional supply for the oscillator becomes unnecessary unless difficulty is experienced with keying the 40- or 20-meter crystals. The r.f. voltage developed across the tank circuit by the crystal is quite high, so adequate spacing of the oscillator plate-tank condenser is essential. The

voltage across the crystal tank circuit to allow proper impedance matching by merely tapping at the proper point on the crystal plate-tank coil. The coupling condenser consists of two 0.001- $\mu$ fd. mica receiving condensers in series to withstand the crystal plate voltage plus the bias voltage on the doubler.

#### BUFFER-DOUBLER STAGE

The buffer-doubler stage is essentially a plate-neutralized amplifier using a split-stator tank condenser. This tank condenser, like the tank condenser in the crystal circuit, must have adequate spacing for the plate voltage used. This condenser uses mycalex insulation. Any insulation is none too good at high radio frequencies; therefore only condensers employing mycalex,

isolantite or similar insulation should be employed in this transmitter. The neutralizing condenser can be any of the newer types made for use with low capacity tubes. The one in this transmitter is a rebuilt Cardwell "Trim-air" receiving condenser. Only one stationary plate remains, with two on the rotor. The spacing between rotor and stator is approximately 5/16 inches.

The degree of efficiency in a frequency multiplier depends almost entirely upon the amount of excitation available and the value of bias. This statement assumes that the plate tank circuit is of low-loss construction and that the tuning capacitance is not excessive. Efficiencies of the order of 50 to 60 percent are realized when the plate tank of the doubler is tuned to the fourth harmonic of the grid excitation voltage, the output of the circuit when quadrupling being approximately 50 watts. This output is more than sufficient to excite a pair of 35T's as operated in this transmitter. In actual practice the final is operated with plate input of approximately one kilowatt, though this input at 2500 volts is greatly in excess of tube ratings. With only 1500 volts and 250 ma. on the final, the output of the quadrupler is more than sufficient for excitation. The power gain from the buffer when quadrupling is not great. This means nearly as much power must be supplied to the grid circuit as is obtained from the plate circuit. The output, however, is at four times the crystal frequency. The output from this stage when doubling or as a straight amplifier is very high. A marked improvement in power gain when amplifying or doubling could be realized by readjusting the value of bias, but such adjustment is deemed unnecessary since more than sufficient drive to fulfill the purpose is available both from the oscillator and the buffer.

The grid leak resistance is 50,000 ohms and the cathode bias resistance is 2500 ohms. The grid current is approximately 16 milliamperes, which gives a total bias of about 1000 volts. The cathode bias resistor is such that the plate current is reduced to a very low value in case of excitation failures. The high degree of plate efficiency realized even when quadrupling results from the fact that the pulse of plate current flows for such a short portion of the excitation cycle. The  $\mu$  of the 35T is 30, making cut-off for 1275 volts (1500-225 volts = 1275, the 225 volts representing automatic bias) only about 45 volts. Hence the value of bias employed in this doubler is approximately 22 times cut-off! This degree of bias would shame even the most ardent supporters of the early "high efficiency" technique. The fifth

and sixth harmonics are very pronounced and fairly good output can be obtained on these higher frequencies, although their use is limited to special applications; these harmonics do not fall within the amateur bands.

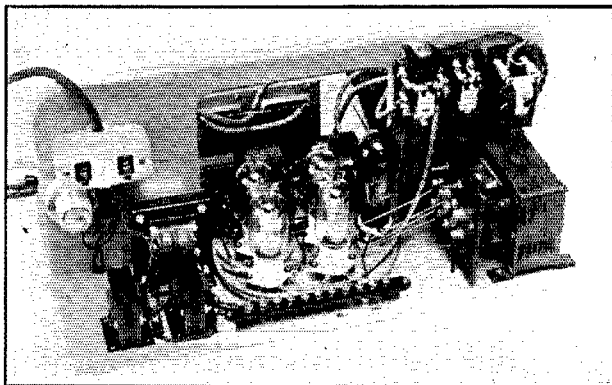

POWER SUPPLY USING 4 TYPE 35T's

The use of an r.f. choke is necessary at the center of the plate coil to prevent undesirable interaction between the buffer and final, especially if only a single power supply is used.

#### THE PUSH-PULL FINAL STAGE

The grids of the push-pull 35T final are capacitively coupled to the buffer circuit through pairs of 0.002- $\mu$ fd. mica receiving condensers connected in series to withstand the plate voltage of the buffer and the grid bias of the final. The d.c. grid return is through small r.f. chokes. An exact impedance match between the grid circuit of the final and the plate circuit of the buffer can be obtained by the proper placing of the taps on the coil. The conventional method of cross neutralization is employed. The neutralizing condensers, while homemade in this transmitter, are similar to the National NC800, and this type may be employed to advantage.

Our personal preference is for the push-pull connection of the tubes in the final amplifier. There is much in favor of the parallel arrangement, though we believe that for use on the higher frequencies the push-pull connection is by far the better. The tank tuning condenser (Johnson Type 70DD70) employs mycalex insulation and has adequate spacing for plate modulation with 1500 volts on the plate, or for c.w. operation with 2500 volts on the plates. Grid-leak bias is used on the final amplifier. Since the high  $\mu$  of the 35T's permits a comparatively low value of grid-bias voltage, a grid current of between 25 and 30 milliamperes per tube is sufficient for 1500-volt operation. When the transmitter is used with 1000 watts input, a higher value of grid current is desirable (35 to 40 milliamperes). For

1500-volt operation a grid leak of 2500 ohms is about right. To prevent overloads on the power supply in case the final tank condenser should spark over, the rotor of this condenser is insulated from the metal chassis and the r.f. return is made to the filament circuit by a 0.002- $\mu$ f. condenser capable of withstanding the maximum plate

chassis. Wood screws are used to mount the parts, the thin aluminum being easily pierced by a sharp pointed tool or a drill. A "satin" finish is obtained by rubbing the aluminum down with steel wool.

No filament by-pass condensers are used, nor are center-tapped resistors or transformers necessary, direct connection being made to one side of the filament. Each filament circuit is by-passed to the metal chassis by a 0.01- $\mu$ f. mica condenser. All r.f. returns to the filament circuits are joined at one place to prevent undesirable inter-coupling effects. The r.f. returns to the filament circuit should be as short and direct as possible.

#### POWER SUPPLY AND KEYING

For the utmost in simplicity, a single power supply is used; this power supply is capable of delivering 1500 volts at 400 milliamperes. A novel method of combination rectification and keying control is obtained by using a pair of 35T tubes as rectifiers. The power to the entire transmitter is keyed by biasing the grids of these tubes. By a simple circuit, the grids are made negative during the time the key is up and positive when the key is down. With the grids positive, the voltage drop through the tubes is about 100 volts when delivering

400 milliamperes d.c.

The keying circuit is more or less self explanatory. The negative bias is obtained from the cheapest b.c.l. receiver transformer available. The filament winding on the transformer is used as the primary, being connected directly to filament circuit of the two 35T's. By using the filament circuit for the primary voltage, no difficulty will be experienced with transformer insulation since there exists only the normal voltage for which the transformer was designed between primary and secondary. *Caution:* Do not ground the frame of this transformer. If a metal chassis is used insulation capable of withstanding the peak voltage of the main power transformer must be used between the frame of the bias transformer and the chassis. The bias rectifier tube is an 80. The filament voltage is the same as that of the 35T's and so the 80 filament can be connected directly in that circuit. The 80 socket, like the bias transformer, must be insulated for high voltage.

The positive bias is obtained by means of a special transformer. This transformer is conventional except that the secondary has sufficient insulation to withstand the high voltage of the main transformer between primary and second-

(Continued on page 98)

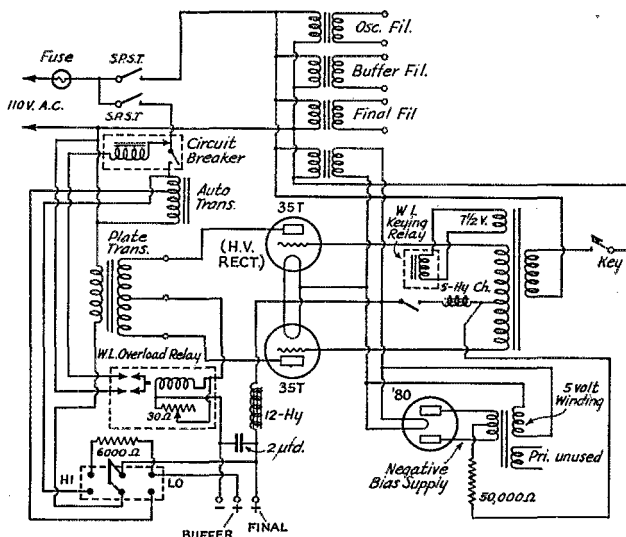

FIG. 2—CIRCUIT OF THE POWER SUPPLY USING TRIODE RECTIFIERS WITH CONTROL-GRID KEYING

Four 35T's are used as rectifiers (two in parallel on each side) if output current is to be greater than 350 or 400 ma.

voltage. No provision is made for an antenna coupling network, a non-resonant 600-ohm line connected directly to the plate tank circuit being intended.

#### COILS AND CONSTRUCTION

Air-wound coils are used in every circuit because this type was found more efficient than those wound on solid forms. Two-inch diameter coils are used in the crystal and doubler stages, while a four-inch diameter coil is used in the final. The coils are provided with plug-in plugs (General Radio Type 247) mounted on strips of mycalex. The coil jacks are mounted directly on the tank condensers, supported by the tank-circuit leads. It is very important that the tank leads be short and of low-resistance solid material. Braid of any form is to be avoided in the tank circuit because this material has very high r.f. resistance. The proper taps are soldered directly to the coil and are also brought out through plugs and jacks, making unnecessary any coil readjustments when changing frequency.

The baseboard of the transmitter consists of a piece of wood over which is nailed a sheet of 30-gauge aluminum. The result is a very economical "bread-board" that has the advantage of a metal

# Amateur Applications of the "Magic Eye"

Using the 6E5 as a Vacuum-Tube Voltmeter, as a Resonance Indicator, etc.

By L. C. Waller,\* W2BRO

In Two Parts—Part I

EVER since the 6E5 was first announced it has seemed obvious to many amateurs that it should be useful for other applications than those involving visual tuning of receivers. Designed primarily for service as an inertialess, visual tuning indicator in radio receivers the tube has a really surprising number of uses in the average amateur station. Because of its comparatively low cost, the simplicity of the auxiliary apparatus with which it can be used, and the numerous practical services which it can perform, the 6E5 has possibilities which should not be overlooked.

Fig. 1 shows the basic circuit for the 6E5. With zero grid bias, the fluorescent screen or target at the top of the tube will produce a greenish glow, except for a shadow sector of approximately 100 degrees; this pattern is shown in Fig. 2. The shadow is cast on the screen due to the fact that

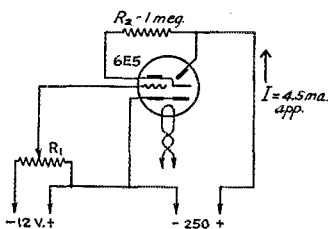

FIG. 1—FUNDAMENTAL CIRCUIT FOR THE 6E5

the blade-like ray-control electrode (which can best be seen when the tube is inspected at close range) is negative with respect to the target. The ray control derives its negative bias from the  $RI$  drop across the plate resistor,  $R_2$ , this  $RI$  drop existing as long as any triode plate current flows.

If the triode grid bias is now made more negative, by means of  $R_1$ , the triode plate current will decrease, the  $RI$  drop across  $R_2$  will also decrease, the ray-control potential will become less negative (with respect to the target) and the shadow angle will close up. About 6 or 8 volts of negative bias on the triode grid will cut off practically all triode plate current and will reduce the shadow sector to a narrow line, as shown in Fig. 2. Additional triode bias may cause the pattern to close completely, or even to "over-close"; in this case,

\* RCA Radiotron Division, RCA Mfg. Co., Harrison, N. J.

the shadow line may change into a luminous line having greater brilliance than the rest of the target. Fig. 3 shows several curves giving the rela-

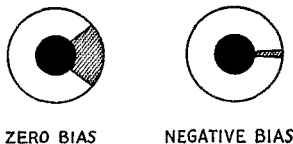

FIG. 2—TARGET PATTERNS WITH ZERO TRIODE-GRID BIAS AND WITH TRIODE-GRID BIAS NEAR CUTOFF

tions between grid voltage and target current, plate current, and shadow angle.

Because the variations of the shadow sector on the target are definitely controlled by the triode bias it is apparent that the 6E5 is a negative-grid voltage indicator which *does not draw power*. It can, therefore, be applied to *high-impedance* circuits with little or no loading effect. In addition, it possesses the inertialess characteristic of the electron beam (as do cathode-ray tubes) and can follow radio-frequency voltages, as well as d.c. voltages, within wide limits. It is free from the undesirable effects of mechanical inertia which accompany many types of meters.

## V.T. VOLTMETER

Although the 6E5 can be used in a great number of different ways, it seems probable that the best all-around amateur application is that of the vacuum-tube voltmeter, which is a very useful instrument to have around the station. Fig. 4 shows the complete circuit of a vacuum-tube voltmeter, originally described by Mr. P. A. Richards<sup>1</sup> and the present writer in another publication.<sup>2</sup>

If the v.t. voltmeter is to be used to the greatest advantage, it is necessary that its manner of operation be thoroughly understood. By way of explanation, we shall first short-circuit the test prods "A" and "B" and assume that the movable arm of  $R_7$  is at the upper (plus) end of its voltage range. The plate current of the triode-connected 6C6 is practically cut off because of the negative bias developed by the 2-megohm cathode resistor,

<sup>1</sup> Research & Development Laboratory, RCA Radiotron Div., Harrison, N. J.

<sup>2</sup> *Radio Retailing*, December, 1935.

$R_1$ . Because about 14 volts of bias is required to reach approximate cutoff of the 6C6, the cathode end of  $R_1$  (point X) is about +14 volts with respect to the other end of  $R_1$  (point Y). The potentiometer  $R_5$  (the "zero-reset" control) is next

$E$ , where  $E$  is the unknown screen voltage. The bias on the grid of the 6E5 is no longer -7 volts, but is some positive value ( $E-7$ ), so that the pattern on the 6E5 screen "flips" entirely open. Now, the movable arm of the slide-back potentiometer,  $R_7$ , is adjusted toward its negative (-B) end until the shadow area of the 6E5 again closes to its "zero" or narrow-line position. When this occurs, the d.c. voltmeter "V" will read the true value of the screen voltage being measured. In simpler words, the voltage to be measured robs the 6E5 of its original bias (opening the pattern) and the potentiometer  $R_7$  adds just enough additional negative bias to cancel the unknown voltage, thus restoring the pattern to its original position. The v.t. voltmeter will give a direct reading, because the "bucking" voltage introduced by  $R_7$  is always adjusted just to cancel the unknown voltage across AB. The d.c. voltmeter "V" is preferably one of the

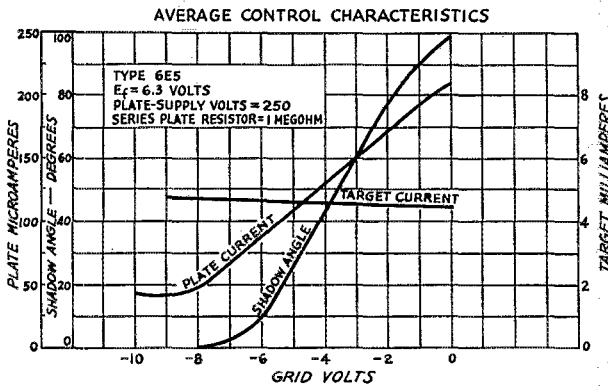

FIG. 3—AVERAGE CONTROL CHARACTERISTICS OF THE 6E5

adjusted so that the voltage difference between the 6E5 cathode and point "Y" is about 21 volts. Thus, this 21 volts bucks the 14-volt drop across  $R_1$  so that the net difference places a -7 volt bias on the 6E5 grid. The fluorescent pattern on the 6E5 will now be closed to a narrow, dark line. This is the correct "zero" setting for all v.t. voltmeter measurements. In practice, these voltages need not be measured, the only adjustment being that of  $R_5$ , with  $R_7$  set at the plus end of its range.

With the target pattern correctly set at the zero position, any d.c. or a.c. voltage applied across prods "A" and "B" will cause the plate current of the 6C6 to increase, so that the  $RI$  drop across  $R_1$  will increase by an amount substantially proportional to the applied d.c. or peak a.c. voltage. The action in the case of a.c. is similar to that of a simple diode detector, where  $R_1$  is the load resistance. Rectification occurs on each positive half cycle, the large condenser,  $C_1$ , holding the d.c. voltage developed across  $R_1$  at practically the peak value of the a.c. wave. Because of the high-resistance circuit across which it is placed, condenser  $C_1$  must be of the high-quality, low-leakage type. A good paper condenser has been found satisfactory. The value of  $C_1$  depends on the lowest-frequency a.c. voltage that it may be desired to measure; a value of 4  $\mu$ f. is good for frequencies of 60 cycles per second or more. When a d.c. voltage is to be measured, test prod "A" must be connected to the plus side of the voltage source.

To complete the explanation, let us assume that the test prods are connected from screen to ground on a tube whose screen voltage at the socket is to be measured. The voltage drop across  $R_1$  immediately increases from 14 volts to 14 +

1000-ohms-per-volt variety having three ranges, such as 10, 250, and 750 volts.

It is important that the protective resistor  $R_2$  be used in the grid lead of the 6E5, because any voltage above 7 volts across AB will swing the 6E5 grid positive, as explained above. The  $RI$  drop across  $R_2$ , produced by the grid current of the 6E5, automatically biases the tube until  $R_7$  is put to work at its cancelling function. If  $R_2$  is omitted, the 6E5 is likely to "go up in smoke," due to excessive grid current.

#### ACCURACY

Before delving into the more interesting part of the discussion—having to do with applications—a word about the accuracy of the v.t. voltmeter is warranted. The accuracy of this type of voltmeter, in general, will depend upon the care with which the 6E5 pattern is adjusted before and after the unknown voltage is applied, as well as upon the inherent accuracy of voltmeter "V." D.c. voltages between about 25 and 200 volts (the latter value being the upper limit of the v.t. voltmeter with the circuit shown) can be read to one volt or better, depending mainly on the readability of the scale on "V." Between 0.5 and 10 d.c. volts, the approximate accuracy is plus or minus 0.1 to 0.2 volt. A.c. voltages will give readings which are in error by a fairly constant value of 0.8 to 1.3 volts, on the low side of the correct value; this is apparently due to the reaction of the negative half of the a.c. cycle on the static value of the 6C6 plate current. For example, a peak a.c. voltage of 1.4 volts gave a v.t. voltmeter reading of only 0.6 volt; a peak voltage of 2.8 volts read 1.75, etc. The percentage error is smaller for larger values of a.c. voltage, so that the higher a.c. readings are quite accurate.



or i.f. transformer secondary. The true bias variation (due to the a.v.c. circuit only) can be accurately measured, either with a signal or with a test oscillator. The 6E5 will at the same time serve as a resonance indicator or as an alignment meter, inasmuch as the a.v.c. voltage will vary as the different circuits are adjusted. The minimum fixed bias can be measured, under no-signal conditions, between the grid of the r.f. tube and ground.

Screen and plate voltages can be checked with

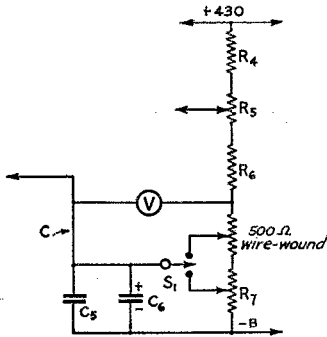

FIG. 5—PARTIAL SCHEMATIC OF V.T. VOLTMETER CIRCUIT SHOWING USE OF A 500-OHM POTENTIOMETER AS A VERNIER CONTROL FOR MEASUREMENT OF SMALL VOLTAGES

This revision of Fig. 4 is recommended if many measurements are to be made in the 1-to-10 volt range. S<sub>1</sub> is a s.p.d.t. switch.

precision, even where a very large series resistance is included in the circuit. For example, the screen voltage of an r.f. amplifier is supposed to be about 100 volts. A 1000-ohms-per-volt meter reads only (say) 50 volts, because screen voltage is obtained through a large series resistance and because the d.c. voltmeter draws as much or more current than the screen. The v.t. voltmeter will show the true voltage at the screen, and at the same time indicate any irregularities in the screen resistor or screen by-pass condenser. The true plate voltage at the plate of a resistance-coupled a.f. amplifier can as easily be determined, even if the plate load has a value of 0.5 megohm or more (incidentally, the voltage at the plate should usually be about one-half of the plate supply voltage, if the a.f. tube is biased correctly). Likewise, the grid bias on any a.f. stage can be measured directly between the grid and cathode, regardless of how the bias is obtained.

I.f. or r.f. stages can be checked in operation by measurement of the r.f. voltage across the transformer secondary. The test lead "A" from the 6C6 should be short and should have very little capacity to ground. The 6C6 may, even with very short input leads, introduce a capacity load of 5 to 10  $\mu$ fd. which will de-tune the circuit under test more or less, depending on its nature. Such detuning can usually be compensated by

re-adjustment of the trimmer condenser. This trimmer must be reset to its original position, of course, after the voltmeter capacity load is removed. If much r.f. measuring is to be done, a 954 acorn tube, connected as a triode, should be used in place of the 6C6; the loading introduced by the 954 is relatively small.

If an output meter is desired, the test prods can be applied to almost any part of the a.f. circuit. Where it is necessary to separate the a.c. from a d.c. source which may be mixed up with it (as in the primary of an a.f. transformer), a 0.1- $\mu$ fd. blocking condenser and a 1- to 5-megohm leak can be employed, as shown in Fig. 6. The grid leak should not be made larger than actually necessary, however. When the v.t. voltmeter is connected between the grid and cathode of an a.f. output tube (through a blocking condenser, as explained), the instrument will serve both as an output meter and to measure the peak a.f. driving voltage applied to the grid. Low-volume troubles are frequently traced to insufficient a.c. driving voltage.

The actual gain of an a.f. amplifier stage can readily be measured. A known peak a.f. voltage (from a 60-cycle source shunted by a voltage divider) is applied to the grid of the a.f. tube. The peak a.c. voltage across the plate load (transformer, choke, or resistor) is next measured. The latter voltage divided by the peak input voltage gives the true gain of the stage, at the test frequency. The condenser-and-leak input circuit should be used in this case, even if the plate load is a choke or a transformer winding.

Many times we should like to know the turns

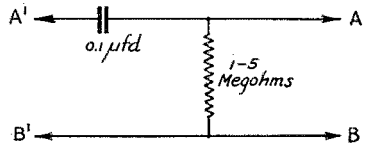

FIG. 6—INPUT CIRCUIT TO BE USED WHEN D.C. VOLTAGE MUST BE BLOCKED OFF IN MAKING A.C. MEASUREMENTS

ratio of an audio or power transformer—or to check up on a manufacturer's specifications. To determine a ratio, place a suitable a.c. voltage (from any convenient source) across the primary and then measure the peak primary and secondary voltage. The ratio of the peak voltages is substantially that of the two windings. Care should be taken, however, that the primary voltage used will not give an excessive secondary voltage, as in the case of high-voltage transformers. In such cases, the test voltage can be applied to the secondary instead of the primary, to avoid the high step-up.

The power output of an audio power amplifier can be determined with the aid of the v.t. voltmeter and a little arithmetic. A test signal of



(say) 1250 cycles from an audio oscillator having a *sinusoidal* wave form (see Fig. 7) is applied to the audio system at any convenient stage. This signal is then increased until its peak value at the grid of the power tube (or at one tube in a push-pull stage) is the maximum permissible for the tube and circuit under test. For a power tube operating Class A, the peak signal voltage should not exceed the grid bias. The signal can also be adjusted by listening to a loud speaker—the critical maximum limit being reached when the tone changes and begins to lose its purity. A pure resistance load of the correct value and wattage (for example, 7000 ohms for a single 47 pentode) is then shunted across the primary of the output transformer, no secondary load being used. The peak a.c. voltage across the resistance load is measured with the v.t. voltmeter. Using the 47 as an example, we find that the measured peak output voltage  $E_{pk}$  is about 186 volts. This must be changed to an r.m.s. value, for power calculations, by multiplying by 0.707. Thus,

$$E_{rms} = (0.707) (186) = 132 \text{ volts.}$$

From the relation

$$P = \frac{E_{rms}^2}{R}$$

we find that

$$P = \frac{(132)^2}{7000} = 2.5 \text{ watts, the power output.}$$

The peak plate current of a mercury-vapor rectifier can be measured as a check on rectifier operation. A 100-ohm resistor is placed in the -B lead of the system, between the filter and the center tap of the high-voltage transformer. The v.t. voltmeter will measure the peak d.c. voltage developed across the resistor while the rectifier is under normal load. Ohm's Law gives the peak plate current in the circuit,  $I_{pk} = \frac{E_{pk}}{100}$ . Such a check will show whether or not the input choke of the filter system is limiting the peak plate current of the rectifier tube to a safe value, as judged by the tube manufacturer's rating.

The ripple voltage of high-voltage power supplies can be determined, provided that there is enough ripple to measure (0.5 volt or more). The d.c. blocking circuit of Fig. 6 is used, of course, to keep the high d.c. voltage away from the 6C6. The blocking condenser should have a voltage rating sufficiently high so that there will be no danger of its breaking down. The peak ripple voltage is then measured in the usual manner, by adjustment of the slide-back potentiometer,  $R_7$ .

In a subsequent issue of *QST*, Part II of this article will describe several applications of the v.t. voltmeter in the adjustment of transmitters. Modulation measurements will be discussed, as well as an entirely different, simple circuit using a 6E5 for the sole purpose of checking modulation. In addition, normal applications of the 6E5 as a

visual tuning indicator will be covered. It will be shown that the "Magic Eye" can be employed to advantage for tuning purposes in many receivers *not* having automatic volume control.

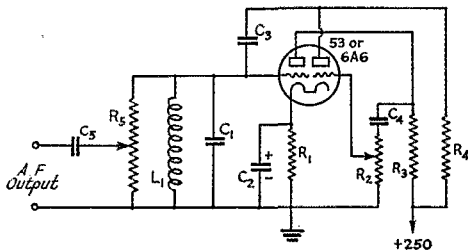

FIG. 7—SIMPLE SINE-WAVE AUDIO OSCILLATOR OF THE CAPACITY-FEEDBACK TYPE

With the L-C constants given below, the generated frequency is approximately 1250 cycles per second. (This oscillator makes a good tone generator for i.c.w. in 5-meter transmitters.)

- $C_1$ —0.1  $\mu$ f.
- $C_2$ —16- $\mu$ f. electrolytic, 15-volt.
- $C_3, C_4, C_5$ —0.1  $\mu$ f.
- $R_1$ —750 ohms,  $\frac{1}{2}$  watt.
- $R_2$ —500,000-ohm potentiometer.
- $R_3, R_4$ —50,000 ohms,  $\frac{1}{2}$  watt.
- $R_5$ —50,000-ohm potentiometer.
- $L_1$ —1500-turn honeycomb coil (160 millihenrys).

## Flash! W9ERU Wins Code Speed Contest

EUGENE A. HUBBELL, W9ERU, of Rockford, Illinois, is winner of the Amateur Code Speed Contest held at the A.R.R.L. Central Division Convention in Chicago on September 6th. Mr. Hubbell attained an official computed speed of 52.2 words per minute! He was awarded a beautiful silver trophy. All contestants were examined on plain language text with tape transmission for two-minute intervals, ranging from 25 w.p.m. upward and at 52.7 w.p.m. W9ERU made but one error. The runner-up was John Huntoon, W9KJY. Those participating in the finals, without indication of order of merit, were W8BKM, W8SS, W9DKZ, W9ERU, W9ERS, W9HUM, W9KJY, and W9MKX. Judges were T. R. McElroy, W1JYN, holder of the world's code speed record; G. J. Maki, W9RQZ, ex-K7HV, Chairman, Code Speed Contest Committee; and F. E. Handy, WIBDI, A.R.R.L. Communications Manager.

This was the first official Amateur Code Contest ever held. Only bona-fide amateurs, holding at least an amateur operator's license, were eligible. Holders of commercial licenses were ineligible, with the following exceptions: (a) Holders of commercial licenses without experience under same. (b) Holders of commercial licenses whose duties specifically are not telegraph operating (i.e., 'phone licenses). (c) Holders of commercial licenses engaged specifically as attendants

(Continued on page 108)

# H A M D O M



**T**HERE are few of the hundreds of thousands of people intently interested in radio below two hundred meters who do not know of Judy



Leon, HC1FG, and announcer at b.c. station "Prado"—6,618 kc.—key to the Indo-Latin chain of which she is "Capitana." She learned the code in 1929, worked the world with a 5-watt Phillips valve in t.p.t.g., and in 1934 went on 'phone with 200 watts on 40-20-10, 5 stages, c.c. So much 'phone was worked that c.w. friends

charged she had forgotten the code. To show them, she entered the 1935 DX tests and garnered more points than any other station outside W-VE. In June, 1935, she and LUSDR succeeded in providing two-way telephone contact for weeks between an Argentinian seriously injured in a plane crash near Medellin, Colombia, and his wife at Buenos Aires, with the Colombia b.c. system's aid. Besides radio she loves automobil- ing, horseback riding, and dancing. The picture tells the rest!

**G**UY WILSON got into ham radio in 1911 while still in knee pants. The start was a spark coil and two-slide tuner with silicon detector. Later there came a 12,000-volt transformer and homemade condenser of glass jars immersed in salt water in a large metal pan; a considerable annoyance, for it was under the operating table and every time one's knee came in contact with it one was blotto for five minutes or more! Eventually there was a 1-kw. Thor, a photographic-plate oil condenser, a rotary gap, and one of the oft-illustrated oscillation transformers. This station was licensed as 9EP from early in 1913 until the war. One of the old "Green Ink" gang, he reached all corners of the U.S., and was the first station east of the Rockies to be heard by 6EA. Eventually there was a Paragon RA6 with deForest audion; the first audion bulb was



obtained by paying \$5 for a burnt-out bulb just to have the privilege of exchanging it with another \$5 for a new bulb! From the war until 1931-32 activity was dormant; but now, as W9EL, 40 and 20-meter work, convention attendance and ham radio business all more than make up for the lapse.

**A** SORT of radio Abou Ben Adhem, is B. P. Hansen's summation of his ham radio career. He started in the game as a Boy Scout in 1916 or thereabouts, becoming 9BQ in Logan, Iowa. This call was used with various rigs, finally moving to Chicago and a research lab job in 1922. Then in broadcasting, consulting, and finally E.R.P.I., with ham work lagging. In 1931 his health broke down, necessitating a stay in a sanatorium at Woodmen, Colo. Thanks to W9EYN, interest in ham radio revived under the call W9JNV. In 1933 removal to Colorado Springs (where he's now back to work for Erpi) created W9KNZ. There every angle of the game is played, on all bands—with 28 mc. and the "ultra" family in the forefront now. "Hans'" idea is that amateur radio has been such a wondrously valuable form of occupational therapy to him he needs must help others in the game of getting into it as much as time and ability permit. There is ample evidence that he succeeds in his objective.



**T**HE old-timers rule the roost in Hamdom this month. C. Bronson Weed, W1BHM, too, began in 1912, in Cleveland. Still remembers soldering up his first "B" battery and the Amrad quenched gap that would work 18 miles. Went c.w. in 1922, first worked foreign with G2NM on 80 in 1924; down the wave-length ladder to 40 and 20 (with a 203 in '27) and lodged there. Now bemoans the "good ol' days" on 20, when there weren't "phones all over the band and all the poor notes . . ." Over

(Continued on page 108)

# A Laboratory-Type Beat-Frequency Audio Oscillator and R.F. Signal Generator

Constructional Details for the Advanced Amateur

By Clinton B. DeSoto,\* WICBD

## Part II—The Signal Generator\*\*

**T**O AVOID taking up space with introductory comment, the reader is requested to refer to page 45 of the April, 1936, issue of *QST*, wherein the why's and wherefore's of the devices now under discussion were given.

The signal-generator portion of the combination unit has been a major headache in design and development. John Clayton once told us that, given all essential design specifications and general layout data, it still takes the G.R. engineers a good many months to produce a commercially acceptable standard-signal generator. There's no questioning the truth of that statement. For an amateur to attempt to develop, or even to duplicate, such a device is about as foolhardy as a test pilot making his "9 G's" in a ship of radically new design. Yet the 9 G's must be, and are, made. Hams should have decent signal generators, and at moderate cost. The problem is to determine the points at which compromises can be made, the circuit methods which come closest to being fool-proof under ham methods of construction and adjustment, and the combination of these considerations into workable units. The final version of the signal generator and its associated microvolter is therefore a structure piled high with compromise, yet it works. It does the job it was intended to do, and it does it reasonably well. However, its operation is far from "single-control" and there are numerous precautions to be observed. Summing up: reasonable accuracy and reliability have been achieved and cost has been kept low, this at the expense of a certain amount of convenience. If you want to spend \$50, here's your gadget; if you want to spend \$500—well, then you can start looking in the nice shiny catalogs the makers of expensive laboratory gear will be happy to send you.

Referring to Fig. 1, the circuit diagram indi-

icates the relative simplicity of the oscillator proper. The illustrations indicate the mechanical layout; again, refer to Part I of this article for correlative detail.

A type 58 tube is used in the oscillator. It is a fairly rugged tube, has a good suppressor-grid characteristic, and it provides enough power output (a signal generator is nominally a voltage-creating device, but output impedances are so low that moderate power is necessary) for most needs. The type 24 is a more stable oscillator tube, but it has no suppressor grid; with that grid used for modulation a simple electron-coupled oscillator can be used with reasonable modulation

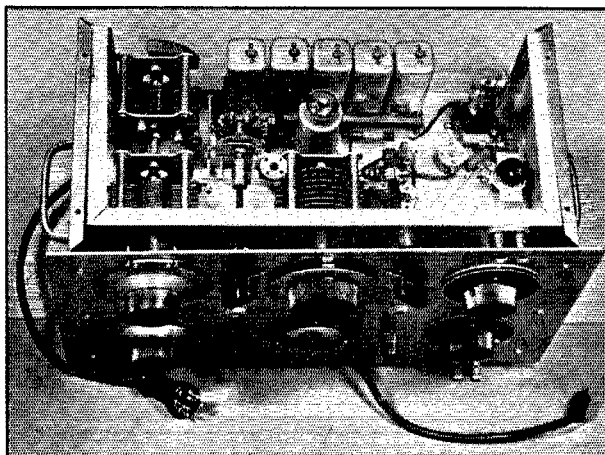

THE SIGNAL GENERATOR OCCUPIES THE UPPER DECK OF THE G.R. UNIT PANEL ASSEMBLY

Left to right, the main panel controls are: Main tuning dial, band switch, auxiliary tuning dial (see text), series attenuator, output attenuator. The location of the various parts is self-evident. Output is taken from the binding posts mounted on the false front panel at upper right.

stability, eliminating the need for resistance- or impedance-coupled buffer amplifiers as used in the expensive commercial signal generators. The e.c. circuit provides adequate dynamic stability, output circuit isolation, and the possibility of achieving a useful percentage of amplitude modulation without objectionable frequency modulation. The

\* Assistant Secretary, A.R.R.L.

\*\* In two parts. Part I appeared in the April, 1936, issue.

utility of the signal generator was greatly increased by using the beat-frequency audio oscillator as the modulation source.

Five tuning ranges are provided, covering from 150 kc. to more than 30 mc. in overlapping ranges. The coil for the 150- to 500-kc. range is a 2.2-millihenry universal winding; that for the 500- to 1500-kc. range a 220- $\mu$ h. 4-layer bank; and the remaining three, covering 1500-5000, 5000-15,000,

elimination of all stray reactances. The internal coil shielding is grounded to the chassis at only one point. The oscillator circuit and attenuator are grounded at only one point on the chassis. The chassis, in turn, is grounded to the main assembly at only one point, three of the four mounting screws being insulated with fibre washers and all couplings to panel controls being made with bakelite shafts. It has been found that failure to observe any one of these precautions will result in the difference between an appreciable signal in a sensitive receiver at zero attenuator setting (especially at the high frequencies), and no signal.

The main tuning capacity is a 500- $\mu$ fd. General Radio condenser, which has an approximate straight-line wavelength characteristic. The 20-1 capacity ratio provides a large tuning range; the National type "N" precision vernier dial enables accurate adjustment within these ranges.

Ganged to the main tuning condenser through an insulated flexible coupling is an identical 500- $\mu$ fd. condenser, which is wired in series with a 100- $\mu$ fd. condenser having a separate panel control. This latter tuning condenser is especially useful in running selectivity characteristic curves on receivers, for it covers an equal frequency band at any point in any given frequency range. This effect is achieved through the series

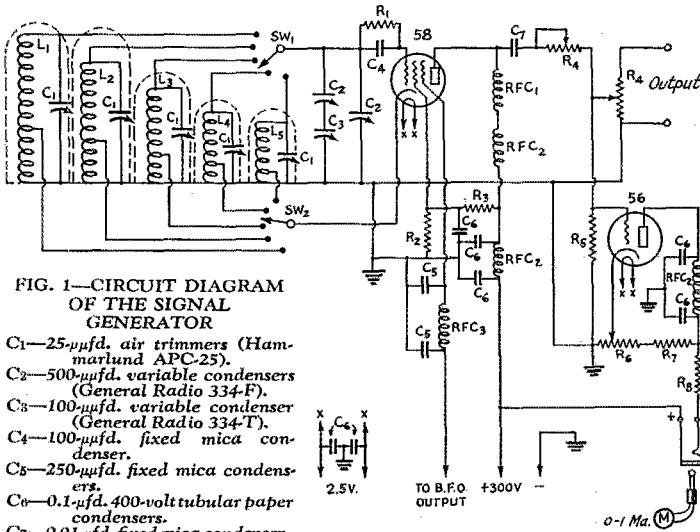

FIG. 1—CIRCUIT DIAGRAM OF THE SIGNAL GENERATOR

- C1—25- $\mu$ fd. air trimmers (Hammarlund APC-25).
- C2—500- $\mu$ fd. variable condensers (General Radio 334-F).
- C3—100- $\mu$ fd. variable condenser (General Radio 334-T).
- C4—100- $\mu$ fd. fixed mica condenser.
- C5—250- $\mu$ fd. fixed mica condensers.
- C6—0.1- $\mu$ fd. 400-volt tubular paper condensers.
- C7—0.01- $\mu$ fd. fixed mica condenser.

- R1—50,000-ohm 1-watt molded fixed resistor.
- R2—20,000-ohm 1-watt fixed resistor.
- R3—20,000-ohm 2-watt fixed resistor.
- R4—200-ohm non-reactive potentiometers (General Radio 603-316).
- R5—100,000-ohm 1-watt molded fixed resistor.
- R6—5,000-ohm variable potentiometer.
- R7—20,000-ohm 1/2-watt fixed resistor.
- R8—50,000-ohm 1-watt fixed resistor.
- L1—2200- $\mu$ h. oscillator coil (see text) (made by F. W. Sickles Co., Sample No. 3670).
- L2—220- $\mu$ h. oscillator coil (Sample No. 3671).

- L3—22- $\mu$ h. oscillator coil (Sample No. 3672).
- L4—2.2- $\mu$ h. oscillator coil (Sample No. 3677).
- L5—0.22- $\mu$ h. oscillator coil (Sample No. 3678).
- RFC1—2.5-mh. sectionalized r.f. choke (National R-100).
- RFC2—40-mh. universal-wound r.f. chokes.
- RFC3—25-mh. universal-wound r.f. choke.
- SW1-SW2—2-circuit 5-point all-wave switch (Yaxley 1315).

and 15,000-40,000 kc., of 22, 2.2 and 0.22- $\mu$ h. inductance, respectively, are single-layer space-wound high-Q solenoids. All cathode taps are at 1/3rd of the coil. All are wound on extra-thick high-grade bakelite tubing of 3/16-inch diameter, baked and impregnated, mounted at three points in addition to rigid wiring support, for stability. They are mounted in 1 3/8-inch square shield cans, equivalent to 1 3/4-inch round cans, which do not greatly affect their Q. The five shield cans are lined up on a heavy copper sub-base, which is grounded to the chassis at one end only. This ground is bonded to the single common chassis ground.

ELIMINATING STRAY CURRENTS

At this point it may be emphasized that a vitally important feature of the design is the

condenser ganged to the main tuning control. As the setting of the main tuning condenser is varied, the series capacity changes, providing exactly the same capacity ratio between the main condenser and the auxiliary condenser at any point. Thus, with the auxiliary dial set at 50 and the main tuning dial at the test frequency, rotation of the auxiliary dial in either direction will give approximate arithmetical equality to both sides of selectivity curves, based on a predetermined calibration. What is more important, however, is the fact that the frequency range covered by the auxiliary dial will be almost exactly the same no matter what the setting of the main dial. For instance, the coverage of the auxiliary dial in the 150-500-kc. region is about 20 kc., a convenient range for selectivity measurements. No matter what intermediate frequency is under inspection,

whether 175 or 456 kc., one rotation of the auxiliary dial will cover about 20 kc. On the higher-frequency bands the coverage increases by a multiple of 3.16; i.e., about 60 kc. are covered in the broadcast band, and so on. These ranges, it will be noted, coincide in very general fashion with the approximate selectivity characteristic of an ordinary single tuned circuit in the respective frequency ranges. Although requiring extra space, two additional tuning condensers and another dial, the feature is decidedly worth while to the experimenter who does much work with receiver design. If nothing else, it is a uniquely convenient vernier because of the constant frequency change it provides.

The suppressor grid of the 58 is biased 10 volts negative when modulated, bias being derived from the voltage divider shown in Fig. 1 of Part I. It is placed at ground potential when unmodulated, enabling somewhat increased output. The suppressor characteristics of a group of sample tubes, measured under operating conditions in this unit, showed an average essentially linear range of from  $-35$  to  $+16$  volts. A 10% variation occurred in the tubes checked, all of which were quite new. For 100% modulation, then, a 25-volt a.f. swing is required. With the beat-frequency audio oscillator in the circuit it is thus possible to realize 100% modulation, although this is rarely done in practice since some frequency modulation occurs with amplitude percentages in excess of 60%.

Parallel plate feed to the oscillator is used, two chokes being connected in series as the parallel impedance. In view of the relatively low actual load impedance this may seem an unnecessary refinement; however, while it was found desirable to use the sectionalized choke with its low self-capacity at the high frequencies, use of that choke alone brought an appreciable drop in output near 150 kc. The series arrangement is satisfactory.

The plate circuit is carefully filtered, as are all other leads going to the b.f.o. compartment. It was found that these filters and the precautions previously mentioned concerning common grounds were even more important considerations in design than shielding. It will be noted from the photograph that the signal generator chassis bears a flanged front panel and end walls. The original intention was to have triple shielding (dust cover, a sheet of aluminum attached to these flanges completing an internal box shield, and the individual coil shields), but with the rest of the design adequately consolidated it was found that this intermediate shield was unnecessary. The false "front panel" is a desirable baffle, however, and without it "hot" shafts and the attenuator terminals would be exposed.

#### THE ATTENUATOR

The attenuator in the signal generator proper is not a microvolter as well, as it is in commer-

cially-built standard-signal generators. It was on this point that much of the celebration and experimentation that preceded completion of the gadget was spent. Resistance attenuators, capacitive attenuators, inductive attenuators—all were

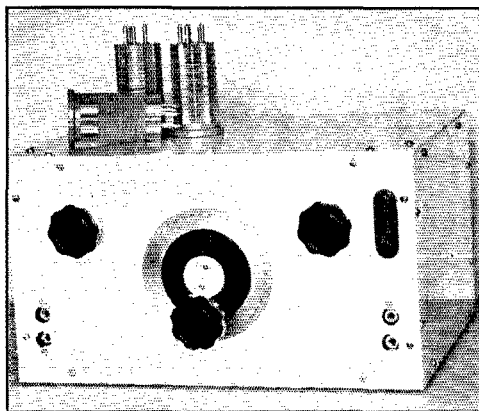

THE SECOND-HARMONIC MICROVOLTER IS BATTERY OPERATED

Two 2-volt screen-grid tubes are used in a balanced modulator arrangement, with four plug-in coils, covering (on second harmonics) approximately 900-3000 kc., 2500-8000 kc., 7000-24,000 kc., and 20-60 mc. Good accuracy is maintained up to the highest frequency limits.

considered on the basis of home construction and calibration and found wanting. The crux of the matter lay in the fact that, while it might be possible to build an attenuator with accurate individual reactive elements, precisely calibrated at the input and with equal maximum and minimum output on all bands, it would be impossible of ready duplication by amateur constructors.

The possibility of securing a commercially-built attenuator and installing it in the home-built signal generator was investigated. It was found that a practicable system could be secured for—\$150! At that rate, one might as well buy the complete unit. Cheaper systems were available, it is true, some much cheaper; but none of them were sufficiently fool-proof, or adequately stable, or generally satisfactory for the purpose. This does not mean that a suitable unit will not be made available. It is even now being worked on by a reputable manufacturer. But it is not yet a part of this signal generator, and therefore not a part of this story. (Incidentally, if any of the existing commercial attenuator systems are to be adapted to this oscillator, some means of boosting the output will be required, such as a plate feedback coil or positive suppressor biasing; as it is, not enough hop is available for the very low impedance circuits.)

The attenuator that is provided consists simply of a pair of 200-ohm non-reactive potentiometers connected in series. The series rheostat

permits adjusting the signal to a predetermined reference value for rough alignment measurements, while the potentiometer is used for varying the output.

A vacuum-tube voltmeter is provided to indicate a fixed reference point for output on different frequencies and under different conditions. In its existing form it is not particularly successful. In fact, in practice it is rarely used; the constructor duplicating the unit will be as well-advised to leave it out. One reason for this is the fact that a 1-ma. meter is used. Since the maximum output on the high frequency ranges with 10 volts negative suppressor bias is about 0.1 volt, to use the v.t.-v.m. means that output over all ranges must be limited to this value. With no d.c. amplifier, accurate reading of 0.1 volt is difficult on a 1-ma. scale. If the voltmeter is desired—and it does serve certain purposes—it would be a better plan to use another tube as a d.c. amplifier, or, perhaps preferably, use a dual triode like the 53.

So far, so good. But the problem of accurately measuring the exact output microvoltage still remains. The solution to that problem was finally, albeit reluctantly, achieved by the construction of a separate unit. This unit actually constitutes a direct-reading microvoltmeter, equally accurate at all frequencies, and with an accuracy greater than is obtainable in almost any other form. These results are achieved by applying the generated signal to the grids of a full-wave square-law detector and utilizing not the fundamental but the second harmonic content appearing in the plate circuit. Along with this second harmonic appears a rectified d.c. current of an amplitude exactly proportional to the peak amplitude of the second harmonic. Thus the measurement of the former with a microammeter gives an accurate indication of the latter.

This second-harmonic microvolter is not new. Originally developed by Walter Van B. Roberts of the RCA License Laboratory, we first heard it described by David Grimes at a meeting of the Connecticut Valley I.R.E. Section, four or five years ago. The circuit has since been published,<sup>1</sup>

<sup>1</sup> W. F. Diehl, "A Standard Microvolter Using the Second Harmonic Principle," *Electronics*, July, 1932.

although utilization has not been particularly great. The scheme is quite useful for our purpose, however, in that it depends only on one readily-constructed resistor for its accuracy, and, since only the second harmonic is utilized, shielding problems in the microvolter and couplings in and out thereof are minimized.

#### THE SECOND-HARMONIC MICROVOLTER

In its practical form, the device exists as shown in the photographs and Fig. 2. All parts and the battery power supply are mounted in a 12 x 10 x 7 inch box made of  $\frac{1}{16}$ -inch aluminum and  $\frac{1}{2}$ -inch aluminum L-angle pieces. Connections to the signal generator and to the receiver under test are made with short lengths of single-wire line in  $\frac{1}{2}$ -inch shielded braid, connected to G.R.

Type 274-ML plugs. The corresponding G.R. jack connectors are mounted behind the panel.

Plug-in coils are used, the difficulty of switching while at the same time preserving the absolutely essential perfect balance between the two sides of the winding and the coupling link appearing too much like that Mt. Everest climb. A large split-stator condenser gives a reasonable tuning range, reducing the number of coils required. To repeat, the two sides of this circuit must be ab-

solutely balanced; otherwise, the output will fall down rapidly at the high-capacity end of the dial, and the appearance of a fundamental component in the output will lead to erroneous results.

If the output resistor  $R_4$  is made precisely 1.41 ohms, the microammeter will read microvolts directly,  $20 \mu\text{a.}$  representing exactly  $20 \mu\text{v.}$  This resistor,  $R_4$ , is the crux of the whole device, for on its accuracy depends the accuracy of the results. It should be a perfect resistance, entirely non-reactive. As an approach to this ideal, the resistor used in this device is made by taking about 2 inches of No. 37 Nichrome and wrapping the ends around two lengths of heavy bus bar, mounted directly on the output terminals. The effective length of the resistance wire (32.3 ohms per ft.) is made 0.52 inches. The wrapped ends are embedded firmly in solder, the half-inch of wire between being stretched tight.

An external portable microammeter is used to

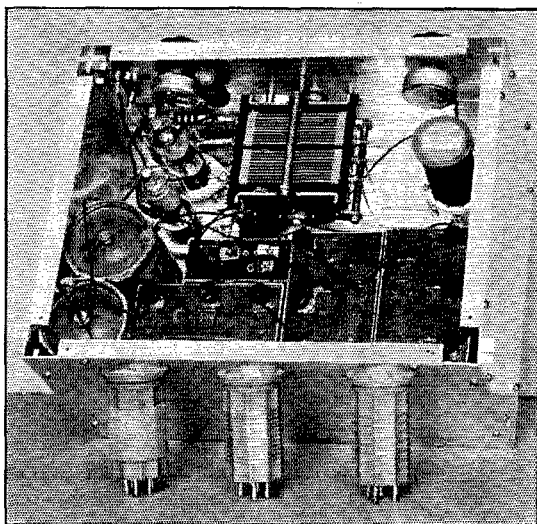

MICROVOLTER WITH SHIELD COVER REMOVED

read the d.c. increment in the balanced modulator plate circuit, such instruments being sufficiently expensive as to prohibit tying one up in a permanent set-up. A 200-microampere meter is satisfactory, although one having a lower range is eminently desirable for measuring low microvoltages. A balancing arrangement for "bucking out" the residual plate current of the tubes is built into the unit itself.

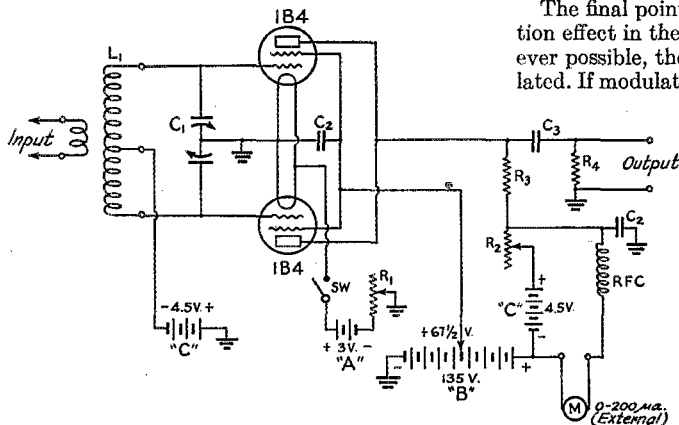

FIG. 2—CIRCUIT OF THE SECOND-HARMONIC MICROVOLTER.

C<sub>1</sub>—Split-stator 500  $\mu$ fd. per section variable condenser (Cardwell XR-500-PD).

C<sub>2</sub>—0.1- $\mu$ fd. 400-volt tubular paper condensers.

C<sub>3</sub>—0.01- $\mu$ fd. mica fixed condenser.

R<sub>1</sub>—15-ohm rheostat.

R<sub>2</sub>—5,000-ohm rheostat.

R<sub>3</sub>—1.41-ohm non-reactive resistor (see text).

L<sub>1</sub>—500- $\mu$ h. coil, 164 turns No. 30 d.s.c. close-wound on 1 1/2-inch dia. form, center-tapped, with 6-turn coupling link of No. 24 d.c.c. wound inside, centered.

L<sub>2</sub>—70- $\mu$ h. coil, 52 turns No. 24 d.c.c. close-wound on 1 1/2-inch dia. form, center-tapped, with 2-turn coupling link of No. 20 tinned wire wound inside, centered.

L<sub>3</sub>—8- $\mu$ h. coil, 18 turns No. 20 tinned wire, winding length 1 1/2 inches on 1 1/2-inch form, 1-turn-plus coupling link of No. 14 tinned wire wound inside, centered.

L<sub>4</sub>—1- $\mu$ h. coil, 6 turns No. 20 tinned wire, winding length 1 1/2 inches on 1 1/2-inch form, 1-turn-minus coupling link of No. 14 tinned wire wound inside, centered.

RFC—2.5-mh. sectionalized r.f. choke.

Battery complement: Two No. 6 dry cells, two 4 1/2-volt C batteries, three portable-size 45-volt B batteries.

Note: If it is desired to cover i.f. frequencies as well, an additional coil of 2.5 millihenries inductance, universal wound and center-tapped, can be employed. The turns ratio to the coupling link should be about 25 to 1.

The unit is battery-operated in order to achieve a high order of short-time power-supply stability without undue expense or complication, and also to enable a completely shielded unit. Current drain is low, so battery expense is nominal. The necessity for a stabilized supply will become apparent with the first adjustment of the d.c. balancing control. At currents of a few microamperes, a.c.-operated heaters alone induce sufficient variation to make readings difficult. Even with batteries there is a continual small drift, but this can be compensated for over any one measurement.

As stated before, the second-harmonic microvolter is simple to construct and accurate, but its adjustment is relatively complex. Circuits must be tuned precisely. The d.c. plate current must be maintained in precise adjustment. In effect, it adds two quite critical controls to the signal generator (the output potentiometer on the generator being used as the level-setting control).

The final point to be mentioned is the modulation effect in the second-harmonic output. Wherever possible, the signal should be used unmodulated. If modulation is necessary, the fundamental

percentage should be kept low, for the degree of modulation in the output will be  $4/(2 + m^2)$  times the percentage modulation of the fundamental. In addition, there is a second harmonic component of the modulation frequency that is  $m/4$  of the desired modulation. Modulation increases the amplitude of both the second-harmonic component peak amplitude and the rectified d.c., but in equal amounts, so the accuracy of

the reading is not disturbed.

With the existing oscillator, the microvolter is primarily useful for measuring only over-all receiver characteristics, since the maximum

(Continued on page 108)



## DIXIE JONES' OWL JUICE

I'LL be dadblamed if sumpn hadn't oughto be done about all these 40-meter mugs flopping back on 80 every year about this time or sooner and yowling all over us 80-meter gentlemen that belong here. Every year it is the same, only some it's worse. It runs in cycles like rabbit years in Kansas. Some years you ain't pestered by so many of them. In them years hen hawks grab 'em up more'n usual or they git to eatin' loco weed or buckeye sprouts and there ain't so many, and you can kinda manage to keep a few skeks and move what hamgrams there is without having some big squawk pop up all over your man and say: "This here 80 band is too crowded fer me, I'm going back on 40." Brother, he coulda went at the same time he come and it would suit me fine. If I was running this ham racket I would make them 40-meter jaspers git somewhere and stay there and not be floppin' around messin' up guys that's trying to do sumpn. It ain't right.

—W4IR of the "Dixie Squinch Owl."

# Watt a Chirp From Dominica!

By John M. Murray,\* W2AMD-VP2MK

**B**ATTERY he finished, Boss!" "Whataya mean?" I gurgle, shoving the earphones northward and looking up at my native headman, Yotee.

"Vito he finish too, Sar. You come look!"

With salty beads raining from my brow, Yotee and I slowly retrace our way through the dripping jungle, he slashing murderously at the chebef and blaguard roots, and I following in the narrow passage behind him.

Forty-eight hundred feet above the sea, we are on the jagged back of Trois Pitons, Dominica's second highest peak. Between intermittent rain squalls, and when the waving tree ferns straighten for a moment, we can see out over green valleys to the east and west. Patterns of sunlight and speeding white clouds against a blazing blue sky. But only for fleeting instants. We are drowned about every eleven minutes. Three hundred inches of rainfall in this vicinity! Far off on one horizon lies the rolling blue Atlantic, while on the other our leeward Caribbean, nearer and bluer in the bright afternoon light.

Though the transmitter and receiver are small, it has been a frightful pull getting them up on this wild tropical mountain. And now Vito, my black idiot, has fallen in the chartagnier roots along with 180 volts of "B" batteries. He had come up more slowly with his extra load.

But we find him, his eyes rolling and his feet nearer the sky. Several yards he has fallen through the woven roots and horizontal trunks over which we had passed. Vito is too scared and I too mad to talk. It is a terrific job fishing the batteries up, but finally they are lined up on a log and not much the worse for wear. I turn to Vito.

"Now, my little cherub, whathehell's the big idea? You said your feet were sure. You've bloody well near wrecked the whole business. Grab those batteries and let's get going!"

"No Sar, dear boss," comes Vito, the white dice in his mouth rattling.

"Whataya mean?" I shriek.

"Debbil in them blocks, green firey debbil. Cocht my hand in he teeth. . . . No Sar, dear boss, I no . . ."

"Well, you ———!" I change my tactics. . . . "Listen to me, Vito. There's no devil in those batteries. If you'd keep your blasted lunch hook off them . . ."

"Launch hoo-ok? debbils, firey debbils. . . ."

But there's no use explaining. Finally Yotee and I lug the four blocks back over the trail, and I set to connecting up the gear. Vito goes off in

the bush to get bamboos and balezier leaves for my *ajoupa* which he will build before nightfall. Yotee climbs a stunted palm and drapes the sixty-six foot antenna. I twirl the dial of my three-circuit tuner, a wild receiver made up of ancient parts resurrected from different planters on the island. . . . Forty meters. Ah, VP6NW roaring in on phone. Small fry—only a hundred and thirty miles to Barbados. . . . I slip the dial slowly around. . . . K4DUZ, with low growling c.w., is talking to Antigua. Then the commercial-sounding clip of K5AF calling CQ. But I am after the U.S.A.; none of these locals for me!

Next, to hook up the transmitter. Night falls fast out of the equatorial twilight. A Hartley she is, using one '45. Filament batteries will only last a short time. . . . I beat the transmitter with the receiver and set it at about the middle of the 7-mc. band.

Vito is now finished with the lean-to *ajoupa* and is squatting before it, his cutlass folded in his arms. There is a wild look in his eyes; I am sure he thinks I am playing with the devil. Yotee has a small grass and root fire going and prepares supper. Now the sun has set and Caribbean maidens of the sky are blowing their warm breath through the night. The regeneration of my receiver competes bravely against the steady rushing and sighing of the trees.

And there he is again! "VP6NW calling test forty meters. . . ." What modulation! I raise him, though, and he gives me QSA5 R8, but VERY CHIRPY, like tweeking a violin string. Soon I swing into a 73 and go after the W's. . . .

I hear a W4 and give him a long call. ND. Many W's are beginning to pound in; in fact if I don't QSO soon, the QRM will be too heavy. . . . All this work for nothing. Then comes the slow DX drawl of W2HFO. . . . A crystal note—with a hand key, the sending smooth as ivory. . . . "CQ CQ CQ DX de . . ."

I push the switches. . . . "W2HFO . . . W2HFO de VP2MK . . ." And back he comes! QSA5 R7 T8 he gives me, but VERY CHIRPY. . . . What a thrill! My input is barely one watt! I give him my QRA, and we chew the rag for a few moments. Then I remember W8ZG's stunt back in the twenties of working a Zedder with a UV199 transmitter with fly speck input. . . . Perhaps I can get rid of the chirp. . . . So I tell W2HFO to QRX while I start cutting off the "B" batteries one by one.

My hands are wet, and I am squatting Buddha-like on the damp ground. I catch a look at Vito across the fire light, his eyes riveted on me. I

\* 157 William St., Catskill, N. Y.

(Continued on page 86)



# Results, June '36 A.R.R.L. "F.D.!"

**T**HE League's Fourth Annual Field Day is over, with a record of higher participation and higher scores than ever before. Perfected operating technique and more practical equipment developed with emergency needs in mind have contributed to this result. Some 387 operators and additional S.W.L.'s and visitors were on the job! Numerically about 15.7% more took part. The impetus that building of portables has received is reflected in the increased demand for an additional summer field day this year.

Most operators divided their operating time between the 7- and 3.5-mc. bands. Any amateur frequency could be used, voice or telegraph, from a portable station in the field. With few exceptions, practically all the work was telegraph, which gives most output and most DX for a given weight and drain on batteries. Some used 56 mc. of course for extra points and fun. This amateur band was third in popularity and the hottest 'phone band for field-day activities.



**FIELD DAY WINNERS —**  
W3AJF-QV-3 (1287)

York Road Radio Club at Sunday dinner. L. to R.: W3EWO, ETM, FZQ, BYS, EEW, EHZ, AYH, GDC, BZF, CTB, KF, (next two unknown), ALB, BWQ, FEJ, ECD, DMF, ERF.

+ + +

W5EHM-5 (1170)

An individual tent set-up by W5ENE, ESC, DYH, EHM.

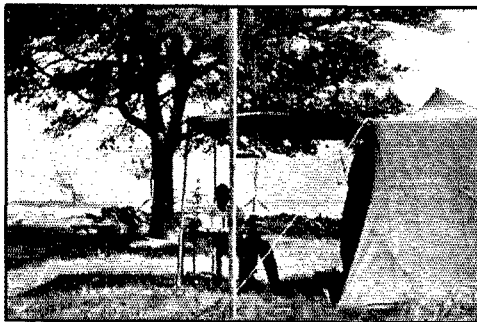

The winner? There were many groups making scores running into the hundreds and all deserve greatest credit since they each proved a high degree of "communicating ability". The York Road Radio Club set to in earnest and brought the honors back east, placing first by making 143 contacts with different stations for a score of 1287 points! 24 club members slept in tents, others arriving Sunday. An enjoyable week-end was had by all—as may be judged from the photograph which shows the whole crew taking care of the output of the culinary department of

the expedition. The location was Ringing Rocks Park near Pottstown, Pa. Two 18-watt transmitters, both 47-46 crystal rigs were used running from 350-volt dynamotors and 12-v. batteries and the gang was surprised at the fine performance of this power on 3.5- and 7-mc. bands.

The August activities will be reported as soon as reports are complete.

The object of the "F.D." was to give a practical operating test to equipment transported and set up at a distance from commercial power supplies. The communicating work of different stations is compared by the scores, these based on the number of contacts made with any other amateurs besides stations of those in the group making the test of course. Each contact counts a point and the total number of points is then multiplied by 2 or 3 depending on whether either or both transmitter and receiver are independent of commercial power sources. Another multiplier of 3, 2, or 1 applies for plate powers falling between 0-20, 20-60, and 60-1000 watts respectively.



W2DXO-2 (1161)

Northern Nassau Wireless Association. Back row: W2AOL, 1CO, GZS, DJO, DDU, HQJ, BWC. Front row: S.W.L., W2DUA, DXO, AYJ, S.W.L.

Those not operating enjoyed ball games, roller skating, and other sports.

The leading station in the individual group scores gave the Y.R.R.C. plenty of competition, and W5EHM-5 was the second highest of *all* (130 QSO's, 1170 score), with work entirely on 7 mc. All the active Dallas hams listed with this report missed the centennial opening to help put this Field Day test over and are to be congratulated on the outstanding work. The station was located on a hill near White Rock Lake. The ops took two hour watches. Sets were on hand for all bands but it was thought best to keep doing well on 7 mc. CM's, VE's and XE's were among those worked, using push-pull 45's. A high wind threatened the set up, and the gang was ready to aid in Wichita Falls work, where tornado conditions threatened, had it become necessary. The next highest *individual* score was that of W1EZ-1. With W1IZM he worked 95 stations (855) on 7 and 3.5 mc. using a single '10 and 12 watts from a vibrator-transformer, QTH on top of East Mountain (Vermont).

Four club groups rolled up scores over the 1000 mark! The winner has been mentioned. Next in line we find keen competition—W2DXO-2 with 129, W6ERT-6 with 125 and W9AIU-9 with 121 contacts. The Northern Nassau Wireless Association (score 1161) set up at Poundridge Reservation, Cross River, N. Y. 14 and 56 mc. were used as well as the usual low-frequency bands. The United Radio Amateurs (last year's winner) made 1125 points with a large and successful set up in the Palos Verdes Hills near San Pedro. The main transmitter was a 41-'10 crystal rig used on both 7 and 3.5 mc., power from a 300-volt gasoline driven a.c. generator of W6IVG's. A supervised schedule gave every member part of the responsibility and assured a high degree of success. The Egyptian Radio Club *doubled* their contacts from the previous year's record, working all districts, besides VE4 and VE5 with just a single 802 crystal oscillator and various crystals for 3.5, 7 and 14 mc. The location was Riverview Park, Alton, Ill. on a bluff 250 feet above the Mississippi. A dynamotor supply was used. The score, 1089!

The South Cleveland Radio Club, W8IK-8, considerably bettered its records of last year, working 20 states and two VE licensing areas. A movie of the fellows in action was taken. The transmitters; all crystal rigs: (3.5 mc.) '12A and 71's in parallel. (7 mc.) 6A4, 6A4 doubler, and 6A4's in parallel in the final. (14 mc.) 6A6 osc-

doubler and RK25 second doubler. With 104 QSO's for 936 points, the fellows found time for baseball and fishing when not operating. The S.C.R.C. and the Hamilton Amateur Radio Club, VE3KM, both maintain the same relative position in the list of scores recorded last year! VE3KM using a 47-802 (37 s.a.) rig made 93 QSO's for 837 points from Waterdown, Ont. overlooking Lake Ontario. All hands enjoyed the camping and operating to the utmost.

Incidental use of 56 mc. was noted in quite a number of reports. W1HDQ-1, as usual, led this field, topping his previous record of 49 QSO's by working 62 stations in the party (558 points) all



W8FBC-8 WAS LOCATED UNDER A STRAW STACK  
W8FBC, JNJ, LEV

+ + +

VE3SP ON LOCATION WITH VE3KM

Hamilton Amateur Radio Club (837) represented by VE3KM, IA, SP, led all Canadian entrants.



with just 3 watts! FB, HDQ!

We are sorry that space does not permit a story on each successful set up—the fun of an outing and superlative results went hand in hand and we hope these all too brief sketches will give

some idea of the stations set up. Rigs varied from the simplest individual sets to those where clubs pooled local effort and established camps with three or four tents and a dozen or more storage batteries. The power classifications are noted in full with the scores of each group. As W8DRW-8 reports, "This contest, like other A.R.R.L. contests is growing in popularity by leaps and bounds as evidenced by the great number of stations 'signing portable' June 6th and 7th. Last year we (W8DMK and myself) found about 10% of our QSO's with other portables. This year it was 40%!"

—F. E. H.

W8KRG relieved W8HMJ at times. Plans for next years F.D. include more power, but the 41-42 rig worked well this year. Highlight, with QRN at worst refreshments arrived.—W8HMJ.

W1FGO and I pooled equipment, got in on the F.D. and haven't had so much fun for months. Push-pull 42's with crystal were used.—W1EWF-1.



W1EZ-1 PLACED SEVENTH HIGH FROM THIS LOCATION WITH JUST TWO OPERATORS, W1IWM LEFT, W1EL RIGHT

Many speak of the pleasures and benefits of camping in the open for this A.R.R.L. activity.

W1FGC-1 worked entirely on 56 mc. from Mt. Monadnock working 42 stations. A Genemotor run on storage bat. was used giving 300 v. 60 ma for 112 osc., 41 mod., 76 speech.—R. M. Slavin, W1FGC.

Put rig in a tent and we walked up a 12' ladder for antenna support. Made 51 contacts in spite of the rain.—VE3GI, VE3LK, V.L.

Field Day was enjoyed by the entire club, operating W9LLV-9 on 3658 kcs.—W9VNM.

The W.R.O.C.'s eight operators located on Rib Mountain, three miles south of Wausau, entirely battery operated using 89 crystal, and P-P 89's. Due to QRN we were glad the set could work any band.—W9PRM-9.

The R.F.C. had an enjoyable outing, looked forward to for a long time. Our portable rig used 6A6 and P.P. 6A6's with both a dynamotor and gas driven generator for W8ENO-8. Due to publicity on our plans we had many ham and layman visitors. Break-in was used at all times and made possible many contacts.—W8ID.

The annual F.D. is one of the best features promoted by A.R.R.L. and we three thoroughly enjoyed it in spite of QRM from June bugs. More Halifax stations would have been worked but the weather was so good they were out in the open, too.—VE1JM, VE1GL, VE1HJ.

Set at W8OFO was very compact, a 112A with 180 volts B giving 3.6 watts input.—W8OFO.

But for the myriads of bugs and other insidious animals, crawling and otherwise, the weekend was fun—and I mean real fun! Next year, now, we are going to town in the contest—just wait! Hi!—W1FGO, W1EWF.

On without a stop for 22 hours using 110 v. self-excited generator on my car. Used 45 watts to RK20 with band switching.—WGDVE-W6BVK.

6A6 P-P osc. link coupled to a 43 amplifier was used with 200 volts B bats. The set on a trailer was moved into the car. A choke had to be repaired, and also it isn't so hot to start on the antenna at the time the contest starts. Plenty of preparation is necessary.—W9NJZ.

Ready to go to the Cascades but activity was confined to

indoor work, but we worked numerous other portables. Set readily accessible for emergencies.—W7FHZ.

112A crystal osc. with 5 watts to a half wave 80 m. Zepp. on 7150 kc. with a tree—for shade.—W6KC, A.E.C.

Sure had a fine time. Camped out five days. Ran a.c. generator belted from rear wheel of car. Two transmitters. Will double score next time!—W8NCD-8.

Would suggest a pound-per-watt limitation, with everything over 50 watts disqualified. Had a grand time. Am a ship op. and pack a portable to pass the time in port, meet local hams, etc. 89-48-P.P. 48's, 12 watts input, 15' x 7' x 5', weight 7 pounds.—W6BOY-7.

Loads of fun. We were three miles from the nearest telephone and truly portable in all respects.—F.L.T.S., W8BVD-8.

The Buckeye gang journeyed 23 miles west of Akron. In spite of adverse weather, winds, rain, static, everyone claims he thoroughly enjoyed it. Over 50 hams, wives and YL's visited. Recommend two FD's each year.—B.S.R.A., W8BDG.

Too many S8's and S9's for a measly 16 watts input. I never put much faith in reports and now I never will.—Evans, W1BFT.

Operated a 2kw ac generator from a 4 cylinder Austin motor at Hanging Rock Mt., 35 miles from Winston Salem, N.C. 59-46 was used by 20 club members, also 8 non-lic. men were log keepers, watching gas and oil and deserving much credit. All had a big time.—W.S.A.R.C., W4NC-OG.

One swell time . . . lots of fun and brasspounding. Every contact enjoyed 100%. Raised W7FFQ (Boise) on a CQ and got 589X on our 4 watts! We were at Riverton between Sacramento and Lake Tahoe.—W6KMB-6.

Two miles from Sunset Beach with 42 (7123 kc. crystal) and 42 final with 8 watts input until the vibrator power supply gave up, but we got back on the air with just the m.g.—A.R.A. of L.B., W6MHH-6.

W4CUW made a short test on A.R.R.L.'s Field Day making 35 contacts . . . proved our portable a.c. supply was dependable in time of need. It taught us never to set up near a high power transmission line (noisy) and others should be warned of this for future contests.—W4CUW-4.

W3NF, W3GM and W3EOP put up a tent 6 mi. south of Easton, Ed and I keeping 4 hour shifts. Our score was made with 6A4 crystal and 201-A and later a 210 final with 17 watts from B bats.—W3EOP.

Six enlisted men and four civilian ham (guest) operators scheduled an overnight camp on the F.D., the company cook preparing our meals. 42-6A3 with a hand driven generator makes a good emergency supply but it is too much work to keep it going for hours.—W8BDM-3 (Whitaker, 2nd Lt. O.N.G.)

42 crystal with 15 watts from bats and filament from car battery. Had a swell time with lots of eats, mosquitoes, spare time and QST to read.—W3FFC-3 and W3EYP.

We parked on a boat house (at Baie D'Urfe, Lake St. Louis, 17 miles west of Montreal) using 2.6 watts on a '01A crystal with 135 v. A good time was had by all.—VE2CO and VE2CX.

Also used 59-801 MOPA on 40 and 80. Used a one cylinder gas engine and a.c. generator. By every test we could apply the equipment worked well. It was just lots of fun, and we would not have missed it.—W9NIU, A.E.C.

No matter what our power be

Or how they report our sig

We give them a better report

On their low powered rig!

(Inspired by a-9 '01A sigs)—W9BOP-9

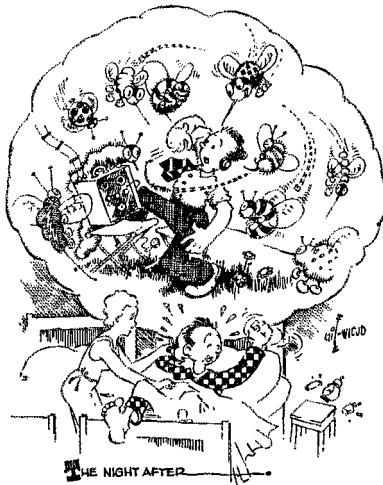

The Frontier Radio Club of Windsor, Ont. set up a tent and chow house at Oxley Beach, using a re-wound Dodge generator and gas engine for the rig and lights. 59 triet was used . . . one of the swellest weekends the gang ever had. The experience was invaluable.—V E3ZO.

Having placed first on 56 mc. in '34 and '35 we have had a new rig "in the works" for a long time with this F.D. in mind. It uses a 19 Colpitts osc., 19 Class B mod., 30 speech amp. with a pr. of 30's in a super-regen. all running from three 45 v. B bats. Perfect wx and the full moon was a big help.

Worked from Sweetman Mt., Granville, Mass. Saturday and Mt. Monadnock, Jaffrey, N. H. Sun.—Tilton, W1HDQ-1. The S.M.R.A. had its F.D. at Edgewater Park, Albert Lea, Minn. A Kato a.c. gas engine generator put 115 watts on the final. 32 of 40 W9RHT-9 contacts were on 75 meter 'phone.—W9MZN.

Joint field day plans were made by the M.V.B.P. and U.A.R.C. and 10 members drove 40 miles north into the mountains. Using 802-'10 we had a swell time.—W8LGR for W9LMT-8.

## Field Day Participation

Club Station	QSOs	Score*
W3AJT/QV-3	York Road Radio Club <sup>1</sup> . . . . .	143-A 1287
W2DXO-2	Northern Nassau Wireless <sup>2</sup> Association . . . . .	129-A 1161
W6ERT-6	The United Radio Amateurs Club of Southern California <sup>3</sup> . . . . .	125-A 1125
W9AIU-9	Egyptian Radio Club <sup>4</sup> . . . . .	121-A 1089
W8KCP-8	South Cleveland Radio Club <sup>5</sup> . . . . .	104-A 936
VE3KM	Hamilton Amateur Radio Club <sup>6</sup> . . . . .	93-A 837
W8ODJ-8	Buckeye Short Wave Radio Association <sup>7</sup> . . . . .	90-A 810
W4NC-4	Winston-Salem Amateur Radio Club <sup>8</sup> . . . . .	89-A 801
W8MLV-8	Akron Progressive Short Wave Radio Association <sup>9</sup> . . . . .	73-A 657

\* The "power classification" used in computing the score is indicated by A, B, or C after the number of QSOs shown. A indicates power up to and including 20 watts (multiplier of 3); B indicates power over 20 up to and including 60 watts (multiplier of 2); C indicates over 60 watts (multiplier of 1). More than one letter means that at different times different power inputs fell within different classifications. An R or T after the score indicates that receiver or transmitter were supplied from the public mains; no indication after scores where work was entirely independent of mains, r or t is used where only part of operation used mains supply.

Club operators: <sup>1</sup> W3EWO, W3ETM, W3FZQ, W3BYS, W3EEV, W3EDZ, W3AYH, W3DCQ, W3ALB, W3BWQ, W3FEJ, W3EDC, W3DMF, W3ERF, W3KFP, W3CTB, W3BZF, W3AJT, W3GV, W3FLN, W3FKX, W3EJH, W3EIC, W3LEH, Dick Boyer, Charles Koster, <sup>2</sup> W2AOI, W2ICC, W2GZS, W2DJO, W2DDU, W2HQJ, W2BWC, W2DUA, W2DXO, W2AYJ, & 2 SWL's. <sup>3</sup> W8CIP, W6DBF, W6DIS, W6E2B, W6ERT, W6EJL, W6FV, W6FXI, W6GZO, W6HBC, W6HCF, W6HLE, W6HOJ, W6HJK, W6IVG, W6IZT, W6JCK, W6JZL, W6LAA, W6LX, W6ON, W6CLY, W6CSO, W6CWV, W6CYS, W6DJD, W6DZG, W6DZU, W6KEH, W6NDH, W6PJJ, W6PNX, W6RCQ, W6RYE, W6VLY, <sup>4</sup> W8IKP, W8ICS, W8OBG, W8LJV, W8N2D, W8NIC, W8LXE, W8CMB, W8LWO, W8LZV, W8KXZ, <sup>5</sup> VE3VZ, VE3ESQ, VE3KM, VE3LA, VE3AD, VE3GZ, VE3ABQ, VE3ZX, VE3MZ, VE3JU, VE3HT, VE3QU, VE3CC, VE3XT, VE3AEM, VE3ADF, VE3PO, VE3NH, VE3SF, <sup>6</sup> W8BDG, W8AXQ, W8BSR, W8GSR, W8KG, W8GCI, W8BZL, W8DRO, <sup>7</sup> W4RA, W4CFR, W4BOH, W4CYA, W4BYU, W4CFT, W4GO, W4BPT, W4DCQ, W4BFP, W4LHF, W4DEL, O'Brien, Snider, Thibode, Mowery, Snow, Dalton, Spencer, <sup>8</sup> W8MMN, W8EXI, W8PJG, W8JTI, W8NYY, W8MMB, W8LBE, W8NYP, W8NLI, W8KAY, W8NHO, <sup>9</sup> W8BII, W8CHU, W8JU, W8CJJ, W8DZC, <sup>10</sup> W9RQM, W9LED, W9PRM, W9FEE, W9WJD, W9VEK, W9WMK, W9EOI, <sup>11</sup> W3AAF, W3MCL, W3OFE, W3EWM, W8KBU, W8MCR, W8NAI, <sup>12</sup> W9TGL, W9GJZ, W9VFB, W9LBP, W9GTM, <sup>13</sup> W4CDC, W4PL, W4BFT, W5CPX-4, W4DIJ, <sup>14</sup> W8BDV, W8LWN, W8MQG, W8JQV, W8CTJ, W8DSU, W8BGV, W8BCN, W8LDA, <sup>15</sup> W8AAL, W8IBU, W8DEZ, W8DCA, W8HRE, <sup>16</sup> W8FJR, W8DDD, W8TD, AI W8EKA, W8DHI, W8EBO, W8VCC, W8HJL, <sup>17</sup> W4CBE, W4DCZ, W4DIN, W4AZE, W4ACB, W4AJX, W4CBN, W4ADM, <sup>18</sup> W1LJ, W1FFK, W1COI, W1LZN, W1JAD, W1JAH, W1JXY, <sup>19</sup> W9DJA, W9HJG, W9JCW, W9RQM, W9FTE, W9UMR, <sup>20</sup> W3AZN, W3DFJ, W3EXG, W3FYV, W3EJ, W3DYV, W3AOC, W3GLU, W3GAG, <sup>21</sup> VE3ZV, VE3AEY, VE3AIL, VE3AHI, Geo. Brooks, G. McFarlane, VE3CP, VE3MY, VE3AHK, <sup>22</sup> W9LJN, W9BNZ, W9LJI, W9KDO, W9VWU, W9TWI, W9GJZ, W9VQG, W9VKI, W9KXB, W9UFA, <sup>23</sup> W8DNE, W8LGE, W8ADZ, W8LVZ, W8MKA & 5 others, <sup>24</sup> W6GAL, W6LEE, W6MHH, W6MNT, W6MGO, W6MPY, <sup>25</sup> W9LTV, W9NCT, W9WMC, W9FRY, W9OEC, W9TRN, <sup>26</sup> W9TGE, W9MZN, W9UKA, W9OGU, W9JYA, W9RQV, <sup>27</sup> W9VH, W9FI, W9AYE, W9KZY, W9VYQ, W9SCH, <sup>28</sup> VE2CX, VE2CO, <sup>29</sup> W4PQ, VE4MB, VE4XB, VE4UC, <sup>30</sup> Not given, <sup>31</sup> W8FJA, W8OIL, VE4KA, VE4LV, VE4IG, VE4EY, W8GEB, Chesert, Benson, <sup>32</sup> VE3WU, VE3TD, VE3AID, VE3SG and Gord. Colman, <sup>33</sup> W8LXG, W8AVH, W8MOK, W8MWO, W8GUL, W8NYC, W8NIP, W8MXX, W8ESX, W8BCE, W8LVH and W8BXG.

W8DZC-8	Elmira Amateur Radio Association <sup>10</sup> . . . . .	68-A 594
W9PRM-9	Wausau Radio Club <sup>11</sup> . . . . .	64-A 576
W8EWM-8	Bluefield Amateur Radio Club <sup>12</sup> . . . . .	50-A 450
W9TGR/NJZ/OWB-9	The Northwest Amateur Radio Club <sup>13</sup> . . . . .	51-A 450
W4CDC-4	Chattanooga Amateur Radio Club <sup>14</sup> . . . . .	72-B 432
W8BDV-8	Finger Lakes Transmitting Society <sup>15</sup> . . . . .	66-AB 405
W8AAR-8	Trico Radio Club <sup>16</sup> . . . . .	41-A 369
W8ENO-8	Radio Frequency Club of Tiffin <sup>17</sup> . . . . .	38-A 342
W4AZF-4	Tampa Amateur Radio Club, Inc. <sup>18</sup> . . . . .	56-A 336 T
W1FTS-1	Hoosac Valley Radio Club <sup>19</sup> . . . . .	34-A 306
W9DJA-9	Fond du Lac Amateur Radio Club <sup>20</sup> . . . . .	31-A 279
W3GAG-3	The Philadelphia Wireless <sup>21</sup> Association . . . . .	28-A 252
VE3ZO	Frontier Radio Club <sup>22</sup> . . . . .	27-A 243
W9LJL-9	Topeka Radio Amateur's Association <sup>23</sup> . . . . .	53-B 212 T
W8LMT-8	Mohawk Valley Brass Pounders & <sup>24</sup> Utica Amateur Radio Club The Queen City Amateur Radio Club <sup>24</sup> . . . . .	28-A 207
VE3SG	Associated Radio Amateurs of <sup>25</sup> Long Beach . . . . .	48-B 192 T
W6MHH-6	Goshen Amateur Radio Club <sup>26</sup> . . . . .	21-A 189
W9LLV-9	Southern Minnesota Radio Association <sup>27</sup> . . . . .	41-B 164 T
W9RHT-9	West Towns Amateur Radio Club <sup>28</sup> . . . . .	40-C 120
W9VH-9	Montreal Amateur Radio Club <sup>29</sup> . . . . .	39-A 117 RT
VE2CO	Saskatoon Amateur Radio Club <sup>30</sup> . . . . .	11-A 99
VE4AAA	Raleigh Amateur Radio Club <sup>31</sup> . . . . .	10-A 90
W4BUE-4	Westlake Amateur Assn. <sup>32</sup> . . . . .	9-A 81
W8LXG-8	Marietta Amateur Radio Society <sup>33</sup> . . . . .	9-A 81
W8KYC-8	Moose Jaw Amateur Radio Club <sup>34</sup> . . . . .	10-A 60
VE4LV	INDIVIDUAL AND GROUPSCORES	6-A 54
W5EHM-5	W5ENE-W5ESC-W5DYH-W5EHM . . . . .	130-A 1170
W1EZ-1	W1ZM-W1EZ . . . . .	95-A 855
W8DRW-8	W8DRW-W8DMK . . . . .	116-A 696 T
W1BFT-1	W1IOC-W1HOV-W1BFT . . . . .	70-A 630
W1HDQ-1	E. P. Tilton . . . . .	82-A 558
VE3GT	VE3GT-VE3JT . . . . .	62-A 558
W8NCD-8	W8NCD-W8PQQ-W8PMA-W8OBA . . . . .	60-AB 495
W3NF-3	W3NF-W3EOP-W3GJM . . . . .	50-A 450
W3EHW-3	W3EHW-W3FQZ-W3GAC-W3FRB-W3EJB . . . . .	49-A 441
W1FGO-1	W1EWF-W1FGO . . . . .	44-A 396
W1FGC-1	Robert M. Slavin . . . . .	42-A 378
W8BDM-8	W8BDM-W8EVL-W8FKY-W8IMC-W8KND-W8MMH-W8MWH-W8NGR-W8OHO-W8OJE-W8OYH-W8PWD . . . . .	42-A 378
W8KZL-8	Winchell Keller . . . . .	37-A 333
VE3HI	VE3HI, VE3LK, Vic Lawton . . . . .	51-A 306 T
VE1JH	VE1JM-VE1JH-VE1GL . . . . .	31-A 279
W1NH-1	Forrest Hassom (56mc.) . . . . .	31-A 279
W6MVK-6	Tom S. Chow . . . . .	45-B 270
W9TYF/UYP-9	W9TYF-W9UYP-Tony Seifert (SWL) . . . . .	81-A 267 RT
W6BVK-6	W6BVK-W6DVE . . . . .	41-B 246

(Continued on page 88)

# Class-B "Squirt" Modulation With a Pentode Class-C Stage

An Economical Transmitter with RK-20 Output and Quick Switching for Controlled- or Constant-Carrier Operation

By E. S. Young,\* W9AEN

**T**HIS rig has been in use here at W9AEN for the past year, and has far exceeded expectations in performance both as to DX and to simplicity of operation. One may wonder, after examination of the tube lineup, why more power is not used in the final stage to obtain more power in the antenna; but let it be known here and now that two major issues are involved. First, financial considerations, and second, the thrill of working with low power. The main idea in presenting this article is to demonstrate a working model transmitter that has controlled carrier, with Class-B modulation of a pentode Class-C amplifier. Controlled-carrier principles have been presented in the A.R.R.L. *Handbook* as well as in past issues of *QST*, and will not be treated here.

The r.f. front end of this transmitter is the standard "universal exciter" circuit, using alternative Tri-tet crystal or electron-coupled oscillator control. Complete details of two arrangements were given in Oct. and Nov. 1933, *QST*. The second of these is also described in the current edition of the A.R.R.L. *Handbook*. It is therefore unnecessary to repeat the circuit details. Even the coils are as previously specified. However, in place of the 59's specified for the oscillator and buffer-doubler stages of the original design the later transmitting-type r.f. pentodes are used.

Getting on, an RK-23 is used in the oscillator circuit. This tube has a number of advantages over the 59 in this position, mainly that no trou-

ble is experienced in operating both the input and output circuits at the same frequency. While the crystal is incorporated in the transmitter for Tri-tet operation, the writer has never found occasion

to use it, as one very often finds that one's signals are right in the middle of a bunch of QRM and a shift of frequency is in order. This is readily accomplished using the electron-coupled oscillator connection. Otherwise another crystal must be switched in the circuit, which involves additional expense. If one wants crystal control, however, it is only necessary to switch to the crystal position and choose between electron-coupled or Tri-tet operation.

The buffer is another RK-23 which is used to furnish sufficient excitation in the event the oscillator is operating at the lower frequencies. Also, additional isolation between the final stage and the oscillator is provided and an excellent degree of stability is maintained. The operation of the Universal Exciter Unit is covered very thoroughly in the October, 1933, issue of *QST*, page 9. To use 59 tubes with this unit it is only necessary to provide an insulated peg of some sort to fasten the plate clip (to keep it from dangling around), and

to run a jumper between the plate prong on the bottom of the socket and the plate connection which fastens to the top of the tube. This is arranged in permanent form in this rig, and to substitute 59 tubes it is only necessary to replace tubes in their sockets and hang up the plate lead clip on the insulated peg. All other connections remain the same as in using the RK-23 tubes; the

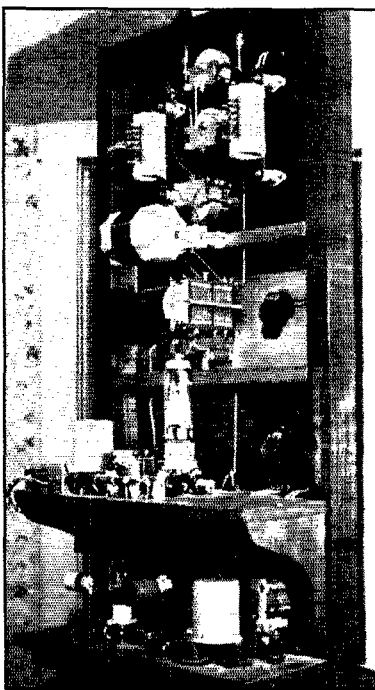

REAR VIEW OF THE R.F. UNITS, PROGRESSING FROM THE UNIVERSAL EXCITER AT THE BOTTOM TO THE ANTENNA TUNING NETWORK AT THE TOP

The audio unit is built on a separate chassis mounted under the operating table.

\* 1306 Forest Ave., Maysville, Ky.

plate terminal on the 7-prong tube base of the RK-23 is a blank, since the plate connection of this tube is brought out to the top. The RK-23 tubes provide superior performance, however, and much more output than the 59's.

The final stage is rather conventional, and several closely similar circuits have been presented in *QST* and the *A.R.R.L. Handbook*. The only reason for deviation from constants as shown elsewhere was not having the particular values

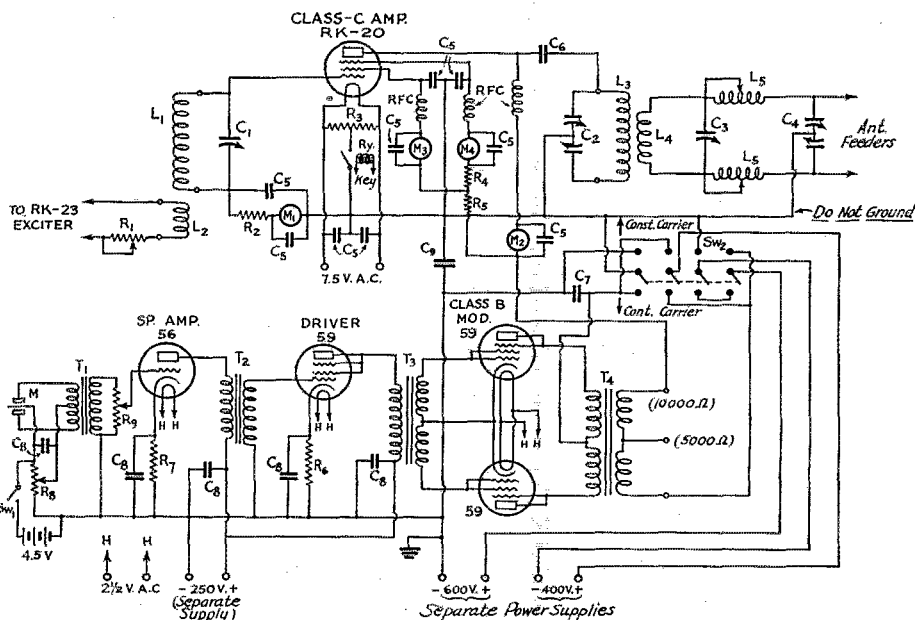

FIG. 1—CIRCUIT OF THE CLASS-C FINAL STAGE AND AUDIO SYSTEM WITH SWITCHING FOR EITHER CONSTANT-CARRIER OR CONTROLLED-CARRIER OPERATION

Tuned circuit coil and condenser values of the Class-C stage are according to usual practice, as specified in the *A.R.R.L. Handbook*. Other values are as follows:

- |  |  |   |
|--|--|---|
| C <sub>5</sub> —0.002- $\mu$ f. r.f. by-pass condensers (mica).            | R <sub>3</sub> —75-ohm filament center-tap resistor.                         | T <sub>1</sub> —Double-button microphone input transformer.               |
| C <sub>6</sub> —0.002- $\mu$ f. 5000-volt plate blocking condenser (mica). | R <sub>4</sub> —25,000-ohm 10-watt (suppressor voltage dropping).            | T <sub>2</sub> —Interstage audio transformer (3-to-1 step up).            |
| C <sub>7</sub> —4- $\mu$ f. 1000-volt or higher filter condenser (paper).  | R <sub>5</sub> —10,000-ohm 25-watt (screen and suppressor voltage dropping). | T <sub>3</sub> —Class 59 input transformer (single 59 to Class-B 59's).   |
| C <sub>8</sub> —1- $\mu$ f. audio by-pass condensers (paper).              | R <sub>6</sub> —1500-ohm 2-watt (driver bias resistor).                      | T <sub>4</sub> —Class-B output transformer (Class-B 59's to 10,000 ohms). |
| C <sub>9</sub> —0.002- $\mu$ f. high-voltage r.f. by-pass (mica).          | R <sub>7</sub> —2750-ohm 1-watt (speech amp. bias resistor).                 | SW <sub>1</sub> —S.p.s.t. microphone battery switch (toggle type).        |
| R <sub>1</sub> —50-ohm variable rheostat (r.f. citation control).          | R <sub>8</sub> —1000-ohm variable (microphone voltage adjustment).           | SW <sub>2</sub> —Four-pole double-throw knife switch.                     |
| R <sub>2</sub> —15,000-ohm 1-watt grid leak.                               | R <sub>9</sub> —500,000-ohm potentiometer (volume control).                  |   |

Note that negative side (filament center-tap) of Class-C stage should not be grounded for controlled-carrier operation. The keying relay, R<sub>9</sub>, is above ground with SW<sub>2</sub> in the controlled-carrier position and should have sufficient insulation to ground to stand the full plate voltage.

#### THE CLASS-C FINAL STAGE

Next, we find link coupling to the final stage, which is thoroughly conventional except that a rheostat is connected in series with the twisted line to adjust excitation to the grid circuit of the RK-20 tube. Since this tube operates best within fairly close limits of excitation, the rheostat allows a fine degree of adjustment and does not detune the circuit, the line being low-impedance. This resistor is a wire wound affair removed from a defunct b.c. receiver. A carbon-pile type which will hold adjustment should work better.

specified in the junk box. Those shown for this rig in Fig. 1 do business nicely, so let's skip the argument.

Now to the unconventional part of it. First of all, a screen and suppressor voltage divider is not connected across the Class-C amplifier plate supply because this would place a dead load on the modulator; and, since modulator power is expensive, why do it? The series resistors merely serve to drop the voltage to the correct value for the screen and suppressor grids. This voltage varies in accordance with the modulation applied to the plate, thus keeping the voltage ratio to the

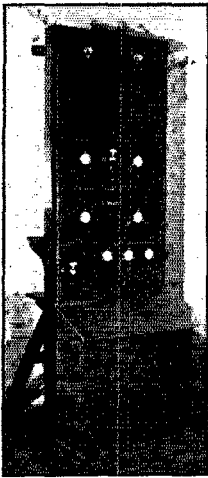

various elements proper. One may dispense with the suppressor-grid resistor, however, and connect the suppressor direct to negative h.v. with good results.

In order to obtain controlled-carrier operation, the modulator and final amplifier plate feed circuits are placed in series. The plate resistance of

PANEL VIEW OF THE TRANSMITTER'S R.F. SECTION IN ITS CONVENIENT "CONSOLE-TYPE" RACK

Note the adequate metering.

the Class-B tubes is varied according to the audio level impressed upon their grids; and, as the audio signal varies, the varying plate resistance of the modulator tubes thus allows more or less d.c. current to pass through to the Class-

(Continued on page 106)

## Picking Out the Receiving Tubes

### "Preferred Types" in Tabular Form

WITH the passing of the moratorium on new receiving tube types, the manufacturers have got back into the swing of the thing and are bringing them out at a pretty fair rate. Gradually, however, order is coming out of what looked like chaos; logical grouping is pretty well in sight. In making up the additions and revisions for the tube tables in the next *Handbook*, we found it possible to prepare a table of what might be called "preferred types" of receiving tubes; the idea being that these types are practically the only ones that need be given consideration in planning a new receiver.

This table is presented herewith. The popular tube designs are listed in the left-hand column; everything is included except the electron-ray tubes, which are mere accessories rather than essential parts of a receiver, and a few hybrids such as the triode-pentode 6F7, which was made only in one series. In the power amplifiers, triodes and pentodes are listed according to how they are constructed rather than used; it is customary, for

(Continued on page 110)

PREFERRED RECEIVING TUBE TYPES BY FUNCTIONS

Descriptions	Metal Octal	Glass 6.3 V. Octal	Glass 6.3 V. Old	Glass 2.5 V. Old	Glass 2.0 V. Octal	Glass 2.0 V. Old
General Purpose Triode . . . . .	6C5	6C5G 6J5G	76	56	1H4G	30
High- $\mu$ Triode . . . . .	6F5	6F5G 6K5G	...	....	....	....
R.F. Amplifier, sharp cutoff . . . . .	6J7	6J7G	6C6	57	1E5G	1B4
R.F. Amplifier variable- $\mu$ . . . . .	6K7	6K7G	6D6	58	1D5G	1A4
Twin Diode . . . . .	6H6	6H6G	....	....	....	....
Duplex-Diode Pentode . . . . .	6B8	6B8G	6B7	2B7	1F7G	1F6
Duplex-Diode G.P. Triode . . . . .	6R7	6R7G	85	55	1H6G	1B5
Duplex-Diode High- $\mu$ Triode . . . . .	6Q7	6Q7G 6B6G	75	2A6	....	....
Pentagrid Converter . . . . .	6A8	6A8G 6D8G	6A7	2A7	1D7G 1C7G	1A6 1C6
Pentagrid Mixer-Amp. . . . .	6L7	6L7G	....	....	....	....
Pentode Power Amp. . . . .	6F6 6L6	6F6G 6L6G	42 (41)	2A5	1F5G 1E7G	1F4 33
Triode Power Amp. . . . .	....	6B4G	6A3	45 2A3	....	31
Twin Triode Power Amp. . . . .	6N7	6N7G	6A6	53	1J6G	19
Direct-Coupled Power Amp. . . . .	6N6MG	6N6G	6B5	....	....	....

# HINTS and KINKS for the Experimenter



## The Class C Audio Amplifier Applied to Regenerative Receivers

THE amateur c.w. operator will readily recognize the added readability of a signal that "stands out" from the background noise present in nearly every short-wave receiver. We find some operators who like a slight modulation on the signal, others who like the piercing qualities of a pure d.c. note, but all will agree that the ultimate condition is that which would exist should

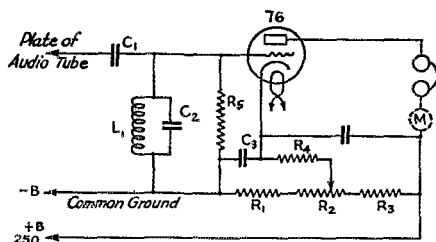

FIG. 1—CLASS-C AMPLIFIER FOR NOISE REDUCTION

- |                         |                             |
|-------------------------|-----------------------------|
| $C_1$ —0.01 $\mu$ f.    | $R_1$ —7500 ohms            |
| $C_2$ —0.00025 $\mu$ f. | $R_2$ —500,000 ohm variable |
| $C_3$ —0.01 $\mu$ f.    | $R_3$ —50,000 ohms          |
| $C_4$ —0.002 $\mu$ f.   | $R_4$ —15,000 ohms          |
- $L_1$ —Primary of output transformer with about half turns removed

there be no sound in the 'phones other than the desired signal.

The Class-C amplifier as described by WLEYM in the July issue of *QST* affords a simple but effective means of accomplishing a marked reduction or complete elimination of background noise. As the article describing this amplifier pertained largely to selectivity, the use of this amplifier as a means of reducing background noise in other than the superheterodyne type of receiver, may have been overlooked by many readers.

The accompanying diagram (Fig. 1) shows a Class-C amplifier somewhat similar to that described by WLEYM. Although an outgrowth of a background-noise reducer designed for use when copying short-wave press in commercial work, it nevertheless offers many possibilities for application to amateur work.

This amplifier may be used with any short-wave receiver having a reasonable amount of gain and properly constructed to have a fairly high signal to noise ratio—provided the receiver is equipped with a power output tube to insure plenty of "drive" for the Class C stage. The writer used the amplifier with a common four-tube t.r.f. receiver with extremely gratifying results.

The output stage of the receiver is coupled to the Class-C amplifier through the condenser  $C_1$ . The condenser-coil combination,  $C_2L_1$  is not absolutely necessary, but was found to eliminate a low frequency "hash" present in the output when the bias was adjusted nearly to the point of plate current cut-off. In addition, it serves to "peak" the amplifier at about 500 cycles. The coil is the primary of an output transformer with about half the turns removed.

The resistor network across the "B" supply is used to obtain the necessary bias for Class-C operation. The center resistor,  $R_2$ , is variable, the arm being connected to the cathode through a 15,000-ohm resistor,  $R_4$ . In this way, the cathode can be made quite positive with respect to ground. Thus, the grid may be placed at a negative potential with respect to the cathode, variable from nearly Class-A to Class-C conditions.

In operation a signal is tuned in and the bias control adjusted to the point where all background noise drops out. The strength of the signal will decrease but slightly, although a change in tone will usually be noted.

It has been found that a certain minimum difference must exist between the strength of the desired signal and the strength of the background noise level to assure satisfactory operation. Thus, the usefulness of the device will be somewhat limited. The extent of this limitation will depend on the receiver, the location, frequency band use, and upon the amateur himself. Whereas the DX man, listening to weak or fading signals, might find the gadget of little value, the traffic man having schedules with several stations consistently loud or R8 or R9 at his QRA might find his work made much easier and hence the amplifier quite valuable.

Incidentally, the milliammeter in the plate circuit may be used as a means of comparing signal strength. Although of little value on weak signals, it may be used to compare any signals sufficiently loud to permit satisfactory operation of the Class-C amplifier as a background noise reducer.

—Forrest A. Bartlett, W9FYK/6

## A Method of Measuring Frequency Drift

RADIO amateurs having a piano can measure the frequency drift of their transmitters by the following method. Allow the station monitor to warm up for an hour or so. Then turn on trans-



mitter oscillator and quickly adjust the monitor until the beat note heard is middle C (261.6). Leave the transmitter oscillator and the monitor running, and after ten minutes listen to the beat note and identify it on your piano. It will perhaps be F or some other note above middle C. Repeat

## Automatic Tone Control

THE utility of a tone control for cutting off high audio-frequency noises in amateur receivers is generally recognized. The type of tone control customarily used is that which attenuates

FREQUENCIES (V.P.S.) OF ALL NOTES ON THE PIANO, BASED ON THE 1925 STANDARD PITCH (A<sub>49</sub> = 440)

Note								
A	27.50							
A#-Bb	29.13							
B	30.86							
C	32.70	65.40	130.80	261.60	523.20	1046.40	2092.80	4185.60
C#-Db	34.64	69.28	138.56	277.12	554.24	1108.48	2216.96	
D	36.70	73.40	146.80	293.60	587.20	1174.40	2348.80	
D#-Eb	38.89	77.78	155.56	311.12	622.24	1244.48	2488.96	
E	41.20	82.40	164.80	329.60	659.20	1318.40	2636.80	
F	43.65	87.30	174.60	349.20	698.40	1396.80	2793.60	
F#-Gb	46.24	92.48	184.96	369.92	739.84	1479.68	2959.36	
G	48.99	97.98	195.96	391.92	783.84	1567.68	3135.36	
G#-Ab	51.91	103.82	207.64	415.28	830.56	1661.12	3322.24	
A	55.00	110.00	220.00	440.00	880.00	1760.00	3520.00	
A#-Bb	58.27	116.54	233.08	466.16	932.32	1864.64	3729.28	
B	61.73	123.46	246.92	493.84	987.68	1975.36	3950.72	

this process at ten-minute intervals until there is no more drift. Then the frequency of the final beat note minus 261.6 is the total frequency drift. The chart gives the frequencies of all the piano notes.

The following comment may be helpful. When first tuning the monitor be sure that it is set on the proper side of zero-beat; otherwise the pitch will go down instead of up. It is obvious that one may start with a high note instead of middle C and the frequency will drift downward. In fact this will be the best method in some cases. Windows and doors should be closed to prevent temperature changes that might affect the monitor. If a frequency doubler is monitored the actual oscillator drift will be one-half of the apparent drift. At W1FUB a calibrated Hartley-Dow 160-meter master oscillator is used when transmitting on 80, 40 and 20 meters, and the measured drift on 80 meters was found to be 1218 cycles during the first hour, after which the frequency varied slowly over about 30 cycles. Hence the maximum oscillator drift of this station is about 609 cycles and the total drift of the emitted signal is two, four or eight times 609 on 80, 40 or 20 meters.

If the piano has not been tuned recently, the accuracy of the results obtained will be only slightly impaired. The piano need not be in the operating room. One should have a fair so-called musical ear and considerable care should be used when identifying the notes, as it is easy to mistake a note for its octave.

—Alpha Learned, W1FUB

high frequencies only. Also useful under certain conditions, particularly in voice work, is a control attenuating the lower audio frequencies, leaving only the most useful center or "communication band" of frequencies in the output. Interference of the variety that can be cured in a.f. circuits is largely inversely proportional to signal

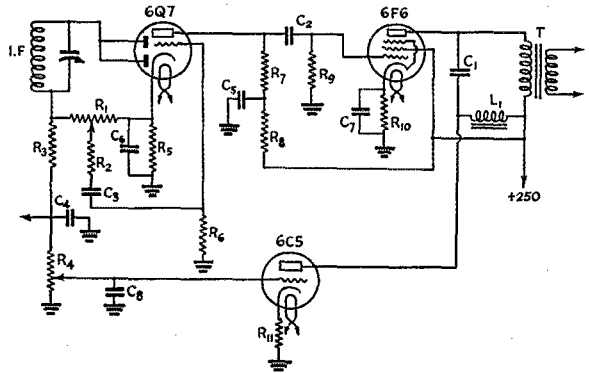

FIG. 2—AUTOMATIC TONE CONTROL CIRCUIT PROVIDING BOTH BASS AND TREBLE ATTENUATION

The arrow, shown between R<sub>3</sub> and R<sub>4</sub>, indicates a connection to the receiver a.v.c. line.

- R<sub>1</sub>—500,000-ohm volume control
- R<sub>2</sub>—50,000 ohms, ½ watt
- R<sub>3</sub>—2 megohms, ½ watt
- R<sub>4</sub>—2-megohm volume control
- R<sub>5</sub>—5000 ohms, ½ watt
- R<sub>6</sub>—1 megohm, ½ watt
- R<sub>7</sub>—250,000 ohms, ½ watt
- R<sub>8</sub>—10,000 ohms, ½ watt
- R<sub>9</sub>—500,000 ohms, ½ watt
- R<sub>10</sub>—650 ohms, 2 watt
- R<sub>11</sub>—250 ohms for 6C5; 1000 ohms for 56 or 76.
- C<sub>1</sub>—0.02-μfd., 400 volt rating (values between 0.01 and 0.05 μfd. should be tried)
- C<sub>2</sub>, C<sub>3</sub>, C<sub>4</sub>—0.05 μfd.
- C<sub>5</sub>—4 μfd. electrolytic, 400 volts
- C<sub>6</sub>, C<sub>7</sub>—10-μfd. electrolytic, 400 volt
- C<sub>8</sub>—0.01 μfd.
- L<sub>1</sub>—42-185 henry swinging choke (Thordarson T-7430)
- T—Pentode output transformer (tube load 7000 ohms)

strength; i.e., tone controls are usually needed only on weak signals, with correspondingly less need on strong signals.

An automatic tone control providing both bass and treble attenuation proportionately to signal strength is shown in Fig. 2. A 6C5 is used as the automatic tone control tube (either a 56 or 76 could be substituted, with a change in the cathode bias resistor as indicated). The grid of this tube is tied in to the a.v.c. circuit by means of a potentiometer enabling adjustment of operating levels; the a.v.c. voltage is used to increase the negative bias on the 6C5 grid in accordance with signal levels. At no signal the cathode bias alone is applied to the 6C5 grid, and its plate resistance is therefore only about 8000 ohms. Ten volts from the a.v.c. circuit increases this plate resistance to 30,000 ohms, with a rapid rise thereafter. Thus we have the automatic variable resistor for the automatic tone control.

This resistor is effectively in series with  $C_1$ , which is of such value that with minimum resistance in the 6C5 circuit a quite complete attenuation of the high frequencies will occur. On strong signals, on the other hand, the total effective resistance paralleling the pentode output load circuit will be so great as to have little effect.

So much for the treble control. The bass control is derived more or less as a by-product of the circuit just described. The 6C5 plate is fed through  $L_1$ . As far as audio frequencies are concerned this circuit is effectively in parallel with  $C_1$  on weak signals, and in series, with a resistance shunt, on strong signals. On weak signals the operation is as follows:  $C_1$  and  $L_1$  in parallel add impedances in such relationship as to establish a decreased load resistance at both low and high frequencies

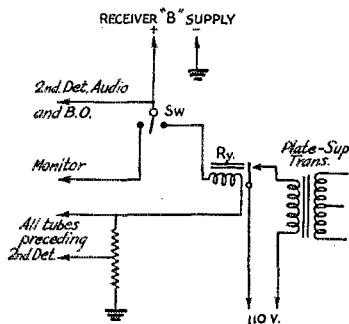

FIG. 3—ONE-OPERATION CONTROL OF RECEIVER, MONITOR AND TRANSMITTER PLATE SUPPLIES

The relay,  $R_y$ , is described in the text. The switch,  $Sw$ , is a s.p.d.t. toggle switch, mounted on the receiver panel.

(with the greatest decrease for high frequencies) in the pentode plate circuit. The medium frequencies are, however, scarcely attenuated. The pass band is thus effectively narrowed.

On strong signals two actions occur which render the entire circuit effectively inoperative. Increased resistance in the 6C5 plate circuit effectively places  $L_1$  and  $C_1$  in series across the load

circuit, rather than in parallel. Normally, the effect of this would be to boost the ends of the frequency range and attenuate the middle frequencies. However, the increased grid voltage on the 6C5 lowers the plate current, which at no signal is 15 ma. At the same time the inductance of  $L_1$  which at 15 ma. is only 42 henries, rises to maximum of 185 henries. Its impedance therefore becomes so great that its effect paralleling the load circuit resistance is negligible.

A surprising improvement in intelligibility and general noise level can be achieved through the proper operation of such a circuit as this, and the elimination of at least one manual control is a decided operating asset.

### Single Control of Transmitter, Receiver and Monitor

THE diagram of Fig. 3 shows a simple device used here to overcome one of the minor irritations of operating. It should appeal to lazy hams. The purpose is to make one switch on the receiver panel do three things: first, suspend the operation of the r.f. portion of the receiver, second, to put the monitor into operation and third to apply plate voltage to the whole transmitter. It is still

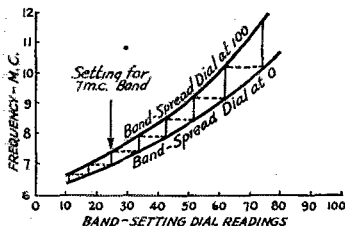

FIG. 4

necessary to key the transmitter, however. Besides performing these functions it will reduce the power consumption due to plate transformer and filter losses during listening periods, which with a large transmitter is no small item.

Referring to the diagram, the relay used is a Yaxley automatic power control, originally intended for use with a battery receiver to cut a B-eliminator on and off. The coil was rewound with No. 36 wire, which happened to be convenient, until the spool was full, and gave positive action on about 25 mils. The two sets of contacts are operated in parallel to increase the current-carrying capacity. The monitor, which is an integral part of the receiver, consists of an electron-coupled oscillator tuned to the signal frequency plus or minus the intermediate frequency, and loosely coupled to the second detector. This beats with the beat-frequency oscillator and puts an audible frequency through the audio system. The panel switch is a three-way toggle switch. Otherwise the diagram is self-explanatory.

—D. C. Ketcham, W4BBX

## Measuring Power With Wattmeter

THE following trick was given me by an unknown public service meter tester and I am passing it on for what value it may have.

To determine the number of watts used by any electrical device operating on the regular line, simply disconnect the other apparatus in the house on the same meter and apply the following formula to the data obtained from the watt-hour meter reading in the cellar.

$$\frac{\text{No. of turns} \times \text{"K"} \times 3600}{\text{time in seconds}} = \text{watts}$$

Simply count the number of turns of the aluminum damping disc in the meter for the length of time that it was observed. As for "K," this is the so-called "disc constant" and for Westinghouse meters it is  $\frac{1}{2}$  for 5 amp. meters,  $\frac{2}{3}$  for 10 amp.

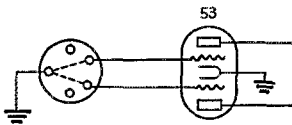

FIG. 5—SHIFTING THE CRYSTAL FROM ONE 53 SECTION TO THE OTHER FOR EITHER STRAIGHT-THROUGH OR DOUBLING

meters and 1 for the 15 amp. meters. In the other meters such as the General Electric, Duncan and Sangamo the constant is stamped on the disc. In the newer Sangamos the constant is not marked and follows the same rules as the Westinghouse.

—Maynard B. Chenoweth, W2GCC

## Calibrating the Receiver for General Coverage

ON finishing the construction of a receiver using the parallel-condenser method of band-spreading, with the band-spreading condenser across only a part of the coil on the higher frequency bands, the following method was used to lay out calibration curves for each set of coils. Such a calibration is useful in locating commercial and b.c. stations of known frequency, and also as a guide to band-spread tuning across the whole range without overlapping and without missing any frequencies.

First, with the band-spread dial at zero, tune across the whole range with the band-setting or tank condenser and get a series of readings from signals of known frequencies. Plot a curve for these. Then set the band-spread dial at 100, repeat this operation, and plot a second curve. Then the intersections of the two curves with a vertical line at any particular location (corresponding to any particular setting of tank condenser dial) will show the range of frequencies that can be covered by the band-spreading condenser for that particular setting of tank condenser. A typical curve is shown in Fig. 4.

To get the proper settings of the tank condenser

to cover the whole range on band spread, start with some particular setting—say the setting used for the ham band—and mark a vertical line. The point where it intersects upper curve will be highest frequency for this setting. Then follow across horizontally on this frequency to the lower curve and this will be the next setting of tank condenser

(set dial at next lower figure to give slight overlap). Continue this over the whole range, marking the tank condenser settings necessary to give complete coverage.

If a low-frequency oscillator is available, the calibration can be made in a very short time. Set oscillator by some b.c. station and get a series of calibration points from its harmonics.

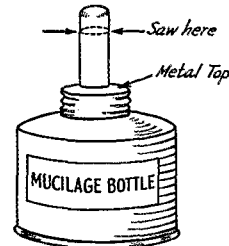

FIG. 6—ALCOHOL LAMP MADE FROM AN EMPTY MUCILAGE BOTTLE

For ordinary use, the approximate setting of band-spreading condenser in order to tune in a station of known frequency can be estimated near enough by noting the position of this frequency on the vertical line between the two curves, but if greater accuracy is wanted, a few more points could be obtained, for other settings of band-spreading dial, say for 20, 40, 60 and 80, and additional curves drawn through these points.

—H. S. Britt, W7CQE

## Switching 53 Sections

A NOTE from Vernon S. Parks, W9SZK, points out a simple way of getting around the necessity for neutralizing the second section of a 53 when working straight through in exciters using this type of tube as a crystal oscillator and doubler. The scheme is shown in Fig. 5. Since most crystals plug into five-prong sockets, the socket wiring is very easily arranged so that simply by selecting the right pair of socket holes the crystal can be connected to the grid of either 53 section. When working the transmitting on the crystal frequency, the section which is normally the crystal oscillator tube is jumped entirely, the second section taking its place.

## A Handy Alcohol Lamp from the Junk Box

THE drawing of Fig. 6 shows the essentials of an alcohol lamp which costs nothing to make, but which nevertheless is a handy gadget to have around the station. Kenneth Ashton, VE5BK, suggested the idea. He writes: "Procure an empty mucilage bottle, the type with the brush inside. Cut off three quarters of an inch of the cap, as indicated in the sketch, make a wick

(Continued on page 112)



# CALLS HEARD



**J2HJ, Kunio Shiba, 12 Akebonocho Hongo, Tokyo, Japan**

(28-mc. band during March)

wlavv wlcmx wlewf wlsw wlts w1sd w2tp w3air w3pc w5auj w5ehm w5ql w8atr w6iqy w6grx w6jn w6grl w6ith w6ann w6iju w6byb w6djj w6kjp w6fay w6cis w6csi w6eyc w6cxw w6jnr w6ejj w6nky w6tt w6bpd w6cuh w6awt w6khd w6eje w6fmy w6bam w6fni w6lbr w6dvt w6ewc w6gex w6kjj w6hb w6bnu w6mdn w6ioj w6ewj w6rh w6hit w6aix w6ldj w6exq w6bxn w6mov w7avy w7amx w7byw w7daa w7llu w7evv w7cht w9cjj w9fur w9haq w9pgs w9pri w9lf w9flh w9fla w9ped ea4ao d4arr on4ac vu2bl xu8ky lu9ax zsh oh5nc u3ag vk2ae vk2as vk2eo vk2ls vk2hs vk3bd vk3yp vk3cp vk3kx vk3jj vk3oc vk3kr vk4el vk4gk vk4bb vk5ac vk5ih vk5lj vk5wj vk6sa vk7jb

(14-mc. band during contest)

w1axa wlex wlibd w1ni w1ts w1si w1xw w2bvj w2cbo w2dc w2byp w2gjk w2fhi w2fvt w2gts w3cda w3eas w4cfd w4dhs w4ef w5asg w8ra w8kkq w9bpu w9baq w9cvt w9flh w9gdh w9haq w9jfb w9mks w9nb w9sie ve2ee ve4ro

(7-mc. band during contest)

w5cax w5exr w5dtj w5amo w8ica w8kky w9awp

(3.5-mc. band during contest)

w6ewd w6neq w6mndi w6mvq w6nfk

**Editor's Note.**—This list was compiled by J2HJ before his death and forwarded by his brother.

**W6KNH, Clyde Schoenfeld, Jr., 1548 31st Ave., San Francisco, Calif.**

(14-mc. band)

g2bh g2pl g2tr g2zq g5ps g5ms g5ni g5rh g5ss g5yh g5qy g6ax g6br g6gn g6hb g6if g6js g6kk g6my f3ir f3kh f5ne f8bs f8eo f8lg f8ps f8tq f8xh d3den d4arr d4biu d4osa d4gfw d4jpk d4npr d4sba ok1be ok1ro ok2ak ok2hx ok2ko ok2rn vp1wb vp2bx vp2tg vp5aa vp5ab ul1 ulr uler ulen u2as u2ne u3ag u3am u3qe u3qt u3vb u3vc u5ae pa0kh pa0ce pa0jmw pa0sd pa0un oh3np oh3ob oh3oi oh5nr ea3an ea4av ea7av oe1cm oe1er oe3fl on4ib on4my on4ru ly1j lylag ei5f ei8b pk1rl pk3lc splad splhj sm5uu sm6wb la4k spllb sc6cn y12bb hb9j oz3fl haf3d hjd2 ynl1aa yv4ac fb8ab y5idl yr5aa fo8aa

**11KS, Florence, Italy**

(14-mc. 'phone)

w1ajs w1ify w2bsd w3md w4up ve1ex vol1 yp9r hpl1a ti2av hi7g hi5x hi6o co2md co7ex vp6yb oa4r py2ej py2ba py1dk ex1aa lulex ct2av ea8aj ea8lv v12bg pk4dg

**G2SO, Malcolm Geddes, 44 Lindistarre Ave., Leigh-on-Sea, Essex, England**

(14-mc. band)

w6awt w6cam w6cuh w6cxa w6hcf w6hid w6lrc w7ayo j2lu xu3fk ox7esk py2qd px1e sv1ke

**W6NSV, Ed. Gessert, Westminster College, Salt Lake City, Utah**

(14-mc. c.w.)

vp9ad yv4bv g5vb d4sld i1tkm g6nj hh3l k6eau em2do k5am py2ap cm8jc ox7cc an2m g5ms cm7ai g2pl g5ya g8vy cm2rm vplwb k5ah z13ja cm2bg cm7ab z1fk k5ac cm8gf vp5ad

cp1aa oz3h vk2fy vk2da vk2dh vk4hr vk7ky z1lmx z1lby vk7ne vk5fm vk3kx z1ldv

(14-mc. 'phone)

yv4bv f8dr co2az co2sv co2hy co2ok ti2rc k6kpk ny2ae on4vk k6kdx

(28-mc. c.w.)

hk3bj cm8ai celaa

**W9RIZ, Jack Burns, Agra, Kans.**

(14-mc. band)

cc3el ei5f f8qq f8lg f8el f8wh f8ef fa8jo fb8ab g5ms g2bk g6ir g6gh g6nj j2lu j2jj hk3jb lu8ad oa4j ok2hx on4id on4fx pa6ce pagjmw py8az vk2xj vk2bq-fone vk2rj vk2bz vk3lx vk2uu vk3rj vk3cp vk2zj vk4le vk4us vk4rc vk4kx vk4ur vk5qr vp2tg z1lfe z1lao z1lii z1zpv z1zgr z1zjd z1zja ynl1aa

(28-mc. band)

w4deb w4ajy w6qg k6nvv

**WSMQU, Robert Lewis, Lawton, Mich.**

(14-mc. 'phone)

lu4bh hk1aa hk1s co2ws co6om co2ny co8yb co2ra ti2ro hi5x hi4f hi7g ny2ae k4ddh xelg xelhh g5ml g5ni g5ja g6xr py2ba

**W1OXDA, S.S. "Morrisey," Clifton Foss, Op.**

(Heard at 75° north latitude, Northeast Greenland)

(14-mc. 'phone)

co2ra co2se co2ws co7hf g5bj g5jo g5ni g5ml g5vl g6ax hi5x hi7g k6jlv k6kkt lalq lu8ap lu8ab ny2ae on4vk py2ba py2ek py2ej sm5ax ve1er ve1dc ve1dq ve1gr vol1 w1ccz w1chg w1ebo w1ged w1qv w2ber w2bsd w2btv w2cls w2ct w2cvi w2dh w2gzz w2hfs w2idq w2joa w2kr w2mj w2oj w3apo w3axt w3bbb w3bd w3crg w3eoz w3eyk w3gy w3ir w3ox w4ahl w4cxs w4dgo w5acf w5bdb w5dlc w5eel w5nt w6ayw w6ert w6fy w6ith w6lr w6rx w7va w8bfg w8bra w8dw w8mnj w8mpx w8obx w9bbu w9btv w9boo w9fj w9jlr w9med w9rgf w9rnx

**U9AL, V. Solomin, Sibirska, 7, Movosibirsk, Siberia, U.S.S.R.**

(14-mc. band, March 15th-April 7th)

wlied w1dx w1ts w1cmx w3tr w3dbv w3fyr w4cei w4cen w4bhr w4coo w4bbr w4eg w4tr w4cch w5ux w5avm w6hfb w6eja w6brq w7dx w7ayo w8jmp w8dce w8mfv w8lke w8ra w8kkq w8dod w9ruv w9gcs w9apf w9asu w9apu w9rme w9cpq w9kg w9uox w9gch w9rjp w9lbb w9ahh w9ggu w9tj w9afo cx1cg cx1cx cx2ak lu5an lu6ax lu6jb lu9ax lu9dv py1br py1di py2ap py2ko py2gd py2ea

**Bob Everard, Westgate House, Great Grandson, Sandy., Bedfordshire, England**

(14-mc. 'phones)

vk2ap vk2bw vk2bq vk2ud vk2nh vk2rd vk3lx k6kpk k6ljb k6cmc k6baz w5ahk w5dq w5bgt w5zs w5ebp w5ml w5sf w5dep w5egf w5exl w5dvk w5ith w5sj w6cls w6cgg w6mxw w6dky w6gal w6bay w6buy w6llu w6llq w6lrx w6byw w6ftu w6lr w6kso w7ao w7if w7md w7dnb w7qc w7va w7eaw w7eaw w7eas w7eot (w1, 2, 3, 4, 8 and 9 too numerous to list)

(Continued on page 112)



# Amateur Radio STATIONS



## VK4DO, Rockhampton, Queensland, Australia

A CONSISTENTLY low-power station is VK4DO, owned by Harold L. Hobler and located at Rockhampton, Queensland, Australia. Although the station has been in practically continuous operation since 1923, the input has never been more than 50 watts. VK4DO started out

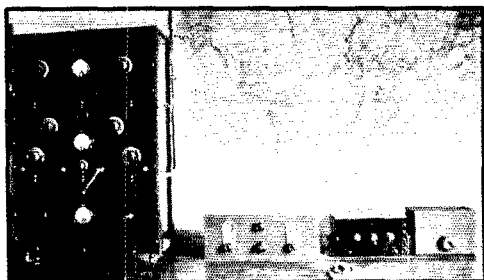

doing a little amateur broadcasting for the benefit of the few local BCL's at the time, using a 202. Nothing bigger than a 210 has been used since.

The panel-mounted transmitter shown in the photograph was built about a year ago, replacing a Hartley set which had given long service. This rig is crystal-controlled, using a 47 oscillator on 80, 46 doubler to 7 mc., 46 doubler to 14 mc. (when that band is used) and a 10 final. Most operation is on 40 and 20 meters. The antenna is a special affair used in conjunction with a counterpoise, and although only 7 feet high in the center because of conditions existing at the present location, gets as good signals into the U. S. as higher antennas used at former locations.

A battery-model Super Wasp, made up from a kit, is used for receiving. Beside the receiver in the photograph is a home-made "B" eliminator. On the extreme right is a Gross monitor.

Some 34 countries have been worked with VK4DO's 50 watts. This station was winner for Queensland in the Jewell Miles-Per-Watt Contest held in 1926, and was QSO the U. S. with only 140 volts on a 202!

## W6ETX, Los Angeles, Calif.

FIRST on the air in 1928 with c.w. on 40 meters, W6ETX as now operated is chiefly on the various amateur 'phone bands. In the operation of the station its owner, Earle C. Ward, is given a great deal of aid by the XYL, formerly W6CTZ. Although the photograph gives no inkling of it, the station is located in a garage, which has been transformed into a real ham shack by putting varnished panels on the walls and installing a wood floor.

The transmitter, occupying the frame at the right, uses a 53 crystal-oscillator-doubler, 45 first buffer, carbon-plate 10 as the second buffer, and a carbon-plate 211C in the final. The last buffer and final stage are link coupled. The speech amplifier uses three 53's in cascade, working into a pair of 45's which serve as drivers for Class-B 10's. Resistance coupling is used up to the grids of the 45's. The microphone is a double-button carbon job. There are five power supplies, with mercury-vapor rectifiers and oil-filled condensers throughout. The transmitter can be operated on all bands from 160 meters down to ten, doubling in the final on the latter band.

Two transmitting antennas, both Zepps, are used. One, cut for 7 mc., runs north and south, while the other, cut for 3.5 mc., runs east and west. The antenna poles are arranged in diamond form, one being 50 feet high and the other three about 33 feet. Separate antennas are available

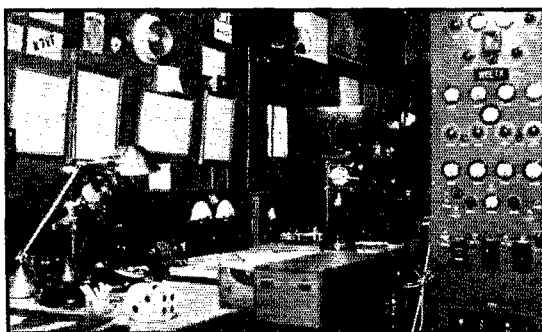

for reception; a vertical half-wave for ten meters and a horizontal about 150 feet long.

(Continued on page 88)

# ● I. A. R. U. NEWS ●

Devoted to the interests and activities of the

## INTERNATIONAL AMATEUR RADIO UNION

Headquarters Society: THE AMERICAN RADIO RELAY LEAGUE, West Hartford, Conn.

### MEMBER SOCIETIES

American Radio Relay League  
Associazione Radiotecnica Italiana  
Canadian Section A.R.R.L.  
Ceskoslovenski Amatéri Vysilac  
Deutscher Amateur Sende-und-Empfangs  
Dienst  
Experimenterende Danske Radioamatører  
Irish Radio Transmitters Society  
日本アマチュア無線聯盟  
Liga Colombiana de Radio Aficionados

Liga Mexicana de Radio Experimentadores  
Nederlandsche Vereniging voor Internationaal Radioamateurisme  
Nederlandsch-Indische Vereniging voor Internationaal Radioamateurisme  
New Zealand Association of Radio Transmitters  
Norsk Radio Relæ Liga  
Oesterreichischer Versuchssenderverband  
Polski Związek Krotkofalowców  
Radio Club Venezolano

Radio Society of Great Britain  
Rede dos Emissores Portugueses  
Reseau Belge  
Reseau des Emetteurs Français  
South African Radio Relay League  
Suomen Radioamatöörlitto r.y.  
Sveriges Sandareamatörer  
Unión de Radioemisores Españoles  
Union Schweiz Kurzwellen Amateure  
Wireless Institute of Australia

Conducted by Byron Goodman

### SV:

Perhaps in none of the European countries is as little known of the amateur transmitting situation as in Greece. Like Italy, the government does not license amateurs. Unlike Italy, however, it is less energetic in their suppression. Consequently, the few amateurs who are now, after these many years, first putting Greece on the amateur map, operate only more or less under cover.

W9PPD, who has recently toured Greece and investigated the amateur situation there, supplies the details concerning which we have been wondering. There are five stations on the air: SV1KE (who has worked a great deal in the past few months), SV1AZ, SV1NK, SV1RX and SV1SM. All operate on 14 mc., with the exception of SV1SM who uses 7-mc. 'phone.

SX3A is a government-owned Marine experimental station. It uses a Marconi tube in a T.N.T. circuit with from 250 to 500 watts input, and anything from d.c. to 500-cycle or r.a.c. plate supply. A long-wave antenna is used, harmonic-operated. Wavelengths between 15 and 90 meters are used; the operator works hams on 20.

At the present time an organization is in process of formation, to be called the G.R.R.L. There are at present about ten prospective members—Greece's entire amateur-interested population!

None of the SV stations are c.c.; they prefer to use 59 e.c. Receivers range from 3-tube regenerative to American-made ham superhets. Receiving conditions on 14 mc. are very good from 1 A.M. to 5 A.M. (one hour ahead of G.T.), the W's rolling in from R6 to R9. All the active Greek hams speak English—SV1KE speaks five languages fluently—so you don't need to be bashful.

### Necrology:

Two internationally-known figures in the radio world met death in recent months.

In April there occurred the death of Lieut.-Colonel Egon Casimir Krulisz, of Poland. In addition to a long and distinguished record in military radio, he was the founder and first president of



TWO CALLS EVERYONE WILL RECOGNIZE  
Left, Captain S. W. Thorpe, Z5IAH; right, G. A. Shoyer, Z5IH.

the original Polish Amateur Transmitters' Society. As chairman again in 1933, and as a member of the Board of the P.Z.K., he further served amateur radio. His many writings constitute a valuable technical heritage. He was decorated with the Order of "Polonia Restituta" and the "Golden Merit Cross," for services rendered in the Army and in civil life.

In August there occurred the death of Dr. Pierre Corret, famed French radio pioneer. He was particularly known for his organizational work in connection with the *Radio-Club de France* and the *Société des Amis de la T.S.F.* His



Gordon Kempton, VK2CI, and his pet Australian arboreal marsupial (koala, or native bear, to you!)

early pioneering in technical radio fields was outstanding. He was instrumental in the organization of, and participated in a committee sponsoring, early amateur trans-atlantic tests. He presided at the dinner in 1924 from which the I.A.R.U. initially sprang. His services to all the radio world will occupy a notable place in history's pages.

— . . . —

**General:**

Back writing this column again for one month while W1JPE (ex-W6CAL) is experiencing W7-VE5 hospitality, is W1CBD . . . . Comes now Bill Atkins, W9TJ, who asserts that he holds the 9th District WAC record, having hooked them all in 90 minutes back on March 30th last . . . . First South American to WAC on 'phone is Antonio Restrepo, HK1Z, of Cali, Colombia . . . . Look for some improvement in the Colombian licensing situation soon, by the way . . . . ZELJM is providing quite a few DX 'phone contacts these days . . . . If you want a relatively easy new country, W's, VP8B, operated by Thomas Hennah at Port Stanley in the Falkland Islands, is now on 14 mc. consistently . . . . Still another good one is HS4T on 14,450 kc. with a 500-cycle note . . . . W1FUY gives the QRA as Yishkat, Bangkok, Siam . . . . Another Italian undercover station is I1RRA . . . . And now to the autumn listing of foreign QSL Bureaus . . . .

— . . . —

**QSL:**

The latest revised list of QSL Bureaus of the world:

- Algeria: See France.
- Argentina: Radio Club del Argenina, Rividavi 2170, Buenos Aires.

- Australia: W.I.A. Federal QSL Bureau, George W. Luxon, VK5RX, 8 Brook St., Mitcham, South Australia.
- Austria: O.V.S.V., Willy Blaschek, Bahngasse 29, Klosterneuberg.
- Azores: See Portugal.
- Belgium: Baron Bonaert de la Roche, Château de Marchiennes, Harvengt near Mons.
- Bolivia: H. E. J. Smith, c/o Standard Oil Co. of Bolivia, La Paz.
- Brazil: L.A.B.R.E., Caixa Postal 26, São Paulo.
- British West India: Alfred E. Redman, "Elsing," Middle Road, Devonshire, Bermuda.
- Canada: A.R.R.L., West Hartford, Conn., U. S. A.
- Canal Zone: John J. Carr, 78th Pursuit Squadron, Albrook Field.
- Ceylon: A. M. Rahim, "Rillington," Wellawatte, Colombo.
- Chile: Luis M. Desmaris, Casilla 761, Santiago de Chile.
- China: I.A.R.A.C., Box 685, Shanghai.
- Colombia: L.C.R.A., Apartado 330, Bogota.
- Cuba: Adolfo Dominguez, Jr., CM2AD, Milagros 37, Vibora, Habana.
- Czechoslovakia: C.A.V., Post Box 69, Praha I.
- Denmark: E.D.R., Post Box 79, Copenhagen K.
- Dominican Republic: H. H. Gosling, Calle Cesar Nicolas Penson, Ciudad Trujillo.
- Egypt: F. H. Pettitt, Catholio Club, Mustapha Barracks, Alexandria.
- England: R.S.G.B., 53 Victoria St., London, S.W. 1.
- Estonia: V. Suigusaar, Hove t. r., Pernau.
- Finland: S.R.A.L., Pohjola, Box 42, Helsinki.
- France: R.E.F., 6 square de la Dordogne, Paris 17<sup>e</sup>.

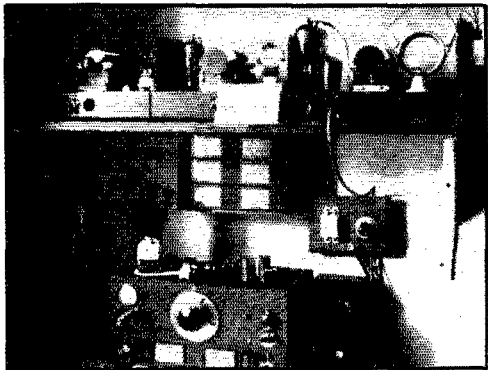

HJ3AJH-HK3JB, operated by Joseph Bond, ex-TL3LA, and Kenneth G. Kaiser, at Barranquilla

- Germany: D.A.S.D., Schweinfurthstr. 78, Berlin-Dahlem.
- Greece: c/o A.R.R.L., West Hartford, Conn., U. S. A.
- Guam: Foster D. Brunton, 62 Santa Cruz St., Agana.
- Haiti: J. D. Poindexter, Pan-American Airways, Port-au-Prince.
- Hong Kong: H.A.R.T.S., Box 651.
- Hungary: National Union of Hungarian Short-Wave Amateurs, VIII, Matvas-ter 6, Budapest.
- India: B. M. Tanna, Iamail College, Jageshwari, Bombay.
- Iraq: L. A. C. Lewis, No. 1 A.C.C., R.A.F., Hinaidi, Baghdad.
- Irish Free State: W. Howard Coombs, EI6J, 23 South William St., Dublin.
- Italy: c/o A.R.R.L., West Hartford, Conn.
- Jamaica: Cyril M. Lyons, 2-B North St., Kingston.
- Japan: J.A.R.L., P. O. Box 377, Tokyo.
- Java: Th. F. Leyzers (vis), Van Heutz Boulevard 2, Batavia, Centrum.
- Jugoslavia: Stephen Liebermann, Meduluceva 9, Zagreb.
- Kenya: Radio Society of East Africa, Box 380, Nairobi.
- Latvia: A. Karklin, 2 Lenca dz. 8, Riga.
- Lithuania: L.R.M., Post Box 100, Kaunas.
- Luxembourg: J. Wolff, 67 Avenue du Bois.

(Continued on page 110)



# OPERATING NEWS



Conducted by the Communications Department

F. E. Handy, Communications Manager

E. L. Battey, Asst. Communications Manager

**O**CTOBER, and fall weather is with us again. Cool nights. Little static or none at all. Swell sigs rolling in from near and far! The operating season is on. With the coming of fall both the number of station activities and the results recorded always turn up sharply from the summer low. There hardly seemed to be any let down this summer. An unusual number of requests reached us from hams wanting to know how to get in on A.R.R.L. doings. O.R.S. and O.P.S. appointments are in new demand. Many ask a place in the system of A.R.R.L. Trunk Lines that covers the nation. We predict that it will be a great year in every branch of ham activity.

There will be the usual full schedule of things going on in amateur radio circles in which you will want to take part. All require and develop resourcefulness and proficiency at the same time we have a good time operating. W-VE hams are cordially invited to take part in the VK-ZL contest each week-end this month. All amateurs should look up NAA and NPG on their receivers and try their hand at the A.R.R.L. Navy Day Receiving Competition on October 27th. In November comes one of the biggest things of the whole year—the "SS"! Special new plans will make A.R.R.L.'s 7th Annual Sweepstakes a more fascinating and productive test of stations and ability than ever, with an easy system of recording exchanges as you go along. It's to be a two week-end activity. Set aside November 14th-15th 21st-22nd for the best fun yet. We'll tell you all about it next month. On December 11th get set for another A.R.R.L. Copying Bee.

If you're a ham who builds stuff to operate you will be on the air regularly all season and you will want to be in on all important operating projects in every group, not just such "specials" as are announced above and from time to time. In that case we remind you that Official Relay Station appointment or Official 'Phone Station appointment (for voice stations) is open to you, as to every other A.R.R.L. member. Application blanks and information will be sent on request, and appointments are made by the elected S.C.M. of your territory.

Take part in all phases of your A.R.R.L. organization. Get into this amateur game wherever your inclination and experience makes you best fitted, to get all that's coming to you, not only in the

way of bulletins and practical helps and enjoyment, but that you may find yourself rated as a "doer" with standing among your fellows, not just one of those hams who look on from afar. It's all right to start as a tinkerer. Almost every ham did! The haphazard operator is given a higher rating by his fellows as he improves. The point is, "Don't stay still; be up and doing." Get appointed and make your station known. Make and take suggestions. Develop your operating. You know, in this life, one gets back in proportion to what he puts in. We're all in amateur radio and like the swimmer on the beach must muster up courage to jump in all over to get the benefits that amateur organization offers. There's O.R.S. or O.P.S. appointment—not to mention the invitation of the N.C.R. and A.A.R.S. Organized amateur radio needs you. You need organized amateur radio. Drop a line to A.R.R.L. or your S.C.M. today.

## WEIGHTED CREDIT

"Weighted credit" is indicated in rules for several A.R.R.L. activities. Take, for example, the one-year Milwaukee Radio Amateurs Club-A.R.R.L. 56-mc. ACHIEVEMENT AWARD. The rules in January QST show: (1) For the number of weekly reports to A.R.R.L. on five-meter work—50%; (2) for the summary of DX contacts (one point per each 100 miles)—50%. All reports submitted count for work through December 31, 1936.

Someone asks just how an accounting is made for various factors under "weighted credits." We are glad to explain. We recollect that in last year's 28-mc. contest which ran through '35 that the order of standing of the winners was importantly affected by the "weighting" or evaluation of each factor in the contest with just the importance that we stated was attached to that factor. Competitors should consider all the factors and not work to lead in one factor alone. Our contest winners determine the best all-round man on all factors included in the rules.

As an illustration, the 56-mc. M.A.R.C.-A.R.R.L. AWARD rules will show the judging procedure for all activities with weighted credits: (1) The man with the highest number of weekly reports rates the full 50% credit for that part of the standing. The man with the second high num-



ber of weekly reports gets part of "50%." If he had 20 reports at weekly intervals, and the highest man had 25 weekly reports, the judges would assign him 20/25ths of 50% or 40% on this factor. Each man's rating is compared in turn with the high man to give him an actual figure of merit. The man with reports at Hq. for only 12 weeks will rate only 12/25ths of 50% or 24% on this factor. How poor or how good those reports are makes no difference in determining this factor; that is taken care of in the other contest rules. (2) Next the points for all DX reported and substantiated are set down for all contestants. The man with the highest number of DX points, regardless of the actual number, is given the whole 50% for this factor. All other men are given percentage ratings that compare with this 50% in proportion as their points compare with the record total. Next the percentages given each man for factor one and factor two are added. If the same man leads in both the number of reports, and the communication (miles) factor, this man of course gets 100%, but as more often happens the man who is way ahead on one factor may have overlooked another so that the man who has put in some good substantial work on every count will be the winner.

In the "annual" 28-mc. Contest (See Nov. '35, Dec. '35 and Jan. '36 *QST's*) there is (1) 50% credit for scored points for DX QSO's; (2) 25% credit for description of equipment and development-research work; (3) 25% credit for the number of weekly reports to A.R.R.L. Don't forget to submit something on all three factors if you wish credit for all three. If you have a nice DX list but forget to give your line-up and tell what you built and tested . . . or are way down on the number of weeks you reported, you are seriously jeopardizing your chance to lead.

Similarly there are "weighted credits" in the O.R.S. and O.P.S. all-season competitions announced in this department right in this issue.

If, as an O.R.S. you handle traffic and head the B.P.L. every month but neglect the quarterly fraternizing and station testing you may not win . . . or if you are a 100% consistent party leader and not there with much in your traffic reports, it may cost you an award next spring.

O.P.S. should watch four factors: experimentation and construction, 50; general QSO's and DX, 20; rating in three quarterly station tests, 20; station log and records, 10. Take part in the activities most in your line—and don't pass up any bets by overlooking any factors given any mention or credit by the rules.

—F. E. H.

W1IP wonders how many hams have kept complete records of their station operation. His records for ten years' operation show that he has made 14,416 contacts with 2904 different stations during 6366.5 hours of actual operation, not counting time spent just listening. About 1¾ hours of actual transmitter operation per day over the ten-year period.

## Oct. '36 to May '37 O.P.S. Competition

### O.B.P. Chapters Offer Cup Trophy

THREE bronze medallion watch charm awards will be given by A.R.R.L. with calls inscribed to the three O.P.S. winners. In addition, the St. Louis and Kansas City O.B.P. Chapters offer a cup trophy to the leading participant. O.B.P. makes this offer in an effort to place stimulus where it will benefit all amateur radio without regard to 'phone or telegraph. After a study of awards being offered in other fields and needs for additional incentives in the advancement of all of amateur radio, they determined on a cup trophy in this O.P.S. competition. New men joining O.P.S. ranks up to March 1 are welcome to take part. Rules are as follows:

1. The competition shall be judged on an examination of amateur work performed between October 16, 1936 and May 15, 1937. In the case of new O.P.S., their work between the date of appointment and the end of the contest will be considered.
2. Experimental and constructional factors shall count 50%.
3. Operating results shall count another 50%, the standing in three quarterly activities (contact record) counting 20, the station log and records receiving consideration for another 10, the consideration of general QSO's and DX submitted (exclusive of parties) as another 20.



4. Photograph, concise report of experimental work and conclusions submitted, and ingenuity in use of parts and equipment shall be examined and evaluated in judging (2) above. The excellence of arrangement and adjustment, appearance,—the engineering ability and conclusions that result in good performance without regard to size, power or elaboration, shall be weighted by the judges in giving credits under (2).

5. In connection with (3) a short written summary of the work in Oct.-Jan.-April parties, and log (for inspection and immediate return) and separate summary of nr. QSO's and DX for each frequency band worked, and the station's input, and equipment will be considered and evaluated on a fair basis for all contestants.

6. Decision of an award committee of A.R.R.L. staff members shall be accepted as final.

7. Entries must be submitted to reach Headquarters on or before June 1, 1937, to count for the awards.

### OBSERVERS' HONOR ROLL

#### Cairo Commercial Occupancy Survey For August 1936

6000-8000 kcs.

W0EFK	DE2420/R	DE2255/N	DE3069/H
W. R. Faries	W2HAY	W9WKO	DE3102/H
W8NQ	W80OW	DE2800/N	P. R. Randolph
W4ACC	D3DBN	DE2881/O	L. L. Simmons
W2CSH			

4000-4500 kcs.

W0EFK	W9WKO
-------	-------

The Schooner *Wander Bird*, KMUP, is scheduled to leave Morocco, September 5th, sailing around the Horn. Calling frequency is 6210 kc., working frequency 6230 kc. W3QP has a schedule with her for various times throughout September.

The article by Mr. A. David Middleton, W9WFFV, wins C.D. article contest prize this month. Each month we print the most interesting and valuable article received marked "for the C.D. contest." Contributions may be on any phase of amateur operating or communication activity (DX, phone, traffic, rag-chewing, clubs, fraternalism, etc.) which adds constructively to amateur organization work. Prize winners may select a 1936 *Handbook*, six logs, six message files, six pad blanks, or equivalent credit toward other A.R.R.L. supplies. Send your contribution today!

—F. E. H.

## "CQ SS"

By A. David Middleton,\* W9WFFV  
(ex-W4CA-W8UC)

THE 1935 Sweepstakes was the greatest ever staged. Many records were made and a few broken. *BUT*—think what those scores might have been had more stations been on in those "hard-to-get" sections! In the 1935 tests, Mississippi, Western Florida and the Philippines were not represented in the official scoring. New Mexico was not represented by a *bona fide* New Mexican ham, as it took a *visitor* to the state to get into the contest and provide contacts for the boys. Nevada was just barely in the SS, as the one scoring station entered the SS at 4:20 p.m. of the last day; I know, for W4CA-9 was his first SS QSO. Hawaii and Alaska had only one score each. Oh, sure—there were plenty other stations on in the various sections, and many took active SS part. But, where are their scores?

It is not a question of time, of station equipment input or of anything except interest.

The writer spent some time in New Mexico and while there visited many amateurs. Some of these stations had low power and the operators complained bitterly that "nobody would answer them." It was pointed out that in every SS in the past, "NM" stations had been scarce, and that if they would operate just a little in the coming tests they would get plenty of calls. And if you think that isn't correct, just ask W6FDE, who won the New Mexico award. He got more answers than he could handle after he stuck an "NM" onto his sine. The same would be true of any of the smaller sections. It has been true each year. It takes nothing but the time to get on. An hour a day will produce wonders for even the lowest powered station in many of the sections.

It is not a question of continuous operation in making the SS a success for you. Only a few fellows can do this. The majority of the scores are made with systematic operation in whatever time is available.

Some may question the interest for everybody in such a contest. But if you are in need of a few states for a W.A.S., or if you are a beginning ham and need practice, or if you are just a plain old hit-or-miss ham—Boy! you'll get a thrill every minute, if you will only TRY.

Each year suggestions are printed in *QST* which should help an operator get the most out of his time. Many of the ideas are followed to the great benefit of those who use them. But, one of the greatest handicaps to any man engaged in trying to get a score (and a thrill) is the lack of attention of some of the boys they work. Even dyed-in-the-wool SSers are given to this habit. Hi. If you don't think so, try operating portable in a section foreign to your call and see what a time you have beating it into some heads that your address is NOT that in the call book. Why is this so? Simply because these boys are expecting to hear one thing and, when something entirely different hits their cans, they just don't get it—at least for a long time!

A few pointers cannot be repeated too often, such as—use of break-in operation; the placing of your Section abbreviation at the end of every sine; judicious listening following a CQ SS; and attentiveness after a station is contacted. Both your time and the other feller's is valuable. Don't waste it!

\* Box 496, Rifle, Colo.

The next SS is not far off. It's a big time—to be enjoyed to the fullest extent possible. Co-operation by more stations—participation by more fellows in the scarcer sections (the SS is even more incentive to them)—and general reporting by all hands will make the 1936 SS even greater than the last one. And who knows—maybe YOU will work all the sections and earn the plaudits of the entire gang of SSers! And you will deserve it, too, just for trying!

## Seventh A.R.R.L. Sweepstakes Contest

Scheduled for week-ends of November  
14th-15th and 21st-22nd

Get ready for the 1936 "SS." This year the contest will take place within two consecutive 33-hour week-ends, only 40 hours' contest operating time being permitted out of the total 66 hours. New easy-style contest exchanges will replace former message exchanges. Complete details in November *QST*. Certificate awards will be made both to the C.W. leader and the Phone leader in each Section and in each club, with a special Gavel Trophy to the winning club. HQ's will provide convenient record sheets for keeping score as you go along (although advance entry is not required). Send a QSL card or radiogram for your log sheet NOW and be all set for the opening gun!

## All-New England Birthday Party, October 10th-11th

Open to All N. E. Amateurs

Percy C. Noble, W1BVR, New England Division Director, announces an all-New England QSO Party to start the new season!

**Date:** Saturday, October 10th, 3:00 p.m., EST, to Sunday, October 11th, 10:00 p.m. EST.

**Eligible:** All New England amateurs (whether League members or not).

**Frequencies:** Any, or all, amateur bands.

**Call:** "CQ BP" (birthday party).

**To be exchanged:** *Date of your birth* (month, day, year), and *county and state* in which your station is located.

**Scoring:** Five points each contact (10 points for 56-mc. contacts). Multiply sum of points by number of counties worked. Information must be exchanged *both ways* before any points may be counted.

**Report:** Send report to the S.C.M. of your Section within 5 days of close of party. S.C.M.'s will combine reports and mail to W1BVR. Give following information:

- (1) List of stations worked (with their counties, states and birth dates).
- (2) Frequency band used for each contact.
- (3) Sum of points; multiply by number of counties worked; total score.

All reported scores will be published in *QST*.

## Brief

While tuning over the 3.5-mc. band, K7DEV, Nome, Alaska, heard an unidentified station sending this information by voice: "If anyone in Nome hears this please phone Mirow Air Service to come to Teller immediately as there is a man here in need of medical attention." This was repeated several times. K7DEV called the Air Service and the doctor. Going back to his set he managed to contact the unknown station, which turned out to be the new government radio-telephone station just being installed. Contact was maintained until the plane and doctor arrived at Teller.

## Amateurs Help in Florida Hurricane

ONCE again amateurs were called upon to furnish emergency communication during the almost inevitable annual Florida hurricane. This year activities centered around W4KB at Valparaiso, which city was in the heart of the storm area. The story of just what took place at W4KB (manned by the owner, James T. Long and his wife) is best told in "Jimmie's" own words:

"We started working W4UW (Pensacola) at 8:50 a.m., July 30th, then all along through the day; we got weather dope, etc. At 5:20 p.m. we started working W4BGO. At 6:10 we got weather reports from W4BKD in Marianna. At 10:05 p.m. we started contacts with WM6 at the Valparaiso Airport; prior to this Mr. Johnson, WM6 operator, and Captain Arnold, officer in charge at the Airport, had been coming down here giving us barometer readings, wind velocity, etc., which we would pass along to W4BGO at Ft. Barrancas (just outside Pensacola). The Weather Bureau decided about 10:30 or 11:00 p.m. that they were going to have the real storm down in Pensacola and that we were going to have just a nice little blow here. The OW and I decided we had better get a little shut-eye, as there was just a little breeze blowing, about 50 or 55 miles per. We took a little nap.

"A little after 2:00 a.m., July 31st, we came to the conclusion the WX Bureau was probably wrong as the breeze was now blowing at about 75 or 80 per and the house would shiver now and then as if it were cold. We got in contact with W4BGO and WM6 and exchanged barometer readings; we were soon informed by the WX Bureau that there was a hurricane going on right in our little town of Valparaiso. From then on we kept regular schedules with W4BGO until late afternoon. We handled messages of all kinds; those concerning perishable goods; yards of press; and many of the 'I am well. Hope you are too' type. We handled them to Birmingham so fast we didn't even get them written down. We handled messages from people here who had friends and relatives in Birmingham. We would give them to W4AUP (Bessemer, Ala.) and while the parties waited he would deliver by telephone, and they would hear the reply come right back through the loud speaker. And Red Cross traffic; I guess we handled at least 50 for them alone; some of them very important. The Red Cross representative, Mr. Eaton, would send his messages over the mike to Headquarters in Pensacola; then we would stand by and he would get his reply and orders. Much traffic was also handled for various public utilities. We reported one ship missing from here, and a Cuban fishing vessel that had run aground, to the Coast Guard in Pensacola, and they took immediate action. When the missing boat was found we had the Coast Guard cutter notified. We must have handled two or three hundred messages. Many were handled as conversations; for instance, WX conditions and barometer readings.

"We have a letter of commendation from F. W. Kone-mann, Captain, 321st F. A. Dist. G, in Fort Barrancas, saying we helped the prevention of injuries to the personnel here in the C.C.C. Camp. The Universal people made a newsreel of us in action."

W4KB used 3.9-mc. 'phone entirely, Mrs. KB spelling the OM at the mike. W4MS, Western Florida S.C.M., writes, "Throughout the storm James Long, W4KB, kept his 4-mc. 'phone going and kept in touch with the outside. Mrs. W4KB and the junior operators were right in there working, and the KB's turned in one of the finest jobs possible. Few hams realize that Jimmie is a shut-in as a result of an airplane crash and has been confined to his bed for several years. W4KB furnished all information needed to his community and cannot be praised too highly. We don't know the names of the two C.C.C. boys who kept the antenna system going for W4KB, but they really deserve credit. W4KB says that W4BGO deserves as much credit as he does, as he was on the receiving end!"

W4BGO at Fort Barrancas was manned by Benton Letson (W4BGO), W4AJP and W4BZM. They maintained schedules for W4BGO, delivering traffic and handling WX reports and messages for Red Cross Headquarters at Pensacola. When regular power facilities were cut off an emergency power supply was used, consisting of a small gasoline driven

motor-generator set. The major emergency work was carried out between W4BGO and W4KB.

Other amateurs were on the job doing everything possible to assist. W4ECT at Panama City, on 3.9- and 1.75-mc. 'phone, gave the necessary reports from his locality. W4BJF assisted W4ECT. W4UW had his 3.9-mc. 'phone on the air at the Pensacola airport and made several contacts with



JAMES T. LONG, W4KB, AND FAMILY

W4KB; he was on the job all through the emergency period. W4ECN, Pensacola, kept a constant watch throughout the storm, having the good fortune to have power most of the time; he passed along weather data as it was sent by W4KB. In the Naval Reserve Unit at Pensacola, N4QU, N4ASY, N4HQ, N4SZ and N4MS made all Reserve equipment ready for emergency operation. N4QU also had equipment in readiness on the ham bands. W4MS was on 7 mc. for the Gulf Coast Storm Net. At midnight (July 30th) the power lines went out, putting him off the air. At 5:30 a.m. (31st) W4MS lost his 65-foot lattice mast. While the storm was still raging he rigged temporary antennas. When the power finally returned he handled Red Cross traffic with W4ECT and private traffic for individuals. Other stations aiding in the storm work were W4DIC, W4DVE, W4AXP, W4EAD, W4QK, W4DHC, W4COG and W4DAO.

In Alabama, members of the Mobile Amateur Radio Club manned the club station, W4CIQ, throughout the entire night of the storm, working with W4KB, gathering information and handling messages for anxious individuals, meteorologists, newspapers, utilities and wire services. The operators at W4CIQ were Thompson McRae, M. J. McDermott, Aaron Bush (W4FB), Thomas Lynch and James Robinson. At Birmingham, W4DGS, Alabama S.C.M., aided in relaying traffic from the storm area.

Emergency communication work is not new to Florida and Alabama amateurs—they have many times been called to service and have always come through with flying colors. To all who aided in this most recent emergency, congratulations, and well done!

## DX Notes

A QSL card received by W1BB from FA8BG indicates that the first U.S.A.-Africa QSO on 1.75 mc. was between FA8BG and W1BB, rather than W2UK and FA8BG as previously reported in these columns. . . . W3QP recently worked a new British district—G8CT; upon being asked about the district the G explained that licensing started only a week or so before the QSO; his QTH: G. James, Blackwood, Monmouthshire, England. . . . W1ELR reports J5CC coming through on 14,270 kc. between 8:00 and 10:00 a.m., EST; he worked him at 9:00 a.m., August 18th. . . . W8NGZ worked ZC6CN (T5-r.a.c., outside

14-mc. band), Palestine, on August 12th, 2340. . . . W8CPT (Clarendon, Texas) finds DX better than it's been for years in his area; he has recently worked CX, CE, PY, VP1, K6, ZS and J—and all with a 78 Tri-tet oscillator—12A final with 8 watts input; he says a beam antenna helps. . . . VE3AU worked FB8AB (14,360 kc., 579X) at 7:20 a.m., EST, August 25th—FB8AB said he'd QSL only if VE3AU sent him a few Jubilee stamps! Has the QSL problem become that bad? HI. . . . Speaking of DX QRM, on August 12th W3CWE heard SP1DE calling CQ DJDC; while waiting for



VU2CQ, BOMBAY, INDIA

The signals from this station have been logged in many a North American shack. Both 'phone and c.w. are used. Input to the final stage is about ten watts.

him to finish, FT4AB, W7FFA, PY8AG and VK4YL all came on calling CQ on the same frequency, then G2ZY came on calling a VU2—if he had six transmitters, W3CWE thinks he could WAC in about five seconds! . . .

LA5N is looking for W/VE contacts on 14 mc., especially on Wednesday mornings from 4:00 to 7:00 Norwegian Time; he operates on 14,080 and 14,100 kc., c.c., and is looking for a W/VE QSO for WAC. . . . If any hams in New Mexico, North Dakota, South Dakota, Wyoming or Nevada hear G5QY, please give him a call—he needs those states to complete W5A. . . . W1WV's total of different G's worked is now 552. . . . W8OSL (ex-W8DVS), president of the "210 DX Club," worked YV5AP on August 1st for his 100th country. . . . 8OSL reports all continents coming through regularly on 14 mc. between 7:00 and 10:30 a.m. EDST. . . . W8BSF worked ZP2AC for country number 90 using '10's. . . . W9PNE (Westville, Ill.) expresses his DX observations: "PY's seem to prefer the low-frequency end of 14 mc., while VK's seem more plentiful on the high end. The J's have been coming in FB about 7:00 to 8:30 a.m. CST; they are at the high-frequency end. Europeans are coming in from 2:00 or 3:00 p.m. on until 11:00 p.m. or midnight. Worked J2LU for WAC on August 18th; hooked P21AL at 7:50 p.m." . . .

OS1BR, Hedjaz, is one of the newest reported. WIBUX worked him on August 9th at about 1:25 p.m.; frequency about 14,430 kc., T8; QTH was given as Karana, near Jeddah, Hedjaz. . . . G6KQ worked OS1BR at 0040 GT on August 6th; frequency was 7150 kc. and 1BR reported having 1-kw. input and directive antennas to U.S.A. . . . W3BFD, Norfolk, Va., is another to work OS1BR; during this QSO, 1BR said to be on the lookout for OS1BW, who was also on the air in Hedjaz. . . . On August 22d at 1400 GT W9UBB, Loraine, N. Dak., worked J8CA, Chosen, on 14 mc. . . . W9UBB also reports K7EVM in Ft. Yukon coming through about 0400 GT on 14,300 kc.; he was worked on August 25th. . . . W5FBQ (Dallas, Texas) makes his 30 watts talk. On the morning of August 23th he worked these stations in 1, 2, 3 order: VP5AD, J2CG, VK3TU, VK2VQ, VK5LY—all 14 mc.; J2CG was about 14,270 kc., T9X. . . .

W6CUH's monthly DX letter (dated August 25th) contains its usual amount of "meat": "During the past month conditions followed the predicted DX cycle quite closely.

It should be pointed out, however, that conditions usually begin to drop off several days before the minimum dates that were published in QST, said dates being supposed to approximate the middle of the dead period. I also should have made clear that the DX maximum does not fall exactly half way between the minimums, but occurs usually about 2½ weeks after the minimum; the DX builds up more slowly than it drops off, taking some 2½ weeks to come to a maximum and requiring only 1½ weeks or less to hit bottom.

"I'd like to post a couple of new 'Olympic' records for working Europe from the West Coast: 11 QSO's in one hour, and 37 QSO's in 6¼ hours during the evening of August 15th. Many new Europeans are putting through strong and consistent signals. Among the rarer ones (all worked): LA2B T9 14,290, LA3C T9 14,430, LA3V T9 14,100, 11ZZ T8 14,420, 11LD T8 14,415, OK1KL T9 14,105, OK2PN T9 14,075, YR5AR T9 14,095, YR5OR T7 13,995, SP1CS T9 14,080, SP1DC T9 14,410, OZ2B T9 14,300, OZ3D T9 14,280, OZ3G T9 14,260, OZ5G T9 14,390. Best time is around 0530 GT. FT4AG (T8 14,050) was worked twice for country number 121 about 0600 GT. The mornings are getting better with Africans all over the band S7 to S9 1300 to 1600 GT. Europe also beginning to show up around 1600 to 1700 GT—looks like a great fall DX season for 14 mc. It is now possible to work Africa about 29 days out of each month from here; will be glad to QSP traffic going that way, also to any other part of the world."

-----

## All Season O.R.S. Contest

### W4NC Trophy Cup Award and Three A.R.R.L. Watch-Charms Awards To Be Made

Three bronze medallion watch-charm awards (see cut with O.P.S. announcement) will be given by A.R.R.L. with the winners' calls and appropriate inscription to the three O.R.S. leaders in a 7-month contest. New men joining the O.R.S. ranks as well as those now holding appointment are welcome to take part. One charm goes to the winner in each, the Pacific, the Atlantic, and the Central area (regions into which the country has been divided for competition purposes). Every O.R.S., in every one of the 69 Sections of the field organization, will be taking part.

With this announcement we show for the first time the graceful and striking W4NC Trophy which is now on display at A.R.R.L. Headquarters awaiting the high man in this '36-'37 O.R.S. Competition for operating supremacy. The W4NC Trophy has been donated by the Winston-Salem Amateur Radio Club, and is a sun-gold cup— inches high! It's a beauty, and if you're not in there putting out a signal to win it get in touch with your S.C.M. today and find out how. It's a high privilege to be an O.R.S. and be "in the class" that will have its operating activity count toward such an unusual prize as this W4NC Trophy.

Here are the rules:

1. The contest shall be judged on the records and evidence substantiating the communication work of Official Relay Station appointees between October 16, 1936 and May 15, 1937. New O.R.S., appointed on or before January 15, 1937, also will be eligible for the above awards (based on a 7-month traffic average and two instead of three quarterly activities).

2. The traffic totals for the seven monthly reports for the period of the contest shall count 50%. Rubber stamp traffic is "out" as per Handbook definition of same as well as such

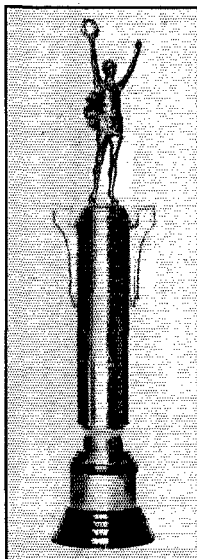

contest messages as used in past Sweepstakes, A.A.R.S., etc. competitions. *Good* originations count!

3. The contact record of the station in three \* quarterly tests, as determined by the O.R.S. Party (Bulletin) rules, shall count 50% (\* two, for new O.R.S. enrolled too late for October activities but on or before Jan. 15, 1937).

4. Message files and the station log must be kept available for call and check at any time after the conclusion of the competition, as may be necessary in substantiating (2) and (3).

5. A brief description, summary, or outline of the sending and receiving equipment and control arrangement (preferably with a snapshot or QSL-card, though this is not required) must be submitted separate from any letter or other papers, and plainly marked **ORS CONTEST ENTRY**. This may be sent at any time between now and June 1, 1937—the earlier the better.

6. Monthly reports on (2) must be made on time via S.C.M.s and reports on (3) Oct.-Jan.-April quarterly doings must be sent within 10 days of such activities direct to Hq.

7. Decision of an award committee of A.R.R.L. staff members shall be accepted as final, and, as always, staff personnel are ineligible for awards.

Put in your best lies—and if you're not an O.R.S. by any chance, better QSO your S.C.M. and get lined up. It's going to be a great season.

(Operating News continued on page 116)

## BRASS POUNDERS' LEAGUE

(July 16th—August 15th)

Call	Orig.	Del.	Rel.	Extra Del.	Total
W6FDR	521	265	944	230	1960
W6KFC	20	35	481	—	536
W7DUE	11	31	484	—	526
W6LLW	15	24	372	102	513
W6LNW	36	295	174	—	505

### MORE-THAN-ONE-OPERATOR STATIONS

Call	Orig.	Del.	Rel.	Extra Del.	Total
W6OW	748	139	511	—	1396
KA1HR	182	36	244	—	1093
W6NI	292	309	—	—	601

These stations "make" the B.P.L. with totals of 500 or over. Many "rate" extra credit for one hundred or more deliveries. The following one-operator stations make the B.P.L. for delivering 100 or more messages; the number of deliveries is as follows: Deliveries count!

W6RU, 212	W7APS, 155	W5EGP, 125
W5BAM, 200	VE5DB, 152	W6GRA, 111
W5FOJ, 184	W1E0E, 139	W2GVZ, 110
VE5JS, 165	KALLC, 139	W9FRC, 109
W6ITH, 160	VE5KC, 137	W5M5N, 103
W6RJ, 156	W6EWC, 126	

### A.A.R.S. STATIONS

#### MORE-THAN-ONE-OPERATOR STATIONS

Call	Orig.	Del.	Rel.	Extra Del.	Total
W6LMI (W6GXM)	258	421	980	—	1659
W6LM (W3CXL)	47	59	407	—	513

A total of 500 or more, or just 100 or more deliveries will put you in line for a place in the B.P.L.

## ELECTION NOTICES

To all A.R.R.L. Members residing in the Sections listed below: (This list gives the Sections, closing date for receipt of nominating petitions for Section Manager, the name of the present incumbent and the date of expiration of his term of office.) This notice supersedes previous notices.

In cases where no valid nominating petitions have been received from A.R.R.L. members residing in the different Sections in response to our previous notices, the closing dates for receipt of nominating petitions are set ahead to the dates given herewith. In the absence of nominating petitions from Members of a Section, the incumbent continues to hold his official position and carry on the work of the Section subject, of course, to the filing of proper nominating petitions and the holding of an election by ballot or as may be necessary. Petitions must be in Hartford on or before noon of the dates specified.

Due to resignations in the Michigan, Ontario and San

Joaquin Valley Sections, nominating petitions are hereby solicited for the office of Section Communications Manager in these Sections, and the closing date for receipt of nominations at A.R.R.L. Headquarters is herewith specified as noon, Thursday, October 15, 1936.

Section	Closing Date	Present SCM	Present Term of Office Ends
Tennessee	Oct. 1, 1936	Merrill B. Parker, Jr.	Oct. 14, 1936
Michigan	Oct. 15, 1936	Kenneth F. Conroy (resigned)	
San Joaquin	Oct. 15, 1936	Vernon C. Edgar (resigned)	
Oklahoma	Oct. 15, 1936	Carter L. Simpson	Feb. 15, 1936
Philippines	Oct. 15, 1936	N. Thompson	Mar. 15, 1936
Hawaii	Oct. 15, 1936	Atlas O. Adams	Apr. 23, 1936
Iowa	Oct. 15, 1936	Phll D. Boardman	June 14, 1936
Indiana	Oct. 15, 1936	Arthur L. Braun	July 19, 1936
Ontario*	Oct. 15, 1936	(resigned)	
Arkansas	Dec. 1, 1936	Henry E. Vette	Dec. 15, 1936
Louisiana	Dec. 1, 1936	W. J. Wilkinson, Jr.	Dec. 15, 1936
Quebec*	Dec. 1, 1936	Stan Comach	Dec. 14, 1936
Ga.-S. C.-Cuba-I. of P.-P. R.-V. I.	Dec. 1, 1936	Bannle L. Stewart	Dec. 14, 1936
Colorado	Dec. 1, 1936	Glen Glasscock	Dec. 17, 1936
San Francisco	Jan. 5, 1937	Alan D. Whittaker, Jr.	Jan. 18, 1937

\* In Canadian Sections nominating petitions for Section Managers must be addressed to Canadian General Manager, Alex Reid, 169 Logan Ave., St. Lambert, Quebec. To be valid such petitions must be filed with him on or before the closing dates named.

1. You are hereby notified that an election for an A.R.R.L. Section Communications Manager for the next two year term of office is about to be held in each of these Sections in accordance with the provisions of By-Laws 5, 6, 7, and 8.

2. The elections will take place in the different Sections immediately after the closing date for receipt of nominating petitions as given opposite the different Sections. The Ballots mailed from Headquarters will list the names of all eligible candidates nominated for the position by A.R.R.L. members residing in the Sections concerned. Ballots will be mailed to members as of the closing dates specified above, for receipt of nominating petitions.

3. Nominating petitions from the Sections named are hereby solicited. Any A.R.R.L. members residing in any Section have the privilege of nominating any member of the League as candidate for Section Manager. The following form for nomination is suggested:

(Place and date)

Communications Manager, A.R.R.L.  
38 La Balle Road, West Hartford, Conn.  
We, the undersigned members of the A.R.R.L. residing in the.....Section of the.....Division hereby nominate.....as candidate for Section Communications Manager for this Section for the next two-year term of office.

(Five or more signatures of A.R.R.L. members are required.) The candidates and five or more signers must be League members in good standing or the petition will be thrown out as invalid. The complete name, address, and station call of the candidate should be included. All such petitions must be filed at the headquarters office of the League in West Hartford, Conn., by noon of the closing date given for receipt of nominating petitions. There is no limit to the number of petitions that may be filed, but no members shall sign more than one.

4. Members are urged to take initiative immediately, filing petitions for the officials for each Section listed above. This is your opportunity to put the man of your choice in office to carry on the work of the organization in your Section.

—P. B. Handy, Communications Manager

## ELECTION RESULTS

Valid petitions nominating a single candidate as Section Manager were filed in a number of Sections, as provided in our Constitution and By-Laws, electing the following officials, the term of office starting on the date given.

Eastern Florida	William C. Shelton, W4ASR	Aug. 15, 1936
Santa Clara Valley	Elbert Amaranates, 6FBW	Aug. 15, 1936
Nobleska	S. C. Wallace, W6FAM	Aug. 17, 1936
W. Massachusetts	William J. Barrett, W1JAH	Aug. 17, 1936
Kentucky	G. W. Mossbarger, W9AUH	Sept. 8, 1936

In the Western Pennsylvania Section of the Atlantic Division, Mr. Kendall Speer, Jr. W8QFO, Mr. L. B. Fabian W8GJM, and Mr. Henry Wickenhiser, W8KWA, were nominated. Mr. Speer received 117 votes, Mr. Fabian received 68 votes and Mr. Wickenhiser received 34 votes. Mr. Speer's term of office began July 10, 1936.

In the Illinois Section of the Central Division, Mr. L. John Huntoon, W9KJY, Mrs. Carrie Jones, W9LH, and Mr. John H. Smith, W9MIN, were nominated. Mr. Huntoon received 212 votes, Mrs. Jones received 123 votes and Mr. Smith received 77 votes. Mr. Huntoon's term of office began July 10, 1936.

In the Ohio Section of the Central Division, Mr. E. H. Gibbs, W8AQ, Mr. Percy E. Buchtel, W8FTY, and Mr. John W. Lamey, W8BDG, were nominated. Mr. Gibbs received 199 votes, Mr. Buchtel received 87 votes and Mr. Lamey received 75 votes. Mr. Gibbs' term of office began August 17, 1936.

In the New Hampshire Section of the New England Division Mr. Carl B. Evans, W1BFT, and Mr. Homer H. Richardson, W1AXW, were nominated. Mr. Richardson withdrew prior to holding election so Mr. Evans was automatically elected. Mr. Evans' term of office began September 1, 1936.

In the Oregon Section of the North-western Division, Mr. Eugene E. Lovejoy, W7AJV, and Mr. D. L. McPherson, W7AFP, were nominated. Mr. Lovejoy received 59 votes and Mr. McPherson received 44 votes. Mr. Lovejoy's term of office began September 3, 1936.

# STATION ACTIVITIES

## CANADA

### MARITIME DIVISION

**MARITIME**—SCM, A. M. Crowell, VE1DQ—IN provides the local gang with an opportunity to work an expedition. HH would like a few reports on his bi-weekly O.B.S. EY while not QRL service work schedules W1AJ. IB got his license endorsed for unlimited 'phone. Summer-side news via FR: CO is still looking for an Asian for W.A.C. AP is busy on 3.5 mc. most of the time, BD has the 3.5-mc. Class "B" 'phone going places. AC is rebuilding the new rig for higher power. CW using flea power gets out very well. AF is getting the 3.9-mc. 'phone rig ready for fall. BE is putting in some work on a 'phone rig. JG is doing some rebuilding while not busy at CHGS. FR is pounding out on 3.5 and 7 mc. with flea power. GB has his 3.5-mc. 'phone going. HX was away for the summer—at Camp Borden, Ont. IA is working a low-powered battery rig on 7 and 14 mc. IV at summer school worked some from JL. Moncton News via EV: CX turned temporary B.C.L. for two weeks after vacation. IJ has nice 7-mc. rig which gets out well on 3.5 mc. Congratulations to GI on the arrival of the new jr. op. EV is back on 3.5-mc. 'phone after swell visit to the P.E.I. gang on vacation. FF has non-radiating antenna (what pattern?). DC reports great time on vacation to W2's and W3's. IK is QRL work. GS is on again. DI has remote control working very FB. IL and EL have annexed new receivers. The Halifax gang regret the departure of JM to the VE3 Section,—for not more than one term—we hope. Look for new VE3 on 14,360 and 7180 kcs. Recent visitors to Halifax gang were VOIP and VE1JK; the latter, together with KJ and JM, had some nice "car to car" 56-mc. chats. AW has been taking a whirl at 14-mc. 'phone again with new type antenna. ET left for another trip on the "Lady Nelson." EK was heard on 14 mc. chasing (and catching) DX. EF attended the N. S. Guides Meet at Lake William while on his vacation. GL is working on the new band-switching rig. EX schedules VE2DR every Wed. night; reports competition at last: VE1JZ. HI!

Traffic: VE1IN 390 HH 7 EX 5 EY-IB 4.

### ONTARIO DIVISION

**ONTARIO**—SCM, John Perdue, VE3QK—R.M.'s: 3TM, 3WX, 3QK, 3DU, 3GT, 3SG, 3GG and 3MB. P.A.M.: 3NX. AE has a JOB! and is trying to promote Sunday a.m. VE3 QSO Parties. AEM has new super-band-frequency-break-in-high efficiency-switching rig and is waiting to leap on the traffic bandwagon. LT is active with 53, 2A3 rig. CG still threatens O.R.S. ranks and reports ACL having new six-foot steel panel job. ACJ complains that DX is expensive proposition; his first twelve countries costing him no less than \$2.25 each thru blown condensers, tubes, etc.! He operates CZ4Z on "90 meters" way up at Sioux Lookout for O.F.B. using a Hartley '52 with 2000 volts on it! NX is ready to open O.F.N. activity after visiting CNE. MB had his usual quota of visitors and also did a lil calling himself during the U.S. Coastguard "Jackson," NRLV's trip thru his canal. MB is new R.M., incidentally. SS comes thru with his usual FB letter and reports a blown RK-23 put him back in the '45 class; he intends to gather news from the Peninsula gang for us. FB! It was a boy! at 3YW . . . add, a cute lil gal at 3NC. Congrats. Gosh! AJN represents Preston and is a brand-new one. DU promoted a sports program for the London gang which, of course, was a swell-egg affair . . . among those present: NI, CB, AJQ, GY (R.I.), FD, all with XYL in tow plus GC, QC, GE, EI and YL cousin YJ—a good time was had by all. ADH and AJG are newcomers in Welland. ZQ, who also holds forth at CZ4A at Adair Tower in the northland for O.F.B., sends forth apologies to the many schedules he had to QRT when suddenly called for duty at forestry work. XS has new RK-20. UO has O.R.S. aspirations. Wireless Association of Ontario have the following officers for the coming year: pres., ADO; vice-pres., YY; publicity manager, XJ; secy-treas., AEX. MA is active again in Ottawa. AIU is keeping things alive in Goderich . . . ditto OT, in Port Robinson. TI and UH at Niagara Falls work 56 mc. with OT, AEX, MJ, KM, XX and TW, the latter representing Ham Radio at the recent Henley Regatta. FLASH! DJ is O.R.S. again and will be helping no end this fall. AAZ is on 7 mc. when not helping ACC with flea-power 'phone. GG reports plenty of

black flies and lots of ideas for fall traffic season. AU got up early August 15th, 7 a.m. to be exact, and started to work DX with unusual success; at four continents he reached for a report card to tell us about it! At exactly 7:30 a.m. he was W.A.C.! Nice work, Don. AJE is London's latest addition. CUL, gang, 73.

Traffic: VE5AU 36 QB 14 NC-DU 3 GT 2 MB 1.

### QUEBEC DIVISION

**QUEBEC**—SCM, Stan Comach, VE2EE—56-mc. activity grows apace; we understand that CO, CX and AP are having lots of fun on that band. HH changed his location. DF is building to an RK-20. EP is quite interested in traffic. KY is doing fine work with a single 50. II cycled down thru Vermont and visited 1GXF, 1BJP, 1JZF and 1DQK. JZ is active with traffic. EA gets out swell on 3.9-mc. 'phone. HE visited JZ and IL. IR had his Skyriver lined up. GO claims he is first VE2 to work a G8. HG is now W.B.E. EU is rebuilding. DA is operating 'phone on 3.9 mc. JK claims the record of having worked 8 YL's in one day: VE2DA, W9TSV, W9UOH, VE2EK, W1FTJ, W3FXZ, W1FRO and SPIYL. JJ is on 14-mc. 'phone. DR is keeping schedules with Sweden. EC is trying to improve an already FB rig. DD is building with a pair of 6L6 tubes. LV is back on with a rack job. LJ has not finished his new job yet. IN is saving up for a pair of 35T's. LU won a scholarship. Congrats. ER has had key klix. JD is giving code practice on 3.5 mc. BF is on 7 mc. with a '10 final. KM is building a 6L6 oscillator. LC is new O.R.S. HI is operating in the country with a motor genny. BO built a classy rack for his receiving equipment. AX is seriously considering an NC-100. LO motored out to Winnipeg on vacation. IY converted his t.r.f. into a Super-Gainer; works swell. II is still building his super-het. CR can't decide what receiver to build or buy. IE is getting out well on all bands. HM is active on 14-mc. 'phone. IL has an FB signal on 14 mc. LQ has been pounding in on 14 mc. The C.G.M. was down to Moncton at the Maritime Convention and had a swell time. DU was also present at same gathering. DQ is doing very well with low power. The Committee of the M.A.R.C. wish to remind the gang that the Club is again in session. Thanks to KM, JZ, DF and all the others who very kindly sent in scandal! A bit more would fill a real column. The Section is in need of good operators for O.R.S. Any applicants? Doc Sheehan, VE2DG, is the new Route Manager for Quebec.

Traffic: VE2II 166 JZ 9 GO 6 JK 25 JJ 12 DR 24 BU 29 EC-EP 14 HH 6.

### VANALTA DIVISION

**ALBERTA**—SCM, Alfred D. Kettenbach, VE4LX—HM visited hams in Prince George and Vancouver. CY visited Edmonton, Hanna, Rockyford and Strathmore hams. BW has new-fangled antenna coupling. JJ has had spheroid crystal mike. AA has new crystal mike and 801's in final. OA at Veteran now has low-power 'phone. VS is new 3.9-mc. 'phone ham at Lethbridge. OJ is back on 'phone. RV lost one of his two grid mills. EOP had his tonsils removed, the better to send O.B.S. deo. DV has hefty wollop. HQ called CY's bet, but Sam won't ditch the doublet. GM has FB new pair of 66-foot lattice masts. SN visited Lethbridge, Kalispell and Bonners Ferry. GD called CQ to the fish in the Bow River—and hooked one. CT has double-button mike. ZD revamped his speech amplifier. GX visited Calgary and Edmonton hams. LA is busy with harvest. New calls in Edmonton: AEA, ADW, ADZ. LG brought back Eimac 50T from Spokane. EA has been contacting several VK 'phones since putting up vertical doublet. 14 mc.

Traffic: VE4LX 29 QK 5 EO 5 HM 3 GE 1.

**BRITISH COLUMBIA**—SCM, Don Vaughan-Smith, VE5EP—Greetings and salutations from the scene of the 1936 Official Vanalta Division Convention. When this gets to you, Convention 'Daze' will be over but the memory lingers on! Fall is the time to have the heap in ship-shape condition for traffic work, QRR, DX and what have you! Look out for coming A.R.R.L. activities that are both interesting and useful. Let's be ready for them. B.C.A.R.A. expects to have new RK-20 rig going soon; watch for them on 7 and 3.5 mc. Victoria Short Wave Club enjoyed cruise to Gulf Island. Okanagan Club reports steadily increasing membership and FB picnic with some of the W7 boys. Collingwood Club is enlarging the clubhouse. FG is back in harness and active as heck! HP breezed into town in time to

(Continued on page 104)

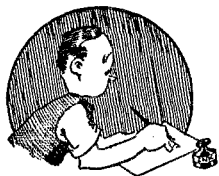

# CORRESPONDENCE

The Publishers of *QST* assume no responsibility for statements made herein by correspondents

## Modulated C.W. in 'Phone Bands

188 Linden Blvd, Brooklyn, N. Y.

Editor, *QST*:

There is great danger to the whole amateur radio game in the current c.w. vs. 'phone controversy due to the friction within our own ranks. It is a fact that the amateurs who use 'phone exclusively in the 3900- to 4000- and 14,150- to 14,250-ke. 'phone bands are in a minority as compared to the amateurs who use c.w. exclusively on the 80- and 20-meter bands—nevertheless, the former are a most vociferous minority.

I am neither a "c.w. man" nor a "phone man" in that sense of the word as I use both methods of communication. However, I may get more enjoyment from c.w. operation especially in connection with A.A.R.S. operations and traffic handling—but that is just a personal opinion. The use of A-3 emissions is increasing all the time, and, therefore, provision should be made for more frequencies for 'phone operation in the near future.

In view of the above and the fact that, at present, such additional 'phone channels can only be obtained at the expense of the existing c.w. frequency territories, I would like to submit the following suggestion as an aid in the solving of this very pressing problem:

That the present 75- and 20-meter 'phone bands be extended by an additional 50 to 100 ke. *provided* that tone-modulated c.w.—modulating frequency not to exceed 1000 cycles and the modulation to be less than, say, 75%—be permitted in the additional frequencies which may be opened to A-3 emissions.

Tone-modulated c.w. is being used extensively on the five-meter and other ultra-high-frequency bands without detriment to 'phone operation. The frequency channel taken up by a tone-modulated c.w. signal—although greater than a c.w. signal—is still about 30% of that occupied by the average amateur 'phone station. Tone-modulated c.w. could be used by 'phone stations for calling purposes, as is now done on the 56-mc. band, and it will also serve to keep the 'phone man in practice on his code speed. The equipment required for tone modulation of c.w. signals is very simple and can be easily incorporated in the speech amplifier, or grid modulation of the final stage can be used. Incidentally, tone-modulated c.w. should not be confused with i.c.w. operation or a transmitter using a plate supply which is not pure d.c. in accordance with the present F.C.C. regulations.

My reasons for the above suggestion are based on the premise that it is very difficult if not impracticable, at present, to receive c.w. signals within channels used by 'phone stations due to the heterodyne effects of many carriers beating with each other, etc., when the receiver is regenerating or the beat oscillator is in use. These conditions are eliminated to a great extent when the receiver is not regenerating or the beat oscillator is not used in the superheterodyne receivers as is the case in the reception of 'phone or tone-modulated c.w. signals. Also, since additional 'phone channels can only be provided at the expense of the present c.w. frequencies, it seems only fair and proper that means for reliable telegraphic communications on such additional frequencies as may be made available to 'phone operators be maintained by permitting the use of tone-modulated c.w. telegraphy.

I firmly believe that if more "c.w. men" will use 'phone and the "phone men" work on c.w. it will bring together these factions, overcome the internal jealousies which are causing dissension within our organization, and in general bring about a "united front" by all amateurs so that we cannot only keep our present rights and privileges but regain those which we have lost in the past.

—David Talley, W2PF

EDITOR'S NOTE.—Apart from "political" considerations: (1) It is hardly true that tone c.w. is used on u.h.f. bands "without detriment to 'phone operation." General experience is that the m.c.w. signal causes fully as much interference as the 'phone signal of equivalent stability and percentage modulation. It is only justified on the u.h.f. bands by the fact that the transmitters and receivers are not generally of sufficient stability to permit c.w. transmission with heterodyne reception. The m.c.w. signal consists of at least three frequency components, carrier and two sidebands; while the p.c.w. signal has only one, which may be considered as a single sideband. The three components of the m.c.w. signal produce three beat-notes with a 'phone carrier, while the p.c.w. signal produces only one beat-note with the 'phone carrier. In heterodyne c.w. reception, the local oscillator introduces another r.f. component to beat with the desired signal and the interfering 'phone carrier, but still leaves us with one less r.f. component to give beat products than is the case with m.c.w. and no local oscillator. (2) The equip-

ment required for m.c.w. transmission with proper modulation is practically the same as for voice modulation. The essential difference is that a tone generator of some sort is substituted for the microphone. (3) With a receiver of high selectivity, especially of the s.s. type, best discrimination against 'phone interference obtains when the desired signal is p.c.w. In fact, receivers of this type treat a m.c.w. signal as three separate c.w. signals, discriminating effectively against the sidebands when the receiver is tuned to the carrier. The interference created by 'phone carriers beating with each other and with the desired signal is not lessened by eliminating the local oscillator for reception of m.c.w. The only thing eliminated is the heterodyne products resulting from beating of the local oscillator against the undesired carriers. But, the three-frequency m.c.w. signal supplies a still-additional component to give further beat products, as previously described. (4) P.c.w. transmission is of itself equivalent to single-sideband transmission and possesses all the advantages of that technique. The trend is toward the parallel method in 'phone transmission—single sideband for voice—to bring these same advantages to 'phone communication. For the present, the best modern technique for c.w. telegraph is, unquestionably, pure c.w. transmission with high-selectivity reception. No complaint based on use of a receiver of ordinary selectivity can be justified, so far as technical considerations are concerned.

In general, technical considerations would lead to the conclusion that m.c.w. transmission would increase the interference by at least one-third while simultaneously reducing the transmitter efficiency by at least one-third, since one-third the emitted power would be in the tone sidebands which are sent along to the receiver to do the same job as the beat oscillator in c.w. reception.

## Get Your QSLs

La Paz, Bolivia

Editor, *QST*:

I recently received a long and most interesting letter from the W2 District QSL Manager, Mr. Henry Yahnel, with reference to this sad business of "Unclaimed QSL Cards." I was positively astonished to learn that our friend Mr. Yahnel has on hand some 10,000 cards, and this merely represents the Second District. One is therefore safe in assuming that there must be some 75,000 to 100,000 unclaimed QSL cards floating around in the files of the various A.R.R.L.-QSL Bureaus, and of these at least 50,000 will probably be from foreign DX stations that have been QSO with W stations.

I also understand that in many cases QSL Managers have used their personal funds in an endeavor to clear the files, writing to stations and informing them that many cards are on file for them and asking them to remit the necessary postage and envelope. . . .

It seems a great pity that more of the fellows do not make full use of the excellent and really inexpensive service that has been set up for them. Personally, I never send a QSL card direct unless the QSO is with a personal friend, consequently this letter may stand as a reminder that no W station with whom I have been in contact can expect to receive his card unless he gets in touch with his QSL Manager, and as fully 95% of the W stations contacted ask for "QSL?" and receive a reply in the affirmative, it is assumed that these stations are interested to get their cards from DX stations. How about it, fellows? The QSL Managers do their part as distributing centers, we DX stations take the trouble to send in our cards and most of our contacts are DX so why not send in your envelopes to your QSL Managers and get those same cards you constantly complain are never received?

Whilst on the subject of QSLs and DX stations the following procedure is suggested to any W station replying to a DX "CQ."

1. Use the "Three by One" system of replying, i.e., CP1AA CP1AA CP1AA de W9—CP1AA CP1AA CP1AA de W9—, etc. This especially applies when the replying

station desires to send traffic or something of more than ordinary interest to the DX station.

2. Terminate the call with the R Strength or, alternatively, CP1AA CP1AA CP1AA r6 de W9— etc.

3. Avoid giving your full QRA unless specifically requested.

4. Mention type and/or number of tubes in receiver also transmitter power as this information has more than mere academic interest to the foreigner.

5. Avoid going into long dissertations on non-relevant matters until the QSO has been thoroughly established as a regular "rag chew" by mutual agreement. (Nothing is more exasperating for a DX station than to have a fellow with an R2 signal sending lots of "dope" at 30 w.p.m. with receiving conditions poor to boot.)

6. Positively *do not* say "QSL?" unless you are prepared to collect same when it arrives at your QSL Bureau.

—H. E. J. Smith, CP1AA-ex-CT#BK

## The F.C.C. Seems to Think So, Too

4643 N. Capitol Ave., Indianapolis, Ind.

Editor, *QST*:

I am an s.w.l. who would like to chip in my two cents on this thing that Miss Irene Kahn spoke of in March *QST*. I have just finished fifty-five minutes of listening to a certain W9 in Minneapolis. This very witty gentleman is apparently practising his imitations with the idea of joining some amateur hour. The transmission ran like this:

"Hello CQ, hello you blawsted blighter, are you theah?" (this in a very bad cockney voice). He then switched to what he thinks is mountain dialect and called another ten-minute CQ, hardly able to keep from laughing at the funny (?) things he was doing. This procedure was continued in French, German, and Lord knows what else.

As I said, I am not an operator, but as yet an s.w.l. I realize that it is considered bad form by some for one of my standing to criticize a ham, but I feel, as do many of my ham friends, that this business of someone cluttering up the air with useless and meaningless tripe should not be allowed. I think it would be a darn good idea if the A.R.R.L. would investigate this matter.

—Wm. Bruce Cameron

## New Message Form

Sanford, Fla.

Editor, *QST*:

The change in the A.R.R.L. message form as announced in August *QST* is certainly FB, and is something I had been hoping for since my first shot at ham traffic in 1930. . . . I venture to say that this new form will become so popular in six months' time that the gang will have to strain a large hunk of *dura mater* to recall what the old form was like.

The allowance of the extra credit point for additional means or effort used in delivering a message is also very FB, as in most cases this extra effort makes up about 99.9% of the whole transaction. . . .

—C. J. Schaal

## For Shut-Ins

1709 Perry St., Davenport, Iowa

Editor, *QST*:

The World Shut-In League is desirous of contacting . . . physically handicapped radio amateurs and would appreciate any cooperation that amateurs throughout the country would give in the way of forwarding names and addresses of physically handicapped people.

—Victor F. Hampton, Managing Director,  
The World Shut-In League



# WHY?

Number thirty-two of a series

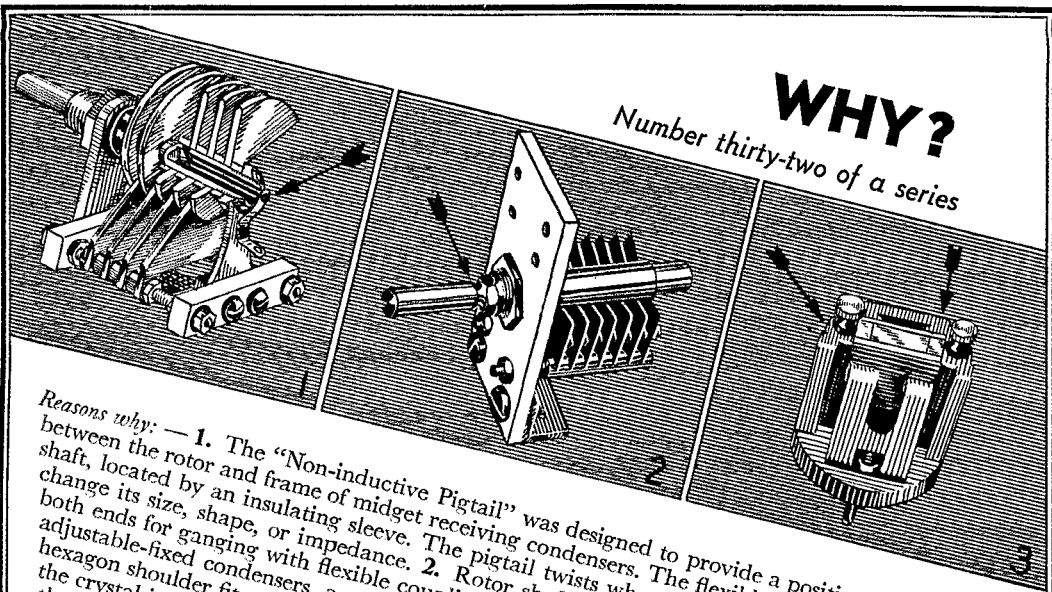

Reasons why: — 1. The "Non-inductive Pigtail" was designed to provide a positive electrical bond between the rotor and frame of midget receiving condensers. The flexible pigtail is inside the rotor shaft, located by an insulating sleeve. The pigtail twists when the rotor is turned, but it does not change its size, shape, or impedance. 2. Rotor shafts on the UM condensers have extensions on both ends for ganging with flexible couplings when used as tuning condensers. But when used as adjustable-fixed condensers, a groove (see arrow) makes it easy to cut the shaft off clean, and a hexagon shoulder fits a standard socket wrench for adjustment. 3. National crystal holders mount the crystal in a vertical position for free vibration. For resonator use, two ground glass bars space the plates to give the proper air gap (as illustrated). For transmitting, recesses in the sides of the holder take larger plates and the spring backs off to provide even pressure on the larger crystal.

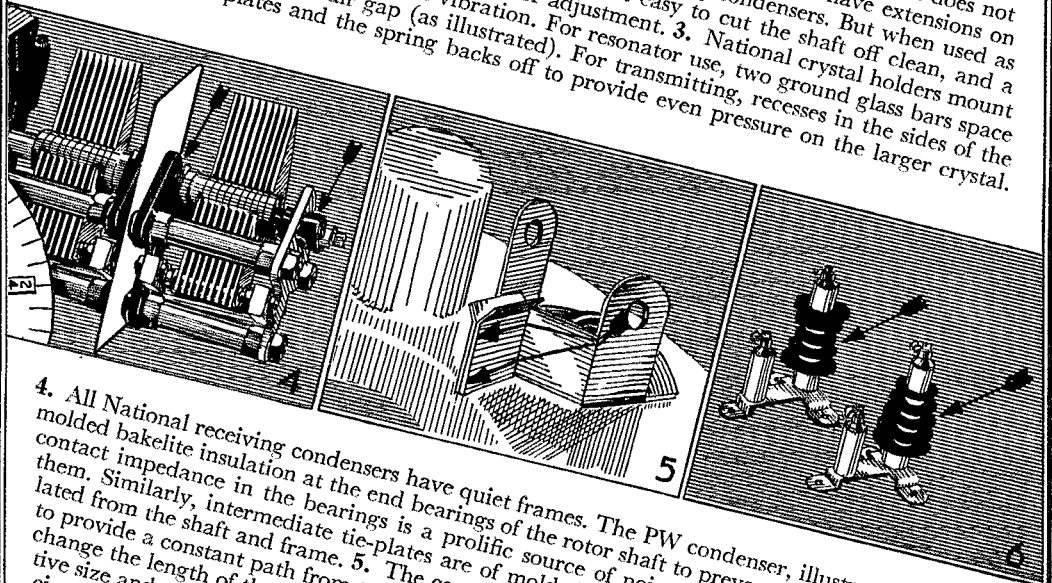

4. All National receiving condensers have quiet frames. The PW condenser, illustrated above, has molded bakelite insulation at the end bearings of the rotor shaft to prevent stray currents. Varying contact impedance in the bearings is a prolific source of noise when current is passing through them. Similarly, intermediate tie-plates are of molded bakelite, and rotors are individually insulated from the shaft and frame. 5. The constant impedance clip for acorn tube sockets is designed to provide a constant path from terminal to tube. Slight changes in the position of the tube do not change the length of the current path appreciably. 6. National transmitting chokes have the relative size and position of their windings chosen to give maximum choke action at amateur frequencies. Although either choke is universal, and can be used in all amateur bands, the R-152 has greatest impedance in the 160 meter band, while the greatest impedance of the R-154 is in the 40 meter band.

James Miller



# IS YOUR Line Voltage LOW?

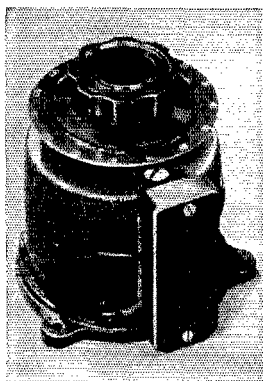

**I**F YOU live "at the end of the line" and have to call it a night when the tube filaments just won't come up to normal, and the plate voltage sags way off then you need a Variac.

The Variac is an auto-transformer furnishing continuously adjustable output voltages from zero to 135 volts when used on a 110-volt circuit. Connect a Variac between your line and the transmitter, and you can compensate for low line voltage at any time.

The Variac is fine too in the primary of the high-voltage transformer of your rectifier system. So used it gives high voltage control from zero.

The model illustrated, Type 200-CU, is rated at 900 watts, and is intended for behind-the-panel mounting, altho it can be used on the table as well. Its price is only \$14.50.

*Write for the new Variac Bulletin 53-Q for a complete description of all of the Variacs including two new models*

**GENERAL RADIO COMPANY**  
30 State Street                      Cambridge, Mass.

## A Medium-Power Transmitter

(Continued from page 17)

frequency. In some cases it has been found, however, that merely opening and closing the key without the transmitter operating at all will cause a click in a receiver in the same house. The phenomenon is similar to that observed when turning a lamp on or off, and is not likely to bother the neighbors. It can be eliminated by installing an r.f. filter right at the key contacts. Suitable r.f. filters are described in the *Handbook*.

### POWER OUTPUT

Tests with a lamp as a dummy load show power outputs of better than 150 watts on 7 and 14 mc. with the RK36 loaded to draw 160 ma. plate current. This is with the power supply already described. The excitation gives all the signs of being more than ample, so that with a 2000-volt supply it should be readily possible to get outputs between 200 and 250 watts without exceeding the tube ratings. On 28 mc. the measured output is about 100 watts, which was plenty for our purposes. If higher efficiency on this band is wanted, it might be secured either by putting in another exciter stage or perhaps by using a 14-mc. crystal. In our case, however, convenience in changing bands dictated the use of 7-mc. crystals for all work.

For grid-bias modulation, any of the speech amplifier combinations described in past *QST*'s or the *Handbook*, capable of giving a few watts of audio output, can be used. The general method of adjustment already has been described.<sup>3</sup>

## A Cheap and Efficient Vertical Antenna

(Continued from page 18)

in the background indicates the point at which the line leaves the shack through the baseboard of a second floor window.

This vertical antenna was raised in October 1935 and has successfully withstood all of the severe wind, sleet, and other elements for nearly a year without any signs of weakening. Apparently it will continue to give good service for a long time with safety. The small amount of BCL interference formerly caused by our rig has been materially reduced since this antenna has been in service. We are led to believe this reduction can be attributed to the matched impedance line as compared to the Zepp feeders previously used, because the location and the power remain the same as before.

It must be remembered that if this 66-foot radiator is to be used on 20 meters, some type of phasing device must be placed in the center of the radiator. This can very easily be made from a

# VARIABLE Crystal Frequency Control

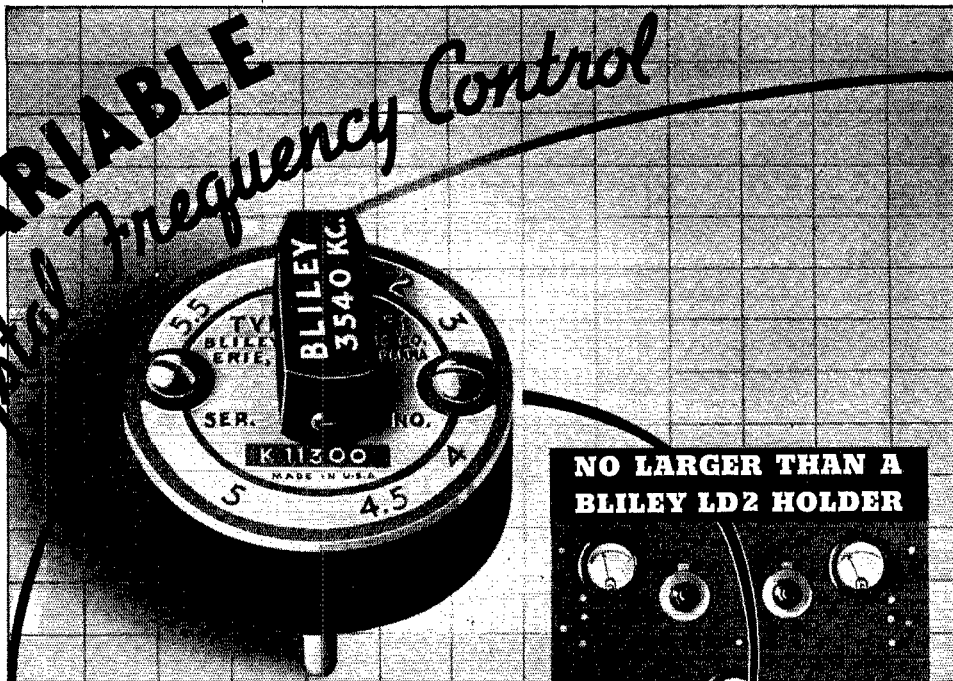

## BLILEY TYPE VF1 VARIABLE CRYSTAL UNIT

Think of the many times a few kilocycles shift in your frequency would have enabled you to dodge QRM, which absolutely ruined an otherwise perfect QSO. Now, with a Bliley VF 1 Variable Frequency Crystal Unit, you can easily shift your frequency. A mere twist of the control knob mounted on the holder will vary your frequency up to 6 KC. at the 80 meter fundamental, 12 KC. when doubling, and 24 KC. when quadrupling to 20 meters.

The VF 1 Unit contains a low drift crystal (under 4C./MC./°C.) and provides positive frequency control without appreciable loss of activity or frequency stability. Power output varies but 20% over the entire range. The holder, which is no larger than a Bliley LD2 Unit, plugs into a standard 5 prong tube socket. It may be mounted in any position and can be used to replace crystal units now in use.

The only circuit change recommended is a slightly higher C to L ratio crystal tank than customarily employed. With practically all transmitters, no change in tuning will be required over the entire adjustable range of the VF 1 Unit.

Price—VF 1 Unit—minimum frequency within 5KC. of specified...\$ 8.00

Price—VF 1 Unit—minimum frequency to exact specified.....\$10.00

**NO LARGER THAN A  
BLILEY LD2 HOLDER**

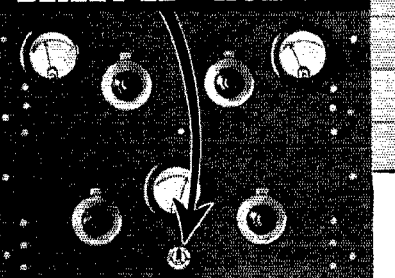

*Only* **BLILEY**  
*offers this complete  
crystal line*

Type VF 1—80 Meter Band  
Variable Frequency Unit - \$8.00

Type HF 2—High Frequency  
Unit, 14-15 Mc. - - - - \$6.50

Type LD 2—Low Drift Unit  
40—80—160 Meter Bands \$4.80

Type BC 3 X-cut Crystal Unit  
40—80 Meter Bands - - \$3.95

Single Signal Filters  
Holders Ovens  
Standard Frequency Crystals

General Communication Frequency  
Crystals between 28 Mc. and 20 Kc.

Watch for new Bliley Catalog  
about to be released.

# BLILEY CRYSTAL UNITS



## Centralab

### HANDY FIXED RESISTOR RACK

YOU asked for it — so we repeat the offer. The Rack is yours absolutely FREE with a

#### SPECIAL DEAL

consisting of 20 1½ watt 316 type and 20 ½ watt 310 type CENTRALAB RESISTORS.

The Rack is of heavy sheet metal and will give years of service. The R.M.A. Color Chart is in full colors.

Hang this CENTRALAB RACK on your wall and know at a glance just where they are, and what resistance values you have on hand.

Write or descriptive information today

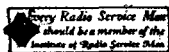

# Centralab

Milwaukee, Wis.

British Centralab, Ltd.  
Canterbury Rd., Kilburn  
London N.W.6, England

Centralab  
68-70 Rue Amelot  
Paris, France

## VOLUME CONTROLS FIXED RESISTORS

midget condenser and a small coil of such size that this tank will tune to the operating frequency. When this tank is connected into the middle of the radiator the two halves will be properly phased to give low angle radiation. It will be noted that with the tank cut into the antenna we have two half-wave vertical antennas stacked, one above the other. For 40-meter operation this tank can be either removed or shorted. On either hand, then, low-angle radiation can be had all around the compass, barring too many nearby objects that will affect the field pattern.

The pleasant part of this whole arrangement was that our total cost was just under ten dollars, exclusive of labor and most hams can arrange to get the necessary help from fellow addicts, just as we did.

A 3-inch gutter pipe had been used previously for a radiator and was supported on an ordinary quart milk bottle and held in place by eight guy wires secured to the roof by four large screweyes. This radiator was 33 feet high from the base insulator to the top. The guy wires seemed to have some effect on the field pattern, but the mast was easy to put up, low in cost, and is very strong. The gutter-pipe antenna was displaced when the self-supporting cedar mast was put up, because our average report jumped about two R's. It was also noted that more consistent contacts were possible, in all probability due to the low angle of radiation in all directions from the new antenna.

In conclusion we wish to give credit and thanks to the several sources of help and information that so materially aided us in building this antenna and its associated equipment: Professor Hartig, University of Minnesota; *Radio Engineering*, by F. E. Terman; Westinghouse Electric and Mfg. Co., Antenna Booklets; Chet Ofelt, W9BFC, Minneapolis; Fred Shidel, W9CIU, Minneapolis; Northern States Power Co., Minneapolis; Northwestern Bell Telephone Co., Minneapolis; Geo. Luxton of the *Minneapolis Star* (for pictures), and Neighboring BCL's.

## Multi-Tube Oscillators for the Ultra-High Frequencies

(Continued from page 25)

other side of the condenser. Adjustment of this condenser is obtained by rotating the threaded member. A knurled knob is provided for the purpose. Providing the adjustment at the bottom end of the circuit is a marked improvement, for here the radio-frequency potential is zero; this condition makes it safe to handle the circuit as well as completely frees it from body-capacity effects.

The multi-tube oscillator shown in Fig. 2 was tested for power output and efficiency with one to eight tubes. Fig. 7 shows the output and efficiency obtained as the number of oscillator units was varied. It is interesting to note that the



## Seaworthy! Burgess Batteries "Have Never Let Us Down"

Captain Bob Bartlett's testimonial before sailing on his tenth Arctic expedition in the schooner Morrissey tells again why Burgess Batteries are the choice of most experienced scientists and amateurs—why they are best for your own radio and experimental work:

"When an expedition, such as the one I am about to embark on, passes into the Arctic far beyond the last lines of

civilization, it is then too late to turn back for the renewal of equipment. It is therefore vital that we carry only those supplies which can absolutely be depended upon for all emergencies. That is why Burgess flashlight and battery products go along with us this time—they have never let us down. Signed, R. A. Bartlett."

**BURGESS BATTERY COMPANY**  
Freeport, Illinois



# BURGESS



Say You Saw It in *QST* — It Identifies You and Helps *QST*

**500,000-WATT  
OR 50-WATT  
TRANSMITTERS...  
G-E CAPACITORS  
DO THE JOB**

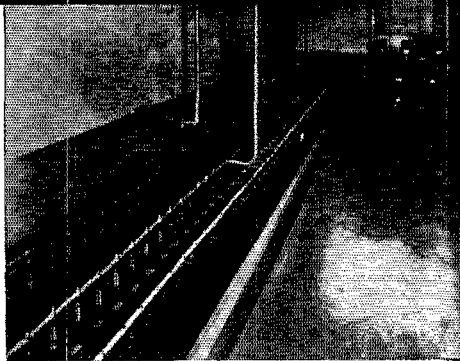

**T**HE above photograph shows part of the 147 G-E transmitter capacitors installed in WLW, the Crosley 500-kw station—largest broadcasting station in the country.

They are the same capacitors, except for size, which you want for your transmitter. Treated with Pyranol—the noninflammable dielectric developed by General Electric—these capacitors are compactly built and have permanent operating characteristics. They are conservatively rated for dependability and long life.

You can obtain these capacitors from your dealer. Bulletin GEA-2021 on request. Radio Dept., General Electric, Schenectady, N. Y.



360-111

**GENERAL  
ELECTRIC**

efficiency remains essentially constant up to the total of oscillator units tried. The solid output line shows the actual output obtained, the dropping off in output being accounted for by power supply regulation under the heavy load presented by the large number of tubes. With constant voltage, an output of 105 watts could have been obtained at a wavelength of 120 cm. on the basis of the observed efficiency of 21% and the use of eight oscillator units. With the present input an output of 80 watts was obtained at this wavelength. The efficiency is the same as that obtained with a pair of the same tubes used in push-pull under the same voltage limitations and at the same wavelength.

It seems to the writer that the general scheme presented here is applicable to most of the existing short-wave oscillators such as the Barkhausen-Kurz, electronic and negative-resistance magnetrons, as well as dynatrons. It is too early to predict the usefulness of the method; but if it is desired at the present time to obtain at the shortest possible wavelength an output greater than that obtainable with a push-pull circuit, this method is one way of accomplishing it.

### 5-Meter Crystal Control

*(Continued from page 26)*

becomes necessary to mount the 802 and the single 800 so that there is quite a distance between them. Otherwise the grid coil of the 800 is mounted in inductive relation to the plate coil of the 802 and the excitation of the 800 controlled by this means. Bias on the 802 and all the 800's is used as a means of protection in case excitation fails. The coupling condensers in the other cases are of the midget variety and of 100- $\mu$ fd. capacity. Attention must be paid to the r.f. choke coils in the 10- and 5-meter stages. Home-made choke coils seem to do better than some of the store kind, a winding of 2 inches of fine wire on a  $\frac{1}{4}$ -inch dowel filling the bill. A small neon tube is a good indicator to determine how far the r.f. goes along the choke.

You may wonder why some other tube was not used at the 10- to 5-meter stage. However, unless you have a lot more excitation power available than the 42 gives at 10 meters, you will find that the 802 is about the only tube that can be used. The excitation requirements for a tube go way up as the frequency is raised and when you get down to 10 and 5 meters the resultant output is also down, especially when you attempt to double from 10 to 5 meters. All the tubes from the 45 to the 801 were tried in place of the 802—with the choice remaining with the 802. Many other tube combinations for the driver or final are, of course, possible after the 802.

Plate modulation is used for the final from a Class-B modulating system. No trouble with feed-back has ever been experienced. The input transformer from the microphone is kept at a low

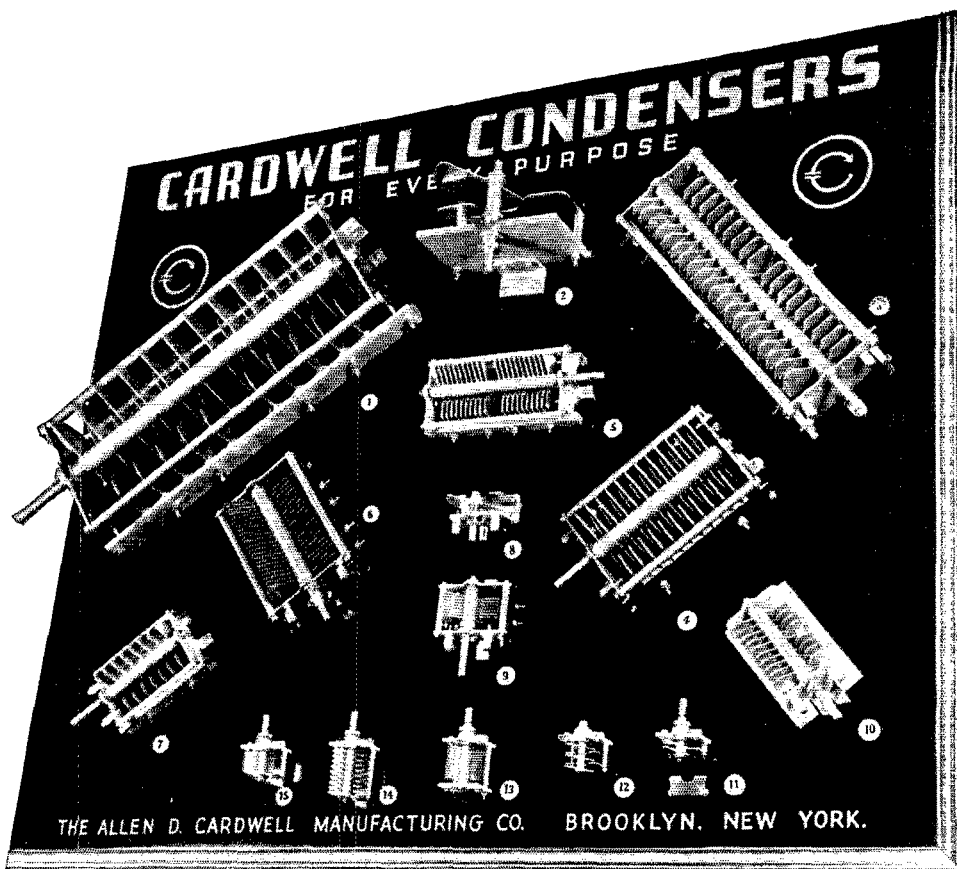

## Popular Numbers in a Quality Line

OF 100 CONDENSERS FOR ANY TYPE OF CIRCUIT AND ANY POWER INCLUDING ONE K.W. PHONES

- |                                    |   |                                    |  |
|------------------------------------|---|------------------------------------|--|
| (1) <b>TZ-40-RD</b><br>\$25.28 net | Cap. 40-40 mmf. Airgap .500 in. 12,000 V. Tank condenser for plate modulated P.P. 150-T's, T-200's, HF-200's, etc.            | (8) <b>NA-4-NS</b><br>\$2.12 net   | Cap. and gap adjustable. Normally a 7,000 V. 4 mmf. neutralizer for 852's and 800's.   |
| (2) <b>VZ-5-RS</b><br>\$9.70 net   | Max. capacity and gap adjustable. Mycalex insulated neutralizer for above.  | (9) <b>MR-150-BS</b><br>\$1.62 net | Cap. 150-10 mmf. Airgap .031 in. 1,000 V. Ideal buffer stage unit. Also S.W. Receivers.  |
| (3) <b>XC-75-XD</b><br>\$10.00 net | Cap. 75-75 mmf. Airgap .200 in. 6500 V. condenser for P.P. tanks. Mycalex.  | (10) <b>NP-35-GD</b><br>\$3.53 net | Cap. 35-35 mmf. Airgap .084 in. Buffered plates. Isolantite insulation. Designed for 10 and 5 meter P.P. tanks.  |
| (4) <b>XG-110-KS</b><br>\$5.29 net | Cap. 110-26 mmf. Airgap .171 in. 5,000 V. plate modulated tank condenser.   | (11) <b>ZV-5-TS</b><br>75c net     | 5 meter 4-in-1 Trim-Air. Both split segment and solid stator plate supplied.   |
| (5) <b>MT-100-GD</b><br>\$4.70 net | Cap. 100-100 mmf. Airgap .070 in. 3,000 V. Mycalex Midway for P.P. plate modulated high power 10s.                            | (12) <b>ZS-4-SS</b><br>\$1.09 net  | Cap. 4-1.5 mmf. Special 4,500 V. Trim-Air neutralizer for 35-T's.  |
| (6) <b>XT-210-PD</b><br>\$4.70 net | Cap. 210-210 mmf. Airgap .070 in. An old favorite. 3,000 V. P.P. tank unit. Cardwell rotor lockshown attached, 35c extra net. | (13) (14) (15)                     | <b>ZU-140-AS, ZT-30-AS, and ZR-50-AS</b> respectively. Trim-Airs you all know and use for exciter tanks, low power neutralizers and buffer tanks. And, of course, for receivers. |
| (7) <b>MG-35-GS</b><br>\$3.53 net  | Cap. 35-12 mmf. Airgap .171 in. 5,000 V. Mycalex insulated special Midway neutralizer for plate modulated 211's and 203-A's.  |                                    |  |

**AMATEURS:** No matter what circuit you use, choose a **CARDWELL** combination and "go to town" ahead of the crowd  
**DISTRIBUTORS:** Lead the parade with the largest and most complete line of **QUALITY** air condensers ever presented

SEE COMPLETE LISTING OF 100 TYPES IN NEW ARRL HANDBOOK

**THE ALLEN D. CARDWELL MANUFACTURING CORPORATION**  
 83 PROSPECT STREET, BROOKLYN, NEW YORK

WAIT A MINUTE . . .

LET'S GET THIS  
STRAIGHT!



This is a No. 771—4½-volt Radio "C" Battery. It contains cells compounded especially for "C" battery work. This makes its capacity bear the correct relation to "B" battery capacity. This means that on modern battery receivers, practically all of which bleed the "C" Battery during periods of operation, the "C" voltage goes down in step with the "B" voltage. This preserves the ideal relationship between grid and plate voltage for best receiver performance throughout the entire life of the batteries. The No. 771 Battery *should never be used for other than "C" battery purposes.*

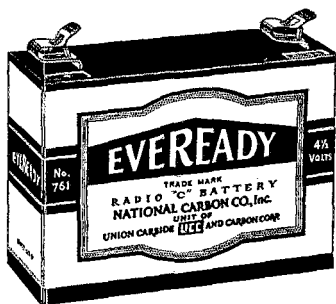

This is a No. 761—4½-volt General Purpose Battery. The size and composition of the cells in this battery make it suitable for such purposes as filament current supply for two 2-volt tubes in series, microphone battery, relay battery, and other uses where the No. 771—4½-volt Radio "C" Battery is not recommended.

NATIONAL CARBON COMPANY, INC.



General Offices: New York City  
Branches: San Francisco, Chicago

Unit of Union Carbide  and Carbon Corporation

The word "EVEREADY" is the trade-mark of National Carbon Co., Inc.

ratio of 3/1 and results in very good quality throughout the voice range. The normal range of the transmitter is 50 miles with daily contacts to beyond Northampton, Mass., without benefit of reflector antennas.

The writer wishes to thank the many amateurs who have so kindly helped in the tests that have been made with this transmitter when using various tubes and circuits, and for their criticism when things were wrong.

 **Strays** 

We are advised by the National Bureau of Standards that famous old Circular 74, once the standard text on radio measurements, is permanently out of print.

-----  
The only two hams in the Federated Malay States listed in the summer edition of the Call Book are VS2AB, Mr. Gee, and VS2AG, Mr. Bee. HI7G wants to know whether the authorities out there got their reins crossed or whether the call book staff has the "heebeegeebees"!

-----  
And speaking of the same Call Book, give a look at XE1AA and see what he thinks of us!

What the League Is Doing

(Continued from page 87)

of the F.C.C. the League put on a most comprehensive presentation for the amateur, illuminated by charts and statistical studies showing the extent of our congestion and demonstrating our need for additional frequencies from 4000 to 4500 kc. and from 7300 to 7500 kc.—as well as showing that, in the latter band particularly, the world-wide observance of better allocation engineering would make such an increase readily possible without embarrassing other services. (August *QST*, pages 21 and 81. A few more copies of the A.R.R.L. presentation are available to members at 50 cents.) When the Cairo Preparatory Committee on Allocation assembled in July, the representatives of the League put in for these additional frequencies for which need had been demonstrated at the June hearings. The request was denied, as we reported last month. The A.R.R.L. Board thereupon instructed Messrs. Segal and Warner to prepare and file a minority report and get the further consideration of the main preparatory group. This group met on August 5th, with representatives present from all the government departments using radio and from the major American commercial interests—the traditional United States preparatory method. There the Allocation Committee's report and our minority report were both received and examined, and again we were turned down, only the voice of our own representative being heard in favor of



**THIS PLATE  
WAS HOTTER THAN**

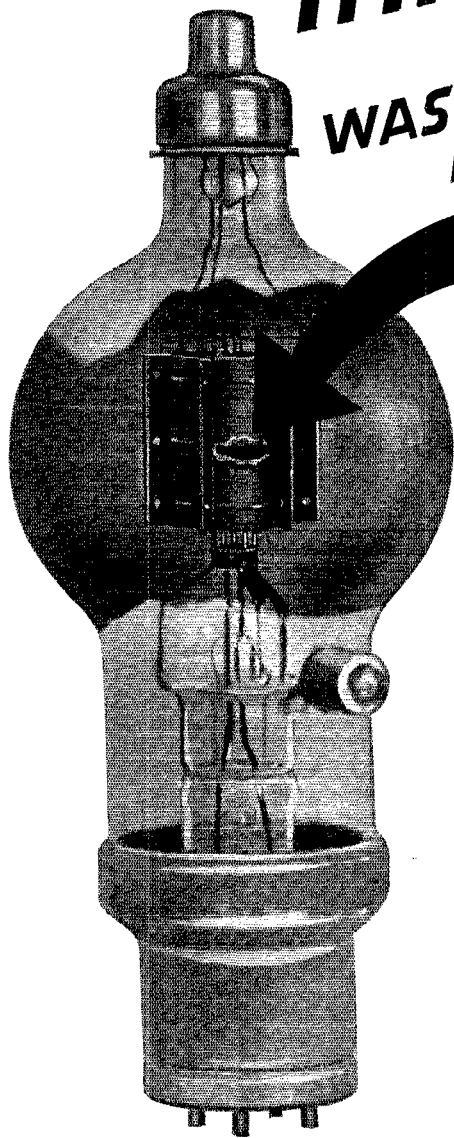

**A FILAMENT OF  
AN INCANDESCENT  
ELECTRIC LAMP!**

3000 watts or 20 times the normal plate dissipation of this EIMAC 150T was necessary to melt this tantalum anode. ● Absolutely no gas was released during this tremendous overload! ● EIMAC exclusive exhausting process permits an unconditional guarantee of complete freedom from gas during tube life.

**PLAY SAFE - BUY EIMAC  
EITEL-McCULLOUGH, INC.**

San Bruno, California, U. S. A.

*At Leading Dealers Everywhere*

# THREE STORES

**Hartford, Conn.**  
203 Ann Street

**New Haven, Conn.**  
36 Meadow Street

**Bridgeport, Conn.**  
195 Cannon Street

*Fulfilling the frequent need of the Connecticut amateur for prompt, efficient, satisfactory service on amateur supplies.*

## NEW and SPECIAL

Taylor T55 Tubes . . . . .	\$8.00
Thor. 1200v. CT, 100MA. . . . .	2.45
Thor Filt. Ck, 12 HY. 250MA. . . . .	1.95
39 Unit Rack (6 feet) . . . . .	8.50
Prest-Wood Crackle Panels	
3 unit 3 1/2 x 19 . . . . .	.54
5 unit 8 3/4 x 19 . . . . .	.87
7 unit 12 1/4 x 19 . . . . .	1.23
All Sizes Stocked — Standard Slotting	
Thor 6L6 Input . . . . .	2.21
Thor 6L6 Mod. Output . . . . .	5.88
Thor 6L6 P.A. Line v.c. Out. . . . .	3.53
Thor 6L6 Power TR. . . . .	5.30
RCA 6L6 Tubes . . . . .	1.18
National NC 100, Hallicrafter, RME 69, ACR-175, Hammarlund	

TIME PAYMENTS FOR CONN. HAMS

# HATBY & YOUNG

*Radio Since 1912*

our proposal. The government departments of state, war, navy, commerce, the Coast Guard, the commercial services—fixed, marine, aviation, broadcasting, press, police—not one of them raised a voice in support of us, and again we were alone. Most of these agencies have sympathy for us in our congestion but feel the need for more space themselves, think that it is impossible to remake world allocations to accommodate the amateur, do not see how the United States' position will possibly permit her to back such a view, feel confident that in any event the other nations of the world would not agree. (It about goes without saying that if the United States, most generous backer of amateurs, won't back an increase for us, no other major power will.) The League's minority report is here reproduced for the information of members. It was accompanied by a copy of the June "Presentation."

### COMMITTEES PREPARING FOR CAIRO RADIO CONFERENCE (Meeting of August 5, 1936)

*Report of Minority, Committee III on Allocation*

At the first meeting of Committee III on Allocation, July 16, 1936, we presented a motion that the Committee report it to be desirable that the specification of amateur service as amongst the allowable services in the frequency range 3500 to 4000 kc., be made also applicable to the range 4000 to 4500 kc., so that the entire range from 3500 to 4500 kc., would be shared amongst the amateur, fixed and mobile services.

We also requested the Committee to approve our suggestion that the band assigned exclusively to amateur service, now reading 7000 to 7300 kc., be enlarged to provide for the operation of the amateur service throughout the range 7000 to 7500 kc.

A number of other persons present at the meeting representing other services and branches of other services found themselves unable to agree with us and indicated disapproval. Accordingly, the minutes of the meeting of Committee III (F.C.C. Mim. 17710) report that the Committee does not suggest to you that these changes in the allocation table should be proposed by the Government of the United States.

Minutes of the meeting reflect the views which were expressed. We do not find in them any statement of principle why this request should be denied. We find only expressions tending to suggest the difficulties of readjusting frequency assignments of some other stations now operating and which would be affected. As to this, we suggest that with the progress of the radio technique such adjustments may from time to time be necessary and that they can be accomplished.

It is necessary, on the other hand, to point out certain manifest advantages from the standpoint of the United States to the frequency expansion of the amateur service contemplated in our motion.

When data were presented to the Federal Communications Commission at the June engineering hearings, it was done with the view that they would have the consideration of the Communications Commission and of these Committees in the preparation for the Cairo Conference. Accordingly, on behalf of the amateur service, there were presented at the June hearings many reasons and much factual material showing why, in the judgment of the American Radio Relay League, an expansion of frequency assignments of the amateur service to the extent which we have indicated should be accomplished.

We feel that the data submitted at the June hearings before the Federal Communications Commission should receive your careful consideration now. We therefore attach to this report copies of the statements which were made on behalf of the amateur service at the June hearings.

We believe these matters should be thoroughly examined by the Committees and we feel that such consideration should bring you also to the view that our Government should make the proposals we request.

By way of summary, we call attention that the attached documents show:

*(Continued on page 88)*

RESEARCH KEEPS GENERAL ELECTRIC YEARS AHEAD

# General Electric Announces THE 5<sup>TH</sup> OF A SERIES OF FIELD SERVICE MEETINGS DURING SEPTEMBER



ADMISSION  
FREE!

*Everybody  
Is Invited*

We'll advise you in advance regarding the date and meeting place of the 5th of a series of General Electric Field Service Meetings in your locality. This educational course is FREE. Your interest in radio sales and service is the only requirement for admission.

*For Metal Tube  
Renewals, Specify  
G-E Metal Tubes.*

MAIL COUPON  
OR PHONE  
G-E RADIO  
DISTRIBUTOR  
FOR DATE  
OF LOCAL  
MEETING

RADIO'S  
NEWEST  
MARVEL



## *Focused Tone*

COME, SEE AND LEARN ABOUT THIS  
AMAZING NEW DEVELOPMENT!

**AUTOMATIC FREQUENCY CONTROL** — A device which will automatically and instantly compensate for any reasonable error in tuning, bring the station signal into perfect tune, and thus assure the best possible quality of reproduction.

**COLORAMA DIAL** — A revolutionary tuning indicator which automatically flashes the whole dial from red to brilliant green when the signal is hair-line tuned for perfect tone.

**ILLUSTRATED LECTURES**      **COMPETENT SPEAKERS**  
**SERVICE NOTES**              **OPEN DISCUSSIONS**

*Illustrated Copies of Literature Will Be Distributed*

GENERAL ELECTRIC COMPANY, BRIDGEPORT, CONN.  
Attention: Section R-9510

Please send me the date and address of the next Field Service Meeting in my locality.

Name.....

Firm Name.....

Street Address.....

City.....State.....

# GENERAL ELECTRIC

## *Focused Tone Radio*

APPLIANCE AND MERCHANDISE DEPARTMENT, GENERAL ELECTRIC COMPANY, BRIDGEPORT, CONN.

# JEFFERSON TRANSFORMERS



## A Complete Line to Select From

Jefferson radio transformers meet all requirements of the amateur in applying iron core components to popular circuits. Filament transformers—plate supply, modulation, microphone and audio driver transformers are built to a standard of excellence which marks all Jefferson Products.

Ask your wholesaler for a Jefferson catalog—JEFFERSON ELECTRIC COMPANY, Bellwood (Suburb of Chicago), Illinois. Canadian Factory: 535 College St., Toronto.

### NEW P. P. 6L6 MODULATION TRANSFORMER

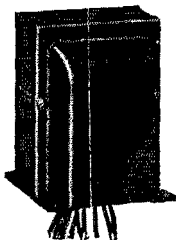

60 Watts Capacity  
Cat. No. 467-526

A new unit for coupling push pull 6L6's to a Class "C" load. *Primary*—3800 ohms—push pull 6L6's.

*Secondary*—7200 ohms—with 120 M.A. D.C. or 3000 ohms—with 120 M.A. D.C.

For single 03A or two 800's.

LIST PRICE . . . . . \$9.00

### NEW HEAVY DUTY

203A Modulation Transformer  
Cat. No. 467-527

A specially designed transformer of rugged construction for use with Heavy Duty Taylor 203A tubes. 500-watt audio capacity to modulate 2-150T's, 2-204A's, or 2-849's.

*Primary* resistance, —8000 ohms; — *Secondary*, — 3000, 4000, 6000 and 10,000 ohms with 500 M.A. direct current. Weight—46 lbs.

LIST PRICE . . . . . \$40.00

Get Our New Catalog

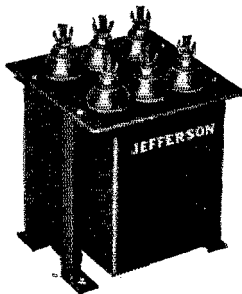

## What the League Is Doing

(Continued from page 80)

1. Amateur radio is a vast training school for personnel for the radio art and industry. It provides a vast reservoir of trained operators available for national defense. It has resulted in manifold contributions to the technique of the radio art. It has proved an invaluable aid to science and research. It is of inestimable public service in supplying communication in time of emergency when all other means fail. It supplies communication for distant scientific expeditions and exploring parties unable to use normal communication facilities. It is making a substantial contribution to better relations between nations. It has high sociological value in the self-improvement of the individual citizen. Its accomplishments and its attributes have received high praise from many leaders of our nation.

2. The development of high-frequency radio, inaugurated by amateurs, has served to reduce the assignments of amateurs at the gain of other services, until the amateurs today enjoy a small fraction of the assignments once made to them. Specifically, in 1929 the amateur allocations were reduced approximately 50%, since which time the number of American amateurs has grown to about 250% of its then value.

3. Amateurs expect interference in their mutual bands, but the present degree of congestion is intolerable for the average amateur, despite high standards of stability and selectivity in apparatus. Amateur occupancy of frequency bands runs from 50 to 400 stations per 0.1% channel. Congestion is now so severe that amateur radio is handicapped in performing its services to the nation, and it is most urgently in need of relief.

4. Relief is needed primarily by expanding the long-distance 7-mc. amateur band to embrace additional frequencies from 7300 to 7500 kc. Relief is also needed in the chief domestic band of amateurs by some substantial addition immediately above 4000 kc.

5. With particular respect to the band 7300-7500 kc., containing 21 channels by F.C.C. engineering practice, we have made a year's survey of this band which establishes that the majority of the stations therein notified are of such low power or of such small degree of activity that they could readily be accommodated in some adjacent portion of the spectrum without appreciable difficulty. We further find that the apparent congestion of the fixed service is one of paper records at Berne rather than of actual occupancy of channels in the ether; in short, that there is an uneconomical employment of Berne notifications. We are convinced by our survey that only nominal readjustments in the fixed service would be necessary in order to provide a desperately-needed increase for amateur radio.

The amateur has been the "Indian" of radio, his holdings periodically depleted for the benefit of other services. Unlike the Indian, his population grows. Interference within the present amateur bands is now so great that the United States is in fair way of losing many of the benefits of amateur radio through their sheer inability to communicate. If the administrations of the world are willing to make the effort, it must be conceded that readjustments of no great moment within the fixed service will make the needed additional assignments available to amateurs. We think that the Government of the United States ought to take the initiative in this matter, make proposals to this end to the nations of the world, and endeavor at the Cairo conference to secure agreement thereto.

Dissenting from the report of Committee III, we respectfully request the general meeting of the Committees Preparing for the Cairo Conference to adopt our proposals as proposals to be made by the United States.

AMERICAN RADIO RELAY LEAGUE

BY KENNETH B. WARNER,  
Secretary.

PAUL M. SEGAL,  
General Counsel.

One final avenue of approach remains. After all, it is our government itself which is preparing for the Cairo Conference. The users of radio who assisted in the preparatory committees have now been dismissed. It remains for the administration itself to resolve the unsolved problems, including our appeal. This now goes before the F.C.C., which will receive the advice of the government

## NEW! Single 6B5 (6 Watt Peak Output) Amplifier

- 3 high gain stages
- Crystal mike input
- Fully fused
- Gain and tone controls
- 5 watt undistorted output
- Tubes used 6J7-6C5-6B5-5Z4

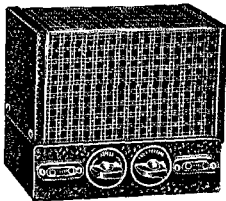

Complete kit of parts, less tubes .....\$8.50  
Wired and tested in our lab., less tubes..10.95  
Matched set of tubes.. 3.50

A versatile and high quality amplifier combining all the desirable features yet at a very reasonable price, is now offered for your use. High gain, sufficient for full output from a low level crystal mike with noiseless high fidelity output. Tube lineup: 1-6J7 high gain input stage, 1-6C5 driver, 1-6B5 power output amplifier, 1-5Z4 rectifier. Fully fused for your protection.

## NEW! Push Pull 6B5 (20 Watt Peak Output) Amplifier

- 3 high gain stages (last two in push pull)
- Crystal or Ribbon mike input
- Fully fused
- Gain and tone controls
- Universal output (4-8-15-500 ohms)
- 15 w. undistorted output.

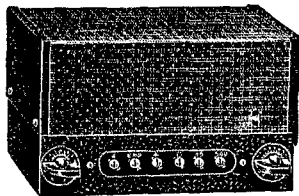

Complete kit of parts less tubes \$16.95  
Wired and tested in our lab., less tubes ..... 20.70  
Matched set of tubes ..... 5.10

As a modulator for a low power transmitter or for general P.A. work this amplifier is unexcelled in its adaptability. May also be used as a driver for high powered modulators. A clean gain of 126 D.B. permits full undistorted high fidelity output from either a ribbon or crystal mike. Tube lineup: 1-6J7 input stage, 2-6J7 p.p. driver stage output p.p. 2-6B5 with phase inversion, tubes, 1-80 rectifier.

Complete kit of parts less coils, tubes, cab. ....\$7.59

2-5-10 meter coils (set of 3)..... .95

9 1/2 to 15 meter coil. .39

15-200 meter coils (set of 4) ..... .95

200-310 meter coil . .39

310-550 meter coil . .39

550-1050 meter coil . .60

1000-2000 meter coil .60

Metal cabinet..... 1.50

Kit of three tubes... 2.40

Wired and tested in our lab., additional 2.00

## NEW! "THE STANDBY" (2 TO 2000 METERS) 3 TUBE A.C. AND D.C. RECEIVER

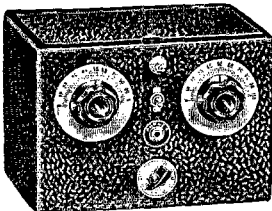

This excellent 2 to 2000 meter receiver is offered with full realization of the present-day need of the amateur for a dependable "standby" receiver which will cover practically all of the radio bands in use today. Super regeneration, which is the most efficient form of detection at these frequencies, is used from 2 to 15 meters. By throwing a toggle switch, straight regeneration and higher wavelengths up to 2000 meters may be had. Throughout the entire tuning range, there are no skips or dead spots. Loud speaker volume is available from practically every station received.

- 1000 to 1 tuning ratio
- Instant change over from straight to super regeneration
- Individual antenna tuning for high and low wave ranges
- 1-76 super regenerative detector, 1-6J7 regenerative detector, 1-12A7 audio amp. and rectifier
- Super regeneration below 15 meters
- Power supply incorporated

## GROSS C C TRANSMITTER—OUTPUT 25-30 WATTS

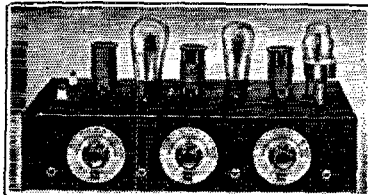

The "CW-25" transmitter kit due to its low cost makes it possible for any one to own a modern crystal controlled station. A schematic hook-up and parts layout sheet as well as tuning instructions are furnished, thus enabling the most inexperienced operator to wire and put the set on the air, for real results. The "CW-25" is supplied with a shrivel finished sturdy metal chassis under which all parts are mounted, making the wiring and components dust-proof. A plug-in crystal holder is furnished with the kit. Only one milliammeter is required for tuning the transmitter and each stage is provided with a jack for this purpose. The "CW-25" uses one '47 as crystal oscillator, one '46 as buffer or doubler and two '46's in the amplifier stage, set of three coils supplied with kit for 20, 40, 80 or 160 band. Additional coils 75c each.

Complete kit, less tubes and crystal..... **\$14.95**

P-25 POWER SUPPLY—for CW-25 transmitter with matching chassis— **\$11**  
450 volts at 200 MA, choke input—complete kit, less tube.....

CW-60 (Uses New Eimac 35T)

## Crystal Control Transmitter

OUTPUT: 60-100 WATTS

COMPLETE KIT, LESS TUBES AND CRYSTAL

**\$20.95**

P-60 DUAL POWER SUPPLY KIT for CW-60 Transmitter—with matching chassis **\$25.95**

Power output depends on plate voltage used

TUBE LINEUP: 47 crystal oscillator—53 Buffer and Eimac 35T in output stage.

POWER SUPPLY REQUIREMENTS: Filament voltages 2 1/2 volts at 4 amps.—5 volts at 4 amps.

PLATE VOLTAGES: 400 Volts at 100 MA and 500 to 1250 volts at 100 MA.

COILS: One set of three coils are furnished with kit for operation on any one amateur band. Coils for 1.7; 3.5; 7; 14 MC may be purchased separately at \$2.75 per set.

SIZE: Overall dimensions of the unit are Height 4 1/2 inches, width 11 inches, length 19 inches.

New Shure 701A Crystal Mike... \$14.70  
Turner S-38 Crystal Mike..... 13.23  
Astatic D-104 Crystal Mike..... 13.23  
Astatic K-2 Crystal Mike..... 22.95  
Shure 74B Crystal Mike..... 22.05

Write for full data on Thordarson and United new 6L6 amplifier

### THORDARSON CASED TRANSFORMER

600 volts each side of C.T. 200 MA 2 1/2 V. 10 amps. C.T., 5 V. 3 amps., 7 1/2 V. 3 amps. C.T.....\$2.45

THORDARSON CHOKE

12 H 250 MA.....\$1.95

### EIMAC UNSURPASSED TRANSMITTING TUBES!

Performance—Ruggedness  
Power—Price

35-T Output 38 to 112 watts...\$8.00  
50-T Output 75 to 250 watts...13.50  
150-T Output 150 to 450 watts...24.50  
300-T Output 350 to 700 watts...68.00  
500-T Output 800 to 1350 watts...175.00

20% DEPOSIT WITH ALL C. O. D. ORDERS

REMIT BY M. O. INCLUDE POSTAGE

Cable Address: GROSSINC

**GROSS RADIO, INC., 51 VESEY STREET, NEW YORK CITY**

# "G<sub>m</sub> 4200 . . . C<sub>gp</sub> 4.5" THIS NEW AMPEREX HF 100

delivers REAL POWER OUTPUT  
down to 2 Meters

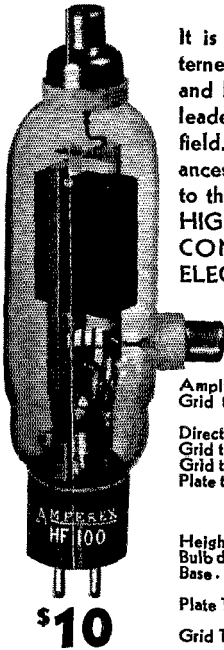

It is a PRACTICAL tube . . . Patterned after the Amperex HF 200 and HF 300, it takes its place as a leader in the ultra-high frequency field. The extraordinary performances of the HF 100 is due largely to the fact that it also possesses the HIGHEST RATIO OF TRANSCONDUCTANCE TO INTER-ELECTRODE CAPACITANCE.

### CHARACTERISTICS

Filament Voltage 10 Volts  
Current 2 Amps.  
Amplification Factor 23  
Grid to Plate Transconductance at 100 mc, 4200  
Direct Interelectrode Capacitances  
Grid to Plate . . . . . 4.5  $\mu\mu\text{f}$   
Grid to Filament . . . . . 3.5  $\mu\mu\text{f}$   
Plate to Filament . . . . . 1.4  $\mu\mu\text{f}$

### DIMENSIONS

Height overall . . . 7½ inches  
Bulb diameter . . . 2½ inches  
Base . . . . . Standard UX-4 — Prong for filament connections only.  
Plate Terminal . . Heat Radiating top cap Diameter .500 inches  
Grid Terminal . . Side cap diameter .500 inches

### MAXIMUM RATINGS

For operation at:	30 mc or lower	60-75 mc	120 mc
Plate Dissipation	75 Watts	60 Watts	50 Watts
D.C. Plate Voltage	1500 Volts	1200 Volts	1000 Volts
Modulated D.C. Plate Voltage	1250 Volts	1000 Volts	800 Volts
A.C. Plate Voltage	1500 Volts	1300 Volts	1250 Volts
D.C. Plate Current	150 Ma.	130 Ma.	120 Ma.
D.C. Grid Current	30 Ma.	30 Ma.	20 Ma.
Max. D.C. Grid Bias Voltage for Class C operation	300 Volts	225 Volts	150 Volts
Max. attainable Plate Power out-put	170 Watts	100 Watts	60 Watts

In June, the Bowdoin-Kent's Island Expedition sailed from Lubec, Maine for a scientific research program in the Bay of Fundy, under the auspices of Bowdoin College. They are based at their scientific station on Kent's Island, N. B., Canada where their main ultra high frequency station is using a high power concentric grid oscillator employing the Amperex HF 300. Thomas O. D. Gross is chief radio operator.

On July 24th, W2HBO picked up this message from their station, VE1LN:

"We have been using Amperex HF 300 and 203 H tubes for some time on heavy loads and have had perfect performance. We are particularly impressed with the ease of excitation and ruggedness of these tubes."

On August 11th, W3BWT, a member of the Army Amateur Radio System, received this:

"We are even more enthusiastic about the HF 300 than when we spoke on July twenty-four . . ."

# AMPEREX

ELECTRONIC PRODUCTS, Inc.  
79 WASHINGTON ST. BROOKLYN, N. Y.

departments through the Interdepartment Radio Advisory Committee, and finally report to the Department of State. Thus the final decision is to be made by the government itself, dissociated from the commercial companies of the country. The League's dissenting report is now before them for this purpose, and we have also brought the matter formally to their attention. The Commission informs us that, in its examination, consideration will also be given to the evidence presented by us at the informal hearing before the Commission on June 15th. So we are QRX now, awaiting the final word.

## Crystal Filter and Noise Silencer

(Continued from page 30)

pitch. Tune the main dial to the same pitch on the other side of zero beat, without touching anything else. This "other side" will be quite weak compared to the right setting. Now vary  $C_2$  slowly until the beat note disappears, or reaches a very low minimum. This process eliminates the audio-frequency image and is an important setting in obtaining maximum selectivity. The selectivity can be further increased by tuning  $C_1$  down in capacity from the resonance setting; maximum selectivity will be found with  $C_1$  considerably on the high-frequency side of i.f. resonance. At maximum selectivity ( $C_1$  all out) some decrease in signal strength results, although when the going is really tough the decrease is unimportant compared with the possibility of pulling the signal out of QRM. Should a strong interfering signal still cause trouble, it can often be pushed out of the picture by careful adjustment of  $C_2$ , which moves the point of maximum rejection over a small frequency range. For tuning across the band, and for most communication, the selectivity will be sufficient with  $C_1$  set for optimum selectivity — at or slightly higher than resonance — and with  $C_2$  set for rejection of the a.f. image.

The operation of the noise silencer with a crystal filter already has been described.<sup>2</sup> The action of the silencer in taking out strong noise peaks of the auto-ignition type, plus the selectivity of the crystal in reducing noise of the more "solid" type, makes it possible to copy weak signals through a noise background which completely masks them with the ordinary superhet arrangement. In c.w. reception, it may be necessary to adjust  $R_3$  occasionally to prevent a strong signal from blocking off the i.f. An extremely strong local signal may require opening  $Sw_2$  to prevent blocking. On 'phone, the a.v.c. will hold it pretty well in line, although very strong carriers may make it necessary to back off on the threshold control. Since the selectivity is not great at the point where the noise amplifier gets its signal, a strong interfering signal near the desired one sometimes will cause blocking, mak-

# THORDARSON *Tru-Fidelity* FEATURES

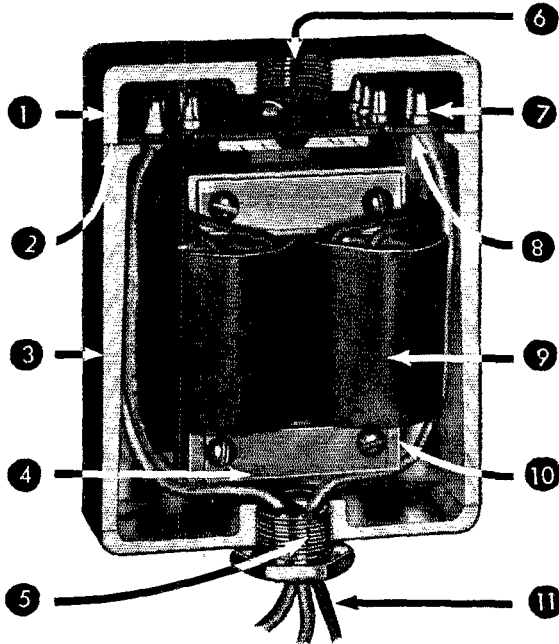

## Most Sensational

- ① **Shield Cap**—No stray pickups in leads—improves appearance—permits reversible mounting.
- ② **Ground Fit**—All case joints are ground fit for increased shielding efficiency.
- ③ **Case Body**—Special metal, gives maximum transformer shielding at all times.
- ④ **Non-Magnetic Clamps**—Brackets and clamps non-magnetic metal. Perfect symmetry.
- ⑤ **Single Hole Mountings**—Drill one hole in chassis. Leads through bushing. Transformer rotation eliminates distortion.
- ⑥ **Reversible Mounting**—Threaded mounting hole. Fits microphone fixtures—for above or sub-panel mounting.

## New Idea in Radio

- ⑦ **Terminal Board**—Husky mounting lugs for all connections. Terminals will not loosen when soldering.
- ⑧ **Sub-Panel Terminals**—Extra row of terminals provides connections for both primary and secondary windings.
- ⑨ **Coils**—Dual balanced coils for “hum bucking”. Extended frequency range. Capacitive—inductive balance. Low leakage reactance. Distributed capacity.
- ⑩ **Core**—Special lamination. High permeability alloy of perfect uniformity. Extreme low frequency response.
- ⑪ **Sub-Panel Leads**—Through bushing. Neat—efficient—effective.

### FREE—CATALOGS AND MANUALS—FREE

Catalog No. 500 Lists Tru-Fidelity prices, curves and complete specifications.  
 Catalog No. 400 Complete listing of all THORDARSON radio transformers except Tru-Fidelity.  
 Send today for your copy or see your parts distributor.  
 6L6 amplifier with either Tru-Fidelity or standard THORDARSON transformer. See Manual SD 258.

## THORDARSON ELECTRIC MFG. CO.

500 W. HURON ST., CHICAGO, ILL.

*Demand "Power by Thordarson"*

# RH-6 DUPLEX TRANSMITTER-RECEIVER FOR THE HIGH FREQUENCIES

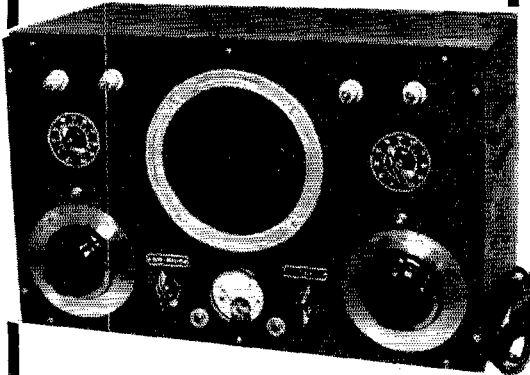

*This Rig is RIGHT*  
You won't want to CHANGE a THING on it

- 6E6 (or RK-34) tube in unusually stable and efficient T.P.T.G. circuit.
- 6L6 fixed bias, beam power modulation.
- A really F. B. receiver, worth the price of the whole job, using the new 6J5G super-regen-detector (still gives smooth super-regeneration over whole condenser with only shorting bar as plug-in coil), a stage of R. F. which does work, and two stage audio with 6L6 output to dynamic speaker.
- 150 mil. plate supply with double filter in same cabinet.
- 150 mil. meter which switches to either oscillator or modulator circuit.
- 15 to 20 watt input with 5 to 10 watt output depending on frequency and antenna used. (More with RK-34.)
- Coils supplied for 2½ to 10 meters on receiver — 5 meters on transmitter (may be shifted to 2½ if desired).

See the RH-6 at your dealers or write us for complete literature on it

RH-6 Duplex complete in hinged-top cabinet, size, 18" x 10" x 8" (Less tubes) only. . . . . **\$35.75**

Kit of six specially picked Sylvania tubes 1-6L6, 1-6E6, 2-6J5G, 1-6D6, 1-5Z3. . . . . **\$5.10**

## HAYNES RIG CHECKER



Hams all over the world are telling us that these two instruments are the biggest values in radio today. Your station is not complete without one. Circular and instructions for using sent free on request.

BIG RIG CHECKER **\$17.90**

LITTLE RIG CHECKER **\$9.85**

RADIO CONSTRUCTORS LABORATORIES  
Dept. Q-4 136 LIBERTY ST., NEW YORK, N. Y.

ing it necessary to retard  $R_3$  beyond the point where it would normally be set for the signal being copied.

One appreciated feature of the silencer is that it wipes out key clicks and similar noise from one's own transmitter. With  $R_3$  properly set, the receiver will block off when the oscillator and buffers in the transmitter are turned on, so that the receiver automatically goes dead during transmission. If a low-level stage is keyed, practically noiseless break-in operation is possible.

## Watt a Chirp from Dominica!

(Continued from page 48)

know he is muttering about "debbils." Then I forget to open the key switch as I unhook the battery wire. . . .

"Damn-n-n-n!" I yowl, doing a neat back flip into the long grass. . . . In the same flash of bright lights, Vito performs like a guillotine. . . . Simultaneously leaping over the fire, his arm whirls in a great sweeping arc, and that wicked cutlass crashes down on the batteries and transmitter. It cleaves two of the batteries from stem to stern, from hurricane deck to keel, and smashes the little oscillator to match wood.

"A-ha!" says Vito triumphantly, if somewhat haltingly, "green debbil no more bite dear boss . . . me fix!"

So Yotee and I,  
With a lingering sigh,  
Made 'way with that horrible man;  
We sliced him in sections  
And made new connections,  
In an effort to get on the air;  
But the chirp was a howl,  
Decidedly foul,  
So we took him apart once more,  
And buried him deep  
With the tube at his feet  
In that soft-matted jungle floor

'Neath a tropical moon  
And the cry of the goon,  
I left my gear asunder;  
Till an expert Creator  
With a new oscillator,  
And Almighty Power to boot,  
Can signal on high  
From that wild tropic sky,  
Not a chirp, Old Man, but a flute!

## Strays

W2AMD recently admired the way in which W2AKH subdued a couple of vicious parasites and couldn't help remarking, "Why not? Look at the name—R. F. Hunter!"

A note from Mr. P. S. Chadwick, Jr., informs us that the Wood Handbook, available from the Superintendent of Documents, Washington, referred to on page 38 of July, 1936, *QST*, is priced at 25 cents, not five cents.



# S O S

## STATION OPERATING SUPPLIES

For full enjoyment of your operating activities this coming season, you will want these new forms designed to meet your needs

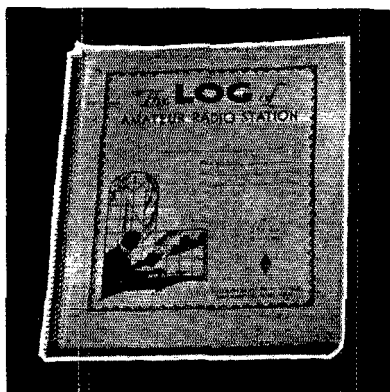

### SPIRAL BOUND LOG BOOK

The most interesting feature of the new LOG BOOK is the incorporation of spiral binding. This permits the book to be folded back flat at any page, requiring only half the amount of space on the operating table and making it easy to write on. The log-sheet has been re-designed by the Communications Department so that there is space provided for recording the number of messages handled and QSL's sent and received. General log information (prefixes, etc.) has been brought up-to-date. The LOG BOOK price has been reduced and is now 35c per book, 3 books for \$1.00, postpaid.

### OFFICIAL RADIOGRAM PADS

The radiogram blank is now an entirely new form, designed by the Communications Department to comply with the new order of transmission. All blocks for fill-in are properly spaced for use in typewriter. It has a strikingly new heading that you will like. Radiogram blanks,  $8\frac{1}{2} \times 7\frac{1}{4}$ , lithographed in green ink, and padded 100 blanks to the pad, are now priced at 25c per pad, postpaid.

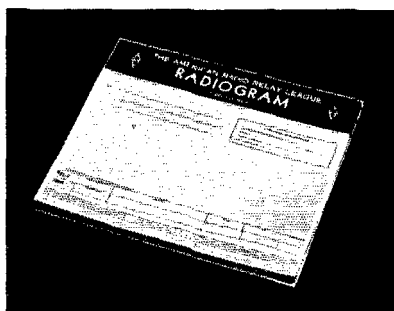

### and MESSAGE DELIVERY CARDS

Radiogram delivery cards embody the same design as the radiogram blank and are avail-

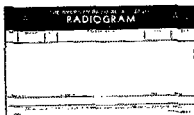

able in two forms — on stamped government postcard, 2c each; unstamped, 1c each.

**AMERICAN RADIO RELAY LEAGUE, INC.**  
WEST HARTFORD, CONNECTICUT

# ALL HAVE WHITE ENAMELED METAL DIALS

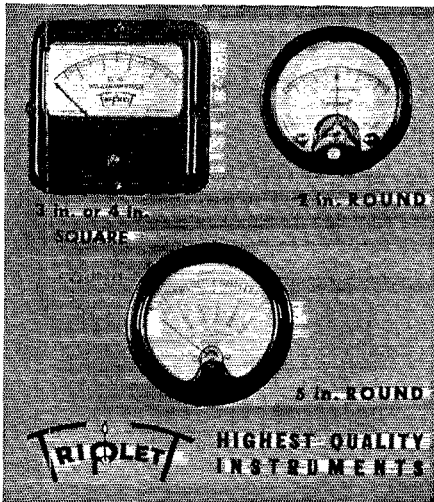

## ALL TRIPLETT INSTRUMENTS HAVE THE LATEST REFINEMENTS

White enameled metal dials are easier to read. They are not affected by climatic conditions. These dials are standard in all Triplet panel instruments. All Triplet instruments are of strictly "Grade A" class. It pays to insist upon nothing less.

Triplet high quality instruments are making a constantly increasing circle of friends. Their accuracy, improved appearance and utmost dependability over a long period of time make them favorites with amateurs, wherever used. Prices, too, are attractive.

Available in round, square and rectangular modern cases, molded and metal. Sizes from 2" to 5". Twin instruments are available with airplane and multi range with changeable single vision scales.

**You Can't Afford to Buy Other Than Class A Triplet Instruments**

PRECISION WITHOUT EXTRAVAGANCE

See Your Jobber

Write for Catalogue



The Triplet Electrical Instrument Co.  
2510 Harmon Dr., Bluffton, Ohio

Without obligation please send me

More information Model.....

New 1936 Catalogue.....

Name.....

Address.....

City and State.....

## Field Day Results

(Continued from page 50)

W6KUK-8 (Tom Lochrie) 22-A 218; W6KME-6 (W6GZY W6KME-W6GHP) 21-A 189; W8OFO-8 (Kendall Speer) 21-A 189; W3BML-3 (W3BML-W3CBK) 20-A 180; W8FBC-8 (W8LEV-W8FBC-W8JNJ) 20-A 180; W8PMY-8 (Jack Nordine) 35-B 140 T; W6BOY-7 (W7ETN-W6BOY) 51-A 135; W2DBF-2 (Erwin H. Enos) 13-A 117; W8HMJ-8 (W8KRG-W8HMJ) 13-A 117; W9SGP-9 (W9KCG-W9SGP) 13-A 117; W2DEN-2 (Bill Blomquist) 12-A 108; W1BDI-1 (W1JTD-W1BDI) 11-A 99; W8BSU-8 (W8BSU-W8DHQ) 10-A 90; W9KGX-9 (W9KGX-W9FNO-W9LPZ-W9AIW-W9LKG-W9UQV) 88-C 88 RT; W2GVZ-2 (J. P. Jessup) 9-A 81; W1JPE-1 (W1JPE-W1IIV) 12-A 72 T; W3FFC-3 (W8EYP-W3FFC) 7-A 63; W9BOP-9 (W9BOP-W9RNU-W9SST-W9RZL-W9SUG-W9ICC) 9-AB 57; W1GOJ-1 (P. A. Swasey & W1GKU) 6-A 54; W5KC-5 (V. L. Rosso) 6-A 54; W9NIU-9 (W9LEP-W9NIU-W9NGG-Geo. Keith) 9-B 54; W4COW-4 (Wes Randles) 13-B 52 T; W4CUW-4 (W4CUW-W4BTH-W4BLP-W4BNK-D. C. Fryar-T. R. Peterson) 29-C 35 rt; W1CJD-6 (Philip Gilderaleeve) 5-A 30 T; W2CHK-2 (Gil McDonald) 2-A 18; W3MG-3 (Paul Le Van) 2-A 18; W7AAN-7 (Wm. Miller) 1-A 9; W7FHZ-7.

## W6ETX

(Continued from page 59)

The receiver is an RME-69. Auxiliary equipment includes a modulation indicator, regular monitor, and wavemeter.

W6ETX is always glad to keep schedules or cooperate in other ways with other amateurs. Visitors are always welcome—some 300 of them have been entertained since September of last year, with a good deal of traffic having been handled for many of them. On 20-meter 'phone, all continents except Africa have been worked, along with all but five states in this country. W6ETX is an O.P.S.

## The Atlantic Division Convention

THE Atlantic Division held its 1936 convention at the Hotel DuPont in Wilmington, Del.

At 1:30 p.m. on Friday, greetings to the visiting amateurs were brought by Willard Wilson, W3DQ, the convention chairman, Joseph Barkley, W3SL, president of the Delaware Amateur Radio Club, and George Bailey, W1KH, vice-president of the A.R.R.L. John L. Reinartz, W1QP, gave an instructive talk on a new four-band band-switching exciter unit using metal tubes. Larry Geno, W8PE, told of his experience with Reinartz's circular antenna on five meters. Further greetings to the convention were brought at this time by Dr. E. C. Woodruff, W8CMP, president of the A.R.R.L. Bob Eubank, W3WS, spoke on "Approaching the Ideal Antenna," after which Roy Corderman, W3ZD, Alternate Director of the Atlantic Division, described his new portable station. Two sound films, furnished by A. T. & T., entitled "Seagoing Telephones" and "Net-work Broadcasting," were shown. Paul Smith, of RCA, then spoke on how to analyze an amateur station with an oscilloscope, after which the convention adjourned for a Dutch treat in the Grill Room of the Hotel DuPont. In the evening all hams were taken in chartered buses to the

# New

# Special Values

NEVER BEFORE OFFERED ANYWHERE  
AT THESE SENSATIONAL LOW PRICES!

Just out . . . *National NC-100*  
. . . the "Perfected" Super-Het!  
Amazingly selective, high sensitivity, low noise level. A wonderful performer. Complete band switching. 540 to 30,000 KC coverage in 5 ranges. No plug-in coils. 12 tubes, one stage RF, two 1F, P.P. Pentode 10 w. audio output. Full AVC circuit. Built-in power supply. Single and double antenna connections. Latest type crystal filter. "Electric Eye" tuning indicator. Large, latest type *Dynamic Speaker* to match. Order *National NC-100's* now at these low prices. These sets will be \$8.00 higher on all orders received after October 1st.



RATES AS LOW AS  
**6%**  
ON TIME  
PAYMENTS!

Oil Filled, Oil Impregnated

### FILTER CONDENSERS

All well known makes. Guaranteed at rated voltages. A "lucky" purchase of a 10,000 lot enables us to offer a few remaining items at these low prices. Hurry, before they're all gone!

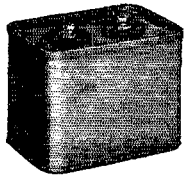

Cap.	Voltage	Size	Weight	Price
1 mfd.	2000 V. DC	5 x 3 3/4 x 1	1 1/4 lbs.	\$1.25
2 mfd.	2000 V. DC	5 1/4 x 3 3/4 x 2 1/4	3 lbs.	1.50
8 mfd.	3000 V. DC	5 1/4 x 3 1/2 x 4	4 lbs.	2.75
9 mfd.	3000 V. DC	5 1/4 x 3 1/2 x 1 1/2	9 lbs.	7.25
(including 2 1/2" bakelite standoffs)				
4.4 mfd.	1500 V. DC	5 x 3 1/4 x 1 1/4	1 1/2 lbs.	1.75
5 mfd.	1500 V. DC	3 3/4 x 3 1/4 x 1 1/4	1 1/2 lbs.	1.99
5.2 mfd.	1500 V. DC	5 x 3 1/4 x 2 1/4	2 1/2 lbs.	2.00
10 mfd.	1500 V. DC	5 x 3 1/4 x 3	2 1/2 lbs.	2.75

Use the 10 mfd. for perfect filtering in class B modulation Power Supply.

**Newark Paper Filter Condensers**  
1 mfd. 1000 V. DC. \$.56  
1 mfd. 1500 V. DC. .66  
Standoff insulators and mounting feet. \$2.45

**Thordarson No. T6877** 2 1/2 V. 10 amp. Filament Heavy Duty Choke. \$2.45  
15 henries at 250 MA 2500 V. insulation for 860's ..... \$3.95

**High Voltage Transformer.** 1000-750-500-0-500-750-1000-300 MA. 3 1/4 x 4 3/4 x 5 1/2 ..... \$5.95

### NEW RAYTHEON TUBES

RK-35 ..... \$8.00      RK-36 ..... \$14.50

### EIMAC

35T ..... \$8.00  
50T ..... 13.50  
150T ..... 24.50

### BLILEY CRYSTALS

BC3 ..... \$3.95  
LD2 ..... 4.80  
HF2 ..... 4.50

ONLY **\$12750**

(Prices and Terms on NC-100 and Other Sets Listed Below)

	Cash Price	Down Payment	6 Months Payments	9 Months Payments	12 Months Payments
NATIONAL NC-100 complete with tubes and speaker.	\$110.10	\$20.10	\$16.05	\$10.80	\$8.16
NATIONAL NCX-100 complete with tubes, crystal and speaker to match.	\$132.60	\$22.60	\$19.42	\$13.07	\$9.91
NATIONAL HRO JR. with tubes, one set of coils, 10 to 20 meters.	\$79.00	\$24.00	\$13.52	\$9.09	\$6.87
NATIONAL HRO less power supply and speaker.	\$167.70	\$37.70	\$22.78	\$15.35	\$11.69
NATIONAL HRO with power supply.	\$183.60	\$43.60	\$24.46	\$16.51	\$12.57
RCA-ACR-136 complete receiver.	\$69.50	\$19.50	\$9.32	\$6.26	
RCA-ACR-175 complete receiver, speaker separate.	\$119.50	\$24.50	\$16.90	\$11.37	\$8.59
RME-69 complete with tubes, crystal, speaker housed in battle.	\$134.90	\$29.90	\$18.58	\$12.50	\$9.47
HAMMARLUND SUPER PRO, complete with tubes, crystal and speaker.	\$241.00	\$51.00	\$32.92	\$22.29	\$16.98

Full details of any set listed, mailed immediately upon request.

A Year to Pay  
THE  
NEWARK  
WAY!

EASY CREDIT  
Longer Terms  
Lowest Rates

EVERY ITEM  
GUARANTEED  
BY  
NEWARK!

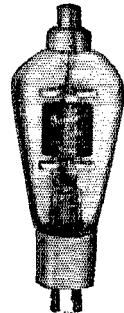

### TAYLOR TUBES

866	.....	\$1.65
750	.....	4.95
203B	.....	7.50
203A	.....	12.50
814	.....	18.50
822	.....	18.50
1200	.....	21.50

### High Frequency Tubes

T55	.....	\$8.00
T155	.....	19.50

Write for Free Complete Taylor Catalog

FREE - GET THIS CATALOG

ORDER DIRECT FROM THIS AD - NOW

Receivers listed in this ad are best values anywhere. Order today on EASY TERMS. Send your down payment with order. Set will be shipped immediately upon approval of your credit. Entire transaction in 1 week. No red tape. Full details of any item, with complete NEW CATALOG FREE upon request.

Big Bargains in Parts, Equipment and Supplies for Hams, Servicemen and Dealers. Lowest wholesale prices. Write quick!



# NEWARK ELECTRIC COMPANY

226 W. MADISON ST. Dept. Q CHICAGO, ILL.

# POPULAR WESTERN ELECTRIC TUBES FOR AMATEUR USE

## For Ultra High Frequency

**304B** Upper frequency limit  
—300 megacycles.  
Maximum voltage—1250 volts.  
Nominal power output, class C  
—unmodulated—  
85 watts **\$1250**

in U. S. A.

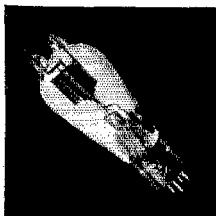

**305A** Full ratings up to 50  
megacycles. Maximum  
voltage—1000. Nominal power  
output class C—un-  
modulated—85 watts **\$3850**

in U. S. A.

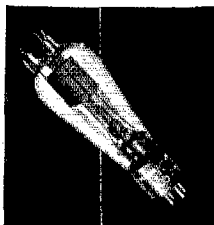

**307A** Full ratings up to 40  
megacycles—reduced  
ratings to 70 megacycles. Maxi-  
mum voltage—500 volts. Carrier  
power output—20  
watts **\$1365**

in U. S. A.

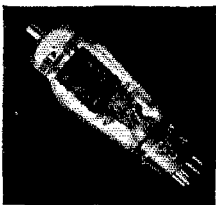

**316A** Upper frequency limit  
—750 megacycles.  
Maximum voltage—450 volts.  
Nominal power output at 500  
megacycles—7.5  
watts **\$1050**

in U. S. A.

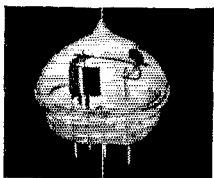

## For Audio Frequency

**300A** High quality audio.  
Maximum voltage—  
450 volts. Maximum  
output—17.8 watts **\$9.75**

in U. S. A.

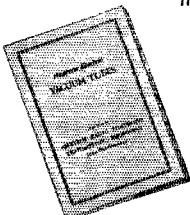

For booklet giving detailed  
information and characteris-  
tics of these Western Electric  
Tubes, address the distribu-  
tors: Graybar Electric, 420  
Lexington Avenue, New York.

**Western Electric**  
BROADCASTING EQUIPMENT  
Distributed by GRAYBAR Electric Company

Delaware Shrine Club, five miles south of Wil-  
mington, where Prof. G. M. P. Fitzgibbon gave an  
entertaining exhibition of hypnotism, using as  
his subjects hams and their YL's who volun-  
teered. After this food and drink was passed  
around while the crowd listened to the Schmel-  
ing-Louis fight.

Saturday morning a meeting of the A.A.R.S.  
was held. This was led by W8HC who introduced  
David Talley, W2PF, of New York. The Atlantic  
Division Radiophone Association was then called  
to order by its president, Dr. Burton T. Simpson,  
W8CPC. After various reports were given the  
meeting was addressed by W8CPC on current  
'phone problems, followed by an open forum.  
W8PE brought some interesting information  
from the F.C.C. hearings in Washington. After  
the election of officers, W8CPC being reelected  
president, a drawing for some really fine prizes  
was held to which only members of the 'phone  
association were eligible.

At 1:00 p.m. John L. Reinartz told of a practical  
vacuum-tube voltmeter. Dr. Woodruff then  
did John one better by bringing a very simple  
combined vacuum-tube voltmeter, ohmmeter,  
and field strength meter, and demonstrating its  
usefulness. Mr. Gerald Gross, Chief of the In-  
ternational Division of the F.C.C., spoke on "Al-  
location Problems Incident to the Cairo Confer-  
ence," after which he answered questions asked  
by the audience. Ted MacElroy gave a demon-  
stration of how to receive code at high speeds—  
and can he do it! George Sterling, W3DF, Radio  
Inspector from Baltimore, spoke on "Monitoring  
of Amateur Stations."

The YL's, XYL's, and OW's were entertained  
by movie parties and a trip to Longwood Gar-  
dens, the estate of P. S. DuPont, as well as at  
the party at the Shrine Club Friday night. At 7:00  
p.m., Saturday night, all assembled in the Gold  
Ball Room of the DuPont Hotel for the banquet  
with Dr. Simpson, W8CPC, as toastmaster. After  
a deliciously served dinner, prominent hams were  
called on for short speeches. Among those present  
from outside the division were G5NI, VE3AHW,  
W4BYY, W9LIP, W3UVA, W1FH and W1KG.

An excellent floor show was presented after the  
speeches. At 10:00 p.m. the drawing for the many  
valuable prizes was begun; the committee is to be  
congratulated on the speed with which they dis-  
posed of so many prizes in a remarkably short  
time without the usual confusion. A Hammar-  
lund Super-Pro was to be awarded to one who  
registered in advance. This was won by G5NI!  
Several other receivers, large tubes, and similar  
valuable awards were made with special prizes  
for the ladies. Before 11:00 p.m. dancing was un-  
der way, which lasted until the wee hours. All in  
all, the convention was a grand success.

## North Dakota State A.R.R.L. Convention

**T**HE third North Dakota State Convention  
held in Fargo on May 30th and 31st was  
hailed as the finest North Dakota Convention  
ever held.

# THE AMERICAN RADIO RELAY LEAGUE

ANNOUNCES THE PUBLICATION OF

## Two Hundred Meters and Down

### *The Story of Amateur Radio*

By CLINTON B. DESOTO

For many years you have heard amateurs say, "When the history of amateur radio is written . . ." Now the history of amateur radio *has* been written, a detailed and yet concise presentation in full book length of all the elements that have served to develop the most unique institution of its kind in the history of the world.

A book of history, but not a history-book, "Two Hundred Meters and Down: The Story of Amateur Radio" tells in spirited, dramatic fashion the entire chain of significant events in the development of the art, from the work of Thales in 600 B.C. to the March floods and the Lamb noise silencer. The chapter headings indicate the scope and the subject matter:

Introduction . . . . . THE RADIO AMATEUR

CHAPTER *Part I — PIONEERS*

- One . . . . . THE DAWN OF THE ART
- Two . . . . . THE NEW HOBBY
- Three . . . . . AMATEUR COMMUNICATION
- Four . . . . . THE COMING OF THE LAW
- Five . . . . . ADJUSTMENT AND DEVELOPMENT
- Six . . . . . THE AMERICAN RADIO RELAY LEAGUE
- Seven . . . . . GROWTH AND EXPANSION
- Eight . . . . . WAR!

*Part II — DEVELOPMENT AND RECOGNITION*

- Nine . . . . . BACK ON THE AIR
- Ten . . . . . SPARK VS. C.W.
- Eleven . . . . . THE BROADCAST BOOM
- Twelve . . . . . RECORDS AND ACCOMPLISHMENT

*Part III — INTERNATIONAL HIGH-FREQUENCY COMMUNICATION*

CHAPTER

- Thirteen . . . . . TRANSOCEANICS
- Fourteen . . . . . THE DEVELOPMENT OF THE SHORT WAVES
- Fifteen . . . . . THE INTERNATIONAL AMATEUR RADIO UNION
- Sixteen . . . . . STABILIZATION
- Seventeen . . . . . READJUSTMENT
- Eighteen . . . . . THE REGULATION OF AMATEUR RADIO
- Nineteen . . . . . EXPEDITIONS
- Twenty . . . . . EMERGENCIES
- Conclusion . . . . . WHITHER AMATEUR RADIO?

**MOST OF TODAY'S AMATEURS HAVE NO MORE THAN FRAGMENTARY KNOWLEDGE OF THE BEGINNINGS OF THEIR ART. THIS BOOK IS AN INVALUABLE RECORD THAT EVERY AMATEUR OUGHT TO OWN, TO LEARN THEREBY THE FASCINATING TALE OF OUR EARLIER DAYS**

The future of amateur radio — what will that be? Television — what place does it hold in the amateur picture? The "phone-c.w. war" — its genesis, an evaluation of the arguments, its probable outcome — a frank, impartial, dispassionate, courageous treatment. The story of the international radiotelegraph conventions, where the destiny of amateur radio is decided — facts never before disclosed. The legislative record of amateur radio. Trends in technical development. Social trends and implications. Virtues and faults — lessons learned and lessons to be learned — a complete, informative, instructive, entertaining picture of the art of amateur radio as a whole.

**NOW READY \$1 POSTPAID**

Approximately 200 Pages, 90,000 Words, with Durable Imitation Leather Red Paper Cover  
De Luxe Edition bound in blue cloth \$2.00

**AMERICAN RADIO RELAY LEAGUE, WEST HARTFORD, CONN., U.S.A.**

## NOW! GOOD NEWS for TAYLOR TUBE PURCHASERS

We are pleased to announce our Special Liberal Time Payment Plan on the complete line of Taylor Tubes.

### NO FINANCE CHARGES

Just a small service charge for credit investigation and account opening.

MONTHLY PAYMENTS ON

**2-Type T200 Only \$8.60**

*Terms on all other types in proportion*

FOR ADDITIONAL INFORMATION

SEE TAYLOR AD ON OPPOSITE PAGE

**We Carry a Complete Stock of  
All Types for Immediate Delivery**

*Time Payments for U.S.A. and Canada only*

**DELAWARE RADIO SALES CO.**

WILLARD S. WILSON — W3DQ

405 Delaware Ave. Wilmington, Del.

The convention officially commenced in the Gardner Hotel at Fargo when W9LOZ of Enderlin registered at 10:00 a.m. after riding his bicycle a distance of over 60 miles. "Grampa" Bill Rogers, VE4GA, without whom a Dakota Convention would be most unusual, was on hand early Friday morning after driving from Regina Beach, Saskatchewan.

A caravan visit to the federal airways radio station, an inspection of broadcasting station WDAX, the Fargo Police Station and various amateur stations inaugurated the convention, with a stag party in the Gardner Hotel winding up the Saturday activities.

A "hidden transmitter" hunt was the main feature of the Sunday afternoon program. Over a dozen cars manned by various of the two hundred "hams" started the search for the 75-meter 'phone at 1 p.m. It took only 52 minutes to locate the portable station on the bank of the Red River, several miles north of Fargo. Instead of employing the customary direction finding apparatus, the winning squad, W9JZI, W9HHN and W9TBF, located the transmitter by listening in the receiver for the sound of their double-barreled Oldsmobile horn.

The highlight of the convention was the banquet, Sunday evening, with Dr. Frank I. Darrow as master of ceremonies, and members of the Police Department providing the entertainment. Principal speakers were Larry Hamm and Director Carl Jabs, who briefly covered the recent Board meeting. The banquet closed with the awarding of prizes from an unusually large prize list, including a 'phone transmitter and three receivers.

Credit for the success of the convention goes to the Fargo Amateur Radio Club, which sponsored the affair, and the many manufacturers and organizations who cooperated so splendidly.

### South Dakota State Convention

**S**SPONSORED by the Black Hills Amateur Radio Club at Rapid City, the 1936 South Dakota State A.R.R.L. Convention overcame the handicap of unfavorable drouth conditions and achieved a marked degree of success. Five states and twenty cities in South Dakota were represented, to a total of 96, the largest attendance thus far had in the state.

The program, beginning on the afternoon of August 8th, featured technical talks by Earl Shirley of Northwestern Bell, Clark Ross on cathode-ray oscilloscopes, and others, as well as the showing of A.R.R.L., G.E. and R.C.A. motion pictures. Following this a trip to Mt. Rushmore and other scenic points and a picnic and campfire program at Canyon Lake were enjoyed by a hundred hungry hams, YL's, XYL's, junior ops, etc.

Sunday morning, the 9th, the code speed contest was won by Robert Tufford, W9FOZ, copying longhand at 26 w.p.m. A number of other visits and pictures and an A.R.R.L. meeting were

**NOW!**

**GTCH-LO  
Power  
Transformers —  
with three  
tremendous  
new advantages!**

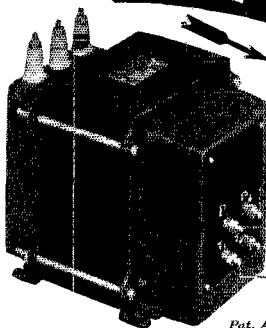

**HI OR LO Power  
Snap of a Switch**

1. Now you can conveniently, safely reduce the power in tubes while tuning. Panel-controlled!
2. You eliminate waste of power — then snap — and the soup's on!
3. Switch is in the 110 volt lead when you use GTC transformers — not in the high voltage lead, which is susceptible to arca.

Pat. Applied for

### SENSATIONAL NEW BOOK YOU NEED

"Progressive" Transmitter Guide, now includes 32-page Supplement on "Progressive II" with 14 illustrations, 8 circuits and 8 working drawings. 25c (U.S.) postpaid. (15c for Supplement only). Bulletin form 20B free for the asking.

**GENERAL TRANSFORMER CORP.**

518 S. Throop Street

Chicago, Illinois

# Taylor **HEAVY** **CUSTOM BUILT** **DUTY** Tubes

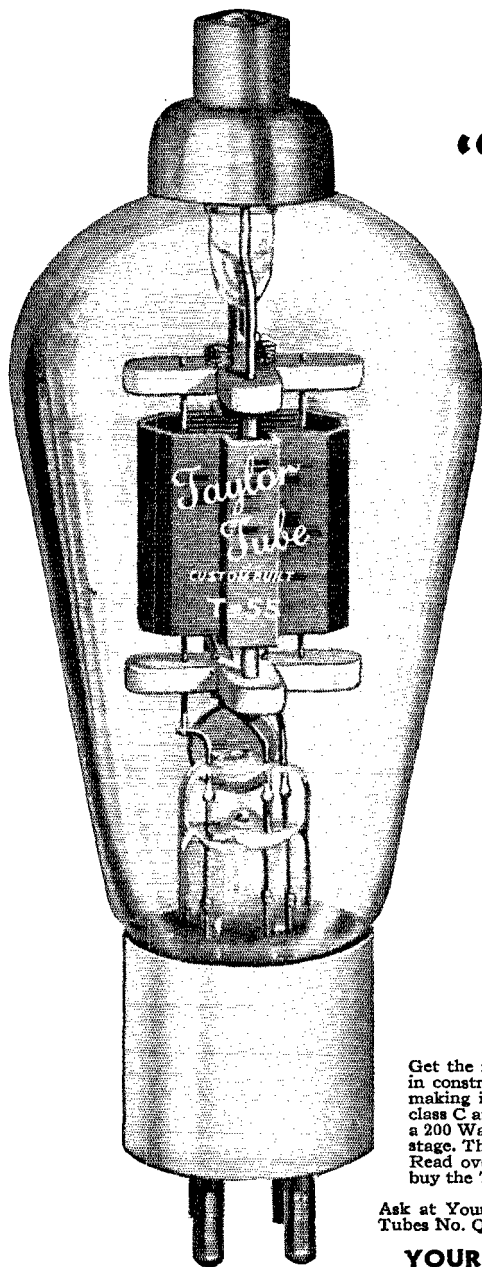

TAYLOR T-55 ACTUAL SIZE

## T-55

### "THE CHAMPION"

Only 3 Months Old and  
THE FASTEST-SELLING  
AMATEUR TRANSMITTING  
TUBE!

Read These Characteristics!

Fil. Volts.....7.5  
Fil. Current..... 2 Amps.  
Class "C"....OSC....and R.F. Amp.

5 METERS		
Class C		OSC
Max. Plate Volts		
Unmodulated D.C.....	1500 Volts	1250 Volts
Modulated D.C.....	1500 Volts	1000 Volts
Max. D.C. Plate		
Current.....	150 M.A.	125 M.A.
Max. D.C. Grid		
Current.....	40 M.A.	40 M.A.
Max. R.F. Grid		
Current.....	5 Amps.	5 Amps.
RF. Output.....	168 Watts (a)	66 Watts (b)
	(a) 75% Efficiency	(b) 40% Efficiency
Plate to Grid.....	2.5 MMF.	
Grid to Filament.....	1.7 MMF.	
Plate to Filament.....	.7 MMF.	

Plate Dissipation—55 Watts  
(Conservatively Rated)

**\$8.00**

*Easy to Drive!*

Before You Buy COMPARE!

Get the most for your money. . . . This is a real Heavy-Duty Tube in construction and performance. All elements are rigidly supported, making it ideal for Mobile Transmitters. Can be used as Oscillator or class C amplifier on frequencies up to 2 meters. The T-55 is the tube for a 200 Watt 20 Meter Transmitter or for a high-power buffer or doubler stage. The T-55 is an outstanding Value among all Transmitting Tubes. Read over the characteristics again . . . compare . . . and you will buy the T-55 . . . the Season's Fastest Selling Transmitting Tube.

Ask at Your Favorite Distributor or Write us for the Big New Taylor Tubes No. QO Combined Catalog and Handbook . . . FREE.

**YOUR DISTRIBUTOR HAS THE T-55 IN STOCK**

*"More Watts Per Dollar"*

**TAYLOR TUBES, INC., 2341-A WABANSIA AVE., CHICAGO, ILLINOIS**

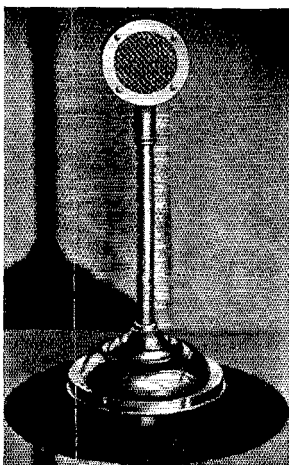

**PROVED  
and  
APPROVED  
'ROUND  
THE  
WORLD**

•  
**“Speech  
Range”**

**MODEL D-104  
CRYSTAL  
MICROPHONE  
with table stand**

Frequency response especially appropriate for quality “speech range” performance — no background noise — not affected by moving or handling. Ruggedly built and low in price. Beautifully finished in chromium. Fully guaranteed. List price \$22.50, with stand as illustrated \$25.50.

**PIONEER MANUFACTURERS OF QUALITY CRYSTAL DEVICES**

SEE YOUR JOBBER

Licensed under Brush Development Company Patents  
**ASTATIC MICROPHONE LABORATORY, INC.**  
Youngstown, Ohio, U.S.A.

**ASTATIC**

*Polyiron  
Conquers the Ether*

**REACH BEYOND THE HORIZON**

**Aladdin**  
TRADE MARK REG. U.S. PAT. OFF.

Send QSL card or 10¢ for new  
Aladdin Polyiron data sheet No. 536

**ALADDIN RADIO INDUSTRIES, INC.**  
466 W. Superior Street . . Chicago, Ill.

followed by technical talks by Boyd Phelps and H. O. Hodson. The banquet was held in the Alex Johnson Hotel Ballroom, with a program of entertainment and enough door prizes to go around.

Particularly interesting were the souvenirs of the convention. The registration badges were of balloon fabric taken from the bag of the Explorer II, the record-making stratosphere balloon. The banquet menu featured such delicacies as High-Gain (D.C.) cocktail, Antenna soup (second harmonic), Bake-o-lite potatoes, R.F. Chokey-Cherry pie, and other similar items not often encountered.

### The Moncton Hamfest

ON JULY 4th, 5th and 6th, the Moncton Amateur Radio Club were hosts to the largest collection of hams ever to gather at one place in the Maritime Provinces. To be exact, there were one hundred, about 50% of the hams in the district. Registration opened at 2 p.m., Saturday, July 4th. At 7 p.m. the banquet was opened by President Bert Horne, VE1DC, welcoming all guests and brother amateurs. Following his remarks a very interesting sketch was put on by three entertainers provided by the club. Later, the proceedings were broadcast through broadcasting station CKCW. His Worship Mayor Thomas H. King presented the key of the city of Moncton to Mr. Alex Reid and also delivered the civic welcome to the guests.

Major Wm. C. Borrett, VE1DD, Halifax, N. S., acted as toastmaster. Following Mr. King's speech, Mr. Art Crowell, VE1DQ, was introduced and delivered a very interesting address on amateur communication, explaining to the listening public that 24 hours a day there are 60,000 experienced operators who are more than willing to take over the nations' communications. Mr. Alex Reid, the C.G.M., was next on the program. He outlined the progress of amateur radio from its beginning, explaining the benefits the young men derive from it.

The public service certificates were then presented to the amateurs participating in the Moose River Gold Mine disaster. Following the banquet, the registration prize, door prize, etc., were drawn for. Then there were windbag contests, rag-chew contests and then the receiving and sending contests were put on. The assembly broke up at 12 p.m.

Sunday the hams had the opportunity of visiting the Royal Canadian Mounted Police Station, VFM, at Indian Point, and continued to Dixon's Point for a picnic. A number of contests such as swimming, tilting, running, etc., were run off here and a hot dog lunch was served at 6 p.m.

Monday morning was given over to transmitter hunts and it proved to be a very popular part of the hamfest. Prizes were donated for this also. Three transmitter hunts were run off. Approximately five or six cars were equipped with portable 5-meter gear. The convention terminated at noon on Monday, July 6th, and since then we have had a large number of commendations on the convention from the boys in the Maritimes.



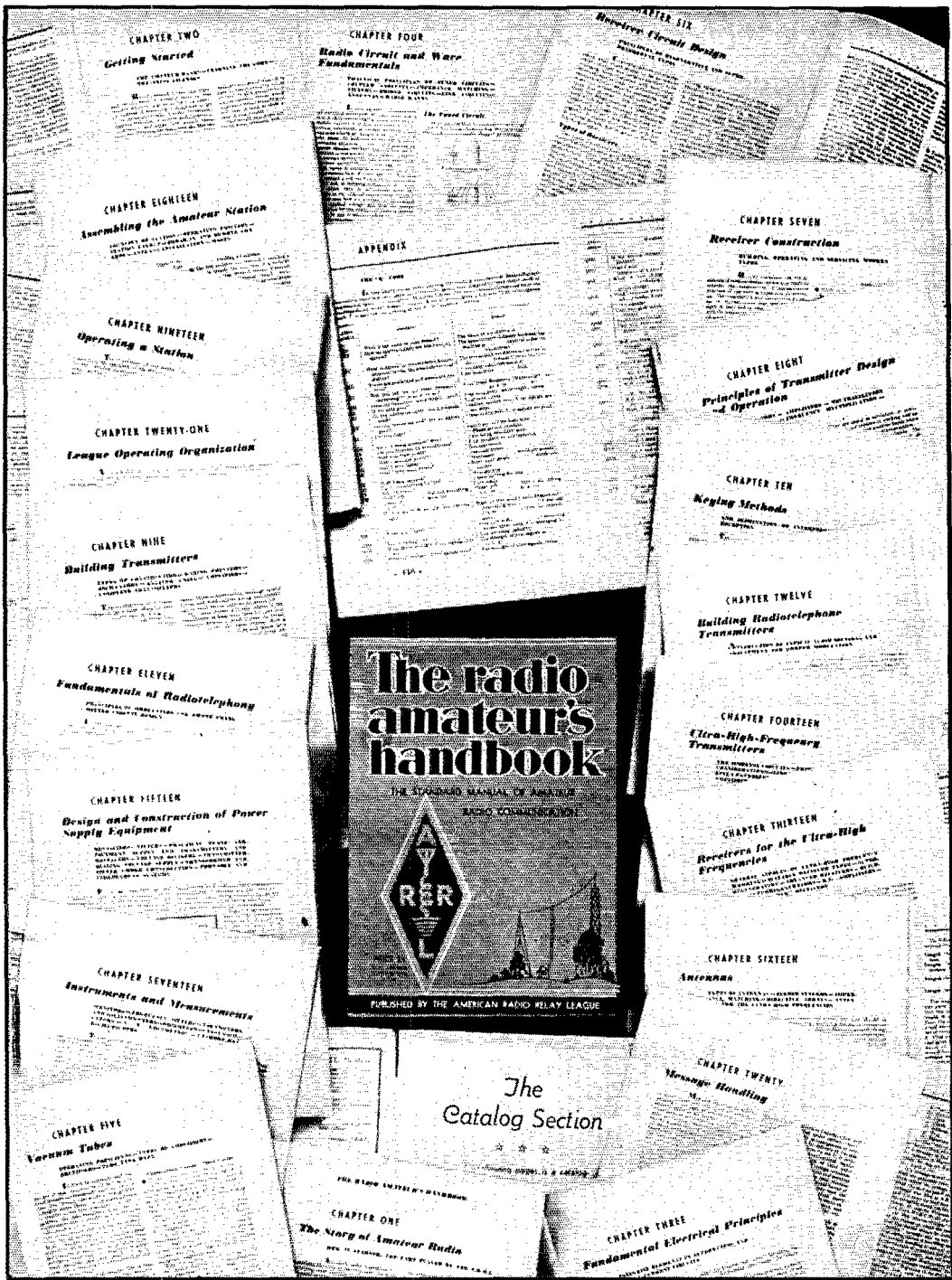

\$1.00 Postpaid in Continental U. S. A.

\$1.15 postpaid elsewhere

Buckram Bound, \$2.50

**American Radio Relay League, West Hartford, Conn.**

# Square R. F. Antenna Meters with Improved Movements

(HOT WIRE)

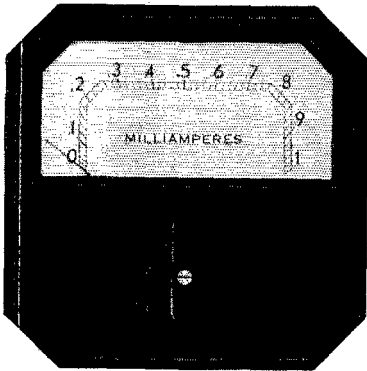

These trim new meters with improved movements are rugged and unaffected by frequency changes. They may be used with entire satisfaction in place of a thermocouple meter. The square bakelite meter measures  $4\frac{1}{4}$  inches and is priced to the dealer at \$5.00. The round bakelite meter measures  $3\frac{1}{4}$  inches and is priced to the dealer at \$3.67. Three ranges are available: 0/1.5; 0/3; and 0/5 amp. If your jobber cannot supply you use coupon below.

**THE BURTON ROGERS CO., 755 Boylston St., Boston, Mass.**  
*Sales Division of the Hoyt Electrical Instrument Works*

Gentlemen: Find enclosed my remittance for ..... of your  
 Type 577 square R. F. meters.  Type 576 R. F. round meters.  
 Kindly send information about other Hoyt Meters.

Name .....

State ..... City ..... Street .....

## Standard Frequency Transmissions

Date	Schedule	Station	Date	Schedule	Station
Oct. 2	BB	W6XK	Oct. 31	BX	W6XK
	A	W9XAN	Nov. 1	C	W6XK
Oct. 3	PX	W6XK	Nov. 6	A	W6XK
Oct. 4	C	W6XK	Nov. 13	B-	W9XAN
Oct. 9	A	W6XK		B	W6XK
Oct. 16	B	W9XAN	Nov. 18	C	W9XAN
	B	W6XK	Nov. 20	B	W9XAN
Oct. 21	C	W9XAN	Nov. 25	A	W6XK
Oct. 23	B	W9XAN	Nov. 26	BB	W9XAN
	A	W6XK	Nov. 27	BB	W6XK
Oct. 28	BB	W9XAN		A	W9XAN
Oct. 30	BB	W6XK	Nov. 28	BX	W6XK
	A	W9XAN	Nov. 29	C	W6XK

### STANDARD FREQUENCY SCHEDULES

Time (p.m.)	Sched. and Freq. (kc.)		Time (p.m.)	Sched. and Freq. (kc.)	
	A	B		BB	C
8:00	3500	7000	4:00	7000	14,000
8:08	3600	7100	4:08	7100	14,100
8:16	3700	7200	4:16	7200	14,200
8:24	3800	7300	4:24	7300	14,300
8:32	3900		4:32		14,400
8:40	4000				

Time (a.m.)	Sched. & Freq. (kc.)	
	BX	
6:00	7000	
6:08	7100	
6:16	7200	
6:24	7300	

The time specified in the schedules is local standard time at the transmitting station. W9XAN uses Central Standard Time, and W6XK, Pacific Standard Time.

### TRANSMITTING PROCEDURE

The time allotted to each transmission is 8 minutes divided as follows:

2 minutes—QST QST QST de (station call letters).

3 minutes—Characteristic letter of station followed by call letters and statement of frequency. The characteristic letter of W9XAN is "O"; and that of W6XK is "M."

1 minute—Statement of frequency in kilocycles and announcement of next frequency.

2 minutes—Time allowed to change to next frequency.

W9XAN: Elgin Observatory, Elgin National Watch Company, Elgin, Ill., Frank D. Urie in charge.

W6XK: Don Lee Broadcasting System, Los Angeles, Calif., Harold Perry in charge.

### Schedules for WWV

EACH Tuesday, Wednesday and Friday (except legal holidays), the National Bureau of Standards station WWV will transmit on three frequencies as follows: noon to 1:00 P.M. E.S.T., 15,000 kc.; 1:15 to 2:15 P.M., 10,000 kc.; 2:30 to 3:30 P.M., 5000 kc. On each Tuesday and Friday the emissions are continuous unmodulated waves (c.w.); and on each Wednesday they are modulated by an audio frequency. The audio frequency is in general 1000 cycles per second.

### Silent Keys

It is with deep regret that we record the passing of these amateurs:

Henry A. Gaillard, W9AFY, Chicago, Ill.  
 Edith May Maxwell, W6EYE, Santa Paula, Cal.

Lawrence Nease, W9FSA, Lawrenceville, Ill.

Melvin T. Spence, W8ILF, Charleston, W. Va.

Gilbert Vale, W4BSU, Southern Pines, N. C.

MR. E. H. RIETZKE



PRESIDENT OF CREI

## INSURE YOUR FUTURE! Start Training NOW in Practical RADIO ENGINEERING

WRITE  
TODAY  
FOR  
FREE  
48-PAGE  
CATALOG

You can't be satisfied with your job today! New technical developments mean ONLY TRAINED MEN ARE WANTED. Right now is the time to start training, so you won't be left behind while others go ahead. A good man today won't necessarily be a good man tomorrow. CREI offers you home-study training that will "insure your future."

"What's Happening in Radio Today?"

Send for this FREE survey. An interesting report on employment and salaries in all branches of Radio. Mailed free on request.

**CAPITOL RADIO  
ENGINEERING INSTITUTE**

Dept. Q-10

WASHINGTON, D. C.  
14th and Park Road

NEW YORK CITY  
29 Broadway



# Announcing **IRC** Metallized VOLUME CONTROLS for Radio Service and Amateur Use

**1. "KNEE ACTION" CONTACT**  
Made by 5 separate silver plated phosphor bronze springs.

**2. NO "JUMPING"**  
Each contactor invariably follows the same smooth "path" across the resistance element.

**3. NO OBSTRUCTIONS**  
IRC contact method on tapped controls eliminates obstructions in path of contactor. Smoother adjustment—no noise.

**4. DUST-PROOF CASE**  
No openings or slots in covers.

**5. CORROSION-PROOF**  
All electrical contacts are proofed against corrosion.

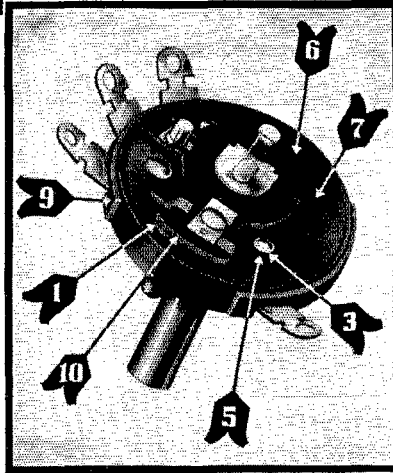

**6. METALLIZED TYPE RESISTANCE ELEMENT**  
Permanently bonded to moisture-proof Bakelite base.

**7. MOISTURE-PROOF**  
The Bakelite base of the resistance element *cannot* absorb moisture—nor will moisture damage the Metallized type resistance coating.

**8. SMALL—BUT NOT TOO SMALL**  
Minimum size for universal application and maximum performance.

**9. PROTECTED TERMINALS**  
Deeply set in molded Bakelite.

**10. AMAZINGLY SMOOTH**

with the **10** MOST IMPORTANT FEATURES EVER OFFERED IN A VOLUME CONTROL

The world's best known maker of fine resistance units scores again! For several years IRC Volume Controls have been supplied to leading radio and electrical manufacturers. Now, in a complete range of types, they are offered for service and amateur use as the outstanding replacement control development in the history of radio! Featured by leading jobbers. See them—try them—write today for catalog.

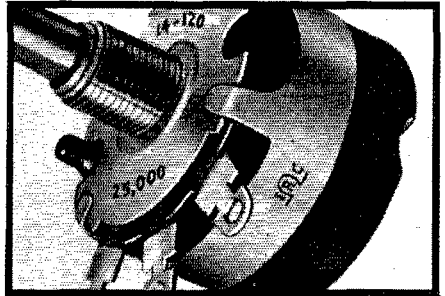

**INTERNATIONAL RESISTANCE COMPANY**  
401 NORTH BROAD STREET • PHILADELPHIA

**FLASH—MORE BIG NEWS!**

NEW Type BT-2 (2-watt) INSULATED Metallized Resistors now ready  
List Price 30c

**NEW LOW PRICES** on both ½-watt and 1-watt

INSULATED Metallized Resistors effective Sept. 1

½-watt (Type BT-½) List 17c      1-watt (Type BT-1) List 20c

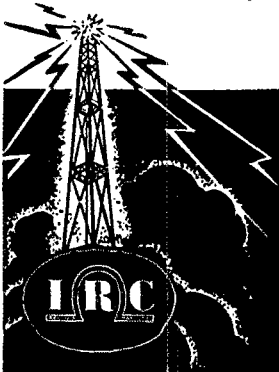

# C-D DYKANOL

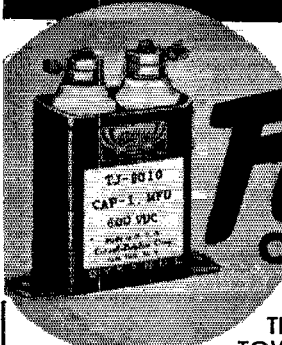

## Filter CAPACITOR

TODAY'S TREND IN TRANSMITTING RIGS IS TOWARD COMPACTNESS

AND the new C-D series of Dykanol transmitting capacitors have been designed with this trend in mind. The high dielectric strength and high dielectric constant of Dykanol has made it possible to produce a capacitor that will safely operate at 10% above its voltage rating and at temperatures and humidities that would prove destructive to condensers of other makes.

**RUGGED . . .** they are constructed in hermetically sealed non-corrosive containers and are supplied with convenient mounting feet. Their high glazed porcelain insulators gives them that extra safety factor that absolutely prevents flash-overs.

We suggest that you look over the new C-D 2 milk filters, they will be ideal for that new job of yours, and they won't take up too much room. Your jobber has them in stock now. Catalog No. 133A supplied free on request.

CORNELL-DUBILIER CORP., 1013 HAMILTON BLVD., N. J.



## A Novel All-Band Transmitter of One-Kilowatt Capability

(Continued from page 34)

ary, and between secondary and the frame. The primary is wound for 110 volts a.c. and the secondary is capable of delivering 200 volts each side of center. The power requirements for this transformer are not very great so any size transformer having physical dimensions adequate to accommodate the necessary insulation will be satisfactory. A 7.5-volt winding, also insulated for high voltage, is used to energize a Ward Leonard keying relay. No rectifier is used in this circuit, the polarity of the transformer being such that the grid of each rectifier goes positive at the same instant that its plate is positive. The relay shorts out the negative bias supply and the voltage drop across the 50,000-ohm resistor is the load for the negative supply when the relay is closed. Keying is accomplished by breaking the primary of the special transformer mentioned above; thus the relay is automatically closed simultaneously with the energizing of the grids of the 35T's.

The d.c. output is adequate for all c.w. work, though the filter is not so large that "tails" will result on the signal. Perfect break-in is effected because the transmitter is completely dead with the key up. Using an 80- or 160-meter crystal this method of keying leaves little to be desired, the output circuit being tuned to 160, 80, 40 or 20 meters. With a 20-meter crystal this transmitter can be worked at full output on 10 meters and at reduced outputs on 5 meters. The 20-meter crystals are a little sluggish, however, so that difficulty may be experienced using the above mentioned method of keying, in some cases. It may be found desirable to use a separate power supply for the crystal oscillator if a 20-meter crystal is used. A good AT-cut 40-meter crystal can be keyed the same as the thicker 80- and 160-meter crystals, though it may be better to use a separate power supply which allows the oscillator to run continuously. With either a 40- or 20-meter crystal, 200 to 300 watts output can be obtained on ten meters, but it is necessary to use a 20-meter crystal if 5-meter operation is desired. The separate power supply is only necessary for 5- or 10-meter c.w. operation because of the rather sluggish response of the 40- or 20-meter crystals in following a bug. The auxiliary supply should be capable of supplying about 800 volts at 50 mills.

No special mention need be made of the power transformer; the one used in this transmitter was obtained from the local power company. We found it highly desirable to use an auto-transformer (such as Thordarson T8211 or the T8212) to adjust the plate and filament voltages to the proper value. In this particular transmitter a double-pole double-throw switch properly used with some resistors and the auto transformer permits us either to operate with 385 watts input (normal) or 1000 watts input to the final. A Ward Leonard plate-current overload relay is used in conjunction with a magnetic contactor to take

## PRICE REDUCED!!

### CONTROL *Coto* WHEEL

Old Price  
**\$3.00 List**

New Price  
**\$2.50 List**

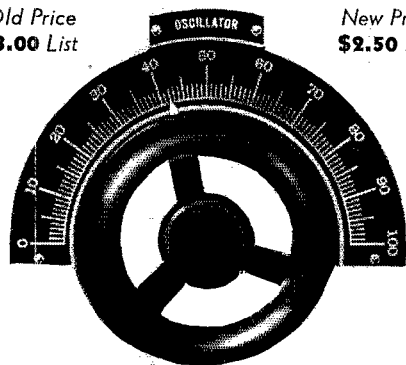

3 1/4 inch—TWO SIZES—2 1/4 inch

Genuine Molded Bakelite Wheel complete with insulated Pointer, Scale, and choice of 22 interchangeable Indicator Plates. Standard for 1/4" shafts. 3/8" and 1/2" on special order.

CI-40	3 1/4" CONTROL WHEEL, complete	.....	<b>\$2.50</b>
CI-41	3 1/4" CONTROL WHEEL, only	.....	<b>2.00</b>
CI-45	2 1/4" CONTROL WHEEL, complete	.....	<b>2.00</b>
CI-46	2 1/4" CONTROL WHEEL, only	.....	<b>1.50</b>

**COTO-COIL CO., Inc., PROV., R. I.**

# STRIPPED for ACTION

Leeds is always prepared to satisfy your needs — Whether it's just advice, or equipment — Leeds always Leads

## LEEDS LEADS AGAIN

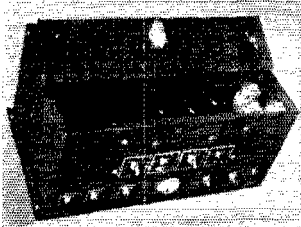

60 watt modulator or amplifier. High fidelity 2 channel mixer. High and low impedance. Reversed feedback and fixed bias circuit. 60 watt modulator to modulate 120 watt R.F. lead at 675w, 200w, 3700w, 5000w, 8000w, 20000w.

**Modulator-60** — complete kit. . . . \$59.75  
60 watt sound amplifier to voice coil or line — 2, 4, 6, 8, 15, 200 and 500 w and c.

**Amplifier-60** — complete kit. . . . \$56.75  
Above kits with 2" Triplett bakelite case milliammeter. . . . \$2.94

With following tubes: 4 — 6C5, 2 — 6L6, 2 — 83V, 1 — 82 Sylvania (List \$12.80) net with kit. . . . \$6.00

Wiring and testing either unit. . . . \$8.95  
For relay rack mounting add. . . . \$5.00

Basic Essential kit includes LEEDS special 16-gauge chassis and cabinet 19 x 11 x 10" power transformer, 4 chokes, 2 high fidelity transformers in castings, one output transformer with reversed feedback winding.

**Modulator 60-B** basic kit. . . . \$45.00  
**Amplifier 60-B** basic kit. . . . \$42.50

Complete specifications included in kit

## Westinghouse and Sangamo Watt Hour Meters

110-120 volt 5 amp. 60 cycle 2 wire meters. The meters are used in instruments in perfect condition, tested and reset to zero. A fifteen dollar value, at the extremely low price of

**\$3.50**

Shipping wt. 15 lbs.



## Leeds Bandwagon Specials

32 watt high fidelity push pull 6L6 amplifier; high and low impedance input — 2% distortion output impedance; 2, 4, 6, 8, 15 v.c. 200 and 500 w. line. . . . \$28.75

Same 32 watt amplifier with modulation transformer (will modulate 64 watt R.F. lead). . . . \$31.75

Set of 6 matched Sylvania metal tubes. \$4.49

1 — Wright DeCoster No. 1590 — 12" speaker. . . . \$7.80

1 — Astatic D-104 microphone. . . . \$13.23

One banquet stand (adjustable 67") . . . \$3.95

## SPECIAL COMPLETE SYSTEM FOR ELECTION

32 watt amplifier, two 1590 W D C speakers, Astatic crystal microphone and two 20" sound projectors. . . . \$68.95

**\$55 Special** — 11 watt 6L6 Amplifier, high and low impedance input. . . . \$14.50

Set of four matched Sylvania metal tubes, \$2.73

Complete election special — amplifier, tubes Wright DeCoster 990 speaker, Bell projector, crystal microphone. . . . \$39.95

**SPECIAL Leeds velocity microphone**, \$42.00 list. . . . \$14.95

SEE LEEDS for your sound requirements

## Rack Panels



By LEEDS are furnished with black shrivell finish in the standard 19" length, 1/4" thick. Mounting slots are spaced according to Bureau of Standards specifications, insuring freedom from all trouble in mounting or interchanging panels.

Steel	Price	Width	Aluminum	Price
PS-1	\$.52	1 1/4"	PA-1	\$.74
PS-2	.57	3 1/4"	PA-2	1.03
PS-3	.68	5 1/4"	PA-3	1.30
PS-4	.71	7"	PA-4	1.55
PS-5	.95	8 3/4"	PA-5	1.90
PS-6	1.15	10 1/4"	PA-6	2.45
PS-7	1.30	12 1/4"	PA-7	2.90
PS-8	1.50	14"	PA-8	3.35
PS-9	1.70	15 3/4"	PA-9	3.70
PS-10	1.90	17 1/4"	PA-10	3.95
PS-11	2.05	19 1/4"	PA-11	4.45
PS-12	2.30	21"	PA-12	5.20

Brass panel mounting screws 1/2" long 10/24 thread, 15c per dozen.

## Important Announcement

### On Our NEW LD-5 Mounted Crystals



These low drift plates, factory sealed in the new LEEDS metal holder are outstanding from the standpoint of stability, accuracy, high output and low cost. Low Drift — 5 cycles per million per degree. Accuracy of calibration —

better than .05%. Orders filled plus or minus two kc. of specified frequency. Last but not least, the price of the mounted crystals, anywhere in the 160-80 and 40 meter bands is only . . . . **\$3.50**

Money back guarantee if you are not completely satisfied.

Leeds type A.L. metal crystal holder, as illustrated above, fits standard 5-prong socket. . . . \$1.00

Western Electric 3:1 uncased audio transformers. . . . 25c

Western Electric cased condensers 500 v. working 1 mfd. . . . 10c. 2 mfd. . . . 15c

Premier Midget Magnetic Speakers 3", 90c

5" — \$1.00. 6" — \$1.20

LEEDS all brass key with 1/4" contacts

95c, with navy knob. . . . \$1.15

Johnson side wiping contact, 50 watt sockets. . . . 88c

NEON BULBS 1/4 watt — 1/2 watt — 1 watt. . . . 29c



## LEADS THE FIELD

World Wide Service to Amateurs

45 Vesey Street  
New York City

Tel. COntlandt 7-2612

Cable Address: "RADLEEDS"

## BASES and DEMI-BASES



By LEEDS for use with rack panels are now available in a greatly increased variety at lower prices. Crystalline finished units of 20 gauge steel; each base is finished with a bottom cover plate, so that apparatus underneath the chassis may be kept free from dust and at the same time electro statically and electro magnetically shielded.

8 1/2 x 8 x 2. . . . \$ .65	10 x 17 x 2. . . . \$1.10
8 1/2 x 10 x 2. . . . .70	10 x 17 x 3. . . . 1.30
8 x 17 x 2. . . . .95	12 x 17 x 2. . . . 1.30
8 x 17 x 3. . . . 1.15	12 x 17 x 3. . . . 1.40
4 x 17 x 2. . . . .70	

## RELAY RACKS

Our Relay Racks are built to stand up under the heavy loads of modern transmitter construction. Uprights are made of 3/16" stock, 1 1/4" wide. Welded angle supports, cross braces and sturdy cross bars insure extreme rigidity. LEEDS Racks unlike some units on the market, are drilled for panel mounting according to Bureau of Standards specifications.

Table Rack Type RAD 33 3/4" panel space high, 20 3/4" wide, 12" deep, with a complete set of drilled and tapped panel mounting holes. . . . **\$5.75**

Shipping weight 30 lbs.

Type RBD rack 66 1/4" panel space high, 20 3/4" wide, 12" deep, with a complete set of panel mounting holes. . . . **\$7.45**

Shipping weight 50 lbs.

Brackets — 4" high, 5 3/4" deep, 3/4" bend for mounting; pair 25c; 7 1/4" high, 9 1/4" deep, 1/2" bend for mounting, pair 35c

## Raytheon Transmitting Tubes

RK-10	\$.35	RK-28	\$.38
RK-15	4.50	RK-30	10.00
RK-16	4.50	RK-31	10.00
RK-17	4.50	RK-32	12.00
RK-18	10.00	RK-34	3.50
RK-19	7.50	RK-36	14.50
RK-20	15.00	RK-100	7.00
RK-21	5.00	841	3.25
RK-22	7.50	842	3.25
RK-23	4.50	866A	5.00
RK-24	2.25	872A	18.50
RK-25	4.50		

WRITE FOR FOLDER

NATIONAL HRO JUNIOR in stock. Need we say more about it. Circular on request.

Thordarson Neon Transformers, 115 v. primary — 1500 volts at 20 mls. . . . \$1.45

## GENERAL RADIO

Amateur accessories are always in stock. Here are two handy forms for that multiband xmitter.

Type 677-U — 21 turns, 2 1/4" diameter, resonant on 3.5 mc with 100 mfd. capacity; shipping weight 2 lbs. Price. . . . 50c

Type 677-Y — 30 turns 4" diameter, resonant 1.7 mc with 100 mfd. capacity; shipping weight 3 lbs. Price. . . . 75c

Also 7-pin base to fit above forms at 70c and a matching base with jacks at 65c.

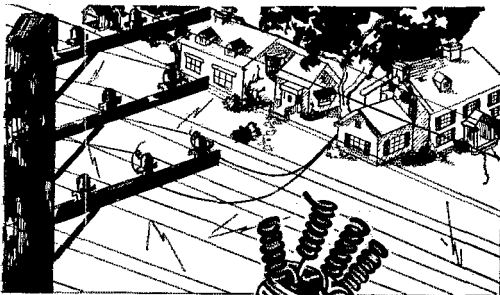

## Block a-c line QRM!

Your neighbor's vacuum cleaner is no help when you're listening for an Aussie

To block line noise from your neighbor's appliances, **CONTINENTAL Carbon**, manufacturers of low-power factor transmitting condensers and insulated resistors, offers a power line Filtercon, 10 amps. capacity, which is very effective in keeping out of your shack r-f QRM from the power line. Filtercon F1005DH contains two chokes and two capacitors for use on 110 to 220 v lines. List price, only \$5.00. Ask your jobber for Filtercon data. Bulletin 104-A.

**CONTINENTAL CARBON Inc.**

13924 Lorain Ave., Cleveland, Ohio

Toronto, Canada

## TYPE OR-5 TRANSMITTER *with* 5 BAND OPERATION

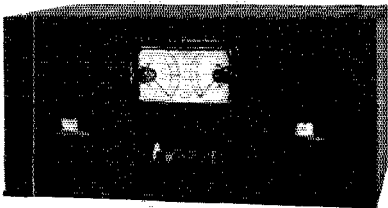

**\$97.50** COMPLETE WITH COILS  
FOR ONE FREQUENCY BUT  
LESS TUBES AND CRYSTAL

MORE THAN just another transmitter, the OR-5 embodies mechanical and electrical refinements which offer the amateur operator maximum efficiency and a definite pride in ownership.

Write for illustrated descriptive booklet

**OTTAWA RADIO COMPANY**  
OTTAWA, ILLINOIS

care of arcing condensers or other momentary overloads. A 30-ohm rheostat across a 250-milli-ampere coil allows complete adjustment of current necessary to trip the relay.

### TUNING PROCEDURE

The first step in tuning is to get the crystal oscillator going. Because automatic bias is used, the plate current will tend to rise as the circuit first begins to oscillate, but without external loading the plate current will drop to a low value at resonance. When coupled to the doubler the plate current will be 50 to 75 milliamperes, a higher value than when the circuit is in a non-oscillating condition.

With plate voltage removed the grid current of the buffer will be about 20 milliamperes through the 50,000-ohm grid leak. The buffer is neutralized in the conventional manner. The only reason neutralization is used in this stage is to allow operation on the same frequency as the crystal. After neutralizing, plate voltage is applied. The unloaded minimum plate current is practically the same whether the buffer is used as a straight amplifier or is tuned to the second or fourth harmonic. The taps for the grid circuit of the final are arbitrarily chosen a few turns each side of the coil's center tap.

After re-tuning the buffer tank for maximum grid mils to the final, we proceed with the neutralizing of the final. The low capacity of the 35T's makes the neutralizing simple and complete, though it is necessary that the spacing of the neutralizing condenser plates be approximately the same. *Apparent* neutralization can be obtained with the spacings of the condenser plates differing widely from one another; but when plate voltage is applied the tubes will tend to heat unevenly under such conditions. After neutralizing, readjust the grid taps for maximum grid current with the plate current to the buffer about 60 to 90 milliamperes through a 3000-ohm grid leak. When plate voltage is applied the unloaded resonance plate current to the final should be in the neighborhood of 25 mils.

The use of tubes that display color on their anodes at their ratings has very decided advantages. After determining normal dissipation, it is a simple matter to figure the efficiency of the circuit by deducting the plate losses from the input; and, after making due allowances for circuit losses, a fairly accurate idea of the power output is obtained. The second advantage is that the entire transmitter can be tuned without meters simply by noting the anode color. Where only one or two meters are handy, this feature greatly facilitates the finding of trouble as the circuit with a "hot" tube will indicate where the difficulty is. The third advantage is that it is possible by observing the color on the plates of a push-pull stage to determine how evenly the tubes are sharing the load. One tube running "hotter" than the other indicates unbalance either in neutralizing, grid excitation or the way the output load is connected.

In order that the operator familiarize himself

# ACCEPTED AND APPROVED

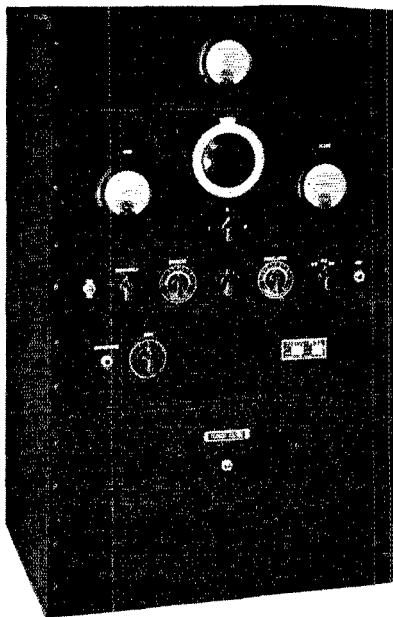

**200-R**  
200 Watts CW  
60 Watts Phone  
Amateur Net \$245

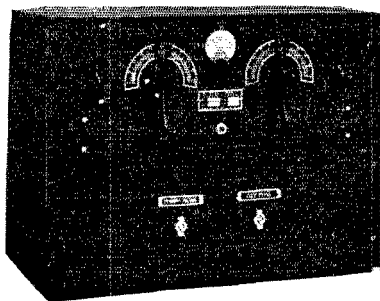

**60-X**  
50 Watts CW  
Amateur Net \$69.50

NOTE—All Prices are Less Accessories  
and f.o.b. Brookline

*Write For Complete Information*

**B  
Y  
A  
M  
A  
T  
E  
U  
R  
S  
  
E  
V  
E  
R  
Y  
W  
H  
E  
R  
E**

**60-T**

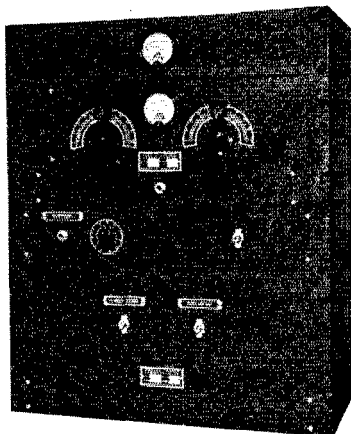

50 Watts CW  
15 Watts Phone  
Amateur Net \$88.20

**UHX-35**

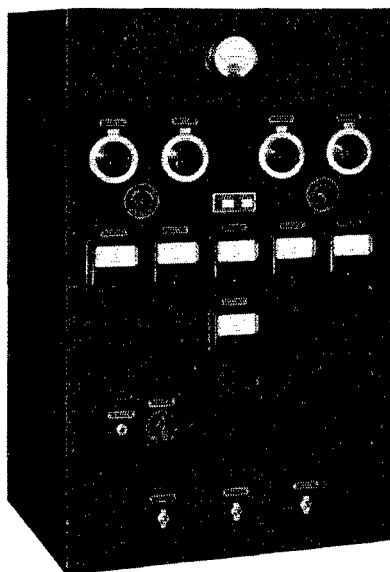

35 Watts Phone and CW  
Range: 2.5 to 20 Meters  
Amateur Net \$290

## HARVEY RADIO LABORATORIES, INC.

12 Boylston Street, Brookline, Mass.

Export: 25 Warren Street, New York City

Cable: "Simontrice"

# I WILL SHOW YOU

that it is to your advantage to buy from me. Your inquiry about any amateur apparatus will prove that to you.

I give you specialized personal service of genuine value that is not available from other jobbers.

I take in trade used apparatus. I sell on time with terms to suit you with only 6% interest. I won't be undersold.

I am jobber for Collins, RCA, Eimac, Marine transmitters and the All Star transmitter in kits or assembled. Trade in your transmitter. Buy on time.

I stock at lowest prices: RCA, Eimac, Taylor, United transmitting tubes. National, Hammarlund, Thordarson, Cardwell, Cornell-Dubilier, Dwyer, Johnson, Astatic, Shure, Ohmite, Trimm, Triplett, Weston, Barr, Peak, Bliley, Mac-Keys, other parts.

I ship all receivers on ten day trial. You need send but \$5.00 with order.

## TRADE IN YOUR TRANSMITTER OR RECEIVER

The new National NC-100s	.....	\$110.10*
The new NC-100Xs	.....	132.60*
RME-69s	.....	118.80
Breting 12s prepaid	.....	87.00
National HROs	.....	167.70
National HRO Jrs.	.....	99.00
RCA ACR-175s	.....	119.50
Super Pros	.....	223.44
The new Sky Buddy	.....	29.50
The new Ultra Skyrider S-10	.....	99.50
The new 1937 Super Skyrider S-11	.....	89.50

### IN STOCK—SHIPPED PREPAID

Eimac: 35Ts, \$8.00, 50Ts, \$13.50, 150Ts, \$24.50  
 Taylor: T55s, \$8.00, T155s, \$19.50, 203-As, \$12.50  
 Bliley: BC3s, \$3.95, LD2s, \$4.80, HF2s, \$7.50

\* Price increases \$8.00 on October 1

## HENRY RADIO SHOP

211-215 North Main Street

Butler, Missouri

# GULF RADIO SCHOOL

Radiotelegraphy

Radiotelephony

Radio Servicing

SECOND PORT } 1007 Carondelet Street  
 U. S. A. } NEW ORLEANS, LA.

## Money Back Guarantee



**NEW  
 HOLDER  
 DESIGN**

**15 SECONDS  
 TO INSTALL  
 CRYSTAL**

**For All Bands  
 GREATER  
 STABILITY**

**Plugs in 5 prong  
 tube socket**

**Beautiful  
 Appearance**

## MODEL AH HOLDER \$1.00

At your dealer or direct

**HIPOWER LOW DRIFT CRYSTALS:**  
 within 10 kc. or Choice of stock

AH-10, 1700-3500 Kc. bands \$2.35  
 AH-10, 7000-7300 " band 3.90

write for new Literature

Hipower Crystal Co., 2035 Charleston St., Chicago

with the proper value of plate dissipation we suggest that he connect up a power supply capable of giving approximately 700 volts. At this plate voltage, with the grid of a 35T grounded to filament, a plate current in the neighborhood of 50 milliamperes will flow. If there is no self-oscillation, the total input will be dissipated at the plate, thus giving the operator an idea of what the plate temperature (color) should be. Oscillation can be detected by touching the grid or the plate terminal of the tube with a large mass of metal insulated from the operator to avoid shock. A kick of the meter indicates oscillation. An oscillating condition gives an erroneous indication of plate dissipation because part of the input power is then present in some external circuit. The plate dissipation, if no oscillation is present, will be near the tube's rating of 35 watts. The normal plate dissipation is exceeded by nearly 300% when the two tubes are running with 1000 watts input, but repeated tests have shown no ill effects from such operation. Tests made with this transmitter actually on the air have proved its effectiveness.

## W9ERU Wins Code Speed Contest

(Continued from page 39)

of licensed equipment, involving no telegraph operating. It was a truly amateur competition.

The congratulations of the entire amateur fraternity go to W9ERU on a remarkable performance! It is something to shoot at, gang.

—E. L. B.

## Hamdom

(Continued from page 40)

4000 foreign contacts in 70 countries—but in 12 years trying never heard an Asian. Now it's mostly 80-meter traffic and rag-chewing. O.R.S. since 1926, R.M. since 1930, he is also Charter Member Al Ops Club, O.O., and A.R.R.L. Emergency Corps member. Other hobbies: golf, tennis, swimming, photography (movie and still), piano, saxophone and tenor banjo. An investment authority, securities analyst for the New Haven Bank, his friends in the New England Division regard him as a well-balanced, all-around ham.

## A Laboratory Type Beat-Frequency Audio Oscillator and R.F. Signal Generator

(Continued from page 45)

second harmonic that can be obtained is about 50 microvolts. With a more powerful oscillator, of course, higher output voltages could be secured. However, the present system is entirely utilitarian. For alignment purposes at high levels no accurate input indication is necessary. Overall sensitivity measurements are the most customary and necessary. With the availability of variable audio modulating frequencies, a unit of decidedly useful overall characteristics is obtainable at a moderate cost.



# PROBLEMS

**PROBLEM: HOW MANY TURNS ON A 1/2" DIAMETER FORM 1/2" LONG MUST I USE WITH A 25 μMFL CONDENSER TO TUNE TO 4000 KC.?**

$$L = \frac{10^8}{(2\pi f)^2 C} \text{ MICROHENRYS}$$

$f = 4 \times 10^6$   
 $C = 25 \times 10^{-8}$

$$L = \frac{10^8}{(2\pi \times 4 \times 10^6)^2 (25 \times 10^{-8})}$$

$$= \frac{10^6}{15776}$$

$15776 \overline{) 1000000.0}$   
 $\underline{94656}$   
 $53440$   
 $\underline{47328}$   
 $61120$   
 $\underline{61120}$   
 $0$   
 $= 63.4 \text{ MICROHENRYS}$

$6.28 \quad 4$   
 $\underline{6.28} \quad 4$   
 $5024 \quad 16$   
 $\underline{1256}$   
 $3768$   
 $\underline{394384}$   
 $16$   
 $\underline{23664}$   
 $3944$   
 $\underline{63104}$   
 $25$   
 $\underline{315520}$   
 $126208$   
 $\underline{1571600}$

$$N = \sqrt{\frac{3A + 9B \times L}{0.2A^2}}$$

$A = 1.5$   
 $B = 0.5$   
 $L = 63.4$

$$N = \sqrt{\frac{3(1.5) + (9)(0.5) \times 63.4}{(0.2)(1.5)^2}}$$

$$= \sqrt{\frac{36 \times 63.4}{0.45}}$$

$$= \sqrt{1268.135}$$

$35 \overline{) 1268.135}$   
 $\underline{1050}$   
 $218135$   
 $\underline{218135}$   
 $0$   
 $= 35 \text{ TURNS ANS.}$

**EASY**

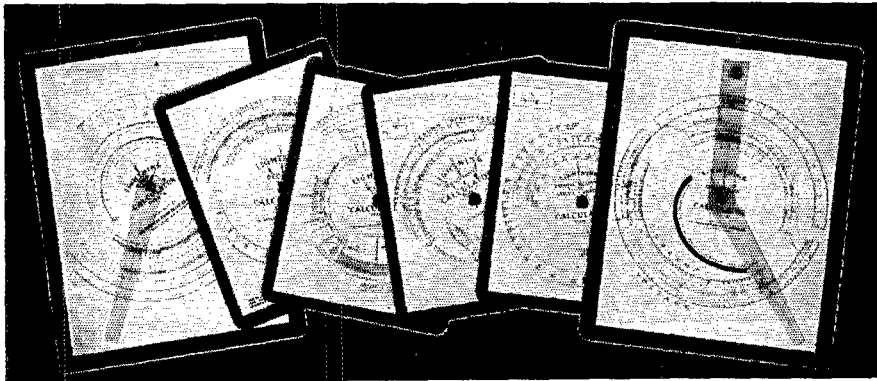

## LIGHTNING CALCULATORS

Six Types Solve ALL Problems

**TYPE A** — For problems involving frequency, inductance and capacity, in design of radio frequency circuits. Direct reading answers for size of coils and condensers for any range between 400 kc. and 150 mc. Price, \$1, postpaid.

**TYPE C** — More information on electrical conductors than you could find in a book full of tables. Price, 50c, postpaid.

**TYPE E** — Direct reading total resistance of resistors connected in parallel, and total capacity of condensers connected in series. Price, 50c, postpaid.

**TYPE B** — Gives direct reading answers to calculations involving current, resistance, voltage and power with scale for resistance of copper wire and scale for calculating decibel gain or loss. Price, \$1, postpaid.

**TYPE D** — Gives decibel gain or loss when input and output voltages, currents or power are known. Price, 50c, postpaid.

**TYPE F** — Permits measurement of resistance, from 1 ohm to 1 megohm by use of a voltmeter. Makes an ohm-meter of your voltmeter. Price, 50c, postpaid.

AMERICAN RADIO RELAY LEAGUE, INC., West Hartford, Conn.

Say You Saw It in QST — It Identifies You and Helps QST

This Problem Quickly and Easily Solved with Type A Calculator

## STATION ACTIVITIES

(Continued from page 68)

help mail "Amachewer" OK, Victoria visitor to town, finds Commercial logging sometimes interferes with schedules! PI pulls the pins for the Caribou for a month or so. Good luck, Art. EC adds to his DX countries. PT is going on 14 mc. with c.c. tens. IR works potent DX with his hl '45's. DV spent pleasant holiday with 7DGY. CB is loath to leave Vancouver, for Victoria at least! NE is having a lot of fun with 6I.6. BI tried out his new V8 during holidays. NL's s.s. super still has plenty of bugs! "Aboutto comebacks": HZ, GF and FU. New calls: SM, SP, SH, RV, RT, TR and RY. RI is not Radio Inspector!—Just a regular ham putting Trail on the map. KS (OM and XYL) have a lot of fun with the Vancouver bunch; Mae is teaching George how to make that bug rattler! PE in Armstrong puts a swish sig on 7 mc. KW piles up operating hours. KC, JS and "Y" station DB, make the B.P.L. JK contacted WIOXDA on 14-mc. 'phone—S7 both ways.

Traffic: VE5JS 225 FQ 48 KC 191 DB 483 OK 20 DV 36 AC 2 JK 32 AL 3 ND 2 EP 25.

### PRAIRIE DIVISION

**MANITOBA**—SCM, A. J. R. Simpson, VE4BG—56 mc. is enjoying considerable popularity and we now have several stations of a mobile nature, namely, SR, UX, OK, ZU, GC and RC. ADP, ADV, GQ and QC are also heard on 56 mc. ZV has been trying to get a rig perking on 56 mc. QF, who pioneered on this band, is coming back with a new arrangement. GC is still filling in the Trunk Line position for AG. WBXC was a visitor to Winnipeg. VE4HX was in Winnipeg for a couple of weeks working on one of the local broadcasting stations. NI has an FB new skyhook. RO finds the new vertical better than the old straight wire. UX is off 14 mc. due to robbing the rig for a 56-mc. transmitter. QF works lots of DX with a new antenna. LH acquired part of MY's rig. ZK will shortly be in the throes of rebuilding with a 150T final. QC is looking for a new tube for the final and thinks an RK20 is it. SS and NM have strong and FB 'phone signals on 14 mc. EK works out nicely with his 14-mc. 'phone. TO and MK put out strong 14-mc. signals. IP has his 14-mc. 'phone perking again at new QTH. KX finds time from golf to work DX. MV won't part with his '03A's and threatens to come on again with them. The annual summer hamfest of the M.W.E.A. was held at Selkirk, August 15th.

**SASKATCHEWAN**—SCM, Wilfred Skafie, VE4EL—LI rejoined Sask. gang and is working 3.9-mc. 'phone. TN and RS are active on 3.9-mc. 'phone. TW has new rig—53 osc.—doubler-P.P. '45's final on 7 mc. QZ chalked up a rare one when he snagged YSIFM (Salvador) on 7 mc. UD is working out FB on 14 mc. with his 18-watt Class A mod. 'phone. MB and UC are also giving 14-mc. flea-power 'phone a try-out. BF has been rebuilding. MB tries early morning rising for elusive "J's" with no luck. PQ's flea power tickled the ear drums of PAQJMW one eve on 14 mc. and got good report from his first European. JV sure got the odd DX in VP2 (Fiji). IG got a good one, YJ (New Hebrides). SY says catching salmon is as hard as DX. PG is still after W.A.S. ZB moved to Winnipeg and VQ to Regina. ZC has new antenna—centre-fed. KA is rebuilding e.c. job. OM and OP are heard testing quality of sigs. EP is the 3.5-mc. rag-chewer. HI RE is now c.c. on 7 mc. UL is on vacation and looking up VE1's in Halifax. EL is on delayed vacation at Carlyle Lake. KB is on Holiday at Yellowstone Park. New ham: ADK, Oly Olson at N.B. KV worked two K6's and is building s.g. receiver for 30 mc.

Traffic: VE4QZ 14 PQ 4.

### CENTRAL DIVISION

**ILLINOIS**—SCM, John Hunton, W9KJY—R.M.'s ILH, RMN, P.A.M.: WC, HQH worked YV3SN and YNIII for two new countries on 7 mc. VEE, new from Mo., made over 33,000 pts. in O.R.S. contest—FB, OM. WC visited entire western portion of the country on his vacation. Schedule with Canal Zone keeps up deliveries at IYA. EBX is planning big schedule list this season—write him if you want 3.5-mc. schedules. JO, QSL managor, worked two new countries—J2LY and FBSAD. ANQ is DXing—handled message with WIOXDA of the *Morrissey*. VLN is Rockford's newest ham, but the oldest in years. DTB from Iowa visited ACU. Asia and Africa are needed to complete W.A.C. for S.C.H. MLE, after trying for two years, is now the proud father of a 14-mc. transmitter! Camping trip for

SKR broke a record of some kind for consecutive QSO's. AND, former member of Bachelors Club, went and got hisself hitched! Congrats, Wes. Trunk-line operation interests SKF, KRX is trying to get a mast that will meet specifications of city officials. DBO at MKS, and also TAY took part in Field Day work. Portable work under call 8QDC keeps NUF busy. J2LU completed W.A.C. for PNE. VZG, visiting ULR, was more interested in his sister than the rig—results—a wedding with UZU, VZG's brother, as best man! Sympathy to MIN in the loss of his mother; congratulations on the new YL opr.. Joan Elizabeth. SUW's antenna, long idle while he rebuilt, came down just as he finished the transmitter! Too much convention work for SG. 3FRE of Bell Labs visited COW. NXG, RAQ, NIU, KJY and TBZ are rebuilding in preparation for a big winter season. VES claims to be the youngest and the northernmost ham in Chicago. Taylorville seems to be a Navy town—EMN on cruise, KPS and LIV reorganizing an N.C.R. unit. *Illinoise* will return with September issue—report to get yours.

Traffic: W9EBX 53 IYA 38 DDO 24 VEE 16 LIV 10 WC 9 RAQ 8 NXG 6 NHF 5 HQH 4 VEE 2 ANQ-FTX-SKF-PNV-HPG 1.

**INDIANA**—SCM, Arthur L. Braun, W9TE—SYJ leads state in traffic this month. CB is rebuilding. HUF is now at New Castle. HSF is now at Indpls. DET is on 3.5 mc. HUV has 55 countries now. UNI is ready for DX on 1.75-mc. 'phone. TYF likes contests. NQJ has motorcycle now. URX is an ice man. WBA is staging a come-back. TWC has 53-802-10-P.P. '10's in new rig. LLL is building a new mike. EGQ wants Asia for W.A.C. SXU is building 56-mc. rig. LYK worked YR, ZB and LY for DX. NTP is giving 3.5 mc. a try. HKU has new RME-69. WMC is going on 1.75-mc. 'phone. LKI is on 14-mc. 'phone. VVG has new rotating ant. JTU is commercial op. on Lakes. JOQ plans 56-mc. mobile 'phone. YMP is new in Ft. Wayne. SQH rebuilt speech equipment. YLH is new at Green Castle. JHQ and TBM are lining up fall traffic schedules. GFS pounds brass at JXB. TE is ready for N.C.R. drills and traffic. YMA is new at Indpls. HFM is ready for winter traffic. All new amateurs as well as old-timers are invited to join the Naval Communication Reserve. The Reserve will do a lot toward developing new amateurs into efficient amateurs. Every amateur should take an active part in his hobby, and Naval Reserve and Army Amateur organizations offer the finest training for any operator. The drills offer splendid code practice, and ANY and ALL hams will increase their code speed and proficiency. Address all Naval Reserve requests to 9STQ and all Army Amateur inquiries to 9HUO. Don't delay. Write today while it is on your mind.

Traffic: W9SYJ 246 TBM 3 TYF 16 EGQ 14 FHM 31. **MICHIGAN**—Acting SCM, Harold C. Bird, W8DPE, R.F.D. 2, Pontiac, Mich.—Ass't SCM, Joseph Lessard, W9PDE, Box 223, Munising, Mich. Nice letter from IFQ giving us the dope on the Ludington gang. JTK and LLL are still running the ferries across the lake, recently being responsible for National Guard troops. DWI is sailing on Str. *Richard J. Reiss*. IDW is operator for Ann Arbor Railroad. JWH is commuting between home and Ann Arbor on account of having leg smashed in auto accident—glad to report he's coming along okay. KST and LRX are getting ready for big season. NVX is working as carpenter. CPY is running for county clerk and campaigning via 3.9-mc. 'phone; he says first ham to get married in Mason County will get marriage license (if he's elected). HI. HZY is rebuilding (remodeling old dwellings). IFQ will be on soon with an RK-20. JTK, NVX, LLL and IFQ recently visited ALL at Northport. New ham there also: PUR. FWU at Lenox is waiting for new rectifier tube. AF moved and has been QRL fixing the new shack. EGF is operating S.S. *Greater Buffalo*. WSBH, FX says has receiver working FB now and 200-watt transmitter ready to go—FB. DYH is very busy with plumbing work and landscaping, also replacing condensers in old Lizzie (?). PKX, Bay City, is QRL with one schedule and swimming. BR5 will be on 3.5 mc. this winter, or else. BFP is planning and practicing for c.w. 8NUV whoops for work on the Bulletin and wants us to keep it up—we sure will as long as the reports keep coming in. A report each month from each of you will help greatly to make this column and Bulletin the success we want it to be. Ye Acting S.C.M. is still helping C.C.C. with schedules to side camp. 8NXX has been on 7 mc., came to 3.5, handled couple messages, then back to 7 mc. 8QDK, newly hatched ham, expects to be active when he gets organized. 8HZC moved to new QTH. 8AKN is still working the old G.M.C. station. 8EPI says 'phone is good and c.w. isn't so bad either. 8NXX is busy with new receiver. 8NMX is rebuilding for

14-mc. rig. 8KXX is still dickering for some equipment. 8COW says rebuilding; will have 53-53-53 exciter 804 buffer and HK354 final when completed. 8LSF hopes to get big reports soon. 8QDG, formerly 9NUF of Chgo., wants O.R.S. 8DED has made a crystal grinder out of 8MYF. 8JTV got a job as operator on a small boat. 8DSQ is coming back to 3.5 mc. this fall. 8NUV wants O.R.S. 8NQ is still sailboating and Cairo surveying. 8JKO says Mich. A.A.R.S. started. 8OQG is now on U.S.S. *Pontchartrain*. 8ECI took a trip to Nova Scotia. 8NJC hears rumors that CHJ, FJL, LKE, ONK and NJC will all be on high-freq. end of 14 mc., all within a few blocks of each other. WOW. 8ONK expects to resume schedules this fall. MICHIGAN NINES: 9RTG was seen in Detroit. 9RTI is going back to Baltic for two weeks' vacation. 9IOV would like a job—got? 9SQB moved to new QTH; was on Isle Royal at PCU for two weeks but got chased out by forest fire. 9PCU on Sat., Aug. 8th, sent out "QRR" for boat to stand by to take them off the island because forest fire so near. 9TTY went on camping trip with 9YMR.

Traffic: W8DPE 81 HTK 72 OCU 38 DSQ 20 ISF-NYV 14 ARR 12 BJ 8 BPB 4 MCD-NOV 1 LFS 19 QDG 13 DED 9 NDL-NUV 2 ECI 1 MCV 2 LTT 10 NXT 2. W9TTY 18 SQB 15.

OHIO—SCM, Everett H. Gibbs, 300 High St., Wadsworth—CIO leads the Section with a fine total for this dulltest time of year. BBH complains of heat (unanimous!), but punches out plenty just the same. EEQ enjoyed two weeks U.S.N.R. cruise. Turn the gain down for WE this season—increased soup. NYY does his stuff on 1.8 mc. and will soon be O.P.S. LZE has new center fed 7-mc. skywire. The 56-mc. bug bit AQ on his vacation trip to W1. AXQ is active on 1.8 'phone and 7-mc. C.W.T. MXW sends initial report and wants traffic schedules. Rebuilding keeps BMK, CMI, ISK and DCI busy. FNK returned to single wired Hertz after trying them all. RN can be heard temporarily on 400kc. signing WDDS. DIH reports for Norwalk gang. GBZ moved to new QTH. FGC now has two comm'l tickets and wants chance to use 'em. KLP returned from trip to W6-7. LUT got kick out of last O.P.S. party. LRV rebuilt to rack and panel. EDR and DXB, P.A.M.'s, are lining up prospects for O.P.S. MFV is new O.B.S. on 1.8-mc. 'phone. OPT has finished rebuilding. Ditto LAW with QRO. FKW moved to new QTH but may move again. Add temporarily sagging antennas: BKE, HCR, EEI, NOV, LCY and NGJ—causes various. A fine bunch turned out for the State Convention at Columbus and the gang awaits fall WX with enthusiasm. As the new season comes along, let's all help keep OHIO on the map. Reports are welcomed from all stations interested in any phase of organized ham activity. It is regretted that some station reports were unavoidably delayed in the change of S.C.M.'s. The gang sends hearty thanks to Bob, W8CIO, for his fine work of the past two years. At 8YX, at the University of Cincinnati, a new c.w. transmitter has recently been installed to replace the old one, which has been in continuous use since 1926. O.P.S. notes (by 8DXB, P.A.M.): ICF is building new shack on rear of lot. KNF is at new location. GMI has 14-mc. rig under construction. EMV has cooperation of a local pilot for u.h.f. ship-to-ground work. OXK gets fine results on 56 mc. from air, water and underground cave at Put-in-Bay. ARF has new junior operator. HFR took part in August Field Day.

Traffic: W8CIO 75 BBH 50 EEQ 29 WE 18 NYY 16 LZE 7 AQ 6 AXQ 3 BMK 1 MXW 2.

WISCONSIN—SCM, E. A. Cary, W9ATO—The state net started Sept. 14th. It meets at 6:30 p.m. daily except Sunday on 3775 kc. W9JAW is control station. Everyone interested in joining, drop a card to him or ATO. What say, gang? Shall we put Wisconsin on top this year? It's up to each of you individually. A report to ATO on the 16th of each month for the rest of the season, whether you are A.R.R.L. member or not, will add to our totals. Let's have a report from every station! WSY visited LAD and ULE. RBI is one station handling traffic on 'phone; he was W.A.C. and W.A.S. on 1.75 mc. SZL is getting set for traffic. VNB reports for first time; he is on 7 mc. with '45 Hartley. ONI installed 6L6 and says it's the best crystal oscillator yet. WQT is new ham in Oconomowoc. OXP works at Western Electric. PFQ likes Brown's new blotters. UGE moved next door to OXP! KXS is new ham in LaCrosse; he hails from St. Louis. AZN and AKY are going in for 56 mc. in a big way. HSK was on for O.R.S. party. RSR plans attending U. of W. this fall. RSA moved to West Allis. WIR is working as sewing machine salesman; he announces the arrival of new jr. YL. RZY's antenna went up two feet since he put

a new basement under the house. RJT has new 1928 Chevy. PSC is looking for a 50-watt bottle. DXI bought a new service truck. TPO is planning using 6L6 as buffer-doubler. JAW's O.B.S. schedules now 9:30 p.m., 3572 kc., and 10:00 p.m., 3775 kc., Sunday, Wednesday and Friday. ULE built teleplex. KQB used two dollars' worth of solder with no better results. UMQ has 3.5-mc. zepp erected with the aid of a steeple jack. OZR, OZQ, KZU and KYI were on Naval cruise. PFH is finishing new crystal rig using P.P. '03A's. PFT built new ham shack. Clubs: Racine Club is planning a picnic; YL's, prizes n'everything. Superior Club held a picnic Aug. 2nd; at last meeting a lecture on the relation between radio and astronomy was given by Mr. E. H. Schreiber of State Teachers College.

Traffic: W9JAW 14 WSY 10 RBI 7 SZL-VNB-WQM 3 ONI (WLTN 2).

## MIDWEST DIVISION

KANSAS—SCM, O. J. Spetter, W9FLG—Looks like we are to lose the old man of the mountain, RIZ; he has left for California and is not sure he will return. NI is in camp again and doing big business. UTK reports RHG in Florida and keeping in touch with home thru schedule with VBQ. RHG is new call of 4EFZ. UTK is on 7 mc. with '10's in final.

Traffic: W9NI 601 GRA 243 FRC 226 ICV 59 GWN 55 UTK 15 RIZ 13 (WLUV 232) KXB 5.

MISSOURI—SCM, J. Dewey Mills, W9CJR—Former S.C.M., 9EYG, comes to life and reports arrival of Junior op; congrats, OM. DI left this Section for his former Section, Nebraska; sorry to lose you and hope you prosper in your new venture; Missouri loses good O.R.S. and Nebraska gains. DI wants schedules with Missouri, and WPJ will carry on for him at St. Louis. TDU moved rig into new rack. BMA is rebuilding. LLW is using 6L6 rig. LHQ is rebuilding for 1-kw. input. Grandstand at ball park fell on FHV. JWI has improved note—congrats. TDU has makings of pool expert. OOU is on 56 mc. some. OUD is still hunting Africa to make W.A.C. ARH works plenty of DX. KCG is on 7 mc. KEI wants to get trunk line going early this year. AID is back among the active! The Missouri Convention at Jefferson City really went over with a BIG BANG, thanks to the Capitol City Amateur Radio Association; they worked hard and long and were rewarded with a splendid attendance. The highlight of the Saturday evening stag party at the club house was the QSO with IQP, John Reinartz, in person.

Traffic: W9OUO 56 LLW 46 EYG 9 KEF 6 ARH 5 SGP 2 (WLUX 6) OUD 2 DI 33.

NEBRASKA—SCM, S. C. Wallace, W9FAM—EDI of Lincoln stopped in to see FAM. EHW has been doing a little rebuilding. TBF made a trade for a new NC-100. MZF reports. DLK reports a nice picnic down there and plenty of good eats; this was held in the Legion Park at Auburn. SUS spent a week in Des Moines with his brother, NWC. RUJ after so long a time has started to build his "sky hooks." KPA is building new transmitter and expects to be back with us this fall. UHT went back to Mich. and bought a new boat. KVZ spent two weeks in Nat'l Guard Camp. RQK, AVX and SQR have Class "A" tickets.

## DAKOTA DIVISION

SOUTH DAKOTA—SCM, Andrew J. Kjar, W9SEB—Well, gang, we sure had a swell time at the Rapid Convention; sure a swell bunch of fellows there; something doing all the time. CMJ and BP used their 56-mc. rigs in tour through the hills. The 'phone men and c.w. men staged a tug of war; the 'phone men finally won out. In the balloon busting contest OED won the buffer stage. Hi. ULQ won the big transformer, ONV won the big tube, while SXN won a pencil. WSJ and YNW, new hams at Sioux Falls, are using a 2A5 crystal and ten final. WUU is new ham at Alcester. DIY, WUU, CPP, FJQ and WGY were recent visitors at ALO. ALO is breaking in a new MacKay. CPB has new Jr. opr. Congratulations. WAJ is experimenting with antennas. CFU is rebuilding speech and modulator. FLO has new Breting receiver. OED has new Sky-Buddy. GYG is adding a 2A5 to his s.s. super. OXC, TY and WES are active again. PPR is building new crystal rig. SRX is using 6L6 osc. and getting out FB. IQZ is building new 6L6 crystal and 6L6 final. PFI, our old S.C.M., got a new wife. How about the cigars, Mike? CRY is using 6L6. VOD and VQN are experimenting with 58-mc. beam antenna. 2CBJ is located in

(Continued on page 108)

# LEARN CODE

the way you'll be using it—

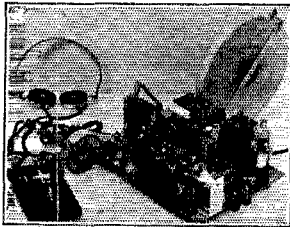

by SOUND

THERE is only one way to learn to read code and that is by listening to code. There is only one way to learn to send code and that is by hearing your own sending

repeated back to you. With the Master Teleplex Code Teaching Machine you learn code the natural, easy, fascinating way. Only instrument ever produced which records your sending then SENDS BACK your own key work at any speed you desire. We furnish complete course, lend you the New All Electric Master Teleplex, give you personal instruction with a MONEY BACK GUARANTEE—all at a surprisingly low cost per month. Write today for FREE catalog Q. 10. No obligation.

## "HAM" SPECIAL STANDARD TELEPLEX

A highly efficient code teacher using heavy specially prepared waxed paper tape, having two rows of perforations. Write for Free folder "Q.T. 10."

We are the originators of this type instrument

### TELEPLEX CO.

72-76 Cortlandt St.

New York City

The New Master Teleplex "The Choice of Those Who Know"

## QUALITY "HAM" ACCESSORIES

Upon your selection of the small but important accessories, depends the proper operation of your rig. The use of Birnbach Ham accessories takes care of this problem. Buy Birnbach — Be Sure.

Cat. No.	List Price
431	.15
431J	.20
432	.20
432J	.25
433	.25
433J	.50



1" High 1 1/4" High 2 1/4" High  
No. 431 No. 432 No. 433  
No. 431J No. 432J No. 433J

## BIRNBACH RADIO CO.

145 HUDSON STREET • NEW YORK CITY

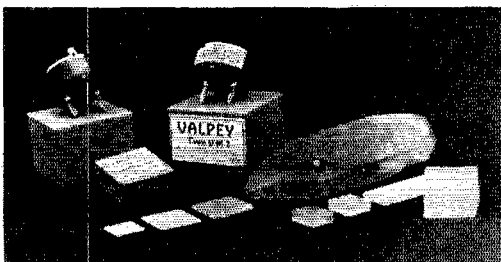

Type VM2. Mounted crystal within 5 Kc of specified frequency 1.7, 3.5, 7 Mc Bands.....\$3.00

Type VM2A. AT cut mounted. Drift less than 4 cycles per Mc per degree C 1.7, 3.5 Mc Bands.....\$4.50

See your dealer or write direct for catalog describing complete line

THE VALPEY CRYSTALS  
377 Summer St., Medway, Mass.

## Class-B "Squirt" Modulation With a Pentode Class-C Stage

(Continued from page 53)

C amplifier, varying the carrier output likewise. Inspection of the modulator diagram shows the condenser  $C_7$ , connected between the modulator primary center tap and cathodes, which gives audio-frequency filtering and the proper time constant. Some experimenting may be necessary to obtain best results and prevent distortion, although 4  $\mu$ f. works best in this case.

Two separate 200-ma. power supplies are used for the modulator and Class-C final stage, one delivering 600 volts and the other 400 volts. With the switch in the constant-carrier position, the 400-volt supply takes care of the Class-B modulator and the 600-volt supply feeds the final r.f. stage. In the controlled-carrier position, the two power supplies are connected in series, the negative of the 400-volt supply going to the positive side of the 600-volt supply. Since the 400-volt supply is then "above ground," no ground connection should be made to any part of its high-volt circuit and its components should be adequately insulated.

Tuning adjustments for this system have proved much simpler than anticipated. By means of the switching system shown, the rig can be instantly changed from controlled carrier to constant carrier. Thus the rig may be tuned up in normal manner as for constant-carrier operation and then switched over for controlled-carrier, leaving all adjustments intact. The writer has used a buzzer placed in front of the mike to supply a constant tone to the rig when adjustments are made in the normal manner. Since complete cut-off of the final is not obtained, there will be a weak carrier present during no-talking intervals. Adjustments are made by obtaining maximum antenna current through tuning of the final stage and the antenna filter. The same rules apply to tuning this rig as to any conventional type with respect to matching the Class-C load to the modulator impedance, antenna filter adjustments, and tuning to resonance in the Class-C stage. All r.f. circuits should be tuned accurately to resonance. All of the standard tuning procedures have been given in past issues of *QST* and the *Handbook*.

If one wishes more power it would only be necessary to add a pair of RK-18's or similar tubes to the modulator unit, using the 59's as Class-A drivers and raising the plate voltage to double maximum recommended for the tubes. A pair of RK-20's would be ideal in the Class-C final stage with this arrangement.

This rig has proved to be highly successful here and the writer is prone to believe that anyone changing his rig to the pentode "squirt" system using plate modulation will be more than pleased with the way it gets out. During several QSO's the writer has been asked why controlled carrier should be used. Excellent arguments were given

(Continued on page 110)

## Do Decibel Calculations Upset Your Equilibrium?

To Regain Your Composure Get Your Copy of the NEW KENYON ENGINEERING NEWS and be COOL, CALM and COLLECTED the Next Time You Use Them. This large size 16-page new magazine contains full page Ken-O-Grafs that cover every phase of decibel calculations used in radio. This live wire is full of real up-to-the-minute dope.

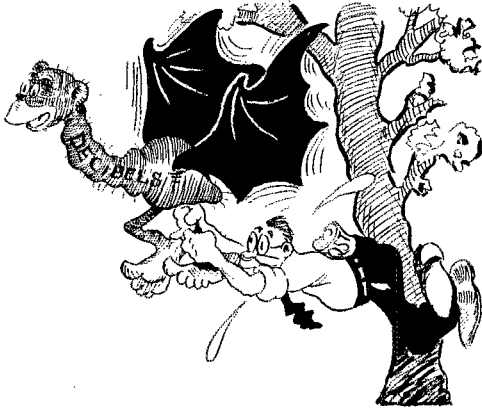

We are also pleased to announce a new Amateur Transmitter guide that is entirely free from blah. The large schematics show how to construct rigs from 5 to 500 watts. The circuits used are the most modern and were designed for you by competent, recognized radio engineers . . . men who have been actively engaged in amateur radio for years. Every ham should have a copy of this book. A new exclusive Kenyon development in plate transformer design enables you to change your transmitter to higher power with the same power transformer. This feature is the most modern and economical method yet devised for going into higher power without hurting the old pocket-book. The variable voltages available from this transformer provide the utmost in flexibility. To receive these valuable books free send your Q R A on a post card to

**Chief Engineer — Amateur Section**

**KENYON TRANSFORMER CO., INC., 842 BARRY ST., NEW YORK, N. Y.**

Radio Operator's  
Course

Complete in  
Telegraphy—  
Telephony

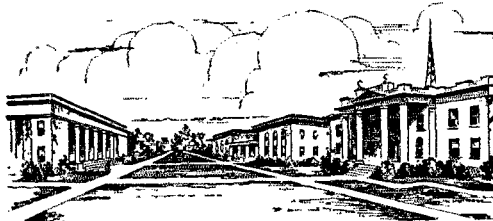

Practical  
Experience  
Studio—  
Transmitter—  
Announcing

P. A. C. is an endowed, educational institution — not privately owned, not operated for profit, college rank maintained. Course consists of maximum knowledge necessary to secure Commercial Telegraph Second-class, and Radio-telephone First-class government licenses. Course includes Wireless Code, Radiophone, Announcing, Microphone-Studio Technique, Service, Police, and Aeronautical Radio. We are authorized to teach RCA texts. At the completion of course you receive practical studio technique experience in our commercial broadcast studios located in the administration building, and experience as an operator on K P A C (500-Watt Commercial transmitter located on the campus, owned and operated by the college), and inter-departmental marine communication experience.

*If interested, write for Bulletin R*

**PORT ARTHUR COLLEGE** ■ **PORT ARTHUR (World-known port) TEXAS**

## A NEW TIME PAYMENT PLAN—NO INTEREST CHARGES

We now offer you a special five payment plan, which applies to all receivers, transmitters, and parts. A nominal \$3.00 account charge is made to cover credit investigation, etc. No time payment sales outside U. S. A.

	EXAMPLES:	Net Cash	Down Payment	Four Monthly Payments of
RME 69 Receiver Complete	.....	\$134.90	\$29.98	\$26.98
NC-100X Complete, Tubes, Speaker, Cabinet	.....	140.60*	31.12	28.12
2 Type 805 RCA Tubes	.....	36.00	10.20	7.20

\* New Price Effective Oct. 1, 1936

Our regular ten payment plan, with a down payment of only 10%, is available to those who desire longer terms. Finance charges are made on this plan. Parts and accessories are sold for either cash or five payments.

**WILLARD WILSON—W3DQ—DELAWARE RADIO SALES COMPANY**

405 DELAWARE AVENUE

Est. 1920

WILMINGTON, DELAWARE

(Continued from page 105)

Custer C.C.C. Camp and will be on soon. PVP is building a 59 crystal—RK-20 final. Say, gang how about some more reports??

Traffic: W9AZR 480 PGV 32 SEB 29 WAJ 21 VOD 13.

NORTHERN MINNESOTA—SCM, Leonard Hofstad, W9OWU—HEO is chief traffic handler this month. IZG, SNP and SAW visited HEL on Aug. 16th. TEF made a trip to twin cities and Milwaukee, attended a meeting of the Kilocycle Club and on his way home stopped in at your S.C.M.'s place. DOQ and YKO stopped in on KQA and the gang. YKD, the only active station in Ironton, uses a '45 in TNT on 3.5, 7 and 14 mc. Doq gave OVB permission to resume his radio work; he now schedules your S.C.M. on Saturday mornings again; he also attended radio picnic at Pine City. VJP spent eight days on a canoe trip up in Canada. RFP of Waterloo, Iowa, spent two weeks at a lake near Little Falls. VJP visited YAZ at Grey Eagle. YAZ has a 59 crystal-RK-20 transmitter working on 14 and 3.5 mc. DOQ and YKO visited VJP. FTJ rebuilt his rig. 47 crystal, 2-'46's, '03A with 200 watts input; mod. SB mike, 56, 2-'45's, 4-'46's; keying look on crystal coil for bk-in. YAP is having a little trouble getting enough excitation for 'phone. OOV finally got back on the air for the rest of his vacation. OTW is experimenting with the 6L6 that he got at the last Min-Dak Club meeting. Your S.C.M. rebuilt his rig AGAIN! HI; now it's a 59 Tri-tet, a 59 buffer-doubler, link coupled to a single '10 with about 50 watts input. 73. CU next month.

Traffic: W9HEO 16 VJP 1.

SOUTHERN MINNESOTA—SCM, W. F. Soules, W9DCM, TKX took his a.c. operated 56-mc. rig to Chicago on a visit, but found only d.c. in the hotel. YNQ is a new ham in Spring Valley. KUI should be on the air soon with two rigs. DH has returned from vacation and is back on 3.9-mc. 'phone. DEI is still having fun working DX. DHP has been on a vacation in the north woods. ExDUL/RB is getting the bug again. TUO is a new call in Minneapolis. RTE was reported in the 3rd district on 56 mc. HXR has moved to a new QTH in Minneapolis. DOP wants O.R.S. HFF has been quite sick, but we are glad to report he is up and going again. FPY got his old call back and is rebuilding so he can get on 1.75-mc. 'phone. NMB still operates at Fort Snelling. Ex-IRT is on vacation from school at Ames and is getting the urge to get back on the air. CPP keeps his first in action by operating at DOP. Ex-EES, an old ham from Luverne, made a short visit to the old home town; he is an operator with R.C.A. at Rocky Point. BFC is using a pole vault pole and a fish pole for antenna supports and expects to get out with 5 watts input on 14-mc. 'phone. SJK is finishing an article for QST. ELA bought BFC's exciter unit to bring East with him. EPD and the AVH brothers are in the forestry service. BTW and ex-BLG are rooming together in the East. EFF's new junior operator sleeps so much that he has not had the chance to teach Joe Jr. the code yet. Ex-AUU, now 2FVT, has worked schedules with several of the gang. ELA has been working Europe on 8 watts input since he moved East. If any of the fellows want to turn in their reports via radio, listen for DCM on 3940 kc. UBY is rebuilding for 'phone and looking for 14-mc. DX. A short time ago ITQ had a QSO with 9 BP via 56 mc. ITQ was using a 35T in his final and had plenty of soup on it. His antenna was supported by a piece of rope. During the QSO ITQ told BP that he smelled smoke. Upon investigation he saw the rope burning and informed BP of the fact. BP not believing this started to come back to razz ITQ about using too much power when he noticed that his own receiver was on fire. He was then convinced that ITQ had plenty of power!

Traffic: W9UBY 20 DEI 7.

#### WEST GULF DIVISION

NORTHERN TEXAS—SCM, Richard M. Cobb W6BII—BAM met quite a few of the gang on the N.C.R. cruise, also VP5AB at Kington. DXA is a very busy Route Manager and is doing a swell job with our traffic net. EOE reports the 7-mc. traffic net starts operation on 3.5 mc. about Sept. 3rd. EES is back on the air at new QTH in Childress. AID operated portable 'phone and c.w. at the T.N.G. Camp for two weeks. FEW would like a few schedules between 6 and 7 a.m. for traffic or? FMZ installed new 3.5-mc. antenna. CPB rebuilt his rig into a rack and panel job. FBQ raised a VK on a plain CQ and got a heard card from England on the same CQ. CHJ expects to be active in the A.A.R.S. this fall. FZG, a new ham, would like to get in touch with some traffic men. GPT is now W.A.C. with 8

watts, 4 of them on 1 watt (45 volts). Is this a record!? NW is active on 7 mc. with schedules with A.R.R.L. headquarters. COK is on the air. ROP reports for first time. EEW is up in the Rockies on a big fishing trip. BII is about ready to fire up the new 50-watt rack and panel job; he met several of the gang at Camp Hulen with the National Guard. #36 Division Amateur Radio Club was organized at the Texas National Guard Camp, Palacios, with a charter membership of 40; officers elected are: AID, president, FQQ, vice-president; DRO, secretary; FMX, treasurer, and CIJ, sgt.-at-arms.

Traffic: W5BAM 305 DXA 254 EOE 78 EES 39 AID 34 FEW 24 AZB 20 FMZ 17 CPB 6 FBQ 2.

OKLAHOMA—SCM, Carter L. Simpson, W5CEZ—RU took his rig to Ft. Sill during N.G. Camp and handled a nice bunch of traffic. FOJ signed up with the A.A.R.S. C.W. Net; he with EGP maintained schedules with RU during N.G. Camp. CEZ is trying a 6L6 crystal oscillator. BJJ is using a 6L6 osc. to kick a 211 in new rig. FX got promoted to Chief's job. Congrats, OM. FFK reports two new hams: FVY and FZF in Seminole. CVA spent two weeks at Ft. Sill in N.G. Camp. FXG is new ham at Henrietta with a 3-band transmitter. AIR passed a "J" for W.A.C. ESP got his Class A ticket. AMT needed his telegraph Second Class exam and now hopes to find time to renew activities in A.A.R.S. DQV has worked 13 countries. CEQ has trouble making schedule with GA, who has gone to Bakersfield, Calif. CFA announces the arrival of a son, August 4th. Congrats. DWB volunteers for A.A.R.S. WX Net. ERM spent most of summer at C.M.T.-C. Camp. AIR reports a 6L6 osc. Doesn't do so well on a 14-mc. crystal, but kicks a 211 up to 200 watts input on 3.5 mc. DZU and BKK both have new rigs and are ready for A.A.R.S. season. FIK worked a K6 with 8 watts input to a 59. DTU is running 500 watts to his rebuilt '03A rig. CJZ moved to Drumright and reports the YL is now the OW. Congrats, Barney. BLT got back into A.A.R.S. FLY reports from N.G. Camp that the rig is rebuilt and ready to go. For those who were interested in the Oklahoma Amateur Police Net, the following is quoted from a letter received from the F.C.C. after their investigation of its activities: "There is no objection to the organization of such a network provided that the amateur stations involved receive no compensation, material or otherwise paid or promised." What say we get it going again?

Traffic: W5RU 487 FOJ 391 EGP 310 CEZ 268 (WLJC 10) BJJ 69 FX 46 FFK 38 DDW 32 CVA 35.

SOUTHERN TEXAS—SCM, Ammon O. Young, W5BDI—CWW applies for O.R.S. appointment. DWN spent two weeks with the National Guard at Mineral Wells and one week at the Centennial at Dallas. EYV applied for O.P.S. Ft. Stockton is still being represented by BEF. DBR says the QRM and QRN are too much for his 25 watts. FNH is champion DX hound of Kerrville. DSH has been having QRM from B.C.L.—hi! EBN increased power. FNX is hunting DX. EZE moved back to Kerrville. TF is QRL honeymoon. BSF is living in a camp for the summer. FYD is new station in San Antonio. MN is ready for the A.A.R.S. season. OI, ERC, EYR and their respective YF's attended the recent hamfest held at Corpus Christi, and they report a swell time. FMZ was the first station to get a W.A.K. certificate. DTJ reports from way up in Massachusetts; he hopes to visit A.R.R.L. headquarters on his way home. FDR is planning on 1-kw. rig. FDS has been working some nice DX. BHO handed traffic from the National Guard Camp. EKP has been on a seven weeks' vacation in Texas hill country. FI is still building on his rig which ends with P.P. '52's. EYW is having his troubles with his 35T's. EEX is planning on going to the convention. BDI is rebuilding.

Traffic: W5FDR 1960 OW 1396 MN 257 CWW 40 BEF 30 DWN 25 BHO 22 FYD 8 DBR 6 FDS 1.

NEW MEXICO—SCM, Joseph M. Eldodt, W5CGJ. Traffic: W5DZY 56 ENI 8.

#### ROCKY MOUNTAIN DIVISION

COLORADO—SCM, Glen R. Glasscock, W9FA—August saw the annual convention come and go, and what a time everyone had! The official count was somewhat over 200 and, with about 425 hams listed for the state, that is a very good percentage. The latter part of August saw the State Fair in full swing; the hams in Pueblo had a booth there. WWB, a new Pueblo ham, sends dope on activity there: TWJ installed his rig at the fair grounds to act as distribution point for all Pueblo stations, consisting of WWB, TSQ, WTW, TEJ and NVE. Messages of greeting for the Governor of every State from the Governor of

Colorado were the first messages transmitted. SMN has moved to Climax, WFV/9, "MID," is still wandering around in the Colo. Hills; he's now at Cliff Lake, and reports working 25 states with the portable, and only three watts input. PWU enjoyed himself this summer with three rigs to play with, working 'phone on 1.75 and 3.9 mc. with about 400 watts and 14 mc. with an 801, and a transceiver on 56 mc. EHC sold the ACR136 and now possesses a Sky Buddy; he had visits from 9LBB of K.C., Mo., and 9IRB of Holdrege, Nebr. TTD at Las Animas made application for O.R.S. SBB moved back to 3.5 mc. PWO made a tour of the state to see N.C.R. members during his vacation. PTI, REU and UYS joined the N.C.R. ESA took in the Jenny Lake Hamfest again this year and then went on up into Washington for the rest of the summer. APR also went to Jenny Lake and Yellowstone but returned via Salt Lake City. DSB is spending a month at Colo. College in the Springs. FCK went along, too, just to see if he could play hockey. ESX is seriously contemplating the purchase of an "HRO." MKN got the skywire mounted at the new QTH. JFD re-enlisted in the N.C.R. and is now wearing a service stripe. Congrats, OM. VXX is now working on 3.5 instead of 56 mc. EYN is in the process of building a 75-ft. vertical. 6LN, ex-9DKM, was a recent visitor in Denver. Let's have more dope for this column, fellows. Activity should be on the increase from now on through the winter.

Traffic: W9WVB 60 WFV 29 YAD 18 PWU 17 EHC 9. UTAH-WYOMING—SCM, Townsend J. Rigby, W7COH—7BXS, Casper, reports having had a wonderful time at Jenny Lake. 7AMU is still active A.A.R.S. 7EOT was appointed D.N.C.S. No. 2 in place of 7COH, who was promoted to S.N.C.S. No. 3. 7NY and 7CBL are on occasionally. 7CLG moved to Midwest and is rebuilding. 6KOP, Salt Lake City, is rebuilding and schedules VE4ZK on 14 mc. Ogden news (by 6LLE): 6GBO is building a new shack and is rebuilding to a new RK20 rig. 6CAI has a new station; 59 crystal RK-20 transmitter and new super receiver. 6NPU works some DX with a '45 on 3.5 mc. 6MDP has QRM from hospital and power leaks. 6FYR still works out of town and pounds brass on Saturdays and Sundays. 6LLE has built a new rig, a 59 crystal osc. and 804 final. 6IWY is building a 1-kw. job. 6BLE has begun to warm up the old rig again. 6FEB will be on again this fall. 6GRB is monkeying with grid-bias modulation. 6NOX, new ham, has a good rig line-up.

#### ATLANTIC DIVISION

**E**ASTERN PENNSYLVANIA—SCM, James M. Bruning, W3EZ. R.M.'s: 3AKB, 3AQN, 3EOP, 3ASW. P.A.M.: 3EOZ. IMPORTANT NOTICE TO TRAFFIC MEN: We are about to start an "Eastern Penna. Traffic Band" in which traffic will be cleared in the same manner as ship-to-shore service. How many East Penna. O.R.S. or other traffic stations have crystals in the 3640- to 3665-kc. band? Please send a postal card at once to SCM-3EZ, giving your name, call, power and frequency available in this designated band. 3ETM is looking for new A.A.R.S. prospects in Montg. and Bucks County. 3BRZ continues his good work on 28-mc. 'phone. 3AQN is back on for the fall season. 3BYS moved to new location. 3CZS is new O.P.S. making our Section total 8; Roy is police operator at WFFE. 3GMK is about to become Official Observer. 3IU enjoyed the last O.P.S./O.R.S. party. 3MG was on for last O.P.S./O.R.S. party. 3EOP did some nice work in last O.R.S. party. 3EUP has been nearing lots of DX on his new s.s. super. 3ADE is having a little trouble with his new rig. 3GGM has been completing his rack and panel rig. 3FBJ has been working on new relay rack job, using hand tools, and says, "It's some work!" 3EWJ returned from C.M.T.C. and is back on the air. 3EZ worked two South Africans on the "unlucky" day of August 13th. 8NNC had more trouble with his final power supply. 3EPJ has been working lots of DX. 3FLA will soon be back on the air. 3AKB spent her vacation at a mountain camp and has now resumed activities. 3EOP wants to put his First Class Broadcast license to work before the ink dries out. 3BGD had good luck and lots of fun in the German Jubilee Tests.

Traffic: W3ETM 30 BYS 24 AGK 17 FBJ 5 GGM 1 8NNC 4.

MARYLAND-DELAWARE-DISTRICT OF COLUMBIA—SCM, E. L. Hudson, W3BAK. R.M.'s: W3CQS, 3CXL, 3EQU. Chief R.M.: 3BWT. P.A.M.: 3WJ. CXL reports Capt. S. P. Collins has recently been appointed to succeed Capt. R. W. Minckler as liaison officer A.A.R.S. He is an ex-amateur of spark days and very much interested in

amateur radio work. BWT handled traffic from Bowdoin Kent's Island expedition. FPQ is making application for O.R.S. CWE worked several new countries. FSP was in O.R.S. party. GFF had 562 QSO's in 125 days. EZN is rebuilding with pair of 860's in final. BAK, GAU, FQB, EDS, and CDG report. CDQ has new mast erected and is getting ready for 82-mc. work using a 14-mc. crystal. EYB is going to work portable in Indiana on his vacation. GAB is a YL; an FB call for a YL, HII FGD recently had a visitor who wanted to know if his final tank condenser was an egg chopper.

Traffic: W3CXI 41 (WLM 513) BWT 224 CIZ 136 FPQ 83 CWE 47 FSP 12 GFF-EZN 9 GAD 7 GKT 4 EPD 3.

SOUTHERN NEW JERSEY—SCM, C. D. Kentner, W3ZX—All O.R.S. and R.M.'s take notice! The South Jersey Spot Net will start off for a big winter season on October 6th. The same procedure, tie and frequency will be used unless you are advised differently. 7:15 EST, Tues., Thur. and Sat., 3700 kc. Knock the cobwebs off the rectifiers, shine up the spot crystal, and let's go, gang! The South Jersey Radio Ass'n is all set for its annual Field Day and station hunt; the prize winners must locate three stations hidden in the Jersey pines, and the day will be climaxed by a big feed and chew-fest at the shore. AWH sends in nice total handled with Pine Camp, N. Y. EKL is still on vacation in Rehoboth Beach; he plans 6L6 osc., 6L6 buffer, 830 amplifier, and 50-T final for his transmitter this fall. BO reports nice total handled with Pine Camp. FTK is getting his schedules started, and is anxious for net to start. FOS has joined National Guards, and A.A.R.S. DNU reports QSL from G6PD on 14 mc., which band he never works. FFE reports from Friends Service Camp in Cressville, Tenn. The Section is sorry to hear of the death of BR's father. ZX and BEI kept RM-Nite contact while ZX was at 9CVN in Wichita, Kansas. FBM will be on with RK-20 this winter.

Traffic: W3AWH 51 BO 46 FTK 87 DNU 44 ABEJ 9.

WESTERN NEW YORK—SCM, C. F. Smith, W8DSS—LQU, operating from Y.M.C.A. Camp at Lake Pleasant, N. Y., handled a nice bunch of traffic and leads the gang this month. FB, OM. CSE is in line for nice promotion in A.A.R.S. NWZ is making schedules and getting interested in O.R.S. CPJ again leads the O.P.S. although CGU is giving him some competition now that he has received Class A ticket. FUG reports nice traffic via radio. DHU is back in the fold again, having transferred from Northern N. J. LGV and EUY are benedicts now. Congrats. GWT spends his spare time working DX. ACY received card from MX2A for his seventy-third country. AQE wants some morning traffic schedules. DX has new YL op. HTT passed O.R.S. test with flying colors. FB, OM. JZT reports for first time in years and says he is going to Alfred U. this year. JTT entertained MBI, PCV, PMZ, OGH and PUM of Jamestown. MBI is entering Tri-State College soon. AVF toured the state with GWT. BJO and BHK sent in identical reports: "TFC NIL." NNJ has FB 56-mc. rig. ONC spent his vacation fishing in the St. Lawrence River. The ex-SCM, DSP, visited DSS recently. There will be plenty of cancellations of O.P.S. and O.R.S. very soon, if the S.C.M. doesn't receive regular reports from more of the gang. Now is the time to get those winter schedules lined up. W.N.Y. traffic season opens Oct. 15th. Let's be prepared to lead the Division right from the start. Shall we have a W.N.Y. O.P.S.-O.R.S. QSO Party this fall? Send in any suggestions with your next report. 73.

Traffic: W8LQU 173 DSS 92 CSE 55 NWZ 34 CPJ 31 FUG 20 CGU 8 DHU 6 LGV 5 GWT 4 HTT 3.

WESTERN PENNSYLVANIA—SCM, Kendall Speer, Jr., W8OFO—R.M.'s: 8GVF-KWA-MOT. New O.R.S.-QAN. New O.P.S.-QAN. New O.O.-GLA. Prospective O.R.S.-LZT (LGD). Prospective O.P.S.-FIP. LZT (LGD) is working hard for O.R.S.; has a nice total this month. DGL has been vacationing at the seashore. QCR is a new station in Monessen and QCK-QCL in Charleroi. CMP (CIK) is still vacationing in Michigan. OFO has a generator on his emergency rig now. KBM is trying to find the bugs in his receiver. CHT has been on the sick list. KUN is ready for an active season. AXD and KDM helped put on a 56-mc. demonstration at the recent Bradford Air Meet. MIW is renewing schedules. QAN is an Old Timer (ex-8DE-8LF) back in the game with 440 watts on 'phone and a kw. on c.w. (Wow!); he has just been appointed O.R.S. and O.P.S. FIP was in Cleveland attending a convention. GJM says the S.H.B.P. & M. will have a rig at the County Fair at South Park. GXQ is working at WCAE.

Traffic: W8LZT (LGD) 90 DGL 14 CIK (CMP) 21 OFO 7 KBM 4 CHT-KOB-KUN 1.

## BEGINNERS

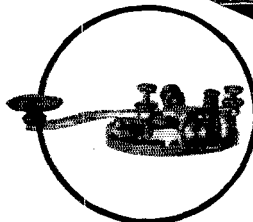
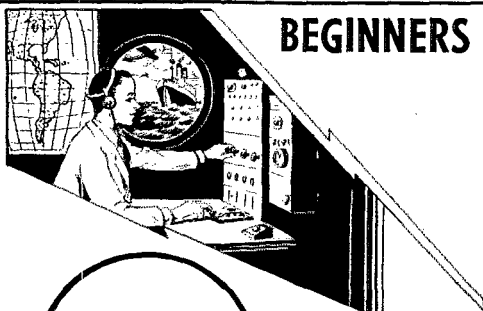

## YOU'LL LIKE THIS SIGNAL WIRELESS KEY

Every beginner who has used this Signal  $\frac{1}{4}$  K.W. key approves it for its desirability and inexpensiveness. It is well made, with polished key lever and lacquered parts. Contact points are platinum. List price \$2.80.

Signal's line of Wireless Keys, Telegraph Instruments and Wireless Practice Sets is complete. Send for our bulletin.

**SIGNAL ELECTRIC MFG. CO.**

Menominee, Michigan

U. S. A.

**SIGNAL**  
MANUFACTURERS OF ELECTRICAL PRODUCTS

## T. R. McELROY

WORLD'S CHAMPION RADIO TELEGRAPHER  
23 Bayside Street, Boston, Mass.

MAC KEY @ \$7.95 a real speed key.  
MAC KEY DELUXE @ \$15.00.  
MAC CORD @ \$1.00 speed key cord.  
MAC CASE @ \$3.95 speed key case.  
MAC OSC @ \$3.95 ac/dc oscillator. Tone control.

If u hv Mac Key wri me fo xmy lpt & dsrb lfn.  
All my stuff emcy gad best pdtus obl. 73 Mac.

## BUD MIDGET RELAY RACKS

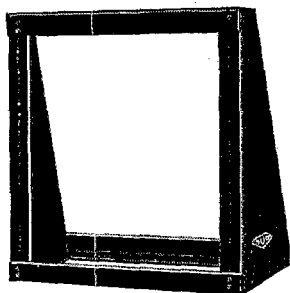

It is an ideal unit for that low power transmitter, amplifier, P.A. system, or test panel.

Made of heavy gauge sheet steel. Finished in baked-on black crackle enamel. Drilled to fit standard 19' rack panels. Light in weight and sturdily built. Shipped knocked down with necessary self tapping screws. Easy to assemble.

No. 1248 — Over-all height 25" — Width 20" —  
Depth of base 10" — Panel Space 21". List... \$6.50  
No. 1249 — Over-all height 32" — Width 20" —  
Depth of base 12" — Panel Space 28". List... \$8.50

**BUD RADIO, INC.**

1937 E. 55th STREET

CLEVELAND, OHIO

## Class-B "Squirt" Modulation

(Continued from page 106)

in the January 1935 issue of *QST*, page 9. However, two reasons predominate. First you can reduce power by talking lower into the mike, thus preventing unnecessary QRM; and the Light Company will furnish additional evidence in the form of a decreased light bill, because quite a saving of power is effected by the use of this system.

The writer will be glad to answer any inquiries by mail if return postage is included.

## I. A. R. U. News

(Continued from page 61)

Madeira: See Portugal.  
Malaya: J. MacIntosh, c/o Posts and Telegraphs Dept., Penang, Straights Settlements.  
Mexico: L.M.R.E., Apartado Postal 907, Mexico D.F.  
Morocco: A.A.E.M., BP 50, Casablanca.  
Netherlands: N.V.I.R., Post Box 400, Rotterdam.  
Netherlands East Indies: N.I.V.I.R.A., M. M. van Heusden, Jr., Burg. Coopsweg 28, Bandoeng.  
Newfoundland: Newfoundland Amateur Radio Association, P. O. Box 650, St. John's.  
New Zealand: N.Z.A.R.T., P. O. Box 517, Dunedin.  
Norway: N.R.R.L., P. O. Box 2253, Oslo.  
Palestine: See Egypt.  
Peru: Radio Club Peruano, Apartado 538, Lima.  
Philippine Islands: George L. Rickard, P. O. Box 849, Manila.  
Poland: P.Z.K., Bielowskiego 6, Lwow.  
Puerto Rico: Francis M. McCown, Family Court No. 7, Santurce.  
Portugal: R.E.P., Rua Primerio de Dezembro 33-3, Lisbon.  
Rumania: Victor Cantunari, YR5VC, Str. Matei Rasarab, 3 bis, Bucaresti IV.  
Salvador: J. Frederico Mejia, 7a Calle Poniente 76, San Salvador City.  
South Africa: S.A.R.R.R.L., P. O. Box 7028, Johannesburg.  
Spain: U.R.E., Apartado 262, Madrid.  
Sudan: Frank H. Pettitt, Catholic Club, Mustapha Barracks, Alexandria, Egypt.  
Sweden: S.S.A., Stockholm 8.  
Switzerland: U.S.K.A., Neu Allschwil near Basle.  
Tunis: See France.  
Uruguay: U.S.W.C.G., Box 37, Montevideo.  
U.S.S.R.: C.S.K.W. QSL Bureau, 1 Samotechny per., 17, Moscow

## Picking Out the Receiving Tubes

(Continued from page 53)

instance, to use many of the pentode types a triodes in high-output Class-AB amplifiers, the change being made by switching the grid connections. The 6L6 is called a pentode in this table because of its characteristics.

Going across the table from left to right, it can be seen that the tubes now fall into six divisions. The metal series constitutes one classification, then glass 6.3-volt tubes with either octal or old-type bases, 2.5-volt tubes with old bases only, and 2.0-volt battery tubes with and without octal bases.

It is no news to amateurs that a.c. tubes these days are all being made with 6.3-volt filaments or heaters; except for replacement purposes the 2.5-volt tube has passed out of the picture completely. The trend to octal bases is equally marked; the table shows that practically all the needed types can now be obtained in glass with



**AMATEUR RAYTHEON TUBES**

## RK-36

Designed for high plate efficiency and wide output at all amateur frequencies.

**CHARACTERISTICS**

Filament Voltage . . . 5 Volts  
 Filament Current . . . 1.5 Amperes  
 Grid/Plate Capacitance . . . 10 uuf.  
 Input Capacitance . . . 10 uuf.  
 Output Capacitance . . . 4 uuf.  
 Typical Operation . . . Class C  
 Amplifier or Oscillator

Plate Voltage . . . 2000 Volts  
 Plate Current . . . 150 M. A.  
 D. C. Grid Current . . . 30 M. A.  
 D. C. Grid Voltage . . . -360 Volts  
 Required Driving Power 15 Watts  
 Power Output . . . 200 Watts  
 Amateur Net Price \$14.50

Prices Subject to Change Without Notice

## New RK-35

A triode designed especially for outstanding performance at ultra-high frequencies.

**CHARACTERISTICS**

Filament Voltage . . . 7.5 Volts  
 Filament Current . . . 3.25 Amperes  
 Grid/Plate Capacitance . . . 7 uuf.  
 Input Capacitance . . . 25 uuf.  
 Output Capacitance . . . 4 uuf.  
 Typical Operation . . . Class C  
 Amplifier or Oscillator

Plate Voltage . . . 2000 Volts  
 Plate Current . . . 96 M. A.  
 D. C. Grid Current . . . 15 M. A.  
 D. C. Grid Voltage . . . 320 Volts  
 Required Driving Power 6.5 Watts  
 Power Output . . . 81 Watts  
 Amateur Net Price . . . \$8.00

**RAYTHEON TUBES** . . . recognized for years as the finest tubes that money can buy . . . have increased in popularity because of their dependability! Amateurs look for Raytheon Tubes, because they are conservatively rated, and do all that is claimed for them. Buy RAYTHEON Tubes and be sure of results.

**THE MOST COMPLETE LINE - ALL TYPES - GLASS, METAL, OCTAL BASE, AND AMATEUR TRANSMITTER TUBES.**

**RAYTHEON PRODUCTION CORPORATION**

420 Lexington Ave., New York, N. Y.; 445 Lake Shore Dr., Chicago, Ill.; 415 Peachtree St., N. E., Atlanta, Ga.; 555 Howard St., San Francisco, Cal.; 65 Chapel Street, Newton, Mass.

**How to Become**

**A RADIO AMATEUR**

Published by the AMERICAN RADIO RELAY LEAGUE, INC., West Hartford, Connecticut

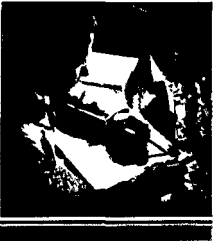

Price 25 Cents

" " " "

## NOT to Make More Amateurs But to Make GOOD Amateurs

is the purpose of the League's beginner's booklet

# HOW TO BECOME A RADIO AMATEUR

There is, inevitably, a constant flux of newcomers to the amateur game; it takes thousands of beginners each year to make up the annual 40% turn-over in our numbers. The policy of the F.C.C. and the League is to maintain, as nearly as possible, the status quo.

It is also the policy of the League to insure that these newcomers are competent, adequately-trained amateurs by supplying authentic instruction and trouble-proof beginner's designs. Such information is provided in the beginner's booklet.

Keep the beginner - QRM down — start your beginning amateur friends with **HOW TO BECOME A RADIO AMATEUR.**

**AMERICAN RADIO RELAY LEAGUE**  
WEST HARTFORD, CONNECTICUT

Say You Saw It in QST — It Identifies You and Helps QST

# VISASIG

## FULL AUTOMATIC SIPHON TAPE RECORDER

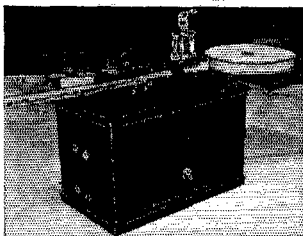

Records signals from a radio receiver or telegraph land line at any speed up to and in excess of 100 W.P.M. Use it to improve your fist.

VISASIG — complete with electrically driven tape puller.....\$49.00

VISASIG — without tape puller.....\$35.00

AUTOTRANS — auto code xmitter A.C.—D.C. \$50.00

PRICES F.O.B. NEW YORK CITY

### UNIVERSAL SIGNAL APPLIANCE

64 West 22nd Street New York City

Blueprints of either machine — \$1.00 each

# SICKLES COILS

ALL TYPES OF RF AND IF WINDINGS

Manufactured by

F. W. SICKLES COMPANY

300 Main Street

Springfield, Mass.

# LEARN RADIO

New Classes Now Forming! Send for 40-page catalog, explains

fully, 300 licensed graduates placed in past 4½ years in broadcasting, shipping, police radio, aviation, etc. We teach all branches. Oldest, largest and best equipped school in New England. Equipped with Western Electric sound and broadcasting equipment and RCA marine transmitter. Course prepares for United States Government telegraph or telephone license.

MASS. RADIO SCHOOL, 18 Boylston Street, BOSTON

# LEARN CODE RIGHT — the Practical, Easy Way —

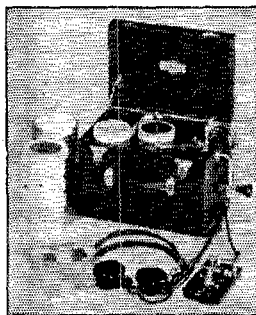

## Instructograph

Radio amateur code exams now require 30% more speed. And experts agree: "It pays to learn from a perfect teacher — Instructograph." It's easy to become a real operator when you can practice Radio or Morse at your convenience — at any speed you want. Comes in two models — Senior or Junior Economy. You may buy or rent, at low cost. Just send post-card for complete details now to —

INSTRUCTOGRAPH CO.

Dept. Q-10

912 Lakeside Place Chicago, Illinois

Representatives for Canada

Radio College of Canada, Ltd.

868 Bay Street, Toronto

octal bases, both in 6.3- and 2.0-volt filaments. Glass tubes with octal bases all have the suffix "G" tacked on the type number; in the 6.3-volt series a "G" number corresponding with a number of the metal series indicates that the "G" tube has the same characteristics as the metal tube. A few "G" tubes are actually independent types, not being exact duplicates of existing tubes in either metal or glass with old bases. We do not attempt to give the characteristics here; complete information is in the new *Handbook*, while most of the tubes have already been described in past issues of *QST*.

One thing this table shows is that octal bases now can be used throughout the receiver, whether designed for metal or glass tubes, a.c. or battery operation. In fact, it is now possible to adapt a battery set to a.c. and vice versa simply by changing a few—very few, at that—socket connections and substituting the appropriate tubes. It's not a bad idea, therefore, to ignore the tubes with old bases in planning a new layout; the needed ones already are available with octal bases.

—G. G.

## Hints and Kinks

(Continued from page 57)

by the use of several folds or layers of cotton cloth, and fill up with alcohol. Methyl hydrate also works well, but don't use gasoline! You'll be surprised at the number of jobs this lamp fills where the usual little soldering iron is out."

## Calls Heard

(Continued from page 58)

(3.9-mc. 'phones)

wlbes wlfir wlfce wldwm wlqv wlli wisk wldvr w2eve  
w2kr w2hyp w8ay w3dq w3axr w3gy vclbo vclci co8yb

James Warding, Lara, Victoria, Australia

(14-mc. 'phones)

wlzd w1gj w1end wlebt w1eit w1br w1ufd w1woj w1gr w1uh  
w2bsd w2e1x w2ebw w2bw w2bf w2buo w2ekt w2bh (Port-  
able) w2csy w2eh w2elo w2eoy w2eug w2aru w2eda w2aio  
w2hjs w2hfs w3eoz w3ppo w3apo w3qb w3beh w3bvx w3asy  
w3boh w3abn w3oxo w3bxc w3exp w3brk w3me w3rx w3abs  
w4cpg w4ddd w4cw w4up w4dco w4dqk w4lla w4oc w4bqb  
w4ab w4axp w4glk w4dsa w5cqi w5akf w5atb w5ebp w5act  
w5dq w5df w5aki w5ss w5ahk w5hoe w6kso w6abf w6enc  
w6cag w6bda w6isu w6iyh w6day w6sj w6anu w7qc w7ao  
w7dox w7aof w8dmu w8et w8jk w8ahc w8pqq w8dlc w8sc  
w8hcx w8ara w9jnv w9ipx w9hrb w9klk w9bj w9ruk w9rmx  
w9jng ny2ae ve5ot ve1bq

VK3CZ, A. Ingham Berry, Kembla St., Hawthorne E.2, Melbourne, Australia

(28-mc. band—April and May)

d4arr fb8ab fb8ag g6dh hj3ajh j2ce j2is j2lu j3cg j3dc j3fj  
k4kd ny2ae ve5bi w2ayj w2tp w3air w4bbp w5ql w6ac  
w6bbq w6bjb w6bpd w6pex w6grx w6jn w6kb w6gk w6rh  
w7avv w9aeh xelay zeljj zilba zilda zlidv zilcg zilkw  
z12bg z12bp z13ab z13d j13ja z14fw z11h z16k z16y

W8KAY, Akron, Ohio

(14-mc. 'phones)

vp3bg vp6yb vp9r vk2iq vk2mh vk2ap vk2fy vk3ho vk4jx  
py2ek celar celbo oa4aa oa4ak oa4r lu8ap on4vk yv5aa  
g6xr g5ml g5ni

W. N. Haugh, 34 Charlotc Place, Baltimore, Md.

ct1by ct1gu ea4am ea4ao g2nh g5by g5ml g5ni g6xr h6ifg  
hh6pa h1zk h17g hpl1a hpl1f k4sa k6bas k6kcp lu8op lu8ap

# QST YEARLY BINDERS



THOSE who take pride in the appearance of their lay-out and wish to keep their reference file of *QST*'s in a presentable manner, appreciate the *QST* binder. It is stiff-covered, finished in beautiful and practical maroon fabricoid. Cleverly designed to take each issue as received and hold it firmly without mutilation, it permits removal of any desired issue without disturbing the rest of the file. It accommodates 12 copies of *QST* and the yearly index. Opens flat at any page of any issue.

With each Binder is furnished a sheet of gold and black gummed labels for years 1919 through 1938. The proper one can be cut from the sheet and pasted in the space provided for it on the back of the binder.

A file of several years of *QST*, kept in order in binders, is a most valuable reference library for any Radio Amateur.

Price **\$1.50** postpaid

*Available only in United States and possessions*

**THE AMERICAN RADIO RELAY LEAGUE**  
WEST HARTFORD, CONNECTICUT

## This Month

Elsewhere in this issue of *QST* you'll find announcement of The Story of Amateur Radio. If ever there were a subject created for the purpose of recording its achievements between the covers of a book, amateur radio is it!

## Next Month

The A.R.R.L. AMATEUR RADIO MAP OF THE WORLD will be announced. Entirely new in conception and design. To contain every bit of information useful to the radio amateur. See November issue of *QST*.

**AMERICAN RADIO RELAY LEAGUE**  
West Hartford, Conn., U.S.A.

## Help

**For the  
AMATEUR**

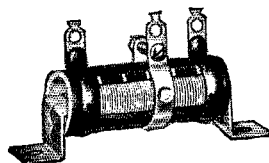

USE Electrad "Variohm" Dividers and get exactly the right plate, screen and suppressor voltages for those new pentodes. Five sizes from 25 to 200 watts to suit all power packs. 85¢ to \$3.75 each list.

Write Dept. Q-10 for Complete new Catalog of Resistors for All Purposes



# DOLLARS

## AND FIDELITY

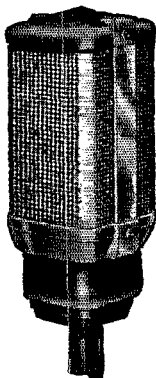

THE MU-X

Dollar for dollar you buy more real truthful reproduction in a Mu-X microphone.

So fine they are used in the most critical spots all over the world — and surprisingly low in price too!

Licensed under Patents of the Brush Development Company.

**THE TURNER CO.**  
CEDAR RAPIDS, IOWA

### RADIO COURSES

RADIO OPERATING: Prepare for Gov't License Exam. ●  
RADIO SERVICING: including Short Wave ● AMATEUR  
CODE ● New Course in ELECTRONICS.

Day and Evening classes — Booklet upon Request

**NEW YORK YMCA SCHOOLS**  
4 West 63rd Street, New York City

Power  
X cut

**O. C. L.  
Control Crystals**

High  
Output

Unconditionally Guaranteed

7000 KC ± 5 KC . . . . . \$1.85  
3500 or 1750 KC ± 5 KC . . . . . 1.50

**OMAHA CRYSTAL LABORATORIES**

544 World Herald Bldg.

W9JRY

OMAHA, NEBR.

W9CPM

**NOW!**

A compact Portable Transmitter and  
Non-Radiating Receiver for the popular  
Ultra-High Frequencies . . .

● AN IDEAL FIXED OR MOBILE STATION ●

"Type TR-6A6"

- Better Than Ever
- 7 Tubes — JENSEN
- 5" Dynamic Speaker
- New 6E6 Unity Coupled
- 10 Watt Carrier
- 100% Modulation
- Duplex Operation — PHONE ● ICW

F.O.B. FACTORY  
Less Tubes

**\$39.75**

**RADIO TRANSCEIVER LABORATORIES**

8627 — 115 Street, Richmond Hill, New York

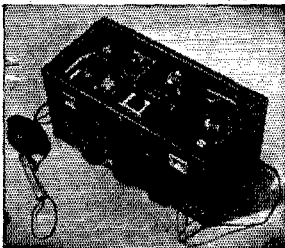

on4ac on4za tilbb ti2fg ti2rc ti3av voli vp2cd vp3bg vp5by  
vp5is vp6yb vp9r vp90

*Arni Sigurosson, P. O. Box 743, Reykjavik, Iceland*

(14-mc. 'phones during March-June)

w2esa w2edw w2cla w2bsv w1ajz w9kcl w2bad w1jhs  
w4cdv w2cbo w9rgl w1hac w3aac w2cnd w1arc w1hag w8wa  
w3coz w3gdu w1hem w3abn w8sd w3esa w3eoc w1cd w9jfe  
w9dmf w1dmf w1ctf w1ebo w2nk w1hkm w8ena w3cdc  
w9nrh w3dcj w4oc w2dc w1cb w1ctf w2cay w9fba w1bel  
w2bc w9fda w9wvr w9xq w9wd w1qb w3tbd w3bdi w2jos  
w2ctb w2aga w2cdr w9fc w1iab w8lfi w1cbe w1bnj w1cqq  
w3mv w9fa w3fh w5bee w1qm w1caw w9tha w2byp w8lyc  
w3ua w1cpd w9tqu w1axa w4alq w2ecr g2dl g2al g2bn g6pc  
g5na g5ml g6wu g5rb g6rv g5vl g5vd g6pc g5jv g5jo g6ok  
g6lk g6fs g5ni g6ak g2ao g6my g6yy g6bk g5dl g5so g6tc  
g6qs g6os g6lx g5tz g2bh g5je g6ox g6fa g6ah g5us g6sg  
ve2hd ve3jy ve3jb ve2ac velen ve3js ve2ca sm5sx celar  
pa6fb vp8yb ny2ae oa8a pa6idw ha4x pa6sb k4ddh  
spilm sm5tq voli vo4y vk2vq vk2xl f8bu f8ii f8dr ok3va  
sulch w2lqk on4vk ka2sq ny2ab on4ap on4pn on4ndb  
ct1by co6om co2xy co2hy co6cq.

*ZE1JJ, F. G. Whitmore, P. O. Box 591, Bulawayo,  
Southern Rhodesia*

(28-mc. band—March 6th—April 6th)

w1ahi w1cbs widze w1ry w2al w2cpa w4dhs w4ef w4ft  
w5afx w5wg w6cuh w8cra w8ifd w9ij w9spb w9tj fb8ab  
lulep on4jb z1lar vk3cz vk3mr vk3yp vk3zc vk3bq vk8sa  
zslh.

*OK2HX, Emil Zavadil, Sl. Ostrava, Czechoslovakia*

(28-mc. c.w.)

w1af w1ahi w1ayx w1dbe w1df w1duk widze w1ebr w1ewd  
w1ewf w1fju w1hio w1hqn w1lqz w1lje w1lz w1ry w1wv  
w1zd w1zi w2aiw w2bxz w2cpa w2cuz w2fkw w2icq w2smz  
w2sz w2tp w3afc w3air w3bew w3biw w3bdk w3hc w3pc  
w3wa w4ah w4au w4axt w4dhs w5afx w5dnv w8biq w8dgp  
w8dml w8drj w8dsu w8dsw w8ebs w8fsa. w8iil w8ixm  
w8mmh w9abe w9ach w9aeq w9bye w9cog w9dxx w9kfa  
w9min w9ptc veled ve2dc ve3aq ve3er ve3kf cp1ac ei8b  
g6oy fa8bg suljt sulro zeljj zslh

*YR5FD, Ing. F. Dinescu, Str. Buzesti 69, Bucu-  
rest, Roumania*

(14-mc. band)

velet velex velaa velae ve2dg ve2fg ve3js ve3dd ve3xq  
ve4bg ve5g w4coo w4cyl w4dgt w4caf w4cpg w4drd w4mr  
w6hx w6cxw w6cuh w6fal w6jwl w7bac w7dpc w7euk w7bin  
w7euy w8fub w8cn w8duh w8gfl w8lvh w8pst w8rum w8fob  
w8onr w9ar w9fa w9ag w9arj

**D4MDN**

(28-mc. band—April 2d-15th)

w1cgy w1hio w1fh w1ine w1lrb w2aog w2cuz w2dyk w2dth  
w3drb w3dgp w3far w3hc w3evt w4bbq w4mr w4ah w4ujy  
w5afx w8agu w8ifd w8ktw w9arn w9bt w9kpd w9tj w9ny  
ve1am ve1dc vk3bd vk3yp vk4el vk5zc z13aj vv2au lulep  
lu9ax lu9bv zslh zsa2a zelju zeljj zu5b zt5v zt6k fb8ab  
fb8ag ct3ab sulgt ch8mq oh7nc oh7nd oh7nf oa4j u9av

*CT1BY, Dr. Jose Garcia, 16 Praca do Rio de  
Janeiro, Lisbon*

(28-mc. band)

w1cfd w1arc w1elp w1ewf w1duk w1ewd w1dhh w1af w1aur  
w1avv w1lqz w1lqf w1fh w1dma w2icq w2byp w2fhi w2uk  
w2lir w2alk w2bef w2aol w2dc w2cbo w2tp w2dxa w2cqx  
w2aal w2cbo w3pc w3auc w3wa w3bys w3eys w4ajj w4ft  
w4agp w4ajx w4pbv w4ka w5bee w5tqf w5afx w5fhg w5ehm  
w5afx w5bmn w6dob w6dgp w6aet w7byw w7blt w8drj  
w8ixa w8agd w8kol w8ixm w8lea w8fcm w8dsu w8btk w8lly  
w9elf w9epi w9dcb w9gjb w9lxx w9flh w9jnb w9iuk w9ern  
w9hfk w9iuk y4aa ve3wa zslh vu9a oklaw ok2op y6rh  
oh3oi oz2m d4cxa oz7kg oz7x oh2nm d4ajj haf3dc ok2ak  
f8ej ve2ca

*W6AIX, A. E. Wolfe, 1084 Loma Vista Dr., Long  
Beach, Calif.*

(28-mc. band)

ea4so fa8bg g2nh g5by g6nh g6qb hj3ajh j3fk lu9ax on4av  
vk3ep vk3yp vk2lz vp5pz oa4j oa4b



# SPEED UP YOUR CODE

With the Exclusive **SOUND** Method  
That Developed the **CHAMPIONS!**

Trains You Quickly, Easily, To Meet The New  
CODE SPEED Requirements

## WHICH "TICKET" ARE YOU GOING AFTER— AMATEUR . . . COMMERCIAL?

WHEN you enter the Radio Inspector's office to take the examination for any class Amateur or Commercial License, you CAN go in with that feeling of absolute CONFIDENCE that always accompanies CANDLER trained Radio Operators. You can read code as easily as you read print, and make a good "mill" or pen copy at varying speeds without conscious effort.

MANY AMATEURS are entering the field of commercial radio through CANDLER Specialized Training. Com'l ops, embarrassed by their inability to "hit the ball," have doubled their code and "mill" speeds within a few weeks in their own homes or while on the job. Write us your problems today. You will receive a letter of personal advice and the New **BOOK OF FACTS**. No obligation.

**CANDLER SYSTEM, Dept. Q-10, Asheville, N. C.**



CANDLER Trained  
Jean Hudson, 9 Year Old  
Official Champion, Class  
E. Speed 30 wpm.

CANDLER Trained  
TED R. McELROY, Official  
Champion of the World,  
Class A. Speed 69 wpm.

McELROY says: "If you want to learn code quickly so you can read it like print, or increase your code speed, send for **CANDLER BOOK OF FACTS**. It contains the secret of my success."

**FREE—NEW BOOK OF FACTS**  
Contains McElroy's own story and other valuable information. A card will do. No obligation.

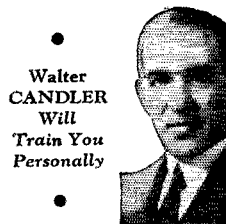
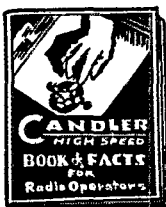

Walter  
CANDLER  
Will  
Train You  
Personally

## LET TERMINAL BE THE END OF YOUR JOURNEY

At **TERMINAL** you are assured of a full selection of  
quality merchandise and understanding co-operation

### TRIPLETT

NEW MODULATION MONITOR

Indicates actual modulation percentage of radio transmitters on direct reading scale. Factory calibrated and no further calibration needed — \$24.83 NET.

### TRANSMITTING TUBES

Taylor	866	\$1.65
Taylor	T55	8.00
Taylor	TI55	19.50
Raytheon	RK35	8.00
Raytheon	RK36	14.50

United Electronic Tubes in Stock

### LIBERAL ALLOWANCE

Trade in your old receiver for one of these new models

WE ARE DISTRIBUTORS FOR  
National Sets and Parts  
NC-100 40% off list prices  
HRO

Write for latest National Catalogue

### THE NEW HALLICRAFTERS

NOW YOU CAN BUY ANY OF THE NEW HALLICRAFTERS ON THE DEFERRED PAYMENT PLAN—INFORMATION SENT ON REQUEST. ALL MODELS IN STOCK

### RME 69 RECEIVERS

IN STOCK FOR IMMEDIATE DELIVERY Complete \$134.90

ALL THE ABOVE RECEIVERS ON DEMONSTRATION

### THORDARSON

In stock all Tru-Fidelity Transformers, 6L6 Amplifier Kits, Transmitting Kits.

Descriptive catalogues on request

### NEW CRYSTAL MICROPHONES

Shure Astatic  
Turner Brush  
American

### BLILEY CRYSTALS

A complete stock of Bliley Crystals on hand at all times.

## TERMINAL RADIO CORPORATION

80 CORTLANDT STREET

BILL FILLER

W2AOQ

NEW YORK CITY

ADOLPH GROSS

**Meissner**

## "Align-Aire" AIR TUNED Transformers

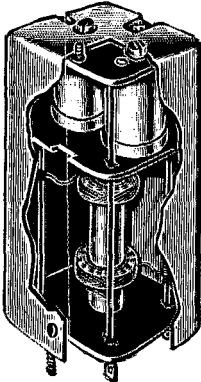

Align-Aire tuning means 3600 degrees of hair-line smooth micrometer adjustment; never changing self locking setting eliminating shifting; moisture proof; dust proof; temperature proof. Complete elimination of "drifting." Align-Aire I.F. transformers are double tuned, with top tuning for ease in aligning circuits and uses the new Meissner Perma Strut construction, permanently placing every lead so that they will not "shift."

Furnished in either AIR-CORE or IRON-CORE (Ferrocort) for input, interstage, output, beat-frequency oscillator, noise silencer, crystal filter and band expanding I.F. transformers in all frequencies from 175 KC to 3000 KC.

**SOLD BY ALL LEADING JOBBERS**

**MEISSNER MFG. CO.**  
Mt. Carmel, Illinois

### JACOBS ADJUSTABLE SEPARATOR (Improved)



U. S. Patent 1,950,170 — March 6, 1934 — others pending  
Using this improved glass Separator 2 wire R.F. feedlines of any separation from 1" up to and including 9" (used in conjunction with Hertz Antenna Systems) may be rapidly and efficiently constructed. \$1.75 for a set of 6.

CHARLES F. JACOBS (W2EM)  
270 Lafayette St., New York, N. Y.

## PRECISION CRYSTALS

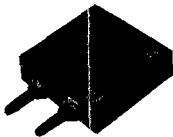

Crystal Holder

Highest quality crystals one-inch square, carefully ground for frequency stability and maximum output. Be sure of your transmitter frequency — use PRECISION CRYSTALS.

\* 'X' cut PRECISION Crystals carefully ground for maximum power supplied within 0.1% of your specified frequency and calibrated to within 0.03% are priced as follows: 1750, 3500 and 7000 kc. bands —

\$3.00 each. Add \$1.00 to above price if plug-in, dustproof holder is desired. (Holder as illustrated to fit G.R. jacks or round holder to plug into a tube socket can be furnished) G.R. jacks to plug illustrated holder into — \$1.15 pair.

Low frequency drift crystals (Type LTC) having a drift of less than 5 cycles per million per degree C. are supplied at the following prices: 1750 and 3500 kc. bands — \$3.50 each; 7000 kc. band — \$4.00 each. Holder \$1.00.

\* 'AT' cut crystals for commercial use quoted on at your request. When ordering our product you are assured of the finest obtainable. Now in our sixth year of business.

PRECISION PIEZO SERVICE

427 Asia Street

Baton Rouge, La.

## Strays

The report of the Eastern Canada Convention in August *QST* erred in reporting the winner of the Burgess Trophy. It was won by Val Sharp, VE2CR.

The author of Zepp Pointers in September "Hints and Kinks" was George Dery, W6HG.

### Operating News

(Continued from page 87)

The wife of Cliff Foss, W2OJ, operator on the Schooner *Morrissey* (W1OXDA), now has her own license and call W2JZJ.

W3GGE'S nomination for the "most exacting ham": The W9 heard calling "CQ R9 DX"!

The following general message (ZLVA) was transmitted to all members of the Army Amateur Radio System from WLM/W3CXLL, Washington, D. C., on August 3d: "Hereafter the Liaison Officer of the A.A.R.S. in this office will be Captain S. P. Collins. He is an old-timer in amateur radio and much interested in Army Amateur work. To all Army Amateurs I wish to extend my appreciation and thanks for the excellent cooperation and service rendered to your Corps Area and this office during the past two years while I have been Assistant to the Chief Signal Officer for Army Amateur matters. Under Captain Collins the A.A.R.S. will progress well and rapidly. 73."—Captain Minckler L.O., A.A.R.S.

Howard Seefred, W6EA, announces the arrival of a Junior Op on August 9th; Mrs. W6EA is also the sister of W7CY, so the lil' fellow has a good ham background!

The Tennessee Traffic Net operates on 3737 kc. as a directed net daily at 6:30 p.m. CST. The members of this net have good southern outlets and keep an ear open for outside stations that may have traffic for them.

Read and take warning!—The amateur operator license of William Henry Schuck, Los Angeles, Calif., was suspended by the F.C.C. under authority of Sec. 303(m) of Communications Act of 1934, for the period September 15, 1936 to and including January 30, 1938, because he transmitted profane language by radio; maliciously interfered with police radio communication; failed to maintain a log of operation; operated an amateur radio station on an unauthorized frequency, and permitted the operation of station by an unlicensed operator.

## Amateurs Needed to Aid 56-mc. Experiments

ON JUNE 24th, a cellophane stratosphere sounding balloon, under the supervision of Dr. Jean Picard and Professor John D. Akerman, was released from the Memorial Stadium at the University of Minnesota, Minneapolis. The balloon was 15 feet in diameter and 32 feet high and carried a 56 mc. radio transmitter, which was keyed by a clockwork mechanism to send out altitude signals. The balloon was released at 7:56 a.m. and traveled 613 miles south to Huntsville, Arkansas, where it was sighted at 5:30 in the evening. Signals were heard at the University for approximately two hours after the balloon was released. This experiment was to test the practicability of sending up an unmanned cellophane balloon carrying instruments and radio equipment which would transmit signals intelligible to a listener without special recording equipment. We are preparing to send up a number of others beginning the latter part of September and continuing through October and November.

We appeal to the "Hams" within a six hundred mile radius of Minneapolis for assistance in these flights. The frequency on which the transmitter will operate will probably be 62,000 kc. The signal will be modulated at 1000 cycles. The



- ... planning to add voice transmission?
- ... going to increase your power?
- ... having trouble with QSY (frequency change)?
- ... failing to get maximum output and service from tubes?

● if the answer is YES you need the **OHMITE AMATEUR HANDBOOK**

The revised, enlarged second edition has complete sections on modulators, power supplies, band-switching, filament control, meter-monitors, etc. Ingenious tables and charts eliminate formulas and do away with difficult calculations.

Here's the BIGGEST dime's worth of data you ever bought. Get it from your dealer or send 10c to

**OHMITE**  
 MANUFACTURING COMPANY  
 4831 Flourney Street Chicago, Illinois

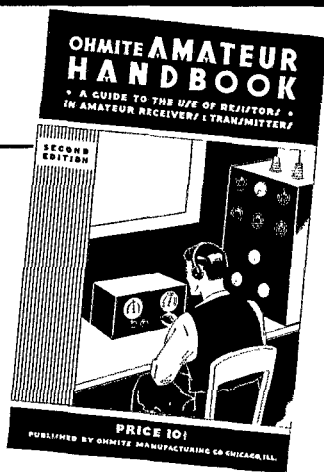

● HANDBOOK PAGES  
 458-459  
 CATALOG SECTION

**HOW IS YOUR SUPPLY OF Ideas?**

If they ever run low, make sure that you have a copy of **HINTS & KINKS** handy.

It is chock-full of money-saving ideas and stunts of interest to you. There are many times when you will find it invaluable. The price is 50c postpaid.

**American Radio Relay League**  
 West Hartford, Connecticut

.. UNITED ..



# MERCURY RECTIFIERS

WE CLAIM they are better  
WE EXPLAIN why they are better  
WE PROVE they are better

NEW FOUR-PAGE BULLETIN MAILED UPON REQUEST

UNITED ELECTRONICS COMPANY

42 SPRING ST., NEWARK, N. J.



## Much for Little

Large capacity on a flat pocketbook . . . that's the "why" of AEROVOX PBS series electrolytics. Sturdy cardboard case. Mounting flanges. Color-coded leads. Single, dual and triple sections. Ideal for receiver power-pack filtering.

Write for latest catalog covering complete condenser and resistor line. Also sample copy of monthly Research Worker.

200 and 450 v. working. All standard capacities. Ultra compact. Lowest prices.



73 Washington St. Brooklyn, N. Y.

## SENCO Neon Tuning Wand

- Easy to adjust any transmitter or receiver. An accurate instrument for the old timer — a short-cut method for the new experimenter.
- Increase or decrease inductance with a wave of the hand.



ONLY \$1.00

● Bright NEON LIGHT indicates relative strength of R.F. fields of transmitters, resonance, etc. 10 inch neon filled tube so constructed to increase inductance of a transmitter or receiver when left cap is placed inside the coil and decreases inductance when right cap is inserted. Sensitive tube illuminates when placed near the transmitter tank coil. COMPLETE \$1.00. Postage Prepaid. Guaranteed.

SUNDT ENGINEERING COMPANY

4246 Lincoln Avenue

Chicago, Illinois

call letters W9XOF will be sent from the balloon by a clockwork mechanism. The time of the ascension will be published in the daily newspapers and broadcast over Minneapolis-St. Paul radio stations. The signal you may hope to hear will be: W9XOF, 15 second dash, W9XOF, 15 second dash, 1 to 24 dots indicating altitude, 1 to 12 dots indicating temperature, 1 to 12 dots indicating relative humidity, an irregular series of dots indicating cosmic ray impacts for a two minute period, and one minute of silence.

Here is what to do. Tune up your 56-mc. receiver so she ticks; then watch the papers for the exact date and frequency. Record the time and the number of dots appearing in each of the four series in order and the direction, if you know it, and send it to the Aeronautical Engineering Department of the University of Minnesota. Here's a tip. The signals are sent from a clockwork mechanism and the complete cycle is repeated every eight minutes. See where the second hand of your watch is on the first W of the call letters; there will be call letters and tuning dashes for two minutes from this time; the altitude dots will fall in third, the temperature dots in the fourth, the humidity dots in the fifth, and the cosmic ray dots in the sixth and seventh, and silence during the eighth minute from that time. Any of you who are able to help us are asked to write to Professor John D. Akerman, Department of Aeronautical Engineering, University of Minnesota, Minneapolis, Minnesota, as soon as possible, advising him of your desire to cooperate. This will give us an opportunity to send you advance notice post cards giving the time when we expect to release the balloons, weather permitting. We will appreciate your help. "What do you say, fellows?"

—Robert M. Silliman, W9AST

## O.P.S. Scores High

MID-SUMMER operating of A.R.R.L. Official 'Phone Stations surpassed previous records of the number taking part, the number reporting, and the scores rolled up. J. H. Bricker, W8IJZ, of Mantua, Ohio, smashed all O.P.S. records working 40 stations in 13 Sections in the brief space of a week-end party, making 3016 points. There were 17 scores above 1000. W2HNP, N.N.J., nearly won again working 36 stations in 15 Sections for 2976 points. W2CBO, E.N.Y., hooked 15 Sections, 27 stations, 2265 points. More voice-operated stations are making application to S.C.N.'s for the appointment as O.P.S. Interest in quarterly activities is bound to keep looking up during all the coming season. See Oct. '36-May '37 O.P.S. Competition announcement elsewhere! Leading O.P.S. scores in the summer party were:

Station	QSOs	Sections	Heard	Score	Power	Section
W8IJZ	40	13	16	3016	250	Ohio
W2HNP	36	16	3	2976	150	No. N. J.
W2CBO	27	15	8	2265	500	E. N. Y.
W8EMV	28	12	12	1968	100	Ohio
W9TTA	28	12	11	1944	100	Indiana
W8JTT	23	12	15	1740	180	Ohio
W8CPJ	20	12	21	1704	25	W. N. Y.
W2DC	25	13	4	1633	500	E. N. Y.
W8KNF	24	12	7	1608	125	Ohio
W3MG	20	11	16	1452	65	E. Pa.

Call	QSOs	Power	Score	Call	QSOs	Power	Score
W8LJQ	18	45	1340	W8LUT	14	190	720
W8HFR	23	100/350	1271	VE3NX	14	35	702
W1COI	15	15	1216	W8C8X	18	75	660
W3BSY	22	200	1214	W3BTG	15	150	606
W4CYE	21	200	1167	W3NE73	12	150	544
W8BDR	21	200	1089	W1AVP	12	185	544
VE3KM	26	200	1072	W8JM	9	72	515
W2AV8	12	50	924	W9LVL	12	31	492
W3EOZ	15	800	869	W8CDR	13	40	395
W8AAR	18	...	832	W8CHT	12	100	390

## A.R.R.L. Official Broadcasting Stations

CURRENT information on expeditions, special tests and activities, new F.C.C. regulations concerning amateur operator and station licensing, DX conditions or new records on 28-mc. or u.h. frequencies, etc., is sent regularly (new information each week) in the different amateur frequency bands by the following A.R.R.L. Official Broadcasting Stations. This information is addressed "to all amateurs." The list is revised to include only active appointees. The operators of these stations render amateur radio a distinct service. You will find stations in your own district, and neighboring

(Continued on page 122)



# NEW ITEMS FROM OUR FALL CATALOG

## SPECIFICATIONS

1— Completely enclosed transmitter housings, including panel, shelves, etc., nothing else to buy, three sizes \$12.50 to \$22.50 net. 2— Complete U.H.F. resonant line oscillator \$12.50 net. 3— Improved Q-Max R.F. lacquer .25 per can net. 4— Concentric transmission line cable 10 to 50 foot lengths 70 ohm impedance. 5— 12" stand-off for insulating H.F. antennas, etc. \$1.50 net. 6— Universal neutralizing condensers \$1.95 net. 7— Large 160 meter Vitrolex coil form \$1.25 net. 8— Vitrolex shaft coupling \$.35 net. 9— All Vitrolex 50 watt socket, special contacts \$.75 net.

Send for Catalogue

Communication Products Incorporated  
245 Custer Ave., Jersey City, N. J.



## RADIO ENGINEERING



RCA Institutes offer an intensive course of high standard embracing all phases of Radio. Practical training with modern equipment at New York and Chicago schools. Also specialized courses and Home Study Courses under "No obligation" plan.

Illustrated Catalog on request

**RCA INSTITUTES, INC.** Dept. ST-36

75 Varick St., New York 1154 Merchandise Mart, Chicago  
Recognized Standard in Radio Instruction Since 1909

"The Crystal Specialists Since 1925"

**PIEZO-ELECTRIC CRYSTALS**  
Guaranteed Accurate to BETTER than .01%  
**SCIENTIFIC RADIO SERVICE**  
UNIVERSITY-PARK, HYATTSVILLE, MD.

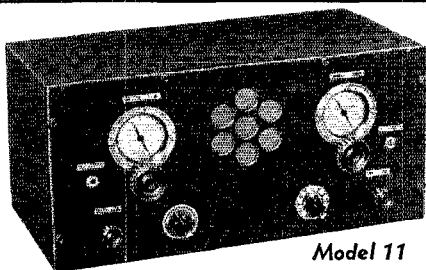

Model 11

Many experienced operators prefer the extreme sensitivity and quiet efficiency of T.R.F. receivers, especially for C.W. A T.R.F. set, with its lack of tube noise will get those real weak signals from distances not commonly heard on ordinary receivers. Increase your radio enjoyment 100 fold with a Marine or Universal tuning range receiver, — something more than just an amateur receiver. Be there, on 600 meters, for the next SOS, — cover the beacon, navy, time signal and press waves, and give your station efficient all-wave coverage. When you get tired of the 40 meter CQS, switch to 36 and hear the ships from the Mediterranean to "west of Penang" and "south of Pernambuco." Thrill? And how!

**Model 11 Net Prices for 110 V. 60 cycles operation**  
Model 11-UA, UNIVERSAL tuning range, 9.5 to 20,000 meters \$75.00  
Model 11-MA, MARINE tuning range, 9.5 to 3,750 meters \$54.00  
Model 11-AA, AMATEUR tuning range, 9.5 to 550 meters \$46.00

Prices include power supply, speaker and R. C. A. tubes

Model 11 is available in all A.C., D.C. and battery voltages.

**IMMEDIATE DELIVERY**

Write for full description

## Marine Model T.R.F. Receiver

We believe Model 11 to be the finest receiver of its type ever built. Note the neat, business-like appearance of the chassis, and the construction of the long wave coil unit, spaced up off the chassis for complete isolation. With well-designed, Litz-wound honeycombs inside this unit, the reason for the receiver's long-wave efficiency is apparent. Model 11 has all-wave band spread, coil switching, built-in power supply, Jensen dynamic speaker, fully calibrated dial, phone jack, break-in switch, R. F. gain and regeneration controls and antenna trimmer. Everything the experienced operator can possibly want is on there.

By  
"Well  
Built"  
we  
mean  
this

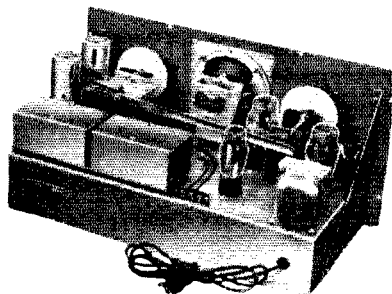

**E. M. SARGENT CO., 212 9th St., Oakland, Calif.**

# Where to buy it

A directory of suppliers who carry in stock the products of these dependable manufacturers.

**ASTATIC**  
Crystal Microphones and Pickups  
ASTATIC MICROPHONE LABORATORY, Inc. YOUNGSTOWN, O.  
Pioneer Manufacturers of Quality Crystal Products

- AKRON, OHIO 110 E. Market Street  
Brighton Sporting Goods Corp.
- CHICAGO, ILL. 833 West Jackson Blvd.  
Allied Radio Corporation
- CHICAGO, ILL. 601 W. Randolph St.  
Pioneer Automotive Supply Co.
- CHICAGO, ILLINOIS 226 W. Madison Street  
Newark Electric Company
- CHICAGO, ILL. 901-911 W. Jackson Blvd.  
Wholesale Radio Service Company, Inc.
- KANSAS CITY, MO. 1012-14 McGee St.  
Burstein-Applebee Company

super sky rider  
hallicrafters  
ultra sky rider

- AKRON, OHIO 110 E. Market Street  
Brighton Sporting Goods Corp.
- CHICAGO, ILL. 833 W. Jackson Blvd.  
Allied Radio Corp.
- CHICAGO, ILLINOIS 415 S. Dearborn Street  
Chicago Radio Apparatus Company
- CHICAGO, ILLINOIS 19 S. Wells St.  
Hinds & Edgerton
- CHICAGO, ILL. 901-911 W. Jackson Blvd.  
Wholesale Radio Service Company, Inc.
- CINCINNATI, OHIO 633 Walnut St.  
Steinberg's, Inc.
- COLUMBUS, OHIO 61 E. Goodale St.  
Bell Radio Parts Co.
- DETROIT, MICHIGAN 5027 Hamilton Ave.  
Rissi Brothers, Inc.
- DULUTH, MINN. 109 E. 1st St.  
Northwest Radio
- HANNIBAL, MISSOURI 1204 Broadway  
Modern Radio Company
- INDIANAPOLIS, IND. 34 W. Ohio St.  
Van Sickle Radio, Inc.
- KANSAS CITY, MO. 1012 McGee Street  
Burstein-Applebee Company
- OMAHA, NEBRASKA 2855 Farnam St.  
Radio Accessories Company

- ST. LOUIS, MO. 927 Pine Street  
Gordon Radio Company
- THE PAS, MANITOBA, CANADA  
L. J. Hamers & Company

E.F. JOHNSON COMPANY  
MANUFACTURERS OF  
RADIO  
TRANSMITTING EQUIPMENT  
WASECA, MINN  
U.S.A.

- AKRON, OHIO 110 E. Market Street  
Brighton Sporting Goods Corp.
- CHICAGO, ILLINOIS 226 W. Madison Street  
Newark Electric Company
- CHICAGO, ILL. 901-911 W. Jackson Blvd.  
Wholesale Radio Service Company, Inc.
- WINNIPEG, CANADA 310 Ross Ave.  
Electrical Supplies Limited

RAYTHEON  
TRADE MARK  
AMATEUR TUBES

- AKRON, OHIO 110 E. Market Street  
Brighton Sporting Goods Corp.
- CHICAGO, ILLINOIS 226 W. Madison Street  
Newark Electric Company
- CINCINNATI, OHIO 633 Walnut Street  
Steinberg's, Inc.
- CLEVELAND, OHIO 2073 West 85th Street  
Northern Ohio Laboratories

RCA  
AMATEUR  
RADIO  
EQUIPMENT  
RCA Victor Division of RCA Manufacturing Co., Inc.

- AKRON, OHIO 110 E. Market Street  
Brighton Sporting Goods Corp.
- BUTLER, MO. 211 N. Main St.  
Henry Radio Shop
- CHICAGO, ILL. 226 W. Madison Street  
Newark Electric Company
- CHICAGO, ILL. 833 W. Jackson Blvd.  
Allied Radio Corporation

# Where to buy it

A directory of suppliers who carry in stock the products of these dependable manufacturers.

**CHICAGO, ILL.** 901-911 W. Jackson Blvd.  
Wholesale Radio Service Company, Inc.

**CINCINNATI, OHIO** 633 Walnut Street  
Steinberg's, Inc.

**CLEVELAND, OHIO** 2073 West 85 Street  
Northern Ohio Laboratories

**DETROIT, MICH.** 171 E. Jefferson Ave.  
Radio Specialties Co.

**FLINT, MICH.** 203 W. Kearsley St.  
Shand Radio Specialties

**KANSAS CITY, MO.** 1012 McGee St.  
Burstein-Applebee Company

**MINNEAPOLIS, MINN.** 1124-6 Harmon Pl.  
Lew Bonn Co.

**PEORIA, ILL.** 707 Main Street  
Klaus Radio & Electric Company

**TORONTO, CANADA** 1137 Bay St.  
Wholesale Radio Company, Ltd.

**YOUNGSTOWN, OHIO** 325 West Federal Street  
Ross Radio Company



**AKRON, OHIO** 110 E. Market Street  
Brighton Sporting Goods Corp.

**CHICAGO, ILL.** 226 W. Madison Street  
Newark Electric Company

**CHICAGO, ILL.** 833 W. Jackson Blvd.  
Allied Radio Corp.

**CHICAGO, ILL.** 901-911 W. Jackson Blvd.  
Wholesale Radio Service Company, Inc.

**CLEVELAND, OHIO** 610 Huron Road  
Goldhamer, Inc.

**DETROIT, MICH.** 171 E. Jefferson Ave.  
Radio Specialties Co.

**MINNEAPOLIS, MINN.** 1124-6 Harmon Pl.  
Lew Bonn Co.



**AKRON, OHIO** 110 E. Market Street  
Brighton Sporting Goods Corp.

**CHICAGO, ILL.** 226 W. Madison Street  
Newark Electric Company

**CHICAGO, ILLINOIS** 833 W. Jackson Blvd.  
Allied Radio Corporation

**CHICAGO, ILLINOIS** 415 S. Dearborn Street  
Chicago Radio Apparatus Company

**CHICAGO, ILL.** 901-911 W. Jackson Blvd.  
Wholesale Radio Service Company, Inc.

**CINCINNATI, OHIO** 633 Walnut St.  
Steinberg's, Inc.

**CLEVELAND, OHIO** 2073 West 85 Street  
Northern Ohio Laboratories

**CLEVELAND, OHIO** 610 Huron Road  
Goldhamer, Inc.

**COLUMBUS, OHIO** 178 N. 3rd Street  
Hughes-Peters Electric Corp.

**DAYTON, OHIO** 140 E. 3rd Street  
Burns Radio Company

**DETROIT, MICH.** 171 E. Jefferson Ave.  
Radio Specialties Co.

**PEORIA, ILL.** 707 Main Street  
Klaus Radio & Electric Company



**AKRON, OHIO** 110 E. Market Street  
Brighton Sporting Goods Corp.

**ANN ARBOR, MICH.** 331 S. Main St.  
Purchase-Radio

**CHICAGO, ILL.** 833 W. Jackson Blvd.  
Allied Radio Corporation

**CHICAGO, ILL.** 226 W. Madison Street  
Newark Electric Company

**CHICAGO, ILL.** 901-911 W. Jackson Blvd.  
Wholesale Radio Service Company, Inc.

**CINCINNATI, OHIO** 633 Walnut Street  
Steinberg's, Inc.

**CLEVELAND, OHIO** 610 Huron Road  
Goldhamer, Inc.

**INDIANAPOLIS, IND.** 34 W. Ohio St.  
Van Sickle Radio, Inc.

**MINNEAPOLIS, MINN.** 1124-6 Harmon Pl.  
Lew Bonn Co.

**TORONTO, CANADA** 1133-1137 Bay St.  
Wholesale Radio Company, Ltd.

(Continued from page 118)

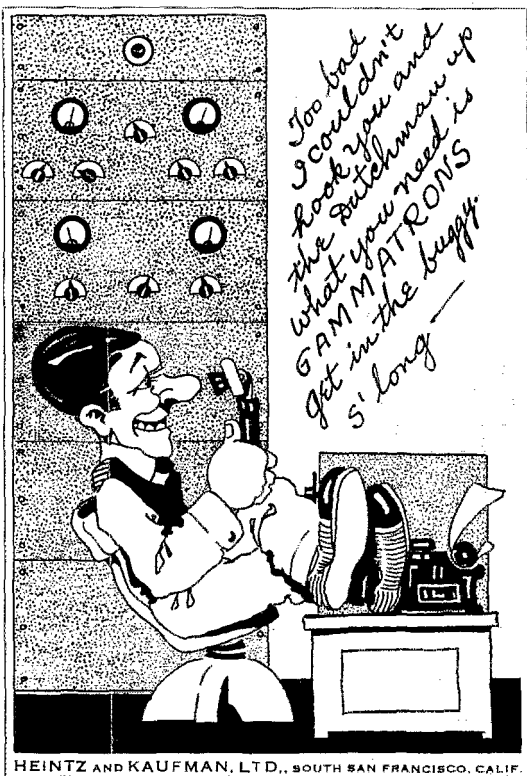

HEINTZ AND KAUFMAN, LTD., SOUTH SAN FRANCISCO, CALIF.

RADIO and sound engineers, servicemen and amateurs are keeping informed on latest development in every phase of the electronics art through articles by leading research engineers in the new

## RCA REVIEW

A Quarterly Journal of Radio Progress

The next issue appears this month. Each subscriber will receive without extra charge a copy of *Television*, a 452-page book on the development of the art to date.

\$1.50 (foreign, \$1.85) for four issues, including *Television*

RCA INSTITUTES TECHNICAL PRESS

A Department of RCA Institutes, Inc.

75 Varick Street, New York

districts in the list. Make a practice of listening to the "QST" sent from these stations. Report results to these stations when you hear them, so the operators will know their transmissions are successfully received by you and their work appreciated and successful.

W1ACV, W1APK, W1AQL, W1ASI, W1AUY, W1BEF, W1BFT, W1BVR, W1BWW, W1CCX, W1EAW, W1EEY, W1FFL, W1FPS, W1GAE, W1GZL, W1IJB, W1INF/MK, W1JSK, W1SK, W1WR, W1ZS/BZI.

W2AZV, W2BJP, W2FF, W2HBQ, W2HON, W2SN, W3AEJ, W3AOJ, W3AQN, W3AVR, W3BGD, W3BIG, W3BIE, W3BIW, W3BSY, W3BWT, W3CDQ, W3DNU, W3EKL, W3EXW, W3UVA.

W4AIS, W4DBG, W4DGS, W4DHG, W4QI/W3FSSO, W4VX, W4ZH.

W5AAX, W5DAQ, W5DLG, W5DPX, W5FPO, W6BRI, W6FBW, W6GZY, W6JTV, W6LFZ, W6ZX, W7COH, W7DP.

W8AQ, W8AXV, W8BZY, W8DED, W8DLG, W8DME, W8DZO, W8DZY, W8EEQ, W8EWP, W8FZE, W8GJM, W8ESX, W8HWT, W8IOH, W8IWT, W8JQE, W8JTI, W8JTW, W8LAJ, W8LUD, W8LUT, W8MFV, W8MMN, W8NW, W8WE.

W9ACU, W9AXH, W9CWG, W9DBO, W9DEI, W9EDW, W9FNK, W9GFA, W9HPQ, W9HQH, W9HUO, W9HUX, W9PN, W9IQL, W9JAW, W9JO, W9KEF, W9KEI, W9KQJ, W9NCZ, W9OXP, W9RH, W9RPA, W9SDQ, W9TBF, W9TE, W9UEU.

KA1GR, VE1GL, VE1HH, VE2EE, VE3PL, VE4EO, VE4HM, VE5DD.

## W9IU, W3EOP and W3AMR July O.R.S. Leaders

THE July Official Relay Station activities, like the summer party of the previous year, included a bonus or premium of more points for work on 7 and 14 mc. Conditions were fine and Gregg, W9IU, made the "new high" of 104,805 points. His 161 contacts in 20 hours compare with just 153 contacts 12 months before. His leadership was closely contested by two eastern rivals, W3EOP and W3AMR, who while not making such a large Section multiplier, boosted the number of QSOs to 179 and 170 respectively! The high group of operators speaks for itself, including all sorts of outstanding work. Look them over:

Station	QSOs	Sections*	Heard	Score	Power	Section
W9IU	161	85	34	104,805	250	Indiana
W3EOP	179	68	97 pl 26	99,620	500	E. Pa.
W3AMR	170	72	50 pl 12	97,704	300/400	E. Pa.
W8BYM	150	74		88,208	150	Ohio
W1EZ	154	65	0	70,815	100	Vermont
W1BFT	130	64	39	68,688	250/500	N. H.
W9MN	125	64	30 pl 5	67,200	400	Kentucky
W8FIP	129	67	0 pl 8	63,114	600	W. Pa.
W1TS	124	61	33	62,342	170/250	Conn.
W1GME	126	58	28 pl 1	61,016	75	Conn.

Call	QSOs	Power	Score	Call	QSOs	Power	Score
W2AHC	118	400	57523	W9RBV	96	50	36895
W3OFO	133	400	53130	W4ABT	90	300	36250
W3ONK	115	60	52725	W3CWE	85	80	35673
W3ZT	110	50	51414	W6LDJ	75	80	35640
W6KFC	90	60/50	49392	W4OC	91	300	33813
W2AYJ	107	...	48204	W4CJG	78	100	33663
W9ELL	100	...	47538	W9VEE	77	150	33648
W6RZ	104	...	47200	W5EIP	89	100	33497
W8IAW	111	90	46375	VE3EM	98	94	33374
W2HZY	120	60	45450	W9ENH	82	145/160	33369
W7BSU	83	700	42714	W3EXW	76	200	31429
W3BSY	98	500	37532	W9SKF	69	25/115/110	30450
W1EOB	99	150/75	36950	VE4GE	75	80	30408

\* Multiplier this time includes duplicated Sections.

## October 24/25 O.R.S. Party

With the fall and winter season we shall go back to the factor of 4 points for midwest QSOs, 5 points for each contact for stations in the eastern area, and 7 points per contact for stations located in the Pacific area. For detailed rules see the next Bulletin. The rules given in that issue will remain fixed for the whole season's activities. Be on deck October 24th/25th without fail. It's the first set-to in the W4NC Trophy Contest for O.R.S.!

# HAM-ADS

(1) Advertising shall pertain to radio and shall be of nature of interest to radio amateurs or experimenters in their pursuit of the art.

(2) No display of any character will be accepted, nor can any special typographical arrangement, such as all or part capital letters be used which would tend to make one advertisement stand out from the others.

(3) The Ham-Ad rate is 15¢ per word, except as noted in paragraph (6) below.

(4) Remittance in full must accompany copy. No cash or contract discount or agency commission will be allowed.

(5) Closing date for Ham-Ads is the 25th of the second month preceding publication date.

(6) A special rate of 7¢ per word will apply to advertising which, in our judgment, is obviously non-commercial in nature and is placed and signed by a member of the American Radio Relay League. Thus, advertising of bona fide surplus equipment owned, used and for sale by an individual or apparatus offered for exchange or advertising inquiring for special equipment, if by a member of the American Radio Relay League takes the 7¢ rate. An attempt to deal in apparatus in quantity for profit, even if by an individual, is commercial and takes the 15¢ rate. Provisions of paragraphs (1), (2), (4) and (5) apply to all advertising in this column regardless of which rate may apply.

Having made no investigation of the advertisers in the classified columns, the publishers of *QST* are unable to vouch for their integrity or for the grade or character of the products advertised.

**QUARTZ**—direct importers from Brazil of best quality pure quartz suitable for making piezo-electric crystals. Diamond Drill Carbon Co., 719 World Bldg., New York City.

**RADIO** engineering, broadcasting, aviation and police radio, servicing, marine and Morse telegraphy taught thoroughly. All expenses low. Catalog free. Dodge's Institute, Byrd St., Valparaiso, Ind.

**NATIONAL**—Hammarlund, Patterson used sets, 60% off list. W3DQ, 405 Delaware Ave., Wilmington, Del.

**CLASS B** transformers—Universal for two or four 46s, 210s, 800s, RK18s, etc., \$7.75 pair postpaid, 70 watts audio for 46s, 100 watts from 10s. Write for details. W8UD, Douglas, Mich.

**QSL'S**, W2SN, Helmetta, N. J.

**WRITE** us for trade-in price on your old receiver. We buy meters. Walter Ashe Radio Co., St. Louis, Mo.

**TELEGRAPH** speed keys in kit form, only \$2.89. A post card brings full information. Electric Specialty Mfg. Co., PO Box 645, Cedar Rapids, Iowa.

**CALLBOOKS**—new DX calls, new prefixes, thousands of new W and VE calls, in the Summer 1936 Radio Amateur Call Book. Sent postpaid \$1.25, or a whole year (four issues) for \$4. (In foreign countries \$1.35 and \$4.35.) Your call and QRA printed in large type, \$1. per year. Radio Amateur Call Book, 610 S. Dearborn, Chicago.

**WANTED** Rider's Service Manuals. Also modern servicing equipment. M. J. Duke, W4VB, Rocky Mount, N. C.

**WANTED**: used bug, William Reynolds, Tuscaloosa, Alabama.

**BLILEY** LD-2, 1917, new. \$3.50. W9VTP.

**NEW** RCA 175 receiver. Won at Hamfest. W9PJJ.

**BLILEY** crystals! Stocked! Patronize W8DED.

**QSL!** Unbeatable! What's your desire? Samples? (stamp) W8DED, Holland, Mich.

**QSLs**. Free samples. Printer, Corwith, Iowa.

**BETTER** QSL's reasonably priced. Samples. "Fritz", 203 Mason, Joliet, Illinois.

**TRADE**: Hipower equipment, 2-204As, meters, etc., Want: 35MM. movie camera. Trade for anything, W4AIS.

**WANTED** "QST" December 1916, and membership edition copies (with section reports) of June 1925, and April and October 1930. Must have both covers. Sumner B. Young, "Maplewoods", Wayzata, Minn.

**QSLs**, SWLs. Superlative quality. Samples (stamps) W8ESN, 1827 Cone, Toledo, Ohio.

**BEAUTY** aids—the new pressed steel all-welded relay racks, chassis, panels, give your station class. Light, rigid, super-power transformers, reactors. Rectifier Engineering Service, 4837 Rockwood Road, Cleveland, Ohio.

**TRANSMITTER** for sale. Write for photo and price. W9OYF, Oswego, Kansas.

**WANTED**—used Candlercourse, junior or advanced. W9UXD, Moline, Illinois.

**SELL**—Westinghouse dynamotor 27 1/2/350 dc. Want DeForest 510s. W8BDI, Dexter, Mich.

**CRYSTALS**: guaranteed, 80-160, Y \$1.; X or A \$1.50. Blanks-X and Y 50¢. "A" 75¢. Postpaid anywhere. Roy Scherman, W9FHS, 4433 North Kilbourne, Chicago.

**SELL** 6 tube super. "A.V.C." Best offer over \$25. Wm. Hess, Denville, N. J.

**SELL** 1 RCA 845 and socket, \$8. f.o.b. W8OKI, Patton, Penna. 616 TRANSMITTER, 30 watts. Complete: V cut crystal, coils, tube, \$12.95. Write W2JHB, 3008 Avenue L, Brooklyn, N. Y.

**SAXOPHONE**, Buescher C silver. Trade for commercial short wave receiver. Derrick, Eriton, N. J.

**FOR** sale or trade. Complete station including gross CB25 transmitter, home built transmitter, ACR receiver, 300 watt Janette rotary converter 110VDC to 110VAC. W4CTX, Fargo, Georgia.

**QSLs**. Finest at lowest prices. Samples. Maleco, 1512 Eastern Parkway, Brooklyn, New York.

**SKYRIDERS**, prepaid. W7BDs. Roundup, Montana.

**CRYSTALS**: 80M "X", \$1.95, 80M-160M "V", 10 cycle, \$2.25, 4 cycle, \$3.25. Plug-in holders, \$1. Written guarantees. Write for complete catalog. Ham Crystals, 1104 Lincoln Place, Brooklyn, N. Y.

**BARITONE** and alto saxophones. Trade for RME, Skyrider, RK28's or what have you? W8DNO, Crafton, Pa.

**SACRIFICE** complete rack transmitter RK20 final. LaCrosse Radio Club, care W9HSK.

**QUICK** service on QSL cards. Send for samples. Radio Printers, Lewiston, Minn.

**WANTED**—old style Hoyt hot-wire ammeters. W8TI, 527 Davis Ave., Elkins, W. Va.

**QSLs**, 75¢ a 100, 3 color, samples. Lapco, 344 W. 39th St., Indianapolis, Ind.

**QSL** printing service. Free samples. Theodore Porcher, 7708 Navajo Street, Philadelphia, Penna.

**FOR** sale: PBXA and Sargent model 10 special. T. Porcher, Chestnut Hill, Penna.

**NATIONAL** ACSW 45, tubes, coils 13.5 to 115 meters, power supply, speaker. \$20. W4CQZ.

**QSL** cards, new style, reasonably priced. Samples. Becker Bros., Port Chester, N. Y.

**QSL** cards, two color, cartoons, snappy service. Write for free samples today. WIBEF, 16 Stockbridge Avenue, Lowell, Mass.

**QSL's**—W7DRR-W7DSO

**FABERADIO** folder free. Crystals, holders, blanks, all cuts Faberadio, Sandwich, Ill.

**TWO** RCA 860s, \$7, each. Trade? W9DAX, Sandwich, Ill.

**BEST** offer takes perfect W. E. 251A, Thordarson T6419, two Weston model 425 thermocouples 0-5. W9MIQ.

**FOR** sale. Forty and eighty meter transmitter with monitor DX 29 states. \$25. W1HWG, Stafford Springs, Conn.

**QSLs**—samples. Prices on request. W2AEL.

**CRYSTALS**: Zero cut. Guaranteed to compensate at near zero without oven, 80-160 meters, \$1.85. Forty meters, \$2. Holders 75¢ postpaid. Fisher Lab., 4522 Norwood St., San Diego, Calif.

**EIDSON** T9 40 meter X cut crystals, dependable-powerful. \$1.50. Very close frequency. Satisfaction guaranteed, instant service. Efficient low-loss ceramic plug-in holder, \$1.10 postpaid. Shipments c.o.d. if preferred. Eidson's, Temple, Texas.

**CRYSTALS**: Eidson T9 40 meter X cut crystals \$1.50. None better at any price. Immediate shipment from largest stock in New York. Low-loss, efficient, ceramic holder with banana prongs, \$1.10 postpaid. W2GWS, 88-34 209th St., Queens Village, N. Y.

**SELLING** ACSW3, tubes, 40-80 coils, power supply, \$16. Complete parts 1kw transmitter, 125 QSTs, 10¢ copy. W9GFC.

**CRYSTALS**: 1" sq. x cut 80-160 meters, \$1.40, 40 meters \$2.50. Within 3-kc. of desired frequency. Guaranteed the very best. The Ransom Laboratory, North Syracuse, N. Y.

**SW3** at bargain. Write Winston Emmons, South Ridgewood, Daytona Beach, Florida.

**SELL** several crystals. W8MYF.

**WANTED**—used superhet. W2GJL.

**SPECIAL** bargain! Limited supply of used six volt automobile motor generators input 6 volts at 2 amps. output 135 volts d.c. at 40 to 60 MA. Just right for use on five meter portable rigs. All in A-1 condition. Net \$3. f.o.b. Walter Ashe Radio Co., St. Louis, Mo.

**SELL** PR16C used about two hours. Best offer. W5VK.

**TRADE** ham parts, tubes, meters, etc. for motors, Leica camera, small Collins phone cw rig. What have you? W5VK.

**SELL** ACSW-3, power supply, coils, tubes for \$25 c.o.d. W3EPI.

**WANT** McMurdo-Silver 5B. W2ISI.

**NEW** ideas in QSLs, maps, message cards. Free samples to licensed hams only. W2FJE, 143 DeKalb Avenue, Brooklyn, N. Y.

TRANSFORMERS, new, guaranteed, Hilet 2½ kw, 160 lb. cost \$78. Sell \$35. State voltages wanted, get photograph and details. Leitch, Park Drive, West Orange, N. J.

SELL, trade, General Radio Precision Wavemeter, Hanovia Professional medical arc, surplus small Weston meters. Want quality miniature camera, enlarger. Fred Smeltzer, 1507 Eleventh Street, Altoona, Penna.

QSLs—Special introductory offer. Radio Headquarters, Ft. Wayne, Indiana.

BARR transceiver, W8ODY.

REBUILT Vibroplexes \$6. New large base bugs \$9. Lydeard, 28 Circuit, Roxbury, Mass.

USED SW3 receiver—W8ANT.

RCA 860—\$5.00 W8ANT.

USED filter condensers—W8ANT.

USED high voltage tank condensers. W8ANT.

PAM 19 amplifier—cheap, W8ANT.

NEW transmitters—factory built, W8ANT.

NEW and used receivers and transmitters. All types and makes of equipment bought, sold and exchanged—cash or time payments. Write to Southern Ohio's only amateur owned amateur business, Jos. N. Davies, W8ANT, 2767 North Bend Road, Station A, Mt. Airy, Cincinnati, Ohio.

GENERAL Cable Corp. EO-1 Cable now obtainable any length—W8DT.

PLATE transformers built to order. 300-600 watts \$5. to \$8.50. R. Laurensen, 812 Coal Street, Wilkensburg, Pa., W8EFX.

CRYSTALS: See September QST Ham-ads for crystal prices, etc. William Threm, W8FN, 4021 Davis Ave., Cheviot, Ohio.

SELL: National FB7s with tubes \$22., FBxs \$28., FBxAs \$32.; Super Skyriders \$35.; ACR-136 \$45.; AGS complete \$57.50; other receivers. WE276As and 261As \$6.95, WE251As \$45.; RCA 203As carbon plate \$6.95, RCA852s \$8.00, RCA860s \$12.; RCA 204-As \$19., other tubes. W9ARA, Butler, Mo.

BACK issues QST: 1921 to 1925 40¢ each; 1926 to 1935 inclusive \$25. Excellent condition. Schumacker, Box 50, Ampere, N. J.

KEEP posted. Save money with Radio Data Digest. Stamp brings sample. Kladag, Kent, Ohio.

TRANSFORMERS built to your specifications. Highest grade materials used. Conservative ratings in actual d.c. watts output. Prices at least 20% less than elsewhere. Ward Transformer, 27 Houston Street, Buffalo, N. Y.

QSLs—\$1. hundred. Finest obtainable. Attractive. 2 colors. Quality stocks, inks. Samples. (stamp) W8NOS.

FIRST \$22.50 cash takes Thordarson 6-watt amplifier complete. Output transformer grid-modulation or 600 ohms. Commercial wiring. Also \$50. for practically new ACR136. W3DTD.

BRETING 12's: The receiver with the exclusive features. In stock. Get the dope and compare. Johnstone Studios, Saginaw, Michigan.

McMURDO Silver Masterpiece 1V-A like new. Sampson two fifty amplifier. Glenn Watt, Chanute, Kansas.

1KW input to pair Ewing 100s. Tantalum elements, thoriated Bl. (5V-8A or 10V-4A). Plate 3000V max., 175 mls. Low bias and excitation needed. Each \$12.50. Data. Ewing, 1057 Pratt, Chicago.

METERS repaired accurately at reasonable rates. Electrical Instrument Laboratories, 1542 Hertel Avenue, Buffalo, N. Y.

SWAP—New 16 gauge Winchester pump gun and leather case. Want good receiver. W9EKC.

TELEPLEXES, Onnigraphs, Vibroplexes, receivers, meters bought, sold, traded. Ryan Radio Co., Monroe City, Mo.

FOR sale, 3-750 volt, 150 watt generators \$11. each. Also a few other generators and motors. Wilmot Auto Supply Company, 1970 Wilmot Street, Chicago.

COLLINS 30 FBX complete. See previous QST. Cline Cole.

SELL—complete 1 kw. transmitter, 5 stages, pair 204As in final, 3 power supplies, 12 meters (Jewell and Weston), all first class equipment. Built in 6 ft. rack and panel frame, very commercial. \$275. Write for detailed description and picture. Can be easily grid-modulated. W7AJV, 5013 N. E. Clackamas St., Portland, Ore.

UNUSUAL buy, WMK units reconditioned since flood. 3-units Esco M.C. set. (1) 2,000 v.d.c. at 750 ma. (2) 14 v.d.c. field gen., runs filaments if desired (3) 4 H.P. 2 phase 220 v.a.c. motor. Also 50 amp. 4 pole manual switch. Also GE 110 v 60 cycle magnetic switch. Two field rheostats with above. Original cost over \$450. Sell \$125. cash, crates, f.o.b. Hartford. Will quote separately on motor and switches if requested. Following meters will be reconditioned (at factory) for buyer and sold at 15% above repair cost to us. Write for details on any meter that interests you: 1 10-0-10 amp. Type 354 Weston; 1 0-5 ma. d.c. Model 506 Weston; 1 0-7 v.d.c. Type 301 Weston; 1 Jewell Pat. 64 0-3 r.f. amps. ARRL Communications Department, West Hartford, Conn.

SW-5 complete with tubes, National power supply, 5 sets coils. Highest cash offer takes. L. C. Waller, W2BRO, c/o RCA Radiotron Division, Harrison, N. J.

SPEAR transformers. Heavy construction. Guaranteed. 1000-750V, 160ma, \$4.30; 300ma. \$6; 1575-1350-850, 300ma, \$7.50; 500ma, \$11; 2500-2000V, 300ma, \$13; 3000-2500, 500ma, \$19. Voltages are each side. Spear Manufacturing Co., Bowling Green, Ohio.

# Prices Reduced!

## BLILEY BC3 CRYSTAL UNITS

### 40-80 METER BANDS

### Supplied to exact specified frequency\*

\* integral Kc's. only

# Now \$ 4.95

(WITHIN 5 K.C. ... \$3.95)

## —and HOW! THEY PERFORM!

### SHURE



### Crystal Microphones



The 8 exclusive features built into Shure "ULTRA" Microphones mean just one thing — SUPERB MICROPHONE PERFORMANCE — thrilling life-like reproduction — dependable 24-hour-a-day service — at low cost.

Make your own tests — satisfy yourself now that Shure "ULTRA" is the Best Microphone Buy!

Available in Swivel, "Grille-Type" and Spherical models. List price each model, complete with cable, \$25.

See your Jobber or write for Bulletin 140Q today!

Licensed under patents of the Brush Development Company. Shure patents pending.

**FREE!** New "Microphone Applications Chart." Write for your copy of Chart 227Q now.

## SHURE MICROPHONES

SHURE BROTHERS • MICROPHONE HEADQUARTERS  
215 WEST HURON STREET • CHICAGO, U. S. A.

# Your Nearest Dealer Is Your Best Friend

Your nearest dealer is entitled to your patronage. You can trust him. He is equipped with a knowledge and understanding of amateur radio. He is your logical and safe source of advice and counsel on what equipment you should buy. His stock is complete. He can supply your needs without delay. His prices are fair and consistent with the high quality of the goods he carries. He is responsible to you and interested in you.

Patronize the dealer nearest you — You can have confidence in him

## CHICAGO, ILLINOIS

Allied Radio Corporation  
833 West Jackson Blvd.

Complete standard lines always in stock—W9PVH—W9IBC—W9RZI

## CHICAGO, ILLINOIS

Chicago Radio Apparatus Company  
415 South Dearborn Street (Est. 1921)

W9RA and W9PST — Amateurs since 1909

## DENVER, COLORADO

Inter-State Radio & Supply Co.  
1639 Tremont Place

Amateur Radio Headquarters in the Rocky Mountain Region

## DETROIT, MICHIGAN

Radio Specialties Company  
171 E. Jefferson Avenue

Ham Supplies — National & Hammarlund Sets and Parts

## DETROIT, MICHIGAN

Rissi Brothers  
5027-31 Hamilton Ave. at Warren  
W8KXK Manager Amateur Department

## DETROIT, MICH.

Serlin Stores  
1419 Broadway, near Grand River  
Amateur parts — receivers — transmitters

## FRESNO, CALIFORNIA

Ports Manufacturing Co.  
3265 E. Belmont Ave.

Wholesale: RCA-Thordarson-Bliley. All Standard Lines

## DES MOINES, IOWA

Iowa Radio Corp.  
1212 Grand Avenue  
Complete amateur stock, W9OCG—W9EMS—W9KAY

## KANSAS CITY, MISSOURI

Burstein-Applebee Company  
1012-14 McGee Street  
"Specialists" in supplies for the Amateur and Serviceman

## KANSAS CITY, MISSOURI

Radiolab  
1515 Grand Avenue  
Amateur Headquarters in Kansas City

## MILWAUKEE, WISCONSIN

Radio Parts Company, Inc.  
538 West State Street  
Complete stock Nationally Known products

## MINNEAPOLIS, MINNESOTA

Electric City  
1607 Hennepin Street  
Headquarters for standard lines of amateur and servicemen parts

## MINNEAPOLIS, MINNESOTA

Lew Bonn Co.  
1124-26 Harmon Place  
W9BP—W9TLE—W9HOP—W9DKL—W9LEX

## SALT LAKE CITY, UTAH

Felt Radio Company  
150 South Main Street  
W6IAL Intermountain Radio Headquarters

## SAN FRANCISCO, CALIFORNIA

Offenbach Electric Company, Ltd.  
1452 Market Street  
"The House of a Million Radio Parts"

## TORONTO, CANADA

A & A Radio Service Supply  
101 Queen Street, West  
Canada's foremost radio supply house

# You Are Protected When You Buy From QST Advertisers

“Advertising for QST is accepted only from firms who, in the publisher’s opinion, are of established integrity and whose products secure the approval of the technical staff of the American Radio Relay League.”

Quoted from QST’s advertising rate card.

Every conceivable need of a radio amateur can be supplied by the advertisers in QST. And you will know the product has the approval of the League’s technical staff.

## For Your Convenience QST’S INDEX TO ADVERTISERS IN THIS ISSUE

Aerovox Corporation	118
Aladdin Radio Industries, Inc.	94
Amprex Electronic Products	84
Astatic Microphone Laboratory, Inc.	94
A. R. R. L. Calculators	103
Handbook	95
How To Become a Radio Amateur	111
License Manual	113
Story of Amateur Radio	91
Supplies	87
Birnback Radio Company	106
Bliley Electric Company	73, 124
Bud Radio, Inc.	110
Burgess Battery Company	75
Burton Rogers Company	96
Candler System Company	115
Capitol Radio Engineering Institute	96
Cardwell Mfg. Corporation, Allen D.	77
Centralab	74
Cohen’s Sons, I. S.	113
Collins Radio Company	Cov. 2
Communication Products, Inc.	119
Continental Carbon, Inc.	100
Cornell-Dubilier Corporation	98
Coto-Coil Company	98
Delaware Radio Sales	92, 107
Fitel-McCullough, Ltd.	79
Electrad, Inc.	113
Freck Radio & Supply Company	113
General Electric Company	76, 81
General Radio Company	72
General Transformer Company	92
Gross Radio, Inc.	83
Gulf Radio School	102
Hallcrafters, Inc.	4
Hammarlund Manufacturing Company	1
Harvey Radio Laboratories	101
Hatry & Young	80
Heintz & Kaufman, Ltd.	122
Henry Radio Shop	102
Hinds & Edgerton	5
Hipower Crystal Company	102
Instructograph Company	112
International Resistance Company	97
Jacobs, Chas. F.	116
Jefferson Electric Company	82
Kenyon Transformer Company	107
Leeds	99
Marine Radio Company	2
Massachusetts Radio School	112
McElroy, T. R.	110
Meissner Manufacturing Company	110
National Carbon Company	78
National Company	71, Insert, Cov. 3
Newark Electric Company	89
New York V. M. C. A. Schools	114
Ohmite Manufacturing Company	117
Omaha Crystal Laboratories	114
Ottawa Radio Company	100
Port Arthur College	107
Precision Piezo Service	116
Radio Constructors Laboratories	86
Radio Mfg. Engineers	127
Radio Shack	6, 113
Radio Supply Company	117
Radio Transceiver Laboratories	114
Raytheon Production Corporation	111
RCA Institutes, Inc.	119, 122
RCA Manufacturing Company	Cov. 4
Sargent Company, E. M.	119
Scientific Radio Service	119
Shure Brothers	124
Sickles Company, F. S.	112
Signal Electric Manufacturing Co.	110
Sundt Engineering Company	118
Sun Radio Company	118
Taylor Tubes, Inc.	93
Teleplex Company	106
Terminal Radio Corporation	115
Thordarson Electric Manufacturing Co.	85
Triplett Electric Manufacturing Co.	88
Turner Company	114
United Electronics	118
United Transformer Company	128
Universal Signal Appliance	112
Valpey Crystals	106
Western Electric Company	90



**R M E**  
**ANNOUNCE**

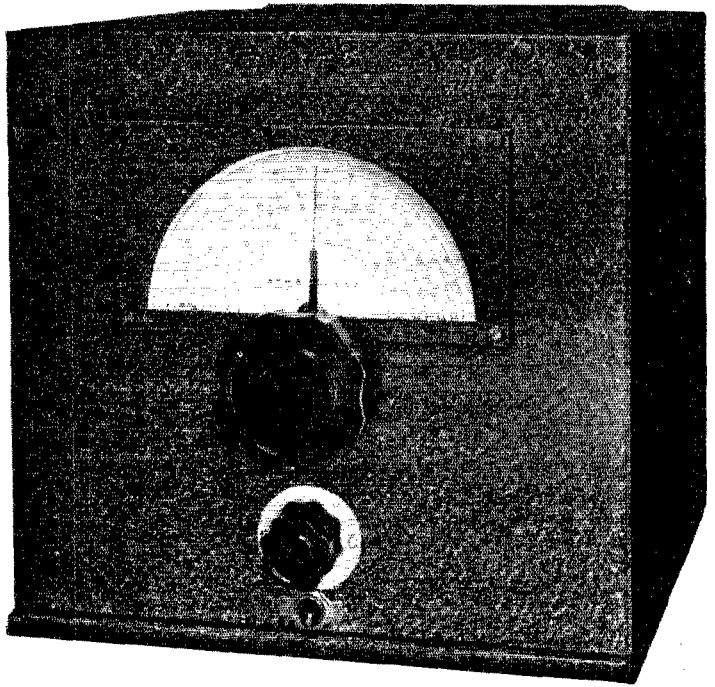

*a New*

# SIGNAL INTENSIFIER and IMAGE REJECTOR

Available on or about  
OCTOBER 1ST, 1936

Briefly, these are the specifications which have been met in the design of the new RF Amplifier-Selector.

- (1) Complete frequency coverage, 550 KC to 32,000 KC.
- (2) Uniform average gain of signals of 20 to 25 db.
- (3) Average image frequency ratio of 20,000 to 1.
- (4) Self-contained power supply.
- (5) Input circuit designed for either doublet or Marconi type antenna.
- (6) Output impedance of 250 ohms (matching input to RME-69 Receiver).
- (7) Individual gain control, illuminated dial, finger-tip control.
- (8) Cabinet and general design matching RME-69 and older RME-9D Receivers.
- (9) Rigidly built and carefully tested to RME specifications.
- (10) Tube complement: 2-6K7s and 1-80.

The coming radio season will require something special in the way of radio reception.

DX is good, but it can be made *better*. Selectivity and sensitivity of receivers are good. They *must* be made better. Image interference has always been a problem. For the first time we have increased the signal to image ratio to a point heretofore never accomplished.

The new DB-20 will now do the trick.

SEE YOUR DEALER or WRITE for DETAILS

**RADIO MFG. ENGINEERS, INC.**  
306 First Avenue, Peoria, Illinois

# Power to spare . . .

Built-in integrity that Hamdom associates with every UTC product... at prices that every Ham can afford...

**the *New* UTC PLATE TRANSFORMERS are superior and do not cost any more**

ASK YOUR UTC DISTRIBUTOR FOR THESE UNITS

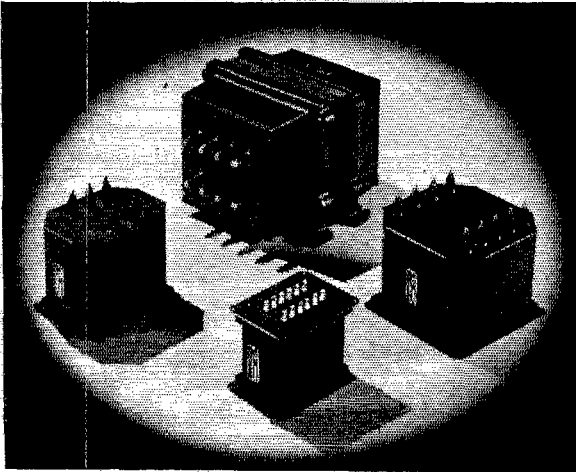

HIGHER VOLTAGES, more current at no increase in cost! Primary 105, 115, 220, 230 volts A.C. 50/60 cycles.

		Net to Hams
PA-110	515 or 625 each side of center at 200 MA 400 VDC or 500 VDC. PA-3	\$ 6.00
PA-111	750 or 950 each side of center at 350 MA; DC voltage 600 or 750. PA-4	10.80
PA-112	1250 or 1500 each side of center at 500 MA; DC voltage 1050 or 1250. PA-6	21.00
PA-113	1750 or 2100 each side of center at 500 MA; DC voltage 1500 or 1750. PA-6	28.50
PA-114	1750, 2350, 3000 or 3500 each side of center at 500 MA; DC voltage 1500, 2000, 2500 or 3000. UTS mtg.	45.60
PA-154	3500, 4000 each side of center at 500 MA 3050 VDC or 3500 VDC. UTS case	60.00
PA-115	C bias plate transformer for class B 203A's, 830B's, 800's, or 210's using one or two 82 rectifiers. PA-3	6.00
PA-116	1250 or 1500 each side of center at 300 MA; DC voltage 1050 or 1250. PA-5	15.00
PA-117	3500 or 3000 each side of center at 1 ampere. 2620 VDC or 3050 VDC. UTS case	69.00
PA-118	1750 or 2400 each side of center at 325 MA; DC voltage 1500 or 2000. PA-6 mtg.	23.40
PA-119	1500 or 1750 each side of center at 1 amp. DC voltage 1250 or 1500. UTS case	45.60

NOTE: For reduced power operation, and when required, using these transformers on the 115 volt line, the DC output voltage can be reduced to half of normal value by switching to the 230 volt tap. These transformers will also operate on 25 to 40 cycle current if the 115 volt line is connected to the 230 volt tap.

NOTE: CS types are similar in appearance and design to PA types but differ from PA types in that they are designed ONLY for operation on 115 volt 50/60 cycle current.

		Net to Hams
CS-200	450 each side of center at 150 MA; 5V-3A; 2 1/2 V-10A. CV mtg.	\$ 3.90
CS-201	500 each side of center at 200 MA; 2 1/2 V.C.T. 14 A; 5 V.C.T. 3 A; CD mtg.	4.80
CS-202	600 each side of center at 200 MA; 2 1/2 V-10A; 7 1/2 V-3A; 5V-3A. CD mtg.	6.00
CS-203	800 each side of center at 150 MA; 660 V. P.S. CD mtg.	4.50
CS-204	800 each side of center at 250 MA; 650 V. DC. CD mtg.	6.60
CS-205	750 or 950 each side of center at 350 MA; DC voltage 600 or 750. PA-4 mtg..	10.20
CS-206	1250 or 1500 each side of center at 500 MA; DC voltage 1050 or 1250. PA-6 mtg.	19.20
CS-207	1750 or 2100 each side of center at 500 MA; DC voltage 1500 or 1750. PA-6 mtg.	26.10
CS-208	1750, 2350, 3000 or 3500 each side of center at 500 MA; DC voltage 1500, 2000, 2500 or 3000	39.00
CS-209	1250 or 1500 each side of center at 200 MA; DC voltage 1050 or 1250. PA-5 mtg.	12.00
CS-210	1750 or 2400 each side of center at 325 MA; DC voltage 1500 or 2000. PA-6 mtg.	21.00
CS-212	475 each side of center at 500 MA; 5 V.C.T. 6A, for 4-6L6's fixed bias etc. DC voltage 400 CD mtg.	8.40
CS-213	1250 or 1500 each side of center at 300 MA; DC voltage 1050 or 1250. PA-5 mtg.	13.80
CS-214	1500 or 1750 each side of center at 1 amp. DC voltage 1250 or 1500. UTS mtg...	39.00

## UNITED TRANSFORMER CORP.

72 SPRING STREET

NEW YORK, N. Y.

EXPORT DIVISION: 100 VARICK STREET NEW YORK, N. Y. CABLES: 'ARLAB'

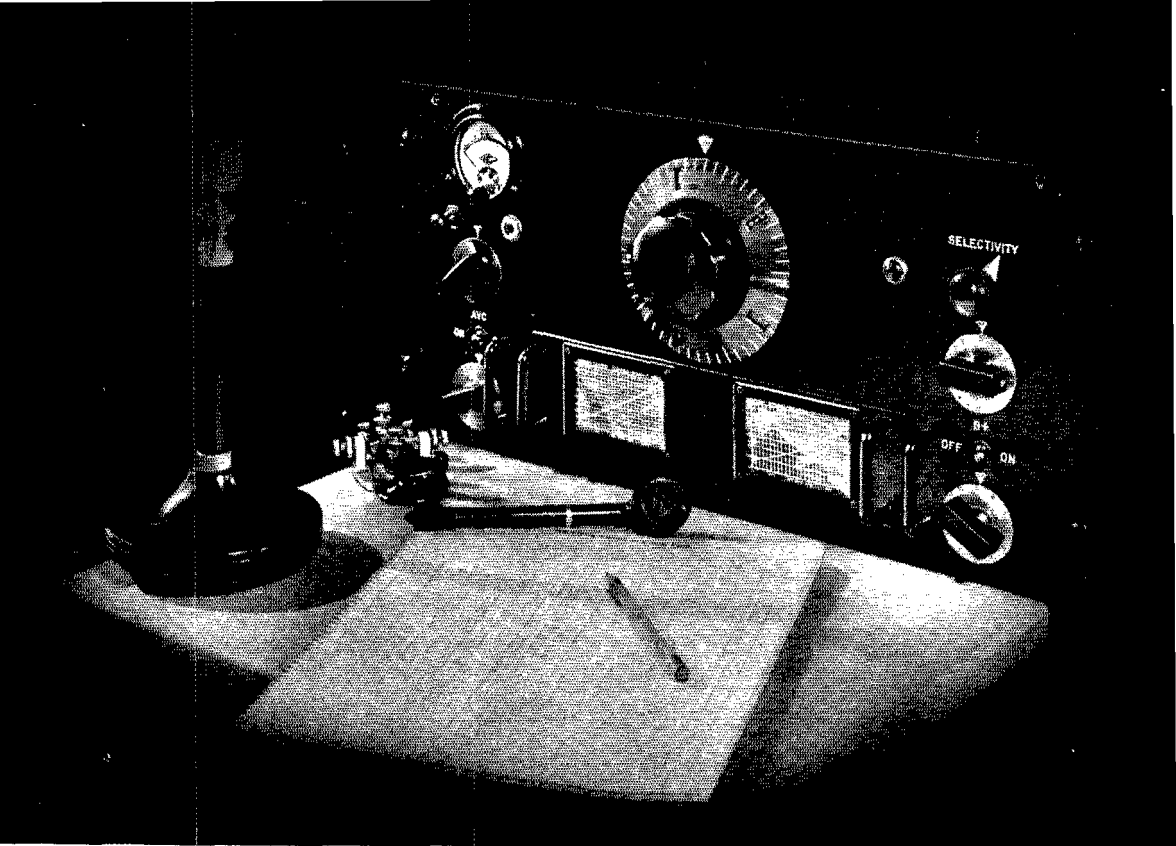

**A**NY night on the amateur bands you will hear a better advertisement of the Standard HRO than we could write. The unqualified enthusiasm of men who have spent years mastering the fine points of high frequency communication counts for more than a long list of unusual details, even though those details include such items as the PW Precision Condenser, calibrated band spread and a crystal filter as effective on phone as c.w. The demands of modern radio are rigorous, and the proof of the pudding is in the eating.

---

*An illustrated folder describing this receiver will be mailed on request*

---

NATIONAL



COMPANY

# Razor-like Selectivity

**MAKES SEPARATION OF INTERFERING STATIONS EASY**

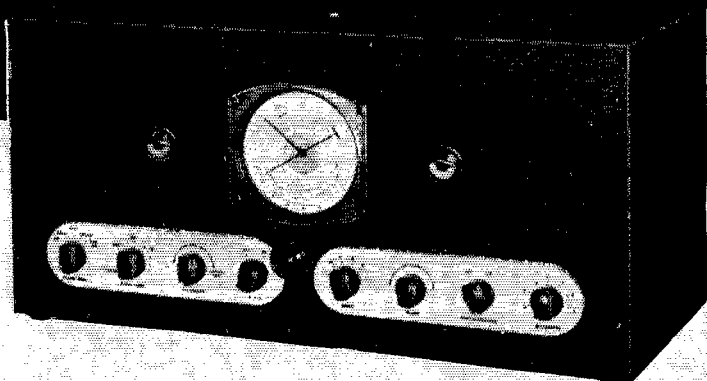

*New ACR-175 receiver provides the features desirable for amateur performance —yet is available at modest cost . . . only \$119.50 net, f. o. b. factory*

**T**HE keen selectivity of the ACR-175 plus the brilliant performance of a specially designed crystal filter, makes the separation of interfering stations easy. Even in the most crowded amateur bands!

A smooth-handling, single control band spread system gives easy tuning and provides for accurate logging without the use of reference points.

The unusual tuning range—500 to 60,000 kilocycles—gives coverage of

many services unreached by other communication receivers.

Two stages of high-gain i. f. amplification provide the high degree sensitivity needed for reception under adverse conditions.

For further information about these and the many other fine features of the ACR-175, see your distributor or write to us. A demonstration will convince you that the ACR-175 is the receiver for your station.



## *for Amateur Radio*

Address Amateur Radio Section, RCA Manufacturing Co., Inc., Camden, N. J.

A service of the Radio Corporation of America

***The New Edition is Ready!***

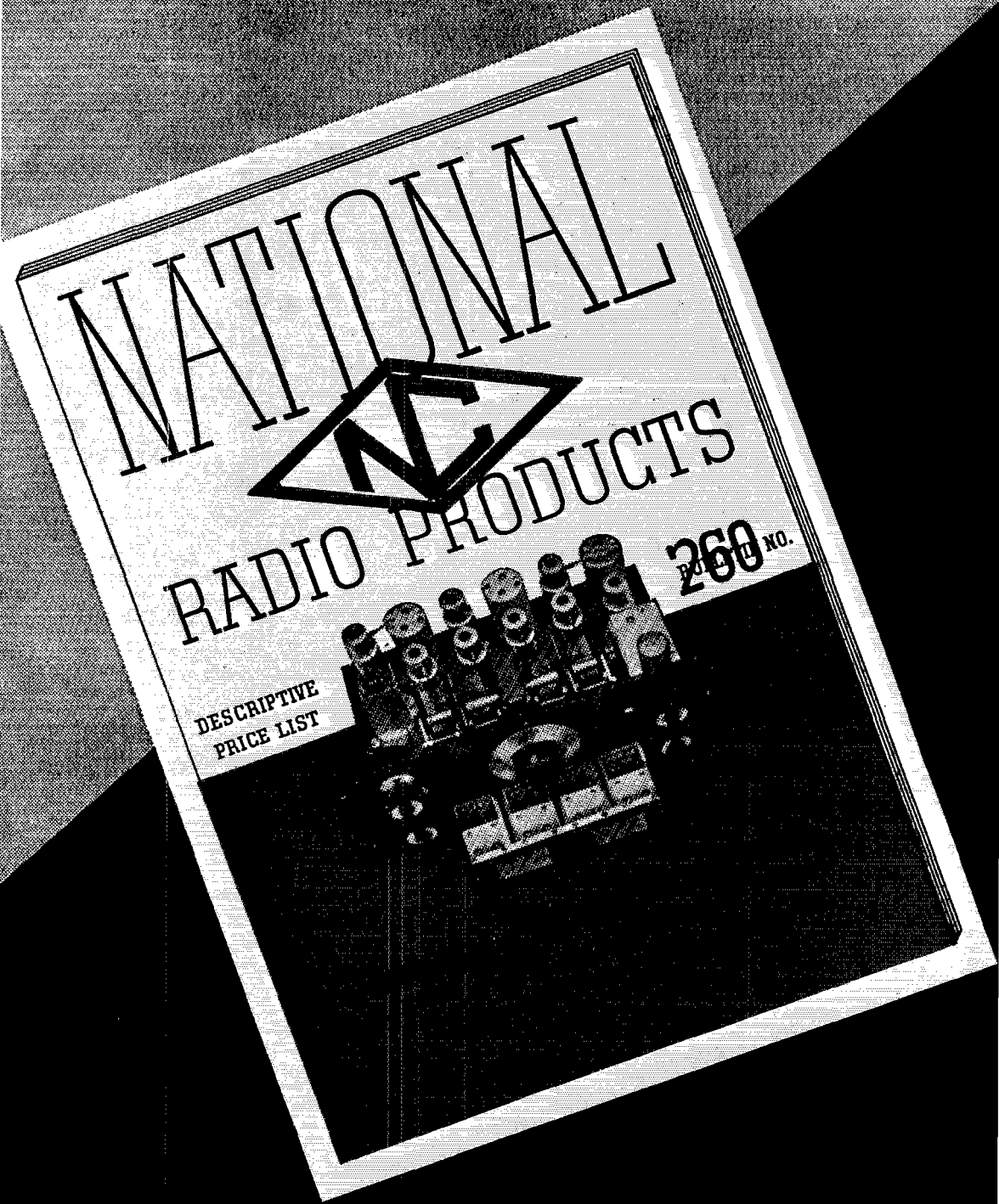

***A Free Copy is Waiting at Your Dealers***

# NEW CATALOGUE



October having come around again, a new edition of the catalogue is ready, and as before a copy will be bound into the current edition of the Handbook. That custom seems to be a very useful one, — even we who have thousands of catalogues lying around find that the Handbook is the one place where we can always find a copy. As for the catalogue itself, it is a darn complete job, listing not only the things that you want to buy, but also the things that the other fellow wants to buy. For instance, there are I.F. transformers of the much-described iron-core type. We have done as good a job on them as we know how, and probably the other fellow will prefer them, but you know as we do that the air-core units are better. Then there is the HRO, Standard or Junior, for the fellow who is after a WAC, and the NC-100 for the man who takes his hobby in smaller doses. Someday we hope to have a catalogue that lists everything that any amateur would ever need, no matter what sort of rig he builds. That is a pretty large order, and the goal is a long way off. For the present we will have to content ourselves with supplying the things that an amateur needs most, — the things that he can't get anywhere else. Along that line, the new catalogue lists a number of new products that would be hard to duplicate. The big TML condenser for instance, is a **BIG CONDENSER**, not a collection of pint-sized parts scaled up. The Hollister Crystal Holder which makes the crystal tunable is also new to the catalogue, although it seems hard to believe that it is less than a year old. But it is a newcomer, like the PB-10 which has not yet even been announced, and the UR-13 Buffer Coil Form Assembly, and the O Dial, and the FXT Fixed Tuned Exit Tank, and a host of others. We know these parts are useful, because we needed them so darn badly ourselves that we just had to make them. However we shall not try to condense the catalogue on this page. Better get a copy for yourself and study up on these new contributions to the gentle art of radio.

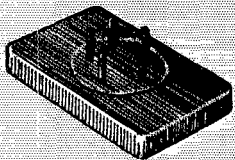

**NATIONAL COMPANY, INC.**