

# QST

September, 1938  
25 cents

devoted entirely to

# amateur radio

*In This Issue—*

The  
Ionosphere  
From the  
Amateur  
Angle

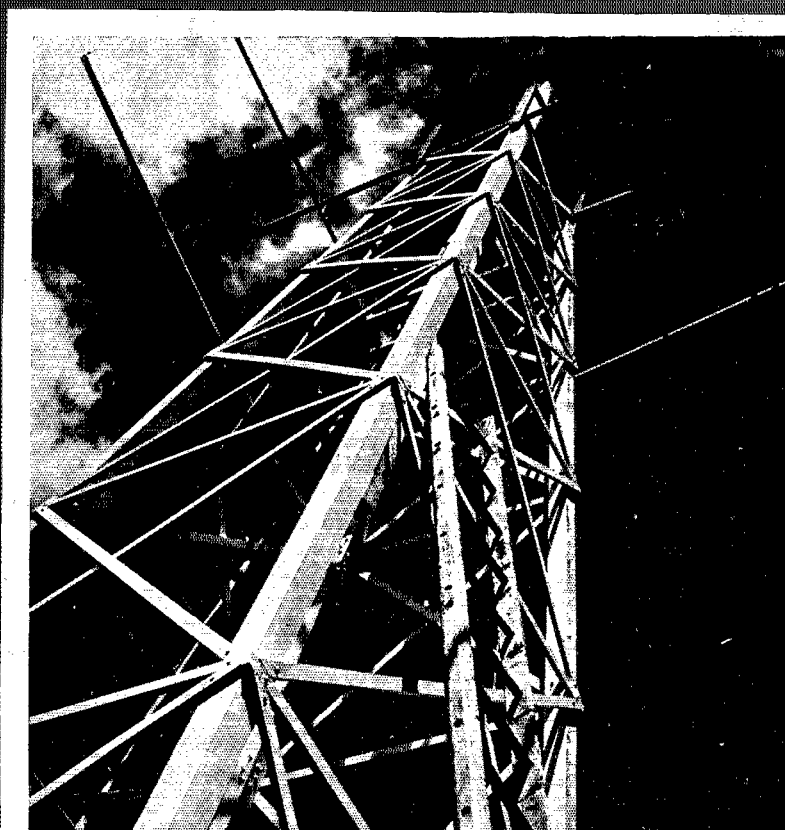

# Coördinated Design — *Equipment and Tubes*

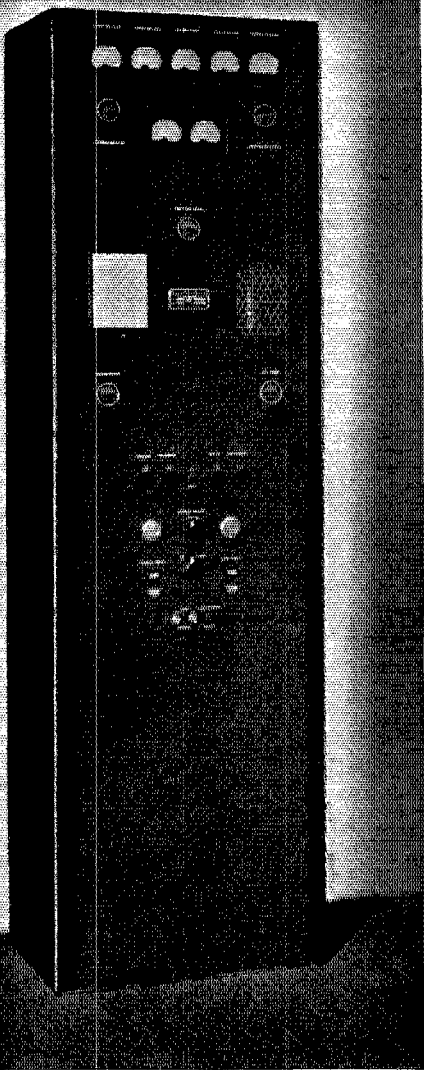

The average characteristics of Collins transmitting tubes are set out in tabular form in a four page folder. Twenty types of triodes and six types of mercury vapor rectifiers are available. Unusually complete operating data is shown in the table and more detailed information is given in individual tube data sheets. Although Collins transmitting tubes were developed primarily for use in Collins transmitting equipment they are finding extensive application for all kinds of service. Certain new types, such as C200, C201, C300 and C375A have assisted in achieving greater efficiency and operating economy in equipment design. Other types are available to provide interchangeability with existing types. In all Collins tubes the most advanced design and rigid inspection of materials has contributed to superior performance and proven long life.

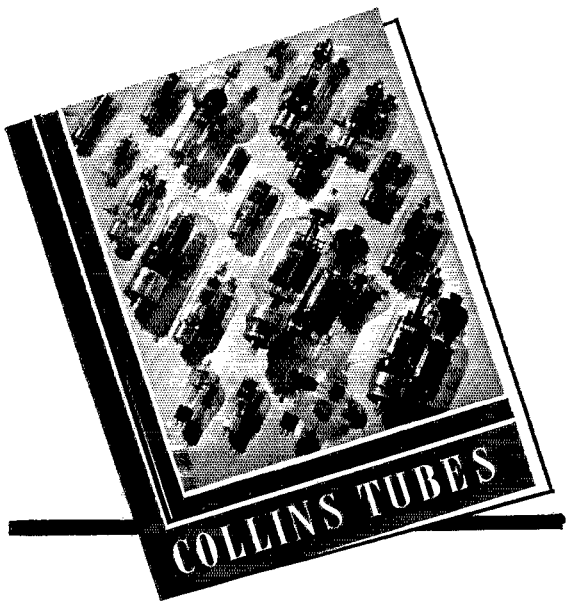

★ ★ ★ The 600A Transmitter with a CW output of 700-800 watts and a radiophone output in excess of 200 watts makes efficient use of the new Collins tubes including C200, C300, C866, C866A and C100A. Complete data on the 600A Transmitter will be sent upon request. ★ ★ ★ ★

## Collins Radio Company

CEDAR RAPIDS  
New York  
11 West 42nd St.



IOWA, U. S. A.  
Mexico City  
Edificio "La Nacional"

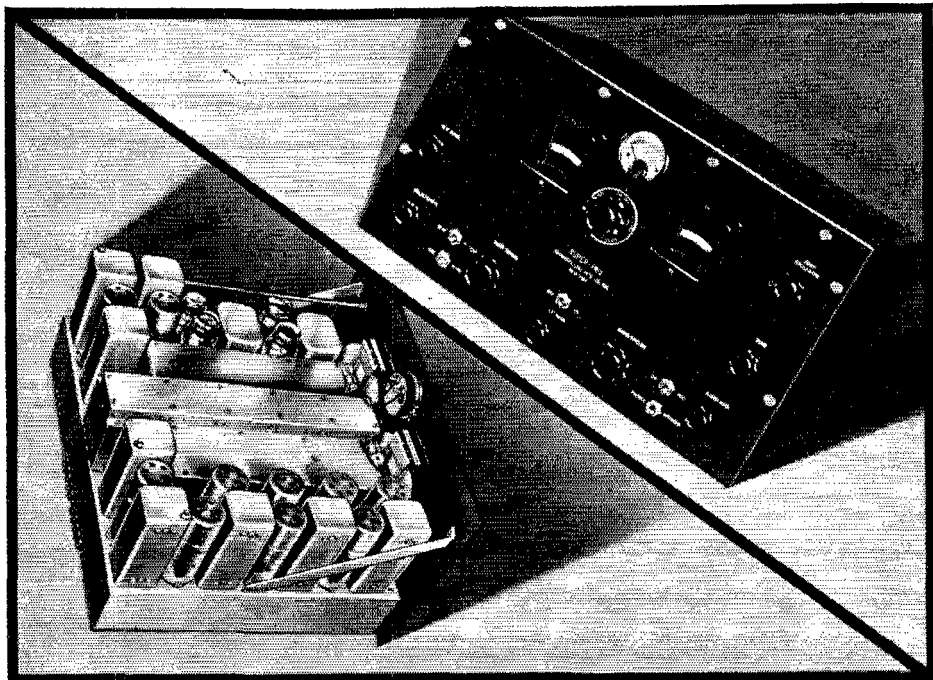

# "SUPER PRO'S" *Acclaimed!*

**P**PROMPTLY upon its introduction, the Hammarlund "Super Pro" assumed instant leadership because it fulfilled every "hard-boiled" demand of the professional operator and advanced amateur. Daily, the "Super Pro" continues to blaze a path in view of its conspicuous performances.

The Plant Supervisor of W.O.R., Charles Singer, says: "Regarding the 'Super Pro', . . . it is operating in our immediate 50,000 watt field. We are using three doublet antennas, 50' high and exposed to an R.F. field from W.O.R. transmitter of 10 or more volts of R.F. We are able to tune in all broadcasting stations between 500 and 1600 kc. with no inter-channel interference. On shorter waves, we experience pre-selection enough to pick up all foreign and local stations with 5 and 10 kc. separation from our harmonics. We followed the Queen Mary from its dock in England to New

York. It is the only receiver of the many tested that performed so well in our immediate transmitter field."

The Hammarlund files bulge with similar praise from "Super Pro" users — amateurs, professionals, expeditions, police, broadcasting networks — in every corner of the world who chose this amazing receiver after exhaustive competitive tests.

Among the features that are gaining such acclamation for the "Super Pro" are the electrostatically shielded input; two tuned R.F. stages on all bands; silver plated, precision 5-band switch; continuously variable selectivity; three air tuned I.F. stages; direct, accurately calibrated dial; band spread tuning, and variable crystal filter.

A special booklet describing the "Super Pro" in detail has been just prepared. Write for your copy now!

## MAIL THIS COUPON!

HAMMARLUND MFG. CO., Inc. Q-9  
424-438 W. 33rd St., New York

- Check here for complete data on the new Hammarlund "Super Pro."
- Check here for 1936 Hammarlund General Catalog.

Name.....  
Address.....  
.....



# HAMMARLUND'S 25<sup>TH</sup> YEAR

Say You Saw It in QST — It Identifies You and Helps QST

# MARINE TRANSMITTERS

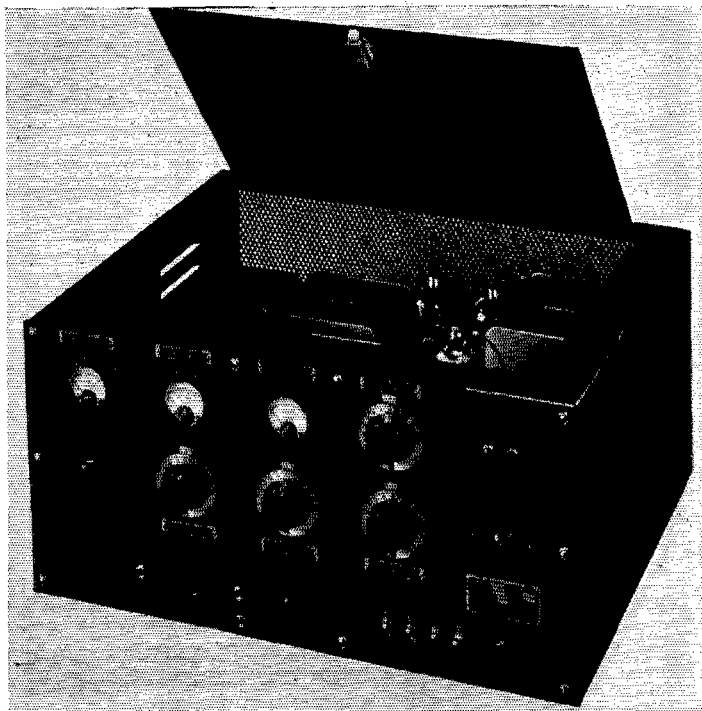

"As Modern As Tomorrow"  
is a fitting description of the compact  
**MARINE 18A**

With pentodes in each RF stage, band switching and an all metal tube audio system, new standards of performance and ease of operation are obtained. Naturally the basic points of design that make MARINE transmitters outstanding, have been skillfully blended with these ultra modern features.

*Write for complete details and photographic illustrations of this and other models for all purposes.*

## 160 Watts C W

Frequency range 1500-30000 KC  
Band switching  
Pentodes in all RF stages  
Fully metered RF circuits  
Filament and plate voltage indicators  
Low original cost.

## 40 Watts Phone

Metal tube audio system  
Suppressor grid modulation  
Excellent A F response from 30 to 10000 c.p.s.  
Employs any type of microphone  
Overload relay protection  
Safety cover switch  
Rigid construction with ample ventilation  
Low operating cost



**MARINE RADIO CO.**  
60 Lispenard Street New York City

# QST

devoted entirely to  
**AMATEUR RADIO**

PUBLISHED, MONTHLY, AS ITS OFFICIAL ORGAN, BY THE AMERICAN RADIO RELAY LEAGUE, INC., AT WEST HARTFORD, CONN., U. S. A.; OFFICIAL ORGAN OF THE INTERNATIONAL AMATEUR RADIO UNION

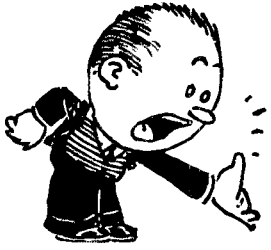

**SEPTEMBER**  
**1936**  
*Volume XX*  
*Number 9*



Kenneth B. Warner (Secretary, A.R.R.L.), *Editor-in-Chief and Business Manager*; Ross A. Hull, *Associate Editor*; James J. Lamb, *Technical Editor*; George Grammer, *Assistant Technical Editor*; Clark C. Rodimon, *Managing Editor*; David H. Houghton, *Circulation Manager*; F. Cheyney Beekley, *Advertising Manager*; Ursula M. Chamberlain, *Assistant Advertising Manager*.

*Editorial and Advertising Offices*

38 La Salle Road  
 West Hartford, Connecticut

Subscription rate in United States and Possessions and Canada, \$2.50 per year, postpaid; all other countries, \$3.00 per year, postpaid. Single copies, 25 cents. Foreign remittances should be by international postal or express money order or bank draft negotiable in the U. S. and for an equivalent amount in U. S. funds.

Entered as second-class matter May 29, 1919, at the post office at Hartford, Connecticut, under the Act of March 3, 1879. Acceptance for mailing at special rate of postage provided for in section 1103, Act of October 3, 1917, authorized September 9, 1922. Additional entry at Concord, N. H., authorized February 21, 1929, under the Act of February 28, 1925.

Additional second-class entries to cover sectional editions authorized March 20, 1935. Copyright 1936 by the American Radio Relay League, Inc. Title registered at United States Patent Office.

## The Contents

Editorials . . . . .	11
"Move Over" . . . . . <i>H. W. Castner, W1IIE</i>	12
The Kennelly-Heaviside Layer—Its Relationship to Our Everyday Communication Problems <i>G. W. Kenrick, K4DDH</i>	13
Some Trick Crystal Circuits <i>J. Stanley Brown, W3EHE</i>	19
A.R.R.L. QSL Bureau . . . . .	21
Working at One Meter and Below . . . <i>Ross A. Hull</i>	22
Hudson Division Convention . . . . .	25
What the League Is Doing . . . . .	26
A Volume-Compressing Method for 'Phone Transmission <i>Wilbert B. Smith</i>	28
The 6L6 As Amplifier and Doubler . . . . .	30
Oscillator-Mixer Design Considerations for the Amateur- Band Superhet . . . . <i>Clinton B. DeSoto, W1CBD</i>	31
The Results of the 1936 DX Contest . . . . .	33
Southwestern Division Convention . . . . .	37
Midwest Division Convention . . . . .	37
Dixie Jones' Owl Juice . . . . .	37*
Hints and Kinks for the Experimenter	
Transceiver à la "Minute Man" — R.F. Amplifier for the "Minute Man" — A Cure for Blanketing — Kink for Using Single-Wire End-Fed Antennas — Some Zepp Pointers — Calibrated Band-Spread and General Coverage with the Same Coil — Break-in Monitoring	38
I.A.R.U. News . . . . .	41
Operating News . . . . .	43
Correspondence Department . . . . .	49
Silent Keys . . . . .	52
The Iowa State Convention . . . . .	64
New Line Chokes . . . . .	66
A New Antenna Relay . . . . .	68
Grid Bias Cells . . . . .	68
Standard Frequency Transmissions . . . . .	70
Hamads . . . . .	91
QST's Index of Advertisers . . . . .	94

We have just published a **NEW** Log Book. It is very much **BETTER** than heretofore and, even so, it's

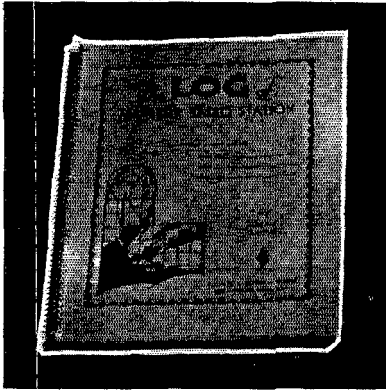

**CHEAPER.** In the first place, we have taken advantage of modern **SPIRAL BINDING**

which is particularly desirable because the book will fold back flat at any page. Therefore, it takes only half the space on an operating table, and is perfectly

flat to write on. Everybody likes this feature. The Communications Dept.

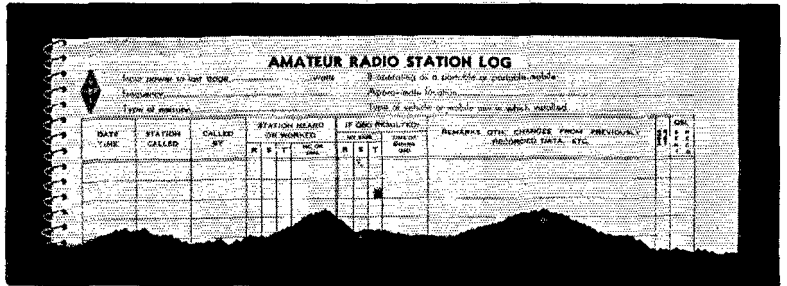

has produced an **IMPROVED LOG SHEET**, and has added two useful new columns at the right-hand edge where

we can record messages handled and QSL's. Of course, the book still has in it the same **INFORMATION** sheets it had before except everything has been brought up to date and the graph sheet is now lithographed in green and has wider margins. Better send today for a New Log Book.

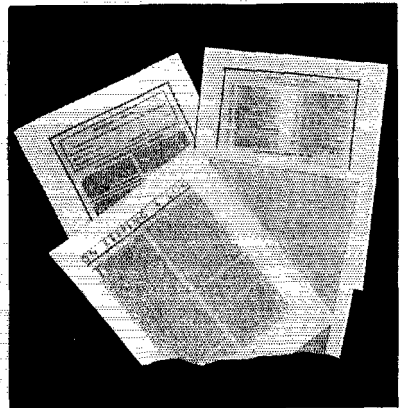

*New price: 35¢ each, 3 for \$1, postpaid*

**AMERICAN RADIO RELAY LEAGUE, INC., West Hartford, Connecticut**

*Now*  
YOU CAN BUY ANY NEW 1937  
hallicrafter receiver

on

*Time Payments*

COINCIDENT with the introduction of the new 1937 Hallicrafters Line of Communication Receivers, we are also announcing the new Hallicrafters Time Payment Plan. No longer do you need the full purchase price to have the latest in receiving equipment.

Now you can have and enjoy one of these superb precision-engineered short wave receivers merely by paying a modest down payment and the easily met monthly installments. All arrangements can be made through your local radio jobber.

Don't be satisfied with obsolete equipment! See the new 1937 Hallicrafters Line at your jobber's today! Select your receiver, pay the moderate down payment, and enjoy real short wave reception.

*W. J. Halligan, Pres.*

**the hallicrafters**

Marion, Indiana, U. S. A.



**NEW HALLICRAFTER RECEIVERS**

SEE FOLLOWING PAGES



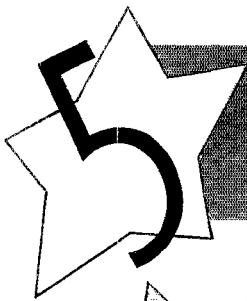

# NEW hallicrafter

## AMERICA'S LEADING

**FIVE NEW RECEIVERS** — each one unsurpassed in its class — with new features of engineering, of design, of construction. Now there's a Hallicrafters precision-engineered communication receiver for every purpose, for every purse — all available to you on the new Hallicrafters Time Payment Plan! See them at your jobber's, or write for complete details!

SKY BUDDY

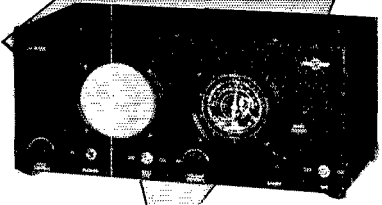

### THE SKY BUDDY — Hallicrafters 5-Tube Junior Model Communication Receiver

A real communication receiver, precision-engineered by Hallicrafters, with performance characteristics that compare favorably with many higher priced receivers. It's a superheterodyne that tunes from 16.5 MC to 544 KC in three bands, a single iron core I.F. stage and an improved mechanical band spread. Astonishing selectivity and sensitivity for a receiver of this class. A splendid receiver for the beginner in Amateur Radio.

- Combined I.F. and Beat Frequency Oscillator.
- Iron Core I.F. (High gain greater selectivity).
- 5 tubes do the work of 8.
- Automatic Volume Control.
- Greater Band spread — 36 to 1.
- Bands changed with switch.
- Direct-reading calibrated dial.
- Built-in Speaker and Power Pack.

SKY CHIEF

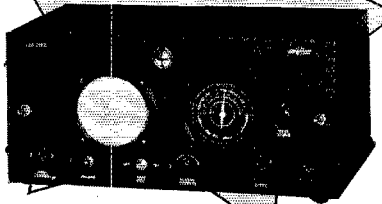

### THE SKY CHIEF — A New 7-Tube Superheterodyne with excellent performance at an attractive price

The Sky Chief is designed with all the latest features usually found only on much higher priced sets. Tunes from 17.6 MC to 540 KC and is equipped with all the features and controls so desirable to critical operators. Good sensitivity and selectivity.

- Single Stage 465 K.C. Iron Core I.F.
- 17.6 to 540 K.C. in three bands.
- Variable Beat Oscillator.
- Automatic Volume Control.
- Positive 3 Band Selector Switch.
- Mechanical Band Spread.
- Built-in Speaker and Power Pack.

### The Hallicrafters Speaker

A 12-inch Permanent Magnet Dynamic Speaker especially designed for use with the New Super Sky Rider, the Ultra Sky Rider and the Sky Rider Commercial. Utilizes the new high permeability steel and is an answer to the new demand for high quality phone reception by the radio amateur.

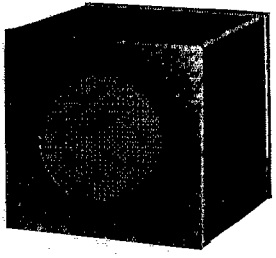

# the hallicrafters

Marion, Indiana, U. S. A.

## NOW Available On Easy Terms



# RECEIVERS for 1937!

## COMMUNICATION RECEIVER LINE!

### The NEW 1937 SUPER SKY RIDER — now with 11 Tubes — even finer performance and added features

It didn't seem possible but we did it. We've made the Super Sky Rider even better than ever before. With Eleven Tubes, Selectivity beyond last year's model, Greater Sensitivity and a new high fidelity power output (17 Watts Max.), this new receiver has reached greater heights in performance. Many new features add to its efficiency and convenience in operation. Now the Super Sky Rider is more than ever before the "perfect" receiver for the amateur.

- 11 Tubes — 10 of them metal.
- 40 M. C. to 535 K. C. in 5 Bands.
- 338 degree main tuning dial.
- Electro-Mechanical Band Spread.
- 14 Watts Undistorted Output.
- Direct Calibration Tuning — No Charts or Tables.
- Field Strength Indicator.
- Improved 10 meter performance.
- Single Signal Crystal Action.
- 465 K. C. Iron Core I. F. for improved selectivity.
- Ceramic Insulation.

### THE ULTRA SKY RIDER — a new and unique approach to high frequency reception

This, the finest Hallicrafters receiver, has received commendation wherever presented. It is the receiver for the Ultra High Frequency operator, tuning from 3.76 to 53 meters in four direct calibrated bands, and operating with equal efficiency on them all.

- Built-in Noise Silencer.
- 1600 K. C. Iron-Core Air-Trimmed I. F. Transformers.
- Electro-Mechanical Band Spread.
- 338 Degree Dial.
- Direct Calibration Tuning — No Charts or Tables.
- Individual Coils for each band.
- Generous Isolantite Insulation.
- 100 K. C. Expansion.

### THE SKY RIDER COMMERCIAL — an 11-Tube Super- heterodyne especially fitted for commercial service

A new Hallicrafters receiver tuning from 30 to 3000 Meters that can be used for practically all long wave reception as well as short waves to the 31 meter short wave broadcast band. With the Ultra Sky Rider, it provides complete reception of this radio spectrum, with suitable sensitivity and selectivity on all bands. A thoroughly workmanlike receiver with all the outstanding features of the Sky Rider series.

- Micro-Vernier Band Spread.
- Direct Calibration Tuning — No Charts or Tables.
- 1600 K. C. Iron Core I. F. System.
- 338 Degree Dial.
- 14 Watts Undistorted Output.
- Field Strength Indicator.
- All Metal Tubes.
- Illuminated Band Spread and Main Tuning Dial.

### NEW 1937 SUPER SKY RIDER



### ULTRA SKY RIDER

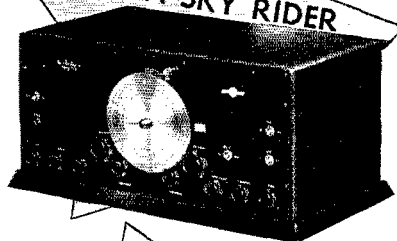

### SKY RIDER COMMERCIAL

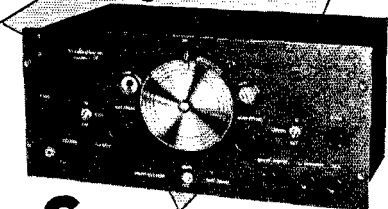

# the hallicrafters

Marion, Indiana, U. S. A.

## From Your Own Parts Jobber

# TIME PAYMENTS

on the  
Entire 1937  
Hallicrafters  
line!

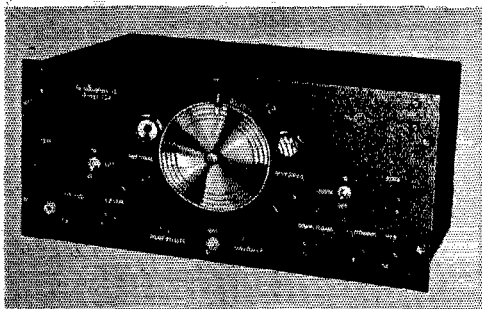

**WE ARE PROUD** to present the amazing new 1937 Hallicrafters Line. We have seen these marvelous new receivers, listened to them, and are glad to extend them our fullest endorsement.

We like the new Sky Buddy for what it has to offer the junior operators in its astonishing sensitivity and all-around fine performance.

The Sky Chief is an amazingly efficient receiver with many of the features found only on much higher priced receivers, at an astonishingly low cost.

The new 1937 Sky Rider is better than ever before, with greater sensitivity and selectivity, more features and is now offered with 11 tubes —

amateur radios popular receiver and one of its greatest values.

The Ultra Sky Rider is for the Ultra High Frequency fan. — It has amazed us as well as the experts with its astonishing performance over its full tuning range.

And the Sky Rider Commercial, another new and different receiver, designed for long wave reception, is as outstanding as the rest of the line.

We can say with authority that this 1937 Hallicrafters Line is the most complete of fine amateur radio receivers. Mail the coupon below for complete specifications and details of our time payment plan today.

## MAIL THIS COUPON

**HINDS & EDGERTON**

ESTABLISHED 1914

19 South Wells Street  
CHICAGO, ILLINOIS

### TIME PAYMENTS

Buy your new Hallicrafters receiver on Hinds & Edgerton's Time Payment Plan — small down payment and easy monthly payments — write at once for details!

Gentlemen:

Please send me complete details of the New 1937 Hallicrafters Line and the Hinds & Edgerton Time Payment Plan.

Name .....

Address .....

City ..... State .....

**OPERATED BY W9APY AND W9WR**

## Section Communications Managers of the A.R.R.L. Communications Department

All appointments in the League's field organization are made by the proper S.C.M., elected by members in each Section listed. Mail your S.C.M. (on the 10th of each month) a postal covering your radio activities for the previous 30 days. Tell him your DX, plans for experimenting, results in 'phone and traffic. He is interested, whether you are an A.R.R.L. member or get your QST at the newsstands; he wants a report from every active ham. If interested and qualified for O.R.S., O.P.S. or other appointments he can tell you about them, too.

Eastern Pennsylvania Maryland-Delaware-District of Columbia Southern New Jersey Western New York Western Pennsylvania	W3EZ W3BAK W3ZX W8DSS W8OFO	<b>ATLANTIC DIVISION</b> James M. Bruning	339 W. Lancaster Ave.  1107 Park Ave. 310 E. Walnut St.	Haverford  Laurel, Delaware Collingswood Onidell Lowerber
Illinois Indiana Kentucky Michigan* Ohio Wisconsin	W9KJY W9TE W9AUH W8DPE W8CIO W9ATO	<b>CENTRAL DIVISION</b> L. John Hutton Arthur L. Braus G. W. Mossbarger Harold C. Bird Robert P. Irvine E. A. Cary	327 Brandon Ave. 530 East Morris St. Box 177 R.F.D. 2 5508 Northliffe Ave. 3922 No. 19th Pl.	Glen Ellyn Indianapolis Camp Taylor Pontiac Cleveland Milwaukee
North Dakota South Dakota Northern Minnesota Southern Minnesota	W9OEL W9SEB W9OWU W9DCM	<b>DAKOTA DIVISION</b> Hartwell B. Burner Andrew J. Kjar Leonard Hofstad Webster F. Soules	257 Prospect Ave.  3549 36th Ave., So.	Hope Pierre Elbow Lake Minneapolis
Arkansas Louisiana Mississippi Tennessee	W5ABI W5DWV W5CWQ W4BBT	<b>DELTA DIVISION</b> H. E. Velte W. J. Wilkinson, Jr. J. H. Weems, Jr. Merrill B. Parker, Jr.	2918 West 15th St. 1523 Laurel St. P. O. Box 244 1912 Oak St.	Little Rock Shreveport State College Chattanooga
Eastern New York N. Y. C. & Long Island Northern New Jersey	W2LU W2AZV W2FOP	<b>HUDSON DIVISION</b> Robert E. Haight E. L. Bainach Charles J. Hammersen	511 South Holmes St. 7823 10th Ave. 92 Claremont Ave.	Scotia Brooklyn Verona
Iowa Kansas Missouri Nebraska	W9LEZ W9FLG W9CRH W9FAM	<b>MIDWEST DIVISION</b> Phil D. Boardman O. J. Spetter L. Dewey Mills Samuel C. Wallace	325 Kirkwood Blvd. 305 Western Ave. Box 203 Green St.	Davenport Topeka Mount Vernon Clarks
Connecticut Maine Eastern Massachusetts Western Massachusetts New Hampshire* Rhode Island Vermont	W1CTI W1CDX W1ABG W1BVR W1AXW W1HRC W1GNF	<b>NEW ENGLAND DIVISION</b> Frederick Ellis, Jr. John W. Singleton Albert N. Giddis Percy C. Noble Homer Richardson Clayton C. Gordon Alvin H. Battison	19 Merrill Rd. 73 Allen St. 128 Crawford St. 37 Broad St. 31 Sixth St. 206 California Ave. 1 Central St.	Norwalk Wilton Lowell Westfield Dover Providence Windsor
Alaska Idaho Montana Oregon Washington	K7PQ W7NH W7CRH W7AMF W7WV	<b>NORTHWESTERN DIVISION</b> Richard J. Fox Nellie H. Hart Russell U. Richmond Frank L. Black Robert H. Votaw	Box 301 Box 6 1502 McPherson St. Route 1, Box 398	Ketchikan Twin Falls Somers North Bend Vancouver
Hawaii Nevada Santa Clara Valley East Bay San Francisco Sacramento Valley Philippines* San Joaquin Valley*	K6EWO W6BIC W6FBW W6JTV W6SG W6DVE K6IGR W6LPE	<b>PACIFIC DIVISION</b> Atlas O. Adams Edward W. Heim Elbert Amarantes Harold J. Burchfield Alan D. Whittaker, Jr. Geo. L. Woodington George L. Rickard Angelo V. Astone	21st Infantry Brigade 509 Claremont St. 475 So. 11th St. 2240 106th Ave. 79 Elinor Ave. 716 Redwood Ave. Box 849 729 Safford	Schofield Barracks Reno San Jose Oakland Mill Valley North Sacramento Manila Fresno
North Carolina Virginia West Virginia	W4OG W3UVA W8KKG	<b>ROANOKE DIVISION</b> H. S. Carter Charles M. Waff, Jr. Dr. Wm. H. Rihelddaffer	115 Crafton St. P. O. Box 1212	Winston-Salem Univ. Charlottesville Lost Creek
Colorado Utah-Wyoming	W9FA W7COH	<b>ROCKY MOUNTAIN DIVISION</b> Glen Glasscock Townsend J. Rigby	2164 So. Corona St.	Denver Midwest, Wyoming
Alabama Eastern Florida Western Florida Georgia-So. Carolina-Cuba- Isle-of-Pines-Porto Rico- Virgin Islands	W4DGS W4ASR W4MS  W4CE	<b>SOUTHEASTERN DIVISION</b> James F. Thompson William C. Shelton Edward J. Collins  Bannie L. Stewart	2248 S. Arlington Ave. 556 Westmoreland Drive 1517 East Brainard St.  C. C. C. Co. 4466	Birmingham Daytona Beach Pensacola  York, S. C.
Los Angeles Arizona San Diego	W6GXM W6LVG W6EOP	<b>SOUTHWESTERN DIVISION</b> Don M. Draper C. C. Day Harry A. Ambler	4421 West 63 St. "L. Posta Quemada" 4101 Hamilton St.	Los Angeles Vail San Diego
Northern Texas Oklahoma Southern Texas New Mexico	W5BHI W5CEZ W5BDI W5CGJ	<b>WEST GULF DIVISION</b> Richard M. Cobb Arter L. Simpson Ammon O. Young Joseph M. Eldott	Box 185 2010 So. 4th St. 4803 Eli St.	Dodd City Ponca City Houston Chamita
Maritime	VE1DQ	<b>MARITIME DIVISION</b> A. M. Crowell	69 Dublin St.	Halifax, N. S.
Ontario	VE3QK	<b>ONTARIO DIVISION</b> John Perdue	229 Askin Boulevard	Windsor, Ont.
Quebec	VE2EE	<b>QUEBEC DIVISION</b> Stan Comach	780 Brault Ave.	Verdun, P. Q.
Alberta British Columbia	VE4LX VE5EP	<b>VANALTA DIVISION</b> Alfred D. Kettenbach D. R. Vaughan-Smith	1221 Burnaby St.	Rockyford Vancouver
Manitoba Saskatchewan	VE4BG VE4EL	<b>PRAIRIE DIVISION</b> A. J. R. Simpson Wilfred Skaike	71 Thelmo Mansions 2040 McTavish St.	Winnipeg Regina

\* Officials appointed to act until the membership of the Section choose permanent S.C.M.'s by nomination and election.

# The American Radio Relay League



• T

HE AMERICAN RADIO RELAY LEAGUE, INC., is a non-commercial association of radio amateurs, bonded for the promotion of interest in amateur radio communication and experimentation, for the relaying of messages by radio, for the advancement of the radio art and of the public welfare, for the representation of the radio amateur in legislative matters, and for the maintenance of fraternalism and a high standard of conduct.

It is an incorporated association without capital stock, chartered under the laws of Connecticut. Its affairs are governed by a Board of Directors, elected every two years by the general membership. The officers are elected or appointed by the Directors. The League is non-commercial and no one commercially engaged in the manufacture, sale or rental of radio apparatus is eligible to membership on its board.

"Of, by and for the amateur," it numbers within its ranks practically every worth-while amateur in the nation and has a history of glorious achievement as the standard-bearer in amateur affairs.

Inquiries regarding membership are solicited. A bona fide interest in amateur radio is the only essential qualification; ownership of a transmitting station and knowledge of the code are not prerequisite. Correspondence should be addressed to the Secretary.

HIRAM PERCY MAXIM, FOUNDER

## OFFICERS

*President*.....EUGENE C. WOODRUFF, W8CMP  
State College, Pa.

*Vice-President*.....GEORGE W. BAILEY, W1KH  
Weston, Mass.

*Secretary*.....KENNETH B. WARNER, W1EH  
West Hartford, Connecticut

*Treasurer*.....ARTHUR A. HEBERT, W1ES  
West Hartford, Connecticut

*Communications Mgr.*...F. EDWARD HANDY, W1BDI  
West Hartford, Connecticut

◆

*General Counsel*.....PAUL M. SEGAL  
1010 Shoreham Building, Washington, D. C.

◆

Address all general correspondence to the executive headquarters at West Hartford, Connecticut

## DIRECTORS

*President*  
EUGENE C. WOODRUFF.....W8CMP  
234 W. Fairmount Ave., State College, Pa.

*Vice-President*  
GEORGE W. BAILEY.....W1KH  
74 Webster Road, Weston, Mass.

*Canadian General Manager*  
ALEX REID.....VE2BE  
169 Logan Ave., St. Lambert, P. Q.

*Atlantic Division*  
WALTER BRADLEY MARTIN.....W3QV  
Box 612, Roslyn, Pa.

*Central Division*  
EDWARD A. ROBERTS.....W8HC  
2699 Endicott Rd., Shaker Heights, Cleveland

*Dakota Division*  
CARL L. JABS.....W9BVH  
1822 James St., St. Paul, Minn.

*Delta Division*  
E. RAY ARLEDGE.....W5SI  
P. O. Box 286, Pine Bluff, Ark.

*Hudson Division*  
KENNETH T. HILL.....W2AHC  
115 Willow St., Douglaston, L. I., N. Y.

*Midwest Division*  
FLOYD E. NORWINE, JR.....W9EFC  
120 South Fourth St., St. Louis, Mo.

*New England Division*  
PERCY C. NOBLE.....W1BVR  
37 Broad St., Westfield, Mass.

*Northwestern Division*  
RALPH J. GIBBONS.....W7KV  
c/o United Air Lines, Pendleton, Ore.

*Pacific Division*  
S. G. CULVER.....W6AN  
2962 Russell St., Berkeley, Calif.

*Rosnoke Division*  
H. L. CAVENESS.....W4DW  
State College Station, Raleigh, N. C.

*Rocky Mountain Division*  
RUSSELL J. ANDREWS.....W9AAB  
1867 So. Lafayette St., Denver, Colo.

*Southeastern Division*  
BENNETT R. ADAMS, JR.....W4APU  
1512 Grove Place, Homewood, Ala.

*Southwestern Division*  
CHARLES E. BLALACK.....W6GG  
443 Main St., El Centro, Calif.

*West Gulf Division*  
WAYLAND M. GROVES.....W5NW  
c/o Humble Pipe Line Co., Neches, Texas



# THE EDITOR'S MILL

NOVEMBER is election month in A.R.R.L. as well as in the nation at large. It is our custom each November to point out on this page the importance to A.R.R.L. members of picking good men for the A.R.R.L. Board from the candidates whose names appear on those November ballots. But the job really begins much earlier than that. It begins in September when nominations are made. Desirable men must be nominated before they can be elected.

Therefore the time to think about good men for directors is right now—while there is leisure to think. It isn't necessary to emphasize why our society must have competent directors. To survive it must, to progress it must. Our form of government is democratic. Under it, our members have this prime responsibility, that they select the men who control our League's affairs. The voter in "politics" may not be intelligent, may not take his responsibilities seriously. We pride ourselves that we are better than that in A.R.R.L. Let us, then, get going.

If your present director suits you and is willing to run again, FB—we would suggest that you join with your fellows in nominating him again this year. If you do not think he is the man for the job, or if he is not willing to serve again, or if you know a better man, it is both your right and your duty to put up the name of a candidate in whom you believe. This is your part in the government of the League, something that no one can do for you. You are about to turn over the representation of your division to somebody for two years. You owe it to yourself to name a man with whom you will be satisfied. Think well, we urge you, of the responsibilities of a director, the needed qualifications. Go over the men of your acquaintance. If you know one of outstanding capabilities, induce him to run, promote him with your fellows, see if he appeals to them and, if he does, join with them in putting his name in nomination. Good candidates are the first step towards the selection of good directors.

The League is governed by its directors. Theirs is the personal responsibility of giving the best of their intelligence to A.R.R.L. affairs. They must be much more than mere reflectors of division opinion on the matters of the day. There is no such thing as "instructing" an A.R.R.L. director. We hear that term mentioned but we would like to point out that the thought has no place in our scheme of government. A director is precisely what his title implies—he directs, and he does so of his own intelligence and knowledge. Our system does provide that he must arm himself with

the knowledge of his division's needs and views but he is required to ascertain the whole national scope of our problems and then do his deciding in terms of what is best for amateur radio. He possesses discretion and the free exercise of judgment. We repeat: there is no such thing as a division instructing its director. Therefore he cannot be a mere messenger boy, parrot-like repeating preconceived opinions. He must face realities, think objectively, be able to form wise conclusions when he sees the whole nationwide picture of our problems. On our Board personal popularity can be no offset to infantile modes of thinking. We need men of mature minds, men who can wrestle with facts and find the answers.

Your duty as a member is to find the man in your division, whether your present director or another, to whom you are willing to turn over the reins of government for two years. Obviously he must be a man you can trust to do the best possible job. His knowledge, his balance of judgment, his hard-headed thinking—these are the things that must concern you. Particulars on the actual filing of nominations will be found in the election notice elsewhere in this issue.

WITH the early arrival of Autumn we call attention to a resolution of the A.R.R.L. Board at its last meeting deploring contests "on the air" sponsored by manufacturers or dealers. You all know what the Board means: these offers of prizes for contests involving actual operating.

The manufacturers of America have supplied us with the most delectable lines of apparatus. Distributors and dealers assemble wide ranges of choice under one roof, supply the service that brings the gear when we need it. By their advertising patronage of A.R.R.L. publications they supply much of the wherewithal to keep the League's signals radiating. For all of this we're fully grateful. But our Board does think that operating contests on the air so sponsored are "something else again." It's a simple question of arithmetic. If the idea came into general adoption there wouldn't be room on the air for anything else. And when we do it we're using our space in the spectrum and our stations and ourselves to boost the trade of some particular sponsor, which to us does not seem proper.

So let us have an end to it. With the best of good will to all reputable manufacturers and dealers, *QST* will not accept the advertising of such contests. We urge our members to have no part in such cluttering up of the ether. Let's keep amateur operating amateur!

K. B. W.

# "Move Over!"

## A True Story

By H. W. Castner, W1IIE\*

GATHER 'round, all you moss-faced muscle-wristed old timers, and get up in the front seats where you can hear me unwind this yarn about one of our distinguished compatriots in the brass-pounding business. You young squirts, get where you can listen and learn that necessity had to be the mother of invention in the old days of radio when there "wa'n't no sech critter" as a place where you could buy a 1-kw. rig all ready to put on the air.

Back in the distant past when there was real romance in ham radio there lived a boy in a small Maine town. This boy was one of those one-hundred-percent red-blooded typical American lads. He had the misfortune to overhear a part of a conversation between two hams about radio and received a "nibble" from the radio bug. Like the rest of us, he never got over it.

In those days of the dim past your humble servant eked out the bread and beans by running a radio store. This, of course, was long before the advent of commercial broadcasting. The merchandise consisted of Murdock (ah, who will ever forget those moulded transmitting condensers!), Acme, General Radio, Amrad, Clapp-Eastham, and so on. There were bushels of switch levers, variometers and all the rest of it. Galena was bought by the keg and pounded up as required. Business was conducted on the principle of giving free about a couple of dollars' worth of chin oil and an armful of diagrams with every ten-cent purchase.

Into this picture stepped our young hero with a fist full of change and a determination to rig up a 1/2-kw. Acme or Blitzen and blast his way to fame—and *he did it!*

At that moment, however, we gave the cash register a feeble nudge and out went the lad with the junk, diagrams, etc., and set his course straight for home, while yours truly sank into a chair to recuperate from the mental and physical ordeal.

We learned on good authority that our hero labored far into the night and ultimately blossomed out with the whole rig, including the inevitable rotary gap which we describe by quoting

a couple of lines from a piece of poetry on such things:

"That rotary gap, so loud and deep,  
Was liable to disturb your sleep."

Along with the enthusiasm which came when the rig actually perked there arose a determination to work Halley's Comet and all points East.

We now call your attention to the accompanying photograph of the rig. The component parts will be "no sale" to the young squirts, but they'll be a treat to the eyes of the old timers. Especially do we gloat over the privilege of calling your attention to the detector panel containing the old reliable Audiotron. We also spy the porcelain base rheostat on the lower panel—and brother, you don't have to tell any old timer what that did to the note of a gap. Our hero sure had the set-up for "them" days and he knew it, and proceeded to burn the midnight oil and blast the air with a vengeance.

Pa and Ma had begun to realize that their youthful offspring was truly a wizard, and for a time the perpetual nocturnal *dow de dou dils* were overlooked. In due time, however, a horrible realization began to dawn upon the parental minds that the nights had been made for sleep. More and more the parental constitutions waned for lack of rest. More and more their anger rose, until finally endurance was exhausted. Then came the crash! One fateful moment the "riot act" was read. Just when our hero was about to smash the world's DX record the thread broke, and down came the sword of Damocles slap dab.

Ah, how our tender sympathies go out in heartfelt grief to our noble hero! What pain and anguish surged through his manly breast! No more would the sonorous old gap be permitted to sound its clarion call to friends afar. For several days all was silence and gloom. Our hero was a broken man. The sun seemed a dull and faded sphere. The song of the birds was no longer heard. There was no further reason for living.

Despondent, dejected, discouraged, disheart-

(Continued on page 58)

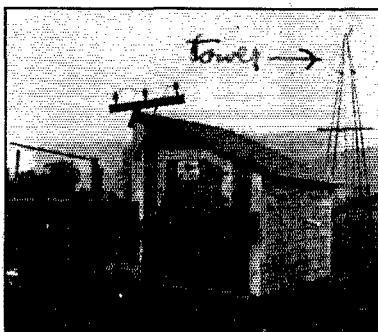

# The Kennelly-Heaviside Layer—Its Relationship to Our Everyday Communication Problems

Modern Knowledge of the Ionosphere Summarized in  
Answers to Practical Questions

By G. W. Kenrick,\* K4DDH-K4XOA

The recent extraordinary performance of high- and ultra-high frequency waves in DX communication has aroused high interest in the changing transmission characteristics of the Ionosphere. In this timely article Dr. Kenrick, active amateur and outstanding scientific authority on radio transmission phenomena, gives practical answers to our practical questions.—EDITOR.

SCARCELY more than a decade has elapsed since interest in technical studies of radio transmission turned from a study of signal intensities over various paths to a study of the refraction, or reflection, of radio waves from that region of the upper atmosphere known as the Kennelly-Heaviside Layer, or, more recently, the Ionosphere. Nevertheless, the developments during this brief period have been so rapid that the amateur frequently has difficulty in evaluating the importance of discussions of critical frequencies in the  $E$ ,  $F_1$ , and  $F_2$  regions to the everyday communication phenomena which he observes.

In this article we will endeavor to define some of this terminology as simply as possible, and to discuss the relationship of some of the observations to everyday communication problems. The most advanced workers still have only a preliminary and incomplete picture of the details of this relationship, but even at the present state of our knowledge many significant facts of interest to the amateur may be deduced from the results reported.<sup>1</sup>

Our discussion should, perhaps, present descriptive definitions of the terminology employed. These may be introduced in the form of questions and answers, even if the answers may not at the moment be necessary to the amateur desiring to secure his Class A, or Commercial "ticket."

**Question 1.** What is the Kennelly-Heaviside Layer?

\* Professor of Physics, University of Puerto Rico, Rio Piedras, P. R.

<sup>1</sup> Throughout this article data and facts have been freely borrowed from the published literature of the subject. Since this is merely a descriptive summary, it makes no pretense to the presentation of a complete bibliography, nor to the acknowledgment of priority; but a few bibliographical references are given for the convenience of readers wishing to pursue in greater detail subjects suggested in this brief outline.

**Answer 1.** The term Kennelly-Heaviside Layer, or Ionosphere, is used to designate that electrically conducting region high up in the stratospheric regions of the earth's atmosphere which is responsible for the propagation of radio waves to great distances by means of multiple refraction.

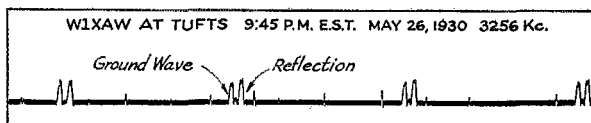

FIG. 1—EXAMPLE OF GROUND WAVE AND SINGLE F-LAYER REFLECTION RECORDED BY THE OSCILLOGRAPHING OF INDIVIDUAL DOTS SPACED THIRTY TO THE SECOND

tions, or reflections, between the conducting surface of the earth and this "layer." It is not a sharply defined region, but extends for several hundred miles. Conductivity begins to be important at various heights above the earth depending on the wave length, but the conductivity at heights as low as fifty miles may be of importance in the case of low-frequency (long-wave) propagation. Recently the term "ionosphere" has been introduced to describe this whole region. However, the ionosphere does have sub-regions in which the conductivity varies more rapidly than in others. These are given special names according to their refracting properties for different frequencies. We will discuss this in greater detail later.

**Question 2.** What is the source of the conductivity in the upper air which gives rise to this ionosphere?

**Answer 2.** The art is not as yet ready to give a complete answer to this question. Several factors may contribute to the ionization of the region as a whole, and these phenomena may be of varied importance in the sub-regions, or layers. However, certainly the radiation from the sun seems to be

the most important source of ionization. This radiation may again be of several types; i.e., it may consist of heavy positively charged ions (alpha radiation), of negatively charged electrons (beta radiation), or it may be ultra-violet light (gamma radiation). While all these types of radiation probably contribute to some extent, it appears that the ultra-violet light, which breaks up the atoms of the rare gas already existing in the upper regions of the earth's atmosphere, is the most important source of ionization. Various regions of the atmosphere absorb certain wavelengths from this radiation with greater or less rapidity according to their chemical constitution, and this may prove to be the reason for the stratifications, or sub-layers.



FIG. 2—EXAMPLE OF EFFECTIVE HEIGHT RECORDS ON TWO DISTINCT FREQUENCIES

Note multiple reflections during daytime on the higher frequency, together with absence of night reflections. Note also multiple night reflections on the lower frequency and absence of strong daytime reflections on this frequency.

**Question 3.** What is the cause of the great changes recently observed in the behavior of the K.H.L.?

**Answer 3.** Because of the importance of solar radiation as a source of ionosphere conductivity, the variation of the conditions in the Kennelly-Heaviside Layer becomes intimately associated with changes on the sun affecting solar radiation. Some of the most important of these changes are associated with the areas of activity on the sun known as sunspots. Now, since the sun rotates once every twenty-seven days, an apparent monthly period is found in radio conditions which, on longer examination, will be found to average 27.5 days, rather than twenty-eight, or thirty-one days. Since the phenomena of sunspots have an eleven-year (or, more strictly, a twenty-two-year) period of development, radio transmission phenomena naturally also show prominent evidence of the presence of these longer periodicities, and close observation discloses other harmonic periods corresponding to fifteen months, etc., which are not infrequently confused with annual changes, just as the twenty-seven-day period is often confused with monthly and lunar periods. (Some evidence for the latter seems to exist in some transmission phenomena; just why,

we don't know.) It happens that we are now approaching a "sunspot maximum" portion of the eleven-year cycle of solar activity, and it is during this period that we encounter the most violent outbreaks in solar activity. The 27.5-day period hence becomes very pronounced, together with auroral displays, and magnetic storms (disturbances in the earth's magnetic field due to violent currents set up by the changes in solar radiation and the consequent ionization changes). During magnetic storms, radio conditions are violently disturbed, and the signal intensities in general greatly depressed (as, for example, during the week of April 19, 1936). Other phenomena associated with the sunspot maxima in the eleven-year sunspot cycle are the possibility of high-frequency (i.e., ten-meter and occasionally five-meter) long-distance communication and short skip distance on twenty meters.

**Question 4.** What means are used to study the ionization conditions in the K.H.L.?

**Answer 4.** The most modern, and now almost universally employed, method for measuring the conditions in the K.H.L. is by means of observing the reflections received when a short dot of about 0.0002-second duration is transmitted on the desired wavelength. The ground wave is received at, or near, the transmitter and the time interval elapsing before the echo of the dot is received is measured with the aid of oscillographic equipment. The time elapsing before the return of the dot is used to measure the effective, or virtual, height of the K.H.L., just as the time-delay of audio echoes is used in depth-finding. The height thus measured depends on the wavelength of the pulse, as well as the conductivity of the layer, and sometimes echoes of various time delays are received from the same pulse; hence, the importance of the term "effective," or "virtual" height. This term "virtual height" is necessary to emphasize the difference between the apparent height computed using a velocity of propagation equal to that of light, and the actual depth of penetration of the wave into the stratosphere, which is, in general, less than is indicated by this computation. This variation of layer height with frequency yields much significant information from which conclusions may be deduced as to the constitution of the layer and also as to what skip distance phenomena are to be expected, and how these are likely to vary with time of day, path, etc.

**Question 5.** What is meant by the term "critical frequencies" associated with the K.H.L.?

**Answer 5.** In the earlier experiments using the echo method, oscillographic records were taken of the echoes received from a single short pulse, the time delays measured, and the experiment repeated at frequent intervals during as long a period as possible, preferably at least twenty-four hours. (See Fig. 1.)



Later, photographic means were developed, permitting a photographic record to be made on a slowly moving film so that a statistical record of layer height against time could be secured. Thus, in this method, the equally spaced dots transmitted formed an origin line for a graph of layer height against time. This method was still limited, however, to the recording of reflections on a few fixed frequencies. These records disclosed that, in general, on the lower frequencies the virtual layer height rose in the evening, and, if the frequency recorded was high enough, the reflections disappeared entirely during part of the night. This was due to the fact that, after the sun's rays were removed, the ions in the upper air gradually recombined, reducing the conductivity and permitting the radio waves to penetrate deeper and deeper into the stratosphere, and finally to pass out into space. When this latter condition was attained, reflections disappeared, usually returning after dawn at which time the reflections reappeared, and, in most cases, the effective height of the layer rapidly fell to its day value.

Now, if the frequency of the radio signal is low enough, reflections are observed all night, and conversely, if the frequency is high enough, reflections do not occur even in the daytime. It follows, therefore, that a somewhat similar curve is obtained if the frequency of the radio signal transmitted is varied rapidly at a given time of day and the reflections corresponding to various wavelengths are observed. If this is done with frequencies starting in the American broadcast band and increasing, the first phenomenon to be observed is general reflections from a layer about 100 km. in height (the E region). These reflections persist and usually increase in intensity, so that frequently multiple reflections may be observed. If the observations are taken in the daytime in temperate zones, when a frequency between three and four megacycles is reached the "height of the layer" from which the reflections seem to be returned begins to increase rapidly as the frequency is varied, and reflections begin to

appear from another region at a height of about 230 km. (the  $F_1$  region). E reflections often reappear for a time as the frequency continues to increase, but they are usually weaker. When the frequency has attained six or eight megacycles (depending on location, time of year, etc., etc.) another rapid rise in height is observed with in-

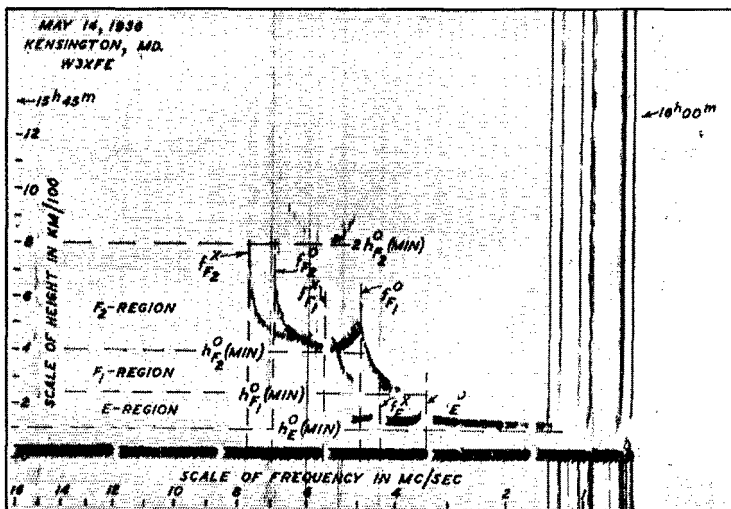

FIG. 3—EXAMPLE OF CONTINUOUSLY-VARIABLE FREQUENCY VIRTUAL-HEIGHT RECORD SHOWING CRITICAL FREQUENCIES AND VARIOUS LAYERS

(Typical graph of the ionosphere giving virtual height versus frequency obtained by the Department of Terrestrial Magnetism of the Carnegie Institution of Washington.)  
 $f_{FE}$ —Critical-frequency for extraordinary (x) wave-component in F<sub>2</sub>-region.  
 $f_{oF_2}$ —Critical-frequency for ordinary (o) wave-component in F<sub>2</sub>-region.  
 $f_{x_{F_1}}$ —Critical-frequency for x wave-component in F<sub>1</sub>-region.  
 $f_{o_{F_1}}$ —Critical-frequency for o wave-component in F<sub>1</sub>-region.  
 $f_{x_E}$ —Critical-frequency for x wave-component in E-region.  
 $f_{o_E}$ —Critical-frequency for o wave-component in E-region.  
 $h'_{F_2}(\text{min})$ —Minimum virtual height of o wave-component in F<sub>2</sub>-region.  
 $2h'_{F_2}(\text{min})$ —First multiple reflection of the o wave-component at  $h'_{F_2}(\text{min})$  caused by the signal making two complete paths from the earth to  $h'_{F_2}(\text{min})$  and back.  
 $h'_{F_1}(\text{min})$ —Minimum virtual height of o wave-component in F<sub>1</sub>-region.  
 $h'_{oE}(\text{min})$ —Minimum virtual height of o wave-component in E-region.

creasing frequency, and the reflections frequently split, showing two heights of slightly different value. As the frequency is further raised the major reflections are observed from very high apparent heights of about 500 km. and finally disappear (critical  $F_1$  frequency). Further increases in frequency, however, cause a reappearance of reflections from a layer that progressively decreases in height as the frequency increases, and then proceeds to increase until reflections disappear. The form of the curve is shown in Fig. 3. By comparison with Fig. 2 taken on two fixed frequencies, it will be noted that the form of the curves obtained by varying the frequency at the fixed time, or varying the time and observing on a fixed frequency are much the same. Now the frequencies corresponding to the rise of the effective height of the layer to infinity are called "critical frequencies." The similarity in form for the frequency range curve and the time variation on a

fixed frequency arises because of a gradual decrease of critical frequencies with time, causing them to drift through the frequency under observation as darkness approaches. The "splits" are due to double refraction phenomena in the layers due to the effect of the earth's magnetic field.

**Question 6.** What is the nature of the phenomenon associated with the abrupt change in virtual height at the critical frequencies?

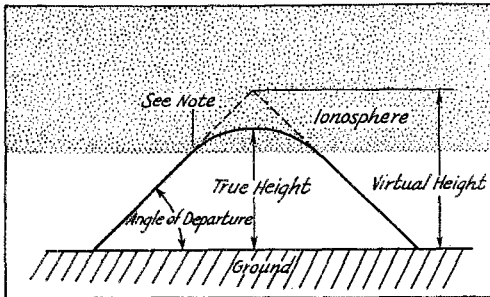

FIG. 4—SHOWING RELATION OF VIRTUAL AND ACTUAL HEIGHTS OF A SINGLE LAYER

By Breit and Tuve's theorem, the virtual height is the altitude of the triangle whose sides are tangent to the actual ray path at the angle of departure and arrival. The smaller the base line (distance of transmission) the smaller this angle and the greater the tendency to penetrate the layer. Hence, "skip distance."

**Answer 6.** In order to understand clearly the phenomena occurring at the critical frequencies, it is necessary to appreciate the full significance of the term "virtual height" which we have employed so frequently in this discussion, and how it is related to true height.

With certain approximations, the path of the radio signal refracted from the ionosphere may be represented by a ray, just as we indicate the path of light rays. Now the "virtual height" of the ionosphere is obtained by assuming the path of the ray to be a triangle such as would exist if the reflection took place at a plane reflection surface and the velocity of propagation in all the region below was that of light in free space.

The computation of this virtual height is very easy, since it only requires the construction of a triangle with the known base and altitude such that twice the length of hypotenuse divided by the velocity of light in free space (300,000 km./sec.) equals the observed time delay. If the path is nearly straight up and down, i.e., if the triangle has a small base, the virtual, or effective, height is merely the velocity times the time divided by two (half the time is required up and half back). Thus a time delay of 0.001 second corresponds to an effective height of 150 km. if the base line is nearly zero.

Actually, however, the path pursued by the ray is not up to a sharply reflecting surface and back again, but through a medium of gradually varying conductivity. This causes the ray path

to bend as shown in Fig. 4. Now there is an important theorem proved in an early paper by Breit and Tuve (and generally known as Breit and Tuve's theorem) which states that the time required for the ray to pursue the curved path is (under certain plausible assumptions)<sup>2</sup> equal to the time required to pass over a triangular path having the same angle of departure from the earth. It will be noted, however, that the virtual height thus computed is, in general, considerably greater than the actual height reached by the ray. Now, when we measure layer height by the pulse method, we are measuring virtual heights and not the actual heights reached by the ray.

This distinction is an important one, since probably the actual height penetration of the ray at and near the critical frequencies does not change abruptly. What, then, is the true nature of these critical frequencies? They are the frequencies at which the electron density of the particular stratum is just sufficient to turn back the ray entering perpendicularly. As this frequency is approached, the ray is bent abruptly near the top of its path, and a big difference between virtual and true height is produced. The virtual height, therefore, changes rapidly at these points and permits the critical frequency to be accurately located.

Now it may be shown that a simple relation exists between these critical frequencies and the maximum electron density occurring in the stratum in question. Hence, these critical frequencies are of particular interest to the physicist interested in determining the maximum electron densities in the stratosphere and their variation; i.e., just measure the critical frequency changes during a solar eclipse, or other change under observation, and you have the change in electron density in the stratosphere.

**Question 7.** What is the relation of critical frequencies to skip distance and allied transmission phenomena?

**Answer 7.** The phenomena causing critical frequencies are closely allied, of course, to those producing skip distance. In fact, if the critical frequencies are known, the skip distances may be computed with the help of certain approximations, relative to the form of the ray path, etc.

Skip distance arises from the fact that the necessary electrons required to turn a radio wave back to earth from the stratosphere increase with the square of the frequency of the wave, so that as the frequency of the signal is increased, all the energy finally leaks out through the layer into space, instead of being returned to earth. Now it also may be shown that the angle of penetration of the radio wave into the layer is a factor in determining the electron density necessary to turn back the ray, and that the more oblique the angle at which the ray enters the layer, the less the

<sup>2</sup> The theorem neglects conductivity compared to dielectric changes.

electron density required. (The electron density required is proportional to the sine of the angle the ray makes with the horizontal.) Therefore, the critical frequencies of the layer may be said to be the frequencies where skip distance begins; i.e., the frequencies at which vertically directed rays entering these layers penetrate and are not returned.

Now since the angle of penetration of the ray for distant transmission is not vertical, but increasingly oblique as the distances increase, it follows that less electron density suffices to return oblique rays of a given frequency from a given sending point than is required to return vertically directed rays, and we have the phenomenon of skip distance. Thus the lower the electron density available, the more oblique must be the wave and the greater will be the skip distance. Also it will be noted that, in general, the higher the critical frequency, the higher the maximum frequency which is workable over given paths. Probably the  $F_2$  critical frequency is usually most important.<sup>3</sup>

**Question 8.** What changes in critical frequencies have been observed?

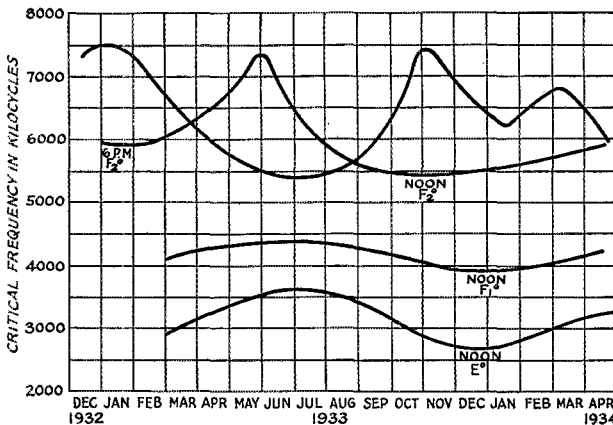

FIG. 5—NOON VARIATION OF CRITICAL FREQUENCIES OF VARIOUS LAYERS

Note also comparative variation of 6 p. m.  $F_2$  critical frequencies. (See bibliographical reference No. 4, Figs. 2 and 3, pp. 673-4.)

**Answer 8.** Observations taken during the past five years both here and abroad have shown a number of interesting facts relative to daily and seasonal changes in the critical frequencies for the various layers. The salient points of these

<sup>3</sup> This statement is probably generally so, but the actual picture is complicated by the successive bending of the rays in the various regions which in turn depend on their relative heights and the electron disturbances in them. A complete theory is not yet available.

conclusions may be summarized as follows:

(a) There is a general upward trend of the critical frequencies during the five-year period of

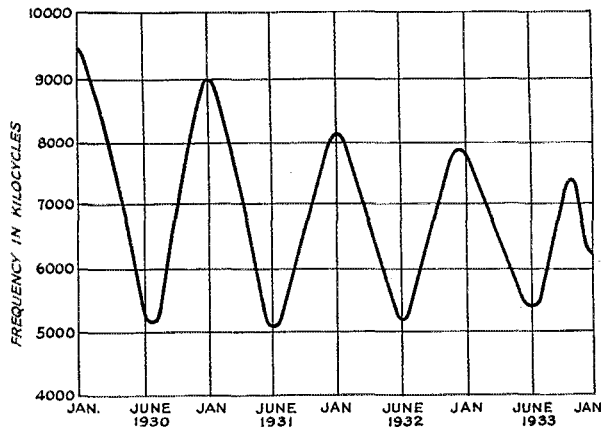

FIG. 6—LONG-PERIOD VARIATION OF NOON CRITICAL FREQUENCY OF  $F_2$  REGION

(See bibliographical reference No. 8, Fig. 19, p. 510. Also reference No. 4, Fig. 3, p. 674.)

observations, corresponding probably to the progress of the eleven-year sunspot cycle from its 1931 minimum.

(b) All the critical frequencies, of course, show large annual and daily variations, but the form of these variations is not the same for the different layers. Thus, the  $E$  and  $F_1$  critical frequencies are usually highest at noon and are lower in the winter than in the summer, but the  $F_2$  critical frequency is higher in winter at noon than at summer noon. However, the critical frequency may be almost as high in summer in the late afternoon, or early evening, as at winter noon. Curves showing the form of these variations are shown in Fig. 5. Perhaps the most surprising phenomena to be noted are the greater  $F_2$  critical frequency at winter noon than at summer noon, and the fact that in summer the maximum  $F_2$  critical frequency does not occur at midday.

**Question 9.** What may an observer learn from the available data on the daily change of skip distance relative to the behavior to be expected from the ten- and twenty-meter amateur bands, etc.?

**Answer 9.** In view of the facts outlined in Answers 7 and 8 relative to the  $F_2$  layer, we would expect long time and seasonal changes very much in accord with those we are encountering, i.e., with the increase of sunspot activity and the higher critical frequencies, lower skip distances are noted on twenty meters, also ten- (and

occasionally five-) meter long distance communication has become possible. Furthermore, skip distance is in general shorter in winter than in summer, and it does not necessarily follow that summer noon skip distance will be the shortest observed during the day. In fact, particularly during the summer, the skip distance may be shorter in the early morning or evening than at noon.

*Question 10.* What of future transmission conditions?

*Answer 10.* So many factors enter into a complete picture of the complex phenomena influencing radio transmission that he who predicts too boldly is likely to have his predictions come up to damn him a few years hence. However, in general, past experience and the observations of critical frequencies taken thus far lead us to expect:

(a) A gradual increase in frequencies available for long-distance communication (including perhaps more frequent five-meter DX) for a year or two more, when the maximum of the present sunspot cycle will be reached.

(b) A subsequent gradual decrease in critical frequencies with sunspots until about 1944, when five- and ten-meter DX will probably again be history.

(c) A repetition of the cycle with eleven-year period. (See Fig. 6.)

(d) A superposed annual period wherein noon skips are shortest in winter and daily minimum skips do not occur at noon in summer.

*Question 11.* What of the pitfalls of prediction?

*Answer 11.* There are a number of factors which render dangerous predictions such as those given above. To begin with, the "eleven-year sunspot period" is really a twenty-two or twenty-three-year period, since the magnetic forces associated with the northern and southern hemispherical spots reverse in alternate eleven-year periods. Since practically all of our observational data is limited to the past few years, we would be rash indeed to assume that this would not lead to marked differences. In fact, what transmission data we have from 1925 to date seems to show that history is not quite repeating itself.

The not-too-consistent observer is likely to find these conclusions inapplicable due to other factors which complicate the situation, i.e., the phenomena of magnetic storms which are most frequent during sunspot maxima. Actually, radio transmission probably reacts to a common cause rather than to the storm itself.

Magnetic storms, or abnormally large changes in the earth's magnetic field, and large aurora borealis displays appear to arise from solar radiation changes associated with sunspot groups. The abnormal radiation thus produced impinges on the ionosphere each time the given sunspot group gets broadside on the earth in accord with the sun's 27.5-day period of rotation. Thus, radio transmission exhibits violent 27.5-day periods

(sometimes more than one when there are numerous active groups of spots). The magnetic disturbances appear to arise from the currents corresponding to the large movement of electrons associated with the abnormal ionization produced by the changes in solar radiation and corresponding equilibrium changes.

*Question 12.* What of magnetic storms?

*Answer 12.* We are still not very clear as to just what happens to radio transmission during these magnetic storms. The observing amateur can assure you that it gets bad, but how and why?

Critical frequency observations do confirm that great and rapid changes in critical frequencies usually accompany these disturbances. However, the general tendency is for critical frequencies to rise, rather than fall. This would lead one to expect abnormally high cut-off frequencies, and, in short, a tendency to turn night conditions into day conditions. Actually, short skip and phenomenal high-frequency ranges are sometimes observed, but the outstanding effect appears to be an almost universal tendency of the bands to go "dead."

To understand these phenomena we would probably have to consider what is happening in the absorption encountered in the lower layers as well as the cut-off frequencies. This portion of the theory remains largely for future investigations, but it does seem fairly clear that the lower in the atmosphere the ionization is found sufficient to turn back the wave, the more frequent the collisions between the refracting electrons and the gas, and hence the greater the absorption of the ray in the reflecting process. Herein probably lies the answer to the paradox.

*Question 13.* What of freak conditions, skips, etc.?

*Answer 13.* In the preceding discussion we have not attempted to treat the complications introduced by the double refractive effects produced by the earth's magnetic field. This causes two reflections to be returned from the same layer with quite different virtual heights which vary widely near the critical frequency. (See Fig. 3 where these effects are clearly shown.) Also we have not discussed interlayer refractions, absorptions, due to critical frequencies of certain layers, etc. This was partly because we do not wish unduly to prolong our discussion, and partly because as yet there is relatively little worked out in this fertile field. However, with three or more layers and their critical frequencies to work with, the enterprising analyst should have little difficulty in finding combinations adequate to explain most of the "freaks." We shall not attempt a contribution to this as yet somewhat hazardous field.

Perhaps it may be well to end with Question 13, and to close with a few comments relative to a region which seems to have escaped undue attention, that is the borderline region between twenty

(Continued on page 60)

# Some Trick Crystal Circuits

By J. Stanley Brown,\* W3EHE

A PREVIOUS article<sup>1</sup> described features of a simple transmitter that was developed in over a year of off-and-on experimenting, during which time a lot of more or less useful "tricks" were run into. These will be described particularly for those independent builders who never copy anyone.

We all know that the limit of output for any given crystal circuit is the amount of abuse the crystal can stand. Heavily loaded triodes are normally poison to crystals. Some pentodes are

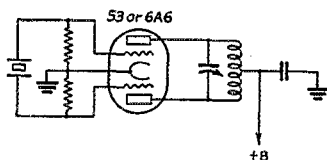

FIG. 1—THE JUMPING-OFF PLACE—THE SIMPLE PUSH-PULL CRYSTAL OSCILLATOR

quite easy on them and Jim Lamb's Tri-tet can be adjusted so that crystal r.f. is very low. John Reinartz has described an oscillator using an 802

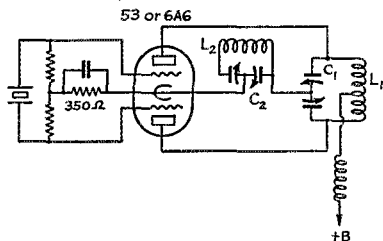

FIG. 2—PUSH-PULL OSCILLATOR AND SECOND-HARMONIC GENERATOR

The harmonic is collected by the tank  $L_2C_2$  which, incidentally, can be single-ended instead of double-ended as shown.  $C_1L_1$  tuned to fundamental,  $C_2L_2$  to second harmonic.

which, with about 700 volts on the plate, will deliver 25 watts fundamental output with crystal current as low as 20 mils. This circuit is similar to the familiar pentode oscillator except that a cathode tank tuning to half the crystal frequency

\* 3039 Macomb St., N. W., Washington, D. C.

<sup>1</sup> Brown, "Simplifying the Push-Pull-Push Crystal Oscillator," July, 1936, *QST*.

Incidentally, the author writes in connection with the July article that 6L6's have been found to be unsuitable for the push-pull-push circuit. Although satisfactory as a straight push-pull oscillator, giving better than 50 watts output from a 40-meter crystal, when connected p-p-p the principal result is a vicious parasitic oscillation causing a high circulating current in the crystal and holder and giving practically no second-harmonic output. This in reply to numerous questions about using the tubes in the circuit.

is used to provide a capacitive reactance load to the highly inductive crystal. For harmonic output, the common-connected screen and suppressor are tuned to the crystal frequency with a

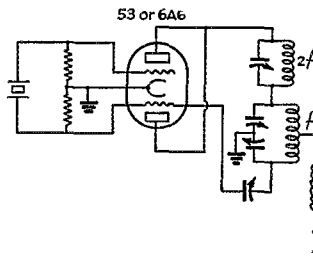

FIG. 3—ANOTHER VERSION OF THE PUSH-PULL-PUSH TRIODE OSCILLATOR

third tank, and a doubling plate tank is inserted. About 12.5 watts second harmonic output, at the same low crystal current, can be obtained.

For kindness to a crystal, however, nothing can quite touch the push-pull crystal oscillator for a given amount of fundamental output. The principal reason for this low r.f. current may be that the input capacitances of the tube or tubes are in series, the resultant being but half of the input capacity of one tube. Higher plate voltages are permissible before a dangerous value of crystal current is reached. It also permits each alternation of excitation voltage to be effective in causing plate current flow. A 53 with a crystal in one grid and about 250 volts on one plate will produce about 5 watts fundamental output. Connect both sets of triodes of the tube push-pull and the output can be 10 or more watts with less crystal current.

Fig. 1 shows the simplest push-pull oscillator circuit. This is a good steady oscillator and keys nicely in the cathode. We are told that the second harmonic is cancelled out or suppressed in the tank of this type of circuit. That is too bad, because if we could use it for doubling we would have a way to make a three-frequency 10-watt exciter with just two 53's. Well, if there was ever any second harmonic, some of it probably got to ground in one way or another; and if there wasn't any, we might try to produce some for the purposes of our experiment. A large order? Fig. 2 shows how it is done.  $L_1C_1$  is a crystal-frequency tank with a ground path through  $L_2C_2$ , which is a doubling tank: Output, 10 watts on fundamental, 5 watts doubling, using 350 ohms of cathode-bias resistance and about 300 volts on the plate with the key down. The theory used in arriving at this

circuit is two-sided: First, with high bias there is bound to be some tendency to generate second harmonic at each plate, and this harmonic goes through one side of  $C_1$  (which is a 500- $\mu\text{fd.}$  split condenser, 125  $\mu\text{fd.}$  effective), and thence to

meter output may be taken from  $L_3$ , the second tube working as a locked push-pull oscillator. If this locked condition does not seem desirable, the grids of the second 53 may be connected through condensers to the ends of  $L_1$  and the second tube operated as a push-push amplifier. Further, the second 53 can be neutralized if you wish. Also with the same crystal and the circuit of Fig. 4, 10 watts at 40 meters may be taken from  $L_3$  with the second 53 again being used as a push-push doubling amplifier. Fig. 4-B shows the same 2 tubes in an alternative arrangement. If four bands are de-

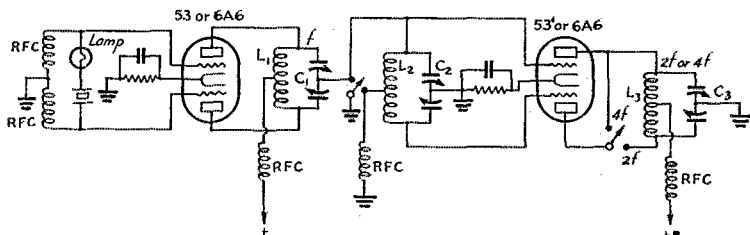

FIG. 4A—CIRCUIT DIAGRAM FOR A TWO-TUBE THREE-BAND 10-WATT EXCITER

$L_1C_1$  tuned to the crystal fundamental,  $L_2C_2$  to second harmonic,  $L_3C_3$  to either second or fourth harmonic. With the switch at 2f the second 53 or 6A6 is a locked oscillator; with the switch at 4f the circuit becomes a push-push doubler.

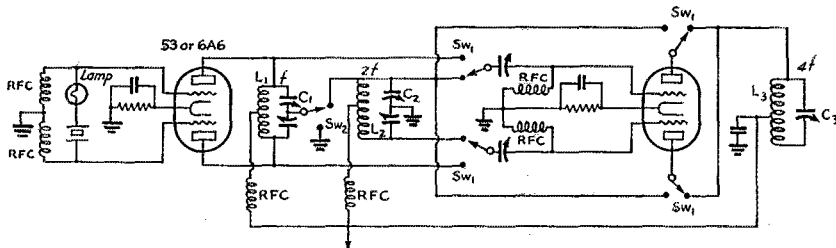

FIG. 4B—AN ALTERNATIVE ARRANGEMENT OF FIG. 4A

With this circuit changing bands in the output circuit does not require a change of coils. Switch  $Sw_1$  should be a four-pole double-throw unit of the low-capacity type.  $Sw_2$  is a s.p.s.t., also low capacity. Output is taken from  $L_1C_1$  at the crystal fundamental,  $L_2C_2$  on the second harmonic, and  $L_3C_3$  on the fourth harmonic.

ground through  $L_2C_2$ , which is tuned to the harmonic frequency. Second, the two plates are in parallel through the two sides of  $C_1$  and the tank  $C_2L_2$ , and push-push action, as described in the previous article, takes place.  $C_1$  must be a split condenser.  $C_2$  can be a single section condenser of about 1  $\mu\text{fd.}$  per meter, effective capacitance.<sup>2</sup> Cathode bias seems to be easier on the crystal than grid-leak bias. If a cathode resistance of 500 ohms or more is used, 400 to 450 volts can be used on the plates with substantial increases in output. This is especially true of the doubling output.

Fig. 3 is another version of the push-pull-push triode crystal oscillator. It performs about the same as Fig. 2 except for the necessity of adjusting a feed-back condenser. Several other "trick" circuits of similar nature were tried, but none of them held any promise—and one of them "busted" a crystal.

Fig. 4 is a three-band two-tube 10-watt exciter evolved from the circuit of Fig. 2. With a 160-meter crystal, 10 watts may be taken from  $L_1$ , in which case the tap to  $L_2$  might just as well be grounded. With the same crystal, 10 watts of 80-

<sup>2</sup> I.e., 40  $\mu\text{fd.}$  at 40 meters, 80  $\mu\text{fd.}$  at 80 meters, etc.

sired, another push-push 53 will be necessary. Tests of this circuit show it to be superior to current 53 circuits using one triode as a crystal oscillator and the other triode of the same 53 as a harmonic amplifier.

The circuit of Fig. 2 could probably be refined to produce more second harmonic if one difficulty

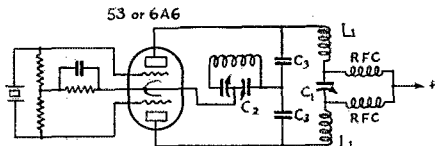

FIG. 5—A SUGGESTED MODIFICATION OF FIG. 2 TO INCREASE HARMONIC OUTPUT

could be overcome:  $C_1$  has to be large to present a low-impedance path from the plates to  $L_2C_2$  for the second harmonic, and being large it causes a large no-load circulating current at fundamental frequency in  $L_1C_1$ . Fig. 5 suggests a remedy for this condition, although it has not been tried out. Condensers  $C_3$  could be quite large (0.002- $\mu\text{fd.}$  fixed mica) while  $C_1$  could be a small 50  $\mu\text{fd.}$

variable.  $L_1C_1C_3$  would then be very low- $C$  to the fundamental, would produce necessary feedback voltage with low circulating current and losses, and make more of the tube output available for the push-push generation of double frequency.<sup>3</sup>

In the previous article some mention was made of the difficulty of getting much drive from even a good 40-meter crystal, which is apt to exclude

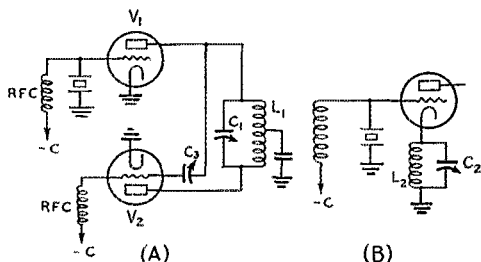

FIG. 6—AN IDEA FOR GETTING POWER FROM LOW-OUTPUT CRYSTALS

$V_1$  is a small triode or pentode crystal oscillator of usual design.  $V_2$  a larger triode or pentode. The large tube is regenerative. The tank  $L_2C_2$  may be inserted in  $V_1$ 's cathode circuit, as shown at B, to help increase output without running up the crystal current.  $L_2C_2$  is tuned to half the fundamental frequency.  $C_3$ , the feedback control, is a 50- $\mu$ fd. magnet.

many X-cuts. This difficulty was overcome largely in the 802 transmitter circuit by making a more suitable top electrode for the crystal, but with tubes causing high crystal current for any amount of output, the 40-meter crystal just will not equal lower frequency crystals. There is a very simple trick by which this difficulty can be overcome. It has been tried here on triodes and pentodes. Figs. 6-A and 6-B show the schematic details. A small triode or pentode is wired as an oscillator. The plate is connected to one end of a push-pull tank and the plate of a larger tube is connected to the other end of this tank. The grid of the second tube is fed through a variable condenser as shown. The circuit can be arranged to give very good power outputs and is not difficult of adjustment. It can oscillate at other than the crystal frequency but with normal care in adjusting, it prefers not to. It does not seem to act very much as a locked oscillator because removing or shorting the crystal will normally cause it to stop oscillating. Fig. 1 of the July article was modified to use this circuit for the grids and screen-anodes and gave even better outputs than those shown

<sup>3</sup> Although the tank circuit is low- $C$ , the effective impedance into which each tube is working would be quite low because each plate is in effect shunted across only a small part of the tank. So far as the tube is concerned, this simulates the effect of the high- $C$  tank, and may nullify the increase in actual  $L-C$  ratio. Because the two desirable factors—high impedance for the tube loads, and low series impedance in the harmonic circuit—are mutually antagonistic, however, it may be that this circuit will represent a better compromise than Fig. 2. Only a trial would show.—EDITOR.

under *Outputs and Conditions of Operation* for all bands, and especially better outputs when using the 40-meter crystal.

The preceding are the principal useful findings during this series of experiments. They may not all be new "tricks" by any means but they were not copied. In justice to others, the similarity of some of these "tricks" to those described by Carl C. Drumeller, W9EHC, in May 1936, *QST*, Experimenters' Section, should be noted. Mr. Drumeller has added a useful means of doubling where these tests left off with Figs. 6-A and 6-B.

## A.R.R.L. QSL Bureau

FOR the convenience of its members, the League maintains a QSL-card forwarding system which operates through volunteer "District QSL Managers" in each of the nine U. S. and five Canadian districts. In order to secure such foreign cards as may be received for you, send your district manager a standard No. 8 stamped envelope. If you have reason to expect a considerable number of cards, put on an extra stamp so that it has a total of six-cents postage. Your own name and address go in the customary place on the face, and your station call should be printed prominently in the upper left-hand corner.

- W1—J. T. Steiger, W1BGY, 35 Call Street, Willimansett, Mass.
- W2—H. W. Yahnel, W2SN, Lake Ave., Helmetta, N. J.
- W3—R. E. Macomber, W3CZE, 418 10th St., N. W., Washington, D. C.
- W4—B. W. Benning, W4CBY, 520 Whiteford Ave., Atlanta, Ga.
- W5—E. H. Treadaway, W5DKR, 2749 Myrtle St., New Orleans, La.
- W6—D. Cason Mast, W6KHV, 423 East E Street, Ontario, Calif.
- W7—Frank E. Pratt, W7DXZ, 5023 So. Ferry St., Tacoma, Wash.
- W8—F. W. Allen, W8GER, 324 Richmond Ave., Dayton, Ohio.
- W9—George Dammann, W9JO, 319 Sherman Ave., Evanston, Ill.
- VE1—J. E. Roue, VE1FB, 84 Spring Garden Rd., Halifax, N. S.
- VE2—W. H. Oke, VE2AH, 5184 Mountain Sights Ave., N. D. G., Montreal, P. Q.
- VE3—Bert Knowles, VE3QB, Lanark, Ont.
- VE4—Dr. J. J. Dobry, VE4DR, Killam, Alberta.
- VE5—E. H. Cooper, VE5EC, 2024 Carnarvon St., Victoria, B. C.
- K4—F. McCown, K4RJ, Family Court 7, San-turce, Puerto Rico.
- K5—John J. Carr, K5AV, 78th Pursuit Squadron, Albrook Field, Canal Zone.
- K7—Frank P. Barnes, K7DVF, Box 297, Wrangell, Alaska.
- KA—George L. Rickard, KA1GF, P. O. Box 849, Manila, P. I.





filament lead within the tube is short enough to allow the filament to operate substantially at ground potential. In the neighborhood of 112 mc., with conventional tubes, the filament lead will usually be an appreciable fraction of a wavelength long. In this case it is not sufficient merely to by-pass the filament terminal to ground. In order to obtain satisfactory operation it is usually necessary to extend the filament lead in the form of a resonant line so that there will be a half wave between the filament itself and the point at which the filament circuit is grounded. The filament leads of the 316A are, of course, much shorter than in the conventional tube and it is possible to obtain satisfactory operation up to about 300 mc. merely by by-passing the filament to ground at the filament terminals. At frequencies higher than this it is essential to include a resonant line in the filament circuit.

#### THE SIMPLEST OSCILLATOR

The two transmitters illustrated were selected from a group of experimental rigs built. The first example is the result of an attempt to build the simplest possible transmitter for 224 mc. (1¼-meter) operation. The foundation for the transmitter is a breadboard covered with close-mesh bare copper gauze. This gauze serves as a ground for the transmitter and proves to be invaluable in facilitating by-passing and preventing r.f. from getting into the wrong places. With the idea of getting effective by-passing in the filament circuit, the filament leads were made in the form of copper strip which served not only to support the tube but to provide a capacity across the filament and between each filament lead and the gauze "ground." The strips of copper sheets measure 3 inches by 1 inch before bending into the shape shown in the photograph. The filament terminals accommodating the tube are the smallest Yaxley binding posts soldered to the upper ends of the copper strip. The two strips are separated by a piece of thin mica and held together with a machine screw insulated from one of the strips by a small fiber washer. The "feet" of these filament supports are similarly insulated with mica from a base plate soldered to the copper gauze.

The tank circuit is a single split turn of No. 14 bare wire 3¼ inches in diameter. The open ends of this turn are attached to the tube leads with a pair of the small Yaxley binding posts on each lead, the binding posts being joined together with a small sliver of threaded brass rod. The idea in this case is to avoid any soldered joints in the

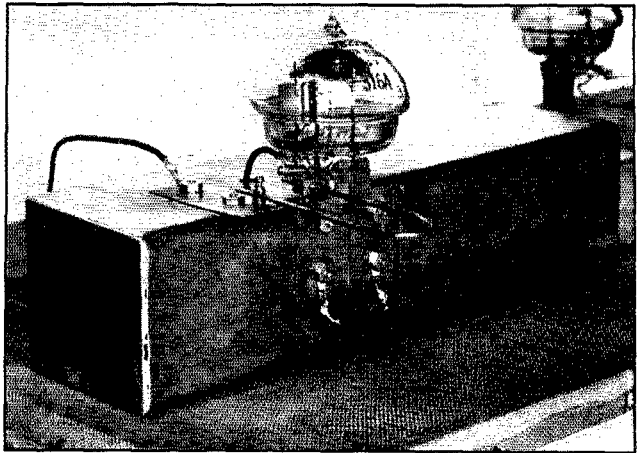

WITH A TROUGH LINE IN THE GRID CIRCUIT: A NEW EXPERIMENTAL TRANSMITTER FOR 224 MC.

The resonant-line grid circuit serves as a chassis for the transmitter with the tube mounted on it by means of the filament by-pass condensers. The plate by-pass condenser also uses the shell of the grid line as one of its elements.

vicinity of the plate or grid terminals. Provision is made for varying the location of the grid and plate return leads so that they may be located on a node.

No difficulty should be had in putting an oscillator of this type into operation. The oscillator

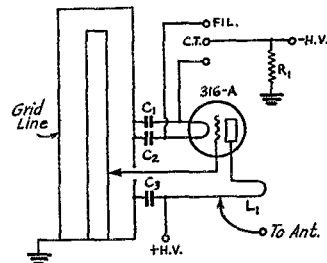

FIG. 2—THE CIRCUIT OF THE TROUGH-LINE CONTROLLED TRANSMITTER

- L<sub>1</sub>—Hairpin-shaped loop of No. 14 bare wire 3¼ inches long and 1 inch wide.
- C<sub>1</sub>, 2—Filament by-pass condensers made of copper strip, see text.
- C<sub>3</sub>—Plate by-pass condenser made in similar fashion.
- R<sub>1</sub>—30,000-ohm 10-watt resistor.

The outer conductor of the grid line is one quarter-wave long (about 12 inches at 1¼ meters). The inner conductor is 8 inches long and fitted with a sliding extension piece made of copper sheet rolled into tube form.

will function with the grid and plate lead connected at the terminals of the condenser. The position of the leads may then be varied to give minimum plate current—with the oscillator unloaded. In making preliminary adjustments it is always desirable to connect a 1000-ohm resistor in series with the plate supply.

#### A STABILIZED TRANSMITTER

The second transmitter illustrated is an ex-



matter, we found innumerable problems in setting up a satisfactory matched line. Strange to relate, the most effective scheme in these particular experiments proved to be the use of the old-time single-wire feeder tapped directly on the plate tank and tapped slightly off center on the antenna. With this type of transmission line we found it readily possible to avoid standing waves

began a thorough-going exploration of the ultra-ultra-high frequencies. The 316A gives us the first really efficient means of generating the power. We already have the acorn as a solution to receiving problems. Let's go.

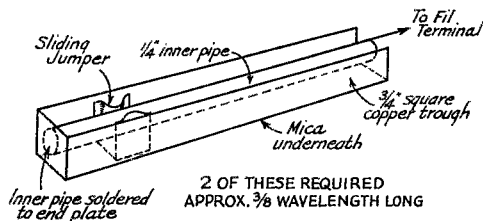

FIG. 4—SHOWING THE CONSTRUCTION OF TROUGH-TYPE LINES SUITABLE FOR THE FILAMENT CIRCUIT OF FIG. 3.

on the line and to get appreciable power into the antenna. We recommend the method as being unquestionably the simplest of them all and one which seems to be quite "sure-fire" in its operation. The feeder—preferably a length of bare copper wire—is tapped down toward the plate feed end of the plate tank and approximately  $\frac{1}{4}$  the distance from the center of the half-wave antenna to its end. Power is then applied and a neon bulb is run the length of the feeder in order to observe any standing waves which may exist. Adjustment of the tap on the antenna and at the tank end will enable the standing wave effect to be reduced to a minimum. The tapping on the tank coil is also adjusted to give the desired value of plate current. Pending further experiments we have nothing better to suggest for an experimental antenna arrangement for frequencies above 200 mc.

On frequencies above 300 mc., as we have already mentioned, it will be essential to use resonant lines in the filament circuit. These lines might well be made in the "trough" manner in accordance with the sketch. With the oscillator in operation their length will be varied until the no-load plate current is lowest. Fig. 3 shows the complete circuit for an oscillator suitable for operation above 300 mc. The plate tank may be either a split turn, as in the transmitter illustrated, or a pair of parallel rods. The split stator condenser might well be made of a pair of 1-inch square copper plates with a third plate interleaving them. The inner plate could be mounted on an insulated support in such a fashion that its position with respect to the outer plates could be varied. This is a type of circuit which would be used in exploring the upper frequency limits of the tube.

It certainly is about time that we amateurs

#### CHARACTERISTICS OF THE 316 A

Nominal filament voltage	2.0 volts, a.c. or d.c.
Nominal filament current	3.65 amperes
Average thermionic emission	0.45 ampere
Average Characteristics at maximum direct plate voltage and dissipation	
Amplification factor	6.5
Plate resistance	2700 ohms
Grid to plate transconductance	2400 micromhos
Average Direct Interelectrode Capacitances	
Plate to grid	1.6 $\mu$ fd.
Grid to filament	1.2 $\mu$ fd.
Plate to filament	0.8 $\mu$ fd.
Operation	
Maximum Ratings	
Max. direct plate voltage	450 volts
Max. direct plate current	80 milliamperes
Max. direct grid current	12 milliamperes
Max. plate dissipation	30 watts
Maximum plate voltage may be used at any frequency if maximum plate dissipation is not exceeded.	
Radio-Frequency Oscillator or Amplifier—Plate Modulated	
Max. direct plate voltage	400 volts
Max. direct plate current	80 milliamperes
Max. direct grid current	12 milliamperes
Nominal carrier power at 500 Mc.	6.5 watts
Grid bias or leak should be adjusted to optimum value for the particular tube.	

## Hudson Division Convention

October 2nd and 3rd at Schenectady, N. Y.

FOR the second time in the history of Hudson Division Conventions this year's affair will be held outside of New York City. And what a program is being prepared by the Schenectady Amateur Radio Association, the sponsors. Fellows, make a note of the following: Convention to be held at the Hotel Van Curler, Schenectady, N. Y., October 2nd and 3rd. It will be a gala affair. Tours through the General Electric Company plant, ultra-high-frequency demonstration, General Electric House of Magic Show; WGY, W2XAF, W2XAD Inspection Trips, good technical talks, banquet, excellent prizes and floor show. Special features are in store for the ladies. Bring the YL and the XYL, it will add to the interest.

Advance registration, \$3.50; at the door \$4.00. The sooner you send in your registration to C. H. Crawford, W2CVZ, 605 South Toll St., Scotia, N. Y., the better the chance of being taken care of.

# What the League Is Doing

League Activities, Washington Notes, Board Actions—For Your Information

**Election Notice** To all members of the American Radio Relay League residing in the Central, Hudson, New England, Northwestern, Roanoke, Rocky Mountain, Southwestern, and West Gulf Divisions:

You are hereby notified that, in accordance with the constitution, an election is about to be held in each of the above-mentioned divisions to elect both a member of the A.R.R.L. Board of Directors and an alternate thereto, for the 1937-1938 term. Your attention is invited to Sec. 1 of Article IV of the constitution, providing for the government of A.R.R.L. by a board of directors; Sec. 2 of Article IV, defining their eligibility; By-Laws 11 to 21, providing for the nomination and election of directors; and By-Law 12, providing for the simultaneous election of an alternate director.

Voting will take place between November 1 and December 20, 1936, on ballots that will be mailed from the headquarters office in the first week of November. The ballots for each election will list, in one column, the names of all eligible candidates nominated for the office of director by A.R.R.L. members residing in that division; and, in another column, all those similarly named for the office of alternate. Each member will indicate his choice for each office.

Nomination is by petition. Nominating petitions are hereby solicited. Ten or more A.R.R.L. members residing in any one of the above-named divisions may join in nominating any member of the League residing in that division as a candidate for director therefrom, or as a candidate for alternate director therefrom. No person may simultaneously be a candidate for the offices of both director and alternate. A separate petition must be filed for the nomination of each candidate, whether for director or for alternate director. The following form for nomination is suggested:

*(Place and date)*

*Executive Committee*  
*The American Radio Relay League*  
*West Hartford, Conn.*

*Gentlemen:*

*We, the undersigned members of the A.R.R.L. residing in the . . . . . Division, hereby nominate . . . . . of . . . . ., as a candidate for director [or for alternate director] from this division for the 1937-1938 term.*

*(Signatures and addresses)*

The signers must be League members in good standing. The nominee must be a League member

in good standing and must be without commercial radio connections; he may not be commercially engaged in the manufacture, selling or rental of radio apparatus or literature. His complete name and address should be given. All such petitions must be filed at the headquarters office of the League in West Hartford, Conn., by noon E.S.T. of the first day of November, 1936. There is no limit to the number of petitions that may be filed, but no member shall append his signature to more than one petition for the office of director and one petition for the office of alternate director. To be valid, a petition must have the signatures of at least ten members in good standing; that is to say, ten or more members must join in executing a single document; a candidate is not nominated by one petition bearing six signatures and another bearing four signatures. Petitioners are urged to have an ample number of signatures, since nominators are frequently found not to be members in good standing.

Present directors from these divisions are as follows: Central, Mr. Edward A. Roberts, W8HC, Cleveland, Ohio; Hudson, Mr. Kenneth T. Hill, W2AHC, Douglaston, N. Y.; Northwestern, Mr. Ralph J. Gibbons, W7KV, Pendleton, Ore.; Roanoke, Prof. H. L. Caveness, W4DW, Raleigh, N. C.; Rocky Mountain, Mr. Russell J. Andrews, W9AAB, Denver, Colo.; Southwestern, Mr. Charles E. Blalack, W6GG, El Centro, Calif.; West Gulf, Mr. Wayland M. Groves, W5NW, Neches, Texas. At this writing the New England directorship is vacant, a special election being in process to choose a director for the remainder of this calendar year to fill out the term of Mr. Bailey, elevated to the vice-presidency.

These elections constitute an important part of the machinery of self-government in A.R.R.L. They provide the constitutional opportunity for members to put the direction of their society in the hands of representatives of their own choice. Members are urged to take the initiative and file nominating petitions immediately.

*For the Board of Directors:*

K. B. WARNER,  
*Secretary.*

July 25, 1936.

-----

**Election Results**

Because the former directors of the Atlantic and New England Divisions were elected president and vice-president, respectively, at the meeting of the Board in May, special elections

have been held in those divisions to choose new directors to finish out the terms. Thus there come two additions to the A.R.R.L. Board of Directors, Walter Bradley Martin, W3QV, of Roslyn, Pa., from the Atlantic Division; and Percy C. Noble, W1BVR, of Westfield, Mass., from the New England Division. The balloting was as follows:

#### ATLANTIC DIVISION

In the Atlantic, Mr. Martin won handily over his several opponents, the tally being as follows:

Walter Bradley Martin, W3QV.....	441
Roy C. Corderman, W3ZD.....	296
Joseph P. Vancheri, W8BWH.....	130
Clyde L. Bunch, jr., W3DUK.....	23

Mr. Martin has been continuously active in amateur radio since 1920, and has long been one of the assistant directors of his division. He is president of the York Radio Club, which for years has been of 100% A.R.R.L. membership. His business is coal and builders supplies. He is an ensign in the Naval Communications Reserve. His term of office runs until the end of 1937.

#### NEW ENGLAND DIVISION

To serve the remaining months of 1936, before which time another election will be held, the New England Division chose Mr. Noble from a field of seven candidates, the greatest number ever nominated for an A.R.R.L. election. The voting was as follows:

Percy C. Noble, W1BVR.....	209
Raymond W. Woodward, W1EAO.....	182
Joseph A. Mullen, W1ASI.....	140
Frank Hawks, W1JJI.....	109
Horace Young, W1CAB.....	60
Donald S. Bennett, W1BPH.....	34
Isaiah Creaser, W1BSJ.....	22

Director Noble is by profession the principal of a grammar school in Westfield, Mass. For the last several years he has been S.C.M. for Western Massachusetts. In fact he has been amazingly active as a practicing amateur for many years back. His service affiliation is the Army, W1BVR in the net control station for the 1st Corps Area in the A.A.R.S.

Since his present term expires at the end of this year, nominations for director of the New England Division are again being solicited, so that by December a director may be elected for the 1937-38 term.

QST congratulates both the new directors and the divisions which have elected them as their representatives.

#### Cairo Matters

The request of the A.R.R.L. for the widening of the 3.5- and 7-mc. bands was turned down by the United States Preparatory Committee on Allocations at its meeting on July 16th. Perhaps because virtually every service wants more space, the senti-

ment of the preparatory group is overwhelmingly in favor of maintaining the Madrid status as it is, as the only possible solution. Not even the government radio services would support our request. Our Board of Directors is deciding what steps should now be taken.

U. S. preparatory plans include a new definition of the amateur service that will strengthen our existing situation. No changes are contemplated in the international amateur regulations, Article 8.

#### Documents For Sale

A few copies remain available of the "Presentation for the Amateur Service" made by the League at the June 15th hearing before the F.C.C., as reported last month; also of the annual reports of the A.R.R.L. officers to the Board of Directors, as rendered at the last annual meeting. While the supply lasts they are available to members of the League at 50 cents per copy for either, postpaid.

#### Code Test

F.C.C. has standardized the amateur code examination as given by the inspectors. The exam runs about 4 minutes at a speed of 65 characters per minute, the standard word being of 5 characters. During this time the applicant must copy 65 consecutive characters correctly. (Punctuation marks and figures, if any, will count as 2 characters each.) All applicants henceforth will also be required to demonstrate ability to send perfectly for one minute at 13 w.p.m., being granted up to three opportunities to do so. International regulations require both a sending and a receiving test. Candidates not passing both tests will be adjudged to have failed, may try again in 90 days.

#### Growth Figures

Amateur station licenses in the U. S. showed a slight increase for the fiscal year ended June 30, 1936, with a total of 46,850. The previous year the figure was 45,561. Our net gain was 1289, or 2.8%.

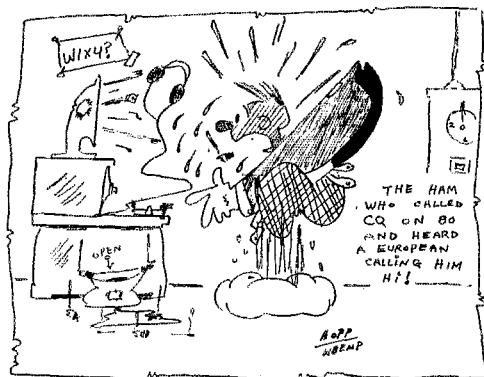

# A Volume-Compressing Method for 'Phone Transmission

## Automatic Audio Gain Control Using the Differential Thermal Bridge

By Wilbert B. Smith\*

ONE of the major problems facing the broadcast technician and 'phone operator is that of keeping the level fed to the transmitter constant. Too high a level means overload with its attendant distortion, while too low a level means inefficient transmission. The range of levels encountered in the usual run of transmission varies over about 40 db. For proper transmission this variation must be reduced to about 10 db.

So far, the most practical method of gain control seems to be manual; but here the personal equation enters in and slips seem to be the rule rather than the exception. For instance, the operator in anticipation of a peak reduces the gain by 20 db when 10 db would have been sufficient, resulting in the peak being relatively low by 10 db rather than approximately the same level or the original 10 db high. If an automatic gain control could be devised, the personal equation would be eliminated and ideal transmission could be approached. It remains, then, for the engineer to develop such a device having the necessary characteristics.

There are four major requirements to be met in the design of any automatic gain control. First, there must be no audio frequency distortion re-

certain metal filaments, a suitable device can be constructed quite simply.

Consider first an ordinary tungsten-filament

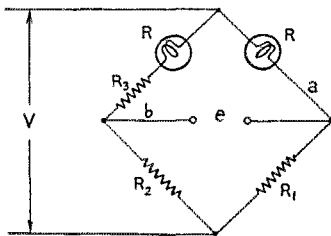
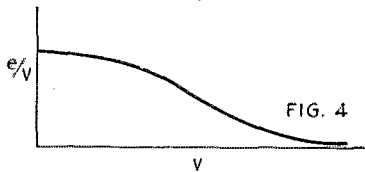
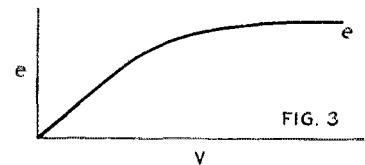
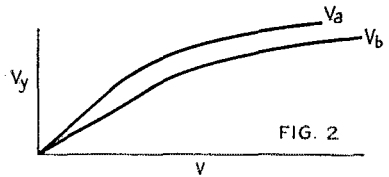

FIG. 1

sulting from its use; second, the device must guard against overload; third, the general character of the transmission must be preserved; and fourth, it must not bring up background noise or purposely weak signals. At first sight this seems like a rather tall order for anything short of a laboratory setup, but by utilizing the non-constant resistance-temperature characteristics of

electric light bulb. The equation linking resistance with applied voltage is approximately

$$R = R_0 + KE^x,$$

which merely means that the resistance increases in proportion to the  $x$ th power of the applied voltage. Now, if this increase in resistance can be put to work to regulate the amount of audio energy passing through a circuit, the problem is solved.

Consider next the differential bridge circuit in Fig. 1. The potential at point  $a$  will be

$$V_a = \frac{R_1 V}{R_1 + R} \\ = \frac{R_1 V}{R_1 + R_0 + K(V - V_a)^x};$$

and that at the point  $b$  will be

$$V_b = \frac{R_2 V}{R_2 + R_3 + R_0 + K(V - V_b)^x}.$$

These two potentials are plotted against applied voltage in Fig. 2. It follows at once that the potential difference  $e$  will be the difference between these two curves, as in Fig. 3.

\* Radio Station CJOR, Hotel Grosvenor, Vancouver, B. C.

It may be seen at once that  $e$  is proportional to  $V$  as long as  $V$  is small; but as  $V$  is increased, the ratio  $e/V$  becomes smaller, and  $e$  becomes more nearly constant. The ratio  $e/V$  is plotted in Fig. 4.

Let us now analyze these curves with the automatic gain control in mind. Requirement No. 1 is fulfilled immediately, since being a purely resistance device, it can have no frequency discrimination; and because of the thermal inertia of the lamp filaments, no waveform distortion will take place at audio frequencies. Requirement No. 2 is very closely approximated, as may be seen by curves in Figs. 3 and 4. Very large increases in  $V$  cause very little increase in  $e$ , thus preventing undue overload. Of course there is the practical limit of the lamps burning out, but this may be overcome by by-passing the excess voltage through some such device as a neon bulb.

Because of the thermal inertia of the filaments, the proportion of loud to soft signals remains momentarily constant; hence the character of the transmission is unaltered, thus fulfilling requirement No. 3. Again, since the control does not begin to take place until quite an appreciable voltage  $V$  has been applied, it is impossible to bring up background noises, etc., out of proportion to the rest of the signal, thus fulfilling the last requirement.

It is only fair to remark that this system of automatic gain control has two important features which may or may not be classed as disadvantages; namely, it requires a very definite range of input and it is quite inefficient from the power transmitting standpoint.

In the practical design the choice of values of  $R$ ,  $R_1$ ,  $R_2$ ,  $R_3$ , will depend on the degree of control desired and the audio power available to drive the device. If  $R$  consists of 2-volt pilot light bulbs, and  $R_1$ ,  $R_2$ ,  $R_3$  are each 6 ohms, with the entire bridge driven from a 10-ohm circuit at a maximum level of +16 db there exists a normal attenuation of about 16 db at low levels and of about 30 db at high levels. In other words, a variation of about 26 db is reduced to about 10 db, which is quite permissible for broadcasting. If closer regulation than this is required, two or more such sections might be used in cascade—with, of course, appropriate amplifiers preceding each unit.

The speed with which this automatic gain control is capable of acting depends entirely on the thermal inertia of the lamp filaments. Generally speaking, the time lag is about proportional to the current drawn by the filaments at incandescence. With a filament drawing about 60 milliamperes the time lag is from  $\frac{1}{6}$  to  $\frac{1}{10}$  second. If a smaller time lag than this is required, special lamps must be obtained since the 60-ma. variety is about the lowest-current type generally available.

Fig. 5 shows a typical amplifier set-up using this system of volume control. The input signal is relatively high-level, +16 db or approximately 0.25 watt, which may be obtained conveniently

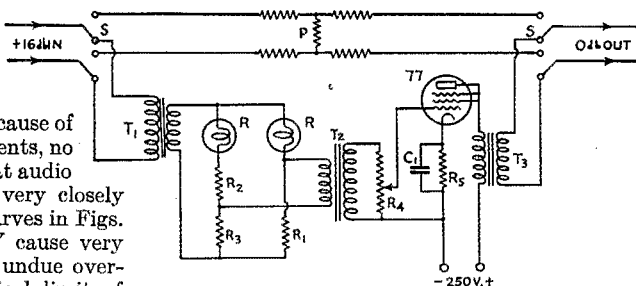

FIG. 5—CIRCUIT OF A TYPICAL SETUP USING AUTOMATIC AUDIO GAIN CONTROL

- $R$ —2-volt pilot bulbs.
- $R_1$ ,  $R_2$ ,  $R_3$ —6-ohm resistors.
- $R_4$ —250,000-ohm volume control potentiometer.
- $R_5$ —2500-ohm bias resistor.
- $C_1$ —25- $\mu$ fd. by-pass condenser.
- $S$ —4 P.D.T. switch to cut out automatic control and cut in pad.
- $T_1$ —Matching transformer, 500 ohms to 10 ohms.
- $T_2$ —Input transformer, 200 ohms to grid.
- $T_3$ —Output transformer, plate to 500 ohms.
- $P$ —Compensating pad, about 16 db attenuation; for 500-ohm circuit each arm is about 180 ohms.

from a pair of 89's in push pull. Since the impedance of the thermal bridge is about 8 ohms to 10 ohms, a matching transformer must be used to couple the line to the bridge.

It was found advisable to use a coupling transformer between the bridge and the following amplifier, because of the increased step-up necessary and the leakage normally encountered. The primary impedance of this transformer should not be too low, since otherwise it will tend to equalize the potential between the points  $a$  and  $b$ , and some of the gain-control effect will be lost. A value of 200 ohms was found to be quite satisfactory.

A switch and compensating pad  $P$  may be inserted in the circuit to by-pass the automatic gain control if desired, in which case the pad should have a value equal to the attenuation of the bridge at low levels, minus the gain of the following amplifier with matching transformers, in order to make possible a smooth changeover without disturbing the overall transmission too much.

— . . . —

### Brief

On June 27th the Private Flyers Association started its second annual air meet at the Eugene (Oregon) Airport. 56-mc. tests between air and ground were conducted by members of the Valley Radio Club. W7FIA and W7AEZ operated a rig in a plane which flew over the airport and over the city. Communication was maintained with a ground station manned by W7KL and another ground station, which was connected to broadcast station KORE from where transmissions from the plane were rebroadcast. W7BIK was in charge of the event.

# The 6L6 As Amplifier and Doubler

NOW that metal tubes are apparently a definite part of our radio life, it is only natural that their adaptability in the transmitting end of things has become a subject for conjecture by many amateurs. Of them all, the beam power tube, the 6L6, is of particular interest because of its newness and electrical features. The latter, it will be recalled, include the ability

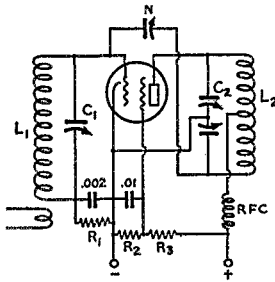

FIG. 1—THE 6L6 AS A STRAIGHT AMPLIFIER

R<sub>1</sub>—50,000 to 75,000 ohms.  
R<sub>2</sub>—4000 ohms, 10-watt.  
R<sub>3</sub>—30,000 ohms, 5-watt.

ity to give power outputs much larger than were obtainable with forerunning receiving-type tubes.

Since the 6L6 as a crystal oscillator has already been treated,<sup>1</sup> we were particularly concerned with finding out how the tube behaved as the neutralized amplifier and doubler. To get this information, a simple bread-board layout was built up, using the 6L6 in a conventional amplifier circuit driven by another 6L6 used as a Tri-tet oscillator. A 3.5-mc. crystal was used in the grid-cathode circuit of the oscillator; the plate circuit was tuned to the second harmonic, or 7 mc. Link-coupling this excitation to the grid tank of

floating. Grounding the shield added so much capacity between plate and ground that it was well-nigh impossible to strike a balance. A very small neutralizing condenser had to be used; two one-inch square pieces of aluminum, separated 1/4 inch or so, proved to be quite adequate. Apparently the tube is quite tolerant of neutralization—no sharply defined point of neutralization was found, but there was no tendency towards oscillation. Probably the shields could be grounded in a push-pull amplifier because of its symmetry, but the floating shield arrangement is easy to adjust, and adding the extra capacity of the shield across the tuned circuit would certainly not help the L-C ratio in the plate circuit.

On applying plate and screen voltages the amplifier was found to behave in a perfectly normal manner. The minimum plate current dipped to around 10 ma., and with 375 volts on the plate the plate current was run up to 90 or 95 milliamperes by using a 25-watt lamp as a dummy load.

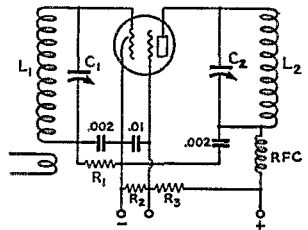

FIG. 2—THE 6L6 DOUBLER CIRCUIT

R<sub>1</sub>—100,000 to 150,000 ohms.  
R<sub>2</sub>, R<sub>3</sub>—Same as in Fig. 1.

At this input approximately 20 watts output was obtained, as measured by a Photronic cell which previously had been roughly calibrated, with the

## TYPICAL RESULTS WITH THE 6L6

Excitation Freq.	Output Freq.	Plate Volts	Plate Current	Grid Current	Grid Leak	App. Output Watts	App. Efficiency
7 mc.	7 mc.	375	90-95 ma.	2 ma.	50,000-75,000 ohms	20	60%
7 mc.	14 mc.	375	80 ma.	3 ma.	100,000-150,000 ohms	13-15	50%
14 mc.	28 mc.	375	60 ma.	3 ma.	100,000-150,000 ohms	10	45%

the 6L6 amplifier, a series of tests was run to find the optimum values of grid leak, screen voltage, and other values of interest.

### NEUTRALIZING

The first thing to become apparent was that if the tube was to be neutralized—and it had to be, despite previous hopes to the contrary—it would be necessary to leave the metal envelope or shield

<sup>1</sup> Edmonds, "The 6L6 As a High-Output Crystal Oscillator," *QST*, June, 1936.

particular lamp, against watt-meter readings on commercial a.c. Optimum efficiency was obtained with a grid leak on the order of 50,000 to 75,000 ohms. The grid current was 2 ma., indicating very low excitation requirements.

### SCREEN VOLTAGE

In working with the tube both as a straight amplifier and doubler it was found, as is common with other screen-grid type tubes, that the out-

(Continued on page 58)



# Oscillator-Mixer Design Considerations for the Amateur-Band Superhet

By Clinton B. DeSoto,\* W1CBD

THE problem of mixing is as old as the superheterodyne receiver. From the earliest autodyne oscillating "first detector" through the numerous stages of evolution—grid coupling, plate coupling, screen- and suppressor-grid coupling, triode oscillators and electron-coupled oscillators, to the present-day variety of pentagrid tubes—undoubtedly the most persistent stumbling-block in superheterodyne design has been the question of efficient frequency conversion.

Some adequate solutions have been achieved, but, unfortunately, these do not in every case hold good when the designer makes excursions into the higher-frequency region beyond the 14-mc. band. In a current attempt to design a receiver that would operate successfully in all amateur bands from 30 mc. to 3500 kc., with optimum performance in the ultra-high-frequency region, this problem was found especially troublesome. Some of the points uncovered in its examination may be found useful by other builders of high-frequency superhets.

## 6K7-6L7 COMBINATION

Naturally, when starting on a new project, an attempt is made to use the latest and best materials available. In the case of a mixer, the tube that naturally comes to mind is the 6L7,<sup>1</sup> announced a year ago as the cure-all for mixer troubles. On the lower frequencies this tube performs very successfully indeed, but at 10 meters a different story must be told. The simple fact is that at the higher frequencies it is impossible to secure sufficient oscillator voltage on the injector grid with ordinary methods, while maintaining the isolation between oscillator and mixer so essential to the operation of an amateur-band superhet. This was brought out in the work on the "simplified high-performance superhet,"<sup>2</sup> where electron-coupling from the oscillator was found impractical even on 20 meters. The system finally adopted and described (shown in Fig. 1) was satisfactory on 14 mc., but not wholly so on 28 mc., although adequate performance was achieved in comparison with other methods. The biggest disadvantage was that discarding electron-coupling appreciably lessened the oscillator

stability, and the use of the 6L7 in itself did not eliminate pulling.

This system was about the best that ordinary amateur design practices could achieve, being excelled in general effectiveness only by the

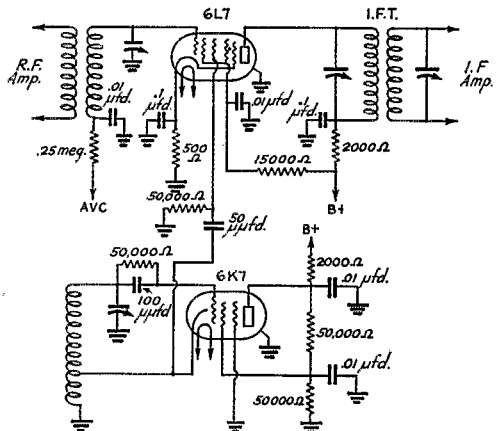

FIG. 1—THE OSCILLATOR-MIXER ARRANGEMENT WIDELY USED IN AMATEUR-BUILT RECEIVERS

It is satisfactory on frequencies below 15 mc. Alternatively, coupling may be direct to the 6K7 control grid, with more interaction, or by electron-coupling to the plate, with less. The e.c. arrangement is satisfactory below 7 mc., but not at 20 meters.

critical and frequently troublesome combination of a 24-A oscillator coupled to the control-grid of a pentode mixer. Yet the unavoidable compromises were, at the least, undesirable. These were:

1. Low conversion efficiency. 6L7 conversion conductance is given as 425 micromhos with 15 volts on the No. 3 grid, but only 200 with 7.5. (In speaking here and later in this article of the "injection-grid voltage," the voltage referred to is that developed in the injection-grid resistor by the flow of rectified r.f. current furnished by the oscillator. The injection grid is leak-biased, in other words.)

2. Oscillator instability. In contrast to relatively stable electron-coupling, pulling of several hundred cycles was experienced with cathode-coupling from oscillator, of kilocycles with the alternative control-grid coupling.

In the present investigation, it was a relatively simple matter to cure the first difficulty by increasing oscillator power. A metal tube being

\* Assistant Secretary, A.R.R.L.

<sup>1</sup> "Data on the Metal-Shell Receiving Tubes," *QST*, p. 35, July, 1935; "Using the 6L7 to Improve Superhet Performance," *QST*, p. 48, Feb., 1936.

<sup>2</sup> "Building a Simplified High-Performance Superhet," *QST*, p. 19, April, 1936.

desired for the position, the 6F6 audio power pentode was finally selected as the most logical choice, having considerable power-handling ability and adequate internal and external shielding. By pushing this hard, it was possible with cathode coupling to get adequate output to operate the

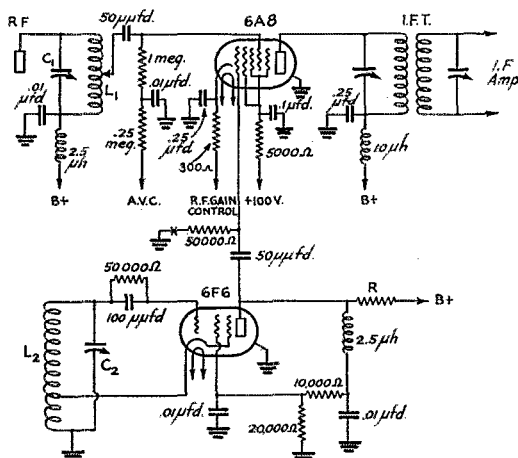

FIG. 2—THE COMBINATION FOUND SUCCESSFUL ON 28 MC.

An electron-coupled power pentode oscillator is used in conjunction with a 6A8 pentagrid mixer.

R should be of such a value that the current flowing at the point marked X is not less than 100 microamperes (preferably not less than 200) at the highest operating frequency, and not more than 500 microamperes at the lowest.

Leaving the shield on the 6F6 floating rather than grounded gives somewhat better output.

A tuned plate r.f. amplifier is recommended for ultra-high frequency work, with resistance coupling to the mixer grid. The coupling condenser should be of the large 1000- or 2500-volt type, with low-loss bakelite or ceramic insulation; the coupling resistor should be stable, with low capacity, one of the new 1-watt molded types being suggested. The position of the tap on  $L_1$  must be determined experimentally for maximum gain, the type of r.f. amplifier tube and gain of the pre-selector affecting its location.

$C_1$  and  $C_2$  are the lumped tuning and trimmer capacities, etc., in the tuned circuit.  $L_1$  and  $L_2$  can be designed in accordance with suggestions in the text.

6L7 properly, but frequency stability was poor. With electron-coupling, on the other hand, an input of several watts to the 6F6 was required—and having a young transmitter in the receiver introduces plenty of complications in the way of circuit isolation, shielding, etc.

#### PENTAGRIDS AND PENTAGRIDS

At this point a critical eye was turned on the 6L7. According to the dope sheets its most important virtue was its elimination of "pulling" effects. Yet here, with instability rampant, it obviously was not doing a very good job. Perhaps a different tube—one of the other pentagrid types—could be successfully substituted. In the glass tube line the 2A7 and the 6A7 had been found to be reasonably good mixers when used with separate oscillators. Perhaps the improved

metal-tube counterpart, the 6A8,<sup>1</sup> would be "over on the alkaline side," too. Certainly, it had more "ginger" in its characteristics, giving 425 micromhos conversion conductance (the 6L7 peak for 15 volts) at but 150 oscillator-grid microamperes or, with a 50,000-ohm leak, 7.5 volts.

The 6A8 proved to be a willing worker. Direct substitution in the 6L7 socket with no change in operating potentials resulted immediately in stronger signals. Not only was the oscillator voltage requirement less, but, all other conditions being maintained the same, the injector grid current in the 6A8 was approximately double that in the 6L7 on 28 mc., with the same oscillator input—presumably because of the difference in the internal impedance of the tube due to the location of the No. 3 grid higher in the electron-stream. And, highly gratifying from the stability standpoint, the 6F6 could be used electron-coupled with entire success.

The net result of the change-over was that the conversion efficiency on 28 mc. increased to optimum, and the oscillator stability was entirely adequate. That was fine—on 28 mc. On the lower frequency bands, however, a new problem presented itself.

In the case of the 6L7 the *minimum* oscillator voltage was important. That minimum reached, almost any reasonable higher value can be used satisfactorily. The 6A8, due to the different element order, is more critical. Too much, as well as too little, voltage on the No. 1 or oscillator grid lowers the conversion efficiency. The recommended minimum and maximum range lies between 100 and 500 microamperes (5 to 25 volts), ranging from 300 to 500 micromhos conductance with a peak of 515 at about 400  $\mu$ a. The highest conversion efficiency is realized when the oscillator provides between 10 and 25 volts across a 50,000-ohm leak. (Incidentally, it may be remarked here that at the present time both 6A8's and 6L7's are far from uniform insofar as the effective injection-grid current flowing with a given applied oscillator power is concerned, differences as great as 25 per cent being noted between different new tubes, fresh from the carton. Some care should be taken to pick one that is easily driven.)

It was relatively easy to obtain 10 volts at 28 mc. However, with the arrangement first set up, considerably more than 25 volts was had at 3500 kc. A re-design of the tuned circuits brought the effects within the above limits—use of a 28-mc. coil with high  $Q$  and feedback (cathode tap half way between grid and ground) and of a 3.5-mc. coil with relatively low  $Q$  and reduced feedback. (Cathode tap  $\frac{1}{4}$ th up from ground.)

#### COIL DESIGN AND INSULATION

This brings up the important point of coil design at 28 mc. There is little new to be said on

(Continued on page 82)

# 1936 DX-Contest Results

**T**HE DX portals were open wide during A.R.R.L.'s Eighth International Competition, March 14-22, 1936. It was as though OM Handy had waved a magic wand summoning the elusive and rare DX out of hiding. If ever the bands were alive with new countries, new stations and new records in the making, it was during the 1936 DX-Contest! WAC's, TBTOC's and FBTOC's were accomplished by the score. It is estimated that stations were active in at least 100 countries; W8CRA alone heard stations in 87 countries!

An all-time high in amateur contest participation is represented by the 1521 operators in the score list! 1103 operators in the United States and Canada and 418 in 68 foreign countries and outside localities reported their contest work. We wish to gratefully acknowledge the assistance of Ken Bishop, W1EWD, in the tremendous task of checking and tabulating scores!

## HIGH W/VE SCORERS

Well in the lead among the U. S. and Canadian participants is Dave Evans, W4DZH, Atlanta, Ga., with 91,530 points—226 QSO's with 69 different foreign localities in 86 hours and 40 minutes' operating time!! It should be noted that 69 is a new record for number of countries worked during any single contest. W4DZH used an HK354 in his final stage with 900 watts input on 3.5, 7, 14 and 28 mc. He worked 9 countries on 3.5, 39 on 7, 58 on 14 and 29 on 28 mc.

Second-high in the W/VE group is W3SI, Charlie Meyers, Harrisburg, Pa.—79,788 points, 218 QSO's with 62 different countries. W3SI operated a total of 77 hours, 10 minutes, using a kilowatt input on 3.5, 7, 14 and 28 mc. 8 countries were worked on 3.5, 34 on 7, 56 on 14 and 24 on 28 mc.

Third-high position goes to Ralph Thomas, W2UK, Quogue, N. Y., who made 222 QSO's with 68 foreign localities for a total score of 75,210 in an operating time of 86 hours, 59 minutes. Three bands were used with 1-kw. input on each. 29 countries were worked on 28, 63 on 14 and 23 on 7 mc.

Congratulations are extended to W4DZH, W3SI and W2UK on their excellent work! The highest scoring Canadian is VE2EE with 27,594 points. Any score over 40,000 is "not to be sneezed at," and we list here all other W's topping that figure: W2BYP 69,495, W1FH 61,263, W1DZE 59,622, W9TB 58,195, W2AIW 58,176, W6GRL (3 oprs.) 57,222, W1ZI 54,795, W1SZ 53,550, W2DC 51,700, W6CXW (2 oprs.) 50,661, W3EMM 50,102, W1TS 48,609, W3DMQ 46,636, W3EYS 43,860, W5EHM 41,850, W1CMX

41,571, W9IJ 40,908, W1EWD 40,568, W6KRI 40,416.

The greatest number of QSO's was made by W4DZH—226. W2UK was second with 222, followed by W3SI 218, W2BYP 205, W9TB 198, W1ZI 191, W2AIW 191, W1FH 189, W6GRL (3 oprs.) 187, W3EMM 178, W1DZE 177, W3DMQ 176, W2DC 173, W1SZ 172, W3EYS 172, W1TS 165, W9IJ 164, W6CXW (2 oprs.) 160, W1EWD 158, W6GRX 157, W5EHM 155, W1CMX 151, W8LEA 150.

The highest multipliers (total of different countries worked on each band used) are credited to the following, indicating greatest agility in use of bands and greatest ability to ferret out the most countries: W4DZH 135, W3SI 122, W2UK 115, W1DZE 114, W2BYP 113, W1FH 108, W1SZ 104, W9TB 103, W6GRL (3 oprs.) 102, W6CXW (2 oprs.) 102, W2AIW 101, W2DC 100, W1ZI 99, W1TS 99, W6KRI 96, W3EMM 94, W1CMX 93, W5EHM 90, W2CBO 89, W3DMQ 89.

Those working the greatest number of *different* countries are W4DZH 69, W2UK 68, W1DZE 62, W3SI 62, W6KRI 61, W6CXW (2 oprs.) 60, W1SZ 59, W6GRL (3 oprs.) 58, W1FH 57, W1TS 57, W2BYP 56, W9TB 55, W1ZI 55, W3DMQ 55, W6GRX 53, W1CMX 53, W2CBO 52, W8LEA 52, W1EZ 50, W3EMM 50, W2DC 50, W6FQY 50, W5EHM 49, W6CUH 49.

The highest scoring station in each W/VE district: W1FH, W2UK, W3SI, W4DZH, W5EHM, W6GRL, W7AMX, W8LEA, W9TB, VE1EA, VE2EE, VE3WA, VE4IG, VE5EO.

## HIGH FOREIGN SCORERS

Head and shoulders above all participants is XE2N, Juan Lobo y Lobo, with the amazing total of 189,081 points!! He made 1370 QSO's with all 14 W/VE districts! Power at XE2N was 150 watts input. The 3.5-, 7-, 14- and 28-mc. bands were used. 15.2 QSO's per operating hour were averaged! We believe XE2N has made a record that will stand for some time. FB, OM!

EA4AO, J. M. deCordova, is second-high world scorer with 122,180 points—an eye-opener bettered only by XE2N's accomplishments! EA4AO made 1002 QSO's with all W/VE districts using 3.5-, 7-, 14- and 28-mc. bands and operating the full 90 hours. Power used was 1 kw. on 7 and 14 mc., 800 watts on 3.5 mc. and 600 watts on 28 mc.

Other noteworthy foreign scores: D4ARR 90,000, F8EB 85,100, K5AY 83,244, EA8AO 74,100, K4KD 72,360, ZL2KK 71,820, F8EO 67,977, VK3MR 66,842, OA4J 65,975, EA3EG 59,346, EA4BM 54,848, K6CGK 52,410, HJ3AJH

51,156, FA8BG 50,717, HB9J 50,505, K7PQ 50,352, NY2AB 50,304, CM2AD 50,112. The following each made over 30,000: EI8B (2 oprs.), K6AUQ, OK2AK, OK1BC, D4BIU, PAØPN, K4DDH, ZL1DV, F8KJ, PAØUN, G6NJ, K6IDK, VK2EO, VK7JB, XE1AA, VK3CP, ZL2KI, CX1CG.

The highest multipliers (total of different W/VE districts worked on each band used) are credited to XE2N 47, F8EB 46, K4KD 45, K4DDH 43, K5AY EA3EG 42, EA4AO 41, D4ARR OK2AK 40, FA8BG F8EO 39, VK3MR EA8AO 38, CM2FA G2PL 37, ZL2KK G5YG (2 oprs.) 36, OA4J, VK3CP, XE1AA, HB9J, F8KJ 35. A multiplier of 30 or higher was made at 43 stations.

87 foreign participants made 200 or more QSO's. Those making the greatest number include XE2N 1370, EA4AO 1002, D4ARR 750, K5AY 666, ZL2KK 665, EA8AO 653, OA4J 642, F8EB 617, HJ3AJH 611, K6CGK 603, F8EO 595, VK3MR 592, EA4BM 588, EI8B (2 oprs.) 550, CM2AD 550, K4KD 536, K6AUQ 536, NY2AB 524, K7PQ 520, D4BIU 514, EA3EG 508, K6IDK 506.

The highest scoring station in each continent: Africa—EA8AO, 74,100. Asia—J2LO, 12,117. Europe—EA4AO, 122,180. North America—XE2N, 189,081. Oceania—ZL2KK, 71,820. South America—OA4J, 65,975.

#### GENERAL

Several new rules were introduced in the 1936 DX-Contest each of which met with the widespread approval of a majority of contestants. The "quota" rule, whereby it was permitted to work only three stations in any given country on any one band, is believed to have reduced QRM and to have increased the number of countries worked. It was allowed to work the same station on more than one band provided the quota of three for any one country was not exceeded on any band. The basic number exchanges as proof of contact were retained as in previous years with the slight change that the first three numbers of the groups consisted of the RST report of the station worked; this was found advantageous in that it speeded up QSO's. The multiplier used to determine the final score this year consisted of the total of the different countries (or total of W/VE districts, in the case of foreign contestants) worked on each frequency band used. The same country could be worked on a different band and could then again be included in the multiplier. This helped QRM since it caused greater diversification in use of bands, spreading operating among more bands than in previous years. A total of 90 operating hours was permitted. For more than 90 hours of operation the Grand Total Score was multiplied by 90/number of hours.

Approximately 4.3% of all W/VE participants and 10.6% of foreign contestants used 4 bands.

This would indicate that amateurs in the foreign localities make a more even use of the various bands, whereas W/VE amateurs are slower to diversify their operation. However, W6ITH and VE1EA were the only reporting participants who made successful contacts on 5 bands—1.75, 3.5, 7, 14 and 28 mc. 28 mc. was wide open during the contest and proved a match for the popular 14-mc. band.

Certificate awards are being made to the leading operators in each A.R.R.L. Section and each foreign country and outside locality. Scores were received from 68 countries and localities (including P. I., Hawaii and Alaska sections) and from 65 A.R.R.L. Sections; awards are being made in all Sections except Mississippi, from which no entry was received.

The usual complaints were made about bad notes, long CQ's, unnecessarily long calls, CQ's by W/VE contestants, out-of-band operation, edge-of-hand operation, QRM from thoughtless individuals tuning up during busy operating periods and not enough use of the QHM, QML series of abbreviations. There are always these things to "gripe," but the majority sentiment is that "it was plenty of fun, regardless!"

This report would not be complete without a word of praise for the many operators who sacrificed contest points to assist in the flood emergency work, which broke right in the middle of the competition. Too much cannot be said for their splendid showing of coöperation! They won the admiration of the whole fraternity! An interesting sidelight, showing at the same time that 3.5-mc. conditions were certainly good for DX during the contest, is that W1BDI had to call a foreign operator on "80-meters" and ask him to change frequency because he was QRming flood emergency work!

#### CLUB AWARDS

Special certificates offered to the highest scoring operator in each A.R.R.L.-affiliated club where three or more individual members took part and submitted scores are being awarded to the following: W2AYJ, Northern Nassau Wireless Assn. (Sea Cliff, N. Y.); W3BZE, Richmond (Va.) Short Wave Club; W3DMQ, The Frankford Radio Club (Phila., Pa.); W4AAQ, Birmingham (Ala.) Amateur Radio Club; W4DIQ, Jacksonville (Fla.) Radio Club; W4OG, Winston-Salem (N. C.) Amateur Radio Club; W6LEA, The Oakland (Calif.) Radio Club; W8ACQ, operating W8CJJ, Elmira (N. Y.) Radio Amateur Assn.; W8IIL, Beaver Valley Amateur Radio Club (Aliquippa, Pa.); W8LVH, Westlake Amateur Radio Assn. (Rocky River, Ohio); W9AFN, South Town Amateur Radio Assn. (Chicago, Ill.); W9GIL, Milwaukee Radio Amateurs' Club, Inc.; W9KA, Chicago Radio Traffic Assn.; W9LKI, Fort Wayne (Ind.) Radio Club; W9RCQ, Egyptian Radio Club (Nameeki, Ill.).

Awards are made only when three or more club members report. Amateurs in 57 clubs submitted entries but we are able to make but fifteen awards. If the secretary of any A.R.R.L.-affiliated club where an award has not been made will notify us of three members who took part in the contest and reported, we will gladly award a certificate to the highest scorer promptly upon receipt of the information.

Attention is called to May *QST* (page 35) where Don Mix, W1TS, presented some interesting contest highlights, and to "DX Notes" in July *QST* where many items of interest on contest participation are listed. Those two references coupled with this report provide a complete picture of the 1936 DX-Contest.

As VE2EE aptly puts it, "Another contest has

faded into history. A battle of wits, good operating and good equipment. I tip my hat to the boys with the big scores." In many a ham shack plans are now being made for "next year's battle"—and those plans, no doubt, include beam antennas East, West, North, South; s.s. supers; and 1-kw. input! FB, but don't forget that a good dose of "operating ability" will help, too!

VK3OC's desk calendar for the last day of the contest carried this appropriate quotation:

"Weariness

Can snore upon the flint, when rusty sloth  
Finds the down pillow hard."

—Shakespeare.

Amen!

—E. L. B.

## Scores

### Eighth International DX Competition

(Operator of the station first-listed in each Section and Country is winner for that territory, unless otherwise indicated. . . . Asterisks denote stations not entered in contest, reporting to assure credit for stations worked. . . . The multiplier used by each station in determining score is given with the score—in the case of W/VE entrants this is the total of the different countries worked on each frequency band used; in the case of non-W/VE participants is the total of the different W/VE Districts worked on each frequency band. . . . The number of bands on which successful contacts were made is next listed. . . . The letters A, B and C approximate the power input at each station; A indicates power up to and including 100 watts input; B indicates over 100 watts up to and including 500 watts; and C indicates over 500 watts. In cases where power was varied, this is shown by the use of more than one letter. . . . The total operating time to the nearest hour is given for each station and is the last figure following the score. . . . Example of listings: W1FH 61236-108-4-B-90, W1WB 2438-23-2-A-34, multiplier 108, 4 frequency bands used, power over 100 watts and not exceeding 500 watts, total operating time 90 hours. . . .)

<i>E. Massachusetts</i>				W1WB	2438-23-2-A-34
W1FH	61236-108-4-B-90	W1IOB	2438-23-1-A-21		
W1DZE	50622-114-3-B-89	W1BWJ	2318-19-1-B-31		
W1ZI	54795-90-3-BC-90	5W1FET	3121-21-2-A-39		
W1CMX	41571-93-3-B-90	W1ICA	2001-23-3-A-33		
W1BUX	34830-88-3-B-85	W1NA*	1960-20-1-B-31		
W1ME	26483-71-4-B-58	W1JAF	1360-20-1-B-51		
W1RY	22360-65-4-B-72	W1JOO	1216-16-1--24 <sup>1</sup>		
W1AXA	17180-50-3-C-71	W1DDO	1056-16-3--18		
W1BXW	14025-55-3-AC-63	W1IKU	894-13-3-A-23		
W1HX	11562-47-4-AB-55	W1HPV	728-13-2--		
W1WV	10704-48-4-B-84	W1HBD*	648-12-1-B--		
W1GLF	10675-43-3-A-55	W1DHI*	612-12-1--		
W1BKL	9947-49-4-AB-61	W1BB	552-12-2-C-10		
W1CJP	8862-42-3-B-66	W1BFR	495-11-1-B-16		
W1CBZ	8694-42-3-A-41	W1CMZ	459-9-1-A-25		
W1HER	8560-41-2-B-53	W1KH	374-17-4-AB-10		
W1DMA	8040-40-3-B-81	W1DDE	324-9-2-A-7		
W1CCA	7998-43-3-B-73	W1KM*	297-9-1--		
W1GDY	5508-34-3-B-32	W1HUU	279-9-1-A-25		
W1GNE	4031-20-2-B-46	W1YJ	185-5-1-B-5		
W1LQ	3050-25-2-B--	W1YCI	162-6-1-AB-20		

W1HYR*	154-7-1--	W1BPN	168-7-1-A-24
W1AII*	144-6-1-B--	W1HET*	168-6-1--6
W1CUY*	135-4-1--	W1HFA	120-5-1-A-4
W1EHT	86-3-1-A-9	W1AJ	36-3-1-A-4
		W1LW	4-1-1--

### Connecticut

W1BZ	53550-104-4-C-62*	<i>New Hampshire</i>	
W1TS	48608-89-4-C-71*	W1DUX	26385-69-3-B-94
W1EWD	40568-88-4-AB-80*	W1BET	23667-69-4-B-45
W1ED	10120-44-2-B-48	W1AVJ	10212-46-4-B-41
W1FTR	8096-44-2-B--		
W1FUP	8040-40-2-B-48		
W1DGG	7280-40-3-B-64	<i>Vermont</i>	
W1JPE	6264-36-3-B-34	W1EDJ	25875-69-3-B-90
W1GME	4350-29-2-A-42	W1BTP	15517-59-4-B-56*
W1GCX	3936-32-2-B-37	W3EEB-1	1482-19-2-B-46*
W1BTT	3810-30-2-A-35	W1GNF*	120-5-1-A--
W1EBO	3690-30-2-B-26		
W1WR	2574-26-2-B-45	<i>Maine</i>	
W1AFB	2400-25-4--	W1AKR	16632-54-3-B-75
W1AFA	1800-20-2-B-35	W1IQZ-1	16588-58-3-B-50
W1IGZ	1660-20-1-C-49*	W1DUJ	8229-39-1-B-88
W1AB	1600-20-2-BC-42	W1FUC	2900-25-1-A-40
W1AGU	1584-18-2-B-15	W1GKJ	2736-24-2-A-60
W1DX	1245-16-1-A--	W1DFQ	1456-18-1-B-29
W1QV	1024-16-1-B-16	W1QH	1122-17-1--20
W1GVV	978-15-3-B-16	W1CBQ	288-9-1-B-30
W1BHM	972-12-3-A-27	W1BOR	260-10-1-B--
W1MK	871-13-2-C--	W1CIX*	252-7-1--8
W1EAO	840-14-2-B-32	W1EJ	105-5-1-A-21
W1CSO	824-14-2-B-16	W1AQW	3-1-1-A--
W1CNU	578-12-1-B-9		
W1EEO	528-11-1-B-23	<i>Rhode Island</i>	
W1IGC	462-11-2-A-8	W1AFO	6030-33-2-B-39
W1AVV*	189-8-1--	W1CAB	5160-30-2-B-36
W1HRE	135-5-1-B-5	W1IQF	2288-28-2-A-66
W1IKE	18-2-2-A-9	W1BBN	1458-18-2-B-22
W1AFG	3-1-1-A-9	W1GBO	1008-16-2-B-11
W1BDI*	3-1-1-B-9	W1CPV	510-10-1-A-16
		W1HJ*	297-9-2--21

### W. Massachusetts

W1ZD	24777-83-4-C-89	W2UK	75210-115-3-C-87
W1ZB	28860-77-4-BC-77	W2DLO	22425-65-4-C-38
W1DLD	16912-56-3-B-71	W2HUF	17784-57-9-B-41
W1AEP	12600-50-3-B-56	W2CQU	17400-60-3-B-73
W1JLT	11466-49-4-B-60	W2GKR	14098-53-2--
W1AFU	5700-32-3-B-33	W2ALB	12950-50-2-B-86
W1CC	3024-28-2-B--	W2EFL	12150-50-3-B-50
W1BGY	1950-13-3-A-14	W2EIL	11092-47-2-B-50
W1BDW	1500-17-2-B-34	W2CTO	11074-49-2-B--
W1FPP	819-13-1-A-21	W2BJ	10368-36-2-B-46
W1IKT	732-12-1-A-58	W2GTZ	10206-42-1-C-88
W1FAK*	506-11-1--24	W2AYJ	7956-30-2-B-45

### N. Y. C.-L. I.

<sup>1</sup> Harvard University Radio Club; ops. W1HKK, W8KBS, W8KIP. <sup>2</sup> The Conn. award goes to W1EWD since W1SZ and W1TS (both of HQ's) are not eligible. <sup>3</sup> Aero Radio Club of Torrington; ops. W1KWK ISG IRH JJJ FND DNJ BQL. <sup>4</sup> H. M. Stevenson, Jr., opr. <sup>5</sup> Two ops.; W2CPU 12 pts. <sup>6</sup> Three ops., A. Talamini, D. Peacock, B. Wiebe. <sup>7</sup> Portable at Linden, N. J. <sup>8</sup> Portable at Livingston, N. J. <sup>9</sup> Portable at Burlington, Vt. <sup>10</sup> Dickinson Radio Club, Carlisle, Pa.; ops. W3ELV DHO BKV BML FOW CBK. <sup>11</sup> Two ops. <sup>12</sup> W1ALS, opr. <sup>13</sup> W3EIS, opr. <sup>14</sup> Portable at Gainesville, Fla. <sup>15</sup> Due to a question on this score, a North Carolina award has not yet been made. <sup>16</sup> Portable at Houston, Texas. <sup>17</sup> Portable at Tucuman, N. Mex. <sup>18</sup> Due to a question on individual-operator scores at W6GRL and W6CKW, an award has not yet been made in the Los Angeles section; ops. at W6GRL: 6CRL, 6DTY, 6BDZ; at W6CKW: H. Y. and Sam Sasaki. <sup>19</sup> Portable at San Jacinto, Calif. <sup>20</sup> Portable at Los Angeles. <sup>21</sup> 20-40 Club; W6JBO, opr. <sup>22</sup> Three ops., O. C. Miller, L. L. Stevens, G. A. Herndon. <sup>23</sup> W6ITY, opr. <sup>24</sup> Port. 7's Radio Club. <sup>25</sup> Portable at Marshfield, Ore. <sup>26</sup> Portable at Medford, Ore. <sup>27</sup> Two ops.; W7BRU 75 pts., W7FFN 3 pts. <sup>28</sup> Two ops.; HK 945, FR 1243. <sup>29</sup> Denison University Radio Club; W8EDU, opr. <sup>30</sup> W8MUD, opr. <sup>31</sup> Station score, two ops.; opr. W8ACQ, 13,825 pts. <sup>32</sup> Three ops.; W9SI, BEP, UZN. <sup>33</sup> Three ops.; W9OQP, FV, MVG. <sup>34</sup> University of Kentucky, Ft. Paul Fulcher, opr. <sup>35</sup> Three ops.; W9PEV, W9EKK, W9NMA. <sup>36</sup> Station score, two ops.; W9SLK 510 pts., W9EIK 147 pts. <sup>37</sup> Two ops.; W9LXK 2805 pts.; VE1YV 855. <sup>38</sup> Score of opr. T. H. Holby; opr. Mrs. T. H. made 30 pts. <sup>39</sup> Station score, two ops.; highest scoring opr. 23,268 pts. <sup>40</sup> Two ops.; Jack Wylie, J. P. Stove. <sup>41</sup> Station score; four ops.; CCL, NLB, PWB, JLM; 4788 points made by opr. CCL. <sup>42</sup> W2HCJ, opr. <sup>43</sup> OE3JB opr.



## Southwestern Division Convention

Los Angeles, Calif., October 3rd and 4th

The Place: Hotel Biltmore.

Time: Starting Saturday, October 3rd.

Auspices: Federation of Radio Clubs of the Southwest.

- - - - -

## Midwest Division Convention

Topeka, Kansas, October 17th-18th

**T**OPEKA will be the Mecca towards which the radio amateur pilgrims will trek for the official Midwest Division Convention to be held at the Hotel Kansan, October 17th and 18th, under the auspices of the Kaw Valley Radio Club. Needless to tell the amateurs that this convention will far exceed our former state convention. Good speakers are assured and there will be plenty of entertainment also. A representative from A.R.R.L. in the person of Clark C. Rodimon, managing editor, and well known over the air as "Roddy" of WISZ, will be present.

Further information may be obtained from Frank K. Tiffany, president, 1512 West 21st St., Topeka, Kansas.

## Strays

When cheap milliammeters go bad under overload, the trouble is that the small permanent magnet in back of the solenoid has lost its magnetism. The needle no longer goes back to zero but flops loosely all over the scale. To fix it, take the meter apart and take out the small magnet. Wind some cotton-covered wire, about No. 20, around it, starting with one pole and going around to the other; the direction of winding is not important. Then connect the wires to a



storage battery for a moment. The magnetism will be restored and the meter will be as good as ever. The calibration should not be seriously affected. —W2DTE



## DIXIE JONES' OWL JUICE

**I** WISH fone guys would git another word for mojulation. I'm sicka hearin' it. Ever time you tune one of these monkeys in you can bet your last blame dime that he'll say "mojulation" seven times before he stops talkin'. Of course, I don't haf to lissen, but fone guys is guys like other guys, except the difference, and lots of them I call friend in spite of their affliction, and I lissen in a lot in hopes that some day I'll hear one of them say sumpn I want to know about like for instance how is he, and how's the younguns, and is he still got a job, and does the OW still love him as much as could be expected, and things like that, but all I heard so far is mojulation. One time this writer was a Signal Corps soldier on his way to be a radio op in Nome. My little group had to tarry at Fort Lawton, on the fringes of Seattle, for a week or two, awaiting a steamer to take us to the land of dog teams and dried salmon and thermometers with the zero mark half way up. Fort Lawton was garrisoned by negro troops, a disquieting circumstance to those of us from a land where it is contrary to long established custom for whites and negroes to eat together. There may be "abolition men and maids" somewhere within the vast throng of readers of this magazine which has no rival, who will say that the custom is more honored in the breach than the observance. I do not know. I merely state a fact. I follow the customs of my clan, as a rule, but not to the extent of going hungry. My quick decision to eat was accelerated by the fact, that negro soldiers, throughout the Army, probably realizing their handicap, swing hard in the other direction, and positively glow, glisten, shine and sparkle with cleanliness. At the mess hall door a Georgia youth newly arrived and mentally unprepared for what he saw gave voice to his objections to breaking a custom of the land we know. A solemn old patriarchal negro mess sergeant standing by the open portals watching the hungry horde file into his spotless domain, heard, and rumbled deep within the capacious confines of his dusky interior: "Go on in, white boy, God made us dis way." Negro soldiers are soldiers like white soldiers, except the difference. Perhaps it is just as well that our feller man comes in assorted shades and sizes and in different degrees of mental inaptitude, but I still wish fone men would say sumpn else for a change.

—W4IR of the "Dixie Squinch Owl"

# HINTS and KINKS for the Experimenter



## Transceiver à la "Minute Man"

AN ADAPTATION of the popular "Minute Man" 56-mc. receiver, originally described in October 1935 *QST*, to make it into a trans-

ceiver of course all be on one handle—a triple-pole double-throw switch, in other words. The transformer *T* may be one of the kind made for transceivers or a home-brewed gadget of the type made by W9KNZ, who adapted a midget audio transformer by winding 300 turns of No. 32 wire over the other coils for the microphone.

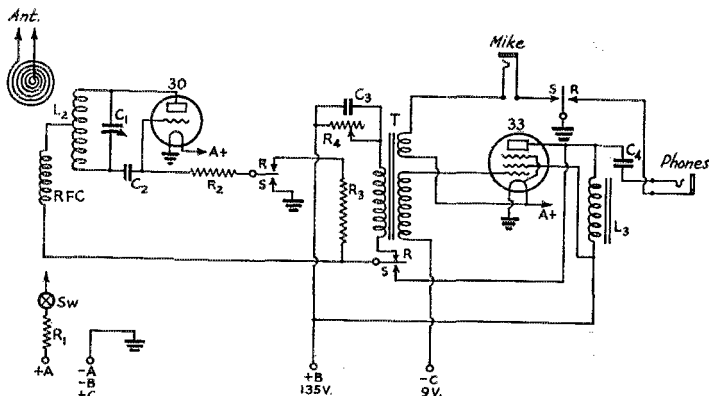

FIG. 1—"MINUTE MAN" TRANSCEIVER

- |  |                      |                                   |
|--|----------------------|-----------------------------------|
| $C_1$ —Two-plate midget variable, low-loss.  | $C_4$ —0.1 $\mu$ fd. | $R_4$ —50,000 ohms variable.      |
| $C_2$ —100 $\mu$ fd.   | $R_1$ —3 ohms.       | $L_1$ —Four turns in flat spiral. |
| $C_3$ —0.25 $\mu$ fd.  | $R_2$ —10,000 ohms.  |                                   |
| $L_2$ —10 turns No. 14, $\frac{1}{2}$ inch inside diameter, spaced diameter of wire.                             | $R_3$ —5 megohms.    |                                   |
| $T$ —See text.   |                      |                                   |
| $RFC$ —45 turns No. 25 cotton-covered wire, inside diameter $\frac{1}{4}$ inch, close wound and self supporting. |                      |                                   |

ceiver for portable work has been made by B. P. Hansen, W9KNZ. The revamped circuit, which besides working well has the virtue of using about the minimum of parts, is shown in Fig. 1. Aside

## R.F. Amplifier for the "Minute Man"

A SUGGESTION for using a broadly-tuned r.f. amplifier with the "Minute Man" receiver also comes from W9KNZ, these amplifiers being in wide use among the Colorado five-meter gang as a means for preventing radiation. He writes:

"The r.f. stage is nothing but a 36 with conventional values. The only unconventional thing is the antenna being brought into the cathode tap and the fact that the cathode is tapped up on the grid coil a little to give some regeneration. The primary of the r.f. transformer (interstage) is the spiral pancake coil mentioned in the original article on this receiver (Oct. '35 *QST*). The r.f. socket must be placed so that the plate lead is of negligible length, and the cold end of the plate coil must be by-passed to ground by a good mica condenser through the shortest possible path. Slotting both the detector and r.f. tube bases between all pins also will help. Everything the original article said about the operation of this receiver still applies. The r.f. grid coil is made of No. 18 bell wire, 22 turns  $\frac{1}{2}$  inch in diameter, close wound. By varying the turns a little one way or

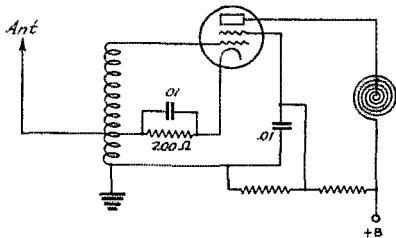

FIG. 2—SELF-RESONANT REGENERATIVE R.F. STAGE FOR THE "MINUTE MAN" RECEIVER

The tap for cathode and antenna should be a few turns from the ground end—not far enough to permit the tube to oscillate.

from following the specifications given, the constructor will find no special precautions necessary except the usual one of making all r.f. leads short.



the other the coil can be made to peak pretty well over the five-meter band."

The circuit is given in Fig. 2.

### A Cure for Blanketing

**B**CL trouble among about twenty-four b.c. receivers located in the same apartment building with my transmitter had refused to respond to traps, "broom-handle" chokes, filters, new antennas or changes in the operating fre-

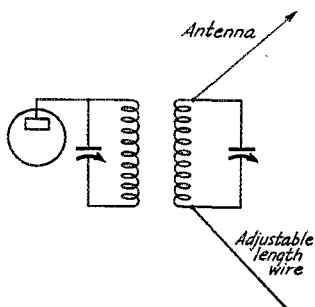

FIG. 3—COMPENSATING FOR WRONG ANTENNA LENGTH IN THE END-FED ANTENNA SYSTEM

quency. This condition had caused self-imposed quiet hours for about two years. Key clicks and thumps were eliminated by conventional methods but blanketing remained very serious, especially in an old t.r.f. relic. The finally-discovered cure—and an absolute cure at that—was the insertion of one "pie" of a National R100 choke right at the antenna post of the BCL receiver. The cure was so complete that the owner of the aforementioned set, whose antenna is about ten feet from mine, does not know when this station is on the air, either with 'phone or c.w.

A word of instruction: Insert all four pies of the choke first, and tune the receiver to the highest-frequency b.c. station audible at the time. Cut out pies as necessary until the b.c. station maximum volume is slightly attenuated—not more than 25% by ear. One pie does the trick on most jobs, but in the case of an indoor antenna it is sometimes necessary to pull a few turns off even one pie. Save the other three pies—they are OK for the same purpose when mounted on a burned-out resistor.

—J. Stanley Brown, W3EHE

### Kink for Using Single-Wire End-Fed Antennas

**H**ERE'S a tip from Bill Reeder, W2HLX, which may help some of those hams having trouble with end-fed antennas when coupling to the final tank is through an additional tuned circuit. He writes:

"In using the end-fed single-wire antenna system I find that the set-up does not always function properly. A parallel tuned coil and condenser circuit will load up an r.f. amplifier regardless of whether an antenna is coupled to it or not. I have found that sometimes although my antenna tuning circuit loaded the r.f. amplifier very nicely, very little r.f. energy was getting into the antenna. This trouble was due to incorrect length of the antenna proper and was cured as follows: Another wire, the length of which must be determined by the cut and try method, is connected to the opposite side of the antenna tuning circuit, as shown in Fig. 3. The length of this wire is adjusted until an equal amount of r.f. voltage, as judged by a neon bulb, is present at both ends of the antenna coil. Often if the antenna is not the right length exactly all the r.f. voltage tends to be at the end of the antenna coil opposite from the antenna.

"One very useful application of this arrangement is when a station has several different frequencies. In this case a number of single-pole switches can be inserted in the wire for adjusting the length to suit the frequency."

### Some Zepp Pointers

**I**T IS surprising how few amateurs are using the once popular Zepp antenna since the advent of crystal control. Many amateurs contend that this type of antenna will not couple tightly enough to draw sufficient power from their amplifiers and so

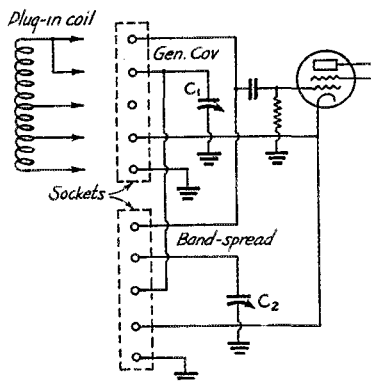

FIG. 4—WITH THIS CIRCUIT, EITHER GENERAL COVERAGE OR FULL SPREAD OF AN AMATEUR BAND CAN BE OBTAINED ON THE SAME COIL WITHOUT RESETTING A VARIABLE CONDENSER

*C1 is the tuning condenser (100 to 140  $\mu$ fd. maximum capacity). *C2, a screwdriver adjusted air padder, is the band-setting condenser which is adjusted only once. Band-spread or general coverage is obtained by shifting the coil from one socket to the other.**

they use single-wire matched impedance antennas which are difficult to get working properly. I believe the following dope will help these men to

build a Zepp which will outperform most "yardstick tuned" single-wire affairs.

To begin with, the multiple 1.56 times the wavelength in meters is a little short—so short, in fact, that an antenna so designed will fall too far above the crystal frequency to resonate properly.<sup>1</sup> The multiple used here is 1.59 and thus a 65-foot flat-top will tune to 7228 kc. and a 66.5-foot one to 7185. This is proven by tuning a self-excited oscillator to the antenna and measuring the frequency.

A Zepp is a one-frequency affair. No amount of juggling a feeder series condenser will affect the length of the flat-top. Therefore we can cut the feeders to half the length of the flat-top minus the number of feet of wire in the antenna coil. Thus an antenna 66 feet long with 3 feet of wire in the antenna coil will use feeders 31.5 feet long. This eliminates the series condensers.

Most manufactured feeder spreaders are too short. Sterling's Manual is my authority for using 1/200th wave spacing or 7 inches for the 40-meter band.<sup>2</sup> The simplest low-loss spacers may be

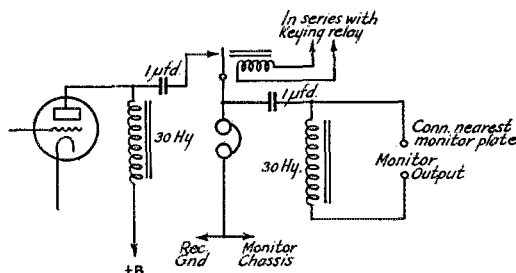

FIG. 5—CONTINUOUS MONITORING WITH PROVISION FOR ELIMINATING RECEIVER NOISE WHEN TRANSMITTING

This circuit is readily applied when the transmitter is keyed through a relay.

made by using a hard rubber dowel 8 inches long with hack-saw cuts in the ends and machine screws passed through to tighten them to the wires. The rods come in two-foot lengths and a pair of these will make six spacers, which is enough for quarter-wave feeders at 40 meters.

No. 14 wire is the easiest to work and will carry all the antenna power an amateur may legally use.

<sup>1</sup> In many cases the opposite has been found to be true, the factor 1.56 giving an antenna length slightly too great for the frequency. The length for a given frequency will vary somewhat with local conditions; if the antenna is to be adjusted exactly to frequency a little cut and try is called for.—Editor.

<sup>2</sup> The closer the wires the better the cancellation of the fields about them, hence the requirement that the spacing should be small compared to the wavelength. Since the capacity between wires increases as the spacing is reduced, closely-spaced feeders will show larger currents for a given amount of power, which tends to increase the ohmic losses slightly. Neither factor is of great importance in the ordinary amateur tuned feed line, however, customary practice being a fair compromise.—Editor.

Paraffin-impregnated wood is not recommended for spreaders because in my experience they leak in damp weather and throw the system out of tune.

To make the system even more low loss the antenna insulator is slipped along the flat-top to the proper spot and the wire twisted around the insulator and brought down as a feeder. This does away with a soldered connection and the antenna is one piece from skywire to antenna coil!

It is well to remember that a half-wave antenna radiates best broadside. This effect may be marked, and on a low-power rig here it meant the difference between working Africa, Hong Kong and Japan with a north and south antenna and merely Australia with the same antenna pointed east and west.

Many of these Zepps are in use around Los Angeles with consistently good results. Accuracy in measuring the wire and care to keep the antenna far enough from tin roofs to prevent absorption are the main considerations. Also it is poor practice to use a No. 10 flat-top and No. 16 feeders. No. 14 is cheap now and four bits or so is a good investment in the most important part of your station.

## Calibrated Band-Spread and General Coverage With the Same Coil

THE idea diagrammed in Fig. 4 is suggested by Thomas C. Moore, VE3AFT. The circuit shown is particularly adapted to a superhet oscillator when used with a separately-tuned first detector circuit, in which case the rather uncritical tuning of that circuit makes band-spread unnecessary. Two coil sockets are used, with the wiring arranged so that when the coil is plugged in the "general coverage" socket the tuning condenser,  $C_1$ , is connected across the whole coil. In the "band-spread" socket, the padder,  $C_2$ , is connected across the coil, while the tuning condenser is connected across a number of turns which will spread the particular band satisfactorily. In practice  $C_2$  is set to bring the band on  $C_1$  when the coil is in the band-spread socket; no further adjustments are necessary when going to general coverage. The advantage of this system is that both the band-spread and general coverage ranges can be calibrated, since the business of returning a band-setting condenser to a predetermined point to hit the band is eliminated, along with errors in setting.

The same idea can be applied to the regular regenerative detector circuit by making provision for antenna coupling. The antenna might be connected directly to the cathode tap, as was done in the *QST* two-tube receiver, or if six-prong forms are used the extra pin could be used for the antenna connection of a separate coupling coil, the other end of the coil being returned to the

(Continued on page 74)

# • I. A. R. U. NEWS •

Devoted to the interests and activities of the

## INTERNATIONAL AMATEUR RADIO UNION

Headquarters Society: THE AMERICAN RADIO RELAY LEAGUE, West Hartford, Conn.

### MEMBER SOCIETIES

American Radio Relay League  
Associazione Radiotecnica Italiana  
Canadian Section, A.R.R.L.  
Československi Amatéri Vysílací  
Deutscher Amateur Sende-und-Empfangs  
Dienst  
Experimenterende Danske Radioamatører  
Irish Radio Transmitters Society  
日本アマチュア無線聯盟  
Liga Colombiana de Radio Aficionados

Liga Mexicana de Radio Experimentadores  
Nederlandsche Vereniging voor Internationaal Radioamateurisme  
Nederlandsch-Indische Vereniging Voor Internationaal Radioamateurisme  
New Zealand Association of Radio Transmitters  
Norsk Radio Relæ Liga  
Oesterreichischer Versuchssenderverband  
Polski Związek Krotkofalowcow  
Radio Club Venezolano

Radio Society of Great Britain  
Rede dos Emissores Portugueses  
Reseau Belge  
Reseau des Emetteurs Français  
South African Radio Relay League  
Suomen Radioamatööriitto r.y.  
Sveriges Sandareamatörer  
Unión de Radioemisores Españoles  
Union Schweiz Kurzwellen Amateur  
Wireless Institute of Australia

Conducted by Byron Goodman

## The Amateur Regulations of the World: 1936

IT IS the privilege of this column to record each year the progress made by the various amateur radio societies throughout the world in obtaining satisfactory amateur radio legislation in their respective countries. The August, 1934, and the October, 1935, issues of *QST* carried previous stories; it is interesting to observe the advances that have been made. In general, except for power restrictions (which apparently do not prove a serious handicap) and the refusal to permit the handling of third party message traffic, the outlook is quite good.

Austria refuses the use of the 160-meter band, and use of 3500-3600 kc. is only by special permission. License fees are \$10 for a 10-watt power input limit license, \$20 for a 50-watt limit. Type A2 transmission may be used if special permission is obtained. The O.V.S.V. has 167 members; there are 37 licensed amateurs. (In this report, as well as those that follow, figures are as of the reporting date, early 1936.)

At the moment of writing, we have on hand unconfirmed rumors that conditions in Colombia are improving rapidly. Amateur radio as we know it is still not permitted, but through the persistent efforts of the L.C.R.A. and their secretary, Italo Amore, favorable recognition by the Ministry of War and the Ministry of Education has been obtained for the amateur. However, the Ministry of Correos y Telegrafos is not yet favorably inclined towards the granting of amateur privileges (official licensing), but there is every indication that the situation will be cleared up shortly.

In Denmark, spot frequencies of 1730, 1830, and 1970 kc. are allowed in the 160-meter band, 3500-3600 kc. in the 80-meter band, and all of the 7-, 14-, 28-, and 56-mc. bands except for buffer bands on each end of 10, 20, 30, and 100 kc. respectively. 3550-3600 kc. is set aside for beginners (8 w.p.m.), whereas the other bands are available to all regular amateurs (12 w.p.m.). A power limit of 100 watts is in force; third party traffic is not permitted. The E.D.R. has increased its membership to 350; the licensed amateurs number 220.

In Finland the 160-meter band is denied, but all other bands are open, with 'phone assignments in the 3.5-, 14-, and 28-mc. bands. Stations are shut down for six months if off-frequency operation results in interference with a commercial station. Third-party traffic is permitted. Power input is limited to 200 watts. The S.R.A.L. has 232 members; there are 180 licensed amateurs in the country.

In France all of the Madrid bands are available, for both 'phone and c.w., the only restriction being that type A2 transmission is not allowed. Power limits are determined by the license fee—up to 50 watts the fee is \$11, for 100 watts it is \$16.50. The R.E.F. has 1268 members; there are 834 licensed amateurs.

Radiotelephony is not open to the amateurs of Germany. They cannot use the 160- or 5-meter bands, and their 80-meter operation is confined to 3500-3600 kc. Power is limited to 50 watts, although upon request 100 watts may be used. Third-party traffic is prohibited. The D.A.S.D. has 4200 members; the licensed amateurs number 600.

In Great Britain the c.w. and telephony bands

are: 1720-1995, 3505-3730, 7005-7295, 14,005-14,395, 28,005-29,995 (television 30-32 mc.), and 56,005-59,995 kc. Stations are originally licensed for 10 watts; after a year the R.S.G.B. may recommend for an increased privilege of 50 watts. The R.S.G.B. totals over 2600 members—amateurs with full licenses total 1612, with artificial antenna licenses 967.

In Italy amateur radio is not tolerated, and even the distribution of QSL cards is officially forbidden. The A.R.I. has 121 members.

In the Netherlands the N.V.I.R. has 513 members; the number of licensed amateurs is 310.

New Zealand allows the amateurs there all of the Madrid bands, as well as a special 100 to 105-meter band for the Radio Emergency Corps, an N.Z.A.R.T. activity. Amateurs have increased to a total of 939, members of the N.Z.A.R.T. to 663. Power has been reduced to a 100-watt input limit from the previous 100-watt output limit. The government looks with favor upon amateur radio, especially the development of telegraphy.

The amateurs of Norway are not allowed the use of the 160-meter band except by special permission; their assignments are 3540-3960, 7050-7250, 14,060-14,340, 28,100-29,900, 56,150-59,850 kc., with all bands open to both 'phone and c.w. Type A2 transmission is prohibited, and the antenna power must not exceed 20 watts. Third-party traffic is prohibited. The N.R.R.L. now has 400 members; the number of licensed amateurs is 109.

In Sweden all of the Madrid bands are allowed and there is no power limit. The license fee is \$10. Third-party traffic is prohibited. The S.S.A. has 230 members, the licensed amateurs total 155.

Regulations in Switzerland remain unchanged; no 160-meter operation is permitted and the 80-meter band is restricted to 3500-3700 kc. with 3700-3800 kc. available for club stations and 60-400 open for experimental work. Power is limited to 50 watts.

In general, amateur radio is looked upon with favor by most governments, and although many of the other countries do not accord their amateurs all of the privileges enjoyed in the United States, the official recognition demonstrates the value of the work done by the respective amateur radio societies.

-----

#### Short Wave Broadcast Station:

Operators in the 7-mc. band will be pleased to hear that the British Guiana broadcast station, VP3MR, has been moved out of the amateur band into the 6-mc. band, through the efforts of the R.S.G.B. Complaints of other British Empire stations operating as broadcast stations in the amateur bands will be handled in a similar manner as soon as reported.

#### General:

We hope you have not been waiting hopefully for a card from ZD2A, ZD5A, ZB7AC, or whatever call he was using when you worked him, because the odds are that you won't get it, along with the new country you hoped it would be. Apparently some W amateur, with a very poor sense of humor, has been giving the local lads the run-around by signing these enticing calls. But he wasn't very clever; often he would sign "de W . . ." break, get a little flustered, and then sign one of those juicy calls. If we have him figured correctly, we don't think he's much of an amateur; if he is authentic, we apologize sincerely . . . . . J. Bond, HJ3AJH of 28-mc. fame, now signs HK3JB . . . . . Here's news for the tired DX man: Mr. A. Bles will be on shortly signing PK6DX in Dutch New Guinea, a country heretofore devoid of amateur stations. QSL care N.N.G.P.M., Babo . . . . . The cards for VP7AA have been returned to A.R.R.L., along with a note to the effect that 7AA is not licensed. But he was operating from the Bahamas, so it counts . . . . . Incidentally, licenses are obtained in the Bahamas by applying to the Superintendent of Telegraphs, Nassau N.P., Bahamas . . . . . W7AYO reports CR9AB, Macao, coming through around 7150 kc. . . . . The first WAC in the VK6 district was awarded to Mr. S. C. Austin, VK6SA. All continents but South America had been worked many times on 7 and 14 mc., but it took the 28-mc. contact with HJ3AJH to give him his WAC and the first VK6-South America contact on any band. His contact with ZS1H was the first Africa-VK on ten . . . . . Cards for VQ3FAR should be sent to: J. A. Farner, Tanganyika Central Gold Mines, Ltd., Senkenke via Kinyangira, Tanganyika. Many of his cards have gone astray by being addressed to VQ3BAL, who is QRT and now at Mdeya. Thank you, W1DLD . . . . . United States amateurs have no monopoly on emergency work—a note from ZS5AB encloses a clipping of an account of splendid work done by Durban amateurs ZU5P and ZT5J when their city was cut off by a storm damaging telephone lines . . . . . If you haven't received some of those DX cards you are waiting for, don't overlook the possibility that they are waiting for you at the office of your District QSL Manager (listed each month in *QST*). CP1AA, ZE1JN, and ZE1JS write to say that they QSL every W contact, but only via the QSL Bureaus . . . . . W2BSR adds some more on last month's tongue-twister: Baumanabad is the name of the town, "bad" being a suffix meaning "city" in the Tajik language. Sovhoz means "State Farm" . . . . . VU7FY and K4SA claim that their 'phone WAC's, made last September, were the first to be made *exclusively* on two-way 'phone, without first raising the station on c.w. Any dissension? . . . . . Has anyone

(Continued on page 58)



# OPERATING NEWS



Conducted by the Communications Department

F. E. Handy, Communications Manager

E. L. Battey, Asst. Communications Manager

THE F.C.C. states that in the twelve months March 1935 to February 1936 it handled 2842 complaints of BCL's about amateur interference. While only about a quarter of all amateur operation is radiotelephone operation according to frequency registration statistics, 62% of the complaints were traceable to amateur 'phone work, while telegraphy accounted for 38%.

The Commission has not stated how the c.w. telegraph BCL-QRM divides by bands, but the following are the data \* on the 62% traceable to radiotelephone work:

1800-2000 kcs.....	69.59%
3900-4000 kcs.....	16.23%
14,150-14,250 kcs.....	5.84%
28-29 mc.....	.70%
56-60 mc.....	7.37%
	100.00%

Nearly 2000 of the complaints, then, were traced to 160-meter radiotelephone operators, more cases of this type existing than brought against amateur telegraph operators in all bands put together. The complaints are numerous and vociferous. The F.C.C. people regard the situation as serious and requiring action, and also state their opinion that the type of amateur work that often goes forward leading to complaints against telephone operators is not any credit to amateur operators or amateur radio in many cases. If amateurs responsible do not speedily correct this situation, it is pretty certain that drastic steps will be taken by the F.C.C.

In the situation cited, 160-meter and 75-meter 'phone interference are greatest in volume. We know of cases in which at least three individual amateurs had little regard for their responsibilities in meeting the public in a friendly and genuinely helpful manner when interference was discovered. If such cases known to us are typical examples, it is little wonder that the Commission feels obliged to take the matter under study. Should anything untoward happen, 'phone men generally will have only the individual "don't care" attitude that some of the fraternity who have been in trouble have developed to thank. It is unfortunate that Official 'Phone Stations and others who have adopted OPS standards and

ethics must suffer the same stigma that some blasé, self-assured individuals bring on the whole brotherhood. However, if all amateurs are tolerant of abuses that exist in their midst and do not develop a general amateur pride or condemnatory attitude sufficiently effective in controlling those cases, then it must be expected that regulatory measures will be taken that will stop the interference and the complaints.

We suggest that all ham 'phone station operators get busy and check locally to see that no interference is occurring. If it is, then handle it so as to get the full good will of the public and cut off complaints to the F.C.C. Get your club vigilance committees functioning to collect and handle local complaints through the local press so the F.C.C. will not be needed. Naturally, if we disregard the experience and consideration for others that has proved good policy through the years we will suffer. The public's investment will always be protected by the Commission if a general situation is allowed to develop that proves special action in the public interest necessary.

When a test *does* show interference a ham should make friends with the complainant, write A.R.R.L. for its prepared interference circular, ask us for the long circular giving "reasons why" and the short one suitable for your BCL neighbor. We amateurs must do our own local trouble shooting and complaint soliciting . . . which prevents complaints by seeing that the source of complaint is removed or non-existent, and heads off incipient complaints so they never reach the F.C.C. Tell your ham friends to avoid any attitude of standing pat on rights (which often reacts to hurt the whole ham fraternity). The correct measures to retain the respect of the public go deeper than that. The recent public hearings of F.C.C. emphasize the point that every radio service, and every branch of every service must continuously justify the performance and uses made of radio.

— . . . —

A.R.R.L.'s Board requested F.C.C. to increase the code speed in operator license exams to 12½ w.p.m. The Federal Communications Commission actually raised it to 13 w.p.m., effective at once. Directors discussing the idea with ham groups before the Board meeting found many who wanted 15 w.p.m. There has been agitation a long

\* Includes 3.76% of "unknown" not definitely proved against particular frequency bands but distributed in the proper proportion to each band by the ratio of figures assigned to each band.

time for some such restriction and this was a modest step in that direction. Amateurs have felt that "lid QRM" was just too much to stand in our valued frequency bands. Constructive consistent work in training for emergency-work justification of amateur radio must not be handicapped. A.A.R.S. and N.C.R. operations in ham bands constitute one other strong reason why we get the backing of these services in holding our frequencies—and the newcomer who has no interest in organized amateur radio must at least be a *real* amateur who knows his code. The ham body as a whole is relieved and pleased to know the F.C.C. acted so promptly and effectively to "make better hams" of those joining the fraternity.

Both code speed and technical requirements have been raised before, as amateur radio has grown in public appeal so that hams have found their valuable frequencies cluttered up by those who have found ways to get in with no true qualification or operating technique. As emphasized in a contribution by Mr. Allen last month, not all individuals have "what it takes" to become real hams. Until they have proved themselves by exercising a little patience and persistent practice in "learning by listening" (or otherwise, since the beginner today is surrounded by reams of literature and a myriad of helps not available to old timers) the Commission does not intend to class them with "the qualified."

WIINF, station of A.R.R.L. Headquarters Operators Club, is raising the speed of its tape transmissions (from 13.2 and 22.5 w.p.m.) to alternate between 15 and 24 w.p.m. (for the mature ham who knows his stuff). The 15 words per minute speed is calculated, like the old 13.2 w.p.m. speed, to give maximum help to beginners in "learning by listening." Such a speed as 15 w.p.m. is chosen based on the idea of making a two words per minute allowance for the possible nervousness of the candidate when he takes Uncle Sam's test. In addition to the transmissions on 3825 and 3575 kcs. (8.30 and 10.30 p.m. EDST except Wed. and Sat.) WIINF expects to start simultaneous transmissions on the 7-mc. band on all these messages "to all radio amateurs" starting sometime in October.

—F. E. H.

## O.B.S.

The following is a supplement to the list of A.R.R.L. Official Broadcasting Stations in November *QST* (page 60): W1BVR, W1GAE, W6LFZ, W8MFV.

## Briefs

W3BXJ is located in the same city as W3XBJ, the Harrisburg, Pa., Police Radio.

The American Legion, Department of Ohio, is taking steps to organize an amateur radio network throughout Ohio

for the purpose of establishing a communications system which will be available to the Major Disaster Units of the Legion in Ohio when they function in time of emergency. Ohio amateurs interested in cooperating should communicate with Gerald G. Gifford, 58 S. Huron Ave., Columbus.

What is believed to be the first Hawaii-United States chess tournament by amateur radio in which there were more than two players involved was played July 19th between the Hollywood Chess Club and the Hawaiian Army Chess Club. Each club won one game. 7 mc. was used for the radio connections. K6EWQ (Johnny O'Conner and Sgt. Bunn Mills operating) on the Hawaiian end and W6GXM (W6CII and W6GXM operating) on the Hollywood end. A total of 134 messages were handled by each station. The games lasted six hours starting at 7:30 p.m. PST.

The Olympic trials for amateur oarsmen were held on the course of the Canadian Henley Association at St. Catherine's, Ontario, on June 17th. The progress of the races was transmitted on 56 mc. from a boat following the oarsmen to the grandstand, where the signals were transferred to a P.A. system. The races were greatly enlivened by this arrangement, since but a small part of the course is visible to spectators. VE3TW's equipment was used in this work.

## 56-mc. Net

The Interstate 56-mc. Net, organized by W2HUT, is reported to have a membership of sixty amateurs in three states. Most activity is in the New York City area. Control stations in the net are located about ten miles apart. Accurately timed schedules are maintained, messages handled, DX reports relayed in from other groups issued, DX tests arranged and good operating procedure encouraged. A relay chain is being formed from Connecticut to Pennsylvania. Any amateur interested in further details on the Interstate Net should communicate with Felix Nerod, W2HUT, 478 Dean St., Brooklyn, N. Y. Membership is free, the only essential being active cooperation.

Several trips on the briny deep as "Sparks"; a trip to Hollywood, where he played a part in "The King Steps Out," starring Miss Grace Moore; a month or so spent on the desert prospecting for gold; and now, the part of a Southern sheriff in a Broadway show—such is the record of Victor Killian, W2GPP, of Scotch Plains, N. J., for the past two years. Any ham want to challenge him as "Odd Job Champion"—W2GGY, P.A.M., N.N.J.

The Indianapolis (Ind.) Radio Club will sponsor an emergency transmitter and receiver contest at Brown County State Park, August 30th; prizes will be awarded the winners.

On June 10th at 11:00 p.m., W9VTP worked VE4ABI, Moose Jaw, Sask. Immediately afterwards he worked VE4ABH, Edmonton, Alberta. Making this a greater coincidence is the fact that VE4ABI's first QSO was with VE4ABH, and their rigs are identical, P.P. '45's!

Free classes in radio theory (both telegraphy and telephony) and code practice are held in Cleveland, Ohio, at the East 131st Branch Library, 3330 E. 131st St., Tuesdays and Thursdays from 6:00 to 9:00 p.m., and at N.C.S., 3529 E. 143rd St., Mondays, Wednesdays and Fridays from 7:00 to 10:00 p.m. These classes are open to everyone interested.

Speaking of low-power DX, when the S.S. *Senator* sank off Port Townsend, Wash., her SOS sent on a 16-volt spark coil was heard by NPL at San Diego, Calif.—W6HG.

Leland Ford, N6GXN, 3959 Marathon St., Los Angeles, Calif., would like to see a network similar to the Army Amateur Radio System organized among members of the Naval Communication Reserve to enable Reservists to keep their traffic in NCR channels. Members of the NCR really interested in forming such an organization, exchange views with N6GXN.

# A.R.R.L. Emergency Corps

Join Now!!

**M**EMBERSHIP in the A.R.R.L. Emergency Corps now totals 297. The A.E.C. is divided into two groups: (1) Emergency Powered Stations, (2) the Supporting Division. For membership in the first group it is necessary to possess equipment suitable for operation in an emergency when regular power and communication facilities are disrupted. Auxiliary power must be on hand or must be obtainable from a reliable source upon a few minutes' notice. Membership in the Supporting Division is open to all amateurs who will pledge themselves to assist in the event of failure of regular communication facilities as long as normal power is available; these members do not have to possess auxiliary power, although all members are urged to join the Emergency Powered group at the earliest opportunity.

To join the A.E.C. simply send a postal to the Communications Department, A.R.R.L. (or write for application blank), listing what equipment you have. Applicants for Emergency Powered membership should list carefully all emergency apparatus, especially the auxiliary power facilities.

Members of both groups are expected to make known their availability for emergency communication to local Red Cross officials, railroads, military units, police departments, representatives of press associations and the like. A membership card is furnished all members; this card provides a convenient introduction to the various officials when making known your availability. An Emergency Manual to be prepared later this season will contain definite suggestions and rules relative to emergency work; this will be furnished free to all A.E.C. members.

The goal of the A.R.R.L. Emergency Corps is "An amateur radio Emergency Station in every community." Every red-blooded ham should want to do his part! Send your application TO-DAY!!

## Members, A.E.C.

### EMERGENCY POWERED

W1ACV W1ANM W1APA W1APK W1APW W1ASI  
W1AWW W1BAP W1BCF W1BDI W1BFT W1BGA  
W1BNL W1BRL W1BVR W1CWX W1CJD W1DFT  
W1DUZ W1FE W1FL W1FYE W1GNE W1GOC W1GO  
W1GRU W1GTW W1GZL W1HE W1HJM W1IBY  
W1ICS W1IEI W1IGU W1IIP W1IIS W1IJB W1IOZ  
W1IVV W1JLK W1MC W1VF

W2ALP W2AQQ W2AQJ W2BGO W2BLU W2DBF  
W2DWW W2FBU W2FRG W2GTW W2GYY W2HOC  
W2HWS W2HZJ W2HZL W2IBT W2IEP W2INF W2IOP  
W2JDO W2JFC W2QY

W3AQN W3BWT W3CQS W3CXL W3DOR W3EDA  
W3EFM W3ETM W3EZN W3MA W3MG W3NF W3QV  
W3ZI

W4AKI W4AO W4AVQ W4BDG W4BIN W4BRN  
W4BUE W4BXL/BXM W4CJP W4CNA W4COB  
W4COW W4CXY W4DGS W4DPA W4DSW W4DVJ  
W4DVL W4KU W4LN W4SC

W5BHO W5BKJ W5BUK W5BZR W5CMQ W5COK  
W5CPT W5CVW W5DLZ W5DPX W5DWN W5EDD  
W5EHF W5EHK W5EQO W5FGU W5KC W5SP

W6ALK W6AM W6AZP W6BCF W6BPU W6DKZ  
W6FMI W6GAS W6GTM W6IHK W6LYN W6KUS  
W6KVQ W6LIQ W6LLW W6MAG W6MVE W6MYK  
W6QC W6RJ W6TI W6ZB

W7AAN W7AF W7AIF W7APN W7AW W7ASX  
W7BDD W7BEE W7BWH W7BXQ W7COU W7EEI  
W7ENQ W7EY/6 W7REZ W7WY

W8BHE W8BHK W8BHN W8BSU W8DGZ W8DIG  
W8DPY W8ENS W8EYZ W8FAK W8FBC W8GMZ  
W8GWY W8GZC W8HAM W8HEG W8HHO W8ICD  
W8IRY W8JC W8JWL W8KIM W8KNF W8KSY  
W8KUK W8LAJ W8LLH W8MHE W8MJJ W8MYG  
W8MYW W8NAW W8NCX W8OFO W8OLM W8OXI  
W8PPD

W9AB W9ABB W9ALO W9BN W9BRA W9BSF  
W9BWX W9BYV W9CDE W9CJC W9CRU W9CSJ  
W9DBO W9DEQ W9DHS W9DNX W9EFP W9EHC  
W9EHW W9EJM W9GQN W9HUO W9IGF W9IGZ  
W9IU W9JAR W9JAW W9JHP W9JQM W9KHC  
W9MYV W9NIU W9NQJ W9OVU W9PGV W9PKB  
W9PKC W9PJT W9POB W9PRM W9PWU W9RIL/TMB  
W9RQX W9SC W9SSC W9TGU W9TXQ W9TYF  
W9TZD W9UDU W9UFD W9UON W9UPW W9URX  
W9UVH W9VES W9VVJ W9WEC

VE1CE VE2HE VE3GG VE4KJ VE4WG XE1C  
Holyoke (Mass.) Amateur Radio Club, W1JJO; Lake Worth (Fla.) Radio Club, W4AWO; Winston-Salem (N. C.) Amateur Radio Club, W4NC; Manteca (Calif.) Radio Club; Stanford University Radio Club (Calif.), W6YX; Missoula (Mont.) Radio Operators Club; Marietta (Ohio) Amateur Radio Society, W8KYC; Boys Club of St. Marys (Pa.), W8INE; Carnegie Tech Amateur Transmitters Club, W8NKI; Pennsylvania State College, W8YA; Ira Lou Spring Post, No. 149 (American Legion), Emergency Unit, W8GPS (Jamestown, N. Y.); Pike's Peak Amateur Radio Association (Colorado Springs, Colo.), W9OKY; D.T.R.I. Radio Club, W9SAL.

### SUPPORTING DIVISION

W1AFG W1ASD W1BHM W1CCM W1CPG W1FPS  
W1GTX W1HOP W1HRE W1HYF W1IOM W1IST

W2IYH W3AKB W3CIZ W5CRG W6CV W6KOI,  
W6MUR.

W8HD W8ITS W8JM W8OIG W9EQX W9GFS/JXB  
W9HAX W9LG VE1EX.



KMUP RADIO SHACK

Schooner Wander Bird (see page 48, Aug. QST) is contacting amateurs while on a 20,000-mile cruise.

## OBSERVERS' HONOR ROLL

### Cairo Commercial Occupancy Survey For July 1936

6000-8000 kcs.		
ON4JB	W9TAY	W3BGD W4ACC
W. R. Faries	ON4HM	W3FCQ W9DQD
W9CHH	W8APQ	ON4SS W9SJK
W8NQ	W2CSH	W9NGG P. R. Randolph
W2HAY		
4000-4500 kcs.		
W9WKO	W8NQ	W3BGD

## Correct Speaking

By Wilfred A. Thompson,\* W3AQV

The article by Mr. Wilfred A. Thompson, W3AQV, wins C.D. article contest prize this month. Each month we print the most interesting and valuable article received marked "for the C.D. contest." Contributions may be on any phase of amateur operating or communication activity (DX, 'phone, traffic, rag-chewing, clubs, fraternalism, etc.) which adds constructively to amateur organization work. Prize winners may select a 1936 *Handbook*, six logs, six message files, six pads blanks, or equivalent credit toward other A.R.R.L. supplies. Send your contribution today! —F. E. H.

**T**HERE is a very important phase of 'phone operation a large percentage of our operators on the radiophone frequencies neglect—that of speaking correctly and proper behavior in operating.

With thousands of BCL's using all-wave receivers and listening to our amateur 'phone conversations, we amateurs may thoughtlessly, by constant use of slang and silly chatter, get labelled by these listeners as a very ignorant bunch of fellows. And for all we know, if some of the perfectly senseless and idiotic conversations on our 'phone bands today are not curtailed, the F.C.C. may take the matter into consideration and do something about it.

On the other hand, if every 'phone operator would practice carefully correct speaking with each QSO it would not only clear up the situation but the value to the operators outside their 'phone contacts would be inestimable. Correct speaking to the 'phone man is of the same value as a good fist to the c.w. operator.

The 'phone bands could be made into a veritable school of good speech. With a little care and patience the 'phone operators can accomplish wonders along this line. After you answer a CQ and contact is established with another 'phone and he is one of those fellows who gives no thought to the construction of his sentences, uses slang and mispronounces half his words, what will he think when you go back to him, speaking correctly with well enunciated words and with the absolute absence of silly slang? He will, to be sure, take notice of that transmission of yours and when he again comes back to you his conversation will be quite improved. Try it sometime.

Besides using good English, certain meaningless phrases and needless abbreviations should be stopped. The use of telegraph operating procedure such as saying "K" at the end of a transmission is poor taste for a 'phone man. "Go Ahead" is much better.

I think it quite advisable and proper to disregard some (not all, however) of the "Q" signals in 'phone operation, giving in their stead the exact meaning in words in a simple and concise form. For example, say, "My address," for "My QRA"; "change frequency" for "QSY"; and instead of saying, "QRX a minute, OM," say, "Stand by." There are a few more of these signals which only have their usefulness in telegraph work.

That "hi diddle de dit" silliness, heard so much on all bands, has no place whatever in amateur 'phone. If you say something which may be of a humorous nature, let the fellow you are talking to do the laughing. As mentioned above, "Go Ahead" is proper when standing by—never those inane and out moded phrases, "doe de doe" and "diddle de bump de bump."

In giving a fellow his signal report it would be much better, and just as easy, to say something like this—"Your readability is four. Your signal strength is seven," instead of the old worn-out "QSA" and "R" reports.

By being constantly alert, old habits of speech, now considered detrimental to radiophone operation, may be corrected and new methods used in their place. All that is necessary to clean up these bad practices is for a few to start speaking correctly, and the others will follow.

Now a word or two about those drinking parties we often

\* 810 Maplewood Lane, Cumberland, Md.

hear coming from a ham station. They are pretty disgusting, to say the least, even to the fellow who likes to break loose on a "tear" himself, occasionally. And I have heard some of the boys say this sort of thing should be as much a violation as off-frequency operation. I am inclined to believe just that. Think what the thousands of SWL's, themselves not used to such things, would say of amateur radio after listening to one of those practically nightly affairs.

Surely our hobby of amateur radio with all it has stood for and accomplished the past few years is worth more to us all than to be labelled a group of silly and unmannerly fellows!

Think it over! Let us use correct speech always over the microphone and confine drunken brawls to the barrooms and nightclubs, thereby keeping our hobby on the high intellectual level to which it belongs.

## DX Notes

**S**M7UC advises via W1IEK that he is working towards W.A.S. He has so far worked 32 states, lacking only Rhode Island in eastern U.S.A. Watch for him after 2200 GT on about 14,338 kc. . . . G2WQ is also plugging for W.A.S. and has worked 39 states. He is looking particularly for Nevada, Arizona, Kansas, Wyoming and New Mexico, and sends word via W9TSV for the gang to look for him on about 14,100 kc. . . . W9TSV reports a new one heard—HZ2A on about 14,300 kc., r.a.c. . . . W2DTB Worked All Continents in one hour and fourteen minutes on June 30th—OA4J, YK3JK, ZL4AO, FB8AB, G2XD, W2CVJ, J2JJ. OA4J was raised at 1200 GT, and by 1250 all had been worked but Asia, which came through a bit later. . . . A freak condition was encountered by W3AYS recently when he heard PK6AK, S5, T9X, on 14 mc., at 12:00 noon, also K6BUX heard at about the same time. . . . ZP2AC, Paraguay, is heard by W3AYS on about 14,340 kc., T9. . . . J's are coming through on 14 mc. between about 7:00 and 9:00 a.m. CST. . . . W8OQV, Shaker Hgts, Ohio, reports ZS1AL worked, about 14,100 kc. . . .

Louis P. Urban of Dayton, Ohio, sends some information on amateur activities in Lithuania: "The Ministry of Posts has issued licenses to 13 hams. Of this number only 9 are active: LY1X, 1J, 1AC, 1AG, 1S, 1MB, 1AF, 1AD, 1AA. The oldest ham is LY1X, who began operating in 1922. The most powerful transmitter is used by LY1J, having an output of 90-100 watts on c.w. Each transmitter is crystal-control. All transmitting gear is purchased either in Germany or the U. S. An RK-28, for example, costs \$30 (American)."

W6CUH sends the following news under date of July 26th: "Conditions have been excellent all month and ran exactly according to the DX cycle. The diamonds at the new QTH are proving remarkable; worked Europe 175 times during the month, reports averaging 87 1/2. Dozens of new European stations are coming through. New ones (rarer) worked are YU7AU T8 14400, IITKM T9 14375, SP1JB T6 14320, SP1FP T8 14440, HAF7H T9 14360, YM4AA T7 14430, J9CA (Formosa) T7 14300 about 1430 GT, and heard were HS1PJ T9 14200 at 1500 GT, ZB1H T9 14370. Had 50th QSO with G2PL. The other night we tried a QRP test; ZPL was S5 at 1 1/2 watts input; he then got a worn-out B battery and was S3 with 22 1/2 volts at 10 ma. Worked FA8BG for 114th country and LA3H for 115th. DX in the mornings is good but thin. The J's are on with J8CF a new one in Korea. VS1AJ is S9 and has P.P. RK-20's, so should get over to the East Coast still better. VS2AG is also on with a powerful signal, 14290, T9. PK6AJ is r.a.c. near 14400 around 1500 GT."

## Briefs

W8BQ writes, "Pse announce in QST that I will be more than pleased to supply patrons for the keys of these bug artists, who insist upon aping Army and CCC ops with 90 w.p.m. dots on 20 w.p.m. xmissions."

W6JYA, Reno, Nev., is on 7200 and 7085 kcs. looking for W.A.S. contacts every night from 9:00 to 11:00 PST and Saturdays and Sundays until 2:00 or 3:00 a.m. PST.



## W.A.S.—New Members

There are now 161 members in the Worked All States Club. The following new members have qualified for the certificate award: F. M. Whitaker, W4OC; J. Wesley Davis, W4DS; Wilbur E. Gustafson, W5DBR; Harvey O. Platt, W6DWV; W. Lee Williams, Jr., W8PAJ; Bernard F. Piper, W9CRM; Herbert S. Brier, W9EGQ; Homer Biedebach, W6GFE; W. A. Kelso, VE1AE; D. Reginald Tibbetts, W6ITE; Lewis H. Cook, W9FWW; H. L. Cavens, W4DW; Richard E. Becker, W5FBQ; A. C. B. Havens, W8ISK; F. E. Pratt, W7DXZ; Wm. W. Brantley, W3EZN; L. M. Sparks, W4DRE; Clayton L. Wise, W8IOH; Robert S. Grant, W8LDA; Evelyn S. Sanford, W4DAI; Stanley Comach, VE2EE; A. C. Kronos, W9UIT; Clyde D. Larimore, W9BBS; Wm. G. Wilson, OA4J; W. A. Morain, W1FUY; Carl W. Luhn, W8BTI; Bruce Lathrop, W6ABB; Katsushi Nose, K6CGK; Charles W. Nicholson, W1BAU; Reno W. Goetsch, W9RQM; Ray N. Flood, W1FPS; C. M. Goo On, W3EVT; Michael A. Bakos, W8LY (SAKO); F. Norman Davis, W1GKJ; Lorentz Arnold Morrow, W9VKF; Theodore Parker, W5FNX.

OA4J is the first amateur outside the United States and Canada to qualify for W.A.S. K6CGK is the second.

Forty-eight cards or other confirmations submitted to the A.R.R.L. Communications Dept. as proof of contacts with the forty-eight United States will make you eligible for the W.A.S. certificate. Sufficient postage must be sent with the confirmations to finance their return. Contacts may be made on any of the amateur bands and at any number of different addresses, provided no two addresses are more than twenty-five miles apart. A special rule permits either a confirmation from the District of Columbia or one from Maryland itself to count for the state of Maryland. Send your confirmations as soon as you can qualify!

## Briefs

One of the first messages of congratulations to the Republican presidential nominee, Governor Landon of Kansas, was an amateur radiogram sent by W8KRS, Pontiac, Mich. W8KRS sent the message to W9MUU, Topeka, Kans., who made delivery by telephone; this was about five minutes after the BCL chains had concluded the nomination broadcast.

Celebrating the annual visit of Bill Nightingale, G5NI, to the United States, members of the Garden City (L. I.) Radio Club dined the well-known British amateur and his traveling companion, Ernest H. Derricott, on June 9th at the Roosevelt Field Hotel, Mineola, L. I. Following dinner, W2TT demonstrated a new aircraft transmitter and receiver. Later, the group went to the shack of W2CLA. Those who attended the dinner included G5NI, W2CLA, W2SB, W2GP, W2PF, W2BRI, W2BN, W2DKJ, W2GYL, W2IER, W2FV, W2TT, W2GC, W2FPB, W2WD, W2GDU, A. F. Williams, ex-W2CVG, E. H. Derricott and R. A. Piel.

## College Net

W1GTW/GTX and W3GFM are interested in forming a network of college amateur radio stations. They would like to get one active station from each college and university in the northeast, and perhaps arrange for spot frequency operation. W1GTW is a student at Wesleyan University, Middletown, Conn., W3GFM attends the University of Virginia. College station operators interested in the organization of such a network should communicate with W1GTW, Everett B. Gladding, Box 77, Wesleyan Station, Middletown, Conn.

Murray Miller, secretary of the Stuyvesant High School Radio Club, believes his to be one of the oldest clubs in the country. The "Stuyvesant Radio Club" was founded in the school (Brooklyn, N. Y.) in 1910 by Mr. Raymond B. Brownlee, author of the "First Principles of Physics" series. Passing through all the stages of radio, the club today has a

## BRASS POUNDERS' LEAGUE

(June 16th—July 15th)

Call	Orig.	Del.	Rel.	Total
W6KFC	17	19	793	829
W2BCX*	8	15	698	721
W9AZR	64	108	412	584
W6MTX	150	15	350	515
W8ZCC-BDI	495	9	9	513
K6FKB	310	173	19	502

### MORE-THAN-ONE-OPERATOR STATIONS

Call	Orig.	Del.	Rel.	Total
W5OW	141	234	389	1264
KAIHR	480	259	182	921

These stations "make" the B.P.L. with totals of 500 or over. Many "rate" extra credit for one hundred or more deliveries. The following one-operator stations make the B.P.L. for delivering 100 or more messages; the number of deliveries is as follows: Deliveries count!

VE5IC, 231 VE5OK, 174 W6HML, 149 W1EOB, 13 W6LKE, 125

### A.A.R.S. STATIONS

Call	Orig.	Del.	Rel.	Total
WLMH (W6GXM)	56	182	945	1180
WLMH (W6HIG)	5	6	907	918
WLNH (W2BCX)*	21	85	581	688
WLVH (W6BMC)	6	4	490	507

### MORE-THAN-ONE-OPERATOR STATIONS

Call	Orig.	Del.	Rel.	Total
WLM (W3CXL)	76	76	1201	1353

A total of 500 or more, or just 100 or more deliveries will put you in line for a place in the B.P.L.

\* May-June.

100-watt crystal-controlled transmitter operating under the call W2CLE. How many clubs can top this Association's age?

Rag-chewers should be on the watch for W8NFO and W3ERD, who were in QSO for 3½ hours steady on the night of April 7th.

W2IUQ and W2EQS/W3DPY urge more telegraphing amateurs to use the 1.75-mc. band. They point out that QRM is as rare on that band as it is plentiful on the higher frequency assignments. They also remind the gang that DX has been worked on "160 meters" with apparent ease during winter months. All W & VE districts are reported heard, and they feel sure 1.75 mc. holds big things in store, if C.W. men will but show more occupancy. "C'mup and see us on 160," say these chaps—and why not? With cooler weather in the offing and the let-up of static, "160" should prove plenty inviting. Give it a whirl!

More than 3000 messages were handled for delegates attending the American Physical Educational Association Convention by members of the Greater St. Louis Amateur Radio Club from the hobby exhibit of the convention.

Phantom signals are rare in amateur radio, but W9SHP, W9KXD, W9KXE and Howard Singer thought they heard one at the shack of W9HQH. While listening in the broadcast band (in the process of lining up a receiver) they heard one of the most clean-cut CQ's ever keyed . . . and, believe it or not, it signed a call also. This went on for some time and was found to be over the whole band. Suddenly, however, the keying stopped and then started up again, going about 100 per like a tape transmitter. All this time W9HQH's transmitter filaments were turned on, but no more. It was finally decided to turn the filaments off while the search continued for the mystery signal, which was now sending words occasionally! Off went the transmitter and off went the phantom also. The transmitter on again, back came the signal. Close inspection disclosed a loose cathode connection in the 83 tube in the keying unit; replacement of this killed the ghost signal! It was just "one of those things" that make amateur radio interesting. Hi! W9HQH is now trying to reconstruct the "Frankenstein" to provide himself with a second operator.

### A.R.R.L. Headquarters Operators

Hal Bubb, "Hal," Chief Opr. WIINF/WIMK

The following calls and personal sines belong to members of the A.R.R.L. Headquarters gang:

W1AL, J. J. Lamb, "jim"  
W1BAW, R. B. Beaudin, "rb"  
W1BDI, F. E. Handy, "fh"  
W1CBD, C. B. DeSoto, "dc"  
W1DF, George Grammer, "gg"  
W1EH, K. B. Warner, "ken"  
W1ES, A. A. Hebert, "ah"  
W1GS, F. C. Beekley, "beek"  
WIINF, A.R.R.L. Headquarters Operators Club  
W1JEQ, Vernon Chambers, "ve"  
W1JFN, A. L. Budlong, "bud"  
W1JPE, Byron Goodman, "by"  
W1JTD, Hal Bubb, "hal"  
W1MK, Official Headquarters Station  
W1SZ, C. C. Rodimon, "rod"  
W1TS, Don Mix, "don"  
W1UE, E. L. Battey, "ev"

The Amateur Radio Research Club of Seattle, Wash., was sponsor of a very successful picnic, radio treasure hunt and dance at Shady Beach, Lake Washington, on June 21st. Over 200 of the ham fraternity were present. Much good publicity was obtained for amateur radio; Wide World photographer took numerous pictures of the activities; KOL dramatized a ham radio skit over its "Seattle Streets" program; KOMO gave full mention in its news broadcast; broadcast chains gave several lines on a west coast hook-up. Among the prominent amateurs present were W7BG BB TS EJD MB CR BRS EOP TD DYH DZ and LD. Six local concerns donated over \$100 worth of radio gear for prizes. 56-mc. rigs were much in evidence and some fine experiments were conducted.

The hams of Calgary, Alberta, staged their Annual Hamfest on July 4th and 5th. The 'fest opened on the morning of the Fourth with registration of the visitors at the York Hotel. Among those present were W7FL, W7CCR and W7ABT from Montana, and VE4EA, VE4HM and VE4BW from Edmonton, as well as others from the surrounding district. At an afternoon technical session Mr. Rhodes of the Alberta Technical Institute gave an illustrated lecture on the various causes of radio interference. In the evening a banquet was staged at the Renfrew Club; about one hundred were present. A surprise was sprung on the gathering when the chairman announced that since coming to Calgary W7FL had taken unto himself a bride. The bride was thereupon presented with a bouquet of flowers by VE4SW and the bridegroom with a baby buggy by VE4HQ. Messrs. Frei and Gluesing of the General Electric House of Magic entertained with interesting demonstrations of what can be done with light and sound. On the morning of the 5th the hams were guests of the Alberta Government at the Automatic 'Phone Exchange where an explanation was given of the working of the automatic telephones as well as the Government Radio Carrier System. The doors of radio station CFAC were also opened to the hamfesters. The afternoon was spent in visiting ham stations. The day ended with a Picnicwimbomfireweineroast, after which the expression of all was "The end of a perfect day."

### Amateurs Ready for Emergency

On July 27th an atmospheric disturbance was reported off the Louisiana coast and forecast to hit that coast that afternoon. About 2:30 p.m., when the wind had picked up to about 25 miles per hour, W5CQF and W5DAQ went on the air to stand by as there were rumors of death and injuries on Grand Island; this island was torn asunder about 1865 or 1870 and about 1000 lives lost. The Coast Guard sent two cutters to the scene and at 3:30 p.m. their reports were

picked up on 2700 kc. that all was OK and no damage or injuries. The wind never exceeded more than 38 m.p.h. The point is, however, that amateurs were ready and on the air had they been needed. Information was furnished to one man that his brother on Grand Island was safe. W5CQF, W5MH, W5LT and W5DAQ were on both 'phone and c.w. (3.5 mc.) and prepared had the storm developed into something serious.

In late July a hurricane hit east of Pensacola, Fla. Starting when the blow first came into the Gulf from the south coast of Florida, W5DAQ sent warnings on 7- and 3.5-mc. c.w. The Gulf Coast Storm Net, with W5BTK as control and W5DAQ, W5BUZ and W5BUK as members, passed along dope on the progress of the hurricane and stood by for any calls which might come through.

W4DVL, a member of the A.E.C., was on the job at Tampa, Fla., giving out weather reports and advising people from Bow Grand up to Cedar Keys and Apalicola as to the course of the storm.

### Get-Togethers Held

Sixty-two amateurs registered at the Abilene (Texas) hamfest on April 25th-26th. Prizes were plentiful with nearly every visiting ham "taking home the bacon." A mid-night lunch was served on the 25th as well as breakfast and a big dinner on the 26th. The West Texas Fair Assn. donated its Textile building for the hamfest; many of the lads brought coats and blankets along and got in a little "shut-eye"; most of the boys, hamfest-fashion, stayed up all night. W5SP had his FB portable rig along and worked 'phone on 1.75, 3.9 and 14 mcs. Contacts were made in the 4th, 5th, 6th and 7th districts as well as in Canada.

The Sixth Annual Dinner of the Connecticut Brass-pounders' Assn. was held at Stamford, Conn., on the evening of May 16th. Over two hundred hams and their ladies were in attendance. A very attractive 56-mc. station was the main attraction (until the turkey dinner appeared on the scene!). Fine contacts were made and portable/mobile hams were in constant touch with the station while en route to the rendezvous. Some air-minded chaps (Walter Rosenbush and Ralph Bray) contacted the hamfest en route from Bridgeport from a height of some 2000 feet. Among the guests of note were George W. Bailey, W1KH, newly elected A.R.R.L. vice-president; A. A. Hebert, W1ES, and F. E. Handy, W1BDI, from A.R.R.L. HQ's; Harold I. June and Captain Verleger of Byrd Expedition fame; and "Dr. Peterson from Norway," who later unmasked and revealed himself to be none other than Frank Hawks, W1LJ, world-famous speed flyer. An accordionist and an expert baton swinger entertained during dinner. Don Meserve, W1FL, first president of C.B.A., acting as toastmaster, introduced Dick Pickard of N.B.C., the main speaker of the evening. Mr. Pickard showed films of Dr. Stevens' first stratosphere flight and gave an interesting account of the events that took place, including the explosion of the bag. Some forty-odd door prizes were donated. The Connecticut Brass-pounders' Assn. holds weekly meetings at its club house at Noroton Heights, Conn., where a 150-watt c.w. rig is in operation on 3.5 mc. A new rig is nearing completion for 14-, 7- and 3.5-mc. c.w. and 14-mc. 'phone. C.B.A. is fortunate in having the call W1CBA.

The Merrimack Valley Amateur Radio Club held an outing on June 20th at the summer home of W1JDK at Wheeler Dam in North Salem, Mass. A fine program was arranged by the committee, consisting of W1JNU, W1IZE, W1IWR, W1BQR, W1ILD, W1IQH and Carter Hart. The feature event was a horseshoe-pitching contest, won by W1JDK and Richard Paul. Other contests included treasure hunt, wire guessing, bean guessing, gurglers' contest and rag-chewing. There was plenty to eat and prizes for the various events. A satisfied group of hams left for home—until the next time.

### Station Activities

(Continued on page 72)

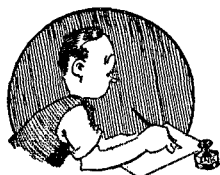

# CORRESPONDENCE

The Publishers of QST assume no responsibility for statements made herein by correspondents

## The June 15th Hearings

Munsey Bldg., Washington, D. C.

Editor, QST:

There was held before the entire Federal Communications Commission between June 15th and 26th one of the most important engineering hearings yet held before that administrative body. In short, the purpose was to obtain information concerning the problems involved in the allocation of frequencies to the various classes of services, particularly relative to the frequencies above 30 megacycles. It was my pleasure to be in attendance at the entire hearing.

Various services were asked by the Engineering Department of the Commission to present all the information they had acquired in their experiments. The various services were also requested to make certain recommendations as to the frequencies they would require for their work in the future.

The A.R.R.L. was asked to participate in this hearing on behalf of the amateurs. Messrs. Warner, Handy and Hull, under the able supervision of the League's counsel, Mr. Segal, were present and testified on our behalf.

Being rather well acquainted with the radio picture through my law practice before the Federal Communications Commission, I believe that I am fairly well qualified to judge the value of the various testimony given at the hearing. Of all the services that participated, without the slightest doubt the amateurs had the best prepared case, and the engineering information presented was the most comprehensive. Not only was there more of it, but it showed the greatest amount of research and preparation, and it will prove, I wager, without question, to be valuable to the Commission in its work.

I was indeed thrilled beyond words as I listened to the testimony of Warner, Handy and Hull as they pointed out what we had done and what paramount position in the radio sun we hams occupy and what our needs for additional frequencies are. It made me exceedingly proud of the fact that I am an amateur. I think that we should be proud, too, of the men who represented us at this hearing and presented our case. They did a most excellent job; no one could have done better. I, for one, give them a most hearty vote of praise and thanks.

I wish that more of the hams could have heard our case presented. I was very pleased to hear,

and I understand it to be true, that the amateur's case may be printed up in a book form for sale to the amateurs at a small cost. I have no idea when it will be out, but, having heard the case when it was presented, I am looking forward to the possibility of being able to secure it in permanent form.

Again I say, I am proud that I am a "Ham."

—Fred W. Albertson, W3FMC—ex-W8DOE

EDITOR'S NOTE.—The amateur presentation was made up into "books" illustrated with water-colored charts, and presented to members of the F.C.C. staff and representatives of government services. Copies have also been sent to the active affiliated clubs and the S.C.M.'s. A limited number of copies remain on hand and are available to members, as long as they last, at the nominal price of 50 cents (less than cost), on the basis of "first come first served."

## Proposals

11846 Longview, Detroit, Mich.

Editor, QST:

Most of us have heard the story of "Acres of Diamonds" and such phrases as "Fields afar look greenest" which are meant to convey the truth that the advantages and wealth one has are seldom exploited to their fullest degree. And so it might be said of amateur radio. There is surely a restlessness among the fraternity because of the congestion and interference. We want more frequencies in which to expand. And a listen on the bands is quite a convincing argument that we need more frequencies. Unfortunately there are numerous other interests who also have the same idea. And still more unfortunately, there aren't enough frequencies to allot to all. . . .

Not the least of our difficulties is the problem of interference to broadcast receivers. It is probably generally agreed that most of this is caused by the amateurs who operate a 'phone on the 160-meter band. The 160-meter band has been a popular one, especially with the new ham. But, unfortunately, the new ham who sets up some apparatus is rarely equipped by training, knowledge or experience to put out a wholly proper signal—even though he has passed his examination and received his ticket. I have been through it myself and know whereof I speak.

Amateur radio is a grand hobby—basically full of good fellowship, adventure, knowledge, and the capacity for progress in an art which is only just

beginning. We need amateur radio—and so does the whole world for the actual good it does. As a device of mutual interest it holds an appeal for the extension of fellowship and good will among the people of the earth. Under proper control it should spread. And yet before it can do this it first must be strong and healthy in internal structure. There should be a minimum of strife and diversion of interests.

To my mind there are at present a few sore spots in amateur radio, as it applies to us in the U. S. particularly, which should be looked into by Old Doctor Common Sense and sterilized with a sizeable application of understanding.

Let me summarize the points I am driving at:

1. Congestion on the bands.
2. Interference between stations from signals too broad for optimum results.
3. Interference caused by close proximity of the most popular, unrestricted 'phone band to the broadcast band.
4. Need for expansion of the present Class A 'phone bands.
5. The antagonism of the c.w. operators toward biting out more of their present assignments to benefit the 'phone operators and thus cause more congestion for the c.w. operators.

These are probably not all the things which we could wish to have corrected, but it perhaps covers the most annoying problems. We have them here set up. Can we do anything about them? I think we can—and without much of a fuss. Of course I should be an egotist and a fool to think that any proposal on a problem such as this could meet with universal approval. And so I shall accept any criticism and denunciation which may obtain—as part of my desire to help the ultimate progress and the general good of amateur radio.

I propose that all present frequency allocations for 'phone operation in the 160-meter band be restricted to Class A privileged operators.

The present use of this band by inexperienced operators tends to mar the standing of amateur radio by the poor quality and overmodulated signals from too many stations. The close proximity of the 160-meter band to the broadcast band makes overmodulated signals easy to cause b.c.l. interference. The more experienced Class A operators probably can put out a proper signal by reason of their experience and knowledge. A 200-kilocycle addition would be provided for 'phone operation for the operators who are so crowded together in the 75- and 20-meter bands at present. The 160-meter band is a good one and suitable for local and DX operation up to 1000 miles and would be used by the Class A operator if he did not have to contend with the QRM from new operators.

The 5- and 10-meter bands should be left unchanged and provide the field for new 'phone stations to operate in, and experiment, test, talk, ham and enjoy (with improving signals of course) as is now done on the 160-meter band. This will tend to more quickly develop the available frequencies in the ultra-high section of the spectrum. It will provide the room for expansion due to the increase in the number of Class A operators, by relinquishing the 160-meter 'phone band to them.

The 10-meter band has 1000 kilocycles for 'phone operation and another 1000 kilocycles for c.w. operation which should be used lest other interests think we don't want them and try to get these frequencies from us. The 5-meter band has been developed faster than the 10-meter band. . . . Just think of the room on ten—the DX which many of the more pioneering amateurs have hung up should be a strong incentive for the faster development of the band. It only needs a greater number of men down there to work the band to be sure of more frequent contacts. The information and gear available for 10-meter operation is within reach of everybody—so let's get going.

—Robert C. Lydon, W8KSY

## Antenna Couplers and Harmonics

Hazleton, Kans.

Editor, QST:

In my opinion it would be worth while to use a small portion of the Correspondence section of QST to warn amateurs against the use of various impedance matching net-

works in the antenna system. From my own experience and what other hams say, these systems are very bad for harmonic radiation. This of course gets you in bad with the F.C.C., and first thing you know you receive a green ticket in the mail stating that you are radiating a strong or fairly strong harmonic at such and such a frequency, and maybe you will have to observe quiet hours as in my case. Never use anything but a good old pick-up coil.

—Everett M. Norman, W9VZL

## Et Cetera

Lenoir City, Tenn.

Editor, QST:

I have not been in this game very long—that is, the ham part—but I've been splashing along on the theory of wireless as a hobby for about eighteen "long" years, which shows I'm not such a young squirt after all. I've been reading QST and various and sundry magazines for so long my library smells like a wireless institute, probably stronger than some of the mail order ones. I read what is in QST from lid to lid, even including the fine print in the ads, and what hams have to say in other mags as well, and striking a cross section on the "hull bunch" of us I'm inclined to believe we are a very good bunch of Democrats after all. We're not all alike; no, party "hominy" is bad, ideas are widely divergent in places, and we have our family fights just like the well-regulated ones do. But just let some outsider try to butt in on one of our private scraps and see how soon he gets h&\*@! We'll all fly in and chew his ears in short order. . . .

Are there too many of us? Positively no. The more numerous we are the faster we progress, while if we were only a few we would find it hard sledding. In increased numbers the simple become learned, the learned progress and become practical, and the practical lend a hand to society which in turn helps us all in a civilized world. Then why should we go about walling against a wall about some trifle? Maybe some "lid" is taking quite a slice of the ether with an r.a.c. note or some high-powered mug is clattering it all up. Sooner or later (most frequently sooner) he will get tired and quit or become rational, or else he will be like a soap box orator—having nothing to say no one will listen to him, or else they will send him to Congress.

This amateur game is large enough to have a lot of talk. With a station on about every ten cycles of available frequency space surely there is something for all of us. Let's set up a big howl for more frequency space and more bands (a big cheer from the crowd lasting ten minutes). Let's all have xtal control (a big mixture of cheers and groans). Let's have no code test for five meters and below (more cheers from the guys who don't know code and the raspberries from the guys who do). Let's spot the high-powered stations and the lids, divide the sheep from the goats (more cheers and groans). And it all comes down to this, my fellow hams: Neither the A.R.R.L. nor the F.C.C. is going to ask a regulation or pass one that will answer every ham's Utopian dreams. The Lord knows they sure would like to but with our divergent ideas and special interests in amateur radio so mixed up, believe me, I think their efforts to suit us as a whole should be highly praised and that bouquets are in order as it is. But don't get me wrong—like the Supreme Court, they are not above constructive criticism and, frankly, I believe the A.R.R.L. and the F.C.C. are wide open to valuable and constructive ideas and, further, will do what is necessary to meet the requirements of the majority. One more thing—when we as hams begin to bellyache about our liberties and privileges, let's not forget that a good definition of "liberty" is, "Your liberty ends where my nose begins," and that in our case our nose reaches just about around the world. We must remember that the 'phone hams, the traffic hams, the old-timers, the young squirts, and even us lids have a few rights, and the best we can do is to not overemphasize our own requirements and exclude the others. Let's take a quotation from a very old ham, Ben Franklin: "Unless we hang together we will surely hang separately."

This amateur organization needs every ham with his shoulder to the wheel and if we do so we will be getting some-

(Continued on page 58)



THE Ten Meter Band seems to be a natural "jumping-off place." Maybe we have neglected the higher frequencies in our preoccupation with the active bands. More likely the difficulties are physical ones, but whatever the reason, the fact remains that ordinary receiving tubes begin to go haywire at higher frequencies, and conventional receiver circuits fail to give their accustomed results. Consequently, National Communication Receivers such as the HRO, cover down to, and through, the Ten Meter Band. And National Experimental Receivers, such as the "One-Ten," begin with the Ten Meter Band, and continue the march down the spectrum.

Apparently this frets some amateurs considerably. Some amateurs seem to think it is just plain cussedness that keeps us from making 5-Meter coils for the HRO. As a matter of fact, it is not cussedness, and it is not lack of experience, either.

We will give some of the reasons why. In the first place, a good deal of the blame can be placed on the receiving tubes commercially available. What happens in a vacuum tube at high frequencies is a pretty involved matter, and we are not going to attempt to explain it in detail here. For the present, it is sufficient to point out that vacuum tubes are not instantaneous in their action, and at high frequencies it takes a tube an appreciable part of a cycle to respond. This time lag is particularly objectionable in the grid circuit, where it shows up as a phase shift that is similar in its effect to a resistor shunted across the grid circuit. If this resistance is measured, it will be found to be of very high value at ordinary frequencies, as might be expected. As the frequency is raised the resistance will drop down gradually to values of a few thousand ohms. No amateur needs to be told what happens to the gain per stage at that point. This limiting frequency depends primarily on the size of the tube, since small tube dimensions mean that the electrons get where they are going in less time and hence have a smaller time lag. This is why acorn tubes will operate at higher frequencies than regular receiving tubes. The latter usually begin to misbehave at about ten meters, and are usually pretty bad at five meters.

The blame can not all be placed on the tubes, however. At high frequencies, losses in the circuit are unreasonably high unless the very best of insulation is used, and unless all parts are specially designed for this service. For this reason results may vary widely between different receivers, even though they use the same tubes. Thus in the HRO, where price considerations did not apply, it proved possible to maintain high performance well beyond 30 MC. In another set of good quality, where price was probably an important factor, level gain was achieved by switching in an entire extra RF stage, tube and all, on the range of highest frequency. And as an extreme case, in still another receiver the RF stages were completely disconnected on the high coil range, presumably because the signal was louder without them!

As we mentioned above, the HRO will give excellent performance at frequencies well above 30 MC, but coils to do this have never been placed on the market as they would be of no value to the amateur. Probably we could make a set of coils that would operate after a fashion even at 56 MC, but they certainly would not give the performance that HRO owners are looking for. For practical work at 56 MC, something more drastic than a new set of coils is needed, and the answer seems to be acorn tubes.

Obviously, acorn tubes could be used in place of the type 58 tubes now used in the HRO, but for a variety of reasons we do not wish to do this. For one thing the type 58 has higher mutual conductance than the 954, and it gives better performance than the latter at the frequencies on which the HRO is most often used. A better plan is to use acorn tubes only on the frequencies above 30 MC, and this can be accomplished by placing the acorn tubes inside the coil shields. No wiring changes are required in the receiver proper to do this, provided that a separate power supply cable is run to the "coil" to supply filament and screen voltages to the tubes. This scheme is quite feasible, and there is no good reason why an ambitious amateur should not attempt it. However, if you build such a unit, you will quickly discover that you have made virtually a complete Ultra High Frequency Receiver, not just a set of plug-in coils. And if you are going to build a complete receiver, you might just as well save yourself a lot of trouble and build it as a separate unit.

That is exactly what we did;— we built the One-Ten Receiver. Although it costs no more than the fancy plug-in coils, it gives better results, and it extends the range not just to 5 meters but to 1 1/4 meters. Which brings us right back where we started. Ten meters is the "jumping-off place." National Communication Receivers cover down to and through, the Ten Meter Band. And National Experimental Receivers begin with the Ten Meter Band, and continue the march down the spectrum.

JAMES MILLEN



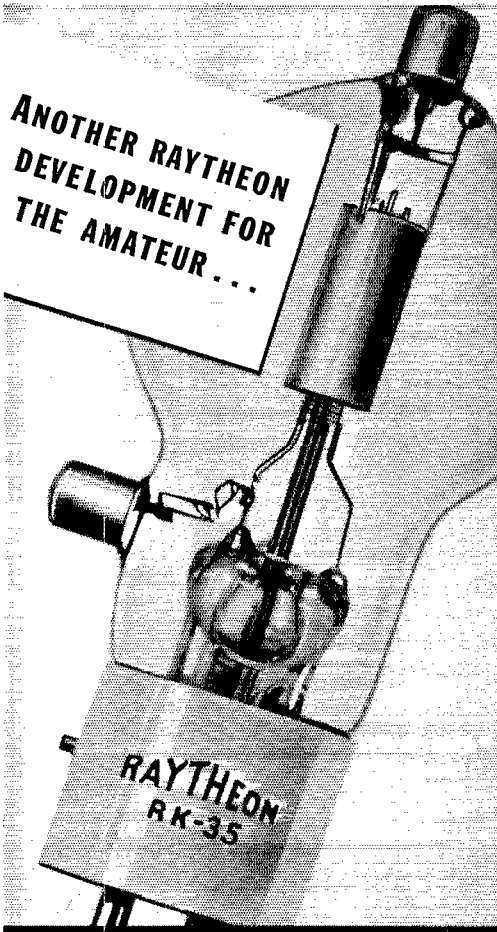

● The Raytheon RK-35 triode incorporates design features which provide outstanding performance at ultra-high frequencies and high efficiency in any amateur band. The plate and grid structures are tantalum, and the bulb and well-type stem are of Nonex hard glass. The RK-35 has a 7.5 volt, 3.25 ampere thoriated tungsten filament. Power output in Class C at 1000 volts plate is 60 Watts. The plate dissipation is 35 watts.

Amateur Net Price . . . \$8.00

See your dealer at once for complete characteristics

**RAYTHEON PRODUCTION CORPORATION**  
 420 Lexington Avenue . . . . . New York, N. Y.  
 445 Lake Shore Drive . . . . . Chicago, Illinois  
 415 Peachtree Street . . . . . N. E. Atlanta, Ga.  
 555 Howard Street . . . . . San Francisco, Cal.  
 55 Chapel Street . . . . . Newton, Mass.

**RAYTHEON**  
TRADE-MARK  
**AMATEUR RADIO TUBES**

## Correspondence

(Continued from page 50)

where. Otherwise, don't be surprised to find some commercial sending a lot of V's on your pet frequency one of these days. We have been fairly lucky up to the present time but from now on we shall have plenty to fight for.

—Dr. R. R. Campbell, W4DFR

## A Substitute for CQ

6015 Harper Ave., Chicago, Ill.

Editor, QST:

How many hams have crawled into their receivers, cranked up their crystal filters, jacked up their audio gain, strained their ears and wilted their collars to dig a feeble CQ out of the muck only to find it was a W8 instead of the XU they had hoped it was? Let's do away with this meaningless signal "CQ" and substitute some signal which has real meaning to the fellow hearing it.

A system which has evoked marked enthusiasm from all those to whom it has been mentioned is essentially this: A station desiring a contact would transmit his prefix followed by either "Q," "L," or "DX." For instance—if our W8 wanted to tune up his resonant filter or shoot the bull with the fellow across the river he would send "WL WL WL de W8—" or if he didn't much care who answered him he would send "WQ WQ WQ de W8—" and if he wanted to waste some power he would send "WDX WDX WDX de W8—" An Australian would send either VKQ, VKL, or VKDX; a Dutchman would use either PAQ, PAL, or PADX. The conventional directional or localizing signal could be added as always. Thus, an amateur tuning onto a station would at once know from the character of the general call the country of the transmitting station and that station's desires. Maybe that wouldn't help in a DX contest!

It seems to me that a suggestion of a somewhat similar though less elaborate nature died a few years ago at its inception; but by now hamdom should be sufficiently fed up with listening to locals CQ when they really want to listen to DX, and should be ready to appreciate some such change as this. How about some comments on this from around the country and from foreign points?

—John P. Kiesselbach, W9CPQ

## Silent Keys

It is with deep regret that we record the passing of these amateurs:

John R. Garinger, W8OQO, Mansfield, Ohio

Charles William Lewis, Jr., W9ANC, St. Louis, Mo.

Roger Nelson, W9GBW, Brainerd, Minn.  
 Clyde L. Phillips, W5AJQ, McKinney, Texas

Frank A. Rafferty, W9SSB, Chicago, Ill.  
 Clifford Warren Smalldige, W1DVN, Northeast Harbor, Me.

Jack H. Thornton, W9IVF, Chicago, Ill.  
 John J. Vickery, W7EZG, Freewater, Ore.  
 Richard Welch, K6KKA, Fort Kamehameha, T. H.

## The 6L6 As Amplifier and Doubler

(Continued from page 30)

put was dependent to a great extent upon the value of the screen voltage. If the screen voltage was too low—around 225 volts or so—it was quite

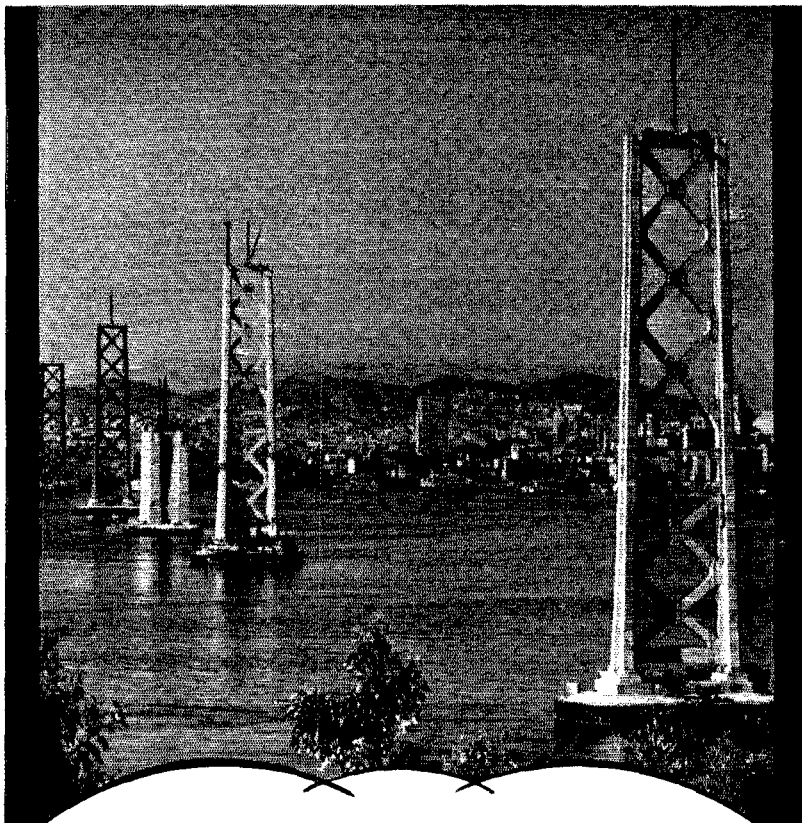

GABRIEL MOULIN

## **San Francisco Miracle Portable Radio Communication Directs Construction Parties**

In the construction of the gigantic San Francisco-Oakland Bay Bridge, operations were greatly facilitated and inestimable time saved by the use of portable radio. Intercommunication was made possible at all times between the dispatcher's office, workmen on the barges, and pylons in the bay.

Here again Burgess Batteries were the choice of engineers who demanded service. In your own radio and experimental work, avail yourself of the same "professional" performance by using Burgess Batteries.

**BURGESS BATTERY COMPANY**  
Freeport, Illinois



# **BURGESS**



Say You Saw It in *QST* — It Identifies You and Helps *QST*

**Now—a high-powered—**

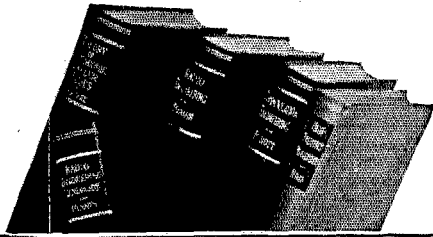

## RADIO ENGINEERING LIBRARY

- especially selected by radio specialists of McGraw-Hill publications
- to give most complete, dependable coverage of facts needed by all whose fields are grounded on radio fundamentals
- available at a special price and terms

These books cover circuit phenomena, tube theory, networks, measurements, and other subjects—give specialized treatment of all fields of practical design and application. They are books of recognized position in the literature—books you will refer to and be referred to often. If you are a researcher or experimenter—if your interest in radio is deep-set and based on a real desire to go further in this field—you want these books for the help they give in hundreds of problems throughout the whole field of radio engineering.

5 volumes, 2981 pages, 2000 illustrations

1. Everitt's COMMUNICATION ENGINEERING
2. Terman's RADIO ENGINEERING
3. Chaffee's THEORY OF THERMIONIC VACUUM TUBES
4. Hund's HIGH-FREQUENCY MEASUREMENTS
5. Henney's RADIO ENGINEERING HANDBOOK

Special Low Price and Easy Terms

Bought singly, the five volumes comprising this library would cost you \$26.00. Under this offer you save \$2.50 and, in addition, have the privilege of paying in easy installments beginning with \$2.50, 10 days after receipt of the books, and \$3.00 monthly thereafter. Already these books are recognized as standard works that you are bound to require sooner or later. Take advantage of these convenient terms to add them to your library now.

**SEND THIS ON-APPROVAL COUPON**

McGraw-Hill Book Co., Inc.  
330 W. 42nd St., New York, N. Y.

Send me Radio Engineering Library 5 vols., for 10 days' examination on approval. In 10 days I will send \$2.50, plus few cents postage, and \$3.00 monthly till \$23.50 is paid, or return books postpaid. (We pay postage on orders accompanied by remittance of first installment.)

Name .....

Address .....

City and State .....

Position .....

Company ..... QST-9-36

(Books sent on approval in U. S. and Canada only.)

difficult to load the tube up to the point where the plate current was 90 ma. or more. As a result, the output was limited. On the other hand, if the screen voltage was made much greater than 300 volts, there was a tendency for the screen current to climb gradually, with the limit of the current depending on the length of time the amplifier was left running. Around 300 volts seems to be optimum, but it may vary with different setups. Probably the best method of adjusting the screen voltage is to use a milliammeter in the screen circuit, adjusting the tap on the voltage divider until the screen draws 6 or 8 ma. Allow the amplifier to run, loaded, for some time, and if there is any tendency for the screen current to climb, the screen voltage should be reduced until the screen current remains perfectly steady.

### AS A DOUBLER

The circuit was modified to eliminate the split-stator tuning condenser and neutralizing condenser, and a 14-mc. plate coil was substituted for the 7-mc. one. The neutralizing condenser was removed simply to avoid any regenerative effect which might give outputs greater than when the tube was working as a simple doubler. It was found that when doubling, slightly better efficiency was obtained by using a grid-leak resistor having a value of from 100,000 to 150,000 ohms. Somewhat greater excitation was required, the grid current running around 3 ma. With 375 volts on the plate, output as roughly measured by the lamp ran about 13 to 15 watts, with a plate current of 80 ma.

The oscillator plate circuit and doubler grid circuit were then tuned to 14 mc. and a 28-mc. coil placed in the plate circuit of the doubler. An output of 10 watts was obtained at optimum coupling, and the plate current was only 60 ma. indicating good efficiency. For the amateur with scanty financial resources, this combination looks like a good one; 3.5-mc. crystal, two 6L6 tubes, and 10 watts output on the ten-meter band, with only a 375- or 400-volt power supply.

### L-C RATIOS

One thing noticed during the experiments that was puzzling for a while was the fact that maximum output and minimum plate current did not occur at the same setting of the tank condenser. It was found that decreasing the number of turns in the coil, and thus increasing the amount of capacity required to tune to the proper frequency, corrected this condition. The 6L6, drawing more plate current than we are used to at the comparatively low plate voltage used, will require the use of a lower L-C ratio than is current practice with the other low voltage tubes. From 80 to 100  $\mu\text{mf}$ . is about right for 7 mc. with half of these values for 14 mc. and one-fourth of them for 28 mc.

In review, the tube appears to be a good amplifier and doubler at plate voltages up to 400 volts or so, requiring but a small amount of driving power. The screen voltage must be adjusted with a fair amount of care if maximum output is to be



# EIMAC

## TRANSMITTING TUBES

YOU WANT A NEW TRANSMITTING TUBE FOR  
A VERY DEFINITE REASON

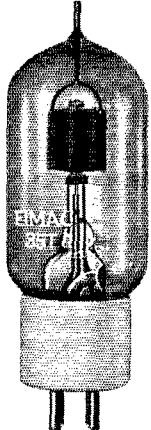

EIMAC 35T

{1} As a high power man you want more power. The additional power must be easily obtained and dependable. The tube chosen must be able to withstand any accidental overload which may take place during a moment of carelessness. EIMAC tubes will not only deliver at the highest possible efficiency but are also designed for abuse.

{2} As an average man you have just lost your tube thru gas released thru accidental overload, or perhaps the stem has punctured or the internal insulator has finally broken down. Use EIMAC tubes and such accidents can never happen again.

{3} As a DX man you probably wish to participate in some of the interesting DX that will take place this Fall on some of our higher communication frequencies. High capacity tubes are highly unsatisfactory at these frequencies. The use of EIMAC tubes with extremely low capacity cylindrical elements will add the necessary punch to your signal.

{4} As a phone man you are interested in improving the quality of your transmitter. You may need more or a better quality of audio power. A well designed low capacity tube possessing excellent electrical characteristics not only will give better audio quality (no loss of highs) but have less tendency for self oscillation. Use EIMAC tubes in your modulator.

{5} As a beginner you want a simple, effective, dependable transmitter. The EIMAC 35T will give from 20 to 40 watts output as a crystal oscillator using a single tube. No undue crystal strain is noted when obtaining the above outputs.

{6} As a designer of radio equipment you may need a reliable, efficient frequency multiplier at a comparatively high power level. Frequency multiplication even at the higher frequencies with a good power gain can be accomplished with the EIMAC 35T (See article page 16 August issue *QST*).

{7} As an experimenter of the ultra high frequencies you will find EIMAC unequalled in performance and dependability. World renown experimenters of the ultra high frequencies inform us that EIMAC tubes are the only tubes that will perform satisfactorily in their work.

### WE INVITE COMPARISON!

CONSIDER THESE EIGHT POINTS BEFORE YOU BUY!

- |                   |                 |
|-------------------|-----------------|
| (1) Price         | (5) Reputation  |
| (2) Quality       | (6) Appearance  |
| (3) Performance   | (7) Ruggedness  |
| (4) Dependability | (8) Versatility |

Your choice will be an "EIMAC" if you  
"COMPARE AND REFLECT"

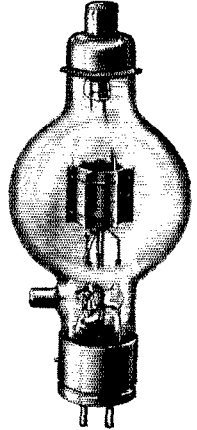

EIMAC 50T

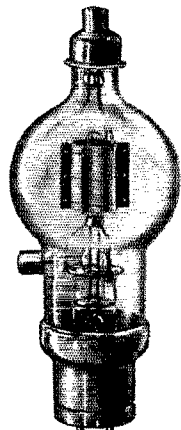

EIMAC 150T

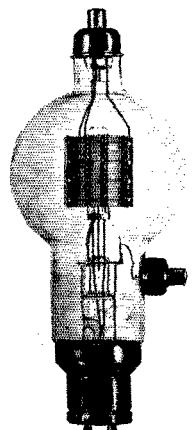

EIMAC 300T

# EITEL-McCULLOUGH, INC.

San Bruno, California, U. S. A.

Say You Saw It in *QST* — It Identifies You and Helps *QST*



Big boy — you've learned your service lesson well when you've memorized this page. For it leads on to page "P" for PROFITS and "S" for Success. Be wise — stick to CENTRALAB for ALL replacement work.

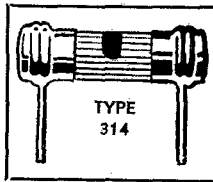
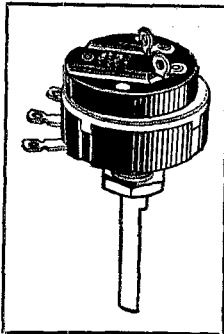

Every Radio Service Man should be a member of the Institute of Radio Service Men

# Centralab

MILWAUKEE, WISC.  
 BRITISH CENTRALAB, LTD.  
 Canterbury Rd., Kilburn  
 London N.W.6, England  
 CENTRALAB  
 68-70 Rue Amelot  
 Paris, France

obtained without screen-current creeping. Things we don't know are how well the tube stands up under service, and whether or not the insulation is satisfactory for use on the higher frequencies, above 15 mc.

From a reliable source it is learned that the 6L6 at maximum ratings does not have the wide margin of safety built in—and expected—in other tubes. The maximum plate voltage rating of 400 volts is just about as high as one should use and expect to get any sort of decent life out of the tube. However, this will probably only serve as a challenge to the average amateur!

A strictly personal remark. The tubes dissipate a considerable amount of heat. We may be an old fuss, but we still like to be able to see the color of the plate!

—B. G.

## I. A. R. U. News

(Continued from page 48)

outside of WIAPA worked HVHO, on the low-frequency end of the 14-mc. band? Gil would like to find out where the station was located . . . . . W5EHX and W6MCQ have the proper spirit, we think. When J2JJ called "CQ OA" the other day, W6MCQ called him and gave him OA4AE's frequency. While J2JJ was busy calling OA4AE blind, W5EHX got busy and gave OA4AE the J's frequency, after which they clicked. J2JJ got his 60th country by the contact . . . . . The first Great Britain-Siam contact was made the other day when G5RV worked HS1PJ. The Siamese station was on 14,210 kc. . . . . OA4J, Barranco, Peru, recently submitted his cards for a 28-mc. WAC . . . . . The 'phone WAC business is picking up: latest additions to the preferred list include F. C. Clark, ZE1JS; D. Reginald Tibbetts, W6ITH; M. A. Lammers, PK1MX; and Dr. Frank E. Breene, W6FQY, whom you recall was the first to complete a 28-mc. 'phone WAC . . . . . WAC's go to Italy's I1KN and I1IT. But of course there is no amateur radio there! . . . . . W2EGQ, operating at EA1BU, took second place and about fifteen dollars for placing second in the U.R.E. DX contest. Many W's were amazed at the excellent English of the Spanish station!

## "Move Over"

(Continued from page 18)

ened, he sank into a chair and buried his head in his hands. In the hush of this fruitless meditation there came a soft, sweet voice as of a guardian angel. It came from nowhere, yet it was everywhere. It whispered two magic words, clear and distinct. They fell upon his ears like the gentle dew upon a rose petal—"remote control." They struck the forlorn and dejected one like a shock. A tingling surge permeated his numbed consciousness. For a moment he hesitated. His heart pounded. His face flushed. He stood erect and

# CW-60

Uses New 35T

## Crystal Control Transmitter

OUTPUT: 60-100 WATTS

Complete Kit, Less Tubes and Crystal

### \$20.95

Power output depends on plate voltage used

TUBE LINEUP: 47 crystal oscillator — 53 Buffer and Eimac 35T in output stage.

POWER SUPPLY REQUIREMENTS: Filament voltages 2½ volts at 4 amps. — 5 volts at 4 amps.

PLATE VOLTAGES: 400 Volts at 100 MA and 500 to 1250 volts at 100 MA.

COILS: One set of three coils is furnished with kit for operation on any one amateur band. Coils for 1.7; 3.5; 7; 14 MC may be purchased separately at \$2.75 per set.

SIZE: Overall dimensions of the unit are: Height 4½ inches, width 11 inches, length 19 inches.

### P-60 DUAL POWER SUPPLY KIT.....\$25.95

for CW-60 Transmitter — with matching chassis

Descriptive Bulletin on Request

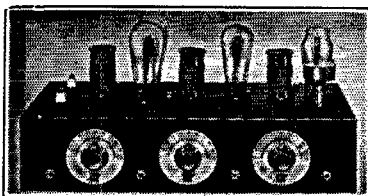

## GROSS C C TRANSMITTER

OUTPUT 25-30 WATTS

The "CW-25" transmitter kit due to its low cost makes it possible for anyone to own a modern crystal controlled station. A schematic hook-up as well as tuning instructions are furnished, thus enabling the most inexperienced operator to wire and put the set on the air for real results. The "CW-25" is supplied with a shrivel finished sturdy metal chassis under which all parts are mounted, making the wiring and components dust-proof. A plug-in crystal holder is furnished with the kit. Only one milliammeter is required for tuning the transmitter and each stage is furnished with a jack for this purpose. The "CW-25" uses one '47 as crystal oscillator, one '46 as buffer or doubler and two '46's in the amplifier stage, set of three coils supplied with kit for 20, 40, 80 or 160 bands. Additional coils 75c each.

Complete kit, less tubes and crystal... **\$14.95**

**P-25 POWER SUPPLY** — for CW-25 transmitter with matching chassis—450 volts at 200 MA, choke input—complete **\$11**  
kit, less tube.....

Very Special

# GROSS CB-100

A 100-Watt Radiophone and C.W. Transmitter completely housed in an entirely enclosed floor rack of ingenious design. All units are fully accessible through the removable front gates, for coil changing, antenna network adjustments, etc. Incorporates everything from microphone jack to impedance matching antenna network.

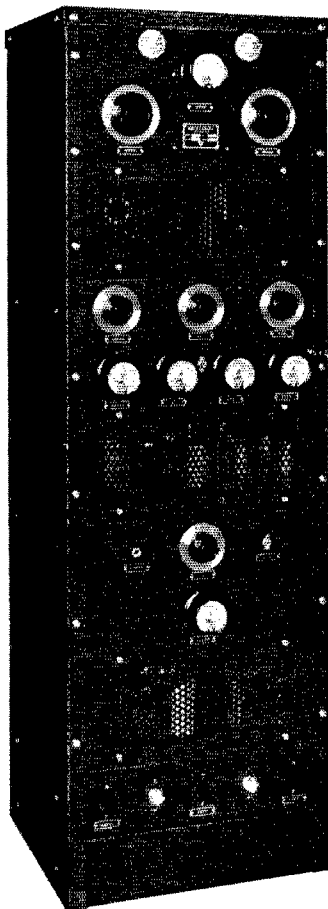

● **R. F. LINE UP** — 47 crystal oscillator, two 46's buffer 838 amplifier.

● **FREQUENCY COVERAGE** — 1.7, 3.5, 7 and 14 MC Bands.

● **POWER SUPPLIES** — 1050 and 1200 volts at 400 MA choke input, 8 mfd Pyranol condenser used and 400 volts at 300 MA.

● **SPEECH AMPLIFIER** — Special four stage high gain speech amplifier, self contained from microphone jack to gain control.

● **MODULATOR** — Two RK31s are used in the Class B Modulator. 100% modulation.

● **BIAS** — No bias batteries of any kind required.

● **ANTENNA UNIT** — Impedance matching network supplied for use with any type of antenna available.

● **OPERATING CONTROLS** — Terminations provided for operating all switches from operating table.

● **SIZE** — 60" high, 19½" wide, 16" deep.

A very limited quantity of these famous transmitters on hand

### Specially priced at \$299

Less Tubes, Crystal and Microphone

As there are only a few on hand these are subject to prior sale

20% DEPOSIT WITH ALL C. O. D. ORDERS

REMIT BY M. O. INCLUDE POSTAGE

Cable Address: GROSSINC

## GROSS RADIO, INC., 51 VESEY STREET, NEW YORK CITY

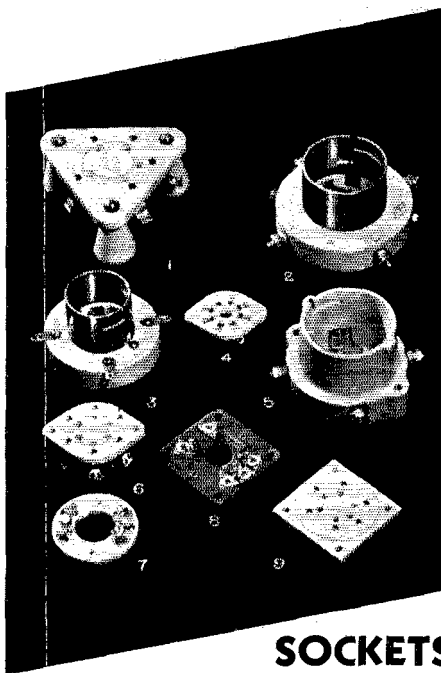

## SOCKETS

■ National has a socket for every amateur need. They are illustrated above. **1** is the big JX-100, a wafer type low-loss socket for the power pentodes such as the RK-28 and the RCA-803. **2** is the XM-50 fifty watt socket with sturdy side wipe contacts and employs the conventional metal shell. **3** is the XM-10, similar in construction to the XM-50, and is designed for those tubes using the type UX base. **4** is the Isolantite wafer socket for Octal (metal) tubes. **5** is the XC-50, another 50 watt socket, made entirely of low-loss Steatite and is for higher voltages and frequencies than the XM-50. **6** is the amateur's favorite Isolantite receiving tube socket. **7** is the XCA Isolantite socket for the triode Acorn tube. **8** is the XMA for the pentode Acorn tube and is assembled on a square copper base with built-in by-pass condensers for stable high frequency operation. And last, but by no means least, is **9**—the amateur's favorite square Isolantite coil socket.



**NATIONAL COMPANY, INC.**  
MALDEN, MASS.

bolted for the door and disappeared around the corner of the house.

A hurried but careful survey of the surrounding buildings found our friend standing with a worried countenance and perplexed. Not far away was the abode of a calm and peaceful soul who passed his earthly days in quiet contemplation of soft, cozy mud, occasionally expressing his satisfaction at the peace and calm of existence by reflective, satisfying grunts. Just at the psychological moment an intermittent series of these amorphous noises were wafted to our hero's ears. Instantly an idea crashed down like a bolt of lightning. Instantly he released all his pent-up emotions and in a state of great mental strain turned abruptly, faced Mister Pig, and shouted victoriously, "Move over!"

Father's box of nails, hammer, pet saw and all went the way of the pile of boards in the cellar—all sacrificed upon the altar of a partition and floor in the half of the pen so abruptly snatched from "the original ham." . . .

We pass now to the convincing evidence so clearly set forth in the accompanying photograph and view the destruction wrought upon the unoffending occupant. Poor Mister Pig! Abandoned and deserted by all mortal friends, he is doomed to a life of pinched-up quarters by day and by night the horrors of an infernal machine that



ozonated him, bedlamized his home and drove him to despair.

Accompanied by members of the S.P.C.A., we visited the side of the pen one night. As usual, the fiery wheel intermittently and with varied pitch whined and growled its messages to the world. Faintly discernible in the din we detected the feeble grunts of protest from the poor soul who was damned for the rest of his existence to live without sleep. None present could conceive any remedy for his plight, and with sad hearts and bowed heads we turned away, never to return. We know now that poor old Mr. Pig has gone to his reward, safe in a pig paradise where radio is forever banned, and we trust that some kind soul has erected a stone over his remains.

*Engineering  
and Producing  
Today*

*Parts for  
the sets of  
Tomorrow*

LOOKING BEYOND THE HORIZON

*Polyiron*  
**Aladdin**

TRADE MARK REG. U.S. PAT. OFF.

These devices are manufactured under one or more of the following U. S. Letters Patents:

1887380, 1940228, 1978568,  
1978599, 1978600, 1982689,  
1982690, 1997453, 2002500,  
2005203, 2018626, 2028534,  
2032580, 2032914, 2035439.

Other patents pending.

Send your QSL card for new ALADDIN Polyiron Data Sheet 536

**ALADDIN RADIO INDUSTRIES, INC.**

**466-Q W. Superior St., Chicago, Ill.**

**Export Dept., 235 E. 42nd St., New York City**

*Licencee Johnson Laboratories, Inc.*

Say You Saw It in QST — It Identifies You and Helps QST

# When in Doubt? Ask LEEDS

## WESTINGHOUSE AND SANGAMO Watt Hour Meters

110-120 volt 5 amp. 60 cycle 2 wire meters. The meters are used instruments in perfect condition, tested and reset to zero. A fifteen dollar value, at the extremely low price of **\$3.50**. Shipping weight 15 lbs.



## IMPORTANT ANNOUNCEMENT

On Our NEW LD-5 Mounted Crystals

These low drift plates, factory sealed in the new LEEDS metal holder are outstanding from the standpoint of stability, accuracy, high output and low cost. Low Drift — 5 cycles per million per degree. Accuracy of calibration — better than .05%. Orders filled plus or minus two kc. of specified frequency. Last but not least, the price of the mounted crystals, anywhere in the 160-80 **\$3.50** and 40 meter bands is only..... Money back guarantee if you are not completely satisfied.

Leeds type A.L. metal crystal holder, as illustrated above, fits standard 5-prong socket..... **\$1.00**

Thousands have discovered noise silencer adapters are a great help on reducing natural static too. Leeds "QUIET CAN" and "SILENT CAN" also provide freedom from ignition noises and afford an ideal arrangement for push to talk phone and break-in CW.

**Leeds "QUIET CAN"**  
for receivers with two IF stages; complete with tubes **\$7.95** and instructions....

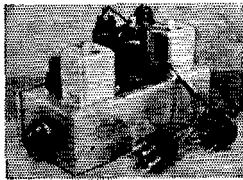

**Leeds "SILENT CAN"**  
Illustrated herewith, for receivers with one IF stage; complete with tubes **\$9.95** and instructions....

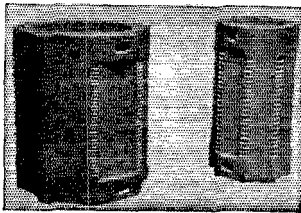

Also 7-pin base to fit above forms at 70c and a matching base with jacks at 65c

## GENERAL RADIO

Amateur accessories are always in stock. Here are two handy forms for that multiband xmitter.

**Type 677-U** — 21 turns, 2 1/2" diameter, resonant on 3.5 mc with 100 mfd capacity; shipping weight 2 lbs. Price..... **50c**

**Type 677-V** — 30 turns 4" diameter, resonant 1.7 mc with 100 mfd capacity; shipping weight 3 lbs. Price..... **75c**

## RAYTHEON TRANSMITTING TUBES

RK-10.....	<b>\$3.50</b>	RK-22.....	<b>\$7.50</b>	RK-32.....	<b>\$12.00</b>
RK-15.....	<b>4.50</b>	RK-23.....	<b>4.50</b>	RK-34.....	<b>3.50</b>
RK-16.....	<b>4.50</b>	RK-24.....	<b>2.25</b>	RK-36.....	<b>14.50</b>
RK-17.....	<b>4.50</b>	RK-25.....	<b>4.50</b>	RK-100.....	<b>7.00</b>
RK-18.....	<b>10.00</b>	RK-28.....	<b>38.50</b>	841.....	<b>3.25</b>
RK-19.....	<b>7.50</b>	RK-30.....	<b>10.00</b>	842.....	<b>3.25</b>
RK-20.....	<b>15.00</b>	RK-31.....	<b>10.00</b>	866A.....	<b>5.00</b>
RK-21.....	<b>5.00</b>			872A.....	<b>18.50</b>

### WRITE FOR FOLDER

JOHNSON side wiping contact, 50 watt sockets. Special..... **\$1.03**

### TAYLOR TRANSMITTING TUBES

Type T-55-plate, 55 watts, dissipation high efficiency to 200 MC. **\$8.00**  
other types in stock

LEEDS OVERSEAS SERVICE has an established reputation for speed, accuracy, safety and low cost. No matter where you live there is a satisfied Leeds customer nearby.



Tel. Cortlandt 7-2612

45 VESEY STREET  
NEW YORK CITY

Cable Address: "RADLEEDS"

60

Say You Saw It in QST — It Identifies You and Helps QST

bearing the appropriate inscription, "Rest in Peace." . . .

Many years have passed. Our hero is still suffering severely from the effects of the original "nibble" of the radio bug. His present call is known wherever hams exist. He signs his checks "F. Edward Handy."

## The Kennelly-Heaviside Layer

(Continued from page 18)

and thirty megacycles. These frequencies are here today and there tomorrow; that is to say, during sun spot maxima they are good for distant communications and hence worthless for local services. Likewise, during sunspot minima, they are erratic and largely useless for long-distance work. Hence, this region is sort of a stepchild. It is difficult, or impossible, to allocate it effectively for particular services, since with the years its effective use changes. This very variability, however, intrigues the amateur and experimenter, and a few years in the future boys who by error get on the third, rather than the fourth, harmonics of their forty-meter crystals may have a distinct advantage in DX work. (See QST for March 1936, page 46.) An examination of the present commercial allocations above twenty megacycles indicates that they are few and widely spaced in frequency, so that a band, perhaps the third harmonic range of the forty-meter band (i.e., 21,000 to 21,900 kc.), might well be made available for amateur experimentation without unduly congesting present allocations. This would enable amateurs to study the lowering in useful frequencies from ten toward twenty meters as the sunspot cycle progresses, and furnish a band usable for daytime work for a much longer portion, although probably not all, of the sunspot cycle.

For the convenience of readers interested in perusing further the matters discussed above, a bibliography of a few salient references is appended. Further references to publications appearing prior to 1930 will be found in a bibliography of a hundred references included in a paper by Kenrick and Pickard entitled, "Summary of Progress in the Study of Radio Wave Propagation Phenomena," *Proc. I.R.E.*, April, 1930, pages 649-668.

## Bibliography

1. Hulburt, E. O., "The Ionosphere, Skip Distances of Radio Waves and the Propagation of Microwaves," *Proc. I.R.E.*, 23, 1492-1506, Dec., 1935.
2. Gilliland, T. R., "Multifrequency Ionosphere Recording and Its Significance," *Proc. I.R.E.*, 23, 1076-1101, Sept., 1935.
3. Kirby, Samuel S., and Judson, Elbert B., "Recent Studies of the Ionosphere," *Proc. I.R.E.*, 23, 733-751, July, 1935.
4. Schafer, J. P. and Goodall, W. M., "Diurnal and Seasonal Variations in the Ionosphere

CARBON ANODES PRODUCE More Watts Per Dollar

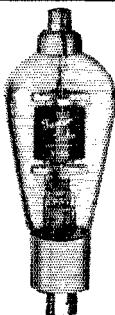

**\$8.00**

## TAYLOR T-55 55 WATTS PLATE DISSIPATION CHARACTERISTICS

Fil. Volts ..... 7.5  
 Fil. Current ..... 3.25 Amps.  
 Class "C" . . . OSC . . . and R. F. Amp.

### 5 METERS

	Class C R. F. Amp.	OSC
Max. Plate Volts Unmodulated D.C. ....	1500 volts	1250 volts
Modulated D.C. ....	1500 volts	1000 volts
Max. D. C. Plate Current .....	150 M.A.	125 M.A.
Max. D. C. Grid Current .....	40 M.A.	40 M.A.
Max. R.F. Grid Current .....	5 Amps	5 Amps
RF. Output .....	168 watts (a)	66 watts (b)
	(a) — @ 75% Efficiency	(b) — @ 40% Efficiency
Amp. Factor .....	25	
Plate to Grid .....	2.5 MMF.	
Grid to Filament .....	1.7 MMF.	
Plate to Filament .....	.7 MMF.	

# GET MORE R-9 REPORTS On Your High Frequency Dx!

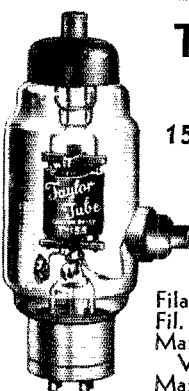

**TAYLOR T-155**  
 155 WATTS PLATE DISSIPATION  
**\$19.50**  
**CHARACTERISTICS**

Filament..... 10 volts  
 Fil. Current.... 4 amps  
 Max. Plate Volts..... 3000  
 Max. Plate Current..... 200 M.A.  
 Plate to Grid... 3 MMF.  
 Grid to Fil.... 2.5 MMF.  
 Amp. Factor... 20  
 Thoriated Tungsten Filament

The instant popularity of the T-55 in amateur transmitters brought a demand for a tube of the same type that would handle larger inputs. The T-155, with a power rating three times that of the T-55, is the result.

Both tubes are ideally suited for use on wave lengths of 2 to 160 meters, and have a high percentage of over-all efficiency.

Like all Taylor Tubes, the T-55 and T-155 have carbon anodes, which radiate heat four times as fast as metal anodes and are designed to permit the use of insulators which make misalignment of elements impossible. The insulators have a resistance of 50 megohms per cubic centimeter, assuring minimum leakage loss.

### EASY TO DRIVE!

**BUY TAYLOR TUBES AT YOUR DISTRIBUTOR!**

# Taylor HEAVY CUSTOM BUILT DUTY Tubes

## Mail Coupon for FREE Catalog!

TAYLOR TUBES, INC.

2341 Wabansia Avenue, Chicago, Illinois

Without cost or obligation send me your new 1936 catalogue, containing valuable transmitter construction data, charts showing proper selection of tube for each stage for maximum efficiency, special reference tables, etc.

Name \_\_\_\_\_

Call No. \_\_\_\_\_

Q. R. A. \_\_\_\_\_

Say You Saw It in QST — It Identifies You and Helps QST

# More Power? Ask OHMITE

THE current trend toward high power transmitters requires new materials, new technique. If you are building more wattage into your rig, you should know all about OHMITE Resistors of various types.

For example, OHMITE Vitreous Enamel Fixed Resistors, in 100, 160 or 200 watt sizes, make ideal power supply bleeders. These units are now turning in perfect performance records in commercial transmitters, and in hundreds of industrial applications.

Many amateurs are already using OHMITE Dividohms which are semi-variable and Multi-volt tapped resistors as bleeders in the C bias power supply. High-gain speech amplifiers have been found to operate much more quietly when composition units were replaced with "Wirewatt," a genuine wire-wound resistor, rated at one watt.

All of these units and many others are fully described in OHMITE Catalog 14, sent on request without charge. Their application is more fully discussed in the OHMITE Amateur Handbook. Get a copy from your dealer, or send 10c to OHMITE MFG. CO.

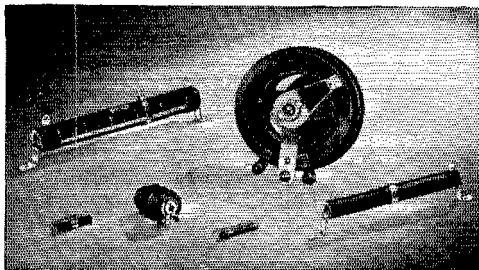

# OHMITE

**MANUFACTURING COMPANY**  
4831 Flournoy Street Chicago, Illinois



**REVISED —**  
enlarged second edition of famous OHMITE Amateur Handbook. From your dealer or sent for 10c postpaid by OHMITE MFG. CO.

HANDBOOK  
PAGES  
**458-459**  
CATALOG  
SECTION

- During the Years 1933 and 1934," *Proc. I.R.E.*, 23, 670-681, June, 1935.
5. Appleton, E. V., "The Seasonal Variation of Ionization in Region F<sub>2</sub> of the Ionosphere," *Phys. Rev.*, 47, 704, May 1, 1935.
  6. Berkner, L. V., "The Ionization of the Earth's Upper Atmosphere," *Trans. of the American Geophysical Union*, 16th Annual Meeting, 20-26, 1935.
  7. Appleton, E. V., "Recent Measurements of Upper Atmospheric Ionization," *Phys. Rev.*, 47, 89, Jan. 1, 1935.
  8. Kirby, S. S., Berkner, L. V., and Stuart, D. M., "Studies of the Ionosphere and Their Application to Radio Transmission," *Proc. I.R.E.*, 22, 481-521, April, 1934.
  9. Kenrick, G. W., "Records of the Effective Height of the Kennelly-Heaviside Layer," *Physics*, 4, 194-195, May, 1933.
  10. Kenrick, Gilliland, and Norton, "Investigations of Kennelly-Heaviside Layer Heights for Frequencies between 1600 and 8650 Kilocycles Per Second," *Bureau of Standards Journal of Research*, 7, 1083, 1931.

## Oscillator-Mixer Design Considerations

(Continued from page 38)

the subject, but a number of old truths can be reshaped with benefit. First of all is the subject of insulation. Good dielectric is of vital importance in all parts of the r.f. circuit. Isolantite or vitron or an equivalent should be used at every point; even the best of the "low-loss bakelite" results in appreciable losses. In the case of the oscillator-mixer circuit under discussion, the use of bakelite insulation across the 28-mc. oscillator coil showed a direct relationship between mixer grid current and the length of the insulation path. More than a 10 per cent change in output was possible. Vitron is now being used! In this connection, the forthcoming new metal tubes with isolantite gridcap and base insulators should prove a decided asset; one of Raytheon's 6A8's with ceramic top insulator alone is an advantage. Band-switch and tuning condenser insulation, too, can be nothing less than a good ceramic or equivalent.

The material in the coil form also makes a difference. With 150 volts supply to the 6F6, the output when a coil wound on a molded bakelite form was used was in one instance 4.8 volts. All other conditions remaining the same, replacement of this coil with another identical in all respects except that it was self-supporting in air raised the output to 6.9 volts—the difference between ineffectual and reasonably good operation. The moral is self-evident; high-Q coils are desirable, and high-Q coils cannot be made with a lot of poor dielectric in the fields or across the ends. Although no such marked differences are noted with the use of coils of different worth in the r.f. tuned circuits proper, here, too, it is believed that coils of the highest efficiency compatible with design considerations should be used. It has been said that at least a 25 per cent increase in



# EVERYONE INTERESTED in Radio Needs THE RADIO AMATEUR'S HANDBOOK



The *Handbook* tells the things which are needed for a comprehensive understanding of Amateur Radio. From the story of how Amateur Radio started through an outline of its wide scope of the present—from suggestions on how to learn the code through explanations of traffic handling procedure and good operating practices—from electrical and radio fundamentals through the design, construction, and operation of amateur equipment—this book covers the subject thoroughly. It includes the latest and the best information on everything in Amateur Radio.



You can depend upon the information to be found in  
THE RADIO AMATEUR'S HANDBOOK

*Contains approximately 500 pages; more than 250,000 words,  
and illustrated with more than 500 diagrams, charts, etc.*

A book unequaled at  
any price

**\$1** POSTPAID IN  
CONTINENTAL U.S.A.

Buckram Bound, \$2.50

\$1.15 Postpaid Elsewhere

**AMERICAN RADIO RELAY LEAGUE** WEST HARTFORD  
CONNECTICUT

# SMALL PANEL ELECTRICAL INSTRUMENTS OF QUALITY

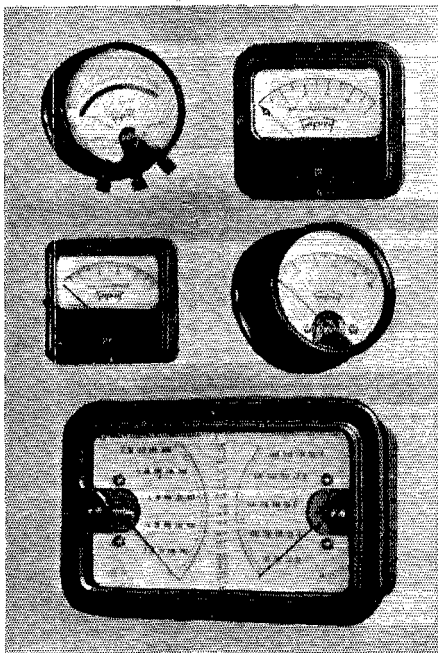

In 5", 3" or 2" round cases. 4" and 3" in square cases. Also twin meters in rectangular cases. Voltmeters A.C. or D.C.; Millivoltmeters; Ammeters, A.C., D.C. and R.F.; Milliammeters and Microammeters A.C. and D.C. Stocks maintained in all popular ranges in all types of mountings. Quick deliveries on special ranges or dials.

Triplett instruments are the last word in quality. Incorporate the latest improvements in materials and design, and manufactured in newly completed dust controlled and temperature regulated factory.

Amateurs as well as professional radio men will find in the large Triplett line an electrical instrument for every need. The cost too is much lower than you might suspect. See them at your local jobbers—Write for more information.

*You can't afford to buy other than Class A Triplett Instruments*



TRIPLET ELECTRICAL INSTR. CO.  
259 Harmon Dr., Bluffton, Ohio  
Without obligation please send me new 1936 Catalogue.

Name .....

Address .....

City..... State.....

the Q of a stage is required before any noticeable difference in performance is observed. That may be true in one stage—but by the time three stages are cascaded, as with two stages of pre-selection, the net improvement from even a smaller increase will be well worth while. If for no other reason, the improvement in pre-selectivity alone lends a valid argument for "finicky" design of high-frequency coils.

The principal design considerations to be borne in mind are form factor, conductor size, and spacing. Start with the dimensions of the coil shield; if a round shield, make the coil diameter about  $\frac{1}{3}$  the shield diameter; if square, make the diameter  $\frac{1}{3}$  the distance between diagonally opposite corners. When less than a 2 to 1 tuning ratio is contemplated, make the length-diameter ratio about 1.5 to 1. By lightning calculation or the other kind, determine the number of turns required to give the desired inductance with these dimensions. Choose a wire size which, when wound, will be spaced (on 28 mc.) just a trifle less than the diameter of the wire; this spacing decreases with decreasing frequency, until at 3.5 mc. it should be about  $\frac{3}{8}$  of the wire diameter. If possible, wind the coil in self-supporting style, and mount it horizontally, so that there will be no long leads trailing down the inside from the grid end. A lot of extra work, perhaps, but in the end it will be found well worth while.

## The Iowa State Convention

THE 1936 Iowa State Convention opened at 9 a.m. on May 15th at the American Legion Building in Iowa City. Rag-chewing and inspection of manufacturers' exhibits took up the time until 1:15 p.m., when the convention was opened with a short address of welcome by Mr. C. A. Bowman, president of the Iowa City Chamber of Commerce. Then followed an interesting talk on the "Iowa State Police Radio System," by Mr. E. F. Brown, W9DKC, supervisor. Mr. Carl Menzer, Director of WSUI, discussed "High Fidelity Disc Recording." A good many of the fellows heard themselves as others hear them for the first time. Mr. J. L. Potter, Communications Instructor at the University of Iowa, spoke on "Television Modulation Systems." In the evening, Director Norwine gave his report of the 1936 Board of Directors' Meeting, after which a mixer and general get-together wound up the first day of the convention.

The Saturday program opened at 10:00 a.m. with a recorded, illustrated talk on "Jim Lamb's Noise Silencer" by the staff of Radio Laboratories. Mr. C. G. Miller of Weston gave an interesting review of "Interesting Features Found in Indicating Instruments," during which more than one ham learned that his meters were built with more precision than he had ever realized. The afternoon session was opened with a two-hour talk by Mr. H. F. Pitzer, RCA field engineer, on "X-raying the Amateur Transmitter with the Cathode-Ray Oscilloscope." Mr. L. M. Craft of Collins then spoke on "The L-Section

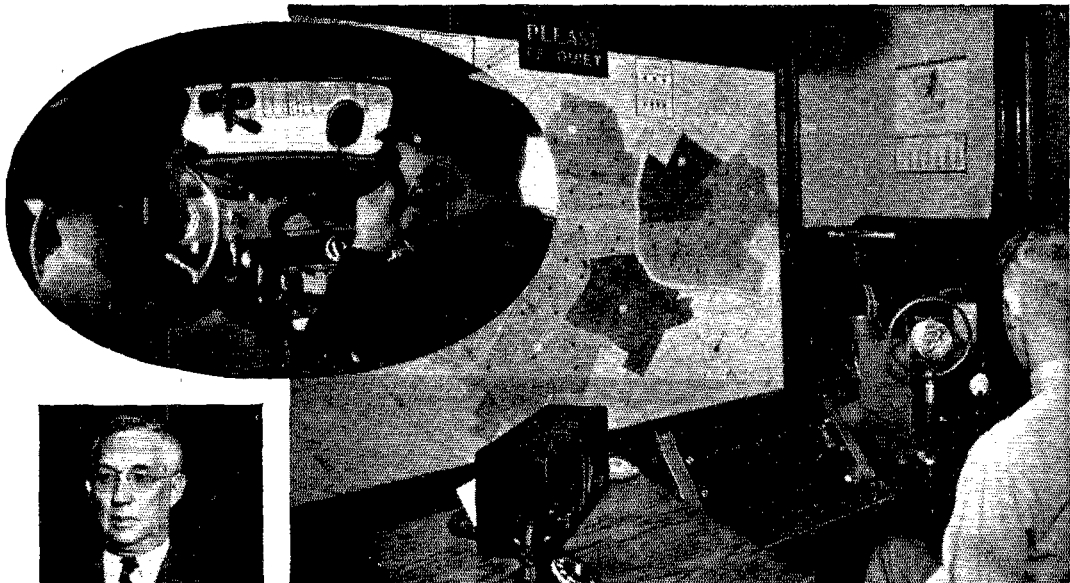

The broadcasting room of the Nashville Police Department



*Radio-equipped police cars must have generators with ample capacity to keep the batteries fully charged. Our Delco-Remy equipment has fulfilled this requirement . . . In addition your generators and regulators have made possible economies in the operation of our cars which further commend them for police car use.*

J. L. FOSTER, Chief of Police  
Nashville, Tennessee



*The Delco-Remy equipment on our radio patrol cars has materially aided in proving to this city the worthiness and efficiency of police cars controlled by short wave radio.*

H. F. HOWSE, Mayor  
Nashville, Tennessee

## "NASHVILLE POLICE CALLING"

Nashville joins the many other cities throughout the country that depend upon Delco-Remy Special Service Generators for adequate current to meet the electrical demands of their radio-equipped police cars. Exhaustive tests have proven that these Delco-Remy generators provide the reliable service and the high output so essential in police work. Amateurs, too, have found that these same Delco-Remy generators provide ample current for two-way radio service in their own cars.

Any Branch or Electrical Service Station of United Motors Service can recommend the proper Delco-Remy high output generator for special installations. They will be glad to analyze your problem and determine the right equipment for it.

DELCO-REMY CORPORATION • ANDERSON, INDIANA



Nashville Police cars. Radio equipped.



United Motors Service is the official distributor of Delco-Remy products, including all service parts for Delco-Remy starting, lighting and ignition systems.

# Delco-Remy

Say You Saw It in QST — It Identifies You and Helps QST

# ASTATIC

## Watchcase Model D-2 Crystal Microphone

Only  
2½" dia.  
½" thick



Its smart appearance makes you want to own it. Its high quality performance and rugged construction make you glad you do. An exceptionally fine frequency response substantially flat from 50 to 6000 c.p.s., an output level of -60 db.

### Get Full Details from Your Jobber

Fully guaranteed. Featuring the exclusive Astatic Dual Diaphragm construction acting on a grafoil bimorph crystal. List Price \$25.

Licensed under Brush  
Development Co. Patents—Astatic pending

Astatic Microphone Laboratory, Inc.  
YOUNGSTOWN, OHIO, U. S. A.

Pioneer Manufacturers of Quality Crystal Devices

Matching Network," and the program was concluded with a trip to the University of Iowa Electrical Engineering Department, where Dr. E. B. Kurtz, head of the department, gave a very interesting talk and demonstration on "The Principles of Television."

Bert Puckett, W9DTB, of the WMT announcers' staff, did a fine job as toastmaster at the banquet held Saturday evening. Short talks by Mr. D. W. Crum, Secretary of the Iowa City Chamber of Commerce; Mr. E. F. Brown, W9DKC; Director Norwine, W9EFC; Mr. Miller; Chuck Morgan, W9ND, Naval Reserve representative; A. W. Kruse, W9LCX, A.A.R.S. representative; Frank Parsons, W9EMS, of Iowa Radio Corporation; Sam Poncher, of Newark Electric Co., and Rex Munger, W9LIP, preceded the prize drawing at which 95% of those in attendance were rewarded through the generous cooperation of the manufacturers and jobbers.

Bids for next year's convention were received by Director Norwine from Burlington and Newton, and it was voted to hold it at Newton.

—Paul E. Griffith, W9DBW

## New Line Chokes

THE "shadow" probably is responsible for the new gadgets shown in the accompanying photograph. When diathermy machines start pumping out not-so-good a.c. notes in parts of the spectrum belonging to communication services, evidently something needs to be done. Since a good deal of the radiation no doubt takes place when r.f. wanders into the power line in-

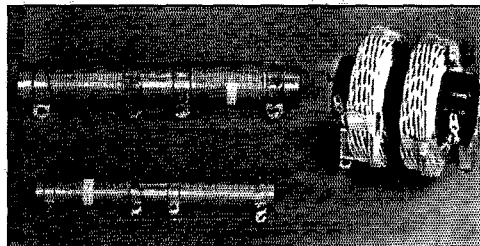

stead of the patient undergoing treatment, it is logical to use chokes to keep it where it belongs.

Two types of line chokes are illustrated. The double honeycomb affair is made by the J. W. Miller Co., Los Angeles, and is one of several models, single and double, designed to carry currents ranging from 2 to 30 amperes. The resistor-type chokes are a product of the Ohmite Manufacturing Co., Chicago. Three models are made, all having dual windings, with wire size ranging from No. 18 to No. 12.

Line chokes also are useful in any application where r.f. is leaking unwanted into the power line, including sign flashers, commutator type motors, radio transmitters, etc.

MR. E. H. RIETZKE

PRESIDENT OF CREI

## ARE YOU LOOKING FOR A JOB . . . OR A FUTURE?

There's Always a Better Job or a Better Man

"Invest" One Cent  
Write Today for Free  
Catalog

Gives complete details about our home study courses and one-year Residence Course (beginning Sept. 21) and easy terms you can afford. Inquiries invited.

If you're satisfied and content with your present job, you won't be interested in CREI. BUT, if you realize the benefits of Technical Training in keeping abreast of the rapid improvements in Radio, then CREI training can help you as it has helped others out of routine jobs into top positions in the Radio industry. Courses designed to meet your individual needs.

## CAPITOL RADIO ENGINEERING INSTITUTE

Dept. Q-9

WASHINGTON, D. C.  
14th and Park Road

NEW YORK CITY  
29 Broadway



# new 6L6 AMPLIFIER CIRCUIT

HERE it is — an ideal use of Tru-Fidelity transformers by Thordarson and 6L6's. This circuit kicks out 60 watts of clear audio power and is so assembled that power supply and amplifier are on one chassis. The unit uses Thordarson Tru-Fidelity transformers No. T-9000 and T-9004 or standard Thordarson transformers No. T-6573 and T-5741. This circuit has a useful audio range from 30 to 10,000 cps. with but 1 db. variation. Listen to this unit at the big Ham Show in Chicago, Sept. 5-6-7.

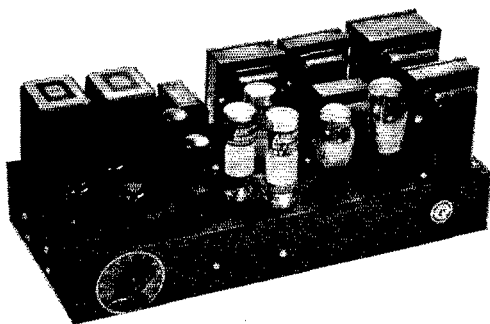

For complete schematic diagram of the above circuit, ask your parts jobber to supply you with our catalog sheet No. SD-258.

## New Fall Catalogs Ready!

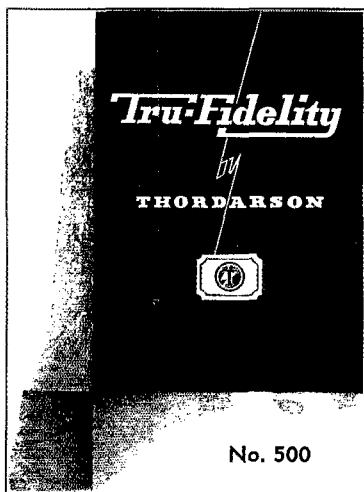

Tru-Fidelity by Thordarson, the big news of 1936, is covered in this beautifully executed, profusely illustrated catalog. In it you will find a complete description of the Tru-Fidelity transformers used in the circuit above. See your parts jobber or write factory for your copy.



A complete transformer guide for 1936. This new catalog gives complete prices and specifications on all standard Thordarson radio transformers, and is a convenient guide in the selection of all Thordarson radio transformers, except Tru-Fidelity. Your copy may be secured from a local jobber or by writing the factory.

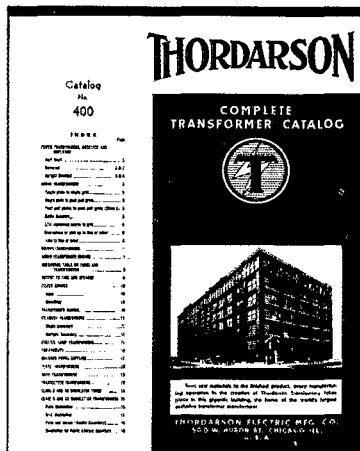

### THORDARSON ELECTRIC MFG. CO.

500 West Huron Street

Chicago, Ill., U. S. A.

# Remember

ONLY UNTIL

## AUGUST 31st

To take advantage of the special offer of membership-subscription and a copy of the 1936 edition of the "Handbook" for

# \$3

**NOW!**  
GTC HI-LO  
Power Trans-  
formers —  
with three  
tremendous  
new advan-  
tages!

# HI OR LO Power at the Snap of a Switch

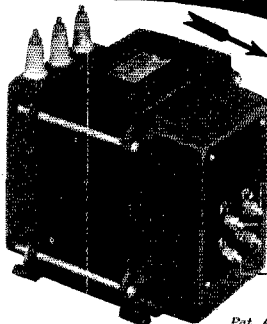

1. Now you can conveniently, safely reduce the power in tubes while tuning. Panel-controlled!
2. You eliminate waste of power. You tune with low power — then snap — and the soup's on!
3. Switch is in the 110 volt lead when you use GTC transformers — not in the high voltage lead, which is susceptible to arcs.

Pat. Applied for

### SENSATIONAL NEW BOOK YOU NEED

"Progressive" Transmitter Guide, now includes 32-page Supplement on "Progressive 11" with 14 illustrations, 8 circuits and 8 working drawings. 25c (U.S.) postpaid. (15c for Supplement only). Bulletin form 20B free for the asking.

**GENERAL TRANSFORMER CORP.**

518 S. Throop Street

Chicago, Illinois

## A New Antenna Relay

AS MORE and more amateurs are turning to using the same antenna for both transmitting and receiving, the desirability and even necessity for a quick-change switch for shifting the feeders from transmitter to receiver becomes apparent. To meet this demand, the relay pictured herewith has been developed. It works directly from the 110-volt a.c. line, hence the coil can be

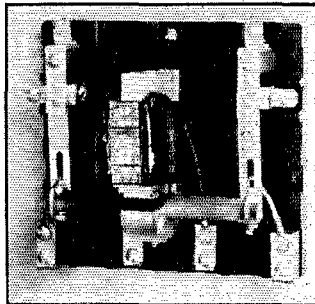

connected in parallel with the plate transformer primary so that application of power automatically connects the feeders to the transmitter and vice versa.

The silver contacts are capable of carrying fifteen amperes. Insulating supports for fixed contacts and moving arms are Mycalex. The new relay is a product of the Ward Leonard Electric Company, Mt. Vernon, N. Y.

## Grid Bias Cells

ALTHOUGH midget grid-bias cells have been standard equipment in a number of broadcast receivers for over a year, it is only recently that they have been put into general distribution through retail radio outlets. The cell, which is about the shape and size of an acorn, is a potential device only and should not be used in circuits

where current is flowing. Each cell develops approximately one volt. The maximum current that it is safe for the cell to deliver is one micro-ampere, hence cells should not be tested with a voltmeter.

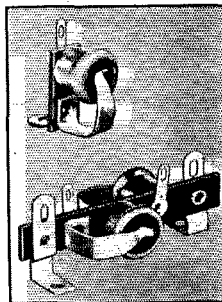

In receivers the cells find their chief use in biasing section of tubes such as the 2A6 or 2B7 when used as audio amplifiers following diode detectors. Simplification of the circuit results, since cathode resistors and attendant bypasses can be omitted. Elimination of these components also improves the frequency response by preventing degeneration at the lower audio frequencies. A similar application suggests

# Newark's SETS on a NEW Deferred Payment Plan LONGER TERMS — LOWEST RATES

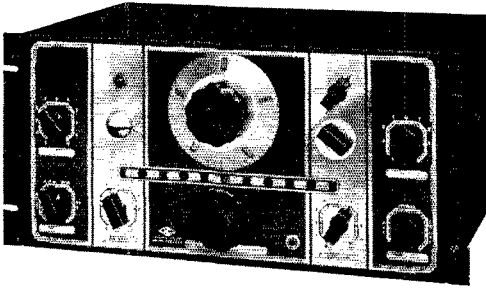

National NC-100, the long awaited "Perfect" Super-heterodyne has arrived. It is a wonderful performing job that will amaze and delight the listener with its selectivity, sensitivity, low noise level and its compactness. We list these important features and suggest that you write us at once for descriptive circular.

Full coverage 540 to 30,000 KC in five ranges — complete band switching — No plug-in coils — 12 tube Superhet — one stage RF — two IF stages — P.P. Pentode 10 watt audio output — Full AVC circuit — Built-in Power Supply — Single and doublet antenna connections — Latest type Crystal Filter — "Electric Eye" tuning indicator — Large latest type Dynamic Speaker furnished in cabinet to match.

The receivers listed below are the best money can buy. Our time payment plan, at the new low rates, makes it easy to own one. COMPARE our rates with others. THE EASY WAY: Send in your down payment with your order. Set will be shipped as soon as credit is OK'd. Entire transaction: One week, TRY US. Write for complete catalogue.

	Cash Price	Down Payment	6 Months Payments	9 Months Payments	12 Months Payments
NATIONAL NCX-100 complete with tubes, crystal and speaker to match.	\$127.50	\$22.50	\$18.58	\$12.59	\$9.47
NATIONAL HRO JUNIOR with tubes, one set of coils, 10 to 20 meters.	\$99.00	\$24.00	\$13.52	\$9.09	\$6.87
NATIONAL HRO JUNIOR complete with tubes, power supply, 2 pair of coils.	\$124.80	\$29.80	\$16.90	\$11.37	\$8.59
NATIONAL HRO less power supply and speaker.	\$167.70	\$37.70	\$22.78	\$15.35	\$11.69
NATIONAL HRO with power supply.	\$183.60	\$43.60	\$24.46	\$16.51	\$12.57
RCA — ACR-136 complete receiver.	\$69.50	\$19.50	\$9.32	\$6.26	
RCA — ACR-175 complete receiver, speaker separate.	\$119.50	\$24.50	\$16.90	\$11.37	\$8.59
RME-69 complete with tubes, crystal, speaker housed in baffle.	\$134.90	\$29.90	\$18.58	\$12.50	\$9.47
HAMMARLUND SUPER PRO complete with tubes, crystal and speaker.	\$241.00	\$51.00	\$32.92	\$22.29	\$16.98
BREITING 12 complete with tubes, crystal and speaker.	\$93.00	\$18.00	\$13.52	\$9.09	\$6.87

Full details of any set listed, mailed immediately upon request

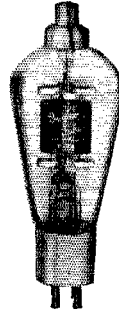

Complete Line of  
**TAYLOR TUBES**  
"more watts per dollar"

866.....	\$1.65
756.....	4.95
203B.....	7.50
203A.....	12.50
814.....	18.50
822.....	18.50
T200.....	21.50

## WELL KNOWN OIL FILLED, OIL IMPREGNATED FILTER CONDENSERS

Our Special OIL IMPREGNATED-OIL FILLED CONDENSERS are guaranteed at rated voltages. All ratings are DC working voltage. These are well-known condensers. We have a few left of each capacity. Send in your orders at once.

Cap.	Voltage	Size	Weight	Price
1 mfd.	2000 V. DC	5 x 3 3/4 x 1	1 1/4 Lbs.....	\$1.25
2 mfd.	2000 V. DC	5 1/4 x 3 3/4 x 2 3/4	3 Lbs.....	1.50
4 mfd.	2000 V. DC	2 1/2 x 2 1/4 x 5	3 Lbs.....	2.25
8 mfd.	2000 V. DC	5 1/4 x 3 3/4 x 4	4 Lbs.....	2.75
9 mfd.	3000 V. DC	5 1/4 x 3 3/4 x 1 1/2	9 Lbs.....	7.25
(including 2 3/4" bakelite standoffs)				
4.4 mfd.	1500 V. DC	5 x 3 3/4 x 1 3/4	1 1/4 Lbs.....	1.75
5 mfd.	1500 V. DC	3 3/4 x 3 3/4 x 1 1/2	1 1/4 Lbs.....	1.90
5.2 mfd.	1500 V. DC	5 x 3 3/4 x 2 3/4	2 1/4 Lbs.....	2.00
10 mfd.	1500 V. DC	5 x 3 3/4 x 3	2 3/4 Lbs.....	2.75
20 mfd.	1500 V. DC	5 x 3 3/4 x 3 3/4	3 3/4 Lbs.....	3.50

Use the 10 and 20 mfd. for perfect filtering in class B modulation Power supply

### Newark Paper Filter Condensers

1 mfd. 1000 V. DC.....	\$.56
1 mfd. 1500 V. DC.....	.66

These condensers have standoff insulators and mounting feet.

Thordarson No. T6878 Heavy Duty Choke. 15 henries at 250 MA.....	\$1.95
HIGH VOLTAGE TRANSFORMER. 1000-750-500-0-500-750-1000-300 MA. 3 1/2 x 4 1/2 x 5 1/2	\$5.95

Thordarson No. T6878 Plate and Filament Transformer, 600-0-600 V. at 200 MA. 2 1/2 V. at 10 amp., 5 V. at 3 amp. 7 1/2 V. at 3 amp.....

2 1/2 V. 10 amp. Filament Transformer — 2500 V insulation for 866's.....

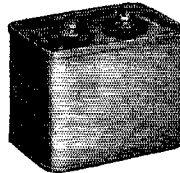

### EIMAC

35T.....	\$8.00
50T.....	13.50
150T.....	24.50

### BLILEY CRYSTALS

BC3.....	\$3.95
LD2.....	4.80
HF2.....	7.50

## See Taylor Tube Ad on High Frequency Tubes

T55.....	\$8.00
T155.....	19.50

Write for Free Complete Taylor Catalog

## NEW RAYTHEON TUBES

RK-35.....	\$8.00
RK-36.....	14.50

Write for Our Complete Catalogue!

ALL OF THE ABOVE SPECIALS GUARANTEED BY NEWARK. ALL OF THE ABOVE SPECIALS ARE "NEW"

# Newark Electric Company

"FASTER SERVICE — BETTER BARGAINS"

226 W. Madison Street

Dept. Q

Chicago, Illinois



**USED BY**  
LEADING *Amateurs*  
**STOCKED BY**  
LEADING *Dealers*  
Write for Bulletin 354-Q

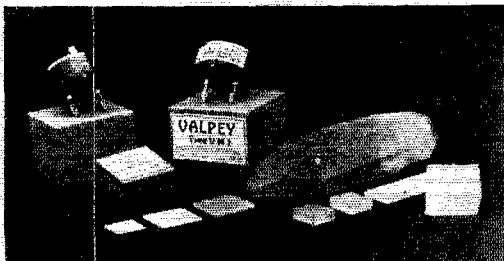

Type VM2. Mounted crystal within 5 Kc of specified frequency 1.7, 3.5, 7 Mc Bands.....\$3.00

Type VM2A. AT cut mounted. Drift less than 4 cycles per Mc per degree C 1.7, 3.5, 7 Mc Bands.....\$4.50

See your dealer or write direct for catalog describing complete line

**THE VALPEY CRYSTALS**  
377 Summer St., Medway, Mass.

itself for the voltage-amplifier stages in amateur speech equipment.

The cells are said to be long-lived when operated under the conditions described above. Suitable mountings for one to three cells also are available. The photograph illustrates two types of mountings with the cells in place.

The grid-bias cells are made by P. R. Mallory & Co., Indianapolis, Ind.

### Standard Frequency Transmissions

Date	Schedule	Station	Date	Schedule	Station
Sept. 2	BB	W9XAN		A	W9XAN
Sept. 4	BB	W6XK	Oct. 3	BX	W6XK
	A	W9XAN	Oct. 4	C	W6XK
Sept. 5	BX	W6XK	Oct. 9	A	W6XK
Sept. 6	C	W6XK	Oct. 16	B	W9XAN
Sept. 11	A	W6XK		B	W6XK
Sept. 18	B	W9XAN	Oct. 21	C	W9XAN
	B	W6XK	Oct. 23	B	W9XAN
Sept. 23	C	W9XAN		A	W6XK
Sept. 25	B	W9XAN	Oct. 28	BB	W9XAN
	A	W6XK	Oct. 30	BB	W6XK
Sept. 30	BB	W9XAN		A	W9XAN
Oct. 2	BB	W6XK	Oct. 31	BX	W6XK

### STANDARD FREQUENCY SCHEDULES

Time (p.m.)	Sched. and Freq. (kc.)		Time (p.m.)	Sched. and Freq. (kc.)	
	A	B		BB	C
8:00	3500	7000	4:00	7000	14,000
8:08	3600	7100	4:08	7100	14,100
8:16	3700	7200	4:16	7200	14,200
8:24	3800	7300	4:24	7300	14,300
8:32	3900		4:32		14,400
8:40	4000				

Time (a.m.)	Sched. and Freq. (kc.)
	BX
6:00	7000
6:08	7100
6:16	7200
6:24	7300

The time specified in the schedules is local standard time at the transmitting station. W9XAN uses Central Standard Time, and W6XK, Pacific Standard Time.

### TRANSMITTING PROCEDURE

The time allotted to each transmission is 8 minutes divided as follows:

- 2 minutes—QST QST QST de (station call letters).
  - 3 minutes—characteristic letter of station followed by call letters and statement of frequency. The characteristic letter of W9XAN is "O"; and that of W6XK is "M."
  - 1 minute—Statement of frequency in kilocycles and announcement of next frequency.
  - 2 minutes—Time allowed to change to next frequency.
- W9XAN: Elgin Observatory, Elgin National Watch Company, Elgin, Ill., Frank D. Urie in charge.  
W6XK: Don Lee Broadcasting System, Los Angeles, Calif., Harold Perry in charge.

### Schedules for WWV

EACH Tuesday, Wednesday and Friday (except legal holidays), the National Bureau of Standards station WWV will transmit on three frequencies as follows: noon to 1:00 P.M. E.S.T., 15,000 kc.; 1:15 to 2:15 P.M., 10,000 kc.; 2:30 to 3:30 P.M., 5000 kc. On each Tuesday and Friday the emissions are continuous unmodulated waves (c.w.); and on each Wednesday they are modulated by an audio frequency. The audio frequency is in general 1000 cycles per second.





**Y**OUR 1937 Communication Receiver should be selected with the utmost care. Good superheterodyne receivers cannot be produced by the assembly methods of mass-production factories. Proper engineering and precision assembly, with step-by-step testing, are essential to perfect reception.

The R M E - 69 is a precision instrument . . . the product of an engineering laboratory . . . custom-built to the highest standards of perfection. It is sold with the definite understanding that you *must* be satisfied.

*Write for Bulletin 69.*

**RADIO MFG. ENGINEERS**

306 First Ave.  
Peoria, Ill.

Save your fist with the  
*Redesigned, Improved, Automatic*  
**ROBOT RADIO KEY**

Repeat calls or messages indefinitely, automatically, by motor driven endless paper tape. Length of tape unlimited. Greater speed and flexibility; sends from 2 to 70 words per minute. Positive roller contacts. Practically noiseless. Induction type motor. New, improved perforating device, easier to use; spacing of characters always uniform. Complete unit, with four rolls of tape, and complete instructions. No additional equipment needed. A practical instrument that answers the long-felt need of amateurs.

**FULLY GUARANTEED**

*Made by Manufacturer of Electrical Instruments*

Price  
**\$12.50**  
Postpaid  
in U. S. A.

PATENT  
PENDING

**Gardiner-Levering Co.** Haddon Heights  
New Jersey, U. S. A.



**8-8-8 mfd. 450 v.**

*. . . in one can!*

New Series GGGL Electrolytics mean better filtering in tight places. ● Three separate sections in single can. Inverted mounting. Hermetically sealed. ● Two ratings—250 and 450 v. workings. In 4-4-4, 8-8-8, 8-8-16 and 8-16-16 combinations.

*Write* for new catalog covering complete condenser and resistor line. Also sample copy of monthly Research Worker

**AEROVOX**  
CORPORATION

73 Washington St.

Brooklyn, N. Y.

# STATION ACTIVITIES

(Continued from page 48)

## CANADA

### MARITIME DIVISION

**MARITIME**—SCM, A. M. Crowell, VE1DQ—Nova Scotia: 11B says DS, DZ and JL dropped in on him for visit while in Amherst. HH is building portable rig. EY still schedules W1AJ. HX is QRL Camp Borden. BZ is back on 3.5 mc. EV and XYL were recent visitors to HH. JM is rebuilding new rig ending up with Eimac 35T. HJ is rebuilding to use new 6L6 metal tube in crystal stage. Congrats to the successful 56-mc. sleuths (JM and HJ) who carried off the honors in the transmitter hunt at Moncton Hamfest. GL has new job at C.P. DQ had several contacts with W1OXDA while off Labrador; VO1I (Oscar and Marge) were recent visitors on way home from the States. W4BBV (Sr. and Jr.), who did such FB work during the recent Georgia tornado, have been in Halifax on vacation. W1AAR of Boston dropped in on few of the boys for quick visit. AG sold his SW5 and is looking around for good buy in used superhet. FQ is rebuilding the 'phone for fall.

Traffic: VE1IB 5.

### ONTARIO DIVISION

**ONTARIO**—SCM, John V. Perdue, VE3QK—R.M.'s: 3WX, 8TM, 3DU, 3GT, 3SG, 3QK, 3GG. P.A.M.: 3NX. AER reports rebuilding activity. YX is doing FB work on 14 mc. and represents Caledonia. DJ is active in Hamilton with low power and looks forward to scheduling VE9CNE. GG has turned over traffic schedules to KH and is very QRL with emergency net plans for fall. WX and RO along with QK are sporting healthy tans in the wilds of northern Ontario. GT and Tommie are vacationing in Flatbush. Don't forget your suggestion on VE3 frequency plan. VD worked Z2L on 7 mc., also CN8MI, 73.

Traffic: VE3WK 30 AU 25 QB 17 CG-GT 4 AE-NC-ZV 1

### QUEBEC DIVISION

**QUEBEC**—SCM, Stan Comach, VE2EE—With the summer months we have had the pleasure of meeting some of our neighbors. W2JPS passed through Montreal playing at Loews Theatre; both the S.C.M. and BU saw quite a lot of Hal. C6UW also paid the S.C.M. a visit and dropped in to see the C.G.M. JK is back on the air after months of hard sledding at school. DR, our genial R.M., regrets having to relinquish that position in our Field Organization; we hate to accept that resignation. Bill, II is still doing good work handling traffic. JZ has built a very FB rack and panel job. EI is a newcomer in Cookshire. MB is located in Megantic. EA is operating 'phone and c.w. on 14 mc. IN is having a fine time at camp, 75 miles north of North Bay, and can be heard on 7 mc. under the call 3AJU. HG is located at St. Gabriel de Brandon for the summer. DA is also at this resort. HG has worked 68 countries. EC, the old reliable, is making improvements on the old rig. IY is talking about 6L6 final and new Super-Gainer. IJ is building a new superhet. EX is using a 6L6 oscillator. LJ is still building. LV is building a rack job. MC is getting out well on 14 mc. LQ sustained a slight injury to his left foot; we understand everything is ok now. We retract our last month's statement that IL has gone crystal; definitely NO. GZ has gone North into the Hudson Bay Territory and Doug Jarvis, x2AG, sailed for the Arctic on the *Nascope*. AH is investing in a pair of 35T's. The M.A.R.C. extends thanks to all who attended and made such a success of their annual picnic; quite a bit of 56-mc. activity was in evidence; regardless of what may be said to the contrary, the 'phone men defeated the c.w. men in the baseball game 24 to 6. HI.

Traffic: VE2JK 27 J2 11 BB 19 BU 33 DR-EC 23 HG 5 EE 6 BG 32. VE2II 62 CA 9.

### VANALTA DIVISION

**ALBERTA**—SCM, Alfred D. Kettenbach, VE4LX—The Calgary hamfest, July 4th and 5th, was a very enjoyable affair, and the Calgary bunch is to be congratulated on

the very successful way it was run off. AH won the only Canadian prize in the HalliCrafter contest. BW took HM and QX to the Calgary hamfest, went by way of Hanna and picked up GM, and then visited LX and LA on the way down and ZD on the return trip. BW is moving transmitter from the attic to a more comfortable position downstairs, and rebuilding at the same time. PH has been QSO several VK's and J's. ADD and ADR are two new calls in Edmonton. HT was at the hamfest. EA attended Calgary hamfest. ZP has returned north, commercial, and has ham rig with him. W7FL and XYL, W7CCR and W7ABT, were among those present at the Calgary hamfest. JK is on 14- and 3.9-mc. 'phone regularly. GD is off the DX fishing for a spell and is trying his luck with the trout. SW is vacationing. JJ is on a trip to the States, and is being heard daily over various stations he is visiting.

Traffic: VE4LX 27 HM 10 EO 7 GE-QK 2.

**BRITISH COLUMBIA**—SCM, D. R. Vaughan-Smith, VE5EP—Heavy traffic is being handled on Vancouver Island in connection with the Y.M.C.A. Camp at Glins Lake, Sooke, B. C. IC holds down the camp end and contacts OK, IL and DV; through this OK and IC make the B.P.L. FB! At the Y.M.C.A. Camp at West Howe Sound DB is the official station with IN operating at present; he is kept in contact with Vancouver through the cooperation of KC, JS and FQ. IL, a first reporter, shoves in a good total. PI expects to QRO soon. HI runs 250 watts of modulated pep on 3.5 mc. and has plans for a half kw. CB, Victoria, and FG, Prince George, were visitors to Vancouver and the B.C.A.R.A. ER hit the club same night and promises to stick around! The Vancouver Club enjoyed an optical lecture which took in the manufacture of crystals, and a very helpful talk on meters, both in the same month. The club is now pushing plans for display and station at Vancouver Exhibition. North Vancouver Club has taken time out for summer holidays! AV is busy with the Island Net. NG is sort of peeved because rig won't perk on 7 mc.!

Traffic: VE5EP 27 OK 316 IC 377 IL 46 DV 82 KC 83 BJ 7 JS 52 FQ 26 DB 172 HI 19 DD 20 PI 1 JY 9.

### PRAIRIE DIVISION

**MANITOBA**—SCM, A. J. R. Simpson, VE4BG—QF returned from a vacation down South and sends his thanks to all the W5's who helped to make his visit most enjoyable. QC returned after vacationing in Toronto and reports an FB time. RO is about the most consistent station and has FB quality on 'phone. A bunch of the Winnipeg gang, namely, QC, KU, MY, UX and BG motored down to Kenora and had an FB visit at VE3ADF. ZK has a pair of 150T's and will have real power soon.

**SASKATCHEWAN**—SCM, Wilfred Skaife, VE4EL—A nice little get-together took place at the shack of KJ when ES, OC and WF from Weyburn and KE and LU from Wicox blew in on Sunday, July 5th. WK left behind motor-generator which KJ is now using with great success in his late "Flea-power but now Grass-hopper" station. YC now has crystal 1.75-mc. 'phone. AT at Govan is getting lined up for 1.75-mc. 'phone. Saskatoon: RJ now has ACR-175 decorating the shack and is going places on 3.9-mc. 'phone. UD while going strong East had his plate transformer go West. HI, QZ snagged a couple of rare countries on 7 mc.: Salvador and British Solomon Islands. UC is on 14 mc. TN is ironing the bugs out of his 3.9-mc. 'phone and has his eye on 14 mc. MB is waiting for those long delayed DX cards. Ex-4EJ took unto himself an XYL. Congrats, OM. XB is socking out on 7 mc. with 53 crystal, doubler and '10 final. FD's 28 watt Class B modulated 'phone is hooking real DX on 14 mc. FB, Charlie. Regina: CM is getting out fine on 3.9-mc. 'phone. Keeping in touch with the gang, your S.C.M. paid a very enjoyable visit with Les. Sedore, and was it hot in AU's shack? Nice contacts were made with Regina, Moose Jaw, Brandon and numerous U.S.A. stations on 3.9-mc. 'phone. Calling at Frobisher EL made the acquaintance of Frank and Harry Meadows, who were old time friends over the air. Continuing to Estevan, I had a good visit with NE and VU and saw ES for a short time at Weyburn.

Traffic: VE4QZ 6 PQ 4.

NEW ENGLAND DIVISION

CONNECTICUT—SCM, Frederick Ellis, Jr., W1CTI—Philip Everett Batteny arrived July 15th. Congrats to Mr. & Mrs. IUEI DOW was in hospital with pneumonia. Sure hope OK now. AFG and BFS are rebuilding. IKE visited GME. DMP is state representative for A.A.R.S. and will give any inquiries his prompt attention. BDI was in Washington for June F.C.C. hearing. HZK is active on 56 and 3.5 mc. CJD is now back in Conn. and on the job as R.M. again. CBA is engaged in building a new transmitter and a 100-foot mast. Several of the gang raised a big crop of blisters digging holes for guy anchors! Send the S.C.M. your idea on best time to operate a Section Net this fall. A time will be set to suit the majority.

Traffic: W1INF 146 UE 23 GME-DOW 17 AFG 16 IKE 11 DMP 6 BDI 5 BQS 1 CTI 2 GKM 9. (May-June, W1UE 23.)

MAINE—SCM, John W. Singleton, W1CDX—BTG has new rack and panel job with 800 in the final. INW handles a little traffic with VE1IN. GOJ will handle schedule for Marine Convention at Boston. EZR reports the death of GPJ's son Richard—the Section expresses its sympathy to GPJ. DHH worked VS and thinks he is 2nd Maine amateur to work that country. JFF has finished new 56-mc. rig—look for him on that band. 2TOP BT1 is operating portable at Cedar Crest Camp in Oakland, Maine. IUA is doing some very fine work on 56 mc. and would like to hear from others interested in 56-mc. work; he has 85 watts input. ICB is active this summer in Lucerne and doing some experimenting with directional antennas. 3GHE is operating portable in N. Jay, Maine; 3AUS is visiting with him.

Traffic: W1BTG 93 INW 40 GOJ 9 EZR 3 CDX 2.

EASTERN MASSACHUSETTS—SCM, Albert N. Giddis, W1ABG—AKS leads the Section this month. HWE keeps up the pace on 56 mc. ABC is undecided on whether to keep his '59 exciter unit or change to straight crystal. ASI looks forward to a busy winter. RE is still keeping schedules. JXU complains of QRN. IWC added an 804 amplifier to his '59 crystal. HKY is continuing the "burning up" process on his rig! JID won radio competition drill at N.C.R. assembly. ZQ did all his operating on Army frequencies. IPK is building a multimeter fit for a "Lab." JOX is working three bands with a '47 crystal-'10 final rig. IZL is back with us and promises a traffic total next month. JED is new Secretary of the M.V.A.R.C. QW is enjoying himself working 56-mc. portable. WV's DX reports look like a couple of pages out of the Call Book! IPK and JOX reported for the first time. Welcome, fellows! AKE, GGB, JID and JRH are going on N.C.R. cruise to Cuba. Well, gang, enjoy your vacations and get plenty of rest so that we can outdo that threatened comeback from Connecticut! Hi.

Traffic: W1AKS 134 HWE 103 KH 52 ABG 34 JCK 28 JSK 21 ASI 18 BEF-GGB-CIK 17 RE-AKE 12 JXU-HWZ-ISM 6 IWC-HKY-JID 4 ZQ 1 (W1LGO 60).

WESTERN MASSACHUSETTS—SCM, Percy C. Noble, W1BVR—EOB makes B.P.L. on deliveries; much of his traffic was handled with IJW, Boy Scout camp at Brimfield. BVR is trying to make a tritet "tritet" on 14 mc., and an 804 final act like a gentleman on same frequency. JAH is handling R.M. schedules three evenings per week. BVG is getting out much better with a new RK20 rig. AJ is keeping schedules with NY1AA and VE1IN; also, he has new aerial, new masts, an ev'rything. HJR seems to be a "traffic-handling" O.P.S. FB. IJR has new job at Sprague's. ISN is getting nearer to W.A.S. COI is changing over from O.R.S. to O.P.S. ARH is working 3.5 and 14 mc. ASY is building new rig for fall. JXN is also rebuilding, and is experimenting with "2 1/2-meter" phone. New appointment: BVR is now O.B.S. Official Broadcasts are sent 3732.5 kc. on Mondays and Fridays at 7:30 p.m. (EDST).

Traffic: W1EOB 241 IJW 149 BVR 61 (W1LG 89) JAH 34 BVG 27 (W1LGE 50) IOR 22 AJ 15 HJR 8 IJR 5 ISN 4 COI 2.

NEW HAMPSHIRE—Acting SCM, Homer H. Richardson, W1AXW—Having been pressed into service by the press of AVJ's printing presses pressing him to retire (apologies to Gertrude Stein) I believe a status report of the Sec-

tion to be in order. As of July 16, 1936, the Official Appointees are: R.M.'s: FFL, IP, BFT. P.A.M.: AUJ. O.R.S.: GKE, EFL, BFT, FFZ, IJB, HJI, EAL, GHT, ILK, JDF, APK, IP, FCI. O.P.S.: AUJ, APK, BDN, IDY, ANS, CEA. O.B.S.: APK, EAW, IJB, BFT, AUJ, FFL, DUK, SK. 31 appointments in 22 stations. 17% of the Section's A.R.R.L. membership or approximately 9% of the State's amateurs now holding appointments. The Section boasts no Official Observer and only one 'Phone Activities Manager. How about it, gang? Please study this and let's hear from you qualified men. Note that the Conn. River Valley is nearly void of appointees. With the start of the next active season I would like to see the State efficiently covered its entire length and width with reliable Official Relay and Official 'Phone Stations. C.R.M., V3, Henry C. Aspinall of the U.S.N.R. is engaged in forming units in Dover, Laconia and Farmington. 24 have signed in Dover to July 10th, 2 in Laconia and 12 in Farmington. Anyone interested should get in touch with Mr. Aspinall at 11 Walnut St., Dover. BRT will be Executive Officer of Dover Unit. BFT is "W.A.S." but needs Nevada card to prove it. AEF finally convinced his 841 buffer that it had been laying down on 14 mc. GQV schedules UE providing a fine outlet for summer traffic from the Beach. HOY's 56-mc. doubler continues to work as well as ever with one feeder off at antenna end. HSC and DUK report visit by 3FTU former football coach at Portsmouth High School (1916). CEA is sporting a new truck, lettered to kill. DUK may be heard nightly at 6:45 EST sending latest Official Broadcast on 14,360 kc.—a worldwide broadcast. IP is taking 56-mc. rest-cure preparatory to a busy 3.5-mc. season. APK now has second operator—a boy. Congrats. Incidentally, lightning also visited APK, doing considerable damage to his equipment. CME was on Press Boat following vacation tour of President Roosevelt. AQX seems to have deserted 14-mc. DX for 3.5-mc. work. GMH is vacationing in northern New Hampshire. IVU is after elusive 14-mc. 'phone and c.w. DX. IJB has his '42A laying on its back but running. Don't forget, fellows, this report is written on the 20th, so yours must be received before then. 73.

Traffic: W1IP 24 GTY 1.

RHODE ISLAND—SCM, Clayton C. Gordon, W1HRC—BVI is on 1.75-mc. 'phone. JUC and JIK play chess on 56-mc. 'phone. Newport 56-mc. gang, including BLS, AWG, JSB, HJ, is working W6's on "5," but they are only out in the Harbor on Navy ships—Hi. JGE has shack so small that if he got kicked by power supply he would end up outside wall. JNO lost some tubes doing it, but made 1.75-mc. 'phone. BJA built his first "standard relay rack" while HRC worked with him and built his second "ditto." JPJ is new O.R.S.

Traffic: W1HRC 2.

VERMONT—SCM, Alvin H. Battison, W1GNF—R.M.: IFSV. AHN returns from trip to N.Y.C. ATF is harvesting hay crop. GAN and GAE received Class A tickets. There are five 3.9-mc. 'phones in Rutland now: AAJ, AVP, CII, GAN and IRO. EZ and IZM visited JHK, FPS, GNF, ELR, EFC and EWF. FPS W.A.S.'d; he also worked VE5 and ZLA. AOO worked ZL and VK on 3557 kc.; he is QRL orchestra five nights a week. EFC renewed O.P.S. and works ZL on 14-mc. 'phone. ELR added RK-20's to his exciter; he now has FBT receiver. GVJ plans to spend the summer in Maine. CUN is now operating from Barre. BD and family returned from visit to the South; we wonder how "Green Mountain Rattlers" and "Dixie Squinch Owls" act turned loose together. EZ, IZM and FGO operated in the Field Day Tests; EZ/IZM was the Vermont winner. JHK is QRL bookstore and getting settled at his new QTH. IQG returned from Ohio. ERJ is practicing marksmanship on the local rifle range. GNF joined A.R.R.L. Emergency Corps. JKE is developing rapidly. GGR is on again and is preparing for fall activities. GAZ is cashier in restaurant. IJU of Hardwick has new Cross transmitter. GAE is now O.B.S.; he visited FSV.

Traffic: W1FSV 91 AOO 52 GNF 38 GAE 21 EZ 16 AVP 12.

(Continued on page 78)

Code translated:  
(MUJT and JEFF)

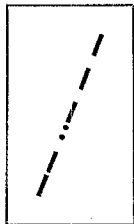

--- --- ---

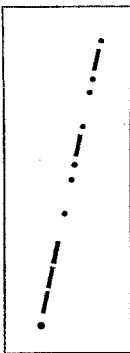

of the microphone world. You will see them in Turner booth No. 41 when you visit the Chicago Trade Show Sept. 5, 6, 7

**THE TURNER COMPANY**  
CEDAR RAPIDS, IOWA

Microphones licensed under patents of the  
Brush Development Co.

Harvey presents

## NEW EQUIPMENT FOR THE MODERN STATION

● 700-A class B linear or class C amplifier using push pull 150-Ts. Inputs up to one kilowatt.

● UHX-35 crystal controlled UHF transmitter with a tuning range of 2½ to 20 meters. 60 watts input to the final amplifier.

● CT-80 transmitter or driver. Tuning range 10 to 160 meters. 125 watts input.

● MI-4 percentage modulation indicator, phone monitor and carrier shift indicator.

### Continuing the Popular

- 60-X CW transmitter — 80 watts input.
- 60-T CW and Phone transmitter — 80 watts input.
- 200-R CW and Phone transmitter — 320 watts input.

Full details on any or all of the above  
Units may be had on request

**HARVEY RADIO LABORATORIES, INC.**  
12 Boylston Street Brookline, Mass.

Export: 25 Warren St., N. Y. C. Cable: "Simonrice"

## Hints and Kinks

(Continued from page 41)

ground pin. Also, the same method can be readily applied to r.f. coils in the set.

— . . . —

## Break-in Monitoring

A METHOD of continuous monitoring which works as instantaneously as the transmitting key, and at the same time eliminates the noise from the receiver so common on those systems which connect both monitor and receiver to a single pair of 'phones, is shown in Fig. 5. This scheme is a suggestion of C. W. Cashatt, W9JMX. Essentially, the method consists of a relay arrangement which disconnects the headset from the receiver when the key is pressed, the monitor being connected to the 'phones continuously. This arrangement is said to be noiseless, since the relay breaks only a small current in the 'phone circuit.

Two audio chokes are necessary, one for the plate circuit of the receiver and the other for the monitor plate. The 'phones are condenser-coupled to both so that there is no d.c. in the 'phone circuit. The relay coil is connected in series with the keying relay, and the contacts should be arranged to open when the key is closed.

## DX Scores

(Continued from page 36)

W5AYO	48-	4-1-	A-14	W6BUO	264-	8-1-	--	--
W5ERS*	3-	1-1-	A-4	W6MPK	228-	7-2-	B-11	
				W6HG	210-	7-1-	A-12	
<i>Louisiana</i>				W6PVD	210-	6-1-	A-10	
W5WG	7020-	36-3-	B-61	W6RR*	210-	7-1-	B-12	
W5KC	3340-	20-2-	B-39	W6BJD*	192-	8-1-	---	
W5BRR	770-	14-3-	B-22	W6DVT	189-	7-2-	B-8	
W5DAQ	65-	5-1-	B-5	W6ELC	175-	7-2-	A-6	
W5BZR	3-	1-1-	---	W6LBE	165-	5-1-	B-4	
W5BDJ*	3-	1-1-	---	W6L BX	144-	6-2-	A--	
				W6AAE*	96-	4-1-	---	
<i>New Mexico</i>				W8ICA-6	54-	3-1-	A-8 <sup>30</sup>	
W5CJP	520-	10-2-	A-14	W6BQQ*	45-	3-1-	---	
W8EWS-5	378-	9-2-	B-7 <sup>12</sup>	W6DTY*	27-	3-1-	A-3	
W5AAX*	182-	6-2-	B-4	W6JGI*	18-	2-1-	---	
				W6MJU	3-	1-1-	---	
<i>Los Angeles</i>								
W6GRL	57222-	102-4-	C-89 <sup>18</sup>	<i>Santa Clara V.</i>				
W6CXW	50661-	102-3-	C-90.4 <sup>18</sup>	W6FQY	35964-	81-4-	BC-67	
W6KRI	40416-	96-3-	C-89	W6CSI	8541-	39-3-	B-52	
W6GRX	39060-	84-3-	B-89	W6HJT	6700-	25-2-	---	
W6CUH	34932-	82-3-	C-86	W6DSZ	4611-	29-2-	C-28	
W6KIP	14280-	51-3-	B-75	W6NEX	1148-	14-1-	AB-53	
W6GAL	12192-	48-3-	AB-54	W6HB*	798-	14-1-	B--	
W6ANN	10935-	45-3-	BC-65	W6L SX	195-	5-1-	B--	
W6TJ	10865-	45-3-	B-38	W6MKD	105-	5-2-	AB-11	
W6IRD	6545-	35-3-	B-74	W6HXY	56-	4-1-	A-6	
W6KRD	6510-	35-2-	B-36	W6DL	3-	1-1-	---	
W6EPD	5577-	33-2-	B-63					
W6KNF	3290-	32-2-	C-43	<i>San Diego</i>				
W6WQ	4354-	27-2-	B-36	W6NKY	31768-	76-3-	C-87 <sup>21</sup>	
W6EWC	3510-	27-3-	B-63	W6EPZ	18005-	55-3-	BC-62	
W6AX	3432-	26-2-	BC-35	W6KBD	11797-	47-3-	B-56	
W6GK	3220-	28-2-	C-47	W6BAM	10191-	43-3-	B-84	
W6JWL	2220-	20-2-	B-24	W6NHC	7752-	38-3-	B-83 <sup>21</sup>	
W6ALX	1640-	20-3-	B-27	W6AXC	5207-	31-3-	B-67	
W6LEZ	1820-	18-2-	B-23	W6LDJ	3192-	24-3-	B-26	
W6GHU	1598-	19-2-	B-19	W6DCY	2808-	24-2-	B-44	
W6IDW	1440-	16-2-	A--	W6GTM	2128-	19-2-	A-26	
W6AM	1215-	15-2-	C-15	W6QG	1312-	16-1-	A-30	
W6FKZ	780-	13-2-	B--	W6BVX	693-	11-3-	B-31	
W8FAD-6	720-	12-3-	A-23 <sup>19</sup>	W6AKY	675-	10-2-	A-13 <sup>28</sup>	
W6DQZ	598-	13-2-	---	W6LHN	284-	8-2-	A-15	
W6BXL*	540-	10-1-	C-14	W6MNV	198-	6-1-	A-5	
W6CII*	369-	9-1-	---	W6LUJ	189-	7-1-	B-7	
W6CPG	312-	8-1-	B-21	W6LTX*	12-	2-1-	A-1	
W6MAN	294-	7-2-	B-36	W6MTU	3-	1-1-	---	
W6KSY	288-	9-2-	C-13					

(Continued on page 78)

# NEW FORM—LOWER PRICE

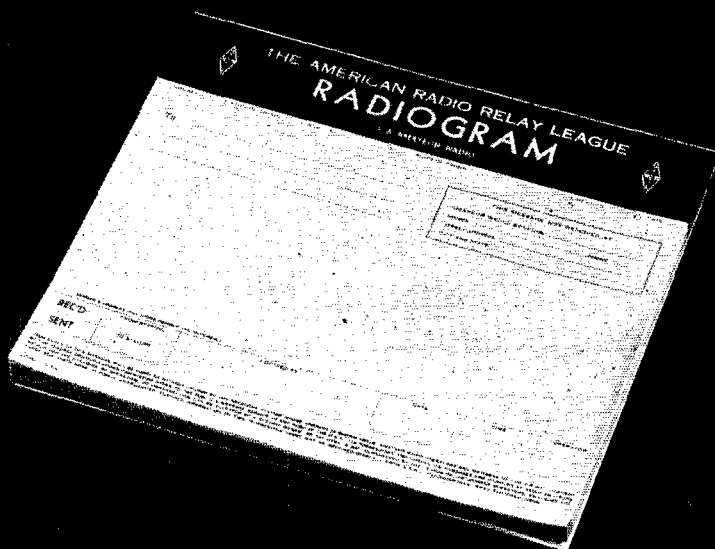

Now—25¢ per pad of 100 blanks

**American Radio Relay League, West Hartford, Connecticut**

## **BUD** IMPROVED MIDGET CONDENSERS

*Note These Improved Features!*

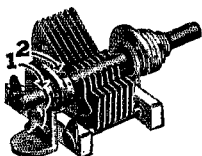

- 1. New Positive Wiping Contact** on rotor shaft with adjusting screw, eliminates mechanical noise on high frequencies.
- 2. Close Fitting Bearings** hold rotor calibration and smoothness of operation.
- 3. Insulated with ISOLANTITE.** Soldered brass plate assemblies, and heavy aluminum end plates make a precision built, ruggedly constructed condenser.
- 4. Shaft extends 5/16" beyond rear bearing** for ganging several units with flexible couplings.

Dual units and multiple space units in various capacities illustrated and described in our new catalog. Free upon request!

**40% DISCOUNT TO AMATEURS**

**BUD RADIO, INC.** 1937 E. 55th Street  
Cleveland, Ohio

## RATTLE THE AUSSIE'S FONES WITH THE MB50

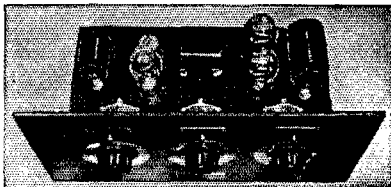

This modern, flexible, inexpensive crystal-controlled Transmitter Kit uses a 59 "Tritet" Oscillator, driving a pair of 802's to 50 watts output. No neutralization is required. Coils are available for operation on all bands from 160 to 10 meters.

The MB50 Kit uses the highest quality parts representing such names as National, Hammarlund, Sengamo, Varley and others equally well-known. The complete kit includes all component parts, a drilled, crackle-finished chassis and panel, metal-etched dials and one set of coils. Complete with instructions. . . . . **\$19.90**

Send for New Radio Catalog Now on the Press

**M & H Sporting Goods Co.**

512 MARKET ST.

PHILADELPHIA

1709 Atlantic Ave.

Atlantic City

## HUDSON DIVISION

**EASTERN NEW YORK**—SCM, Robert E. Haight, W2LU—With the arrival of 8½-lb. YL at LU's, traffic picks up. HCM reports keeping schedules with Camp Smith, V7N; HOA and HKZ assisted HCM. CC is vacationing with 9WR in Illinois. HYC is revamping for fall rush. SOAG bought new bug. 2JAX is on 3.5 mc. JWK is using 150 watts to '03A and sports new Super Sky rider. HCP is working hard down in Dallas, Texas. IVR has matched imp. ant. BDB is on 7 mc. for summer. JAX is pres. of M.P.H.S. Shortwave Club. CL was misquoted in July QST as being on 'phone; he is only on c.w. (ONLY). HNH visited IJMH. We are sorry to hear that FQG, R.M. and O.R.S., is sick at Albany Sanatorium; he would appreciate hearing or receiving a visit from his brother hams. BJP and DSB are new O.P.S. Welcome, OM's. JQS/1 is working portable in New Hampshire camp.

Traffic: W2LU 149 HCM 24 CC 11 HYC 3 SOAG 1 2JAX 1.

**NEW YORK CITY AND LONG ISLAND**—SCM, Ed. L. Baunach, W2AZV—New O.R.S. HLI, IOW and JHB, BLL (O.R.S.) 1 and AVS (O.P.S.) are now in this Section. ITX and JBL are out for O.R.S. appointments. DEQ is back on the air on 3510, 7004 and 14,008 kc. A new Jr. op keeps AHC busy. EYQ is preparing for heavy traffic season. IHT is adding 801's to 3.5-mc. rig and finds 56-mc. operation in car FB with JBL. Lightning struck near PF's antenna July 14th, and burnt out two Weston thermo couple meters. Summer time keeps GDF camping out with the Boy Scouts on week-ends. IZU is trying break-in on 56 mc. FIP is going on N.C.R. cruise aboard U.S.S. Badger, and HRA is going on U.S.S. Yarnall September 12th. FF has been on a vacation in Canada. AKM was a guest artist with other "big shots" at N.B.C.'s initial "Television" broadcast on July 7th. GVX is having a very good success with his controlled carrier 'phone job using a 2A3 to control the 801 drivers and grid-modulating the 150T in the final running from 80 to 325 watts on peaks. JFP is on 56 mc. with '45's in P.P. CYX schedules FNY on 1.75-mc. 'phone at Camp Arrowhead, Poultney, Vt. CHK is operating BC station WGBB. HLI is trying 1.75-mc. 'phone. IOP is operating portable at Cedar Crest Camp, Oakland, Maine. BLK is trying a 53 as combination oscillator and buffer. BMG sends his first report. HGO finds conditions changing on 7 mc. HWS has new crystals on 7006 and 7288 kc. HXT is waiting for cool weather to put up his 1.75-mc. Zepp. GNC is going to California. HRS schedules HTX. APV schedules HA5PA. EYS can be found on 3640 kc. AZV is working on 14 mc. for the summer.

Traffic: W2BMG 118 PF 81 IOP 60 EYQ 53 HRS 41 IET 37 CYX 32 AZV 19 FF 16 FLD 13 DBQ 9 HLI-APV 7 GDF-AHC-HBO-HXT 6 EYS-HRA 5 IZU-HWS 4 HMJ-HGO 3 KI 1.

**NORTHERN NEW JERSEY**—SCM, Chas. J. Hammersen, W2FOP—HNP spent vacation in Ohio. GGE is experimenting with antennas. GGW is going on trip on N.C.R. ship. GVZ is handling DX traffic on 14 mc. HQL is at Camp Knox, Kentucky. HXI was on vacation in Pa. CIZ will stick to c.w. for a spell due to power supply on 'phone rig going west. CTT is home from college looking for a job. IQM is working portable at Millville, N. J. HFB is new O.P.S. IGN and IZV want O.P.S. CQX has new rig. IKD is steamed up over 56-mc. DX. IEU is moving to Yoselle Park. GON is still on 1.75 mc. GCV decided to get on the air after being off for two years. ICM finds his new QRA works out FB netting him a bit of DX. BTZ is on 4-mc. 'phone. DKA is yachting as usual this summer. FFY contemplates grid modulation on 14 mc. due to loss of 42A from his Class B. IDZ is more active on c.w. than 'phone. GZG spends week-ends on the motor cruiser *Sturgeon*. HIX is spending entire summer working portable in Conn. IMB is portable at Point Pleasant. DAC is holding regular schedules with Penn. JDO is working to get on 1.8-mc. 'phone. JOU uses car radio as audio and power supply for 56-mc. rig. EJO and EBR are working mobile on 56 mc. ING is getting ready for M.L.T. this fall. IYG is new member of U.C.A.R.A. AUP, GNN and DZS are on 56 mc. GOJ built new rack and panel job. GBZ is coming back from Hawaii this month.

Traffic: W2HNP 248 GGE 142 GGW 48 GMN 47 GVZ 41 HQL 36 CGG 27 HXI 22 ICJ 18 CIZ 16 BZJ 9 CJX-CTT 6 IQM 5 FOP 2. (May-June. W1BCX 721 WLNF 687.)

## ATLANTIC DIVISION

**EASTERN PENNSYLVANIA**—SCM, James M. Bruning, W3EZ. PAM 3EOZ. RM's: 3AKB, 3AQN, 3EOP, 3ASW, 3BZP, who was confined to bed for the past year, is now allowed to come down stairs. 3FBJ is building angle-iron rack for transmitter. 3CEQ sends first report. 3EWJ enjoyed Fort Meade C.M.T.C. Camp. 3DSG has new batch of QSL cards for distribution. 3EPJ worked CP1AA and OAAJ for his first S.A. contacts. 3BGD is still looking for Utah contact for W.A.S. 3AMR/3NF has been acting Army Net Control on 3.5 and 7 mc. 3EU still travels around the country with his P.A. and Movie system truck. 3ASW has been giving his emergency/portable rig a good workout. 3MRQ is rebuilding. 3BRZ has continued success with 14-mc. 'phone. 3EOP remained active on both c.w. and 'phone during summer. 3GGM says his first CQ was heard in Russia by U5AK. SUV applied for O.R.S. 3OHT expressed interest in O.R.S. appointment. 3IU made changes in crystal and buffer supply to improve regulation. 3ADE has been rebuilding. 3AQN has kept busy doing house wiring. 3EUP worked his first K6 and VK2. 3BY5, 3EOZ and 3ETM are active as usual. 3MG and 3EKG report their activities curtailed by heat. SUV went to National Guard Camp at Indiantown Gap. 3DIG operated again at National Soaring Meet in Elmira and sends following report: "The *FIRST DUPLEX* transmission between a soaring glider and ground station took place at Elmira. Perfect transmission was checked by Dept of Commerce and numerous aviation authorities, and marks beginning of new activity along this line. Work was on 41,000 and 38,600 kc. experimental frequencies under supervision of Elmira Radio Amateur Association." Nice work, "Dig."

Traffic: W3AMR/NF 92 (WLML 451) 3EOP 26 (WLQB 21) 3AGK 26 3FBJ 7 3GGM 6 3BGD 5 3EOZ-EUP 1 W3EKG 31 SUV 26 3MRQ 17 3ASW 7.

**MARYLAND-DELAWARE-DISTRICT OF COLUMBIA**—SCM, Edgar L. Hudson, W3BAK, 3CQS, 3CXL, 3EQU, R.M.'s. 3BWT, Chief R.M. 3WJ, P.A.M. Capt. Minckler, of CXL, attended the Atlantic Div. Convention at Wilmington. EZN is away on maneuvers with 260th Coast Artillery, D.C. National Guard. CWE just returned from a cruise to Panama. FMR is building new 600-watt rig. FSP has new rig with pair of 841's in final. GFF worked all except seventh U.S. district with 14 watts. CDQ, BAK and BKZ attended Atlantic Division Convention at Wilmington. IL reported in person. GKT is new O.R.S. located at Ferris Industrial School, Wilmington, Del. ASE is with U.S. Coast Guard, stationed at Norfolk, Va.

Traffic: W3CXL 139 (WLM 1348) BWT 132 CIZ 28 EZN 20 CWE 5 FMR 4 FSP-FPQ 3 EPD 2.

**SOUTHERN NEW JERSEY**—SCM, Carroll D. Kentner, W3ZX—Members of the South Jersey Radio Ass'n are looking forward to a huge time on their annual outing in August. BEI is replacing his 211's with 805's. BIR reports organization of the Trenton Radio Society; officers: pres., AWE; v-pres., ENZ; sec'y, BIR; treas., AIR. FOS just graduated from Vocational School. GAI is new reporter at Pemberton; he has worked W2 with 1.85 watts. EWF has new rig using crystal mike, 6L6 modulators, and 50T final. The S.C.M. is glad to get report from CFB; he and BO are taking good care of traffic from Pine Camp, N. Y., during encampment of the 112th F.A., ZI, operating portable 3AOV-8 at Pine Camp, is ably handling all traffic originating from the encampment. FTK returned from vacation will resume schedules. CES schedules FFX.

Traffic: W3BEI-BIR 4 ZI 38 AEJ 6 FOS 4 DNU 10 CFB 22 BO 3 CES 14.

**WESTERN NEW YORK**—SCM, Chas. F. Smith, W3DSS—The picnic at Panther Lake sponsored by the Oneida Radio Club in July was a big success. DSS leads the traffic gang with a nice total. CSE handled important traffic from the schooner *Bowdoin*. CPJ is getting better totals each month. LUQ lost his pet 14-mc. antenna in wind storm and reluctantly had to use 3.9-mc. 'phone. NNJ and

ONC are experimenting with 56-mc. mobile outfits. CGU decided to use EO-1 cable in his antenna feeder and immediately lost a strong 3.5-mc. harmonic! BJO is waiting for radio parts. BHK knocks off such DX as D's, G's and OK's whenever he can find a minute or two away from refrigerator sales. AQE is still on night shift. DHU is again O.R.S. in our Section. HTT is trying O.R.S. exam soon. GWT visited many ham shacks on his ten-day trip around the state. MBI will be on soon with increased power. FUG never fails to report. MQX and PFK did Yeoman work with a radio exhibit and station at the Tonawanda Centennial. QBB is new ham in Buffalo. MFB is painting oil wells in Michigan. Probably an oil painting! OMD is coming back with new rig. Due to lack of interest at present in our Section Slogan Contest, the expiration date has been extended to Oct. 31st. How many are in favor of a W.N.Y. QSO Party? Send in your suggestions with the next report. 73.

Traffic: W8DSS 144 CSE 27 CPJ 23 FUG 18 LUQ 5 LGV 3 JTT 2.

WESTERN PENNSYLVANIA—SCM, Kendall Speer, Jr., W8OFO. R.M.'s: 8KWA, 8MOT. Many thanks for the splendid support in the recent S.C.M. election, Gang! Best wishes to the retiring S.C.M. 8CUG. I only hope I can do half as well as Shorty has. Prospective O.R.S.—LZT. KWA has new rig with three '52's in final. MOT, NDE and KBM are rebuilding. FIP wants W.Pa. QSO contest with prizes. (What do you say, fellows?) KOB is busy with aviation. IOH finally received his W.A.S. (Congrats.) JZ is operating YA this summer. ADY is operating on special A.A.R.S. frequency during summer. KUN finds some traffic on 7 mc. PN's grandmother passed away on the Fourth of July. (Our sympathies, Gil.) GUY reports the 35T doing fine on 14-mc. 'phone. DGL is sponsoring a school radio club and reports four new tickets already. (Fine work.) CMP is vacationing in Michigan. UK is just out of the hospital. LOQ will attend the University of Wisconsin this fall. OFO has a new 814 final now with 400 watts. MIW completed his Super Gainer.

Traffic: W8MOT 14 FIP 7 KOB 50 IOH 14 ADY (WLQV) 27 KUN 14 GJM 2 DGL 7 KBM 12 CMP 16 LZT 74 OFO 16.

#### ROANOKE DIVISION

NORTH CAROLINA—SCM, H. S. Carter, W4OG. Oxford: ECH is working on 3.5 and 7 mc. King's Mountain: DOZ is having good results with his 6L6 crystal oscillator. DOQ is rag-chewing on 3.5 mc. DOV worked 4 Europeans in one night; he went to the Army Reserve training camp at Columbia, S. C., for two weeks. CEI has WAC'd and needs only Nevada for W.A.S. Gastonia: CEN worked LA2X, who was a recent visitor to Wilmington. Mount Holly: CYY had "41R, Dixie Jones" as a visitor. Greensboro: AEL is rebuilding. MR is building a small rig to work his 3.5-mc. friends, and will keep his other rig on 7 and 14 mc. for DX. Raleigh: BTC is spending the summer at camp near Asheville. CDD is QRL with orchestra. BUE is building new rack and panel job. BBV and BBV Jr. were visitors at BRT. Morganton: DSO, a new ham, is working plenty on 7 mc. Winston-Salem: EBB of Birmingham, Ala., was a visitor to 4NC and the W.S. gang. DWB is in Virginia working up a storm as portable. CJA is working VK's and ZL's every morning with 35 watts input. CKJ says he has parasites. CNF, home from school, is keeping the 18-watt portable transmitter of 4NC hot while the other rig is being rebuilt. DGV is working plenty of DX on both c.w. and 'phone. With the 'phones: CYB is doing his regular summer rebuilding. CLB, one of the "Traveling Reporters," has just returned from an extended trip to New England. CPT, the other "Traveling Reporter," reports that while at Boston, he went over to Harvard University to visit his friend T. S. McCaleb, instructor in radio in the School of Geographic Exploration. BQZ is building public address systems. BPL is QRL local BC station. FT says 28 mc. is dead so he is on 14-mc. c.w. DYT is trying to find a good receiver. DCQ has returned from summer school and will keep his 750 watts busy on 3.9 mc. 73.

Traffic: W4ECH 14 CEN 11 CJA 6 DSO 4 MR—BRT 3. VIRGINIA—SCM, Chas. M. Waff, Jr., W8UVA—DQB has completely rebuilt, including new receiving and trans-

mitting power supplies and two new transmitters. FQO got on 14 mc. with new rig. MQ is rebuilding—his usual summer pastime. FGW finally finished new rig. AKN has two 211's in final. ADD is on again. AEW is call of Tidewater Amateur Radio Ass'; it will be on 1.75-mc. 'phone soon. BIW is building a high voltage power supply. CLV has a new rig. GBK is getting a new receiver. EVT schedules VK5FM every Sunday; using an 802 with 50 watts input. EVT worked J2KJ, VP7AA, VK6CA, U1CR, FB8AB, OA4J, G6QY and four VK's! EKV schedules IHYC. AVR has new 14-mc. vertical antenna. ALJ has a new aux. rig with 802 final. BSY worked W1OXDA on 'phone. DWE will be active when school starts. FBL and BIG are rebuilding. FIK is going to take Class A exam. EXW is building a 16-ft. Marconi vertical antenna. FGW, RL and UVA are experimenting with 6L6's. BWA wants an 803. FCU and FMY are on 14-mc. 'phone using grid bias modulation. CA blew an '03A. ASK is building a new rig with 6L6 osc., par. 6L6's, and a '52 with 4000 volts at 125 mils. UVA received card from VR2FF. The S.C.M. is working in Richmond temporarily, but will be back on the air in September in Charlottesville. Next meeting of Virginia Floating Club is in Norfolk, Oct. 31st—Nov. 1st. Be sure to attend Roanoke Division Convention at Clarksburg, W. Va., Aug. 28th—29th. No "QRX" this summer on account of low activity. Hope to resume publication in Sept. or before.

Traffic: W8AIJ 7 BSY 3 AVR-EKV-EVT-GBK-WS 1 RL 2.

WEST VIRGINIA—SCM, Dr. Wm. H. Riheldaffer, W8KKG—QBQ is a new station in Carbon and is on 7 mc. with an '03A. HWT is in Norfolk for two weeks' U.S.N.R. training. FQB, who graduated from W.V.U. this June, is in Bridgeport, Conn., with G.E. ANU is back home on the farm this summer. NLE is attending C.M.T.C. camp. OFE is doing receiver service. CZ has a nice sock on 3700 kc. LJX has a new D104 mike. PTJ is on with a pair of 55's. GDF is back home with a nice new job ending up with a '42A. BOK sold his Collins 30PXB. PZP is on 1.75-mc. 'phone. PZT keeps 7 mc. hot, and heard an HS. BOW is on 3.9-mc. 'phone with a dandy signal. LII is working DX on 7260 kc. MCL lost his antenna in a wind storm. MIP has a new '03A final. KGT has a 6L6 crystal oscillator. JRL finally got cards from SX3A and VQ8AG.

Traffic: W8HWT 39 KKG 54 ATT 18 CFB 17 MCL 16 CZ 15 LII 9 LXF 7 AKQ 6 ANU 5 LJX 4 PZP-FQB 1.

#### CENTRAL DIVISION

OHIO—SCM, Robert P. Irvine, W8CIO—EEQ went on U.S.N.R. cruise on U.S.S. *Wilmington*. ISK is still trying to get over effects of A.A.R.S. picnic. RN is waiting for his ship to get out of the dry dock. LZE is back from vacation. LPZ has First Class Radiotelephone ticket. KYI is at Fort Hayes. KLP is on a two months' trip to California and Washington. JLQ reports from Michigan—working out well on 28 mc. OPT is rebuilding for more power. DFL got married. PWB is new reporter from Paris—OHIO. 3DIY will have W8 call soon. LRV is new reporter from Montpelier. KKW is on 7 mc. with 50 watts input to 6L6. OKN went to Camp Knox for two weeks beginning August 1st. LZK finally got enough cards to claim W.A.C. NXN is working hard for DX. NAL is selling refrigerators. UW will be at Camp Knox for two weeks. Sunday, July 12th, was Chair Warmers Day in Cleveland. The boys from Lorain picked up 8GET (Grampa Penfield), chair and all, and brought him to Cleveland in a sedan. After visiting Radio Station WGAR and showing him around a bit, they took him to an outing prepared in his honor. In the meantime the boys around Cleveland picked up Pop Garver, "bed and all," packed him in a truck and brought him to the outing. By the way, gang, to my knowledge, this is second time that 8GET has been out of the house in about ten years, being hopelessly crippled. With all his handicaps he has mastered the code and theory and got himself a license. 'Phone News (by P.A.M. 8DXB); CDR had his schedules interrupted by change of working hours at Wright Field. JTI reports new 'phone stations in Akron, namely LBH, MMH and NYY. KVD is carrying FB transmitter on his annual trip to Los Angeles.

# VISASIG

## FULL AUTOMATIC SIPHON TAPE RECORDER

Records Signals off the air or from a key at any speed up to and in excess of 100 w.p.m.

### USES:

See what your own sending looks like. Find out what the hi-speed stations are sending. Check code reception for speed contests. Decoder code from the air even if you can't read code.

Hooks to Radio receiver in place of Speaker Voice Coil. Roll of tape costs 15c and records over 6000 words. Uses regular fountain pen ink.

Visasig — to opr. from d.c. signals. \$30.00  
to opr. from a.c. signals. 34.00  
to opr. from a.c. or d.c. signals. 35.00

Tape Puller — 25 or 60 cycles as spc. 14.00

Auto Trans. — auto code xmitter — 5-75 w.p.m. 50.00

1-tube code practice osc. (110V a.c. d.c.) less 12A7 tube. 5.00

Prices F.O.B. N.Y.C.

## UNIVERSAL SIGNAL APPLIANCE

64 West 22nd Street New York City  
Blueprints of either machine — \$1.00 each

### JACOBS ADJUSTABLE SEPARATOR (Improved)



U. S. Patent 1,950,170 — March 6, 1934 — others pending  
Using this improved glass Separator 2 wire R.F. feedlines of any separation from 1" up to and including 9" (used in conjunction with Hertz Antenna Systems) may be rapidly and efficiently constructed. \$1.75 for a set of 6.

CHARLES F. JACOBS (W2EM)  
270 Lafayette St., New York, N. Y.

# BRUSH Headphones

● Meet every headphone requirement. They bring in weak signals strong and clear and will handle excessive volume without overloading. Response 60 to 10,000 cycles. No magnets to cause diaphragm chatter. Specially designed cases minimize breakage. Light in weight. Only 6 oz., complete with headband and cords. A quality product at a low price. Details, Data Sheet No. 10. Copies on request. Send for one.

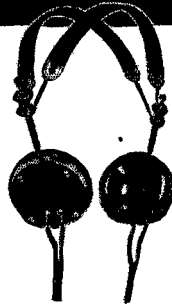

**The BRUSH DEVELOPMENT COMPANY**  
1088 E. 40th St. CLEVELAND, O.  
PIZZO ELECTRIC  
MICROPHONES • MIKE STANDS • TWITTERS • HEAD PHONES • LOUD SPEAKERS

San Francisco		W7AVL		1125- 15-3- B-29	
W6AWT	22528- 64-3- C-81	W7BTZ		858- 11-2- A-20	
W6GPB	7488- 36-3- B-87	W7ESN		702- 13-2- AB-38	
W6JJS	4648- 28-3- B-65	W7ADU		648- 12-1- B-16	
W6IBQ	4410- 25-2- --30	W7DYQ		561- 11-2- B-4	
W6CIS	4340- 24-4- B-47	W7BST		510- 10-2- --	
W6KNH	1512- 18-1- C-15	W7FIM*		432- 9-1- B-33	
W6MCO	1368- 18-3- AB-24	W7BQX		387- 9-1- A-9	
W6FPQ	1326- 17-2- B-51	W7BHW		252- 7-2- B-31	
W6IFP	1170- 15-2- B-17	W7CJE		147- 7-2- A-32	
W6JMR*	495- 11-2- --	W7DQX		144- 6-1- B-28	
W6MZ	200- 8-3- B-11	W7DGX		85- 5-2- A-7	
W6KJ	36- 3-1- --	W7CWX		27- 3-1- A-2	

East Bay		Montana	
W6EYC	15950- 53-3- AB-81	W7AFS	2592- 24-2- B-34
W6ITH	12200- 50-5- C-85		
W6TTF	12385- 45-3- C-60		
W6KQA	8820- 42-2- B-51		
W6FMY	8232- 34-2- B-81		
W6LMZ	1035- 15-3- A-19		
W6LEA	860- 11-2- A-19		
W6MVO	780- 13-2- A-27		
W6KRM	660- 11-2- AB-23		
W6KFX	600- 10-1- B-32		
W6LPC	570- 10-1- A-18		
W6FZH	510- 10-2- A-5		
W6LDD	405- 9-2- A-25		
W6EJA	294- 7-1- B-9		
W6LVI*	203- 7-1- A-10		
W6CUG*	135- 5-1- --		
W6DHS	120- 5-1- B-9		

Sacramento V.		Ohio	
W6EJC	6195- 35-3- B-54	W8AQ	3240- 26-3- B-38
W6GDJ	5190- 30-2- B-55	W8OXG	2856- 28-3- B-41
W6LGD	2835- 21-2- B-43	W8NV	2808- 20-2- B-48
W6IZE	1575- 15-2- B-32	W8BRQ	2450- 34-2- B-19
W6KYO	1408- 16-2- AB-31	W8BIQ	2369- 23-2- B-17
W6BHE	1125- 15-2- A-22	W8FVQ	2205- 21-1- B-40
W6EFM	162- 6-1- B-17	W8FYM	1980- 22-2- B- -
W6GCM	105- 5-1- B-11	W8JTW	1980- 20-1- B-58
		W8JHN*	1784- 21-2- --
		W8NP	1740- 20-2- --
		W8LRE	1710- 19-2- A-29
		W8JXY	1653- 19-2- B-34
		W8MOK	1577- 19-2- B-34
		W8ANN	1425- 19-2- B-20
		W8KC	1424- 16-1- B-37
		W8LVH	1392- 16-2- A-32
		W8HFE	1200- 16-2- B-18
		W8GNN	1200- 16-1- B-32
		W8NAB	1136- 16-1- B-28
		W8FQ	1134- 14-2- B-43
		W8DAE	1072- 16-1- B-34
		W8FZN	986- 14-1- C-29
		W8LZK	885- 15-2- A-36
		W8HGL	840- 14-2- B-36
		W8AVH	683- 13-1- B-15
		W8BSR	580- 11-1- B-65
		W8BXC	648- 12-2- B-28
		W8TUS	605- 11-1- B-18
		W8NL	576- 12-2- B-12
		W8UW	561- 11-3- A-24
		W8EFW	514- 8-1- A-26
		W8APB	495- 11-1- A-25
		W8GFA	341- 11-1- B-17
		W8AAJ	312- 8-1- A-27
		W8JEA	294- 7-1- B-34
		W8LOF	264- 8-1- A-35
		W8JFC	259- 7-1- AB-5
		W8CZR	247- 13-2- B-20
		W8IWS	216- 8-2- A-5
		W8CBI	216- 7-3- B-27
		W8BZB	196- 7-1- --
		W8HZR	196- 7-2- AB-25
		W8GDR	180- 6-1- C-18
		W8MFM*	135- 5-1- A-21
		W8FGC	126- 6-1- B-20
		W8BRB	120- 5-1- A-8
		W8IBM	90- 5-2- B-6
		W8AHP	90- 5-1- B-27
		W8ISK	12- 2-1- A-2

San Joaquin V.		Nevada	
W6CLP	3588- 26-2- C-36	W6LCJ	273- 7-3- A-4
W6MVK	2230- 19-2- B- -		
W6ASV*	612- 12-1- --		
W6KB	234- 6-1- --		
W6EPQ	150- 6-1- A-11		
W6YB*	12- 2-1- --		
W6JWC*	3- 1-1- A- -		

Oregon		Idaho	
W7FLX	19800- 60-3- C-69	W7BYW	18480- 60-3- C-88
W7AVV	11703- 47-4- A-68	W7JL	1953- 21-1- B-26
W7CIK	1324- 19-2- B-39	W7CHT*	1710- 19-3- B-19
W7MH	1586- 16-1- B-47	W7EVB	90- 5-2- A-7
W7DAA	1484- 14-3- A-20	W7A00*	39- 3-1- B- -
W7MD	1444- 19-3- C-47		
W7AJW	1344- 14-2- AB-71*		
W9FYK-7	744- 8-2- A-18*		
W6JDY-7	405- 9-1- A-16*		
W6EYP*	231- 7-2- --		

Washington		Michigan	
W7DL	12750- 51-3- BC-61	23256- 68-3- B-90	
W7EK	12299- 49-2- C-75	15904- 56-3- B-84	
W7DXZ	5394- 31-2- B-57	9471- 41-3- B-86	
W7DOX	3828- 29-3- B- -	8108- 42-2- --	
W7TS	3666- 26-3- B-40*	7752- 38-2- C-51	
W7DVY	2964- 26-2- --	4410- 30-2- B-45	
W7FP	2640- 22-2- B-61	3225- 25-2- A-42	
W7JZ	3337- 19-2- B-47	3075- 25-3- B-28	
W7QI	1539- 19-2- C-32	3024- 28-2- AB-51	
W7CNM	1350- 15-2- A-27	2300- 23-1- B-33	
		1911- 21-3- B-25	
		1680- 16-2- B-56	
		1326- 17-1- B-29	
		440- 10-2- B-35	



# RADIO OPS! Don't Miss This One!

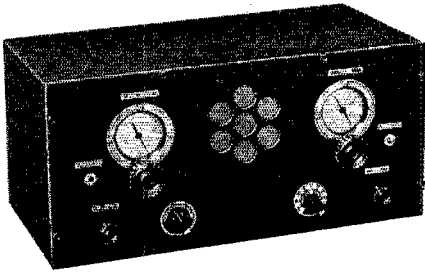

## Sargent Model 11 9.5 to 20,000 Meters

Model 11 Net Prices for 110 V. 60 cycles operation

- Model 11-UA, UNIVERSAL tuning range, 9.5 to 20,000 meters \$75.00
  - Model 11-MA, MARINE tuning range, 9.5 to 3,750 meters \$54.00
  - Model 11-AA, AMATEUR tuning range, 9.5 to 350 meters \$46.00
- Prices include power supply, speaker and R. C. A. tubes.  
**IMMEDIATE DELIVERY.**  
 Model 11 is available in all A. C., D. C. and battery voltages.  
 Write for full description.

**NOT A "BCL" JOB!** Sargent Model 11, Universal Tuning Range, has been designed for the dyed-in-the-wool radio operator. It is the receiver that has long been awaited by the operator who cannot get full radio enjoyment without all-wave coverage on both code and voice. Model 11 covers a continuous tuning range, without dead spots or skips, from the ultra high frequencies to the audio range, 9.5 to 20,000 meters.

The mere fact of covering this tuning range efficiently is an engineering accomplishment of the first order. Model 11 is the only receiver ever built having this range, yet the design has been so carefully worked out that there are no losses added by the increased tuning range. The receiver has every control an experienced operator can possibly want. Phone jack, break-in switch, all-wave band spread, R.F. stage trimmer, regeneration, wave change switch, and an R.F. gain control — one incidentally that packs real authority. The dial is calibrated over the entire range in M.C. and K.C.

Model 11 sets a new standard for T.R.F. performance. Selectivity approaches that of the most expensive, multi-tube receivers, yet the well-known high sensitivity and low noise level of the T.R.F. circuit has been retained. Receiver has one stage of sharply tuned R.F. amplification, regenerative detector, triode first audio, pentode power output — 5 tubes with the rectifier. Available in 3 tuning ranges. Except for coil units, all 3 are identical. The smoothest receiver you ever tuned! Neat, rugged, attractive — an addition to the finest radio station.

**E. M. SARGENT CO., 212 9th St., Oakland, Calif.**

## ANNOUNCEMENT!

I am opening, on Sept. 14th, what I believe to be the finest school in the world for Radio Telegraph instruction. Genuine Creed and Boehme automatics; Kleinschmidts, typewriters, etc. *Personal assistance of T. R. McElroy, World's Champion Radio Operator.* Inquiries sincerely welcomed. Sam Curtis.

**THE SAMUEL CURTIS RADIO SCHOOL**  
 181 Massachusetts Avenue, Boston  
*(Tune in Sundays at 11:15 for WCOP 1120 k.c.)*

## SICKLES COILS

ALL TYPES OF RF AND IF WINDINGS

Manufactured by

**F. W. SICKLES COMPANY**

300 Main Street

Springfield, Mass.



## ALIGN-AIRE CONDENSERS

(Air-Dielectric)

Completely eliminates "DRIFTING" in any circuit

Compact, moisture-proof, dust proof and self locking

Available in three capacity ranges

CAT. NO.	MMFD.	SIZE	LIST
15230	1-12	9/16" x 1 1/4"	\$0.50
15240	25-50	7/8" x 1 1/2"	0.75
15200	50-100	7/8" x 1 1/2"	1.25

**MEISSNER MFG. CO.**  
 Mt. Carmel - Illinois

**NOW!** A compact Portable Transmitter and Non-Radiating Receiver for the popular Ultra-High Frequencies...  
**JUST THE STATION TO TAKE ON VACATION**

### "Type TR-6A6"

- Better Than Ever
- 7 Tubes — Dynamic Speaker
- New 6E6 Unity Coupled
- 10 Watt Carrier
- 100% Modulation
- Duplex Operation — PHONE ● ICW

**F.O.B. FACTORY**  
 Less Tubes

**\$39.75**

**RADIO TRANSCIVER LABORATORIES**

8627 — 115 Street: Richmond Hill, New York

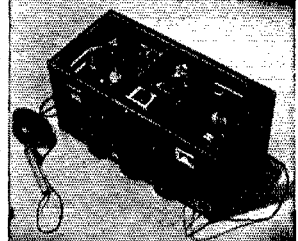

Radio Operator's  
 Course

Complete in  
 Telegraphy—  
 Telephony

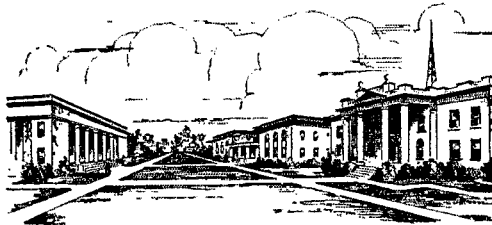

Practical  
 Experience  
 Studio—  
 Transmitter—  
 Announcing

P. A. C. is an endowed, educational institution — not privately owned, not operated for profit, college rank maintained. Course consists of maximum knowledge necessary to secure Commercial Telegraph Second-class, and Radio-telephone First-class government licenses. Course includes Wireless Code, Radiophone, Announcing, Microphone-Studio Technique, Service, Police, and Aeronautical Radio. We are authorized to teach RCA texts. At the completion of course you receive practical studio technique experience in our commercial broadcast studios located in the administration building, and experience as an operator on K P A C (500-Watt Commercial transmitter located on the campus, owned and operated by the college), and inter-departmental marine communication experience. If interested, write for Bulletin R.

**PORT ARTHUR COLLEGE**

Port Arthur (World-known port) Texas

# You Are Protected

When You Buy From

## HATRY & YOUNG

CONNECTICUT'S  
AMATEUR SUPPLIERS

### 3 STORES:

203 ANN ST.  
HARTFORD

86 MEADOW ST.  
NEW HAVEN

195 CANNON ST.  
BRIDGEPORT

National, Hammarlund, Thor, UTC, IRC, Bliley, RCA equipment and tubes, Raytheon, Eimac, Burgess, Eveready, Shure, Astatic, Aerovox, Triplett; ARRL Logs, Handbooks, Pads, Calculators, etc.

Conceivable or Inconceivable the amateur's wants are unusually well supplied by H & Y. From the nut to the tube, the lug to the receiver, the knob to the transmitter H & Y tries to be adequate.

W8JDG	300-11-2	B-38	W9LJ	40908-84-3	--80
W8MKZ	390-10-3	A-31	W9FM	30428-74-4	C-05
W8CVU	385-7-2	--	W9MV	17629-61-3	B-09
W8DLT	351-6-2	B-12	W9FST	15370-58-3	B-70
W8DED	264-8-1	A-11	W9AFN	13962-49-2	BC-56
W8KPL	264-8-1	A-37	W9CRY	13324-49-2	B-53
W8OCQ	264-8-1	A-20	W9BPU	12900-50-3	B-44
W8ISC	189-7-1	B-25	W9ICO	10336-43-3	B-90
W8ONK	96-4-1	A-6	W9KA	9238-43-3	B-76
W8IQS	90-5-1	B-10	W9RO	6825-39-3	B-77
W90WM	90-5-2	B-17	W9FLH	5705-35-3	B-59
W8MSM	64-4-1	A-11	W9AFO	5250-32-2	C-43
W8JKO*	48-4-1	A-12	W9CES	4590-30-3	B-79
W8KSF	27-3-1	B-4	W9TBX	4234-34-2	B-69
W8MSK	24-2-1	A-31	W9AZP	4260-30-2	B-38
W8EFA*	18-2-1	A-8	W9CVI	2156-22-1	A-34
W9CE*	3-1-1	--	W9RKR	2093-23-2	B-48

#### West Virginia

W8KKG	23068-73-3	--61	W9LW	1560-20-2	C-35
W8CDV	1953-21-1	C-27	W9OZS	1170-15-1	B-32
W8PAJ	429-11-2	A-15	W9DHT	1062-18-2	B-79
W8NFO	390-10-1	A-15 <sup>50</sup>	W9RCQ	1050-14-2	BC-20
W8MCL	147-7-1	B-12	W9OKZ	992-16-2	A-24

#### W. Pennsylvania

W8AAT	16390-55-2	B-71	W9JDD	819-13-3	B-32
W8CRA	15709-63-3	C-33	W9MCC	812-14-2	--17
W8FIP	11440-44-2	B--	W9NBM	756-14-2	B-72
W8LXS	11232-48-3	A-81	W9HQH	715-13-2	B-21
W8IIL	8000-40-3	C-82	W9MAL	612-12-2	B-41
W8FTM	4896- --	--	W9IYA	594-11-2	B-50
W8JMP	4704-32-3	--34	W9HB	440-10-1	--
W8HRD	3752-28-1	B-48	W9WC	380-8-2	B-17
W8GRX	2712-24-1	B-41	W9ATS	360-10-1	B-14
W8KER	2300-20-2	--29	W9ISM	351-9-2	--
W8LCI	1008-14-1	C-21	W9GSB	279-9-2	A-11
W8BSF	672- --	--	W9LL	231-7-1	B-6
W8OYK	506-11-3	B-18	W9MUX	138-6-2	B--
W8AYQ	462-11-2	B-16	W9UAV*	120-5-1	--
W8DWV	288- --	--	W9EUL	120-5-2	A-22
W8BWL	162-6-1	--	W9IVF	120-6-1	--15
W8LBD	120-5-1	A-6	W9IWR	120-4-1	B-5
W8IFY	114-6-1	B-6	W9AGV	108-6-1	A-11
W8DLG	108-6-2	A-15	W9BHT	72-4-1	--
W8NRM	105-5-2	A-18	W9SI	60-4-1	B-11 <sup>50</sup>
W8MUT	75- --	--	W9OVY	60-4-1	A-12
W8PT	75- --	--	W9CUX	60-4-1	B-10
W8OSL	12- --	--	W9NWE	48-4-1	A-1
W8NQL*	3-1-1	A-5	W9GG	27-3-1	--
W8LSA	3-1-1	--	W9HUU*	27-3-1	--5
W8MKH	3-1-1	A--	W9CP	24-2-1	B-2
W8NRE*	3-1-1	A--	W9KZW*	12-2-1	--
W8CIR	3- --	--	W9SIV	12-2-1	A-15

#### W. New York

W8LUQ	18060-55-3	B-55	W9KEH	3-1-1	B-1
W8CJJ	17024-56-2	C-86 <sup>51</sup>	W9DA*	3-1-1	--
W8ADG	13804-58-3	B-54	W9PLL*	3-1-1	A--
W8AU	6720-35-1	B-51			
W8AON	6480-36-2	C-44			
W8CYT	6018-34-3	B-46			
W8JV	4144-28-3	AB-40			
W8DZC	3042-26-2	B-25			
W8BFG	3036-26-3	B-46			
W8BAI	2645-23-2	B-85			
W8CKY	2392-23-2	B-22			
W8DSU	2280-20-1	C-20			
W8HXO	2100-20-1	B-42			
W8AYD	1956-21-2	B-26			
W8ERZ	1088-16-1	A-25			
W8IOT	1035-15-2	A-17			
W8F9Y	1005-15-1	A-60			
W8LGO	855-15-2	B-35			
W8JLV*	792-12-1	--			
W8JQV	792-12-2	A-28			
W8APD	660-11-1	B-20			
W8ATE	581-11-2	--			
W8EWB	478-11-1	A-40			
W8JRE	450-10-2	B-40			
W8HTT	405-9-1	A-24			
W8LWN	390-10-1	B-18			
W8DHH	360-10-3	A-35			
W8JIW	360-10-2	A-31			
W8KCA	330-10-2	B-16			
W8EMW	270-9-2	A-11			
W8NWH	242-7-1	A-16			
W8ADE	240-8-1	A-12			
W8BUP	210-7-1	A-20			
W8JUF	180-6-1	A-17			
W8NWT	108-6-1	A-14			
W8BHK	90-5-1	--8			
W8PFM	60-4-2	A-19			
W8FMX*	12-2-1	--			
W8LGV	3-1-1	A-6			
W8HP	3-1-1	--			

#### Indiana

W9JFB	18081-62-2	B-58	W9KDH	25156-72-3	BC-66
W9IU	12054-49-4	B-65	W9OQP	11472-48-2	C-81 <sup>50</sup>
W9RGB	6408-36-3	B-58	W9BEZ	8190-39-3	B-78
W9SPB	4850-25-3	B--	W9AWP	4287-33-3	B-40
W9LQ	4636-38-2	B-46	W9MKZ	3528-28-2	C-22
W9LKI	4131-27-3	B-48	W9JDY	3228-27-2	C-65
W9DBJ*	2398-22-2	--	W9DFY	2664-24-2	B-34
W9AMM	2070-23-3	A-42	W9DMF	440-11-2	--26
W9HUV	1914-22-2	A-19	W9VBQ	405-9-2	B-47
W9AEA	1200-16-1	B-34			
W9ABB	810-15-1	--			
W9EGQ	792-11-1	A-88			
W9PWZ	306-9-2	B-33			
W9GFS	90-5-2	B-14			
W9OKB	48-4-1	B-5			
W9WCE*	3-1-1	A--			

#### Kentucky

W9PLM	16589-53-4	AB-56	W9LH	15675-57-3	C-66
W9ELL	8250-40-4	C-43	W9GL	11703-47-3	B-52
W9WBR	1672-22-3	B-31	W9RH	10763-47-3	B-88
W9LJ	1260-15-1	C-46 <sup>54</sup>			
W9AYH*	561-11-1	B-13			
W9CNE	48-4-2	B-4			

#### Wisconsin

W9PTC	15675-57-3	C-66
W9GL	11703-47-3	B-52
W9RH	10763-47-3	B-88

#### Illinois

W9TB	58195-103-4	C-90
------	-------------	------

# CRYSTAL VALUES!

*A statement to  
all amateurs*

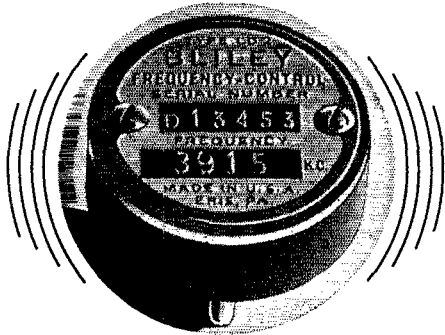

## BLILEY ELECTRIC COMPANY



BLILEY QUARTZ CRYSTALS

UNION STATION BLDG.  
ERIE, PENNA.

August 20, 1936

An Open Letter  
To All Amateurs

It is practically impossible to judge the qualities of a quartz crystal by looking at it, for it is a relatively simple matter for anyone to grind a crystal merely to oscillate. The amateur who uses a crystal of this type will generally find that the power output is low and that the oscillation is erratic and unstable.

With quartz crystals, as with other products, price alone should not be the prime consideration. Always investigate the reputation of the manufacturer and consider the performance of the product in actual service - these factors are the true guides to real crystal values.

Very truly yours,

BLILEY ELECTRIC COMPANY

*F. D. Bliley*  
F. D. Bliley  
General Manager

FDB:NF

BLILEY ELECTRIC CO., ERIE, PA.

.... IN 1925 A TYPE 250-7½ WATT TUBE SOLD FOR \$11.00\*—

... IN 1936—

THANKS

TO—

*Taylor*

**CUSTOM  
BUILT**

*Tubes*

and the progress made by TAYLOR engineers, there is made available a group of tubes, each and every one by comparison with its predecessor — a veritable Lamp of Alladin — Compare the T-55 with its isolantite base, rugged carbon anode Nonex glass envelope, priced at \$8.00 capable of 168 watts output down to 20 M and 2 meter operation with the 7½ watt type 250 at \$11.00

**COMPLETE STOCK OF FAMOUS TAYLOR TUBES ALWAYS ON HAND**

T-55

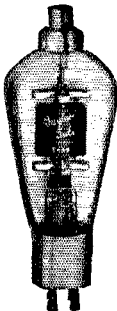

**CHARACTERISTICS**  
Type T-55

Fil. Volt., volts	7½
Fil. Cur't, amps	3.25
Class "C" Osc. and Pwr. Amp.	
Max. Op. Plate Volt.	Cl. C Osc.
Unmod. DC, v.	1500 1250
Mod. DC, v.	1500 1000
Max. DC Plate Cur. mls.	150 125
Max. DC Grid Cur. mls.	40 40
Max. Plate Dissipation, w.	55 55
Max. RF Output, w.	5 5
	168 66

**Price \$8.00**

**Our Taylor Prices**

Type	Price
756	\$ 4.95
203B	7.50
822	18.50
845	12.50
872	12.00
203A	12.50
814	18.50
T-200	21.50
H.D.203A	17.50

Taylor HD 866's \$1.65

\*How much did you pay for yours?

**CHARACTERISTICS**  
Type T-155

Fil. Volt., volts	10
Fil. Cur't, amps	4
<b>Interelectrode Capacities</b>	
Plate to Grid, mmf.	3
Grid to Fil. mmf.	2.5
Plate to Fil. mmf.	1
<b>Class "C" Osc. and Power Amp.</b>	
Max. Oper. Plate Volt	*3000
Max. DC Plate, mls.	* 200
Max. DC Grid, mls.	60
Max. Plate Dissipation watts	155
Power Output, watts	450

**Price \$19.50**

T-155

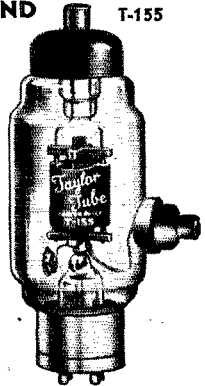

New TAYLOR 31-page catalogue now ready. We shall be glad to mail you one.

All items advertised by us in the June, July and August QST in stock

MAIL ORDERS FILLED . . . SEND MONEY ORDER

**THE RADIO SHACK ■ 46 BRATTLE STREET ■ BOSTON, MASS.**

# ONLY SHURE "ULTRA" Has All These Features!



## Crystal Microphones

● Response approaching True High Fidelity... high output through new Shure "Cruciform" crystal mounting... Screen-Protected cartridge... "Moisture-Sealed" Dual-Drive Grafoil Bimorph crystal—These are but a few of the Right Engineering features that set new standards of performance and dependability in Shure "Ultra" Crystal Microphones.

"Grille" type as illustrated—also "Spherical" and "Swivel" models—List Price only \$25 complete with cable. Licensed under patents of the Brush Development Company.

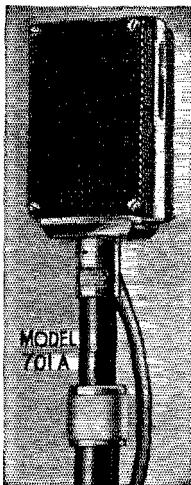

Write for Data Today!

**SHURE MICROPHONES**  
SHURE BROTHERS • MICROPHONE HEADQUARTERS  
215 WEST HURON STREET • CHICAGO, U. S. A.

**GULF RADIO SCHOOL**  
Radiotelegraphy Radiotelephony  
Radio Servicing  
SECOND FLOOR } 1007 Carondelet Street  
U. S. A. } NEW ORLEANS, LA.

# NEON TUNING WAND

Gives More Watts Output to Your XMITTER

- \* RESONANCE
- \* NEUTRALIZATION
- \* OSCILLATION

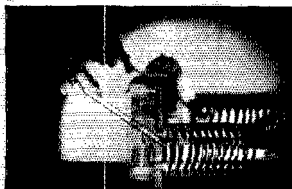

CAT. NO.  
5149

**\$1.00**

Guaranteed

(Postage Prepaid)

Heavy 10 inch sensitive neon tube with insulated caps. Lights very brightly on R. F. One end increases inductance, and the other decreases inductance—merely by inserting the tip of tube into coil. A handy instrument, gives you the most watts output to your rig.

ORDER TODAY

**SUNDT ENGINEERING CO.**

(Affiliate of Littelfuse Labs.)

4246 Lincoln Ave.

Chicago, Illinois

W9GHN	10120-44-3-B-67	Nebraska	
W9POV	6340-36-2-RC-46	W9RME	648-12-2-A-23
W9DIT	5495-35-2-B-61	W9DDM	357-7-2---
W9CCI	4524-29-3-B-51	W9VOG	160-5-1-B-20
W9KYJ	3300-25-2-A-65	W9TBD	150-5-1-A-14
W9BYE	2592-24-3---	W9LEO	144-6-2---
W9PTT*	2222-23-2-A-72	W9FWL	108-6-1-B-6
W9ARE	2200-22-1-B-28	W9ESY	27-3-1-A-4
W9RQM	2040-20-3-B-18	W9DGL	12-2-1-B-7
W9COG	1953-21-3--45		
W9FAW	1938-19-2-B-42	No. Dakota	
W9EQP	1767-19-1-B-48	W9NSP	312-8-1-A-12
W9BQM	1746-18-3-B-47	W9DHQ	210-7-2-A-30
W9MRW	1458-18-1-B-24	W9BTJ	192-6-2-C-12
W9NPE	1054-17-2-B-28	W9UBB	132-6-1-A-15
W9ELQ	723-13-2-A-18	W9WJZ	36-3-1----
W9LW	561-11-2-B-14	W9SWC*	3-1-1-----
W9RKP	510-10-2-A-26		
W9CAS	480-10-1-B-10	Maritime	
W9IHI	390-10-2-B-10	VEIEA	21060-65-5-AB-83
W9OVO	264-8-1-B-11	VEIET	6800-40-2-AB-60
W9RRT	243-9-2-B-20	VEIEX	4991-31-2-A-89*
W9OZQ	96-4-1-A-11	VEIHK	1392-16-1-A-28
W9RTS	36-3-1--35	VEIAE*	324-9-1----
W9LUC	27-3-1----	VEIIR*	144-6-1-----
W9VLH*	12-2-1----		

Misouri		Quebec	
W9TJ	15105-53-2-A-82	VEIDE	27594-73-4-B-73
W9DCB	9717-41-3-A-74	VEIAX	20735-65-2-B-82
W9LLW	4320-30-2-C-43	VEIHZ	6623-37-3-B-19
W9GGH	3570-30-2-B-54	VEIEW	6460-35-3-B-79
W9LBB	3567-29-3-AB-50	VEICR	4832-32-1-B-38
W9LJW	2178-22-2-B-34	VEIDR	2964-26-2--42
W9NNZ	1634-19-3-A-32	VEIBU	696-12-2-B-19
W9DHN	1566-18-3-A-39	VEIBK	378-9-2-B--
W9AIW	756-14-2-AB-12	VEIJK	300-10-1-A-5
W9CTR	510-10-1-B-12	VEIAW	210-7-2-A-27
W9TGN	480-10-2-B-21	VEIFG	114-6-2-A-7
W9EYM	206-8-1-A-20	VEIJD	12-2-1-A-11
W9FZJ	105-5-1-A-8		
W9SXV*	75-5-1----	Ontario	
W9KIK	12-2-1-A-9	VE3WA	22464-64-3-B-86
W9KTC	3-1-1-A-1	VE3KF	6623-37-2-AB-40
		VE3OI	3400-25-1-B-51
		VE3ACS	2016-21-2-A-38
		VE3LI	1140-15-2-B-26
		VE3AQ	924-14-1--27
		VE3WV	672-12-1-A-38
		VE3WB*	561-11-1-A--
		VE3EA	468-12-2-B-40
		VE3KQ	340-10-1-B-9
		VE3DU*	84-4-1-----
		VE3VD	45-3-1-A-6
		VE3QT*	27-3-1-----
		VE3ACY	12-2-1-A-12
		VE3AGM*	4-2-1-B-34

Colorado		Saskatchewan	
W9PSD	12831-47-3-B-58	VE4IG	3202-26-3-B-53*
W9RTQ	1377-17-2-B-45	VE4CV	470-10-1-A-49
W9FFU	1326-17-3-A-14	VE4MB	196-7-2-B-38
W9WFW	840-14-3-A-13	VE4ND	45-3-1-A-14
W9DQD	336-7-1-A-20		
		Manitoba	
		VE4BQ	2060-20-1-B-45
		VE4RO	1653-19-1-B-27
		VE4DU	1106-14-1-B-30
		VE4DZ	126-6-1-AB-13
		VE4SF	60-4-1-A-13

So. Minnesota		Alberta	
W9DWU	5700-38-3-B-59	VE4LK	1008-15-3-B--
W9ELA	4305-31-3-B-57	VE4GD	882-11-2-A-30
W9CYA	1512-18-2-B-55	VE4EA	702-13-1-B-24
W9DGH	1176-14-2-B-33	VE4RU	627-11-2-B-30
W9DEI	1123-17-1-B--	VE4PH	611-13-2-B-16
W9SJK	1008-14-2-B-66*	VE4AP	231-7-1-B-20
W9DOP	924-14-2-B-11	VE4LG	126-6-2-A-35
W9DMA*	840-14-2---	VE4UY*	27-3-2-A-10
W9TQW	702-13-1-A-45		
W9PEV	624-13-3-B-43	British Columbia	
W9SNW	450-9-2-B-33	VE5EO	7605-39-3-B-48
W9PNK*	378-9-2-B--	VE5BI	5456-31-3-B-53
W9VKF*	216-6-2-A-18	VE5FG	1568-10-2-A-68
W9HGN	203-7-2-A-23	VE5QP	1022-14-3-A-46
W9UBY	90-5-1-A-40	VE5NP	450-10-2-B-22
W9AJU	84-4-2-B-5	VE5PW	42-3-2-A-41
W9ZT*	27-3-1-B--	VE5QA*	24-2-2-A--
		VE5MI*	3-1-1-----

No. Minnesota		Africa	
W9BVI	3540-30-3-B-35	Canary Islands—EAS	
W9NTM	1298-18-2-B-19	EASAO	74100-38-3-B-86
W9RXL	490-10-1-A-24		
W9BII	459-9-1-A-21		
W9O00	189-7-1-A-9		

So. Dakota		Algeria—FA8	
W9HHW	1800-20-2-C-19	FA8BG	50717-39-4-A-60
W9RSE	1152-16-2-AB-17		
W9HJU	147-7-1-C-11	Madeira—CT3	
W9MBA	36-3-1-A-3	CT3AB	21294-26-2-A-50
W9FOQ	18-2-1-A-16	CT3AN	5324-11-1-A-39

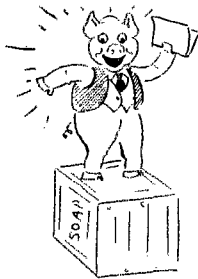

# AN ANNOUNCEMENT

that will be welcomed by all

THE opening of the Terminal Radio Corporation, a new organization run by men with knowledge and experience of complying with the needs of amateurs, engineers, and broadcast stations. Our new and modern facilities make it possible to extend to you a service that has always been your desire to get. We are authorized distributors for all standard "LEADERSHIP" products.

Such as . . . . .

**NATIONAL  
THORDARSON  
RAYTHEON**

**OHMITE  
AEROVOX  
I.R.C.**

**TURNER  
R.C.A.  
JOHNSON**

and many others,  
of course

Make **TERMINAL** your headquarters for "Ham" equipment and find a new **SERVICE** that will surprise you

In stock for immediate delivery

**NATIONAL NC 100 RECEIVER**

**THORDARSON TRU-FIDELITY TRANSFORMERS**

**BILL FILLER . . . W2AQO . . . ADOLPH GROSS**

## TERMINAL RADIO CORPORATION

80 CORTLANDT STREET

NEW YORK, N. Y.

A NEW BOOK

### FUNDAMENTALS OF RADIO

Second Edition. 426 pages 6" x 9", 430 figures. By *R. R. Ramsey*, Prof. of Physics, Ind. Univ. Revised, enlarged, repaged, reprinted. New cover. Radio theory and practice brought up to date. New subjects, problems and questions on each chapter.

**EXPERIMENTAL RADIO**—(255 pages, 168 figures, 128 experiments.) The experimenter's manual.

Price, \$2.75. Fundamentals, \$3.50 postpaid.

RAMSEY PUBLISHING CO. Indiana  
Bloomington



## for the SUDDEN LOAD



Ward Leonard Midget Overload Relays provide protection to the tubes while tuning or through loss of excitation. The underload Relays protect class "B" tubes and transformers. Send for Free bulletin 507B. Learn about Ward Leonard Protective Relays and how to use them.

### WARD LEONARD PROTECTIVE MAGNETIC RELAYS

WARD LEONARD ELECTRIC COMPANY

41 South St., Mount Vernon, N. Y.

Please send FREE Bulletin 507B.

Name .....

Street .....

City and State .....

Call Signal.....Q

## PRECISION CRYSTALS



Crystal Holder

Highest quality crystals one-inch square, carefully ground for frequency stability and maximum output. Be sure of your transmitter frequency—use **PRECISION CRYSTALS**.

'X' cut **PRECISION Crystals** carefully ground for maximum power supplied within 0.1% of your specified frequency and calibrated to within 0.03% are priced as follows: 1750, 3500 and 7000 kc. bands—

\$3.00 each. Add \$1.00 to above price if plug-in, dustproof holder is desired. (Holder as illustrated to fit G.R. jacks or round holder to plug into a tube socket can be furnished) G.R. jacks to plug illustrated holder into — \$1.15 pair.

Low frequency drift crystals (Type LTC) having a drift of less than 5 cycles per million per degree C. are supplied at the following prices: 1750 and 3500 kc. bands — \$3.50 each; 7000 kc. band — \$4.00 each. Holder \$1.00.

'AT' cut crystals for commercial use quoted on at your request. When ordering our product you are assured of the finest obtainable. Now in our sixth year of business.

**PRECISION PIEZO SERVICE**

427 Asia Street

Baton Rouge, La.



# USE MYCALEX INSULATED CARDWELL CONDENSERS

in your H.F. — R.F. circuits  
for Lowest Dielectric Losses and Maximum Efficiency

## CARDWELL TYPES STANDARD WITH G.E. MYCALEX (all plates buffed and polished)

Double Section Type	Frame	Capacity	Airgap	Peak Flash v. at 4 M.C.	Your Price (double sect.)	Your Price (single sect.) *
MT-100-GD	MIDWAY	100-100	.070"	3500 v.	\$4.80	\$....
XP- 90-KD	ST'D	95- 95	.084"	4000 v.	4.50	2.70
XP- 165-KD	"	165-165	.084"	4000 v.	6.60	3.90
XP- 325-KD	"	325-325	.084"	4000 v.	13.20	.....
XE- 240-KD	"	240-240	.100"	4250 v.	12.60	.....
XG- 110-KD	"	110-110	.171"	5250 v.	10.80	.....
XC- 40-XD	"	40- 40	.200"	5800 v.	7.80	4.50
XG- 75-XD	"	75- 75	.200"	5800 v.	10.20	5.70
TL- 50-UD	16-B	50- 50	.294"	7500 v.	15.00	9.90
TL- 100-UD	"	100-100	.294"	7500 v.	20.70	13.20
TL- 160-UD	"	160-160	.294"	7500 v.	26.40	18.00
TZ- 40-RD	"	40- 40	.500"	12,000 v.	25.80	16.80
TZ- 80-RS	"	80	.500"	12,000 v.	.....	23.70

\*To order single section condensers, specify same type number as double condenser, changing last letter ("D") to "S"

MANY OTHER TYPES AVAILABLE — SEND FOR CATALOGUE

## THE ALLEN D. CARDWELL MANUFACTURING CORP.

83 PROSPECT STREET, BROOKLYN, NEW YORK

### SUN SPECIALS TRANSMITTING CONDENSERS

Mfd.	Volts	Price
1	1000	\$1.10
2	1000	1.50
1	1500	1.45
2	1500	2.00
1	2000	1.75
2	2500	2.45

## SUN RADIO CO.

15 YEARS OF RADIO RELIABILITY  
227 Fulton Street, New York City, N. Y.

### SUN SPECIALS

**THORDARSON Heavy Duty Power Transformer.** 1200 V. C.T. 200 mills, 7½ V, 5 V, 2½ V. **\$2.45** Net

**THORDARSON Filter Choke.** 12 hrs, 250 mills **\$1.95** Net

## COMPLETE STOCK of NATIONALLY KNOWN AMATEUR EQUIPMENT!!

**NEW!! NEW!!**  
**NATIONAL NC100X RECEIVER** The Outstanding Receiver of the Season! Self contained Power Supply Band Switching, Metal Tubes \$132.60  
Crystal filter and speaker in metal cabinet

**NEW!! NEW!!**  
**TAYLOR T55 TUBE**

Carbon plate — Isolantite base 1500 volt-150 Ma. — 168 watts output **\$8.00** NET  
NEON OSCILLOSCOPE TATTELITE \$2.00

### HAYNES RIG-CHECKER

This is a dandy for a field strengthening Meter, Overmodulation Indicator, Monitor and Many Other Applicable Uses. Complete with Tube, Battery and All Coils \$17.90

Special 200 watt Adjustable Resistors with 6 extra slides **\$1.89**

RAYTHEON RK 36 \$14.50

All types of Metal Cabinets, Chassis, Panels, and Racks. Prices on request

Complete Stock of All Types of R.F. Chokes, Air Inductors made by Cotocoll, Barker and Williamson.

THORDARSON XMITTING KITS IN STOCK

All RCA, Raytheon and Taylor Tubes in Stock

Guardian and Dunco Relays; all Voltages and Types in stock

Complete line of Weston, Beede, and Triplett Meters in Stock

We carry a complete stock of Test Meters, Oscillographs, Oscillators, Analysers, Tube Checkers

### Sun Xmitting Tubes

801.....	\$2.95	203-A.....	\$8.45
841-A.....	2.95	211.....	8.45
830-B.....	7.50	304.....	10.00
838.....	12.45	305.....	12.75
866.....	.98	304-A.....	7.95
866-A.....	1.45	330.....	6.00

The Tubes carry  
SUN'S GUARANTEE

### THORDARSON

#### Class B Input and Output

for 6L6's. Secondary is tapped for 2500, 5000, and 7500 Ohms, and will deliver 60 Watts of Audio.

INPUT \$2.21 OUTPUT \$5.88  
RCA No. 6L6 Tubes.....\$1.18 each

### RCA COMMUNICATIONS

RECEIVER. Tubes — Speaker, Complete \$119.50

#### MICROPHONES

Piezo Astatic	
D.104	\$13.23
Turner S-38	13.23
Shure 74B	22.05
Astatic K2	22.05

#### MAC-KEY \$7.95

TRANSFORMER for 866's — 2½ v. 10 Amperes. Unceased **\$1.62**

COMPLETE NATIONAL LINE IN STOCK. 40% DISCOUNT. All Mail Orders promptly filled. 20% deposit with all C.O.D. orders. Remit by M.O. Include postage. Always remember when placing your order, that you are dealing with a supply house that is by and for the Amateur. Literature from various manufacturers mailed upon request.

# LEARN CODE

the way you'll be using it—  
by SOUND

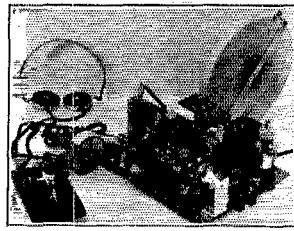

THERE is only one way to learn to read code and that is by listening to code. There is only one way to learn to send code and that is by hearing your own sending

repeated back to you. With the Master Teleplex Code Teaching Machine you learn code the natural, easy, fascinating way. Only instrument ever produced which records your sending then SENDS BACK your own key work at any speed you desire. We furnish complete course, lend you the New All Electric Master Teleplex, give you personal instruction with a MONEY BACK GUARANTEE—all at a surprisingly low cost per month. Write today for FREE catalog Q. 8. No obligation.

## "HAM" SPECIAL STANDARD TELEPLEX

A highly efficient code teacher using heavy specially prepared waxed paper tape, having two rows of perforations. Write for Free folder "Q.T. 8."

We are the originators of this type instrument

### TELEPLEX CO.

72-76 Cortlandt St. New York City  
The New Master Teleplex "The Choice of Those Who Know"

## T. R. McELROY

WORLD'S CHAMPION RADIO TELEGRAPHER  
23 Bayside Street, Boston, Mass.

MAC KEY @ \$7.95 a real speed key.  
MAC KEY DELUXE @ \$15.00 U.S.N. Spfn.  
MAC CORD @ \$3.00 U.S.N. Spfn speed key cord.  
MAC CASE @ \$3.95 U.S.N. Spfn speed key case.  
MAC OSC @ \$3.95 ac/dc oscillator. Tone control.  
If u hv Mac Key wri me fo xmy ipt & dsrb infn.  
All my stuff emcy gad best pduts obl. 73 Mac.

Power X cut **O. C. L. Control Crystals** High Output

Unconditionally Guaranteed

7000 KC ± 5 KC . . . . . \$1.85  
3500 or 1750 KC ± 5 KC . . . . . 1.50

**OMAHA CRYSTAL LABORATORIES**  
544 World Herald Bldg.  
OMAHA, NEBR. W9JRY W9CPM

# NEW! BIRNBACH STEATITE CONE INSULATORS

Ideal insulation for ultra high-frequency circuits because of its superior physical and electrical qualities. Mount in small space. Complete with mounting screw and cork washer.

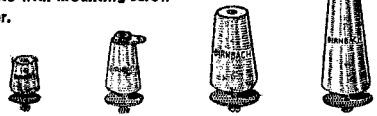

Write for Bulletin Q-9

5/8" High No. 430 10c  
1" High No. 431-15c  
1 1/2" High No. 432-20c  
2 3/4" High No. 433-25c  
No. 433J-20c No. 432J-25c No. 433J-50c  
("J" denotes Jack Type)

**Birnbach Radio Co., Inc.** 145 Hudson Street New York City

PA0QZ	1584-8-1	A-1	Lithuania-LY		
PA0JJ	1410-10-2	A-28	LY1J	6292-11-1	A-35
PA0OO	380-5-1	A-18			
PA0QL	276-6-1	A-10	Sweden-SM		
PA0WHS	215-5-1	A-17	SM6WL	5831-17-3	B-43
			SM5UU	1540-10-1	B-19
			SM7UC	1442-14-3	A-41
			SM6SS	1184-8-1	A-32
			SM5SX	180-6-1	B-4
			SM7YG	36-3-1	A-1
			Norway-LA		
			LA1G	4433-11-1	A-47
			LA2B	1170-10-2	A-29
			LA4K	1100-11-2	A-26
			LA6A	882-9-1	A-26
			LA3B	315-7-1	A-1
			LA3F	252-6-1	A-4
			LA1M	113-4-1	A-2
			LA1X	12-2-1	A-2
			LA3V	12-2-1	A-7
			Finland-OH		
			OH3NP	3696-14-1	A-39
			OH8NF	88-4-1	A-1
			Italy-I		
			I1TKM	2844-12-1	A-43
			Roumania-YR		
			YR5AA	2415-15-3	B-18
			Latvia-YL		
			YL3CD	427-7-2	A-32
			YL2BQ	10-2-2	A-8
			Malta-ZB1		
			ZB1E	108-4-1	- - -
			Jugoslavia-YT		
			YT7KP	80-4-1	A-9
			OCEANIA		
			New Zealand-ZL		
			ZL2KK	71820-36-3	A-88
			ZL1D	38396-29-3	A-82
			ZL2RY	31320-30-3	A-58
			ZL1CK	38025-25-2	A-54
			ZL1HY	26156-26-3	A-1
			ZL1GX	24324-29-3	A-66
			ZL8DJ	21431-29-3	A-54
			ZL3GR	11293-25-2	A-49
			ZL1CK	5584-16-2	A-22
			ZL2HR	3990-14-1	A-23
			ZL1CV	2904-11-1	A-38
			ZL1BC	1370-10-2	-18
			ZL1LM	1023-11-2	A-1
			ZL1JW	529-6-1	A-1
			ZL1FT*	427-7-1	- - -
			ZL1AR*	18-1-1	- - -
			Australia-VK		
			VK3MR	68542-38-3	A-90
			VK2EO	34133-29-3	A-79
			VK3CP	31955-35-8	A-70
			VK4AB	27090-30-3	A-1
			VK2AS	24472-28-3	A-71
			VK3OC	20925-27-3	A-45
			VK2PX	14280-21-2	A-1
			VK4GK	10980-30-3	- - -
			VK3JK	10466-22-3	-40
			VK3WV	9639-21-2	-41
			VK3HK	8220-20-2	A-25
			VK3MK	5984-17-2	A-43
			VK3JT	4731-19-2	A-26
			VK3CX	4298-14-1	- - -
			VK2FM	4260-20-2	- - -
			VK3XP	4256-19-2	A-53
			VK3WH	3990-19-2	A-46
			VK4ER	3726-18-2	A-41
			VK3RJ	3468-17-2	A-18
			VK3YO	2954-14-2	A-36
			VK3PM	2030-14-2	A-18
			VK4LV	2024-11-2	A-21
			VK2TI	1755-13-1	B-13
			VK3GU	1680-14-2	A-12
			VK2IG	1467-9-2	A-22
			VK2VA	1250-10-1	A-23
			VK3UW	1120-14-2	A-23
			VK5HG	930-10-1	-22
			VK4US	759-11-2	A-21
			VK3NG	572-11-2	-6
			VK2QE	462-7-1	A-11
			VK3CZ	336-7-1	A-14
			VK3J	290-8-1	- - -
			VK3BW	210-7-2	A-1
			VK3MX	210-7-2	A-3

(Continued on page 90)



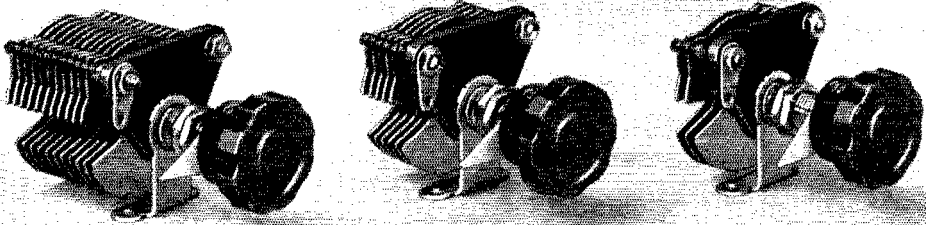

**CONVENIENT SIZE • LOW LOSS • INEXPENSIVE**

These condensers are used widely by amateurs in all circuits requiring small, simple-to-mount, low-loss units. They can be used either as single hole panel or bracket mounting. The insulation is a small end-plate of hard rubber placed in a weak field. Rated at 500 volts, peak, they are very suitable for use in low power transmitters. The plate shapes are straight-line capacitance.

The Type 368 Condensers are supplied in three sizes:

- Type 368-A: 15  $\mu\text{f}$  maximum, 2  $\mu\text{f}$  minimum, \$0.75
- Type 368-B: 50  $\mu\text{f}$  maximum, 3  $\mu\text{f}$  minimum, \$1.00
- Type 368-C: 100  $\mu\text{f}$  maximum, 4  $\mu\text{f}$  minimum, \$1.50

Write for bulletin 29-Q for a description of the many General Radio amateur parts and accessories

**GENERAL RADIO COMPANY**  
Cambridge, Massachusetts

"The Crystal Specialists Since 1925"

**PIEZO-ELECTRIC CRYSTALS**  
Guaranteed Accurate to BETTER than .01%  
**SCIENTIFIC RADIO SERVICE**  
UNIVERSITY PARK, HYATTSVILLE, MD.

**RADIO COURSES**

**RADIO OPERATING:** Prepare for Gov't License Exam. ●  
**RADIO SERVICING:** Including Short Wave ● **AMATEUR CODE** ● New Course in **ELECTRONICS.**  
Day and Evening classes — *Booklet upon Request*  
**NEW YORK YMCA SCHOOLS**  
4 West 63rd Street, New York City

UNIVERSITY COURSE IN

**RADIO COMMUNICATION**

High Standard of Instruction and Equipment  
Registration begins September 16, 1936

Write for descriptive folder

UNIVERSITY OF WISCONSIN EXTENSION DIVISION  
623 West State Street Milwaukee, Wisconsin

**A 'PHONE MONITOR**

Which gives actual linear reproduction of your carrier modulation and costs only

**\$9.85 COMPLETE!**

No wonder our dealers can't keep them in stock

**THE LITTLE HAYNES RIG CHECKER**

Also shows over-modulation.

It is an excellent Output Meter for either R.F. or A.F. (V.T. Voltmeter)

Measures voltages up to 1000 volts.

Contains an 0-1 M.A. meter (better than 2% accuracy guaranteed) with variable shunt which may be used independently; and

**OPERATES FROM THE 110-VOLT LINE**

Get full description and instruction circular from your dealer or write

**RADIO CONSTRUCTORS LABORATORIES**  
Dept. Q-3, 136 Liberty St., New York, N. Y.  
Export Dept., 105 Hudson St., N. Y. C.

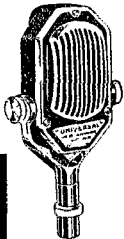

**UNIVERSAL VELOCITY AND CARBON MICROPHONES**

Universal's latest achievement — Ideal for stage use — Not affected by temperature or humidity — Flat frequency response curve from 40 to 10,000 c.p.s.; Output-63 db; Low impedance or direct to grid types. Compact 2 3/4 x 4 3/4 in. by 1 3/4 in. thick — Weight, less than 16 oz. — Head swings to any desired angle — Beautifully finished in black enamel and artistic chrome plate — ask for new catalog sheet describing models RL, RP, RH and CB — List \$22.50 — Latest model music type sectional stand for above microphones — List \$10.00.

**UNIVERSAL MICROPHONE CO., LTD.**  
424 Warren Lane Inglewood, Calif., U. S. A.

# Where to buy it

A directory of suppliers who carry in stock the products of these dependable manufacturers.

**ASTATIC**  
*Crystal Microphones and Pickups*  
 ASTATIC MICROPHONE LABORATORY, Inc. YOUNGSTOWN, O.  
*Pioneers Manufacturers of Quality Crystal Products*

NEWARK, N. J. 219 Central Ave.  
 Wholesale Radio Service Co., Inc.  
 NEW YORK, N. Y. Harvey's Radio Shop 103 W. 43rd St.  
 NEW YORK, N. Y. Wholesale Radio Service Co., Inc. 100 Sixth Ave.  
 PHILADELPHIA, PENN. Eugene G. Wile 10 S. 10th Street

**BURGESS BATTERY COMPANY**  
*"Chrome" protected*  
**RADIO BATTERIES**  
 Look for the Black and White Stripes  
 FREEPORT, ILLINOIS

ALBANY, N. Y. Uncle Dave's Radio Shack 356 Broadway  
 BALTIMORE, MD. Radio Electric Service Co. 3 North Howard St.  
 BOSTON, MASS. Radio Shack 46 Brattle Street  
 BUFFALO, NEW YORK Dymac Radio 216 E. Genesee St.  
 HARTFORD, CONN. Stern & Company, Inc. 210 Chapel Street  
 MONTREAL, CANADA 285 Craig Street, West  
 Canadian Electrical Supply Co., Ltd.  
 NEWARK, N. J. Wholesale Radio Service Company 219 Central Ave.  
 NEW YORK, N. Y. Harrison Radio Company 12 West Broadway  
 NEW YORK, N. Y. Wholesale Radio Service Company 100 Sixth Avenue  
 SPRINGFIELD, MASS. T. F. Cushing 349 Worthington St.

**super skyrider**  
*hallicrafters*  
**ultra skyrider**

ALBANY, N. Y. Uncle Dave's Radio Shack 356 Broadway  
 BALTIMORE, MD. Radio Electric Service Company 3 North Howard St.  
 BOSTON, MASS. Radio Shack 46 Brattle Street  
 HARTFORD, CONN. Radio Inspection Service Co. 227 Asylum Street  
 NEWARK, N. J. Wholesale Radio Service Co., Inc. 219 Central Ave.

NEW YORK, N. Y. Gross Radio, Inc. 51 Vesey St.  
 NEW YORK, N. Y. Harrison Radio Co. 12 West Broadway  
 NEW YORK, N. Y. Harvey's Radio Shop 103 W. 43rd St.  
 NEW YORK, N. Y. Wholesale Radio Service Co., Inc. 100 Sixth Ave.  
 READING, PENN. George D. Barbey Company 404 Walnut St.  
 SPRINGFIELD, MASS. T. F. Cushing 349 Worthington St.

**E. F. JOHNSON COMPANY**  
 MANUFACTURERS OF  
**RADIO EQUIPMENT**  
 WASECA, MINN.  
 U.S.A.

BUFFALO, NEW YORK Dymac Radio 216 E. Genesee St.  
 MONTREAL, CANADA 285 Craig Street, West  
 Canadian Electrical Supply Co., Ltd.  
 NEWARK, N. J. Wholesale Radio Service Company 219 Central Ave.  
 NEW YORK, N. Y. Harrison Radio Company 12 West Broadway  
 NEW YORK, N. Y. Wholesale Radio Service Company 100 Sixth Avenue  
 PITTSBURGH, PENN. Cameradio Company 603 Grant Street  
 READING, PENN. George D. Barbey Company 404 Walnut Street

**RAYTHEON**  
 TRADE MARK  
**AMATEUR TUBES**

ALBANY, NEW YORK Uncle Dave's Radio Shack 356 Broadway  
 BOSTON, MASS. The Radio Shack 46 Brattle Street  
 BOSTON, MASS. Selden Radio Company 28 Brattle Street  
 BUFFALO, NEW YORK Radio Equipment Corp. 326 Elm Street  
 CONCORD, NEW HAMPSHIRE Carl B. Evans 80 N. State Street  
 NEWARK, NEW JERSEY Wholesale Radio Service Co. 219 Central Street  
 NEW YORK, N. Y. Harrison Radio Company 12 West Broadway  
 NEW YORK, N. Y. Harvey's Radio Shop 103 W. 43rd St.  
 NEW YORK, N. Y. Wholesale Radio Service Co. 100 Sixth Avenue

# Where to buy it

A directory of suppliers who carry in stock the products of these dependable manufacturers.



**RCA de Forest**  
**RADIO TUBES**  
RCA Radiotron Division of RCA Manufacturing Co., Inc.

**ALBANY, N. Y.** Uncle Dave's Radio Shack 356 Broadway  
**BALTIMORE, MD.** Radio Electric Service Company 3 North Howard St.  
**BOSTON, MASS.** H. Jappe Company 46 Cornhill  
**BOSTON, MASS.** Radio Shack 46 Brattle Street  
**BUFFALO, NEW YORK** Dymac Radio 216 E. Genesee St.  
**NEWARK, N. J.** Wholesale Radio Service Co. 219 Central Avenue  
**NEW YORK, N. Y.** Bruno-New York, Inc. 460 W. 34th St.  
**NEW YORK, N. Y.** Sanford Samuel Corp. 136 Liberty St.  
**NEW YORK, N. Y.** Wholesale Radio Service Co. 100 Sixth Avenue  
**NEW YORK, NEW YORK** Harrison Radio Company 12 West Broadway  
**PHILADELPHIA, PENN.** Eugene G. Wile 10 S. 10th Street  
**PHILADELPHIA, PENN.** Raymond Rosen & Company 117 North 7th St.  
**PHILADELPHIA, PENN.** M & H Sporting Goods Company 512 Market Street  
**PITTSBURGH, PENN.** Cameradio Company 603 Grant Street  
**READING, PENN.** Bright & Company 8th & Elm Streets  
**SPRINGFIELD, MASS.** T. F. Cushing 349 Worthington Street  
**WASHINGTON, D. C.** Sun Radio & Service Supply Co. 938 F Street, N. W.



**RCA AMATEUR**  
**RADIO**  
**EQUIPMENT**  
RCA Victor Division of RCA Manufacturing Co., Inc.

**ALBANY, N. Y.** Uncle Dave's Radio Shack 356 Broadway  
**BOSTON, MASS.** H. Jappe Company 46 Cornhill  
**BOSTON, MASS.** Radio Shack 46 Brattle Street  
**BUFFALO, NEW YORK** Dymac Radio 216 E. Genesee St.  
**CAMDEN, N. J.** Radio Electric Service Company 811 Federal Street  
**ERIE, PENN.** J. V. Duncombe Company 1011 West 8th St.  
**GREENWICH, CONN.** Mead Stationery Company 252 Greenwich Ave.  
**HARTFORD, CONN.** Radio Inspection Service Co. 227 Asylum Street  
**MONTREAL, CANADA** Canadian Electrical Supply Co., Ltd. 285 Craig Street, West  
**NEWARK, N. J.** Wholesale Radio Service Company 219 Central Avenue  
**NEW YORK, N. Y.** Bruno-New York, Inc. 460 W. 34th St.  
**NEW YORK, N. Y.** Harrison Radio Co. 12 West Broadway

**NEW YORK, N. Y.** Sanford Samuel Corporation 136 Liberty Street  
**NEW YORK, NEW YORK** Grand Central Radio, Inc. 124 E. 44th Street  
**NEW YORK, N. Y.** Wholesale Radio Service Company 100 Sixth Avenue  
**PHILADELPHIA, PENN.** Radio Electric Service Company 3145 N. Broad Street  
**PHILADELPHIA, PENN.** Radio Electric Service Company N. E. Cor. 7th & Arch Streets  
**PHILADELPHIA, PENN.** M & H Sporting Goods Co. 512 Market Street  
**PITTSBURGH, PENN.** Cameradio Company 603 Grant Street



Use **SHURE**  
**MICROPHONES**  
Microphone Headquarters

**ALBANY, N. Y.** Uncle Dave's Radio Shack 356 Broadway  
**BOSTON, MASS.** H. Jappe Company 46 Cornhill  
**BUFFALO, N. Y.** Radio Equipment Corporation 326 Elm St.  
**NEWARK, N. J.** Wholesale Radio Service Company 219 Central Avenue  
**NEW YORK, N. Y.** Harrison Radio Co. 12 West Broadway  
**NEW YORK, N. Y.** Wholesale Radio Service Company 100 Sixth Avenue  
**NEW YORK, N. Y.** Sun Radio Company 227 Fulton Street  
**READING, PENN.** George D. Barbey Company 404 Walnut Street  
**SPRINGFIELD, MASS.** T. F. Cushing 349 Worthington Street

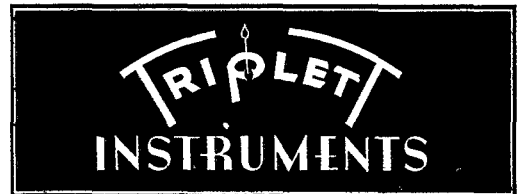

**TRIPLET**  
**INSTRUMENTS**

**ALBANY, N. Y.** Uncle Dave's Radio Shack 356 Broadway  
**BOSTON, MASS.** Radio Shack 46 Brattle Street  
**BOSTON, MASS.** Seiden Radio Company 28 Brattle St.  
**BUFFALO, NEW YORK** Dymac Radio 216 E. Genesee St.  
**MONTREAL, CANADA** Canadian Electrical Supply Co., Ltd. 285 Craig Street, West  
**NEWARK, N. J.** Wholesale Radio Service Company 219 Central Ave.  
**NEW YORK, N. Y.** Wholesale Radio Service Company 100 Sixth Avenue  
**PITTSBURGH, PENN.** Cameradio Company 603 Grant Street  
**READING, PENN.** George D. Barbey Company 404 Walnut Street

# I WILL SHOW YOU

that it is to your advantage to buy from me. Your inquiry about any amateur apparatus will prove that to you.

I give you specialized personal service of genuine value that is not available from other jobbers.

I take in trade used apparatus. I sell on time with terms to suit you and practically no interest charges. I won't be undersold.

I am jobber for Collins, RCA, RME, Marine transmitters and the All Star transmitter in kits or assembled. Trade in your transmitter. Buy on time.

I stock at lowest prices: RCA, Eimac, Taylor, United transmitting tubes. National, Hammarlund, Thordarson, Cardwell, Cornell-Dubilier, Dwyer, Johnson, Astatic, Shure, Ohmite, Trimm, Triplett, Weston, Barr, Peak, Bliley, Mac-Keys, other parts.

I ship all receivers on ten day trial. You need send but \$5.00 with order.

## TRADE IN YOUR TRANSMITTER OR RECEIVER

The new National NC-100s.....	\$105.00
The new NC-100Xs.....	127.50
RME-69s.....	118.80
Bretting 12s prepaid.....	87.00
National HROs.....	167.70
National HRO Jrs.....	99.00
RCA ACR-175s.....	119.50
Super Pros.....	223.44
Super Skyriders.....	79.50
The new Ultra Skyrider.....	99.50
The new Sky Buddy.....	29.50

Every inquiry and order is personally attended to by Robert Henry, W9ARA, an active amateur for eleven years; graduate E.E. from M.I.T.; and owner of Henry Radio Shop selling amateur supplies for seven years. You can reach me by letter, telegram, phone call, or visit 24 hours a day, 365 days a year. When in a hurry order from W9ARA. Write for any information.

**HENRY RADIO SHOP**  
211-215 North Main Street Butler, Missouri

## IMPROVE YOUR MODULATION

WITH A  
SERIES 7  
DYNAMIC  
MICROPHONE

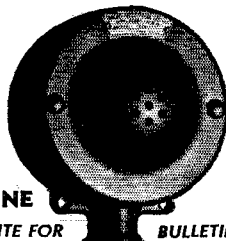

WRITE FOR BULLETIN 3012

HIGHER  
OUTPUT  
WITHOUT  
PRE-AMP-  
LIFICATION

## RADIO RECEPTOR CO., INC.

110 Seventh Ave., New York City

## LEARN CODE RIGHT — the Practical, Easy Way —



### Instructograph

Radio amateur code exams now require a 30% more speed. And experts agree: "It pays to learn from a perfect teacher — Instructograph." It's easy to become a real operator when you can practice Radio or Morse at your convenience — at any speed you want. Comes in two models — Senior or Junior Economy. You may buy or rent, at low cost. Just send post-card for complete details now to —

**INSTRUCTOGRAPH CO.**  
Dept. Q-9

912 Lakeside Place Chicago, Illinois  
Representatives for Canada  
Radio College of Canada, Ltd.  
863 Bay Street, Toronto

VK2PN	120- 4-1	B-11	CM2AI	16200- 27-3	A-62
VK5RD	90- 5-1	A- 4	CM7AC	11224- 22-3	A-41
VK4YI*	75- 5-1	-- 7	CM7AI	9315- 22-2	A- 7
VK3FG	60- 4-1	-- 7	CM2AO	6707- 18-2	A-34
VK2GG	44- 4-2	A- 5	CM8OP	4680- 13-2	A-14
VK4RY*	18- 2-1	A- 3	C06OM	12- 2-1	---
VK4RC	9- 1-1	A- 3	C07CX	3- 1-1	---
VK5RY*	3- 1-1	---			
VK3PX*	3- 1-1	---			

### Hawaii—K6

K6CGK	52410- 30-4	A-89	Newfoundland—VO		
K6ATIQ	48949- 31-3	AB-59	VO1P	22950- 27-3	B-48
K6IDK	35424- 24-2	B-69	VO2N	2720- 16-3	A-28
K6GHI	26542- 22-2	A-57	VO1N*	1170- 16-3	A-12

### K6EO

K6LBIH	3949- 11-1	B-36	Antigua—VP2		
K6AIU	2064- 16-2	B- 6	VP2J	13020- 21-2	A-42
K6BUX	1560- 10-1	B- 8	VP2BX	2484- 12-2	A- 7
K6MVV*	120- 5-1	---			

### Tasmania—VK7

VK7JR	33210- 27-3	A-66	Costa Rica—TI		
VK7PA	119- 6-2	A-12	TI2FG	11700- 15-2	B-35
VK7RC	36- 3-1	---	TI2EA	5680- 20-2	A-26
VK7AB*	6- 1-1	---			

### Guam—OM

OM2RX	10526- 10-2	B-40	Virgin Islands—K4		
			K4AAN	5264- 16-2	B-10
			K4DRN	688- 8-1	A- 3

### Philippine Islands—KA

KA1US	6790- 14-2	B-55 <sup>11</sup>	British Honduras—VP1		
KA1MD	3498- 6-1	B-45	VP1JR	2364- 16-2	A- 7
KA1LB	1476- 9-1	B-11	VP1MR	3220- 8-1	B- 7
KA1RB	392- 4-1	A- 7	VP1WB	1768- 6-1	A- 7

### Java—PK3

PK3BX	1224- 4-2	A-28	Panama—HP		
PK3LC	790- 5-1	A-23	HP1A	1230- 10-3	B-16
PK3ST	27- 3-1	A- 7			

### Fiji Islands—VR

VR1FF	837- 9-1	A-9	Bahamas—VP7		
			VP7NB	1067- 11-2	A-10

### Sumatra—PK4

PK4DA	576- 8-2	A-10	Bermuda—VP9		
PK4XM	120- 2-1	A- 7	VP9B*	360- 8-1	---

### NORTH AMERICA

Mexico—XE			Peru—OA		
XE2N	189081- 47-4	B-90	OAAJ	65975- 35-3	B-83
XE1AA	32890- 35-4	BC-35			
XE1AM	19215- 21-3	B-59	Colombia—HJ		
XE1AY	14328- 24-3	A-27	HJ3AJH	51156- 23-2	B-79
XE1AG	7452- 23-4	A-15			

### Canal Zone—K5/NY

K5AY	33244- 42-4	A-90	Uruguay—CX		
NY2AB	50304- 32-3	B-75	CX1CG	30069- 31-3	AB-58
K5AV	5709- 11-1	A-44 <sup>12</sup>	CX2AK	8460- 15-2	B-34
K5AE*	504- 8-1	-- 3			

### Porto Rico—K4

K4KD	72360- 45-4	A-87	Argentina—LU		
K4DDH	40076- 43-4	AB-66	LU1EP	27660- 30-3	A-81
K4DTH	9486- 11-2	A-51	LU9BV	18308- 27-3	A-88
			LU7EF	14535- 17-3	A-64
			LU7BH	2100- 10-1	B- 7
			LU2AX	1168- 8-1	B-24
			LU1CH	891- 9-1	A- 9
			LU2AM	45- 3-1	A- 7

### Alaska—K7

K7PQ	50352- 32-4	AB-65	Chile—CE		
K7ENA	5072- 16-2	A-22	CE7AA	5868- 12-1	---
K7VF*	12- 2-1	B- 7	Brazil—PY		
			PY2BX	3663- 11-1	A-22

### Cuba—CM/CO

CM2AD	50112- 32-3	A-90	Bolivia—CP		
CM2FA	29822- 37-4	A-51	CP1AC	2132- 13-2	B-13

## Brief

Listening on the 56-mc. band W2IUN heard W2IYX (portable mobile) calling CQ. Not having a transmitter on 56, W2IUN keyed the B lead of his receiver and called IYX. Contact established, IYX gave IUN a description of the house in front of which he was parked. Realizing that the description resembled his own home IUN rushed out to find IYX right in front of the house!

## LEARN RADIO

New Classes Now Forming! Send for 40-page catalog, explains fully. 300 licensed graduates placed in past 4½ years in broadcasting, shipping, police radio, aviation, etc. We teach all branches. Oldest, largest and best equipped school in New England. Equipped with Western Electric sound and broadcasting equipment and RCA marine transmitter. Course prepares for United States Government telegraph or telephone license.

**MASS. RADIO SCHOOL, 18 Boylston Street, BOSTON**

# HAM-ADS

(1) Advertising shall pertain to radio and shall be of nature of interest to radio amateurs or experimenters in their pursuit of the art.

(2) No display of any character will be accepted, nor can any special typographical arrangement, such as all or part capital letters be used which would tend to make one advertisement stand out from the others.

(3) The Ham-Ad rate is 15c per word, except as noted in paragraph (6) below.

(4) Remittance in full must accompany copy. No cash or contract discount or agency commission will be allowed.

(5) Closing date for Ham-Ads is the 25th of the second month preceding publication date.

(6) A special rate of 7c per word will apply to advertising which, in our judgment, is obviously non-commercial in nature and is placed and signed by a member of the American Radio Relay League. Thus, advertising of bona fide surplus equipment owned, used and for sale by an individual or apparatus offered for exchange or advertising inquiring for special equipment, if by a member of the American Radio Relay League takes the 7c rate. An attempt to deal in apparatus in quantity for profit, even if by an individual, is commercial and takes the 15c rate. Provisions of paragraphs (1), (2), (4) and (5) apply to all advertising in this column regardless of which rate may apply.

Having made no investigation of the advertisers in the classified columns, the publishers of *QST* are unable to vouch for their integrity or for the grade or character of the products advertised.

**QUARTZ**—direct importers from Brazil of best quality pure quartz suitable for making piezo-electric crystals. Diamond Drill Carbon Co., 719 World Bldg., New York City.

**RADIO** engineering, broadcasting, aviation and police radio, servicing, marine and Morse telegraphy taught thoroughly. All expenses low. Catalog free. Dodge's Institute, Byrd St., Valparaiso, Ind.

**NATIONAL**—Hammarlund, Patterson used sets, 60% off list. W3DQ, 405 Delaware Ave., Wilmington, Del.

**CLASS B** transformers—Universal for two or four 46s, 210s, 800s, RK18s, etc., \$7.75 pair postpaid. 70 watts audio from 46s, 100 watts from 10s. Write for details. W8UD, Douglas, Mich.

**QSL'S**, W2SN, Helmetta, N. J.

**QSLs, SWLs**. Best quality reply getters. Samples. (Stamps) W8ESN, 1827 Cone St., Toledo, Ohio.

**FOR** sale, 3-750 volt, 150 watt generators \$11. each. Also a few other generators and motors. Wilnot Auto Supply Company, 1970 Wilmot St., Chicago.

**WANT** modern factory-made ham receiver; medium power transmitter, parts, tubes. Exchange fine collections Indian relics; U. S. coins. All letters answered. W9POB, Wauneta, Nebraska.

**CALLBOOKS**—new DX calls, new prefixes, thousands of new W and VE calls, in the Summer 1936 Radio Amateur Call Book. Sent postpaid \$1.25, or a whole year (four issues) for \$4. (In foreign countries \$1.35 and \$4.35.) Your call and QRA printed in large type, \$1. per year. Radio Amateur Call Book, 610 S. Dearborn, Chicago.

**WRITE** us for trade-in price on your old receiver. We buy meters. Walter Ashe Radio Co., St. Louis, Mo.

**KEEP** posted. Save money with Radio Data Digest. Stamp brings sample. Kladag, Kent, Ohio.

**TRADE** in your old receiver or equipment. Get ham apparatus from us. Can use some office equipment. Palmer's Trading Post, Route 1, Duluth, Minn.

**METER** Repair Service—Accurate and expert work. Typical prices. Milliameters shunted to different range, with new scale; hairsprings repaired and hands straightened; \$1.50—\$2.00. Send your meter in for estimate. Braden & Apple Co. 305 Park Dr., Dayton, O.

**SELL**—big discount—complete 50 watt phone transmitter, rack-panel, pictures on request. First \$80. takes it. W9KHC, 1239 Kinsmore Ave., Fort Wayne, Ind.

**FOR** sale—complete factory-built 60 watt CW phone transmitter and super-hot communications receiver. Need cash. W2BJR, Nevins 8-0783

**SELLING** testing equipment, Masterpiece IV receiver. Write Ryser, 1719 Majar St., Salt Lake City, Utah.

**QSLs**. Free samples. Printer, Corwith, Iowa.

**WORTH** a million in improved station appearance, operation. New all-welded relay racks, panels, chassis. Heavy duty Hi-power equipment. Rectifier Engineering Service, 4837 Rockwood Road, Cleveland, Ohio.

**SELL** SW3-eight coils—supply. W2HWO.

**HAVE** two Racon and ten special dynamic speaker units using Fox or Macy diaphragms with 10,000 and 5 ohm fields respectively. All in good condition. Voice coils, 15 ohms; handle 15 watts continuously. \$20. per pair. Write Sereno Smith, 4218 Valley Road, Cleveland, Ohio.

**20-80** meter transmitter in rack, complete \$75. Bargs in Skyriders, RME, ACR 136, etc., Cameras & binoculars wanted in trade. Wells Smith Radio Corp., 26 North Wells St., Chicago.

**VICINITY** Cleveland complete automatic mercury adc 18 bucks. W8APB.

**BLILEY** crystal bargain! Write W8DED.

**QSLs! SWLs!** What's your desire? Samples? (stamp) W8DED, Holland, Mich.

**QSL's**. 300 one-color cards \$1. Samples. 2143 Indiana Avenue, Columbus, Ohio.

**QSL** printing service. Samples. Theodore Porcher, 7708 Navjo St., Philadelphia, Penna.

**COLLINS** 30 FXB complete equipment latest model new equipment. Can arrange finance and accept late model used car trade. Road job forces portable operation this winter. Chlne Cole, 511 Division, Jackson, Tennessee.

**BAUSCH-LOMB** microscope. Trade for equipment. Hackney's, Durham, N. C.

**QSLs**. Finest cards. Lowest prices. Maleco, 1512 Eastern Parkway, Brooklyn, New York.

**GROSS** CB-25 50-80 watt fone and CW xmitter. Plate modulated, 3-stage with xtal control. Factory-owned plug-in coils for 20, 40, 80 and 160 bands. Smooth operation, good DX record, excellent quality. Rack mounting, crackle finish. Tubes, xtal holders, double-button mike and stand, \$85., \$10. remittance, balance C.O.D. Photo, SW-3 perfect condition. 9 pairs of factory-wound coils from 9 to 550 meters including 20, 40, and 80 meter band-spread, tubes, \$25.—\$5. remittance. W2HZP, 166 Clinton Ave., Jersey City, N. J.

**UNUSUAL** buy, WIMK units reconditioned since flood. 3-units Esco M.C. set. (1) 2,000 v.d.c. at 750 ma. (2) 14 v.d.c. field gen., runs filaments if desired (3) 4 H.P. 2 phase 220 v.a.c. motor. Also 30 amp. 4 pole manual switch. Also CB 110 v 60 cycle magnetic switch. Two field rheostats with above. Original cost over \$450. Sell \$125. cash, crated, F.O.E. Hartford. Will quote separately on motor and switches if requested. National 6-inch 100-0 180° dial for frequency meter, \$3. postpaid. ARRL Communications Department, West Hartford, Conn.

**KLEINSCHMIDT** power driven perforator and Wheatstone transmitter in perfect commercial condition, recently overhauled. Best offer over \$120 takes both. G20A.

**CRYSTALS**: Zero cut. Guaranteed to compensate at near zero without oven. 80-160 meters \$1.85. Holders 75¢ postpaid. Fisher Laboratory, 4522 Norwood Street, San Diego, California.

**CRYSTALS**: "V" cut. Most active known. 80M-160M within five kilocycles. 10 cycle coefficient, \$2.25. Four cycle, \$3.25. Accuracy, mounted, .03%. Formica holders, \$1. Catalogue. Ham Crystals, 1104 Lincoln Place, Brooklyn, N. Y.

**CRYSTALS**: When in need of a good crystal order from Bill Threm, W8FN, 4021 Davis Ave., Cheviot, Ohio. No dealers. Direct to you. 160-80 meter, X cut, within ten kilocycles, less than 1", \$1.35. Exact frequency, 1" square, \$2.50. Plug-in holders 85¢.

**CRYSTALS**—Unmounted 1.7, 3.5, 7 megacycle amateur band crystals. Your approximate frequency, X cut, \$1.50; Low drift cut \$2.50—New 14 megacycle thick cut \$4.50—Holders \$1. Calibration accuracy 99.99%—Postage prepaid. Southwest Piezo Service, Box 792, Abilene, Texas.

**YOUR** photo on QSL cards. Low prices. Samples free, Baker Bros., 204 Carroll, Akron, Ohio.

**TELEPLEXES**, Omnigraphs, Vibroplexes, meters, receivers, bought, sold, traded. Ryan Radio Co., Monroe City, Mo.

**CRYSTALS**—excellent oscillators. 80-160, within five kilocycles—Y cut, \$1. X or 4 cycle A, \$1.50. W9FHS, 4433 North Kilbourne, Chicago.

**TELEGRAPH** speed keys in kit form, only \$2.89. A post card brings full information. Electric Specialty Mfg Co., PO Box 645, Cedar Rapids, Iowa.

**FOR** RME-69 or Hallierafter write W5CQF, 819 Perdido, New Orleans.

**SELL** SW-3, coils, good condition \$15. W5CQF, New Orleans.

**REBUILT** Vibroplexes \$6. New heavy base bugs \$9. Lydeard, 28 Circuit, Roxbury, Mass.

**CRYSTALS**:—Eidson "T-9" 40 meter X cut, dependable—powerful, \$1.50 approximate frequency. Satisfaction guaranteed, instant service. Attractive "T-9" ultra low-loss ceramic plug-in holder \$1.10 postpaid. A post card brings your order CO.D., if preferred. Eidson's Temple, Texas, or W2GWS, 83-34 209th Street; Queens Village, New York.

**2 1/2** kw New Hilet plate transformers \$35. Leitch, Park Drive, West Orange, N. J.

**QSL's**—W7DRR-W7DSO.

**WRITE** for list of used transmitters and parts. Harvey Radio Labs., Inc., 12 Boylston St., Brookline, Mass.

**SEPTEMBER Special:** one 1936 "Radio Handbook", one "Radio Antenna Handbook", five issues of "Radio", all for \$1.95; Canada, \$2.25; foreign, \$2.65. "Radio", 7460 Beverly, Los Angeles.

**"ANTENNA Handbook"** by "Radio". Most complete antenna data ever issued. Receiving, transmitting, general, directional, "all-band". Detailed dimensional tables; no calculations necessary. 80 pages, profusely illustrated. 50¢ in U.S.A. and Canada; 60¢ elsewhere. "Radio", 7460 Beverly, Los Angeles.

**CRYSTALS AT cut** with shielded mounting. 80 and 160 meter bands \$2.35. White Radio Laboratory, Sandpoint, Idaho.

**QSL cards.** Attractive, different. 75¢ per hundred up. Stamp for samples. W8DDS, 2156 West 80th Street, Cleveland.

**TRANSMITTERS**—100 watt, 200 watt, and one kilowatt. Real bargains. Mims Radio Company, Texarkana, Ark.

**USED receivers**—bargains in good sets. Mims Radio Co., Texarkana.

**NEW bargain list.** Mims Radio Co., Texarkana, Ark.

**QSL's**—special introductory offer. Radio Headquarters, Ft. Wayne, Indiana

1 kw. input to pair Ewing 100s. Tantalum elements, thoriated fil. (5V-8A or 10V-4A). Plate 3000V max., 175 mils. Low bias and excitation needed. Each \$12.50. Data. Ewing, 1057 Pratt, Chicago.

**QSL's, SWL's,** 200 two colors \$1. W8LQM, 942 Linwood Avenue, Columbus, Ohio

**RECEIVER,** 5 tube A.C. complete \$20. W8HQN.

**FB ham rovr,** three tubes, coils (20-40-80M), power supply—\$15. W8FND, Pa.

**QST de Central Division Convention,** Hotel Sherman, Chicago, Sept. 5-7. Meet Woodruff, Bailey, McElroy, Handy, Reinartz, Phelps, Roberts, others. Banquet, entertainment, contests, exhibits, prizes, fun. Write W9KJY.

**CQ CQ de Nationwide Amateur Radio Show,** Hotel Sherman, Chicago, Sept. 5-7. Equipment displays, technical discussions, entertainment, eats. CU here. Write W9HPG.

**W9PZ** holding their annual fall hamfest Sept. 5th as part of the Central Division Convention, Chicago. Don't miss it!

**MCMURDO** Silver 111 custom receiver. Large two fifty power amplifier. Motorola, Philco car radios. Want oscillograph. Glenn Watt, Chanute, Kans.

**"NEON-Stick"** modulation monitor—\$1.25. 196 Van Houten, Passaic, N. J.

**WANTED** Salesman in New York City capable of selling equipment and parts to amateurs and experimenters. Pleasing personality. State salary desired and past experience. Write Salesman, Box Z, QST.

**EIMAC tubes**—WSANT

**NEW receivers,** all makes—WSANT

**EQUIPMENT** built to order—WSANT

**SERVICE** men's supplies. Volume controls, resistors, condensers—WSANT

**EQUIPMENT** sold on time. Easiest terms in country—WSANT

**ALL** lines of new and used equipment for sale or trade, cash or time payments, by southern Ohio's only amateur owned amateur business—Jos. N. Davies—WSANT, box 602—R.R. 9 North Bend Road, Mt. Airy, Cincinnati, Ohio.

## Specialists

In Earphone Units of more different types with more resistances for more applications than those produced by any other manufacturer in the world.

TRIMM headsets occupy a position of international leadership. A phone for every need.

**TRIMM RADIO MFG. COMPANY**  
1770 W. Berteau Ave., Chicago, Ill.

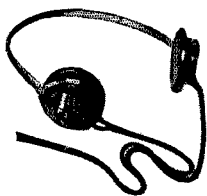

## NEW HOYT JUNIOR SQUARE METERS

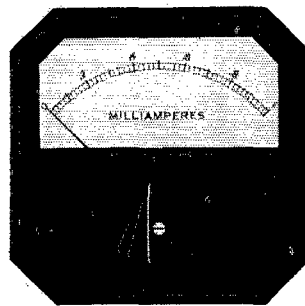

**THIS** Series 579 was developed in response to insistent demand for moderately priced D. C. instruments with all the following features. Modern square bakelite

case measures 3¼ inches and mounts through a 2 13/16 inch panel hole. Long arc scale with knife edge pointer. Rugged movement of 2% accuracy—Sensitivity is 50 MV in the 0/1 MA range.

Milliammeters supplied in ranges of 0/1 up to 0/500. Voltmeters from 0/10 to 0/150, high resistance voltmeters from 0/150 to 0/1000. Ammeters from 0/1 to 0/25.

Any panel can be modernized at low cost with these attractive, compact meters. Ask your jobber for these smart new instruments. If he cannot supply you, clip the handy coupon below.

### THE BURTON-ROGERS COMPANY

755 BOYLSTON STREET BOSTON, MASS.  
Sales Division of the Hoyt Electrical Instrument Works

Gentlemen: Kindly send me full information and price list of the Hoyt Junior Square Meter Series 579.

Name .....

City .....

## SPEED UP YOUR CODE

At Home or on the Job

With **CANDLER Scientific Sound System That Trained the Champions**

**PLENTY OF OPPORTUNITIES** for well trained com'l ops. Many amateurs are obtaining good jobs thru **CANDLER Training**. Can be taken at home or while on the job during spare time. Amazing results. **CANDLER** trained ops in all com'l stations.

**IF YOU'RE "STUCK"** below 12wpm ask about Junior Code Course for beginners. If above 12wpm, and want to get into 35 to 50wpm class, and copy behind, ask about Advanced Course for Radio ops, also specialized "Mill" Course.

**SAVE TIME AND MONEY** by sending for **FREE BOOK OF FACTS**. Answers all your questions. Tell us what you want to accomplish. We'll advise and help you. *No obligation.*

**CANDLER SYSTEM CO.**

Dept. Q-9

Asheville, North Carolina



# Your Nearest Dealer Is Your Best Friend

Your nearest dealer is entitled to your patronage. You can trust him. He is equipped with a knowledge and understanding of amateur radio. He is your logical and safe source of advice and counsel on what equipment you should buy. His stock is complete. He can supply your needs without delay. His prices are fair and consistent with the high quality of the goods he carries. He is responsible to you and interested in you.

Patronize the dealer nearest you—You can have confidence in him

<p><b>ALLENTOWN, PENNSYLVANIA</b> Radio Electric Service Co. 1024 Hamilton Street Complete stocks transmitting equipment</p>	<p><b>PITTSBURGH, PENNSYLVANIA</b> Cameradio Company 601-3 Grant Street "Ham" Headquarters for Pennsylvania-Ohio-W. Virginia</p>
<p><b>BALTIMORE, MARYLAND</b> Radio Electric Service Co. 303 W. Baltimore Street Everything for the amateur</p>	<p><b>PHILADELPHIA, PENNSYLVANIA</b>  Eugene G. Wile 10 S. Tenth Street Complete Stock of Quality Merchandise</p>
<p><b>BIRMINGHAM, ENGLAND</b> Radio Mart 19 John Bright Street Drop in and meet Bill Nightingale—G5NI</p>	
<p><b>BUFFALO, NEW YORK</b> Radio Equipment Corp. 326 Elm Street W8GJ—Ham, service and sound equipment—W8BTS</p>	<p><b>PROVIDENCE, RHODE ISLAND</b> W. H. Edwards Co. 32 Broadway National—Hammarlund—RCA—and other leaders</p>
<p><b>MANCHESTER, NEW HAMPSHIRE</b> Radio Service Lab. of N. H. 1187-1191 Elm Street—Tel. 218-W Branches—Portland, Me. and Barre, Vt.</p>	<p><b>PROVIDENCE, RHODE ISLAND</b> Kraus &amp; Company 89 Broadway Everything for the amateur and serviceman</p>
<p><b>MONTREAL, CANADA</b> Canadian Elec. Supply Co., Ltd. 285 Craig St., W. Quality parts and equipment for discriminating buyers</p>	<p><b>ROCHESTER, NEW YORK</b> Radio Service Shop 244 Clinton Avenue, North Complete stock amateur-BCL parts. Standard discounts. W8NUC</p>
<p><b>NEW YORK, N. Y.</b> Gross Radio, Inc. 51 Vesey Street Fair dealings plus fair prices. Anything in radio</p>	<p><b>SYRACUSE, NEW YORK</b> Roy C. Stage, W8IGF Complete stock of standard Ham &amp; BCL parts Standard Discounts. Free technical service</p>
<p><b>PHILADELPHIA, PENNSYLVANIA</b> Consolidated Radio Corp. 612 Arch Street Ham receivers, Transmitting tubes, Collins transmitters, etc.</p>	<p><b>SPRINGFIELD, MASS.</b> S. S. Kresge Company 1540 Main Street Standard discounts on standard lines. Advisory service: W1JQ, W1FOF</p>
<p><b>PHILADELPHIA, PENNSYLVANIA</b> Radio Electric Service Co., Inc. N. E. Cor. Seventh &amp; Arch Sts. All nationally-advertised lines in stock</p>	<p><b>WHEELING, WEST VIRGINIA</b> Cameradio Company 30 Twelfth Street Complete stock of amateur Equipment at standard discounts</p>

# You Are Protected When You Buy From QST Advertisers

“Advertising for QST is accepted only from firms who, in the publisher’s opinion, are of established integrity and whose products secure the approval of the technical staff of the American Radio Relay League.”

Quoted from QST’s advertising rate card.

Every conceivable need of a radio amateur can be supplied by the advertisers in QST. And you will know the product has the approval of the League’s technical staff.

For Your Convenience

## QST'S INDEX TO ADVERTISERS IN THIS ISSUE

Aerovox Corporation	71
Aladdin Radio Industries	59
Asatic Microphone Laboratories	66
A.R.R.L. Handbook	63
Log Book	4
Message Blanks	75
Birnbach Radio Company	86
Billie Electric Company	81
Brush Development Company	78
Bud Radio, Inc.	75
Burgess Battery Company	53
Burton Rogers Company	92
Candler System Company	92
Capitol Radio Engineering Institute	66
Cardwell Mfg. Corp., Allen D.	85
Centralab	56
Cohen's Sons, I. S.	85
Collins Radio Company	Cov. 2
Curtis Radio School, Samuel	79
Delco-Remy Corp.	65
Eitel-McCullough, Ltd.	55
Freck Radio & Supply Company	81
Gardiner-Levering Company	71
General Electric Company	95
General Radio Company	87
General Transformer Company	68
Gross Radio, Inc.	57
Gulf Radio School	82
Hallcrafters, Inc.	5, 6, 7, 8
Hammarlund Mfg. Company	1
Harvey Radio Laboratories	74
Hatry & Young	81
Heintz & Kaufman, Ltd.	70
Henry Radio Shop	90
Hinds & Edgerton	8
Hipower Crystal Company	84
Instructograph Company	90
Jacobs, Chas. F.	78
Leeds	60
M & H Sporting Goods Company	75
Marine Radio Company	2
Massachusetts Radio School	90
McElroy, T. R.	86
McGraw-Hill Book Company	54
Meisener Manufacturing Company	79
National Company	51, 58, Cov. 3
Newark Electric Company	69
New York V.M.C.A. Schools	87
Ohmite Mfg. Company	62
Omaha Crystal Laboratories	86
Port Arthur College	79
Precision Piezo Service	83
Radio Constructors Laboratories	87
Radio Laboratories	85
Radio Mfg. Engineers	71
Radio Receptor Corp.	90
Radio Shack	81
Radio Supply Company	81
Radio Transceiver Laboratories	79
Ramsey Publishing Company	83
Raytheon Production Corp.	52
RCA Institutes, Inc.	84
RCA Manufacturing Company	Cov. 4
Sargent Company, E. M.	79
Scientific Radio Service	87
Shure Brothers Company	82
Sicles Company, F. W.	79
Sundt Engineering Company	82
Sun Radio Company	85
Taylor Tubes, Inc.	61
Teleplex Company	86
Terminal Radio Corp.	83
Thordarson Electric Manufacturing Co.	67
Trimm Radio Manufacturing Company	92
Triplett Electrical Instrument Company	64
Turner Company	74
United Electronics	84
United Transformer Company	96
Universal Microphone Company	87
Universal Signal Appliance	78
University of Wisconsin	87
Valpey Crystals	70
Ward Leonard Electric Company	83



YOU'RE  
INVITED  
TO THE

5

TH OF...  
A SERIES  
OF FIELD  
SERVICE  
MEETINGS

DURING AUGUST  
AND SEPTEMBER



WHAT IS



*Focused Tone*

THAT REVOLUTIONIZES TUNING . . . AND  
AUTOMATICALLY ASSURES PERFECT TONE?  
AUTOMATIC FREQUENCY CONTROL — Automatic  
Frequency Control is a system by means of which a con-  
siderable error in tuning is automatically compensated;  
bringing the signal into perfect tune and permitting proper  
audio reproduction.

COLORAMA DIAL — The G-E Colorama Dial auto-  
matically flashes from red to brilliant green when the  
station is hair-line tuned for perfect tone.

COME, SEE, AND LEARN ABOUT  
THIS AMAZING NEW INVENTION

Illustrated Lectures  
Service Notes

Open Discussions  
Competent Speakers  
Illustrated Copies of Literature Will Be Distributed

GENERAL ELECTRIC COMPANY, BRIDGEPORT, CONN.  
Attention: Section R-959.  
Please send me the date and address of the next Field  
Service Meeting in my locality.

Name..... State.....  
Firm Name.....  
Street Address.....  
City.....

MAIL COUPON OR PHONE G-E  
RADIO DISTRIBUTOR FOR DATE  
OF LOCAL MEETING

ADMISSION  
FREE!

EVERYBODY IS  
INVITED



We'll advise you in ad-  
vance regarding the date  
and meeting place of the  
5th of a series of General  
Electric Field Service  
Meetings in your locality.  
This educational course  
is FREE. Your interest in  
radio sales and service is  
the only requirement for  
admission.

APPLIANCE AND  
MERCHANDISE DEPT.,  
GENERAL ELECTRIC  
COMPANY,  
BRIDGEPORT,  
CONN.

BY



# DON'T FORGET . . . the NEW UTC VARIMATCH Modulation Transformer will match ANY modulator tubes to ANY RF load . . . .

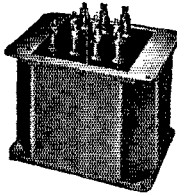

VM-4

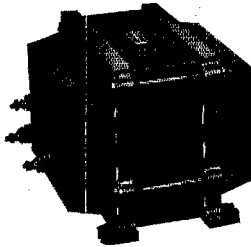

VM-5

The Varimatch transformer will not only match PRESENT available modulator tubes, but any tube that may be released at a FUTURE date.

All you have to decide is the DC input to your RF stage. Then just pick the VARIMATCH output transformer that will handle the maximum audio power required.

These transformers will also match the line impedance output of PA or similar amplifiers direct to the Class C tubes.

TYPE	VARIMATCH Modulation Transformer	List Price	Net Price
VM-1	Will handle any power tubes to modulate a 20 to 60 watt Class C stage	\$8.00	\$4.80
VM-2	Will handle any power tubes to modulate a 40 to 120 watt Class C stage	12.50	7.50
VM-3	Will handle any power tubes to modulate a 100 to 250 watt Class C stage	20.00	12.00
VM-4	Will handle any power tubes to modulate a 200 to 600 watt Class C stage	32.50	19.50
VM-5	Will handle any power tubes to modulate a 450 watt to 1 KW plus, Class C stage	70.00	42.00

The secondaries of all Varimatch transformers are designed to carry the Class C plate current.

THE VARIMATCH TRANSFORMER NEVER BECOMES OBSOLETE

## Look to UTC for REAL Advancements in Audio Transformers . . .

UTC, FOR MORE THAN TWO YEARS, HAS PIONEERED

- THE HIGH PERMEABILITY CAST SHIELD . . . maximum shielding from inductive pickup.
- THE TRUE HUM BALANCING COIL STRUCTURE . . . maximum neutralization of stray fields.
- THE BALANCED VARIABLE IMPEDANCE LINE . . . permits highest fidelity on every tap of a universal unit . . . no line reflections or transverse coupling.
- THE REVERSIBLE MOUNTING . . . permits above chassis or subchassis wiring.
- FULL ELECTROSTATIC SHIELDING

BETWEEN WINDINGS . . . brought out to separate terminal.

- THE MULTIPLE COIL, SEMI-TOROIDAL COIL STRUCTURE . . . minimum distributed capacity and leakage reactance.
- PRECISION WINDING . . . accuracy of windings .1%, perfect balance of inductance and capacity; exact impedance reflection.
- HIPERM-ALLOY . . . a STABLE high permeability nickel-iron core material.
- HIGH FIDELITY . . . UTC Linear Standard transformers are the ONLY audio units with a GUARANTEED uniform response, of  $\pm 1$  db, from 30 to 20,000 cycles.



### THE WINNER

and his wife

" . . . I was very happy to receive your wire notifying me that my entry had been chosen as winner of your contest . . .

. . . Having been quite active on 75 and 160 meter phone for the last two years, I can make very good use of the transmitter. I have a mike that has very good quality, so I feel fairly sure that it will do justice to the speech system of the transmitter, which I am sure is really f.b. I have used U.T.C. components for some time, and I KNOW.

**W. S. COBB, W6KOB**  
Santa Maria, California

**VALUABLE . . .** Our engineering staff has compiled a thorough study of transmitter design, public address hookups, circuits and applications into a 44-page illustrated bulletin. It is now available at your local distributor for only 25c.

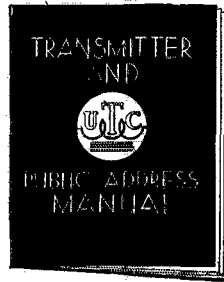

WE THANK THE JUDGES for their cooperation. It was no easy task to select ONE name from TEN THOUSAND ENTRIES. We give you the winner . . .

"UNITYPE"

# UNITED TRANSFORMER CORP.

72 SPRING STREET

NEW YORK, N. Y.

EXPORT DIVISION 100 VARICK STREET NEW YORK, N. Y. CABLES "ARLAB"

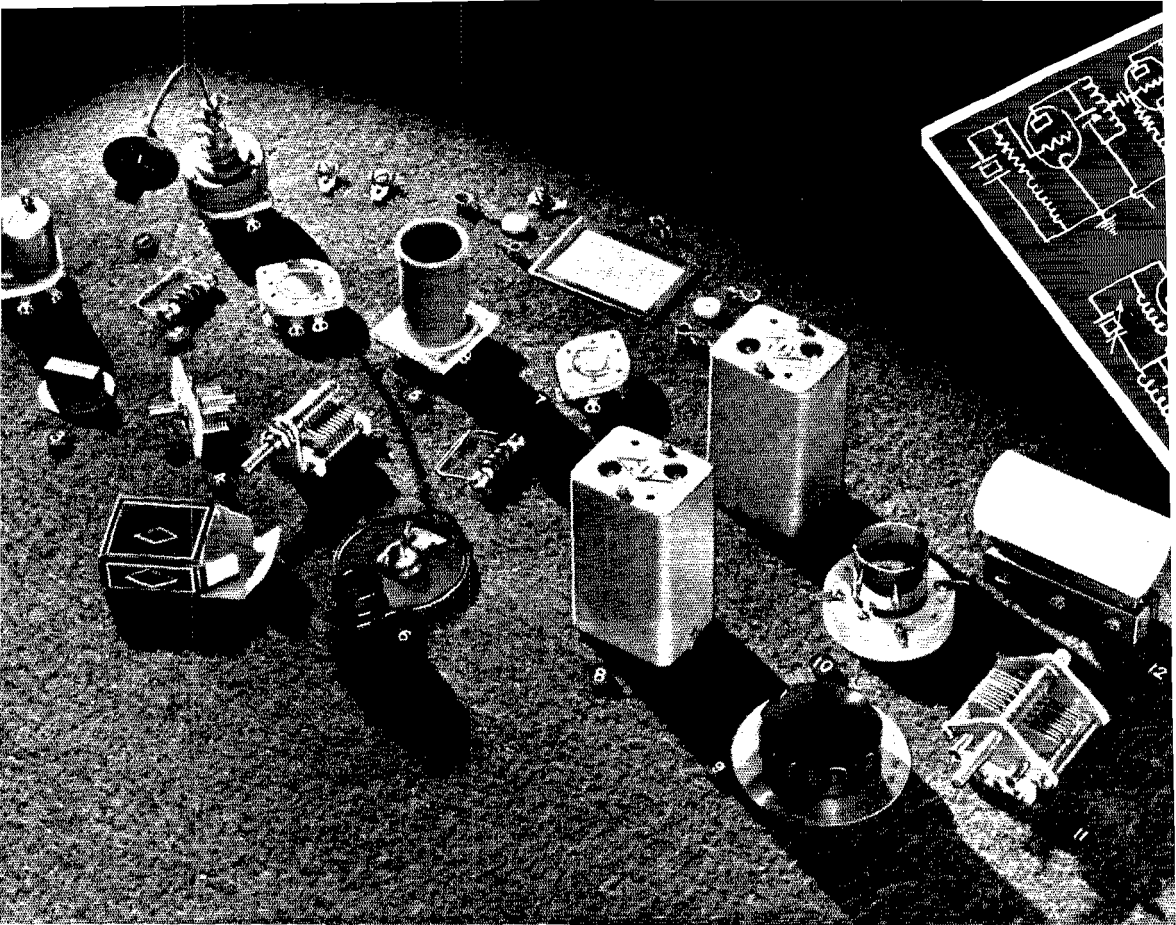

**W**HEN building or remodeling your transmitter, remember there is no substitute for National Radio Products, either in quality or in price. Genuine National parts will insure better performance of the old rig and peak operating efficiency of the new. A highly efficient exciter may be built around the group of parts illustrated above. They are ideally suited in every particular for this application. Nothing less will do.

## NOTHING LESS WILL DO

*The numbered parts shown above are as follows:*

- 1.** CHT and CHV Crystal Holders
- 2.** R-100 R.F. Choke
- 3.** HRO Dial, Type 10-0
- 4.** UM and ST Condensers
- 5.** XR-6 Coil Form with Square Socket
- 6.** BM Dial
- 7.** 6-prong Socket
- 8.** FXT Fixed Tuned Exciter Tank
- 9.** O Dial, Type 0-100
- 10.** XM-10 Transmitting Socket
- 11.** TMSA-50 Condenser
- 12.** UR13 Buffer Coil Form Assembly

NATIONAL

COMPANY

# What about Driving Power?

WHEN making a selection of tubes to be used in your transmitter, consider the driving power required to obtain full output, since the driving power required by the final stage will influence greatly the cost of the exciter stages.

Values of d-c grid current and driving power required to assure full output from a transmitting tube are subject to variations depending upon the impedance of the load circuit. High-impedance load circuits require more driving power and grid current to obtain the desired output, while low-impedance circuits require less. With low impedance load circuits, however, plate-circuit efficiency is sacrificed.

In general, the driving stage

should have a tank circuit of good Q and should be capable of supplying considerably more than the required amount of driving power.

RCA Transmitting Tubes are designed to require very low driving power consistent with good operation. Nominal driving power requirements for all RCA Transmitting Tubes are given in our technical bulletins. Consult these bulletins and see for yourself how little driving power is required in each instance.

The low driving power requirements of RCA Transmitting Tubes make them economical to excite, their long life makes them economical to use and their low cost makes them economical to buy.



## for Amateur Radio

Address Amateur Radio Section, RCA MANUFACTURING CO., Inc., Camden, N. J.

A Service of Radio Corporation of America