

# QST

August, 1936  
25 cents

devoted entirely to

# amateur radio

*In this issue—*

**Building  
C.H.P.  
Crystal-  
Controlled  
Transmitters**

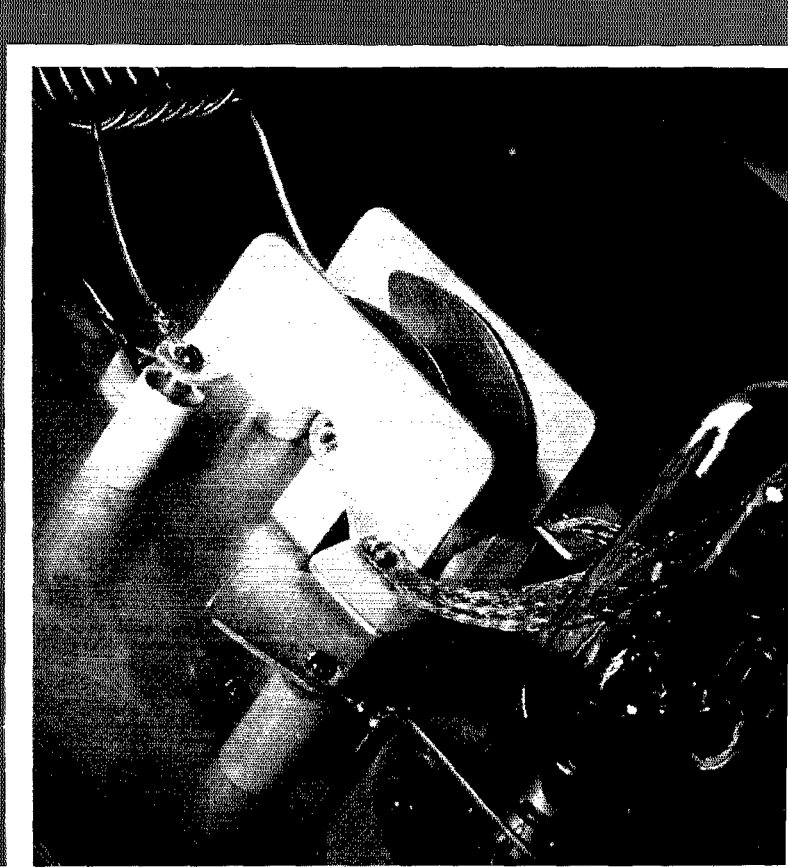



20C - 1000 WATT TRANSMITTER

300C - 100/250 WATT TRANSMITTER

50H MIXING PANEL

12E SPEECH ASSEMBLY

# Collins Broadcast Equipment

# A

MATEURS think of Collins Radio Company as a manufacturer of fine amateur gear. Unless they are also in commercial radio they may not know that more Collins transmitters are built for government, air transport, commercial communication and broadcast than for amateur use. Collins broadcast transmitting and studio equipment is of special interest at the present time when many broadcasters are modernizing their plants to meet new technical standards.

A wealth of experience in all transmitting fields enables Collins Radio to accomplish something outstanding in each. Most jealously guarded is Collins' reputation among amateurs, the group which includes the men who are and will be "doing things" in all branches of radio.

## Collins Radio Company

CEDAR RAPIDS  
New York  
11 West 42nd St.



IOWA, U. S. A.  
Mexico City  
Edificio "La Nacional"

# A NEW APPROACH TO ULTRA HIGH FREQUENCY RECEPTION!

## THE NEW ULTRA SKYRIDER

RANGE 3.8 TO 54.5 M.

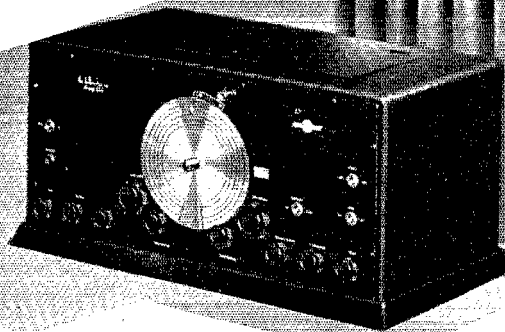

### These Features Make the Ultra Sky Rider a Fine Short Wave Receiver

- ★ Noise Silencer — reduces noises so prevalent in high frequency reception.
- ★ 10 All-Metal Tubes, with 13 tube performance.
- ★ 340° Micro-Vernier Frequency-Calibrated 4-Band Dial.
- ★ Continuous Electro Mechanical Band Spread.
- ★ Individual Air-Condenser Trimmed R.F. Coils for each band.
- ★ Iron-Core Air-Condenser Trimmed Expanding I.F. Coils.
- ★ Isolantite-insulated coil switch.
- ★ Integral Tuning Unit combines Condenser, Coils and Switch.
- ★ Built in Power Pack with output range for either 5000 Ohm Load for any Magnetic or Dynamic Speaker and 500 Ohm Load for feeding Broadcast Transmitter.
- ★ Ceramic Coil Forms.
- ★ Antenna Compensator.
- ★ Inertia Controlled Tuning reduces tuning fatigue.
- ★ Continuously Variable Beat Oscillator Injection Circuit.

It's the finest receiver Hallicrafters have ever built — a magnificent victory of skillful and painstaking engineering over almost unsurmountable difficulties—a masterpiece of design.

A complete description of the new Ultra Sky Rider is impossible here, a hundred pages couldn't tell the story of its many outstanding features — the amateur must see it and watch it perform for a complete appreciation of this new approach to ultra high frequency reception.

Hundreds of amateurs all over the country have been eagerly waiting for the Ultra Sky Rider — it's here at last — a receiver that will provide 5 and 10 meter reception, and 20 and 40 meter reception, as well — with sensitivity and efficiency.

It's precision at a price — engineered to satisfy the most critical — moderate in cost to suit every purse — with every feature the amateur could desire. Be sure to see this great contribution to Short Wave reception at your jobber's today!

See it at your Jobbers or write for full information

# the hallicrafters

MARION

INDIANA

Say You Saw It in *QST* — It Identifies You and Helps *QST*

# High Spots of the New "MARINE" 270-B Transmitter

- 1 Ideal tube line-up. 802 Crystal oscillator — 802 buffer — 804 inter-amplifier — pair of 203-H's in push-pull. Two 838s as modulators.
- 2 Built-in oscilloscope for visual monitoring of modulation.
- 3 Self-contained power supply built for continuous full-load operation. No auxiliary batteries needed. Front of panel and remote controls. Safety door interlocks. Complete overload protection.
- 4 Adequately metered in all stages to insure precision tuning and efficient operation.
- 5 Working frequency range 1500 to 30,000 kcs., phone or C.W.
- 6 Built-in universal antenna impedance matching network.
- 7 Husky and rigid double-wall all-metal steel cabinet with each component chassis easily removable as a unit.
- 8 Attractively finished to resist corrosion in all climates. Exterior black wrinkle finish, interior in duco aluminum. All chassis cadmium plated.

## MARINE RADIO COMPANY

60 Lispenard St.  
New York, N.Y.

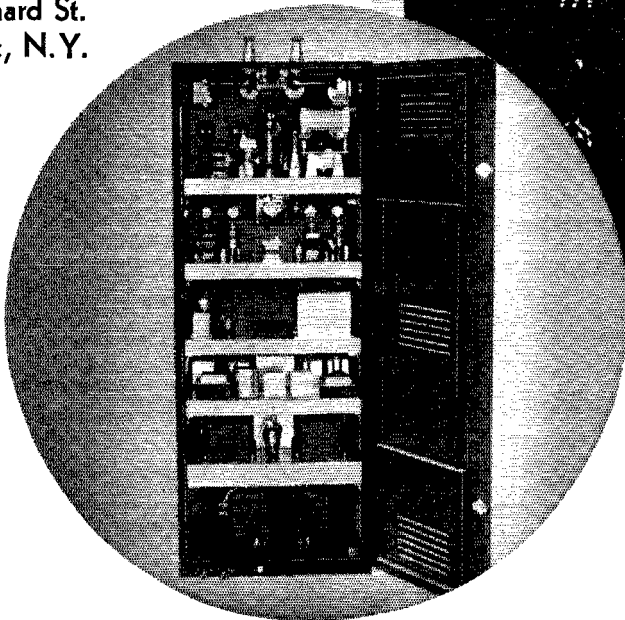
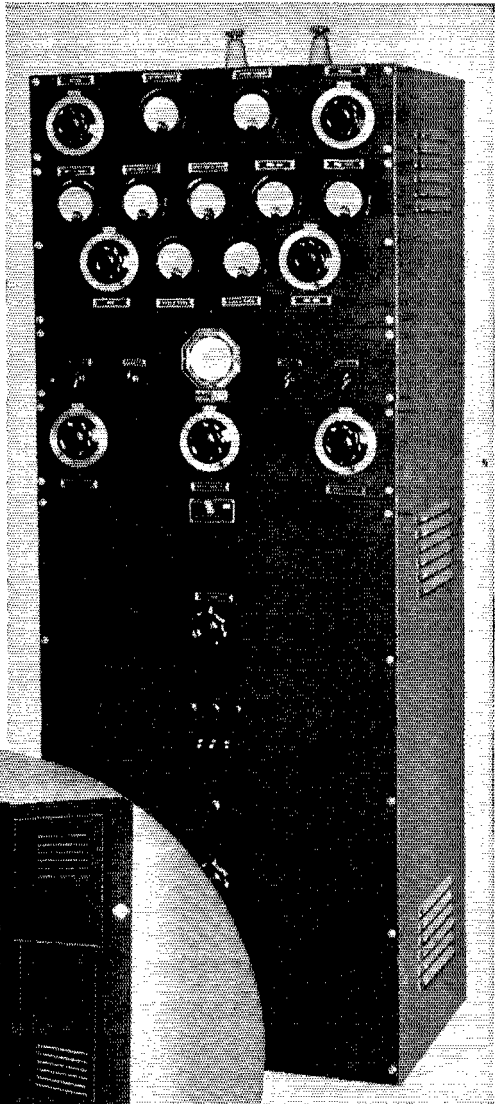

● Get the whole story of this and other ultra-modern transmitters by writing for Bulletin No. 836. ●



# QST

# devoted entirely to AMATEUR RADIO

PUBLISHED, MONTHLY, AS ITS OFFICIAL ORGAN, BY THE AMERICAN RADIO RELAY LEAGUE, INC., AT WEST HARTFORD, CONN., U. S. A.; OFFICIAL ORGAN OF THE INTERNATIONAL AMATEUR RADIO UNION

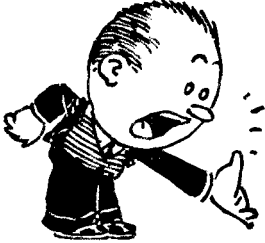

**AUGUST  
1936**

*Volume XX  
Number 8*



Kenneth B. Warner (Secretary, A.R.R.L.), *Editor-in-Chief and Business Manager*; Ross A. Hull, *Associate Editor*; James J. Lamb, *Technical Editor*; George Grammer, *Assistant Technical Editor*; Clark C. Rodimon, *Managing Editor*; David H. Houghton, *Circulation Manager*; F. Cheyne Beekley, *Advertising Manager*; Ursula M. Chamberlain, *Assistant Advertising Manager*.

*Editorial and  
Advertising Offices*

38 La Salle Road  
West Hartford, Connecticut

Subscription rate in United States and Possessions and Canada, \$2.50 per year, postpaid; all other countries, \$3.00 per year, postpaid. Single copies, 25 cents. Foreign remittances should be by international postal or express money order or bank draft negotiable in the U. S. and for an equivalent amount in U. S. funds.

Entered as second-class matter May 29, 1919, at the post office at Hartford, Connecticut, under the Act of March 3, 1879. Acceptance for mailing at special rate of postage provided for in section 1103, Act of October 3, 1917, authorized September 9, 1922. Additional entry at Concord, N. H., authorized February 21, 1929, under the Act of February 28, 1925.

Additional second-class entries to cover sectional editions authorized March 20, 1935. Copyright 1936 by the American Radio Relay League, Inc. Title registered at United States Patent Office.

## The Contents

Editorials . . . . .	7
What's Happened to Ten? . . . . .	8
Licking the Crystal Control on the U.H.F. <i>Charles Moody, W6HJN and Frank Kilby, W6WI</i>	9
56-Mc. Crystal Control with Resonant Line Coupling <i>Ed. Sanders</i>	12
100-Watt 56-Mc. Crystal-Control Output with Only Four Stages . . . . . <i>Byron Goodman, W1JPE</i>	16
A General Purpose V.T. Voltmeter With Ray Tube Indicator . . . . . <i>F. T. Griffin</i>	19
What the League Is Doing . . . . .	21
An Inexpensive Four-Band Transmitter <i>Vernon Chambers, W1JEQ</i>	23
Results A.R.R.L. Copying Bee . . . . .	27
An Improved Method of Voltage Control <i>J. D. Blitch, W4IS</i>	29
When the Cat's Away . . . . . <i>Joe Gish</i>	30
Northwestern Division Convention . . . . .	30
Hamdom . . . . .	31
Remote Tuning of U.H.F. Receivers <i>Marshall W. Rife, W9IWV</i>	32
DX By the Calendar . . . . . <i>Charles Perrine, W6CUH</i>	34
Dixie Jones' Owl Juice . . . . .	35
Handling Ham Messages . . . . .	36
Resistance-Coupled Input for Carbon Microphones <i>Orville Sather</i>	38
Another A.R.R.L. Field Day — August 22nd, 23rd . . . . .	39
For the Experimenter	
Keying the E.C. or Tri-tet Oscillator — Five-Meter Interference to BCL's — Improved System of Regeneration Control for the S.G. Detector — An Effective Regeneration Control — Relayless Audio Oscillator for Monitoring Keying — Monitoring Audio Oscillator with Keyer Tubes — Car Antenna Kinks — Twenty-Meter Crystals — Regen Receiver Using 53 . . . . .	40
Amateur Radio Stations . . . . . <i>W7CHT, W6NCT</i>	43
I.A.R.U. News . . . . .	44
Operating News . . . . .	46
Correspondence Department . . . . .	53
Standard Frequency Transmissions . . . . .	72
A.R.R.L. QSL Bureau . . . . .	74
Central Division Convention . . . . .	78
Vanalta Division Convention . . . . .	78
Delta Division Convention . . . . .	82
Southeastern Division Convention . . . . .	82
Roanoke Division Convention . . . . .	82
Pacific Division Convention . . . . .	84
West Gulf Division Convention . . . . .	84
South Dakota State Convention . . . . .	86
Eastern Canada Convention . . . . .	90
Hamads . . . . .	91
QST's Index of Advertisers . . . . .	94

# Hammarlund "Super-Pro"

To-morrow's Receiver—TO-DAY!



**Y**OU always wanted a receiver like the "Super-Pro." You knew that some day somebody would build your ideal receiver with revolutionary features which mean **PERFORMANCE** in capital letters. Features, not merely to talk about, but features that **DO THINGS!** • Don't wait longer. To-morrow's receiver is here **TO-DAY!** • The nation's leading research laboratories, airways, commercial broadcasters, government departments, ships and "Hams"

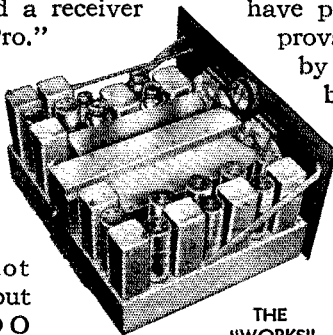

have put their stamp of approval on the "Super-Pro" by *buying* it, and coming back for *more* — hundreds of them. • That endorsement speaks more eloquently than any advertisement ever could. • Not room enough here for details, but you ought to have them. You can't afford to let an advanced receiver like the "Super-Pro" pass you by without getting the real low-down.

THE "WORKS"

*Mail the Coupon NOW!*

HAMMARLUND MFG. CO., INC., 424-438 W. 33rd St., New York O-8  
 Check here for complete data on the new Hammarlund "Super-Pro".  Check here for 1936 Hammarlund General Catalog.  
 Name..... Address.....  
 .....

## HAMMARLUND'S 25<sup>TH</sup> YEAR

## Section Communications Managers of the A.R.R.L. Communications Department

All appointments in the League's field organization are made by the proper S.C.M., elected by members in each Section listed. Mail your S.C.M. (on the 16th of each month) a postal covering your radio activities for the previous 30 days. Tell him your DX, plans for experimenting, results in 'phone and traffic. He is interested, whether you are an A.R.R.L. member or get your QST at the newsstands; he wants a report from every active ham. If interested and qualified for O.R.S., O.P.S. or other appointments he can tell you about them, too.

Eastern Pennsylvania Maryland-Delaware-District of Columbia Southern New Jersey Western New York Western Pennsylvania	W3EZ W3BAK W3ZY W8DSS W8CUG	<b>ATLANTIC DIVISION</b> James M. Bruning	339 W. Lancaster Ave.	Haverford
Illinois Indiana Kentucky Michigan Ohio Wisconsin	W9WR W9TE W9AUH W8DYH W8CIO W9ATO	<b>CENTRAL DIVISION</b> Fred J. Hinds Arthur L. Braun G. W. Mossbarger Kenneth F. Conroy Robert P. Irvine E. A. Cary	6618 West 34th St. 530 East Morris St. Box 177 18030 Waltham Ave. 5508 Northcliffe Ave. 3922 No. 19th Pl.	Berwyn Indianapolis Camp Taylor Detroit Cleveland Milwaukee
North Dakota South Dakota Northern Minnesota Southern Minnesota	W9OEL W9SEB W9OWU W9DCM	<b>DAKOTA DIVISION</b> Hartwell B. Burner Andrew J. Kjar Leonard Hofstad Webster F. Soules	257 Prospect Ave. 3549 36th Ave., So.	Hope Pierre Elbow Lake Minneapolis.
Arkansas Louisiana Mississippi Tennessee	W5ABI W5DWV W5CWO W4BBT	<b>DELTA DIVISION</b> H. E. Velte W. J. Wilkinson, Jr. J. H. Weems, Jr. Merrill B. Parker, Jr.	2918 West 15th St. 1523 Laurel St. P. O. Box 244 1912 Oak St.	Little Rock Shreveport State College Chattanooga
Eastern New York N. Y. C. & Long Island Northern New Jersey	W2LU W2AZV W2FOP	<b>HUDSON DIVISION</b> Robert E. Haight E. L. Baunach Charles J. Hammersen	511 South Holmes St. 7823 10th Ave. 92 Claremont Ave.	Scotia Brooklyn Verona
Iowa Kansas Missouri Nebraska	W9LEZ W9FLG W9CJR W9FAM	<b>MIDWEST DIVISION</b> Phil D. Boardman O. J. Spetter J. Dewey Mills Samuel C. Wallace	325 Kirkwood Blvd. 305 Western Ave. Box 205 Green St.	Davenport Topeka Mount Vernon Clarks
Connecticut Maine Eastern Massachusetts Western Massachusetts New Hampshire* Rhode Island Vermont	W1CTI W1CDX W1ABG W1BVR W1XWV W1CHR W1GNF	<b>NEW ENGLAND DIVISION</b> Frederick Ellis, Jr. John W. Singleton Albert N. Giddis Percy C. Noble Homer Richardson Clayton C. Gordon Alvin H. Battison	19 Merrill Rd. 73 Allen St. 128 Crawford St. 37 Broad St. 31 Sixth St. 206 California Ave. 1 Central St.	Norwalk Wilton Lowell Westfield Dover Providence Windsor
Alaska Idaho Montana Oregon Washington	K7PQ W7NH W7CRH W7AMP W7WV	<b>NORTHWESTERN DIVISION</b> Richard J. Fox Nellie H. Hart Russell U. Richmond Frank L. Black Robert H. Votaw	Box 301 Box 6 1502 McPherson St. Route 1, Box 398	Ketchikan Twin Falls Somers North Bend Vancouver
Hawaii Nevada Santa Clara Valley East Bay San Francisco Sacramento Valley Philippines* San Joaquin Valley	K6EWO W6BIC W6BMV W6JTV W6SG W6DVE KA1GR W6CRF	<b>PACIFIC DIVISION</b> Atlas O. Adams Edward W. Heim Charles J. Camp Harold J. Burchfield Alan D. Wittaker, Jr. Geo. L. Woodington George L. Rickard Vernon C. Edgar	21st Infantry Brigade 509 Claremont St. 318 Hawthorne Ave. 2340 106th Ave. 79 Elmor Ave. 716 Redwood Ave. Box 849 232 Blackstone Ave.	Schofield Barracks Reno Palo Alto Oakland Mill Valley North Sacramento Manila Fresno
North Carolina Virginia West Virginia	W4OG W3UVA W8KKG	<b>ROANOKE DIVISION</b> H. S. Carter Charles M. Waff, Jr. Dr. Wm. H. Rihelafffer	115 Crafton P. O. Box 1212	Winston-Salem Univ., Charlottesville Lost Creek
Colorado Utah-Wyoming	W9FA W7COH	<b>ROCKY MOUNTAIN DIVISION</b> Glen Glasscock Townsend J. Rigby	2164 So. Corona St.	Denver Midwest, Wyoming
Alabama Eastern Florida Western Florida Georgia-So. Carolina-Cuba- Ile-of-Pines-Porto Rico- Virgin Islands	W4DGS W4BCZ W4MS W4CE	<b>SOUTHEASTERN DIVISION</b> James F. Thompson Philip A. McMasters Edward J. Collins Bannie L. Stewart	2248 S. Arlington Ave. 731 Arlington Ave. 1517 East Brainerd St. C. C. C. Co. 4466	Birmingham St. Petersburg Pensacola York, S. C.
Los Angeles Arizona San Diego	W6GXM W6LVG W6EOP	<b>SOUTHWESTERN DIVISION</b> Don M. Draper C. C. Day Harry A. Ambler	4421 West 63 St. "La Posta Quemada" 4101 Hamilton St.	Los Angeles Vail San Diego
Northern Texas Oklahoma Southern Texas New Mexico	W5BII W5CEZ W5BDI W5CGJ	<b>WEST GULF DIVISION</b> Richard M. Cobb Carter L. Simpson Ammun O. Young Joseph M. Eldott	Box 185 2010 So. 4th St. 4803 EII St.	Dodd City Ponca City Houston Chamita
Maritime	VE1DQ	<b>MARITIME DIVISION</b> A. M. Crowell	69 Dublin St.	Halifax, N. S.
Ontario	VE3QK	<b>ONTARIO DIVISION</b> John Perdue	229 Askin Boulevard	Windsor, Ont.
Quebec	VE2EE	<b>QUEBEC DIVISION</b> Stan Comach	780 Brault Ave.	Verdun, P. Q.
Alberta British Columbia	VE4LX VE5EP	<b>VANALTA DIVISION</b> Alfred D. Kettenbach D. R. Vaughan-Smith	1221 Burnaby St.	Rockyford Vancouver
Manitoba Saskatchewan	VE4BG VE4EL	<b>PRAIRIE DIVISION</b> A. J. R. Simpson Wilfred Skaife	71 Thelmo Mansions 2040 McTavish St.	Winnipeg Regina

\* Officials appointed to act until the membership of the Section choose permanent S.C.M.'s by nomination and election.

# The American Radio Relay League



• **T**HE AMERICAN RADIO RELAY LEAGUE, INC., is a non-commercial association of radio amateurs, bonded for the promotion of interest in amateur radio communication and experimentation, for the relaying of messages by radio, for the advancement of the radio art and of the public welfare, for the representation of the radio amateur in legislative matters, and for the maintenance of fraternalism and a high standard of conduct.

It is an incorporated association without capital stock, chartered under the laws of Connecticut. Its affairs are governed by a Board of Directors, elected every two years by the general membership. The officers are elected or appointed by the Directors. The League is non-commercial and no one commercially engaged in the manufacture, sale or rental of radio apparatus is eligible to membership on its board.

"Of, by and for the amateur," it numbers within its ranks practically every worth-while amateur in the nation and has a history of glorious achievement as the standard-bearer in amateur affairs.

Inquiries regarding membership are solicited. A bona fide interest in amateur radio is the only essential qualification; ownership of a transmitting station and knowledge of the code are not prerequisite. Correspondence should be addressed to the Secretary.

HIRAM PERCY MAXIM, FOUNDER

## OFFICERS

*President*.....EUGENE C. WOODRUFF, W8CMP  
State College, Pa.

*Vice-President*.....GEORGE W. BAILEY, W1KH  
Weston, Mass.

*Secretary*.....KENNETH B. WARNER, W1EH  
West Hartford, Connecticut

*Treasurer*.....ARTHUR A. HEBERT, W1ES  
West Hartford, Connecticut

*Communications Mgr.*... F. EDWARD HANDY, W1BDI  
West Hartford, Connecticut

*General Counsel*..... PAUL M. SEGAL  
1010 Shoreham Building, Washington, D. C.

Address all general correspondence to the executive headquarters at West Hartford, Connecticut

## DIRECTORS

*President*  
EUGENE C. WOODRUFF.....W8CMP  
234 W. Fairmount Ave., State College, Pa.

*Vice-President*  
GEORGE W. BAILEY.....W1KH  
74 Webster Road, Weston, Mass.

*Canadian General Manager*  
ALEX REID.....VE2BE  
109 Logan Ave., St. Lambert, P. Q.

### Atlantic Division

*Central Division*  
EDWARD A. ROBERTS.....W8HC  
2699 Endicott Rd., Shaker Heights, Cleveland

*Dakota Division*  
CARL L. JABS.....W9BVH  
1822 James St., St. Paul, Minn.

*Delta Division*  
E. RAY ARLEDGE.....W5SI  
P. O. Box 286, Pine Bluff, Ark.

*Hudson Division*  
KENNETH T. HILL.....W2AHC  
115 Willow St., Douglaston, L. I., N. Y.

*Midwest Division*  
FLOYD E. NORWINE, JR.....W9EFC  
120 South Fourth St., St. Louis, Mo.

### New England Division

*Northwestern Division*  
RALPH J. GIBBONS.....W7KV  
c/o United Air Lines, Pendleton, Ore.

*Pacific Division*  
S. G. CULVER.....W6AN  
2962 Russell St., Berkeley, Calif.

*Roanoke Division*  
H. L. CAVENESS.....W4DW  
State College Station, Raleigh, N. C.

*Rocky Mountain Division*  
RUSSELL J. ANDREWS.....W9AAB  
1867 So. Lafayette St., Denver, Colo.

*Southeastern Division*  
BENNETT R. ADAMS, JR.....W4APU  
1512 Grove Place, Homewood, Ala.

*Southwestern Division*  
CHARLES E. BLALACK.....W6GG  
443 Main St., El Centro, Calif.

*West Gulf Division*  
WAYLAND M. GROVES.....W5NW  
c/o Humble Pipe Line Co., Neches, Texas



# THE EDITOR'S MILL

THE deep interest that this journal and its staff for many years have displayed in the ultra-high frequencies has been born of the conviction that these waves are destined to play a most important part in the radio of the future. We are fully confirmed in that feeling by the avid interest that every radio service showed in the subject at the June hearing of the Federal Communications Commission. What we believe will become the most interesting portion of the spectrum is about to be opened to public occupancy.

A great deal of bunk has been written and spoken about the potentialities of the ultra-highs. Fortunately most of this has been exploded at these very hearings. Gone is the myth that an inexhaustible number of channels exists the moment one steps above 30 mc. It is realized now that between 30 and 200 mc. there are less than 2000 telegraphing channels of 0.1% width, less than half that number of telephone channels at present technique. Gone, too, is the notion that ultra-highs carry only to the horizon and that they may be reassigned every thirty miles all over the nation. We were particularly proud at these hearings that amateurs were able to demonstrate their continuing record of pioneering in every new field. It has become apparent that no one has so thoroughly used the ultra-highs as we, that no one has maintained the long indirect communication paths that we have nor engaged in long-distance sky-wave communication on such frequencies. Particularly is brought out the value of the amateur observations of the bending of such waves in the lower atmosphere, establishing that the interference range of the "medium-ultras" is many times the visible horizon. Our work in these respects has established anew the value of the amateur investigator and will be instrumental in securing for amateurs a fair portion of the new frequencies.

We are about to witness the establishment of many interesting new services. Chief of these, of course, will be television, the practice of which has had to await the opening of the ultra-highs to secure bands of sufficient width. While its economic and sociological problems are as yet unsolved, it seems ready now, from the technological standpoint, to step forth. Not only are we apparently on the eve of television broadcasting but the military and naval and press services seem interested in it for their own particular purposes.

Facsimile is on the make, too, not only facsimile broadcasting to bring news and possibly a morning paper into the home but public-service communication from point to point on tariffs based on the square inches of matter transmitted rather than the number of words. Newspapers want it too. Then there is high-fidelity aural broadcasting, including Armstrong's frequency modulation and its unusual capabilities. And not only these services but their pick-ups and their chain relays across the country. We should expect a considerable expansion in the facilities made available for municipal police radio, an established service that has splendidly proved its value. The fire departments want theirs, as do the power industry and the fire-protection sections of the forestry services. Familiar services reappear in the u.h.f. applicants in new forms: the government services, air and marine navigation aids, air and marine voice communication, geophysical; the fixed service talks of point-to-point public telephony or at least radio jumps at the ends of the wire networks. More bizarre services are mentioned: a doctor's paging service, radio typewriters for business and press, locomotive-to-caboose communication, radio meteorographs on sounding balloons, radio telephoto for the press and even mobile pack-set communication between reporter and city desk! In fact, frequency requests for new services have been limited only by man's fertility in thinking up new uses for radio. Estimates of needs greatly exceed the supply of frequencies. The Commission has a difficult task on its hands, deciding what is in the public interest and who should get what frequencies as this new segment of the public domain is opened to settlement. Profiting by the lessons of the past, it is to be hoped that the Commission will go slowly and carefully, making regulations no more rigid than necessary until technical uncertainties are dissipated and the angles of public interest become more discernible.

For our own part we simply desire, as most League members know and approve, a continuation of our family of amateur bands into the ultra-high spectrum as far as definite allocation to services is carried. Below 200 mc. we shall be content with one new band, 112 to 120 mc., the harmonic sister of our 30- and 60-mc. bands. The League has shown the Commission that amateurs richly deserve such an allocation and that it is

reasonable to expect continuing contributions to the art from such an assignment to the amateur experimenter.

Many new problems await solution in this fascinating new world. If a fence is erected now at 200 mc. it will be only because the frequencies beyond that fence have not yet been licked. "200" will become the new frontier, the "high-ultras" the new promised land of infinite possibilities. Meanwhile we commend 56 and 112 to all

our members, not only those of an inquiring turn of mind but those of strictly practical bent: for it is well established that these bands serve us admirably for short-range communication and that we ought to relieve our lower bands of such correspondence. Our job now is to continue to keep just a little ahead of the rest of the radio world in the development and occupancy of our peculiar parts of the ultra-high spectrum.

K. B. W.

## What's Happened to Ten?

**J**UST before the DX contest a goodly proportion (we imagine about ninety percent, anyhow) of the amateurs working on ten meters, whether regularly or casually, had no doubts whatever but that hams had "ten" firmly by the tail. WAC's, DX, lots of countries, regular communication—all were present and accounted for. The old "we showed 'em" spirit was very much in evidence.

But glance at the band *after* the DX contest, particularly during April and May. The hosts have departed for easier, if not greener, fields. The band, it seems, is "shot"; and whether it is or not, practically nobody is on to find out. So who showed who what? As we see it, the happy conquerors proved nothing except that conditions were good last winter—and the fact that conditions do get good on ten is not a new addition to the sum of amateur knowledge.

The practically complete collapse of activity at the first onset of bad conditions is a truly remarkable phenomenon. Always excepting a certain faithful few, it seems that practically everybody has gone back to his knitting, the departed glories of ten-meter communication being but a memory. Wasn't there once an impression around that amateurs stuck to a job until it was finished? We're a long way at this writing from knowing what the 28-mc. band can or can't do for us; furthermore, no period of weeks or even months is going to show us anything significant. We might as well face the fact that it's going to take some years of digging to unearth information of any value. Ten is a borderline band, and as such is likely to go through erratic cycles of communication possibilities over a period of years.

Despite wide variations in activity on the band, a few things have been observed over the past year. Those who have kept track of what's going on will remember that it was in March of 1935 that a revival of ten-meter DX occurred, mostly through a coincidence of time and stations in the right places. It wasn't wholly coincidence, though; without hopeful plugging on the part of those to whom their own often fruitless endeavors were sufficient reward the coincidence never would have had an opportunity to do its stuff.

But with the end of March there was an end to DX, even an end to work between the East and West coasts of this country. There was the same dead period in April and early May, deader perhaps than this year because fewer stations were on. But with the latter part of May the band opened up for communication over distances from 500 to 1500 miles and continued that way, with a few poor periods, all summer long. South Americans began to filter through in the summer; an occasional European or VK came over. And then at about the time of the September equinox things opened up with a bang, to continue at a high pitch until the equinox the following March.

What has happened this year shows a striking similarity to the events of 1935. Not duplication by any means, but a general trend toward the same sort of conditions. Good DX conditions ended with March. As this is being written, the 500-1500 mile stations are beginning to come through again—when any are on. Here in the East the familiar growls of 31-mc. police carriers of unknown QTH greet the inquiring ear almost any evening. Old reliable XE1AY, now well past his 1000th ten-meter QSO, puts in a good signal between 4 and 7 E.S.T., and a few LU's also are on the job. Those fellows also can work Europe now and then, but it is seldom that a European signal gets into the U. S., at least in the New England region. And West Coast stations are just as scarce.

Based on experience of two summers, then, we might expect that the months between April and August will bring with them relatively-short distance communication in random directions, plus fairly good DX in a generally north-south direction. It may be that we can take this as a fairly general rule, subject to modification in future years as we enter different portions of the sunspot cycle. DX in all directions probably should be expected between September and March. But this only represents a glimmer of what may happen. As always, the future is an unpredictable quantity.

At that, the dope is good enough to make it

(Continued on page 88)



# Licking the Crystal-Control Problem on the Ultra-High Frequencies

## Medium- and High-Power Combinations for 56-mc. Transmitters

By Charles A. Moody,\* W6HJN; and Frank Kirby,\*\* W6WI

**E**ARLY in the development of the 56-megacycle band it was quite obvious that more selective receivers were needed which would of course necessitate stabilizing the transmitters. Crystal control was desirable for many reasons; among them being a knowledge of the exact frequency at all times, freedom from drift, ease of adjusting the circuits (as compared with short-line control) and use of the transmitter on lower-frequency bands. Of course there is the objection of the difficulty of shifting frequency. This can be overcome to a great extent by having two crystals fairly close together in frequency, it being merely necessary to change crystals to QSY, the remaining circuits being closely enough aligned to give nearly maximum output.

Many systems for getting stability were tried, such as short-line control, multi-stage master-oscillator power-amplifier, and electron-coupled oscillators. The crystal oscillator gave the best stability.

Enough for the history. Now to get on to the circuit. Originally a 53 was used as an oscillator-doubler. As shown in Fig. 1, a 6A6 can be used in place of the 53 in order to eliminate the odd filament voltage. The plate voltage of the 53 or 6A6 should not be more than 400 volts, at which voltage the total current will be about 55 milliamperes. A 25,000-ohm grid leak on the doubler gives a little better efficiency on 20 meters than a lower value. A 40-meter crystal is generally used, since it is desirable to drive the 802 fairly hard when used as a quadrupler. However, when the 802 is used at lower frequencies as a straight amplifier, care should be taken to see that it is not over-driven. The 53 was tried as an oscillator-

quadrupler and the 802 as a doubler, but this did not give any more output than the 53 oscillator-doubler and 802 quadrupler arrangement.

### PENTODE QUADRUPLER

The 802 quadrupler is shown inductively-coupled to the 53, the spacing between the coils being  $1\frac{1}{2}$  inches. In case the units are put on separate shelves they can be link-coupled using a

two-turn loop at the ground end of each coil. Regeneration is used on the quadrupler to increase its efficiency, this regeneration being obtained by a 2000-ohm non-inductive resistor shunted by a 50- $\mu$ fd. mica condenser in the cathode circuit. The screen voltage should be maintained at not over 200 volts by the use of a bleeder arrangement of resistors. With higher screen voltage the current climbs rapidly and a momentary overload will damage the cathode. The total current at best output is 25 ma.

The 802 works equally well mounted either vertically or horizontally. However, if mounted vertically, care should be taken to make the plate lead as short as possible and to bring all r.f. bypass condensers directly to the tube socket. If a long lead is necessary, the grid lead should be made long in preference to the plate lead. Unfortunately, all 802's will not perform satisfactorily as quadruplers, there being a great difference in the output on 5 meters. About 1 in 3 tubes is a good quadrupler. However, the ones which are poor quadruplers work quite well as straight amplifiers, as will be explained in more detail later.

The quadrupler can be tuned by watching the plate current, the grid adjustment being noted by maximum plate current. There will be a slight dip when the plate tank condenser is tuned through resonance. The frequency should then be checked with an absorption-type frequency meter. A

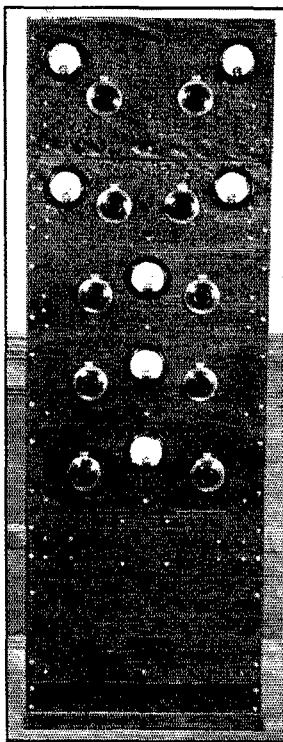

COMPLETE RACK ASSEMBLY OF THE W6HJN-W6WI 56-MC. CRYSTAL-CONTROLLED TRANSMITTER

\*Cogswell Polytechnical College, 3000 Folsom St., San Francisco, Cal.

\*\*244 Allison St., San Francisco, California

usable meter can be made up and checked against the 56-mc. receiver. Extreme accuracy is not necessary, because one is merely checking to see that the right harmonic is being selected. However, if the coil sizes are followed, little trouble will be had on this score. The suppressor of the

connection is then necessary between the condenser stator and the tube plate.

Right here a word about insulation on 56 mc. might be in order. On the 6A6 oscillator-doubler, bakelite will be satisfactory, as well as on the grid circuit of the quadrupler; but the insulation of

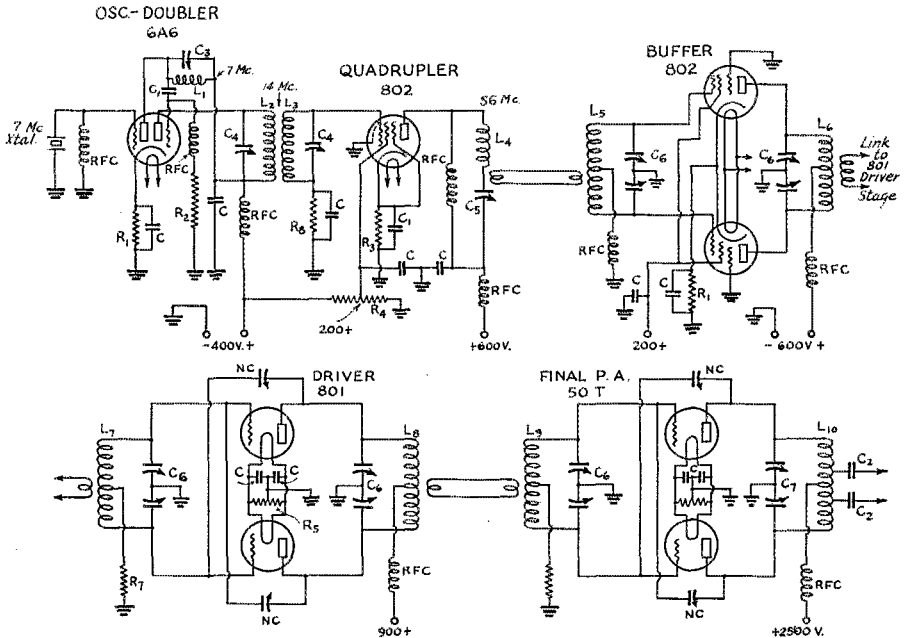

FIG. 1—CIRCUIT OF THE W6HJN-W6W1 LOW-HIGH-POWER COMBINATION

- L<sub>1</sub>—15 turns No. 20, 1½" diameter, no spacing.
- L<sub>2</sub>—9 turns No. 20, 1½" diameter, spaced thickness of wire.
- L<sub>3</sub>—7 turns No. 20, 1½" diameter, spaced thickness of wire.
- L<sub>4</sub>—7 turns No. 12 e., 1¼" diameter, spaced thickness of wire.
- L<sub>5</sub>—5 turns No. 12 e., 1¼" diameter, spaced thickness of wire.
- L<sub>6</sub>—5 turns No. 12 e., 1¼" diameter, spaced twice thickness of wire.
- L<sub>7</sub>—4 turns No. 12 e., 1¼" diameter, spaced twice thickness of wire.
- L<sub>8</sub>—4 turns No. 12 e., 1¼" diameter, spaced twice thickness of wire.
- L<sub>9</sub>—4 turns No. 12 e., 1¼" diameter, spaced twice thickness of wire.
- L<sub>10</sub>—5 turns No. 12 e., 1¾" diameter, spaced twice thickness of wire.
- C—0.01-μfd. 1000-volt mica by-pass condensers.

- C<sub>1</sub>—50-μfd. 1000-volt mica grid-coupling condenser.
- C<sub>2</sub>—0.002-μfd. 5000-volt mica.
- C<sub>3</sub>—100-μfd. variable receiving-type condenser.
- C<sub>4</sub>—50-μfd. variable receiving-type condenser.
- C<sub>5</sub>—25-μfd. variable receiving-type condenser.
- C<sub>6</sub>—Split-stator isolantite variable condenser (double-spaced) 36-μfd. per section.
- C<sub>7</sub>—Split-stator isolantite variable condenser, spacing 0.19", 15-μfd. per section.
- NC—Neutralizing condensers.
- R<sub>1</sub>—400-ohm 3-watt.
- R<sub>2</sub>—25,000-ohm 1-watt.
- R<sub>3</sub>—2000-ohm non-inductive.
- R<sub>4</sub>—50,000-ohm adjustable 10-watt.
- R<sub>5</sub>—50-ohm center-tapped.
- R<sub>6</sub>—6000-ohm 50-watt.
- R<sub>7</sub>—10,000-ohm 25-watt.
- R<sub>8</sub>—250,000-ohm 1-watt.
- RFC—Standard pie-wound ultra-high frequency chokes.
- RFC<sub>1</sub>—High-frequency transmitting choke.

802 is connected to the cathode at the socket. This connection is necessary for prevention of secondary emission at a plate voltage of 600.

The plate tank of the quadrupler is series-tuned when used on 56 mc. (as shown in Fig. 1) and parallel-tuned when used on the lower frequency bands, the series tuning arrangement giving much better efficiency at 56 mc. An r.f. choke is shunted across the tuning condenser to provide the necessary d.c. path to the tube. This choke is omitted on the lower frequency bands, with the regular tank coil taking its place. A

the rest of the circuit should be some high-grade non-organic material. Isolantite is perhaps the easiest obtainable and works much more efficiently than bakelite, which has a propensity for growing blisters at ultra-high frequencies. Unfortunately the 802's have bakelite bases; but the r.f. is comparatively low at the grids, so there is little tendency to blister, although the efficiency is probably poor. The coils in the oscillator-doubler and the grid circuit of the quadrupler can be wound on bakelite without incurring too great a loss. The coils on 56 mc. are self-supporting

and are wound with No. 12 enameled wire, and fitted with slotted lugs which mount directly on the tuning condensers.

The quadrupler is link-coupled to the push-pull 802 buffers. This link makes it handy if the buffers are on another shelf, and it also helps to isolate the quadrupler and buffer stages.

#### PUSH-PULL PENTODE BUFFER

The 802 buffers are mounted horizontally in order to keep the leads as short as possible. It is highly desirable to use most tubes in push-pull at ultra-high frequencies as this effectively reduces the interelectrode capacities across the tuned circuits, thus giving a better  $L-C$  ratio. While an 801 will work single-ended with fair efficiency on 56 mc., the efficiency of a single-ended 802 is rather low. It is not necessary to neutralize the 802 buffers, but care must be taken to keep the input and output circuits as far apart as possible without increasing the length of the leads to the tubes. In the original set-up, a shield between the input and output was not necessary. In order to prevent oscillation the input and output circuits should be loaded down as heavily as possible. Then the slight amount of regeneration left is helpful. Many tubes were tried as buffers, but none equalled the 802 for output on 56 mc. There is enough output from a pair of 802's to light up a 25-watt lamp; this, of course, being more than enough to excite the 801 drivers. Some of the other low-power tubes tried were 42's, 45's, 46's, 47's, 801's, and 205D's. The push-pull 42's gave the best output in this group.

The plate current of the 802 buffers runs 40 ma. per tube. As in the quadrupler, the screen voltage should be kept at 200 volts. A self-biasing resistor of 400 ohms is used in the cathode circuit, the suppressor being connected to the cathode at the socket with the internal shield grounded to the chassis.

The buffers are also link-coupled to the low-power finals by a two-turn coil located in the center of the plate coil of the buffer, and another two-turn coil in the center of the final grid tank. Because of the superior design in the 801's, they are preferable to other u. h. f. tubes. They can be driven to 70 watts input without difficulty.

There is little to be said about the 801's when used as a push-pull output amplifier aside from the fact that the leads should be as short as possible. A 500-ohm 2-wire transmission line couples to the 500-ohm points on the output tank. The original transmitter was built in rack and panel form, using masonite for the panels and bases. A similar transmitter was later built on metal. There was no apparent difference in the efficiency of the two transmitters.

#### HIGH-POWER FINAL

The high-power final amplifier consists of a pair of Eimac 50T tubes in push-pull, the 50T being

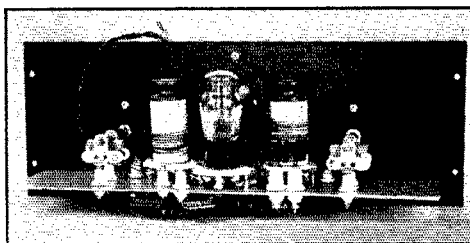

OSCILLATOR-DOUBLER UNIT OF THE W6HJN-W6WI TRANSMITTER



THE 802 QUADRUPLER STAGE



THE PUSH-PULL 802 BUFFER COULD ALSO BE USED AS A GRID- OR SUPPRESSOR-GRID FINAL

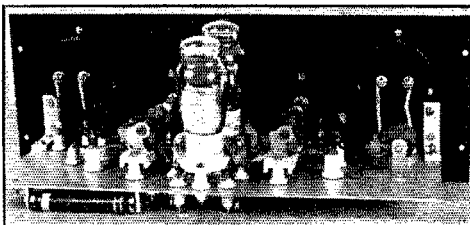

THE 801 DRIVER STAGE, WHICH WOULD MAKE AN EXCELLENT 40-WATT FINAL STAGE

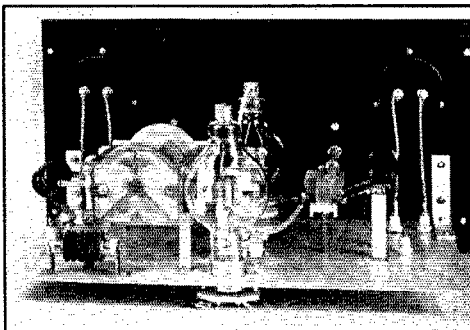

THE PUSH-PULL 50T HIGH-POWER FINAL WHICH RUNS AT INPUTS UP TO 500 WATTS FOR C.W.

used because of its comparatively short transit time and low interelectrode capacitances. The final amplifier is push-pull, split-stator condensers being used to tune both the grid and plate tanks. The 801 drivers are link coupled to the final amplifier with a 2-to-3 step-up ratio. The grid current under load is approximately 50 ma. with a power input of 500 watts, the plate efficiency under these conditions approaching 60%. For continuous 'phone operation, however, it is desirable to run the tubes at a somewhat lower input. If grid-leak bias is used, a satisfactory value for Class-C operation is about 6000 ohms.

#### OTHER LOW-POWER COMBINATIONS

A lower-power transmitter could be built using receiving tubes throughout, but the overall efficiency would be somewhat lower. The lineup used for some time consisted of a 53 oscillator-doubler, 42 quadrupler, 42 push-pull buffers, and 46 push-pull final. The plate voltage should not be over 400 volts and the screen voltage not over 200. It is necessary to neutralize the 42 pentode buffers and suitable neutralizing condensers can be built by using stand-off insulators and small copper plates one-inch square, spaced about one quarter inch apart. The 46's were used as low- $\mu$

triodes; that is, with the second grid connected to the plate. About 125 volts fixed negative bias was used on the grids of the 46's. It is desirable to use split-stator condensers as shown in the diagram, since this simplifies the neutralizing difficulties. For the low-powered stages, National ST-50 condensers were used, the stator being cut in half, thus making a split-stator condenser of about 12  $\mu$ fd. effective capacitance.

The authors have used crystal control for the past three years and it has always proved to be much more stable than any of the other oscillators tried, the signals being perfectly readable on selective superheterodynes. The transmitter could be run with two less stages on low power if the 802 buffers were grid or suppressor-grid modulated. It would not be advisable to plate modulate the 802's with 600 volts on the plates. A two-tube transmitter was also used, having a 53 oscillator-doubler and a 47 quadrupler without regeneration on the quadrupler. The power output from this lineup was, of course, low.

While the transmitter here described is far in advance of the customary 56-mc. practice and is hardly an attainable one for the beginner, it offers many possibilities for the advanced experimenter.

## 56-Mc. Crystal Control With Resonant-Line Coupling

By Ed. Sanders,\* WIEDY

**A**CTIVITY in the five-meter amateur band has become sufficient so that in some localities serious interference conditions are now encountered. The better five-meter stations have already incorporated some form of frequency stabilizing equipment. Since the band is so wide (400 10-kc. channels) it is merely a matter of improving equipment to eliminate the interference.

Let us get a rough idea of what frequency stability may be expected of various types of amateur five-meter equipment. Using a super-het with beat oscillator operating, it is easy to estimate the band width over which the carrier frequency swishes under modulation. Self-excited transmitters using a coil and condenser for frequency control occupy roughly 200-300 kc. Similar rigs, but using high- $Q$  frequency determining elements such as pipes or "hats," occupy about 50 kc. M.o.p.a. transmitters can of course be made to do somewhat better. (The carrier shift was reduced to about 5 kc. on one rig by

using 2-inch pipes enclosed in a copper shield for a grid line of the m.o.,  $\frac{1}{2}$ -inch pipes for the plate line, a short line with tuning condenser for the p.a. grid and  $\frac{1}{2}$ -inch pipes for the p.a. plate circuit. Push-pull 800's were used for both oscillator and amplifier.) Finally, we have crystal control as the ultimate where the frequency shift of the carrier is reduced practically to zero. These figures are somewhere near average values and, of course, will vary widely depending on the care taken in construction and adjustment of the equipment.

Let it be said in passing that those rigs, consisting of an oscillator-doubler driving a power amplifier are pretty good. The one described in *QST* using a 58 to drive another 58 was heard on the air while using the superhet and mistaken for crystal control.

There seems to be a popular impression that crystal control at five meters is very difficult to achieve when in reality it is quite simple. We have recently constructed a crystal-controlled experimental transmitter for operation at 63.5 mc. to be

\* WTIC, Travelers Broadcasting Service, Hartford, Conn.

used at the transmitter of WTIC in Hartford for some high-frequency development.

The exciter unit is quite conventional being a pair of 53's as recently described in *QST*, with a few modifications to adapt it to our needs. The chief of these was to rearrange the circuit so that we could ground the condenser rotors. Also the plate meter jacks are Yaxleys with the springs rearranged so that the sleeve which goes through the panel is insulated from the high voltage. This sleeve is of course hot while the plug is in place but the plug then protects the operator from contact with it. The crystal is on 80 meters using half of the first 53 on the oscillator. Frequency doubling is accomplished in the plate circuit of this section by using the usual double plate tank, one tuned to 80 and the other to 40. The original design was for a 40-meter crystal using a simple plate tank, so the 80-meter tank is an afterthought which could not conveniently have its tuning condenser on the panel. The other triode section of this tube doubles to 20. One section of the next 53 doubles to 10 and the other section doubles to 5, delivering about 1 watt at 63.5 mc. The inefficiency of tubes operating at ultra-high frequencies shows up in this unit in higher and higher plate currents per stage as 5 meters is approached, accompanied by lower and lower outputs per stage. It is quite possible that the use of separate tubes for doubling to 10 and 5 meters would be better than the 53. The 802 makes an excellent doubler at high frequencies and would probably give a bit of extra gain for driving the pair of 802's which are capable of handling higher power than they are here required to handle.

In the construction of this unit the chief

precaution is to keep all leads to grids and plates and their returns to cathode as short as possible. At 5 meters a two-inch lead is long and it is worth spending time to find a way to shorten it up. Another prime consideration is the reduction of capacity in the tuned circuits. *QST* has been

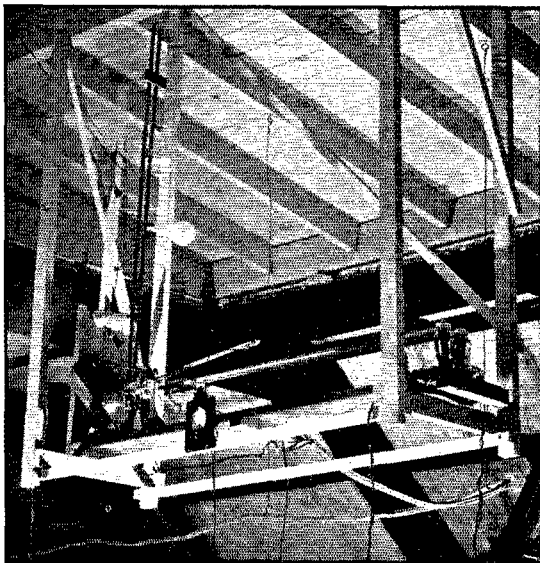

SUSPENDED FROM THE RAFTERS: THE DRIVER AND FINAL STAGES OF THE 60-MC. TRANSMITTER

The 802's are at the right, their linear plate circuit running horizontally to the pair of 800's at the left. The linear tank of the final amplifier is mounted vertically. The bulb halfway up the tank serves as a dummy load.

incessantly trying to drive home the point that low-*C* tanks will give higher efficiencies. Remember that at 5 meters the tube capacity is so relatively large that really low-*C* tanks can never be attained — so don't make matters worse by hanging a big condenser (30- $\mu$ fd. or over) across your coil. A good stunt, although somewhat unwieldy, is to throw the tuning condenser away and tune by spreading or pinching up the coil. The tube will provide plenty of capacity.

Link coupling is used to conduct this 1 watt at 5 meters to a 60-mc. straight amplifier consisting of a pair of 802's in push-pull. Con-

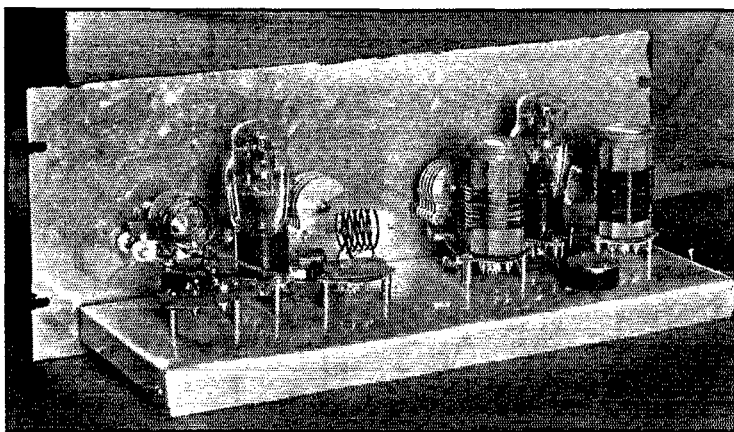

THE EXCITER UNIT FOR THE 60-MC. TRANSMITTER

The components are mounted on a simple folded aluminium chassis. The crystal is at the right, the doubling business being carried on from right to left.

sidering the low power output of the exciter unit, it was decided to put only 300 volts on the 802 amplifier. Incidentally, RCA recommends holding down to 275 volts at this frequency. The grid tank for this stage is of the

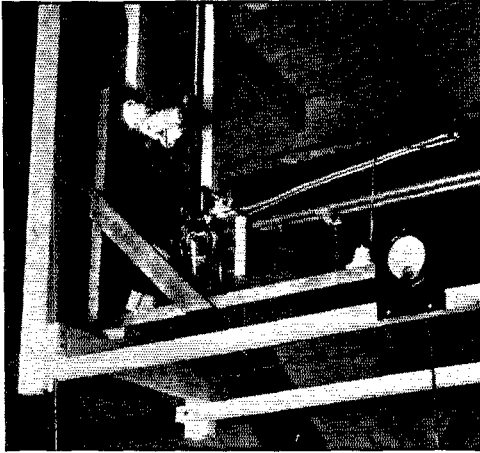

THE FINAL AMPLIFIER

Coming in to the picture from the right is the linear tank of the 802 stage. The grid circuit of the final is above it and tilted upward. The grid tuning condensers and neutralizing condensers are mounted immediately above the 800's.

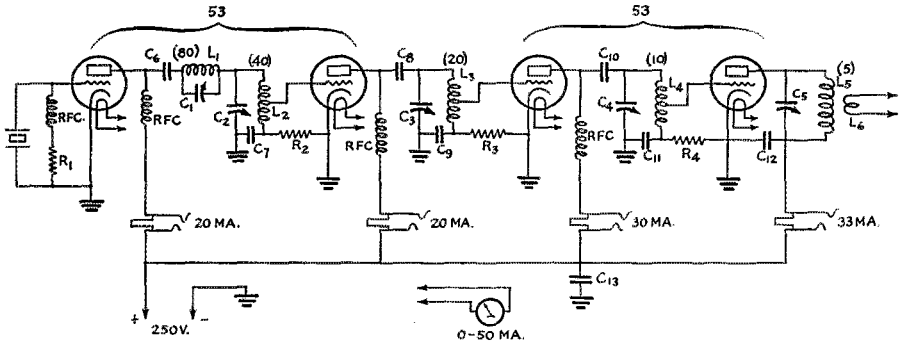

FIG. 1—THE CIRCUIT OF THE EXCITER UNIT

- R<sub>1</sub>—10,000 ohms, 1 watt.
- R<sub>2</sub>—20,000 ohms, 1 watt.
- R<sub>3,4</sub>—10,000 ohms, 1 watt.
- C<sub>1</sub>—140 μfd. leaf type trimmer condenser.
- C<sub>2, 3, 4</sub>—35 μfd. receiving type midjet condensers.
- C<sub>5</sub>—15 μfd. ditto.
- C<sub>6</sub>—100 μfd. leaf type trimmer condenser.
- C<sub>7</sub>—0.001 μfd. fixed.
- C<sub>8</sub>—100 μfd.

- C<sub>9</sub>—0.001 μfd.
- C<sub>10</sub>—100 μfd.
- C<sub>11</sub>—0.001 μfd.
- R. F. C. National R100 chokes.
- L<sub>1</sub>—10 feet of No. 26 d.s.c. wire scramble wound on a 1/2-inch diameter dowel.
- L<sub>2</sub>—20 turns of No. 14 wire occupying 1 1/2 inches. Tap is 6 turns from grounded end.
- L<sub>3</sub>—10 turns of No. 14 wire spaced

- to fill 1 inch. Tap at four turns from grounded end.
- L<sub>4</sub>—6 turns of No. 14 spaced to fill 1 inch. Tap at center of coil. This coil is self supporting.
- L<sub>5</sub>—4 turns of No. 14 spaced to fill 1 inch. This coil also self supporting.
- L<sub>2</sub> and L<sub>3</sub> are wound on Hammarlund receiving coil forms.
- L<sub>6</sub>—2 turns No. 14, 1 1/4 inch diameter.

“pinch-to-tune” type with no apparent tuning condenser. The plate tank consists of a pair of half-inch copper pipes adjusted to resonance with the usual slider. Approximately 10 watts are available at the output line of the 802's, representing a power gain of 10 in this stage.

A short grid line — 16 1/2 inches — of 1/4-inch

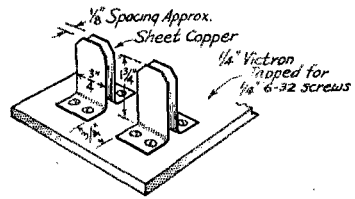

FIG. 3—SHOWING THE CONSTRUCTION OF THE NEUTRALIZING CONDENSERS FOR THE 800's

copper tubing tuned with a split-stator condenser feeds the grids of a pair of 800's in the final modulated amplifier. These two line tanks are in-

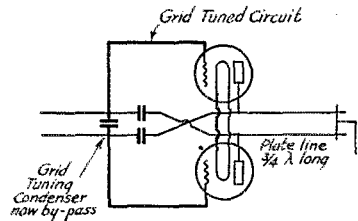

FIG. 4—ILLUSTRATING THE MANNER IN WHICH PARASITIC OSCILLATIONS MAY BE CREATED

ductively coupled. The output tank of the 800's is another pair of 1/2-inch copper pipes inductively

coupled to the antenna. The power output is approximately 100 watts.

The 800's, being triodes, are neutralized by the condensers shown in Fig. 3. Adjustment of these condensers is obtained by bending the copper plates. Wedge-shaped sticks cut from dry wood were used for spreading the plates more or less



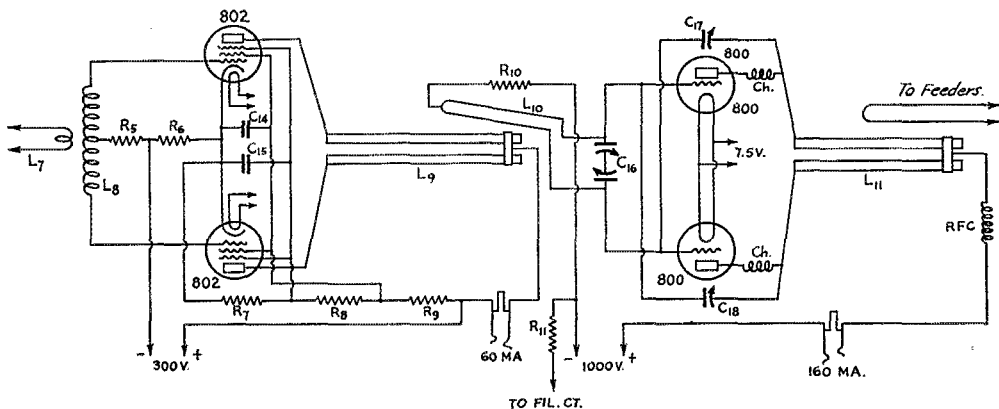

FIG. 2—THE CIRCUIT OF THE DRIVER AND FINAL AMPLIFIERS

$C_{14,15}$ —0.001  $\mu$ f.  
 $C_{16}$ —National STD 50 split stator condenser, 50  $\mu$ f. per section.  
 $C_{17,18}$ —Neutralizing condensers, see text.  
 $R_5$ —15,000 ohms, 10 watt.  
 $R_6$ —300 ohms, 10 watt.  
 $R_7$ —5000 ohms, 5 watt.

$R_8$ —20,000 ohms, 10 watt.  
 $R_9$ —2000 ohms, 10 watt.  
 $R_{10}$ —10,000 ohms, 10 watt.  
 $R_{11}$ —500 ohms, 10 watt.  
 $L_7$ —2 turns No. 14, 1 inch diameter.  
 $L_8$ —8 to 10 turns No. 14,  $1\frac{1}{8}$  inch diameter. Turns and turn spacing varied for tuning.

$L_9$ —Linear tank of  $\frac{1}{2}$  inch copper pipes spaced 1 inch between centers. The line will be between 39 and 46 inches long.  
 $L_{10}$ —See text.  
 $L_{11}$ —Same construction as  $L_9$ . Length will be between 28 and 36 inches.  
 Ch.—See text.

during preliminary adjustments but these were removed once the proper adjustment was determined. The usual type of condenser was first installed with much longer leads due to their bulk and mounting difficulties. Erratic climbing plate current with no excitation was observed and finally traced to oscillation at about 200 mc. where the circuit became that of Fig. 4. The grid tuning condenser became a by-pass and the leads to the grid of the tube became the grid line. The plate line operated  $\frac{3}{4}$  of a wave long and the neutralizing condensers merely doubled the effective plate-filament capacity of the tube. This was remedied by the short leads, small neutralizing condensers and small parasite chokes in the plate leads of the tubes. These chokes consist of three self supporting turns  $\frac{1}{2}$ -inch in diameter. This kind of oscillation should be watched out for since a set of pipes can resonate at its harmonic frequencies whereas the coil and condenser tank cannot. Thus we have a new kind of parasite with which to contend but it is fairly easily overcome if we understand what it is doing. My solution is one of detuning — the short grid leads give the grid circuit a high natural frequency and the chokes give the plate circuit a relatively low natural frequency.

So by the use of care in selecting tubes and tank circuits we can get reasonably high power gains and efficiencies even at five meters. The plate efficiency of both these amplifiers is approximately 60%. Also the exciter unit is simple to construct and easy on the pocketbook. Let's start to make our five-meter equipment as modern and up to date as that we use in the other amateur bands. The high level modulator

and control circuits for this transmitter may be described in a future article.

## Strays

It's an ill wind that blows no good. After flood traffic died down a bit, W1GZL couldn't resist the temptation to give ten meters a whirl. As the flood waters had detoured traffic to other sections, there was no ignition QRM and receiving conditions were quiet as never before.

— . . . —

Through W8AU we learn that ON4CJJ is anxious to make contact with the U. S. on 28 mc., and for that purpose has been working on the band every day between 1630 and 1730 GMT. Chance for another country on "ten."

— . . . —

Once again we are under the necessity of repeating the warning that every high-voltage power supply is a potential dealer of sudden death. Grimes R. Waller, W2CTS, joined the list of power-supply victims on June 12th, when his badly-burned body was found still in contact with parts of his transmitter and high-voltage transformer. It is thought that he fell asleep while operating and inadvertently came in contact with the unprotected high-voltage supply.

It's not difficult to take the simple precaution of enclosing high-voltage apparatus so that it cannot be touched while in operation. And the tendency for familiarity to breed lack of caution must be watched—one careless instant is more than enough, for a high-voltage supply with the power turned on never takes time out for rest.

# 100-Watt 56-Mc. Crystal-Control Output With Only Four Stages

By Byron Goodman,\* W1JPE

**T**HE five-meter band has always resisted strenuously any attempts to utilize crystal-controlled transmitters. True, 56-mc. crystal-controlled transmitters have been built, but they involved such a multiplicity of stages that the overall efficiency (final output compared with total power input) has usually been so low that the application of crystal control has been handicapped. However, the advent of acorn tubes and improved reception methods has enabled the construction of receivers with a stability of the same order as on the lower frequencies. The serious high-frequency enthusiast is now looking towards crystal-control on the 56-mc. band.

When the regenerative Tri-tet showed its splendid ability as a quadrupling crystal oscillator, it was immediately thought that here was a short cut to 56-mc. crystal control. Using a 7-mc. crystal, it would be possible to quadruple to 28-mc. in the oscillator, double in another pentode to 56-mc. and drive a pair of 35T's as was done on the other bands. It was tried. The Tri-tet quadrupled satisfactorily to 28-mc. with the addition of 30 volts positive bias on the suppressor grid; but it was found that the going from 28 to 56-mc. in the pentode was mighty tough, and no matter what was done, adequate output could not be obtained to drive the pair of 35T's Class-C on five meters. If the voltage was reduced to 600 on the 35T's, and everything tuned up to the last fraction of a degree, satisfactory modulation could be accomplished with this 3-stage combination; but ambition dictated that the final stage be run at full rating. So the original exciter unit, which delivers from 12 to 15 watts on 28-mc. with a 3.5-mc. crystal, was used to drive an additional 35T as a doubler to 56 mc. By running the bias resistor up to 60,000 ohms, the tube performed admirably well as a doubler with 1000 volts on the plate, delivering 40 or so watts output

with normal plate dissipation, more than enough to excite fully a pair of similar tubes in the final amplifier.

This experience showed a few things that had merely lurked hazily in the back of the cranium before. First, it forcibly brought out the point that efficient triode doublers require a grid bias resistor that seems all out of proportion compared to the size used for straight amplifier work, since the normal bias resistor of 5000 ohms had to be increased to over 50,000 ohms before the tube performed well. Possibly a trick regenerative circuit would also have increased the efficiency; but simplicity and straightforwardness are desirable at this high frequency. Secondly, it was obvious that in any 56-mc. crystal-controlled transmitter, tubes designed for the higher frequencies should be employed. With suitable tubes, 56-mc. responds to exactly the same treatment as the lower

frequencies—providing, of course, that proper attention is given to leads, *L-C* ratio, and parts placement. And triodes still appear to be the thing, until a suitable high-frequency pentode is produced.

The final amplifier and the driver-doubler stage for use with the previously described exciter are built on a piece of 1/16-inch aluminum, of the same dimensions as the previous final amplifier base. The base is reinforced along the back edge with a strip of Dural angle bar, to prevent sagging of the aluminum. The filament transformer, all power supply leads, and the various fixed condensers and resistors are mounted under the base, following usual practice.

The tuning condensers for the doubler stage are insulated from the aluminum base by mounting them on strips of 1/4-inch bakelite. The condensers could have been mounted directly on the metal base, but this would have dictated parallel feed to grid and plate, a risky business at this frequency where chokes lie down on the job without warning. The tuning condensers used are of a low

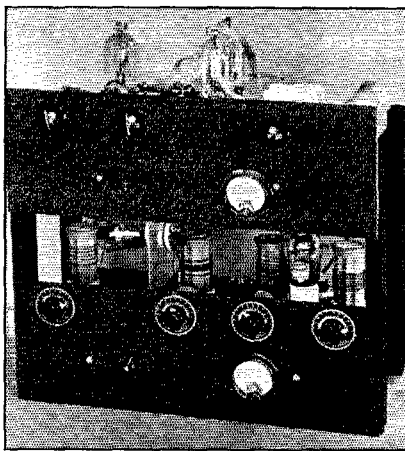

**THE FOUR-STAGE 56-MC. CRYSTAL-CONTROLLED TRANSMITTER**

*Built around the exciter unit described in the June issue of QST, the final amplifier takes 200 watts input without a whimper.*

\* Assistant Secretary, A.R.R.L.

minimum capacity, to permit favorable *L-C* ratios.

The final stage is coupled to the driver stage by a one-turn link, which furnishes adequate coupling. The plate tuning condenser is home-made, since a low-capacity split-stator condenser of the type wanted was not available at the time. That a low capacity condenser was obtained is evidenced by the fact that one turn must be removed from the tank coil in going from 56 to 60 mc.!

The construction of the tank condenser is quite simple, as can be seen from the photograph. The two stator plates were cut from 1/16-inch aluminum, suitable mounting lugs and tabs for the neutralizing condensers being provided. The stator plates are mounted on small National Isolantite stand-off insulators. To provide a perfectly balanced circuit, the connection for the rotor is made between the two rotor plates, and at the same time it furnishes the bearing for the rotor. The rotor plates were made of copper (because it can be readily soldered) and are soldered to small brass collars made by sawing a brass coupling in half. The bearing for the rotor shaft is made of heavy brass. On one side a spring bearing is provided to take up any play in the shaft and the two rotor plates are

fastened by means of their collars to the shaft, adjusting the pressure on either side of the bearing so that the shaft does not turn too freely. Additional support to the rotor shaft is furnished by a bakelite bearing mounted between the brass

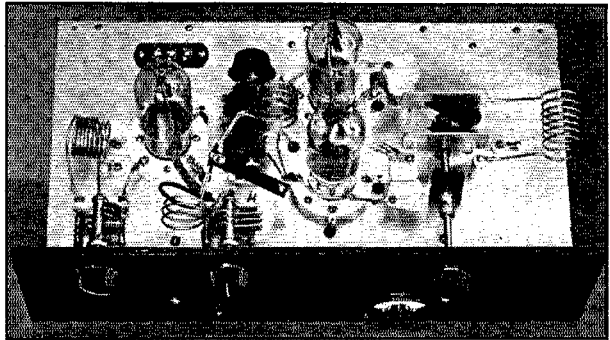

THE DRIVER-DOUBLER STAGE AND THE PUSH-PULL FINAL AMPLIFIER

The 35-T doubler on the left is link-coupled to the grid circuit of the final amplifier. The tuning condensers for the doubler stage are mounted on bakelite strips, not visible in the photograph. The simple home-made final tank condenser and the associated neutralizing condensers make it possible to realize a very effective *L-C* ratio. The toggle switch on the front panel switches the milliammeter from doubler to final.

bearing and the panel. The spacing between stator and rotor plates is 1/4 inch. The neutralizing condensers were completed by mounting two tabs of aluminum below those on the tank condenser stator plates. (Note details in cover photo.)

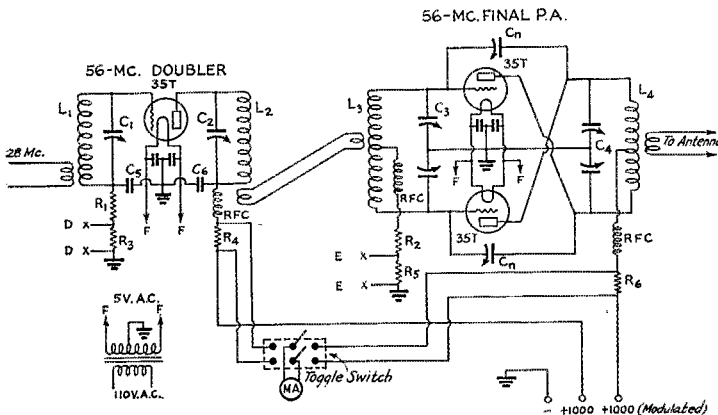

- $L_1$ —7 turns No. 12, 1 1/4" diameter, 1" long.
- $L_2$ —3 turns No. 12, 1 1/4" diameter, 3/4" long.
- $L_3$ —4 turns No. 12, 1 1/4" diameter, 1" long, center-tapped.
- $L_4$ —8 turns No. 12, 1 1/4" diameter, 1 3/4" long, center-tapped. One turn must be removed for 58- to 60-mc. operation.
- $C_1, C_2$ —15- $\mu$ fd. double-spaced variable condenser (National SEU-15).
- $C_3$ —Split-stator double spaced variable condenser, 33  $\mu$ fd. each section (Hammarlund MCD-35-SX).
- $C_4$ —Home-made split stator-variable condenser. See text.
- $C_5$ —0.001- $\mu$ fd. mica receiving condenser (Sangamo).
- $C_6$ —0.001- $\mu$ fd. mica condenser. (Aerovox).
- $C_8$ —60,000-ohm 50-watt wire-wound (Ohmite).
- $R_2$ —3000-ohm 20-watt wire-wound (Ohmite).
- $R_3, R_4, R_5, R_6$ —20-ohm 10-watt wire-wound (Ohmite or Electrad).
- RFC—Doubler and final grid, 125 ma. (National 100). Final, 500 ma. (Coto-coil C120).

The coils used in the 28- and 56-mc. portions of the transmitter are wound with No. 12 tinned copper wire, made self-supporting by the natural springiness of the wire. They are mounted directly on the respective tank condensers.

Complete metering of the transmitter is obtained by the use of two meters, the 100-ma. meter on the lower deck which switches into the exciter grid and plate circuits and the 300-ma. meter on the upper deck which can be switched to either the doubler-driver or the final amplifier.

#### TUNING THE TRANSMITTER

Tuning up the transmitter is a perfectly straightforward process.

Assuming that the exciter unit previously described is delivering its typically good 28-mc. output, the grid circuit of the 35T doubler is tuned to resonance. From 8 to 10 ma. of grid current should be obtained through the 60,000-ohm grid leak. Initial tuning, until the coil is properly adjusted for the correct number of turns, should of course be done with about 400

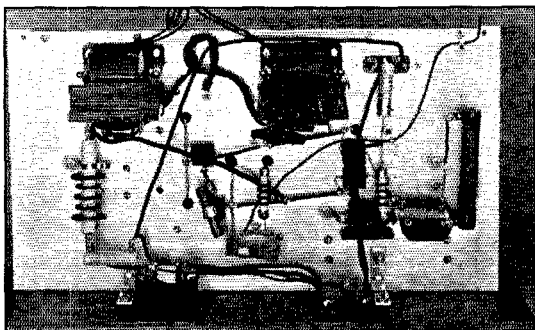

**UNDERNEATH THE BASE**

*Two filament transformers, with secondaries in series and primaries in parallel, were used to supply the filaments. Since there is no r.f. under the base, wiring is haphazard, the only precaution being adequate insulation wherever necessary. The link-coupling from the exciter unit is brought into the two Isolantite insulators on the left center, near the grid leak.*

volts on the plate. With 1000 volts on the plate of the doubler, a very good resonance dip in plate current should be obtained, the current dropping down to 40 or 45 ma., no-load. Tuning the grid circuit of the final amplifier to resonance, between 60 and 75 ma. grid current should be obtained through the 3000-ohm grid leak, with the doubler plate showing just faint color (pink) and drawing from 75 to 80 ma. The neutralizing condensers are opened wide, and the plate coil of the final amplifier adjusted by squeezing or spreading the turns until rotating the tank condenser produces a large dip in the grid current. Adjusting the neutralizing condensers until the grid current shows no flicker when the plate condenser is tuned through resonance indicates that the stage is neutralized. It is not advisable to use the neon-bulb method for final neutralization, since the capacity unbalance introduced will throw the push-pull stage out of symmetry, and a true indication of neutralization will not be obtained. The neon bulb can be used in the preliminary steps, however. It may be found that the push-pull tank coil will have to be adjusted as the neutralizing condensers are run in, since the capacity of the tank condenser is quite low; in fact, it is insufficient to cover the whole 56-mc. band.

Coupling the final tank to the antenna through a low-impedance link, and applying reduced plate voltage until the stage is tuned to resonance, the tubes should show their normal cherry-red color at an input of 200 watts (200 ma. at 1000

volts). If one plate runs at a brighter color than the other, look for unbalance in the grid or plate circuit, since such a condition indicates unbalanced excitation or loading. It is easy to prevent any unbalance by taking ordinary precautions as to symmetry in the amplifier.

The 100-watt modulator can now be connected, and you are ready to go on the air—with a carrier of over 100 watts, crystal controlled on 56 mc.

## Metal Tubes

AT intervals since the original group of metal tubes was announced new ones have been trickling along singly and in pairs. Without consciously making an effort to remember them, or keeping a running list handy, the chances are that the ordinary amateur doesn't realize what is available these days in metal. So-o-o, here's a quick *résumé* of the type numbers and the purpose of each:

- 6A8—pentagrid converter, to do the same job as the 2A7 and 6A7
  - 6C5—general-purpose triode (a better job than the 56 or 76)
  - 6F5—high- $\mu$  triode, amplification factor 100
  - 6F6—pentode power amplifier, about the same as the 2A5 and 42
  - 6H6—twin-diode rectifier, for diode detector circuits
  - 6J7—pentode r.f. amplifier, sharp cut-off type (same characteristics as the 57 and 6C6)
  - 6K7—pentode r.f. amplifier, variable- $\mu$  type (same as 58 and 6D6)
  - 6L6—beam power tube
  - 6L7—pentagrid mixer-amplifier
  - 6N7—Class-B twin amplifier, equivalent to 53 or 6A6
  - 6Q7—duplex-diode, high- $\mu$  triode; for same purposes as 2A6 or 75
  - 6R7—duplex-diode triode; in same class as the 55 and 85
  - 25A6—pentode power amplifier for a.c.-d.c. sets
- Rectifiers:
- 5W4—full-wave rectifier, filament type; a bit lighter than the 80
  - 5Z4—full-wave rectifier, heater type; a bit heavier than the 80
  - 6X5—full-wave rectifier, heater type; for auto sets
  - 25Z6—rectifier-voltage doubler; about equivalent to a 25Z5

Data on the 6A8, 6C5, 6F5, 6F6, 6H6, 6J7, 6K7, 6L7 and 5Z4 will be found in the 1936

(Continued on page 70)

# A General Purpose V.T. Voltmeter With Ray-Tube Indicator

By F. T. Griffin\*

**T**HE many uses of the vacuum tube voltmeter are known to the amateur who reads *QST*, and the applications to which it may be put need scarcely be mentioned. The voltage range over which the meter is to be used, the wave-form and frequency of the voltage that is to be measured, and such factors as portability, cost, etc., determine the design of a meter—and sometimes make the uninitiated hesitate to build one fearing that it will not be useful under most circumstances. It is not the intention here to expound on the merits or weaknesses of the various types of voltmeters, though it is true that such factors are to be considered in every case. However, for the average use where freak wave form, zero input capacity and zero current drain are not paramount in importance, a meter may be built that is inexpensive, easy to use, and which will do good work.

The meter described here was built for some experiments in advanced physics, especially for measuring harmonic distortion in audio-frequency amplifiers, and since the unit has the advantage of being high-range, a.c. or d.c. operated, with easily adjusted zero-setting and without an expensive microammeter (the 6E5 acting as the indicator), it was thought that others might be interested in the circuit.

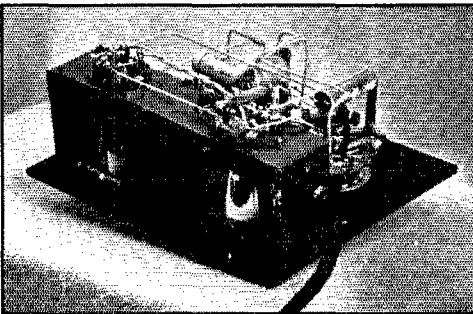

SHOWING THE INTERNAL CONSTRUCTION OF THE UNIT

The general layout consists of a 6F7 pentode-triode with the plate and screen of the pentode section connected to the cathode (ground). The control grid is connected as a grid-leak detector with a d.c. input resistance of 6 megohms. Half of the grid-leak is made up of a tapped resistance

\*205 North Church St., Fayetteville, Ark.

which allows a wide voltage range to be covered at the input circuit. The direct-current voltage developed across the grid leak is applied to the grid circuit of the triode-section of the 6F7. The

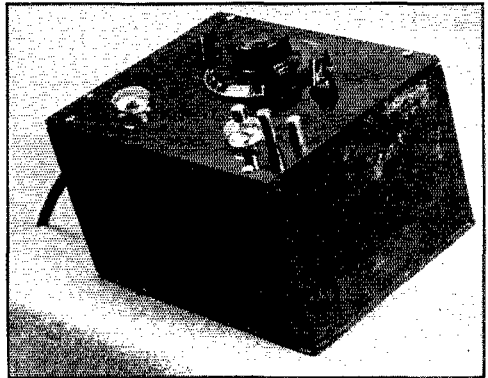

THE COMPLETED V.T. VOLTMETER IN ITS CASE

The large dial controls resistor  $R_{11}$ . The 6E5 indicator is at the left and the 6F7 (with grid cap) at the right.

plate circuit of the triode-section is in turn directly coupled, in a modified Loftin-White style, to the grid of the 6E5 tuning indicator, which takes the place of the commonly employed microammeter.

So far the writer has not seen any published characteristics of a pentode connected as a grid-leak detector with the screen and plate grounded to cathode. A set of curves was made, with 6 megohms as a leak resistance, showing the relation between applied voltage and grid-leak current. The effect of the variable-spaced grid under these conditions isn't known, but the relation results in a smooth curve somewhat exponential in nature.

A description of the 6E5 has been given previously in *QST*. In general, the anode of the tube, at the top, is coated with a fluorescent material which glows when struck by electrons from the cathode. Near one side of this anode a second anode in the form of a wire distorts the electrostatic field producing a shadow on the main anode. Between the cathode and the second anode a grid is placed which controls the effectiveness of this second anode. In short, the potential of the grid affects the width of the shadow on the fluorescent anode. Under normal voltages the shadow varies from one quadrant width at zero

bias, to zero width at -8 volts bias. The tube operates somewhat under normal voltages in this circuit and the shadow cut-off is approximately -5 volts.

The range of the meter is from 0-1.5 to 0-1500 volts in as many steps as one cares to make. This one was made with four ranges between these two

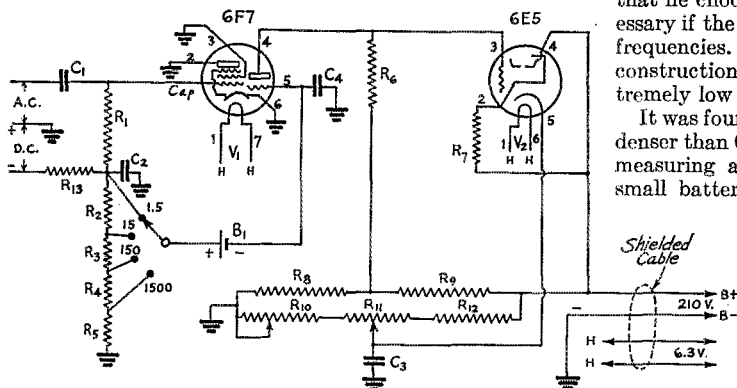

FIG. 1—CIRCUIT OF THE WIDE-RANGE V. T. VOLTMETER

$C_1$ —0.1  $\mu$ f. (See text.)

$C_2$ —0.08  $\mu$ f.

$C_3$ —0.25  $\mu$ f.

$C_4$ —0.03  $\mu$ f.

$R_1$ —3-megohm 1-watt.

$R_2$ —2,700,000-ohm 1-watt.

$R_3$ —270,000-ohm 1-watt.

$R_4$ —27,000-ohm 1-watt.

$R_5$ —3000-ohm 1-watt.

$R_6$ —10,000-ohm 2-watt.

$R_7$ —1-megohm 1-watt.

$R_8$ —20,000-ohm 10-watt.

$R_9$ —30,000-ohm 10-watt.

$R_{10}$ —10,000-ohm wire-wound pot.

$R_{11}$ —1000-ohm linear wire-wound pot (Yaxley).

$R_{12}$ —37,500-ohm 5-watt.

$R_{13}$ —500,000-ohm 2-watt.

limits, each step being a multiple of the next lower scale by a factor of 10.

The circuit is shown in Fig. 1. An a.c. voltage applied through the blocking condenser  $C$  and the cathode, causes a direct current to flow through resistances  $R_1$ ,  $R_2$ ,  $R_3$ ,  $R_4$ ,  $R_5$ . The voltage developed across the tapped resistances is applied to the grid of the triode section of  $V_1$ . The plate resistance of the triode section is increased, thus changing the current through  $R_6$ . This alters the potential on the grid of  $V_2$ . The cathode of  $V_2$ , which is above ground, must be moved yet farther from ground to maintain the original bias on the grid of the 6E5. A measure of the amount the cathode arm is moved ( $R_{11}$ ) determines the applied voltage at the input. Thus the 6E5 is merely used as a null indicator for a Wheatstone bridge, the plate resistance of the triode section of  $V_1$  acting as a variable arm of the bridge.

It was thought that a calibrated potentiometer would not be accurate enough, and a tapped resistor was made up with accurate resistors; but it proved to be no more desirable than a good quality Yaxley, or its equivalent, so the commercial product was used for  $R_{11}$ .

The meter was not made with an incorporated power supply, since one already existed which could be used. However, one may be made in the meter itself providing the 6E5 is shielded. Other-

wise the edges of the shadow will appear "fuzzy," because of 60-cycle induction. Fig. 2 shows the diagram of the power supply, which is the usual type found everywhere. In fact, anything that will give 210 volts d.c. at 15 milliamperes, and 6.3 volts at 0.6 amperes, will suffice.

The builder may use any style construction that he chooses. Good shielding is necessary if the unit is to be used on high frequencies. The "gooseneck" style of construction might be used if an extremely low input capacity is desired.<sup>1</sup>

It was found that a larger input condenser than 0.1- $\mu$ f. was not needed for measuring a.c. above 25 cycles. The small battery used to bias the triode grid consists of one pencil-type flashlight cell. Alternatively, one of the new bias cells (Mallory) might be used here.

The adjustment of the circuit is quite easy. First, the a.c. input terminals are shorted and the arm of potentiometer  $R_{11}$  is moved nearest to ground, at which position the dial setting should be zero. The filament and plate voltage

(which is adjusted to 210 volts) are then applied.  $R_{10}$  is then adjusted so that the shadow in the 6E5 is exactly zero. This zero setting will vary only slightly with the various voltage ranges. The pre-

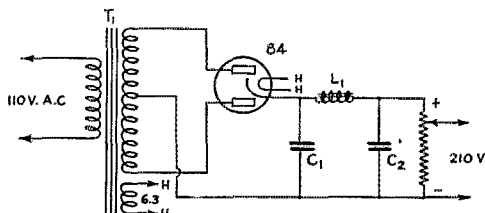

FIG. 2—CIRCUIT OF THE POWER SUPPLY

$L_1$ —30 henrys.

$C_1$ —8.0- $\mu$ f.

$C_2$ —8.0- $\mu$ f.

$T_1$ —300-0-300 h.v., 6.3 fil. (See text.)

liminary adjustment is now complete. The voltage range selector is then moved to a position that will accommodate the voltage to be measured, and the unknown voltage is applied to the input terminals (after the short is removed). As a result, the shadow in the 6E5 increases in width. The arm of the potentiometer  $R_{11}$ , which is attached to the 3-inch dial, is moved toward the

(Continued on page 64)

<sup>1</sup> Page 90, QST, May, 1935.



# What the League Is Doing

League Activities, Washington Notes, Board Actions—For Your Information

**The June Hearing** The biggest parade in the history of American radio occurred in Washington in June, when from the 15th to the 26th the entire art and industry passed in review before the Federal Communications Commission's informal engineering hearing. High frequencies and low, every recognized radio service and many projected new ones, all stated their cases to a total of 103 appearances before the Commission *en banc*, supported by its engineers and lawyers.

It scarcely seems wise to take a great amount of space here to report the hearing in detail. Some of its u.h.f. aspects are treated in this month's editorial. What our members here want to know is what was done about representing the amateur. Well, the amateur was represented—very thoroughly, we trust. The Board of Directors regarded this job as an important step in Cairo plans and put it in the hands of Secretary Warner and General Counsel Segal with instructions to put on a comprehensive presentation and with authority to call upon any needed assistance. A half a dozen members of our staff worked some weeks in preparation. Our case made use of Messrs. Handy, Hull and Warner as witnesses, with Mr. Segal in charge as counsel.

When our time came, Mr. Segal first sketched the historical background of amateur radio, what an amateur was, and explained the ground to be covered by our presentation. He then presented Mr. Warner as a witness testifying on the accomplishments of the amateur, to establish the fact that the national policy of encouraging amateur radio has richly repaid the nation. Mr. Handy was then introduced to disclose the amateur's operating status on the lower-frequency bands, the congestion, the need for more frequencies. (This was no allocation conference but a hearing merely reviewing conditions on frequencies below 30 mc.; allocation studies come later, when the government preparatory committees for Cairo meet.) Our purpose was to show what we are doing with our frequencies, what our operating conditions are. We believe we thoroughly demonstrated that if we are to continue to make the best contribution to American life it will be necessary to expand two of our bands, the 4-mc. one to 3500–4500 kc. and the 7-mc. one to 7000–7500 kc. Mr. Hull followed, with an exposition of what the amateur has done in ultra-high-frequency investigation, reporting the bending of u.h.f. waves disclosed by his studies and establishing that the interference range of such frequencies

is many times the visible horizon. Mr. Warner then reappeared as a witness to defend our 60-mc. band against encroachment by television and to renew our request for the assignment of additional u.h.f. bands.

The testimony of our witnesses was illustrated by a series of large colored charts on an easel. Our presentation had been well rehearsed and went off without a hitch, consuming, with the questioning, some three hours. Because it had been made interesting, it held the complete attention of the Commission and the audience. We were very pleased to be publicly congratulated by the chairman for a most interesting and effective presentation, and at the conclusion of the meeting were showered with congratulations. People tell us that the amateur's case was the best-prepared and most effectively presented of any at the hearing and that it was the high spot of the whole conference.

What now happens as a result of the hearing no one is quite sure. The Commission has assembled a vast amount of information and advice and requests. It is probable that some time in the winter it will announce allocations of ultra-highs to services, covering the range from 30 to 200 mc., and that above 200 will continue to be experimental. At that time we hope for a definite amateur assignment from 112 to 120. The lower frequencies come under study later in the summer when the Cairo preparatory groups meet. The great majority of American radio interests make it plain that they think there should be no changes of moment below 30 mc. at Cairo.

A.R.R.L. members are aware that for a long time television has been threatening our 60-mc. band, and that for an even longer time A.R.R.L. has been planning its defense. At this hearing no responsible interest attacked any of our bands (although some irresponsibles did). Some spokesmen for television did make reference to this band of ours, and a chart was displayed to illustrate how it is an unfortunate interruption in the continuity of frequencies desired for that service, 42 to 90 mc. But the general attitude was that it would be asked for only if the Commission found that we could well get along without it, and for our part we demonstrated that it is an indissoluble part of the amateur family of bands, that we are entitled to a continuation of our "test slices" of the spectrum, and that amateur developments in u.h.f. thoroughly display the wisdom of that national policy. The 56–60 band, occupied by us since 1924, is intact and will remain in our family.

As a matter of fact, our technical studies convince us that television ought to start at no lower a frequency than 60 mc. Considering the great number of demands for frequencies between 30 and 56 mc., we wouldn't be surprised to see television assigned between 60 and 112 mc. Wishful thinking, perhaps, but the sound thing from the technical standpoint, we're convinced.

### Code Speed Increased

It will be remembered that the A.R.R.L. Board petitioned the F.C.C. to raise the required code speed in amateur examinations to  $12\frac{1}{2}$  words per minute instead of 10. The Commission found  $12\frac{1}{2}$  messy to calculate and grade but they saw us and raised us a half, so on June 2d the required speed became 13 w.p.m. Pull down your copy of the *Rules & Regs* and your *License Manual* and in Rules 404 and 407 change the figure to 13. The change applies to all statements of the required speed and to all amateur applicants henceforth, whether for Class A, B or C. Seems a pretty good thing, to us, as all amateur standards are a great deal higher than they were a few years ago.

### 'Phone Freqs.

The Board also requested the F.C.C. to increase the 4-mc. Class-A 'phone assignment to read 3850-4000 kc., as has been reported in *QST* and as is known, we suppose, to every amateur. The Commission finds itself unconvinced that this change would be in the best interests of amateur radio, inasmuch as it has received protests from about 6000 radiotelegraph amateurs petitioning against any increase in the 'phone frequencies. It has therefore designated the matter for formal hearing before an examiner on October 20th and meanwhile holds up any action. Nothing will happen, then, until November in any event. The headquarters office of the League meantime is securing further instructions from the members of the Board.

### License Figures

Deletions of amateur station licenses during the second half of 1935 totalled 3369, mostly on account of expiring licenses not renewed. New station licenses issued during the same period amounted to 3335, indicating a slight net decrease. Not until this autumn will all amateur licenses be on the present uniform 3-year system. Starting then, reliable growth statistics will become available—for the first time in several years. The "deadwood" that accumulates in three years of course won't be eliminated and there will be no index to activity, but we shall be able to see whether our trend is up or down. Indications are that our total has been about stationary the past year.

### Death of Adams

Many an old-time reader of *QST* will hear with regret of the sudden death, in an automobile accident, of Edwin Carter Adams, former advertising man-

ager of the A.R.R.L. publications. Adams joined our staff in late 1919, and as our advertising manager from 1920 to 1926 did much to build up the post-war *QST*. His unseasonable passing brings sorrow to all who knew him.

### Monitoring

Our Board at its annual meeting called upon the F.C.C. to engage in more effective monitoring of the amateur bands, particularly as concerns bad notes and overmodulation. The Commission in reply points out that it is already devoting several hours a day at each monitoring station to our activities, that hundreds of citations have been and are being made, and expresses its belief that conditions have improved since Rule 382 was modified a year ago. They do not think it possible, with the limited force available, to expand upon their present schedule of work in the field, but they believe that we ourselves can be of assistance by observing the emissions within our bands and reporting one another in cases which appear to be in violation of the regulations.

The job, then, comes back to us. Amateur radio is already pretty well self-policing. It always has been, as a matter of self-preservation. For many years our system of Official Observers has been doing valuable work in intramural "citing." If the Commish can't do more for us, let's do more for ourselves along this same line. Most fellows appreciate an O.O. notice: it saves more serious consequences, results in the speedy correction of a difficulty that impairs the effectiveness of communication. The several hours a day that the monitoring stations devote to amateur radio will inevitably get the others, sooner or later. We are so crowded that we *must* cooperate. Bad signals and other offenses against regulations are unwarranted intrusion upon the rights of others, give us a black eye with the public and the other services, particularly reduce the enjoyment of the offender's own work. Let's individually clean up!

### Bootleggers

Everybody knows that there are a lot of 5-meter bootleggers, many of them masquerading as amateurs because they have purchased transceivers intended for amateur use. The F.C.C. has gone on the warpath against this activity and is circulating a letter to manufacturers, dealers and individuals stating that complaints are being received that transceivers and other types of low-power transmitters are being operated as unlicensed radio stations. The letter says: "These stations are in use in all sections of the country and are often operated in the amateur band, the nature of the transmissions usually being of the type carried on by amateurs. Such operation challenges this Commission's authority to regulate radio communications, and serious interference has resulted to the

(Continued on page 35)

# An Inexpensive Four-Band Transmitter

Complete Constructional Details of a Simple Rig for Use on the  
1.7-, 3.5-, 7- and 14-Mc. Bands

By Vernon Chambers,\* W1JEQ

**T**HIS compact, low-powered rig, has the ability to deliver a goodly amount of output in comparison with its size. A single power-supply, low-priced tubes and parts, and four-band operation with only two crystals, make the transmitter an inexpensive one. The Type 10 in the final, a tube that speaks for itself, is driven directly by a 47 pentode at 1.7 and 7 mc., while 3.5 and 14 mc. are reached with the aid of a 46 doubler. For the power and cost this arrangement is convenient for at a later date with the addition of one or two more tubes, a decided increase of power can be had. The layout is by no means a startling new development; but taking all things into consideration, it certainly is a transmitter well worth having.

## THE OSCILLATOR

The oscillator, arranged in a triangular layout at the left end of the baseboard, is a standard pentode crystal circuit. A 7500-ohm resistor,  $R_1$ , in series with an r.f. choke, furnishes grid-leak bias. The crystal is grounded on one side and connected to the grid on the other.  $R_4$ , a 20-ohm center-tapped resistor, is hooked in parallel with the filaments, its center tap serving as a ground terminal for all oscillator ground connections.

The plate is tied to the stator side of the tank circuit,  $L_1-C_1$  and also to the coupling condenser  $C_5$ . A closed-circuit jack, in series with the high voltage, provides connection for the plate milliammeter. In the entire transmitter, four of these jacks are used. There are three terminals on each of these jacks and in each case the center connection is soldered to the jack frame.  $R_7$  is the screen-grid voltage dropping resistor. Positive high voltage is series-fed, to the rotor (ground) side of the tuned plate circuit. Negative high voltage can go to any ground point.  $C_7$  and  $C_8$  are the by-pass condensers. A double tip-jack strip mounted in some convenient spot makes it possible to shoot the

oscillator excitation either into the doubler or around it. This switching is done by fastening a 'phone tip to a lead running to the grid side of  $C_5$ . This tip, of course, plugs into either of the two tip jacks, one of the jacks connecting to the grid of the 46 and the other to the jack located near the final amplifier.

## DOUBLER CONSTANTS

With the two grids of the 46 tied together, it acts as a triode. The bias supply, filament wiring and tank circuit connections are the same as those of the oscillator. Two 'phone jacks are used in this circuit, one to read plate current and the other as a switch to cut plate voltage off the doubler when it is not in use. Coupling condenser  $C_6$  goes from the plate to the tip jack strip located near the amplifier.

## THE AMPLIFIER

We find the Type 10 amplifier at the right end of the rig, the plate is connected to the stator side of  $L_3, C_3$ . Positive high voltage is applied at  $L_3$ 's center tap, a jack being in series with this lead. Neutralizing condenser  $C_4$  has its stator plate connected to  $C_3$ 's rotor, and its own rotor hooked to the tube's grid. Also to the grid goes an r.f. choke and a lead with a 'phone tip, the 'phone tip plugging in the desired jack mentioned previously. Bias resistor  $R_3$  is in series with the grid r.f.c. and the negative side of a 45-volt B battery. This battery prevents the drawing of too much plate current should excitation from the previous stage fail. One side of the by-pass condenser  $C_{11}$  is connected between the grid leak and the grid r.f.c. and the other side to ground. At this point the positive connection of the battery is made. The key is connected between this point and the filament resistor center tap. Other well-known methods of keying probably will be equally effective. By-pass condenser  $C_{10}$  is between the high-voltage lead and the ground terminal.

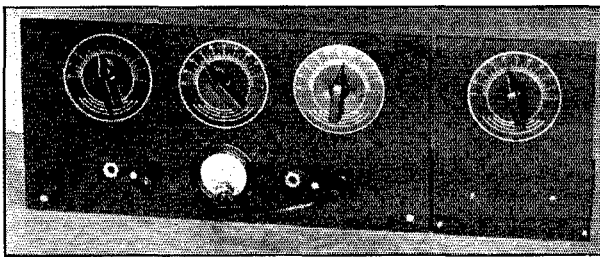

COMPLETE TRANSMITTER AND ANTENNA COUPLER

\*QST Laboratory Assistant

### CONSTRUCTION HINTS

Both the baseboard and the panel are cut out of a sheet of tempered masonite. The baseboard measures 15 by 7 inches, the panel 16 by 7 $\frac{3}{4}$  inches. A good idea is to mount the doubler con-

wide are screwed to the bottom, one at each end. Small, one-lug terminal strips for the various positive and negative voltage leads, will be of great help in the wiring job.

The neutralizing condenser mounting bracket is drilled so as to fit and mount on one of the stator terminals of the final tank condenser. Wood screws through the panel and into the strips on the bottom of the baseboard, and also two small angle brackets on top of the baseboard, will hold the panel firmly in place. A four-screw terminal strip mounted in back of the oscillator circuit will take care of all power supply leads to the oscillator and buffer, as these two circuits operate at the same plate and filament voltages. The final power filament and keying leads are brought to a six-screw strip in the rear of this section.

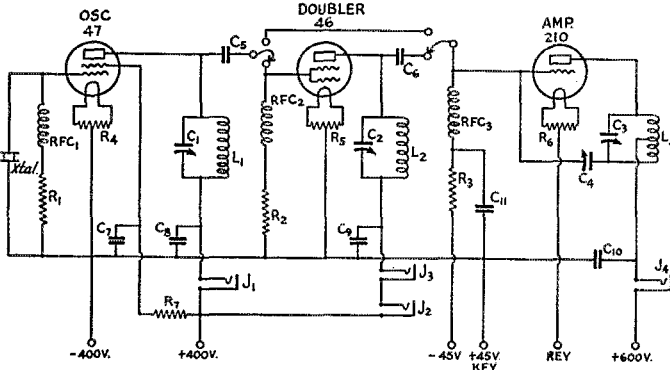

FIG. 1—THE TRANSMITTER CIRCUIT

- C*<sub>1</sub>, *C*<sub>2</sub>—100- $\mu$ fd. midget variable oscillator and doubler tank condensers (Hammarlund MC 100 M).  
*C*<sub>3</sub>—150- $\mu$ fd. variable amplifier tank condenser (Cardwell MR 150 BS).  
*C*<sub>4</sub>—Neutralizing condenser (Cardwell ZT 30 AS).  
*C*<sub>5</sub>, *C*<sub>6</sub>—0.0001  $\mu$ d. fixed mica coupling condensers, transmitting type.  
*C*<sub>7</sub>, *C*<sub>8</sub>, *C*<sub>9</sub>, *C*<sub>10</sub>, *C*<sub>11</sub>—0.002 fixed mica bypass condensers.  
*R*<sub>1</sub>—7500-ohm 2-watt resistor.  
*R*<sub>2</sub>—20,000-ohm 2-watt resistor.  
*R*<sub>3</sub>—15,000-ohm 10-watt resistor.  
*R*<sub>4</sub>, *R*<sub>5</sub>—20-ohm center-tapped, wire wound.  
*R*<sub>6</sub>—60-ohm center-tapped, wire wound.  
*R*<sub>7</sub>—50,000-ohm 2-watt.  
*RFC*<sub>1</sub>, *RFC*<sub>2</sub>, *RFC*<sub>3</sub>—National Type 100 r.f. chokes.

#### Additional parts—

- 4—closed circuit jacks (Bud 233).
- 1—4-screw terminal strip.
- 1—6-screw terminal strip.
- 2—double tip jack strips.
- 2—phone tips.
- 1—foot microphone cable.

#### Additional parts—

- $\frac{1}{2}$  lb. 18 d.c.c.
- $\frac{1}{4}$  lb. 22 d.c.c.
- Hook-up wire, screws and nuts.
- 4—Large 4-prong coil forms (Bud 734).
- 3—2 $\frac{1}{4}$ -inch bakelite knobs (ICA 1156).
- 3—3 $\frac{1}{2}$ -inch dial plates (ICA).

denser in the center and slightly over two inches from the top of the panel. After this, the doubler circuit can be arranged directly in the rear of this condenser and the other two circuits to the right and left of it. The meter is centered under the doubler condenser. A quarter-inch hole is drilled below the meter for the meter cable. The four 'phone jacks are spread out in line with the meter, two on each side. The jack on the right is for reading oscillator plate current, the second acts as the 46 plate-voltage switch, and the third and fourth for reading of the doubler and final plate currents.

The oscillator and doubler condenser scales slip over the condenser shafts and are fastened by the nuts that hold the condensers in place. The final and antenna tuner scales are grounded to prevent hand capacity effects. A piece of celluloid is cut to size and placed between the dial and the panel. These two dials are mounted either with escutcheon pins or small wood screws.

To permit the wiring and placing of the parts below the baseboard, two strips of wood  $\frac{3}{4}$ -inch

total turns, where the wire is clipped and soldered to one of the small prongs of the coil form. The second half is started from the other small prong of the form. These two prongs must then be connected together on the coil socket.

### THE ANTENNA TUNER

The antenna tuner diagrammed in Fig. 2 is constructed so as to make it useable with either a half-wave or a quarter-wave (grounded) antenna. The panel is cut to the same height as that of the transmitter and is six inches wide. The baseboard measures 6 by 7 inches and is mounted on strips of wood the same size as those used to support the transmitter. Two binding posts are mounted, one at each side of the rear of the tuner. Looking from the front of the tuner, the right-hand one is the antenna terminal and the other is the ground terminal for 1.7-mc. operation. The antenna used is 132.6 feet long, which operates as a voltage-fed system on all bands except 1.7 mc. At this band the coil and condenser are put in series and a ground attached, the antenna

then working as a quarter-wave grounded affair. Small copper clips soldered to the various connections make these changes, quickly and conveniently.

**THE POWER SUPPLY**

The power supply is a dual choke-input affair giving two outputs, one for the oscillator and doubler, and the other for the final. The use of two rectifiers (an 82 for the oscillator and an 83V for the final) makes possible the application of a steady voltage to the oscillator and doubler. Should the final be supplied with voltage from the oscillator supply, keying would cause an undesirable variation of plate voltage on the 47 and the 46. The single plate transformer gives 600 volts each side of c.t. and also has several filament windings. Of these, the 7.5-volt winding only is used, this for the 210. The separate filament transformer has three windings, one at 5 volts for the 83V; two at 2.5 volts, one of which

these condensers are in both cases connected in series, increasing the voltage rating and halving the capacity value. Incidentally, should one be bold enough to try running the 210 consistently

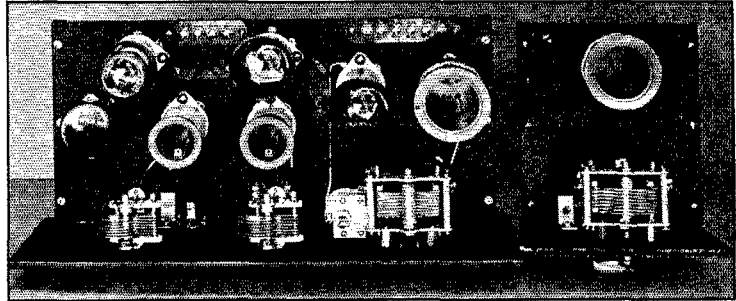

**TOP VIEW OF COMPLETE RIG**

*Note the coupling link between final tank and antenna coupler.*

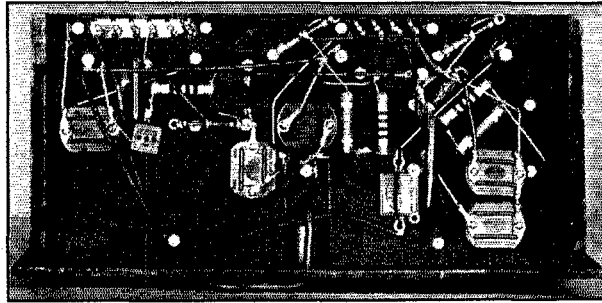

**WIRING UNDERNEATH THE TRANSMITTER**

takes care of the 82 and the other the 47 and 46.

Each of the rectifier circuits has but one filter choke in it. The 82 circuit uses a 5/25-henry 200-ma. swinging choke. That of the 83V circuit is of the 12-henry 200-ma. type.

Sprague CL-88 electrolytic condensers are used, one for each circuit. The two sections of

at 700 or more volts, the addition of another condenser, preceding the choke of the 83V circuit, will give a condenser output of approximately 750 volts. A series-connected condenser as used above will do the trick nicely. The bleeder for the oscillator is a 100-watt 25,000-ohm resistor tapped at 22,500 ohms, at which tap the 47 and 46 plate voltages are obtained. A 50,000-ohm 35-watt resistor acts as the bleeder across the Type 10 plate supply terminals. The two positive and the negative high-voltage leads are brought out to a three-screw terminal strip. Likewise, the filament leads are brought to a four-screw strip. The plate supply switch has been mounted on the side of one of the base-board mounting strips, although this switch will very likely be mounted on the operating table or some more convenient place.

The power supply base board is 15 inches by 7 inches, made of 1/4-inch tempered masonite. It is mounted on

two strips of 1/2-inch wood, each 3/4-inch high by 15 inches long.

**OPERATION AND ADJUSTMENT**

The first adjustment step is to tune up the oscillator. If the doubler is not to be used or the particular band to which the rig is being tuned,

**COIL TABLE**

BAND	Osc. (L <sub>1</sub> )	DOUBLER (L <sub>2</sub> )	AMP. (L <sub>3</sub> )	ANT. TUNER
Wire	No. 18 d.c.c.	No. 18 d.c.c.	No. 22 d.c.c.	No. 22 d.c.c.
1.7 mc.	51 t. (c.w.)	21 t. (c.w.)	36 t. (c.w., c.t.)	36 t. (c.w.)
3.5 mc.	12 t. (s.d.w.)	6 t. (s.d.w.)	13 t. (c.w., c.t.)	13 t. (c.w.)
7 mc.			9 t. (s.d.w., c.t.)	9 t. (s.d.w.)
14 mc.			6 t. (s.d.w., c.t.)	6 t. (s.d.w.)

c.t.—center tapped

s.d.w.—turns spaced diameter of wire

c.w.—turns close wound

the doubler plate voltage is cut off. The oscillator is then tuned to resonance, as indicated by minimum plate current or the glow of a neon bulb held on the plate side of the tank circuit. If the oscillator excitation is to be fed directly into the amplifier, this circuit now requires neutralizing. This is done with no voltage applied to the tube. With a neon bulb held to the "hot" side of the

Voltage is now applied to the final and this circuit tuned to resonance.

When using the doubler, the adjustment procedure is the same as mentioned above except that the plate voltage is applied to the 46 before tuning this circuit to resonance. The amplifier adjustment is then carried on from this point.

Coupling to the antenna tuner is merely a matter of setting the coupler next to the final and tuning it until it draws a satisfactory amount of plate current. The tuner is tuned to maximum plate current, and the final to minimum. The coupling is adjusted correctly when the final

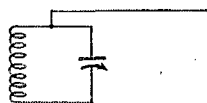

A—3.5, 7, and 14-Mc. OPERATION

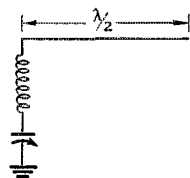

B—1.7-Mc. OPERATION

FIG. 2—ANTENNA TUNER CONNECTIONS

See table for coil data.  
C<sub>1</sub>—165- $\mu$ fd. variable condenser (Cardwell XP 165 KS).

tank condenser the final is tuned to resonance (maximum neon glow). The neutralizing condenser is then adjusted until the neon bulb no longer glows if held against the grid and the tank circuit condenser swung through resonance. It will be found that if the neutralizing condenser is rotated past this adjustment, the neon bulb will again give evidence of r.f. Between these two settings is the correct adjustment.

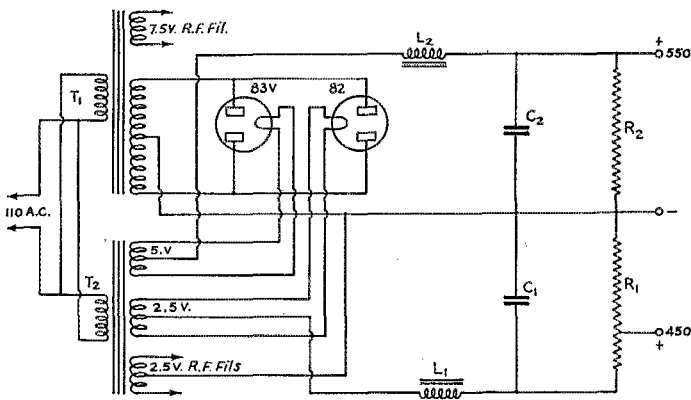
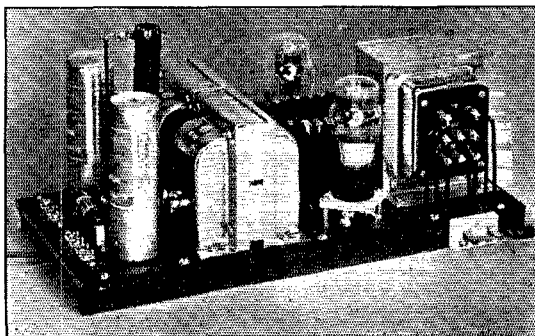

FIG. 3—POWER SUPPLY

- L<sub>1</sub>—5-25-henry, 200-ma., d.c. resistance 140 ohms (U.T.C. CS-304).
- L<sub>2</sub>—13-henry, 200-ma., d.c. resistance 140 ohms (U.T.C. CS-301).
- C<sub>1</sub>, C<sub>2</sub>—8- $\mu$ fd. 475-volt electrolytic condensers (connected in series) Sprague C1-88).
- R<sub>1</sub>—50,000-ohm 35-watt (Ohmite 0392).
- R<sub>2</sub>—25,000-ohm 100-watt slider type (tapped at 22,500 ohms, Ohmite 0968).
- T<sub>1</sub>—600 v. each side center tap. 200 ma.  
Fil. windings 2½ volt 10-amp.  
7½-volt—3-amp. (only fil. winding used).  
5-volt 3-amp. (United Transformer CS-202).
- T<sub>2</sub>—3 fil. windings.  
2½ volt c.t. 5-amp.—46-47 fil.
- 2½ volt c.t. 5-amp.—82 rectifier.  
r v.c.t. 3-amp.—83V rectifier.
- 1 piece tempered masonite 7 by 15 inches.
- 1 3-screw terminal strip.
- 1 4-screw terminal strip.
- 2 pieces wood ½ by ¾ by 15 inches.
- Screws, nuts, lug terminals.
- Roll No. 14 tinned wire.
- 4 lengths spaghetti.



COMPLETE POWER SUPPLY UNIT

draws a minimum plate current of about 70 ma. At 1.7 mc. the tuner coil and condenser are put in series and a ground attached. The tuner may, of course, be mounted in some other place than that described. In this case link coupling from the final tank to the antenna tuner would be used.

With careful tuning to obtain maximum output from each stage, this rig will deliver a cheerful little wallop on each band for which it is intended. Naturally, do not expect the same output on the higher frequencies as compared to the lower ones; but nevertheless there's enough sock to do an effective job.



# Results, A.R.R.L. Copying Bee

**A**BILITY to copy code at a good rate of speed is one of the goals of the true radio amateur. The annual A.R.R.L. Copying Bee provides a splendid opportunity to test your proficiency under actual operating conditions.

The second "Bee," held in December, 1935, was conducted through stations W1MK, W2AYN, W6AM, W6ZF and W9UZ. W9ABU was also scheduled to send the copy but "relay" trouble developing at the last minute prevented a successful transmission. All stations transmitted at approximately 22.5 words per minute—and that was plenty fast considering the material transmitted!! Different texts were sent from the east coast, central and west coast stations. As many stations could be copied as desired but it was only necessary to submit *one* copy, the copy which the operator considered to be "best."

## ELIMINATION CONTEST

Due to the fact that six operators each made perfect copy, it will be necessary to hold a special "elimination contest" for these six men in order to determine who is to receive the cup award. Since all six made their copies from east coast stations (W1MK and W2AYN), eastern stations will be utilized for the elimination test. While competition in this test will be between the six leaders, it will provide an opportunity for all operators to try their skill at copying—new text will be used.

Transmissions will be at 9:00 p.m. EST, August 14th, from W2AYN on 7290 kc. and from W1INF on 3825 kc. From 8:50 to 9:00 p.m. both stations will send V's with frequent identification by call signals. Also, on August 13th at 9:00 p.m., both stations will conduct a special test transmission so that the six contestants may spot the stations on their receivers. Anyone wishing to do so may copy the elimination text on August 14th (save your copies—the text will be printed in *QST*). But the real battle will be between the six "masters of code": William H. Schnaars, W2DHI; David R. Wingate of Leonia, N. J.; E. W. Mayer, K4KD; F. McCown, K4RJ; Wilburt C. Gross, W8BKM; and J. W. Parker, YN1AA. Fine work, OM's, and may the best man win the elimination bout. F. G. Gottsch, W2BTF, sitting in at W2AYN made perfect copy of the transmission from that station, but does not enter the competition due to being employed as a commercial operator.

Each text transmitted contained 50 words or groups totalling 345 characters (letters and numerals). In grading copies each word or group was considered either "right" or "wrong," and each one right counted 2% toward a possible 100%. The copy was composed of difficult and

misspelled words, letter and numeral combinations, etc. Trick combinations were designed to throw operators off their guard and in many cases succeeded! The text transmitted from each station is given after the scores. The texts are presented as punched on the tapes at the various stations. There were several instances where the actual transmission of some of the groups varied due to relays missing, minute failure of power, etc., at the transmitting stations; these instances have been taken into account and credit given accordingly to those operators noticing the discrepancies.

## THE SCORES

Operators are grouped by transmitting stations, showing from which station each contestant made his "best copy." Contestants are listed in each group according to accuracy of copy within that group. For final ratings to determine "winners" the scores of all operators in all groups were compared. Operators whose calls are in italics are the highest rating participants in their respective A.R.R.L. sections.

Copies were submitted by 159 amateurs; 80 contestants heard and attempted copy of W1MK, 66 attempted copy of W6ZF, 55 of W9UZ, 46 of W2AYN and 14 of W6AM; 69 made their best copy from W1MK, 42 made best copy from W6ZF, 30 from W2AYN, 13 from W6AM and 5 from W9UZ.

*Those making their "best copy" from W1MK: W8BKM—David R. Wingate 100% W1BFT-W4DML 98% W1GBY 96% W1JL-W2HHG 92% W8CDK 90% W1ALJ-W8AEH 88% W1BVR-W1EZV-W8CBN-W2ETT-W9KJY 86% W3UX-W9RMM 84% W3CUG-W8DOD 82% W1FNM-W1GHQ-W8LEC 80% W1IRH-W3CBF-W8HS W1INQ W1IYC-W9DOU VESSS W2BJA W1DJQ-W8EU W3ADE-W8JTT-W8KEV-W8LGR W1CEJ-W1GUA-W2CCZ-W2GXG-W3DR-W9SFC W1BZS-W1IP-W3ESM-W8AFE-W8NKU W1CTB-W8KPL W1KH W2HPV-W3EIL W1AV-W1IUQ-W9AUH-W9KZL W1SM-W3FPP. W8MZX W9MFH W2DYF W1EAL VE3BI W1FRK-W3BXE W2HYC W1HKF W8NWI W8OCA.*

*Those making their "best copy" from W6ZF: W6JVH/7-W7BXQ 94% W6AZH-K6HUO-W7BVE-W7CZX-W9LHV 92% W8BEN 88% K6MWN 86% W5NF-Andrew Kinnich (ex-KA1XT) 82% W1Z1 80% W1IGB-W6ASH W9KUI W7ELF W6HJT W1GAE W6MCU-W9FYK/7 W6KEX VE4OC-W6KHE W9TY W2GKW-W9KQC W3FVX-W9RLB W7CWN W3COK-W3FLZ-W3FMS-W3ZL-W6LWZ K6CGK-K7EBR W7COU W7ALS/3-W9IGZ W9PGN W2GMS W5ENR.*

*Those making their "best copy" from W2AYN: W2DHI K4KD-K4RJ-YN1AA 100% W9HCC 98% W9ASV-W9KCG 88% W8ANR 86% W2EGI-W6BKH 84% W9RJF W4BOU W4CRZ W2BMM-W8OIC W4CA/W9WTF W2IGQ-W8LUG H. F. Sturm W9JSL W9CEX W8FLD W2GAC-W3CWE W8FYH W9EFK-W9TWV W4CJM W9GFN W8GFP.*

*Those making their "best copy" from W6AM: W6EPZ 96% W6CLV 90% Wm. P. Hopwood (ex-W9CIW) 84% W6MQS W8CXX-W6EYR W6FYW-W7BDS W7BWS W2GPP/6-W7EBQ VE4TX W9KSE.*

*Those making their "best copy" from W9UZ: W1WV W9VDA W2HXT W9PJT G2TM.*

The text transmitted from W1MK and W2AYN:  
 ETUI FINITE ALLUVIAL AILERON JOCKO ORMAZD  
 TERRET FAERJE EMPANEL YEGGMAN VRAI-  
 SEMBLANCE TURF SIGYN PANETELA AFFERENT  
 JUGGERNAUT KEA AERODROME LEES ANELEI  
 SM7M5 SHILLALAH PNOMPENH LIXIVIAE  
 ALATE VSTVT ETTARRE FINIKIN UTILITARIAN-  
 ISM PANADA TEETHE EVANESCE WATTLE  
 H5SEI KUMQUAT IXTLE TUTELAR INVEIGH  
 MEMNON ACETANILIDE ABNEGATE BOSTOM  
 RENEGE NEOTERIC IODIDE VEDETHE RHT55H  
 FLEXUOUS INFANTILE FERNERY

The text transmitted from W9UZ:  
 ILEX MANANA PASIPHAE MARQUIS ENNUI  
 NJORTH TUREEN IREFUL LAOCOON ZEMSTVO  
 UMBELLIFEROUS TUFT TYCHE QUAGMIRE AL-  
 LELUIA YGDRASILH TUX GAZETTEER WEIR  
 TWINK 7SM4H CHIHUAHUA PRZEMYSL DIS-  
 SEIZIN TATAR CULSD EUTERPE PERIGEE PARAL-  
 LELEPIPED SZEGED TAUTOG EUTECTIC DIOMED  
 IES5H BIFROST XEBEC IQUIQUE TARANTO  
 SEETHE VLADIVOSTOK ABERRANT HARFRB  
 GEMINI PIERIDES OSIRIS JEJUNUM QSAH4E  
 FACETIAE FLAGEOLET ULYSSES

The text transmitted from W6AM and W6ZF:  
 KERF ZAFFER INFINITE ZOOTOMY AERIE JO-  
 TUNN FINNIC MIZZEN NITRATE YCLEPED  
 THERMOTROPISM DUNE UTHER PELERINE KAN-  
 AZAWA KIESELGUHR FID DIRIGIBLE WEEN  
 VESTA M53VW TSITSIHAR LOCOFOCO EXEQUA-  
 TUR SHIVE QSARH IGRAINE TERPENE IRRECON-  
 CILABLE UNFURL SEISIN DUPIABLE DENIER  
 5EHSH IMAGIST UKASE BETWIXT SEGMENT  
 WIEPRZ QUADRUPLANE DEIANIRA TENESE  
 VISENU TEETOTUM ISMENE BRISEIS QFAJ1H  
 FERRIAGE PEREGRINE WEASAND

— E. L. B.

## The 6E6 Twin Power Amplifier

ALTHOUGH the 6E6 has been made by some manufacturers for several months, it is probable that few amateurs are familiar with the tube. Containing two triodes in one bulb, the tube differs from the familiar twin triodes in that it is intended for Class-A, not Class-B, amplifiers.

Ratings and typical operating conditions are as follows:

Heater voltage.....	6.3 volts
Heater current.....	0.6 amp.
Class-A power amplifier (single section)	
Plate voltage.....	250 180 volts
Grid voltage.....	-27.5 -20 volts
Amplification factor.....	6 6
Plate resistance.....	3500 4300 ohms
Mutual conductance.....	1700 1400 $\mu$ hos
Plate current.....	18.0 11.5 ma.
Load resistance.....	7000 7000 ohms
Power output.....	0.8 .375 watts
Class-A push-pull amplifier (two sections)	
Plate voltage.....	250 180 volts
Grid voltage.....	-27.5 -20 volts
Load resistance (plate to plate).....	10,000 15,000 ohms
Power output.....	2.0 0.95 watts

The 6E6 has a medium 7-prong base. Pin connections are the same as for the 53 or 6A6.

## The 6G5—A New Electron-Ray Tube

To make the "magic eye" more adaptable to receivers in which the a.v.c. voltage developed is greater than that which gives zero shadow angle

with the 6E5, a new tube known as the 6G5 has been added to the receiving-tube line. The triode section of the 6G5 is of the remote cut-off or variable-mu type, more desirable for the purpose than the sharp cut-off type because of the logarithmic characteristic.

Ratings on the 6G5 are as follows:

Heater voltage.....	6.3 volts
Heater current.....	0.3 amp.
Plate and target voltage..	100 200 250 max. volts
Series triode plate resistor.	0.5 1 1 megohm
Target current, approx....	4.5 4.5 4.5 ma.
Triode plate current for zero grid voltage.....	0.19 0.19 0.24 ma.
Triode grid voltage	
For Shadow angle of 0 deg.....	-8 -18.5 -22 volts
For Shadow angle of 90 deg.....	0 0 0 volts

The tube has the small six pin base, and is identical in dimensions with the 6E5. Pin connections are as follows: Pin 1, heater; Pin 2, plate; Pin 3, grid; Pin 4, target; Pin 5, cathode; Pin 6, heater.



## British 56-mc. C.W. Transmissions

In the hope of uncovering some international 56-mc. DX on 56 mc., the R.S.G.B. has been instrumental in getting some G stations on the air with regularly-scheduled c.w. transmissions. Stations participating are listed below, together with the days and times of transmission. It is expected that more stations will join the group as the summer progresses.

Call	Frequency	Days and Times (B.S.T.)
G2GB	56.784 mc.	Wed. and Sat., 1130-1200
G2HG	56.32	Sat., 1430-1700
		Sun., 1000-1300
		1400-1800
G2VK	56.2	Sun., 1100-1130
G5FN		Sat., 1500-1700
G5LB	56.72	Mon., Tues., Thurs., Fri., 1815-1900
		Mon., Tues., Fri., 2230-2300
		Sat., 1600-1900
		Sun., 1200-1300
		1400-1700
G5JU		Sun., 1100-1200

Note that times given are summer time; subtract one hour for G.T. Reports may be sent to R.S.G.B. direct, or through A.R.R.L.

Stations in this country keeping similar schedules are invited to send them to A.R.R.L. for publication both in *QST* and the *T. & R. Bulletin*.

A leaflet showing tube base diagrams for more than sixty different prong arrangements and connections, including base diagrams for octal base tubes, has been issued by the Weston Electrical Instrument Corporation, Newark, N. J. A table in the folder classifies more than 300 makes and types of tubes according to their base connections as shown on the diagrams. The leaflet is available without charge to service men.

# An Improved Method of Voltage Control

## Effective Use of the Auto Transformer

By J. D. Blitch,\* W4IS

THE use of toy transformers for voltage bucking or boosting is quite well known to the fraternity and is described in the *Handbook*. However, no one seems to have suggested the logical extension of the idea—making a single auto-transformer do the job of putting the right primary voltage on every transformer in the set. While there is nothing particularly unique in the circuit and construction, I believe it is more versatile and effective in application than the usual dope. The general principles are illustrated in the diagram, Fig. 1. This arrangement has the following features:

1. Adjustment of  $S_1$  to make the voltmeter read 105 volts automatically adjusts all primaries to the predetermined correct voltage.

2. The necessity for having all primaries work at the same voltage is eliminated. Thus, 110 volts can be applied to the primary of one transformer, 115 to another, etc.

3. Independent control of the plate transformer is afforded by the tap switch  $S_2$ . This permits power input control and does not require an extra auto-transformer.

It is hardly necessary to point out that the system simplifies the adjustment of various filament voltages, since the primary voltage can be selected over a range of 20 volts or so, and that if these voltages are properly set when the rig is constructed then forever afterward a single adjustment of  $S_1$  takes care of all of them. When filament transformers are home built it is a little difficult to get, for example, exactly 10 volts at 6.5 amps without excessive cut-and-try. The expedient of tapping the particular primary along the auto transformer until the proper voltage is obtained at the filament terminals is most convenient. It is of course presupposed that this adjustment is made after proper regulation of  $S_1$  and after all filament wiring has been finished. Some fifteen taps at  $S_1$  are needed for close regulation, although only a few have been shown for the sake of simplifying the diagram.

The auto-transformer need not be expensive nor even tedious to wind. Ninety per cent of burned-out broadcast-receiver transformers have a good primary left, and can be picked up for little or nothing at a service shop. If the secondaries are removed and the insulation isn't "shot," the transformer may be connected to the line for a few minutes to see if heating occurs. Usually the high-voltage secondary will be badly charred but

the primary will be in good shape. Choose a large transformer (the kind used for ten- or twelve-tube sets or for P.A. systems). A 250-watt unit will handle some 1000 watts in the circuit shown. The voltage per turn can be readily determined, either by counting turns on one of the filament windings of known voltage output, or by winding

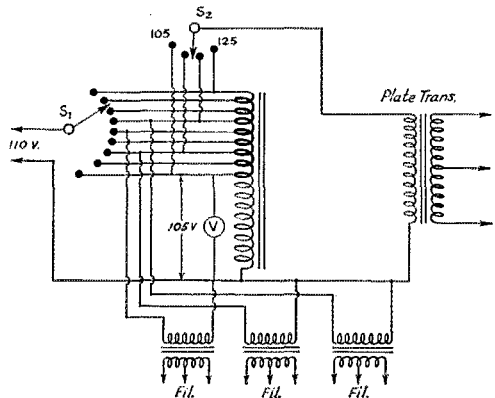

FIG. 1—WITH THIS CIRCUIT, A SINGLE ADJUSTMENT OF SWITCH  $S_1$  PLACES THE CORRECT PRIMARY VOLTAGE ON ALL TRANSFORMERS IN THE TRANSMITTER

Information on constructing a suitable auto-transformer at negligible cost is contained in the text. The light winding represents the regular primary of a revamped transformer, the heavy winding the voltage-regulating section.

on a few turns and measuring with a low-range voltmeter. (Measured voltage divided by number of turns equals volts per turn.) This figure divided into the voltage range desired (20 volts is usually sufficient) gives the number of turns on the new winding, shown in heavy lines in the diagram. The winding is then put on, taps being taken out at suitable intervals—approximately 1.5 volts between each tap. The taps preferably should be staggered along the winding to avoid bunching and to make identification easy. Taps can be made quite easily by slipping a piece of cambric under the turn to be tapped, scraping off the insulation at the desired point, and soldering on a length of stranded rubber-covered wire. No. 10 enamelled wire can be used for the winding; with this size wire and a husky b.c. transformer the regulation from no-load to full-load will be very good.

The plate transformer switch,  $S_2$ , need not have as many positions as the regulating switch,

\*Box 392, Statesboro, Ga.

$S_1$ ; taps at every 5 volts will be ample. The same taps can be used for both switches, of course.

An outfit like this is so simply and inexpensively made that it should be a welcome addition to every transmitter. With the heavy cooking and heating loads now carried, even on well-operated power systems the voltage regulation often is poor. But so far as the transmitter is concerned,

manipulation of  $S_1$ , when necessary, will compensate for widely-varying line voltages. Needless to say, the life of the transmitting tubes will be lengthened by its use.

An incidental advantage of the system is that only one a.c. voltmeter is needed for the whole transmitter once the preliminary adjustments have been made.

## When the Cat's Away or the Sourdough's Lament

By Joe Gish\*

**W**HY did I give up hamming? Well, fellows, it's a long way from curiosity to crystal control and there's many a slip twixt the 210 and the chromium-plated 861.

It all started in good old Seattle where I was busting the ether with as pretty a jumble of haywire as you ever hoped to lay eyes on, and giving my favorite YL the rush between times. Ah! Those were carefree times. Anyway, one day a fellow steps up and asks me as how I'd like to go to Alaska and wetnurse airplanes. Seeing that this would be my chance to set aside a nice little nest egg with which I could tie my YL in the fatal knot, and end forever the terrible QRM which persisted in spite of my efforts, I accepted. Next day I QSO's my YL and tells her as how I'm going to K7 for a year and that in the meantime I wish she'd sorta QRT and give a few of them CQ hounds the QRU QSC QSK. Whereupon she comes back very sweetly and replies that maybe I ought not count my chickens before they were incubated, but that she would QRX until my triumphant return or until some other RST599 came along for a QSO.

A month later I finds myself in a little jerk-water village in Alaska with a radio station, a nice batch of sourdough, and two hundred Indians. In between my commercial QSO's I was throwing together a little rig using a pair of ten's in the old standby, with which I was hoping to QSO some W7 in Seattle and get him to QSP to the girl friend.

Finally I gets the rig perking and, after calling CQ Seattle for three weeks (during which time I worked everybody but Mahatma Ghandi's cat), I finally got disgusted and sent a plain CQ. Tuning over the dial I hears an RST599 sig calling me which signs W7XXX. GE OM, I says, QRA? Well, when he comes back and tells me he's in Seattle I pretty near faints. Say OM, I

\*This is not the author's real name—you see, it's a true story.

says, can you call EL 0409 and ask for Lucy and tell her this is her little shoepack and that I still QTC? Sure thing, he says. From then on followed many a pleasant QSO; and my soul was full with richness of life, baked beans and burnt biscuits.

Gradually I began to notice that my Lucy's words of endearment weren't so dear and her sigs not so QSA. One day W7XXX says that he had met the YL and she was sure a honey. A few days later (my hair was now getting grey around the temples where there was any) I receives a very nice msg from Lucy, which states as how she was sort of tired QRXing and that she had met a very sweet boy, that I was QRJ, and that she was going to get married next week.

Well fellows I took it like a man but when I read in Dear old Quist that W7XXX had married a gal none other than my Lucy!!! Well I solemnly obliterates the two tens with a meat axe. Can you blame me, fellows?

### Northwestern Division Convention

August 21st, 22nd and 23rd at Walla Walla, Wash.

**A**CORDIAL invitation is extended to all amateurs of the Northwestern Division and surrounding states to attend the Eleventh Annual Divisional Convention to be held at the Hotel Marcus Whitman, Walla Walla, Wash., on August 21st, 22nd and 23rd, under the direct supervision of Director Ralph J. Gibbons.

As in the past the committee is preparing a diversified program which should satisfy every one. Several prominent speakers are assured and A.R.R.L. Headquarters will be represented by Byron Goodman, assistant secretary.

The registration fee is \$2.50, and further information may be obtained by writing Ralph J. Gibbons, 1106 Raley Street, Pendleton, Oregon.

# H A M D O M



**T**HIS man W6CUH simply shows no respect for manufacturer's tube ratings. Remember, "Thirty-Three Watts per Dollar"? That wasn't



so far removed from the "1st 210" that withstood the lethal effects of 1100 volts back in 1927; it was followed, however, by a 10-kw. water cooled 863 which he couldn't overload! Now three 150T's in parallel have them all licked—completely controlled from the operating table, even to band and frequency-changing.

Charles D. Perrine was

born a bit more than a quarter-century ago in Argentina where Perrine, Sr., was after real DX as an astronomer. On the air almost continuously since 1927, DX ragchewing is his forte. The BPL has been made, but two hectic months at W6USA with 2-hour watches during which the League of Nations jabbered in one ear and traffic pounded in the other cured the traffic bug. Participant in every DX contest since 1927, 110 countries worked, WAC over 500 times—now at a new YF-picked location that is ideal, behind an array of beams containing over a mile of antenna wire—W6CUH is still going strong.



**T**HE hero of the Southern California earthquake of 1933 was Al Martin, W6BYF—now W1IFQ. Located in the American Legion building, Al was on the air within ten minutes after the first tremor and his rig stayed on continuously for eight

days, handling some 3000 messages. Right in the midst of the earthquake, his location was strategic. In recognition of his services the City of Long Beach presented him with its Certificate of Appreciation—the only one issued to an individual participant in the emergency work. As in most successful amateur emergency work, there was a long background of experience behind this performance. W1IFQ started in amateur radio in 1914. After a diversified war experience he became one of the old Bristol (Conn.) spark

gang, which included Don Mix and other famous old-timers. There followed several other posts, as a pro op; the ham calls held include W1ANT, W1AVG, W8AWQ, and, of course, W6BYF and W1IFQ. Now he's back in Bristol, active as ever.

**K**EAT" CROCKETT, W9KG-W9ALV-WLUC, has pretty well run the gamut of amateur radio in the sixteen years he has been on the air. He has been a rag-chewer, a traffic-handler, and a DX man. He put in ten years as traffic-handler beginning in 1925, and for some time occupied a key position as the central link between the east-west trunk lines. An RM, he has maintained one of the biggest lists of consistently-kept skeds in the country. The last year or two, however, has seen him more on the DX bands than anywhere else, and he has rung up some nice DX results. Outside of the three calls currently held, Keat has been licensed as 9AKF and 9AYK. He is O.R.S., R.C.C., and a charter member of the A-1 Operators Club. There has been some experimental and 28-mc. work, too. An all-around ham—that's W9KG.



**T**HE connecting link between model airplanes and radio represents the lure that brought Miss C. Ciccello, W8NAL (she prefers to be called "General") into amateur radio. Now the pride of Ohio O.R.S., it was when she and W8MQO attempted to build radio-controlled model airplanes that she first learned about the ham game. It wasn't long before amateur radio displaced amateur aviation as a hobby. An active O.R.S., last fall W8NAL was delegated the task of sending out messages informing former residents of Dennison, Ohio, where she lives, of a big homecoming being planned by the city. W8NAL's objective in the game is to have some fun and help others—which makes her a typical ham.



# Remote Tuning of U.H.F. Receivers

A Simple Method Using "Condensometer" Frequency Control

By Marshall W. Rife,\* W9IWW

**S**INCE the advent of ultra-high-frequency transmission, many amateurs would like to locate their 5-meter transmitters and receivers on the top of some hill at a distance from their home, or on the roof of an apartment building or other tall structure, but hesitate to do so because of the inaccessibility of such a site for a

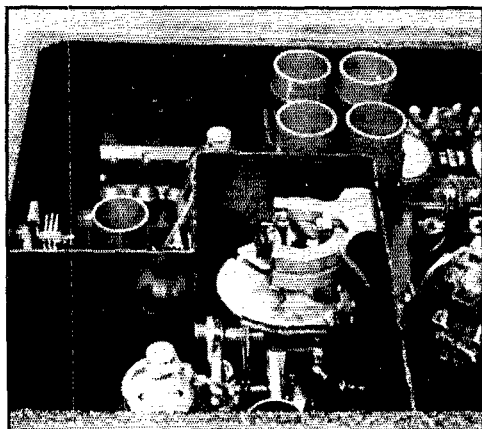

THE RECEIVER HOUSE IS MOUNTED ON THE ROOF OF AN EIGHTEEN-STORY BUILDING

The antenna consists of a half wave vertical aluminum rod guyed by means of three twine stays. In this view the cover is removed to show the receiver and battery power supply. The receiver house is constructed of masonry and wood, ventilation being provided so that heat of the sun will not cause excessive deterioration of the supply batteries.

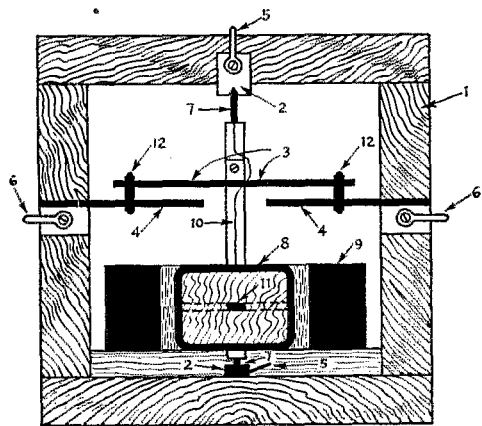

\* 6537 North Maplewood Ave., Chicago, Ill.

station location. Such a location provides the necessary antenna height for efficient transmission or reception without the use of long and relatively inefficient r.f. transmission lines. To be able to control the transmitter from a remote location is not much of a problem with the many suitable relays now on the market. The receiver, however, is usually not fixed-tune and up to the present time no suitable inexpensive device to accomplish remote tuning has been placed on the

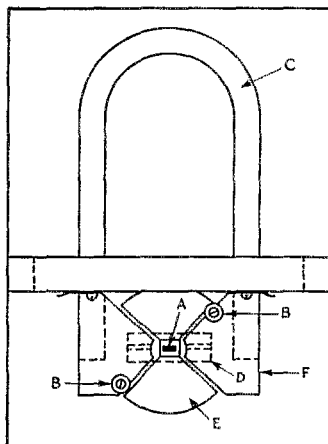

FIG. 2—INDICATING POSITIONS OF THE SMALL IRON ROD AND ROTOR STOPS, TOP BEARING NOT SHOWN

- A—Small iron rod.
- B—Rotor plate stops.
- C—Horseshoe magnet.
- D—Moving coil.
- E—Rotor plate.
- F—Stator plate.

market. The method described requires but one circuit and the associated equipment is not great.

The receiver, remote tuning device, associated relay equipment and power supply can be housed in a small weatherproof box and need be inspected

FIG. 1—OUTLINING THE CONDENSOMETER DETAILS

1. Framework.
2. Bearings (see text).
3. Condenser rotor plates (aluminum).
4. Condenser stator plates.
5. Rotor coil terminals.
6. Condenser terminals.
7. Axes (phonograph needles).
8. Moving coil.
9. Horseshoe magnet.
10. Spindle.
11. Small iron rod (see text).
12. Rotor stops.

or serviced only occasionally. Commercial power is not required to operate the remote tuning device and most any small-gauge wire can be used for the control and receiver output circuits.

The wiring diagrams are self-explanatory with the exception of the special tuning condenser or "condensometer." This consists of a rotor element of a variable condenser directly coupled to a power-type moving-coil galvanometer. This operates so that when the current through the galvanometer moving coil is increased beyond a certain value, the condenser rotor meshes with the stator and tuning can be accomplished by varying the galvanometer current by means of a control rheostat. This small variable condenser is of the 90-degree rotation "butterfly" type and is wired in parallel with the tuning condenser of the receiver or across a portion of the coil in the tuned circuit. Although the one described shows but one set of plates to tune a single circuit, more could be added to tune additional circuits if desired.

It will be noted that the vernier condenser does not immediately intermesh when current is sent through the galvanometer. The reason for this is that it is necessary to permit enough current to flow to energize the on-off relay associated with the receiver power supply before the tuning operation starts. Indication of the degree of tuning is shown by the millimeter connected in series at the control end of the circuit.

The galvanometer coil, which is on a wood form, can be wound to give maximum deflection at 50 ma., which is a good value to use. The sensitivity depends to a large extent on the ampere-turns; hence a large amount of wire should be used on the moving coil. Sufficient wire to provide a total coil resistance of 50 to 100 ohms has been found to be quite satisfactory. The supply voltage required varies with the resistance of the line but usually is not greater than twelve volts. Several old No. 6 dry cells can be used for this purpose.

Regarding the number of turns, size of wire, etc., of the galvanometer proper there is nothing particularly critical. The model shown in the photograph has a



THE REMOTE TUNING UNIT MOUNTED IN A TYPICAL ULTRA-HIGH-FREQUENCY RECEIVER

Permanent magnets from an old pair of W. E. headphones were used. The regular tuning condenser is mounted just below the condensometer.

d.c. resistance of 200 ohms and a battery voltage of twenty was necessary for proper operation, while the first preliminary model that was constructed had a d.c. resistance of only twenty ohms and a 4½-volt battery was all that was required. The maximum capacity position was reached in both cases when the current through the galvanometer was 50 ma. These voltages are higher than actually required to swing the galvanometer because of the external resistance of line, repeat coils, ground return, etc. The suggested value of 75 to 100 ohms with a 12-volt source of supply apparently makes a very good combination to use.

Because of the difficulty of finding a spring of the proper "springiness," a more conven-

(Continued on page 64)

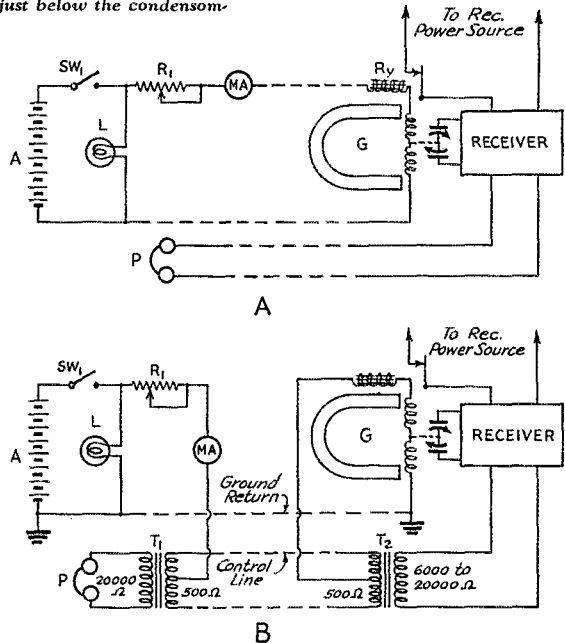

FIG. 3—ALTERNATIVE CONTROL AND OUTPUT LINE ARRANGEMENTS FOR REMOTE RECEIVER OPERATION

Separate circuits for control and audio are shown in A, while B employs audio coupling transformers in a two-wire and ground-return system.

- A—Battery.
- SW—On-off switch.
- L—Indicator light.
- P—Headphones.
- R<sub>1</sub>—Control rheostat.
- MA—Tuning indication, 0-50 d.c. milliammeter.
- R<sub>y</sub>—Receiver power relay.
- G—Condensometer.
- T<sub>1</sub>—Line-to-headset transformer.
- T<sub>2</sub>—Tube-to-line transformer.

# DX by the Calendar

Practical Month-to-Month Forecasts Based on the 27-Day Solar Cycle

By Charles D. Perrine, Jr.,\* W6CUH

HOW would you like to know that DX conditions will hit a peak right in the middle of the 1937 DX Tests? Or that rotten conditions will prevail over Labor Day, 1936, so you can go on that trip and miss no DX? Or that this year's Christmas Holidays will see DX at another peak? Sounds a bit far-fetched; but observations made at W6CUH for the past two years have led to surprisingly accurate predictions of the rise and fall of DX conditions. Hence it is a safe bet that the above predictions will hit the mark within a day or two. The purpose of this story is to show you how you can do your own long- and short-range predicting of DX, and at the same time help in the investigation of solar effects on radio.

Before 1934, DX (chiefly 14 mc.) was not frequent or consistent enough to evince any definitely recurring cycle in DX conditions. But since the spring of 1934 it has been possible to hear or work Europe at least weekly from the West Coast. And as European signals reaching W6 are the most subject to varying conditions, their variation has been taken as an easily observed index of general DX. Enough checks have been made to assure us that these general DX conditions follow the European signals faithfully. And through the cooperation of Dave Evans, W4DHz, and Frank Lucas, WSCR, additional comparisons show definitely that DX varies in the same manner over the whole United States. Even scattered checks with foreign stations in all continents indicate that world DX also varies in unison with the European signals here on the West Coast.

In observing the European signals (both night and morning) from day to day, considerable judgment is required to obtain a correct picture of conditions. The signal strengths of certain prominent Europeans was the most important factor (in this our hats are off to F8EO for his tireless brass-pounding which enabled nightly checks for three months in 1935). The length of time the signals break through each night is also important. And to eliminate the effects of the variation in the vertical angle of signal arrival, several widely different types of receiving antennas were always used. The results of such a procedure are of course only qualitative, but over a period of two years the average of the variation periods should be quite accurate.

\* 8125 Gonzaga Ave., Venice, Calif.

In 1934 DX was still spotty, but European signals seemed to peak (during the fall and spring DX seasons) every 28 days, close to the time of the full moon. Hence we started watching the moon for our DX. But 1935 brought better conditions and the DX peaks were then found to be coinciding with the moon's last quarter just one year after they had corresponded to the full moon. This represents a phase of lag of 20 days per year; and now in 1936 the peaks in June are at the time of the new moon, which corresponds to a lag of 20 days more since June 1935. Thus each DX cycle is  $1\frac{1}{2}$  days shorter than the moon's period of approximately  $28\frac{1}{2}$  days, or 27 days.

This 27-day DX period closely approximates the period of rotation of the sun about its axis, which would indicate that sunspot clusters on the sun's surface might be to blame. At any rate, the simultaneous variation of general DX conditions on both dark and lighted portions of the globe point to a more fundamental source of disturbance than the moon.

More complete daily observations were begun June 1, 1935, and the 27-day period further confirmed. At this time it became evident that the DX peaks were hard to judge accurately because frequently the increase in European signals was due to sleeplessness on the part of the gang across the pond rather than to improved DX conditions. Hence the DX *minimums* were observed and more accurate results obtained. During these minimums only the best of the Europeans come through, and even these usually drop out for a day or two when conditions hit bottom.

By September 1935 we were fairly certain of the 27-day period, so the next step was to make some predictions of future DX. The fall DX minimums were all predicted within two or three days—there will always be some variation because the minimums last some six to eight days. In December, 1935, a long shot was made and we sent Communications Manager Handy a prediction for the 1936 DX Contest, to the effect that minimums would occur at the end of February and near the end of March, making the test dates seem very favorable. By the end of January observations indicated that the March minimum could be expected about March 24 (the drop-off to begin about the 20th). The contest ran almost exactly true to form, the first weekend's DX far exceeding the second.



A secondary variation in DX during each cycle has been consistently noted throughout the two years' observations. Particularly evident on the evening (P.S.T.) European and African signals, the skip distance seems progressively to shorten as each 15- to 18-day DX peak wears on. As an example, the latest recorded minimum was about June 13th, and as conditions subsequently improved FB8AB in Madagascar and some ZS stations were the first loud ones through. The Balkans, Central and Eastern Europe followed (Western Europe also in there but weaker than usual). Lastly, just before the next minimum on July 8th, the G's are loudest and most consistent with the rest of Europe down a bit and the Balkans and Africa almost nil.

The accompanying table gives a list of dates for DX minimums observed during the last year at W6CUH. It will be of great interest to check these dates with your log and note their relative accuracy. A second list of dates is for future minimums predicted by extending the 27-day cycle through next March.

The advantages of being able to predict DX in this manner are obvious. Most of us cannot operate all the time; we must make the best of the available time. What a help it is to know well ahead of time just when to put on the pressure for some real DX! At W6CUH the monthly DX minimums are marked on the family calendar, so the YF can then schedule company or parties without objections from the OM about lost DX. Furthermore, rebuilding can be timed to miss the DX peaks, and even antenna tests can be corrected for the effects of the DX cycle.

In conclusion, it is our hope that this information will set more of the gang to observing DX variations throughout the world. The relation between radio and the sun is still much of a mystery, and it should be possible for us to furnish valuable data (though only qualitative) by reason of the fact that we are scattered all over the world and can observe signals from almost every part of it at will.

Observed Past Minimums		Predicted Future Minimums	
1935	June 9	1936	July 8
	July 2		Aug. 4
	July 26		Aug. 31
	Aug. 22		Sept. 27
	Sept. 18		Oct. 24
	Oct. 15		Nov. 19
	Nov. 10		Dec. 16
1936	Dec. 7	1937	Jan. 11
	Jan. 3		Feb. 7
	Jan. 30		Mar. 5
	Feb. 26		Mar. 31
	Mar. 24		
	Apr. 20		
	May 17		
June 13			



## DIXIE JONES' OWL JUICE

I KNOWED a feller in Alaska one time that cussed so much you couldn't hardly tell what he was tryin' to say. Just plain, ordinary cussin' it was, nothin' special. He done it because he didn't have no sense and couldn't think up nothin' to say so he just mostly cussed when it come his turn to talk. It's the same way with these vacant faced imbeciles that write all these stop-query hamgrams. They ain't got no sense to think with and they fill up their message with stops and querys. Dear aunt ellen stop how are you query i am well stop love stop goodbye stop write soon stop Marjorie. What they need is a whack on the head with a iron door stop, and the operator at the originating station needs the same thing and I'd like to be the one to give it to him. Stop.

—W4IR of the "Dixie Squinch Owl"

### What the League Is Doing

(Continued from page 22)

television, amateur and commercial service bands." It is pointed out that the courts have without exception held that radio signals are interstate in character and that the provisions of the Act apply to all stations which produce radio emissions intended for reception. Then the letter says: "You are advised that in the field of engineering it is an established fact that in any use of radio the signals will at times have effects which extend beyond the borders of a state and/or interfere with transmission to or reception from other states; and the question of this Commission's jurisdiction over the operation of such stations is too well established to any longer admit of doubt or leave room for serious question in any judicial proceeding."

People are coming to refer to this bootlegging as "unlicensed amateur operation." Of course it isn't amateur but a proper regard for our own skins should prompt us to do something about it. We recommend that our members be merciless in turning in bootleggers. Our bands belong to us, not to them. If they can't qualify for licenses they have no business operating. We have qualified, we sign our assigned calls and run risks of penalties for infractions of regulations. They blithely skate along in our bands, committing all the sins in the calendar, receiving no penalty for the most serious offense of all: unlicensed operation. It ain't right. Let's turn the beggars in and be damned to them!

# Handling Ham Messages

## Announcing Changes in A.R.R.L. Message Form, and Delivery Credits

**A**MATEUR traffic handling today is highly developed and very effective *if one knows how to use it*. Don't expect that you can get on the air with the message you have written and give it to the first station that comes along and expect the maximum in results! You fellows who get your fun principally from DX, rag-chewing, and building equipment should appreciate that you must place the occasional message you start and wish to have reach its destination, not in the hands of others like yourselves, but in the hands of one of the many operators who specializes in keeping schedules and handling messages, one who gets his fun mainly out of this branch of our hobby, who knows the best current routes and is in a position to use them. Reference to the "station activities" of the latest *QST* to identify calls of such men actually handling and reporting traffic regularly will enable anyone to start a message through a "reliable."

Whether or not traffic is one's main interest, the aim of every ham is, of course, to keep his station and his operating at highest efficiency, with real communication capabilities ready to step into the situation in any communications emergency. There are also experimental, card-collecting, conversational, and DX objectives, but we doubt if the amateur exists who does not want to know how to phrase a message, how to put the preamble in order, and how to communicate effectively when called upon to do so. Scarcely a month passes but what some of us in some section of our A.R.R.L. are called upon to add to the communication service record of the amateur. Not all of us hams appreciate the utility that results from using amateur message service in our ham correspondence. No ham can help but feel the satisfaction of having really accomplished something tangible in exchanging traffic with another amateur. Of course not all beginners develop the advanced operating technique of the finished message handler, but it is within the reach of all who will try. Message handling is one of those things that we amateurs can do to show our amateur radio in a respected light, not only from the novelty standpoint. Statement of a few basic points in handling messages seems in order at the same time the new message form is explained.

It is not always the station that sends fastest that gets best results. Careful, steady sending gauged to the conditions and receiving speed of the operator you are working with, combined with conscientious attention to use of proper procedure and proper message form, will get

your hook clear in a minimum of time. Consider the direction and destination of your traffic; place it in the right hands for reliable handling by willing operators; use common courtesy in all your work, repeating proper names, and difficult portions and allowing a few seconds after each message for the purpose of changing blanks in the "mill" and making time and date notations thereon as each message is received.

### CHANGE IN A.R.R.L. MESSAGE FORM

A year ago, in August *QST*, we announced a simplification of amateur message checking with the adoption of the land-line check. The land-line or text-only check is simply the count of the words in the text or body of the message. The change met with favor.

In the last year there have been some discussions of our message form and of the subject of delivery credits in *QST*. 25% of our Official Relay Stations and 80% of A.R.R.L. Trunk Line Stations are members of the A.A.R.S. Basically, many have agreed that one form of message is about as good as another, as long as the important component parts are all included. There are many individual message forms used by different services and private companies. With many stations in the most ardent traffic handling groups handling traffic the necessity for uniformity seems apparent. A study of advantages and disadvantages of different forms has been made. A number of Directors who sent questionnaires to their members before this year's Board meeting discussed the subject of message form. We are pleased to announce a change at this time, effective with the publication of this notice. We recall opinion in a typical Division as "63% in favor." In every survey taken this form now announced met the approval of the majority.

The order of transmission in A.R.R.L. message form is now:

- (a) Number
- (b) Station of Origin
- (c) Check
- (d) Place of Origin
- (e) Time filed
- (f) Date
- (g) Address
- (h) Text
- (i) Signature

A standard form is useful because it enables one to know just what is coming next, and makes accuracy possible with speed.

To further illustrate the new message form, a typical message is shown on one of the new

A.R.R.L. blanks. It is logical that the number and station of origin should be together. The check, placed where it is, immediately informs the receiving operator of the length of the message before too much time has been taken. He can "get set" for a long one when necessary. This form also facilitates the transfer of messages to commercial circuits in emergencies or whenever necessary. If the city of origin is different from the station of origin it can be so shown directly in use of the new A.R.R.L. form. Use the new message form at once, on the air. Start some messages to familiarize yourself with the proper way to write and send traffic in good form. Just as you would be ashamed to admit it if you could not qualify as an experienced amateur by at least "15 w.p.m." code capability, be equally proud of your basic knowledge of how to properly form and send record communications.

#### WHEN STARTING MESSAGES

The importance of a complete address cannot be over-estimated in starting messages. Senders should be encouraged to give as full and specific an address as possible in all cases. This avoids delays and promotes speedy delivery. Misspelled words should be changed with the consent of the sender and punctuation marks (only where necessary) should be spelled out. All words should be sent in full (no abbreviations except in service messages). The check is now definitely part of the preamble. Let us see that each message we start carries the proper "text" check.

#### COUNTING MESSAGES

A message received in person, by telephone, telegraph, or mail which is filed at your station and transmitted by radio in proper form counts as *one message originated*. A message received by radio and delivered in person by telephone, telegraph, or mail counts as *one message delivered*. A message received by radio and sent forward by radio counts as *two messages relayed*, one when received and again one when sent forward. All messages counted must be handled within a 48-hour delay period to count. A "service" message counts the same as any other type of message. The message *total* is the sum of the messages originated, delivered and relayed.

#### NEW ADDITIONAL DELIVERY CREDIT

In April, 1936, QST a proposal was made (by W2PF) to credit additional effort in making deliveries with the good purpose of bettering our 90% delivery averages of recent years. From letters received it appears that this idea was universally approved as good. So, in addition to the basic count of *one* for each time a message is handled by radio, an *extra credit* of one point for

each delivery made by mail, telephone, in person, by messenger or other external means *other than use of radio* (which would count as a "relay" of course) will now be allowed. A message received by an operator for himself or his station or party on the immediate premises continues to count *only* "one delivered" as now, but a message for

THE AMERICAN RADIO RELAY LEAGUE									
RADIOGRAM									
VIA AMATEUR RADIO									
CLASS	STATION OF ORIGIN	CITY	STATE	TIME	DATE	THIS MESSAGE WAS RECEIVED AT			
54	W2CFP	14	Ponca City Okla.	1:15p	June 28	STATION			
TO: A. R. R. L.						NAME			
WEST HARTFORD						E. J. Byrne			
CONN						132 TAMMAMBA AVE. N.E.			
						WASHINGTON, D.C.			
DETAILS NEW WEATHER REPORTING OKLAHOMA - NEW ON 3.0 BAND SENT AIR MAIL									
GARTER L SIMPSON									
IF THIS IS CHECKED AND FULFILLED BY THE MESSAGE									
RECD	W2CFP	State College, Pa.	5/29/36	6:20pm	03				
SENT	W2CFP	West Hartford, Conn.	6/29/36	7:07pm	ED				

AN EXAMPLE OF PROPER FORM AND CHECK . . . ALSO THE NEW OFFICIAL BLANKS, A NEW STRIKING HEAD-ING, AND NEW REDUCED PRICE GO ALONG WITH THE NEW A.R.R.L. FORM FOR TRANSMISSION

another amateur or third party delivered by an *additional means or effort* of the operator, in addition to such basic count, will receive a point under "extra delivery credits." This does not invalidate our present system of checking our national total or comparing originated and delivered messages for performance, but shows the number of deliveries made to other than the personnel manning the station.

All operators (whether League members or not) are invited to report activities to the S.C.M. (see address page 5, this issue). When you report, include traffic if you handled any—but report anyway. Activity reports and reports of messages originated, delivered, and relayed run from the 16th of one month to the 15th of the following month, inclusive. A postal to the S.C.M. in mid-month will insure that your report is included in Station Activities. Effective at once the new "extra delivery credits" should be claimed in your reports.

The individual handling of traffic is our most effective means for developing our operating ability. Through it we organize our relay lines, and make ourselves a valuable asset to the public and our country in every communications emergency that comes along, not to mention the individual service we perform for others by each message! Where messages are for third parties it

(Continued on page 66)

# Resistance-Coupled Input for Carbon Microphones

By Orville J. Sather\*

IT IS sometimes desirable to use resistance coupling in a microphone circuit and amplifier, especially where high fidelity is desirable and high gain is not so important. In a transformer-coupled circuit there is a gain due to the step-up ratio between primary and secondary windings, while this gain is sacrificed in resistance-coupled amplifiers. However, resistors and condensers are cheaper than transformers, particularly when the transformers are designed to give a good frequency response; also, with the advent of high- $\mu$  tubes of all types, voltage gain from transformers is not so important. Present-day trends are to use resistance coupling in small amplifiers when high fidelity is desired.

In the diagrams shown, resistance coupling is used on the output of the double button carbon microphone, the signal voltage being applied across  $R_1$  from grid to cathode of the first tube. The principle of operation is as follows: Suppose a direct current of 10 mils is flowing in each button of the microphone, and through  $R_1$  from  $a$  to  $b$  and from  $c$  to  $b$ . This will develop a voltage from  $a$  to  $b$  and from  $c$  to  $b$  of  $0.010 \times 200$  or 2 volts. Since  $a$  and  $c$  are then at the same potential with respect to the

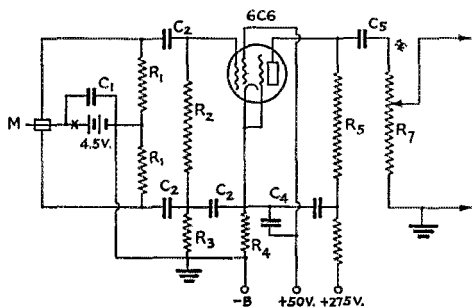

FIG. 1—TRIODE INPUT STAGE WITH BIAS FILTER  
 $C_1$ —1- $\mu$ f.d.  
 $C_2$ —0.2- $\mu$ f.d. (paper).  
 $C_3$ —2- $\mu$ f.d. 400-v.  
 $R_1$ —200-ohm.  
 $R_2$ —500,000-ohm.  
 $R_3$ —200,000-ohm.  
 $R_4$ —2800-ohm.  
 $R_5$ —50,000-ohm.

center, there is no potential difference between them. Then suppose an instantaneous pressure is

\* WCCO, Northwestern Broadcasting Inc., Minneapolis, Minn.

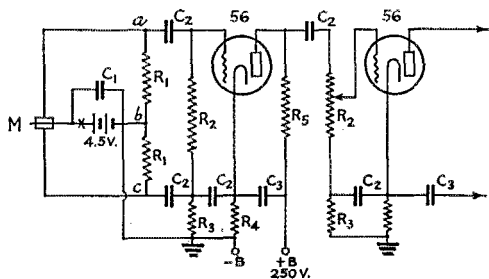

FIG. 3—HIGH-GAIN PENTODE INPUT  
 $C_1$ —1- $\mu$ f.d.  
 $C_2$ —2- $\mu$ f.d. (paper).  
 $C_3$ —2- $\mu$ f.d. 400-v.  
 $C_4$ —1- $\mu$ f.d. 400-v. (paper).  
 $R_1$ —200-ohm.  
 $R_2$ —250,000-ohm.  
 $R_3$ —100,000-ohm.  
 $R_4$ —3500-ohm.  
 $R_5$ —200,000-ohm.  
 $R_6$ —50,000-ohm.  
 $R_7$ —500,000-ohm potentiometer for following a.f. tube.

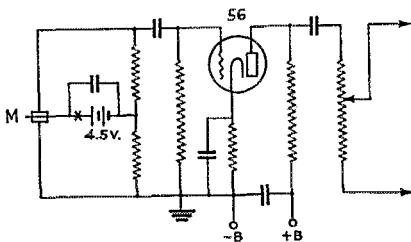

FIG. 2—SIMPLE TRIODE INPUT STAGE  
 $C$ —5- $\mu$ f.d. 50-v.  
 Other values same as for Fig. 1.

applied to the diaphragm of the microphone in such a direction that the resistance is decreased in the upper button and is increased in the lower button. The current will then momentarily increase from  $a$  to  $b$  (to 11 mils), and will decrease from  $c$  to  $b$  (to 9 mils). The voltage drop from  $a$  to  $b$  will then be  $0.011 \times 200$  or 2.2 volts, and the voltage drop from  $c$  to  $b$  will be  $0.009 \times 200$  or 1.8 volts. There will then be an instantaneous potential difference of 2.2—1.8 or 0.4 volts between  $a$  and  $c$ , or a signal of approximately 0.4 volts will be applied to the grid of the first tube.

The circuits shown are designed for a W.E. 600-A microphone having an impedance of 200 ohms per button. If other microphones are used having a different load impedance,  $R_1$  should be changed accordingly. A single-button microphone will work just as well; in this case the center tap on  $R_1$  would be omitted and the microphone would be connected at points  $a$  and  $c$ . In Fig. 2 the microphone is grounded through the 200-ohm resistor in parallel with one button of the microphone. The signal voltage measured from  $a$  to  $c$  was approximately from 0.04 to 0.05 volts, or about -35 db. This output voltage is still considerably above the level of other types of microphones.

The amplifier circuit shown in Fig. 1 was

thoroughly tested and the response was exceptionally good, the voltage gain being approximately 140. The output may be used to drive a pair of 45's in Class B by means of transformer

to that of a stage using transformer coupling into an ordinary triode. Fig. 4 shows the use of a high-gain push-pull amplifier using two 53 tubes.

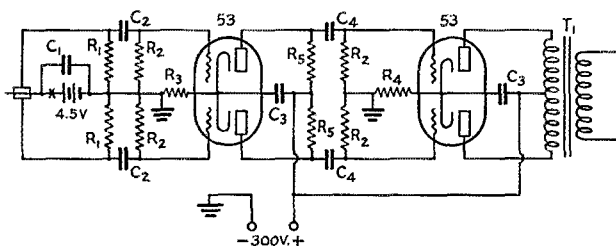

FIG. 4—HIGH-GAIN PUSH-PULL AMPLIFIER

- $C_1$ —1- $\mu$ fd.
- $C_2$ —0.1- $\mu$ fd. (paper).
- $C_3$ —2- $\mu$ fd. 400-v.
- $C_4$ —0.2- $\mu$ fd. 400-v. (paper).
- $R_1$ —200-ohm.
- $R_2$ —2.5-megohm.
- $R_3$ —3000-ohm biasing resistor.
- $R_4$ —900-ohm biasing resistor.
- $R_5$ —250,000-ohm.
- $T_1$ —High-impedance coupling transformer.

coupling. Fig. 2 is merely a modification of Fig. 1. Fig. 3 shows the use of a high-gain stage employing a pentode tube. The stage has a voltage gain of approximately 100, so the output is equivalent

The response of this amplifier is practically flat for all frequencies in the audio range (flat within  $\frac{1}{2}$  db from 30 to 10,000 cycles). It has an overall gain of 55 db or a voltage amplification of approximately 550. (This test was made using input from a crystal microphone having an output level of approximately -68 db.) These tests were made in the communication laboratories at the University of Minnesota. The circuit was designed by Ralph E. Allison. It makes a very nice pre-amplifier for use with any type of microphone or low-level audio source.

In any of the amplifiers shown it is quite simple to use any other audio source of low impedance by substituting it for the microphone across  $R_1$ ; or, in case of high impedance, across  $R_2$ . It is advisable to use the volume control after the first or following stages rather than before the first stage in order to prevent amplification of noise picked up in the potentiometer leads or the potentiometer itself.

## Another 1936 A.R.R.L. Field Day— August 22nd-23rd

**I**N RESPONSE to persistent demand for another opportunity to test portables, combining outdoor radio work with an outing before the colleges open in September, A.A.R.L. announces a second 1936 Field Day.

Starting Saturday, August 22nd (4 p.m. local time) and ending Sunday, August 23rd (7 p.m. local time), U. S. A. and Canadian operators are invited to enter portables in another F.D. The rules will correspond exactly to those detailed on page 22 of June 1936 QST, to which please refer. Each different station contacted counts *one point*. Points may be multiplied by 2 if either transmitter or receiver is independent of commercial power mains, by 3 if both are supplied from an independent local-power source. Power multipliers of 3, 2, or 1 also apply, if the plate power input to the final is not more than 20, or 60 watts, or over 60 watts, respectively.

Polish up the portable gear now. Complete the outfit you planned to modify after the June A.R.R.L. Field Day tests. Give it a thorough test August 22nd and 23rd. Send us a postal card or letter listing the stations worked and your score. "Manufactured" contacts between the field groups' transmitter and spares of other operators belonging to the same gang entering the field competition are out—but all other stations worked count. Use any band. Suggestions for equipment combinations are given on page 43 of June QST. We expect to give the report on the June F.D. next month. Analysis of scores of reports reveals the first seven or eight of the following combinations most practical and popular for emergency transmitters: 802, 42-42, 71A, 112A, 59-46, 42, 45, 41-'10, '10, 41-42, 42-802, 112A-'71A, 802-210, '10-'10, 71A-802, 37-42, 41-45, etc. Build now! Drop us a line giving your F.D. results, large or small as soon as the August field work is completed.—F. E. H.

# HINTS and KINKS for the Experimenter



## Keying the E.C. or Tri-tet Oscillator

IN AN attempt to get clickless and chirpless keying of an electron-coupled oscillator, the circuit of Fig. 1 was worked out by H. C. Cooper, W4CUW. Trials of other systems, such as straight cathode keying, breaking the -B lead, and so on gave plenty of clicks, but these were eliminated by keying across a high-resistance cathode resistor as shown in the diagram. With oscillator inputs up to ten watts there is no sign of a click

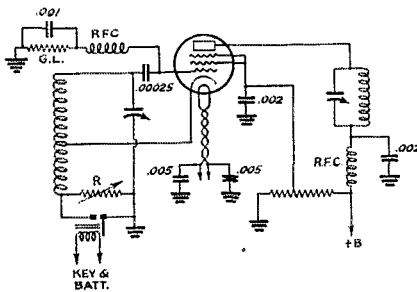

FIG. 1—CLICKLESS AND CHIRPLESS KEYING SYSTEM FOR THE ELECTRON-COUPLED OR TRI-TET OSCILLATOR

The value of resistor *R* is discussed in the text.

in a b.c. receiver only a few feet away from the transmitter, which consists of a 59 e.c. oscillator (the keyed tube) and an RK-20 amplifier.

The value of resistor *R* should be adjusted, with the key open, to reduce the plate current practically to zero. W4CUW found a resistance of about 100,000 ohms to be satisfactory; the actual resistor used was an adjustable carbon-pile type taken from an old Majestic "B" eliminator. Somewhat more resistance was required with the oscillator converted to a Tri-tet; the actual value will depend somewhat on the particular crystal used, since some tend to "hang on" more than others.

The rig at W4CUW is keyed through a relay, as indicated in the diagram. The connections to the relay contacts should be short, since these contacts form part of the tuned circuit when closed. It should be possible, however, to connect a mica by-pass (about 0.001  $\mu$ fd.) across *R* and use leads of any convenient length to the key. Should this be done, the relay may be omitted, the key itself being connected across *R*. There is no sparking at the contacts, and no thump filter is needed, at least up to the aforementioned 10 watts input.

## Five-Meter Interference to BCL's

HOW one case of interference to a modern all-wave receiver from a five-meter transmitter was cured is described in the following letter from Martin Schwartz, W2EPZ. It may help others.

"For eight months this station has been actively engaged on five meters with a rig consisting of a 53 long-line oscillator, modulated by a Class-B 53. The antenna is a matched affair fed from a line eighty-five feet long. Input to the oscillator is 12 to 14 watts.

"Recently one of the sixty-eight tenants in the building purchased a new Philco Model 29X all-wave receiver. The interference from W2EPZ on this receiver was terrific—no place on the dial was clear of me and the volume was greater than any broadcast station.

"A check on the receiving antenna showed it to be but six feet away from the transmitting antenna and at the same height. Disconnecting the antenna from the receiver reduced the QRM to about 75%. It was decided to convert the antenna to a regular doublet, replaced in the same position. This change removed 90% of the interference. Success was in sight, so a pair of small hand-wound chokes of fifty turns each on a quarter-inch dowel was installed in each of the feeders at the receiver. This eliminated all of the QRM. The new antenna increased the selectivity and sensitivity of the receiver, and needless to say the owner was very greatly pleased. No ground was used."

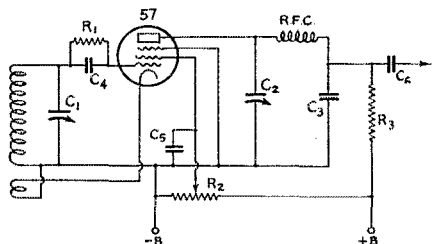

FIG. 2—A NOISELESS REGENERATION CONTROL WHICH DOES NOT AFFECT TUNING

- C<sub>1</sub>—Tuning condenser.
- C<sub>2</sub>—Regeneration control condenser, 100 to 250  $\mu$ fd. max. capacity.
- C<sub>3</sub>—100  $\mu$ fd.
- C<sub>4</sub>—100  $\mu$ fd.
- C<sub>5</sub>—0.01  $\mu$ fd., paper.
- C<sub>6</sub>—0.01  $\mu$ fd., audio coupling condenser.

- R<sub>1</sub>—5 megohms.
- R<sub>2</sub>—50,000-ohm potentiometer.
- R<sub>3</sub>—Plate coupling resistor, 300,000 ohms (Choke may be substituted).
- RFC—High-frequency r.f. choke.

## Improved System of Regeneration Control for the Screen-Grid Detector

THE circuit of Fig. 2 is suggested by Manfred Asson, ES2D, to overcome some of the disadvantages of screen-voltage regeneration control of a screen-grid type detector. As is well known, screen-voltage control tends to cause a frequency change in the circuit and, unless a very good potentiometer is used, is likely to be noisy. Also, since the detector sensitivity is considerably dependent upon a rather critical value of screen voltage, the effective sensitivity is likely to vary considerably if in order to obtain oscillation it is necessary to go very far from this optimum value. This is especially the case when the detector is coupled to the antenna without the benefit of an isolating r.f. stage.

In ES2D's arrangement the working regeneration control is  $C_2$ , a variable by pass across the plate circuit. Screen-voltage is controlled by potentiometer  $R_2$ ; this serves as an auxiliary control which, once set so that  $C_2$  functions properly, need not be touched. The number of turns on the cathode tickler should be adjusted so that with  $C_2$  at about half scale, the tube will go into oscillation when  $R_2$  puts about 30 volts on the screen grid. ES2D has used this system on 7 and 14 mc., and writes that the regeneration control has no effect on tuning, and is of course noiseless.

— . . . . —

## An Effective Regeneration Control

FIG. 3 shows a modification of the ultraudion circuit that I have found very effective as a regeneration control in a t.r.f. receiver. As you

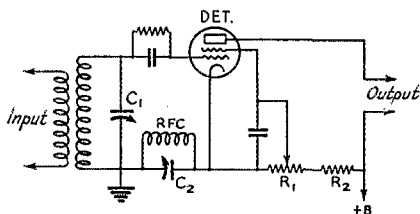

FIG. 3—MODIFIED ULTRAUDION CIRCUIT FOR CONTROL OF REGENERATION

$C_1$  is the usual tuning condenser;  $C_2$  the regeneration control condenser.  $R_1$  is a 50,000-ohm potentiometer,  $R_2$  a 25,000-ohm fixed resistor. RFC is a short-wave type sectional-wound choke.

will note, the cathode circuit is through an r.f. choke to ground, shunted by a variable condenser. By using a fairly large condenser (350  $\mu$ fd.) with a low minimum capacity, regeneration can be controlled from the broadcast band to above 28 megacycles.

The rest of the circuit is conventional. It will be noted that we have retained the 50,000-ohm potentiometer in the screen circuit. This is optional, but useful in maintaining screen voltage

at the point which gives greatest detector sensitivity.

The advantage of the circuit is the extreme smoothness of control and absence of any tuning effect.

—H. H. Marlin, W9CFG

— . . . . —

## Relayless Audio Oscillator for Monitoring Keying

MANY keying monitors and oscillators have been described in these pages, but never one which has satisfied the needs of this station, as well as others who are operating under the same conditions.

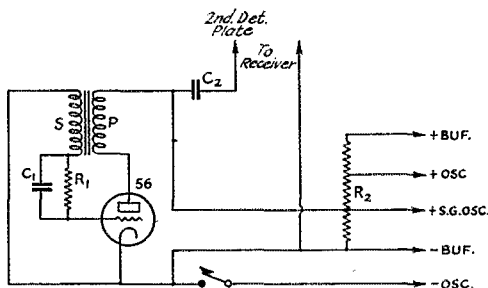

FIG. 4—KEYING MONITOR, USING AN AUDIO OSCILLATOR, WHICH REQUIRES NO RELAYS FOR SIMULTANEOUS KEYING OF AUDIO OSCILLATOR AND TRANSMITTER

$C_1$ —250  $\mu$ fd.  
 $C_2$ —0.003  $\mu$ fd.  
 $R_1$ —1-3 megohms.  
 $R_2$ —Crystal oscillator voltage divider.

We wanted a system requiring no batteries or relays, to go with the 59 Tri-tet exciter unit, keyed in the oscillator negative lead, in use here. The circuit finally used is shown in Fig. 4. Most of the apparatus can be fished out of the old junk box.

It makes a difference which way the leads to the audio transformer are connected. If it fails to oscillate the first time reverse the leads on one side. Be sure to get the negative lead to the audio oscillator on the proper side of the key or bug in order to make and break the contact to the oscillator.

As shown in the diagram, the audio oscillator gets its plate voltage from the screen grid tap on the exciter voltage divider, the negative lead on both audio oscillator and crystal oscillator being keyed simultaneously. Incidentally the rig works well on voltages down to ten volts.

The signal from the keying oscillator is fed to the 'phones on the plate side of the second detector and keying can be monitored right up to your own frequency. A change in the note to suit the operator's fancy can be obtained by using various values of grid leak, although we found around one or two megs the best.

—D. C. Strawn, W6AXN

## Monitoring Audio Oscillator with Keyer Tubes

FIG. 5 shows a keying system which needs no relays but will key both the transmitter and a monitoring oscillator. An audio oscillator and a

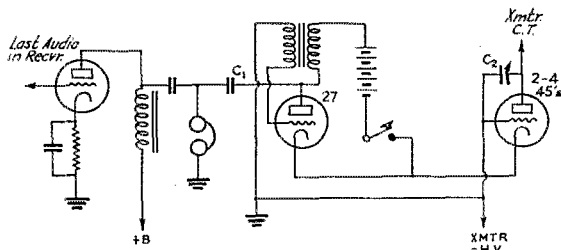

FIG. 5—AUDIO OSCILLATOR FOR KEYING MONITORING COMBINED WITH TUBE KEYING

$C_1$ —0.0025 to 0.05  $\mu\text{fd.}$ , mica.  
 $C_2$ —0.002 to 0.06  $\mu\text{fd.}$ , mica.

set of keyer tubes with their filament transformer are all that are necessary. As shown in the diagram, the audio oscillator is used as a grid leak for the keyer tubes, the output of the oscillator being fed through  $C_1$  to the headphones or speaker used for reception. A standby switch may be necessary if the receiver clicks badly. At the other end of the circuit the keyer tubes are connected in parallel. The key is connected to the grids and to one side of the filaments. A center-tapped resistor is not necessary. A by-pass condenser or r.f. choke should be inserted in the keying line to keep r.f. out of the keyer tubes and the oscillator. The plates of the keyer tubes go to the cathode of the stage to be keyed and the grids go to ground (B negative). If the crystal oscillator is keyed, break-in operation is possible and the system is very smooth, since one pair of 'phones handles both receiving and monitoring.

—Jack Allen, W7ELG

## Car Antenna Kinks

MANY amateurs are confronted with the problem of trying to install a five-meter transceiver in a new car. I have one of the turret-top cars, which added to my troubles when working out the aerial problem.

The aerial itself is a factory-made telescope-type five-meter antenna, with four mounting holes very conveniently placed at the base. In these I placed four rubber suction cups, of the type one can buy at any automobile supply store. These make a very excellent support for the aerial. When wet these suction cups have an amazing strength and will resist the wind pressure very well.

By placing the aerial on the roof or any convenient place, the feed problem was very quickly overcome by the use of concentric feeders. For this I used low-capacity shielded wire, which

works very well. This allows the transceiver to be placed anywhere in the car. Without marring the car in any way the aerial can be very easily and quickly put up and taken down. The connection of the concentric feed in my particular case was one and one-half turns from the cold end of the tank coil. Judging by reports, the aerial seems to be quite efficient.

—John D. Woodlock

## Twenty-Meter Crystals

THE following extract from a letter from R. N. McCord, W9MYX, is worthy of consideration by those contemplating using the new 20-meter crystals, or who may have been having trouble with them:

"Recently I purchased a crystal for fundamental operation in the 14-mc. band, using a 47 tube in the familiar pentode oscillator circuit. The circuit and constants used were exactly according to the bulletin furnished with the crystal. Several hours were consumed in attempting to make the crystal function, during which time I changed all of the circuit constants and even went to the extent of building a separate oscillator, but the crystal refused to oscillate. It was not until after a tank coil with spaced turns had been made up, that oscillation was finally obtained. A tank capacity of 50  $\mu\text{fd.}$ , with a coil consisting of eight spaced turns of No. 14 wire on a 1½-inch form, were used. The rather heavy wire was found to be

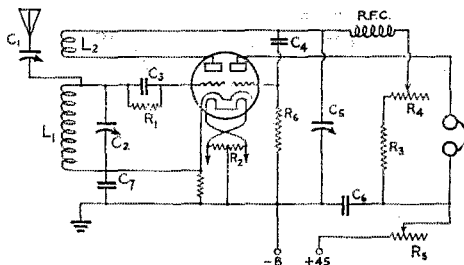

FIG. 6—REGENERATIVE RECEIVER USING A 53 TUBE

$C_1$ —15- $\mu\text{fd.}$  variable.  $C_6$ —0.01  $\mu\text{fd.}$   
 $C_2$ —100- $\mu\text{fd.}$  variable.  $C_7$ —2  $\mu\text{fd.}$   
 $C_3$ —100  $\mu\text{fd.}$   $R_1$ —2 megohms.  
 $C_4$ —0.004  $\mu\text{fd.}$   $R_2$ —25 ohms, center-tapped.  
 $C_5$ —250- $\mu\text{fd.}$  variable.  $R_3$ —3500 ohms.  
 $R_4$ —Bradleyohm, min. resistance 1500 ohms.  
 $R_5$ —High-resistance Bradleyohm.  
 $R_6$ —1 megohm.  
 $R_7$ —250 ohms.

Coil Data:

Band	$L_1$	$L_2$
1.75 mc.	45 turns	11 turns
3.5 "	18 "	9 "
7 "	9 "	6 "
14 "	7 "	5 "

necessary because the crystal actually was a powerful oscillator, and the use of smaller wire caused the coil to heat considerably. The introduction of a winding form for the wire undoubtedly

(Continued on page 62)





# Amateur Radio STATIONS

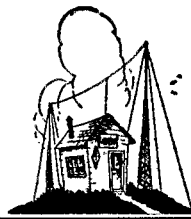

## W7CHT, Payette, Idaho

**D**URING the last winter the call W7CHT was a familiar one to the Eastern ten-meter gang; both on c.w. and 'phone. However, the activities of this station, owned by Howard Earp of Payette, Idaho, are not confined to any one part of the spectrum. Operation is carried on on both 'phone and c.w. on the 20-meter band, on 40-meter c.w., and on 75-meter 'phone. Under the circumstances, fairly rapid band-changing is desirable, accomplished in this case by using plug-in coils in the transmitter in conjunction with different antennas for the various bands.

The transmitter, which occupies the rack at the left in the photograph, consists of a 59 Tri-tet oscillator, a buffer with a pair of 46's in parallel, and a W.E. 211 final. The plate input to the final is 200 watts on 'phone, 300 watts on c.w. Power supplies are contained in the lower section of the rack. The speech amplifier and modulator, built into the cabinet which is at the rear center in the photograph, works from a double-button mike into a 57 followed by a 56 into a pair of 45's, which drive the Class-B modulator. Four 46's are used in this latter stage. On top of the speech cabinet is a neon-tube oscilloscope, highly useful

February, 1936, QST, is used with the receiver. It is expected that a superhet will be installed soon.

Four doublet antennas, each with twisted-pair feeders, see to the business of getting W7CHT's signals out into space.

W7CHT has been in existence for about four years, has obtained a W.A.C. certificate, and has



W6NCT

held appointments as ORS and in the A.A.R.S. Some thirty countries have been worked.

## W6NCT, Santa Barbara, Calif.

**T**HE imposing-looking layout shown in the accompanying photo is W6NCT, owned by Henry H. Wilson, of Santa Barbara, Calif. The station was established in 1935, although its owner's interest in radio dates back to 1919.

Two transmitters are used, one being at each side of the picture. That at the left operates on 160 and 80 meters. The rather unusual construction combines the good features of breadboard and cabinet construction. The cabinet is of metal with glass windows in the doors. The transmitter is completely enclosed, including the tuning controls. The tube line-up includes a 2A5 oscillator, 46 first buffer, 10 second buffer, and 203A final. The 203A is modulated by a pair of 801's in Class-B. Carrier output is approximately 125 watts.

The transmitter at the right has been doing a

*(Continued on page 68)*

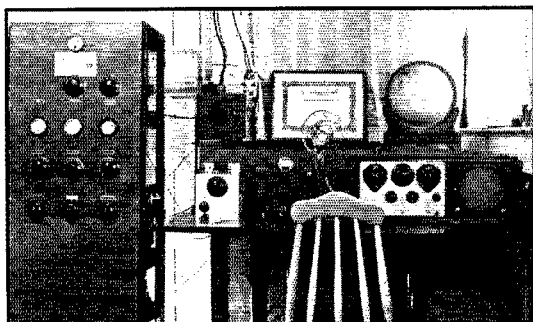

W7CHT

for checking modulation percentage, hum and distortion.

W7CHT's receiver, at the right on the table, is a 5-tube t.r.f. job, a.c. operated. For ten-meter work a converter similar to the one described in

# ● I. A. R. U. NEWS ●

Devoted to the interests and activities of the

## INTERNATIONAL AMATEUR RADIO UNION

Headquarters Society: THE AMERICAN RADIO RELAY LEAGUE, West Hartford, Conn.

### MEMBER SOCIETIES

American Radio Relay League  
Associazione Radiotecnica Italiana  
Canadian Section, A.R.R.L.  
Ceskoslovenski Amatér Vysilac  
Deutscher Amateur Sende-und-Empfangs Dienst  
Experimenterende Danske Radioamatører  
Irish Radio Transmitters Society  
日本アマチュア無線聯盟  
Liga Colombiana de Radio Aficionados

Liga Mexicana de Radio Experimentadores  
Nederlandsche Vereeniging voor Internationaal Radioamateurisme  
Nederlandsch-Indische Vereeniging voor Internationaal Radioamateurisme  
New Zealand Association of Radio Transmitters  
Norsk Radio Reize Liga  
Oesterreichischer Versuchsenderverband  
Polski Związek Krotkofalowcow  
Radio Club Venezolano

Radio Society of Great Britain  
Rede dos Emissores Portugueses  
Reseau Belge  
Reseau des Emetteurs Français  
South African Radio Relay League  
Suomen Radioamatööriilitto r.y.  
Sveriges Sandreamatörer  
Unión de Radioemisores Españoles  
Union Schweiz Kurzwellen Amateure  
Wireless Institute of Australia

Conducted by Byron H. Goodman

### Calendar:

Most amateurs know that the business of the I.A.R.U. is transacted by means of semi-annual calendars, in which proposals are presented and voted upon, and by special calendars and letters. Calendar No. 17, the June Calendar for 1936, has, at the moment of writing, just been sent out to the officials of the member-societies. It contains several items of universal amateur interest, and we shall, therefore, review it briefly.

As previously reported in this column, the I.A.R.U. had accepted the offer of the A.R.R.L. to send its representatives to the C.C.I.R. meeting at Bucharest in 1937 to act in the name of the I.A.R.U. At the recent Board of Directors meeting of the A.R.R.L., John Stadler, VE2AP of Montreal, Canada, and James J. Lamb, technical editor of *QST*, were selected as the official representatives, and will, therefore, represent the I.A.R.U. at the Bucharest meeting. John Stadler is a prominent Canadian amateur, well-versed technically, and speaks with equal facility English and French, the two languages used at these meetings. James J. Lamb accompanied our secretary to Lisbon in 1934 to attend a similar conference, and enjoys an international reputation among radio men. The I.A.R.U. can well be proud to have such splendid representation as these two men will provide.

A large and unanimous majority voted for the admission into the Union of the Radio Club Venezolano (R.C.V.) as member-society from Venezuela, our twenty-seventh member-society. All members of the society join in welcoming this latest addition to our roster.

Of greatest amateur interest is Proposal No. 23, adopted by a vote of 16 to 2. Under the terms of the new ruling, where the applicant for a WAC

certificate "resides in a country not represented in the Union by a member-society thereof, it shall be necessary for him to pay to the Headquarters society of the Union the sum of 50 cents, in order to receive the award." This nullifies the recently enacted provision that one in a country represented by a member-society could obtain a certificate upon payment of the fee. *It is now necessary to be a member of the society wherever the country is represented in the Union by a member-society.*

Among other items discussed were: a planned use of the 7-mc. band, the stand of the I.A.R.U.

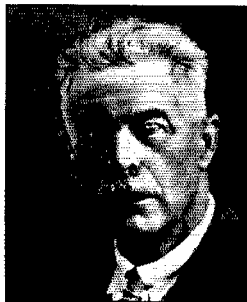

MR. RENE KERSE, ON4GW, NEWLY-ELECTED PRESIDENT OF THE RESEAU BELGE.

at the Cairo Conference, and limiting participation in contests, etc., to society-members only, in line with the feeling that the amateur should support his society as fully as possible if he is to share in its activities.

### B.E.R.U. Contest:

Via radio from G6NJ, we learn the results of the recent B.E.R.U. Contest. In the senior class, VK3EG was high man, followed by VK3MR and

G2ZQ. G2ZQ wins the new Colonel Thomas Trophy as leading English station in the senior class. In the junior class, VK2AE was the winner, closely followed by VU2JP and VK6KZ. The receiving contest was won by BERS195 of Australia. The contest was a big success, entries for both transmitting and receiving contests being 50% greater than during the previous contest. The high spot in the contest was the entry of 8 ZE stations, out of 12 licensed, and the low spot was the total entries from Canada—5! VE3WA, as the leading Canadian station, is being awarded a special certificate.

— . . . —

#### Denmark:

The EDR tells of its proposed addition to the RST system. First it is pointed out that the RST and WRT systems are identical, the numbers in one corresponding exactly to the numbers in the other. They then go on to suggest several additions to the suffixes of the T system, namely:

- C—chirpy
- K—key clicks
- S—spacing wave
- T—tail on each character
- U—unsteady frequency (creep)
- X—crystal-controlled

No formal proposal is made, the suffixes are merely suggested. Whether the system enjoys popular usage or not is, of course, up to the amateur.

The annual convention, held at Kalundborg, was attended by 75 Danish amateurs during the two days of the meeting.

The club transmitter at Copenhagen operates under the call OZ5EDR, and the camp station, located at Fuen, will use the call OZ7EDR.

— . . . —

#### Austria:

Dr. J. L. Tavener, W9GNU, while doing post-graduate work in surgery in Vienna, had the opportunity to meet many of the Austrian amateurs. He persuaded one of them to tell us something of amateur radio in Austria. Fritz Haas, OE1FH, writes: "We first obtained licenses in 1930, and since then licenses could be obtained regularly from the Ministry of Trade and Commerce. Input to the final stage must be limited to 50 watts in all cases, but despite this limitation nearly all of our amateurs are WAC. Crystal control is practically universal, being used so that a good note will be obtained. Receivers are mostly of the O-V-1 or O-V-2 type. All stations are home-made, and many of the components also. Although Vienna has quite a lot of tourist traffic only a few hams seem to come along, and the gang certainly would be delighted to see more of them."

— . . . —

#### QSL Bureaus:

The following addresses should be added to your list of foreign QSL Bureaus:

Canal Zone: John J. Carr, 78th Pursuit Squadron, Albrook Field, Canal Zone.

Irish Free State: W. Howard Coombs, EI6J, "Farnagh," York Road, Dun Laoghaire, Irish Free State.

— . . . —

#### WAC:

From time to time we receive queries asking about the correct procedure in obtaining a WAC (Worked All Continents) certificate. Two certificates are awarded, one for telegraphy and one for telephony. They are awarded to any amateur submitting satisfactory proof to his society that two-way communication has been estab-

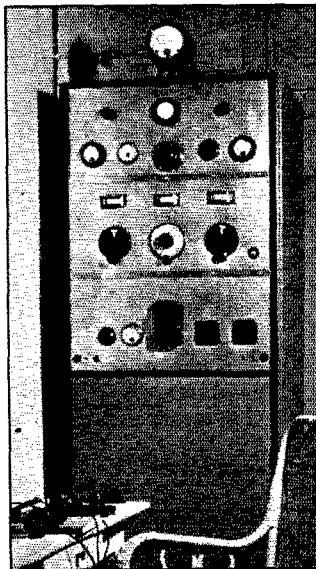

WHERE THE WELL-KNOWN SIGNAL OF FA8BG, ORAN, ALGERIA, GETS ITS START

With this transmitter, using a 211 in the final with 100 watts input, Dr. M. Cassé has made an enviable record on all bands. WAC on 28-mc., his activities are confined to no one band, as demonstrated when he made the first 160 meter Africa-North America contacts last winter with W1BB and W2UK.

lished with a station in each of the six recognized continental areas: North America, South America, Europe, Africa, Asia, and Oceania. QSL cards are generally considered satisfactory evidence, but in the event that a foreign station is worked during a DX contest but doesn't send a card, we will check in his log, if submitted. In countries represented by a member-society of the I.A.R.U., the cards should be sent to the offices of the member-society, and *not* to I.A.R.U. headquarters.

It has been observed by some that a few amateurs use the letters "WAC" on their cards when they do not possess a certificate. While there is no reason why one should not mention the fact on

(Continued on page 68)



# OPERATING NEWS



Conducted by the Communications Department

F. E. Handy, Communications Manager

E. L. Battey, Asst. Communications Manager

**U**NIFORMITY is that quality or state of having always the same form, shape or structure created by custom or etiquette. A form is a prescribed standard, ideal, plan, order, or intrinsic pattern to follow. It is good radio etiquette and productive of time saving in operation for all hams to know thoroughly the most-used Q Code, the common Readability-Strength-Tone (R-S-T) system used by amateurs, and the correct form for handling messages. Lack of complete uniformity and understanding of these things may create serious delays and misunderstandings in the operation of radio circuits. It therefore seems most appropriate at this time, in the interest of improved uniformity, to announce the new standard of A.R.R.L. message form. Full details of this form are given elsewhere in this issue.

This step has been taken only after giving the matter thorough study and consulting the wishes of representative groups of the membership interested in the subject. General understanding of continental code itself, of operator signals, of expressions used in voice or code in receipting for traffic or expressing understanding or getting necessary repeats, requires that *uniformity* be observed. A few hours spent in reading up on operating procedure and in putting the various forms into practice in regular amateur work so that we are entirely familiar with them will repay us a thousand fold both through the improvement in our own communicating abilities, and through the increased respect of other operators. We suggest this.

With the new uniform A.R.R.L.—A.A.R.S order of transmission the various parts of a message are sent in the following order: NUMBER—STATION OF ORIGIN—CHECK—PLACE OF ORIGIN—TIME FILED—DATE—ADDRESS—TEXT—SIGNATURE. It is a good idea to keep this order of listing the parts of a message before us until we are thoroughly familiar with it, to make our work conform to the new accepted standard without delay. New improved A.R.R.L. official message delivery forms carrying this order of precedence of the component message parts are now available, and help in taking down the words in the right order.

Uniformity as we refer to it here is essential, and helpful. We urge the adoption of the new standard preamble at once, with publication of this *QST*.

There is, of course, one type of uniformity that is outside this consideration. We refer to so-called rubber-stamp QSOs. The short "formula" QSO results from habit, or a moronic inability to think or contribute anything broad or useful to a conversation. Insofar as it saves time, even this may have its advantages, because it wastes a minimum of time "for the other fellow." However, we lean to the view that there always is useful information to be exchanged, that a real purpose should exist before one sits down to his operating table to add to the use of the amateur bands. We utilize uniformity in making our characters, in the order of sending parts of a message, in strength scales and Q Codes all for the purpose of increasing our efficiency and understanding, thus saving time *to the end* that this may be usefully employed in transmitting the really worthwhile ideas and thoughts to each other. Uniformity is the tool that enables us to cut down on the time used for non-productive radio efforts, in order that more time may be available for profitable communication.

In our radio contacts we can report on our equipment, discuss the course of our experiments, exchange recorded messages for ourselves and others, develop the personal and fraternal side of our hobby by discussions of our occupations, activities, schedules, the course of technical developments. By operating with useful ends in view toward definitely constructive objectives we improve our service to others, our individual operating ability and increase the enjoyment and values derived from our amateur radio hobby. Only by properly training ourselves in the use of this tool, "uniformity," and applying ourselves with a purpose to the organized development of our communications, both the operating utilization of our frequencies, and experimental side of amateur radio, can we properly justify our individual existence and really derive the social benefits which amateur radio offers in such abundance.

—F. E. H.

Johnny was a little ham,  
His sigs were ruff and raw;  
The R.I. heard and did his stuff,  
Dit-Dit-Dit-Daw-Dit-Daw!!

—T9X, Saskatoon Amateur Radio Club.

The winner of the Sweepstakes award in the Northern Minnesota Section (undecided at the time July *QST* went to press) is W9DNY with 15,120 points. The highest scoring operator at W9PUC made 11,352 points.

# The D ASD's Jubilee DX-Contest, August, 1936

## All European Stations in "DJDC" Will Look for All Overseas Amateurs

By Werner Slawky,\* D4BUF

THE idea of the contest is to contact as many amateur stations as possible, and exchange a six-cipher serial number. Send logs in the form shown to the D.A.S.D. showing exchanges. Advance entry is not required.

**Time:** The Contest takes place during the five weekends of August 1936, from 0000 GMT Saturday and running to 2400 GMT Sunday.

**Frequency bands:** All amateur frequency bands may be used. (German amateurs are not licensed for 1.75 and 56 mc.)

**Contest QSOs:** The call for contest QSOs will be CQ DJDC de. . . . An oversea amateur who wishes to work with Germany directly may call CQ D de. . . . In every contact between the participating stations the reception report and a six-cipher serial number similar to those in previous contests must be exchanged. In making up six-numeral groups, choose the first three as you like. Use these unchanged during the whole contest. Add three zeros to the group sent on the first QSO. On the following QSOs add to the first three figures (your own number) the first three of the serial number you have received on the last contact. Contest QSOs may take place only once between the same stations during each weekend and on each amateur band.

**Report-QSOs:** The D.A.S.D. wants reports of contest progress from amateurs outside Germany. These reports also count heavily in the score. "Report" or QTC-contacts are between stations outside Germany, oversea as well as European, and German amateurs. The station outside Germany sends as many reports to its German partner as it has worked Contest QSOs apropos the contest. The German station must receipt for (QSL) these reports. Such contacts are not handled as "Contest QSOs." The call for QTC traffic has to be: CQ D QTC de. . . . German stations which wish to work QTC traffic, call QTC de D. . . . Each individual Contest QSO can be reported to Germany only once. As many reports may be sent to the German station as are available at one time. Schedules may be arranged with any D station as often as liked during a weekend. Each QTC-report must have a Contest QSO (Europe-Overseas) as its text. The reports to D's must include the call of the station worked with a contest exchange, the local time of QSO, and the serial number received.

Example: W8HD sends three reports originating from contest QSOs with G6CL, F8RJ and CT1AH. (Assume contact with D4BIU following "CQ D QTC de W8HD"):  
D4BIU de W8HD = hr qtc =  
G 8 CL 0935/123 456 =  
F 8 RJ 1245/432 678 =  
CT 1 AH 2356/987 345 = ok? +

According to the above W8HD has worked (on any day of the contest) G6CL at 0935 EST, receipting for serial number 123 456. The same scheme is used for the other reports. D4BIU acknowledges (QSLs) by sending "3 QTC ok +." In the same way other European stations report their contacts with oversea hams to German amateurs.

**Summary:** At times when oversea amateurs find conditions good for working Germany, they report contest work with European stations outside Germany in the form of QTC to Germany.

\* Deutscher Amateur Sende Dienst, Contest Manager, Berlin-Dahlem, Schweinfurthstr. 78, Germany.

**Scoring:** The scoring of the Contest QSOs as well as QTC-Traffic is done by points. There are for Contest QSOs between:

Germany and Oversea: 4 points for each 1000 km. between capitals of contacting countries.

Europe and Oversea: 1 point for each 1000 km. between capitals of contacting countries.

For each report during any QTC-contact:

Europe-Germany QTC 12 points each report.

Oversea-Germany QTC 6 points each report multiplied by each 1000 km. distance between capitals.

The sum of all points, multiplied by the number of German districts worked in QTC or Contest QSOs give the final score. There are 19 German districts, see the last letter of German calls: a, b, c, d, f, g, h, i, j, k, l, m, n, o, p, r, t, u, v (I. e D4BAF, D4ARR, D4BIU, D4KPL etc.)

**Awards:** Amateurs of each country compete among themselves. All participants get an artistic verification card of their cooperation in the German Jubilee DX-Contest 1936 and the issue of the magazine CQ-MB in which the results are published. The competitors of each country with the highest score get an artistic diploma. If there are more than 5 competitors in one country, three awards are given. (In U. S. A., Canada, and Australia, each licensing area is counted as a "country"). The participant is the operator,



**LOG**  
**DASD Jubilee DX-Contest 1936**  
A contest apropos of the Olympiade in Germany and  
the tenth anniversary of the DASD  
**"DJDC"**

Final score: \_\_\_\_\_ points

Prefix: \_\_\_\_\_

Call: \_\_\_\_\_ Name, Address: \_\_\_\_\_

Input: \_\_\_\_\_

RX: \_\_\_\_\_

German Districts worked:

Date	Stn wkd	W	R	T	Time local	Serial number sent	Serial number received	Distance (miles/km)	Points claimed	In QTC were reported contacts with
9. 8. 36	G6 CL	526	576	452	12:15	587 124	171 456	8	8	Examples G6 CL 0935/123456 F 8 RJ 1245/432678 CT 1 AH 2356/987345
10. 8. 36	CT 1 AH	526	568	526	12:15	587 124	171 456	8	8	
15. 8. 36	D 4 BIU	526	568	526	12:15	587 124	171 456	8	8	

not the station. If a station has more than one operator, each must submit his own log.

**Log:** All contacts claimed for scoring must be entered in a Log, which shall be similar to the form shown. Date, Time, Frequency band, stations worked in Contest QSOs, report (W-R-T or R-S-T) and serial number sent and received must be shown. For QTC-Traffic, there must be entered: Call of the German station which received the reports, what and how many reports, date; time and frequency band. At the top of the log, the name and address of the competitor, his input and final score must be given.

The log must be in possession of the D.A.S.D. HQ not later than November 30, 1936. Our contest is held at the time of the Olympic Games commemorating the 10th anniversary of the D.A.S.D. and all hams are cordially invited to take part.

Bill Stull, operator at W3CXL, had quite a night of three-way QSO's on June 21st, with the following hook-ups: W2BMX-W3BPT-W3CXL; W8UW-W9ABE-W3CXL; W9SPB-W8HIN-W3CXL.

The article by Mr. Fred C. Allen, VE3SA-2MA, wins C.D. article contest prize this month. Each month we print the most interesting and valuable article received marked "for the C.D. contest." Contributions may be on any phase of amateur operating or communication activity (DX, phone, traffic, rag-chewing, clubs, fraternalism, etc.) which adds constructively to amateur organization work. Prize winners may select a 1936 Handbook, six logs, six message files, six pads blanks, or equivalent credit toward other A.R.R.L. supplies. Send your contribution today!

—F. E. H.

## Selecting Potential Hams

By Fred C. Allen, \* VE3SA-2MA

**M**OST chaps like to lend a helping hand to the beginner in any line of endeavor, be it plumbing, printing or piano playing—to give him a few tips, teach him a few tricks of the trade that aren't to be learned in school. Radio hams pride themselves in being a little more friendly than most other people; hence a chap desiring to "go on the air" need never lack a little friendly assistance if there be an experienced ham within a few miles of his QRA.

Now I don't like to criticize anybody's good intentions. But it does seem to me that the goodwill stuff can be misdirected, if such a thing be possible. What I mean is the habit some hams have of dragging the most unlikely "would-be's" into the game. You meet these fellows often, chaps who would love to go on the air—if they didn't have to wait to get experience before they could use 'phone; if learning the code weren't such a long, arduous process; if they didn't have to attend so many parties which keep them from their radio work. There are such fellows who make excellent BCLs and SWLs. They like to listen for DX, but their limit so far as learning anything about the technical end of radio is concerned is looking at the pictures in the Handbook—indeed, they even go as far as getting a Handbook. They come around to your shack, taking up perfectly good floor space, asking why their receivers don't work; and you show them the chapter on receivers, tell them to read it over and they'll have no trouble fixing up the receivers. Do they read it? *They do not.* In a week or so they are back, still wondering what is wrong with their receivers. One such chap asked me, when I turned on my regenerative detector and two-step: "Isn't there something you can do about that oscillation?" Sure, this fellow was an expert, who eyed my haywire with pleased condescension. He'd studied radio for years. He'd looked at every picture in all the radio magazines he could lay his hands on, and even learned to read wiring diagrams. He knew all the ops in the town broadcast stations, and bought anything any serviceman told him would work on shortwave.

Now I ask you, do such fellows show any promise whatever of becoming good hams? Have they any indication of possessing the persistence required to become really good operators? Yet, there are hams, enthused with their own hard-won success in ham radio, who will buttonhole one of these chaps, cram the dope down his throat, give him a sales talk every now and then to restore his failing energy, and finally push him thru the exam with much effort. With the result that soon another floppy signal makes its appearance to block the local receivers. Sometimes he may get out of town and cause interference to a lot of other hams too. Now, this sort of thing strikes me as good will overdone. Not so much overdone, perhaps, as misdirected.

I once had the pleasure of introducing two *real* hams to the game. They were school chums of mine who heard I had "my own code station." One day they asked if they might drop in and see my stuff. Having been on the air only a few months myself, I was only too pleased to show them my haywire. As they had never seen any radio station before, even ray roomful of junk impressed them. They wanted the dope on "getting on the air."

I gave them the address of good ole A.R.R.L. and sug-

\* Malartic P.O. via Amos, Quebec, Canada.

gested they get a couple of *Handbooks*. This they did—and, incidentally, they read the *Handbooks*, every word. They learned the code, mostly by listening to their own receivers. Within three months, two new signals—nice ones—were blocking my detector two step. Today, both these boys, hardly yet out of their teens, are fine operators. One, incidentally, now makes his living from radio operating, and still "hams" on the side.

These boys are examples of the type of enthusiasm and persistence that goes to make a really good ham. There is little enough room in the crowded ham bands, surely, just for fellows of this sort alone, without going to the trouble of getting these birds on the air who have to be cajoled, encouraged and pushed at every little difficulty. Yet there are hams, who misdirect laudable goodwill on chaps who never make good amateurs because they haven't the spirit.

I might mention, in conclusion, that I have been in the game for five years—got my ticket when I was fifteen years of age—and the fact in which I take greatest personal pride is that I got on the air "under my own steam," as it were; was on several months before even meeting another amateur personally. Hams were scarce in my town at that time. A copy of *QST* got me started; the *Handbook* gave me all the dope I needed, and a friendly serviceman provided me with most of the necessary second-hand parts to put a fly-power rig on the air. One of the saddest moments of my life was when I flunked in my code speed the first time I tried the exam! It took a long time to get over that, but a few months later I went back and passed—two weeks before my sixteenth birthday.

And I'm no mental prodigy, although perhaps by now you are beginning to think I'm trying to convey that impression. It's not hard to get on the air; it can be done—if you're *genuinely* interested in the good old game. If a fellow is really enthusiastic, he'll get on the air in spite of hell an' high water. Your big trouble would be to keep him off once he got the bug into his head, not to get him on. Those who have the necessary stuff to "learn by listening" will invariably make good amateurs and are really worthy of any help. Individuals who do not have natural aptitude, but interested and dragged into our hobby under pressure may do more harm to the game than good.

## O.B.S.

The following is a supplement to the list of A.R.R.L. Official Broadcasting Stations in November *QST* (page 60): W3BSY, W3EXW, W5AID, W8MMN, W9KEI.

— \* — \* —

## Schooner *Wander Bird*—KMUP

The American schooner-yacht *Wander Bird*, owned and commanded by Captain Warwick M. Tompkins, sailed from Gloucester, Mass., June 26th, on the first leg of a 20,000-mile voyage in the course of which she will round Cape Horn. KMUP is the radio call. Capt. Tompkins will be his own radio operator. The transmitter is a Harvey Type 50S, Model B 50-watter, receiver is an FB7A. The yacht is licensed to work amateurs as well as commercials. A calling frequency of 6210 kc. and a working frequency of 6230 kc. are used. Schedules are maintained at 1115 GCT Monday, Wednesday and Saturday with W1HVV and W8ZZM, and KMUP will look for other amateurs on 7 mc. Schedules are also maintained with W1M/WCC, Chatham, Mass., Wednesdays and Fridays, at 0230 GCT. WCC uses 6320 kc. Amateurs wishing to follow the yacht may listen for her at these times. The *Wander Bird* is an 85-foot ex-Hamburg pilot schooner. Her present voyage will take her around the Horn via the Azores, Madeira, Tenerife, Cadiz, Tangier and Rio. To facilitate the handling of messages, addresses will be designated by numerals; each numeral will represent a certain addressee; a complete list of addressees is on file at A.R.R.L. Headquarters, and any amateur picking up messages from KMUP may deliver them via A.R.R.L., West Hartford, Conn. All amateurs working or hearing the *Wander Bird* are requested to send full details to Headquarters, A.R.R.L., giving position reports when worked or heard, etc.

## DX Notes

In connection with the R.S.G.B.'s WBE award, it is pointed out that for WBE purposes there are only five continents of the world, North and South America counting as a single continent. . . . W1WV recently worked his 500th "G" station—all different, too. . . . W5EIP, Blytheville, Ark., made WAC in 18 hours and 5 minutes (between 7:20 a.m., June 24th, and 1:25 a.m., June 25th); stations were J2KJ PY5AF ON4GW VK4DO FT4AG W9UUM. . . . W9RSO, Webb City, Mo., lists some of the DX (with freqs.) that he has worked in the past few weeks: LY1J 13,998 kc., VQ8AB 14,001, OK2HX 14,004, U1CR 13,997, U1AP 14,401, PY7AA 14,040, K6LEJ 14,020, K6NRF 14,033, SM7YA 14,016, K6KSI 14,025, LU8EN 14,070, D4XCG 13,998, EA8AN 14,001. . . . W5EIP worked VQ8AB on June 12th and 16th, both times at about 9:00 p.m. CST. . . . W8LEC lists some good ones—worked: VP7AA (8LEC's 80th country) approx. 14,420, r.a.c.; VP2DF (Grenada, BWD) 14,440, r.a.c.; VQ4SNB (his first W8 QSO) 14,250, T9; YR5OR 13,980, T9; J2CB 14,300, T9; others: OM2RX 14,200, ES2D 14,400, ES5C 14,300, PK1PK 14,150, YL2BB 14,420, I1Y 14,450, YR5CP 14,275, FB8AG 14,275. . . . W8NQL, Pittsburgh, reports the first W8 contact with ZK1LA, Rarotonga, Cook Islands, on July 1st, 4 p.m. EST. ZK1LA was on about 14,300 kc. using P.P. '03A's with about 300 watts input. His full QTH: Hans Mueller, Rarotonga, Cook Islands. . . .

W3EVT worked FK8AA for his 76th country. . . . W9AFN's countries total 84, W2GVZ 83, W9PST 77, W9PK 75. . . . Low power note: W3BVN was QSO VP7AA on 14 mc. June 8th—VP7AA was using one '01A with 4 watts input; W3BVN using one 112 in Hartley rig with .081 watts. . . . W9TJ, Raymore, Mo., finds Asians plentiful on 14 mc., coming through between 1300 and 1500 GT. Between 2300 and 0300 GT U9's and U6's are consistently heard, W9TJ worked VR4EI (14,415, T9), British Solomon Islands on May 1st at 1215 GT, 103 countries worked is claimed by W9TJ, with QSL's from 92 of that number. . . . KA1AN's asks the East Coast W's to be on the watch for KA's. KA1AN uses 'phone and c.w. on 14,063 and 14,198 kcs. . . . W9FNK offers two suggestions for DXers: (1) That as few W's as possible work between 14,250 and 14,350, since he finds that territory poor for calling and since that is where much DX is heard. (2) To use more judgment in calling DX—shorten calls. . . . W5EBQ reports a contact with J2JJ (14,276 kc., T9X) on June 29th, 2:11 a.m. CST; FBQ was using 24 watts input. . . .

Worked by W6KRI during the DX contest: TF3AG 7 mc., EA8AO 14,010 kc., U3VC 14,300, FB8AD 7200, VO2N 7 mc., I1IR 14,300, PZ1AA 13,990, HAF2L 14,100. . . . W6CUH is now at new QTH in Venice, Calif., at the spot vacated by W6CNX; CNX's antenna systems are being put to good use by CUH. W6CUH reports Europe coming through every evening from 6 p.m. to 1 a.m. PST. He had an hour and a half rag-chew with OK2AK recently, using bugs at both ends. Some new ones for his vicinity are reported by 6CUH: YM4AA 14,000 kc., T9, LA4M 14,080, T9, SP1EJ SP1AO SP1CM, all d.c. about 14,430, SX3A, about 14,390 when last heard. CUH worked CN8AD and J9PA for 108th and 109th countries. J9PA (r.a.c., self-exe., 14,300) is operated by T. Suzuki on the island of Oulai in the Marshall Group. CN8AD is d.c., 14,440. . . . W2IOP worked SX3A, June 20th, and reports his signals T4, frequency shifting between 14,270 and 14,310. . . . ES2D reports his as the second Estonian station to WAC; first was ES7C. ES3YY is a comparatively new ES station. . . . On June 25th at 12:43 p.m. EST W8EQ, Lima, Ohio, worked J2LU—RST 439, 14,295 kcs. . . . In QSO with W1DDL, VQ3FAR gives his correct QTH: J. A. Farrer, Tanganyika Central Gold Mines, Ltd., Skenke via Kin-gangira, Tanganyika. . . . VQ3FAR is in about 14,135 kc., using three-stage c.c. rig with 25 watts input to final—11:00 p.m. EST is the best time for him to work W's. . . . W1DDL reports bagging a rare one, XU1B on about 14,145, T9. . . . J. W. Vizard of London, England, reports hearing W4KA and W3LM working on 14-mc. 'phone at approximately 0130 British Summer Time, June 18th. Both stations were of loud-speaker strength. . . .

## BRASS POUNDERS' LEAGUE

(May 16th-June 15th)

Call	Orto.	Del.	Rel.	Total
W6KFC	65	117	928	1110
W6LLW	18	40	790	848
W6MTP	27	16	716	759
W6LMD	2	23	608	633
W6IMI	98	183	342	623
W6GCF	32	33	543	608
W9AZR	—	—	542	542
W6FDR	64	146	318	528

### MORE-THAN-ONE-OPERATOR STATIONS

Call	Orto.	Del.	Rel.	Total
W5OW	111	73	1106	1290
KAIHR	544	419	176	1139

These stations "make" the B.P.L. with totals of 500 or over. Many "rate" extra credit for one hundred or more deliveries. The following one-operator stations make the B.P.L. for *delivering 100 or more messages*; the number of deliveries is as follows: Deliveries count!

W5MN, 192	W6GHD, 147	W6LQY, 105
W3FTK, 184	W9FSA, 144	W6MYK, 101
W6KNK, 183	W6HRH, 119	

### A.A.R.S. STATIONS

Call	Orto.	Del.	Rel.	Total
WLJJ (W6HIG)	5	7	862	874

### MORE-THAN-ONE-OPERATOR STATIONS

Call	Orto.	Del.	Rel.	Total
WLM (W3CXL)	150	130	1909	2189
WLMT (W6GXM)	97	233	868	1198

A total of 500 or more, or just 100 or more deliveries will put you in line for a place in the B.P.L.

## Hams Afloat

NY1AB, W9CIW and W6BLZ are on the U.S.S. *Pensacola*. W1AVT is operating on the oil tanker *Sylvan Arrow*, W8CX, W5DZL is on the S.S. *Brazos*, WHCB, plying between New York, Miami, Key West and Galveston. W5DXW is on the S.S. *Wm. N. Page*, WFOO, running between New York, Boston, Wilmington and Galveston. Oper-



ROANOKE DIVISION OFFICIALS SNAPPED AT A RECENT GET-TOGETHER

Left to right: W4DW, Director; W3ZA, Alternate Director; W8KKG, S.C.M., West Virginia; W3UVA, S.C.M., Virginia.

ating for the U. S. Bureau of Fisheries are W7BTW on the *Scoter*, W7BHL on the *Eider* and W7DHR on the *Teal*; these three boats will be in Alaskan waters until October, when they return to Seattle. W9AAR is operator on the S.S. *North American*, WTBA, on the Great Lakes. Also on the Lakes is W8CEU/W9SOS aboard W8DC, the S.S. *Samuel Mitchell*. W6GW is on the S.S. *Chiriqui*, W6EJA on the *H.F. Alexander*. Behind the Telefunken 1/2-kw. rig on KXOE, the S.S. *Severance*, is W9PNO. W8FFK is now operating on the S.S. *Colonel*, WDDS; the rig uses four 211's. W7CPK is operator on the S.S. *North King*, sailing monthly from Bellingham, Wash., to S. W. Alaska. W8BPE is RA13C aboard the U.S.S. *Indianapolis*, leaving for China in the fall.

## OBSERVERS' HONOR ROLL

### Cairo Commercial Occupancy Survey For June 1936

6000-8000 kcs.			
M. Vauthier	W6CPM	O. D. Shelley	W9WKO
W9CHH	W6ITK	W3FEW	F3IW
W9OM	W6LCY	W8FEF	F8JD
F8RM	W6UP	W9LEB	F8TJ
W8APQ	W9EFK	F3AI	REF2150
W. R. Fairies	VE3SG	W2DBQ	VE3TH
W8NQ	W6JMG	W3FLD	VE3ZE
W6JLR	W7EHT	W6MHH	P. L. Randolph
W2CSH	W7FDZ	W6MOQ	Ernest Reith
F8KQ	W800W	W9SJK	
4000-4500 kcs.			
W1ABG	W3EQP	W6JMG	W8NQ
W7AAN-W7DRF	W6JLR	W6UP	VE2KM

### August Hamfests

The South Hills Brass Pounders and Modulators of Pittsburgh will hold their annual Hamfest Sunday, August 2d, at Clatty's Driving Range, Bower Hill Road, Mt. Lebanon, Pittsburgh, Pa. All radio amateurs residing in the Tri-State district are invited. Tickets are 75¢ and may be obtained from any ham supply house in that area. Interesting events, prizes (and plenty of 'em) and a good feed comprise the program. If you were among the 500 present last year, you won't want to miss it—if you missed it last year, don't let history repeat itself!!

The Fourth Annual WIMU Hamfest will be held at Jenny Lake near Moose, Wyo., on August 8th-9th-10th. This annual affair provides a meeting place for amateurs of the Rocky Mountain region, WIMU being made up of the first letters of Wyoming, Idaho, Montana and Utah. However, amateurs from states other than these are welcome, and the roster of past years has included guests from Nebraska, Iowa, Colorado and Washington. Jenny Lake is situated at the foot of the Teton Mountains in the Teton National Park. Nearly all who attend the meeting come prepared to camp, and a section of the park is set aside each year for the WIMU amateurs. There is little formality connected with this hamfest, its primary purpose being to renew old acquaintances, discuss all phases of amateur radio and to enjoy an outing amid scenery as beautiful as any in the world. Any licensed amateur is invited to attend and should feel free to bring his family; entertainment is provided for the ladies and children. Further details may be obtained from K. L. Long, W7BXS, or from Arty Clark, W6GQC

The Annual Picnic/Hamfest of the Marin Radio Amateurs will be held August 23d at McNear Beach, out of San Rafael, Calif. There will be a fine list of prizes and exhibits of radio equipment. Bring your lunch, bathing suit and baseball gear. There are plenty of hills for ultra-high operation. Teams from Marin, San Francisco and Oakland clubs will play a soft ball baseball series to determine the "champeens" of the Bay Area. The Director and Alternate will umpire. Come as early as you like and stay as long as you want, but if you're not interested in having a good time, stay home! BCNU—W6SG, SCM.

### Briefs

Ted R. McElroy, code speed champion, is now licensed as W1JYN.

VEIIN, station of the Bowdoin-Kent's Island Expedition, is on the air again this summer using all amateur bands above 28-mc., mostly 3.9- and 14-mc. 'phone. The scientific objectives of the expedition include a study of Meteorology, Ornithology, Biology, Geology and intensive surveying operations. Magnetic disturbances near the Island will also be investigated.

### New O.R.S., Welcome!

The field organization welcomes 102 new Official Relay Station appointees, all received into the ranks of "reliables" since the last roster appeared in *QST*. We had hoped to present a reproduction of the W4NC-Trophy for which every O.R.S. will be eligible, this to be awarded in a 1936-1937 season competition to start soon. We'll try to have full information on this for next month. All new O.R.S. will of course get details via the O.R.S. Bulletin sent at regular intervals from A.R.R.L. Headquarters. All interested and qualified hams are invited to drop a card to their S.C.M. (address in front of each *QST*) or direct to A.R.R.L. Hq. for details on O.R.S. appointment, and application blank for same. Take steps now to be eligible for the several activities and plans, competitions, etc., for the coming season. Sample bulletin also sent on request.

To the new O.R.S. listed herewith, we call special attention this month to the change in A.R.R.L. message form, and "extra count" for deliveries of messages by external means ('phone, messenger, mail etc.) which is detailed elsewhere in this issue:

W1HOW	W2CGG	W4DMQ	W7CEG	W9OTR
W1FSV	W2HRS	W5FLY	W8FFK	W9VQT
W1DCW	W2IHT	W5FDW	W8NNC	W9STQ
W1ISM	W2IQM	W5EDY	W8ONK	W9EBX
W1AKS	W3DQB	W5FJY	W8JKO	W9TQD
W1JTD	W3FOS	W5BAM	W8LJX	W9SJK
W1INF	W3ARV	W5EES	W8LWD	W9AQD
W1IOR	W3EWJ	W5DBR	W8MRQ	W9VOD
W1JSK	W3EEQ	W6DWP	W8PBL-ANU	W9CFU
W1LEZ	W3FBL	W6MXE	W8AME	W9PGV
W2FLD	W3GFM	W6ITH	W8KUN	W9VQN
W2EXR	W3EXW	W6NDF	W8ECI	W9WAJ
W2HCO	W3FSP	W6MYK	W8NDE	W9ARH
W2HGO	W3AMR	W6MYI	W8MIW	W9VES
W2IAP	W3BSY	W6MUR	W8NIV	KA1DS
W2BNZ	W3CES	W6FS	W8KBU	VE1EV
W2HQL	W3WS	W7CZX	W9UHT	VE3TM
W2HLX	W4AEL	W7CSC	W9HEO	VE3KH
W2ICJ	W4CTM	W7FCM	W9ACB	VE5DD
W21ZU	W4LN	W7FLA	W9DCM	VE5EO
	W4DJP		W9IGZ	

### Official 'Phones Appointed

Cordial welcome is also extended to 51 new O.P.S. appointed since the last official A.R.R.L. station listings appeared in *QST*. Quarterly station tests for July, October, January and April are announced for Official 'Phone Stations in the bulletins issued to the A.R.R.L. 'phone organization of O.P.S. in these months. Also there will soon be news of plans for the coming season of activities, and a competition based on experimental and operating factors determined by the leaders of this progressive and advancing group. If you have a good 'phone (readers not now O.P.S.) why not drop a line to your S.C.M. for details, application form and sample bulletin which can be sent from Hq. as long as extra copies last.

#### New additions to the O.P.S. group:

W1CEA	W3BRZ	W5FPO	W8JLQ	VE3NC
W1HJR	W3NF	W5AID	W8CGU	VE3AEV
W2CBO	W3U	W5EKP	W9SDQ	VE3KM
W2GYI	W3BSY	W5BHO	W9OOY	VE3TM
W2DKA	W3EXW	W6CSX	W9UJZ	VE4GM
W2FFY	W4CJP	W6GZU	W9EYV	VE4JJ
W2IDZ	W4CXO	W6LFZ	W9PNV	VE4LA
W2BTZ	W4LN	W6ETX	W9SYJ	VE4EO
W2APV	W4CBS	W7CPY	W9IYA	VE4CY
W3BIR	W5CYQ	W8LIG	KA1AN	VE5DD
		W8CDR		

### ELECTION NOTICES

To all A.R.R.L. Members residing in the Sections listed below: (The list gives the Sections, closing date for receipt of nominating petitions for Section Manager, the name of the present incumbent and the date of expiration of his term of office.) This notice supersedes previous notices. In cases where no valid nominating petitions have been received from A.R.R.L. members residing in the different Sections in response to our previous notices, the closing dates for receipt of nominating petitions are set ahead to the dates given herewith. In the absence of nominating petitions from Members of a Section, the incumbent continues to hold his official position and carry on the work of the Section subject, of course, to the filing of proper nominating petitions and the holding of an election by ballot or as may be necessary. Petitions must be in Hartford on or before noon of the dates specified.



Due to a resignation in the New Hampshire Section nominating petitions are hereby solicited for the office of Section Communications Manager in this Section, and the closing date for receipt of nominations at A.R.R.L. Headquarters is herewith specified as noon, Monday, August 17, 1936.

Section	Closing Date	Present SCM	Present Term of Office Ends
Indiana	July 10, 1936	Arthur L. Braun	July 19, 1936
Eastern	Aug. 3, 1936	Phillip A. McMasters	Aug. 15, 1936
Florida			
Santa Clara Valley	3, 1936	Charles J. Camp	Aug. 15, 1936
Iowa	Aug. 17, 1936	Phil D. Boardman	June 14, 1936
Nebraska	Aug. 17, 1936	S. C. Wallace	July 1, 1936
Philippines	Aug. 17, 1936	N. F. Thompson	Mar. 15, 1936
Hawaii	Aug. 17, 1936	Atins O. Adams	Apr. 23, 1936
Oklahoma	Aug. 17, 1936	Carter L. Simpson	Feb. 15, 1936
Western	Aug. 17, 1936	Percy C. Noble	July 6, 1936
Mass.			
New Hamp-shire	Aug. 17, 1936	Robert Byron (resigned)	.....
Kentucky	Sept. 1, 1936	G. W. Mossbarger	Sept. 8, 1936
Mississippi	Sept. 1, 1936	J. H. Weems, Jr.	Sept. 6, 1936
Tennessee	Oct. 1, 1936	Merrill B. Parker, Jr.	Oct. 14, 1936
Kansas	Oct. 1, 1936	O. J. Spetter	Oct. 15, 1936

\* In Canadian Sections nominating petitions for Section Managers must be addressed to Canadian General Manager, Alex Reid, 169 Logan Ave., St. Lambert, Quebec. To be valid such petitions must be filed with him on or before the closing dates named.

1. You are hereby notified that an election for an A.R.R.L. Section Communications Manager for the next two year term of office is about to be held in each of these Sections in accordance with the provisions of By-Laws 5, 6, 7, and 8.

2. The elections will take place in the different Sections immediately after the closing date for receipt of nominating petitions as given opposite the different Sections. The Ballots mailed from Headquarters will list the names of all eligible candidates nominated for the position by A.R.R.L. members residing in the Sections concerned. Ballots will be mailed to members as of the closing dates specified above, for receipt of nominating petitions.

3. Nominating petitions from the Sections named are hereby solicited. Five or more A.R.R.L. members residing in any Section have the privilege of nominating any member of the League as candidate for Section Manager. The following form for nomination is suggested:

(Place and date)

Communications Manager, A. R. R. L.,  
38 La Salle Road, West Hartford, Conn.

We, the undersigned members of the A.R.R.L. residing in the ..... Section of the ..... Division hereby nominate ..... as candidate for Section Communications Manager for this Section for the next two-year term of office.

(Five or more signatures of A.R.R.L. members are required.)  
The candidates and five or more signers must be League members in good standing or the petition will be thrown out as invalid. The complete name, address, and station call of the candidate should be included. Such petitions must be filed at the headquarters office of the League in West Hartford, Conn., by noon of the closing date given for receipt of nominating petitions. There is no limit to the number of petitions that may be filed, but no member shall sign more than one such petition.

4. Members are urged to take initiative immediately, filing petitions for the officials for each Section listed above. This is your opportunity to put the man of your choice in office to carry on the work of the organization in this Section.

—F. E. Handy, Communications Manager

### ELECTION RESULTS

Valid petitions nominating a single candidate as Section Manager were filed in a number of Sections, as provided in our Constitution and By-Laws, electing the following officials, the term of office starting on the date given.

Utah-Wyoming Townsend J. Rigby, W7COH June 15, 1936

In the South Dakota Section of the Dakota Division Mr. Andrew J. Kjar, W8SER, Mr. Walter B. Beeler, W9CFU, and Mr. Lee C. Campbell, W9PQV, were nominated. Mr. Kjar received 22 votes, Mr. Beeler received 19 votes and Mr. Campbell received 16 votes. Mr. Kjar's term of office began May 18, 1936.

In the Los Angeles Section of the Southwestern Division Mr. Don M. Draper, W6GXM, and Mr. Donald F. Wilson, W61IK, were nominated. Mr. Draper received 202 votes and Mr. Wilson received 73 votes. Mr. Draper's term of office began July 1, 1936.

## Station Activities

### CANADA

#### MARITIME DIVISION

MARITIME—SCM, A. M. Crowell, VE1DQ—VE1HJ, together with JM and GL, went to the country for Field Day and had a swell time at Upper Sackville. ER shoots in some Halifax traffic. GL has new job with C.P. FLASH—It's a boy at EK's! New station: JQ. EA has a few African reports on his work in G 1.75-mc. tests. FE made a nice contact with Trinidad, making four continents. EX is

straining the ether for more new countries. IW is active on all bands including 1.75-mc. 'phone. DW's 10-watt rig sounds like a 100-watter. GD says his antenna is N.G. but he still gets the R9 reports. BT schedules BC at Halifax—the "hamfest" mike still sounds nice. DO runs his '10's on 'phone (series mod.) with 800 volts at 200 ma.—the tens run cool! BK sends in a swell line of information on the Sydney and Glace Bay boys; he's soon going W.A.C. as not long ago he hooked SV1KE. AB talks of building a crystal rig. CC still copies press for CJCB. CR has fine new rig using pair of HF-200's with band switching from 3.5 to 28 mc.; also has new HRO and ACR-175. DL is going crystal control. DM has new antenna and new receiver perking FB. DR has QSO'd about everything on the old globe on 14 mc. FV is QRL with the Mar. T. and Tel. Co. FW got the ticket endorsed for 14-mc. 'phone. JA is kept busy at the Dom. Coal Co. JE is doing radio repair work in addition to the daily toil at Eastern Light and Power Co. Dope via EV on Moncton gang: EV has new pair of 801's and expects to be on 3.9-mc. 'phone soon. DC was very busy on the Moncton Hamfest. CX went on a trip to Montreal. GI's final fell out of the rack and ruined his '10's. GS is moving to new QTH. FF is building a c.c. transmitter. EL expects to be on shortly from new QTH. IK is busy giving swimming instructions at local Y.W.C.A. DI and LJ visited BO and Fredericton gang for week-end. IL is back on the air from his new QTH at Richibucto with an FB signal. BB is studying hard for Comm. ticket. EY schedules WIAJ and has new ACR136. IA schedules CE on 7 and 3.5 mc. EZ is back on pounding away.

Traffic: VE1HJ 30 ER 50 GL 5 IB 6 HH 10 EY 2.

### ONTARIO DIVISION

ONTARIO—SCM, John Perdue, VE3QK—R.M.'s: 3WX, 3TM, 3QK, 3DU, 3GT, 3SG, 3GG. ABW got back from VE2 convention in time to lead the Section in traffic again. He and YE went down via motorcycle, and on their return it went out of oscillation some 300 miles from home . . . now both have had case of hitch-hikeitis. MB took them in and sent 'em on their way much happier. XS is RK-20ing. GG has turned most of the reins over to KH for the summer and reports for BB, who is rebuilding with '03 intentions. UA drives '52's P.P. self-excited!!! AGM is O.R.S. aspirant with new half-kw. rig. RA has retired to the bush with Commercial ticket. KH chases the OM out of the shack and uses the Brass Hat for a gobboon. FW's 'phone is rated tops at the Lakehead. BV was victim of a clean KO when he worked his first out-of-town station. GS is doing swell job of making life a bit interesting for a shut-in B.C.L. at Port Arthur . . . FB! LY is the only man in the world that has worked all four members of Caveney family: GG, KH, BB, ADZ, and claims W.A.C.! HV has a Collins 32F and an FB7, both being punished by father and son. AJL reports for first time and writes FB letter . . . encore! Letter from Toronto Short Wave Club tells of much activity with club rig which signs JR and is operated by NO, NS, KA, SU, HB, ABV, AFE, AHC, SE, UK, UN, NU and AEE, who make up the complement of the crew at the club located at 338 Sackville St. Letter from Third District (HAM) Picnic and Recreation Committee who held a successful shindig at Queenston Heights with many hams from Toronto, Hamilton, and Buffalo areas in attendance. SA has forsaken us for an indeterminate period to sign VE2MA at Malartic way up in P.Q., via Amos, P.Q. Salaams from NX on the FB letters the gang crashed through with during his convalescence . . . he's back in the line-up again and batting 100%. PL waves a sad farewell and heads for the wide-open spaces to sign VE4TA for the summer . . . we would appreciate reports from anyone hearing or working him in VE3. IB has entered Christie St. Hospital in Toronto for a spell and would like to hear from the gang . . . don't forget him, gang! KM, the pied piper, led his tyros to a hill-top on the escarpment near Waterdown and they made a point apiece, all 864 of 'em during last Field Day. GT and JI dug in somewhere near Alton and did a swell job to the tune of 568 points. The Frontier Club and the S.O.R.A. gang went at it hammer and tongs at spots along the shores of Lake Erie. QB still has plenty cardboard from abroad for VE3 wallpaper. AU is back in Unionville for the summer. 9AL is about to sojourn

at Camp Borden before leaving for Stony Lake and portable 3AL. XX has left 1.75 for 56 mc. after ADO's demonstration. QD would give half his 60 countries for Asia and W.A.C. NC was visited by SY and AEV. SY is moving into Little Britain just two doors away from George. AEM is QRL new rig and worries about trophy he won in VE3 contest. WA has moved QRA and traps and is faced with antenna array aspirations after listening to a dandy lecture by Johnny Krause of W8JT with WX, TM, WJ, QK, ZV, CP, AHK and YL, NQ, BZ, etc., during the Central Division Radiofone Hamfest in Detroit . . . and did Hdqtrs. have the Michigan YL's buckfeverish by sending WISZ along. BY the way, how would an exclusive VE3 Field Day second week-end in September strike you bush whackers? . . . away from home field operation with a prize to boot . . . any seconds? AU bummed a ride west through W8, W9 and W7 (i.e. Yellowstone Park) and visited in Alberta.

Traffic: **VE5ABW** 119 WK 2S AEM-QB 7 PL 12 AU-ZE 6 KM 3 NC 2 AID 1. **VE9AL** 14.

### QUEBEC DIVISION

**QUEBEC**—SCM, Stan Comach, VE2EE—EP is handling traffic; call the R.M. for schedules. 3SA is now located in Malartic, Que., and signs 2MA. Welcome to the Division. II is operating with a single '46. HG is moving to St. Gabriel de Brandon for the summer. FO has moved out to the Lake Shore. BH has been confined to bed. Our best wishes for a speedy recovery are extended to BH and also to IR, who crashed from a motorcycle. FS is experimenting with 28 and 56 mc. IP is pounding on 7 mc. with 200 watts. JG is building. AG is keeping the 3.5-mc. band lively. JY is putting in an RK-20 final. CM, BW, EC, LA, IT and IG are holding schedules on 3.9-mc. 'phone. DN, the official station of the Club Canadiens Français, is on the air consistently. EE has invested in a new receiver. IQ has completely recovered. IJ is building a Super-Gainer with frills on it. IY has landed a job at last. FU and BP have left for Labrador. KA has a crystal right on top of G5NI. HK is hoping that his neighbors will have no key klix. AP has been chosen to go with the North American contingent to Bucharest. DA moved into the country for the summer. DX still schedules his Toronto station, 3AHW. FG received certificate for winning the SS Contest. EE received W.A.S. certificate. FI is operating in the North country. HM is now operating at his new address. IE has erected skyhooks on Victoria Ave., a nice location. IL has gone crystal control. KO is the new call of an old-timer. LV is rebuilding in rack and panel. LJ is building to higher power. LN has left us to return to Nassau; VP7NA will be heard again. DM has at last got rid of that T's signal, one condenser too much. Another YL appears on the air, the call is KZ. Welcome. Bill Stephen of LC is back with us working 7 and 14 mc. BG and GA are having lots of fun on 56 mc. 4NI and the YF were down for the Convention. EW is thinking of trying a 6L6 oscillator. W1ACV and W1APA ask us to extend their thanks to the boys who gave them such an FB time at the Convention. The S.C.M.'s thanks to AG for his contribution to this column. Have we any more Winchells among the gang? Do your bit and send in news.

Traffic: **VE2II** 91 DR 83 BU 30 EC 38 EP 4 EE 10.

### VANALTA DIVISION

**ALBERTA**—SCM, Alfred D. Kettenbach, VE4LX—GD has his W.A.C. certificate. Congrats, Jim. SW is on 'phone with fine new rig using P.P. tens in final. EA has new crystal mike. BW has new 'phone rig. HT is heard on 3.9- and 14-mc. 'phone. IN has moved to new QTH at Vulcan. LA is on 'phone at new QTH at Strathmore. JJ has FB new rig. AA is trying 14-mc. c.w. OF and CY are looking for an African to complete W.A.C. JK is on 14-mc. 'phone daily. TA is heading south on Geological Survey. ABM and ACS are new Southern Alberta hams. 3PL is operating portable 4TA in this Section. OF does lots of work on 14-mc. antennas. VN is still hunting DX; W7ABT paid Calgary hams a short visit. BZ is back home and on trunk line after extended trip East.

Traffic: **VE4LX** 24 QK 8 GE-WX 6 EO 4.

**BRITISH COLUMBIA**—SCM, Don Vaughan-Smith, VE6EP—Plans are being pushed for the Great Golden Jubi-

lee Convention for the Vanalta Division to be held in Vancouver, B. C., Aug. 29th and 30th. First-class speakers have arranged to be on deck, lots of prizes to be won, and a cruise and picnic are only some of the features that will make this an outstanding event in amateur radio. Visitors will be welcomed and every arrangement is being made to give everyone the time of his life. The B.C.A.R.A. is installing a booth at the Vancouver Exhibition as well as entering a float in the big parade. The New Westminster Club and the Royal City Amateur Radio Club have applied for affiliation with the B.C.A.R.A. and plan an active and useful season. Victoria Club is very busy getting a lot for its new club house. FG shoots in nice total via HP, who has found ideas for a pair of 150T's. CH got back on the air and promptly blew plate transformer! PT sends solemn promise of T9 from new plate. OA and MR within the Arctic Circle are QRL with new 1/2-kw. crystal rig. JY applied for O.R.S. GI, new B.E.R.U. appointee, handled birthday message to the King. GF has new super! NL, club president, is going sniggle-sniggle! GX is on at new QRA. BJ had swell time entertaining flock of VE4's. IA's chief bane is trying to modulate 75 watts, Class B. Our YL, NG, handled another message! SI is YL at Cranbrook. RS got his rig going but now needs antenna. OT had nice time in W7 and worked Vancouver gang. OK is blowing rectifiers with new transformer and his pal PI was QRT'd by bug in rig. DV turned in nice total from Victoria. DD reports T.L. "F" closed down for summer. EP finds his job interferes with schedules. 9AJ now boasts an RK20.

Traffic: **VE5GI** 11 ND 2 EO 15 FG 29 OK 8 JY 3 BJ 4 KA 2 IA 4 DV 24 PT 11.

### PRAIRIE DIVISION

**MANITOBA**—SCM, A. J. R. Simpson, VE4BG—The Trunk Line will be inoperative for the next few months, and AG can now take a well-earned rest with the fishing reel after many months of faithful service. 'Phone station IP is busy putting in a half-wave vertical, new pre-amplifier in the modulator and building a super. BQ is working plenty of DX. DU is kept busy at the local broadcasting station. GC is away on a vacation to Toronto. QF is down South visiting the W5's. GQ's 14-mc. 'phone sounds very FB. KX installed a 53 crystal stage in place of the old '47. LH has a pair of 242A's which will be heard from shortly. LL is having trouble exciting his 211. MV has to spend all his time at the shop. NI returned after a trip to Montreal. NM is putting out an FB 'phone signal on 14 mc. RO has a pair of '52's in his second transmitter. SS is now connected with CKY and finds his 56-mc. experience useful. MY is back from Kenora and heard on 14- and 3.9-mc. 'phone. EK has an RME69 receiver. The M.W.E.A. is planning a hamfest near Winnipeg in the next few weeks. Your S.C.M. would appreciate to continue receiving reports from the gang even though summer is here.

Traffic: **VE4AG** 72 IP 25.

**SASKATCHEWAN**—SCM, Wilfred Skaife, VE4EL—CM has nearly finished 14-mc. 'phone with Class B modulation. QD, Ernie Strong, is on again at 3550 kc. after many years' absence. KY gets FB results on 1.75-mc. 'phone. FW worked K6's four nights in a row on 14 mc. with one on 'phone, and has nearly completed his W.A.S. UL visited YC. AT is back on the air. UD won 211 at hamfest, but VZ took it home. QS' rig is 53-53 RK20-P.P. '52's. TN has new super à la Skyriver perking FB. RB is on 3.9-mc. 'phone. MB's skywire bit the dust (melted) shortly after QSO and R8 report from a VK. RJ contemplated an ACR-175. BF is back from States and rebuilding. MA and YX work out FB on 14-mc. 'phone. XB is building for c.c. QZ hooks K6's and VK's on 14 mc. UC and UD are on 14 mc. PQ with his ultra flea-power had a bad heart attack when his signal sneaked off the continent and bagged a VK on 7 mc. AAA, the S.A.R.C. portable, joined in A.R.R.L. Field Day and scored 90; rig is 42-6A6 final, 8 watts input. OR is back in Regina. ML wants car for R.C.A. 12-tube Victor. XM changed QTH. VR has left Regina. ABS is back. ABR is going strong. EL is rebuilding. BR is building '47 crystal-'46-'46-'10. KV gets FB results with '45 P.P. TNT-'46 P.P. final. KB has '45 P.P.-'10 P.P. final. KR is building 2A5-'10-'10 P.P. final.

Traffic: **VE4FW** 14 QZ 8 PQ 7 EL 6 QD-MB 2 KJ 1.

(Continued on page 76)



# CORRESPONDENCE

The Publishers of QST assume no responsibility for statements made herein by correspondents

## W8FRC Vindicated

315 Lafayette Ave., Brooklyn, N. Y.  
Editor, QST:

I received a letter from the Governor's office at Harrisburg telling me that their investigation found me "not guilty" of the charges placed against me by Mayor Shields and the press.

Of course we expected that, but we still await an apology from "Hizzoner." We don't expect that, so I guess our little case is past history.

Your work in my behalf will never be forgotten. Your efforts not only helped me but every ham in the U. S. . . .

—Gerald D. Coleman, W8FRC

EDITOR'S NOTE.—The letter, signed by Robert L. Myers, Jr., secretary to Governor Earle, reads:

"As you are aware, the Governor some time ago instructed Attorney General Charles J. Margiotti to investigate charges that you had precipitated a panic in the City of Johnstown on March 18, 1936, by broadcasting over station W8FRC a statement that the Quemahoning Dam had broken.

"The Governor stated that if such charges were true your broadcast was indefensible and appropriate legal action should be taken.

"Findings of fact have been submitted by Deputy Attorney General Thomas Bender and on the basis of these findings the Attorney General has reported to the Governor that there is no evidence which would justify prosecution.

"Since the Attorney General's report absolves you of blame in this matter, I am very happy to inform you that so far as this office is concerned the case is closed."

All credit to Dr. J. P. Vancheri, W8BWH, who was instrumental in securing the Governor's investigation absolving Coleman.

Chester, Mont.

Editor, QST:

I read your splendid article in the May issue of QST, concerning this spring's great Eastern floods. What interested me most of all was the "battle" between W8FRC and the Mayor of Johnstown, Pa.

I believe such "fights" are absolutely unnecessary and am suggesting the following—a "Treaty of Peace."

Every amateur should visit his local Mayor, Police Department, telephone office, and any

other public office of responsibility, and outline capabilities and past emergency performances of amateur radio. He should offer his time and equipment for use when such emergencies exist and should receive in return the whole-hearted support and respect of the community itself.

This procedure will save a lot of time and embarrassment. Let's give the amateurs a better local and national standing with the public.

—Alex G. Keldrank, W7FSQ

EDITOR'S NOTE.—Such procedure is a part of the specific activity in which A.R.R.L. Emergency Corps stations are instructed. Amateurs possessing emergency-powered equipment should join this Corps; those others who are interested should join its auxiliary. Write the A.R.R.L. Communications Manager. All amateurs everywhere should take advantage of every opportunity to build amateur radio prestige by personal contacts and general publicity; on such prestige will largely depend our continued existence as a service.

## Resonant-Pipe Length

Stromberg-Carlson Telephone Mfg. Co.,  
Rochester, N. Y.

Editor, QST:

In the article on page 64 of your May issue entitled, "A Resonant Loud-Speaker for C.W. Reception," the graph of pipe lengths appears to be fundamentally in error in that the primary resonance is indicated as occurring when the tube is a quarter-wavelength long, whereas it actually occurs at the half-wavelength in a tube driven by a piston at one end and open at the other. (It is assumed that this is the condition described in the article, which does not state specifically that the undriven end of the tube is open, although the latter must be the case if sound is to be radiated.)

The theory of the piston-driven tube as given in Crandall's *Theory of Vibrating Systems and Sound*, page 100, shows that at the frequency corresponding to a quarter-wavelength an anti-resonance occurs and the acoustic driving-point impedance rises to a value limited only by dissipation in the system. Under usual conditions, the velocity of the piston is thus reduced and little sound is radiated from the open end. At the first half-wavelength, however, the (usually low) impedance at the open end is transferred bodily to the driving-point, the tube itself contributes

no reactance to the system, and the air at the open end is driven as if directly by the piston; the latter, in the usual case, vibrates at higher velocity and sound radiation is at a maximum. The anti-resonances are repeated, as the frequency rises, when the tube length is an odd number of quarter-wavelengths, and the resonances recur when the tube length corresponds to any integral number of half-wavelengths. In the course of a study dealing with the back-radiation of loudspeakers, the writer recently demonstrated the above theory by acoustic impedance measurements.

It seems probable that the author of the article has confused the case in hand with that of a pipe closed at one end and driven at the open end, as is the familiar stopped organ pipe; and to the latter condition his graph correctly applies. This condition could be realized in a device of the type described by closing one end of the pipe and coupling the other end loosely to the loudspeaker by leaving a gap between the two. It would appear, however, that a resonator of the Helmholtz type employed in this manner at its fundamental frequency would be superior to a pipe because the response of the former to its harmonic frequencies is weaker than that of the latter.

In the light of existing theory, the results described in the article can be explained only by assuming that the pipe was operated at one of its half-wavelength resonances and the author was mistaken as to the frequency. Incidentally, the graph may be made to apply correctly to the case he describes by doubling the indicated pipe lengths.

—B. Olney, *Acoustical Engineer*

## On B.C.L. QRM

255 Bay St., Toronto 2, Ont., Can.

Editor, *QST*:

I have just received the June issue of *QST* and note therein the first editorial about interference from radio-telephone stations with broadcast reception. As a partial answer to your editorial let me give you a recent experience which I had with a neighbor.

Some three months ago I completely rebuilt my transmitter which now consists of a pair of 852 tubes in a final Class-C amplifier modulated Class B by a pair of 805 tubes. The input of these final Class-C tubes is about 450 watts and the modulated current from the pair of 805's runs anywhere up to 300 mills at 1250 volts so you can see that there is a fair power being consumed and presumably emitted into the air. When the station was first put on the air a couple of months ago I fed the output into a 20-meter vertical doublet with a twisted pair transmission line (EO-1 cable). Subsequently this aerial has been changed to a Collins multi-band antenna 137 feet long with two 66-foot copper tube feeders. As soon as I put this transmitter on the air I had a most frenzied squeal out of my neighbor to the back, who was most offensive, adopting practically entirely the attitude of the writer quoted in your editorial except, of course, that he had the additional argument that he paid a license fee for the use of his receiver and that he was entitled to protection from my transmitter.

Immediately upon my hearing of this trouble I turned on my own broadcast receiver, which consisted of a super-heterodyne model of some four years of age, connected to an antenna which crossed the vertical doublet at right angles but the spacing at the closest point being not more than three or four feet from my transmitting antenna. I was able on my own receiver to receive all the usual signals available on the broadcast band without interference from my own transmitter and, in fact, for the satisfaction of the radio inspector I actually rebroadcast from my own transmitter broadcast reception from stations 500 to 1000 miles away.

These tests having been concluded to my satisfaction I was then satisfied that the defect arose from the receiver operated by my neighbor and accused him of having an antique, out-of-date receiver. Judge my pain, therefore, when I was informed by him that he had just bought some month or so before a 14-tube R— receiver complete with metal tubes, short wave, radio-phonograph and all the trimmings. Subsequent tests by the local Radio Inspector with myself disclosed that this receiver was not tuning my

transmitter at all but was receiving it some way on the audio system as the signals were just as loud from my transmitter with all the tubes in the receiver being interfered with taken out as far back as the first audio stage. In other words, some species of shock excitation was being had on the grid of the audio tube which was operating as a detector.

Thinking this might be an isolated case with a defective resistor, a second receiver of the same brand was brought up which gave the same result. Thereupon the dealer brought up a standard all-wave S— receiver, whereupon all interference ceased immediately and it was possible for the receiver to tune in reception at one end of the 20-meter band while I was operating at the other end of the 20-meter band.

The Radio Department here has recently made a ruling that interference with isolated receivers of antique design where other interference is not experienced cannot be used against the amateur. In this case, however, I was interfering with what was presumably an up-to-date receiver with all the latest improvements, whereas, as a matter of fact, obviously it was a receiver with inbuilt interference possibilities. In this case I deliberately said that in view of the fact that reception with other receivers of different make was not interfered with, I did not propose to do anything about the trouble. This caused the broadcast listener to exchange his R— receiver for the S—, and no further complaint has been experienced. No doubt dozens of other cases of interference are experienced where the broadcast listener will not exchange his receiver and yet surely this is a case where it is not the fault of the amateur.

Another matter which I might bring to your attention is the fact that I recently received a somewhat trenchant radiogram from a New Jersey amateur reporting my "harmonic" at 3540 kilocycles. As a matter of fact under Canadian law I am operating at 3528 kilocycles *fundamental* and not harmonic. I would suggest a stray or some other notification in *QST* to the effect that Canadian stations heard operating on 'phone in the band from 3500 to 3550 kilocycles should not be considered as harmonics of the 160-meter band.

—Keith Russell, *VE9AL*

## "Resonant-Filter" Notes

Breen Ave., College Point, L. I., N. Y.

Editor, *QST*:

In reference to Mr. Magee's Letter in June *QST* on r.a.c. sigs, I should certainly like to add a few words to the editor's note. W8CNC endeavors to differentiate between r.a.c. and so-called "resonant filter" notes. A resonant filter, instead of attenuating the ripple passed to it by the rectifier actually increases its amplitude (and generally the strength of the third harmonic also); thus, on the plate of the tube which the supply feeds, the effect is essentially the same as if no filter was used. In fact it is worse, because the ripple is *increased!* This is a direct violation of the adequate-filter ruling. I cannot see at all where Mr. Magee gets the idea that a resonant-filter note causes less QRM than a T9X one. The presence of ripple upon the tube plate implies modulation at the ripple frequency and modulation means side bands, causing the signal to occupy more than one frequency. Particularly if there is a bad second or third harmonic in the ripple wave, we have the signal covering the band to the amount of twice the highest modulation frequency, which is quite a bit in our already over-crowded channels. These notes may have that "distinctive" sound but they certainly indicate lack of respect and downright "hoggishness" on the part of the operator. If W8CNC believes that a resonant-filter QR1 can be copied better than a p.d.c. sig let him try to copy a ship on 600 at seven p.m. with a dozen other i.c.w. signals near the same frequency.

—E. F. Youds

Clarendon, Texas

Editor, *QST*:

... W8CNC's letter made me sore—resonant QR1 better than p.d.c.! They may be beautiful, but they are

(Continued on page 58)

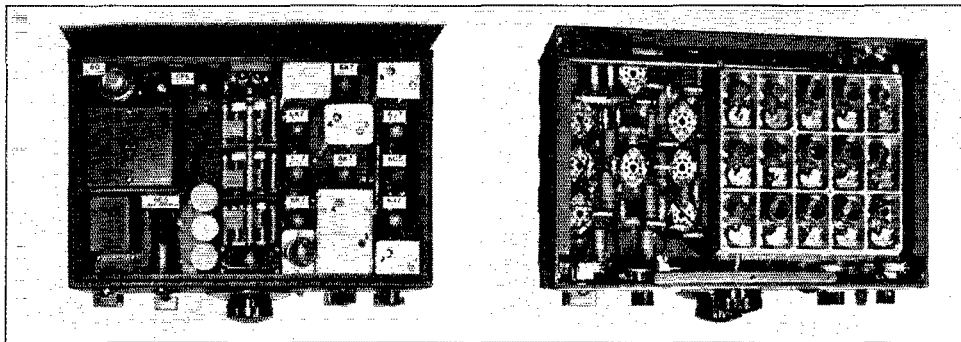

## On Accessibility

There seems to be almost a conspiracy of silence on the part of radio manufacturers when it comes to discussing the servicing of their receivers. Offhand we cannot remember a single advertisement where the subject was even mentioned. The reason for this is obvious. Unthinking customers might interpret any mention of repairs as an admission of weakness. The fact remains, however, that parts like volume controls and switches wear with use just as tubes do, electrolytic condensers deteriorate, and even conservatively rated paper condensers occasionally blow up. And even if a set were proof against normal wear and tear, abnormal operating conditions sometimes impose excessive stresses on individual parts.

So that even if manufacturers coyly ignore the subject, the user often has to face it sooner or later. When this unhappy time arrives, nothing engenders more profanity than an inaccessible repair. Most amateurs will remember having serviced such a receiver at some stage of their careers, where half the parts in the set had to be removed before the socket connection could even be seen, and where an attempt to follow the wiring diagram was almost hopeless because so many of the wires disappeared into tin cans full of pitch, which might contain almost anything.

Other industries have gone through this period, but it is no longer considered quite proper to design automobiles so that the body must be removed from the chassis to change a spark plug. And the modern motoring public regards accessibility as nothing more than good engineering.

We believe that most people realize that accessibility in a radio set is good engineering too. So let's bring the subject out in the open. Like every other manufacturer we hate to admit that our products ever need repairs. We would not dare mention it at all, were it not for the extraordinary reputation for reliability which our receivers have built up. We have consistently tried, for many years, to design our receivers with every feature we thought the amateur really wanted, and accessibility has been one of them. The two photographs on this page will illustrate National design. Both are of the NC-100 ("automatic plug-in coil") Receiver. One is a top view with the hinged cover raised, the other is a bottom view with the bottom cover removed (eight screws) and the cast aluminum coil cover also removed (six screws). Nearly everything is open for inspection and repair. As photographed, the power supply connections are covered by the coil shield, but a spin of the coil shift knob uncovers them.

Next time you purchase a receiver, or advise a friend, *see what you can see*. And if the dealer says "These parts are so good they never need to be replaced!" your answer is "How do you know they are good if you have never seen them?" For on a receiver like the NC-100, there is no gamble. It is an open book, revealing in every detail high quality parts, sturdy construction and fine craftsmanship.

JAMES MILLEN



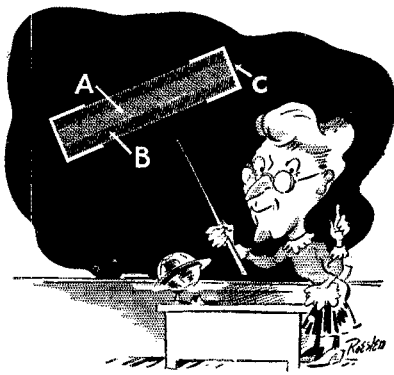

## The "ABC" of Sturdy Resistors

You'll go to the head of the class if you stick to CENTRALAB Fixed Resistors for your replacement jobs.

You'll get A-1 marks and earn special distinction as a fellow who "knows his stuff." Take teacher's advice and always use CENTRALAB Fixed Resistors (and Volume Controls).

- A. Center core of resistance material is surrounded by a dense shock-proof ceramic, providing strength and protection against humidity.
- B. Core and jacket are fired together at 2500 degrees F. into a single, solid unit, hard and durable as stone.
- C. Pure copper covers the resistor end for wire lead contact. Contact to the resistance material is at the extreme ends only, providing uniform resistance and load distribution over *entire* length. End contacts do not short circuit part of resistance as in other types.



Every Radio Service Man should be a member of the Institute of Radio Service Men

# Centralab

Milwaukee, Wis.

British Centralab, Ltd.  
Canterbury Rd., Kilburn  
London N.W.6, England

Centralab  
68-70 Rue Amelot  
Paris, France

**VOLUME CONTROLS  
FIXED RESISTORS**

## Correspondence Dept.

(Continued from page 54)

broad. He should listen to some of the resonant filter signals on 14 mc. when they get caught in the skip and are weak and sound somewhat like DX; they are no longer broad and distinctive but just like any other note. In the article "BERU INGANG" the author said that the W6 with their rough notes were p.d.c. in Europe. Therefore it seems that the fellows using resonant filters are not gaining anything for themselves, but are just hurting other W's by their broad signals. It seems that it would be enough for them to have two kilowatts without intentionally broadening their notes. It is not right for the F.C.C. to send the little fellow who made a slip tuning his transmitter and accidentally got a rough note a green ticket and then let these frequency hogs get by with broadening their notes on purpose.

—James Headrick, W6CPB

**EDITOR'S NOTE.**—The actual effect of a typical tuned filter circuit is to suppress the fundamental but to accentuate the harmonics. Thus, with a full-wave rectifier on 60 cycles, there would be little or no 120-cycle component, but 240 cycles, 360 cycles, 480 cycles, etc., etc., would be apparent. Although the modulation percentages of these higher harmonics may be relatively low and they may not be objectionable at great distances, at moderate distances from the transmitter they are plainly audible and create disturbing (and illegal) QRM. It is QST's technical policy not to advocate use of such filters.

## QRR Channel

912 S. W. 8th Ct., Miami, Fla.

Editor, QST:

May I take the liberty of commenting on an article in June QST written by Morton Slavin, W2IZX, in regard to setting aside 20 kc. between 3890 kc. and 3910 kc. to be used for c.w. and 'phone in time of emergency.

No one, except those who have actually tried to get out with a low-power rig, such as battery operated, knows how impossible it seems at the time of emergency.

I feel that there are many hams like myself who really know what it means to communicate under severe conditions, especially since there are still among our numbers a class of operators who set themselves up as "big shots" and are insulted when asked to QRT.

I am justified in making this statement, since I was one of the original operators to set up a rig in the last Florida Keys hurricane, and we had such an experience along the East Coast.

Here is a big cheer for all the boys in the flood work, and let's hear from them along this line. This particular phase of ham work is not a hobby, but a vital necessity.

—F. P. Duckett, W4AEB

Cutter "Apache," U. S. Coast Guard, Baltimore, Md.  
Editor, QST:

... Why not have a frequency outside of the amateur bands for such work? Let us say, frequencies of 3540 and 6980 kilocycles. The Army Amateurs' have frequencies of 3545 and 6990 kilocycles. Let us take into consideration the fact, also, that they are very efficient in handling traffic. With frequencies of this nature you would be near enough to one of the most efficient traffic nets in the States. They would not have trouble in locating you and would be bothered with no QRM from other stations in the amateur band. Also, all amateurs would know exactly where to find you. . . .

—Haywood N. Perry, R.M.3C.—W3DHZ

**EDITOR'S NOTE.**—One of the great utilities of amateur radio as an emergency communications system is that there is always someone somewhere "on guard" in the amateur bands. A QRR call will never go unheeded, for there are always at least a few amateurs listening. This would not be as true of a special emergency channel outside our regularly-assigned bands.

(Continued on page 58)

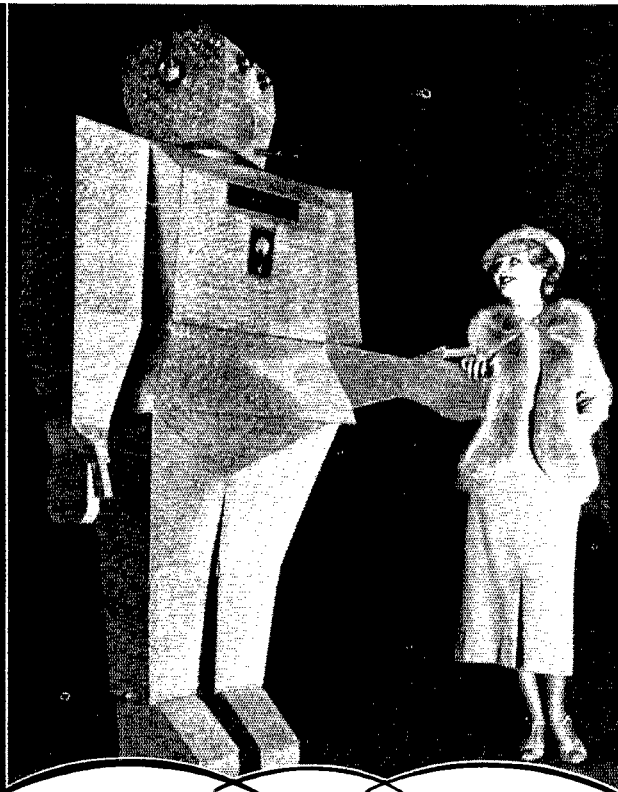

## This Iron Man Comes to Life with Burgess Portable Power

This is Robie, an unusual mechanical man. He walks, talks, smokes, and winks his eyes. Not a single wire connects him with the outside world. Wherever he goes, he is followed by mystified, curious crowds.

Robie is, in reality, a highly complicated radio station. His call is W9XIO.

It took Arthur Wilson of Chicago and three assistants over a year to design

and construct this mechanical wonder.

Mr. Wilson, writing about Robie, says, "The power station is a unit upon which everything depends . . . so, when designing, I turned to an old friend of many years' standing, whose reliability had been proven to me many times—a Burgess Battery."

**BURGESS BATTERY COMPANY**  
Freeport, Illinois



# BURGESS



Say You Saw It in *QST* — It Identifies You and Helps *QST*

# G-R DIALS

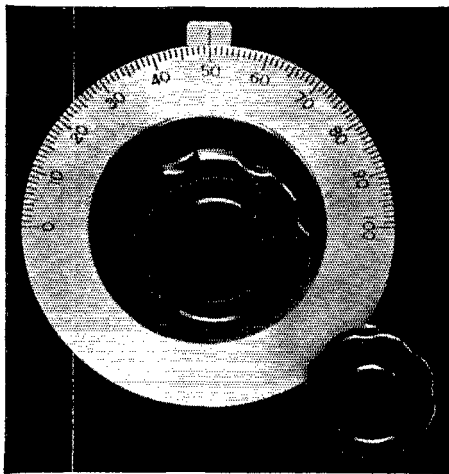

General Radio dials, popular for a number of years with amateurs, experimenters and manufacturers, are available in a large number of styles. Inexpensive — easy to handle over long periods of time — scales accurately divided — these dials fill the bill in any amateur station.

## Features

Dials: photo-etched on nickel-silver.

Sizes: dial diameters of  $2\frac{3}{4}$  inches,  $3\frac{1}{4}$  inches, 4 inches for either  $\frac{1}{4}$  or  $\frac{3}{8}$  inch shafts.

Drives: either direct or slow-motion through positive friction drive.

Indicators: machined to ride on edge of dial, eliminating parallax.

Knobs: polished bakelite, fluted for convenient handling.

Prices: from \$1.00 to \$2.00

Write for Bulletin 20-Q for complete descriptions

General Radio Company  
Cambridge Massachusetts

## An Old, Old Argument

(Continued from page 58)

4511 N. Keating Ave., Chicago, Ill.

Editor, *QST*:

Almost any ham will tell you that his QRA is the hardest in the world from which to work DX. If you ask him for proof of his statement he will say that his best proof is the fact that he doesn't work *enough* DX. Now I have yet to find the ham that can work *enough* DX; still, they can't all have the worst location on earth. Just because I thought a few figures on the subject of DX might be interesting the following percentages have been compiled by the OW and myself.

The percentage of the world's stations in each U.S.A. district and also those of the rest of the world have been determined by using a late copy of the Call Book. The only means of determining the amount of DX worked by each group of stations of the world was to use the lists of WAC certificates issued as published in *QST* from time to time. The WAC certificates issued beginning with the year 1926 and continuing through 1935 were used as a basis for the DX figures.

Continental U.S.A. has 60% of the amateur stations of the world. All the rest of the world combined has the remainder.

The U.S.A. has 41% of the WAC certificates of the world. 59% of the WAC certificates were issued to stations outside of U.S.A. in spite of the fact that U.S.A. stations as a rule use many times the power of the other stations of the world. That should prove that North America is the *hardest* continent from which to make WAC.

Now for a little look inside our U.S.A. boundaries to see how our several districts compare with each other.

District	Per Cent of the World's Amateur Stations in Each District	Per Cent of the World's WAC Stations Located in Each District
W1.....	5½	4½
W2.....	5½	4
W3.....	4½	2½
W4.....	3½	2
W5.....	4½	3
W6.....	9	10
W7.....	3½	2
W8.....	10	6
W9.....	14	7
Total.....	60	41

It will be noticed that the W6 district has the most WAC certificates per station of all U.S.A. districts. Also, it will be noticed that the W9 district has the least WAC certificates per station of all the U.S.A. districts.

Summary: North America is the hardest continent from which to make WAC. The W9 district is the hardest U.S.A. district from which to make WAC; therefore, the W9 district is the hardest place on earth from which to WAC—until someone proves differently with figures, at least!

—Roy W. McCarty, W9KA

## BT/Portable

8527 Germantown Ave., Chestnut Hill, Phila., Pa.

Editor, *QST*:

I think I can explain the confusion that often follows the use of the dash and district number following a call to indicate portable operation.

It is customary procedure on the part of many operators to use a dash to separate the calls from the conversation that ensues, e.g.: W1MK de W3QP BT gm—etc. Would it not seem reasonable to ask the F.C.C. to change the sign to the fraction bar (/), instead of the dash, for portable indication: W3QP/2? As a matter of fact, I have been in the habit of using the fraction bar myself as it put the idea across much more satisfactorily, and never has anyone asked me what it meant: it apparently was obvious.

As long as the indication is given, I don't see that it would even require a ruling of the F.C.C. to go ahead and use the fraction bar. The principal thing is to give the indication and have it understood, and the fraction bar fits into the picture with a much better swing than the dash. You probably have some comments of your own on the subject.

—John Buck Morgan, W3QP

(Continued on page 60)



**RESEARCH KEEPS GENERAL ELECTRIC YEARS AHEAD**



*Focused Tone*

It is G.E.'s new radio circuit that **AUTOMATICALLY** and **VISIBLY** shifts itself into hair-line tuning—perfect tone.

It is the new G-E Colorama Dial that changes from red to green to tell you that your program is perfectly tuned.

It is the Personalized Radio with the custom-tailored dial—your own local station letters flash on when you tune in.

It is Silent Tuning—you can switch from one program to another without a single squeal, squawk, or screech.

It is the combination of all the new and revolutionary G-E Radio inventions and developments—G-E Metal Tubes; G-E Sentry Box; G-E Stabilized Dynamic Speaker; G-E Sliding-rule Tuning Scale; G-E "V-doublet" All-wave Antenna—which give you the finest, truest tone of any radio ever built—that's Focused Tone! Only the new G-E gives it to you — **AUTOMATICALLY!** — **VISIBLY!** — **INSTANTLY!** — every time you tune in.

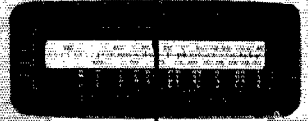

**RADIO'S  
NEWEST  
MARVEL**

**REVOLUTIONIZES  
TUNING**

**AUTOMATICALLY  
ASSURES  
PERFECT  
TONE**

**GENERAL  ELECTRIC**

*Focused Tone Radio*

APPLIANCE AND MERCHANDISE DEPARTMENT,  
GENERAL ELECTRIC CO., BRIDGEPORT, CONN.



# LEEDS Leads

## WITH SUMMER BARGAINS



### IMPORTANT ANNOUNCEMENT

On Our NEW-LD-5 Mounted Crystals

These low drift plates, factory sealed in the new LEEDS metal holder are outstanding from the standpoint of stability, accuracy, high output and low cost. Low Drift—5 cycles per million per degree. Accuracy of calibration—better than .05% Orders filled plus or minus two kc. of specified frequency. Last but not least, the price of the mounted crystals, anywhere in the 160-80 C and 40 meter bands is only **\$3.50** Money back guarantee if you are not completely satisfied.

Leeds type A.L. metal crystal holder, as illustrated above, fits standard 5-prong socket. **\$1.00**

### WESTINGHOUSE AND SANGAMO Watt Hour Meters

110-120 volt 5 amp. 60 cycle 2 wire meters. The meters are used instruments in perfect condition, tested and reset to zero. A fifteen dollar value, at the extremely low price of **\$3.50** Shipping weight 15 lbs.



Thousands have discovered noise silencer adapters are a great help on reducing natural static too. Leeds "QUIET CAN" and "SILENT CAN" also provide freedom from ignition noises and afford an ideal arrangement for push to talk phone and break-in CW.

#### Leeds "QUIET CAN"

for receivers with two IF stages; complete with tubes **\$7.95** and instructions....

#### Leeds "SILENT CAN"

Illustrated herewith, for receivers with one IF stage; complete with tubes **\$9.95** and instructions...

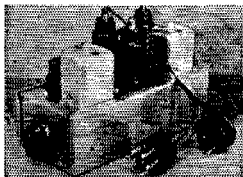

### BASES and DEMI-BASES

By LEEDS for use with rack panels are now available in a greatly increased variety at lowest prices. Crystalline finished units of 20 gauge steel; each base is finished with a bottom cover plate, so that apparatus underneath the chassis may be kept free from dust and at the same time electro statically and electro magnetically shielded.

8 1/4 x 8 x 2... \$65	8 x 17 x 2... \$95	8 x 17 x 3... \$1.15
8 1/4 x 10 x 2... .70	10 x 17 x 2... 1.10	10 x 17 x 3... 1.30
4 x 17 x 2... .70	12 x 17 x 2... 1.30	12 x 17 x 3... 1.40

### Rack Panels

Steel	Price	Width	Alum.	Price
PS-1...	\$5.2	1 1/2"	PA-1...	\$7.74
PS-2...	.57	3 1/2"	PA-2...	1.03
PS-3...	.58	5 1/2"	PA-3...	1.30
PS-4...	.71	7"	PA-4...	1.55
PS-5...	.95	8 1/2"	PA-5...	1.90
PS-6...	1.15	10 1/2"	PA-6...	2.45
PS-7...	1.20	12 1/2"	PA-7...	2.90
PS-8...	1.50	14"	PA-8...	3.35
PS-9...	1.70	15 1/2"	PA-9...	3.70
PS-10...	1.90	17 1/2"	PA-10...	3.95
PS-11...	2.05	19 1/2"	PA-11...	4.45
PS-12...	2.30	21"	PA-12...	5.20

Brass panel mounting screws 3/4" long, 10/24 thread, 15c doz.

Taylor transmitting tubes—type T-55-plate 55 watts, dissipation high efficiency to 200 MC.—\$8.00, other types in stock.



Tel. COrnland 7-2612

45 VESEY STREET  
NEW YORK CITY

Cable Address: "RADLEEDS"

Say You Saw It in QST — It Identifies You and Helps QST

EDITOR'S NOTE.—The A.R.R.L.'s original suggestion to the F.C.C. in this connection was for the use of the oblique (- . . .). However, for reasons of its own, the Commission substituted the double dash (- - - -).

Use of the oblique is in violation of the present regulations, which specifically state that the break sign (BT) followed by the district numeral shall be used.

## An Open Letter to the Editor, Manufacturers, and Dealers

Peace River, Alta., Canada

Editor, QST:

Some time back, under the exhilarating influence of the "Handbook," I decided to build the band-switching exciter unit prominently displayed therein, and after puzzling over the manner in which the RK23 tank coils are mounted (which subject is airily passed over in the "Good Book") I wrote the Technical Department which passed me the good word. Since then I have made every endeavor to select the parts necessary to build the aforesaid unit from the 1052 catalogs around the shack. The fact that none of these dispensers of merchandise ever considers it necessary to mention details of mounting space required for various components (particularly variable condensers) forced me to leave the selection of the parts to the firm from whom I decided to order. Incidentally, the said firm quoted me for a 5-lb. spool of No. 10 wire to wind the inductances. Hil Undaunted by these setbacks, I straightened out the parts list, and proceeded to figure out a power pack for the 53's.

Ye gods, Mr. Ed! Have you ever tried to pick out a transformer from a catalogue? This is a sample:

Very FB Transformer High Voltage C.T.  
Fil. 5v at 3a. etc.

What voltage? What current? Jehovah alone in His omniscience knows! Or else a d.c. output voltage is given. But what kind of filter is necessary to obtain that figure? Once again the matter is beyond earthly help. I am nearly 400 miles from the nearest supply house. If I write to this firm and that firm for details it will be six months before that unit is built.

Please, Mr. Editor, show this to your radio supply friends and please ask the Handbook department to remember that us Y.S.'s haven't got the two original copies of QST that Noah took in the Ark with him. No wonder the Y.S. is always getting into difficulties—nobody ever remembers that there are such things when writing anything for QST or the Handbook. The only time they think of him is when they hear an r.a.c. note or a long CQ and then they are too peeved to remember that it's probably because they never told him all there was to know about building a good outfit. Hil! So puhleeze publish this and save my sanity and that of other squirts who are burning the midnight oil in the cause.

—P. A. Fair, VE4YD

## About That 160-Meter Band . . .

6740 N. Catlin St., Portland, Ore.

Editor, QST:

. . . After reading the letter sent in by W2BBK dealing with 160-meter 'phone antics, I would like to express some ideas that I've had for some time. I would like to propose that we make all 'phone bands below 29,000 kc. open only to operators holding Class "A" licenses. There are many old-timers on 160-meter 'phone who take pride in their rigs and who would be affected by this change, but then if they are old-timers and if they do take pride in their rig and the signal it emits, they surely have some knowledge of 'phone and could pass the Class "A" exam easily. If there are fellows who want to be real 'phone men, but who haven't been on the air a year, and who want to work 'phone to get the "hang" of it before trying for Class "A," they can get on the 5- and 2 1/2-meter bands and, maybe to their surprise, find real enjoyment in it. Then after their first year is over these fellows can get on 'phone with real knowledge of 'phone.

(Continued on page 82)

# A. C. RELAYS

Made by

## Allen-Bradley

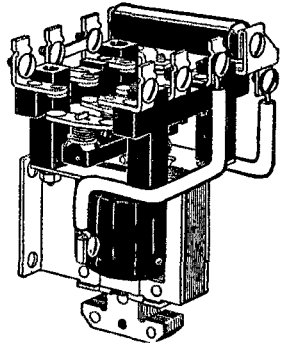
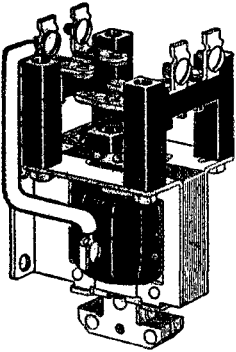

These A. C. solenoid relays are ideal for remote control of transmitters, for control of crystal ovens, and for any general remote control application except for keying. THESE RELAYS WILL NOT OPERATE IN KEYING SERVICE. Silver-to-silver double-break contacts are used throughout.

The maximum contact rating is 10 amp. at 220 v. or 3 amp. at 550 v. The relay coils are wound for 115 volts 60 cycle alternating current. Relays for other voltages can be supplied on special order. Use coupon below.

Type No.	Poles	Nor-mally	Action	Circuit Diagram	Price		Type No.	Poles	Nor-mally	Action	Circuit Diagram	Price	
					Open	In Cab.						Open	In Cab.
A107	1	Open	SP ST		\$3.50	\$4.50	A177	1	Closed	SP ST		\$7.50	\$8.50
A117	1	Closed	SP ST		4.50	5.50	A207	2	Open	DP ST		4.00	5.00
A127	1	Open and Closed	SP DT		5.00	6.00	A217	2	Closed	DP ST		6.00	7.00
A137	1	Open	SP ST		4.00	5.00	A227	2	Open and Closed	DP DT		7.00	8.00
A147	1	Closed	SP ST		5.00	6.00	A237	2	Open	DP ST		4.50	5.50
A157	1	Open and Closed	SP DT		5.50	6.50	A247	2	Closed	DP ST		6.50	7.50
A167	1	Open	SP ST		6.50	7.50	<p><b>Radiostat</b>—A stepless graphite compression rheostat for primary of 550 watt filament or plate supply transformer. Range 4 to 150 ohms. <b>Price \$6.50</b></p>						

### ORDER BLANK—MAIL WITH REMITTANCE TO

Allen-Bradley Co., 108 W. Greenfield Ave., Milwaukee, Wis.

Enclosed find money order for \$..... for which please send me, shipping charges prepaid, the following items:

..... for..... Volts..... Cycles

Name.....

Address.....

# Newark's

## SETS on PAYMENT PLAN at New Lower Rates

The receivers listed below are the best money can buy. Our time payment plan, at the new low rates, makes it easy to own one. COMPARE our rates with others. THE EASY WAY: Send in your down payment with your order. Set will be shipped as soon as credit is OK'd. Entire Transaction: One week. TRY US. Write for complete catalogue.

### NOW! NEW HOT NC-100

	Cash Price	Down Payment	6 Months Payments	10 Months Payments
NATIONAL NC-100 — complete with crystal—10" speaker	\$127.50	\$22.50	\$18.58	\$11.28
NATIONAL HRO JR. — with tubes — 1 set of coils, 10 to 20 meters (2 amateur bands)	\$99.00	\$24.00	\$13.52	\$8.20
NATIONAL HRO JR. — complete with tubes — power supply — 2 pair of coils	\$124.80	\$29.80	\$16.90	\$10.25
NATIONAL HRO — less power supply and speaker	\$167.70	\$37.70	\$22.78	\$13.89
NATIONAL HRO — with power supply	\$183.60	\$43.60	\$24.46	\$14.93
RCA — ACR — 136	\$69.50	\$19.50	\$9.32	\$5.65
RME69 — complete with crystal — tubes — speaker housed in baffle	\$134.90	\$29.90	\$18.58	\$11.28
HAMMARLUND SUPER PRO — Complete with tubes and speaker	\$223.44	\$43.44	\$31.23	\$19.11
HAMMARLUND SUPER PRO — Complete with crystal, tubes and speaker	\$241.00	\$51.00	\$32.92	\$20.16
NEW ACR-175 — complete as advertised	\$119.50	\$24.50	\$16.90	\$10.25

Full Details of Any Set Listed, Mailed Immediately upon Request

#### WELL KNOWN OIL FILLED, OIL IMPREGNATED FILTER CONDENSERS

Our Special OIL IMPREGNATED-OIL FILLED CONDENSERS are guaranteed at rated voltages. All ratings are DC working voltage. These are well-known condensers. We have a few left of each capacity. Send in your orders at once.

Cap.	Voltage	Size	Weight	Price
1 mfd.	2000 V. DC	5 x 3 3/4 x 1	1 1/4 Lbs.	\$1.25
2 mfd.	2000 V. DC	5 x 3 3/4 x 2 1/4	3 Lbs.	1.50
4 mfd.	2000 V. DC	2 1/2 x 2 3/4 x 5	3 Lbs.	2.25
8 mfd.	2000 V. DC	5 x 3 3/4 x 4	4 Lbs.	2.75
9 mfd.	3000 V. DC	5 x 3 3/4 x 11	9 Lbs.	7.25
(including 2 1/2" bakelite standoffs)				
4.4 mfd.	1500 V. DC	5 x 3 3/4 x 1 3/4	1 1/4 Lbs.	1.75
5 mfd.	1500 V. DC	3 3/4 x 3 3/4 x 1 1/4	1 1/4 Lbs.	1.90
5.2 mfd.	1500 V. DC	5 x 3 3/4 x 2 1/4	2 3/4 Lbs.	2.00
10 mfd.	1500 V. DC	5 x 3 3/4 x 3	2 3/4 Lbs.	2.75
20 mfd.	1500 V. DC	5 x 3 3/4 x 3 3/4	3 3/4 Lbs.	3.50

Use the 10 and 20 mfd. for perfect filtering in class B modulation Power supply

#### Newark Paper Filter Condensers

1 mfd. 1000 V. DC. . . . \$ .56  
1 mfd. 1500 V. DC. . . . .66  
These condensers have standoff insulators and mounting feet.

Thordarson No. T6877 Heavy Duty Choke. 15 henries at 250 MA. . . \$1.95

HIGH VOLTAGE TRANSFORMER. 1000-750-500-0-500-750-1000-300 MA. 3 3/4 x 4 3/4 x 5 1/2 . . . . . \$5.95

Thordarson No. T6878 Plate and Filament Transformer, 600-0-600 V. at 200 MA. 2 1/2 V. at 10 amp., 5 V. at 3 amp. 7 1/2 V. at 3 amp. . . . . \$2.45  
2 1/2 V. 10 amp. Filament Transformer — 2500 V. insulation for 866's . . . \$ .95

Advance sale of tickets for Convention  
Sept. 5-6-7, Chicago — \$2.00 each

WRITE FOR OUR COMPLETE CATALOGUE!

## NEWARK ELECTRIC CO.

FASTER SERVICE — BETTER BARGAINS

226 W. MADISON ST. DEPT. Q CHICAGO, ILL.

The next change would be to drop the band from 1715 kc. to 1750 kc. because harmonics from this area fall in aviation bands and interfere with a more important branch of radio than amateur radio. Still another change and probably one not so important would be to run the 160-meter band from 1750 kc. to 1850 kc. This would chisel some 'phone frequencies away but then if all the Class "B" fellows were taken out there wouldn't be so many to QRM and I know that most of the 75-meter 'phones would go to fill it back up. Perhaps you are thinking that adding 50 kc. to the c.w. band is crazy and maybe it is. However, if this 100 kc. (1750 to 1850 kc.) were opened to traffic nets what a swell time would be had for the traffic man who has to get messages through the QRM on 80-meter c.w. . . .

—Herbert Davidson, W7FDZ

### Hints and Kinks

(Continued from page 42)

edly adds to the heating effect, and I would advise anyone building a similar oscillator to use self-supporting coils. With a plate voltage of 400 and screen voltage of 150 a power output of six watts was obtained."

### Regenerative Receiver Using a 53

SINCE a number of amateurs showed considerable interest in the "cigar-box" receiver described in Experimenters' Section in November, 1934, *QST*, it may be that some recent changes made in the set to substitute a Type 53 for the 19 will be of interest to those who built the original model. Filament supply for the 53 is generally more convenient, and it seems to be a bit easier to tune in 'phone stations. Otherwise, results are about the same as with the 19.

The 53 set is housed in the same shielded cigar box described in the reference. The same tuning coils have been used. The approximate turns, using No. 26 or No. 28 enameled wire on old tube bases, or 1 3/8-inch coil forms, are given in Fig. 6.

It is convenient to use the antenna condenser for fine adjustment instead of ordinary hand-spread, and for this a section of insulating shaft should be used to connect the rotor shaft to the knob, in order to avoid hand-capacity effects. When  $C_7$  is less than 2  $\mu$ fd., results are not satisfactory.  $R_7$  is not critical; anything up to 500 ohms will do, but 250 seems a good compromise, giving sufficiently undistorted reception without too much loss of volume. A 500-ohm variable would give control over the whole range. The grid resistors for grids No. 1 and 2 are not very critical;  $R_1$  may be 2 or 3 megs and  $R_2$  1 or 2 megs.

The capacity of coupling condenser  $C_4$  is not critical. For convenience, both  $R_4$  and  $R_5$  should be variable so that the detector plate voltage may be varied around 30 volts and the amplifier plate voltage around 36 volts. However, a single 1-watt fixed resistor of 5000 to 7500 ohms may be substituted for  $R_3$  and  $R_4$  together.  $R_5$  is simply to reduce the "B" supply voltage to 36 volts. Under the above conditions the total plate current is about 4 milliamperes.

If interference from a nearby broadcast station occurs on any band, a wave-trap made from a variable condenser and its coil in parallel, taken from an old broadcast receiver and connected in series with the antenna lead, will solve it.

—Charles W. Clifford, W6KFE

**● RECEIVER HEADQUARTERS ●**

# New! Hallicrafter Sky-Buddy

5 Tubes Superheterodyne, Built-in Power Supply, and Speaker **\$29.50**

Tuning from 18 to 555 meters

## Hallicrafters Ultra Skyrider 5-10 Meters\*

\*ACTUALLY 3.9 TO 46 METERS

With the new LAMB NOISE SILENCER. A ten-tube Superheterodyne of remarkable sensitivity and many features.

With tubes.....\$99.50 Tubes, crystal.....\$114.50  
Speaker. \$12

## Barr DB3 Class B Modulated 5 Meter Transceiver

- Utilizes a Class B audio amplifier and modulator giving an output of 2.1 watts which is many times greater than that of ordinary transceivers.
- Can be operated as receiver, transmitter or both, in a car, plane, boat or while being carried for portable work.
- Working range anywhere between 2 and 100 miles depending upon the location.

## SUPER-SKYRIDER

Complete.....\$79.50. With crystal.....\$89.50  
**SUPER SEVEN**, complete..... 49.50  
**HAMMARLUND "SUPER PRO" SP-10**, complete..... 223.44  
**SP-10X**, complete with crystal filter..... 241.08  
**RME69**, receiver only..... 118.80  
**RME69**, complete, tubes and mounted speaker. 134.90

## RCA-175 AMATEUR RECEIVER

Complete with Tubes, Crystal, Speaker.....\$119.50

- Compact convenient carrying size.
- 30 tube Audio Amplifier — 49 tube Super Regenerative Detector or Oscillator — 19 tube Class B Audio Amplifier or Modulator.

We were surprised at the marvelous value offered in this transceiver, just as you will be when you own one of them.

Price, less tubes, batteries and accessories. **\$16.20**

**MATCHED SET OF SYLVANIA TUBES.** One 30, one 19, one 49. **\$1.56**

**DOUBLET TYPE TRANSCEIVER ANTENNA**.....\$2.65

**UNIVERSAL TRANSCEIVER HANDSET.** Single button mike, 2,000 ohm receiver.....\$5.88

**EIMAC UNSURPASSED TRANSMITTING TUBES!**  
 Performance — Ruggedness — Power — Price  
 35-T Output 38 to 112 watts. **\$8.00**  
 50-T Output 75 to 250 watts. **\$13.50**  
 150-T Output 150 to 450 watts. **\$24.50**  
 300-T Output 350 to 700 watts. **\$60.00**  
 500-T Output 500 to 1350 watts. **\$175.00**

**BLILEY CRYSTALS**  
 Largest Stock in New York  
 HF2-20 M Mounted Crystals. **\$7.50**  
 BC2 Crystal Holders..... **\$1.00**  
 BC3-40-80 M Mounted Crystals. **\$3.95**  
 LD2-40-80-160 M Mounted Crystals **\$4.80**  
 Exact Frequency if in stock

**THORDARSON CASED TRANSFORMER**  
 600 volts each side of C.T. 200 MA 2½ V. 10 amps. C.T., 5 V. 3 amps. 7½ V. 3 amps. C.T.....\$2.45  
**THORD. CHOKE 12 H 250 MA. \$1.95**

# Gross Recommends—For the Best "Buy" of the Season

CW-60 (Uses New Eimac 35T)

## Crystal Control Transmitter

OUTPUT: 60-100 WATTS

Complete Kit, Less Tubes and Crystal

**\$20.95**

P-60 DUAL POWER SUPPLY KIT for CW-60 Transmitter — with matching chassis **\$25.95**

*Descriptive Bulletin on Request*

Power output depends on plate voltage used  
 TUBE LINEUP: 47 crystal oscillator — 53 Buffer and Eimac 35T in output stage.  
 POWER SUPPLY REQUIREMENTS: Filament voltages 2½ volts at 4 amps. — 5 volts at 4 amps.  
 PLATE VOLTAGES: 400 Volts at 100 MA and 500 to 1250 volts at 100 MA.  
 COILS: One set of three coils are furnished with kit for operation on any one amateur band. Coils for 1.7; 3.5; 7; 14 MC may be purchased separately at \$2.75 per set.  
 SIZE: Overall dimensions of the unit are height 4½ inches, width 11 inches, length 19 inches.

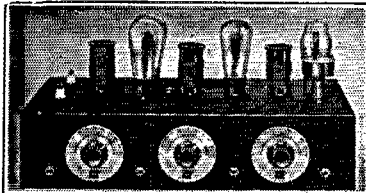

## GROSS C C TRANSMITTER — OUTPUT 25-30 WATTS

The "CW-25" transmitter kit due to its low cost makes it possible for anyone to own a modern crystal controlled station. A schematic hook-up and parts layout sheet as well as tuning instructions are furnished, thus enabling the most inexperienced operator to wire and put the set on the air, for real results. The "CW-25" is supplied with a shrivel finished sturdy metal chassis under which all parts are mounted, making the wiring and components dust-proof. A plug-in crystal holder is furnished with the kit. Only one milliammeter is required for tuning the transmitter and each stage is provided with a jack for this purpose. The "CW-25" uses one '47 as crystal oscillator, one '46 as buffer or doubler and two '46's in the amplifier stage, set of three coils supplied with kit for 20, 40, 80 or 160 band. Additional coils 75c each.

Complete kit, less tubes and crystal..... **\$14.95**

P-25 POWER SUPPLY — for CW-25 transmitter with matching chassis — **\$11**  
 450 volts at 200 MA, choke input — complete kit, less tube.....

20% DEPOSIT WITH ALL C. O. D. ORDERS

REMIT BY M. O. INCLUDE POSTAGE

Cable Address: GROSSINC

**GROSS RADIO, INC., 51 VESEY STREET, NEW YORK CITY**



If you want the best results — distance — good tone quality on phone sets — steady notes on CW — don't be careless in selecting the transformers for your rig.

Jefferson Transformers — expertly engineered and backed by many years of specialization — comprise a whole line made expressly for the latest circuits and modern tubes. The correctness of design, selection of materials, and precision manufacturing methods are reasons for their unusual stamina.

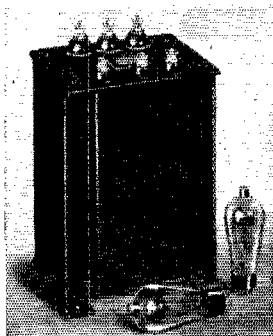

One of the "OVERSIZE" Jefferson Plate Supply Transformers — A complete line for conventional and bridge rectification

The JEFFERSON line is complete: — Filament, Modulation, Plate, Microphone, Power and Input TRANSFORMERS. . . . Ask your wholesaler for catalog and prices, or forward the coupon below, direct to the factory. JEFFERSON ELECTRIC COMPANY, Bellwood (Suburb of Chicago), Illinois, Canadian Factory: 535 College St., Toronto.

## JEFFERSON TRANSFORMERS

Jefferson Electric Company  
Bellwood, Ill.

Send Amateur Radio Catalog and  
Amplifier Diagram to:

NEW P.P. 6B5  
20 WATT AMPLIFIER  
DIAGRAM FREE

Name

Address

City  State

## A General Purpose V.T. Voltmeter With Ray-Tube Indicator

(Continued from page 20)

high-potential side until the shadow is reduced to zero.

The meter may be calibrated in several ways. An a.c. voltmeter and a potentiometer, of a standard resistance and a thermo-couple milliammeter, may be used. The calibration is "straight line" and if the values of  $R_2$ ,  $R_3$ ,  $R_4$  and  $R_5$  are correct the ranges are in multiple steps of 10.

There are so many uses, such as calculation of percentage modulation, voltage gain in amplifiers, etc., that describing them would be merely repeating what *QST* has published previously. The meter has been used around the laboratory here by various persons, many inexperienced, and stands up well with use.

## Remote Tuning of U.H.F. Receivers

(Continued from page 33)

ient method of securing the pull required to bring the rotor back to zero tuning position was found. This consists of a small soft-iron rod which is imbedded in a hole drilled through the center of the wooden coil form. This hole is drilled in such a direction that the magnetic pull of the horseshoe permanent magnet would tend to keep the magnetic plane of the coil at right angles to that of the permanent magnet when the coil was not energized. This sounds a little complicated, but Fig. 2 shows where this is located. It is possible to reduce the amount of "pull" simply by shortening the rod with a file or cutters. Stops are provided so that the moving coil will swing in one direction only. The bottom bearing consists of a small piece of metal in which a shallow dent has been made by means of a punch or drill. The top bearing consists of a small strip of spring metal in which a dent has been made by means of a punch. The spindle axles are two phonograph needles. Soft metal such as coin silver or soft brass has been found to be unsuited for bearings because the axles tend to drill into the metal thus making a deep bearing that causes friction and erratic operation of the rotor mechanism. Spring brass, stainless steel or phosphor bronze is best suited for this purpose. The connections to the moving coil are made through the spindles and bearings.

The mechanical details shown might be varied somewhat to suit the builder. The sketch shows a rather large permanent horseshoe magnet of the type used in telephone ringer boxes. Smaller permanent magnets might be substituted with a corresponding decrease in sensitivity. The model shown makes use of a permanent magnet from an old headphone and is small enough to fit inside an ultra-high-frequency receiver without the necessity of making any mechanical changes in the receiver itself. The use of a rather long horse-

We have just published a **NEW** Log Book. It is very much **BETTER** than heretofore and, even so, it's

**CHEAPER.** In the

first place, we have taken advantage of modern

**SPIRAL BINDING**

which is particularly desirable because the book will fold back flat at any page.

Therefore, it takes only half the space on an operating table, and is perfectly

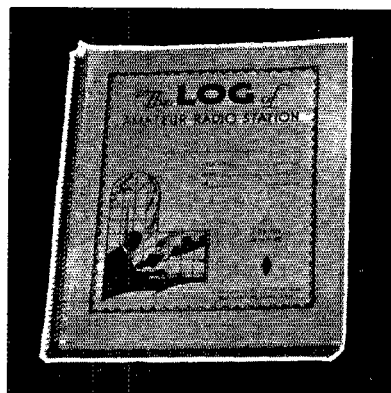

flat to write on. Everybody likes this feature. The Communications Dept.

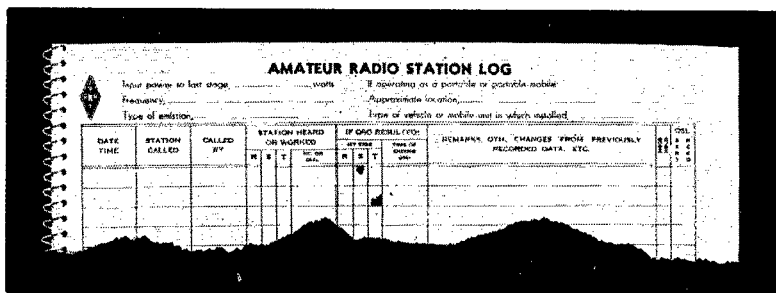

has produced an **IMPROVED LOG SHEET**, and has added two useful new columns at the right-hand edge where

we can record messages handled and QSL's. Of course, the book still has in it the same **INFORMATION** sheets it had before except everything has been brought up to date and the graph sheet is now lithographed in green and has wider margins. Better send today for a New Log Book.

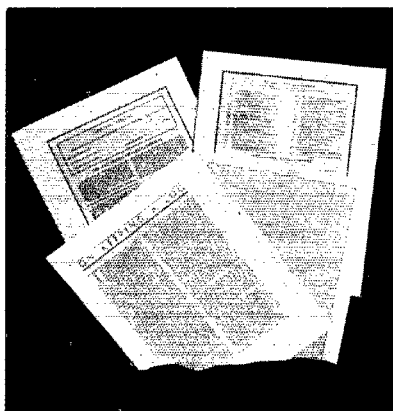

*New price: 35¢ each, 3 for \$1, postpaid*

**AMERICAN RADIO RELAY LEAGUE, INC., West Hartford, Connecticut**

# EVEREADY

## BATTERY POWER

This is the new micro-wave transmitter developed by N. B. C.



Used to broadcast the national party conventions at Cleveland and Philadelphia, the power is supplied by "Eveready" Radio Batteries exclusively.

BATTERY HEADQUARTERS

**NATIONAL CARBON COMPANY, INC.**

General Offices: New York, N. Y.

Branches: Chicago, San Francisco

Unit of Union Carbide  and Carbon Corporation

shoe magnet is recommended, however, as less difficulty will be experienced in adjusting the small iron rod to the length required to bring the rotor back to the zero capacity position.

Adjustments are simple. If the moving coil does not respond properly for the maximum current that has been decided upon for your setup, possibly the top spring bearing is too tight or else the iron rod inside the moving coil is too long. The spring bearing should be adjusted so as to be rather light. After this has been done, final adjustments can be made by decreasing or increasing the length of the iron rod in the moving coil. It is essential that the moving coil and rotor plates are light and well balanced, that the assembly is mounted in an upright position and that the unit is protected from the wind.

This method of remote control is best adapted to "broad-tuning" receivers, such as the super-regenerative type. It has some advantage over the motor-driven type of tuning devices; there is less possibility of going by the desired station since it is practically impossible to stop a motor without some over-carry. With a certain amount of care in the construction of the tuning unit, operation is smooth enough to permit its use with the more selective types of receivers such as the superheterodyne or the plain regenerative. The capacity can be adjusted to suit the receiver and provide handsread over the entire amateur band which it is desired to cover.

### Handling Ham Messages

*(Continued from page 37)*

is important that deliveries be made in business-like fashion to give the best impression. They should be typed or neatly copied, preferably on a standard blank, retaining original for the F.C.C. station file where these are mailed. The new A.R.R.L. blanks and new delivery card developed to meet this special ham need are the snappiest and most convenient forms ever produced for making deliveries.

We repeat that it is a good idea for us all to start a few messages to get accustomed to the new form. Keep the form on the operating table until it has been used enough to be entirely familiar. Experience is the only real teacher. Proficiency depends on practice. By adding to your knowledge and ability to operate you better your chances of being able to perform creditably for your community or country when the next communications emergency arrives. For those breaking into amateur radio, may we add that any Official Relay Station appointee, or Trunkliner, or experienced A.A.R.S. or A.R.R.L. traffic handler will be glad to answer further questions or give pointers on what constitutes the best procedure or station arrangement for efficient effective two-way communication work—or drop a line to A.R.R.L. Headquarters about your problem.

—F. E. H.

**Always Appreciated**

*(See page 78)*



Announcing...

# Tru-Fidelity

BY  
**THORDARSON**

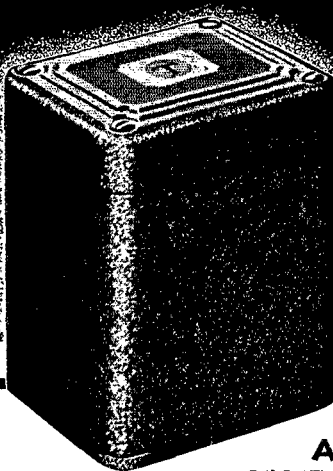

## FEATURES

- ▶ Wide Range Frequency Response—  
High permeability core—Special coil construction for low distributed capacity and leakage reactance.
- ▶ Maximum shielding from external fields through case design. (Additional shielding cases unnecessary.) Electrostatic shielding between primary and secondary coils.
- ▶ Capacitively and Inductively balanced for use on equalized transmission lines. Effect of stray fields neutralized.
- ▶ Line coupling transformers reflect proper impedance on ALL taps, reducing line reflection.
- ▶ Ingenious mounting permits above panel—sub-panel or combination wiring—single hole mounting bushing permits rotation without disturbing connecting leads.

**MOST ADVANCED  
AUDIO DEVELOPMENT  
SINCE THE DYNAMIC SPEAKER  
HISTORY MAKING! TRU-FIDELITY  
by THORDARSON.** For the first time, full range, clear, undistorted audio reproduction is available. Others have tried, THORDARSON has succeeded and brings you laboratory perfection in commercial production with **TRU-FIDELITY.**

Ask your jobber for catalog No. 500 for complete listing and data of models, or write factory.



**THORDARSON ELECTRIC MFG. CO.**  
500 West Huron St., Chicago, Ill., U. S. A.

**500,000-WATT  
OR 50-WATT  
TRANSMITTERS...  
G-E CAPACITORS  
DO THE JOB**



**T**HE above photograph shows part of the 147 G-E transmitter capacitors installed in WLW, the Crosley 500-kw station—largest broadcasting station in the country.

They are the same capacitors, except for size, which you want for your transmitter. Treated with Pyranol—the noninflammable dielectric developed by General Electric—these capacitors are compactly built and have permanent operating characteristics. They are conservatively rated for dependability and long life.

You can obtain these capacitors from your dealer. Bulletin GEA-2021 on request. Radio Dept., General Electric, Schenectady, N. Y.



360-111

**GENERAL  
ELECTRIC**

**What's Happened to Ten?**

*(Continued from page 8)*

worth any fellow's while to get the ten-meter rig shined up in anticipation of a return of good conditions in the early fall. And the chance for some good short-distance QSO's during the hot weather should not be missed. There are times when even blank silence should be preferable to QRM—and when, as it is most of the time, the silence is due to a lack of activity rather than lack of facilities, we're simply neglecting an opportunity to do ourselves a favor. So far as the coming fall and winter is concerned, all the information we can gather indicates that the next DX season will be even better than the last. We shall see.

Meantime, more activity is badly needed on ten right now. Best times for operation during the summer are not, as might be expected, during the middle of the day, but in the late afternoon and early evening. The corresponding period around sunrise should be equally good—except that activity in these early hours is about at the vanishing point. Last year the band regularly was open until nine and ten o'clock, Eastern Time; sometimes as late as midnight. Certainly lack of opportunity to get on during the good periods is pretty thin as an excuse.

Gents, we still have a job ahead of us on ten meters. Let's keep it under way.

—G. G.

**W6NCT, Santa Barbara, Calif.**

*(Continued from page 43)*

good deal of work on 28 mc. It consists of a 53 oscillator doubling to 20, a pair of RK-23's in parallel doubling to 10, and a final amplifier using a pair of 800's. The modulator for this rig uses a pair of RK31's in Class-B. For ten-meter work a doublet antenna fed by EO-1 cable does the radiating.

The RME-69 receiver is centrally located on the operating table. To its left is a Peak monitor, while on its right is a metal cabinet containing speech equipment. An unusual touch is that of mounting the grid-current milliammeters on the operating table, with leads running from the transmitters. A crystal microphone is used.

**I.A.R.U. News**

*(Continued from page 45)*

his card that he has worked all continents, the letters "WAC" indicating such work presuppose that he has received the award from the I.A.R.U.

**General:**

Don't think it's a bootlegger if you hear one—G8 calls have recently been assigned by the British government . . . . W3AWH recently completed his FBTOC with HB9J . . . . Latest 28-mc. WAC's are those of Jacques

# NEW FORM—LOWER PRICE

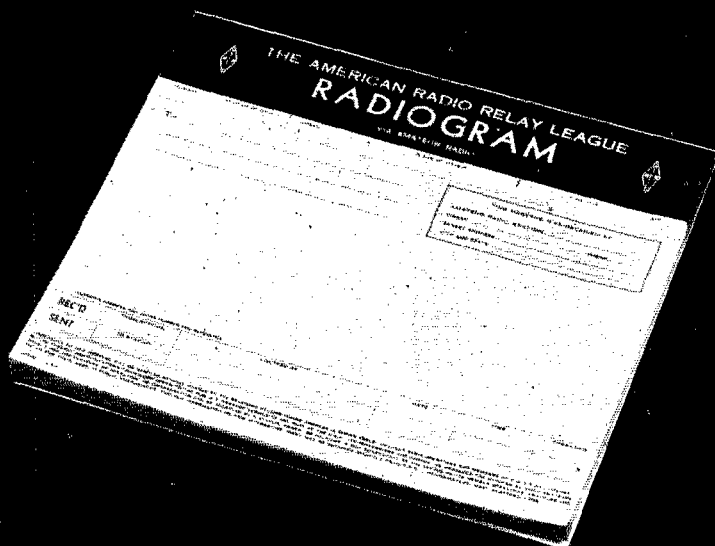

Now—25¢ per pad of 100 blanks

American Radio Relay League, West Hartford, Connecticut

## BUD IMPROVED MIDGET CONDENSERS

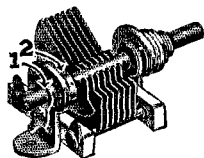

*Note These Improved Features!*

1. New Positive Wiping Contact on rotor shaft with adjusting screw, eliminates mechanical noise on high frequencies.
2. Close Fitting Bearings hold rotor calibration and smoothness of operation.

Insulated with ISOLANTITE. Soldered brass plate assemblies, and heavy aluminum end plates make a precision built, ruggedly constructed condenser.

No. 900 — Cap. 20 Mmfd.....	List \$1.15
No. 902 — Cap. 35 Mmfd.....	List 1.25
No. 903 — Cap. 50 Mmfd.....	List 1.35
No. 905 — Cap. 100 Mmfd.....	List 1.85
No. 906 — Cap. 140 Mmfd.....	List 2.00
No. 908 — Cap. 200 Mmfd.....	List 2.30
No. 909 — Cap. 250 Mmfd.....	List 2.45

Dual units and multiple space units in various capacities illustrated and described in our new catalog. Free upon request!

40% DISCOUNT TO AMATEURS

**BUD RADIO, INC.** 1937 E. 55th Street  
Cleveland, Ohio

## PRECISION CRYSTALS



Crystal Holder

Highest quality crystals one-inch square, carefully ground for frequency stability and maximum output. Be sure of your transmitter frequency—use PRECISION CRYSTALS.

'X' cut PRECISION Crystals carefully ground for maximum power supplied within 0.1% of your specified frequency and calibrated to within 0.03% are priced as follows: 1750, 3500 and 7000 kc. bands—

\$3.00 each. Add \$1.00 to above price if plugin, dustproof holder is desired. (Holder as illustrated to fit G.R. jacks or round holder to plug into a tube socket can be furnished) G.R. jacks to plug illustrated holder into — \$.15 pair.

Low frequency drift crystals (Type LTC) having a drift of less than 5 cycles per million per degree C. are supplied at the following prices: 1750 and 3500 kc. bands — \$3.50 each; 7000 kc. band — \$4.00 each. Holder \$1.00.

'AT' cut crystals for commercial use quoted on at your request. When ordering our product you are assured of the finest obtainable. Now in our sixth year of business.

PRECISION PIEZO SERVICE

427 Asia Street

Baton Rouge, La.

# NEW

## Transmitting Tube for ultra-high frequencies

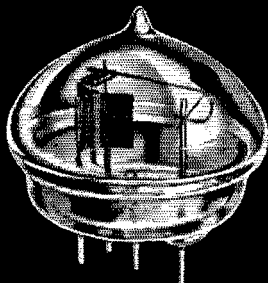

**The Western Electric 316A**  
**6 Watts at 500 MC**

Note radical design including absence of conventional glass press.

**\$ 10<sup>50</sup>**

in U. S. A.

This new tube has been designed specially for use in oscillator circuits of the negative grid type at frequencies up to 600 mc. Close electrode spacings, with consequent reduction of electron transit time, short heavy leads, and low interelectrode capacities produce higher efficiency. The 316A delivers 6 watts at 500 mc. (60 cm.) with 20% efficiency.

The information booklet packed with each tube gives typical oscillator circuit details and complete operating instructions.

Maximum plate voltage.....	100 Volts
Maximum plate dissipation.....	30 Watts
Maximum plate current.....	80 Ma.
Filament voltage.....	2.0 Volts
Filament current.....	3.65 Amps.

For full details: Graybar Electric, Graybar Building, New York, N. Y.

### TYPICAL 316A—60 CM. OSCILLATOR

Requires no critical adjustments such as are necessary with Barkhausen and magnetron tubes.

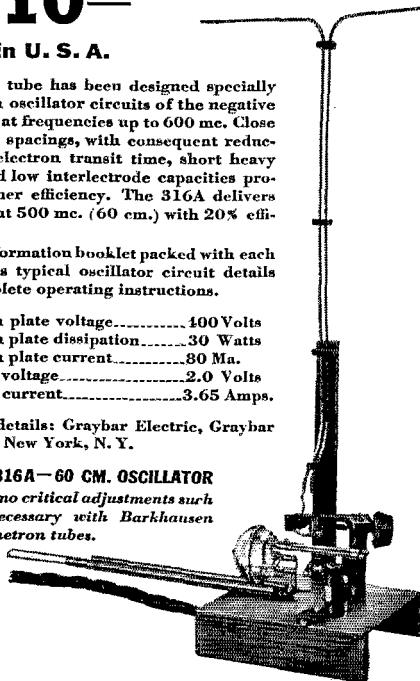

## Western Electric

**BROADCASTING EQUIPMENT**

Distributed by GRAYBAR Electric Company

Mahieu, ON4AU, and Louis Kiss, HAF8C. The contacts of HAF8C with VU2BL and VK4EI were the first Hungary-India and Hungary-Australia 28-mc. QSO's . . . . . W5ASG need worry no longer. From W2BSR, W8KKG, and W3EJO, we learn that URS-896, at Sovhoz, Baumanabad, Tadzhikistan (Tajik), is three kilometers from Afghanistan, north-north-east of Kabul. The operator, R. M. Duhanov, used to be YE2AO. Thank you, gentlemen . . . . . From old CP1AC, via W1BUX, we learn that official licensing of Bolivian amateurs has become effective. CP1AC is now CP3ANE, and CP1AA is now CP3AAA . . . . . W1BUX worked VR2FF in the Fiji Islands for his 135th country . . . . . Cards for ZS1AA may have gone astray because of incorrect addressing—they should be sent to Sub-Lieutenant G. Brunyec, R.N.V.R., The Castle, Capetown . . . . . We had the pleasure of a two-way visit from Mr. J. M. Ross, ZT6A, recently. Ross, one of the leading and very active members of the S.A.R.R.L., and a member of the Council, gave us a much clearer picture of conditions in South Africa than we had had before . . . . . W5EIP thinks he made the first W5-VQ8 contact when he worked VQ8AF the other day. Check? . . . . . G6DX, Patrick Crisp of Ousebank, St. Ives, Huntingdonshire, England, says, "A souvenir QSL card will be sent to the 46 American stations that contacted G6DXP during the R.S.G.B. National Field Day on the receipt of a card from them." . . . . . The WAC record of W9DBC, 5 hours, was pretty fair for the 9th district until W9KG made his in 2 hours and 10 minutes on the 14th of May! KG slipped over the next night—it took him 2 hours and 35 minutes . . . . . W1DDH believes most anything but the QSL card of G6JF, which claims for DX WAC, WBE, and Mars! My, what a skeptic . . . . . VU7FY, via W4CCH, informs us that he will be glad to send a card to any W station he has worked but not yet acknowledged. Address your card to A. O. F. Spindler, Coramandel, South India . . . . . Don't forget the German DX contest, sponsored by the D.A.S.D. For full rules, see the Communications Department in this issue . . . . . Low power is not a lost art. W9RJP used 20 watts to a 46 for his WAC, W8JIW seldom more than 15 . . . . . An unusual WAC record is that of KA1AN. He worked T12RC, OA4AA, W9TIL, VK2RS, ZT2G, VU2JN, and G5MI in 4 hours and 32 minutes, on 'PHONE!

### Metal Tubes

(Continued from page 18)

Handbook; on the 6L6 in June, 1936, QST; on the 6Q7, 25A6, 6X5 and 25Z6 in February, 1936, QST; on the 6R7 in March, 1936, QST; and on the 6N7 and 5W4 in this issue. All in all, quite an assortment of tubes is now available in the metal series, practically all the popular glass types being duplicated, plus a few not made in glass.

# Crystal Control

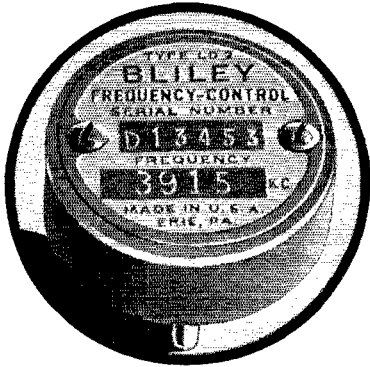

## BLILEY ELECTRIC COMPANY



Manufacturers of

BLILEY QUARTZ CRYSTALS

UNION STATION BLDG.  
ERIE, PENNA.

July 20, 1936

An Open Letter  
To All Amateurs:

In the present overcrowded amateur bands the characteristics of your signals determine to a large extent your ability to make contacts, both local and DX.

Listen to the sharp, clean-out notes on the air—notice how they cut through QRM and QRN and how easy they are to read. Invariably you will find that these signals are from crystal controlled transmitters.

The quality of your note depends, to a great extent, upon the oscillator stage. The use of a good, reliable crystal in this stage is the shortest path to a real signal.

Very truly yours,

BLILEY ELECTRIC COMPANY

*F. D. Bliley*  
F. D. Bliley  
General Manager

FDB:NF

BLILEY ELECTRIC CO., ERIE, PA.

## GULF RADIO SCHOOL

Radiotelegraphy      Radiotelephony  
Radio Servicing

SECOND PORT } 1007 Carondelet Street  
U. S. A. } NEW ORLEANS, LA.

## SICKLES COILS

ALL TYPES OF RF AND IF WINDINGS

Manufactured by

F. W. SICKLES COMPANY

300 Main Street

Springfield, Mass.

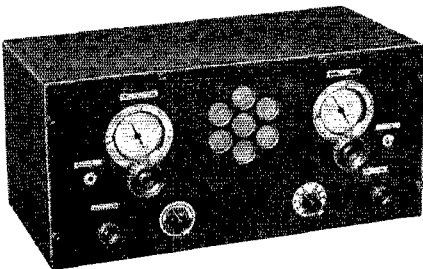

Model 11 Net Prices for 110 V. 60 cycles operation

Model 11-UA, UNIVERSAL tuning range, 9.5 to 20,000 meters \$75.00  
Model 11-MA, MARINE tuning range, 9.5 to 3,750 meters \$54.00  
Model 11-AA, AMATEUR tuning range, 9.5 to 550 meters \$46.00

Prices include power supply, speaker and R. C. A. tubes.  
IMMEDIATE DELIVERY.  
Model 11 is available in all A. C., D. C. and battery voltages.  
Write for full description.

# 9.5 to 20,000 Meters

## MODEL 11 UNIVERSAL

### Wireless Operators . . .

From the ultra-highs to the audio frequencies—that is the tuning range of Model 11 Universal. This is the set you have dreamed about. Sets a new standard in tuned R.F. performance. R.F. stage, regenerative detector, 2 audio, dial calibrated over entire range, break-in switch, phone jack, all-wave band spread. A receiver you will be proud to own—ruggedly built, will last for years. A knockout for C.W. and plenty good on phone and broadcast. Many believe it to be the finest receiver of its type ever manufactured.

### Amateurs . . .

A companion receiver for that big super-het. Extend your tuning range. No amateur station is completely equipped for emergencies without coverage of 600 meters, the airplane beacon waves and the longer Navy wavelengths. Model 11 is an excellent stand-by receiver and once installed you will probably use it more than the large receiver.

## E. M. SARGENT COMPANY

212 9th STREET

OAKLAND, CALIFORNIA

**MODEL 10** This popular receiver unchanged in our line, now available in one tuning range only—9.5 to 550 meters. Longer waves covered more efficiently by model 11. Model 10 for 110 volt 60 cycle operation \$37.50 net complete with power supply, speaker, tubes. Available also for D. C. and battery.

# DUST . . .

"THE ENEMY OF PRECISION"  
IS SEALED OUT OF

**TRIPLITT** FACTORIES

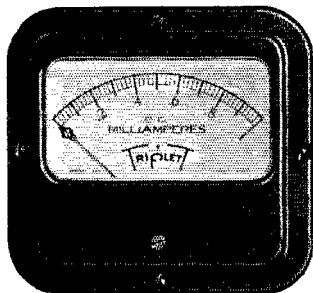

Model 421 —  
4" Square 0-1  
D.C. Milliammeter

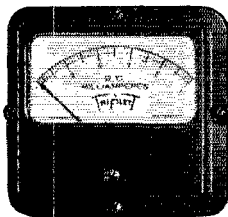

Model 326 — 3"  
Square 0-1 D.C.  
Milliammeter

Photos show relative size of "NEW" 3" square instruments. Triplitt 3" instruments now available in all popular ranges at attractive prices.

QUALITY in fine instruments is dependent upon infinite care in manufacturing. Dust, because of its minuteness, is truly the enemy of precision.

In the new Triplitt factory, dust is sealed out; the entire manufacturing space is air-conditioned and the air is filtered. The temperature — another important factor in building precision instruments — is permanently controlled, both winter and summer. A truly modern plant, modernly equipped for producing today's most modern instruments.

Try Triplitt Instruments for a New Conception of Quality.

TRIPLITT MANUFACTURES a complete line of all sizes and styles electrical measuring instruments for radio, electrical and general industrial purposes both standard and custom built. If you have an electrical instrument problem, write to TRIPLITT.

See them at your jobbers Write for details

Triplitt Electrical Instrument Co.  
258 Harmon Drive, Bluffton, Ohio

Without obligation please send me:

- More information on NEW Square Instruments.
- New 1936 Catalogue.

Name.....

Address.....

City.....State.....

## Standard Frequency Transmissions

Date	Schedule	Station	Date	Schedule	Station
Aug. 5	BB	W9XAN	Sept. 4	BB	W6XK
Aug. 7	BB	W6XK	Sept. 5	A	W9XAN
	A	W9XAN	Sept. 5	BX	W6XK
Aug. 8	BX	W6XK	Sept. 6	C	W6XK
Aug. 9	C	W6XK	Sept. 11	A	W6XK
Aug. 14	A	W6XK	Sept. 18	B	W9XAN
Aug. 21	B	W9XAN		B	W6XK
	B	W6XK	Sept. 23	C	W9XAN
Aug. 26	C	W9XAN	Sept. 25	B	W9XAN
Aug. 28	B	W9XAN		A	W6XK
	A	W6XK	Sept. 30	BB	W9XAN
Sept. 2	BB	W9XAN			

### STANDARD FREQUENCY SCHEDULES

Time (p.m.)	Sched. and Freq. (kc.)		Time (p.m.)	Sched. and Freq. (kc.)	
	A	B		BB	C
8:00	3500	7000	4:00	7000	14,000
8:08	3600	7100	4:08	7100	14,100
8:16	3700	7200	4:16	7200	14,200
8:24	3800	7300	4:24	7300	14,300
8:32	3900		4:32		14,400
8:40	4000				

Time (a.m.)	Sched. & Freq. (kc.)	
	BX	
6:00	7000	
6:08	7100	
6:16	7200	
6:24	7300	

The time specified in the schedules is local standard time at the transmitting station. W9XAN uses Central Standard Time, and W6XK, Pacific Standard Time.

### TRANSMITTING PROCEDURE

The time allotted to each transmission is 3 minutes divided as follows:

- 2 minutes—QST QST QST de (station call letters).
  - 3 minutes—Characteristic letter of station followed by call letters and statement of frequency. The characteristic letter of W9XAN is "O"; and that of W6XK is "M."
  - 1 minute—Statement of frequency in kilocycles and announcement of next frequency.
  - 2 minutes—Time allowed to change to next frequency.
- W9XAN: Elgin Observatory, Elgin National Watch Company, Elgin, Ill., Frank D. Urie in charge.  
W6XK: Don Lee Broadcasting System, Los Angeles, Calif., Harold Perry in charge.

## Schedules for WWV

EACH Tuesday, Wednesday and Friday (except legal holidays), the National Bureau of Standards station WWV will transmit on three frequencies as follows: noon to 1:00 P.M. E.S.T., 15,000 kc.; 1:15 to 2:15 P.M., 10,000 kc.; 2:30 to 3:30 P.M., 5000 kc. On each Tuesday and Friday the emissions are continuous unmodulated waves (c.w.); and on each Wednesday they are modulated by an audio frequency. The audio frequency is in general 1000 cycles per second.

## Strays

The 6L6 is now available in a glass envelope from Raytheon. Carrying the designation 6L6G, the tube has the regular octal base. There is a possibility that the r.f. characteristics may be improved with the iron "Can" removed from close proximity to the tube elements.

"The 6L6 Beam Power Amplifier" is the title of a 22-page engineering bulletin just published by the Ken-Rad Corporation, Owensboro, Kentucky. Detailed operating information and characteristic charts are included. The bulletin may be obtained free of charge from the publishers.

# East meets West — with Gammatrons!

Yes, both winners use the famous "354" Gammatron to insure "getting through"!

You too, can own a winner. See your dealer.



Dave Evans, W4DHz, 1936 Official U.S. DX contest winner from Georgia, is congratulated by O. P. Taylor (left), W6BAX, 1930 Official DX contest winner and now a member of the technical staff of Heintz and Kaufman, Ltd. The picture was made at the HK plant during Mr. Evans' recent California visit.

Type 354 Gammatron

\$24<sup>50</sup>/<sub>net</sub>  
f.o.b. plant



Send a card today for Bulletin No. 354-0

## So Much for So Little!



You "hams" named your own very low price on these genuine oil-filled transmitting condensers. How? By accepting them as standard equipment, and ordering huge quantities. Pure linen paper dielectric. Oil impregnated and filled. Sturdy aluminum can. Flutter-proof winding. High-tension pillar terminals. Seepage proof. What quality at those prices! Ask your local supply house or write us direct for "dope."

**AEROVOX**  
CORPORATION

73 Washington St.

Brooklyn, N. Y.

## IMPROVE YOUR MODULATION

WITH A  
SERIES 7  
DYNAMIC  
MICROPHONE

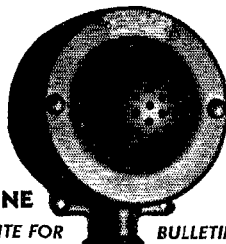

HIGHER  
OUTPUT  
WITHOUT  
PRE-AMPLIFICATION

WRITE FOR BULLETIN 3012

**RADIO RECEPTOR CO., INC.**

110 Seventh Ave., New York City

## Radio Operator's Course

Complete in  
Telegraphy—  
Telephony

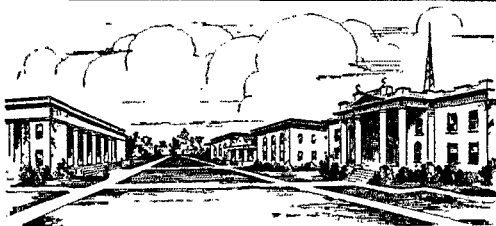

Practical  
Experience  
Studio—  
Transmitter—  
Announcing

P. A. C. is an endowed, educational institution — not privately owned, not operated for profit, college rank maintained. Course consists of maximum knowledge necessary to secure Commercial Telegraph Second-class, and Radio-telephone First-class government licenses. Course includes Wireless Code, Radiophone, Announcing, Microphone-Studio Technique, Service, Police, and Aeronautical Radio. We are authorized to teach RCA texts. At the completion of course you receive practical studio technique experience in our commercial broadcast studios located in the administration building, and experience as an operator on K P A C (500-Watt Commercial transmitter located on the campus, owned and operated by the college), and inter-departmental marine communication experience. If interested, write for Bulletin R.

**PORT ARTHUR COLLEGE**

Port Arthur (World-known port) Texas

# Investigate the D-2

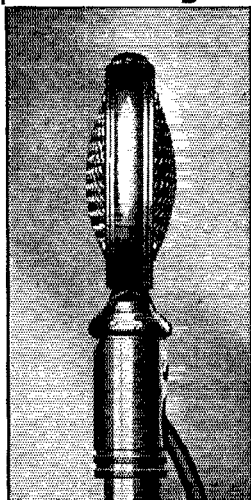

## the NEW ASTATIC DUAL DIAPHRAGM CRYSTAL MICROPHONE

Styled like a watch and weighs only 9 oz. It utilizes the exclusive Astatic dual diaphragm principle, operating on a grafoil bimorph crystal. Essentially non-directional, with fine frequency response substantially flat, from 50 to 6000 cycles. Fully guaranteed and recommended for quality and ruggedness.

### See Your Jobber

ASTATIC MICROPHONE  
LABORATORY, INC.  
YOUNGSTOWN, O.



## A.R.R.L. QSL Bureau

FOR the convenience of its members, the League maintains a QSL-card forwarding system which operates through volunteer "District QSL Managers" in each of the nine U. S. and five Canadian districts. In order to secure such foreign cards as may be received for you, send your district manager a standard No. 8 stamped envelope. If you have reason to expect a considerable number of cards, put on an extra stamp so that it has a total of six-cents postage. Your own name and address go in the customary place on the face, and *your station call should be printed prominently in the upper left-hand corner.*

- W1—J. T. Steiger, W1BGY, 35 Call Street, Willimansett, Mass.
- W2—H. W. Yahnel, W2SN, Lake Ave., Helmetta, N. J.
- W3—R. E. Macomber, W3CZE, 418 10th St., N. W., Washington, D. C.
- W4—B. W. Benning, W4CBY, 520 Whiteford Ave., Atlanta, Ga.
- W5—E. H. Treadaway, W5DKR, 2749 Myrtle St., New Orleans, La.
- W6—D. Cason Mast, W6KHV, 423 East E Street, Ontario, Calif.
- W7—Frank E. Pratt, W7DXZ, 5023 So. Ferry St., Tacoma, Wash.
- W8—F. W. Allen, W8GER, 324 Richmond Ave., Dayton, Ohio.
- W9—George Dammann, W9JO, 319 Sherman Ave., Evanston, Ill.
- VE1—J. E. Roue, VE1FB, 84 Spring Garden Rd., Halifax, N. S.
- VE2—W. H. Oke, VE2AH, 5184 Mountain Sights Ave., N. D. G., Montreal, P. Q.
- VE3—Bert Knowles, VE3QB, Lanark, Ont.
- VE4—Dr. J. J. Dobry, VE4DR, Killam, Alberta.
- VE5—E. H. Cooper, VE5EC, 2024 Carnarvon St., Victoria, B. C.
- K4—F. McCown, K4RJ, Family Court 7, Santurce, Puerto Rico.
- K5—John J. Carr, K5AV, 78th Pursuit Squadron, Albrook Field, Canal Zone.
- K7—Frank P. Barnes, K7DVF, Box 297, Wrangell, Alaska.
- KA—George L. Rickard, KA1GF, P. O. Box 849, Manila, P. I.

MR. E. H. RIETZKE

PRESIDENT OF CREI

## ARE YOU KEEPING PACE WITH RAPID TECHNICAL DEVELOPMENTS?

### Just Released!

An unusual survey showing salary advances... employment changes and progress in every branch of radio. A limited number of copies are available — sent free on request!

Radio is moving fast while many radiomen lag behind, and let others profit by this new prosperity. The fact that you are considered a good man today does not protect your future. You must either go ahead with your profession or it will leave you stranded. You can insure your future by increasing your **TECHNICAL ABILITY NOW.**

"Good Intentions Won't Get You a Good Job"...

Take definite steps now by studying with CREI. Residence course begins Sept. 21st. Begin home study anytime.

Send For FREE 48-Page Booklet

## CAPITOL RADIO ENGINEERING INSTITUTE

Dept. Q-8

WASHINGTON, D. C.  
14th and Park Road

NEW YORK CITY  
29 Broadway

CREI

## ~~Strays~~

VK3AL has picked out quite an itinerary for himself on his tour of this country this summer. Arriving in Monterey in early August, his route will take him through Los Angeles, San Francisco, Salt Lake City, Denver, Chicago, Detroit, Boston, New York, Washington, Pittsburgh, Cincinnati, Dallas, El Paso, and San Diego. Fellows who'd like a personal QSO are invited to drop him a card at the Hotel Clarke, Los Angeles, before August 10th, or the Hotel Times Square, New York, before September 5th.



# CARDWELL COMMERCIAL TYPES

FOR ONE K.W. PHONES

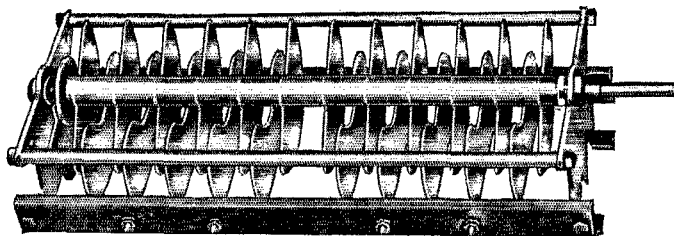

**TZ-40-RD, \$25.80 NET**  
(H. V. TANK CONDENSER)  
40-40 mmfd.

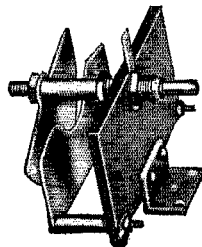

**VZ-5-RS, \$9.90 NET**  
NEUTRALIZER  
NORMAL CAP. RANGE, 2-5 mmfd.  
GAP ADJUSTABLE FOR OTHER CAP. RANGES

## AIR-GAP- .500 INCH INSULATION—MYCALEX

Designed for the new low "C," 3000 V. tubes, these new Cardwell units represent the fulfillment of your need for the best high power condensers money can buy, at a price you can afford. Don't risk expensive failures with cheap equipment! Use Cardwells!

AT YOUR DEALER—OR ORDER DIRECT FROM

**THE ALLEN D. CARDWELL MANUFACTURING CORP.**  
83 PROSPECT STREET + + + + + BROOKLYN, NEW YORK

UNIVERSITY COURSE IN

## RADIO COMMUNICATION

High Standard of Instruction and Equipment

Registration begins September 16, 1936

Write for descriptive folder

UNIVERSITY OF WISCONSIN EXTENSION DIVISION  
623 West State Street Milwaukee, Wisconsin

## MICHIGAN HAMS!

The BRETING 12 is the receiver with the exclusive features you hear so much about on the air!

"Ask the ham who has heard one!"

Complete with meters, crystal, tubes, cabinet and 12" Magnavox, prepaid, \$93.00

JOHNSTONE STUDIOS—Distributors  
315½ E. Genesee Saginaw, Mich.

## THE LITTLE RIG CHECKER

ANOTHER USEFUL GADGET BY A. J. HAYNES

If you MUST economize or don't think field strength measurements are necessary the LITTLE Haynes Rig Checker will still do most everything else around the shack but call C.Q.

Operates direct from your A.C. line — No batteries.

**FEATURES:** 1. Monitor: Voice quality, hum, key clicks, etc. 2. Over modulation indicator. 3. V.T.

Voltmeter, A.F. or R.F.; linear scale. 4. D.C. Voltmeter. 5. Receiver Tuning and Signal Strength Indicator. 6. 0-1 Milliammeter — may be used separately with or without variable shunt or fixed series resistors.

Operates direct from your power line — no batteries.

The LITTLE Haynes Rig Checker, complete with tube . . . . . \$9.85

The BIG Haynes Rig Checker, complete with self contained batteries and tube and 7 plug-in coils. . . . . \$17.90



## NEON TUNING WAND

Gives More Watts Output to Your XMITTER

- ★ RESONANCE
- ★ NEUTRALIZATION
- ★ OSCILLATION

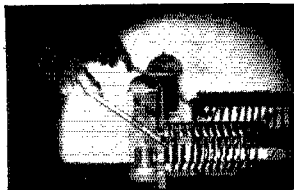

CAT. NO.  
5149

**\$1.00**

Guaranteed  
(Postage Prepaid)

Heavy 10 inch sensitive neon tube with insulated caps. Lights very brightly on R. F. One and increases inductance, and the other decreases inductance — merely by inserting the tip of tube into coil. A handy instrument, gives you the most watts output to your rig.

ORDER TODAY

**SUNDT ENGINEERING CO.**

(Affiliate of Littelfuse Labs.)

4246 Lincoln Ave.

Chicago, Illinois

**RADIO CONSTRUCTORS LABORATORIES**

Dept. Q-2, 136 Liberty St., New York, N. Y.

Export Dept., 105 Hudson St., N. Y. C.

# STATION ACTIVITIES

(Continued from page 58)

## NEW ENGLAND DIVISION

**CONNECTICUT**—SCM, Frederick Ellis, Jr., W1CTI—The Connecticut Association of Radio Clubs came into being at a meeting held in New Haven, May 22nd. A committee was appointed to draft a constitution and by-laws and to nominate officers to be elected at the first regular meeting of the Association, Sept. 11th, at the Bristol Radio Club. The committee has completed its work, and desires to hear from every active club in the state so that they may send them copies of the constitution and by-laws as well as all other information relative to the Association. Club secretaries who have not heard from the committee should get in touch with Milton Chaffee, W1EFW, Milldale, if interested in receiving this information. Most interest during the month centered in CTNITE held May 23rd. Fifteen stations reported results, many more took part, and all had a swell time. GKM won the crystal donated by BHM to the station with the largest number of contacts. R.M.'s, S.C.M. and Headquarters gang did not compete for the prize, but took part in the party. AFG set up a portable 30-watt transmitter in 19 different locations and had more fun than a three-ring circus. Several stations came on the 3.5-mc. band especially for the party and ran up good scores. All O.R.S. and other active traffic stations are asked to give the S.C.M. their ideas on the best times to operate a Section Net this fall. If necessary, a morning and evening net will be put into operation, but we must hear from all the gang in order to set a time that will suit the majority. BDI opened W.I.A.E. exhibition at Sydney, Australia, with 10-minute talk from W2XAF. HVF sends in first report with CTNITE score. GKM starts third year of VE2BU schedule. B.A.R.A. held its annual banquet on the 13th with JPE as guest from Headquarters. IKY needs only 39 more states for W.A.S.! Scores reported in CTNITE (figure indicates number of contacts): W1UE 27, TS 23, GME 23, GKM 21, IKJ 20, AFG 19, EAO 19, IBT 18, IKM 15, HVF 15, TD 9, CTI 9, BQS 7, JIR 5, JFN 4.

Traffic: W1INF 125 DMP 63 AFG 51 IKE 20 GME 19 BDI 16 GVV 14 BNB 9 GKM 8 JUD 3 EAO-IBT 5 GTX 4 BQS 3 TD 2 CTI 1.

**MAINE**—SCM, John W. Singleton, W1CDX—GOJ has been appointed R.M. for southern Maine. INW renewed his O.R.S. for another year. AQW says six C.C.C. boys are taking Class C exams. AQL attended Manchester Hamfest with QH. KAD is new ham in S. Portland. KAM is new ham in Lewiston.

Traffic: W1GOJ 45 CDX 12 INW 32 AQW 30.

**EASTERN MASSACHUSETTS**—SCM, Albert N. Giddis, W1ABG—JSK is working on a new high-power rig. HWE keeps 56-mc. traffic moving. AKS hasn't got warmed up to new QTH yet. DDE is rebuilding. KH must hold the world's record for attending conventions and hamfests! JCK schedules IUQ/1 at C.C.C. Camp. JL is signing WFCP now. EVJ worked J8AA for first Asiatic contact. JID is looking forward to N.C.R. cruise. AKE has taken over ABG's old job. CIK is up to his neck in N.C.R. work. ISM was graduated from school. GQM is back on 56 mc. GGB is having trouble with his crystal. ZW is Official Observing with a vengeance! WV continues on his DX march. MD needs three more states for W.A.S. BMW is on only for N.C.R. drills. JTM, at Ft. Devens, applies for O.R.S. JXU and ALP are both on 7 mc. with '47 crystal osc. and '10 amplifier jobs. HKY needs only four more continents for W.A.C.I. IWC schedules RE and ISM. ZQ has a job and has been working afternoons and evenings, so has no time for wireless. Keep in mind that O.R.S. are required to report whether traffic is handled or not. I want to hear from all O.R.S., and other stations interested in becoming a part of the Section Network, stating the times you can be on the air for schedules. All stations at or near cities or towns whose Police Dept. is not equipped with teletype or similar apparatus are requested to notify the S.C.M. so that they may be included in a proposed Police Network. Get your rigs oiled up—there's going to be plenty doing in this Section from now on!

Traffic: W1JSK 386 HWE 154 AKS 141 DDE 106 IWC 101 KH 62 JCK 56 RE 41 FRO-JL 37 ABG 33 EVJ 27 HCH-JID-AKE 17 CIK 13 ISM 12 GQM-GGB 6 HKY 5.

**WESTERN MASSACHUSETTS**—SCM, Percy C. Noble, W1BVR—IZW leads the Section in traffic. R.M. JAH is getting things lined up for fall activities. IOR sends first report and is looking for 3.5-mc. schedules. BVR is

Acting Radio Aide of First Corps Area A.A.R.S. during the summer. IOT is knocking off the ole DX on 14 mc. BVG is busy grinding crystals and doing B.C.L. repair work. IJR is now WLGN on 3497.5 kc. as West. Mass. S.N.C.3 in A.A.R.S. GZL attended Montreal Convention. AJ has a new superhet now that the Bonus has arrived. HJR is working all bands except 28 and 7 mc. ISN reports the P.B.N. Net active during the summer. EOB is looking for early morning and evening schedules on 3.5 mc. ASY is again active as O.R.S. and O.P.S. BAP is still rebuilding rig wrecked by the flood. BNL is adding meter and coil switching to facilitate band changing. COI is still rebuilding. JKN has new '10 push-pull rig on 56 mc. I wish to thank all of you for your cooperation and loyalty during my two-year term as your S.C.M. Best of luck and 73.

Traffic: W1IZW 113 JAH 86 IOR 78 BVR 63 (WLG 187) IOT 39 BVG 38 (WLG 35) IJR 11 ASU 10 GZL 8 ARH-DIF-NS 7 AJ-DDK-HJR-ISN 6 APP-ICP 5 ATK-EOB 4 DJQ-FXO 3 FNY 1.

**NEW HAMPSHIRE**—SCM, Robert v. Byron, W1AVJ—CEA says the 1.75-mc. gang has gone c.v. for the summer. IP is playing around with 56 mc. for a while. IJB is pounding out traffic with the A.A.R.S. EWF in Hanover says that the Field Day went over big with him; he worked 44 stations with 12 watts input. APK announces the arrival of a new Jr. op at his house on June 9th. BFT has been in the hospital but is now well on the road to recovery. DUK is looking for DX with his HRO. Send your next report to W1AXW, Homer Richardson, 31 Sixth Street, Dover, N. H., who will be Acting S.C.M. until a regular election can be held.

Traffic: W1IJB 332 IP 124 GHT 34.

**RHODE ISLAND**—SCM, Clayton C. Gordon, W1HRC—CAB, Pres. of the P.R.A., has moved to a new QTH, as is his usual annual custom, and now holds Lieut. J. G. in the Naval Communications Reserve. He led the P.R.A. and their families and friends on an outing Sunday, June 21st, to Goddard Park, where a picnic lunch topped off the events of the day. IZO has a new shack in the basement. II-ZS has 56-mc. transmitter-receiver in gas buggy; he established contact from Pownal, Vt., to BFT in Providence, using only 2 watts input, while with the boys at N.G. Camp, using 4035 kc. GTN likes the 59 e.c., RK-20 rig recently completed better than any 50-watter he ever had before. IEX and HVK graduated from Hope High and IEX worked Germany on 7 mc. and got a card with R8 in Madrid, Spain. BLS now has 53 crystal osc. and doubler which drives his RK-20 better than the 59 Tri-tet did. BVI is on 1.75-mc. 'phone. IWZ is making low-power tests. JNO blew 5 tubes trying to get Class 'B' working. HJ is on leave from "Argo." JGE built the rig, and now has to build a shack to hold it. HRC has rebuilt completely. Fellows, if you want O.R.S., please write your request direct to the S.C.M. and application blanks will be mailed promptly. Reports are being received that the call W1BML is being bootlegged on 14-mc. 'phone. This is a very unfortunate choice of calls to bootleg, since the receipt of these cards stirs up very tender memories in BML's family. BML passed away last year.

Traffic: W1IEG 27 IZO 21.

**VERMONT**—SCM, Alvin H. Battison, W1GNF—R.M.: IFSV. The following Vt. fellows attended the N. H. Convention: AVP, AHN, FSV, GVD, GNF, FN, EFC, ELR, CUN, GAN, FSW, BDX and GAE; a fine time was enjoyed by all. FSV, our new R.M., is high traffic man. BNS resigned as R.M.; he is QRL flying. AVP sports a new "Chevy" and a bag of tricks—ask the S.C.M. IAHN visited ET, AVG, and IP and received visits from ISJ, ET, AVP, GVJ and FSV. Dick of ET, Dartmouth College, will sign IRO in Rutland soon with 500-watt 'phone. EZ is our first Vt. station to W.A.S. FPS needs one more state for W.A.S.; he handled message from Honolulu with speed plus. GAE and CUN are radio servicemen. CUN is now operating from Barre. RJU, a new operator from Swanton, visited AVP. CBW is on 7 mc. BJP sends another fine O.O. report; he is now on 3.9-mc. 'phone. EZ and IZM ran up a fine score in the Field Day. BJP is our first Vt. station to W.A.C., with EZ a very close second. AOO is working 56 mc. AHN had great time with AVP's mobile 56-mc. rig on trip to Manchester. GVJ has purchased a couple of 50-watters. It is rumored that ERJ and exBZD both got hitched. Congrats. GNF is operating on 14, 7 and 3.5 mc., mostly the latter. EHB is Diesel engineer at machine shop. JHK moved from Conn. to Brattleboro; he applies for O.R.S. DQK's traffic report was too late for mention last month—82; he has new R.C.A.-175 receiver. JKE is coming along fine. Dr. Tracy is a new amateur in North Troy—call unknown. Summer activity will

contribute toward and give you an edge on the other fellow, in our Vermont Activity Contest.

Traffic: W1FSV 174 GNF 71 GAE 37 BJP 27 AOO 26 AVP 19 JKE 9 EZ 5 FPS-AHN 1.

#### ROANOKE DIVISION

**N**ORTH CAROLINA—SCM, H. S. Carter, W4OG—Siler City: QI and his gang gave the fellows a good time at the Floating Club Meeting, June 7th; QI also reports working his first VK 'phone. DKF has a new daughter. BYE is rag-chewing on 3.5 mc. An operation delayed work on DOR's rig. Kings Mountain: CEI reports for the gang for the first time. FB, OM, DOV is DXing on 14 mc. DOQ has a new home-made super. DOV added a pair of tens to the final and gets out FB on 3.5 mc. CEI is trying for DX on 14 mc. and experimenting with 3.5-mc. portable rig. Oxford: ECH, a new ham, is using an RK-20 crystal Tri-tet with 80 watts input on 3.5 mc. Greensboro: MR reports plenty of DX worked on 14 mc. ZH is working the world with his kw. on 14 mc. Belmont: CXO was sick all month, but is up again now. Mount Holly: CYY finds things quiet since A.A.R.S. went off the air. DLY is working on 7 mc. DJY is working portable in 7th district. Wilmington: CPT, the traveling reporter, continues his FB report; during the month he traveled from Florida to Mass. BPL finished his transmitter, and it is living up to his expectations. BQZ has an FB station; the entire outfit is home made. FT is working 'phone on 28 mc. US is suffering with power supply trouble. EEL is a new ham on the air, but was old 4JG of the good ole' days. They always come back. The Wilmington gang will entertain the Floating Club, August 2nd, and they invite the entire gang to come down and enjoy swimming and a swell ham get-together. Winston-Salem: 4NC worked Field Day from Hanging Rock Mountain. AHF has moved into his new home. CTP graduated from Duke University. CYA graduated from high school. DKI is on 7 mc. regularly. DGV has Class A ticket and plans to go on 3.9-mc. 'phone. AI has moved to Columbia, S. C. North Carolina and 4NC lost a good man. DWB is working portable from Abingdon, Va., during the summer. With the 'Phones: CLB, the P.A.M., didn't report last month as he was on the Atlantic Ocean. AEN has increased power using two RK-20's. BX is building a shack in the attic. ALD is adding push-pull final. BMR is getting out FB on 14 mc. BXF has moved to new QRA. DKB is having trouble with his modulator. BFB is QRL work. DIS is increasing power. ANU had trouble with images on BC when he rebuilt. BQE is going strong on 1.75 mc. CUB is working 3.9-mc. 'phone and schedules TI2AV every other night; they work duplex with TI2AV on 14,120 kc.; CUB says working Costa Rica is a record from Durham.

Traffic: W4NC 26 ABT 22 DWB 12 CUB 10 DCQ 5 OG 4 ECH-BHR 3.

**VIRGINIA**—SCM, Charles M. Waff, Jr., W3UVA—P.A.M. 3AJI. R.M.'s: 3DQB, 3AKN, 3BJX, 3BGS, 3BYA. AAF is putting in a 549 final. AKN put in an RK23 Tri-tet so, so he can get on 7 and 14 mc. CA has finished his new exciter; he blew a 50-watter. FTC has new center-fed antenna. EVT is building a 14-tube superhet; he worked FK8AA for his 76th country. GGU is ex-W4AFQ and is getting out FB on both 'phone and c.w. BZ is active on practically all bands, choosing the one conditions are best on when he operates. DBV is giving his shack a general overhaul. FGJ is using 50 watts on 1850-ke. and 3950-ke. 'phone. FGW is still rebuilding. BFW went to a cabin in the mountains on his vacation. ENO is back on with a '10 Hartley. FQO schedules 3FBL, 4DIT, 4ECH-DVV. BIG is rebuilding. WS wants U.S. stamps. BTR has trouble getting exciters to work to suit him. ALJ schedules BIG. FBL has new YL, so local static is pretty bad! EZL is on 59 mc. He has been heard in Baltimore R6 with 75 watts to a pair of '10's. UVA has a 150-T and RK20, consequently he is rebuilding also. KU chews the fat all over everywhere. EMA wants to know where the Va. 3.9-mc. 'phones are? EXW worked CN8AH, SX3A and ON4CJJ for new countries. BSY is back in University for the summer. 4DGW visited BSY. Roanoke Division Convention is in Clarksburg, W. Va., August 28th-29th. CNY, COJ, BUR, DVW, FMY, BRA, FJ, CFL, WS and UVA attended the Wilmington Convention. Remember, fellows, all who report to the S.C.M. before the 20th of each month will receive "QRX" free, so be sure to send your reports promptly in the future.

Traffic: W8AKN 55 BJX 15 FQO 7 FGJ 6 GGU 2 FTC 1. WEST VIRGINIA—SCM, W. H. Rihedaffer, W8KKG—PME, back home from college, is putting up two new 66-foot towers. JCB is on 1825 kc. with an 801 final. JJA is at Ohio U. for the summer term. PSR and PQQ apply for

O.R.S. LSJ sold his power supply. JWL had JDJ as a visitor. BDD is moving to a new location just for an antenna. KIU is on 14-mc. 'phone with a pair of 803's. CVX has a brand-new son. NTV is driving an RK-20 with a 59 Tri-tet. HD schedules D4BUF. KWU visited KKG. PZT and PZP are new calls in Weston and Lost Creek respectively. FQB will go to Fort Knox for O.R.C. training. NCD has 838 final. PQQ, PMA, OBA and NCD, operating Field Day, made 61 contacts and would have had 62, but PQQ fell asleep working one and couldn't remember the call. JRL and KKG attended Virginia Floating Club meeting at Staunton. BOK wants to buy a hill-top. MZD sold his receiver. PAJ is W.A.S. OK attended A.A.R.S. picnic in Cleveland. BTY is back from Ohio State for the summer. KSJ is back on high power, and sounds like it. GDF took Class B and A the same day. HBL is attending R.C.A. School. The Mountaineer Amateur Radio Association is busy with plans for the coming Roanoke Division Convention to be held in Clarksburg, W. Va., on August 28th and 29th.

Traffic: W8KBU 17 PSR 3 LSJ 44 HWT 21 JWL 1 KIU 3 CZ 25 OXO 9 LXF 6 LII 11 FQB 19 KKG 86 HD 5 CFB 33 MCL 10 ELJ 17 AKQ 22 MCJ 9 PAJ 7.

#### HUDSON DIVISION

**E**ASTERN NEW YORK—SCM, Robert E. Haight, W2LU—Congrats to EGF on another B.P.L.! LU is busy in the garden. HYC sports new Super Skyriders with crystal filter. FWC makes final report in E.N.Y. GTW reports via radio thru EGF. CC is on 14 mc. working plenty DX. HUM is heard on 3550, 3720 and 7076 kc. UL holds daily schedule with the *Counness*, one of sailboats in race to Bermuda from New London. HCM enjoys FB DX on 14 mc. JFE is heard regularly. IUR sports new Oldsmobile. JWK is on 1.75-mc. 'phone. JWK raises onions for a living and wants to know if any other ham in the East does. JRC, ex2AKA, is back on the air after 19 years away. Welcome back. VJ is also welcomed on the air. CJP serves notice to all Canadian hams: "The your transmitters down, CJP is vacationing there." HCP, located at Dallas, Texas, visits 5DLC. FRU reports for the Tri-States Radio Club. QY will spend two months in hospital. Our best wishes for a speedy recovery, Gerry. IYH is busy on the farm. HON will have 200 watts perking soon. BJX reports Mid-Hudson Amateur Radio Club very much alive. CTC displays an excellent assortment of DX QSO's. All E.N.Y. hams keep the first week-end of October open. The S.A.R.A. is hard at work laying plans for the annual Hudson Div. Convention, to be held at Schenectady.

Traffic: W2EGF 608 LU 137 HYC 21 FWC 12 GTW 10 CC-HUM-UL 8 HNH-HCM 2.

**NEW YORK CITY AND LONG ISLAND**—SCM, Ed. L. Baunach, W2AZV—BGO has a complete portable rig using 42 crystal and 2-tube d.c. receiver powered by 6 volts "A" and 560 volts storage "B" 's. EXR gets better performance from his rebuilt SW3. PF tried 3.9-mc. 'phone but enjoys c.w. more. HBO had to move all junk from the shack to give the painters a chance. EVA is still looking for correct QTH's. JPF reports good QSO's on 3.5 mc. with less than 5 watts to a '45 THT. IHT is at Lake Mahopac, N. Y., for the summer, using portable rig. JBL worked his first VK on 7 mc. AHC sends his report from Hazleton, Pa., and reports that Hudson Division Convention will be held in Schenectady on October 3rd. APV has increased power to 500 watts. The P.O. keeps EYS QRL. GWQ's call is being bootlegged on 14 mc.; he is on 7 mc. only. HNG has 340 watts input to an '03A on 14 mc. IRV is trying to master the bug on 14 mc. KI reports that Trunk Line "C" has been closed for the summer. JGR and AQN are working portable in the eighth district at White Lake, N. Y., this summer. HRT is grid modulating a pair of '46's on 1.75-mc. 'phone. GDF schedules 8JZZ on 3800 kc. HGO spends his week-ends at Setauket, L. I. INF has new ACR-136. New officers for the C.C.N.Y. Radio Club: IYI, treas.; JGR, secy.; and AQN, chief opr. ELK has his rig arranged for all-band operation. IOP is operating portable for the summer at Waterville, Me., using a pair of '46's. GIC handled traffic for E. Vines, the golf star. ITX sends his first report. EAR is using Class "B" tens with 800 volts with 5 percent regulation power supply. If HXT's 1.75-mc. Zepp does not perk he is going to design his own. IZU is using break-in system. HMJ reports a new station in S.I., JVC. IBT is looking for new recruits for the N.C.R. in Queens County; the headquarters station is in the Jamaica Post Office Bldg. IOW has been studying for exams. ECL can be found on 3504 kc. for traffic. ING wants a Hallierafters super. DBF has a

(Continued on page 80)

## dykanol

impregnated and filled, in hermetically sealed containers these condensers are impervious to changing atmospheric conditions, abnormal temperatures, and sudden voltage surges.

Available at all authorized C-D distributors. Catalog No. 128 listing in complete detail C-D condensers for amateur transmitters, sent free on request.

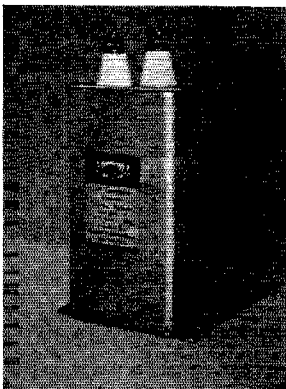

## C-D Transmitting CONDENSERS

Designed upon the experience gained by the exclusive manufacture of condensers for more than twenty-six years. The Cornell-Dubilier Dykanol series of high voltage transmitting capacitors offer the finest in condenser construction to the "Ham", and at a moderate cost.

There is a Cornell-Dubilier Condenser for every circuit requirement  
ELECTROLYTIC \* PAPER \* MICA \* DYKANOL

## CORNELL-DUBILIER

CORPORATION

4373 BRONX BOULEVARD  
NEW YORK

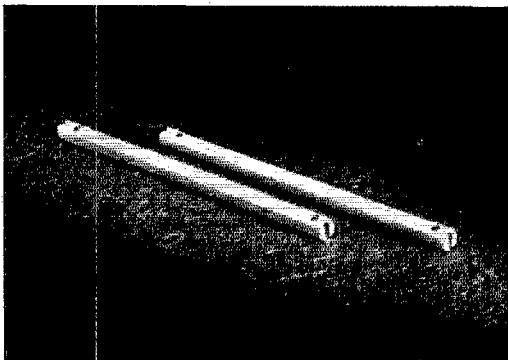

**SPREADER:** Light in weight as well as exceptionally efficient, these NATIONAL spreaders offer unusual advantages. The material is non-hydroscopic and weatherproof. The slender shape minimizes surface leakage. The power factor is of the order of 0.15%. The weight is but one ounce each. Catalog Symbol AA-3.

**Net Price \$1.8**

*Usual Discounts apply*

**NATIONAL COMPANY, INC.**  
MALDEN, MASS.

## Central Division Convention

September 5th, 6th and 7th at Chicago, Ill.

THE Chicago Area Radio Club Council is sponsoring a Nation-Wide Amateur Radio Show in conjunction with the 1936 Central Division Convention. Scientific displays and exhibits of latest ham equipment will be a unique feature of the convention to be held at the Hotel Sherman, Chicago, Ill., September 5th, 6th, and 7th. An unusual feature of the convention will be held Saturday night when those present will be the guests of Thorne Donnelley and the Lakeside Radio Club, who will hold their W9PZ Party in the convention hall. Sunday evening more entertainment will follow with banquet. A.A.R.S., N.C.R., 'phone and c.w. group meetings, code contest, trips for the ladies and technical lectures will round out the program. Notables to be heard will be President Woodruff, W8CMP, and Vice-President Bailey, W1KH, of the A.R.R.L., John Reinartz, Boyd Phelps, Communications Manager Handy and several others.

The show opens Saturday morning and closes Labor Day at noon. Special hotel rates for out-of-town hams will be as low as \$1.00 per night. Registration for the entire show is \$2.00 in advance, or \$2.25 at the door. Send reservations or inquiries to the Chicago Area Radio Club Council, attention of John Huntoon, W9KJY, Room 328, Hotel Sherman, Chicago, Ill.

## Vanalta Division Convention

August 29th and 30th at Vancouver, B. C.

THE Golden Jubilee of Vancouver, B. C., Canada, will provide a magnificent background for the 1936 Vanalta Division A.R.R.L. Convention to be held at Vancouver, August 29th and 30th. A quarter-million dollars has already been spent in providing free entertainment. The Canada Pacific Exposition, this year greater than ever, will be in full swing. It will be a gala occasion. Entertainment for the whole family is assured the ham who brings the YL, XYL and the in-laws.

The convention is being sponsored by the British Columbia Amateur Radio Association and has the full approval of Canadian General Manager Reid and the A.R.R.L. Executive Committee. Prominent speakers will be heard, prizes contested and drawn for and a boat excursion to Bowen Island, one of Vancouver's most prominent summer resorts. The convention headquarters will be at the Hotel Georgia, and registration will commence at 10 a.m. Saturday, August 29th, fee \$2.50. A high light of the convention will be the presentation of a cup, by the B.C.A.R.A., to the outstanding station in British Columbia. This cup will be for annual presentation. Send your nominations to the committee.

Further information may be obtained from the Secretary, Convention Committee, 1349 East 1st Ave., Vancouver, B. C., Canada.

## Peak Value This Year

*(Turn to page 86)*

# "MICROPHONE HEADQUARTERS"

Presents THE NEW SHURE



## Crystal Microphones

with **8** EXCLUSIVE FEATURES

- Ultra "Wide-Range" Reproduction from 40 to 10,000 cycles with response closely approaching True High-Fidelity tolerances.
- New Shure "Cruciform" Crystal Mounting — makes possible highest output level ever attained in a diaphragm-type crystal microphone of comparable frequency response.
- Dual-Drive High-Capacity Grafoil Bimorph Crystal.
- New single high-efficiency Curvilinear Diaphragm.
- Internal Screen-Protected Cartridge Unit.

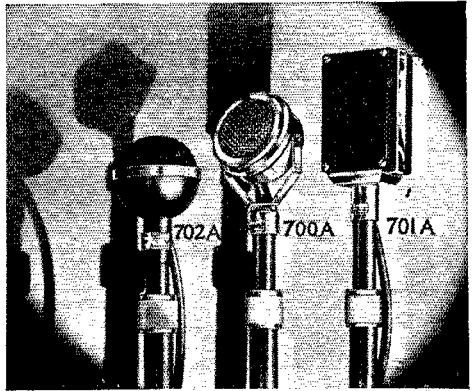

- Complete Barometric Compensation through scientifically designed acoustic network.
- Crystal "Moisture-Sealed" by new special process.
- Semi-Nondirectional and Semi-Directional models with new Spherical, Swivel and "Grille-Type" case designs.

Only Shure "ULTRA" Crystal Microphones give you these new "highs" in performance, dependability and utility at such low cost! Three models... Spherical, Swivel, and "Grille-type"... List Price, each, only **\$25.**

Write for data today!

(Models 701A and 702A available now. Model 700A available August 15.)

Licensed under patents of the Brush Development Company. Shure patents pending.

# SHURE MICROPHONES

SHURE BROTHERS • MICROPHONE HEADQUARTERS  
215 WEST HURON STREET • CHICAGO, U. S. A.

## I WILL SHOW YOU

That it is to your advantage to buy from W9ARA. Write me when you need anything. You will receive full details by return mail. All amateur apparatus in stock at lowest prices. Your used apparatus taken in trade. Time sales of all receivers and transmitters on terms to suit you. Receivers shipped on ten day trial.

TRADE IN YOUR RECEIVER AND TRANSMITTER  
Collins, RCA, RME, Marine Transmitters  
All Star transmitters in kits or assembled

The New National NC-100s.....	\$105.00
RME-69s.....	118.80
Bretting 12s complete with crystal prepaid.....	98.00
National HRO Jrs.....	99.00
National HROs.....	167.70
RCA ACR-175s.....	119.50
PR-16Cs complete prepaid.....	101.70
Crystal Super Pros.....	241.08
S9 metal tube Super Skyriders.....	79.50
The new Sky Buddy.....	29.50
The new Ultra Skyrider.....	99.50

### HENRY RADIO SHOP

211-215 North Main Street BUTLER, MISSOURI

## RADIO ENGINEERING

RCA Institutes offers an intensive course of high standard embracing all phases of Radio. Practical training with modern equipment at New York and Chicago schools. Also specialized courses and Home Study Courses under "No obligation" plan.  
Illustrated Catalog on request

RCA INSTITUTES, INC. Dept. ST-36

75 Varick St., New York 1154 Merchandise Mart, Chicago  
Recognized Standard in Radio Instruction Since 1909



# DON'T SPLASH!

USE A VISUAL

## MODULATION MONITOR

DESCRIBED BY W9QK

\$2.00 net p.p., mounted, with instructions

Dealer discounts

ST. CHARLES LABS., Box 116, St. Charles, Ill.

## NEW! BIRNBACH STEATITE CONE INSULATORS

Ideal insulation for ultra high-frequency circuits because of its superior physical and electrical qualities. Mount in small space. Complete with mounting screw and cork washer.

Write for Bulletin Q-8



5/8" High No. 430 10c  
1" High No. 431-15c  
1 1/2" High No. 432-20c  
2 3/4" High No. 433-25c  
No. 431J-20c No. 432J-25c No. 433J-50c  
("J" denotes Jack Type)

Birnbach Radio Co., Inc. 145 Hudson Street New York City 3

(Continued from page 77)

half kw. rig on 7 mc. AZV is using a vertical antenna for 3.5-mc. operation.

Traffic: W2BGO 123 IBT 112 PF 90 HRS 51 IZU 46 EXR 34 AZV 32 HBO 24 EAR-ECL 22 IHT 21 DBF 22 ADW 14 HUT 11 AA 9 CP 8 AHC-KI-GDF 7 JW 6 IZJ 5 US 4 CIT 5 FLD 3 ENS-HRA 4 BMM-BYL 3 FIP 3 BIK-HJ-ELK 2 JGR-ITX 3 HGO-HKO-IOW 1.

NORTHERN NEW JERSEY—SCM, Chas. J. Hammersen, W2FOP—GWV blew his '03A. HZY will work portable in Maryland for the summer. GGE is trying to hook some DX. HBQ did fine job as chairman of arrangements committee for the QSP Club dinner. GMN is planning to keep in touch with the S.S. *Adventure*. GVZ has worked 83 countries to date. HXI has new Super Sky rider. HTX runs his '03A at 400 watts on 3.5 mc. HQL attended Army maneuvers. ICJ joined the A.A.R.S. IAP is going in for high power. HFT worked his first W6 and VE5. IQM is new O.R.S. Bootleggers are using CIZ's call. 1AMZ now at Albany, N. Y. GAS, AIW and HBQ are working 56-mc. mobile for the summer. ITD is working portable in North Carolina. IDZ is working on self-powered rig for portable and emergency work. CAY won first prize in the N.N.J. QSO party. CQX finished new rig. IYU is trying to get his Class B mod. working on 56 mc. IYT has a new job. HVK, IYT, HMV and HNP are graduating from high school. FFY startled everybody by building a 56-mc. rig. GZG gives up ham radio for surf fishing during the summer. JDO works night shift on his new job. JDY has new 3.5-mc. rig. IIA won two door prizes at the Plainfield Radiophone Club, both crystal holders. IMB is at Manasquan for the summer. IBZ sticks to c.w. HIX has photograph record that calls CQ for him. JOU is the proud father of a YL. IWU tried 112 mc. but is back on 1.75-mc. 'phone. DAC adds a new gadget to his car every day. FLB is now a married man and back on 56 mc. after a long absence. JAB is trying 56 mc. BSE's call is being bootlegged on 14-mc. 'phone. GVN is anxious to find hams interested in 112 mc. for work this fall around Union. GYY will vacation at the Highlands this summer. 3LT hopes to be back on 1.75 mc. this fall. 2FBG has finally finished his super het.

Traffic: W2GGW 428 HZY 276 GGE 267 HBQ 137 GMN 84 GVZ 79 HXI 64 HTX 37 FOP 24 HQL 21 ICJ 23 IAP 17 HFT 13 BZJ 12 IQM 11 ECO 10 CIZ 8 CJX 6 HOC 5 IAMZ 4.

#### ATLANTIC DIVISION

EASTERN PENNSYLVANIA—SCM, James M. Bruning, W3EZ. R. M.'s: 3AKB, 3AQN, 3EOP, SASW. P. A. M. 3EOZ. 3FYO is heard frequently in England and uses only 20 watts input. 3FAJ is completing a new transmitter. 3EUP is looking for a good crystal. 3ETM will soon be O.R.S. 3EPJ is trying 'phone again. 3BRZ would like to hear more O.P.S. on 14 mc. 3FBJ has new rig and would like to be O.R.S. 3EZ reports his new rig rapidly nearing completion. 3AMR and 3NF are incorporated for the time being at Raubsville. 3BGD worked U9MK and is now W.A.C.; he needs only Utah for W.A.S. 3EOP wants to add O.P.S. to his other string of titles. 3EJW is at C.M.T.C. 3ADE and 3FLA are rebuilding. 3EBP is trying to organize a local 56-mc. net for summer activity. 3BZP finds radio a big help to his other hobby of stamp exchanging. 3BFF continues active as 0.0 and Cairo Observer. 3EKG now runs at 600 watts. 3ASW is making new portable transmitter. 3MRQ reports 8PYD new ham in town. 3NNC has rig working fine now on 100 watts. 3AGK, 3BYS, 3EYO, 3MG and 3UV are busy as usual. 3GHP is teaching in New York during summer but maintains contacts with his portable. 3FRY completed a nice 804 rig which performs nicely. 3GHD is anxiously awaiting cards to verify W.A.C. Plans of the Franklin Institute of Phila. to form a new Radio Club are slowly taking form. 3EOZ, P.A.M., enabled two boys who have been away from home for nine years to talk to their parents in Florence, Nova Scotia, thru the cooperation of VE1CN. Two schedules were made and maintained and both went thru 100% on both sides. The boys talked with all the members of their families. 3EU is rebuilding to 6L6—'03A set-up.

Traffic: W3BZP 152 AGK-BYS 58 ETM 45 EZ 44 EBP 42 AMR 33 EOP 29 EPJ 20 FBJ 15 ADE 11 EUP 9 EYW 6 BGD 2 FRY 1 NF (WLML 56) LC (WLQB 22) 8ASW 56 FLA 50 (WLQG 26) MRQ 60 EKG 43 NNC 10.

MARYLAND-DELAWARE-DISTRICT OF COLUMBIA—SCM, E. L. Hudson, W3BAK. R.M.'s: 3CXL, 3EQU, 3CQS. Chief R.M. 3BWT. P.A.M.: 3WJ. The Atlantic Division Convention which was held in Wilmington,

Del., on June 19th-20th was a huge success. The Wilmington boys know their business when it comes to staging a convention. Congratulations. Willard, and the gang. Opr. Wm. H. Stull of CQCLX will leave July 1st on a thirty-day vacation and will be on the air from Williamsport, call SDHL, also WLMO on A.A.R.S. special frequencies. FSP is a new O.R.S. BAK attended the convention at Wilmington. FRV is rebuilding his rig to work 28-mc. 'phone. CWE is home on summer vacation from school in Michigan, and is starting a trip to Panama. CDG is spending most of his time on 14 mc. and had the good luck to work a "J." EPD is QRL with garden. GFF has been on the air 77 days and had 362 QSO's using only 15 watts. The following stations send in reports: EHW, BHE, FJE, FPQ. FAM is still trying to work Highlandtown on 1.75-mc. 'phone. EXY will put a pair of 35T's in his rig when he graduates from City College. GFI, GAH and GBY are new hams in Baltimore. At the Mike and Key Club's last meeting in May, the fellows paid their last respects to 3CDU, who died of double pneumonia. The Mike and Key Club was his idea, and he was one of the first officials in it. EHW had fine luck with portable on Field Day, contacting 49 stations.

Traffic: W3CXL 320 (WLM 2189) CIZ 242 BWT 228 EZN 16 FSP 10 BAK 6 FRV 5 CWE-CDG-EPD 3 GFF 8.

SOUTHERN NEW JERSEY—SCM, C. D. Kentner, W3ZX—The South Jersey Radio Ass'n celebrated its 20th Anniversary of continued activity at its June meeting. The guest of honor was Dr. Woodruff, and other guests present were John Reinarts, Bradley Martin and Roy Corderman. Six of the old-timers, including the club's first president, who attended the first meeting on June 13, 1916, were present and reminisced about the good old days. FOS heard PAQSD on 3.5 mc. BIR is assisting in the organization of the Trenton Radio Society. EKL has a job in Maryland. FFE is coming up for O.R.S. ZI, EEQ and the Trenton gang were down in force to attend the S.J.R.A. Anniversary Meeting. EXM is going from 25 to 75 watts. FTK missed B.P.L. for first time this year, but turned in a fine summer report. FBM is QRL work in New York. AVJ has found his ideal in FLQ's receiver. BEI finds the bugs in his garden just as obnoxious as those in his transmitter.

Traffic: W3QL 18 FOS 5 BPT 152 DNU 22 FFE 8 ZI 79 FTK 214 AEJ 7 FBM 25 AVJ 10 EEQ 20 BYR 121 BEI-ZX 21.

WESTERN NEW YORK—SCM, C. F. Smith, W8DSS—The S.C.M. suggests the originating of good, non-rubber stamp messages in order to boost totals. We have a new leader in the gang this month as MQX takes the honors with a nice total. MBI reports new ham in Jamestown. PUM, EWP signed up MYD in N.C.R. and is looking for more recruits. LUQ leads the O.P.S. in traffic, pounds brass on 14 mc. and sends in suggestions on the slogan contest. CPJ lost his second op (FVY) who is now married and living out of town. LGV and OZN will soon sign up as O.R.S. MBW wants O.P.S. AQE is QRL night work. BHK is up to his neck in work selling and servicing electric refrigerators. CGU is new O.P.S. NNJ and CP received first-class broadcast tickets. Syracuse, Rome, Utica, Rochester, Buffalo and Jamestown Clubs enjoyed the A.R.R.L. Field Day and did some very FB work. BQJ was experimenting with 56-mc. transmitter in plane to ground QSO. BJO had some children try to climb his Zepp feeder ladder and the whole works came down! BSU is an A.E.C. member. DHQ camped at Chestnut Ridge Park, Erie County, during Field Day and made a score of 90 with an input of five watts using an 802 supplied by a 250 volt genemotor. PCU, Rochester, is working nice DX with an all-star transmitter, 45 watts input. BME, LGH, and DPZ spent a pleasant afternoon at the S.C.M.'s shack. ARX is now a benedict. Congrats, Mac. Winner of the slogan contest will be announced in the next report. Happy vacations to all and 73.

Traffic: W8MQX 125 DSS 124 CSE 59 FUG 34 LUQ 17 MBI 11 EWP 11 CPJ 9 JTT 6 LGV 4 AQE 1.

WESTERN PENNSYLVANIA—SCM, C. H. Grossarth, W8CUG—OFO has been busy campaigning for S.C.M. KNB has a yen to attend hamfest this summer. KOB says AXD and KDM are foolin' with 56 mc. UK spent several weeks in the hospital due to trouble with his jaw bone. (He's not a 'phone man either!!) KBM is rebuilding the whole bloomin' works. KUN raised a 50-foot pole to hang the skypiece on. IOH says, "All's quiet on the Western Penna. front." MIW joined the O.R.S. ranks and is building a new super. LWK is still oping at the C.C.C. Camp in Asaph. CUG has been using very low power while rebuilding.

Traffic: W8OFO 111 KNB 107 KOB 90 UK 70 KBM 50 KUN 46 CMP 23 IOH 21 MIW 16 LWK 12 AXD 8.

## W8QBT—Great Lakes Exposition

THE station at the Amateur Radio Exhibit at the Great Lakes Exposition, Cleveland, Ohio, is operating under the call W8QBT. The exposition opened on June 27th and will continue through October 4th. The aim of the committee in charge of the amateur exhibit is not to handle a great volume of traffic, but rather to acquaint the general public as much as possible with amateur radio—of what a typical amateur station consists, something of how it is operated and what can be done with it. In addition, it is expected that many visiting amateurs will take advantage of the opportunity to drop in at the booth, and all amateurs are cordially invited to bring their operators licenses along and take part in the operation of W8QBT. Phone and c.w. is used on 3.5 and 14 mc. and c.w. on 7 mc. A 500-watt controlled-carrier U.T.C. transmitter and HRO and RME69 receivers constitute the main equipment. Local clubs are furnishing operators, and each club is responsible for one night of the week. W8GKG, Operating Supervisor, has appointed seven chief operators, each chief to see that two operators are on duty the night he is responsible for. Daytime operation is taken care of through a central daytime operation control run by W8EPP, who will open the exhibit each morning and have charge of transmitter adjustment. A gala ham get-together is planned for October at the conclusion of the exposition. Those amateurs directly concerned with the planning and operation of W8QBT include W8NGW, W8PKS, W8MKG, W8BAH, W8GOS, W8NEP, W8MMQ, W8APC, W8EPP, W8CIC, W8JMB and W8EFW.



GOVERNOR GEORGE H. EARLE OF PENNSYLVANIA HONORS DR. JOSEPH P. VANCHERI, W8BWH, FOR HIS FLOOD WORK

Before a crowd of 1800 persons in the Jefferson Theatre in Punxsutawney, Pa., on June 14th, Governor Earle, Attorney General Charles J. Margiotti, Mayor George Hughes, and Al Sindlinger of the "March of Time" lauded the tireless work of Doctor Vancheri and the other amateurs during the flood catastrophe. The Governor presented W8BWH with a recording of the "March of Time" broadcast in which 4-mc. phone work was dramatized. In making the presentation, Governor Earle said: "When the Commonwealth was cut off from practically all communication, the first time in the history of the State that the East and West were cut off, Dr. Vancheri, who is a radio amateur by hobby, spent hour after hour delivering messages and acting as a clearing station for important telegrams to State and National headquarters. The State of Pennsylvania would have suffered terribly if it had not been for Dr. Vancheri and his band of amateur operators. On behalf of the Commonwealth of Pennsylvania I express deep appreciation of the work done by Dr. Vancheri."

In the picture, left to right: Al Sindlinger, W9PJW, representative of the "March of Time"; Attorney General Charles J. Margiotti of Pennsylvania; Governor Earle, presenting the recording; W8BWH; and the Hon. George Hughes, Mayor of Punxsutawney.

Add to list of high scorers in April O.R.S. Party (page 51, July QST): W7BSU 26,320-86 QSO's, 40 sections, 31 heard, 750 watts input, Montana Section; W2GGW 20,740-107 QSO's, 34 sections, 50 heard, 130 watts, No. N. J. Section; W1GOJ (W1GKU opr.) 17,184-88 QSO's, 32 sections, 72 heard, 80 watts, Maine Section.

### Red Cross Emergency Corps

Amateurs of Bridgeport, Conn., met with officials of the American Red Cross on March 23d to organize The Red Cross Amateur Radio Corps No. 1 with officers as follows: Gilbert E. Williams, W1APA, Chairman; Charles W. Wight, W1BRL, Vice-Chairman; Charles Sauer, W1APW, Secretary. A permanent home station and a portable station, both with emergency power, are planned. The United Illuminating Co. and the Bridgeport Fire Department have donated two gasoline-driven motor generator sets capable of delivering 1500 watts at 110 volts a.c. All local amateurs will be invited to enroll in an extensive plan for emergency communication. Present at the organization meeting were W1HUA, W1BRL, W1ACV, W1GRU, W1IEV, W1APW, W1BAZ, W1CEJ, W1APA, W1HWQ and W1FYE.

### Silent Keys

It is with deep regret that we record the passing of these amateurs:

Larry J. Cain, W8AWK, Buffalo, N. Y.  
Wm. K. Ennis, W5CUI, Houston, Tex.  
Robert Melvin Furlong, W3CDU, Baltimore, Md.  
George Robert Garrett, W8MUW, Dowagiac, Mich.  
George B. Knox, Jr., W2HQE, New York City  
Albert R. Konetzky, W9CBF, St. Louis, Mo.  
Grimes R. Waller, W2CTS, New York City

## THE AMATEUR PRESENTATION AT THE F. C. C. HEARING

Would you like a copy of the presentation on behalf of amateur radio which the A.R.R.L. made before the Federal Communications Commission at the June informal engineering conference in review of the art? The testimony of our witnesses has been done into books, mimeographed 8½ x 13, illustrated with water-colored charts in reproduction of the large charts displayed by the witnesses at the hearings. The book is an invaluable record of the accomplishments of the amateur, the employment of our bands, our operating conditions, and of the contributions of the amateur to ultra-high-frequency knowledge.

It will be of great interest to those who would like to see what the League has done for amateur radio at these hearings. It is an invaluable storehouse of arguments in favor of amateur radio for those who are interested in helping along the work. It is a compact survey of the whole institution of amateur radio in this country as of this summer.

A limited number of copies are available to the general membership at cost. The supply being quite limited, we can only offer them subject to prior sale, first come first served.

Price 50 cents, postpaid

**If you are interested, order your copy to-day  
AMERICAN RADIO RELAY LEAGUE, WEST HARTFORD, CONNECTICUT**



# GTC AMATEUR PLATE TRANSFORMERS are DUO-PRIMARY

**HIGH OR LOW  
POWER AT THE  
SNAP OF A SWITCH**  
(Patent applied for)

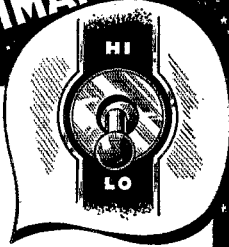

● Off resonant currents get plenty high. Don't damage expensive tubes or equipment when tuning with high power. Use GENERAL

TRANSFORMERS with fingertip control — all switching done in the primary — at low power — safely, economically, practically.

Tune with safe Lo Power — Snap, and the "soup's on!" Snap to Lo for those local QSO's! Snap and you're set for DX!

Switching power with G T C's does not affect efficiency of the unit, whereas tremendous power would be wasted if resistors were used for Hi-Lo Power.

All controls on the front of the panel — you don't reach behind and run the risk of tangling with high voltage. Changing power by switching high voltage terminals is dangerous — 3,000 volts is no toy.

Fingertip switching with GENERAL'S is the safe answer — it eliminates those cold sweat visions of tubes going up in smoke.

**GENERAL TRANSFORMER CORPORATION**  
518 S. Throop Street Chicago, Illinois

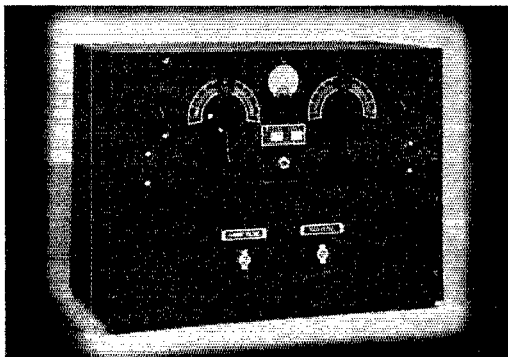

**THE 60-X CW TRANSMITTER**  
**80 WATTS INPUT**  
**\$69.50**

LESS ACCESSORIES

Write For Full Details

**HARVEY RADIO LABORATORIES, INC.**  
12 Boylston Street Brookline, Mass.  
Export: 25 Warren St., N. Y. C. Cable: "Simontrice"

## Delta Division Convention

September 5th and 6th at Monroe, La.

THE Monroe Amateur Radio Club of Monroe, Louisiana, has been awarded the Delta Division convention by Director Arledge and it has also received the approval of A.R.R.L. Headquarters. The committee takes pleasure in extending a cordial invitation to all radio amateurs in Tennessee, Arkansas, Mississippi and Louisiana to attend the affair. The dates are September 5th and 6th, Saturday and Sunday respectively, at the Virginia Hotel, Monroe, Louisiana.

Senator James A. Noe, former governor of state and Hon. Arnold Berstein, mayor of Monroe, will be with us to see that everything is started right. "Bull" sessions have been lined up to make everybody feel perfectly at home. Good technical talks by prominent radio men are being arranged and the first day will end with a boat ride on the Ouachita River on Noe's Ark. The YL's and ex-YL's will be given special attention. The banquet will be held at noon on Sunday and Pat Lynch, W5EGK, will act as toastmaster and in case there are hungry folks the committee has prepared for a barbecue at 6:00 p.m. Send word to Mrs. Jewel L. Caraway, Sec'y, P. O. Box 497, that you will be present or for further information.

## Southeastern Division Convention

September 5th and 6th at St. Petersburg, Florida

THE Hotel Suwannee, one of St. Pete's finest hostleries, has been chosen as the headquarters for this year's annual division convention by the St. Petersburg Amateur Radio Club. A cordial invitation is extended to all radio amateurs of this division and other sections to visit the Sunshine City of the State of Florida and be entertained by a club that knows what real old-fashioned southern hospitality is. There will, of course, be good speakers, contests and the many informal gatherings during the two days of the convention. Special rates at the hotel have been assured. The registration fee will be \$3.00 for hams and \$2.00 for the YL and XYL. Reservation may be made by addressing Mr. Ed. Wallace, Convention Secretary, Suwannee, St. Petersburg, Florida. A special prize will be given to the one registered from the greatest distance.

## Roanoke Division Convention

August 28th and 29th at Clarksburg, W. Va.

THE Mountaineer Amateur Radio Association, which is sponsoring the official Roanoke Division convention to be held at the Waldorf Hotel, Clarksburg, West Virginia, on August 28th and 29th, is putting in every effort to make this year's convention the outstanding event in the Division. It surely will be if you respond to the



# VISASIG

FULL AUTOMATIC SIPHON RECORDER

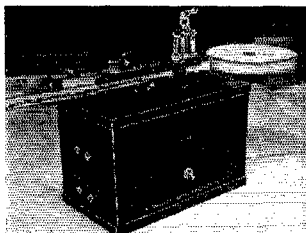

## RECORDS CODE SIGNALS

from the air in excess of 100 w.p.m.

NET PRICE F.O.B. New York City

To operate from D.C. signals..... \$30.00

To operate from A.C. signals..... \$34.00

To operate from A.C. or D.C. signals.. \$35.00

(Tape supplied at 15c per 500 ft.)

Information re VISASIG sent on request

Write for full details re AUTOTRANS Auto Code Xmitter. 5 - 75 w.p.m. \$50.00 net F.O.B. N.Y.C.

## UNIVERSAL SIGNAL APPLIANCE

64 West 22nd Street New York City

Blueprints of either machine — \$1.00 each

## JACOBS ADJUSTABLE SEPARATOR (Improved)



U. S. Patent 1,950,170 — March 6, 1934 — others pending  
Using this improved glass Separator 2 wire R.F. feedlines of any separation from 1" up to and including 9" (used in conjunction with Hertz Antenna Systems) may be rapidly and efficiently constructed. \$1.75 for a set of 6.

CHARLES F. JACOBS (W2EM)  
270 Lafayette St., New York, N. Y.

## LEARN RADIO

New Classes Now Forming! Send for 40-page catalog, explains

fully. 300 licensed graduates placed in past 4½ years in broadcasting, shipping, police radio, aviation, etc. We teach all branches. Oldest, largest and best equipped school in New England. Equipped with Western Electric sound and broadcasting equipment and RCA marine transmitter. Course prepares for United States Government telegraph or telephone license.

MASS. RADIO SCHOOL, 18 Boylston Street, BOSTON

## Learn CODE Right . . . —the Practical, Easy Way—



### Instructograph

Experts agree: it pays to learn from a perfect teacher — Instructograph. It's easy to become a real operator when you can practice Radio or Morse at your convenience — at any speed you want. Comes in two models — Senior or Junior Economy. You may buy or rent, at low cost. Just send post-card for complete details now to —

INSTRUCTOGRAPH COMPANY, Dept. Q-8

912 Lakeside Place Chicago, Illinois

Representatives for Canada

Radio College of Canada, Ltd., 863 Bay St., Toronto

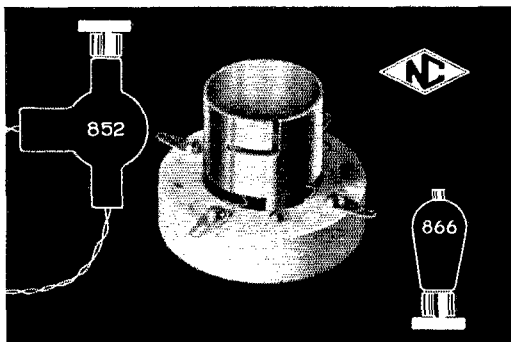

## "210" SOCKET

A bayonet-lock for positive support of upside-down 852's, etc. A low-loss ceramic base with long leakage paths. Positive, side-wipe, high current contacts. Low price. Such is the new Type XM-10 socket, companion to the XM-50 fifty-watter.

Net price \$ .75

NATIONAL COMPANY, INC.  
MALDEN, MASS.

"The Crystal Specialists Since 1925"

## PIEZO-ELECTRIC CRYSTALS

Guaranteed Accurate to BETTER than .01%

## SCIENTIFIC RADIO SERVICE

UNIVERSITY PARK, HYATTSVILLE, MD.

## FAMOUS RCA OSCILLOGRAPH

Now available on  
EASY-PAYMENT PLAN!

Don't envy those with superior equipment! You can now buy the famous RCA Oscillograph, and all other RCA Test Equipment—quickly and at low cost with new EASY PURCHASE PLAN. No red tape. One small down payment and equipment is yours. Up to a year to pay in small monthly payments.



### RCA CATHODE RAY OSCILLOGRAPH

High quality instrument suited to amateur needs. Invaluable for checking modulation, carrier hum, neutralization, parasitics, etc. Self-contained, complete with tubes, \$84.50. EASY PAYMENT PLAN: \$10 down, \$6.92 a month, 12 months to pay. See your RCA Parts Distributor NOW.



## RCA PARTS DIVISION

RCA MFG. CO., Inc., CAMDEN, N. J.

A Service of Radio Corporation of America

# New R. F. Antenna Meters with Improved Movements

(HOT WIRE)

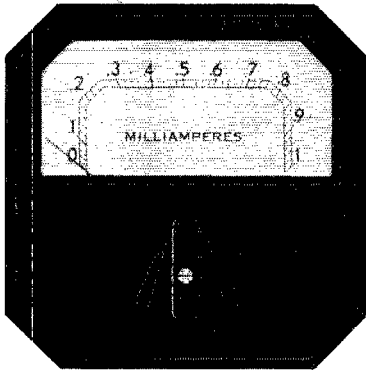

These trim new meters with improved movements are rugged and unaffected by frequency changes. They may be used with entire satisfaction in place of a thermocouple meter. The square bakelite meter measures  $4\frac{1}{4}$  inches and is priced to the dealer at \$5.00. The round bakelite meter measures  $3\frac{1}{4}$  inches and is priced to the dealer at \$3.67. Three ranges are available: 0/1.5; 0/3; and 0/5 amp. If your jobber cannot supply you use coupon below.

**THE BURTON ROGERS CO., 755 Boylston St., Boston, Mass.**  
Sales Division of the Hoyt Electrical Instrument Works

Gentlemen: Find enclosed my remittance for ..... of your  
 Type 577 square R. F. meters.  Type 576 R. F. round meters.  
 Kindly send information about other Hoyt Meters.

Name .....

State ..... City ..... Street .....

**"Swing Through the Air with the Greatest of Ease—"**  
with

## OHMITE BAND-SWITCH

(Patents Pending)

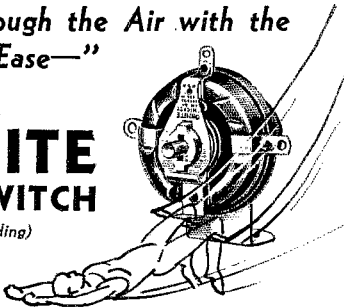

Don't let a crowded wave band keep you off the air because it's too much trouble to change coils. Cut through interference with a flick of the wrist—by using OHMITE Band-Switches on your control panel. They give you instant QSY (frequency change). Bulletin 104 gives diagrams for all basic transmitter circuits.

# O H M I T E

MANUFACTURING CO.

4831 Flournoy Street

Chicago, Ill.

HANDBOOK  
PAGES  
**458-459**  
CATALOG  
SECTION

Send for the enlarged OHMITE AMATEUR HANDBOOK. Useful, interesting, clear. Helpful charts and tables. At your dealer or send 10c.



cordial invitation extended to you. The registration fee is \$3.00 for men and \$2.00 for the ladies. The committee's program shows that the first day, Friday, will be devoted to registration, technical talks and the afternoon session ends with a good old-fashioned ox roast with all the trimmings at the site of the new WMMN Radio Station. The Saturday session will continue with talks, stunts and special events completing the two-day convention with a banquet which will satisfy every one. The ladies will have a theatre party and all courtesies possible will be extended them. Mr. K. M. Zinn, General Chairman, c/o Palace Furniture Company, Clarksburg, W. Va., will gladly furnish further information on request.

## Pacific Division Convention

September 5th, 6th and 7th at Oakland, Calif.

ON September 5th, 6th and 7th the Oakland Radio Club, Inc., will be the host to the 17th Pacific Division Convention which will convene at the Hotel Leamington, Oakland, California. The outlook for this coming gala event promises to be the greatest the West Coast has ever sponsored.

Besides several thousand dollars' worth of radio equipment prizes, the capital drawing will be a Chevrolet four-door Master Sport Sedan, valued at \$914.00 from Cochran and Celli, local distributors.

The many special rooms on the Mezzanine Floor of the hotel will be turned over for the three days for radio exhibits from many nationally known manufacturers, and to world famous guests, including Frank Jones, Don Wallace, Lester Roukema of the University of California; Bill Eitel and Jack McCullough of Eimac, Byron Goodman of A.R.R.L. Headquarters and with the possibility of John Reinartz of R.C.A. and several others being present. The scene of the final banquet will be in the two-million dollar Scottish Rite Temple on the shores of beautiful Lake Merritt. An outstanding floor show, the giving of prizes, and other surprises will round out an evening never to be forgotten. Special attention will be given the ladies attending the convention and several hundred dollars' worth of prizes are reserved especially for them. The regular admission fee for the three days is \$3.75; ladies \$1.50. Men who wish to attend the banquet only, \$1.50.

For further information write Horace R. Greer, W6TI, Convention General Chairman, Room 423, Hotel Leamington, Oakland, California.

## West Gulf Division Convention

August 27th, 28th and 29th at Dallas, Texas

WHAT! An amateur radio convention in Texas in August? Hot? Of course it is, it's always hot in Texas in the summer time, but who cares. Air-conditioned hotels, and even an air-

# MEN or ROBOTS?



List \$22.50  
With stand  
List \$25.00

Allow us to quote columnist  
in *All Wave Radio*  
June 1936, p. 282

"Most of the fone gang do not care to work another fone station whose **quality** is poor even if it is 100% understandable, any more than the average person cares to talk to one whose speech is difficult — it is better to spend what money is available on better speech than on higher power."

Do YOU want a robot's metallic voice?  
Give the pleasing individualizing elements in your voice a chance.

Be a HAM with a non-metallic ACOUSTA-PHRAGM

Ask your dealer, or write

## THE TURNER COMPANY

CEDAR RAPIDS, IOWA

Licensed under patents of the Brush Development Co.

# P Y R A N O L

2MF2-2000 VOLT

(Operating)

## FILTER CONDENSERS

Impregnated and filled with Pyranol. We rate these at 2000 volts working and we know of cases where they are in use at a 50-75% overload. Made by one of the world's largest manufacturers of electrical apparatus.

### ● UNSOLICITED — READ IT.

The Pyranols we bought from you 8 months ago going strong at 200% overload . . . Please send us 1 more.  
J. T., Ben Lomond, Calif.



Guaranteed Unconditionally

For 2 Years

No Restrictions as to use!

## \$2.90

RS 203A Graphite \$9.00	<b>INTERNATIONAL PLATE TRANSFORMERS</b> Outstanding for Value. 750 and 1000 volts each side of c.t. at 300 mills. Cased completely in steel, crackle finish. Model 200 . . . \$5.95 Model 3000 — Same in appearance, 750-1000-1500 each side of c.t. 300 mills. . . . . \$8.95 <i>We know of nothing that equals the value received in these two items.</i>	2.5V-12A 866 TRANS. \$1.50
R. C. A. 802 \$3.90 801 \$4.50 210 \$1.20	Bliley 20M xtals \$7.50 Johnson 20M Q 5.94 Dunco Keying Relay 2.00 Valpey Mid. Crystals 3.00	EIMAC 35T \$8.00 50T 13.50 150T 24.50
866's Heavy Duty \$1.00 Each	Mail Orders Filled—Include Postage <b>THE RADIO SHACK</b> 46 Brattle St. Boston, Mass.	New Sky Buddy \$29.50 R. C. A. Transceiver 19.75 New U. T. C. VARIMATCH UNITS Baldwin Type "C" Phones \$2.50

# QST YEARLY BINDERS



THOSE who take pride in the appearance of their lay-out and wish to keep their reference file of *QST*'s in a presentable manner, appreciate the *QST* binder. It is stiff-covered, finished in beautiful and practical maroon fabricoid. Cleverly designed to take each issue as received and hold it firmly without mutilation, it permits removal of any desired issue without disturbing the rest of the file. It accommodates 12 copies of *QST* and the yearly index. Opens flat at any page of any issue.

With each Binder is furnished a sheet of gold and black gummed labels for years 1919 through 1938. The proper one can be cut from the sheet and pasted in the space provided for it on the back of the binder.

A file of several years of *QST*, kept in order in binders, is a most valuable reference library for any Radio Amateur.

Price **\$1.50** postpaid

Available only in United States and possessions

## THE AMERICAN RADIO RELAY LEAGUE

WEST HARTFORD, CONNECTICUT

AT LAST!

THE PERFECT

# CODE TEACHER!

NEW MASTER TELEPLEX



For beginners, experienced operators, and schoolroom. The sure easy way to learn code and to step up your speed. This amazing new instrument will record your own sending on double row perforated paper and repeat it back to you at any speed you desire. Thousands of words can be recorded on one tape.

No Batteries No Winding  
All Electric

It is the same in principle, and in operation for this purpose is equal to the Wheatstone Perforator and Transmitter, which cost over \$1,000.

### BUY IT OR RENT IT

Send for Folder Q. 7 which tells you how to get the use of this instrument without buying it. No obligation. We furnish complete course and personal instruction with a money-back guarantee. Low cost, easy terms. Write today for information.

## "HAM" SPECIAL STANDARD TELEPLEX

A highly efficient code teacher using heavy specially prepared waxed paper tape, having two rows of perforations. Write for Free folder "Q. T. 7."

We are the originators of this type instrument

TELEPLEX CO.

72 Cortlandt St.

New York City

The New Master Teleplex "The Choice of Those Who Know"

# Help

## For The AMATEUR

**UNDER-VOLTAGE** and over-voltage on the filament shorten the life of transmitting tubes.

Apply exactly the right values with the aid of new-type Electrad Power Rheostats.

Full ranges of resistance values in 25, 50 and 150-watt ratings. \$4 to \$10 each list.

Write Dept. Q-8 for Complete New Catalog of Resistors for All Purposes

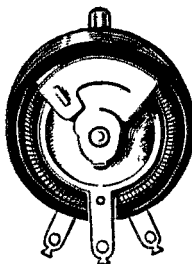

175 Varick St., New York, N.Y.

**ELECTRAD**

INC.

conditioned Texas Centennial Central Exposition. Forget the heat and come to a real hot convention being sponsored by the Dallas Amateur Radio Club to be held at the Hotel Adolphus, Dallas, Texas, August 27th, 28th and 29th. Thursday, 27th August, is to be known as the American Radio Relay League Day at the Texas Centennial Central Exposition and when you register in the morning for the convention you will be handed transportation and tickets to the Centennial, where several special attractions have been arranged in the communications exhibits; in other words it will be your day at the Exposition.

On Friday and Saturday the convention activities will take place, beginning with official opening by the city and A.R.R.L. officials. Friday night will have a real stag party with all the trimmings, plenty of entertainment and refreshments for the men. While this party is under way, the Wives of Radio Amateurs Radio Club of Dallas have planned a special and unique evening entertainment for the OW's and YL's; one they will long remember and be glad they attended. Saturday morning and afternoon devoted to meetings and lectures by prominent men in the radio communication field. Register before August 10th and you will have a chance on a special prize. The registration fee is \$5.00,—a real Amateur Radio Convention and the Texas Centennial Exposition. It can't be beat: come and be convinced.

## South Dakota State Convention

Dakota Division

August 8th and 9th at Rapid City, South Dakota

THE Black Hills Amateur Radio Club is sponsoring the official South Dakota State Convention to be held at the Alex Johnson Hotel, August 8th and 9th, Rapid City, S. D. A cordial invitation is extended to all amateurs of the Dakota Division to attend this affair. The committee was fortunate in obtaining Mr. Shirley of the Bell Co., and Mr. Hardeman, R.C.A. representative, for speakers along technical lines. Several motion picture films of interest to hams will be shown; a scenic trip to major spots in the Black Hills and Saturday evening there will be a campfire picnic in the Stratosphere Bowl. Code contests and stunts are planned for the two days and the convention activities will end with the banquet Sunday night.

For further information write Mr. Ernest C. Mohler, president, 809 Fairview St., Rapid City, S. D.

## Take Advantage

(See Page 96)

## MAC KEY AT \$7.95 finest speed key built

MAC OSC at \$3.95 ac/dc oscillator. Tone control.  
MAC CORD \$1.00 navy spfn speed key cord.  
MAC MARINE receiver 550-850 meters, r u intd?  
Few deluxe MAC KEYS at \$15.00 fm me di. Wri me.  
MAC CASE @ \$3.95 navy spfn speed key case.

T. R. McELROY, 23 Bayside St., Boston, Mass.  
If u hv Mac Key wri me for xmy ipt & dsfb ifn.

# Where to buy it

A directory of suppliers who carry in stock the products of these dependable manufacturers.

**ASTATIC**  
*Crystal Microphones and Pickups*  
 ASTATIC MICROPHONE LABORATORY, Inc. YOUNGSTOWN, O.  
*Pioneer Manufacturers of Quality Crystal Products*

- NEWARK, N. J. 219 Central Ave.  
 Wholesale Radio Service Co., Inc.
- NEW YORK, N. Y. 103 W. 43rd St.  
 Harvey's Radio Shop
- NEW YORK, N. Y. 100 Sixth Ave.  
 Wholesale Radio Service Co., Inc.
- PHILADELPHIA, PENN. 10 S. 10th Street  
 Eugene G. Wile

**BURGESS BATTERY COMPANY**  
*"Chrome" protected*  
**RADIO BATTERIES**  
 Look for the Black and White Stripes  
 FREEPORT, ILLINOIS

- ALBANY, N. Y. Uncle Dave's Radio Shack 356 Broadway
- BALTIMORE, MD. 303 W. Baltimore St.  
 Radio Electric Service Co.
- BOSTON, MASS. Radio Shack 46 Brattle Street
- BRIDGEPORT, CONN. 195 Cannon St.  
 Hatry & Young
- BUFFALO, NEW YORK 216 E. Genesee St.  
 Dymac Radio
- HARTFORD, CONN. 210 Chapel Street  
 Stern & Company, Inc.
- MONTREAL, CANADA 285 Craig Street, West  
 Canadian Electrical Supply Co., Ltd.
- NEWARK, N. J. 219 Central Ave.  
 Wholesale Radio Service Company
- NEW HAVEN, CONN. 86 Meadow St.  
 Hatry & Young
- NEW YORK, N. Y. 12 West Broadway  
 Harrison Radio Company
- NEW YORK, N. Y. 100 Sixth Avenue  
 Wholesale Radio Service Company
- SPRINGFIELD, MASS. 349 Worthington St.  
 T. F. Cushing

super-skyrider  
 halicrafters  
 ultra-skyrider

- ALBANY, N. Y. Uncle Dave's Radio Shack 356 Broadway
- BALTIMORE, MD. 303 W. Baltimore Street  
 Radio Electric Service Company
- BOSTON, MASS. Radio Shack 46 Brattle Street
- BRIDGEPORT, CONN. 195 Cannon St.  
 Hatry & Young
- HARTFORD, CONN. 227 Asylum Street  
 Radio Inspection Service Co.
- NEWARK, N. J. 219 Central Ave.  
 Wholesale Radio Service Co., Inc.
- NEW HAVEN, CONN. 86 Meadow Street  
 Hatry & Young
- NEW YORK, N. Y. 51 Vesey St.  
 Gross Radio, Inc.
- NEW YORK, N. Y. 12 West Broadway  
 Harrison Radio Co.
- NEW YORK, N. Y. 103 W. 43rd St.  
 Harvey's Radio Shop
- NEW YORK, N. Y. 100 Sixth Ave.  
 Wholesale Radio Service Co., Inc.
- READING, PENN. 404 Walnut St.  
 George D. Barbey Company
- SPRINGFIELD, MASS. T. F. Cushing 349 Worthington St.

**E.F. JOHNSON COMPANY**  
 MANUFACTURERS OF  
 TRANSMITTING RADIO EQUIPMENT  
 WASECA, MINN.  
 U.S.A.

- BUFFALO, NEW YORK 216 E. Genesee St.  
 Dymac Radio
- MONTREAL, CANADA 285 Craig Street, West  
 Canadian Electrical Supply Co., Ltd.
- NEWARK, N. J. 219 Central Ave.  
 Wholesale Radio Service Company
- NEW YORK, N. Y. 12 West Broadway  
 Harrison Radio Company
- NEW YORK, N. Y. 100 Sixth Avenue  
 Wholesale Radio Service Company

# Where to buy it

A directory of suppliers who carry in stock the products of these dependable manufacturers.

PITTSBURGH, PENN. Cameradio Company 603 Grant Street

READING, PENN. George D. Barbey Company 404 Walnut Street



ALBANY, NEW YORK Uncle Dave's Radio Shack 356 Broadway

BOSTON, MASS. The Radio Shack 46 Brattle Street

BOSTON, MASS. Selden Radio Company 28 Brattle Street

BUFFALO, NEW YORK Radio Equipment Corp. 326 Elm Street

CONCORD, NEW HAMPSHIRE Carl B. Evans 80 N. State Street

NEWARK, NEW JERSEY Wholesale Radio Service Co. 219 Central Street

NEW YORK, N. Y. Harrison Radio Company 12 West Broadway

NEW YORK, N. Y. Harvey's Radio Shop 103 W. 43rd St.

NEW YORK, N. Y. Wholesale Radio Service Co. 100 Sixth Avenue



ALBANY, N. Y. Uncle Dave's Radio Shack 356 Broadway

BALTIMORE, MD. Radio Electric Service Company 303 W. Baltimore St.

BOSTON, MASS. H. Jappe Company 46 Cornhill

BOSTON MASS. Radio Shack 46 Brattle Street

BRIDGEPORT, CONN. Hatry & Young 195 Cannon St.

BUFFALO, NEW YORK Dymac Radio 216 E. Genesee St.

HARTFORD, CONN. Hatry & Young 203 Ann Street

NEWARK, N. J. Wholesale Radio Service Co. 219 Central Avenue

NEW HAVEN, CONN. Hatry & Young 86 Meadow Street

NEW YORK, N. Y. Bruno-New York, Inc. 460 W. 34th St.

NEW YORK, N. Y. Royal-Eastern Electrical Supply Co. 16 West 22nd Street

NEW YORK, N. Y. Sanford Samuel Corp. 136 Liberty St.

NEW YORK, N. Y. Wholesale Radio Service Co. 100 Sixth Avenue

NEW YORK, NEW YORK Harrison Radio Company 12 West Broadway

PHILADELPHIA, PENN. Eugene G. Wile 10 S. 10th Street

PHILADELPHIA, PENN. Raymond Rosen & Company 117 North 7th St.

PHILADELPHIA, PENN. M & H Sporting Goods Company 512 Market Street

PITTSBURGH, PENN. Cameradio Company 603 Grant Street

READING, PENN. Bright & Company 8th & Elm Streets

SPRINGFIELD, MASS. T. F. Cushing 349 Worthington Street

WASHINGTON, D. C. Sun Radio & Service Supply Co. 938 F Street, N. W.



ALBANY, N. Y. Uncle Dave's Radio Shack 356 Broadway

BOSTON, MASS. H. Jappe Company 46 Cornhill

BOSTON, MASS. Radio Shack 46 Brattle Street

BRIDGEPORT, CONN. Hatry & Young 195 Cannon St.

BUFFALO, NEW YORK Dymac Radio 216 E. Genesee St.

CAMDEN, N. J. Radio Electric Service Company 811 Federal Street

ERIE, PENN. J. V. Duncombe Company 1011 West 8th St.

GREENWICH, CONN. Mead Stationery Company 252 Greenwich Ave.

# Where to buy it

A directory of suppliers who carry in stock the products of these dependable manufacturers.

**HARTFORD, CONN.** Hatry & Young 203 Ann Street

**HARTFORD, CONN.** Radio Inspection Service Co. 227 Asylum Street

**MONTREAL, CANADA** Canadian Electrical Supply Co., Ltd. 285 Craig Street, West

**NEWARK, N. J.** Wholesale Radio Service Company 219 Central Avenue

**NEW HAVEN, CONN.** Hatry & Young 86 Meadow Street

**NEW YORK, N. Y.** Bruno-New York, Inc. 460 W. 34th St.

**NEW YORK, N. Y.** Harrison Radio Co. 12 West Broadway

**NEW YORK, N. Y.** Sanford Samuel Corporation 136 Liberty Street

**NEW YORK, NEW YORK** Grand Central Radio, Inc. 124 E. 44th Street

**NEW YORK, N. Y.** Wholesale Radio Service Company 100 Sixth Avenue

**PHILADELPHIA, PENN.** Radio Electric Service Company 3145 N. Broad Street

**PHILADELPHIA, PENN.** Radio Electric Service Company N. E. Cor. 7th & Arch Streets

**PHILADELPHIA, PENN.** M & H Sporting Goods Co. 512 Market Street

**PITTSBURGH, PENN.** Cameradio Company 603 Grant Street

**NEW YORK, N. Y.** Harrison Radio Co. 12 West Broadway

**NEW YORK, N. Y.** Wholesale Radio Service Company 100 Sixth Avenue

**NEW YORK, N. Y.** Sun Radio Company 227 Fulton Street

**READING, PENN.** George D. Barbey Company 404 Walnut Street

**SPRINGFIELD, MASS.** T. F. Cushing 349 Worthington Street



**ALBANY, N. Y.** Uncle Dave's Radio Shack 356 Broadway

**BOSTON, MASS.** Radio Shack 46 Brattle Street

**BOSTON, MASS.** Selden Radio Company 28 Brattle St.

**BRIDGEPORT, CONN.** Hatry & Young 195 Cannon St.

**BUFFALO, NEW YORK** Dymac Radio 216 E. Genesee St.

**HARTFORD, CONN.** Hatry & Young 203 Ann Street

**MONTREAL, CANADA** Canadian Electrical Supply Co., Ltd. 285 Craig Street, West

**NEWARK, N. J.** Wholesale Radio Service Company 219 Central Ave.

**NEW HAVEN, CONN.** Hatry & Young 86 Meadow Street

**NEW YORK, N. Y.** Wholesale Radio Service Company 100 Sixth Avenue

**PITTSBURGH, PENN.** Cameradio Company 603 Grant Street

**READING, PENN.** George D. Barbey Company 404 Walnut Street



**ALBANY, N. Y.** Uncle Dave's Radio Shack 356 Broadway

**BOSTON, MASS.** H. Jappe Company 46 Cornhill

**BUFFALO, N. Y.** Radio Equipment Corporation 326 Elm St.

**NEWARK, N. J.** Wholesale Radio Service Company 219 Central Avenue

# EIMAC 300T

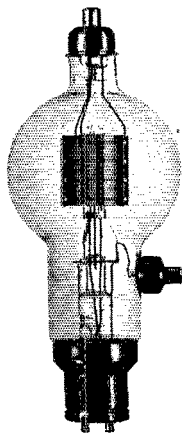

More than fills the requirements for a tube that will really deliver at the ultra high radio frequencies » » »

Your leading dealer has complete information on this remarkable tube

EIMAC 300T

**EITEL-McCULLOUGH, INC.**  
SAN BRUNO, CALIFORNIA  
U. S. A.

## VALPEY CRYSTALS STEP BY STEP PRECISION MADE

Type VM2. Mounted crystal within 5 Kc of specified frequency 1.7, 3.5, 7 Mc Bands .....\$3.50

Type VC2. Unmounted x cut within 5 Kc 1.7, 3.5, 7 Mc Bands .....\$2.25

Type VC2 in 1.7, 3.5 Bands only. Plus or minus 20 Kc.....\$1.50

Type VM2A. AT cut mounted. Drift less than 4 cycles per Mc per degree C 1.7, 3.5, 7 Mc Bands.....\$4.50

Type VC2A AT cut unmounted drift less than 4 cycles 1.7, 3.5, 7 Mc Bands.....\$3.50

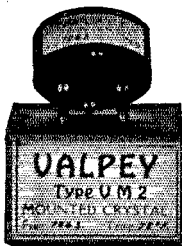

**The Valpey Crystals**

377 Summer Street, Medway, Mass.

Crystals for All Requirements. At Your Dealer's or Order Direct.

**NOW!** A compact Portable Transmitter and Non-Radiating Receiver for the popular Ultra-High Frequencies  
**JUST THE STATION TO TAKE ON VACATION**

"Type TR-6A6"

- Better Than Ever
- 7 Tubes — Dynamic Speaker
- New 6E6 Unity Coupled
- 10 Watt Carrier
- 100% Modulation
- Duplex Operation—PHONE ● ICW

F.O.B. FACTORY  
Less Tubes

**\$39.75**

**RADIO TRANSCIVER LABORATORIES**

8627 — 115 Street, Richmond Hill, New York

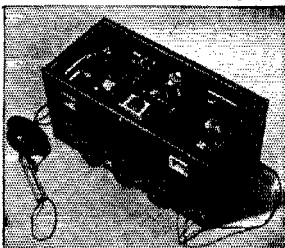

## The Eastern Canada Convention

THE ninth floor of the Mount Royal Hotel, Montreal, was the scene of the A.R.R.L. Eastern Canada Convention, on May 22nd and 23rd. The event, sponsored by the active Montreal Amateur Radio Club, was the second in the history of the Quebec Division. The program opened with a visit to one of the local breweries, which put the delegates in good spirits. Those more technically inclined found an inspection of the Bell Telephone Company's transatlantic telephone system highly interesting.

The evening was devoted mainly to lectures; the first, on vacuum tubes, by Mr. L. M. Price, of the Canadian General Electric Company, the second by Mr. Ray Thornton, VE2AR of Buriek, Ltd., who demonstrated a cathode ray oscilloscope. Games, a couple of skits, and community singing wound up the planned program for the first day.

Next morning an open forum kept Ross Hull of the A.R.R.L. busy answering a barrage of questions on diversified "ham" subjects. VE2DR, Route Manager, spoke on traffic work in the Section, while VE1DQ, S.C.M. for the Maritime Division, gave first-hand information on the part played by amateur radio in the recent Moose River Mine rescue. In the lecture hall, Mr. Charles Fisher, of Northern Electric, clarified a number of erroneous ideas about impedance matching.

After lunch, Ted McElroy demonstrated 65 w.p.m. code reception, and then conducted the Canadian Code Receiving Championship for the Burgess Trophy, which was won by VE2AR, with VE3QR second and VE2DA, Miss M. Ducharme, third.

Lieutenant John Reinartz, WIQP, then spoke on general transmitter design followed by Ross Hull, who detailed some of the interesting high-frequency work done at Headquarters during the past eighteen months. Byron Goodman, A.R.R.L. Assistant Secretary, described his universal exciter unit. The afternoon session ended with the taking of the convention photograph.

Noel Wright, VE2DU, acted as toastmaster at the banquet. The guest of honor was Commander Edwards, Dominion Director of Radio. VE2EE, S.C.M., and representatives from VE1, 2, 3, 4, W1, 2, and 8 addressed the gathering briefly. The highlight of the evening was a 15-minute broadcast by Alex. Reid, VE2BE, Canadian General Manager of the A.R.R.L., over station CFCF, outlining the aims and history of amateur radio. This valuable piece of publicity reached the delegates through a receiver installed in the banquet hall. Assisting VE2BE in his broadcast was Corey Thompson, VE2IR, well-known Canadian announcer.

With the banquet and speeches over, there followed an exhibition of amateur movies by John C. Stadler, VE2AP. Shots of forty VE2 ham shacks were shown, receiving the plaudits of the assembly.

After the prize drawings, one hundred of those present were initiated into the Royal Order of the Wouff-Hong.

—Lindsay Morris, VE2CO



# HAM-ADS

(1) Advertising shall pertain to radio and shall be of nature of interest to radio amateurs or experimenters in their pursuit of the art.

(2) No display of any character will be accepted, nor can any special typographical arrangement, such as all or part capital letters be used which would tend to make one advertisement stand out from the others.

(3) The Ham-Ad rate is 15c per word, except as noted in paragraph (6) below.

(4) Remittance in full must accompany copy. No cash or contract discount or agency commission will be allowed.

(5) Closing date for Ham-Ads is the 25th of the second month preceding publication date.

(6) A special rate of 7c per word will apply to advertising which, in our judgment, is obviously non-commercial in nature and is placed and signed by a member of the American Radio Relay League. Thus, advertising of bona fide surplus equipment owned, used and for sale by an individual or apparatus offered for exchange or advertising inquiring for special equipment, if by a member of the American Radio Relay League takes the 7c rate. An attempt to deal in apparatus in quantity for profit, even if by an individual, is commercial and takes the 15c rate. Provisions of paragraphs (1), (2), (4) and (5) apply to all advertising in this column regardless of which rate may apply.

Having made no investigation of the advertisers in the classified columns, the publishers of *QST* are unable to vouch for their integrity or for the grade or character of the products advertised.

**QUARTZ**—direct importers from Brazil of best quality pure quartz suitable for making piezo-electric crystals. Diamond Drill Carbon Co., 719 World Bldg., New York City.

**RADIO** engineering, broadcasting, aviation and police radio, servicing, marine and Morse telegraphy taught thoroughly. All expenses low. Catalog free. Dodge's Institute, Byrd St., Valparaiso, Ind.

**NATIONAL**—Hammarlund, Patterson used sets, 60% off list. W3DQ, 405 Delaware Ave., Wilmington, Del.

**CLASS B** transformers—Universal for two or four 46s, 210s, 800s, RK18s, etc., \$7.75 pair postpaid. 70 watts audio from 46s, 100 watts from 10s. Write for details. W8UD, Douglas, Mich.

**QLS'S**, W2SN, Helmetta, N. J.

**GENERAL** Electric Dynamotors 24/750 volts 200 mills ball bearing with filters \$25. Two machines for 1500 volts \$40. Westinghouse 27 1/2/350 volt; \$10. Generators 6-15 volt 500 watts \$10. 500 watt 500 cycle \$10. List. Henry Kienzie, 215 Hart Blvd., Staten Island, New York.

**QSLs**, SWLs. Best quality reply getters. Samples. (Stamps) W8EN, 1827 Cone St., Toledo, Ohio.

**MICROPHONES**—Turner condenser mike with battery head amplifier \$35. New Universal KK, \$18. SW3 with tubes and 40, 80, 160 band spread coils \$20. Instructograph \$10. W9IRL, 1007 Fulton, Hannibal, Mo.

**WRITE** us for trade-in price on your old receiver. We buy meters. Walter Ashe Radio Co., St. Louis, Mo.

**SELL**: complete file "QST" December 1915 to Dec. 1934 inclusive, each issue having both covers and suitable for binding. Sumner B. Young, "Maplewoods," Wayzata, Minn.

**ANTENNA**, new design, DX transmitting low and high angle radiations. Booklet 25c coin. W1DZE, Mattapan, Mass.

**QSL's**. Mile-hi quality. 300 2-color \$2. W9TOS.

**FOR** sale. 3-750 volt, 150 watt generators \$11, each. Also a few other generators and motors. Wilmot Auto Supply Company, 1970 Wilmot St., Chicago.

**METERS** repaired—reasonable prices. Braden & Apple Co. 305 Park Dr., Dayton, Ohio.

**REBUILDING** time. Dress up with those new all-welded relay racks, panels, chassis. Peep up with our superlative Hi-power equipment. Rectifier Engineering Service, 4837 Rockwood Road, Cleveland, Ohio.

**WANTED** for cash, d.c. dynamotor. Over 380 volts output, frequency meter, monitor. VE4LY.

**BROWNING** 35 all-wave. Tubes, speaker complete, less cabinet \$30, Patterson preselector \$8. Perfect condition. W8HZC.

**QSLs**, Samples. Stamp? Printer, Corwin, Iowa.

**GENUINE** Philco parts and tubes. Wholesale catalog sent free on request. Williams Philco, Inc., 800 S. Adams Street, Peoria, Illinois.

**RME-69!** Bargain! W8DED.

**QSLs!** SWLs! unbeatable! Samples? (stamp), W8DED, Holland, Mich.

**WANT** modern factory-made ham receiver; medium power transmitter, parts, tubes. Exchange fine collections Indian relics; U. S. coins. All letters answered. W9POB, Wauneta, Nebraska.

**HAM** apparatus wanted—sell—trade. Amateur Exchange, 6341 Broadway, Chicago.

**TRADE**—air wound coils made to your requirements to trade for crystals, meters or parts. W9SCE, Truro, Iowa.

**SELL** complete 75 watts xmtr. \$38. W9TGE.

**SELL** or swap assortment of amateur parts. Over 100 items. Write for list. What have you? W9BNC, 6944 Florence Blvd., Omaha, Neb.

**THE** Ensell communication receiver. Exclusive design 360° band spread tuning. Models from \$165. to \$450. Details on request. Makers of complete station equipment, transmitters, condensers, power units, receivers. Designers of marine (short wave) equipment. Ensell Radio Laboratory, Warren, Ohio.

**NATIONAL** NC100 receivers. W8ANT.

**HAMMARLUND** Comet Pro AVC receiver with new Pro dynamic speaker and Peak preselector. Complete \$75. L. M. Clark, 222 Audubon Drive, Snyder, N. Y.

**SELL** out of complete stations. Need money for trip to South America. W9PWZ 1/2 kw. 4 stage xtal 14 mc xmtr., 5 tube screen grid receiver, tubes, speakers, tools, complete station \$185. W9KDP 150 watt 28 mc. WAC transmitter \$115. New RME69 complete \$125. Tools and all equipment included with transmitter. 741 Michaels, Fort Wayne, Indiana.

**USED** radio equipment. Swap or sell cheap. Wat u need? W7CNA, Nezperce, Idaho.

**SACRIFICE**—2000 watt 20 meter fone transmitter complete. Commercial construction. No haywire, finest parts. Four Eimac 150T's parallel pushpull final amplifier, class B 204A modulators, RCA condenser mike. Best offer over \$750. New RME-9DS receiver (10 meters) \$75. Complete. W8KQQ, R. S. Bailey, Centre Hall, Penna.

**QSL's** 300 one-color cards \$1. Samples. 2143 Indiana Avenue, Columbus, Ohio.

**CRYSTALS**—written guarantee for one year. "X," 80M, \$1.95. "Y," 80M-160M, \$2.25. Holders, \$1. Catalog. Ham Crystals, 1104 Lincoln Place, Brooklyn, N. Y.

**POWERFUL** X cut crystals. Accurately calibrated. Wonderful oscillators. Within 5kc, 40 meter band \$1.85; 80-160, \$1.50. Jobbers write for prices. W9JRY-W9CPM. Omaha Crystal Laboratories, 501 World Herald Bldg., Omaha, Neb.

**WANT** RK100. W9ARJ.

**FOR** sale: 750 watt c.w. transmitter, W.E. rack, 6 units, 8 Weston meters. A real buy, \$175. W9AIO.

**CRYSTALS**—"Summer Sale" continued. See May and July *QST* Ham-Ads. Sale closes Aug. 31. Wolverine Crystal Service, Calumet, Mich.

**USED** a.c. SW3 and coils. W8ANT.

**HARDENED** chassis punches. W8ANT.

**KEEP** posted. Save money with Radio Data Digest. Stamp brings sample. Kladag, Kent, Ohio.

**CRYSTALS**: Zero cut. Guaranteed to compensate near zero without oven. Approximate frequency 80 or 160 meters \$1.85. Ordinary zero cuts \$1.35, small \$1., 40 meters \$2., blanks 50¢ postpaid. Plug-in holders 75¢, dozen \$6. Fisher Laboratory, 4522 Norwood, San Diego, California.

**GUARANTEED** crystals—within five kilocycles, 80-160m., Y \$1.; X \$1.50. Postpaid, W9FHS, 4433 North Kilbourne, Chicago.

**ACSW3-4** sets band spread coils, tubes, power supply \$25. Code machine with tape \$10. Photo cells \$5. New 203A \$9. New 845 \$9.50. Key 75¢ W6LSH.

**QSLs**. Finest quality. Free samples. Maleco, 1512 Eastern Parkway, Brooklyn, New York.

**SPECIAL**—Overstock of new Pioneer dynamotors—input 12 or 32 volts dc.—Output 1000 volts at 150 ma.—Regular list price \$80—Your price \$39, each. Write for our list of used transmitters and parts. Harvey Radio Laboratories, Inc., 12 Boylston St., Brookline, Mass.

**SW-3**, coils five bands; specify tubes desired; highest offer above \$16. takes. L. C. Waller, care of RCA Radiotron Division, Harrison, N. J.

**RME69** \$120. Jack Tyler, Cresskill, N. J.

**QUARTZ**: Direct importers. Suitable for the new zero cuts. G. L. Fisher, 4522 Norwood, San Diego, Calif.

**SELL** or trade! 600 watt 110 volt a.c. Kato light plant in excellent condition. Write B. L. Stewart, W4CE, CCC Camp MP-1, York, S. C.

**TELEPLEXES**, Omnigraphs, meters, Vibroplexes, receivers. Bought, sold, traded. Ryan Radio Co., Monroe City, Mo.

**SW-3** latest model, 10-160M. coils, tubes, \$25. C.O.D. Buying super. W1EWF.

**RADIO** servicemen's supplies. W8ANT.

**EIMAC** tubes. W8ANT.

**CRYSTALS**—Eidson dependable "T-9" 40 meter X cut, approximate frequency \$1.50 postpaid. Now even better than ever. Satisfaction guaranteed, instant service. Attractive "T-9" ultra low-loss ceramic plug-in holder only \$1.10 postpaid. "Eidson's", Temple, Texas.

**CODEDISC**—new way of learning your code. Three lessons on 3 1/2" aluminum records (double-faced) playing any phonograph, electrical pick-up. Instructions contain handling of key, copying, actual sending entire alphabet, numerals, punctuation marks. Also spacing between sending enabling student practice while records playing. Price \$3.50 (plus postage). Audio-Scriptions, Inc., 20 West 47 Street, New York, N. Y.

**TRANSFORMERS**—several new Hilet plate transformers, less than half original cost. 2 1/2 kw 160 lb. \$35. 5kw oil immersed \$65. Write for photograph and voltages. Will trade. Leitch, Park Drive, West Orange, N. J.

**RACKS**, panels, built to order. Estimates free. W8KSA, Greensburg, Pa.

**QSL's**—special introductory offer. Radio Headquarters, Ft. Wayne, Indiana.

**CLOUGH** Brengle CRA oscilloscope. New, complete, \$55. W8JRG, 505 East Grand Ave. Springfield, Ohio.

**SWAP** 40 meter crystals for freqmeter parts. W9ERU.

**SELL** complete cw station, 500 watts. W9ERU.

**QSL's**. Rainbow effects. Stamp. "Fritz", 203 Mason Ave., Joliet, Illinois.

**ARTISTIC QSL's**. T. Vachovetz, Elmsford, N. Y.

**TRANSFORMERS**—200 watt, 1000-750-0-750-1000, \$4.30; 400W, 1575-1350-850-0-850-1350-1575, \$7.50. New address. Spear Manufacturing Company, Biddle St., Bowling Green, Ohio.

**WANTED**—Delta AD13, AD22, AD32, AD42, AD75, AD1011, AD91, Thordarson 6878, 5338, 5822, 7061, GR forms, Pyralol 3000V condensers, 2 1/2V Duncos relays. Cash or trade. W8FOV.

**110 volt, 60 cycle, 600 watt generators** twenty dollars. W4DKW. 851a—\$35., 849a—\$25., 201As—\$18., 50 watters—\$5., 212Ds—\$8., Universal 250W. screen grid \$10., Ewing, 1057 Pratt, Chicago.

**PFANSTIEHL** receiver complete with factory power supply & coils including 28mc. \$25. Cardwell modified 16GB (split stator) \$9. Fair Thor 203A class B xtms. \$9. Thor 30H-300M choke \$4. 8mf., 2000V oil condensers \$2.50. W9HYO.

**CRYSTALS**—Now 40 and 20 meter crystals available priced right. Southwest Field Service, Box 792, Abilene, Texas.

**SELL RME69**, Superskyrider, Sky Buddy, Breting 12, Harvey transmitter, National SW5, Dynatron, Motorola Goldenvoice car radio. W8IV, Argyle, N. Y.

Two used 852's—\$2.50 each. W8ANT.

**EIDSON'S** T-9 40 meter crystals fully guaranteed \$1.50. Impregnated Ceramic holder \$1.10 postpaid, \$1. C.O.D. W2GWS, 8834 209th Street, Queens Village (New York City).

**MICHIGAN Hams!** Breting 12's, \$93 prepaid. W8MKU.

**BRETING 12's** complete, prepaid, \$93. W8MKU.

**WESTON** Thermo-galvanometer used. W8ANT.

**CRYSTALS**: X or Y cut, 1750 to 2000; 3500 to 4000. Exact frequency, 1" square \$2.50. Less than 1", within ten kilocycles \$1.35. Roughcut blanks 60¢. Oscillating blanks 85¢. Small, irregular shaped blanks, five for \$1. Dustproof, plug-in holders 85¢. William Threm, W8FN, 4021 Davis Ave., Cheviot, Ohio.

**MAC**—Keys. W8ANT.

**SPECIAL Crystals**. "AT" cut with shielded mounting. 80 and 160 meter bands, \$2.35. White Radio Laboratory, Sandpoint, Idaho.

**ALL** lines of new and used amateur and servicemen's equipment. Tell me the parts you are looking for. Write to Southern Ohio's only amateur owned amateur business. Jos. N. Davies, W8ANT, Box 602, R.R. 9, North Bend Road, Mt. Airy, Cincinnati, Ohio.

**MCMURDO** Silver Masterpiece two crystal. Skyrider tuned radio frequency, Midwest eight tube all wave. Bernard service oscillator. Large power amplifier. Glenn Watt, Chanute, Kans.

**QSL's**—\$1. hundred. Finest obtainable. Attractive 2 colors. Quality stocks, inks. Samples. (stamp) W8NOS.

**NATIONAL**, Hammarlund, RME, RCA, Patterson, Hallcrafters, Silver used sets at more than 60% off list price. Write for list of sets. W9ARA, Butler, Mo.

"**ANTENNA Handbook**" by "Radio": amateur antennas, all types, receiving, transmitting, regular, directional; detailed tables—no calculations necessary. Complete, practical, easily understood; 80 pages, profusely illustrated, no advertising. 50¢ U. S. A. and Canada; elsewhere, 60¢. "Radio", 7460 Beverly, Los Angeles.

**COMBINATION** offer: "Radio Handbook" and "Radio Antenna Handbook" both \$1. continental U.S.A.; elsewhere, \$1.15. "Radio", 7460 Beverly, Los Angeles.

**FOR sale**: Hammarlund xtal Pro, speaker, Patterson preselector. Western Electric 618A dynamic microphone and two stage pre-amplifier. Bound QST's 1921 to date, all issues Modern Radio, M. L. Potter, Park Ridge, Illinois.

**CALLBOOKS**—new DX calls, new prefixes, thousands of new W and VE calls, in the Summer 1936 Radio Amateur Call Book. Sent postpaid \$1.25, or a whole year (four issues) for \$4. (In foreign countries \$1.35 and \$4.35.) Your call and QRA printed in large type, \$1. per year. Radio Amateur Call Book, 810 S. Dearborn, Chicago.

# BRUSH Headphones

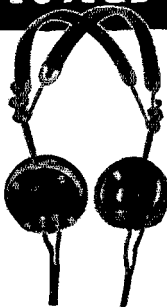

● Meet every headphone requirement. They bring in weak signals strong and clear and will handle excessive volume without overloading. Response 60 to 10,000 cycles. No magnets to cause diaphragm chatter. Specially designed cases minimize breakage. Light in weight. Only 6 oz., complete with headband and cords. A quality product at a low price. Details, Data Sheet No. 10. Copies on request. Send for one.

The **BRUSH** DEVELOPMENT COMPANY  
1883E 40th St. CLEVELAND, O.  
PIEZO ELECTRIC  
MICROPHONES • MIKE STANDS • TWEETERS • HEAD PHONES • LOUD SPEAKERS

## LEARN CODE

Quickly and Easily at Home As 9 Year Old Champion Jean Hudson Did with Candler Scientific Code Course



Increase your Code Speed and Technique as Champion McElroy did with High-Speed Telegraphing and "Mill" Courses.

**CANDLER SYSTEM** teaches you quickly to read code by sound as easily as you read print by sight, to copy behind at high speeds without strain or confusion—to qualify for that com'l ticket!

**CHAMPION JEAN, W3BAK.** Two months after beginning Candler training, Jean could copy 30 wpm on her "mill" easily.



## FREE-1936 BOOK of FACTS

If you're "stuck," want to learn code RIGHT, or to increase your speed and technique for that com'l ticket, this book will help you. Send for it. No obligation.

**CANDLER SYSTEM CO.**  
Dept. Q-7 Asheville, N. C.

# Your Nearest Dealer Is Your Best Friend

Your nearest dealer is entitled to your patronage. You can trust him. He is equipped with a knowledge and understanding of amateur radio. He is your logical and safe source of advice and counsel on what equipment you should buy. His stock is complete. He can supply your needs without delay. His prices are fair and consistent with the high quality of the goods he carries. He is responsible to you and interested in you.

Patronize the dealer nearest you—You can have confidence in him

## ALLENTOWN, PENNSYLVANIA

Radio Electric Service Co.  
1024 Hamilton Street  
Complete stocks transmitting equipment

## BALTIMORE, MARYLAND

Radio Electric Service Co.  
303 W. Baltimore Street  
Everything for the amateur

## BIRMINGHAM, ENGLAND

Radio Mart  
19 John Bright Street  
Drop in and meet Bill Nightingale—G5NI

## BUFFALO, NEW YORK

Radio Equipment Corp.  
326 Elm Street  
W8GJ—Ham, service and sound equipment—W8BTS

## MANCHESTER, NEW HAMPSHIRE

Radio Service Lab. of N. H.  
1187-1191 Elm Street—Tel. 218-W  
Branches—Portland, Me. and Barre, Vt.

## MONTREAL, CANADA

Canadian Elec. Supply Co., Ltd.  
285 Craig St., W.  
Quality parts and equipment for discriminating buyers

## PHILADELPHIA, PENNSYLVANIA

Consolidated Radio Corp.  
612 Arch Street  
Ham receivers, Transmitting tubes, Collins transmitters, etc.

## PHILADELPHIA, PENNSYLVANIA

Radio Electric Service Co., Inc.  
N. E. Cor. Seventh & Arch Sts.  
All nationally-advertised lines in stock

## PITTSBURGH, PENNSYLVANIA

Cameradio Company  
601-3 Grant Street  
"Ham" Headquarters for Pennsylvania-Ohio-W. Virginia

## PHILADELPHIA, PENNSYLVANIA

Eugene G. Wile  
10 S. Tenth Street  
Complete Stock of Quality Merchandise

## PROVIDENCE, RHODE ISLAND

W. H. Edwards Co.  
32 Broadway  
National—Hammarlund—RCA—and other leaders

## PROVIDENCE, RHODE ISLAND

Kraus & Company  
89 Broadway  
Everything for the amateur and serviceman

## ROCHESTER, NEW YORK

Radio Service Shop  
244 Clinton Avenue, North  
Complete stock amateur-BCL parts. Standard discounts. W8NUC

## SYRACUSE, NEW YORK

Roy C. Stage, W8IGF  
Complete stock of standard Ham & BCL parts  
Standard Discounts. Free technical service

## SPRINGFIELD, MASS.

S. S. Kresge Company  
1540 Main Street  
Standard discounts on standard lines.  
Advisory service: W1JQ, W1FOF

## WHEELING, WEST VIRGINIA

Cameradio Company  
30 Twelfth Street  
Complete stock of amateur Equipment at standard discounts

# You Are Protected When You Buy From QST Advertisers

“Advertising for QST is accepted only from firms who, in the publisher’s opinion, are of established integrity and whose products secure the approval of the technical staff of the American Radio Relay League.”

Quoted from QST’s advertising rate card.

Every conceivable need of a radio amateur can be supplied by the advertisers in QST. And you will know the product has the approval of the League’s technical staff.

For Your Convenience

## QST’S INDEX TO ADVERTISERS IN THIS ISSUE

Aerovox Corporation.....	73
Allen-Bradley Company.....	61
Astatic Microphone Laboratory.....	74
A.R.R.L. Log.....	65
Message Blanks.....	69
Special Offer.....	95
Birnbach Radio Company.....	79
Bliley Electric Company.....	71
Brush Development Company.....	92
Bud Radio, Inc.....	69
Burgess Battery Company.....	57
Burton Rogers Company.....	84
Candler System Company.....	92
Capitol Radio Engineering Institute.....	74
Cardwell Mfg. Corp., Allen D.....	75
Centralab.....	66
Collins Radio Company.....	Cov. 2
Cornell-Dubilier Company.....	78
Eitel-McCullough, Ltd.....	90
Electrad, Inc.....	86
Freck Radio & Supply Company.....	85
General Electric Company.....	59, 68
General Radio Company.....	58
General Transformer Company.....	82
Gross Radio, Inc.....	63
Gulf Radio School.....	71
Hallicrafters, Inc., The.....	1
Hammarlund Mfg. Company.....	4
Harvey Radio Laboratories.....	82
Heintz & Kaufman, Ltd.....	73
Henry Radio Shop.....	79
Instructograph Company.....	83
Jacobs, Chas. F.....	83
Jefferson Electric Company.....	64
Johnstone Studios.....	75
Leeds.....	60
Marine Radio Company.....	2
Massachusetts Radio School.....	83
McElroy, T. R.....	86
National Carbon Company.....	66
National Company.....	55, 78, 83, Cov. 3
Newark Electric Company.....	62
Ohmite Mfg. Company.....	84
Port Arthur College.....	73
Precision Piezo Service.....	69
Radio Constructors Laboratories.....	75
Radio Receptor Corp.....	73
Radio Shack.....	85
Radio Supply Company.....	85
Radio Transceiver Laboratories.....	90
RCA Institutes, Inc.....	79
RCA Manufacturing Company.....	83, Cov. 4
Sargent Company, E. M.....	71
Scientific Radio Service.....	83
Shure Brothers Company.....	79
Sickles Company, F. W.....	71
St. Charles Laboratories.....	79
Sundt Engineering Company.....	75
Teleplex Company.....	86
Thordarson Electric Manufacturing Co.....	67
Triplet Electrical Instrument Company.....	72
Turner Company.....	85
Universal Signal Appliance.....	83
University of Wisconsin.....	75
United Transformer Company.....	96
Valpey Crystals.....	90
Western Electric Company.....	70

During  
**JULY and AUGUST**

A Year's  
Membership  
in ARRL

A Year's  
Subscription  
to QST

The Radio  
Amateur's  
Handbook

(Of course the latest twice-  
as-big 480-page edition)

**\$3.00\***  
FOREIGN  
\$3.65

★ This offer applies  
ONLY if your order  
is sent direct to  
A.R.R.L.

**THE VALUE IS APPARENT**

Enclosed please find \$3.00 (foreign \$3.65) for one HANDBOOK and one year's membership in the ARRL including 12 issues of QST beginning with the ..... issue (please state whether new, renewal or extension).

Name.....  
Street or Box.....  
City and State.....  
Call if any.....

**THE AMERICAN RADIO RELAY LEAGUE, INC.**  
**West Hartford, Connecticut, U. S. A.**



*Leads the Field*

Most of the modern developments in quality transformers have been perfected by our engineering staff. This type of research is being done every day on special units to fit specifications and problems of UTC's customers.

Among users of this service are such organizations as RCA, GE, Western Electric, Bell Telephone Labs., ERPI and others of similar calibre.

The UTC research laboratories and staff are at your disposal. We invite you to make use of them.

## New . . . UNIVERSAL BEAM POWER AMPLIFIER

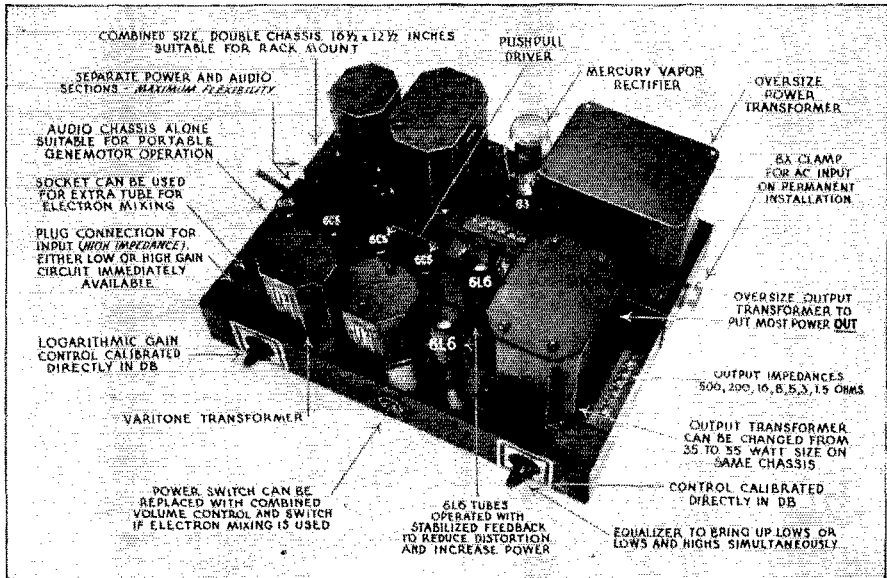

**PAK-1** amplifier kit features: Power output 35 watts self bias, 55 watts fixed bias, Gain 118 DB, immediate change-over to 95 DB, Separate power supply and audio decks; Stabilized feedback; Mobile operation with genemotor — 20 watts output; Provision for electron mixer or low impedance input if desired.

Complete 35 watt kit including all accessories and output transformer with line and voice coil impedances, type PAK-1, net price to hams . . . . . \$45

35 watt kit with modulation output transformer, type PAK-1X, net price to hams . . . . . \$45

PAK-2 amplifier same as PAK-1, but with 55 watts output transformer to line and voice coils, net price to hams . . . . . \$48

PAK-2X same as PAK-1, but with 55 watt modulation output transformer, net price to hams . . . . . \$48

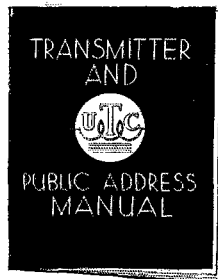

*Ready*

This new 44 page illustrated bulletin is now available at your local jobber's. 44 pages of valuable information; a thorough study of transmitter and public address hookups, circuits and applications. SPECIAL PRICE . . . . . 25c

### TRANSMITTER WINNER IN UTC CONTEST

In the next issue on this page we will publish the name of the winner of the UTC TRANSMITTER KIT. The contest has closed and the names submitted have been forwarded to the judges for their selection.

**UNITED TRANSFORMER CORP.**

72 SPRING STREET

NEW YORK, N. Y.

EXPORT DIVISION: 100 VARICK STREET NEW YORK, N. Y. CABLES: 'ARLAB'

THE NEW  
NATIONAL

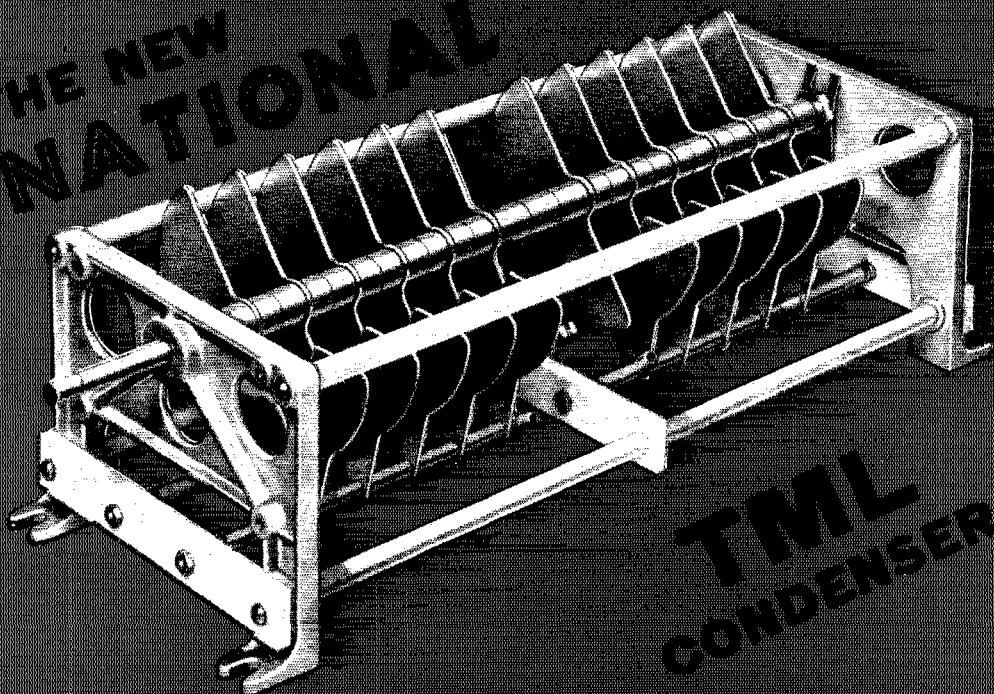

TML  
CONDENSER

# RIGID—EFFICIENT—HEAVY DUTY

## FOR BIG TRANSMITTERS

The TML condenser is a 1 KW job throughout. There are no compromises in its design, as its graceful proportions attest. And no parts are makeshift adaptations from smaller models, as its heavy duty performance proves. Check these points against any other condensers.

**SIZE.** The TML is big. Compare it with the TMA in the drawing opposite. It has to be big, it is designed for heavy duty.

**RIGIDITY.** The TML is sturdy. Heavy cast aluminum end plates anchor duralumin tie bars in accurate alignment.

**PERFORMANCE.** Thick rotor and stator plates accurately rounded and carefully polished give high voltage rating. A big self-cleaning brush provides high current capacity. High conductivity aluminum and Isolantite insulation are used for low losses.

**PRECISION.** Rigid frame and precise bearings preserve the careful factory alignment of every TML. And a PW-type self-locking worm-drive unit can be added to provide smooth precise tuning with the convenience of parallel-to-panel mounting.

Type PWL Drive Unit. Net Price \$5.70 extra.

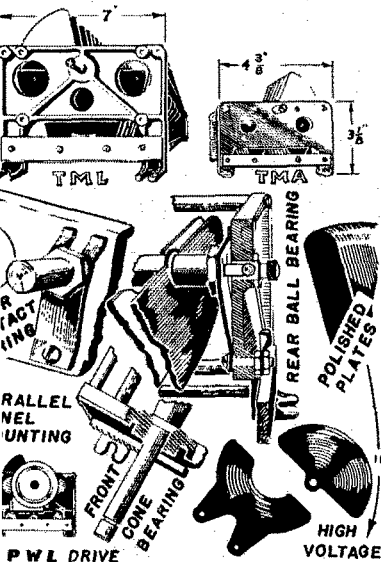

NATIONAL  
COMPANY

Capacity Mmf.	Peak V	Air-gap	Length	Plates	Cat. Symbol	Net Price
75	20,000	.719"	18 1/2"	17	TML-75E	\$14.10
150	15,000	.469"	18 1/2"	27	TML-150D	14.55
100	15,000	.469"	14 1/8"	19	TML-100D	12.90
50	15,000	.469"	8 3/4"	9	TML-50D	9.90
245	10,000	.344"	18 1/2"	35	TML-245B +	15.75
150	10,000	.344"	14 1/8"	21	TML-150B +	14.10
100	10,000	.344"	11 3/8"	15	TML-100B +	13.50
75	10,000	.344"	8 3/4"	11	TML-75B +	9.90
500	7,500	.219"	18 1/2"	42	TML-500A +	19.50
350	7,500	.219"	14 1/8"	33	TML-350A +	15.30
250	7,500	.219"	11 3/8"	25	TML-250A +	14.10
30-30	20,000	.719"	18 1/2"	7-7	TML-30DE	14.40
60-60	15,000	.469"	18 1/2"	11-11	TML-60DD	15.60
100-100	10,000	.344"	18 1/2"	15-15	TML-100DB +	17.10
50-50	10,000	.344"	14 1/8"	9-9	TML-50DB +	15.00
200-200	7,500	.219"	18 1/2"	21-21	TML-200DA +	19.50
100-100	7,500	.219"	11 3/8"	11-11	TML-100DA +	15.90



Mr. S. L. Barriette seated at his new RCA 40-watt transmitter, station W2FIM, Bellaire, Long Island

# Proof of the Pudding!

TWO months with his new RCA 40-watt transmitter, and W2FIM has had all continents on phone and C-W, majority of reports T-9, and over 300 100% Q. S. O.'s, most of them DX!—Here's what he says: "My new RCA is the most stable and consistent amateur transmitter I've operated during my entire thirteen years' experience."—You also can get superior results with this new RCA, ACT-40 Transmitter. Unit construction also provides for increasing power to 200 watts at any time, with minimum additional expense. Skilfully constructed for quality performance, the units can be purchased together or separately, as your funds permit.



*for Amateur Radio*

Address AMATEUR RADIO SECTION

RCA Manufacturing Co., Inc., Camden, N. J. • A Service of Radio Corporation of America