

April, 1958
25 cents

QST

amateur radio

In this issue —
A Simplified
High-
Performance
Superhet

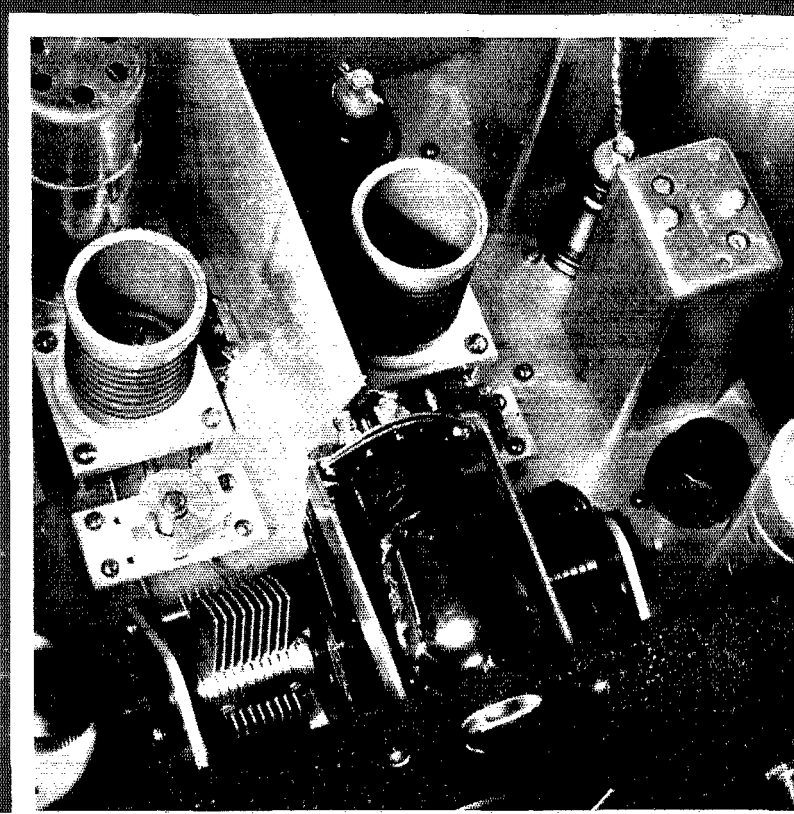

VE1IN

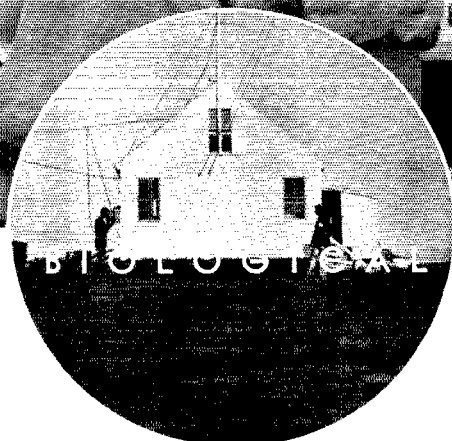
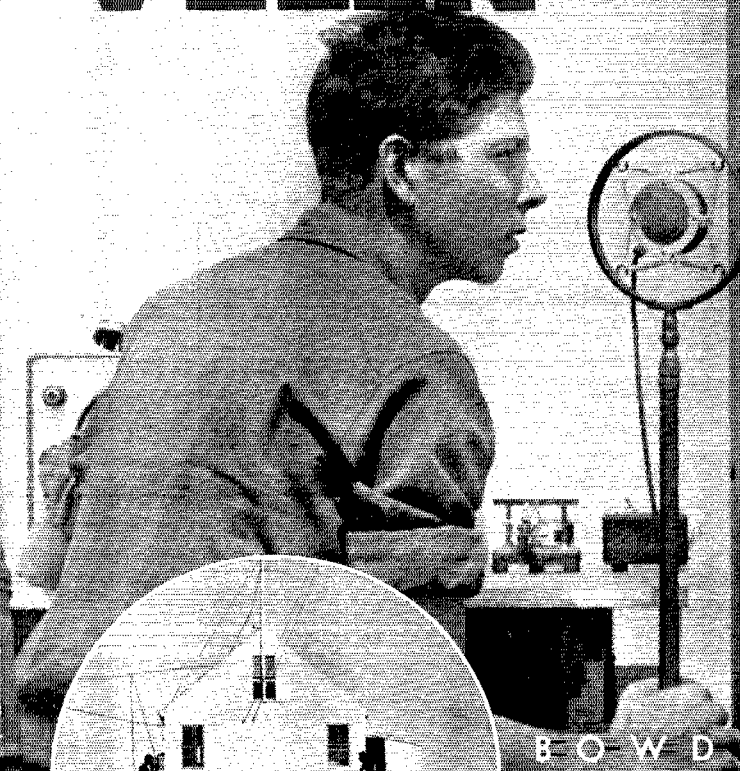

BEWDOIN
EXPEDITION
KENT'S ISLAND
BAY OF FUNDY

..... One of the first radio equipped Biological Stations in the world, VE1IN made remarkable use of a COLLINS 30FXB transmitter during its 1935 expedition.

In less than 3 months (June, July and August) approximately one thousand contacts were made with stations in every United States district and in Spain, Hungary, Russia, England, Holland, Switzerland, France, Germany, Cuba, Mexico and Jamaica.

Daily reports of the expedition's work were sent to the college at Brunswick, Maine and schedules were maintained with W 3 S N, the Army Signal corps at Baltimore, Maryland; and W 1 J L, West Acton, Massachusetts. VE1IN operates on frequencies of 1783, 3515, 3860, 3996.5, 7083, 14060, 14288 and 14392 kilocycles.

The record of VE1IN illustrates the consistent performance which is being obtained every day with Collins transmitters.

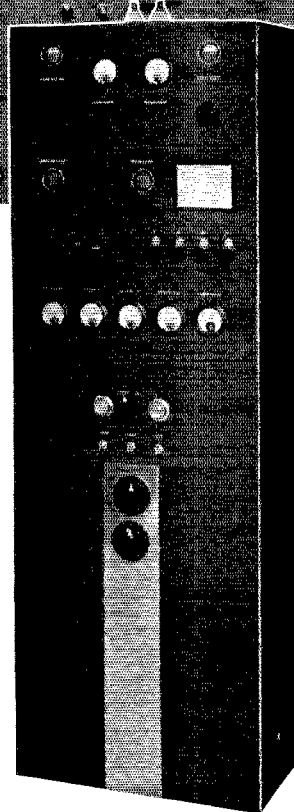

Collins Radio Company

CEDAR RAPIDS
New York
11 West 42nd St.



IOWA, U. S. A.
Mexico City
Edificio "La Nacional"

THE NEW COLLINS
30FXC TRANSMITTER
with excitation band switch
200 WATTS OUTPUT

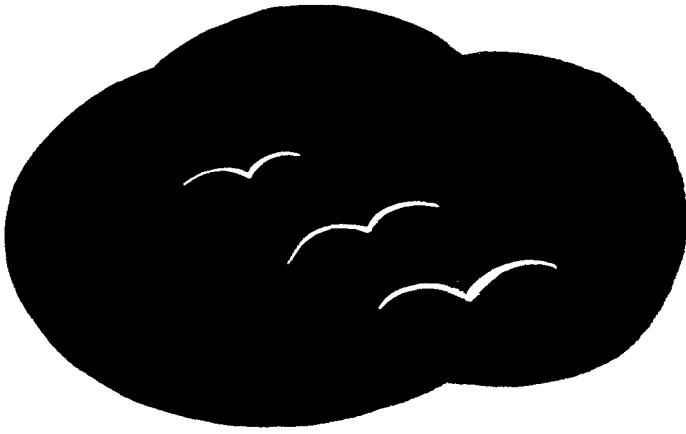

HIRAM PERCY MAXIM
1869...1936

Burgess honors
the memory of
a gifted leader
and
beloved gentleman

BURGESS BATTERY COMPANY

750-B TRANSMITTER

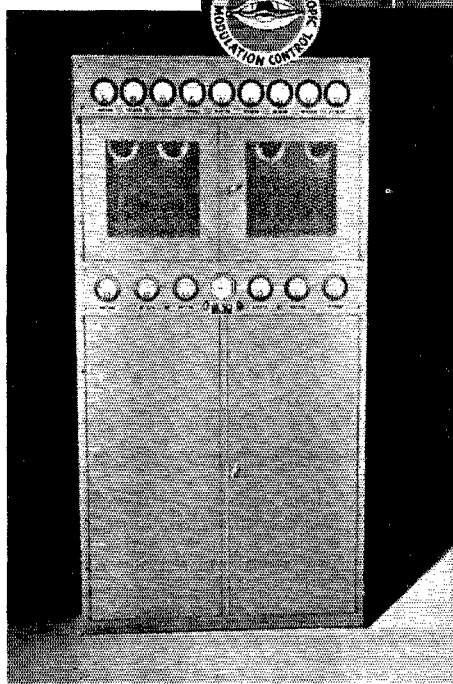

Write for descriptive catalog material and photographic illustrations on this and other models, in our complete line of transmitters for all purposes from 20 watts upward. The Marine deferred payment plan will help you enjoy your hobby with your present income.

MARINE RADIO COMPANY

General Offices and Plant
124-11 101st Avenue,
RICHMOND HILL, N. Y.

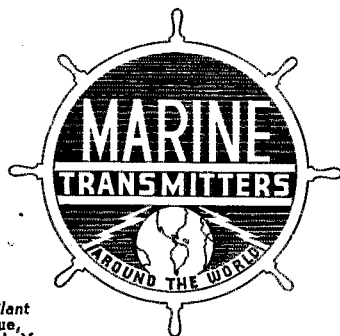

1000 WATT PHONE and C.W.

A powerful 1000 watt phone and C.W. transmitter. Built for the amateur, with specifications demanded of commercial transmitters.

QST

devoted entirely to

AMATEUR RADIO

PUBLISHED, MONTHLY, AS ITS OFFICIAL ORGAN, BY THE AMERICAN RADIO RELAY LEAGUE, INC., AT WEST HARTFORD, CONN., U. S. A.; OFFICIAL ORGAN OF THE INTERNATIONAL AMATEUR RADIO UNION

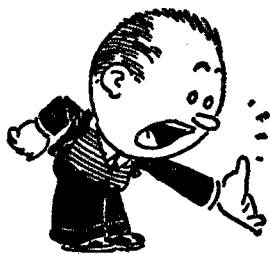

APRIL

1936

Volume XX

Number 4



Kenneth B. Warner (Secretary, A.R.R.L.), *Editor-in-Chief and Business Manager*; Ross A. Hull, *Associate Editor*; James J. Lamb, *Technical Editor*; George Grammer, *Assistant Technical Editor*; Clark C. Rodimon, *Managing Editor*; David H. Houghton, *Circulation Manager*; F. Cheyney Beekley, *Advertising Manager*; Ursula M. Chamberlain, *Assistant Advertising Manager*.

Editorial and Advertising Offices

38 La Salle Road
West Hartford, Connecticut

Subscription rate in United States and Possessions and Canada, \$2.50 per year, postpaid; all other countries, \$3.00 per year, postpaid. Single copies, 25 cents. Foreign remittances should be by international postal or express money order or bank draft negotiable in the U. S. and for an equivalent amount in U. S. funds.

Entered as second-class matter May 29, 1919, at the post office at Hartford, Connecticut, under the Act of March 3, 1879. Acceptance for mailing at special rate of postage provided for in section 1103, Act of October 3, 1917, authorized September 9, 1922. Additional entry at Concord, N. H., authorized February 21, 1929, under the Act of February 28, 1925.

Additional second-class entries to cover sectional editions authorized March 20, 1935. Copyright 1936 by the American Radio Relay League, Inc. Title registered at United States Patent Office.

The Contents

Editorials	7
More Developments in the Noise-Silencing I.F. Circuit <i>James J. Lamb, W1AL</i>	16
Building a Simplified High-Performance Superhet <i>George Grammer, W1DF</i>	19
A 28-Mc. Rotary Beam <i>H. J. Breuer, W6JN</i>	28
Tuning the Crystal <i>J. Herbert Hollister, W9DRD</i>	31
New England Division Convention	32
Silent Keys	32
What the League Is Doing	33
Dixie Jones' Owl Juice	34
Oregon State Convention	34
A.R.R.L. QSL Bureau	34
Cathode-Ray Monitoring of Received Signals <i>Edwin C. Ewing, W9HYO</i>	35
An Automatic Tape Recorder <i>F. H. Schnell, W9UZ</i>	36
Notes on Audio Power Amplifiers in Regenerative Receivers	39
Hamdom	40
Open-Type Transmitter Construction for Small Floor Space <i>Byron Goodman, W1JPE</i>	41
A Laboratory-Type Beat-Frequency Audio Oscillator and R.F. Signal Generator <i>Clinton B. DeSoto, W1CBD</i>	45
To a Lady with Red Hair <i>J. C. Flippin, W4VT</i>	48
Electron-Coupled vs. Crystal Transmitter Control <i>Don H. Mix, W1TS</i>	50
VK-ZL 1935 DX Contest Results <i>R. H. Cunningham, VK3ML</i>	52
With the Affiliated Clubs	54
A 5- and 10-Meter Converter <i>John J. Long, Jr., W8ABX</i>	55
Amateur Radio Stations <i>W2IDQ, W7DET</i>	57
Hints and Kinks for the Experimenter Oscillator-Mixer Coupling with the 6F7 — Filament- Voltage Booster for 6.3-Volt Tubes — Insulating Filter Chokes — Antenna Coupling to the 56-mc. Re- ceiver — Break-in and Monitoring System — Neon Bulb Oscillator for Tone Modulator — Simple Moni- toring System for Checking Hum or Modulation Quality — A 28-Mc. Converter with T.R.F. Receivers	59
I.A.R.U. News	63
New Transmitting Tubes <i>804, 805, 836, 35T</i>	64
Operating News	65
Correspondence Department	73
Arizona State Convention	90
Eastern Canada Convention	88
Standard Frequency Transmissions	88
Hamads	123
QST's Index of Advertisers	126

Hammarlund "Super-Pro"

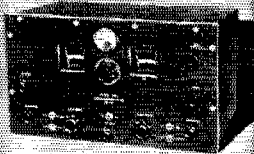

■ The Hammarlund "Super Pro," the new, special amateur — professional receiver, is replete with striking features. It is designed to meet every rigid, precision specification of the professional operator and advanced amateur. For the utmost in efficiency, the following precision controls have been incorporated: accurately calibrated tuning dial in megacycles and kilocycles; band spread tuning dial (both illuminated); five-band switch; audio frequency gain; radio frequency gain; intermediate frequency gain; selectivity; beat frequency; tone control; speaker-phone switch; send-receive switch; AVC-Manual switch, and CW-Modulation switch. ■ The tuning unit (illustrated at right) is an engineering triumph of compactness and precision. It includes the main tuning and band spread condensers, and their respective dial assemblies; the band-changing switch, and all antenna coupling, radio frequency and high frequency oscillator coil assemblies.

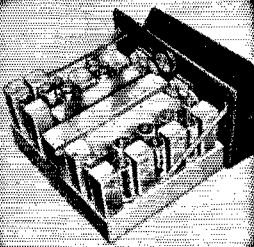
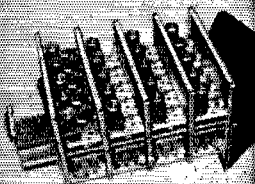

■ Other features of the "Super Pro" are — electrostatically shielded input; two tuned R.F. stages on all bands; four air-tuned I.F. transformers; continuously variable selectivity; three audio stages; silver plated five-band switch; visible tuning meter; separate power supply unit, and separate grid bias supply. ■ In the tuning dial arrangement (illustrated at right) the main tuning dial is accurately calibrated in megacycles in ranges of 2.5 to 5, 5 to 10, and 10 to 20, and in kc. from 540 to 1160 and 1160 to 2500. This dial has an ingenious mechanical shutter which operates in conjunction with the band-changing switch making visible only the frequency band in actual use. The high frequency ranges each have a 2 to 1 frequency range which places the three amateur bands at the same setting of the main tuning dial.

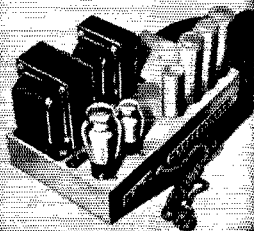
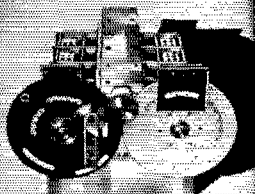

■ The band-changing switch (cutaway view shown at right) is an exclusive Hammarlund development and is a radical departure from switches commonly used for this purpose. Its design incorporates the well-known knife switch principle, actuated by eccentric cams. Specially designed bakelite sections with silver-plated phosphor bronze knife blades gradually slide into silver plated phosphor bronze spring clips, forming a 6-point positive contact. ■ As stated above the power supply (shown at left) is a separate unit. Here two rectifiers are used. A 5Z3 is used for the plate voltage, and a 1-V for the grid voltage. This unit supplies individual C-bias and B voltage. Due to the special filtering system employed, positive humless output is available. This unit is connected to the receiver by way of a special 10-lead cable. The speaker field connections are also obtained from this unit.

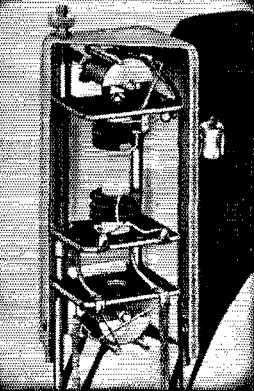
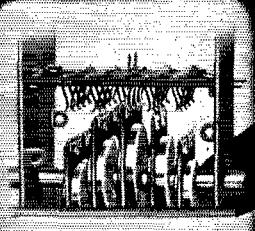

■ Unusual tuning coils assemblies formulate still another feature of the "Super Pro." Coils are wound on the highest grade bakelite available and mounted on Isolantite bases. Each of the units has an inductance adjuster (as shown at right), which aligns the circuits at the low frequency end of the band. A variable trimming condenser is used to align the circuits at the high frequency end of the band. This makes it possible to obtain not only perfect alignment in both circuits, but it also permits exact tracking of the calibrated dial. ■ The variable air transformers (cutaway view shown at left) constitute another of the many important features of the "Super Pro." These transformers permit continuous variation of the mutual inductance between the primary and the secondary throughout a wide range of values without otherwise affecting circuit constants. The approximate range of variation is from $\frac{1}{3}$ critical coupling to over 3 times critical coupling. Any intermediate value is at the disposal of the operator at all times merely by turning a knob on the front panel.

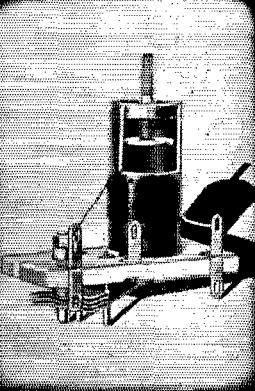

Write dept. Q-4 for further details

THE HAMMARLUND MFG. CO., INC.
424-438 W. 33 Street, New York
Canadian Office: 41 West Avenue, No.,
Hamilton, Ontario

Section Communications Managers of the A.R.R.L. Communications Department

All appointments in the League's field organization are made by the proper S.C.M., elected by members in each Section listed. Mail your S.C.M. (on the 16th of each month) a postal covering your radio activities for the previous 30 days. Tell him your DX, plans for experimenting, results in 'phone and traffic. He is interested, whether you are an A.R.R.L. member or get your QST at the newsstands; he wants a report from every active ham. If interested and qualified for O.R.S., O.P.S. or other appointments he can tell you about them, too.

Eastern Pennsylvania Maryland-Delaware-District of Columbia Southern New Jersey Western New York Western Pennsylvania	W3EZ W3BAK W3ZXX W8DSS W8CUG	ATLANTIC DIVISION James M. Bruning	339 W. Lancaster Ave. 1107 Park Ave. 310 E. Walnut St. 261 N. Ralph Ave.	Haverford Laurel, Delaware Collingswood Oneta Bellevue
Illinois Indiana Kentucky Michigan Ohio Wisconsin	W9WR W9TE W9AUH W8DYH W8CIO W9ATO	CENTRAL DIVISION Fred J. Hinds Arthur L. Braun G. W. Mossbauer Kenneth F. Conroy Robert P. Irvine E. A. Cary	6618 West 34th St. 530 East Morris St. Box 177 18030 Waltham Ave. 5508 Northcliffe Ave. 3922 No. 19th Pl.	Berwyn Indianapolis Camp Taylor Detroit Cleveland Milwaukee
North Dakota South Dakota* Northern Minnesota Southern Minnesota	W9OEL W9CFU W9OWU W9DEI	DAKOTA DIVISION Hartwell B. Burner Walter E. Beeler Leonard Hofstad Francis C. Kramer	231 S. E. Iowa St. W. Bluff St.	Hope Huron Elbow Lake St. Charles
Arkansas Louisiana Mississippi Tennessee	W5ABI W5DWW W5CWO W4BBT	DELTA DIVISION H. E. Vette W. J. Wilkinson, Jr. J. H. Weems, Jr. Merrill B. Parker, Jr.	2918 West 15th St. 1523 Laurel St. P. O. Box 244 1912 Oak St.	Little Rock Shreveport State College Chattanooga
Eastern New York N. Y. C. & Long Island Northern New Jersey	W2LU W2AZV W2FOP	HUDSON DIVISION Robert E. Haight E. L. Baunach Charles J. Hammersen	511 South Holmes St. 7823 10th Ave. 92 Claremont Ave.	Scotia Brooklyn Verona
Iowa Kansas Missouri Nebraska	W9LEZ W9FLG W9CIR W9FAM	MIDWEST DIVISION Phil D. Boardman O. J. Spetter J. Dewey Mills Samuel C. Wallace	325 Kirkwood Blvd. 305 Western Ave. Box 205 Green St.	Davenport Topeka Mount Vernon Clarke
Connecticut Maine Eastern Massachusetts Western Massachusetts New Hampshire Rhode Island Vermont	W1CTI W1CDX W1ABG W1BVR W1AVT W1HRC W1BJP	NEW ENGLAND DIVISION Frederick Ellis, Jr. John W. Singleton Albert N. Giddis Percy C. Noble Robert Byron Clayton C. Gordon Forrest D. Drew	19 Merrill Rd. 73 Allen St. 128 Crawford St. 37 Broad St. 12 Humphrey St. 206 California Ave. 947 E. Main St.	Norwalk Wilton Lowell Westfield Concord Providence Newport
Alaska Idaho Montana Oregon Washington	K7PO W7NH W7AAT W7AMF W7WV	NORTHWESTERN DIVISION Richard J. Fox Nellie H. Hart O. W. Viers Frank L. Black Robert H. Votaw	Box 301 Box 6 Box 265 1502 McPherson St. Route 1, Box 398	Ketchikan Twin Falls Red Lodge North Bend Vancouver
Hawaii Nevada Santa Clara Valley East Bay San Francisco Sacramento Valley Philippines San Joaquin Valley	K6EQW W6BIC W6BMW W6JTV W6SG W6DVE KA1XA W6CRF	PACIFIC DIVISION Atlas O. Adams Edward W. Heim Charles J. Camp Harold J. Burchfield Alan D. Whittaker, Jr. Geo. L. Woodington Newton E. Thompson Vernon C. Edgar	21st Infantry Brigade 716 West Sixth St. 318 Hawthorne Ave. 2940 106th Ave. 79 Elinor Ave. 716 Redwood Ave. P. O. Box 849 732 Blackstone Ave.	Schofield Barracks Reno Palo Alto Oakland Mill Valley North Sacramento Manila, P. I. Fresno
North Carolina Virginia West Virginia	W4OG W3UVA W8KKG	ROANOKE DIVISION H. S. Carter Charles M. Waff, Jr. Dr. Wm. H. Rheldaffer	115 Crafton St. P. O. Box 1212	Winston-Salem Univ., Charlottesville Lost Creek
Colorado Utah-Wyoming	W9FA W6GQC	ROCKY MOUNTAIN DIVISION Glen Glasscock Arty W. Clark	2160 South Josephine St. 260 So. 9th West	Denver Salt Lake City, Utah
Alabama Eastern Florida Western Florida Georgia-So. Carolina-Cuba- Isle-of-Pines-Porto Rico- Virgin Islands	W4DGS W4BCZ W4MS W4CE	SOUTHEASTERN DIVISION James F. Thompson Philip A. McMasters Edward J. Collins Bannie L. Stewart	2248 S. Arlington Ave. 731 Arlington Ave. 1517 East Brainard St. SC-P53, C.C.C. Camp Lawrence	Birmingham St. Petersburg Pensacola Effingham, S. C.
Los Angeles Arizona San Diego	W6BPU W6LVG W6EOP	SOUTHWESTERN DIVISION Howell C. Brown C. C. Day Harry A. Ambler	120 N. El Molino Ave. "La Posta Quemada" 4101 Hamilton St.	Pasadena Vail San Diego
Northern Texas Oklahoma Southern Texas New Mexico	W5BII W5CEZ W5BDI W5CGJ	WEST GULF DIVISION Richard M. Cobb Carter L. Simpson Ammon O. Young Joseph M. Eldott	Box 185 2010 So. 4th St. 4803 Eli St.	Dodd City Ponca City Houston Chamita
Maritime	VE1DQ	MARITIME DIVISION A. M. Crowell	69 Dublin St.	Halifax, N. S.
Ontario	VE3QK	ONTARIO DIVISION John Perdue	229 Askin Boulevard	Windsor, Ont.
Quebec	VE2EE	QUEBEC DIVISION Stan Comach	780 Broad Ave.	Verdun, P. Q.
Alberta British Columbia	VE4LX VE5EP	VANALTA DIVISION Alfred D. Kettenbach D. R. Vaughan-Smith	1221 Burnaby St.	Rockyford Vancouver
Manitoba Saskatchewan	VE4BG VE4EL	PRAIRIE DIVISION A. J. R. Simpson Wilfred Skaife	71 Thelmo Mansions 2040 McTavish St.	Winnipeg Regina

* Officials appointed to act until the membership of the Section choose permanent S.C.M.'s by nomination and election.

The American Radio Relay League



THE AMERICAN RADIO RELAY LEAGUE, INC., is a non-commercial association of radio amateurs, bonded for the promotion of interest in amateur radio communication and experimentation, for the relaying of messages by radio, for the advancement of the radio art and of the public welfare, for the representation of the radio amateur in legislative matters, and for the maintenance of fraternalism and a high standard of conduct.

It is an incorporated association without capital stock, chartered under the laws of Connecticut. Its affairs are governed by a Board of Directors, elected every two years by the general membership. The officers are elected or appointed by the Directors. The League is non-commercial and no one commercially engaged in the manufacture, sale or rental of radio apparatus is eligible to membership on its board.

"Of, by and for the amateur," it numbers within its ranks practically every worth-while amateur in the nation and has a history of glorious achievement as the standard-bearer in amateur affairs.

Inquiries regarding membership are solicited. A bona fide interest in amateur radio is the only essential qualification; ownership of a transmitting station and knowledge of the code are not prerequisite. Correspondence should be addressed to the Secretary.

DIRECTORS

President

Vice-President

Canadian General Manager

ALEX REID VE2BE
169 Logan Ave., St. Lambert, P. Q.

Atlantic Division

EUGENE C. WOODRUFF W8CMP
234 W. Fairmount Ave., State College, Pa.

Central Division

EDWARD A. ROBERTS W8HC
2699 Endicott Rd., Shaker Heights, Cleveland

Dakota Division

CARL L. JABS W9BHV
1822 James St., St. Paul, Minn.

Delta Division

E. RAY ARLEDGE W5SI
P. O. Box 286, Pine Bluff, Ark.

Hudson Division

KENNETH T. HILL W2AHC
115 Willow St., Douglaston, L. I., N. Y.

Midwest Division

FLOYD E. NORWINE, JR. W9EFC
120 South Fourth St., St. Louis, Mo.

New England Division

G. W. BAILEY W1KH
74 Webster Road, Weston, Mass.

Northwestern Division

RALPH J. GIBBONS W7KV
c/o United Air Lines, Pendleton, Ore.

Pacific Division

S. G. CULVER W6AN
2962 Russell St., Berkeley, Calif.

Roanoke Division

H. L. CAVENESS W4DW
State College Station, Raleigh, N. C.

Rocky Mountain Division

RUSSELL J. ANDREWS W9AAB
1867 So. Lafayette St., Denver, Colo.

Southeastern Division

BENNETT R. ADAMS, JR. W4APU
1512 Grove Place, Homewood, Ala.

Southwestern Division

CHARLES E. BLALACK W6GG
P. O. Box 55, Yuma, Ariz.

West Gulf Division

WAYLAND M. GROVES W5NW
c/o Humble Pipe Line Co., Neches, Texas

OFFICERS

President.....

Vice-President.....

Secretary.....KENNETH B. WARNER, W1EH
West Hartford, Connecticut

Treasurer.....ARTHUR A. HEBERT, W1ES
West Hartford, Connecticut

Communications Mgr....F. EDWARD HANDY, W1BDI
West Hartford, Connecticut

General Counsel.....PAUL M. SEGAL, W3EEA
1010 Shoreham Building, Washington, D. C.

Address all general correspondence to the executive headquarters at West Hartford, Connecticut



THE EDITOR'S MILL

FOG lay low on the hilltops of the east. The middle west groaned under its fourth successive blizzard in as many weeks; the air lines were grounded; a Canadian crystal-gazer prophesied the end of the world; the Supreme Court said the TVA would get by; Haile Selassie was reported suing for peace. That week in middle February the heavy hand of the Great Operator reached out and threw the switches that meant QRT for those two grand old men who were the much-loved leaders of the American Radio Relay League, Hiram Percy Maxim, our president, and Charles H. Stewart, our vice-president. Thus passed into immortal history the man who founded our society and gave it its name and who has been constantly our leader and our inspiration, and the man who was our legislative expert and who gave of his services in a fashion never excelled in our annals.

It is with an impossibly heavy heart that we address ourselves to the sad task of chronicling in these pages something of the debt that amateur radio owes these two men. As we sit before our typewriter we wonder whether, in the sorrow we feel, it will be possible for us to find anything like adequate words. That they should leave us at the same time is an appalling loss. It is the loss of friends and of wise and experienced leaders, of men who had the vision clear, a loss that will be felt through the entire structure of amateur radio.

Charlie Stewart was the first to go. He had not been in good health for several years, his troubles dating from an occasion when he ran to catch a train and strained his heart. He was unable to attend last year's Board meeting but by last autumn was greatly improved. He was put in a hospital on February 8th, just to obtain a rest, and there passed on suddenly on the 12th. He was 63 years old. We helped to bury him in beautiful West Laurel Hill, in suburban Philadelphia, on the 15th, under a blanket of roses bearing the letters A.R.R.L. in flowers, and surrounded by innumerable floral tributes from amateur clubs.

The Old Chief, Hiram Percy Maxim, was journeying to the southwest on a vacation with his wife when he contracted a throat infection. Despite treatment between trains in Kansas City he became worse, and at LaJunta, Colorado, he

was removed from the train dangerously ill and put in a hospital there, his children summoned. These events took place on the very day that Charles Stewart passed on. Despite every modern medical aid . . . despite two days of encouraging progress . . . the grand old fellow who gave us birth passed on to join his fathers, on February 17th. He was 66 years old. A few days later, at Hagerstown, Maryland, a wretched group of us upon whose lives Mr. Maxim's had had so profound an influence joined his family in the last sad duties—while amateurs around the world hushed key and mike with bowed heads and many an honest tear.

The widow of our founder-president was not long to survive him. On February 26th she too passed on. Mrs. Maxim was a lovable and remarkable woman, a brilliant one, actively interested in the civic matters of her community; as befitted the daughter of a former governor of Maryland. She was a pioneer suffragist, a leader in the affairs of women, and a member of several of Hartford's city commissions. In Paris in 1925 she acted as interpreter for the American amateurs at the meetings resulting in the formation of the International Amateur Radio Union.

February was a sorrowful month . . . Fog lay low on the hilltops of the east . . .

*Father, in thy gracious keeping
Leave we now thy servants, sleeping.*

CHARLES H. STEWART was born in Philadelphia, July 11, 1873, moving with his family at the age of 13 to nearby St. David's, a place that was ever after to be his home. Always modestly independent financially, he was able, after a brief business career, to indulge his heart's desire in a life which centered upon amateur radio.

He was one of the country's earliest amateurs, having started about 1906. Coherers, spark coils, electrolytic detectors, handmade loose-couplers, transformers and rotary gaps, gooseneck audions—these and everything else in the kaleidoscope of changing amateur apparatus Charles Stewart knew and worked with—up to and including a single-signal receiver. A towering ship's mast on his rear lawn still marks the old days. When the Navy commenced the issuing of "certificates of

proficiency," years before the 1912 law, years before there were operator licenses, Stewart was amongst the first to qualify. With the coming of the law in 1912 he had a first-grade commercial license, although he never operated profession-

A gentleman of the old school and a sterling citizen, Mr. Stewart also found time to serve his community faithfully and efficiently. For fourteen years he was the secretary of the Radnor Township Board of Commissioners, eight years the secretary of his local Board of Health, always active in civic affairs. He was also prominently identified with early journalism in his vicinity.

He served voluntarily during the war with the famous Yale Unit No. 1, organized in July of 1916 by Trubee Davison and Robert Lovett. In October of that year the unit went to Palm Beach for flying training. There Mr. Stewart built and equipped a central radio station, installed equipment in all the planes, instructed every pilot in radio operating. When the unit moved to Long Island in 1917 he went along, completed his instruction of the thirty members, making them expert operators. He also gave his services to the



© Underwood & Underwood
HIRAM PERCY MAXIM
 1869-1936
President, A.R.R.L. and I.A.R.U.

ally. For as far back as we can remember, he was 3ZS. He had a remarkably pretty fist, the smooth clean sending of the skillful old-timer. During much of his radio career he was intensely active from the operating standpoint. He was of course a member-station on the pre-war League trunk lines. Not all of you fellows to-day will remember that the S.C.M. plan is only eleven years old in A.R.R.L. Before that, we had division managers, with district superintendents assisting them, and Charles Stewart was manager of what is now the Atlantic Division from the post-war reorganization of the League until the first of 1925, monthly turning in the operating report for that entire populous region. He was elected an A.R.R.L. director in September of 1919 and vice-president of the League in February of 1922, a post which he filled continuously for fourteen years. After Mr. Maxim, he was the dean of this year's Board.



CHARLES H. STEWART
 1873-1936
Vice-President, A.R.R.L. and I.A.R.U.

air corps as an expert adviser on the purchasing of radio equipment.

The study of radio legislation was a hobby with Mr. Stewart and in that field, as concerns amateur radio, he was the undisputed expert of his

day. This is both a dry and a complicated subject and amateur radio must be lastingly indebted to a man who found it so interesting that he gave years of his life to watching and studying it. He was chairman of the League's Legislative Committee and this was, moreover, a field of work delegated to him by the president, so that for years he was our guardian and adviser on such subjects, and annually rendered a report to the Board of Directors on its manifold detail. But Charles Stewart was more than the League's legislative representative: he was the prime early champion of amateur rights. In February of 1910, four and a half years before A.R.R.L. was formed, he appeared in Washington at the hearings on what was called the Robert's Resolution, on behalf of himself and three other Philadelphia amateurs, the first radio amateur ever to represent our cause at congressional hearings. In the intervening years, until a cohesive national organization had been formed, he was the principal and in many cases the single-handed champion of amateur radio. In March of 1912 he represented the Wireless Association of Pennsylvania, whose chairman he was at the time, at the hearings on what became the Radio Act of 1912. That too was before the formation of A.R.R.L. There were, in fact, thirteen radio bills in Congress that year and they all received his attention. Early 1917 found him fighting another legislative threat alongside A.R.R.L. representatives, and he again represented the W.A.P. in the memorable fight against the Navy-control bill in late 1918, after the Armistice. A member of A.R.R.L. from the first, Mr. Stewart's recognized ability secured him a place on our Board after the war, and until 1928 he was in charge of all of our Washington representation and our participation in all regulatory bodies. The various Poindexter and White bills, the Department of Commerce Conference Committee from which much of the actual regulatory structure of radio eventually came, the four Hoover National Radio Conferences, the hearings culminating in the Radio Act of 1927, the countless sessions of the National Coördinating Committee,—these all fell to his lot; and he was also A.R.R.L.'s principal representative at the international conference in Washington in 1927. Tireless in the defense of amateur rights, he had a wide acquaintance amongst the national legislators, and to his efforts and influence we owe much of the splendid position of amateur radio to-day.

Up to 1928 he gave an unbelievable amount of his time to A.R.R.L. in this work. We had occasion recently to review some of his work for the League in this field and were greatly impressed with the list of the instances upon which he had been our representative. Some idea of the dimen-

sions may be gathered when we say that his traveling expenses over this period ran into several thousands of dollars. For these he obtained reimbursement from the League, of course, but for his services themselves, never a penny—these he gave to the amateur radio he loved.

We have ourselves participated in many a battle shoulder to shoulder with Charles Stewart in the days before amateur radio was fully recognized and upon later occasions when our rights were imperiled. He was an excellent strategist and he never said "done." Recollections of fighting days at Washington flood through our memory as we write these lines. Our coworker is gone, but he will never be forgotten. He set an example of service and self-sacrifice, of unflinching courtesy and human kindness, that will ever inspire us.

HOW can our poor words convey adequately our emotions towards the man who gave organized amateur radio its life? For Hiram Percy Maxim was more than the president of A.R.R.L.: he was its founder, the one who first envisioned its glorious possibilities as a field for good in human life—the one who formed the organization, breathed into it the breath of life and was its constant inspiration. The amateurs of America would have no other president, those of the world no other leader.

But Mr. Maxim was more than the presiding genius of amateur radio. He was one of the greatest men of our times, a man whose superlative qualities have left their impress upon many diverse walks of life. We are not alone in mourning him; many an art, many a group of doers and thinkers, both in this country and abroad, feels his loss even as we.

The Maxim family were French Huguenots who came to this country in the middle seventeenth century to escape religious persecution, landing first at Plymouth, then moving to Maine. Hiram Percy was born in Brooklyn, September 2, 1869. His father was the late Sir Hiram Stevens Maxim, inventor of the Maxim machine gun, his uncle the late Hudson Maxim, inventor of high explosives. He attended Brooklyn schools and Massachusetts Institute of Technology, graduating from the School of Mechanical Arts there in 1886, the youngest member of his class. He was a practising engineer at the age of seventeen!

Let us put to one side for a moment Mr. Maxim's radio career and touch first upon some of his other accomplishments. He was an inventive genius by inheritance. In all, fifty-nine patents issued in his name, in many of the mechanical arts. He was not, however, an inventor of implements of warfare, as incorrectly reported in the press recently. He is perhaps best-known as the inventor of the Maxim Silencer. Originally a

highly ingenious gun silencer, the Maxim Silencer of to-day finds its application in industry, upon the exhausts of motors and the intakes of compressors. They run from small gadgets to great

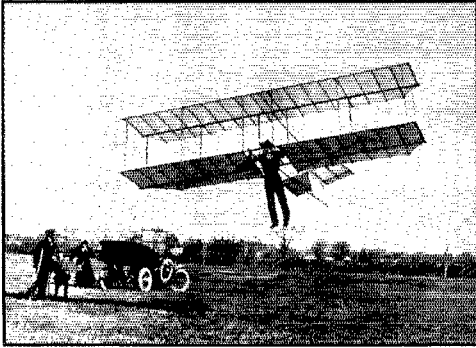

MR. MAXIM'S EARLY GLIDER

in flight over the Hartford meadows, present site of Brainard Field. Mr. Maxim is seen on crutches at the left, after a glider crash in which he injured a knee.

brutes intended for Diesels, shipped in sections on flat cars. Mr. Maxim was a pioneer in visualizing silenced air conditioning for buildings and homes, and in 1930 demonstrated an ingenious development of his organization, the Maxim window silencer, a box-shaped affair that went in a window and permitted ventilation while excluding street noise. An authority on acoustics, humanity is indebted to him for many developments that will make complex urban life more bearable.

He was an enthusiastic motion-picture amateur and gave to this field the same ardent support that he did to amateur radio. In 1926 he had noticed the same necessity for organization in this field that he had previously noted in amateur radio, and as a result of his personal efforts there came into being the Amateur Cinema League, an amateur organization similar in structure to our A.R.R.L., of which he was also the founder and only president. Countless movie amateurs honored Mr. Maxim as their chief, the same as we do, and A.C.L. and A.R.R.L. are one in this loss.

He was greatly interested in aviation. A pioneer glider enthusiast, he badly injured a knee in a glider accident in his younger years. He was one of the originators of the Aero Club of Hartford, was for many years chairman of Hartford's Aviation Commission, and was the man who first envisioned Hartford's municipal aviation port, Brainard Field, where WIMK is now located.

Mr. Maxim was one of the pioneers in the development of the automobile. While in his early twenties, superintendent of the American Projectile Company in Lynn, Mass., he conceived the

possibility of propelling a vehicle by means of a gasoline engine. Knowing nothing of the famous Seldon patent, he built an engine and experimented with it, eventually mounting it upon a second-hand tandem tricycle and securing a machine that would run. This work led to contact with the Pope Manufacturing Company of Hartford, famous early manufacturers of bicycles, and Mr. Maxim moved to Hartford to become manager of the new motor-carriage department of that company. As a result, there came into existence the famous Columbia automobiles, first gasoline, later electric, designed and built under Mr. Maxim's direction. He had the distinction of participating in what was probably the first automobile race in America, between his Columbia and a Stanley, both pitifully inadequate devices, over a distance of five miles. Mr. Maxim won the race: the Stanley couldn't be started! For a while he was vehicle motor engineer for Westinghouse at East Pittsburgh, later returning to his Electric Vehicle Company in Hartford, where he remained until the organization of the Maxim Silencer Company. He had many rare tales to tell of early automobile days. Harper's are to produce soon his book of recollections of the horseless-carriage days. Incidentally, he was the man responsible for transferring automobile

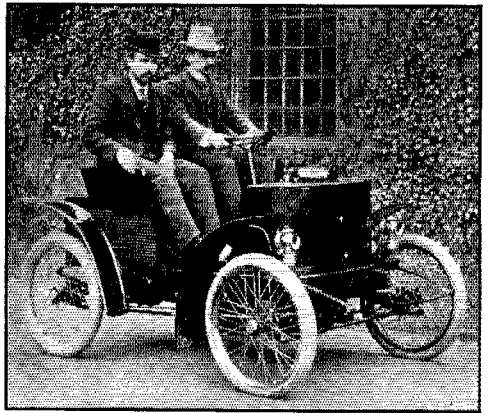

THE WINNER

Columbia Gasoline Carriage designed by Mr. Maxim, an automobile pioneer. This machine won the first automobile track race held in America, at Branford, Conn., in 1899. Mr. Maxim is at the controls.

controls from the right-hand side of cars to the left-hand. You may not remember that American cars once had right-hand drive, but your father will.

Astronomy interested him and in his later years he became quite well informed upon the subject, writing and lecturing upon it, including the philosophical implications of the cosmos. His

always active mind was intrigued with the possibilities of life on other planets and his scientific interest caused him to assemble all available data on the surface conditions existing on the planets. He created a mild stir some years ago with his book, "Life's Place in the Cosmos," in which he speculated upon these possibilities. He was immensely interested in the new 200-inch reflector and witnessed its pouring at Corning. One of the objectives of his last trip was a visit to the Percival Lowell Observatory at Flagstaff, Arizona, where he had been invited to make observations. He was particularly interested in the planet Mars and had a globe of his own making on which he had transferred all the mysterious markings on the face of that planet, to facilitate study.

He was also an enthusiastic yachtsman, a former director of the Hartford Yacht Club, and the skipper of the power cruiser *Moby Dick*. Accompanied by his daughter, he once made a trip of several months through the rivers and lakes of Canada in a folding canvas canoe with outboard motor.

Recently he had been devoting much time to writing and lecturing, mostly on scientific subjects. He had a lucid and entertaining style that delighted his lay audiences. His father had been a remarkable man and concerning that unusual parent Mr. Maxim wrote a book, also soon to be published by Harper's, two installments of which

appeared last autumn in *Harper's Magazine*.

He was immensely active in all his chosen fields. He was the founder and first president of the Hartford Engineers Club, member of the Executive Committee of the M.I.T. Alumni, permanent toastmaster of his class at M.I.T., longtime chairman of the Hartford branch of the American Society of Mechanical Engineers, one-



AN AUTO ROAD RACE IN 1905

Mr. Maxim, early automobile engineer and enthusiast, leading the field in a machine of his design.

time chairman of the Connecticut Section of the Society of Automotive Engineers, president of the Hartford Amateur Cinema Club, and a member of too many technical societies to list. Colgate honored him with the degree of Doctor of Science. He was a retired lieutenant-commander in the U.S.N.R.

We quote from an editorial in *The Hartford Times*:

"Death found the shining mark it loves in Hiram Percy Maxim. Hartford had, perhaps, in this generation, no keener mind, no man who had a greater catholicity of interests, who sought more eagerly new knowledge in whatever field. Everything about life interested him. He had a vast range of knowledge, yet was utterly unostentatious and gifted with a personal magnetism which caused him to be eagerly sought after as a companion. Life was a romance for him and he had a great zest for everything about it. . . . There was almost no field which his keen and alert mind did not wish to explore, whether it had to do with social science, philosophy, astronomy,

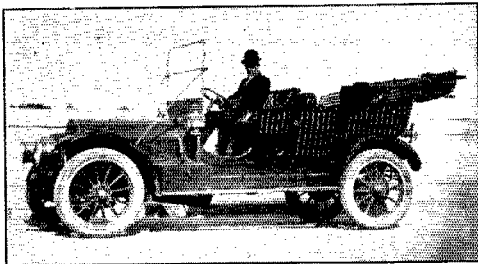

YOU WOULDN'T BELIEVE IT

but here is *The Chief* at the wheel of a somewhat later Hartford-built car, the last word of those days.



THE NAVY DAY BROADCAST

Mr. Maxim at WIMK, A.R.R.L.'s headquarters station, where he annually sent the Navy Day broadcast.

industrial development or whatever it might be. Everything interested him, every man's experience, every happening of any nature. . . . He had a boundless enthusiasm for everything that was new. Unlike most scientists he was not content with a purely materialistic view of the universe. In recent lectures he had said that the more one familiarized himself with all that science had discovered the greater his respect for the orderliness of it all and the stronger the conviction that behind the order must be some su-

preme force. Knowledge made him neither discontented nor pessimistic. Life remained for him to the end a great and exhilarating adventure. He was a remarkable man, a choice spirit."

HIRAM PERCY MAXIM entered amateur radio in 1910 through the interest of his son Hiram Hamilton. He was past forty years of age when he learned the code. Their first station, excellent for that day, enjoyed the call SNY. With the coming of the law Mr. Maxim became 1WH and, later, the special-license station 1ZM. After the war and until the final QRT he was 1AW.

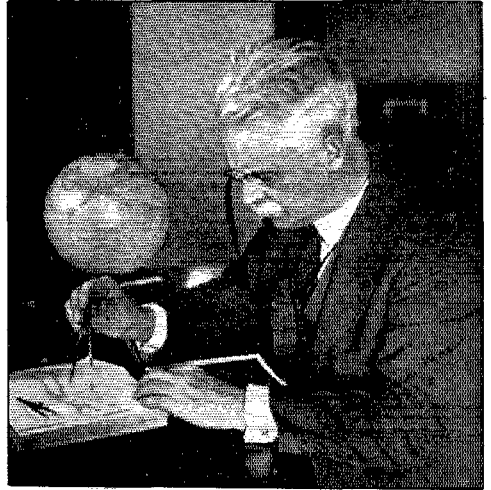

STUDENT OF THE COSMOS

Mr. Maxim wrote and lectured on scientific subjects, particularly astronomy. He was greatly interested in Mars and had constructed a globe bearing all the known data on the markings appearing on that planet. (Photo by R. B. Bourne, WIANA).



IN HIS SILENCER LABORATORY

Mr. Maxim was an authority on acoustics, the inventor of the Maxim Silencer. He is here shown in his experimental laboratory. The 'phone and log are reminiscent of amateur radio.

The story of our A.R.R.L. beginnings has been often told: how Mr. Maxim foresaw the need for national unity in amateur matters, sought carefully for a basis for organizing, found it in the idea of relaying, and then, with the collaboration of that brilliant Hartford youth, Clarence D. Tuska, launched our League, first as a committee within the old Radio Club of Hartford, then on its own in 1914; and how, the following year, together with Tuska, he started our magazine, *QST*. From that day to this, he has been our mentor, our inspiration. The character of Mr. Maxim can be summed up in a few crisp words: he stood for the very highest principles in everything. He was universally respected and no one would think of letting down so grand a chief. With one exception he presided over every meet-

ing of the A.R.R.L. Board of Directors ever held and over 139 meetings of the Executive Committee held under the present constitution. It was always a marvel to us how a man of so many diverse activities could find the time for them all; yet in the affairs of our League he was always ready, willing and eager, and he directed our councils with the wisdom of long experience in the affairs of men.

This is an appropriate time and place for us to disclose a little-appreciated facet of the Maxim personality. We spoke above of Mr. Maxim as an author. We tell now a sad secret, one zealously preserved over many a year: H. P. M. was T. O. M. Yes, fellows the Old Chief himself was The Old Man, that most trenchant observer of amateur practices! It will show our readers, as nothing else could, that The Chief was as keen an amateur as ever lived, that he surely knew his stuff! Surrounded by affairs and living in an atmosphere that required most of the time a considerable measure of dignity, obliged most of the time to express himself in formal language, we have known with what delight the boss had refuge to a pen-name for an opportunity to cut loose and swing cleanly from the shoulder with the language of another world, coupled with good horse-sense talk about our operating foibles. T. O. M. was conceived in the knowledge that homely talk in an amusing vein, employing ridicule as a weapon, would be much more effective in opening the eyes of amateurs

to their weaknesses than columns of editorial preachments. His many yarns have been the most talked-of feature in *QST*. The benign despot who was T. O. M. has ruled our hearts for many years. May he ever do so in memory, while his mysterious instrument, the Wouff-Hong, remains close to hand, ready if needed to preserve the traditions he established!

1AW of the old days was as fine a spark station as ever existed. You remember T. O. M.'s rotary gap, Old Betsy? Well, sirs, Old Betsy herself was at 1AW, cunning product of a mechanical engineer, generator of a tone famous throughout the country in the old days. Old Betsy ran 8,000 r.p.m., belt-driven from a half-horse motor. She was in a box in the corner of the cellar and she was decorated with two large oil drip-cups. From seven o'clock until one A.M. she did her stuff nightly in those glorious days, punctuated only by a trip to the cellar mid-evening to replenish the oil. She is now to be preserved in the A.R.R.L. Museum. The reader may know with what enthusiastic delight such a person as Mr. Maxim sat down at his amateur station. The editor, during his first bachelor year in Hartford, was the junior operator at 1AW, and did we put Old Betsy through her paces! Mr. Maxim believed in message traffic and in relaying, and nothing gave him more operating pleasure than to hook up with a good clean fist and clear the traffic hooks in both directions. 1AW was on one end of almost all

On February 17th

*Across the jeweled curving dome of night
He flashed these words to me, "Maxim
. . . is dead."*

*And then his key was silent.
So was mine.*

*There was nothing more to say,
Nothing we could do . . . but listen—
Listen to that sombre lightning play
Around the spinning globe, as ham told
ham*

"Our President is dead."

*Slowly I drew the veil, muting the set
'Til all the signals died, and silent
Burned the pilot light, beacon of grief,
A candle for the dead.*

*Great men have died before,
Kings, and Princes.
The news ne'er moved me deep, and yet
This abyss where my heart has gone
Plumbs all.*

*Maxim! Yours was the vital spark
Which kindled for us all
Ten thousand friendships
Endeared with loves alike, exchanging keys
To one another's hearts, and homes.*

*The loom you made has spun a mighty
weave
• Netting the whole wide world with threads
invisible,
Patterned the miracle each age so long has
prayed for,
Nation and creed forgotten . . . as man
called man his brother.*

*Henceforth this date all amateurs have
marked*

*As yours. In silent tribute 'tween the
frozen poles*

*The night will muted be,
So that the stars will wonder.*

—Michael J. Caveney, VE3GG

our early A.R.R.L. records and we recall many a thrilling evening there with Mr. Maxim and Fred Schnell when something hot was on. Early amateurs will remember the record-breaking "transcons," when messages were relayed across the continent via several stations and the reply returned from the opposite coast. Six and a half minutes, the record was, and with 1AW the eastern terminal. And do you remember the record of four minutes, eighteen seconds, for a round-trip message from Hartford to Hawaii with only one relay at Sleepy Eye, Minn., away back when? Again, 1AW. Not particularly active the last several years, the Chief still sat in at some of our stations an occasional evening and he regularly sent the Navy Day broadcast from W1MK.

After the opening of international amateur communication Mr. Maxim quickly foresaw the need for international unity. By means of two visits to Europe he brought about the formation in 1925 of the International Amateur Radio Union, a worldwide federation of national societies like our A.R.R.L. As in the case of our League, he was the Union's first and only president. The amateurs of all the world have lost their leader in his passing.

The man who founded A.R.R.L. would never shirk in its defense, and in that field H.P.M. had a brilliant record. The first instance of A.R.R.L. influence at Washington was his appearance before the Commissioner of Navigation in late 1914, as our president, where was secured the concession of operating selected A.R.R.L. relay stations on 425 meters instead of the usual 200—to facilitate long-distance relaying. He directed our fight and personally headed our delegation to Washington in late 1918 when we were having an awful battle with the Navy, which wanted the control of all radio. That was the occasion upon which A.R.R.L.'s famous "blue card" went out, devised and written by Mr. Maxim. The story of that battle is a thrilling tale in itself. Suffice it here to say that the Old Chief won. The next year there was more of the same, with the League, under Mr. Maxim, finally getting the war-time ban lifted and orders issued which permitted the resumption of amateur radio. He attended, we believe, all of the national radio conferences and of course took an active part in our representation at the Washington Interna-

tional Conference in 1927. He is the author of that splendid brief on amateur radio that was delivered before the Senate Interstate Commerce Committee in 1930 when the Dill bill was under consideration; it was printed in *QST* at the time.

Little memories come back vividly at such a time as this. Despite his technical attainments, it was human qualities that prevailed in Mr. Maxim's make-up, and these were such as to endear him to all who knew him. He was, for instance, a rare traveling companion. He and your reporter were together on many a trip, to a Washington hearing or to speak at conventions and club meetings. Barnstormers, he called us, when we would be hopping to several conventions in the same week. He was a most entertaining conversationalist and had a priceless store of anecdotes from his long engineering experience. Mornings in hotel rooms he would take setting-up exercises, in a manner that perpetually amazed us. Where the average person thinks he is accomplishing something when he bends from the waist and touches fingertips to rug, T.O.M. could put his entire palms on the floor. In memory we can still see him, in his pajamas, getting his morning exercise by galloping around

a hotel room on all fours. Then he always took a cold tub bath. Tub half full of cold water, he would perch on the back of the tub, get all set with a deep breath, and slide down the incline all-over-at-once, to a tremendous flailing of arms and legs and yelling bloody murder, while the bathroom floor got an inch of water to the subsequent despair of chambermaids. Let no one think there is a note of disrespect in these anecdotes; they are born of the very fact that T.O.M. was a warm and vital person, rich in the human qualities that make a real companion.

One of Mr. Maxim's major services to A.R.R.L. was his constant insistence, down through the years, upon the highest ethics and standards in our organization. The organization must not be selfish; it must have orderly government in terms of majority opinion; it must work for the greatest good to the greatest number; it must not lend itself to personal axe-grinding. These principles are epitomized in a little article he wrote for *QST* in September, 1927, which we reproduce at the end of next page, commending it to the attention



THE CHIEF

An unusual study of Mr. Maxim that we have always liked. It is typical of a mood of amused incredulity when someone has just proposed "an idea without a handle on it." (Photo by R. B. Bourne, W1ANA.)

of all. Exponent of the charm and the spirit of adventure of amateur radio, champion of our rights and wise leader, Hiram Percy Maxim lives on in the hearts of the world's amateurs!

LEAGUE headquarters gratefully acknowledges the receipt of hundreds of expressions of sympathy upon the passing of our leaders from individual amateurs, radio clubs, foreign amateur societies, and other organizations in the vast radio world. We publish here just one, from the Federal Communications Commission at Washington:

"The Commission has learned with a great deal of sorrow of the recent death of your president, Hiram Percy Maxim, and your vice-president, Charles Stewart. In their relations with the communication world generally and the government particularly, both of these leaders in amateur radio showed a breadth of vision and an understanding of the broader aspects of regulatory problems which went far in the achievement of a

position of leadership for amateur radio. Please present our deepest sympathy to your Board of Directors and to the families of Mr. Maxim and Mr. Stewart.

"Anning S. Prall, Chairman"

The Old Chiefs have passed on. We shall QSO again in that land where signals never fade. No organization ever had leaders of which it could be more proud. Their names go down in our history as men who fought wholeheartedly, unselfishly and successfully for a cause that they saw grow from nothingness to an important force in behalf of science and civilization. They must be continuing models for us and inexhaustible springs of inspiration. We, the living, must carry on the work they have thus far so nobly advanced. Let us now highly resolve that the lessons we have learned at their feet shall never be forgotten, and that no act of ours shall ever impede the great march of amateur radio—"Of, by and for the amateur"!
K. B. W.

The Reason Why

By Hiram Percy Maxim, President A.R.R.L.

(Reprinted from *QST* for September, 1927)

SITTING back in the old armchair, with the last issue of *QST* read from cover to cover and with everybody else in the house asleep hours ago, I fell to thinking of amateur radio to-day and amateur radio of other days. As the blue smoke curls slowly upward from the old pipe, visions of early A.R.R.L. Directors' Meetings float before me. I see those old-timers grappling with problems of organization, with QRM, with trunk-line traffic and rival amateur leagues. I see sinister commercial and government interests at work seeking to exterminate amateur radio. They were dark days, those early ones.

To-day I see Amateur Radio an institution, recognized by our American government and on the road to recognition by the other governments of the world. I see a fine, loyal A.R.R.L. membership of 20,000 standing shoulder to shoulder and believing in each other and still blazing the way in radio communication. I see a rapidly developing world-wide amateur radio brotherhood taking shape, in the form of our I.A.R.U.

And as the last embers of the old pipe turn to grey ash, I ask how it all came about: that the A.R.R.L. should have succeeded and all its opponents failed. The answer is clear. It is because with our opponents there was always some kind of a selfish motive to be served for someone, whereas in our A.R.R.L. we insisted from the beginning that no selfish motive for anybody or anything should ever prevail. Everything that A.R.R.L. undertakes must be 100% for the general good. That policy bred loyalty and confidence. With those two things an organization can prosper forever.

More Developments in the Noise-Silencing I.F. Circuit

Noiseless Reception with Crystal-Type S.S. Receivers—
Circuits For Single I.F. Stage Types

By James J. Lamb,* WIAL

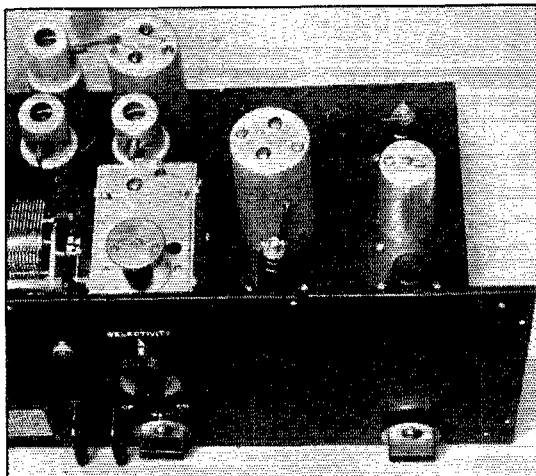

THE NOISE SILENCER UNIT, AT THE RIGHT, COMBINES WITH THE CRYSTAL FILTER OF THE S.S. RECEIVER TO MAKE C.W. TELEGRAPH RECEPTION PRACTICALLY IMMUNE TO ELECTRICAL NOISE INTERFERENCE

The silencer-amplifier and input coupling transformer are at the left, with the noise amplifier, diode coupling transformer and noise rectifier at the right. The threshold adjustment control is on the front panel, at the lower right.

EVERY user of a crystal-filter S.S. receiver is familiar with the drastic reduction in background noise and ordinary electrical interference racket which can be obtained with the crystal switched in circuit. By measure, this improvement in signal-noise voltage ratio runs to ten times and higher (20 db or more), as compared with the straight two-stage i.f. noise ratio in typical superhets. But every user of such a receiver is also familiar with the apparent failure of the crystal filter to maintain this performance under conditions of extraordinary electrical interference—the kind that sets the crystal to “pinging” and makes the

* Technical Editor.

signal lose its identity completely. The crystal is highly effective in cutting down background noise such as tube hiss, motor “hash,” and even “machine-gun” type interference such as automobile ignition interference of relatively low amplitude. This it accomplishes by virtue of straightforward circuit selectivity. But when interference of large amplitude relative to the signal level is encountered, the high-selectivity circuit appears to undergo a radical change in character. Let the ignition system of the oil burner in the basement start up, or a hard-working bus pass immediately in front of the house, and all is lost but the noise.

The explanation of what happens under such conditions was given in the first article on the noise silencer development in February *QST*.¹ Shock excitation of the low-decrement crystal circuit results in prolonged wave trains of relatively small damping. These are of intermediate frequency, of course, and pass on to the second detector where they beat with the c.w. oscillator voltage to give audio output which sounds almost as if an actual c.w. carrier with some weird kind of modulation were being received. With sufficiently small time interval

between the interference pulses (say one-hun-

¹ Lamb, “A Noise-Silencing I.F. Circuit,” *QST*, Feb., 1936.

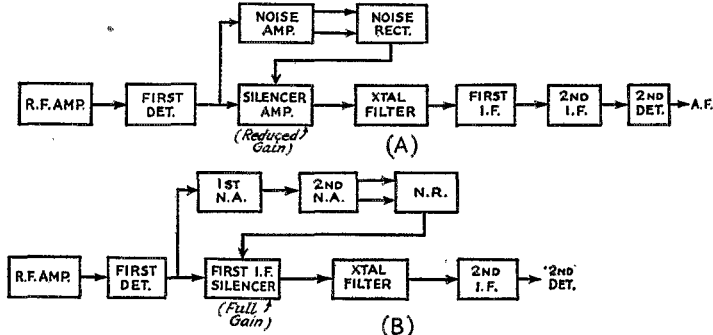
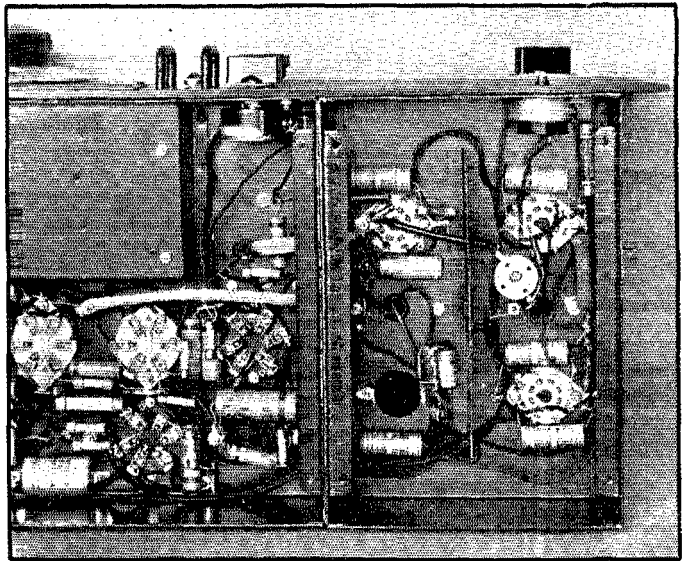

FIG. 1—POSSIBLE METHODS OF ADAPTING THE SILENCER CIRCUIT TO RECEIVERS HAVING ONE OR TWO I.F. STAGES

dredth second or less), the individual wave trains actually overlap, and really cause a continuous

audio-frequency beat-note in the output of the second detector with the c.w. oscillator on for code reception. In Fig. 3 (which will come up for detailed discussion later), oscillograph sketches E and F illustrate what happens in crystal filter reception with this kind of interference—when the crystal is not protected from shock excitation. Such behavior of the crystal filter suggests that we could devise a c.w. transmitter that had no vacuum-tube oscillator, a high-frequency buzzer being used to shock-excite a crystal filter circuit at sufficiently small time intervals to give a succession of overlapping wave trains which would be essentially continuous—after



THE SIMPLE CIRCUIT OF THE SILENCER UNIT VIEWED FROM THE BOTTOM

A baffle shield separates the input transformer and 6L7 circuits from the noise amplifier-rectifier.

discouraged rather than encouraged. Introduction of a little effective noise silencing is indicated.

Application of a silencer circuit to a crystal-filter type receiver so that the crystal will be protected from shock excitation involves a somewhat different technic than shown for the "straight" superhet in the February *QST* article, however. To be effective, the silencer must precede the filter in the circuit line-up. There are two angles to this reasoning. In the first place, the silencer is practically ineffectual in taking out interference of the prolonged train form which is characteristic of the output of a crystal circuit with shock excitation. As was shown in the previous article, the silencer circuit must be able to get at the noise pulses of intermediate frequency while they still have their short-time character. From the other angle, the high-amplitude type of pulse interference against which the silencer is most effective is the very kind against which the high-selectivity circuit is ineffectual. Together, the silencer and the crystal filter should make an ideal team for combating noise interference generally. And they work out

to be just that—when they are properly harnessed so that the silencer gets first crack at the high-amplitude pulses which exceed the signal level

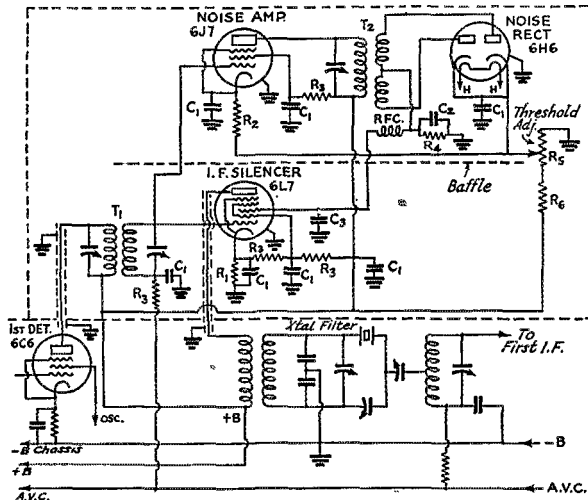

FIG. 2—CIRCUIT OF THE SILENCER UNIT WHICH CAN BE ADAPTED TO S.S. RECEIVERS HAVING ONE OR TWO I.F. STAGES, AND TO "STRAIGHT" SUPERHETS HAVING ONLY ONE I.F. STAGE

- Variations in detail are discussed in the text.
- C₁—0.1- μ fd. tubular by-passes.
 - C₂—100- μ fd. mica.
 - C₃—50- μ fd. mica.
 - R₁—2000-ohm, 1/2-watt.
 - R₂—300-ohm, 1/2-watt.
 - R₃—100,000-ohm, 1/2-watt (may be omitted between 6L7 cathode and screen. See text).
 - R₄—100,000-ohm diode load resistor.
 - R₅—2000- or 3000-ohm variable, volume control type (Yaxley).
 - R₆—30,000-ohm, 2-watt.
 - T₁—Standard double-tuned i.f. transformer to tune to the receiver's intermediate frequency (National 456 kc. or equivalent).
 - T₂—Single-tuned full-wave diode transformer for receiver's intermediate frequency (Sickles 456 kc. or similar).

which it would be just a matter of amplification! But such c.w. generating action serves no useful purpose in our receivers. It's something to be

and the crystal filter follows to take care of the low-amplitude hiss, hash and general background which is beneath the capabilities of the silencer.

As is well known, the crystal inherently works best at relatively low i.f. signal level and therefore must be placed

not more than one stage behind the first detector. While it might be thought that the first detector could serve as the tube in which silencing action occurs, a second look shows this to be impracticable. The noise amplifier-rectifier section must have input taken off at a point in the circuit ahead of the silencer (6L7) stage. Hence, if the first detector were to be used as the silencer stage, it would be necessary to pick off noise voltage at signal frequency (ahead of the first detector). This would entail either a separate signal-input circuit for r.f. noise prior to rectification, or at least a separate converter circuit to change the r.f. noise voltage to a fixed intermediate frequency before rectification. Furthermore, the first detector has enough work to do as a mixer and has its available grids pretty

well occupied at this job without further complication. Although the separate noise input and converter circuits are entirely possible, simpler and more economical arrangements which are better adapted to existing types of receivers will be of greater immediate interest.

Two possible methods of fitting in a silencer circuit to operate ahead of the crystal filter of current types of S.S. receivers are shown in the block diagrams of Fig. 1. Either of these would be adaptable to a receiver already having two i.f. amplifier stages, adding three tubes to the set's complement. Similar arrangements also are adaptable to receivers having a single i.f. stage, the arrangement of Fig. 1-A requiring three addi-

tional tubes, while that of B would add four of the metal variety. The single i.f. stage type receiver will be discussed in detail further on.

Although these arrangements both use a first i.f. stage as the silencer-amplifier, they differ

in that the first shows only one stage of noise amplification while the second includes two noise amplifier stages. This difference is accounted for by the fact that the 6L7 silencer-amplifier in A is operated at reduced gain, with higher than normal cathode-drop bias (approximately 10 volts) on both No. 1 and No. 3 grids. Accordingly, less additional rectified negative noise voltage on the No. 3 (silencing) grid is required for cut-off of this stage. Hence, less noise voltage amplification ahead of the full-wave rectifier is necessary to give full silencing action, as compared with the 6L7 stage operating at normal bias. The screen voltage on the low-gain stage also may be considerably lower than usual (40 to 60 volts instead of the normal 90 to 100 volts).

Even if noise control considerations did not require this reduction in gain of

the 6L7 with the single-stage noise amplifier, stabilization of the i.f. circuit (prevention of regeneration) would make reduced amplification advisable with the usual two-stage i.f. amplifier. There is no need for additional over-all gain. Thus reduced gain in the silencer-amplifier is sound practice from both points of view. It also keeps the input to the following crystal filter at the relatively low level previously pointed out as desirable.

In the arrangement of Fig. 1-B, where the crystal filter is moved one stage farther back in the normal two-stage i.f. line-up, the first amplifier would have to be maintained at normal gain in

(Continued on page 78)

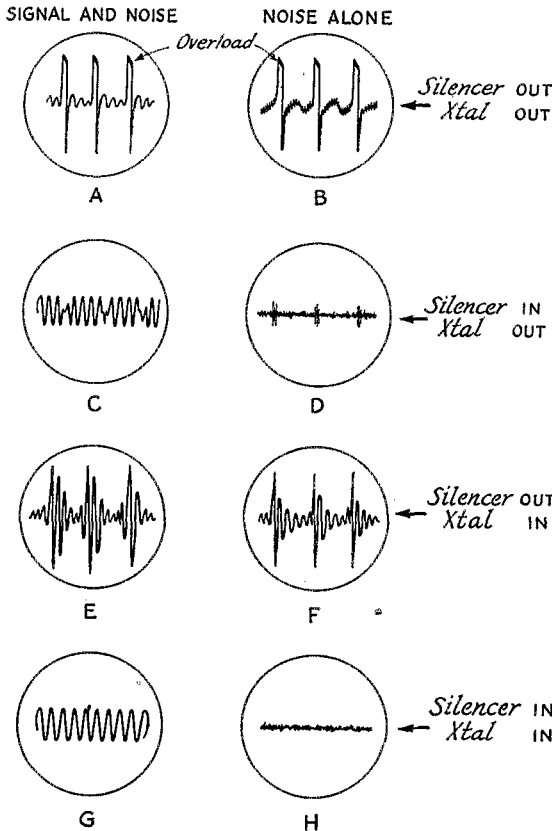

FIG. 3—THE WHOLE STORY OF THE SILENCER-FILTER PERFORMANCE IS TOLD BY THESE REPRODUCTIONS OF OSCILLOGRAPH PATTERNS

The final accomplishment is practically perfect c.w. reception through terrific spark interference.

Building a Simplified High-Performance Superhet

An Inexpensive Receiver Designed on a Results-Per-Dollar Basis

By George Grammer,* W1DF

Hams who are in the habit of dashing through QST, looking at the pictures and then deciding that most of the gear is planned for millionaires, might pass up this receiver because it looks expensive. It will be their sad loss. This new receiver is no freaky, hybrid contraption. Its performance has not been handicapped by obliging two or three tubes to take a crack at half a dozen functions. Instead, the design is a piece of sound engineering in which an almost unbelievable amount of performance per dollar has been obtained.

Show us one receiver that can be built for less than forty dollars and give a performance like this one and we'll show you a dozen freak three and four tubers that should have been dumped in the ash-barrel at birth.

—EDITOR

ONE has only to look through the descriptions of amateur radio stations in several issues of QST to realize that the trend is more and more to manufactured receiving equipment. It must be admitted that the arguments in favor of buying rather than building a receiver are numerous and compelling. Nevertheless, there are still some amateurs who attempt the construction of receivers a bit more complicated than the two or three-tube regenerative rig. Home construction not only saves some money, but also permits wide freedom in choice of circuits and components, whereas the purchaser of a receiver has to take what is offered at the price he can afford to pay.

The receiver described here was built with the idea of getting as much as possible in the way of performance for every dollar of cost, while still keeping the construction within the capabilities of the amateur who has successfully built regenerative-type receivers and who understands what a superhet is all about. The parts in the set total less than forty dollars; add about six for tubes and the cost is well below the price of any amateur-band receiver of reliable make. In sensitivity and selectivity

the receiver is, under average operating conditions, about equivalent to a straight superhet employing a preselector stage and two i.f. stages

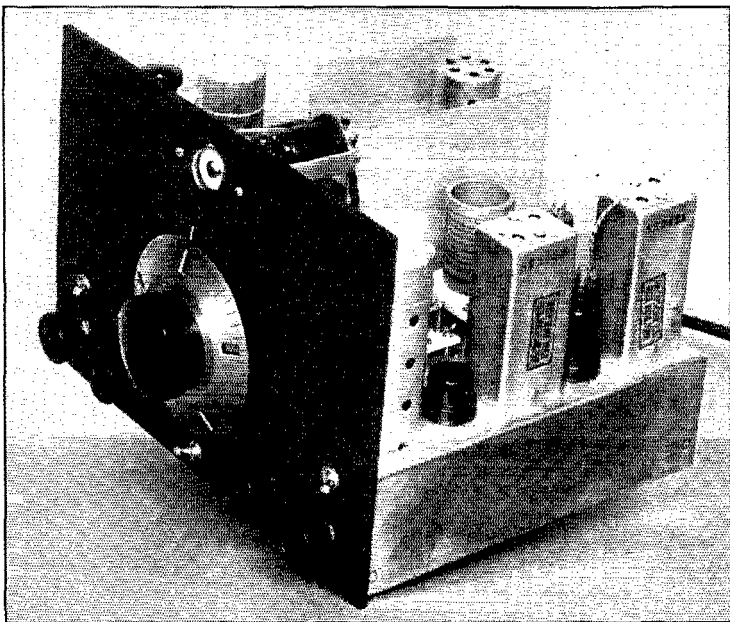

AN EIGHT-TUBE SUPERHET FEATURING AN IRON-CORE I.F. AMPLIFIER REGENERATIVE MIXER, AND ELECTRON-RAY TUNING INDICATOR

Suitable for home construction, this receiver gives full band-spread on all bands, and uses a combination of glass and metal tubes. While relatively inexpensive, its performance compares favorably with that of more elaborate receivers.

with air-core transformers; if necessary, its performance can be pushed to a still higher level without any particular operating difficulties.

SETTING UP REQUIREMENTS

Any receiver reflects to a considerable extent the personal preferences of its builder, insofar as

* Assistant Technical Editor.

those preferences can be exercised with available materials. In our opinion a receiver to be used daily in station operation must have a good deal more than the sensitivity and selectivity which seem to be considered of paramount importance. These are essential, of course, but in addition we want stability, so the signal will stay put while we're listening to it; we want a tuning system that is smooth and easy in action, with band-spread which makes tuning non-critical on all bands, not giving five dial divisions per kilocycle on 80 meters and 5 kilocycles per dial division on 20.

And we want to get these things without too much constructional difficulty. For this reason, coil switching would seem to be out of the question, since a switching system capable of meeting the extremely exact band-spread requirements would be excessively complicated in design and difficult to tailor. On the other hand, plugging in more than two coils is more of a job than we want in changing bands. Besides, it is always desirable to keep down the number of stages, when possible, to avoid oscillation troubles.

These requirements can be met by making use of some of the newer components available to amateurs, and by using circuit arrangements which the commercial people cannot touch because of manufacturing difficulties and the necessity for putting out a receiver which a person who knows nothing at all about radio can handle. With iron-core i.f. transformers, for example, it is possible to get in one stage selectivity as good as, if not better than, with two stages of air-core transformers.¹ The gain in one stage is comparable to that with two air-core stages. Since there is no place for preselection with only two plug-in coils, a regenerative first detector or mixer can be used to get the necessary selectivity. Needless to say, this also gives a marked increase in receiver gain, and is especially valuable at 14 and 28 mc. in comparison with the ordinary non-regenerative r.f. amplifier.

Stability and positive control can be secured by careful construction and the use of a tuning mechanism of the type specified in this receiver. While it costs a bit more than a pair of condensers and a dial, it is certainly more than worth the difference—even in a set where economy is a prime consideration. We're after a high performance-cost ratio, not merely low cost.

We've made no attempt to economize on tubes, believing that much better results can be secured by performing separate functions with separate tubes. To do the same job, the same number of circuits would be required anyway. While at least two tubes could be eliminated by using multi-purpose types, the money saving would be negligible and the constructional and operating difficulties multiplied. This is no "stunt"

receiver, but a job designed for practical, everyday ham operation.

TUBE COMPLEMENT

As the circuit diagram, Fig. 1, shows, a total of eight tubes is used in the receiver. One of these, the 6E5 tuning indicator, is not essential to the operation. The tube line-up is as follows: 6L7 regenerative first detector or mixer, 6D6 high-frequency oscillator, 6L7 i.f. amplifier with iron-core transformers, 6H6 diode second detector-a.v.c. rectifier, 6D6 beat oscillator, 76 first audio, and 42 power output. The choice of tubes probably requires some explanation, since metal and glass types are mixed together.

The 6L7, as most amateurs know, is a five-grid tube designed especially for mixer work, and is reputed to be better than any of the older types for the purpose, particularly at the higher frequencies. There is no equivalent glass type. Electron coupling to the h.f. oscillator is provided through a second control grid, No. 3, which retains the advantages of suppressor oscillator-voltage injection without requiring the large r.f. oscillator voltage demanded by ordinary r.f. pentodes.

We could see no advantage in using metal tubes for the h.f. and beat oscillators. The 6D6 and 6K7 types (the latter would be the logical tube to use for these purposes if the receiver were to be all-metal) have exactly the same characteristics except for input and output capacities; since the glass type is less expensive we decided on glass.

For the i.f. amplifier, the 6L7 was again chosen because of characteristics peculiar to this type alone, unduplicated in the glass line. The high μ of the No. 3 grid makes this tube cut off at relatively low control-grid bias when the same bias is applied to No. 1 and No. 3 simultaneously. The variable- μ action is retained, however, so that the tube will give more effective a.v.c. action than the regular pentode types when only one stage can be controlled, as is the case here.² So far as amplification alone goes, the 6L7 is about equivalent to the 6D6.

Any number of different types of duo-diode tubes could replace the 6H6-76 combination shown in the diagram. However, there are good reasons for using separate tubes for this combination job. For one thing, each of the diodes in the 6H6 has its own cathode, while in the duo-diode types a single cathode must serve for all the individual element groups. This complicates the biasing, since cathode bias puts the same d.c. voltage on the a.v.c. rectifier as on the control-grid of the audio amplifier, thus delaying the a.v.c. action. It is possible to get around this state of affairs by using fixed bias on the audio grid, but this held out no particular appeal for us. Of greater importance, however, is the fact that it is practically impossible to prevent r.f.

¹ Crossley, "Iron-Core I.F. Transformers"; Detrick and Morrison, "Application of Iron-Core I.F. Transformers to Amateur-Band Superhet Design," *QST*, August, 1935.

² "Application Note on the 6L7 as an R.F. Amplifier"; Application Note No. 57, RCA Manufacturing Co., Inc.

from getting to the audio grid with existing duodiode tubes. A certain amount of internal coupling between diode plates and control grid exists in all these types, and no amount of r.f. filtering in the external circuit will reduce it. It is hardly necessary to say that r.f. on the audio grid is undesirable, causing distortion and blocking effects. It can be avoided by using a separate diode rectifier—again available only in metal—and a separate audio amplifier. For the audio circuits the metal tubes offer no particular advantages over the glass types, and the latter are again less expensive.

The 6E5—the famous “magic eye”—offers some advantages not possessed by the conventional “R” meter, even though the shadow movement is limited to an arc of less than 90 degrees. As used in this receiver, it indicates relative signal strength on both 'phone and c.w. signals, and in addition serves as an overmodulation indicator. It is invaluable for lining-up purposes, and is considerably less expensive and less troublesome to install than a d.c. instrument. Tube, socket, and resistor cost only a little over a dollar.

CIRCUIT DETAILS

In oscillator-mixer coupling, the circuit is similar to the one given for the 6L7 in a recent *QST* issue.³ Originally we had hoped to be able to use coupling to the No. 3 grid of the 6L7 from the plate of the oscillator, to secure as much isolation as possible. This method worked satisfactorily at 7 mc. and lower frequencies, but at 14 mc. was not capable of delivering enough voltage to the mixer for satisfactory conversion. It became necessary, therefore, to couple as shown. Unfortunately, there is some interaction between mixer tuning and oscillator frequency with this type of coupling, despite the electron injection. This pulling is negligible at 14 mc. and lower, however, and even at 28 mc. does not introduce serious operating difficulties when the coils are properly adjusted.

To get adequate band-spread on all bands, the main tuning condensers are tapped across por-

³ “Using the 6L7 to Improve Superhet Performance,” *QST*, February, 1936.

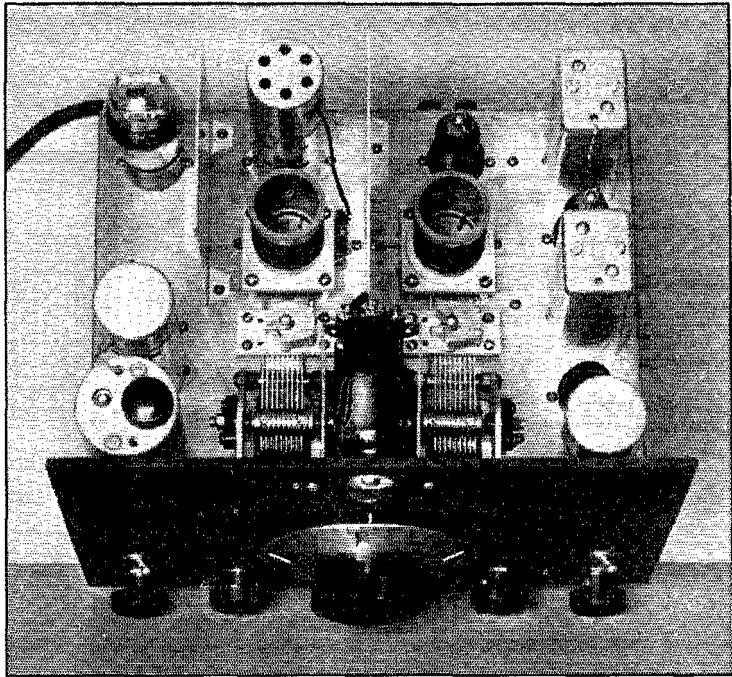

A TOP VIEW, SHOWING THE LAYOUT OF COMPONENTS

The physical arrangement is discussed fully in the text.

tions of the coils, the band-setting being done by air trimmers. This is the only method which will give any desired degree of band-spread without requiring a large number of trimmer condensers. Regeneration in the mixer circuit is secured by means of a coil in the cathode circuit inductively coupled to the grid coil. A shunting variable resistor gives control. While this method causes a slight tuning effect at the higher frequencies, it has the advantage that electrode voltages on the mixer are constant, which means that the tube is working efficiently regardless of the setting of the regeneration control. In practice it has been found that the control is quite smooth and effective.

The 6L7 is given about 6 volts bias and the screen is operated at 150 volts. This type of operation is recommended for high-frequency service to avoid grid-current effects. Screen voltage is secured through a dropping resistor. A voltage divider is used for the oscillator screen in the interests of frequency stability.

I.F. CIRCUITS

Only two points need be mentioned in connection with the i.f. amplifier circuit. The No. 3 grid of the 6L7 is connected in parallel with No. 1 for d.c., but not for r.f., and a voltage divider instead of a simple series resistor is used for obtaining screen voltage. As shown in the diagram, the No. 3 grid is returned to the ground

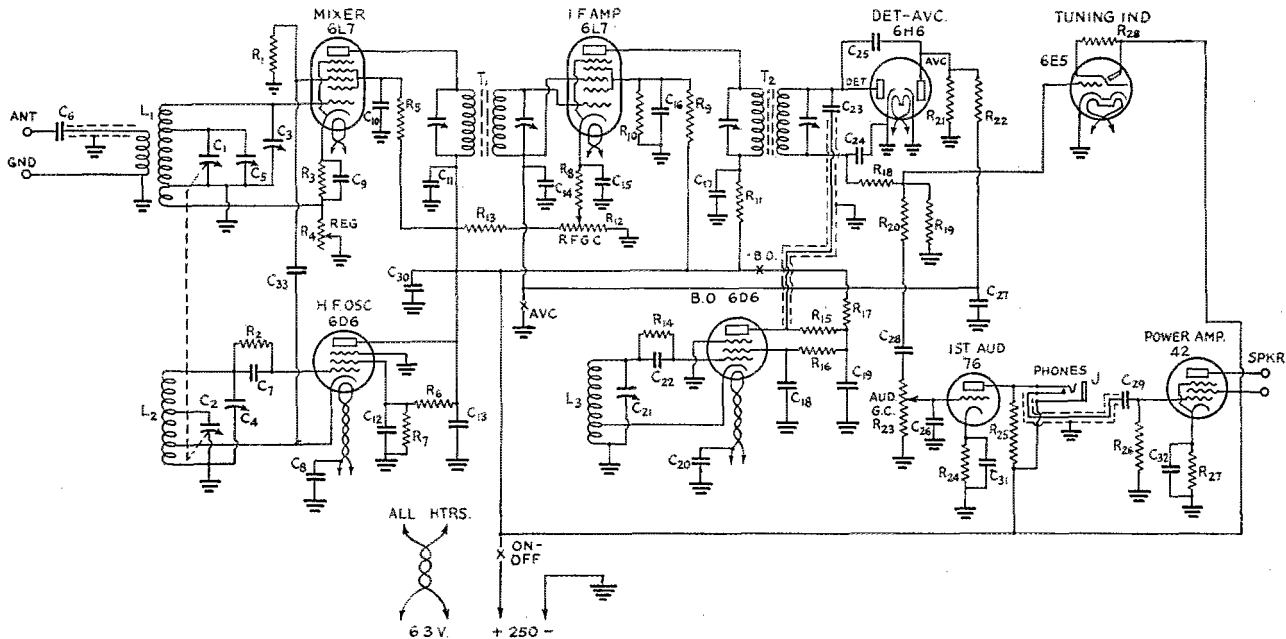

FIG. 1—THE RECEIVER CIRCUIT DIAGRAM

Shells on metal tubes should be grounded. A suitable power supply is described on page 263 of the current Handbook. The current consumption is 2.8 amp. at 6.3 volts and 85-90 ma. at 250 volts.

- C₁, C₂—Ganged condensers, 175 μ fd. each (National type PW tuning unit).
 C₃, C₄—50- μ fd. air trimmers (National type UM-50).
 C₅—25- μ fd. midjet variable (Hammarlund MC-25-S).
 C₉—50- μ fd. midjet mica condenser.
 C₇—100- μ fd. midjet mica condenser.
 C₈—0.002- μ fd. mica condenser.
 C₉—C₂₀, inc.—0.01- μ fd. paper condensers, non-inductive.
 C₂₁—140- μ fd. variable (in B.O. unit).
 C₂₂—250- μ fd. mica condenser (in B.O. unit).
 C₂₃—B.O. coupling condenser, about 5 μ fd. (see text).
 C₂₄, C₂₅, C₂₆—100- μ fd. mica condensers.
 C₂₇, C₂₈, C₂₉—0.1- μ fd. paper condensers.
 C₃₀—0.5- μ fd. paper condenser.
 C₃₁—5- μ fd., 25-volt electrolytic.

- C₃₂—25- μ fd., 25-volt electrolytic.
 C₃₃—50- μ fd. fixed mica condenser.
 R₁, R₂—50,000 ohms, 1/2 watt.
 R₃—500 ohms, 1/2 watt.
 R₄—2000-ohm variable (Centralab 72-101).
 R₅—15,000 ohms, 1 watt.
 R₆—50,000 ohms, 1 watt.
 R₇—50,000 ohms, 1/2 watt.
 R₈—300 ohms, 1/2 watt.
 R₉—10,000 ohms, 10 watt.
 R₁₀—15,000 ohms, 1 watt.
 R₁₁—2000 ohms, 1/2 watt.
 R₁₂—5000-ohm variable (Centralab 72-110).
 R₁₃—50,000 ohms, 1 watt.
 R₁₄—50,000 ohms, 1/2 watt (in B.O. unit).
 R₁₅—10,000 ohms, 1 watt.
 R₁₆—100,000 ohms, 1/2 watt.
 R₁₇—50,000 ohms, 1 watt.
 R₁₈—50,000 ohms, 1/2 watt.

- R₁₉—500,000 ohms, 1/2 watt.
 R₂₀—100,000 ohms, 1/2 watt.
 R₂₁, R₂₂—1 megohm, 1/2 watt.
 R₂₃—1-megohm variable (Centralab 72-116).
 R₂₄—2000 ohms, 1/2 watt.
 R₂₅—50,000 ohms, 1/2 watt.
 R₂₆—1 megohm, 1/2 watt.
 R₂₇—450 ohms, 2 watt.
 R₂₈—1 megohm, 1/2 watt.
 T₁—Air-tuned iron-core i.f. transformer for coupling 6L7 converter to 6L7 amplifier (Aladdin S-2242-A).
 T₂—Air-tuned iron-core i.f. transformer for coupling 6L7 amplifier to diode rectifier (Aladdin S-2242-B).
 L₁, L₂—See coil table.
 L₃—Beat-oscillator coil, 465 kc. (in B.O. unit).
 J—Double-circuit jack.
 All switches single-pole single-throw.

side of the i.f. transformer secondary, where it picks up the a.v.c. voltage along with the No. 1 grid. The rather heavy screen voltage constant potential despite the bias applied to the grids, thus increasing the effectiveness of both the manual and automatic gain controls. The manual gain

control is bled off the plate supply by the usual method.

One section of the 6H6 is used for detection and the other for obtaining a.v.c. voltage. Since the a.v.c. action is limited, it was not found necessary to bias the a.v.c. diode to give delay. There is practically no reduction in signal

strength on weak signals when the a.v.c. is switched in.

The i.f. beat oscillator operates at low plate voltage and is very loosely coupled to the detector. A weak b.o. signal is favorable for the reception of weak signals, tends to limit the beat response on strong ones, and permits using the a.v.c. for c.w. reception. This is helpful in holding down the loud signals when tuning over a band.

The diode load circuit consists of the resistors R_{18} and R_{19} in series. R_{18} serves as an r.f. attenuator, backed up by R_{20} for further attenuation. C_{26} , across the 76 grid, is a further aid to keeping r.f. out of the audio circuits and gives some tone-control action to reduce noises of high audio frequency.

The grid of the 6E5 tuning indicator is connected to the audio-diode load rather than to the a.v.c. line. This method of connection permits using the tube as a strength indicator on c.w. signals, since the shadow movement is instantaneous. Carrier shift and overmodulation also show up very readily.⁴

The audio circuits require no particular comment. The gain is such that a 'phone signal whose carrier barely moves the tuning indicator will give good loud-speaker strength. Headphone signals are rather more than comfortable level with the audio gain wide open. If a "rattling the diaphragms" signal is wanted, the 'phones could be connected in the pentode output through a suitable transformer or choke.

CONSTRUCTION

Decidedly not all of the performance of a receiver is in its circuit diagram. Mechanical construction is of at least equal importance, especially when stability is a prime consideration. It is in the mechanics of set building that commercial manufacturers have a very definite advantage over the home constructor. The fabrication of special chasses, mountings, brackets and the like is beyond the facilities of most of us. We have to use what we can get.

The chassis on which this receiver is built is a standard cadmium-plated steel affair measuring 12 by 10 by 3 inches. The same thing can be obtained in special radio metal which is somewhat easier to work. In our opinion, all the ready-made chasses we have seen are much too flimsy for the job, and this one is no exception. As shown in the bottom view of the receiver, some additional bracing has been applied under the r.f. circuits by means of half-inch L girders of aluminum. Brass probably would be better, but was not available at the time. This bracing is sufficient to prevent the chassis from bending when coils are plugged in, but the whole assembly is still far from rigid when picked up by one corner. If we were doing it over again we'd be tempted to

⁴ "The 6E5 for Checking Overmodulation," Experimenters' Section, *QST*, March, 1936.

make our own chassis out of aluminum at least an eighth inch thick, or else have one cast or made up of heavy gauge metal, braced and welded so that it would be really rigid.

Mechanical stability was one of the reasons for the selection of the National PW tuning unit. It also explains the use of the coil sockets supported at four corners, and likewise the air trimmers, also four-corner supported. The tuned-circuit wiring is all with No. 14 tinned wire with the exception of the leads to the grids of the tubes. Even these should be given attention, especially that to the oscillator. It was found that a marked improvement in stability resulted when the oscillator grid lead ran through a rubber grommet in the tube shield cap rather than simply being led through the slot. With the lead so supported, it is possible to thump the receiver and cause only an instantaneous frequency flutter, the beat note immediately returning to its original tone. Without the grommet, the flutter was considerably more pronounced, lasted longer, and often caused a permanent change in beat note.

All of this simply means that the more attention is paid to even small mechanical details, the better will be the stability of the receiver.

R.F. LAYOUT

The arrangement of the receiver can be followed quite readily from the various photographs. Referring to the top view, the tuning-condenser assembly is centrally mounted, the oscillator condenser being that at the left and the mixer at the right. The air trimmers, C_3 and C_4 , are directly behind the tuning condensers, followed in each case by the coil sockets and finally by the tubes. The coil and socket pin arrangement is shown in Fig. 2. This arrangement becomes of some importance at the higher frequencies if the receiver and coils are to be duplicated, since the lead lengths have their influence on the coil design. A baffle shield measuring $4\frac{1}{2}$ inches high by 6 inches long runs down the center of the chassis from the dial gear box to the rear edge, shielding the oscillator and mixer circuits from each other. A similar baffle, $4\frac{1}{2}$ by $4\frac{1}{2}$ inches, encloses the oscillator on the other side. This shielding seems to be sufficient to prevent coupling between the two tuned circuits, since the mixer tuning has absolutely no effect on the oscillator frequency when C_{33} is disconnected from the oscillator cathode.

Connections from the condenser rotors and from the ground ends of the coils should be made to the chassis with the shortest possible leads. In this case we also have ground leads through the tuned circuit paralleling the chassis grounds to insure good conductivity. *But the short, direct grounds to the chassis itself are of prime importance if the set is to be stable in operation, especially with regeneration on the mixer. Despite the fact*

that the mixer is working in about the same fashion as a regenerative detector when the regeneration is pushed to the critical point, there is no body capacity at the set itself or in the power and 'phone cords, nor is there a change in frequency when the chassis is touched. Those who have operated regenerative detectors coupled to an antenna at 28 mc. will appreciate this.

The same principle holds for ground connections in the under-chassis wiring in the r.f. circuits. Instability encountered when the set was originally wired up with all ground returns made to a single point was entirely cleared up when all grounds were made separately with short, direct connections to the chassis. Evidently the chassis possesses negligible reactance in comparison to even an inch or two of wire.

Wiring for the oscillator and mixer circuits occupies the rear center section of the chassis, as shown in the bottom view. The parts are simply wired in so that short connections can be made, using insulating soldering-lug strips wherever necessary. The antenna-ground post assembly is mounted on the back near the mixer socket, with a shielded lead running through a hole in the chassis to the antenna post on the coil socket.

The regeneration control resistor, R_4 , is mounted on a home-made bracket near the back of the chassis. A flexible coupling and a piece of $\frac{1}{4}$ -inch round brass rod bring the control out to the front panel. The bracket should be made so that the resistor shaft will line up with the panel hole when ready for mounting. A bearing, actually the sleeve portion of a discarded 'phone jack, keeps the extension shaft in place on the panel and helps make the control smooth-turning. It was necessary to mount the regeneration control in the position shown so that the r.f. trimmer, C_5 , could be mounted close to C_1 , and thus make possible a short stator connection between the two. The lead from the mixer cathode to R_4 is therefore comparatively long, but no particular harm results from having it so.

I.F. AMPLIFIER

The first i.f. transformer is in the rear right

corner of the chassis. Progressing toward the front, next in line is the 6L7 i.f. amplifier tube, second i.f. transformer, 6H6 duo-diode rectifier, and 76 audio tube, the latter being in a shield. Sub-chassis wiring, shown to the left in the bottom view, is again simply a matter of fitting in a considerable number of small parts so that short leads are possible. Ground leads once more should be short and directly to the chassis. The use of midget tubular paper by-passes and the new-type insulated resistors simplifies the space and insulation problems.

In the bottom view, the audio volume control is at the extreme left. It is the right-hand control in the right-side-up views, and is mounted on the front of the chassis directly below the audio tube socket. A shielded lead runs from the plate of the 76 along the left-hand bracing girder to the back of the chassis, thence to the right along the rear edge to the 'phone jack. The shield is grounded at several points to prevent r.f. pickup.

A word about the iron-core transformers before leaving the i.f. section. These transformers are adjusted at 465 kc. especially for the tube combination used. They are obtainable under the type numbers given in Fig. 1. Under each transformer

is a chassis hole about the size of a tube-socket hole to allow plenty of room for bringing out leads. Close bunching of leads is undesirable.

BEAT-OSCILLATOR AND AUDIO

The left-hand section of the chassis (top view) contains, in order from front to back, the beat-oscillator transformer, b.o. tube and power output tube. These parts are at the right in the bottom view. The control in the corner is the r.f. gain control—the only rotating con-

trol, incidentally, whose position is not critical with respect to length of connecting leads.

The National beat-oscillator transformer used in the receiver is furnished complete with tuning condenser, grid condenser and grid leak, so that it is only necessary to connect the tube and supply the plate circuit resistors and condensers. If the oscillator circuit is made up from different parts, the values given in Fig. 1 will be satisfactory. The lead from the plate of the b.o.

COIL TABLE

Band	Oscillator, L_2			Mixer, L_1			
	Total Turns	Cath. Tap	B.S. Tap	Total Turns	B.S. Tap	Cath. Turns	Ant. Coil Turns
28 mc.	3.0	1.0	0.25	3.3	0.25	0.8	2
14 mc.	8.3	2.8	1.5	8.3	1.5	0.8	3
7 mc.	16.8	4.8	4.0	16.8	4.0	0.4	4
3.5 mc.	29.3	8.8	11.5	29.3	12.5	0.5	9
1.75 mc.	50.3	17.8	23.5	55.3	30.5	0.5	12

Oscillator coils are space-wound to occupy a length of $1\frac{1}{2}$ inches, on $1\frac{1}{2}$ -inch diameter forms. Mixer coils are space-wound to occupy a length of $1\frac{1}{4}$ inches, on similar forms, except 1.75-mc. coil which is close-wound. Wire is No. 24 d.s.c. The cathode coil on L_1 is wound in the opposite direction to the grid coil, starting from the ground end of the grid coil. It is very closely coupled to the grid coil. Antenna coils are close-wound, spaced about $\frac{1}{4}$ inch from grid coil at ground end.

Specifications are given to the nearest tenth of a turn. The tenths can be measured off quite accurately by making a paper scale equal in length to the circumference of the coil form and dividing it into ten equal parts. Spacing between turns should be adjusted to be as uniform as possible, and the turns doped in place after the coil is finished. Coil forms are National 6-prong, with corresponding coil sockets.

tube runs in shielded wire—grounded at several points—to the diode detector plate, coupled through a small condenser mounted right on the appropriate tube-socket prong. This condenser is a home-made affair consisting of two thin brass plates, separated about a sixteenth inch, the facing areas being about a half-inch square. It was made by removing the center lug from an insulating strip having three lugs, then soldering one brass plate to each of the remaining lugs, on opposite sides of the strip. The size is not critical, but the capacity should be small both to keep down the beat-oscillator signal and to avoid adding any appreciable shunt capacity to the diode circuit.

The output tube is mounted in the rear corner of the chassis rather than being centered, chiefly to keep it as far as possible from the oscillator coil. The shield between the oscillator circuit and the 42 is more of a baffle for heat than electrostatic shield.

The cathode-ray tuning indicator is mounted on home-made brackets of brass strip so that the top of the tube projects slightly through the panel. The 1-meg. resistor is mounted right on the socket, and the necessary leads are twisted into a cable and carried down through the chassis on the detector side of the central baffle shield. The length of these leads does not matter particularly. Be sure to mount the tube with the target side downward (heater pins to the right when viewed from the top) so that the shadow will be at the bottom where it is most easily seen.

The three switches are mounted as follows: At left in panel view, beat oscillator on-off switch; below the tuning dial, B cutoff switch; at right above the audio gain control, a.v.c. on-off switch.

One last point in wiring—keep the filament wires in the corners of the chassis; this is a help in preventing hum.

I.F. ADJUSTMENT

It is always a good plan in building a superhet receiver to get everything behind the first detector working before attempting the job of lining up the r.f. circuits. Probably the best way to do this is to borrow a test oscillator so that the i.f. amplifier can be put on the right frequency with some degree of certainty. To line up the i.f., clip the oscillator leads on ground and the 6L7 mixer grid—with the coils out of their sockets—set the oscillator to 465 kc., and adjust the trimmers to give maximum deflection of the 6E5. If the "eye" closes entirely, decrease the test oscillator output or reduce the r.f. gain control so that a definite maximum point can be passed through on each trimmer.

If no test oscillator is available, the c.w. beat oscillator can be used for the purpose. To set the b.o. on the proper frequency, connect a wire to its plate and bring it near the lead-in to the home broadcast receiver. Tune the latter to 930

kc. and adjust the beat oscillator until its second harmonic is at zero beat with the station heard. This should be fairly easy, since 930 seems to be a rather popular channel. Then couple the b.o. output to the grid of the mixer—simply taking a turn

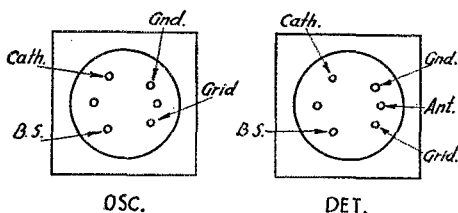

FIG. 2—COIL SOCKET CONNECTIONS FOR OSCILLATOR AND MIXER

These views are looking down on the sockets.

around the grid cap should be enough—connect the grid to ground through a resistor of a megohm or so, and line up as already described.

The i.f. should show no tendency to oscillate with all circuits at resonance, provided the shells of the metal tubes are grounded. Since it doesn't pay to take anything for granted, test the shell against ground with an ohmmeter to make sure there is actually a connection between the shell and its pin inside the tube. We've found several that had no such connections, and if such a tube is used the i.f. will oscillate merrily. The last remnant of instability can be cleared up by installing C_{30} , which is a main by-pass across all plate supply circuits.

If the i.f. and a.f. amplifiers are properly constructed and adjusted, the receiver should be perfectly stable with the r.f. and a.f. gain controls wide open. With a good power pack, there should likewise be a complete absence of hum.

MAKING THE COILS

Really the hardest job in the set is making the coils give the desired band-spread and track properly. The problem is more acute than with non-regenerative r.f. stages, since regeneration makes the mixer tuning nearly as critical as that of the oscillator, especially at the point of maximum regeneration. To save cost and eliminate another cause of instability, no trimmers are provided on the coils, and it is therefore necessary to make the coils fit the trimmer condenser settings. Starting from scratch this was a time-consuming task, but with the specifications in the table as a guide it should not be nearly so difficult. The panel trimmer in the mixer circuit, C_5 , allows for some leeway; extreme accuracy is demanded only when one insists on being able to tune across the band without touching C_5 with the regeneration control set at the critical point. Such accuracy in coil cutting is hardly necessary, since in usual operation the regeneration control will be well back from this point.

The padding condensers, C_3 and C_4 , are left at the same settings for all bands. They provide a fixed minimum circuit capacity against which the coils can be designed. We recommend the following procedure in coil winding:

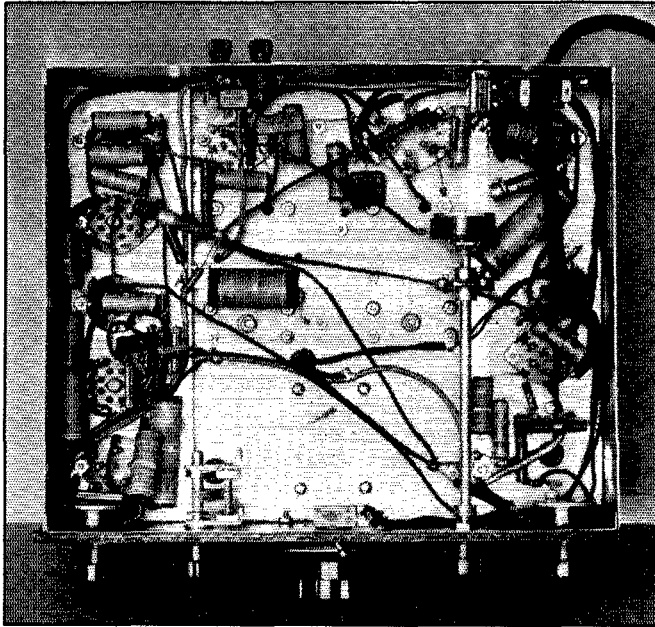

RESISTORS AND BY-PASS CONDENSERS UNDER THE CHASSIS ARE POSITIONED FOR SHORT, DIRECT CONNECTIONS RATHER THAN SYMMETRY

This under-chassis view gives a general idea of the wiring. Exact duplication of this section is not necessary, so long as r.f. leads are short and the precautions mentioned in the text are observed.

Make the 14-mc. set first. This is usually the hardest set to get lined up properly, and it is also the easiest set to duplicate from specifications. Follow the mechanical layout of the oscillator and detector circuits, particularly spacing between condensers and coil sockets so the lead lengths will be about the same as in the original receiver. Wind the 20-meter coils *exactly* as given in the table. Plug in the coils, set the regeneration control at the zero position (resistance all out), and set C_5 at half capacity. Set the tuning dial at about 250, couple on the antenna and tune C_4 carefully until amateur signals are heard. Make a final adjustment to C_4 to bring the low frequency end of the band at about 100 on the tuning dial. It is not advisable to go lower than 100 because the tuning starts to crowd at the maximum end of the condenser scale. This tendency can be avoided by using trimmers of about 40 $\mu\text{fd.}$ capacity across each tuning condenser, but was not deemed worth while in view of the excellent mechanical band-spread available and the extra cost involved. With the low-frequency end at 100,

the high-frequency end should fall between 350 and 400.

Now set the dial again at mid-band and increase the regeneration control, simultaneously tuning C_3 to find resonance. This circuit will behave exactly like a regenerative detector as it is brought near the oscillating point. As resonance is approached, the background and signals will increase tremendously in strength, until finally the circuit breaks into oscillation. When this happens, let C_3 alone, back off the regeneration control a bit, and tune over the band with the main dial. The mixer circuit should stay in tune within reasonable limits over the whole range. Slight readjustment may be necessary occasionally with the regeneration near the critical point. Since the detector is coupled to the antenna, at some points in the tuning range there may be more of a tendency to oscillate than at others. This can hardly be avoided, although the small antenna coupling condenser, C_6 , is helpful to some degree in smoothing out the dead spots. It is seldom necessary to work near critical regeneration, however, so that for all practical purposes the receiver is wholly single control if reasonable care is used in making the coils.

At this point a check should be made to make certain that the oscillator is on the high-frequency side of the signal. Careful retuning of C_4 , with the mixer circuit near critical regeneration, will show two definite points of maximum background. Use the one at the lower-capacity setting of C_4 . If this is the same as the one previously found, the adjustment is finished; but if not, the whole process must be gone through again, using the new setting. There is enough selectivity in the i.f. to give a noticeable offset-tuning or single-signal effect when the beat oscillator is adjusted a kilocycle or so off the intermediate frequency peak. With the beat oscillator so adjusted, note which side of zero beat gives the loudest signal and adjust all the other oscillator coils so that the loudest signal falls on the same side of zero beat. The loud side will reverse itself on images, which makes an image easily identifiable.

When the trimmers are properly adjusted, they should be marked so that they can be returned to the same settings at any time. The correct settings will be found to be somewhere in the vicinity of half capacity.

With the 14-mc. range in working order, the other coils must be wound to fit the trimmer settings just found. Some slight modification of the specifications given may be necessary, but they should work out quite closely with reasonable care in duplication. If any particular band should turn out to be half on and off the dial, or missing entirely, the following hints will be helpful in putting it where it belongs:

Get the oscillator coil straightened out first. The band can always be centered on the dial by readjustment of C_4 as described above. If the new setting is found to be lower in capacity, take a bit off the grid end of L_2 , a fraction of a turn at a time, until the band is in the right spot with C_4 set at the position previously determined for the 14-mc. band. If the new setting is higher in capacity, add to L_2 until it comes out right. If the band-spread is too great or too little, it can be reduced by moving the tap across which C_2 is connected toward the ground end, and increased by moving the tap toward the grid. A fraction of a turn usually will do the trick. It should not be necessary to touch this tap, however.

The mixer coil, L_1 , can be adjusted in the same way, remembering that all adjustments should be made with the regeneration control near the critical point. This is important, since the tuning of the circuit is affected by the setting of R_4 as regeneration is decreased, although this effect is negligible in the normal operating range.

Should continual readjustment of C_5 be necessary to keep the circuits tracking, the band-spread tap should be readjusted. Note the settings of C_5 for resonance at the ends of the band. If C_5 is set at higher capacity at the low-frequency end of the band than at the high-frequency end, the band-spread tap should be moved toward the grid end of L_1 a fraction of a turn at a time until the circuits track without drastic resetting of C_5 . If the reverse is true, the tap should be moved toward the ground end.

The specifications for the cathode coil or tickler in the mixer circuit should be followed closely. Very little coil is needed. Normally the circuit should break into oscillation with the regeneration control advanced a quarter to half-way from the off position. The setting will depend somewhat upon the characteristics of the antenna used. The receiver seems to be non-critical as to antennas, however, since the tracking and regeneration have been found to work equally well on several different antennas of widely differing characteristics. Coupling to the antenna is rather loose—a favorable condition for a regenerative stage. Should too much tickler be used, the regeneration control will be "backwards"; that is, maximum signal strength will be secured with the control set in the "off" position. Complete control of regeneration with the control moved in the normal direction is essential for best results, since the mixer should not be allowed to oscillate.

By the time the coils are wound, the builder will have a very good idea of just how to operate the set to get the maximum results from it. In fact, the whole operating procedure has already been described in the section on making the coils. Normally there is little to do except turn the dial and listen to signals. When a set of coils is plugged in, a preliminary adjustment of C_5 and R_4 should be made to bring these controls to their optimum operating values. This is simply a matter of setting C_5 to resonance and bringing R_4 to the point where there is ample regenerative amplification without getting too near the critical point. If more amplification or selectivity is wanted on a particular signal, these controls can be brought into play again, but for random tuning or looking over the band it should not be necessary to touch them. Anyone who has handled a regenerative receiver will know without being told how to get the most out of the mixer circuit.

Those contemplating building such a set will naturally want to know what it can do. As we have already said, the i.f. selectivity is as good as that of the usual super with two air-core stages. There is ample gain for the weakest signals, even without pushing the regenerative amplification to the maximum point. The image discrimination is such that we have yet to find an image strong enough to interfere with the weakest ham signal, even on the 14-mc. band, especially when the regeneration control is carefully manipulated. With an "average" setting of the regeneration control—quite far removed from maximum sensitivity and selectivity—it becomes necessary to hunt for images in the 20-meter band, where they are usually at their worst. Those who have listened to the set have remarked on its quietness, which probably results from the high amplification secured in the first tube. The audio system gives excellent quality on 'phone reception. The a.v.c., while limited in control, is sufficient to hold strong signals down to a reasonable level, and compensates to a fair extent for fading. It is equally effective on c.w. reception, since switching on the beat oscillator leaves the receiver with plenty of r.f. gain, although naturally not as much as with the a.v.c. off. The receiver is easy to tune, and signals stay put so you can have both hands free for copying.

We've been asked why we didn't make the i.f. regenerative so that full single-signal reception could be secured. The personal element enters again into the answer to this one. We prefer the crystal filter on general principles. We don't like the idea of having i.f. gain and selectivity tied up with each other. Furthermore, we have a belief that one regenerative circuit in a receiver is plenty. But as a matter of fact, it wouldn't be a practical combination, because with two regenerative circuits there would be no good place to put an r.f. gain control so that it would actually con-

(Continued on page 58)

A 28-Mc. Rotary Beam

Details of the System Used by an Outstanding 10-Meter Station

By H. J. Breuer,* W6JN

We suppose nearly every amateur has at some time or another stood by for a change of antennas on the part of the fellow on the other end of a QSO. How many times could we honestly say that such a change made any noticeable difference? But here's one we'll vouch for from personal experience; the beam at W6JN, as compared with the former antenna used there—the average harmonically-operated antenna, well up in the air—has raised his ten-meter signals from the "just another C" level to being about the outstanding west-coast station. The low-angle radiation resulting from the vertical stacking undoubtedly has a lot to do with it—the combination of this with the power gain resulting from horizontal directivity would seem to be hard to beat.—EDITOR.

WITH the increased daily use of the 28-mc. band throughout the world, and with the keen competition brewing amongst those who have experienced the fine DX contacts available there during sunlight hours, there is no doubt that directional antennas will go a long way toward making more regular contacts. New ideas crop up faster than most of us can follow, some of them complicated, others simple, and it becomes a bewildering problem to decide just what to use. There are many ways of producing the desired effects, and most of the directional arrays described in the past have utilized horizontal elements. Keeping the fact in mind that low angle radiation is generally accepted as being most suitable for the higher frequencies, a description of the rotary beam antenna at W6JN might be helpful to those who have small backyards.

The array consists of three half waves in phase, stacked vertically end to end, with three half-wave parasitically-excited reflectors in the rear. The phasing sections are mounted horizontally between the two lines, thus giving a constant spacing even during high winds. The whole assembly is hung from a rope slanting downward from the top of a 100-foot mast, and the bottom terminates at a turning arrangement that is rotated directly from the operating bench. The shaft holding the hand wheel passes vertically through the center of a special chart of the world, mounted on the ceiling. The chart is centered on Emeryville (Oakland) California,

* 1284 W. 6th St., Emeryville, Calif.

and with the use of a pointer attached to the shaft, the beam can be swung through 360 degrees to any point on the earth, thus giving the exact bearing in degrees from true north, distances

read directly from a mileage scale calibrated on the pointer, are given as well. The operation is somewhat like a shipboard radio compass, except that in this case the maximum rather than the minimum signal is desired. The chart is similar to two that are published by the U. S. Navy, titled "Chart of the World Showing Great Circle Distances and Azimuths from San Francisco (No. 5199-A) or from Washington, D. C. (No. 5199) to Points on the Earth's Surface." These can be purchased from firms handling nautical charts for about forty-five cents, and are a great asset to any amateur station. For all practical purposes, one could be used for the western half of the United States and the other for the eastern half,

without too great a discrepancy in bearings for DX work. Those who would care to make theirs for any particular location could do so by applying spherical trigonometry, using a purchased chart for a guide.

The pictures of the various parts of the array show the general construction, all of which has been made as simple as possible. Wood was used throughout for mechanical parts to avoid absorption, and the ordinary backyard workshop can produce the required pieces without getting into much labor. Everyone has his own methods of building such things, and there is no special reason for following all the details so long as the

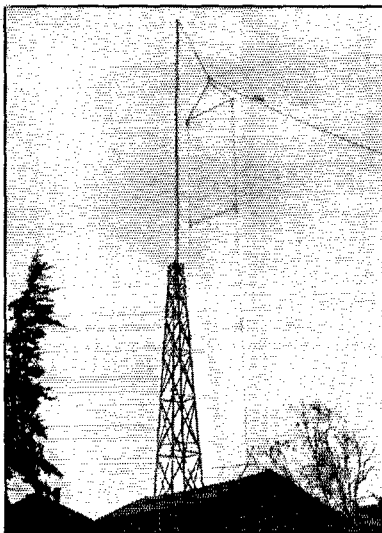

SEVENTY FEET OF HEIGHT IS NECESSARY FOR SUCH AN ARRAY

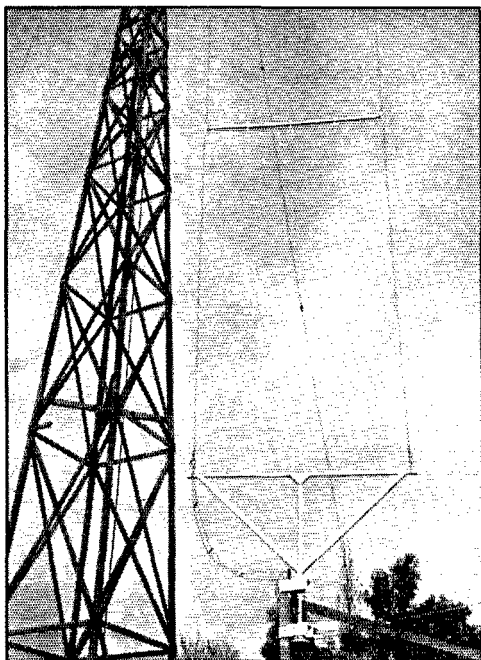

BOTTOM OF ARRAY SHOWING ROTATING DEVICE AND ROPES

electrical part is unchanged. The wooden cross arms are of $1\frac{1}{4}$ by $1\frac{1}{2}$ inches section. The bottom arm has a $1\frac{1}{2}$ -inch diameter shaft extending through holes in supporting blocks nailed to a 4 by 4 set in the ground. One rope drum mounts on the bottom of the shaft; the other drum is on the top end of the control shaft which rises through the chart to the peak of the roof. By winding four turns of rope around each drum, and cinching up tight, it is easy to produce one full circle turn of the beam with a corresponding turn of the hand wheel. The rope is wound reversed on one drum to accommodate correct pointer requirements on the chart. No. 8 cotton clothes line rope, impregnated with hot elastic varnish and stretched until dry, is used for the coupling between the two drums and has not given any trouble since installed on December 9. When all construction was completed, the beam was oriented to magnetic north with a good compass, and the pointer on the chart adjusted to read north 18 degrees east—the deviation for this location. When the pointer was then swung to zero, the beam lined up with true north, and was finished. Night checks against the pole star can also be used.

The phasing stubs use Johnson 6-inch porcelain separators firmly pushed through the cross arms in holes drilled slightly smaller than the average diameter. The ends of the cross arms are tied to corresponding insulators in the vertical lines.

A second wooden collar on the shaft applies the weight of the rotating arm to the top of the supporting block. Under this collar, and under the drum on the control shaft, are ring washers made of No. 6 copper wire, to reduce surface friction with the supporting blocks. The use of plenty of grease makes turning easy. A stop prevents more than one full circle swing and keeps the flexible feeding stub from tangling. The lower end of the bottom radiator connects to this stub, and the latter terminates in the r.f. matching transformer, cut 90% of a quarter wave for the frequency. Each half-inch aluminum tube is mounted with No. 20 Johnson stand off insulators to a 1-inch by 1-inch strip of wood. One strip is screwed to the pole brace; the other hinged to allow variable separation of the tubing for proper adjustment. The untuned transmission line is inductively coupled to the center of the driving tank coil. At present the beam leads the final UV-211 power doubler to 330 watts, a rise of 250 watts over the no load 80 watts input.

When first put into operation on December 9, good results came from all directions. Many rotation tests have been made and much data has been collected. From those reports where the receiving station used an output meter to indicate changes in carrier strength, it is safe to say that an average gain of 12–15 db has been noted between “off 90 degrees” and directly toward the receiver. In some cases, rotating 180 degrees away caused a drop from R9 to R2–3, with very noticeable fading at that strength. Sometimes the minimum was reported from R1 to R5, caused no doubt by variations in skip effect, and aggravated

PICK OUT THE LOCATION AND FIRE!

Rotating wheel centered on a world map with pointer showing position of center of beam at the time.

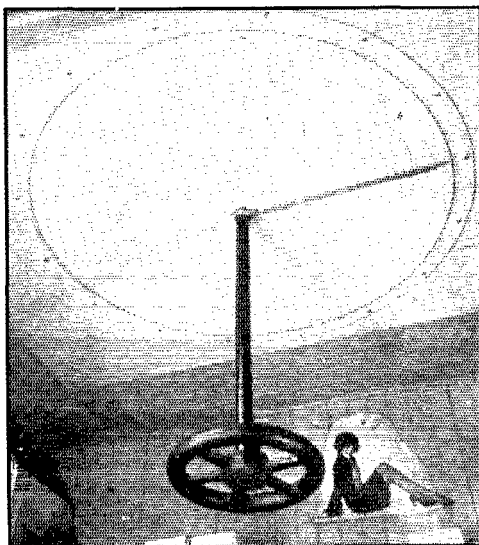

to some extent by the sharpening of the low angle concentration due to stacking the vertical elements. There is plenty room for experimenting here, and it would be foolish to make any fixed rules. From the chart plotted against actual measured carrier values taken at five miles air line across San Francisco Bay, it is noted that the shape of the field pattern resembles somewhat that made by a single reflector behind a single vertical element, except that the rapid drop at 90 degrees is more pronounced. This tallies with many reports showing a marked decrease with beam about 80 degrees off. The small rear lobe, shows radiation from reflectors.¹

Considering that a 12-15 db gain means about three R points difference, or a power gain of more than twenty, the apparent broadness of the pattern, giving maximum strength through one quadrant, makes it favorable for general communication—broad enough to include stations on both sides. Stations at 40 degrees off the beam reporting it as R8, for instance, might still say R8 with beam pointed directly toward them—but with a noticeable absence of fading. It is evident that the low-angle concentration is very helpful. Field patterns of horizontally-polarized beams having the same number of elements show sharper maximum points, but

by adding elements a half wave to each side of the present driving elements, but this would require a bulky rig, measuring eight times the present radius of 4 feet 1½ inches.

It is necessary to use exactly the same length of wire in each phasing stub as in each active element. For 28,030 kc. the half wave was made 16 feet 6 inches, with reflectors set 8 feet 3 inches behind. There seems to be no great mismatch even at 28,800 kc., thus giving good flexibility. The power input does not change perceptibly when rotating through 360 degrees.

An interesting phenomena showed up on December 16 during a QSO with W9WC from 8:30 to 9:20 a.m. PST. While making a rotation test W9WC reported a decided echo from W6JN when the signal dropped down to R1 on "off 135 degrees," with recurrences every time this position was assumed. The next morning the echo again showed up R1 on an R1 minimum signal, but in this case the beam was "off 105 degrees." The main radiation evidently was coursing north-westward around the top of the world and reaching W9WC via the back door.

Consistent reports are received from VP5PZ, LU9AX, VK3YP, and many W's along the Atlantic seaboard, and with the ease of swinging the beam to give them the greatest possible advantage, there is ample proof that sure-fire QSOs can be an everyday occurrence. It is only natural that the beam be used for reception as well, and it certainly shows a great advantage over ordinary receiving doublets. The effectiveness is marked on weak signals, these being heard only when "on beam", and dropping out

entirely at right angles. Stations can be spotted for general location before they sign by swinging the beam for maximum strength. The ratio of maximum to minimum gives excellent results in cutting down interference from stations not in the beam quadrant. In the late afternoons, when working with ZL and VK, at a time when the W9's are strong, it is entirely possible to cut out

(Continued on page 68)

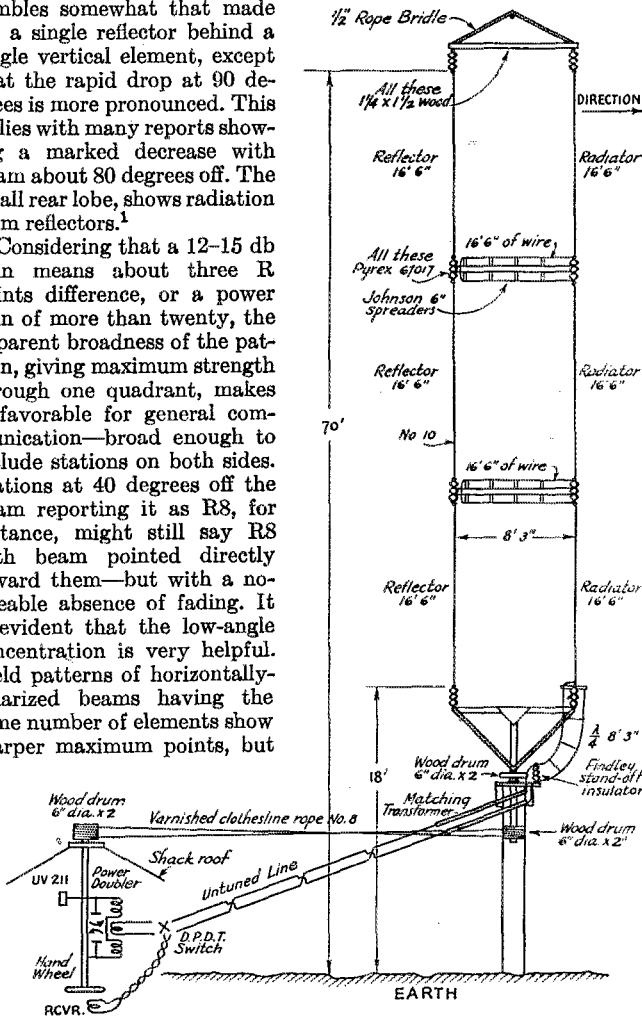

DETAILS OF W6JN'S ANTENNA

the two arrangements are not directly comparable. The vertical array could be sharpened

¹ The magnitude of back radiation such as is shown on the field chart depends upon the spacing between antenna and reflector, which is quite critical for the condition of complete null in the rearward direction. In general, maximum forward radiation and complete cancellation of back radiation do not come at the same spacing because of resistance effects, in contrast to the theoretical patterns in which wire resistance is neglected.—EDROR.

Tuning the Crystal

Smooth QSY By Variable-Gap Mounting With Low-Drift Cuts

By J. Herbert Hollister,* W9DRD

AMATEUR radio has been exposed to three phases of quartz oscillator development. First we fought and worried our way through the rather discouraging era of crazy acting "flee flicker" Y-cut plates. Due largely to careless production and testing methods, and general abuses in application, the Y-cut crystal soon acquired a shady reputation which even contaminated the few really good specimens of the clan. The next move was to the X-cut plate, with its greater stability, more favorable temperature coefficient, but usually lower output. From about 1928 until this year, by far the greatest number of crystals used by amateurs have been of this popular cut.

In the early part of 1934 a few of the so-called "A" cut¹ small temperature coefficient plates were released in this country for airways use. Prior to this time (about 1932), original research was being conducted in Japan by Dr. Issac Koga on zero temperature coefficient crystals, and in papers published in 1933² the story of this development was told.

It is not my purpose to extol the many advantages of this type crystal. I need only point out that low-drift plates may now be produced quite easily with less than one cycle frequency drift per million cycles per degree of temperature change—or less than 3.5 cycles per degree Centigrade in the case of a 3500-ke. plate. Another, and as far as the amateur is concerned, a more important advantage of the low-drift crystal is

its extreme stability with high output. Hence the gradual trend toward the third phase of quartz oscillator development.

Because of its ready willingness to oscillate strenuously under unfavorable conditions, it was noted that a considerable frequency variation could be accomplished with a good A-cut crystal by using a high-C oscillator plate tank and varying the capacity for tuning effect. This range of variation was relatively limited, however, and resulted in a serious loss of output when the plate capacity was reduced very far below the value which caused maximum oscillation of the crystal. Still, it seemed that such an abundance of energy should be turned to advantage in some way. Recalling previous experiments with air-gap holders, and their subsequent shelving because of too much loss of output and lack of stability with X-cut crystals, the obvious thing to do was to try the effect of air-gap on the new crystal.

A little tinkering in the spring of 1935 soon brought out the following facts: A considerable range of airgap seemed to cause no loss of output with A-cut crystals, and its variation resulted in a smooth change in the crystal's frequency of vibration. This useful range of frequency variation amounted to approximately six kilocycles at the fundamental frequency of a 3500-ke. crystal, or 12 ke. in the 7-mc. band, 24 ke. in the 14-mc. band, and 48 ke. in the 28-mc. band.³ It required no great inventive genius to imagine what a powerful weapon this gadget would be in the war on QRM if it could be controlled from the front panel of an amateur transmitter. The method of application was written all over the thing.

Accordingly, an A-cut crystal was mounted in a variable gap holder and the front-of-panel control

³ Dr. Koga has shown a range of 6.5 ke. for a gap variation of 0.5 mm. with constant oscillator power output using a 5000-ke. crystal, indicating a frequency range of well over 1 part per thousand.—EDITOR.

* Knox Road, Merriam, Kansas.

¹ Lack, "Improvement in Quartz Crystal Circuit Elements," *Bell Syst. Tech. Journ.*, July, 1934; also summary, p. 17, *QST*, Oct., 1934.—EDITOR.

² I. Koga and N. Ichinose, "Quartz Plate of Zero Temperature Coefficient," *Suppl. Journ. I.E.E. Japan*, April 1933; I. Koga and N. Takagi, "Quartz Plates With Temperature Coefficients Less Than $10^{-7}/^{\circ}\text{C}$," *Journ. I.E.E. Japan*, Oct., 1933.—EDITOR.

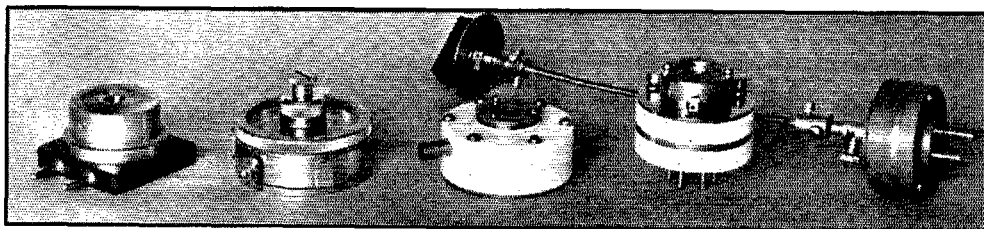

SOME MANUFACTURED VARIABLE-GAP HOLDERS

Left to right: General Radio; Koga, distributed by Mitsui and Co., 350 5th Ave., N. Y. C.; Bliley; Collins; National with front-of-panel control.

was accomplished by means of a length of S.S. White Flexible Shafting. The unit was installed in the four-band exciter,⁴ replacing six crystals which were originally built into it, and W9DRD went merrily about its business of sliding around heterodynes instead of jumping blindly out of the skillet into the flames. "Planned" frequency control, the New Dealers might call it.

At about this time Jim Millen happened along, liked the idea, and agreed to develop it. One of the holders shown in the photograph is a production model of the new National device, and Fig. 1 shows an average curve of its performance with a properly finished A-cut crystal. If a crystal is ground, for instance, so that it has a fundamental frequency of 3550 kc. in an ordinary contact type holder, it may be tuned to something over 3555 kc. when mounted in the varigap mounting. At the second harmonic of this crystal, we cover the range of 7100-7112 kc., at

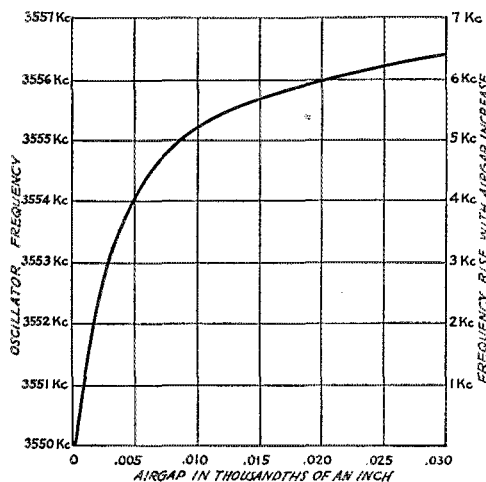

FIG. 1.—OSCILLATOR OUTPUT POWER REMAINS PRACTICALLY CONSTANT OVER A FREQUENCY RANGE OF 6 KC. WITH A 3550-KC. CRYSTAL

the fourth harmonic, the range is 14,200-14,224 kc., and at the 8th harmonic, 28,400-28,448 kc. In actual operation this range is wide enough to permit evasion of heterodyne interference, and still not so wide that out-of-band operation becomes a hazard.

It is important that a carefully ground low-drift type crystal of proper design be used with the mounting described. Many crystals have been found to oscillate smoothly with an air-gap of more than three times the crystal thickness, while some crystals apparently good enough for use in contact-type holders have flatly refused to cooperate in the air-gap mounting.

⁴ H. Hollister, "A Four-Band Exciter," *QST*, July, 1935; also pp. 166 and 167, 1936 A.R.R.L. Handbook.—Edrron.

New England Division Convention

Boston, Mass., April 18, 1936

THE official A.R.R.L. New England Division Convention is to be held in Boston, Mass., on April 18th, Hotel Bradford. The hosts are the Eastern Mass. Amateur Radio Association and the South Shore Amateur Radio Club. For the first time this well known convention will be a ONE DAY affair. The program will start promptly at 8:30 a.m. Saturday, and the committee advises all events will take place on time. The registration fee, \$1.00; banquet, \$2.50. All talks will be on practical problems and there will be an exceptionally fine list of speakers. For those who may reach Boston Friday evening the committee will be prepared to entertain them with "rag chews," etc.

Attention, M.D.'s

Dr. Burton T. Simpson, W8CPC, Dr. Fitzgibbon, W7DNP, and Dr. Maytum, W9MXW, are promoting a meeting of the radio-amateur M.D.'s who attend the annual meeting of the American Medical Association at Kansas City, May 11th-15th. A dinner and a rag-chewing 'fest of the ham medicos present are planned. Will all M.D. amateurs who plan to attend please get in touch with one of the committee for details?

Silent Keys

It is with deep regret that we record the passing of these amateurs.

Dr. L. A. Brown, W2HBW, Walden, N. Y.
Jacob Content, W2CNN, North Bergen, N. J.

R. W. Jacobsen, W9CHS, Kenosha, Wis.
Paul L. Krouse, W5EEQ, El Paso, Tex.
Paul Kurilla, W8HBO, Cuyahoga Falls, Ohio

Hiram Percy Maxim, W1AW, Hartford, Conn.

C. J. McClure, W7NE, Leavenworth, Wash.

Paul J. Potter, W6HXP, Los Angeles, Calif.

W. W. Redfern, W2ARY, Brooklyn, N. Y.
E. D. Reynolds, W6LRW, ex-W7GL, Woodland, Calif.

Harold C. Roeller, W3BQE, Pottstown, Pa.

Charles H. Stewart, W3ZS, St. David's, Pa.

Rutherford B. Udell, W9NK, Wilmette, Ill.

E. H. Weimer, W7HT, Cohagen, Mont.

What the League Is Doing

League Activities, Washington Notes, Board Actions—For Your Information

Conference Preparation

The United States preparation for the Bucharest meeting of the C.C.I.R. got under way in Washington on February 14th when the F.C.C. called a meeting of all interested parties at the request of the Department of State. A.R.R.L. was represented by Secretary Warner and Technical Editor Lamb. Four committees were formed, charged with the duty of assembling the United States material on the eighteen technical questions that are under study. Our representatives are participating in this work. Our headquarters, as the headquarters of I.A.R.U., is also centralizing the amateur study on some of these questions, for which direct contribution to the C.C.I.R. will be made by the Union.

Preparation for the Cairo conference has not yet commenced but it looms on the horizon. The United States proposals for Cairo must be ready to leave the country before the end of this year, so Cairo work will commence at Washington as soon as C.C.I.R. preparation is out of the way. Part of the work for which our A.R.R.L. Cairo Committee has been planning will therefore be taking definite form this coming summer.

F. C. C. Rules

The F.C.C. is engaged in a long program of modernizing the text of its rules and regulations. The first portion of the new job is now completed, treating largely of rules of practice and procedure. This text replaces many of the old F.C.C. rules having low numbers, although none of the amateur regulations as such. We note just one change affecting us: it is now required that when amateurs reply to citations by monitoring stations, they shall send the original of their reply to Washington and a copy to the monitoring station which originated the report.

The new rules commence with the number 100 and subdivisions thereof are given decimal numbers. Thus old Rule 2 becomes new Rule 103.7, and so on. A new and revised print has been prepared of the rules governing amateur operation and in this new printing the revised numbering system is employed, so far as it now exists. Eventually all of the regulations will employ it.

Finances

From the business standpoint our League had an excellent fourth quarter last year. Much of this is attributable to the appearance and distribution of our new Handbook. Net result for the year is a very satisfactory "first gain from operations." For the

information of members the quarterly operating statement is here rendered.

STATEMENT OF REVENUES AND EXPENSES, EXCLUSIVE OF EXPENDITURES CHARGED TO APPROPRIATIONS, FOR THE THREE MONTHS ENDED DECEMBER 31, 1935

REVENUES		
Membership dues	\$16,265.31	
Advertising sales, QST	20,255.23	
Advertising sales, Handbook	5,598.20	
Newdealer sales, QST	12,753.23	
Handbook sales	22,331.48	
Booklet sales	3,157.86	
Calculator sales	1,901.66	
Membership supplies sales	2,594.79	
Interest earned	383.31	
Cash discounts received	215.27	
Bad debts recovered	60.00	\$85,516.34
<i>Deduct:</i>		
Returns and allowances	\$ 3,914.64	
Cash discounts allowed	435.07	
Collection and exchange	27.09	
Increase in provision for news-dealer returns of QST	510.73	
Adjustment of non-ledger unclassified billings	2,505.38	7,392.91
Net revenues		\$78,123.43
EXPENSES		
Publication expenses, QST	\$15,535.44	
Publication expenses, Handbook	17,239.72	
Publication expenses, calculators	692.53	
Publication expenses, booklets	721.14	
Membership supplies expenses	1,354.13	
Salaries	22,430.55	
QST forwarding expenses	757.76	
Telephone and telegraph	771.97	
Postage	1,367.95	
General expenses	2,703.15	
Rent, light and heat	826.19	
Traveling expenses	1,318.83	
Communications Dept. field expenses	98.65	
Headquarters station expenses	39.23	
Bad debts written off	573.16	
Provision for depreciation of furniture, equipment and station	294.39	
Interest on bonds purchased	45.57	
Total expenses		66,770.36
Net Gain before Expenditures against Appropriations		\$11,353.07

Fees

Last month we mentioned that fees for licenses were again under consideration in Washington. QTA that now. The subject is dead for the rest of this year.

Ratifications

Just to keep the record straight, let us advise that Mexico, Turkey and the Dominican Republic are now parties to the Madrid convention and its radio

regulations. Humorous note: France having ratified the *Washington* convention just last year, the governor of French Indo-China has now promulgated the same for his colony. At last report France had not yet ratified the Madrid treaty, although she has announced that she is applying the provisions of the Madrid radio regulations.



DIXIE JONES' OWL JUICE

THIS here species of mammal known as *Pithecahamicus erectus* which closely resembles the human type but is distinguishable by its shrill cry, "See Kew See Kew," which it emits when excited, is in grave danger of becoming extinct. There are three generic classifications of this here faunal specimen, to wit: (1) Young squirts, which was born that way, (2) Ex-squirts, which somehow survived the age of squirthood, and (3) Old guys which got that way after growin' up normal. This here editor is in Class 3, and the reason why our ranks is becoming depleted and we'll soon go and join the dodo, the frizzly auk and the duck-billed platypus, is because as follows: Take young squirts, for instance, that's just beginning to learn how to think. They will hump over their haywire all night, every night, and they don't git no sleep, and it undermines their stamina and purty soon they become extinguished and fill a early grave without ever having had either the ability or the opportunity to comply with certain Biblical instructions with reference to the procreation of their species. Older guys in Class 2 and 3 could, or might could, if they would but they ain't got time. His OW can look like the Queen of Sheby and he don't see it. She can spend hours and hours gettin' fluted and frilled and tinted and curled and sprinkled with smell-goodie, but it don't do no good. He barges right past her (assuming that he's been out halfway holding some kinda job) and plops down at the haywire and there he sets and she can't prize him loose to eat or anything else. Ten o'clock comes, eleven o'clock comes, midnight comes, and she gets up offa the sofa where she's been settin' lookin' at the carpet, and trundles off to bed, a dejected picture of wasted sweetness. When she gets her divorce there ain't nobody left to feed him so he just sets there and hams and hams until he starves to death. If we don't watch out, in about a hunnert years, they'll have the last one of us stuffed and in a glass case with a tag on it saying: "Pithecahamicus Erectus, Now Extinct. He hammed ALL the time."—*W4IR of the "Dixie Squinch Owl."*

Oregon State Convention (N. W. Division)

April 18th and 19th at Salem, Ore.

THE Oregon Amateur Radio Association is sponsoring this year's A.R.R.L. State Convention, and Salem, Ore., is the city in which all convention activities will take place. A cordial invitation is extended to all amateurs to come to this affair, and watch for the publicity to appear in "Grid Leaks."

Meanwhile, H. B. Minturn, Convention Chairman, 442 So. 23rd St., Salem, Ore., will gladly furnish further details on request.

A.R.R.L. QSL Bureau

FOR the convenience of its members, the League maintains a QSL-card forwarding system which operates through volunteer "District QSL Managers" in each of the nine U. S. and five Canadian districts. In order to secure such foreign cards as may be received for you, send your district manager a standard No. 8 stamped envelope. If you have reason to expect a considerable number of cards, put on an extra stamp so that it has a total of six-cents postage. Your own name and address go in the customary place on the face, and *your station call should be printed prominently in the upper left-hand corner.*

W1—J. T. Steiger, W1BGY, 35 Call Street, Willimansett, Mass.

W2—H. W. Yahnel, W2SN, Lake Ave., Helmetta, N. J.

W3—R. E. Macomber, W3CZE, 418 10th St., N. W., Washington, D. C.

W4—B. W. Benning, W4CBY, 520 Whiteford Ave., Atlanta, Ga.

W5—E. H. Treadaway, W5DKR, 2749 Myrtle St., New Orleans, La.

W6—D. Cason Mast, W6KHV, 423 East E Street, Ontario, Calif.

W7—L. Q. Kelly, W7BPC, 4919 So. Prospect St., Tacoma, Wash.

W8—F. W. Allen, W8GER, 324 Richmond Ave., Dayton, Ohio

W9—George Dammann, W9JO, 319 Sherman Ave., Evanston, Ill.

VE1—J. E. Roue, VE1FB, 84 Spring Garden Rd., Halifax, N. S.

VE2—W. H. Oke, VE2AH, 5184 Mountain Sights Ave., N. D. G., Montreal, P. Q.

VE3—Bert Knowles, VE3QB, Lanark, Ont.

VE4—Dr. J. J. Dobry, VE4DR, Killam, Alberta.

VE5—E. H. Cooper, VE5EC, 2024 Carnarvon St., Victoria, B. C.

K4—F. McCown, K4RJ, Family Court 7, San-turce, Puerto Rico.

K7—Frank P. Barnes, K7DVF, Box 297, Wrangell, Alaska.

Cathode-Ray Monitoring of Received Signals

Pointers on Connecting the Oscilloscope to a Superhet

By Edwin C. Ewing,* W9HYO

AT THE time of this writing there are but a few amateur 'phone stations which are equipped with cathode-ray oscilloscopes. Since most other methods of checking modulation are inaccurate or limited in value, there is a real need for a few receiver installations (besides those of the F.C.C.). An installation is not difficult to make, and besides being an exceptionally interesting piece of equipment, it can do a real service for our fellow amateur.

Now let's see what a c.r. tube can on the receiver will do. It will permit reporting to other stations, with a good degree of accuracy, percentage of modulation as well as symmetry of pattern. It will show an over-peaked condition due to possible lack of neutralization and consequent self oscillation of a final amplifier. Or it may indicate a Class-B linear stage whose carrier excitation is excessive and whose power output has not been "quartered." This condition also may represent low filament emission or poor voltage regulation. The c.r. tube may show positive peaks which do not exceed the carrier amplitude and deep valleys, which would indicate carrier shift with downward modulation. It can show a jagged edge (with carrier only) which may indicate a noisy audio amplifier or a high-hiss carbon microphone. A.c. hum on the carrier is very pronounced and in this connection it is interesting to note the degree of visible hum which is not audible at normal loud speaker volume. If the a.c. nodes move slowly back and forth and do not stay synchronized with your 60-cycle sweep, you may be sure the carrier observed is outside your power distribution area. Besides these things there are undoubtedly many other analyses which the ingenuity of the operator will develop.

The cathode ray tube makes an excellent tuning indicator for the receiver. Fading will be readily observed. The c.r. tube can be calibrated in "strength units" by cutting and marking a celluloid scale and fixing it to the fluorescent screen. By means of this, quantitative measurements of fair accuracy can be made. Another use

to which the c.r. tube can be placed is in checking real quality by transmission of tone, permitting examination of wave form, overall fidelity of transmitter, etc. In general, a cathode ray tube on the receiver will show everything and more than one on the transmitter with the exception of the triangle-trapezoid pattern (valuable, but limited in use).

We will now go into the method of connecting a c.r. tube to the receiver, as diagrammed in Fig.

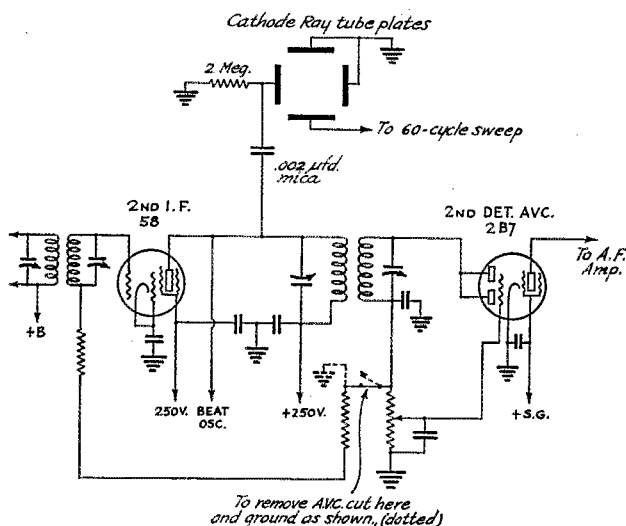

FIG. 1—METHOD OF CONNECTING THE CATHODE-RAY TUBE TO THE SECOND OR THIRD I.F. STAGE OF A TYPICAL SUPERHET

Changes in the a.v.c. circuit are indicated for the author's Pfanstiehl receiver, but would be similar for other types.

1. Any good receiver with two or more i.f. stages should develop sufficient r.f. voltage for deflection. If the receiver has a.v.c., considerably increased output can be had by cutting this out of the circuit. The receiver in use at W9HYO is a Pfanstiehl with a Peak pre-selector. When conditions are favorable, South American 20-meter 'phones have adequate deflecting strength. However, it is important that no component of the receiver is forced in order to get sufficient deflection output. By reducing c.r. tube anode voltage to lower values, beam sensitivity can be improved, although in some cases it may be necessary to add an additional stage of i.f.

(Continued on page 114)

*1057 Pratt Blvd., Chicago, Ill.

An Automatic Tape Recorder for the Radio Amateur

Complete Construction of a Model That Can Be Built for Ten Dollars or Less

By F. H. Schnell,* W9UZ

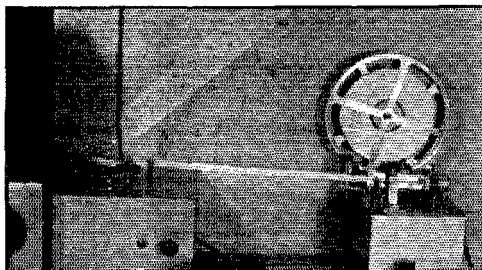

FIG. 1A—THE COMPLETE AUTOMATIC INSTALLATION AT W9UZ

The special amplifier (diagrammed in Fig. 8) sits on top of the receiver. Next, to the right, is the tape-puller unit, while the recording unit is at the extreme right.

WISH you could have heard W9—so—and-so the other night. What a fist and how he could wiggle that bug! In that, like many another wish, there may be one of two meanings; either an unusually good fist or a poor one. But, how often has that expression been made? If only that fist could have been recorded so it could be seen! Ediphone and Dictaphone recordings have been made, but aural recordings fail to disclose those discriminating characteristics which stand out so clearly on the “visual automatic recorder.” It isn’t possible to examine the aural recordings with any degree of satisfaction. The human ear of the radio amateur is quite an accommodating piece of mechanism—in the sense that the optometrist speaks of eye accommodation. The ear makes it possible to hear not only exactly what is being transmitted, but by the inherent process of accommodation, it makes it possible to hear that which is intended to be transmitted. In other words, our ears hear what ought to come from the transmitter, even though that which is actually transmitted may not depart from the antenna in keying form exactly according to the best teachings of radio telegraphy.

* 4915 N. Sawyer Ave., Chicago, Ill.

And, it may be supposed that reference to the word “fist” is an outgrowth of modified slang that simply grew up with amateur radio. What really is meant is “manipulation.” Of course, that word is bulky to handle over the air; it is rather a large package in any form. However, the proper application concerns “key manipulation” when the expression “fist” is used.

Fortunately, an automatic recorder is well within the reach of the serious-minded radio amateur, and at a cost which is amazingly small by comparison with the equivalent commercial article. The home-constructed recorder should cost not more than eight to ten dollars at current amateur prices, or even less with sledge-hammer and chisel discounts. As a matter of fact, the few

parts can be made from such discarded material as may be found in the usual amateur station. Careful workmanship, under any circumstance, is to be recommended if the best results are desired. It is to be observed that no hard and fast rules demand an exact duplication of this recorder. Ingenuity and experimentation make for improved devices of this type. For those who have no desire to enter into that branch

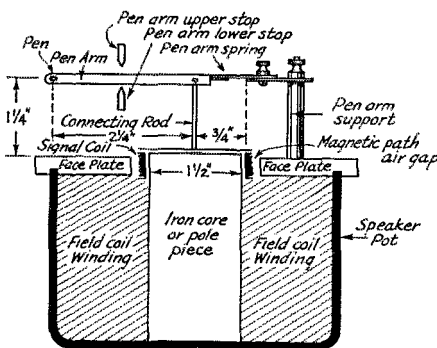

FIG. 1B—SKETCH ILLUSTRATING THE OPERATION OF THE RECORDER ASSEMBLY

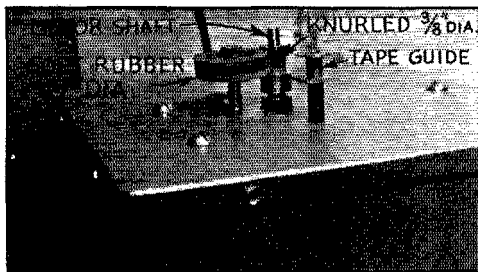

FIG. 2—TAPE PULLER SHOWING KNURLED BRASS SHAFT AND RUBBER WHEEL AND TAPE GUIDE

of the art, let it be said that this recorder works satisfactorily and the illustration in “Fists I have

Seen," March, *QST*, is an example of the results obtained. On that basis, then, the description of the automatic recorder at W9UZ follows.

Many hours of discussion were involved in this recorder design and useful suggestions made by Frank Borsody, W2AYN, have been incorporated. It is doubtful if the many things which have been simplified would have been possible without his timely aid, or without his lathe which was available any hour of the day or night.

PRINCIPLE OF THE RECORDER

The general sketch of Fig. 1B illustrates the essentials of the recording element. The field coil winding is energized with 100 volts at 100 ma., 10 watts d.c. The signal is supplied to the copper-oxide rectifier from the amplifier. The rectified or d.c. voltage is applied to the signal coil. This causes the signal coil to move upward until the pen arm hits the pen arm upperstop. The length of the upward stroke is governed by the position of the pen arm upper stop. The signal coil is linked to the pen arm by the connecting rod. The pen is soldered close to the end of the pen arm. The pen is $\frac{1}{2}$ inch in length and consists of a piece of tubing which has an inside diameter of 0.001 of an inch. One end of the pen fits in the inkwell and the other end of the pen touches the paper tape lightly. The ink flows from the ink well through the capillary pen to the paper. When there is no signal, the pen arm spring forces the pen arm down until the pen arm hits the lower stop. The pen arm is made of a piece of copper strip, $\frac{1}{8}$ th of an inch wide and $\frac{1}{32}$ nd of an inch thick.

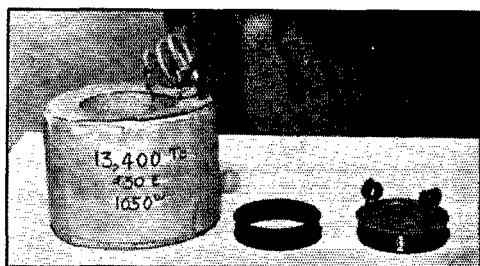

FIG. 4—THE SIGNAL COIL IS WOUND WITH 1600 TURNS OF NO. 42 ENAMELLED WIRE

This type of recorder is capable of more than 40 cycles per second, which is equivalent to 100 w.p.m. The normal input to the signal coil is 6 to 10 volts, d.c. It will operate on 3 or 4 volts when the noise level in the receiver is low. The signal level is controlled by the volume control of the receiver or the one at the input of the 75 tube (of the audio amplifier), or both in combination.

The single-signal receiver is designed after the

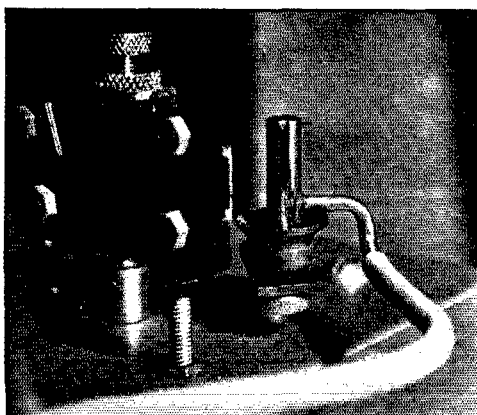

FIG. 5—CLOSE-UP OF INK CONTAINER

original Lamb model, using a 76 tube as output detector. Since there is no audio amplification in the receiver itself, the output of the 76 is supplied to the amplifier of which the 75 tube is the first stage, as shown in the circuit diagram (Fig. 8).

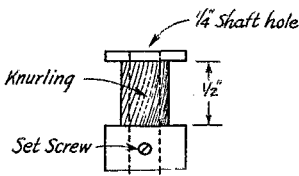

FIG. 3—DETAIL OF TAPE PULLER

Fig. 2 illustrates the manner in which the tape puller and recorder are set up for operation, the amplifier being contained in the metal case which sits on top of the receiver. Immediately to the right of the receiver is the tape puller assembly in a metal case $8\frac{1}{4}$ inches wide, $8\frac{1}{4}$ inches long and $5\frac{1}{2}$ inches high. At the extreme right is the recorder assembly; the metal case is $5\frac{1}{2}$ inches wide, 5 inches high and $8\frac{1}{2}$ inches front-to-back.

The tape puller is powered by an induction motor, in this instance a General Electric turntable type such as is used in radio-phono combinations. Commutator type motors are to be avoided because of interference from sparking. The induction motor is of the variable-speed type, having a small governor for speed control, the speed range being from 5 or 6 r.p.m. to 150 r.p.m. The motor is mounted in the metal case for convenience and appearance. The shaft of the motor is turned down to a diameter of $\frac{1}{4}$ inch and the shaft projects through the top of the case (Fig. 2). The larger diameter disc ($1\frac{1}{2}$ inches) is a piece of soft rubber $\frac{3}{8}$ inch thick. This is the idler. On the shaft which projects through the top of the case, a piece of brass is fitted. It is made from a piece of round brass rod, $\frac{5}{8}$ inch in diameter. It is $\frac{15}{16}$ inch long and has a $\frac{1}{4}$ -inch hole from end to end. A small set-screw holds it to the motor shaft. A groove is turned out which is $\frac{1}{2}$ inch long and the diameter is $\frac{3}{8}$ inch and this section is knurled. The tape passes between this knurled section and the rubber idler, the knurling and rubber idler preventing slippage.

The heart of the recorder is the magnetic

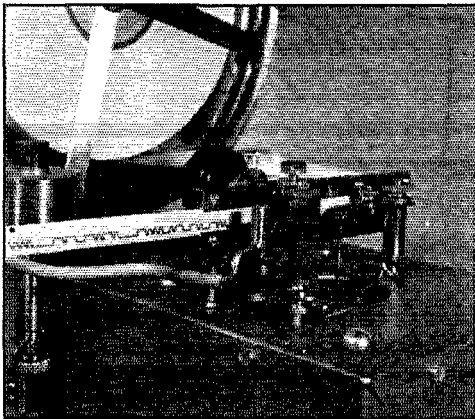

FIG. 6—CLOSE-UP OF TAPE SLIDE, INK RESERVOIR AND PEN ARM AGAINST TAPE

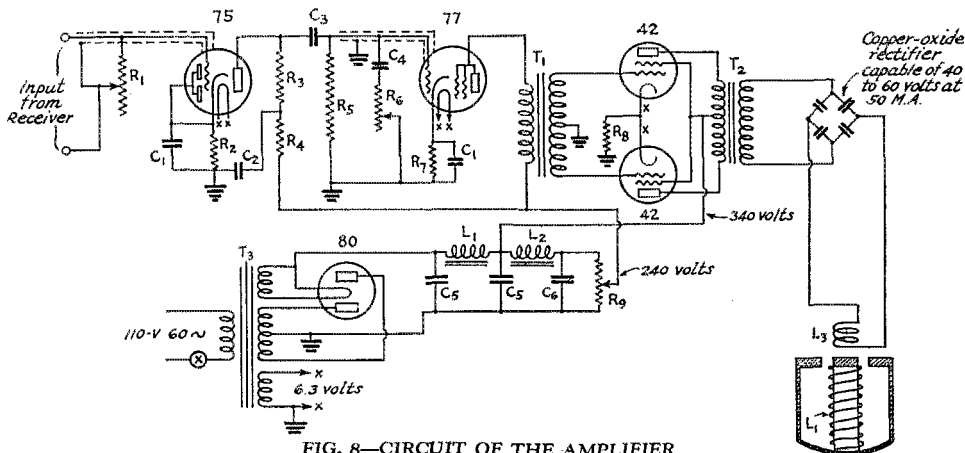
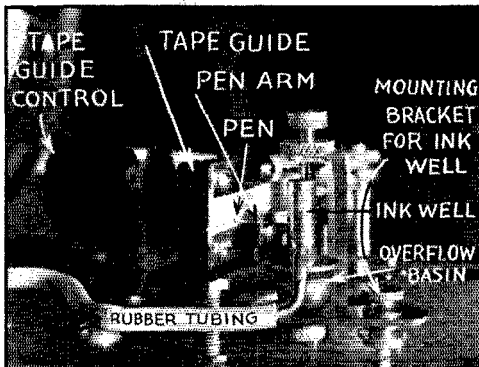

FIG. 8—CIRCUIT OF THE AMPLIFIER

- L₁—1000-ohm speaker field.
- L₂—30-henry filter choke.
- L₃—1000-ohm signal coil (see text).
- C₁—12- μ fd. 50-volt electrolytic condensers.
- C₂—0.05- μ fd. by-pass condenser.
- C₃—0.02- μ fd. coupling condenser.
- C₄—0.02- μ fd. tone-control condenser.
- C₅—10- μ fd. 500-volt electrolytic filter condensers.
- C₆—18- μ fd. 500-volt electrolytic condenser.

- R₁—1-megohm input control.
- R₂—6000-ohm cathode resistor.
- R₃—100,000-ohm plate filter coupling resistor.
- R₄—30,000-ohm plate filter resistor.
- R₅—250,000-ohm grid resistor.
- R₆—500,000-ohm variable tone control.
- R₇—2000-ohm cathode resistor.
- R₈—220-ohm cathode resistor.
- R₉—23,000-ohm 10-watt bleeder-divider.
- T₁—Push-pull interstage transformer.
- T₂—Output transformer (Thordarson 2408).
- T₃—350-volt type power transformer.



one on either end, 1/32 inch wide. Into this groove, 1600 turns of No. 42 enamelled wire are wound—resistance, 1,000 ohms. On one end of the signal coil form (after the winding has been completed) a thin piece of bakelite is glued to which the two leads are secured. In the center of this thin piece of bakelite the connecting rod is secured. This connecting rod attaches to the pen arm, as illustrated. Fig. 4 shows the field coil

(Continued on page 58)

FIG. 7—LEFT-SIDE VIEW, SHOWING THE INK "STORAGE TANK" AND CONTROL FOR REGULATING INK LEVEL

Notes on Audio Power Amplifiers in Regenerative Receivers

Adding a Stage to the Beginner's Set

HAVE you ever added a power audio stage to your two- or three-tube for loud-speaker operation? If you have you may be one of a surprisingly large number who seems to encounter difficulty in avoiding howling or motor-boating. So many letters on the subject have been received within the past few months that we thought it would not be a bad idea to look into the matter and determine how serious the trouble might be and, if possible, to remedy.

Accordingly, the two-tube a.c. receiver using a 56 detector and 56 audio described in the *A.R.R.L. Handbook* and *QST* for June 1934 was set up and a 2A5 pentode audio power stage resistance-coupled to the 56. No decoupling circuits were used and a 10- μ fd. cathode resistance condenser was the only by-passing employed. The resistance used in the plate circuit of the 56 was the usual value of 50,000 ohms.

When the receiver was turned on, a low-frequency audio oscillation started immediately. The oscillation would cease only when the audio volume control was turned below about one-quarter way towards the full volume position. A decoupling network was then tried in the grid circuit of the 2A5. R_3 , a resistance of 250,000 ohms, was inserted and the cathode by-pass condenser connected across both R_3 and R_4 . After this change, the volume control could be advanced to mid-position without motor-boating. A decoupling network in the plate circuit of the 56 had no effect. A large plate by-pass condenser was next tried and when this capacity was increased to 16 μ fds., it was possible to advance the volume control to almost maximum position.

At this point the value of R_1 , the 56 plate circuit resistance, was reduced to 20,000 ohms. Although no reduction in gain could be noticed with the lower value of load resistance, the audio amplifiers were entirely stable at full volume. Later investigation showed that the plate by-pass capacity could be reduced to 8 μ fds. with the lower value of plate circuit resistance.

Transformer coupling between the 56 and 2A5 was next tried. Tests with three or four different transformers showed that this type of coupling not only provided an appreciable improvement in gain over resistance coupling, which might be expected, but that the audio system was much more stable. With one or two of the transformers used no special measures were necessary to prevent oscillation; with others the decoupling resistor in the grid return circuit was necessary

to permit full advance of the gain control. The decoupling resistor also served to eliminate a slight power supply hum which was first experienced.

Since any plate by-pass capacity added is effectively in parallel with the power pack filter condenser, the value needed to obtain complete

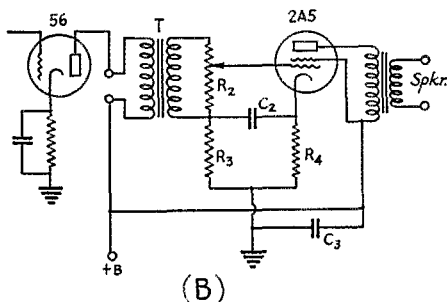
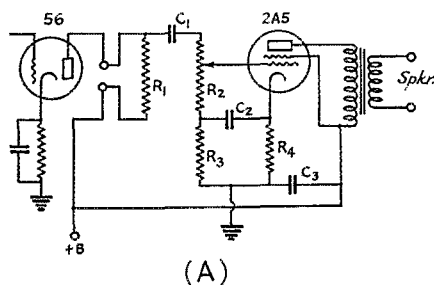

SINGLE STAGE POWER AMPLIFIER

- R_1 —20,000 ohms, 1 watt.
- R_2 —500,000-ohm potentiometer.
- R_3 —250,000, 1/2 watt.
- R_4 —400 ohms, 1 watt.
- C_1 —.02 μ fds.
- C_2 —1 μ fd., 50 volts.
- C_3 —8 μ fds., 400 volts.
- T—Interstage audio transformer.

stability may vary somewhat with the values of filtering capacity used in the power pack.

In using a loudspeaker with a regenerative receiver, more trouble is likely to be encountered from acoustic feed-back from speaker to detector tube than from instability in the audio circuits when proper precautions are taken. This sort of feed-back results in the well-known annoying howl which often builds up when loudspeaker

(Continued on page 98)

H A M D O M



MISS NELLIE HART, O.R.S., S.C.M. Idaho, alternate D.N.C.S. Idaho 3rd district, has an interesting background to her ham career. Raised on a cattle ranch in Eastern Oregon, sixty miles from a railroad, she moved to Twin Falls, Idaho, at the age of 14. After attending the College of Idaho she

was variously employed as a book binder and sound movie projectionist; but now she has retired. W7NH became interested in ham radio while visiting a friend who had a 'phone station. She describes it: "Got into an argument with VE4GM over my having microphone fright. He told me all women were alike and couldn't talk unless they had someone to talk back at them. So I took up radio to prove he was wrong. (Never got over my microphone fright but I don't stutter on the bug!)" Three transmitters are used at W7NH: a portable, with 40 watts to 46's, one with 300 watts to a pair of Eimac 50T's, and the old stand-by, a 212A with 400 watts on 80. The combination of fishing, hunting and ham radio sustain a high pitch of interest in Idaho life.



WE KNOW most good radio engineers were once radio amateurs; many still are. An outstanding example is J. E. Young, transmitter engineer of RCA Victor. An amateur since 1915, an early transatlantic worker, first 3rd district station to work z4AA, WAC, O.R.S., these impressive amateur achievements are paralleled only by his professional activity. Graduating a B.S. in E.E. from Drexel in 1928, he went to work for G.E. on the first "super-power" 50-kw. b.c. station, then being developed. Developmental design on the 5B and 50B rigs completed, Jack turned his hand to high-power s.w. b.c. transmitters, developing a linear amplifier for 2XAF with 160-kw. peak capacity—the highest-power s.w. b.c. transmitter in use at that time. In June,

1932, he transferred to RCA Victor's Engineering Department, where he has designed several transmitters for broadcast and government services, his ideas being distinguished by the combination of beauty and utility. He has been building a new station for the past three years; he estimates it will be completed by about the next minimum of the 11-year sun-spot cycle.

CAPT. FREDERIC B. WESTERVELT, M.C., admits to a bit of a past in ham radio—pre-war 8ATD, licensed in 1916 in Pittsburgh, post-war 8VE in 1919, 3AVG spark at Lancaster, Pa., combining with Parker Wiggin and c.w. in 1922 to form 8ZD, PRR emergency work (as a regional manager) with a McCullough ½-kw. bottle and sync, A.R.R.L. traffic manager for Alleghany, Butler and Washington counties, holder, as well, of the following additional calls: 8ZAH, 8PR, 3MY, W1DOC, and now W3CZO; graduated from Pitt with B.A. in 1925, as M.D. in 1930, accepting thereupon a commission in the Army Medical Corps; now stationed at Carlisle Barracks (Pa.) on duty with the 1st Medical Regiment (1st Div.) and instructing at the Medical Field Service School, while W3CZO with a Collins 30FX works the world on 7 and 14 mc.—



but insists on a present and future, too. He looks back on the "good old days" when one spark in town made the rest give up, and takes ham radio to-day as leaving little to be desired.

DR. ENRIQUE DE MARCHENA, HI6O, of Santo Domingo, Dominican Republic, has two hobbies:

music and amateur radio. By profession he is a lawyer, a graduate of the Domingo National University. His musical interest is centered in composition, and he is a member of the Symphonic Society. His ham career has centered largely around high frequency 'phone work where he is well known.



Open-Type Transmitter Construction for Small Floor Space

Tri-tet All-Band Excitation with Push-Pull 50T Final

By Byron Goodman,* W1JPE

IN RECENT years, the trend in transmitter design has been more or less towards standardization of construction. That is to say, most transmitters are built in either a glorified breadboard arrangement or rack and panel. The advantages of either arrangement cannot be denied. The breadboard layout enables plug-in coils to be changed quickly, the equipment can be laid out following closely the wiring diagram with consequent short leads; and good efficiency, and trouble can, in most cases, be run down quickly. The rack and panel type of construction gives a professional air to the equipment, allows everything but controls and meters to be hidden, but does not lend itself well to flexibility and quick changes.

A quite definite problem had to be faced in the design of the transmitter to be described. The best and most logical location for the transmitter only allowed a space 12" × 18" × any-height-up-to-the-ceiling. With this limitation in mind we set about to lay out the rig.

It had been decided that the final would consist of two Eimac 50Ts in push-pull, since they would give moderate power and, because of their design features, work well on the high-frequency bands. At the same time, they had the advantage that any time ambition dictated a little more power it was simply a matter of increasing the plate voltage.

An idea borrowed from Charles Perrine, W6CUH, started us off on the design. Some time ago he built a push-pull final amplifier that used a so-called "open" type of construction. The possibility of other arrangements was debated, including rack-and-panel in its various forms, but always the

"open" type was returned to as the most logical and the one best suited to our needs. And the 50T's worked into the picture nicely.

When it came to a consideration of the driver stage, another problem became apparent. Should an overgrown Type 10 or comparable tube be used at about 800 volts? It would no doubt drive the final stage nicely with voltages up to 2000 on the plates of the 50Ts, but probably wouldn't give much leeway when the voltage was raised still higher. A pair of 10's might do it, or one of the 1000-volt tubes like the 800. But why not go whole hog, and make sure that there was *always* adequate excitation? We could then raise the plate voltage on the final, or modulate it for 'phone work. And why not take advantage of the present-day medium-powered pentodes, with their low excitation requirements and ability to dispense with neutralization? Yes, that seemed like the best idea, with an RK20 as the logical tube; and since the plate lead is out the top, it could be mounted vertically and fit in beautifully with our type of construction.

At first we thought of simply using a single 802 Tri-tet oscillator as the driver for the RK20, but decided that getting to 28-mc. without using a 14-mc. crystal would be somewhat of a problem. So, in keeping with the policy of "adequate excitation," another 802 doubler stage was added. While it might have been possible to struggle along without the second 802 by carefully tuning each stage and adjusting coupling to critical values, the slightly increased complication of tuning a fourth stage justified its inclusion by the ease with which more than enough excitation could be obtained.

One more line of reasoning that

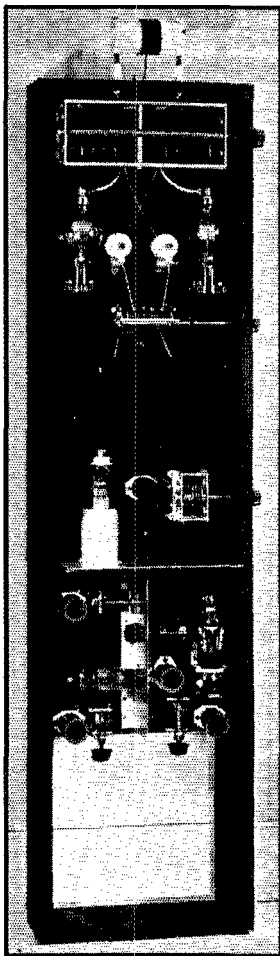

THE COMPACT 500-WATT TRANSMITTER, READY FOR THE ANTENNA AND POWER SUPPLY

*Assistant Secretary, A.R.R.L., ex-W6CAL.

was followed, and then we'll get on with the description. We have often thought, and have found many to agree, that the same careful shielding employed in our receivers should be used in transmitter design, especially in the low-power stages. Using three pentodes as was in-

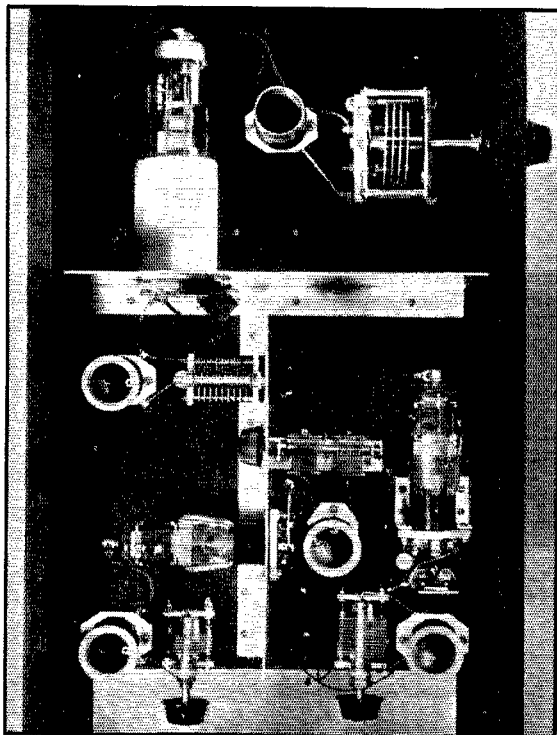

A CLOSEUP OF THE EXCITER STAGES, SHOWING THE SHIELD PARTITIONS AND SHORT LEADS

The crystal is directly under the right-hand 802. By-pass condensers are mounted right at the sockets, to cut down the length of the r.f. returns. The switch to the left of the RK20 cuts in 50 volts positive bias on the suppressor grid.

tended, we could see no reason for not using some shielding. True, a transmitter can be regenerative and still lock in on the crystal frequency, but we wanted to eliminate the danger of self-oscillation. After a little pencil-scratching it was found that a quite satisfactory arrangement could be made using only a few pieces of aluminum as shielding, and they incidentally helped out in a structural way. Testing the transmitter after it was completed disclosed no trace of regeneration, and fully justified the use of shielding.

The frame of the transmitter was made by sawing a five-foot length of 1" x 12" pine down the center and fastening two 13½" crosspieces at top and bottom with flat-head wood screws. Strips of pine 1" x 2" were fastened along the inside back edge of this open box to support the panels of the transmitter. The whole was then

given a coat of "flat black" paint, resulting in a cold, black frame that resulted in comments such as "coffin transmitter" and "do you call in pall-bearers to tune the thing?" But with the panels in place it took on a different aspect.

The panels are made of two pieces of ¼" Lamtex, 13½" x 21". (Lamtex appears to be tempered Masonite, finished on one side in black crackle.) They give a very pleasing effect and are strong enough to support most equipment that might be used. All of the gear is fastened directly to these panels, with the exception of the stand-off insulators that support the final tank coil. The panel used to mount the exciter unit, consisting of the RK20 and the two 802s, is backed up by a piece of ½" aluminum, to complete the shielding and furnish a good r.f. return. To eliminate long leads and consequent voltage drops, filament transformers are mounted on the panels directly in back of their respective tubes. We wanted to take no chances with shortened tube life due to incorrect filament voltage.

The upright 802 in the lower right-hand corner of the transmitter is the Tri-tet oscillator. Directly underneath it are the two porcelain stand-off insulators that furnish the plug-in mounting for the crystal. (Homemade crystal holders are used, employing GR plugs.) Under the crystal is the coil and condenser (L_1-C_1) used in the cathode circuit of the oscillator. By-pass condensers are mounted right under the socket holding the tube, furnishing short r.f. returns. Close to the plate terminal of the oscillator tube is the plate tuning tank, L_2-C_2 . As can be seen in the wiring diagram, this departs slightly from the conventional in that it takes the form of a π -section network. Computation showed that common orders of $L-C$ ratios used in amateur bands would furnish us a π -section

with an impedance of around 3000 ohms, which is close to the optimum load and input impedance of the 802's. In this case, it afforded a simple means of getting short leads; and, too, the only condenser left over was a split-stator one, so this scheme of coupling was used. Tests show it to give results identical with other types of coupling.

The 802 lying horizontally is the buffer-doubler tube used to excite the RK20. The plate tank is adjacent to the plate terminal, and is link-coupled to the grid tank of the RK20. All by-pass condensers for the doubler 802 and the buffer RK20 are mounted right at the socket, for the reason given above.

The shield surrounding the lower part of the RK20 was made from an old coil shield, and there is absolutely no inclination for the pentode to be regenerative. A large (2½"-diameter) coil form

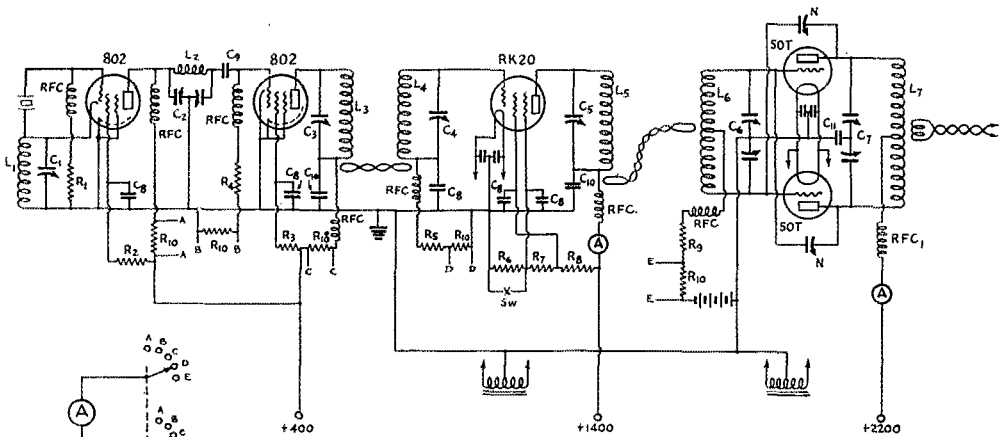

FIG. 1

- C₁—100 μ fd. (National ST-100).
- C₂—Split-stator 100-100 μ fd. (Hammarlund MCD-100-M).
- C₃—50 μ fd. (National ST-50).
- C₄—50 μ fd. (Hammarlund MC-50-MX).
- C₅—50 μ fd., 3000 volt (National TMC-50).
- C₆—Split-stator 70-70 μ fd., 3000 volt (Cardwell MT-70-GD).
- C₇—Split-stator 40-40 μ fd., 12,000 volt (National TMA-40DC).
- C₈—0.01 μ fd. paper, 600 volt (Aerovox Type 684).
- C₉—100 μ fd. mica receiving (Aerovox Type 1450).
- C₁₀—0.002 μ fd. mica, 5000 volt (Sangamo).
- C₁₁—0.001 μ fd. mica, 5000 volt (Sangamo).
- N—Neutralizing condenser (National NC-800).
- R₁—50,000 ohm, wire-wound, 10 watt (Ward Leonard).
- R₂, R₃, R₄—15,000 ohm, 10 watt wire-wound (Ohmite).
- R₅—20,000 ohm, 10 watt wire-wound (Ohmite).
- R₆—2500 ohm, 10 watt wire-wound (Ohmite).
- R₇—12,500 ohm, 25 watt wire-wound (Ohmite).
- R₈—15,000 ohm, 50 watt wire-wound (Ohmite).
- R₉—10,000 ohm, 50 watt wire-wound (Ward Leonard).
- R₁₀—20 ohm, 10 watt wire-wound (Ohmite).
- RFC—Radio-frequency choke, 125 ma. (National 100).
- RFC₁—Radio-frequency choke, 500 ma. (Hammarlund CH-500).

was at first used in the plate circuit, but there was a tendency towards oscillation. Replacing this coil by one of smaller diameter, and rearranging the by-pass condensers, eliminated regeneration completely.

The plate of the RK20 is link-coupled to the grid coil of the push-pull final amplifier, with single-turn links furnishing adequate coupling. The 50Ts, once neutralized, need no further attention on this score when changing coils, since a balanced circuit is used. All links on coils are permanently set so there is no need for adjusting them for various bands, and changing bands is merely a matter of plugging in the proper coils and re-setting the condensers.

An 80-meter crystal is used for operation on 7 and 14 mc. On 28 mc. a 7-mc. crystal is used.

The driver stage is always operated as a straight amplifier—doubling is always done in the 802 stages.

With 425 volts on the plates of the 802s, a rectified grid current of 10 milliamperes is obtained through the 20,000-ohm grid leak of the

RK20. This represents abundant excitation, and drives the RK20 hard enough so that the final amplifier is fully excited. A plate voltage of 1400 is used on the RK20, and the rectified grid current of the 50Ts is 40 to 50 mils on all bands, with a grid leak of 15,000 ohms and 225 volts of battery bias. Plate voltages greater than 2200 are not available here at present, but there is no doubt that the excitation is completely adequate for voltages up to 3500. A switch is shown that, when opened, places 50 volts positive

COIL TABLE

Band	L ₁	L ₂	L ₃	L ₄	L ₅	L ₆	L ₇	Crystal
7 inc.	A	B	C	D	E	F	G	3.5 mc.
14 mc.	A	B	H	I	J	K	L	3.5 mc.
28 mc.	I	H	M	N	O	P	Q	7 mc.

Coil	No. Turns	Size Wire	Diam.	Length
A	21	18 enam	1 1/2"	1 3/8"
B	26	18 "	1 1/2"	1 1/2"
C	24	18 "	1 1/2"	1 1/2"
D	22	18 "	1 1/2"	1 1/2"
E	24	14 "	1 1/2"	2 1/4"
F	26	14 "	2"	4"
G	16	14 "	3 1/2"	2 1/2"
H	12	18 "	1 1/2"	1 1/4"
I	8	14 "	1 1/2"	1 1/2"
J	10	14 "	1 1/2"	1 1/2"
K	14	14 "	2"	3 1/4"
L	10	12 "	2 3/8"	1 1/2"
M	6	18 "	1 1/2"	1 1/2"
N	3 3/4	14 "	1 1/2"	1 1/2"
O	3 1/2	14 "	1 1/2"	1 1/4"
P	8	14 "	2"	3"
Q	6	3/16" tubing	2 1/2"	4 1/2"

bias on the suppressor grid of the RK20 and increases the output considerably, but it has not been necessary to run the tube in this manner as

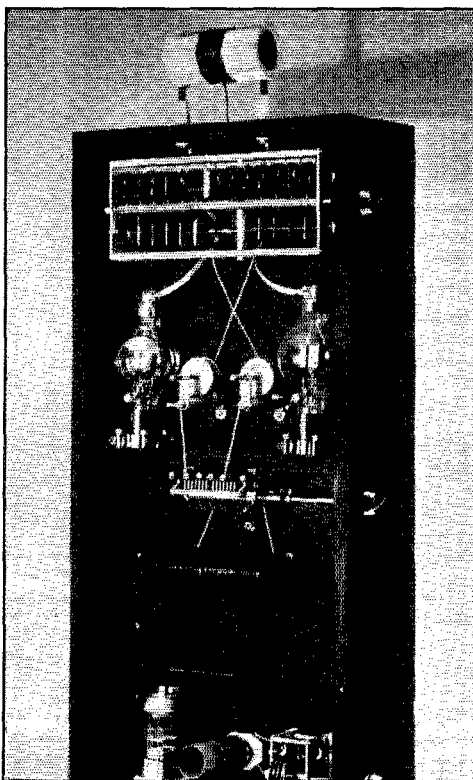

ANOTHER VIEW OF THE FINAL AMPLIFIER, SHOWING THE METHOD OF MOUNTING TUBE SOCKETS AND GRID TUNING CONDENSER

A one-turn link from the driver stage furnishes adequate coupling.

yet. The normal plate current of the final amplifier is 225 milliamperes, representing an input of 500 watts.

The final amplifier is coupled to the antenna tuning unit by a link. One turn at the transmitter and two turns at the antenna coil enable sufficient coupling to be obtained, and it usually has to be backed off so that abnormal plate current will not be drawn. The radiation is well free from harmonics, because not many are generated in the push-pull final, and the link coupling, by lessening the capacity coupling to the antenna, keeps any that might be generated from getting into the radiating system.

It would be well to mention the method of metering the various circuits. This is accomplished in the low voltage stages in both plate and grid circuits, and in the higher voltage stages in the grid circuits by merely cutting the meter in across a 20-ohm resistor by means of a double-pole

five-position switch. Since the resistance of the meter is about $1\frac{1}{2}$ ohms, the error in current measurement is small, and the ease with which the meter is switched from one circuit to another is a convenience that is well worth the slight added complication. Meters are placed permanently in the plate circuits of the RK20 and 50Ts.

Keying is easily accomplished in the primary of the RK20 plate transformer. Only $1\text{-}\mu\text{fd.}$ of filter capacitance is used, and no tails are noticeable. Do I hear shouts of "not enough filter" and "bet you get an RAC note"? The answer is, use adequate filter on the final stage, drive the final hard enough (Class C) and it will not respond to a slight ripple in the exciting voltage. The final is biased to cut-off, and with the key up the last two stages are dead. If there is any trace of a signal with the key up it is because the power lines are radiating. In any event, no trouble at all on this score has been experienced. And the primary keying works beautifully, as all who have used it will testify. At first, very loud clicks were experienced in the broadcast receiver in the house (no clicks were noticed on the air) because of the spark at the key. A simple filter, consisting of two chokes of 100 turns of No. 18 d.c.c. on a $\frac{1}{2}$ " dowel and two $0.05\text{-}\mu\text{fd}$ condensers, eliminated every trace of clicks. The only click noticed now is when the transmitter is turned on and off, and we're too lazy to fix that.

Another thing noticed that might be of interest, is the way the filament voltage acts. When the set is keyed, the lights blink somewhat, and it was expected that the filament voltage would be dropping in accordance. But to our surprise, it was increasing slightly! The explanation was immediately forthcoming. The power line is a three-wire system, 110 volts each side of a common wire. The filaments are all supplied from one branch, and the plates from the other. As a result, when the additional current of the plate supplies flows through the common wire (in the opposite direction to the current supplying the filaments) the total resultant current in this leg is lowered, and would not become greater until the plate supplies took over twice the current the filament transformers take. With the lowered current, there is a lowered drop, and consequent rise in voltage. This would not happen, of course, if the three-wire system were not available. Unfortunately, no simple remedy for poor regulation with a two-wire line is offered.

In conclusion, let us say that this has been written only as a suggestion of one type of construction that can be followed in building a transmitter. We think the thing has merit in that it is a way of dressing up a bread-board layout to the point where it doesn't look so bad. And the exciter unit, including the RK20, would make a nice combination 'phone-c.w. rig, utilizing suppressor-grid modulation.

A Laboratory-Type Beat-Frequency Audio Oscillator and R.F. Signal Generator

Constructional Details for the Advanced Amateur

By Clinton B. DeSoto,* W1C8D

Part I—The Beat-Frequency Oscillator**

THE nearer the ham shack approaches to the attributes of a well-equipped laboratory, the larger the enjoyment coefficient of the operator, the higher the operating standards, and the greater the potential and actual value of the ham station as an experimental enterprise. Like any other plant or institution, the amateur station almost necessarily comprises certain pieces of apparatus that are in themselves non-productive. In addition to the basic transmitter and receiver, there are frequency meters, monitors, modulation indicators, oscilloscopes, service checking instruments, and so on. The measure of the perfection of the average station, once a decent transmitter and receiver have been provided, is the extent and utility of this gear.

Two of the more elaborate items of equipment that are to be found only in the best-equipped ham stations, but are indispensable pieces of apparatus in even the most elementary developmental laboratory, are the signal generator and the beat-frequency audio oscillator. Neither of these devices is essentially a cheap piece of equipment. True, approaches to them are available at nominal sums. But anyone who has used the ordinary serviceman's test oscillator or the type of beat-frequency audio oscillator that contains one or two multi-purpose tubes will be well aware of the insurmountable deficiencies that these cheaper approaches to the problem possess. They are all right for their purpose—even an absorption-type wavemeter has its uses, although it cannot be substituted for a precision-type heterodyne frequency meter—but work of even moderate accuracy and reliability is impossible.

Now what if one gets ambitious, and looks in the catalogs of the purveyors of precision laboratory apparatus for such equipment? Two hundred—three hundred—four—five—six hundred dollars for each, the prices run. Few of us want to struggle along with that 10 in the final and give up a new kilowatt rig just to have a nice, shiny, new signal generator and b.f.o. Obviously, some

other approach to the problem is indicated. At least, that is the conclusion this writer reached back in July, 1934. The intervening months have

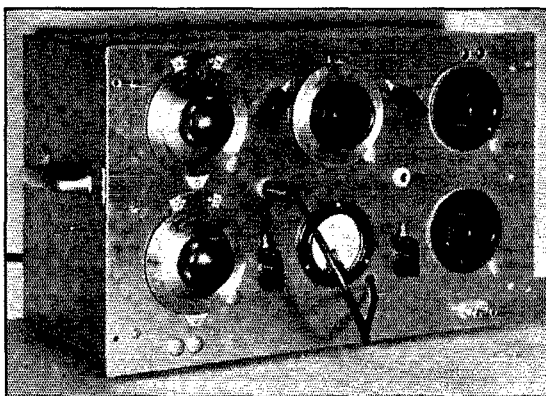

THE COMBINED BEAT-FREQUENCY AUDIO OSCILLATOR AND SIGNAL GENERATOR

The upper row of controls apply to the signal generator, *l. to r.*, main tuning control, band switch, auxiliary tuning control for selectivity measurements, etc., and the two attenuator controls. Below, in the same order, there is the b.f.o. main control, zero-beat control, milliammeter, output transfer switch, and output potentiometer. Output terminals for both units are on the right-hand side of the panel, top and bottom.

been intermittently occupied with seeking a realization of that objective.

The result is shown in the photographs. It represents a combined signal generator and beat-frequency audio oscillator, which can be used individually or collectively, according to the job at hand. The signal generator has an average maximum output of one-half volt across a relatively constant impedance of 200 ohms to the receiver input terminals over a frequency range of 150 to about 40,000 kc., in five overlapping ranges, with a stable modulation capability of 60 per cent and provision for 100 per cent modulation. The b.f.o. has a range of from less than 1 cycle to about 10,000 cycles, with a reasonably open scale, and an average output of 25 volts (modification in design could provide several times this value, if required), controllable in 0.1-volt steps from zero without auxiliary voltage dividers.

The entire unit, with the exception of the

* Assistant Secretary, A.R.R.L.

** In two parts, the second will appear in an early issue.

power supply, is contained in a General Radio unit panel assembly, including a 661-A panel, 661-K end- and base-plate assembly, and 661-R dust cover. (The power supply matches this type of construction, as well, and it has been found uniquely satisfactory for this purpose; the supply, which provides auxiliary variable voltages to

tional type "N" 270° tuning dial has an integral insulated shaft coupling and the zero-beat adjustment is made via a bakelite shaft, thus preserving the isolation of this unit.

The circuit used in the oscillators, it will be seen, is of the self-compensating pentode type with inductive coupling, providing dynamic fre-

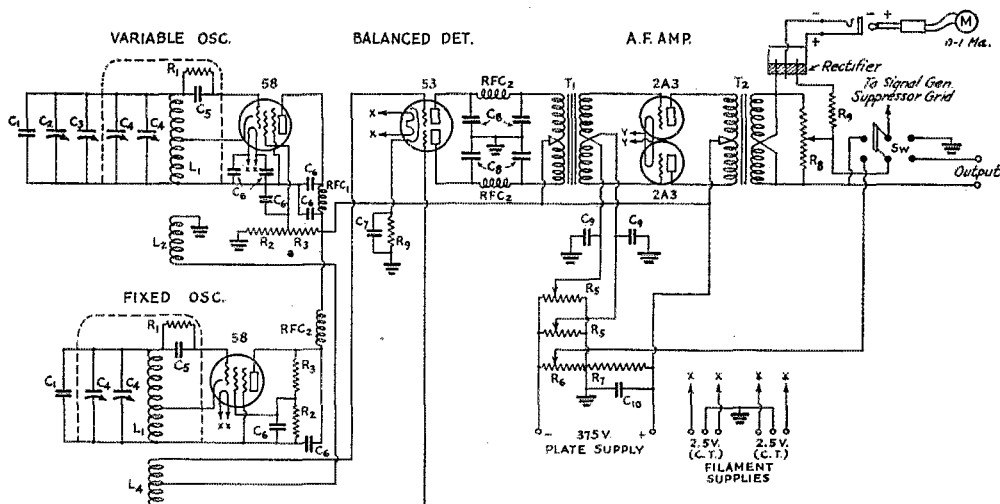

FIG. 1.—CIRCUIT DIAGRAM OF THE BEAT-FREQUENCY AUDIO OSCILLATOR

- C₁—0.03- μ fd. mica condensers (Cornell-Dubilier 9-12030).
- C₂—900- μ fd. variable condenser (see text) (General Radio 539-X).
- C₃—35- μ fd. midget variable condenser (Hammarlund MC-35-S).
- C₄—100- μ fd. air trimmer condensers (National dual i. f. units).
- C₅—500- μ fd. midget mica fixed condensers.
- C₆—0.1- μ fd. can-type paper by-pass condensers.
- C₇—25- μ fd. 25-v. electrolytic condenser.
- C₈—250- μ fd. midget mica fixed condensers.

- C₉—25- μ fd. 100-v. electrolytic condensers.
- C₁₀—16- μ fd. 450-v. electrolytic condenser.
- R₁—50,000-ohm $\frac{1}{2}$ -watt fixed resistors.
- R₂—20,000-ohm 1-watt fixed resistors.
- R₃—20,000-ohm 2-watt fixed resistors.
- R₄—5,000-ohm $\frac{1}{2}$ -watt fixed resistor.
- R₅—1500-ohm 25-watt potentiometers (Ohmite 0159).
- R₆—2000-ohm 30-watt semi-variable resistor (Ohmite 0377).
- R₇—10,000-ohm 30-watt fixed resistor.

- R₈—1000-ohm heavy-duty potentiometer (General Radio 471-A).
- R₉—50,000-ohm precision fixed resistor.
- L₁—600- μ h. oscillator inductances (see text).
- L₂—150-turn coupling coil (see text).
- L₃—20-turn coupling coil (see text).
- RFC₁—85-mh. r. f. chokes.
- RFC₂—25-mh. shielded r. f. chokes.
- T₁—Push-pull input transformer (Kenyon KA22).
- T₂—Push-pull output transformer (Kenyon 2A3MD).
- SW—Double-throw double-pole switch (General Radio 339-B).

facilitate receiver checking, has been previously described in QST.¹)

THE AUDIO B.F.O.

The beat-frequency oscillator occupies the lower half of the assembly. The mechanical layout is shown in the photographs, the circuit diagram in Fig. 1. In order, the stages are: high-output variable oscillator, low-output fixed oscillator, balanced detector, and power output push-pull amplifier.

As is evident in the illustrations, all parts associated with the oscillator circuits are mounted on a special sub-base made of $\frac{1}{8}$ -inch aluminum. This sub-base is attached to the main chassis by four mounting pillars, three of which are insulated to eliminate stray reactive branches. The Na-

frequency compensation but not electron-coupling. It was found that the conventional electron-coupled circuit, no matter how carefully handled, produced objectionable harmonic transmission. The system used is, for all practical purposes, fully as stable, since the compensating effect derived from supplying the screen grid through a voltage divider is utilized; at the same time, harmonic transfer is negligible and a coupling method is enabled that is simple and non-critical.

A fixed-oscillator frequency of about 110 kc. is used. If a suitable method of direct calibration is available, this frequency is not critical; it should be precisely 110 kc., however, if the calibration method later to be described is employed. Identical coils, especially made by the F. W. Sickles Co. (sample No. 3669), are used in both oscillators. They are of 600 millihenries inductance,

¹ Exp. Section, p. 44, December, 1934, QST.

tapped at approximately $\frac{1}{2}$, bank-wound on 1-inch diameter special bakelite tubing having a high crystalline content. After winding, the coils were baked and thoroughly impregnated, making them almost entirely non-hygroscopic.

Coupling to the detector is provided by means of single-layer coils wound on $1\frac{1}{4}$ -inch diameter tubing mounted around the oscillator inductances. In the case of the variable oscillator, the coupling coil contains 150 turns of No. 32 d.s.c. magnet wire, close-wound. The fixed-frequency oscillator coupling coil consists of 20 turns of No. 26 d.s.c., spaced the diameter of the wire, center-tapped. This ratio is sufficient to provide the combination of strong signal and weak signal components essential for distortionless single-side-band detection.

The method of assembling the coil units is as follows: The oscillator inductances were first rigidly mounted to the heavy sub-base with four threaded mounting lugs. Around them were mounted the coupling coils, also with threaded lugs, fastened equally rigidly. After wiring to the sub-panel circuit elements (all securely fastened in place to safeguard against future variations of any sort) was completed, the National dual trimmer condensers were wired in position with self-supporting bus bar. Finally, the National shield can was placed around the assembly and top and bottom mounting screws snugly tightened all around. This assembly is reasonably economical, and at the same time leaves little to be desired from the standpoint of permanent electrical and mechanical stability.

The variable frequency oscillator has an imposing line-up of auxiliary shunt capacities. First there is the .003- μ f. parallel capacity, which also appears across the fixed oscillator. These condensers are of the fixed mica type, of selected accuracy, molded in low-loss non-hygroscopic natural bakelite, with especially low power factor; ordinary mica condensers are not suitable in this application. The dual National air trimmers are also common to both circuits. Next there is the Hammarlund MC-35-S zero-beat-adjustment condenser, which is panel-controlled; a condenser with a smaller capacity range and one at the same time capable of more rigid mounting might well be substituted. Finally, there is the main tuning condenser. This is a special condenser made by General Radio, designed for use in beat-frequency oscillator circuits, and ideal for that job. It is shaped to follow a logarithmic law through part

of the rotation and is linear the rest of the way. This provides something like $\frac{1}{2}$ of the dial for the frequencies below 1000 cycles, in contrast to the few degrees that ordinary straight-frequency-line condensers would give. The condenser itself is a beautiful mechanical job, and is practically immune to variations of any kind except those transmitted through the tuning control.

BALANCED DETECTOR

The outputs of the two oscillators are supplied to the input of a balanced detector, provided by

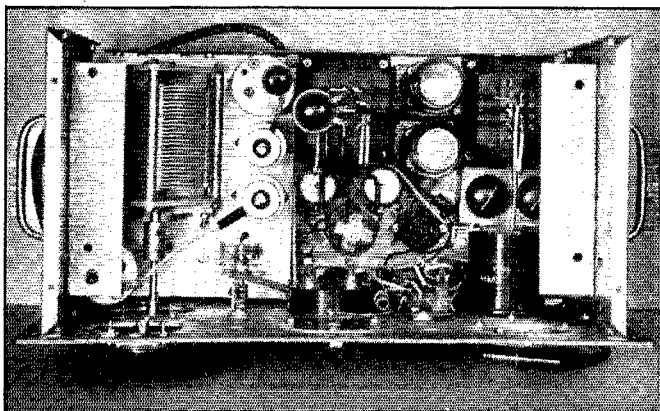

THE SIGNAL GENERATOR REMOVED FROM ITS SUPPORTING BRACKETS, THE BEAT-FREQUENCY AUDIO OSCILLATOR, OCCUPYING THE LOWER DECK, IS DISCLOSED

To the left is the sub-base supporting the fixed and variable oscillators. The 53 balanced detector, its low-pass plate filter and the input a.f. transformer are seen in the center. At the right center appears the socket into which the signal generator plugs, and the 2A3 balancing potentiometers. To the left of the heavy-duty output potentiometer can be seen the output transfer switch, copper-oxide instrument rectifier, meter jacks, and the milliammeter itself.

the dual triodes in the Type 53 tube, that of the fixed frequency oscillator in series and that of the variable oscillator in parallel. With this method of coupling there is no interaction between the oscillator circuits and consequently no "pulling" into step. The satisfactoriness of this coupling method is evident in the completed device; it is possible to adjust the output to less than one cycle per second with no tendency toward pulling, the only limitation being the mechanical problem occasioned by the microscopically minute difference percentages then involved, which make tuning hard.

The 53 is operated as a linear detector. The relatively high voltage ratio of the two oscillators enables sinusoidal output, and at the same time the rectified voltage is substantially independent of variations in the variable oscillator amplitude. This is a desirable characteristic, since even rather good design in the audio circuits will introduce sufficient frequency distortion to make the output voltage relatively non-linear, and, while it makes no essential difference in performance, too much variation is a nuisance.

(Continued on page 106)

To a Lady With Red Hair

A Story

By J. C. Flippin,* W4VT

ALL radio amateurs are not men, and this is a story about an amateur who was certainly not masculine; who was not even an operator; who knew nothing at all about antennas and the gear that excites them, yet was, nevertheless, a real amateur. It is the spirit that determines the measure of an amateur, and this spirit can exist wherever it pleases it to do so.

Ann Yardley wore her profusion of bronze-colored ringlets with the careless grace of the very young. Her eyes were grey, direct; the lashes that fringed them were black and very long, and Ann Yardley's mouth was a shade of surpassing loveliness, cosmetic artistry being what it is. The hands that held the booklet depicting modern console-type all-wave receivers for the well-appointed home were beautiful and wholly in keeping with the lady who was not yet an amateur, but who had everything that it takes. The impatient finality with which she now tossed the booklet aside indicated one of those traits associated with ladies who have red hair.

"What I want," she murmured, "is a very small one, like a book. I want it finished in china blue to match my boudoir, and it must get the foreign broadcasts clearly."

Ann's voice was a soft contralto of an appealing type which the expression of her eyes could reinforce with irresistible effect. The salesmen could not get their fast ones to work, but clung to the ropes, now and then smacking the canvas.

"The price doesn't matter," she said, hoping that this would make all things right. "Couldn't they make one, special, you know? Like this?" holding up two exquisite fingers six inches apart.

All the talk about the size of the chassis needed for various tubes meant nothing to her. Cabinet acoustics and speaker size meant very little more.

"I guess I'll just forget the whole idea," she thought, examining with commercial intentions the refined spider webs which were stockings. "Charge these," she said, "and these, too."

She whipped the dazzling town car deftly through the traffic, her expression serious.

"If Jug were only here he could tell me what kind to get," she thought. "But Jug won't be here until June, and June is a whole lifetime away."

The length of the time until June occupied her thoughts for two blocks.

"I know what — I'll write and ask him."

That night, resting her chin in her small hand, she wrote to Jug Southgate, who was an engineer

(well, anyway, he was studying it, and it was all the same, wasn't it?); Jug, who was tall and hard-boiled and decisive; who was the chief operator at the University amateur radio station; who would not talk about radio to her at all, and who therefore very probably knew all there was to know about it!

"Jug, dear — you are so smart, at least I think so, please tell me what kind of radio to buy that will get programs from anywhere, yet which I can, in my feeble way, jiggle. I want it to be finished in China blue to match my boudoir, and it must be small, Jug, like me. And if I want Barranquilla, or Caracas, or Rabat, let it be there, dear Jug, if I turn gadget 1 to 10 and turn gadget 2 to R. I want DX with a capital D and the X is for you.

— Ann"

* * *

This note lay in an A.C. text between the circle diagram of a synchronous condenser and the mathematical analysis of the effects on transmission line characteristics when field excitation is varied, acquiring three days age while Jug worried with schedules. Being an amateur, he assumed that by DX she really meant DX.

His reply was hurried, apparently, for it was written on the blank side of a piece of chart torn from a recording wattmeter.

"Ordered yesterday latest communication type receiver to be shipped here for test. Will send it along when I've tried it out alongside a similar one we have here at the station. Receiver is black crackle finish, like the business end of a dog's nose, only it is not wet. This is a birthday present. Could use the X right now. How long is it until June? Don't say it.

— Jug"

* * *

In due time the receiver arrived, the letter accompanying it being filled with directions that were explicit. Southgate never left any loose ends.

Ann studied the receiver with consternation. It was as big as ten books, encyclopedia volumes at that. It was black and heavy as lead. She looked at the R meter and folded her hands resignedly.

"It looks like some great engine looking sadly from its one glass eye for its wandering carburetor," she said to the maid. "Look, Nora! What is it?"

Nora looked. "It match me, not de room," she said, finally.

The service man who was summoned to install

* 3222 Choctaw Ave., Memphis, Tenn.

the receiver was an amateur. He examined it with enthusiasm, inside and out, spinning the dial happily.

"I am a ham," he said.

"He says he is a ham," said Ann, approaching the maid down the hall. "Pipe all hands on deck if he gets violent. In another minute he may be Napoleon."

The two stages of pre-selection ahead of the first detector gave the receiver ears like an Iroquois scouting party. It missed nothing. Japan, Rome, and all the rest came in with sustained strength and clarity, the R meter under the influence of the automatic volume control rolling lazily back and forth in highly amiable fashion. The console-type dynamic speaker that Jug had included had a three-inch voice coil. It did not fool around.

Ann was happy.

"Oh, it is wonderful!" she exclaimed. "Listen, Father! That's London! Isn't it clear?"

H. Carlton Yardley looked under his glasses, then over them, examining the receiver with only perfunctory interest. On an intensity scale it would have been about R1. He was chairman of the board of so many concerns he could not name them all without counting up. A radio to him was just something to turn off. He liked horses, and with horses high-frequency superheterodynes have little in common.

"How did you ever decide to get that kind of machine?" he asked, finally.

The lady raised an eyebrow.

"Jug sent it. It's nice."

"Harrumf!" said H. Carlton Yardley.

No communication type receiver can long endure short-wave broadcasts as a steady diet. Something else began to occupy Ann's grey-eyed attention: the pistol-shot key clicks of commercials rambling at high speed, the rich, 500-cycle voices of ship-to-shore stations; the discordant squawking and disconnected heterodynes of vast jumbles of amateur signals that the twist of the beat oscillator control turned into clear, ringing notes, variable from the highest pitches to the hoarsest bass by just spinning the dial an inch or two. Some sounded very, very fast; others were much slower.

"They must be sending something terribly interesting," Ann decided, looking critically at two hands which were poems, "for it is all so secretive in code."

"I must learn this code," she added, later, snapping off the femininely-attired reading lamp. "I can do it. Jug will be so proud of me!"

Ladies with red hair are persons of determination, not easily discouraged. Behind Ann's wide, grey eyes was a mind that was quick. She memorized the code practically over night. But interpreting it on the air was something else. Weeks passed and there was apparently no further progress. She worked so hard, for she was trying

so earnestly to please Jug! But when weeks passed without success, she became impatient and finally angry, both at herself and at Jug, for it did not seem fair, somehow, that he could do a thing that she could not do if she worked at it. She stopped writing to Jug in her diary, spiritually cutting herself adrift to fight it out alone, for she was a lady of spirit.

And then, one night, she recognized an "a," an "n," and a "d" all tied together! It happened so quickly that it took her breath, and she could only squeal faintly, her eyes stary with delight. Oh, Ecstasy! Leaping to her feet, she rushed madly to her door to tell someone—anyone—but discovering in dismay that she had on only her ear rings and bracelets and a few wispy nothings, she abandoned the idea at once and celebrated with only a little cheer. That night she wrote to Jug in her diary, and after that it was easier.

One cold afternoon in early spring, one of the pale blue envelopes addressed in Ann's handwriting appeared at the Sigma house. Jug got it as he was leaving headed for Machine Design. Behind him marched two freshmen, one carrying very carefully the drafting board, for it bore a plate of a locomotive valve gear. The other carried the instruments and T-square.

"Hope it's good news," said one freshman, loudly.

"If it's good news we won't have to come and get these, maybe," ventured the second.

Jug laughed and lit his pipe.

"Come and get them at three o'clock," he said, without turning his head. Then he tore open the envelope. A barely perceptible expression of shock passed across his face. He read it twice.

"Jug, dear," said Ann's upright, rolling script, "I have been keeping a secret from you, but I am simply bursting with it, and because I am simple and child-like, I must tell. I have learned the code, Jug, precious, and I have been copying the University's twenty-meter signals every afternoon. At least, I have been getting your call, but not so very much of the rest. Jug, send something to me Sunday the eighteenth at three o'clock my time, and don't get somebody else to do it, for my womanly intuition will know, and please, please don't forget, for I will die of disappointment!"

—Ann"

* * *

Southgate grunted something, and shoved the letter in his pocket. Only a week ago he had sent through a letter to all operators and to the Transmitting Staff cancelling until further written notice all 14-megacycle operating activity on Saturdays and Sundays. The press of traffic on the 3.5-megacycle trunks, two of which intersected at the University, combined with the originated traffic from the campus pick-up boxes, had the hook jammed over the week-ends,

(Continued on page 98)

Electron-Coupled vs. Crystal Transmitter Control

Practical Circuit and Operating Considerations for Frequency Flexibility

By Don H. Mix,* W1TS

SINCE the introduction of crystal control, its application to amateur transmitters has progressed constantly until it is now estimated that eighty per cent of all amateur transmitters operating below 30 megacycles are frequency-controlled by this method. Possibly the other twenty per cent would use crystal control if circumstances permitted.

The reasons for the universal acceptance of crystal control in amateur transmitters are obvious. The frequency stability of transmitters using crystal control is essentially independent of transmitter adjustment. The operator may tune the transmitter up, without auxiliary frequency checking apparatus, with reasonable confidence that the frequency of the transmitted signal will be within a hundred cycles or so of the value marked on the crystal or of one of its harmonics; assuming, of course, that no mistake is made in selecting the proper harmonic. He may also toss 15 henrys or so of choke and a couple of microfarads of condenser into the power supply filter and be reasonably certain of obtaining a note which will comply with regulations, unless he purposely sets out to violate the law by using "filter" combinations to obtain "that distinctive note." (If the present tendency in this direction continues, a swing-back to p.d.c. may be necessary to secure a note distinctive from others.) Crystal control is much more tolerant in this respect than self-controlled systems.

However, it cannot be said, by any means, that crystal control is wholly ideal. The fact that it will hold the transmitted signal to a single frequency, whether one wants to or not, is its greatest disadvantage when complete frequency flexibility is desired. Again, there have probably been as many occasions for spitting at the cat in attempting to get a cranky crystal to oscillate as in obtaining satisfactory stability with a self-controlled oscillator.

Close personal contact with operating conditions has developed the desire for complete flexibility in transmitter frequency adjustment which even a drawer-ful of crystals could not entirely satisfy. Although something may be and has been said of the logic in tuning the receiver over the entire band after a CQ, or at least listening in different sections of the band in alternation, there are certain practical obstacles which may

be difficult to overcome in popularizing the idea. Because the number of stations operating at any one time has increased greatly within recent years and because receivers have now been developed with extreme selectivity which makes it possible to search thoroughly rather than just skim over the band picking out only the R9 signals, it is hardly practicable to tune over any range greater than 100 kc. at the most and do justice to the job. During a recent ORS party, better than seven contacts per hour were averaged for six consecutive hours and yet no more than the lowest 50 kc. portion of the 3.5-mc. band was covered with a receiver which was not of the ultra-selective type. Compared with conditions a few years ago, each 50 kc. to-day is approximately equivalent in usefulness to the entire band width of that time, with proper equipment and operation.

However desirable this narrow-band practice may be, it does not take care of the case where a transmitting operator, either by signal or position in the band in which he is operating, indicates that he will listen for replies in a given slice of the spectrum. What if he intends to listen from 7000 to 7100 kc., while our own transmitter is tied down to a frequency of 7200 kc. and we desire to communicate with that particular station? Of course, we might wait until the transmitting station indicated that he would listen near our frequency; but, depending upon the transmitting operator's particular interests, it might be a long and fruitless wait. In a case of this sort, shifting the transmitter frequency is the only logical solution. Much less QRM will be caused by shifting transmitter frequency than by long and frequent calling at some frequency remote from the most logical section of the band for the other operator to listen.

Perhaps one of the most useful ways in which the transmitter with a continuously variable frequency range may be used is in multi-way QSO's and net operation. The frequency of the transmitter may be immediately shifted to that of one or more others making break-in operation possible between several stations and reducing QRM. Another case in which a completely flexible frequency adjustment may be very useful is best illustrated by an example. Two other stations, A and B, are communicating. It is desired to contact station A on conclusion to his QSO

* A.R.R.L. Technical Information Service.

with station B. The transmitter may be tuned to the frequency of station B and station A may be called immediately upon conclusion of the QSO with reasonable certainty of raising the desired station, since his receiver will be already tuned to the right frequency. Several other unusual stunts may be worked in communicating readily with a desired station. Of course, a little intelligence and discretion must be used in performing maneuvers of this sort and it is easily possible to abuse the advantage greatly. Pirating a DX contact is one way of becoming mighty unpopular. The oscillator and all circuits but the final amplifier and antenna may be tuned up beforehand without causing interference. Even these two latter adjustments may be made immediately if the settings of the proper tuning positions are tabulated and it is not necessary to apply plate voltage to the final amplifier. The transmitted signal certainly should not be "zwooped" through the band in changing frequency.

Last but not necessarily least, the self-controlled oscillator may be depended upon completely to oscillate strongly whenever plate voltage is applied. Where one crystal out of ten may respond to rapid keying, no trouble on this score is experienced with the self-controlled oscillator.

CONCERNING STABILITY

Complete transmitter frequency coverage dictates the use of some form of self-controlled oscillator to replace the crystal oscillator. While the electron-coupled oscillator is undoubtedly superior to other types, it is far from being a crystal-controlled oscillator in every characteristic, and requires just as much attention in construction and adjustment as any other type of self-controlled oscillator if satisfactory stability and signal character are to be obtained. The erroneous idea which some entertain that the performance of a crystal oscillator may be duplicated by wiring up a four-or-five-element tube in the well-known electron-coupled circuit is demonstrated by the weird signals often heard emanating from transmitters of this type. On the other hand, with proper care in construction and adjustment, crystal oscillator performance may be approached so that at least ninety per cent of the observers will be unable to detect the difference.

A considerable amount of time was spent in determining the factors which affected the stability and signal characteristics and the proper treatment of these factors to obtain desired results. A good monitor is an absolute necessity.

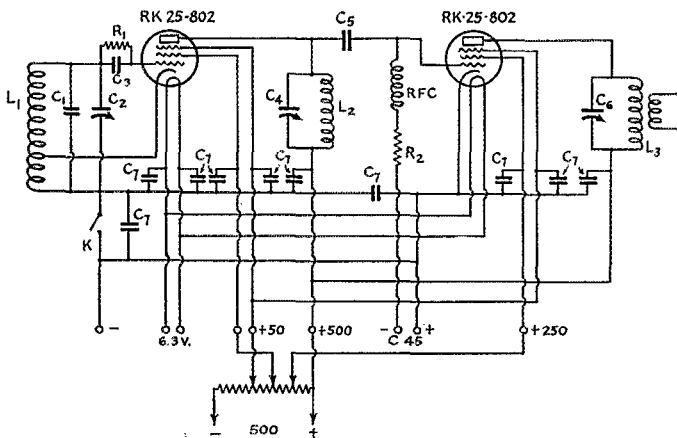

FIG. 1—CIRCUIT OF THE ELECTRON-COUPLED EXCITER UNIT

- R₁—20,000 ohms.
- R₂—50,000 ohms.
- C₁—450- μ fd. mica.
- C₂—250- μ fd.
- C₃—250- μ fd. mica.
- C₄—100- μ fd.
- C₅—70- μ fd. mica.
- C₆—100- μ fd.
- C₇—0.002- μ fd. or larger, mica.
- L₁—10 t. No. 18 d.c.c. or enam. 1½ inches diameter, winding length ⅞ inch, tapped at third turn from ground end. (3.5 mc.)
- L₂—3.5 mc.—30 t. No. 24 d.s.c. 1½ inches diameter, turns spaced diameter of wire.
- L₃—3.5 mc. Same as L₂.
- 7 mc.—22 t. No. 18 d.c.c. 1½ inches diameter.
- 14 mc.—7 t. No. 18 d.c.c. 1½ inches diameter, turns spaced diameter of wire.
- RFC—2.5 mh. r.f. choke (National R-100 or Hammarlund receiving type).

A very well-shielded and stable super-heterodyne receiver may be used to check stability, but will get the operator into plenty of trouble if it is used for frequency checking before the tuning of the transmitter has been definitely checked in terms of receiver setting. The operator will find a receiver tuning range crowded with a confusing sequence of beat notes until experience and check with a good monitor show which ones may be depended upon for calibration. If the transmitter is to be of fairly high power, it will be advisable also to check the frequency stability of the monitor or receiver with changes in line voltage. A receiver which had always appeared perfectly stable in ordinary service indicated a bad keying chirp until a test with an electric toaster and waffle iron intermittently connected to the line showed that the chirp was caused entirely by change in receiver oscillator frequency when transmitter keying varied the line load and receiver supply voltage.

With monitoring equipment check and operating, the oscillator circuit shown in the diagram was set up with an 802 or RK23 tube. First tests

(Continued on page 94)

VK-ZL 1935 DX Contest Results

By R. H. Cunningham, VK3ML*

THE success of a contest can be judged by the number of entrants; the more logs returned, the bigger the show. If this is true, we have every right to say that this contest was even better than the Centenary competition of 1934. October, 1935, aided by good radio conditions, attracted more stations than ever. Aided by support from ZL, the VK's were able to offer the DX stations more contacts. Judging by the comments from the overseas stations, there must have been enough to make everybody happy. The N.Z.A.R.T. and the Victorian Division of the W.I.A. wish to congratulate the many overseas Societies that took our Contest to heart and gave it the support and publicity we so very much appreciate.

Our heartiest congratulations are extended to the top scorers in all parts of the globe. VK3EG obtained his great score on 7 and 14 mc. only. VK4BB after making 188 contacts in 35 countries added a cool 61 contacts on 28 mc. VK3EG worked 50 countries, made W.A.C. in 6 hours 23 minutes and W.B.E. in 80 minutes. VK2LZ made 80 28 mc. contacts. VK3PG worked 17 countries with the usual 3.5 watts input. ZL2CI did a great job with 100 watts and a 7 tube s.s.s. 37 countries made up his multiplier. ZL1GX made 13 contacts on 28 mc. as well as 37 countries on other bands.

W9TB with his P.P. parallel 860's blocked many a second detector and turned in a nice 4800 points. W6KRI, who develops 1 kw. in his P.A., marked up the best W total of 5040 points. W5EHM did splendidly with 3187 points. W5QL made 22 28 mc. contacts and topped the "W" 28 mc. section. W5WG came a good third in that class with 21 28 mc. QSO's. ZL4BT made both W.A.C. and W.B.E. within 5 hours.

D4ARR worked 10 ZL-VK districts and made 3 28 mc. contacts. F8EB worked 10 districts also, all on 14 mc. G6CJ claimed top "G" score with 2220 points. PA0AZ worked 10 districts with 50 watts into a zepp. OA4J was a delight to contact for many VK's who still wanted South America for the coveted W.A.C. VE5BI made a fine impression with his 400 watts and a good fist. VU7FY knocked up a rattling score of 2730 with 10 watts input! VS6AX "pipped" VS6AH by ONE district and no more! Both stations made 72 contacts. ZS2X stuck to 7 and 14 mc. whilst ZS1H rotated the 28 mc. beam all the time.

Due to a misunderstanding that arose due to a too loosely worded contest rule, which related to a 500 point bonus for 28 mc., the Committee resolved that in the interests of the true ham spirit,

* Manager W.I.A.N.Z.A.R.T. Contest Committee.

a compromise must be effected that would be equally fair to all parties. Consequently two separate awards were drawn up and will be made by means of two certificates, one for the man who set out to work a large number of countries and an occasional 28 mc. contact, the other for the one who concentrated on 28 mc. with the understanding that he would receive 500 points for each contact. This means that the 28 mc. man is competing with others in the same section and the all-band man with those that come under his class only. This arrangement applies in all countries.

Many contacts had to be crossed out in the cross-check because of serial numbers not being identical in both cases. Contests which depend on serial numbers as the exchanged message require these numbers to be *accurately* transmitted and received. This is the operators' pigeon and no one else's.

VK3EG's award of £1/1/- to the station that made W.B.E. in the shortest space of time went to VK2EO who worked the British Empire by 0410 on the 6th of October. Congratulations, 2EO! Entries in the Handicap Section were very few. All logs bearing power inputs less than 50 watts were sorted and worked out. Under the rule of 500 points for each 28-mc. contact, VK4GK won this section with a score of 540 points per watt. Under the other meaning of the rule, VK3KX returned a figure of 455 points per watt. Special mention must be made of the ultra fine coöperation tendered by the D.A.S.D. This Society made use of the contest as a local affair as well, special certificate awards being made to the winners of the various Districts as well as a range of prizes (tubes, etc.) in certain cases.

Under the Receiving Section of the Contest Eric W. Trebilcock, B.E.R.S. 195, of Australia made first place with 20,640 points. The scores of the leading stations in this VK-ZL contest were transmitted by radio by VK3EG to W8OE, who relayed them to Hartford via W8EMW-W1MK. Complete results were later received by mail.

United States Scores:			
		W3EVT	1229
		W3SI	1152
W1CMX	624	W3BES	720
W1GSH	72	W3EVW	675
W1APA	12	W3ENX	195
W1ZI	12	W3FKK	189
W1BBN	9	W3DBD	180
W1FFP	3	W3CZO	72
		W3AWH	27
		W3EJO	54
W2BYP	1566		
W2DZA	716		
W2A1W	525	W4AJB	1550
W2HHF	462	W4AJY	876
W2BSR	450		
W2GVZ	36	W5EHM	3187
W2CC	12	W5QL	3017

W5EBT	2280	W6GRX	7720	VK3HL	84	D4DTC	48	PAØRN	90
W5WG	941	W6DIO	10148	VK6CP	72	D4LGM	30	PAØWHS	3
W5AFV	794	W6EPZ	4510	VK3KR	60	D4MLL	27		
W5EUL	135	W6RH	3096	VK2PV	48	D4BEC	24	PK1MO	702
W5BDW	72	W6CIS	1716	VK6PK	48	D4BUB	12	PK1WB	270
W5ARO	72	W7AVV	10744	VK4UR	36	D4HAF	12	PK2MP	648
		W9TB	11350	VK3TL	27	D4OYT	3	PK3LC	3810
W6KRI	5040	W9IJ	6830	VK4CG	27			PK3ST	336
W6CEM	2670	W9FM	6660	VK5MX	6	EA4AO	3120	PK4RM	300
W6FZL	2670	W9BQM	2090						
W6GRX	2220	W9GHN	878	ZL2CI	23099	EI9G	144	SP1LM	72
W6KBD	1560			ZL1DV	19680	EI4G	3		
W6DIO	1148	Australian and New Zealand Scores:		ZL1GX	19400			SM2VP	60
W6TT	918			ZLABQ	17424	GI6YW	864		
W6TI	840			ZL2KK	16512			TI2EA	210.
W6CIS	716	VK3EG	42150	ZL3BJ	16330	ES7C	12		
W6EPZ	710	VK3MR	23750	ZL2GN	11160	F8EB	2250	VE5BI	2070
W6HVU	600	VK3KK	21812	ZL2QT	4650	F8VP	554	VE3WA	216
W6RH	595	VK7RC	21384	ZL3AJ	3065	F8TQ	552	VE1EP	144
W6GTM	165	VK4BB	20240	ZL1FE	2688	F8GV	234	VE4IG	108
W6KJK	96	VK5FM	19982	ZL3AB	1938	F8EO	135	VE1HG	72
W6JH	72	VK4AP	15206	ZL2QM	1365	F3LE	103	VE2HG	3
W6IZE	72	VK2EO	14175	ZL2LE	900	F8RR	48		
W6AM	36	VK7JB	11678	ZL1AR	608			VQ8AF	156
W6DPK	9	VK2HF	11600	ZL4BT	405	G6CJ	2220		
W8BVX	3	VK2OJ	10725	ZL2OD	364	G5YG	1770	VS2AG	288
W6LVQ	3	VK6FO	9275	ZL3JX	144	G2PL	1400	VS6AH	2660
		VK2AS	9236	ZL2FA	45	G6RB	1200	VS6AX	2376
W7DL	2190	VK2DA	6615	ZL2GQ	34	G2YL	506	VS7RP	36
W7AVV	1244	VK2ZC	6472	ZL3CU	27	G2HG	506		
W7DBY	105	VK4GK	5516	ZL3CP	12	G2OI	252	VR2OZ	120
		VK2LZ	5180			G2ZQ	225		
W8ZY	2460	VK3CP	4752	VK-ZL "28 mc. Group" Scores (500 points for each 28 mc. contact):		G5WG	216	VU7FY	2730
W8JIN	1410	VK5LD	4368			G6XN	210	VU2EB	1770
W8LIR	756	VK4EI	4340			G6LK	196	VU2LJ	644
W8AAT	144	VK6SA	4217			G5BP	180	X1AY	1256
W8DGP	48	VK2GM	4161			G5RV	84		
W8APB	24	VK3DP	3240	VK4BB	48740	G2WQ	48	KU3ST	12
W8HGA	12	VK3HK	3009	VK3EG	42150	G5JU	30	YM4ZO	794
W8DWW	12	VK5KL	2823	VK4AP	36206	G5JM	12		
W8CBI	3	VK2HZ	2372	VK2LZ	36180			YL2BB	360
		VK3XQ	2304	VK3KK	25312	HB9AT	2370		
W9TB	4800	VK5DW	2268	VK3MR	24250			ZS2X	9541
W9IJ	3810	VK2OC	2001	VK7RC	21384	J2HJ	1172	ZS1H	503
W9FM	2660	VK5RT	1785	VK5FM	19982	J2LK	456	ZT5Z	285
W9AEH	1755	VK2EL	1709	VK2HF	15100			ZU5U	36
W9GHN	878	VK6KZ	1709	VK4EI	14840	KA1CM	135		
W9BQM	590	VK3PG	1275	VK2EO	14175			"G" and Foreign "28 mc. Group" Scores (500 points for each 28 mc. contact)	
W9ADN	525	VK2YL	1260	VK4GK	13516	K5AZ	2295		
W9BTW	420	VK3WH	1248	VK7BJ	13178				
W9PST	324	VK5ZX	1096	VK2HZ	12372	K6AUQ	1350		
W9CP	234	VK6LJ	1008	VK2AS	11236				
W9LW	180	VK3VW	972			LU1CH	1365	D4ARR	5070
W9NNZ	96	VK5MZ	972	ZL1GX	24900			D4GWF	1144
W9CCV	84	VK3DM	882	ZL1AR	608	LY1AG	12	D4KJPJ	1524
W9TIZ	84	VK3GC	858			LY1J	384	D4ZMK	503
W9RSE	60	VK3UW	756	British and Foreign Scores:		NY2AB	1269	G6LK	2096
W9DQD	48	VK2DR	735			OA4J	2106	G2PL	1400
W9MRW	36	VK6MN	528			CR7MB	225	G2YL	1006
W9UAZ	12	VK3YP	512	CR8AA	1593	OH3NP	63	G2HG	1006
W9LQ	3	VK5WR	504						
		VK3BQ	503	CX1CG	1431	OK2LO	3	J2HJ	13672
U. S. "28 mc. Group" Scores (500 points for each 28 mc. contact):		VK3ZW	399			OK2OP	2220	J2LK	2956
		VK3HD	378	D4ARR	4070			ON4AU	4081
		VK2EG	360	D4CSA	1410	ON4RX	999	VS6AH	2660
		VK3HG	315	D4GAD	660	ON4AU	581		
W2DZA	1216	VK3RJ	252	D4GWF	644	OZ9Q	1140	VU2LJ	644
W3EVT	1729	VK5RX	252	D4KPJ	524	OZ2M	3		
W4AJY	1878	VK3RJ	216	D4DZMK	503	OZ7KG	120	X1AY	1256
W4AJX	1550	VK3OW	192	D4MNL	408				
W5QL	12020	VK2KJ	162	D4JVB	252				
W5WG	10941	VK6DQ	135	D4LWN	231	PAØAZ	1740	YM4ZO	794
W5EHM	2670	VK3ZC	120	D4LYN	120	PAØUN	1269		
W5AFV	1294	VK6JE	90	D4GOF	72	PAØJMW	552	ZS1H	2530

With the Affiliated Clubs

Three-Way Radio Club Meeting

ON THE night of January 9th members of the Mobile Amateur Radio Club gathered at their club station, W4CIQ, members of the Montgomery Radio Club assembled at W4DGY, and the Birmingham Amateur Radio Club gathered at W4DID, for the first Alabama three-way radio club meeting. All three stations were working in the 1.75-mc. 'phone band. The following amateurs were present and took part in the gabfest: At Mobile—W4GP, W4CNI, W4CQW, W4CRF, W4CRR, W4CRY, W4DHG, W4DJG, W4OA, W4DMG, M. J. McDermott, J. C. Whacker. At Montgomery—W4ANT, W4AEZ, W4DPX, W4DVJ, W4DGY, Bill Britton. At Birmingham—W4DGM, W4CNY, W4DUK, W4DGS, W4APU, W4ARR, W4AJP, W4ARJ, W4AAC, W4AAQ, W4BIT, W4DID, C. D. Norris.

The contacts were very successful and various matters concerning club activities and club relations were discussed, and personal comments, renewal of old friendships and a general feeling of good spirit resulted in a most interesting meeting. Where clubs are separated by great distances such joint meetings by radio are a particularly fine thing and create better understanding between clubs and a new interest in club work. The Alabama boys are already planning for more such get-togethers.

Highway Markers

The Miller (South Dakota) Amateur Radio Club has put up highway markers on the principal routes through Miller inviting traveling amateurs to stop and visit the local hams. These markers carry an A.R.R.L. emblem and the calls of active club members, and have resulted in numerous amateurs dropping in on the Miller gang. This seems like an excellent idea, although we must caution any club contemplating such markers to first obtain permission from the state or city highway department.

W9XAZ—31,600 kc.

The Milwaukee Radio Amateurs' Club calls attention to its ham program over W9XAZ (31,600 kc.) every Saturday from 3:00 to 4:00 p.m. CST. Amateurs hearing these programs are requested to report same to the club in care of W9XAZ, *The Milwaukee Journal*, Milwaukee, Wis.

Get Acquainted!

Clubs are excellent places to get acquainted with radio amateurs and to participate in interesting discussions on our hobby. At A.R.R.L.

headquarters there are recorded the addresses of the several hundred amateur radio clubs affiliated with the League, their places and times of meetings. Why not drop in at your local club and "meet the gang"? Address the Communications Manager (enclosing 3¢ stamp, please) for data on affiliated clubs in your vicinity.

Miscellany

1936 officers Astoria (L. I.) Radio Club: W2BAA, pres.; W2AIQ, vice-pres.; W2EVA, secy-treas. . . . The Houston Amateur Radio Club is sponsor of a contest the two weeks starting April 4th. Attendance at club meetings will count appreciably in the final score. The number of states worked will be used for a multiplier. Any clubs desiring complete details may obtain same by addressing the club at Box 707, Houston, Texas. . . . A good time was had by all despite bad weather at the Western Amateur Club's hamfest held in Granite, Okla., on February 2nd. . . . The Central Illinois Radio Club (Bloomington, Ill.) announces its 1936 officers: W9CFV, pres.; W9MIN, vice-pres.; W9BPU, treas.; W9TAQ, secy. . . . The Rockomeka Amateur Radio Club (Livermore Falls, Maine) reports a club QSO contest in progress, and new officers: W1AUR, pres.; W1AHY, vice-pres.; W1ALO, secy. . . . W8LGO was winner of the transmitter offered by the Utica (N. Y.) Amateur Radio Club in a recent contest. . . . The Goshen (Indiana) Amateur Radio Club celebrated its 2nd anniversary with a party for the families of its members; new officers for 1936 were installed: W9TRN, pres.; W9PEU, vice-pres.; W9VNO, secy.; W9VNM, treas. . . . The Santa Clara County Amateur Radio Association (San Jose, Calif.) has undergone a complete reorganization; the new constitution calls for 100% membership in A.R.R.L. Only licensed amateurs, who are actively operating stations, are invited to membership in the Association. The formation of an auxiliary organization, which would admit new amateurs, S.W.L.'s, etc., is being considered. . . .

Activity is high at the Cambridge (Ohio) Radio Club; current matters under discussion include the advisability of an inter-city club and possibility of building a club house and station; profits realized from a recent hamfest are sufficient to build a station and club shack, although such action is still uncertain. . . . The Frontier Radio Club of Windsor, Ontario, announces plans to hold an extra meeting per month—over the air, possibly on 28-mc. 'phone; the club's officers, elected in November, 1935, when a thorough re-

(Continued on page 92)

A 5- and 10-Meter Converter

A Superhet Input Unit Using Acorn Tubes for 28 and 56 mc.

By John J. Long, Jr.,* W8ABX

THE tremendous activity on 28 mc. and the steady improvement on the part of 56-mc. workers in the work of stabilizing their transmitters has made the possession of a good receiver for these frequencies highly desirable. This converter unit is particularly suitable for use with the conventional "all-wave" band-switching superhet receiver. A high order of performance is made possible by the use of acorn tubes. The 954 pentode is used for the input mixer and the 955 for the oscillator. The circuit is given in Fig. 1.

As in any equipment designed for operation on the very high frequencies, it is important to give the layout very careful consideration in order to

allow short leads and a compact assembly. Another important fundamental is to follow carefully the directions given by the tube manufacturer concerning the mounting of the 954, in particular. In my own receiver, a sheet of thin mica is used to insulate the terminal nuts from the chassis and in this way small by-pass condensers are formed right at the terminals. An excellent idea, however, would be to use the new

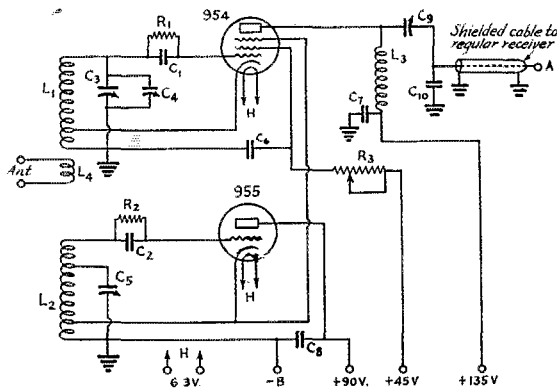

FIG. 1—CIRCUIT OF THE CONVERTER UNIT

- C₁, C₂—100- μ fd. midget condensers.
- C₃, C₆—25- μ fd. variable condensers ganged. Condensers of 15 μ fd. would cover the ham bands, but additional frequency coverage is usually desired.
- C₄—15- μ fd. midget variable.
- C₅, C₇, C₈—0.02- μ fd. fixed condensers.
- C₉—100- μ fd. mica trimmer condenser.
- C₁₀—0.002- μ fd. fixed.
- R₁—2 to 10 megohms—5 megs usually suitable.
- R₂—25,000-ohm half-watt resistor.
- R₃—1-megohm variable resistor.
- L₁—Approximately eight turns of No. 18 wire $\frac{5}{8}$ -inch diameter with turns spaced diameter of wire. Tap on second turn from grounded end.
- L₂—Same as L₁ except that C₅ is tapped two turns from grid end. These coils are for 28 mc. The 56-mc. coils should have four similar turns with double the turn spacing. These dimensions may not hold good in all cases because of the influence of stray capacities.
- L₃—700-micro-henry coil of the type used in i.f. circuits. One coil of an old i.f. transformer will serve. It is assumed that the receiver serving as the i.f. amplifier will be operated on 540 kc. Smaller coils, possibly of the single-layer type, would be used for higher i.f. frequencies.
- L₄—Single turn around L₁.

* 63 Sonora Parkway, Brighton, N. Y.

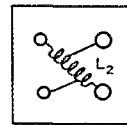
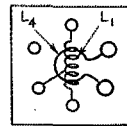
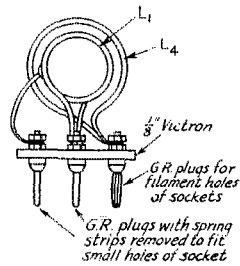
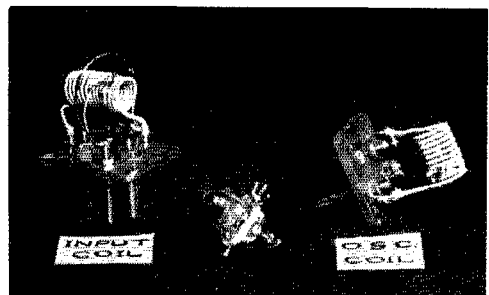

FIG. 2—DETAILS OF THE COIL CONSTRUCTION



THE 28-MC. COILS USED IN THE ORIGINAL RECEIVER

National XMA sockets in which these considerations are provided for.

At W8ABX, this converter unit is used for all bands with appropriate plug-in coils. It is used with a standard superhet broadcast receiver. It

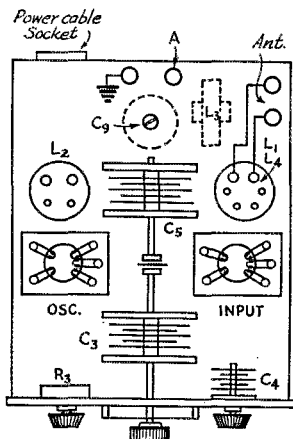
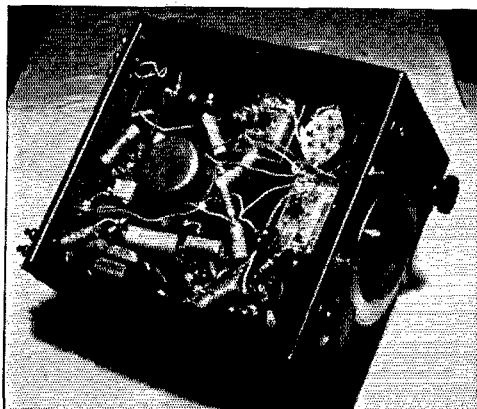

FIG. 3—A SUGGESTED CHASSIS LAY-OUT

is possible to operate the input tube in an oscillating condition for c.w. reception. This scheme is not very satisfactory, however, and a regular beat oscillator is strongly recommended.

Plug-in coils for the ham bands are the standard four- and six-prong type fitting Isolantite



A VIEW OF THE ORIGINAL EXPERIMENTAL RECEIVER IN WHICH THE CIRCUIT WAS DEVELOPED

tube sockets. Coils for 28 and 56 mc. are made by mounting GR plugs on a piece of victron in the manner shown in Fig. 2. It will be noted that the springs are removed from the plugs which are to fit in the smaller holes in the sockets.

For ten- or five-meter operation it is strongly suggested that a doublet antenna be used with a transposed or twisted pair feeder.

This converter unit does not represent any striking departure from normal practice. It is, however, a very useful gadget and one which is capable of an excellent performance when a good superheterodyne is available for use as the intermediate frequency amplifier.

Should the receiver be fitted with one of Lamb's noise silencers, the whole outfit will constitute just about an ideal set-up for ultra-high frequency work providing it is not intended to allow reception of any signals suffering from severe frequency modulation.

Attention, Members

APRIL is the month during which our directors are assembling suggestions and comment looking to their annual meeting in May. Your director will be glad to hear from you. His address is on page 6. If you have ideas for the improvement of amateur radio, thoughts about what ought to be done about our problems, write him soon.

Building a Simplified Superhet

(Continued from page 27)

trol gain without mixing itself in with the selectivity and tuning. Finally, regeneration in the i.f. is exactly what is *not* wanted when a noise silencer is added to a receiver.⁵ And we look with anticipation on the idea of adding a combination filter-noise silencer unit to the set. When that's installed, we think our own receiver problems will be solved for another year at least.

⁵ Lamb, "A Noise-Silencing I.F. Circuit," *QST*, February, 1936. The discussion of the effect of high i.f. selectivity on noise silencing action, with particular reference to the crystal filter, also applies to high-selectivity regenerative i.f. amplifiers.

Strays

Our January *QST* cover depicted a ten-meter WAC station. The idea seemed to be quite complete save that VS6AX did some careful scrutinizing at the cards on the wall and found one addressed to a W1. This in itself wouldn't have been so noticeable save that we had mentioned editorially that W1 had not made a ten-meter WAC at that time!

Just heard W6GAT calling W9GUN the other night. There would probably have been plenty of shooting if they had contacted!

—W9ADG



Amateur Radio STATIONS

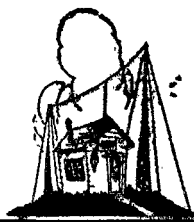

W2IDQ, East Orange, N. J.

ANOTHER apartment station is W2IDQ, owned by H. Leroy Vanderford, located in East Orange, N. J. The whole outfit is installed on a flat-top desk occupying a corner of the dining room. The transmitter is completely enclosed and is quite compact, considering the amount of power used, naturally any haywire had to be eliminated, being intolerable to the average OW except when confined to an unseen part of the house.

The transmitter operates on the 160-, 75- and 20-meter 'phone bands. Band-changing is a matter of about three minutes with plug-in coils and hinged doors. The tube line-up is an 802 oscillator, operated either as a Tri-tet or electron-coupled, parallel 802's in the buffer, and parallel 860's in the final amplifier. Grid-bias modulation of the 860's is used at the present time, although modulation of the plates and screens of the buffers together with screen-grid modulation of the final has been successfully used. Plate input to the final is 375 watts on all bands.

Speech equipment is in the metal box at the left on the operating table. The amplifier is push-pull throughout, using 57's in the first stage, 56's in the second, and 46's in the last. The microphone is a W.E. 387-W.

All of the transmitter stages, as well as the 2500-volt and 700-volt power supplies, are in separate aluminum compartments, with all

wiring in shielded cable. Each unit is mounted on a bakelite base with terminal strips, and can be removed very readily. The Collins antenna-coupling unit, mounted in the top section, is provided with a ganged inductance switch, operated by a knob at the rear, for band changing. In addition to the ventilation provided by the louvres in the metal cabinet, an 8-inch fan is built in the rear panel to aid air circulation in hot weather. Bias batteries and extra coils are kept in the lower desk drawers.

The antenna at W2IDQ is a center-fed "V," 132 feet on each leg, with 99-foot feeders. It is supported on 20-foot poles and crosses the roofs of two apartment buildings. An ACR-136 takes care of the receiving.

W2IDQ is another old-timer come back to the game—after a lapse of nineteen years! Vanderford was originally licensed as 3MF back in the pre-war days of 1916.



W7DET, Seattle, Wash.

THE accompanying photograph of W7DET, owned by William Vandermay of Seattle, Wash., illustrates an attractive arrangement for the home-built low-power station. Both

transmitter and receiver are within easy reach, yet plenty of room is available on a small operating desk for the pencil and paper work which accompanies station operation. A wooden framework supports the transmitter above the receiver and in addition provides some pigeonholes for spare coils, parts and other accessories.

The transmitter is completely contained in one unit, including a 300-volt power supply and antenna-tuning equipment. It is a two-stage rig, using a 47 oscillator and parallel 46's in the amplifier. Handles on the case permit its use as a portable transmitter, the weight being about 40 pounds. The input to the final is about 30 watts. For home station use an auxiliary power supply furnishing 500 volts is available for the amplifier, permitting inputs up to 100 watts.

The receiver consists of two units, the one to the left being the receiver proper and that on the

in Fig. 5. The inkwell is made from a 1-inch length of 1/4-inch copper tubing sawed through lengthwise and then squeezed together so as to permit the up-and-down motion of the pen without touching the sides of the slit and yet with just enough clearance for free motion. Each end of the tubing is closed (soldered), the pen slit being the upper 1/2 inch. The lower section has a piece of 1/16-inch copper tubing soldered into it through which the ink flows into the inkwell. At the bottom of the inkwell an overflow catch basin has been soldered—just in case the ink does overflow, the catch basin prevents the ink from running over the surface of the case.

The tape guide which is shown in Fig. 6 is made from a piece of bakelite, 5 inches long, 1 inch wide and 1/4 inch thick. Two strips of thin metal are screwed lengthwise to the bakelite in such a manner as to provide clearance for the tape which is 0.005 inch thick. The tape is held against the bakelite strip by the two metal strips spaced to provide clearance for the tape which is 3/8 inch wide. The tape slides through easily without binding. The tape guide is mounted on a shaft with a control knob so that the whole unit can be moved forward against the pen for light or heavy contact. The pen touches the tape very lightly.

Fig. 7 illustrates the ink reservoir. Turned out of brass, the inside diameter is 1 1/2 inches and it is 3/4 inch deep. A piece of 1/16-inch copper tubing is soldered to the bottom. A piece of 1/8-inch rubber tubing connects the ink reservoir to the inkwell. The level of the ink in the inkwell is governed by the knurled nut and thread at the base of the ink reservoir, the level being raised or lowered as desired.

Ink is made from methylene-blue, one ounce being dissolved in two quarts of boiling distilled water. The solution is then filtered through a dozen layers of cheesecloth; add 20% grain alcohol after filtering. This

makes an excellent free-flowing blue ink for fountain pens. Parker's Quink, to which about 20% alcohol is added can be used too. Tape is available from Paper Manufacturing Company, Philadelphia, Penna., the type known as "Perfection A Recorder" being recommended.

A new technic arises with the recorder—the business of reading signals by eye. True, the dots are there with the dashes and spaces in full view, yet it is rather awkward to read them at any speed which compares with the ear and sound. Practise, however, is the answer and it is understood that commercial operators take it by "eye" around 90 w.p.m. It is quite interesting and fasci-

(Continued on page 62)

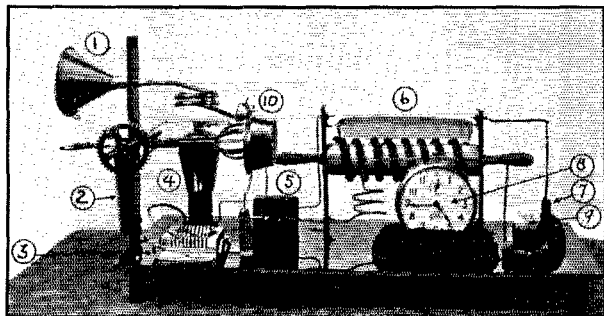

ALL BAND "STANDING-BY" TRANSMITTER AT W3DQ, OTHERWISE KNOWN AS THE WILSON "PUCKERING TOOKEA"

- 1—Hi-funelity talk into-er.
- 2—Stuffing box (for holding cotton from pill boxes, rusty aeroplane wing struts, etc.)
- 3—Main switch—Master control.
- 4—Tube here (just for looks).
- 5—Peachy Heavy Duty stuff.
- 6—Filters out QR.M.
- 7—Feeder.
- 8—Shock proof report giver.

- (Set hands for report you wish to get—QSA5 R9 etc.)—will also record the number of snapshots you haven't taken of Aunt Lila.)
- 9—Super oscillating gimmick (with mud valving).
- 10—Speech chopper-offer (removes harsh irritants from heavy duty voices and stuff).

Inventor's note: My "puckerling tooke" incorporates circuit design of tomorrow; however, tomorrow never comes, so skip it. Dynamic in personality, lavish in generosity, my "puckerling tooke" is a peachy wireless sender.

J. O. Otis, W3EXC, inventor

right a power-supply and speaker. The circuit used is a 57 e.c. detector, 2A6 first audio, and 2A5 second audio.

At the present time the station is operated on 7 mc., using a 65-foot Zepp with 35-foot feeders, 60 feet in the air. Considerable work has been done in the past on 80 meters, however. An entirely home-made station—even including the bug key.

An Automatic Tape Recorder

(Continued from page 38)

winding, the signal coil bakelite form and the completed signal coil with leads.

The inkwell, into which the pen fits, is shown

HINTS and KINKS

for the Experimenter



Oscillator-Mixer Coupling with the 6F7

PROBABLY most amateurs know the 6F7 at least by name. It consists of two separate tubes in one bulb, one an r.f. pentode and the other a triode, a common cathode being used for the two sections. The circuit diagram of Fig. 1 shows a method of using the tube as a combined mixer-oscillator in superhet receivers, the point of interest being the method of coupling between oscillator and mixer sections. This arrangement is suggested by B. P. Hansen, W9KNZ, who has found it superior on many counts to coupling circuits previously tried.

W9KNZ writes: "This is the stablest and quietest converter circuit I have tried so far, and I don't exaggerate when I say I've tried more than a couple. The cathode of the tube is placed above ground by the r.f. drop across the portion of the oscillator coil between cathode tap and ground, and since the cathodes of the two sections of the tube are the same the mixer cathode will also be

dom from the usual 'pulling' so common with electron-stream coupled mixing circuits. The r.f. circuits must be shielded from each other. The r.f. filtering shown might perhaps be dispensed with, but the receiver I'm using it in is rather cramped."

A later letter from W9KNZ indicates that the circuit will handle large signals a bit better if automatic bias instead of fixed bias is used on the mixer section. The proper automatic bias can be secured by inserting a 1700-ohm resistor, bypassed by a 0.1- μ f. condenser, in series with the connection from the lower end of the oscillator coil to ground.

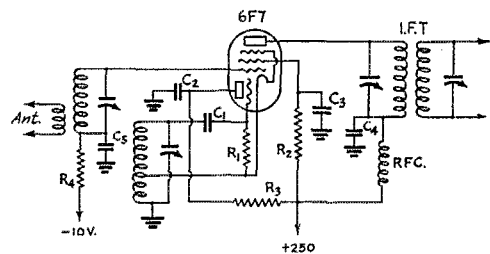

FIG. 1—CATHODE OSCILLATOR-MIXER COUPLING FOR THE 6F7

C₁—500- μ fd. mica.
C₂ to C₆, inc.—0.1- μ fd. paper.
R₁, R₂—100,000 ohms.
R₃—50,000 ohms.
R₄—250,000 ohms.
RFC—60-millihenry r.f. choke.
Tuned circuit constants usual for the type of tuning system employed.

above ground by this voltage. This means that the r.f. drop appearing across this section of the oscillator coil also will be applied to the mixer grid. There may be regeneration in the mixer, too, although this stage is perfectly stable. The conversion gain seems to be rather higher than with the more common layouts, while the noise level is lower than on anything so far tried here. Stability is swell—probably the grounded-plate oscillator has something to do with that. Also, while the coupling is certainly direct enough, there is free-

Simple Filament-Voltage Booster for 6.3-volt Tubes

PROBABLY some of the gang have been hesitant about trying some of the new metal tubes in receivers because of the necessity for getting a separate 6.3-volt filament supply when the existing receiver is geared up for 2.5-volt tubes. W1CD has an inexpensive and simple solution to this one. The gadget is an auto-transformer, made by winding 100 turns of No. 20 wire on an old audio transformer core (every ham has one!). A tap is brought out at the 39th turn and the works connected as shown in Fig. 2. Both 2.5 and 6.3 volts are available.

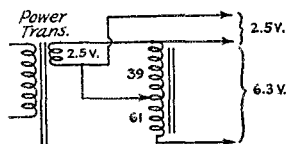

FIG. 2—INEXPENSIVE AND EASILY-MADE BOOSTER TRANSFORMER FOR OPERATING 6.3-VOLT TUBES FROM A 2.5-VOLT SUPPLY

W1CD's transformer handles four 6.3-volt tubes, the other three in his receiver operating at 2.5 volts. He writes that from the way the transformer operates it would seem to be capable of handling the remaining three just as readily. It took about five minutes to build.

W1CD's transformer handles four 6.3-volt tubes, the other three in his receiver operating at 2.5 volts. He writes that from the way the transformer operates it would seem to be capable of handling the remaining three just as readily. It took about five minutes to build.

Insulating Filter Chokes

THE following idea may be of some value to amateurs who have high-voltage power supplies to build. Instead of purchasing an expensive, high-voltage filter choke insulated to withstand umpty-ump thousand volts between

winding and core, one can get along very nicely with any type of choke which has the desired current, resistance, and inductance rating, regardless of its voltage insulation. It is only necessary to mount the "under-insulated" choke on two or more sturdy stand-off insulators, so that its core and frame are isolated from any grounded circuit. The frame and core can be painted red if the operator fears that he may forget the status of this filter arrangement. A still safer procedure is to enclose the choke in a grounded metal box, the frame and core being insulated from the protective covering by the stand-off insulators. It might be decidedly unhealthy and not in the least conducive to longevity for the operator to touch the frame of said choke with himself grounded and the power supply in operation. This dodge, however, is certainly worth remembering as a shekel-saver.

—L. C. Waller, W2BRO

Antenna Coupling to the 56-mc. Receiver

MANY hams on the u.h.f.'s spend a lot of time getting their transmitting antennas way up in the air or have elaborate directional affairs, but I wonder if they do the same for receiving? From observations in this locality I would say that there are very few fellows paying enough attention to it.

I am located in a valley, on sea level, one and a

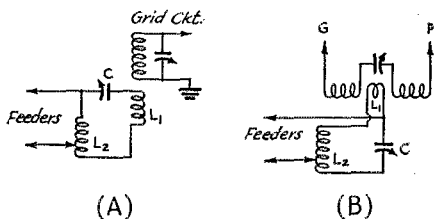

FIG. 3—TUNED COUPLING FOR THE 56-MC. RECEIVER

- L₁—3 turns No. 16 spaced 1/16th inch; coil diameter 1/2 inch.
- L₂—6 turns No. 12 spaced 3/16th inch; coil diameter 1/2 inch.
- C—5-plate midget.

The circuit at A is for receivers having a single grid circuit coil; B for receivers using the split-coil circuit.

quarter miles from Long Island Sound, about forty miles air line from New York. With ordinary equipment, such as a super-regenerative receiver and a pair of 45s in transmitter, I think I'm having more fun per mile than a lot of fellows. My antenna is about 60 feet off ground. It is an 8-foot vertical with 44 feet spaced feeders going down into the shack. The same antenna is used for transmitting as receiving. Of course you can't duplex, but how many DX contacts on 5 are?

My fun started when I took advantage of a tuning scheme suggested by W1EYM, N. Bishop, shown in Fig. 3. It has worked well for all fellows who tried it. Make the receiving antenna just as high as the transmitting antenna—or use same one as we do around here. It makes the difference between no signals at all and signals of the R6 to R7 variety.

The feeders from the antenna are clipped on the circuit as shown. The clip on the 6-turn coil is set so that resonance will be obtainable at some

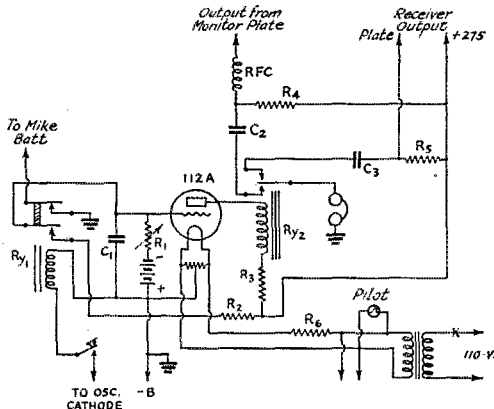

FIG. 4—CIRCUIT FOR AUTOMATIC MONITORING WITH BREAK-IN

- C₁—4- μ d. paper (not electrolytic) condenser, 300-volt rating.
- C₂, C₃—0.1 μ d.
- R₁—50,000-ohm potentiometer.
- R₂—100,000 ohms.
- R₃, R₄, R₅—25,000 ohms.
- R₆—4 ohms.
- Ry₁—D.p.d.t. relay taken from "B" eliminator control unit, rewound to 75 ohms.
- Ry₂—Telephone relay, s.p.d.t., 100-volt, 20-cycle. The relay used has a d.c. resistance of 1000 ohms.

setting of C, indicated by causing the receiver to stop regenerating. Signals will be best with C detuned just sufficiently to permit the receiver to return to the super-regenerative condition.

—Ralph M. Bray, W1CDR

Break-in and Monitoring System

A COMBINED break-in and monitoring system which has given good results for about eight months on c.w., and which is now being applied to 'phone work at this station, is shown in Fig. 4. It is a modification of the time-delay system shown in *Hints and Kinks*.

Two relays are used, one taken from an old "B" eliminator unit, and the other being an a.c. telephone relay. If the system is to be used for c.w. alone, the contacts shown for the mike battery can be connected to the oscillator keying circuit, and the winding of Relay 1 connected to 3 volts d.c. When used for 'phone, the connections are as shown in the diagram.

In the transmitter there is a small Dunco 2.5-volt a.c. relay, with contacts in series with the high-voltage transformer. If the key is left closed, manipulating the a.c. relay in the transmitter will cause the relay system shown to operate automatically. Of course if a type of microphone requiring no current is used, the contacts shown for the mike battery circuit will not be needed except as mentioned above.

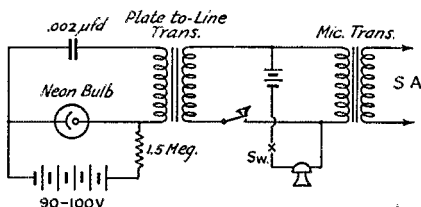

FIG. 5—NEON-BULB OSCILLATOR FOR TONE MODULATION OF THE 56-MC. TRANSMITTER
Condenser C and resistor R are 0.002 μ fd., and 1.5 megohms, respectively. The microphone switch should be open when the tone modulation is used.

The system operates as follows:

When current passes through Relay 1, it closes the contacts to the grid circuit of the 112A, and puts about 50 volts positive on the grid. When the contacts are open, there is -22.5 volts on the grid. With the contacts closed, and the positive difference between -22.5 and 50 volts on the grid, the 4- μ fd. condenser holds the charge, which leaks off at a rate governed by the 50,000-ohm potentiometer. The delay can be adjusted from 0 to about 1½ minutes, depending upon the adjustments of the relays, which, by the way, are quite critical for quick operation. Next, the plate current of the 112A operates the plate circuit relay, the contact arm of which is connected to one side of the 'phones. The other side of the 'phones is grounded. When the relays are open, the arm of Relay 2 rests on the receiver output side. When closed the arm rests on the monitor side, and will stay there after Relay 1 has been opened, depending upon the setting of the grid potentiometer. All voltages, except for the filaments, are supplied by the receiver, and the output of the receiver and monitor are resistance coupled against ground. Of course any type of coupling from receiver and monitor could be used so long as there is a common return for the 'phones, otherwise a d.p.d.t. relay would be required in the plate circuit of the 112A.

One can work virtual duplex with

this system on 'phone by using the key and leaving the high voltage on. All that is necessary is to depress the key while speaking, and let it up when not speaking, the grid potentiometer being adjusted so that the 'phones will come back to the receiver, immediately the key is opened. Regardless of the switching method used, the system enables one to listen to what is being transmitted, whether c.w. or 'phone.

The only difficulty experienced at all was in adjusting the relays for operating at such low currents—15 to 20 ma. oscillator plate current through Relay 1 and 6 to 10 ma. 112A plate current through Relay 2. All resistors, with the exception of the 112A filament resistor and the 50,000-ohm potentiometer, are of the 1-watt type, and all condensers shown are rated at 600 volts (working) d.c. The output tube of the receiver is a 56 and the monitor a 76. The plate resistors should be changed to suit any other type tube used.

—J. P. Neil, VESPN

Neon-Bulb Oscillator for Tone Modulator

THE article in February *QST* by Mr. Schnell, covering the use of neon-tube audio oscillator as a keying monitor or code practice device, suggested another use for this simple and inexpensive equipment, to wit: tone modulator for i.c.w. on the 56-mega-cycle rig.

The writer, being an old-timer recently returned to amateur fold via the ultra-high frequency route, rather tires of 'phone at times, and has a hankering to oil up the old bug and have some QSO's in code. He debated between buzzer tone and a triode oscillator, until Mr. Schnell's timely suggestion came forth. The neon tube settled the question.

A few minor changes in the circuit were made as shown in Fig. 5 and the old-timer was on the air, with FB reports from all parties contacted.

Keying the output instead of the battery circuit resulted in a more constant frequency.

—Ralph E. Henry, W6MXC

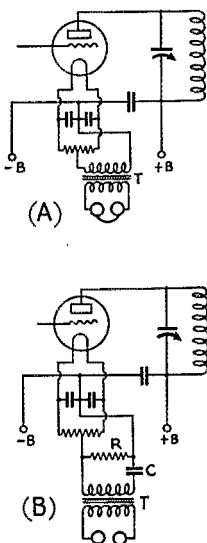

FIG. 6—METHOD OF CHECKING CARRIER HUM OR MODULATION

T—Speaker output transformer, 10 or 15 ohms to tube plate. Low impedance winding connected in center tap; high-impedance winding to 'phones.

R—10 to 15 ohms.
C—2 μ fd.

Simple Monitoring System for Checking Hum or Modulation Quality

A MONITORING arrangement which requires very few parts is

shown in Fig. 6. It has been used for a considerable length of time with excellent results by Seiler Brothers, W8PK. A glance at the diagram will show that the system functions by picking up a small amount of audio voltage from the filament center-tap of the final amplifier and feeding it into a pair of headphones, utilizing an ordinary output transformer of the type used to feed a dynamic speaker for the purpose.

The diagram at A can be used with transmitters of moderate power, while that at B is recommended for high-power rigs. The resistance-condenser coupling will prevent burning out the transformer winding if the plate current of the stage exceeds 300 or 400 milliamperes. The transformer used should have good frequency response.

The signal level in the 'phones is high even with a low-power 'phone rig. This sensitivity makes the system useful for detecting hum in the signal, a feature which will make it appreciated by c.w. as well as 'phone operators.

28-mc. Converter with Tuned R.F. Receivers

THE 10-meter converter described in February *QST* works very FB on a t.r.f. set as well as a band-switching superhet. My t.r.f., 58-57-56-2A5, works fairly well on ten but lacks sensitivity. Coupled to the converter with the coils of the t.r.f. tuned to 3500 kc., the average 10-meter 'phone is several times as loud and by adjusting the regeneration of the detector in the receiver the sensitivity seems to be better than when using the converter on a 7- or 10-tube super. Another advantage is the absence of "birdies" or beats with the h.f. oscillator in a superhet. A separate beat oscillator is desirable for c.w. reception.

To facilitate changing the converter in and out of the circuit I brought out the filament, B plus and -B ground leads from the receiver and wired them to a 4-prong tube socket. The corresponding leads from the converter are wired in a tube base. Then it is only necessary to plug this in and couple the antenna to get on ten.

—Howard Earp, W7CHT

An Automatic Tape Recorder

(Continued from page 58)

nating and the tendency is to sound off the characters. And some of those peculiar or "distinctive" fists look just the way they sound.

Normally, good recording suggests 5 words per foot of tape. To open up or space the characters, the speed of the tape puller is increased and *vice versa*. Assume that a "high-speed bug merchant" promises to deliver signals at 45 w.p.m. That is

one big promise which will be filled by very, very few amateurs. Of hundreds which have been recorded at W9UZ, no one has approached that speed—which would require tape at the rate of 9 feet per minute with the puller motor turning up 81 r.p.m., using the $\frac{3}{8}$ -inch diameter puller. 8.73 r.p.m. would be 1 foot per minute or 5 w.p.m., etc. To take WIZ at 85 w.p.m. requires a motor speed of 148 r.p.m. to pull the tape through at 17 f.p.m.

It is most difficult to leave the recorder alone—a new toy with which the interest and pleasure seem unending in "looking at the fists" on the air. With its completion, an ambition of long standing has been realized at W9UZ—the station is entirely automatic and is capable of handling 100 words per minute transmitting and receiving.

A 28-Mc. Rotary Beam

(Continued from page 50)

the latter in favor of the DX in the opposite direction, which picks up in strength "on beam." On December 20 it was possible to hear VK3YP's crystal oscillator running; 8 watts in the plate circuit of a 6A6! Considering the receiver here—a tuned r.f. job—it was interesting to note the cut off when the beam was swung only a few degrees off.

An R9 power leak originating from an 11,000-volt line $1\frac{1}{2}$ miles northeast is reduced to about R1 when beam is swung 180 degrees off, allowing

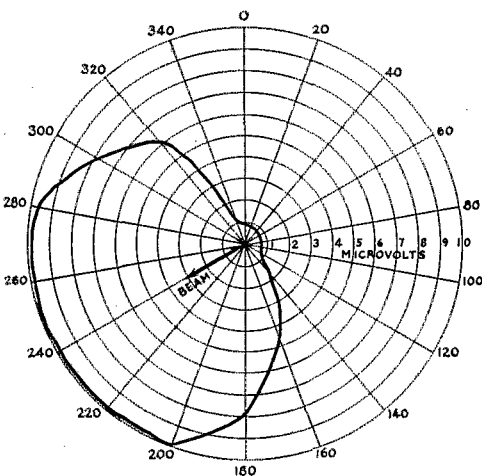

FIELD CHART OF W6JN ANTENNA

clean reception to the southwest. The location here is in a hornet's nest of factory power lines and noisy equipment, but use of the beam has helped immensely; making it possible to hear and QSO Europe and Africa for a ten-meter WAC.

• I. A. R. U. NEWS •

Devoted to the interests and activities of the

INTERNATIONAL AMATEUR RADIO UNION

Headquarters Society: THE AMERICAN RADIO RELAY LEAGUE, West Hartford, Conn.

MEMBER SOCIETIES

American Radio Relay League
Associazione Radiotecnica Italiana
Canadian Section, A. R. R. L.
Ceskoslovenski Amatéri Vysilaci
Deutscher Amateur Sende-und-Empfangs
Dienst
Experimenterende Danske Radioamatører
Irish Radio Transmitters Society
日本アマチュア無線聯盟
Liga Colombiana de Radio Aficionados

Liga Mexicana de Radio Experimentadores
Nederlandse Vereniging voor Internationaal Radioamateurisme
Niederländsch-Indische Vereniging Voor Internationaal Radioamateurisme
New Zealand Association of Radio Transmitters
Norsk Radio Relæ Liga
Oesterreichischer Versuchssenderverband
Polski Związek Krotkotalowcow

Radio Society of Great Britain
Rede dos Emissores Portugueses
Reseau Belge
Reseau des Emetteurs Français
South African Radio Relay League
Suomen Radioamatööriliitto r.y.
Sveriges Sandareamatörer
Unión de Radioemisores Españoles
Union Schweiz Kurzwellen Amateurs
Wireless Institute of Australia

Conducted by Clinton B. DeSoto

TBTOC:

Additional qualificants for this classification: W9BPU with VK2EO, W9PTC with OK1BC, ON4LX with W1AF, and VE2EE, W4EF, W8DYK, and W1FH with EA4AO. Don't forget that either QSL cards or equivalent proof must be submitted before QST mention can be made.

QSA3 W3AWH reports 14 mc. open all the day 'round some days in February, with good DX at almost all hours OZ7T worked four continents on 28 mc. as early as 1928, recalls OZ7Z An unusual contact is CR9DA, operating in Macao on about 14,290 kc., reported by W5DVI QSL's for all CR stations through R.E.P., 'Por-

Erratum:

Incorrectly captioned was the photograph on page 62 of the February issue of QST, cut labels having been mixed up in the process of assembling the issue. Actually, the enthusiastic microphonist is Jean Lory, F8DS, secretary of the R.E.F., a most prominent figure in French amateur radio. Sorry, OM.

General:

Approximately 30 undercover stations are now active in Colombia, with the expectation that licenses will be issued in the not-too-distant future The official hours of working in Belgium are: Weekdays, 0000-1100, 1400-1600, 2300-2400; Sundays, 0000-1100, 2300-2400

Eric J. Lake, VK4EL, travelling in North Queensland with no mains supply, did some excellent QRP work with 1.1 watts to a B406, working VK2-3-4-5-6-7, ZL1-2-3-4, VS6, ZT5 and OA4 The latter three reports were, in order, R6 QSA5, R5 QSA4, R4

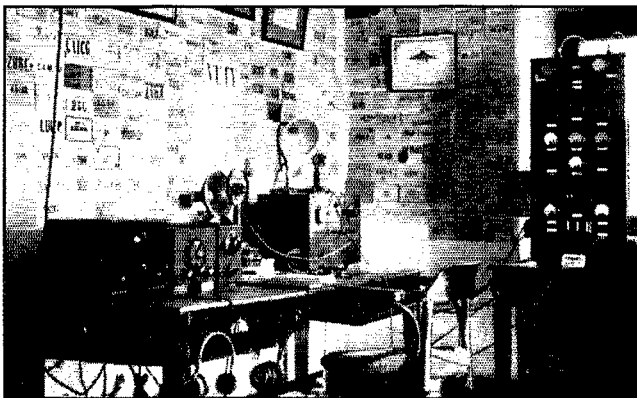

VU7FY INDIA

O. A. F. Spindler states that all "W" stations with whom he has had a QSO have had their QSL cards sent to them either direct or via the A.R.R.L. and he will be pleased to forward another card to any station who has not received their QSL card.

tugal, of course If you need Greenland for a new country to add to the list, look for OX2Z, now active on all the DX bands He is at Eskimonaes, East Greenland, but QSL's should be sent via E.D.R. Latest word concerning the Brazilian situation, from

PY1DI, is that the communist troubles are continuing and all amateur activities will probably continue to be suspended through March Confiscation and worse attend under-cover operation, so PY's are very quiet these days VP7NB and VP7NC are the only stations active in the Bahamas currently FBSAG has been working a lot of W's recently on 14,360 kc.; the QRA is Roger Luzet,

to operate in the region between 14,000 and 14,150 kc. For that matter, why do the majority of DX 'phones in every part of the world congregate in the lower-frequency end of the 14-mc. band? Miles W. Weeks, W1WV, submits a most unusual record for consistent DX: He has worked over 400 G stations in some 875 contacts during the past seven years, about one-fourth of the total number of existing license-holders This is a mark for the G's themselves to shoot at! A new record 9th "district" WAC is reported by W9LEZ on behalf of Niel Werner, W9AJA, who did the job back in 1931 in 9 hours and 35 minutes T. A. Githens, W9AEH, did it in 10 hours and 10 minutes last year D. W. Rowe, W9BPU, believes he is the first 9th district station to WAC on 28 mc., J2LU having completed the group back in January ZS6A and VK5LD did some record relaying during the cricket matches between the Australian Eleven and Transvaal last autumn, shooting a message to Capt. Victor Richardson of Australia and getting his reply back via land telephone and delivered in about ten minutes At the close of the matches the final scores were relayed back to Australia within two minutes of the time stumps were drawn in South Africa, all 100 per cent with QRP

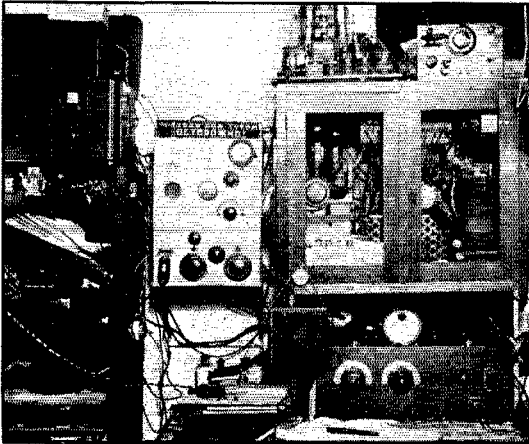

Because of space limitations the QSL Bureaus of the World will be run next month.



U3AG, MOSCOW, U.S.S.R.
Operator N. A. Baikusow is heard quite regularly in U.S.A. Above is the station with 300 watts input. A beam antenna is used.

Tananarive, Madagascar Greville C. Cawood of Sandakan, British North Borneo, has been granted the first amateur license in that region, with the call VS4CS Almost everyone knows by now that CO stations (Cuban 'phones) are operating in the region 7000-7100 kc. ZE1JJ is on about 14,395 kc., according to W2FAR Back in December, Norman Smaha, W6CSI, received a QSL from KA1EF via the China Clipper on its initial flight from Manila to San Francisco, the first Air Mail flight over that route Are there any other QSL's of equal distinction? ZS6AM uses 18 watts input on 'phone Most African 20-meter 'phones seem

New Transmitting Tubes

TWO new transmitting tube types, to be known as the 804 and the 805, have just been released by RCA. The 804 is a pentode practically equivalent to the well-known RK-20, taking the same filament voltage and current, and having the same maximum plate voltage rating, 1250 volts. Plate and screen dissipation ratings are 40 and 10 watts, respectively. The 804 carries a maximum output rating of 80 watts for c.w. telegraphy, the driving power required being approximately 1.2 watts. As a suppressor-modulated amplifier, the tube can deliver a carrier of 21 watts with a driving power of less than one watt. The tube is the same physical size as the RK-20, has the same pin arrangement, and is similar in construction.

The 805 is a new triode of having the "50-watt" type of construction except that the plate connection is brought out to a top cap. The bulb and plate are larger than in the 211-203A types, however. The tube can deliver an output of a quarter kilowatt with 1500 volts on the plate, and can be used at maximum ratings

(Continued on page 88)



OPERATING NEWS



Conducted by the Communications Department

F. E. Handy, Communications Manager

E. L. Battey, Asst. Communications Manager

THERE are good notes and bad, and more poor notes than there *should* be on the air today. Just last night we were listening to a moderately bad note on 14 mc. and speculating whether the station owner had had the misfortune to lose some filter condensers, or what. However, our kind solicitude turned to surprise when we heard the bum note rattle off, "QRU but QRX min . . . gng put de on . . . hi." In other words, that signal could have been a 100% T9 proposition *all* the time if its owner had desired! Adequately filtered power supply equipment is required by regulation. The risk that the sender assumed that the F.C.C. monitoring stations would not pick up this performance and nail him with self-admitted violations of Pars. 381 and 382 is his own business. The business of BAD NOTES that double and treble interference in our bands, that make repeats necessary, that delay traffic, that ruin DX, that take the pleasure out of rag-chews . . . that sort of business is everybody's business.

High station efficiency is an end toward which every individual amateur should work. It can be shown that with hundreds of single signal receivers in ham shacks putting a premium on the signal that is sharp (and ignoring signal energy in sidebands) that there is not even a personal excuse for an operator to use an inefficient, prehistoric and selfish signal in our ham bands.

Bad notes are an outstanding nuisance in whatever bands they turn up. Section Managers comment on the situation in their current reports. It is not a situation common to any one locality. Many amateurs write to complain about it . . . more particularly about certain stations . . . tuned filters, power supply modulation, no filters at all, *intentional* modulation of a telegraph signal. It seems to us that any station using more of the frequency band than *necessary* for communication in these days where efficiency in operation is important to the welfare of all, is guilty of undue selfishness, deserving of the low opinion in which he is held by brother amateurs. When the operator writes for help in answering the discrepancy report he sooner or later is sure to receive from F. C. C. we feel that if the offense was one of the "intentional" category that we shall be able to keep our sympathy within proper bounds. Let's examine our own and all signals heard, and not be guilty of a flattering T-report unless the signal really deserves it. To make our communication frequencies most effective for the large number of operators on the air today it is sound policy for all amateurs to demand of every individual a signal of the highest communication efficiency, that is, one with a good note (no whiskers) and one that occupies the very minimum frequency channel width for that station!

—F. E. H.

DX Notes

VE2HG feels reasonably sure that he is the first VE2 to work India; he worked VU2CQ in early December and would like to know of any VE's who worked India before that time. FR8VX is reported between 2200-2330 GT, T9X, 14,335 kc. and FB3AG, 2230-2400 GT, T8, 14,280 kc. W9ELA, Minneapolis, lists some more or less rare (for W9) DX: ZU6M 14,125 kc., CP1AC 14,440, HB9AT 14,040, ZS2X 14,045, ZP2AC 14,390, ZU5X 14,300, CE3EL 14,400, ZS1AH 14,265, YM4FS 14,140, VS1AJ 14,350, VX2NA

14,400, LY1AG 14,390, ON4CJJ 14,400. A new one was worked by W9ELA on February 21st—ON4CRM, 14,375 kc., T9X. QRA: Ray Meunier, T.S.F., Leopoldville, Belgian Congo; it was his second QSO with the U.S.A. On 7mc. W9ELA worked KA1ER, January 16th, at 8:45 a.m., 7220 kc., and KA1ME, 7290 kc. W6C1S was QSO VU7AB, Mysore, India, 14,325 kc., low r.a.c. note, February 16th, at 3 p.m. PST.

A few of the "kind that count" are reported by W1TS; he has recently worked J2KN, 14,250 kc., 8:30 a.m. EST; VU2BG, 14,400, 8:30 a.m. and 8:00 p.m.; PZ1AA, Surinam, 13,990, 7:30 p.m.; and on "ten meters" J2HJ, 28,400 kc., 6:15 p.m., Mar. 2nd; VU3DV, Andaman Is., 28,800, 8:30 a.m., Mar. 3rd. J8CA has been heard on 14,250 kc. at 8:45 a.m. EST. W1TS recently worked all continents in 8½ hours. Between Dec. 28, '35 and Feb. 6th, W4CQG worked 35 VK's and 10 ZL's on 14 mc., both 'phone and c.w. On Jan. 28th alone he worked 5 VK's and 3 ZL's. W8AVB reports a contact with VK5GW, 14,310 kc., at 4:30 p.m. EST, Dec. 30, '35; he received RST 579 report. The ship call XE8M reported in last month's DX Notes is actually XE3, reports W9MCC. XE3, it seems, is one of several calls, all home-brewed (!), used by commercial operators and ranging from VE1 to VE4 or so.

W4CQR reports SX3A putting through a nice signal, at times S7-8, on 6990 kc., and 14,060 kc., 500-cycle note. VU2CX was heard by W4CQR and W4AUU and is reported operating on the high-frequency end of the 14-mc. band, coming through between 3:00 and 4:00 p.m. EST. Quoting G6ZT: "Please drop a tip to the lads to call a little longer when calling European stations . . . we search the whole band over here . . . and it takes us about one and one-half minutes." PY1DI deplors the habit of calling a station that has just finished calling some other station. He has had several experiences in conjunction with a schedule with F8GI where, after calling F8GI, he will tune onto a long call to PY1DI, and thinking it is F8GI he will remain tuned to that signal, only to find it is some "W." There is little excuse for calling any station unless you are reasonably sure that station is tuning for random contacts and not engaged in two-way work or looking for a definite station.

W8CNC reported, too late for March QST, that the ZL and VK gang will make every effort to establish 3.5-mc. DX contacts during March. They will be active on that band from 2:30 to 4:30 a.m. EST. ZL2GN reports that he will be found between 3505 and 3520 kc. Most VK-ZL stations will be found between 3500 and 3650 kc. Best time to QSO VK-ZL on 3.5 mc. during March is between 2:30 a.m. and 4:30 a.m. EST.

On Feb. 22 at 11:50 p.m. EST, W2UK QSO FA8BG on 1750 kc. for what is believed to be the first USA-African contact on that band beating W1BB by one night. Sigs were S5 at both ends. The first five days of the week of Feb. 23 W2UK snagged VS6BD and used phone when signals were strong enough. On 14 mc. VS6AF was worked twice during that period. W1EWD QSOd VU3DV on ten meters the first week in March. W1EAO worked U9AG who was on 14,160 kc. W1NI and W1FTR QSO VS6AQ on March 8th. W1SZ completed his ten-meter WAC March 1, QSOing J2HJ, who was also worked on the 4th and 6th. W1OMX completed his ten-meter WAC on March 6th with J2HJ. Many Eastern stations are having their first real chance to work Asia with VS6 coming through on 14 mc. each morning for 2 or 3 hours at a time, starting at 7:30 a.m. KA1XA arrived in Los Angeles March 4th.

The Colorado "H.P.M." Circuit

THROUGH the fine cooperation of Colorado amateurs, an efficient radio circuit was established between the La Junta Hospital and Hartford, via Denver, during Mr. Maxim's last illness. Bulletins were sent and received at least twice daily. The 7-mc. message evenings travelled W9CDE-W9ESA-W1MK, while the 28-mc. daylight routing was W9CDE-W9CJJ-W1DF. W9GQD (Fowler, Colo.) got bulletins from W9CDE (La Junta) and worked W9ESA (Denver) twice daily. The afternoon bulletin was 'phoned to W9CJJ, the W9CJJ-W1DF 2000-mile daylight circuit a 100% demonstration of the reliability of 28-mc 'phone. The radio bulletins were awaited eagerly by both the Hartford papers as well as by relatives and the many immediate friends and associates of Mr. Maxim. Not only was Mr. M. O. Davis, W9CDE, helpful in arranging the Colorado circuits but he was in frequent attendance at the hospital, extending many courtesies to Mrs. Maxim and family. No radio amateur could have done more, and his work is a shining example of the true ham spirit.

Radio Silence

Official A.R.R.L. broadcast number 660 suggested that during the funeral services on February 21st, as a fitting



OPERATOR HAL BUBB "PULLS SWITCHES" AT W1MK

The institution of the radio silence period at the Headquarters' Station is symbolic of the observance elsewhere in amateur stations. One journal in referring to the silence period has called this quite fittingly, "A Maxim Silence."

mark of respect for our President and founder, that thirty minutes of "radio silence" be observed. The information was retransmitted and given excellent distribution on all amateur frequency bands.

New Mexico 1.75-mc. 'Phone Net

The New Mexico 'Phone Net meets as an A.A.R.S. Net on Tuesday evenings at 5:00 p.m. MST. Six members are on a spot frequency of 1805 kc., and all will be on that frequency eventually. Stations include W5ZM, Net Control, W5CYQ, W5DLG, W5CYX, W5DAD, W5BHU, W5BRG and W5DWP. The net members would appreciate the cooperation of stations near 1805 kc. in avoiding QRM during net periods, 5:00-8:00 p.m. MST, Tuesdays.

The article by Mr. Dye, W8APC, wins the C.D. article contest prize for this month. Each month we print the most interesting and valuable article received marked "for the C.D. contest." Contributions may be on any phase of amateur operating or communication activity (DX, 'phone, traffic, rag-chewing, clubs, fraternalism etc.) which adds constructively to amateur organization work. Prize winners may select a 1936 *Handbook*, six logs, six message files, six pads blanks, or equivalent credit toward other A.R.R.L. supplies. Contributions should run around 400 words. Send yours today!

—F. E. H.

Re Testing

By Sanford Dye, Jr., W8APC*

YOURS TRULY seldom complains about conditions. In fact, it is my opinion that more actual good can be done by setting an example. But it DOES seem to me that about 98% of the testing on the air could and SHOULD be eliminated. I refer to the nefarious practice of jangling the key and whistling into the mike that can be heard almost any time of the day or night on some amateur band.

Certainly, we are merely amateurs, and naturally we must resort to a *little* testing (the remaining 2%) in order to tune up our antennas; but our bands are already small enough without crowding them with "ABC" and "VVVVVVV" and "Hello Test." Such transmissions are absolutely useless as far as informing us about the quality of our signals.

With a little common sense and the judicious application of two or three meters (they do not have to be accurately calibrated) and a monitor, any multistage transmitter can be fully adjusted up to and including the final amplifier tank circuit without an antenna of any sort (dummy or radiating). Likewise, by using the old bean, a dummy antenna, and two or three meters (only the milliammeter in the modulated stage need be accurately calibrated), any 'phone transmitter can be made to emit intelligible speech.

One more item—to adjust a bug, we should use it with a buzzer, audio oscillator, or dummy antenna. The key is part of the transmitter, and should be adjusted along with it—off the air.

It all sums up to this—we all resent needless QRM, but are we ever guilty of CAUSING it? How many hours and watts do we waste by "testing" with a transmitter that is already adjusted to the maximum of its capabilities? How many more QSO's per year could we make by *calling* instead of simply "testing"? Remember that the inno-

cent must suffer FOR and WITH the guilty. Are you guilty?

Do you have a monitor? If not, then fix up one today so you *know* how your signal sounds, and are less dependent on estimating the reports of others, in which one has to discount reports depending on distance, fading, and a possible desire to flatter! *Have a monitor always at hand.*

What about a dummy antenna? A simple lamp bulb of the proper wattage rating and a couple of clips will take care of that. Better yet leave your dummy antenna connected to the proper points (for impedance matching) on the tank to make it equivalent to the regular antenna, and switch to this while checking anything in the equipment that has gone wrong, when tuning, changing frequency, etc. The A.R.R.L. Board has gone on record for wider use of the dummy antenna to better this situation. Are you up to date? Install this simple, yet important piece of testing equipment in or beside your transmitter today.

* 3550 W. 140th St., Cleveland, Ohio.

Avoid useless TESTING. Operate *your* station efficiently. Make use of these simple devices and principles that mark you as a mature, intelligent amateur, properly considerate of the rights of others. Demonstrate your monitor and dummy antenna to visiting amateurs so they will be encouraged to follow your example.

Official Relay Stations Make Records in January Party

O.R.S. appointees enjoyed fine conditions and success in the January quarterly activities. Fun in traffic handling and pride in schedules ready for any emergency job of communication gives way four times each year to concentration on the problem of making as many solid contacts with brother O.R.S. as possible, and many are the friendships made and renewed, and great the pleasure in these occasions.

Thirty-five stations of the many hundreds on the job ran up scores of over 15,000 points, and every district or licensing area is represented in the results. No A.R.R.L. Section has a monopoly of the leadership, although Illinois and Connecticut stood well in the number making out well above the average score. The 20-out-of-33 hour plan of work received universal approval.

The records made by W3EOP, W4NC and W3NF are the most outstanding, all making over 40,000 points. W9IU the cup-winner (holder of the W9AUH trophy) was right in there with the leaders. But the "statistics" tell the story better than mere words:

Station	QSOs	Sections	Heard	Score	Power	Section
W3EOP	184	47	177	48,081	425 watts	E. Pa.
W4NC (40G)	163	49	77	44,933	800/300	No. Car.
W3NF	149	47	117	41,736	200	So. N. J.
W9IU	184	51	60	39,525	...	Ill.
W2AYJ	135	42	86	33,768	375	N. Y. C.-L.I.
W7BSU	97	45	34	32,210	700	Mont.
W1TS	133	43	28	30,374	750	Conn.
W1BFT	137	38	60	29,260	...	N. H.
W9RAQ	118	47	105	28,294	75	Ill.
W1MK (Hal)	117	40	56	26,680	600/350	Conn.
W6KFC	81	39	77	26,130	68	Ariz.

Call	QSOs	Power	Score	Call	QSOs	Power	Score
		watts				watts	
W1UE	115	55	26,068	W1GME	118	91	20,374
W8AQ	113	200	25,560	W8JTT	92	45	20,052
W8LOQ	128	...	25,382	W2DXO	97	300	19,346
W5DEJ	124	...	24,480	W9RQM	104	275	19,160
W8BYM	118	150	24,442	W4BOU	108	100	18,886
W8KWA	131	...	24,040	W2AHC	107	900	18,208
W1IGN	94	110	23,142	W4CJG	100	95	18,174
W8GUF	115	90	22,755	W2GVZ	95	...	18,016
W3OZ	106	...	22,420	W4APU	94	...	17,390
W8FLP	117	550	21,801	W9DHN	90	40	16,720
W9ENH	105	...	21,629	W2GQX	88	125	15,810
W3FTK	93	100	20,495	W8IUY	110	40	15,808

Briefs

An aeroplane of the Dominion Skyways, Ltd., Canada, damaged a tail-ski when landing at Mud Lake (65 miles southeast of Rouyn, Quebec) in the late afternoon of February 7th. The only means of communication from Mud Lake is by radio through CZ5L (Mud Lake) and CZ5M (Rouyn), stations of the Skyways. At the time the plane was damaged the Rouyn operator had gone off duty for the day. VE2CU, operator at CZ5L, turned to his ham set and raised VE3WK, Toronto, on 3.5 mc. VE3WK wired the information to Rouyn where another plane was made ready, arriving at Mud Lake shortly after sunrise, February 8th. Considerable delay was avoided by the use of amateur radio.

W3DTG, George W. Bruffey, is bandmaster of the U. S. Navy Band!

BRASS POUNDERS' LEAGUE

(January 16th-February 15th)

Call	Orig.	Del.	Rel.	Total
W9JID	918	408	1023	2349
W1FFL	149	181	1937	2267
W4PL	25	23	2211	2259
W2BCX	65	194	1927	2186
W6KGO	62	196	1274	1532
W1AKS	189	127	1079	1395
W2EGF	91	68	1175	1334
W3JTT	47	59	1118	1222
W3ETX	214	67	901	1182
W3FTK	77	66	1028	1171
KALDS	270	202	642	1114
W1IP	16	30	1012	1058
W3GGE	56	98	872	1026
W1IEG	9	50	945	1004
W9HUO	28	9	956	993
OMITB	272	142	515	929
W9FAM	30	34	370	924
W5CEZ	136	133	642	911
W9ESA	34	118	732	885
W2GGW	39	32	742	863
W1DCW	54	---	787	841
W9KG	65	186	568	819
W3BYA	32	27	748	807
W6LCC	78	53	635	769
W3FLG	43	39	624	765
W9RAQ	15	21	723	759
W3BWT	121	95	538	754
W9AJJ	137	36	562	735
W1MK	171	208	350	729
W3ANT	10	8	703	721
W3EFM	59	44	610	713
W9SGP	58	99	516	673
W1ZQ	13	34	610	667
W1IZO	188	32	434	654
W3CIZ	23	55	565	633
W3TGN	59	97	478	635
W6LMD	15	25	370	610
W9KJY	85	200	321	606
W8ICM	40	25	516	581
W3EZ	21	75	484	580
W2EBQ	188	5	378	371
W7KL	13	15	526	554
W2GAS	72	27	437	536
W8LSE	57	51	422	527
W7CRH	37	33	453	523
W8UW	18	15	488	521
W9RJT	84	114	322	520
W4BZA	4	19	492	515
W2BGO	32	55	426	513
W8ADY	11	27	470	508
K6FKB	104	90	308	502

MORE-THAN-ONE-OPERATOR STATIONS

Call	Orig.	Del.	Rel.	Total
W4DUG	3562	---	---	3562
W9BNT	388	1087	1083	2558
KAIHE	589	336	410	1355
W4BBV	75	25	830	930
W3CXL	40	38	504	582

These stations "make" the B.P.L. with totals of 500 or over. Many "rate" extra credit for one hundred or more deliveries. The following one-operator stations make the B.P.L. for *delivering 100 or more messages*; the number of deliveries is as follows: Deliveries count!

W6GHD, 354	W1GHT, 123	W2KI, 109
W2CHK, 267	W8JQE, 118	W1BNS, 107
W6CXK, 252	W4IR, 118	W5DWW, 104
W6BPU, 174	W9KZL, 115	W3ZL, 103
W1RS, 135	W5FDR, 114	W2GVZ, 103
W2HYC, 130	KAIKN, 109	VE3ABW, 101
		W7ABS, 100

A.A.R.S. STATIONS

Call	Orig.	Del.	Rel.	Total
WLNF (W2BCX)	17	119	749	885
WLQT (W3ANT)	36	16	767	819
W1QA (W3OK)	60	74	553	687
W1MI (W8GXM)	121	228	276	625
W1VH (W8BMC)	2	12	584	598
WLQB (W3EOP)	34	11	476	521

MORE-THAN-ONE-OPERATOR STATIONS

W1M (W3CXL)	208	218	2337	2763
-------------	-----	-----	------	------

A total of 500 or more, or just 100 or more deliveries will put you in line for a place in the B.P.L.

OBSERVERS' HONOR ROLL

Cairo Commercial Occupancy Survey

For February 1936

6000-8000 kcs.

W2HNX	W8LVH	W9SXL	W3EWW
W9EFK	W9LDH	F8KQ	W4BUC
W1JHT	VOIC	F8LD	W5NW
F8OM	D. R. Bittner	VE4UN	W7BFI
W4DNA	W1LLE	O.B.P. Amateur	W7EYR
W9LEB	W3FLD	Radio Club	W8CUR
W5BWM	W4DKM	M. Roy	W8LEV
W7AAN-DRF	W8DGL	Francis Worrell	W9DH
W9CHH	W8JZ	W1AMH	W9SJK
W5CVO	W8NQ	W1ASB	W9TNU
Jas. C. Hayes	W9DCM	W1BB	W9VBQ
W1IDH	W9GMT	W1JLJ	F8NC
W1IOA-3	W9KEI	W3DXC	F8PK

4000-4500 kcs.

O.B.P. Amateur	W1JLJ	W1AXS	W1JCN
Radio Club	W1IPU	W1DTZ	W1JHT
W1AFO	W1JAC	W1GTS	W5DWM
W1BMW	W9DH	W1IZO	W6LAH

During the last thirty days 51 Observers have reported with detailed information on the 8-mc. regions, and 15 Observers with like data on the 4-mc. territory being surveyed. Those listed are doing something more than "talk about" more frequencies. They are giving unselfishly of their time to give your amateur representatives at Cairo and the conferences that precede it vital facts, knowledge and information with which to work in our common interest. The listing of calls or names has been arranged as closely in the order of the volume of survey work performed by the individual as possible. This Honor Roll is published each month.

Many more group surveys are getting underway under the sponsorship of those clubs that have the kind of leadership that goes beyond the local community into consideration of the fundamental interests of amateurs. Director Norwine, W9EFC writes about the St. Louis group survey. "We use two receivers, one on each band, and tricks of one hour each. Those not working at the receivers are kept busy with sandwiches, coffee and beer. We used more coffee than any other beverage. All the gang were willing to take their turn long before next listed on the clubs chart." Mr. F. H. B. Saxon, VE3SG, Group leader of the Queen City Amateur Radio Club survey, encloses his with reports from VE3WK, VE3TH, VE3ZE and VE3ACI (for March Honor Roll), and the work in that area is progressing splendidly.

A new "worksheet" form is available for club or group work in addition to the plain logs, and club secretaries are requested to ask for this if they have not received a supply. The "character of occupancy" and actual occupancy for whole slices of frequencies are shown at a glance, once the form is completed by concentrated club work.

The standard Cairo blanks (log form) are available to every W or VE ham who wants more frequencies for operating work and is willing to put in some time making observations in the 4000-4500 kc. or 6000-8000 kc. range. Any receiver with a beat oscillator can be used. A card or message will bring you details.

Briefs

W8KWU, Grant Town, W. Va., reports a QSO on February 27th (4:50 a.m.) with KPQR, the Yacht *Orinoco*, off the northern coast of South America bound for Kingston, Jamaica. KPQR was on approximately 7100 kc.

Add father-and-son schedules: W9IBD, St. Paul, Minn., father; W7FLB, son.

'Phone Notes

A.R.R.L.'s leading group of Official 'Phone Stations comprise a nationwide 'phone operating organization of some 200, all of the better stations. Every station is kept at the highest peak of operating excellence by scheduling quarterly tests.

Since the last additions to the O.P.S. roster appeared in QST, the following 46 O.P.S.'s have received appointment:

W1DFQ	W4AOK	W6EOP	W8LUD	W9GSB
W1GMD	W4DGS	W6BEF	W8OXX	W9CGT
W1BR	W4CE	W6HY	W8ITS	W9MRH
W1GEX	W4DHG	W6MBN	W8AOM	W9TTA
W2HNP	W5CXQ	W7ENS	W9RUJ	W9SQH
W3EOZ	W6HJN	W7FHB	W9SFG	W9RE
W3WJ	W6HTY	W8AXQ	W9UOU	W9NUF
W3EMX	W6ELW	W8JDJ	W9KHC	W9TLQ
W4AGR	W6IKQ	W8KMT	W9UXA	VE5AV
		W8BZY		

All Official 'Phone Stations receive special bulletins from Headquarters. At the present time plans are being developed for an O.P.S. competition for next season. All 'phone operators joining the group within the next few weeks will receive full details and be eligible to take part.

The appointment carries some prestige as the group aim at leadership in 'phone constructional and operating practices. The O.P.S. Contest will weight experimental and constructional factors 50%, with another 50% on operating results in quarterly activities and "in between."

Invitation, all voice-operated stations: Drop a postal to A.R.R.L. for an O.P.S. application form and details on the appointment. On receipt of details fill out the form and send to the local Section Communications Manager elected by members, who will be glad to handle your application.

The January O.P.S. Tests

ALTHOUGH the quarterly tests ran under a new schedule of loss operating hours than in previous parties, results reported were generally excellent. W9WC forged to the front, making the best QSO-record. Conditions all over the country were excellent, and the lists of stations heard that accompany the next bulletin will make mighty interesting reading for all members who were on the job.

All Official 'Phone Station appointees are urged to pass the word along to additional well-designed amateur 'phone stations that new and additional appointments-to-the-qualified will be made in the next few months . . . and that the special plans for the next season's work will be open to them if they get signed up as O.P.S. at an early date. The following tabulation of results in the last operating tests (January 25th/26th) speaks for itself. The next scheduled test starts on April 25th—full information in the O.P.S. Bulletin as usual.

Station	QSOs	Sections	Heard	Score	Power	Section
W9WC	24	15	22	2,460	110	Illinois
W9HSF	22	10	3	1,160	325	Indiana
W8EMV	20	9	12	1,116	80	Ohio
W9CGT	18	8	9	864	170	Illinois
W9LLV	15	8	16	856	31	Indiana
W8GLA	16	8	7	762	300	W. Pa.
W9ITA	15	8	5	630	140	Illinois
W8MOL	14	8	7	672	180	W. Va.
W9ABD	13	7	12	623	190	Iowa
W8DZF	10	7	12	518	140	W. N. Y.
W4BYA	8	7	12	448	175	N. C.

Call	QSOs	Power	Score	Call	QSOs	Power	Score
W8CPJ	9	25	441	W9IDZ	8	160	252
W8IAI	13	260	405	W8JTI	11	180	249
W8AAR	7	...	305	W8ICF	8	150/350	230
W9ACU	9	20	295	W4QI	10	120	224
W8CSX	7	75	292	W3MG	9	45	212
W8HFR	9	100/350	285	W8KEF	5	150	172
VE3NX	9	85	275	W9NTP	4	40	168
W8KFN	6	90	260	W1GZL	2	75	148
W2QY	4	135	256	W9ATS	6	...	102

Worked All States Club

Charter Membership in the Worked All States Club closes with this issue of QST. Ninety-five amateurs have qualified for W.A.S. certificates as this issue goes to press! They deserve the congratulations of all operators on their achievements!!

Hundreds of amateurs missed the charter membership list by only a few states, some needing but one state to complete the forty-eight. Attainment of the W.A.S. award requires the cooperation of all amateurs in the matter of QSL's. Aim never to have it said that you are keeping someone from obtaining confirmations from all states by refusing to QSL!

Additional lists of W.A.S. Club members will appear in QST periodically. Forty-eight cards or other confirmations submitted to the A.R.R.L. Communications Dept. as proof of contacts with the forty-eight United States will make you eligible for W.A.S. certificate. Sufficient postage must be sent with the confirmations to finance their return. Contacts may be made on any of the amateur bands and at any number of different addresses, provided no two addresses are more than twenty-five miles apart. Send your confirmations as soon as you can qualify!!

Charter Members, W.A.S.

Order of listing indicates order in which they qualified for certificates.

Miles W. Weeks, W1WV; Wm. G. Mathis, W3BES; P. E. Littlefield, Jr. W1DUK; Hugh Y. Meetze, W3BBS; C. E. Gresak, W8AZD; Robert V. Byron, W1AVJ; Richard J. Cotton, 9DPX (W8LEC); Leon A. Weaver, W8BOF; F. W. Hartley, VE3JT; Richard C. Burgess, W8KWN; Roger T. Wilson, W8JTT; Roy W. McCarty, W9KA; Howard H. Brokate, W8AAJ; Russell E. Banker, W3BHV; Alva A. Smith, W9DMA; Warren Mallory, W9PGS; D. D. Smalley, W5DDB; Charles P. Weaver, W9DDQ; Ross J. Arrick, W8DPO; Herick Brown, W4Z-W4ABR; Paul B. Lovgren, W9AFN; L. W. Ballard, W3BVN; Roger F. Hathaway, W1RY; M. H. Gravelle, W4AG; J. C. Lisk, W8EQ; David J. Hoyer, W3BUX; E. F. Henning, W5BMI; Wallace H. James, W7AYQ; R. W. Collins, W8EUY; James H. Thomson, W9AQD; Edward H. Leland, W9MRW; B. B. Bachelard, M.D., W6JPW; J. W. Van Schaick, W9TY; C. W. Krueger, W8NKU; Harry G. Burnett, W1LZ; R. Causse, W3EVW; Stanley J. Belliveau, W7AYO; Norman Harrison, W9BTD; W. H. Rihedaffer, M.D., W8KKG; Benton White, W4PL; S. J. Mallory, W2CJX; G. Cecil Bate, W4BDD; Robert G. Creamer, W8ZKO; William Hall, W5ASG; Richard V. Schneider, M.D., W8AVB; E. L. Butcher, W9DMY; William Few, W4TR; Paul W. Hinkle, W9ABB; Robert L. Poucel, W2AYJ; Leland Melvin, W8CED; Elmer Grabb, W8DOD; Joseph B. Tomczyk, W9DBO; I. C. Gartner, W9DGL; Walter H. Smith, W6JMR; Lorents Arnold Morrow, W8DKE; Frederick H. Black, W1LQ; Howard E. Smith, W2GDF; Godfrey S. Summers, W3AAL; Rus Sackers, W8DED; J. P. Jessup, W2GVZ; Stanley C. Reed, W8IQS; Vernon G. Dameron, W8HGA; William Cheley, W8JV; Joseph P. Jatis, W9CYT; William Fritz, W5BZR; Geo. E. Forrest, W9ISM; William Sawyer, W8CGI; R. H. Lucia, W8BEN; W. Frank Clark, W6DHS; Harold Jolliffe, VE3IG; Wilber Harmer Durbin, W3DBD; Frank Reisdorf, W8ERX; Earl Wiseman, W6CPG (W6BHR); John Lucas, W9ICG; William Obrist, W9BEZ; William M. Atkins, W9TJ; Henry W. Hart, W5FHJ; Roger M. Lindley, W8FJN; Hayden W. Evans, W8EQC; Everett Kick, W7EK (7ABB); E. H. Gibbs, W8AQ; Horace Greer, W6TI; Nick Salopek, W8NFO; Frank J. Lundberg, W7BME; Lawrence A. Laser, W3CIC; Emmett Simmons, W5CPT; Oscar L. Short, W9RSO; Clifford Erickson, W8DAE; D. W. Rowe, W9BPU; Joseph K. Abronovich, W8ISA; Alfred A. Simon, W9KIK; Joseph Nester, W8KUN; William J. North, W8NP; Ivan H. Basson, W9DZX; James Headrick, W6CPB.

A challenge! W2EQS Jersey City, N. J., wants it known that he expects to be the first operator to make "WAS" on "160 meter" C.W. Who will take him up?

At the present rate, WAS records are being completed one a day or better! Someone, somewhere makes WAS each day. Did you complete yours today?

A.R.R.L. Trunk Lines

For reliable handling route your traffic via the A.R.R.L. All-O.R.S. Trunk Lines. The stations on each line, and the frequency on which each line operates, are as follows: **Trunk "A"** (3805 kc.): W8LOQ W8LSE W9ENH W9OXP W9KZL W7AAT W7BAK. **Trunk "B"** (3795 kc.): W3APV W8MHM W9EDQ W4CXY W9MZD W9RIZ W9PVZ W6GQC W6GYX W6LBE. **Trunk "C"** (3665 kc.): W1CRP W1IP W1FRO W1AFB W2KI W3EZ W3BWT W3BYA W4DW W4AKJ. **Trunk "D"** (3865 kc.): W4BDT W4BBV W4DS W5CWQ W5ABI W5EXZ W5ZD W5ZM W6KOL W6FQU. **Trunk "E"** (3870 kc.): W3CIZ W8MCR W9PAZ W9KEI W9POB W7DIE W7DBP W7ETO. **Trunk "F"** (3827.5 kc.): VE5FM W7APS W7WY W7HD W7KL W6LMD W6KGO W6BPU W6EFK. **Trunk "G"** (3626 kc.): W1EVJ W2BAJ W8JTT W8ICM W9NNM W9AZR W7COH W7NH W7DUE. **Trunk "H"** (3605 kc.): W9OQV W5AAJ W5KC. **Trunk "I"** (3690 kc.): VE1ER VE2DG VE3ABW VE3GG VE4AG VE4CM VE4MH VE4BZ VE5AV. **Trunk "J"** (3778 kc.): W9HPG W9BAZ W4APU W4AGS W4CQD. **Trunk "K"** (3835 kc.): W9KJY W9ILH W9FLG W5CEZ W5MN. **Trunk "L"** (3615 kc.): W2BCX W2EGF W8MOT W8UW W9HUO W9LCX W9FAM W9EKQ W6AXN. **Trunk "M"** (3655 kc.): W3DSC W3BKZ W8KNB W8HCS VE3TM W8AEQ W9PDE.

Trunk "B" operates as a Net daily at 7:00 a.m. EST. **Trunk "C"** functions as a Net daily except Sunday at 6:45 p.m. EST (northern end), and 8:00 p.m. EST (southern end). The eastern end of line "D" meets at 7:30 p.m. EST daily; the western end meets at 6:15 a.m. PST. **Trunk "F"** operates as a Net at 5:30 p.m. PST daily except Sunday. **Trunk "J"** stations meet daily at 7:00 p.m. CST. The central portion of line "L" meets as a Net daily except Sunday between 8:00 and 9:00 p.m. EST. **Trunk "M"** functions Net-style daily at 7:00 p.m. EST. If you want to hear some snappy traffic work, take a listen to these trunk lines at the times mentioned. The cooperation of all operators in preventing QRM on trunk line frequencies will be appreciated by every Trunk Line Station.

Qualifications for A.R.R.L. Trunk Line Stations are as follows: (1) O.R.S. appointment; (2) Crystal control; (3) Trunk schedules maintained at least five days per week; (4) Use of standard A.R.R.L. operating procedure and message form; (5) Arrangement for an alternate. Biley Electric Company furnished crystals for lines A, B, E, F, I, J, K and M; Murrill & Murrill (W8OK) for line C; and American Piezo Supply Company for line H. Crystals for lines D, G and L were supplied by A.R.R.L.

V.W.O.A. Banquets United By A.A.R.S.

By David Talley, WLNA-W2PFF*

The successful handling of greetings and roll-call messages between the various Chapters of the Veteran Wireless Operators Association on the night of February 11, 1936, fully demonstrated the proficiency and preparedness of the Army Amateur Radio System to furnish channels of radio communication whenever and wherever needed or desired. The Veterans' Wireless Operators Association—a national fraternal association of old-time commercial radio operators—through its National Secretary, Mr. Wm. J. McGonigle, W2ASN, had requested the cooperation of the Army in handling the exchange of messages to and from the banquets or "Cruises" of their Chapters whose members were assembled in hotels on the night of February 11th, in Boston, New York, Miami, New Orleans, Chicago, San Francisco and Honolulu. General Malin Craig, Chief of Staff and Major General James B. Allison, Chief Signal Officer, U. S. Army, made the facilities of the A.A.R.S. available

*Capt. Sig-Reg.

and certain Army Amateurs in the different cities were selected to handle this special demonstration as coordinated by the Liaison Officer, A.A.R.S. in the Office of the Chief Signal Officer, Washington, D. C.

A station was installed on the roof garden of the Hotel Montclair, New York City, where the main "Cruise" of the V.W.O.A. was held, and operated by Captain David Talley, Sig-Res., Radio Aide to the Signal Officer, 2nd Corps Area. This station, WLNA-W2PF, was the acting Net Control Station during this test, and promptly at 10:30 p.m. EST transmitted the net call "VWOA" on the special Army Amateur frequency 3497.5 kcs. This started the VWOA Roll-Call, and greeting messages addressed to the New York banquet were handled by the following Army Amateur stations in cities where the other banquets were being held: WLGO-W1ZQ, WLRO-W4AWO, WLRB-W4GQ, WLRQ-W5BN, WLTA-W9DDE, WLU-W9BNT, WLM-W3CXL, WLVB-W6BMC, WLVB-W6RJ and WYQB-K6EWCQ, all using 3497.5 or 6990 kcs. In addition to these stations, WLN-W2SC and WLN-F-W2BXC were standing by to assist WLNA-W2PF, if necessary. WLRB-W4GQ assisted WLU in handling Miami messages. WLVB-W6RJ backed up WLVB on the San Francisco traffic. WLM-W3CXL, Army Net Control Station, Washington, D. C., maintained a watch on both 3497.5 and 6990 kcs. and relayed the messages from San Francisco and Honolulu direct to WLNA in New York City. It was 11:20 p.m. EST when the last message from Honolulu had been received at WLNA at the Hotel Montclair, New York City. The V.W.O.A. Net was then turned over to WLM, Army N.C.S., who acted as Net Control Station during the interchanging of V.W.O.A. traffic which continued until past midnight.

More than two hundred V.W.O.A. members and their guests, including Colonel Alvin C. Voris, Corps Area Signal Officer, assembled at the Hotel Montclair, New York City, were able to listen to the various messages as received through the facilities of the public address system which was coupled to the output of the short-wave receivers.

ELECTION NOTICES

To all A.R.E.L. Members residing in the Sections listed below:

(The list gives the Sections, closing date for receipt of nominating petitions for Section Manager, the name of the present incumbent and the date of expiration of his term of office.) This notice supersedes previous notices.

In cases where no valid nominating petitions have been received from A.R.E.L. members residing in the different Sections in response to our previous notices, the closing dates for receipt of nominating petitions are set ahead to the dates given here-with. In the absence of nominating petitions from Members of a Section, the incumbent continues to hold his official position and carry on the work of the Section subject, of course, to the filing of proper nominating petitions and the holding of an election by ballot or as may be necessary. Petitions must be in Hartford on or before noon of the dates specified.

Due to a resignation in the Vermont Section nominating petitions are hereby solicited for the office of Section Communications Manager in this Section, and the closing date for receipt of nominations at A.R.E.L. Headquarters is herewith specified as noon, April 15, 1936.

Section	Closing Date	Present SCM	Present Term of Office Ends
Philippines	Mar. 10, 1936	N. E. Thompson	Mar. 15, 1936
Southern Minnesota	Apr. 10, 1936	Francis C. Kramer	Apr. 16, 1936
Utah	Apr. 10, 1936	Arty W. Clark	Apr. 16, 1936
Wyoming	Apr. 15, 1936	Atlas O. Adams	Apr. 23, 1936
Hawaii	Apr. 15, 1936	Chas. L. Simpson	Feb. 15, 1936
Oklahoma	Apr. 15, 1936	Forest D. Drew
Vermont	Apr. 15, 1936	Forest D. Drew (resigned)
Los Angeles	June 1, 1936	Howell C. Brown	June 14, 1936
Iowa	June 1, 1936	Phil D. Boardman	June 14, 1936
Western Penna.	June 15, 1936	C. H. Grossarth	July 1, 1936
Nebraska	June 15, 1936	S. C. Wallace	July 1, 1936
Western Mass.	June 25, 1936	Percy C. Noble	July 6, 1936
Illinois	June 25, 1936	Fred J. Hinds	July 6, 1936
Indiana	July 10, 1936	Arthur L. Braun	July 19, 1936

* In Canadian Sections nominating petitions for Section Managers must be addressed to Canadian General Manager, Alex Reid, 169 Logan Ave., St. Lambert, Quebec. To be valid such petitions must be filed with him on or before the closing dates named.

1. You are hereby notified that an election for an A.R.E.L. Section Communications Manager for the next two year term of office is about to be held in each of these Sections in accordance with the provisions of By-Laws 5, 6, 7, and 8.

2. The elections will take place in the different Sections immediately after the closing date for receipt of nominating petitions as given opposite the different Sections. The Ballots mailed from Headquarters will list the names of all eligible candidates nominated for the position by A.R.E.L. members residing in the Sections concerned. Ballots will be mailed to members as of the closing dates specified above, for receipt of nominating petitions.

3. Nominating petitions from the Sections named are hereby solicited. Five or more A.R.E.L. members residing in any Section have the privilege of nominating any member of the League as candidate for Section Manager. The following form for nomination is suggested:

(Place and date)

Communications Manager, A.R.E.L.
38 La Salle Road, West Hartford, Conn.

We, the undersigned members of the A.R.E.L. residing in the Section of the Division hereby nominate as candidate for Section Communications Manager for this Section for the next two-year term of office.

(Five or more signatures of A.R.E.L. members are required.) The candidates and five or more signers must be League members in good standing or the petition will be thrown out as invalid. The complete name, address, and station call of the candidate should be included. All such petitions must be filed at the headquarters office of the League in West Hartford, Conn., by noon of the closing date given for receipt of nominating petitions. There is no limit to the number of petitions that may be filed, but no member shall sign more than one such petition.

4. Members are urged to take initiative immediately, filing petitions for the officials for each Section listed above. This is your opportunity to put the man of your choice in office to carry on the work of the organization in your Section.

-F. B. Handy, Communications Manager

ELECTION RESULTS

Valid petitions nominating a single candidate as Section Manager were filed in a number of Sections, as provided in our Constitution and By-Laws, electing the following officials, the term of office starting on the date given.

Washington Robert H. Votaw, W7WY Feb. 17, 1936
Alberta Alfred D. Kettenbach, VE4LX Feb. 18, 1936

In the Virginia Section of the Roanoke Division, Mr. Charles M. Watt, Jr., W3UVA, and Mr. C. C. Morrison, W3BIG, were nominated. Mr. Watt received 80 votes and Mr. Morrison received 38 votes. Mr. Watt's term of office began January 17, 1936.

In the Alabama Section of the Southeastern Division, Mr. James F. Thompson, W4DGS, and Mr. J. W. Davis, W4DS, were nominated. Mr. Thompson received 42 votes and Mr. Davis received 39 votes. Mr. Thompson's term of office began January 17, 1936.

1.75-mc. Police Test

The Eastern Illinois and Western Indiana Radio Relay League, meeting on a 1.75-mc. 'phone each Sunday morning, decided to make an actual test of the effectiveness of its network, W9VV, Danville, Ill., secured a message from his Police Chief for transmission to officials in other Illinois and Indiana cities and towns. The message was transmitted by W9VV at 10:15 a.m., January 26th, and was retransmitted by W9AMO, Illinois key station of the network. W9NBZ is Indiana key station. In less than five minutes return messages were being received at W9VV. In all, fourteen direct replies were received from Mayors of towns, Chiefs of Police, Justices of the Peace, Presidents of town boards, etc. A radius of 150 miles was covered. The stations delivering the message and handling replies were: W9AMO, W9SQH, W9VTQ, W9STG, W9NQW, W9VV, W9VUH, W9PRV, W9LIG, W9VWC, W9FNT, W9ROQ, W9UNS and W9VON.

Station Activities

CANADA

MARITIME DIVISION

MARITIME—SCM, A. M. Crowell, VE1DQ—VE1GL keeps the H.A.R.C. net pepped up and schedules PAØASD every Sat. at 12.15 a.m. ER keeps regular T.L. schedules. HH's regular schedules are working FB; new schedule with W1ESI. IV is on 3.5 mc. GR worked G5VL on 3.9-mc. 'phone and got an R7 report. BL wants hook-up of receiver that'll bring in DX and no QRM! DB is running garage. HX is getting new receiver and trying out new transmitters circuits. FT is building new portable receiver for car. EY schedules W1AJ. We are sorry to hear BZ has been ill. GB is operating on 3.5 and 7 mc. GE is working 14-mc. DX. CO is hitting 28-mc. DX quite heavy. AP is chasing local QRM. AF is back on 3.5 mc. BD and EQ are rebuild-

ing. AC is working on new superhet. FR is still using flea power, mostly on 3.5 mc. DZ is on 28 mc. with low-power 'phone and C.W. BG is new ham in Pictou. ES has been doing lots of experimenting. AG is going places on 3.9-mc. 'phone—all battery power. JF on 3.5 mc. is a new station in Truro. GK has an FB sounding new rig. CB is another new ham in Truro. AR rebuilt the outfit to crystal control. HQ makes the low-power Class B 'phone go places. CF gets out well with his 3.5-mc. 'phone. IY, formerly of Alberta, is combining rigs with GG. Wanted by AW: "Excitation—and lots of it." HV is active on 1.75-mc. 'phone. GD sports a new D.B. mike. AA is rebuilding to use an 830 in final. GW just came on with fine 3.9-mc. 'phone using crystal mike. CD has gone crystal control. BH and GE schedule GM, NF'd, daily. FE is still going strong on 3.9- and 14-mc. 'phone. CV is giving 14-mc. DX a try. IX boasts a new SW3. DI has new FBXA. CX has new power transformer and is back on 3.9-mc. 'phone. EI was guest of EV and Moncton gang for FB get-together. Thanks to DC for use of rig to contact home station. IL is back from R.C.M.P. headquarters. DC is getting out swell on 28 mc. JD, week-end, visited DC and attended meeting of M.A.R.C. GS is experimenting on 56 mc. GI is squirting fit at the bugs in his transmitter. JB is working on M.O.P.A. CJ is QRL work. GU has new power supply. DO received W.A.C. certificate. BB doing experimental work on new type relays for remote control. HJ is getting out FB on 7 mc. AX is putting in new pair of '52's. EF gets out very well on 14-mc. 'phone. ET divides time between DX and new 14-mc. 'phone. CP finished new rig. FO is building swell rig with broadcast type steel rack. EK is taking a swat at 14-mc. 'phone. DQ still needs another Asian for that 'phone W.A.C. having talked with ZL3GR for 40 mins. on a recent QSO. DX is still the theme song at EP/HG. GY is putting in an RK20. EV is a new and much needed traffic man in Moncton. FQ landed a new job. GC, HC and Freddy are doing a lot of FB 56-mc. work. GH is rebuilding his 3.9-mc. 'phone. GC will soon be operating his own 'phone rig. BF is chasing an a.c. bug in his power supply. FU started in with 3.9-mc. 'phone and series modulation. CE is now on the air on C.W.; QRA-St. John. DW QSO'd Vancouver with 12 watts input on 3.9-mc. 'phone. BI is working 14-mc. 'phone with '03A final. HN is a 1.75-mc. 'phone man. BU works mostly on 3.9-mc. 'phone. CU and DN are on 7 mc. AI keeps Joggins on the map with 3.9-mc. 'phone. EA worked Africa using a '59 doubler in final on 28 mc. ES installed crystal control. IX is putting on a pair of '45's as temporary rig. JC puts out fine 14-mc. signal from Cariboo Gold Mines. The Halifax Amateur Radio Club extends its thanks for the cooperation of all the gang in making use of the "Report by Radio" plan. The S.C.M. wishes to say congrats to the R.M. and all net stations for the splendid work in handling this very FB traffic. GE keeps a daily schedule with W1HIO and tri-weekly with VE1GM at Gov't Wireless Station at Labrador. GE took a message from G5BP for Montreal and had it in Montreal 10 minutes later. Newfoundland: VO1H and VO1C were active in B.E.R.U. contest. Active during past month: VO1C, VO1F, VO1G, VO1H, VO1I, VO1L, VO1N, VO1P, VO1U, VO1W, VO2Z, VO3HM, VO4Y. VO1I got an FB write-up in one of the American newspapers. VO1C is very pleased with his Skyriider. VO1H is having some trouble with his Collins. VO1W is on in the wee sma' hours on 3.5 mc.

Traffic: VE1GL 176 ER 164 HH 27 GE 15 IV 4 GR 3 EA-EY 2 VO1W 7.

ONTARIO DIVISION

ONTARIO—SCM. John Perdue, VE3QK—R.M.'s: 3WX, 3TM, 3DU, 3GT, 3GG, 3RK, 3SG. 3ABW hauls off and takes the "pole" with enviable traffic total. FB, Jeff. GT challenges all comers in Bridge with a partner known as "Lou." SG is back in harness again with dandy traffic connections, and you will all be glad to learn that Mrs. Saxon is once again in good health after a lengthy session with the pillows. AU threatens activity on 14-mc. 'phone as well as 3.5-mc. traffic schedules. YE blew six tubes under traffic strain. VD does some FB traffic work on 7 mc. AE specializes in long hop traffic over 14 mc. . . . The Toronto Temegang are AIB, AEL, TY, ABE, AGO, ER, AQ, PC, NO, UF, KF, KJ, and XU. Thanks to the lat-

ter and AEL for fine dope on 28-mc. activity. XU works G5BY with 2 watts and is trying to excite P.P. '45's with '04A's MIM. AEL submits a Valentine poem from one of his 28-mc. fans! AEM showed the way in VE3 Contest with 60 QSO's in 21 counties with a total score of 3927 points. VZ is falling victim to the ways of an O.R.S. KM is DXing with his powerhouse along with IA and JU and an occasional shout from PO and QU. Mysterious Mr. X tells us that QE tries to blame the wind for loss of an antenna while HT, AFV, XT and TO laugh that one off. VY and ADH are about to use 1.75-mc. 'phone. TV went back to flea power to hook DX. EE says the service business is swelligent in Brantford. ZG and ACQ are members of Signal Section, 10th Brant Dragoons. We salute you, gentlemen. AES and VV jump off the deep end with XYL's. PS tries hard to go 'em one better by flying all the time. UP, VE, LU, MT, and ACN are active in the Telephone city. DU joined the "common people" with a crystal for Ontario R.M. Net drills on 3765 kc. PA sleeps all day to earn grub at night. AQ works 'em on 28 mc. with 59-802-801, 40 watts input. He may be found twiddling the controls of CRCT/CRCX in Toronto when not brasspounding. AHI is pres. of the Tricolour Radio Club; vice-pres., Mr. H. V. Kinsey; sec.-treas., VE3SR. The old Arts Bldg. houses the rig that signs BY, the club station, whose operating complement numbers SR, AHI, TL, EJ. From way up in the frozen North comes the word that GG's cat has had five kittens and AA hasn't spoken to him since. FW has up his 'phone schedule on 3520 kc. with the GG Man for 3 years. Nice going! There is a warrant out for GW if he is heard on 3.5 mc. after dark. GS uses 14 mc. for 'phone. GB is growing a couple of tamaracks for a 3.5-mc. sky-wire. GN is in the market for FBXA—cheap! HA, ole peerless Joel, is at CFB. DR leaves the land of Nipigon for W-land. BB says that GG has lost his technique, or his Brass Helmet, because all his rig is ashes after the big fire. WD says the YF has at last capitulated and will allow him to bring his rig from the office. Wonder how many sweaters WA wears under that bathrobe while working DX these blawsted frigid mornings. MY grabbed off a new pair of ten's for his final. AHE tests the "trunk lines" with an origination. AHL talks and talks crystal, but we're from Missouri we guess. AHN is QRM'd by auto QRM; he works in a Gas Station and has to brasspound between Tin and Tin . . . get it? CP is wearing kilts with XA and sporting a blond YL. ALL is a newcomer in Windsor on 7 mc. RO, the old salt, says that XA calls his new triple S'er, Tillie! BZ's portable is almost ready for Cairo Survey work. ZV is what GT used to call yours truly, "the flea on the hot griddle." FO twiddles dials at CKLW. FJ raises colles. GP, the ranch foreman, tries to work DX on 14 mc. YV helps QK tempt ex-3EC back into Hamdom. IK awaits the works of a nationally famous artist who was so taken with his layout that he insisted upon making an opus. WJ supplies the local gang with weapons for sparrows, B.C.L.'s, radio meetings and mosquitoes MIM. ABT has gone Hollywood in a projectionist's room. OE and Co. are QRL servicework, and work 56 mc. week-ends. AHK is having QSL trouble with 28 mc. MB is visited by MX quite frequently. Results of VE3 QSO Contest will be published next issue. To date it looks like AEM leads the pack with QB a close second. It is quite apparent that the VE3 'phone gang are cooperating with T.L. "M" on 3855 kc. For such fine spirit we congratulate and thank KM, GO, AU, AHW, etc. Orchids! gentlemen. Says VE3WK: "On Feb. 7th, at 1835 GMT, my CQ was answered by VE2CU, Radio Operator at Mud Lake, Que., for Dominion Skyways. He urgently requested me to put a message on the land-line to effect that a plane had damaged its tail ski in landing in the snow when forced down near Mud Lake. The message was addressed to Air Base at Rouyn, Que., and, as there was no radio op available there for some hours, considerable time would be lost if the message didn't get through immediately with orders to replace the damaged gear. The message was put on the land-line and the necessary parts were dispatched by plane to the scene of the accident as soon as it was received at Rouyn. I received a letter from VE2CU commending the performance of ham radio in this case of QRR."

Traffic: VE3ABW 459 QK 210 GG 180 VZ 144 AEM 134 WX 88 DU 70 MB 52 SG 50 YE 37 ZV 32 PL 30 CG 24

QUEBEC DIVISION

QUEBEC—SCM, Stan Comach, VE2EE—HK has procured an ACR-136 as a standby receiver. DU is sporting a Sky rider-Super-Seven. AR is proud possessor of an FB-7. LV sold his SW-3 and is importing a Super-Gainer. LJ is thinking of building one. BG, FO, ER and CR have been experimenting on 56 mc. CA and EW have been pounding on 28 mc. HP has a nice 'phone signal down there. AB is getting a new transmitter for LA. EC has blown himself to a new bug. DG has been winning lots of prizes, 2nd in W/VE test, 2nd in VE2 contest, and a prize from Communications Dept. of Quist. FB, Doc. KS and JI are newcomers. IJ has that '03A perking FB. IY is still using low power. DD is kicking a 211E on 14 mc. very nicely. BG has the honor of being the first VE2 to contact a VS-Hong Kong. FB, Tommy. HG received card from the VU he worked last December. That makes two new W.B.E.'s. KK is back on the air. HY, GT, CR and EV are operating 14-mc. 'phone. LQ, CU and GZ are still QRL Skyways up North, but can be heard very often on 3.5 mc. BU is still the old reliable traffic man. Speaking about traffic, look at DG and DR; that Trunk sure is busy. An O.R.S. certificate means schedules; no schedules, no certificate; fair warning! LP is giving code practice on 1.75-mc. C.W.; IA is active on 3.5 mc. IN has a nice signal. LN still schedules VE7NB. AG is putting his magic touch on the rig at HG. AM is getting quite a signal from those RK-20's. ER can be heard on 14 mc. every night. DQ is putting a good signal on 7 mc. We regret deeply the passing of W1AW and W3ZS, the Grim Reaper has taken a heavy toll. *Sic monumentum requirit, circumspice.* The days before the Convention are lessening in number. Have you invited your friends? The more we are, the gayer the meeting. Do your best to make it a happy memory. Talk Convention on the air.

Traffic: VE2DG 411 DR 338 EC 37 BB 68 BU 29 JK 41 GO 7 EE 12 CA 7 JI 1 HH 29.

VANALTA DIVISION

ALBERTA—SCM, A. Kettenbach, VE4LX—This is the retiring S.C.M.'s last report. Alf Kettenbach, VE4LX, Rockyford, has been elected to carry on. As Alf has been the leading traffic man, and as he operates both C.W. and 'phone, he should make an ideal S.C.M. Future reports should be addressed to him at Rockyford. QK and GE continue to do their bit. UY is active on almost all bands, including 28 mc. The radio clubs of Calgary are sponsoring a big two-day hamfest in Calgary on July 4th and 5th. Amateurs everywhere are invited to keep these dates open and come for a big time. With Calgary's big stampede and exhibition following from July 6th to 11th, it would make an ideal holiday for hams from any part of the Continent. United States hams interested should write to be placed on the mailing list. Communications addressed to VE4GD will reach the right parties. PB was a Calgary visitor with "Helen of Troy." FI was overheard getting 599 report from Tahiti. ZQ is now on at Seebe at the power dam. Another pilot, Herb Hopson of Calgary, has gone ham-minded, call 4RW. OD is proudly displaying a condenser mike. BW, AW and GD received 3.9-mc. reports from ZL. NV and IO are getting out on 1.75-mc. 'phone. LK has applied soup to an '03A. Thanks for your support, fellows. I enjoyed the S.C.M. job and sorry too busy to carry on. Will be seeing you all at the hamfest.

Traffic: VE4LX 133 GE 19 QK 8 UY 4.

BRITISH COLUMBIA—SCM, D. R. Vaughan-Smith, VE6EP—O.R.S. gang turned out FB for the last party. Among those present were AV, CC, FM, AC and EP. Our artist pal, FH, of "Amachewer" fame, succumbed to Cupid's advances and now it's Mr. & Mrs. Congrats, ole bean. The Island net is still going great guns according to BR. EU clicked with a job on police boat *Adversus*. HC and EO are jubilant at this removal of QR.M. JK is rebuilding with a view to operating 'phone on 28 mc. HC, GI and EP had a crystal-swapping party. Now everybody is happy! ER, now

at Wingdam, puts a husky signal into Vancouver on 3.9-mc. 'phone. HP's ship takes him on another jaunt to W6. JL is plenty busy on the "Anyox" while OK keeps his schedules for him. New Westminster Club recently reorganized and threatens to do big things. Victoria S.W. Club is still working on arc light interference elimination with little success! B.C.A.R.A. plans more active social programme, also a humdinger convention for this summer. Lots of traffic coming through T.L.'s "I" and "F." Let's have more reports next month. 73.

Traffic: VE5KU-GX 4 FM 27 KA 2 GI 11 AL 57 NG 1 AV 97 MK 14 CC 12 EP 37 OK 25.

PRAIRIE DIVISION

MANITOBA—SCM, A. J. R. Simpson, VE4BG—Report by C. W. Ferguson, VE4AG, Acting S.C.M. As our S.C.M. is enjoying a month's vacation in sunny California, it is probable that some of the reports have not reached the writer in time for this issue. We regret if such is the case, but they will be included in next report. Alex, 4BG, could not have chosen a more appropriate time for his trip, what with sub-zero weather for sixty-three days and no let-up in sight! Traffic is again picking up in Manitoba. MY and IS are making strong bids to get started in "Tfc." We are pleased to see MJ turning in good traffic reports again after being QRL due to his father's illness. FN, HF, ZA, IS, AP, MJ, CG, MK, IF, GC, VG, AG and a few others can be heard on 3.5 mc. with most other locals on 7 and 14 mc. and a few on 28 mc. "Mrs." NI is back on the mike on 14 and 28 mc. with the OM showing her how to operate the new "RME" receiver. TV has moved to Thepas, having obtained employment with a lumbering concern. XC of Dominioncity, the only Manitoba ham south of 49, and VE3ADP of Kenora were recent visitors to Winnipeg. TJ is still pulling in the DX and expects W.A.C. shortly. SS, VK-EK and VD are holding down 1.75-mc. 'phone. KU is coming out of hibernation and can be heard tuning up. The Manitoba Wireless Experimenters' Association is holding a beginners class. All those interested see Albert Jebb, VE4TJ. The Association promoted an all-band local QSO on Feb. 16th; winners will be announced later. The M.W.E.A. meets first Thursday of each month in the Tribune Board room.

Traffic: VE4AG 255 MK 23 MJ 17 VQ 58. (Dec.-Jan. VE4IP 28.)

SASKATCHEWAN—SCM, Wilfred Skafte, VE4EL—OC reports 14 mc. staying in until midnight most nights. UZ is getting good results on 7 mc. ES is going strong on 14-mc. 'phone. WF from East Poplar is now living at Weyburn. UL is keeping tab on the sigs. VU is doing well on 3.5-mc. C.W. and 1.75-mc. 'phone. VY talks to his folks each day. NE is up in Alta. but active over BA's rig. BF, QZ and PW are working out FB on 28-mc. rigs. TN and MB are receiving 28 mc. fine. TW, KM and VQ are rebuilding. UD hooked W3 on 1.75-mc. C.W. UH and YX are back on 7 mc. UG is building new receiver. PQ is visiting Toronto hams. UC is winding power transformer. JB is on with a 211. TI is active on 7 and 3.5 mc. FD is ironing bugs out of 14-mc. 'phone. PE went back to TNT. XB is going M.O.P.A. IG worked two VK's on 28 mc. JU is heard on 1.75-mc. 'phone. OM finished rebuilding. KA is making drastic changes. PG is hunting for Del., New Hamp. and Nev. for W.A.S. SY is getting new receiver. JV put split stator con. in final and gets good results. RE is on 3.5-mc. 'phone and C.W. EP is new ham in Moose Jaw. ZB is on 14 mc. ZC has new receiver. KS has B.C.L. trouble. FW is specializing with the Flu. KJ worked 576 miles air line on 3.5 mc. with 5 watts input, and is doing well with M.O.P.A. on 1.75-mc. 'phone. Ex-4JH is now 5EV. OR is operator at Dundurn. XM made velocity mike. UQ now has P.P. '52's in final. UK's 'phone has gone haywire. WO is building t.r.f. receiver. BD is rebuilding transmitter. EB is doing well on 'phone. UT nearly finished rig. OH has FB 56-mc. 'phone. DI is doing very FB on 14-mc. 'phone. He reports chain on 14-mc. 'phone Vancouver to Regina to Port Arthur to Montreal to New Foundland to London. CM is building new 'phone rig, Class B modulation, 53, 69, P.P. '10's; mod: 53, '46's.

Traffic: VE4CM 146 DI 27 EL 10 YM 2.

(Continued on page 104)

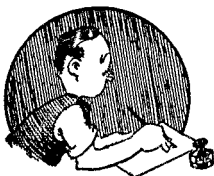

CORRESPONDENCE

The Publishers of *QST* assume no responsibility for statements made herein by correspondents

To T.O.M.

520 Hobart St., Oakland, Calif.

Editor, *QST*:

I shall esteem it a personal favor if you tell The Old Man the following:

Why in tarnation do you not tell
Some of these experts, "amateur gooks,"
Or a beginner, or experienced operator, as the
case stands,

That it is a well-known fact

And interesting to note

That CQ's are like dead sounds falling on deaf
ears

When one is minus a good receiver.

That in order to get out of one's back yard

The receiver must follow the CQ sent.

—O. B. Thomson, W6LFLK

2913 Market St., Wilmington, Del.

Editor, *QST*:

The Old Man's few random remarks in February *QST* were indeed timely and to the point. Have been reading T.O.M.'s quaint remarks in *QST* for years, in fact from the old spark days. W1CJD's cartoon of the old boy is excellent. T.O.M. warms the cockles of the hearts of us old-timers. Listened in on 40 meters after reading the article and noticed that the 45-word-a-minute speed maniacs had slowed up quite a bit. The weights had no doubt found their way back on the speed keys. T.O.M. sure brought 'em down to earth with the Buggbilly.

Do you think that T.O.M. could be induced to come out of retirement long enough to read the riot act to the Young Squirts who fill the air with an endless stream of CQ's before signing their calls? The CQ's go 'round and 'round but nary a signature, and the Y.S.'s wonder why they don't get replays. It's enough to make one give up in despair and pass on to another frequency.

Tell T.O.M. not to be too hard on the Young Squirts, though. They probably know not what to do as they pound the key and dream of worlds to conquer.

—Robert K. Pierson, W3CLU

EDITOR'S NOTE.—T.O.M. will never again "read the riot act" to the young squirts of amateur radio. The "30" of amateur radio's legendary figure, no longer mysterious, more than ever the grandest tradition our art holds, is recorded elsewhere in this issue.

To the defense of young squirts as castigated by T.O.M. in his last pronouncement arose Kent DeVinney, W8MLI; E. P. Haines, Jr.; Phil Robinson, W3EUQ; and John S. Duffy, W7DIE. Other letters were received from G. E. Brown, VE1EV; J. W. Singleton, W1CDX; and S. T. Remsnyder.

In pursuance of the T.O.M. tradition, "A Few Random Remarks" brought in several contributions (mostly anonymous) couched in his singular style and signed by take-offs on his famous characterizations; among them Young Squirt W3—, the Young Squirt's Uncle Edward, T.O.M.'s Offspring, Young Squirt II, the Rotten Young Squirt, etc.

----- Added Credit for Message Delivery?

188 Linden Blvd., Brooklyn, N. Y.

Editor, *QST*:

Each month more and more traffic is being handled as per the reports in the Operating News section of *QST*, and I am again reminded of that old and familiar subject of "deliveries" which has been with us since the first message was relayed.

In past years, the emphasis has been placed on the relaying of a message rather than its delivery as witnessed by the fact that a relayed message counts as two for A.R.R.L. ORS/OPS traffic reports. It is well known that delivery of messages—especially third-party ones—is very slow and unreliable and yet this means of publicity for the amateur is a very valuable one which should be encouraged if we are to ask for more frequencies as well as to increase our standing with the general public.

The emphasis placed on relaying messages and the cost in money and time in delivering traffic to the addressee, I believe, are out of proportion to each other. For example, a message from the Philippines is received by an amateur in the metropolitan area of New York City within twenty-four hours of its filing time by fast relays via the various A.A.R.S. or A.R.R.L. trunk lines. Instead of mailing the message so that it would reach its destination the following day, this amateur is more apt to relay it to another amateur in some part of the city because he gets two points for relaying a message and only one for delivery. Furthermore, it costs at least one cent for a postcard and multiplying this by one hundred messages per month delivered—the number to make the BPL on deliveries—you cannot blame this or

any other amateur for relaying rather than delivering a message. As a result, it may be days or weeks before said message is finally delivered if it has escaped the wastebasket in the meantime.

Therefore, I would like to suggest, as an aid in trying to improve deliveries, in addition to the basic count of one for each time a message is handled by radio, an *extra credit* of one point for each delivery made by mail, telephone, in person, by messenger or other external means other than use of radio (which would count as a "relay" of course). A message received by an operator for himself would continue to count "one delivered" as now, but a message for another amateur or third party delivered by an additional means or effort of the operator would, in addition to such basic count, receive a point under "extra delivery credits." This would not invalidate our present system of checking our national total or comparing originated and delivered messages for performance, but would show the number of deliveries made to other than the personnel manning the station. Comments on this proposal will be appreciated by Headquarters and by the writer.

—David Talley, W2PF-WLNA

Give Your Call, Too

54 Great Tower St., London, E. C. 3, England

Editor, QST:

. . . Say, OM, can you put a line in your columns to ask hams, when calling a station, not to call for five minutes before signing their own call? I have missed many a call through this because generally just as they give their call they either fade out or QRM pops up. Many a time a W—they are the worst offenders—will call me for about five minutes without signing; we here, you know, are supposed to call three times and then sign three times. That is in the terms of our license. . . .

—Gerald Marcuse, G2NM

Tribute to King George

Savary Island, British Columbia

Editor, QST:

I have been asked, on behalf of the members of "The B. C. Island Net" including VE5BL, VE5AV, VE5PH, VE5MK, VE5DE, VE5BY, VE5MU, VE5MV and others, to write to you, and express our great appreciation of the voluntary silence observed by so many U. S. Amateurs on Sunday, January 26, 1936, out of respect to the memory of our late King George V.

We feel that a gracious gesture of this nature does much to strengthen the bond of friendship that exists between the two countries.

—A. J. Spilsbury, VE5BR

Radio "Amateurs"

17 West St., Waterville, Maine

Editor, QST:

In the January edition of QST you ask for suggestions covering the demoralizing of the name "radio amateur" by attempts by amateur entertainers to entertain the public. That "hams" have suffered some from this appropriation of their name is true, but it will be hard to break old habits and give them a new name.

However, here's a suggestion (you asked for it): give hams a fuller name, call them "radio transmitting amateurs." No one can get around that one, I think. . . .

—Frederick W. Smith, W1IKC

37 Broad St., Westfield, Mass.

Editor, QST:

What think you, KBW, of the term "broadcast amateurs" to be used to designate those who warble forth from broadcast stations, instead of the now popular "radio amateurs"? They are amateurs at *broadcasting*; not amateurs at radio.

—Percy C. Noble, WLG-W1BYR

Albany, N. Y.

Editor, QST:

. . . Re Warner's editorial on the confusion of the term "radio amateur." I have often wondered why QST and amateurs in general did not stick to the good old descriptive word "wireless" instead of adopting "radio"? I think the general public would have a better conception of what we were doing and what it was all about if the word "wireless" were used instead of "radio" with reference to our hobby.

I believe the average person readily associates the word "wireless" with communication between ships and ship to shore where communication is carried on between two points. Similarly, the average person associates the word "radio" with broadcasting as he knows it—the b.c. receiver with its blah and what-not.

Since our method of operation and communication is more nearly like the ship and shore work than broadcasting, it seems to me that the average person would come nearer to having an idea of what we were and what we did if he were told we were wireless amateurs or that the message being delivered to him had come by amateur wireless than if we said "radio." And our friends wouldn't think we were trying to get a job through Major Bowes!

—G. M. Ferguson, W2BJA

Another WA(8)C

c/o WKBO, Harrisburg, Pa.

Editor, QST:

I saw in the Correspondence Department the letters of W2GOQ and W9CP in regard to having contacted eight continents WA(8)C so am entering my application in this new "worked all" club.

W3SI has contacted the eight continents on several bands (7- and 14-mc.).

—Charles Myers, W3SI-W3CCF

Reading QST

Station Hospital, Fort Devens, Mass.

Editor, QST:

I wish to comment on Mr. Merrill's fine article in February QST. It's about time that somebody suggested giving QST a little more attention and study. I have been a regular subscriber to your fine "mag" for almost two years now and have been a licensed "ham" for about the same length of time.

I don't think I ever really read QST until I started my second year's subscription. The first few months I'd anxiously grab at my QST when it arrived and spend an intense half hour looking hurriedly through the various articles. Doubtlessly many QST readers are doing that very same thing today.

An older brother, who is a college grad, must have noticed the way I was skimming through the "mag." He suggested a more thorough and systematic reading.

Now, instead of skimming through QST in an hour or so, there's actually enough material in it to last me the whole month. My method is probably not as systematic and thorough as Mr. Merrill's, but here's how I got 100% more practical knowledge and enjoyment out of QST:

1. Read over the article carefully first.
2. Then re-read it, underlining such statements and bits of information as are deemed important.
3. Make marginal notes on such things as are not clearly understood, or on things that seem erroneous or not conforming to the reader's ideas on the subject.
4. The blank space at the bottom of each page does very well for entering general comments and suggestions.

Systematized reading sure has changed my attitude towards the "mag," too. I'll admit that I was once tempted to discontinue subscribing, but now I simply couldn't get along without it.

Some of you hams that never pay any attention to anything but technical articles ought to be advised that there is a wealth of information in the following departments of

(Continued on page 78)

On Measuring Signal Strength at the Receiver

THE MOST obvious use of the S-meter is in making R-S-T reports. To be sure, such reports are often made merely to satisfy the curiosity of the operator of the transmitter, but they can be extremely useful as well. For instance, when a transmitter is being adjusted, or antennae changed, it is far more useful to know that power is up 3 db than to know that the signal is "quite a bit louder." One is apt to be suspicious of the latter report when several days elapse between tests.

Also, much is being done to keep track of the vagaries of radio waves. Some day we will know much more about the effect of sun spots, and movements of the Heaviside layer and so forth, than we do now. When that day comes, we suspect that a lot of the credit will go to amateurs who have kept an accurate log of signal variations from reliable transmitters.

For this kind of work, records in db are more useful than in S units, because nobody knows just how large an S unit is. In calibrating the meter, we made each division from 1 to 9 represent a power ratio of two to one, or 3 db (approximately). This agrees pretty closely with what the average amateur thinks an S unit is, as we found by checking up on actual signals. In addition to being less arbitrary, such a scale has the great virtue of being easy to convert to db, it merely being necessary to multiply by three.

A meter calibration in microvolts does not mean much. In spite of this, many amateurs desire such a scale and a calibration curve is printed in each instruction book. For the benefit of those who have lost theirs, it is reproduced on this page. The calibration was obtained by connecting the receiver through a standard dummy antenna to a standard signal generator. The ordinates represent microvolts across the input terminals under certain load conditions, and have no simple relation to the absolute field strength. For this reason, we do not think it means much, and for this reason, we have not calibrated the meter itself in microvolts.

The fact of the matter is that readings are influenced by so many variables that it is impossible to measure the absolute signal strength in any direct manner. Even if the antenna were calibrated, and an R.F. voltmeter could be made so sensitive that it would measure voltage on the antenna, its readings would be mostly meaningless because they would indicate the general noise and interference level rather than that of any particular signal.

Consequently the measuring device must be connected at (or near) the second detector in order to obtain selectivity as well as sensitivity, and in order to make absolute measurements it is necessary to correct for the selectivity (side-band suppression, etc.) as well as for the overall gain of the amplifier. All of which becomes so complicated that the best way to make absolute measurements is to compare the unknown field with a known radiation from a standard signal generator.

For purposes of comparison, the problem is much simpler. With the measurements made at the second detector, the loud speaker can be used as a monitor to make sure that the noise level is low enough and that the sidebands are coming through. Overall gain of the amplifier is taken care of with sufficient accuracy by the design of the meter.

This last is a story in itself, and we will only touch on it briefly. Since the set is normally used with the AVC in operation, the meter is designed accordingly. With an effective AVC, such as used on the HRO, the carrier strength is practically constant at the second detector throughout the working range. The problem is therefore to design the meter to measure the gain of the amplifier. The mathematical expression for the gain per stage of a receiver is quite complicated, but in a given well-designed receiver many of the terms become constants and the gain is determined by the tube constants, particularly the mutual conductance. Taking another long jump, we found that if a correction was made for the plate voltage, the D.C. plate current was a measure of the gain. In the actual circuit used in the receiver, the plate circuits of the tubes are made one arm of a Wheatstone Bridge, the other arms being resistors, and the meter being the null indicator. Careful tests have shown this arrangement to be surprisingly accurate, even though it may sound like a *reductio ad absurdum* to hard-boiled theorists.

JAMES MILLEN

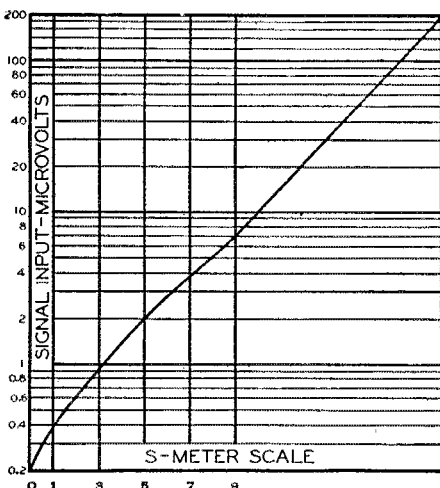
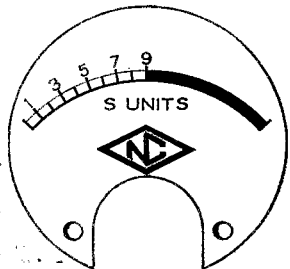

First IMPRESSIONS COUNT



Look!
AT THIS
ATTRACTIVE
ELECTRICAL
INSTRUMENT
FOR YOUR
PANELS

MODEL 321 0-1 D. C.
MILLIAMMETER

**PRECISION
WITHOUT
EXTRAVAGANCE**

Insist on Triplet instruments for your new transmitter. Here is shown but one of the popular models from which you may choose.

Triplet electrical measuring instruments are extremely rugged and dependable. Accuracy within 2%. Attractive, dustproof molded cases. D.C. are D'Arsonval, A.C. — the moving iron repulsion type.

Satisfaction Proven by Comparison

SEE THEM AT YOUR JOBBERS

FHA APPROVAL — Triplet panel instruments, when used in the construction of installed test panels, are eligible for purchase and installation under the Modernization Credit Plan of the Federal Housing Administration.

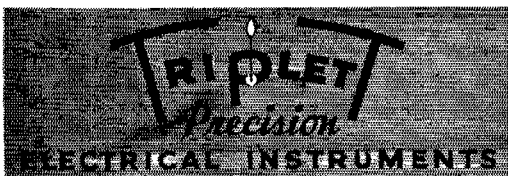

MAIL THIS COUPON!

TRIPLET ELECTRICAL INSTRUMENT CO.
254 Harmon Drive, Bluffton, Ohio

Please send me New 1936 Catalogue

Name _____

Address _____

City _____ State _____

Correspondence Department

(Continued from page 74)

QST that probably concern you and your status, as a radio amateur: The Editor's Mill, I.A.R.U. News, Operating News, and The Correspondence Department.

—Robert J. La Cava, *W1IFR*

Counting Sunspots

E. 14, Sinto St., Spokane, Wash.

Editor, *QST*:

Since activity on the 28-mc. band has increased to such a large extent, it seems worthwhile to investigate some of the reasons for the transmission variations in this band.

It seems possible that sunspot activity may have a bearing particularly on these higher frequencies. The average amateur comes back at you and says "Yes, that seems quite interesting but how do I keep track of the spots on the sun?"

With the aid of a moderately good pair of field glasses or binoculars fitted with dark glasses one can quite easily watch the spots and observe their daily variation. The dark glass which seems most suitable for this purpose seems to be a nearly opaque glass known as No. 12, made for welder's goggles. Although this will work placed either in front of the object glass or behind the eyepiece, it is preferable to use them behind the eyepiece. They have less effect on the optical system in this position. The writer had a single 50-mm. disk cut into two small disks which are stuck into the eyepieces of a pair of 8-power Zeiss Binoculars with two strips of friction tape about 1/16-inch wide. This isn't a fancy mounting but serves the purpose.

Danger—don't look at the sun through any kind of a telescope or field glass without the protection of dark glasses!

Even quite small spots are plainly visible, and observation of their daily variation is extremely interesting.

—L. M. Belleville, *W7CFX*

Name Your State

277 West End Ave., New York City

Editor, *QST*:

When a W2 hears a W9 calling CQ, if the 9 is in Indiana he probably will not call him, yet if in Colorado he is DX. How is he to find this out? To look up each individual call in the call-book would take too long and to call each W9 (especially when new states are wanted for the W.A.S. certificate) would take too long before the right state was worked. Now my suggestion is that at the end of each call the abbreviation for that state be signed. Thus a CQ from W9XX would go "CQ CQ DE W9XX COL" and the W2 listening will immediately know if he wants that W9. . . .

—Larry LeKashman, *W2IOP*

R.A.C. Notes

Los Angeles, Calif.

Editor, *QST*:

I am just a young squirt, as The Old Man says, but I have a good pair of ears on my head. In other words, it's about these super r.a.c. notes on the air these days. The 7-mc. band is quite full of them now. I believe that such a condition is interfering with amateur communication.

I have also noticed that it isn't us young squirts that are guilty of this act. Except for one W6, all of the stations harboring the note were old-timers. Tell The Old Man to put that in his hat and smoke it. Hi!

Personally these notes don't hurt me by interfering, but I'll bet some poor guy has had a swell QSO busted up by one of those r.a.c. stations! So on the behalf of the rest of us guys who like to see the American ham push forward and not backward to the old King Spark days, I am asking those fellows to please put some filter on their rigs and become respectable radio amateurs again.

—Ted Jacobs, *W6LHW*

About Noise Silencing

1100 Glendale Blvd., Los Angeles, Calif.

Editor, *QST*:

Just a line to compliment James J. Lamb and the staff of *QST* on the development of the noise-silencing intermediate amplifier. . . . Several of the West Coast hams

**THOROUGHNESS
IN
EVERY DETAIL**

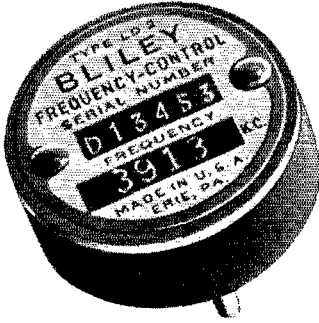

ABOVE: Type LD2
Low Drift Unit
\$4.80

CENTER: Type HF2
High Frequency Unit
\$7.50



RIGHT: Type BC3
X-Cut Crystal Unit
\$3.95

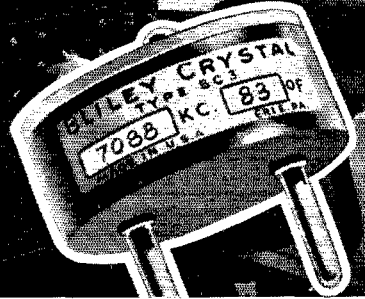

Take Calibration for example

No expense has been spared in securing the finest calibrating equipment possible for checking finished Bliley Crystals.

The General Radio primary standard of frequency — accurate to 1 cycle in 5,000,000 cycles — that guarantees highly accurate calibration of all Bliley Crystals, is characteristic of Bliley thoroughness employed in the production and testing of amateur crystals of outstanding value.

Whether it's the new Bliley HF2 Unit — tailor made for the 20-meter band and which permits simplified 10- and 5-meter operation — the Type LD2 low-drift crystal unit for the 40-80-160-meter bands — or the lower priced Type BC3 for 40 and 80 meters — each offers you the greatest dollar and cents crystal values obtainable today. Bliley Electric Company, Erie, Pa.

In addition to amateur crystals the Bliley Electric Company manufactures a complete line of crystals, holders and ovens for operation between 20 Kc. and 20 Mc. Bliley broadcast frequency crystals and ovens are approved by the Federal Communications Commission

The new Bliley Catalog G-8 contains valuable technical information. Your nearest Bliley dealer has a copy for you.

BLILEY CRYSTAL UNITS

THESE SPLENDID BOOKS FREE!



THINK OF IT! 2 books full of invaluable information, to be had for just the mailing costs! One with 20 complete transmitter designs including 12 tested transmitter RF section designs and 8 modulator and speech amplifier designs. Circuits, complete parts specifications, inductances, etc. all included. Outputs ranging from a little fellow all the way up to the big ones comparable to the best broadcasters.

Ten complete designs for public address amplifiers in the other book. It includes one for every purpose, from 3 Watts to 30 Watts output, tried and tested designs that you can build, with complete parts lists for each.

These books should be in every amateur's technical library. Just 22 cents in stamps, to cover postage, brings them both to you, or get them from any Standard Distributor. Send for your copies today.

STANDARD TRANSFORMER CORPORATION

856 Blackhawk Street, Chicago, Illinois

MAIL THIS COUPON!

STANDARD TRANSFORMER CORPORATION
Dept. A, 856 Blackhawk St., Chicago, Ill.

I am enclosing 12c for Transmitter Manual
I am enclosing 10c for Amplifier Manual

Name.....Address.....

City.....State.....

have the idea built in their supers already and insist it is the greatest asset to 10- and 20-meter reception yet developed. . . .

—Maurice E. Kennedy, W6KQ-W6BGC

131 California St., Ridgewood, N. J.

Editor, QST:

. . . The noise filter works to perfection. Tnx for developing it. . . . On a Comet Pro it is essential to re-align the i.f. transformers both ahead and after the noise filter.

—Pat Jessup, W2GVZ

CAMBRIDGE MASS
CONGRATULATIONS ON YOUR EXCELLENT
IDEA WHICH ELIMINATES MAN-MADE NOISE
IT IS WORKING OUT FB HERE . . .

—CLYDE J. HOULDSON

Hydro, Ontario

Editor, QST:

. . . All the b.c.l.'s are delighted and say no more key clicks from hams with using your rig. They want to build a statue in your honor. . . .

—M. J. Caseney, VE3GG

EDITOR'S NOTE.—From all sections of the radio press, from all branches of the radio industry, from any number of interested laymen, as well as from enthusiastic amateurs, have come letters of praise for the noise-silencing development. The small fraction reproduced above were chosen at random to demonstrate just one point: the thing works as built by hams by ham methods! And that, after all, is the only important point to be conveyed.

More Developments in the Noise-Silencing I.F. Circuit

(Continued from page 18)

order to keep the over-all amplification of the receiver at its original value. This means normally small cathode-drop bias on the No. 3 (silencing) grid of the 6L7 which replaces the usual first amplifier tube. Accordingly, a higher order of rectified noise voltage would be necessary for good silencing action, especially on weak signals, requiring the additional noise amplifier stage. While this is entirely practicable, it would demand a considerable rearrangement of the internals of an existing receiver. Either the receiver's first i.f. stage would have to be cut out, and the silencer-amplifier cut in ahead of the filter unit; or the filter would have to be wired in between the first and second stages (an awkward procedure in almost every type of s.s. job) with the 6L7 silencer tube replacing the conventional first i.f. pentode. The crossing up of r.f. leads that this introduces is almost inevitably certain to lead to regeneration troubles. Regeneration, it must be emphasized, simply cannot be allowed in the silencer and associated circuits. If it does get in, the action immediately becomes sluggish and noise pulses become prolonged just as they do in the crystal filter or in any other low decrement circuit.

Before arriving at the final circuit diagrammed in Fig. 2, which represents the method blocked out in Fig. 1-A, both of the described variations of method B were thoroughly tested in a standard Single-Signal receiver having two high-gain i.f. stages. Although the method of A was anticipated as the simpler and more straightforward in application, there was one important point which needed experimental trial. With the single-stage noise amplifier of the first method there is only

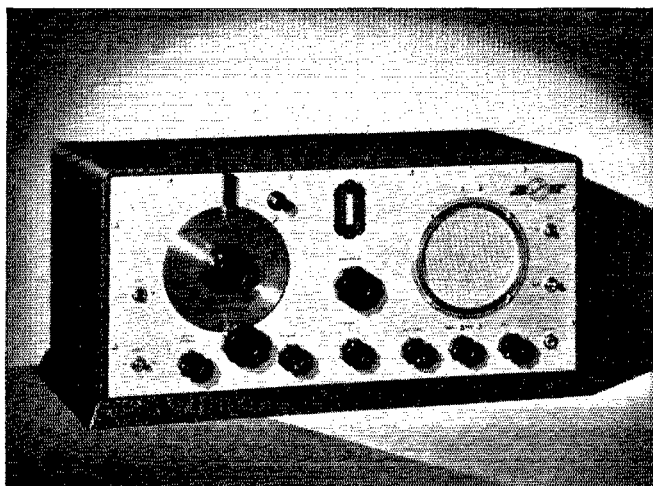

the
**SUPER
 SKYRIDER**
 is
COMPLETE!

THE HAM that buys a Super Skyrider with Crystal Filter at \$89.50 is buying all that he needs for short wave reception. Here is a receiver that covers the radio spectrum, standard broadcast band and the 10 meter band, so active of late. Recent Hallicrafters' laboratory developments have greatly increased the Super Skyrider efficiency on this particular band.

It's complete, without a single extra to buy, with a convenient band switch (no cumbersome plug-in coils), controlled Crystal Filter Circuit (an absolute necessity on any receiver because of amateur band congestion), 9 Metal Tubes with their superior performance characteristics, Iron Core I. F. System (first used on the Super Skyrider) and a dozen other exclusive Hallicrafter developments.

Think of these features when you're buying short wave reception, and see the Super Skyrider at your jobbers today. It's supreme for short wave reception and complete at a single moderate price.

● **9 Metal Tubes** — Dovetail perfectly with our efforts to improve signal to noise ratio — eliminate noisy tube shields — reduced inter-electrode capacities and shorter leads afford greater gain.

● **Iron Core I. F. System** — greatly increased sensitivity and a signal to noise ratio unattainable with an air core system.

● **Duo-Micro-Vernier Band Spread** — provide improved logging accuracy — provides electrical band spreading and micro-vernier tuning in an exclusive and distinctive dial.

● **More efficient Crystal Filter Circuit**, controlled by variable knob on front of set gives one signal selectivity — without reducing sensitivity.

● **Beat Oscillator** with continuous range.

● **Modern Band Changing System** — any desired bands in the short wave spectrum with the turn of an exact positive switch — no cumbersome plug-in coils.

● **Compact** — all completely enclosed in one convenient and efficient cabinet 19 1/4" x 10" x 10".

**Announcing
 the
 Ultra Skyrider**

Hallicrafters new 5-10 meter set. High efficiency. 3.9 to 49 meters tuning. 10 metal tubes. See it at your jobber's on April 20.

SEE YOUR JOBBER TODAY OR WRITE FOR COMPLETE DETAILS



the hallicrafters™

3001-Z Southport Avenue, Chicago, Illinois, U. S. A.

Cable Address: "LIKEX—New York"

Say You Saw It in QST — It Identifies You and Helps QST

EASY TO DRIVE

RAYTHEON RK-31

ZERO BIAS CLASS B MODULATOR

A pair requires but 900 milliwatts grid drive to produce 140 watts of audio power. No bias required. The ideal modulator for all phone transmitters up to 300 watts input.

FILAMENT 2.5 V., 3.0 A.
A. F. OUTPUT: 110 Watts per pair at 1,000 V.
140 Watts per pair at 1250 V.
OVERALL DIMENSIONS . . . 2-1/16" x 8 1/2"
AMATEUR NET PRICE \$10.00

RK-34 . . . Ultra High Frequency Triode
Isolantite Base. Plate leads out top of bulb. Uni-potential cathode system.

HEATER 6.3 V., 0.8 A.
R. F. OUTPUT at 300 V. 14 Watts
AMATEUR NET PRICE \$3.50

RK-23, RK-25 . . . Radio Frequency Pentodes
for the Oscillator and amplifier. Lowest losses, lowest internal capacities, highest output in their size classification.

Isolantite Base. Plate mounted on ceramic spacers. Plate connection at top of bulb. RK-23 equipped with 2.5 volt heater. RK-25 has 6.3 volt heater.

R. F. Output at 200 V. Screen, Plus 45 V. Suppressor and 500 Volts Plate. 24 Watts.
AMATEUR NET PRICE—Either Type, \$4.50.

Ask your dealer or write to the nearest Raytheon Office

RAYTHEON PRODUCTION CORP.
30 EAST 42nd STREET, NEW YORK, N. Y.

55 Chapel St., 445 Lake Shore Dr., 555 Howard St.
Newton, Mass. Chicago, Ill. San Francisco, Cal.

RAYTHEON

AMATEUR RADIO TUBES

the selectivity of its two coupling transformers ahead of the noise rectifier—and the diode input transformer not any too selective, at that; while with the two-stage noise amplifier of B there could be two transformers of pretty good selectivity in addition to the less selective diode transformer. This latter line-up would have about the same order of selectivity as the usual two-stage i.f. amplifier, and would be comparable to the line-up preceding the noise amplifier of the decidedly successful second-stage silencing system described in February *QST*.

The important point demanding experimental check was this: With the noise circuit considerably less selective than the crystal i.f. circuit, would not the stronger of two adjacent c.w. signals trigger the silencer when the attempt was made to receive the weaker signal with the threshold adjustment set for good noise action? Previous experience had shown that the threshold adjustment was generally less critical for c.w. reception than for 'phone with ordinary i.f. selectivity, and the comparison tests showed that it was even less critical with the crystal filter in action behind the silencer, the crystal taking over the burden of cleaning up residual noise after the silencer had brought down the amplitude to a level which eliminates shock excitation of the crystal. While the selectivity and more uniform a.v.c. action of an additional noise amplifier stage still would be advantageous for straight superhet reception, the one stage works out to be generally satisfactory for reception of amateur signals, c.w. and 'phone, crystal in or crystal out of circuit.

CIRCUIT FOR ONE- AND TWO-STAGE INTERMEDIATES

The final circuit for an S.S. superhet having two i.f. stages is given in Fig. 3, while the two photographs illustrate its application to a National HRO receiver. Except for the separate input transformer to the noise amplifier and silencer tubes, and the biasing network for reducing the gain of the silencer stage, the circuit is practically the same as the original versions given in February and March² *QST*. The only part of the i.f. circuit of the receiver which is changed is the path from the first detector plate to the crystal filter input. The leads from the plate of the first detector to the silencer input transformer and from the silencer plate back to the crystal filter are of the low-capacity shielded type, as shown in the bottom view. The added "porch" on which the silencer section is mounted is more roomy than necessary for the silencer equipment, having been made large enough to accommodate another tube and transformer for the two-stage noise amplifier trials. The extra transformer and socket positions may be used for an amplified a.v.c. system, being conveniently located for that purpose.

A higher than normal value of cathode resistance (2000 ohms) is used in combination with a screen voltage bleeder-divider to obtain the in-

² Grammer, "Operating Noise-Silencing Units," *QST*, March, 1936.

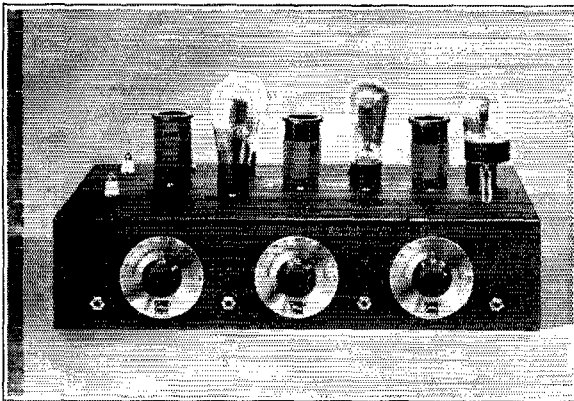

CW-25 Crystal Control TRANSMITTER

Output: 25-30 Watts

**COMPLETE KIT
LESS TUBES AND CRYSTAL
\$14.95**

The CW-25 Crystal Control Unit is designed both for the beginner who is using crystal control for the first time and the old timer who wants good workmanship, fine appearance and dependable operation. It may be used effectively as a medium low powered crystal controlled transmitter or for exciting a larger tube such as a 203-A, 211, 242-A, 800, and the 50-T. Used either as transmitter or exciter, it operates efficiently on the 1.7, 3.5, 7 and 14 mc. bands with an output of from 25 to 30 watts.

For amateurs, however, who wish to achieve the last word in station appearance and reliable, efficient operation, we suggest that they use the CW-25 in combination with the R-25 Rack, frame and meter panel and the P-25 Power Supply. Each of these pieces of equip-

ment has been especially designed in unit form for just such a combination.

Circuit and Tube Lineup: The circuit has been specially designed for operation on all bands with utmost efficiency. It employs a 47 type tube as crystal oscillator; a 46 used as a buffer or doubler and two 46's in the third stage which may be operated as a straight amplifier or doubler depending upon the frequency of the crystal used.

Power Supply Requirements: Filament voltage, 2 1/2 volts at 6 amperes. The same plate voltage, from 350 to 450 volts, may be employed for all stages.

Coils: One complete set of three coils for operation on any one of the amateur bands is furnished as standard equip-

ment. Coils for the 1.7, 3.5, 7 and 14 mc. may be purchased separately.

Power Connections: Contributing to the efficiency and trim appearance of the Unit are the socket and plug and cable-type outlets for all power connections.

Crystal Holder: A standard Gross crystal holder is included in the price of the Unit.

Metering: Four jacks are provided on the front of the chassis for metering all plate circuits and the grid circuit of the amplifier. The grid jack can also be used for keying. The entire unit can be tuned up efficiently, with only one milliammeter.

Size: Overall dimensions of the Unit are height, 4 1/2 in.; width, 11 in.; length, 19 in.

P-25 POWER SUPPLY — for CW-25 transmitter with matching chassis — **\$11**
450 volts at 200 MA, choke input—complete kit, less tube

The "EAGLE" Three-Tube Short Wave Receiver

"Band Spread" over any portion of the tuning range — only finest material used thruout. Employs one '32 R.F., one '32 detector and one '33 Pentode Audio — 15 to 200 meters — four coils supplied. The "EAGLE" is economical — two dry cells will operate the filaments. Excellent value in short wave receivers.

"Eagle" completely wired and tested. . **\$11.95** Three tube tested in your receiver. . **\$3.00**

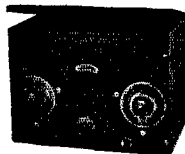

THE ALL-STAR BUILD-IT-YOURSELF TRANSMITTER

See page 83, Feb., 1936, *QST*, then send for circular which gives full details. A high power job (400 watts input) composed of finest parts such as Thordarson, Hammarlund, etc. All chassis and panels are punched, chassis being cadmium finish, panels black crackle finish. Save by building it yourself.

	Less Tubes	With Tubes
40 WATT RF UNIT	\$37.90	\$50.12
LOW VOLTAGE POWER SUPPLY	29.90	30.42
RF AMPLIFIER	46.24	82.24
HIGH VOLTAGE POWER SUPPLY	52.75	57.25
TWO HUNDRED WATT MODULATOR	27.78	63.78
SPEECH AMPLIFIER AND POWER SUPPLY	35.38	39.54

NEW RCA ACR-175 AMATEUR RECEIVER

5 to 600 meters, continuous. Ultra-Selective crystal filter. "Magic Eye" tuning and signal strength Indicator. Iron Core I.F. Transformers (permanent alignment, high gain). 11 Metal tubes, two I.F. stages. Pre-Selection. Band change by switch. Complete with tubes, crystal, speaker **\$119.50**

HALLICRAFTERS SUPER-SKYRIDER

Complete	\$79.50.	With crystal	\$89.50
SUPER SEVEN, complete			49.50
HAMMARLUND "SUPER PRO" SP-10, complete			223.44
SP-10X, complete with crystal filter			241.08
RME69, receiver only			118.80
RME69, complete, tubes and mounted speaker			134.90

20% DEPOSIT WITH ALL C. O. D. ORDERS

REMIT BY M. O. INCLUDE POSTAGE

Cable Address: GROSSING

GROSS RADIO, INC., 51 VESEY STREET, NEW YORK CITY

RME

3R9 TRANSMITTER



More real watts per dollar.

More real performance including the 28 mc. band.

More real efficiency from every stage than ever before.

This transmitter is conservatively rated at 100 watts to the final stage.

At no additional cost to you we have included a controlled carrier phone circuit in addition to the regular Class B.

It is new and highly efficient, modulating the carrier at 100% at all times. Throwing a switch connects either system.

Excellent characteristics throughout.

The neatest appearing transmitter.

Bulletin T505 will give you complete details

RADIO MFG. ENGINEERS INC.

306 First Avenue

Peoria, Ill.

Increased noise control sensitivity and reduced gain in the 6L7 silencer-amplifier. The values given for these resistors are not especially critical, and it is suggested that variations be tried to obtain best results with individual receivers. The resistor R_3 between the cathode and screen may be omitted. This may make the silencing action less sensitive in weak-signal reception with relatively low-level noise interference, as sometimes occurs on the 28-mc. band with ignition QRN, but the threshold adjustment is then less critical and the silencer is less liable to "trigger" on the stronger signals.

If 6-volt tubes are used in the set and the receiver's power pack is a husky one capable of about 25 ma. added B load and an ampere of extra filament current, the B-supply connection for the silencer can be tied into the receiver as shown in Fig. 3, the filaments being connected in parallel with those of the set. If 2.5-volt tubes are used in the receiver, a separate filament supply for the silencer tubes will be necessary. This can be a "midget" type delivering 6.3 volts, mounted in the silencer unit. The receiver's circuit diagram should be studied before connecting into its plate-feed circuit and the connection made at a point which will not upset any screen, tuning meter or other combinations. A safe place to tap in is at the plus-B side of the loud-speaker output circuit.

This same circuit is adaptable to receivers having only one i.f. amplifier stage, the i.f. silencer tube going in as an added first stage. The same circuit values and adjustment procedure also would fit. This also goes for receivers without crystal filters, although in the latter case there might be some advantage in placing the silencer between the i.f. stage and second detector, rather than immediately following the first detector. In every case, the circuit diagram of the particular receiver should be consulted and the general circuit adapted to fit in with the individual set's special requirements. If the receiver should happen to have a cathode biasing system in which the individual cathodes are grounded directly and the negative of the B supply is "below ground," a separate minus-B lead should be run from the center tap of the plate transformer to the negative (ground) side of the threshold adjustment network and the negative (ground) side of the i.f. 6L7 silencer. If this is not done, the additional current drawn through the receiver's cathode-bias network will over-bias all the tubes and impair the overall performance—perhaps to the point of burning out a resistor or two. This method of biasing is used in several 1936 all-wave sets (RCA, etc.)

The adjustment follows the same general routine outlined in the February and March articles, the first step being to line up the 6L7 input and output circuits to the receiver's intermediate frequency. With the particular circuit of Fig. 3, no adjustment of the i.f. transformers in the receiver is necessary, the 6L7 input transformer being in the silencer unit and the primary of the filter input transformer being untuned. In sets having a tuned filter input circuit, this will be

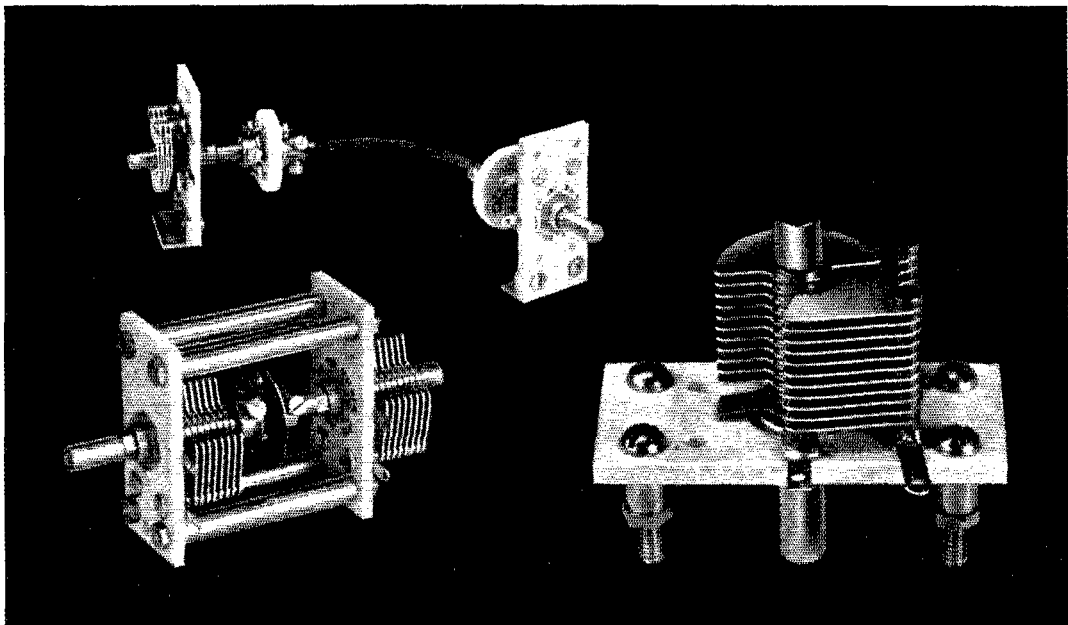

CONTINUED IMPROVEMENT

The wide acceptance of Type UM Ultra-Midget Condensers for use as tuning condensers as well as padders has prompted us to add a new feature. For increased versatility a shaft extension is provided at each end of the rotor, permitting easy ganging with flexible couplings. This, combined with the universal mounting features which have been retained from the previous model, make the unit extremely adaptable to unusual layouts. The righthand illustration above, shows the UM condenser approximately actual size. To the left are shown two of the many convenient methods of ganging, while below are illustrated a few couplings from our unusually complete line. • Other features include a new staked and soldered construction which, together with the "self-locking" rotor design, makes the UM condenser virtually proof to vibration. As before, the prices are extremely low, ranging from \$.75 (net) for the 15 mmf. size to \$1.14 (net) for the 100 mmf. size.

NATIONAL COMPANY, INC., MALDEN, MASS.

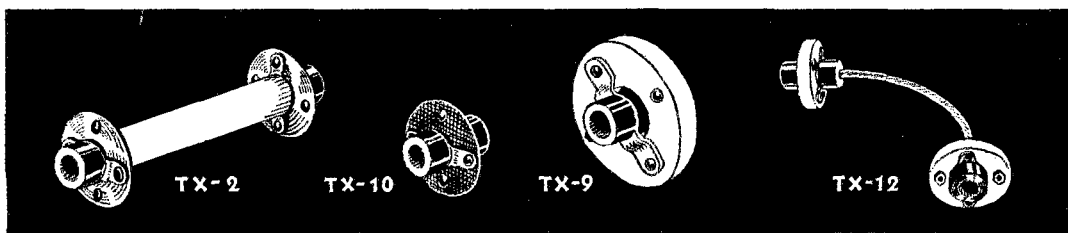

Now—a high-powered—

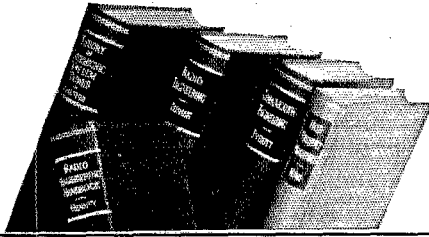

RADIO ENGINEERING LIBRARY

- especially selected by radio specialists of McGraw-Hill publications
- to give most complete, dependable coverage of facts needed by all whose fields are grounded on radio fundamentals
- available at a special price and terms

These books cover circuit phenomena, tube theory, networks, measurements, and other subjects — give specialized treatment of all fields of practical design and application. They are books of recognized position in the literature — books you will refer to and be referred to often. If you are a researcher or experimenter — if your interest in radio is deep-set and based on a real desire to go further in this field — you want these books for the help they give in hundreds of problems throughout the whole field of radio engineering.

5 volumes, 2981 pages, 2000 illustrations

1. Everitt's COMMUNICATION ENGINEERING
2. Terman's RADIO ENGINEERING
3. Chaffee's THEORY OF THERMIONIC VACUUM TUBES
4. Hund's HIGH-FREQUENCY MEASUREMENTS
5. Henney's RADIO ENGINEERING HANDBOOK

Special Low Price and Easy Terms

Bought singly, the five volumes comprising this library would cost you \$26.00. Under this offer you save \$2.50 and, in addition, have the privilege of paying in easy installments beginning with \$2.50, 10 days after receipt of the books, and \$3.00 monthly thereafter. Already these books are recognized as standard works that you are bound to require sooner or later. Take advantage of these convenient terms to add them to your library now.

SEND THIS ON-APPROVAL COUPON

McGraw-Hill Book Co., Inc.
330 W. 42nd St., New York, N. Y.

Send me Radio Engineering Library 5 vols., for 10 days' examination on approval. In 10 days I will send \$2.50, plus few cents postage, and \$3.00 monthly till \$23.50 is paid, or return books postpaid. (We pay postage on orders accompanied by remittance of first installment.)

Name.....
Address.....
City and State.....
Position.....
Company..... QST-4-36
(Books sent on approval in U. S. and Canada only.)

the only i.f. peaking adjustment necessary within the receiver.

When these i.f. circuits are aligned, as indicated by maximum audio output with the silencer threshold adjustment turned to the "off" (positive) side, the noise-rectifier input transformer T_2 should be brought into alignment. For this adjustment, turn the threshold control all or nearly all the way "in" (to the negative side) and adjust for maximum rectified voltage across R_4 , using a steady carrier for a test signal and a high-resistance d.c. voltmeter for the measurement. If the complete circuit is stable (no regeneration), no trouble should be experienced in making these adjustments—assuming, of course, that the tubes are OK and that the circuit is actually as it is supposed to be, with good ground connections on by-passes, etc. If the i.f. circuit should still show signs of regeneration, as evidenced by outright oscillation or by "rumbly" sound output with noise interference, resistors may be connected across the primaries of the i.f. transformers in the stages following the silencer. Resistance of 100,000 ohms across each primary usually suffices. This is not detrimental to the selectivity of the set, since the additional tuned transformer at the silencer input contributes more than enough increased selectivity to compensate.

PERFORMANCE TO BE EXPECTED

Fig. 3 shows true reproductions of oscilloscope patterns indicating the typical noise reduction accomplished by the silencer in straight superhet c.w. reception, and by the silencer and crystal filter combined in single-signal c.w. reception. The interference in each case was from a spark-plug tester using a Ford "Model T" spark coil operating on 60-cycle supply. The receiver gain was adjusted for normal output on a signal of about S7 strength, representing average reception conditions with no noise interference.

The patterns are shown in pairs, signal-and-noise and noise alone for each receiver circuit combination. In c.w. telegraph reception, either aural or recording, the noise output between the dots and dashes is fully as important as the noise output with the signal present, because it is just as necessary to distinguish the spacing intervals as it is to recognize the marking. For this reason, the silencing action with no signal present is tremendously significant.

As the patterns of A and B show, with both silencer and filter out, the audio circuit overloads badly, blocking occurs on the positive noise peaks, and the signal is unrecognizable. The audible noise output (and was it audible!) sounds just the same without the signal as with it. But with the silencer in for straight superhet operation, a tremendous improvement is accomplished, as shown in patterns C and D. With the signal and noise both present, the only visible evidence of the noise in the output is the distortion of approximately every fifth cycle of the 500-cycle beat note, these "wiggles" occurring at the instants the silencer is actuated by the noise pulses.

"THERE'S THE GENERATOR THAT DOES THE TRICK"

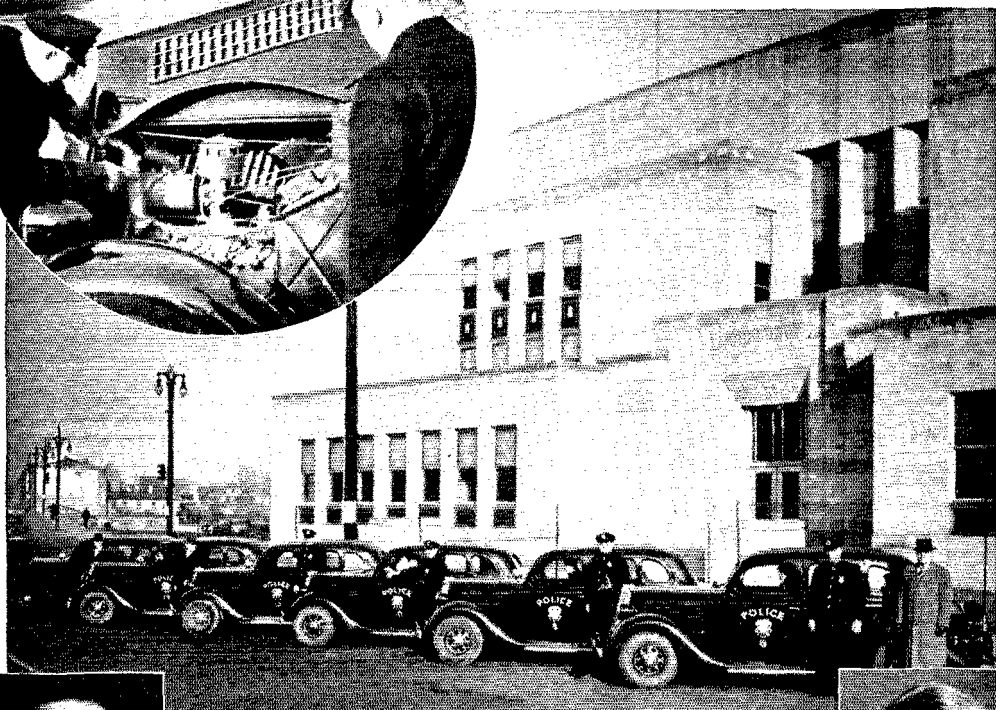
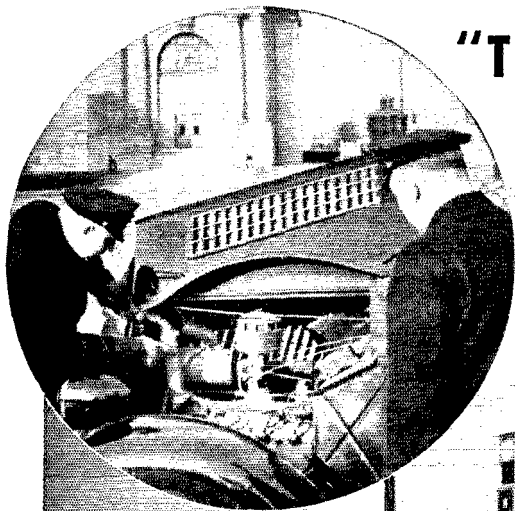

"We have every reason to congratulate ourselves on the selection of Delco-Remy Police Car Generators for our new fleet of radio equipped police cars. We are also pleased with the attention that has been given our installation by the Engineering and Service Departments of Delco-Remy."

**RUSSELL P. PRICE, City Manager
Hamilton, Ohio**



"When we made generator tests under actual police conditions, the Delco-Remy Heavy-Duty Generators proved best for our requirements. One determining factor in our selection was the absence of radio interference in the operation of the Delco-Remy Current and Voltage Regulator. Everything is working out more than satisfactorily."

**J. C. CALHOUN, Chief of Police
Hamilton, Ohio**

When city and police officials of Hamilton, Ohio, bought a new fleet of police cars with two-way radio equipment, the question of generators arose because of the additional burden placed on the cars' electrical systems. A police generator must be designed and built to furnish an exceptional amount of current when needed; it must give continuous, trouble-free operation, and the generator output must be effectively regulated. After a series of rigid tests, Delco-Remy Police Car Generators were selected. These generators

have now been in service for more than six months—during the most severe period in the year. That they are giving perfect satisfaction is evidenced by the statements of City Manager Price and Chief of Police Calhoun.

Any Branch or Electrical Service Station of United Motors Service can supply Delco-Remy high-output generators for either police or amateur installations where special equipment requires greater generator output.
DELCO-REMY CORPORATION, ANDERSON, IND.



United Motors Service is the official distributor of Delco-Remy products, including all service parts for Delco-Remy starting, lighting and ignition systems.

Delco-Remy

HIGH POWER

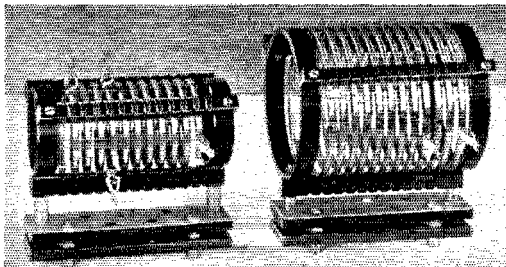

THESE two inductors cover all of the amateur bands to 10 meters, and have current carrying capacity for the highest power transmitter. Plug-in . . . wound with heavily plated copper tubing . . . mounted in rigid supporting frames . . . glazed porcelain insulation . . . outside of supporting ribs notched for additional coils . . . supplied with copper clips formed to fit the tubing . . . three JUMBO-type G-R plugs supplied with each coil.

SPECIFICATIONS

	Type 679-A	Type 679-B
Turns	12	7 and 4
Number of sections	1	2
Inductance	10 μ h	2 and 1.5 μ h
Clips supplied	3	4
Outside diameter of coil	5 $\frac{3}{4}$ inches	3 $\frac{1}{4}$ inches
Length, over all	7 $\frac{1}{4}$ inches	7 $\frac{1}{4}$ inches
Height, over all	8 $\frac{1}{2}$ inches	6 $\frac{3}{4}$ inches
Depth, over all	6 $\frac{1}{2}$ inches	4 $\frac{1}{2}$ inches
Price	\$7.50	\$6.50

Type 680-J Jack Base for use with the Type 679 Inductors, with three JUMBO Jacks, mounting holes, and holes for four additional jacks; Price: \$1.25.

Order direct from this advertisement, sending remittance with order, and we ship prepaid anywhere in the United States

General Radio Company

30 State Street Cambridge, Mass.

Without signal, there are only the slight traces in the form of "whiskers" at these same instants. It is notable that the residual noise amplitude is less than the signal amplitude, being audible only as a softened "hiss" in the marking periods. The slight distortion of the signal wave is aurally discernible as a trace of spark-frequency modulation (approximately 240 cycles in this case), which would not be noticed unless one were looking for it.

Figs. E and F illustrate what happens when the crystal is shock-excited by the noise pulses. Here again the signal is completely masked by the prolonged wave trains of beat-note frequency, which give output practically the same whether the signal is present or not. The aural effect is continuous ringing, with or without signal input.

Finally, Figs. G and H show what the silencer and filter accomplish when both are in operation. The slight discontinuities in the signal beat note which are evident with the silencer but without the crystal (Fig. C) have been ironed out by the crystal filter, as shown in Fig. G, while the residual trace of noise hiss in the spacing periods, evidenced by the little "whiskers" in Fig. D, are also wiped out by the crystal, as shown in Fig. H. These last two patterns illustrate practically ideal reception, as if there were no noise interference input to the receiver at all. So we shall leave the conclusion for this article with them.

New Transmitting Tubes

(Continued from page 64)

at frequencies as high as 30 megacycles. Characteristics are as follows:

Filament voltage	10 volts
Filament current	3.25 amp.
Interelectrode capacitances:	
Grid-plate	6.5 μ fd.
Grid-filament	8.5 μ fd.
Plate-filament	10.5 μ fd.

The following ratings for different types of service have been placed on the tube:

As Class-B Audio Power Amplifier or Modulator:

Maximum plate voltage	1500 volts
Max.-signal plate current	210 ma.
Max.-signal plate input	315 watts
Plate dissipation	125 watts
Typical operation; two tubes:	
Plate voltage	1250 1500 volts
Grid bias	0 -16 volts
Peak a.f. grid-to-grid voltage	235 280 volts
Zero-sig. plate current	148 84 ma.
Max.-sig. plate current	400 400 ma.
Load resistance, per tube	1675 2050 ohms
Max.-sig. driving power (app.)	6 7 watts
Max.-sig. power output (app.)	300 370 watts

As Class-B R.F. Amplifier, Telephony:

Max. plate voltage	1500 volts
Max. plate current	150 ma.
Plate dissipation	125 watts
Typical operation:	
Plate voltage	1250 1500 volts
Grid bias	0 -10 volts

(Continued on page 80)



CALLING all Servicemen!

When "Squad-car" Centralab is at the wheel things happen. He stands for no foolin'. Out goes that noisy control on its ear . . . and a smooth, efficient CENTRALAB RADIOHM preserves the peace.

The best pacifier for noisy receivers, servicemen agree, is a Centralab Radiohm . . . and . . . a mere handful will service practically any set ever made . . . and make it work "better than ever before."

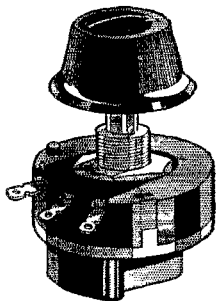

Every Radio Service Man should be a member of the Institute of Radio Service Men

Centralab

MILWAUKEE, WISC.

RADIOHMS SUPPRESSORS
FIXED RESISTORS
WAVE CHANGE SWITCHES

Eastern Canada Convention

May 22nd and 23rd at Montreal, Que.

THE A.R.R.L. Eastern Canada Convention is being sponsored by the Montreal Amateur Radio Club. The place is the Canadian Metropolis City of Montreal; the hotel, the Mount Royal. Prominent speakers will give interesting talks. A speed contest for c.w. men will be a feature, and many other activities are being arranged to ensure a good time for everyone.

Make it a point to visit this Convention and see at the same time Canada's largest city. Interested parties may obtain further information from Harry Ashdown, VE2IO, 4032 Hampton Ave., N.D.G., Montreal, Que.

Standard Frequency Transmissions

Date	Schedule	Station	Date	Schedule	Station
Apr. 3	B	W9XAN	May 6	C	W9XAN
	B	W6XK	May 8	B	W9XAN
Apr. 8	C	W9XAN		A	W6XK
Apr. 10	B	W9XAN	May 13	BB	W9XAN
	A	W6XK	May 15	BB	W6XK
Apr. 15	BB	W9XAN		A	W9XAN
Apr. 17	BB	W6XK	May 16	BX	W6XK
	A	W9XAN	May 17	C	W6XK
Apr. 18	BX	W6XK	May 22	A	W6XK
Apr. 19	C	W6XK	May 29	B	W9XAN
Apr. 24	A	W6XK		B	W6XK
May 1	B	W9XAN			
	B	W6XK			

STANDARD FREQUENCY SCHEDULES

Time (p.m.)	Sched. and Freq. (kc.)		Time (p.m.)	Sched. and Freq. (kc.)	
	A	B		BB	C
8:00	3500	7000	4:00	7000	14,000
8:08	3800	7100	4:08	7100	14,100
8:16	3700	7200	4:16	7200	14,200
8:24	3900	7300	4:24	7300	14,300
8:32	3900		4:32		14,400
8:40	4000				

Time (a.m.)	Sched. & Freq. (kc.)	
	BX	
6:00	7000	
6:08	7100	
6:16	7200	
6:24	7300	

The time specified in the schedules is local standard time at the transmitting station. W9XAN uses Central Standard Time, and W6XK, Pacific Standard Time.

TRANSMITTING PROCEDURE

The time allotted to each transmission is 8 minutes divided as follows:

- 2 minutes—QST QST QST de (station call letters).
 - 3 minutes—Characteristic letter of station followed by call letters and statement of frequency. The characteristic letter of W9XAN is "O"; and that of W6XK is "M."
 - 1 minute—Statement of frequency in kilocycles and announcement of next frequency.
 - 2 minutes—Time allowed to change to next frequency.
- W9XAN: Elgin Observatory, Elgin National Watch Company, Elgin, Ill., Frank D. Urie in charge.
W6XK: Don Lee Broadcasting System, Los Angeles, Calif., Harold Perry in charge.

Schedules for WWV

EACH Tuesday, Wednesday and Friday (except legal holidays), the National Bureau of Standards station WWV will transmit on three frequencies as follows: noon to 1:00 p.m. E.S.T., 15,000 kc.; 1:15 to 2:15 p.m., 10,000 kc.;



SERVICE NOTES

1930—1935

FREE... to Service Men

UPON THE RECEIPT OF
10 "V-DOUBLET"
ANTENNA CARTON LABELS

This Offer Expires May 30, 1936

● Here's an opportunity for radio service men to get a free copy of service notes on all radio receivers sold by General Electric during the past six years. This practical, 887-page volume, just released, is sold at the regular price of \$2.00. Every radio service man, who sells 10 G-E "V-doublet" All-wave Antennas, may have a copy free. Just return CARTON LABELS FROM 10 G-E "V-DOUBLET" ANTENNA KITS, to your G-E Radio Distributor, and this valuable new book will be yours.

THE GENERAL ELECTRIC "V-DOUBLET" ALL-WAVE ANTENNA Points the Way to Make Money

Do you want to cash in on radio's most neglected market? Then, sell and install the G-E "V-doublet" All-wave Antenna System. You'll find it pays big dividends in sales and profits. Canvass for prospective buyers every chance you get. Insist that a G-E "V-doublet" All-wave Antenna be included with every set. Get your share of this large and profitable market. Tune in on its profit possibilities.

*For complete information see your nearest
General Electric Radio Distributor.*

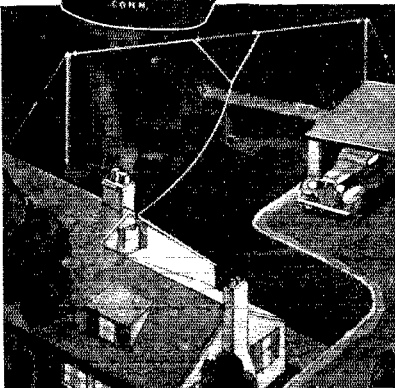

GENERAL ELECTRIC

The Original Metal-Tube Radio

APPLIANCE AND MERCHANDISE DEPARTMENT, GENERAL ELECTRIC COMPANY, BRIDGEPORT, CONN.

Get MORE POWER!

with the

AMPEREX HF200

You will be amazed at the performance of these tubes at ultra-high frequencies

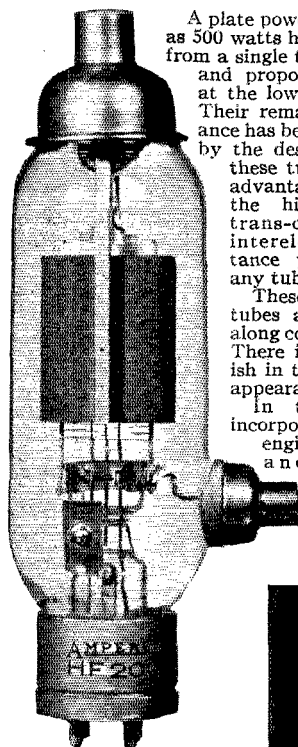

A plate power output as high as 500 watts has been obtained from a single tube at 5 meters, and proportionate outputs at all the lower wave lengths. Their remarkable performance has been made possible by the design which gives these tubes the distinct advantage of possessing the highest ratio of trans-conductance to interelectrode capacitance yet attained in any tube.

These new Amperex tubes are proportioned along conventional lines. There is nothing freakish in their structure or appearance.

In their design is incorporated the latest engineering practice and knowledge of ultra-high frequency operation.

\$24.50



Lee DeForest Says:

"... we have had nothing but most satisfactory results, and frankly have found Amperex tubes superior for our work to those of other manufacturers which we have tried."

We are highly pleased with the results obtained. We feel that manufacturers of radio transmitters are fortunate to have available oscillator tubes possessing this degree of reliability."

WRITE for catalog listing complete line of Amperex transmitting tubes

AMPEREX

Electronic Products, Inc.

77 Washington Street, Brooklyn, N. Y.

2:30 to 3:30 p.m., 5000 kc. On each Tuesday and Friday the emissions are continuous unmodulated waves (c.w.); and on each Wednesday they are modulated by an audio frequency. The audio frequency is in general 1000 cycles per second.

Arizona State Convention

(Southwestern Div.)

April 4th and 5th at Tucson, Ariz.

WITH two years' experience in holding ham-fests the Arizona Association of Radio Clubs, with the cooperation of the Radio Service Men of Arizona, this year are sponsoring the first Arizona State Convention of the Southwestern Division and extend a cordial invitation to all radio amateurs within the state and other sections of the division.

The Hotel Santa Rita has been chosen as the headquarters, where the committee will do its best to entertain every one and show all that Tucson amateurs know their "stuff." Of interest to all is the registration fee, only \$2.00; and what a program.

Walter Ellis, Sunset Villa Court, Tucson, Ariz., will furnish further information on request.

The 805

(Continued from page 86)

Plate current.....	135	115 ma.
Peak r.f. grid voltage.....	75	70 volts
D.C. grid current (app.).....	15	15 ma.
Driving power (app.).....	11	7.5 watts
Power output (approx.).....	55	57.5 watts

As Class-C R.F. Amplifier, Telephony:

Max. plate voltage.....	1250 volts
Max. plate current.....	175 ma.
Max. plate dissipation.....	85 watts

Typical operation:

Plate voltage.....	1000	1250	1500	volts
Grid bias.....	-155	-100	-105	volts
Peak r.f. grid voltage.....	295	230	300	volts
Plate current.....	160	200	200	ma.
Grid current (app.).....	60	40	60	ma.
Driving power (app.).....	16	16	16	watts
Power output (app.).....	110	140	140	watts

As Class-C R.F. Amplifier, Telegraphy:

Max. plate voltage.....	1500	volts
Max. plate current.....	210	ma.
Plate dissipation.....	125	watts

Typical operation:

Plate voltage.....	1000	1250	1500	volts
Grid bias.....	-95	-100	-105	volts
Peak r.f. grid voltage.....	225	230	235	volts
Plate current.....	200	200	200	ma.
Grid current (app.).....	40	40	40	ma.
Driving power (app.).....	8.5	8.5	8.5	watts
Power output (app.).....	130	170	215	watts

The 805 may be used at frequencies as high as 85 mc. with reduced input. Plate voltage and power input should both be reduced to 75% of maximum at 45 mc., and to 50% at 85 mc.

The 836

The 836 is a half-wave, high-vacuum rectifier carrying the same inverse-peak voltage rating as the 866, but with a higher peak-current rating. It is indirectly heated. The tube is fitted with the

(Continued on page 188)

The 1936 Edition of the **RADIO AMATEUR'S HANDBOOK**

THE opening chapters tell of the background and story of Amateur Radio and give the necessary information on how to get started. The electrical and radio fundamentals chapters serve as the foundation for the thirteen apparatus chapters which follow. They deal exclusively with principles which have practical bearing on actual equipment.

A 30-page chapter on vacuum tubes contains the most comprehensive tabulated tube data ever published.

The receiver design chapter treats its subject in an entirely new manner and contains a wealth of circuit features described in concise, practical detail. Receiver construction is given a big chapter of its own. The how-to-make-it of a complete line of successful models, from a simple two-tuber to a Single-Signal model with 12 of the new metal tubes, represents the culmination of months of preparatory work.

In the chapter devoted to transmitter design, the theoretical and practical considerations involved in designing and planning transmitters are given comprehensive treatment, while in the chapter on transmitter construction, all of the very latest circuit developments of proven merit are incorporated. There is, in it, dope on all types of transmitters that any amateur could want, including the most modern multi-band transmitters with coil switching.

A chapter on keying methods is followed by a chapter on the fundamentals of radio telephony which is a thorough and

concise treatment of design — from microphones to controlled carrier systems. The constructional chapter on radio-telephone transmitters gives full details of many successful types.

The ultra-high frequencies are well covered with two big chapters telling how the super-regenerative receivers work, and how to build them; about super-hets and THE SUPER INFRA-GENERATOR RECEIVER. Constructional dope for the various types with the acorn, glass and metal tubes is included. The U.H.F. transmitter chapter is a general treatment of the problems of simple circuits, linear oscillators, and oscillator-amplifiers.

The power supply chapter is treated in great detail, covering receiver-packs, voltage dividers, and supplies for grid bias, as well as all the normal equipment found in modern stations.

Antenna design is covered thoroughly. Numerous charts facilitate the planning of everything from simple single-wire antennas to complex directional arrays. Another chapter is devoted to instruments and measurements, their design and practical use. Included, of course, is the cathode-ray oscilloscope. The chapter on station assembly incorporates new ideas that present equipment has made possible. Communications Department chapters contain the latest dope on good operating practices and the present field organization set-up. In addition, of course, there is the usual — but not so usual — appendix, with its wealth of general information.

\$1.00 Postpaid in Continental U. S. A.

\$1.15 postpaid elsewhere

Buckram Bound, \$2.50

American Radio Relay League, West Hartford, Conn.

... NEVER BEFORE HAS THERE BEEN SUCH A BOOK VALUE!

More than 256,000 words—
over 500 diagrams, charts and
photographic illustrations,
53 basic design formulas,
42 charts and tables
in the NEW

TWICE-AS-BIG

480-PAGE

1936 HANDBOOK

It's the equal of a two-
volume \$7.00 textbook

It's EASY to get one, too—
use the coupon below

.....
A.R.R.L.
West Hartford, Conn., U. S. A.
Your statistics overwhelm me.
Here's my dollar—(or \$1.15; I live outside of U. S. A.
proper).

Please send to:

Name _____

Address _____

Well, fellows, I took it like a man, but when I read in dear old Quist that W7XXX had married a gal none other than my Lucy!!! Well, I solemnly obliterates the two ten's with a meat axe. Can you blame me, fellows?

Notes on Audio Power Amplifiers

(Continued from page 89)

vibration sets up vibrations in the receiver tubes. The only cure for this sort of trouble is proper mechanical isolation between the speaker and the tubes of the receiver, especially the detector tube. Cushioning of the speaker and detector tube or the entire receiver may be necessary. Sometimes proper placing of the speaker in relation to the receiver may be sufficient. Although usually undesirable from the standpoint of appearance, a baffle board between speaker and receiver should reduce the tendency towards acoustic feed-back.

—D. H. M.

With the Affiliated Clubs

(Continued from page 84)

organization took place, are: VE3OH, pres., VE3CP, vice-pres.; VE3ZV, treas.; VE3AHK, secy. . . . The Cornhusker Amateur Radio Club (Lincoln, Nebr.) conducted a demonstration of amateur radio at the local Pet and Hobby Show in January; portable W9OLX was operated from the show, relaying messages to W9UOU, Lincoln, for handling to various stations throughout the state. . . . The miles-per-watt contest run by the Mid-Hudson Amateur Radio Club (Poughkeepsie, N. Y.) from February 1st through March 15th will bring an attractive certificate to the winner. The M.H.A.R.C. is conducting another contest, for non-licensed members, offering any piece of radio equipment valued at not over \$2.00 to each of the first two members to obtain licenses after February 1st. Mid-Hudson's officers include W2GWY, pres.; W. Wheeler, vice-pres.; W2BJX, secy.; W2CGT, treas. . . . The Cleveland Heights (Ohio) Amateur Radio Club now has very fine meeting quarters in St. Ann's Church, after struggling along with more or less temporary meeting places for more than two years. The call W8OVE is now used by the Cleveland Heights High School A.R.C. . . . The Spring Field Day of the Southern Minnesota Radio Association will be held at Albert Lea, Minn., during May. . . . The night of January 25, 1936, will long be remembered by the Nashville (Tenn.) Amateur Radio Club; the hamfest held at the Noel Hotel on that night was thoroughly enjoyed by all. The principal speakers were Mr. J. H. DeWitt, chief engineer of WSM, and Mr. James H. Shultz, XU4JS/W1JJH, who told of Radio in China. . . . The Garden City (L. I.) Radio Club is making definite arrangements to provide 56-mc. communication at the yacht races on Long Island Sound, one of the major boating events of the season. . . .

—E. L. B.

Newark's

Sets on Deferred Payment Plan—At **NEW Lower Rates . . . SPECIALS AT UNHEARD OF PRICES**

★ BUILD YOUR OWN ★ **ALL-STAR** TRANSMITTER

ALL-STAR TRANSMITTER PARTS AND TUBES IN STOCK

Write for Free Bulletin

The receivers listed below are the best money can buy. Our time payment plan, at the new low rates, makes it easy to own one. COMPARE our rates with others. THE EASY WAY: Send in your down payment with your order. Set will be shipped as soon as credit is OK'd. Entire Transaction: One week. TRY US. Write for complete catalogue.

Cash Price	Down Payment	6 Months Payments	10 Months Payments
NATIONAL HRO JR. — with tubes — 1 set of coils, 10 to 20 meters (2 amateur bands)			
\$99.00	\$24.00	\$13.52	\$8.20
NATIONAL HRO JR. — complete with tubes — power supply — 2 pair of coils			
\$124.80	\$29.80	\$16.90	\$10.25
NATIONAL HRO — less power supply and speaker			
\$167.70	\$37.70	\$22.78	\$13.89
STANDARD HRO — with power supply			
\$183.60	\$43.60	\$24.46	\$14.93
NEW SUPER SKYRIDER — less crystal — Model S9			
\$79.50	\$19.50	\$11.00	\$6.67
NEW SUPER SKYRIDER — with crystal — Model SX9			
\$89.50	\$19.50	\$12.68	\$7.69
RCA — ACR — 136			
\$69.50	\$19.50	\$9.32	\$5.65
RME69 — complete with crystal — tubes — speaker housed in baffle			
\$134.90	\$29.90	\$18.58	\$11.28
HAMMARLUND SUPER PRO — Complete with tubes and speaker			
\$223.44	\$43.44	\$31.23	\$19.11
HAMMARLUND SUPER PRO — complete with crystal, tubes and speaker			
\$241.00	\$51.00	\$32.92	\$20.16
PATTERSON PR-16 — complete with crystal, tubes and speaker			
\$101.70	\$26.70	\$13.52	\$8.20
NEW ACR-175 — complete as advertised			
\$119.50	\$24.50	\$16.90	\$10.25

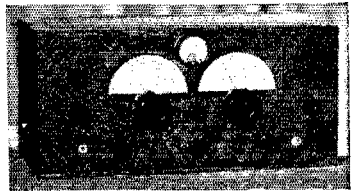
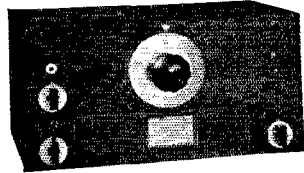

FULL DETAILS OF ANY SET LISTED, MAILED IMMEDIATELY UPON REQUEST

Our Special OIL IMPREGNATED-OIL FILLED CONDENSERS are guaranteed at rated voltages. All ratings are DC working voltage. These are well-known condensers purchased by us at a tremendous cut in price and passed on to you. We have a few left of each capacity. Send in your orders at once.

Well Known Oil Filled, Oil Impregnated Filter Condensers

Cap.	Voltage	Size	Weight	Price
1 mfd.	2000 V. DC	5 x 3 1/4 x 1	1 1/4 Lbs.	\$1.25
2 mfd.	2000 V. DC	5 1/2 x 3 3/8 x 2 1/2	3 Lbs.	1.50
4 mfd.	2000 V. DC	2 1/2 x 2 1/4 x 5	3 Lbs.	2.25
8 mfd.	2000 V. DC	5 1/4 x 3 3/4 x 4	4 Lbs.	2.75
9 mfd.	3000 V. DC	5 1/4 x 3 3/4 x 1 1/2	9 Lbs.	7.25
(including 2 3/4" bakelite standoffs)				
4.4 mfd.	1500 V. DC	5 x 3 3/4 x 1 1/4	1 1/4 Lbs.	1.75
5 mfd.	1500 V. DC	3 3/4 x 3 3/4 x 1 1/4	1 1/4 Lbs.	1.90
5.2 mfd.	1500 V. DC	5 x 3 3/4 x 2 1/4	2 1/4 Lbs.	2.00
10 mfd.	1500 V. DC	5 x 3 3/4 x 3	2 1/4 Lbs.	2.75
20 mfd.	1500 V. DC	5 x 3 3/4 x 3 3/4	3 1/4 Lbs.	3.50

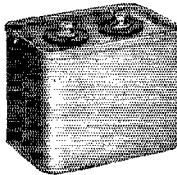

NEW LOW PRICES ON RCA TUBES

203A	\$15.00
211	15.00
838	16.00
845	16.00
860	10.00
830B	32.50
860	4.00
866A	5.00
868	5.00
918	12.50
834	

Use the 10 and 20 mfd. for perfect filtering in class B modulation Power supply

NEWARK PAPER FILTER CONDENSERS

1 mfd. 1000 V. DC	\$.56
1 mfd. 1500 V. DC	.66

These condensers have standoff insulators and mounting feet.

THORDARSON No. T6877 Heavy Duty Choke. 15 henries at 250 MA.	\$1.95
--	--------

THORDARSON No. T6878 Plate and Filament Transformer, 600-0-600 V. at 200 M.A. 2 1/2 V. at 10 amp., 5 V. at 3 amp. 7 1/2 V. at 3 amp. \$2.45

2 1/2 V. 10 amp. Filament Transformer — 2500 V. insulation for 866's \$.95

Write for Our Complete Catalogue!

ALL OF THE ABOVE SPECIALS GUARANTEED BY NEWARK. ALL OF THE ABOVE SPECIALS ARE "NEW"

Newark Electric Company

"FASTER SERVICE—BETTER BARGAINS"

226 W. Madison Street

Dept. Q

Chicago, Illinois



QST YEARLY BINDERS

Those who take pride in the appearance of their lay-out and wish to keep their reference file of QST's in a presentable manner, appreciate the QST binder. It is stiff-covered, finished in beautiful and practical maroon fabrikoid. Cleverly designed to take each issue as received and hold it firmly without mutilation, it permits removal of any desired issue without disturbing the rest of the file. It accommodates 12 copies of QST and the yearly index. Opens flat at any page of any issue.

With each Binder is furnished a sheet of gold and black gummed labels for years 1919 through 1938. The proper one can be cut from the sheet and pasted in the space provided for it on the back of the binder.

A file of several years of QST, kept in order in binders, is a most valuable reference library for any Radio Amateur.

Price **\$1.50** postpaid

Available only in United States and possessions

THE AMERICAN RADIO RELAY LEAGUE

WEST HARTFORD

CONNECTICUT

Electron Coupled vs. Crystal Control

(Continued from page 51)

with the oscillator alone suggested that perhaps previous writers of articles on the subject might have been unnecessarily conservative. No particular difficulty was encountered in readily obtaining signals of good characteristics with circuit values and voltages within reason. But it was an entirely different story when a load was applied to the oscillator. Running the oscillator at 500 volts, and doubling in its plate circuit, it seemed that it should be easy to obtain sufficient output to drive a Type 830. However, after many long hours of testing, it became evident that results approaching those obtained with crystal control could be secured only with a lightly-loaded electron-coupled oscillator. Since the 802 or RK23 requires but little excitation for full output, it seemed to be the logical tube to use in the following buffer-doubler stage. Accordingly this was added as shown in Fig. 1.

Immediate improvements in signal characteristics were evident. With the light loading required to drive the buffer-doubler, the oscillator plate current runs in the vicinity of 20 ma. Previous test with the 830 had shown that a very high-C oscillator circuit was most important. It was also demonstrated that more filtering and better voltage regulation were required in the power supply for the e.c. oscillator than would be satisfactory for a crystal oscillator.

Further checks were made with the new combination. The beat note in the monitor showed "p.d.c." But, since it was deemed essential to key the oscillator for break-in operation, a pronounced chirp had to be eliminated. Further adjustments, already found to be fairly critical, were made in the oscillator suppressor and screen voltages. As the correct combination was approached, the chirp became less pronounced until a point was found where the chirp disappeared entirely when the second-harmonic oscillator plate circuit was tuned very slightly to the high-frequency side of resonance (inductively reactive). A slight additional adjustment brought the stability to the point where good keying characteristics were reasonably tolerant of plate circuit tuning; it could be tuned exactly to resonance or slightly above or below resonance without affecting the characteristics.

With the particular oscillator tube and circuit constants used, the best voltage values were found to be: Plate, 500 volts; screen 180 volts; and suppressor plus 60 volts. While these figures may serve as a guide in initial adjustments, they cannot be depended upon as optimum values for all cases. Most satisfactory values for each individual job must be found experimentally.

All of the foregoing work having been done with the oscillator plate tuned to the second harmonic (7 mc.), an attempt was made to tune the plate circuit to the fundamental (3.5 mc.) so that the same oscillator circuit could be used for three bands (doubling frequency in the second tube for 14 mc.) and the coil permanently shielded. Ap-

SOME NOISE FROM THE SILENCER!

or rather from hundreds of enthusiastic users of Leeds "QUIET CAN." Already we have received a batch of testimonials from the owners of H.R.O.'s — A.G.S.'s — F.B.X.'s — Comet Pro's — R.M.E.'s PRO-9's — PR-16's — All Star Senior and a wide variety of all wave receivers. They all say in chorus LEEDS "QUIET CAN" puts the "quietus" on noise.

A sturdy, completely shielded, dustproof unit, measuring 2½ x 5¼ x 6½" over all. Readily adapted to super-hets with 2 or 3 IF stages. Available with 3 IF frequency ranges; 160-190 kc; 240-300 kc; 430-530 kc. (Specify range).

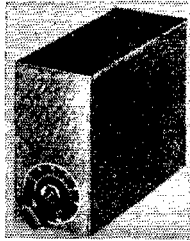

Filament supply for the silencer tubes is obtained from a resistor type line cord. A female receptacle is provided in the rear of the unit. When the receiver power supply is plugged into this receptacle, the A.C. switch furnished on the threshold potentiometer controls the power to both units.

We cannot imagine what else to expect from a noise silencer adapter, unless we include good design, quality parts and the ability to stand up. We know LEEDS "QUIET CAN" has all of these and for this reason the "little tin box" carries our unconditional guarantee. Leeds "QUIET CAN" wired and tested with the diode IF aligned to your IF frequency; 3 R.C.A. metal tubes and detailed instructions is only **\$10.95**. Less tubes **\$7.35**

Shipping weight 5 lbs.

New Wright DeCoster high flux magnetic speaker;
6".....\$2.00 8".....\$2.25

Magic Eye tuning unit for supers with AVC; all parts, complete including tube for either 2½ or 6 volt.\$1.75

NATIONAL Transmitting Condensers are outstanding

Highest efficiency — lowest prices

T.M.A. 40 D.C. split stator, 40 mmf. per section, .375 spacing 12000 volt, per section.\$7.20

We recommend two in parallel for 75 meters, for 1 Kw CW or 500 watt fone transmitter. T.M.A. 60 DB. split stator 60 mmf. per section, .250 spacing, 9000 volt, each section.\$10.20

T.M.A. 100 D.A. split stator 100 mmf. per section. For 500 watt CW transmitter, .185 spacing 600 volt, each section.\$9.60

Exceptional values in single section units. TOO.

T.M.A. 50 mmf. 6000 volt.	\$3.60
T.M.A. 100 mmf. 6000 volt.	5.40
T.M.A. 230 mmf. 6000 volt.	8.70
T.M.A. 50 mmf. 12000 volt.	4.35
T.M.A. 100 mmf. 12000 volt.	7.80
T.M.C. 50 mmf. 3000 v.	\$2.40
T.M.C. 100 mmf. 3000 v.	2.55
T.M.C. 150 mmf. 3000 v.	2.85
T.M.C. 300 mmf. 3000 v.	3.30
T.M.C.-100D 100 mmf. each sec.	4.50

THORDARSON TRANSFORMER special, 1200 volts CT 200 ma. 5 v. 3 amp. 7½ v. 3 amp. 2½ v. 10 amp. a quality cast job.\$2.45

Thordarson 12 henry 250 ma choke, 1.95
Thordarson cased class B transformers input and output.

For 46's. Per pair.\$6.17

For 210. Per pair.8.23

For 203-A. Per pair.17.64

The record is 100% perfect. Thousands of microfarads of Leeds oil filled Condensers are in use without one case of failure.

1 M F 1000 volt D.C. working	\$1.10
2 M F 1000 volt D.C. working	1.45
1 M F 1500 volt D.C. working	1.45
2 M F 1500 volt D.C. working	1.95
1 M F 2000 volt D.C. working	1.75
2 M F 2000 volt D.C. working	2.45

NATIONAL HRO JUNIOR
in stock. Need we say more about it. Circular on request.

TRIPLETT METERS

all standard ranges; 0-10 to 0-1000 MA
3¼" bakelite case.\$3.75
2" bakelite case.\$2.94
READRITE milliammeters 15 to 400 mls; any range, each.59c

WESTINGHOUSE AND SANGAMO Watt Hour Meters

110-120 volt; 60 cycle 2 wire meters. The meters are used instruments in perfect condition, tested and reset to zero. A fifteen dollar value, at the extremely low price of

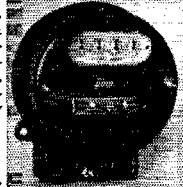

\$3.50

Shipping wgt. 15 lbs.

LEEDS offers outstanding values in quality transmitting TUBES, backed by our name and guarantee.

*203-A.	\$8.45	†*830-B.	\$7.25
†210-HF.	1.75	*838.	11.75
866.	1.50	†*841.	2.95
304-A-UHF.	9.45	*852.	11.50
†*801.	2.95	866-A.	1.95

*Graphite Anode Tubes

†Isolantite Base

Tubes Shipped by Express Only

LEEDS COPPER WIRE SPECIALS

Prices quoted in 100-foot lengths	Enameled		Hard Drawn	Soft Drawn
	Tinned		Tinned	Tinned
Size No. 18	Ideal for Antennas		Stretches	
16	\$3.30			\$.25
14	.40			.30
12	.55	\$4.40		.40
10	.85	.55		.55
8	1.35	.85		.85
			It Doesn't Stretch	For Coil Winding

Larger quantities in one piece are available. Highest quality stranded copper wire with rubber insulation and braided tinned copper shield over all.

No. 20 — 35c; No. 18 — 40c; No. 16 — 45c; No. 14 — 50c. Above prices are for 25-foot lengths. Prices lower on larger quantities.

LEEDS Unconditionally Guaranteed Crystals

X-cut 160 and 80 meters.	\$2.25
X-cut 40 meter.	3.25
Moulded bakelite holder.	\$1.00
Hill all brass adjustable holder.	1.65

PIEZO astatic crystal pickup 8" arm; \$15.00 list, special.\$6.75

ROLA G-12 high fidelity speakers; D. C. models 12" cone; 8 ohm v. c. 6 volt, 1000 or 2500 ohm field.\$8.95
A. C. model.14.95

New ROLA K-12 D.C. speaker 12" cone; 8 ohm v. c.; 6 volt, 1000 or 2500 ohm model.\$5.95

TRIMM 2000 ohm phones.	\$1.80
4000 ohm.	\$2.25
TRIMM featherweight.	\$5.88
FROST 2000 ohm.	\$1.45
FROST 3000 ohm.	\$1.65
DX 20000 ohm imp.	\$2.65
WESTERN ELECTRIC type P-11.	\$3.95

LEEDS Leads as the only distributor in the country, handling G.R. Amateur accessories and laboratory apparatus. Bulletin No. 930 mailed on request.

GENERAL RADIO coil forms type 677-U price 50c; type 677-Y price 75c. G.R. amateur accessories always in stock.

G. R. dials, with fluted knobs 4" — \$1.50; 3¼" — \$1.25; 2¼" — \$1.00.



LEADS THE FIELD

World Wide Service to Amateurs

45 Vesey Street
New York City

Tel. COntlandt 7-2612

Cable Address: "RADLEEDS"



Sturdy cans . . .
hermetic sealing
. . . seepage-proof.

Pure paper di-
electric . . . oil-
impregnated . . .
oil-filled.

Genuine high-
tension pillar
insulator terminals.

Conservative rat-
ings . . . longest life.

Save!

LOWER PRICE . . . HIGHER QUALITY



Mass production economies ploughed back into lower prices! Our regular labelled, voltage-rated, guaranteed X-mitting condensers now available at these new list prices:

TYPE 1005 — 1000 V.			
Cap.	Old List	New List	Your Cost
1.....	\$3.20	\$2.70	\$1.62
2.....	4.25	3.35	2.01
4.....	6.00	4.85	2.91

TYPE 1505 — 1500 V.			
Cap.	Old List	New List	Your Cost
1.....	\$4.00	\$2.85	\$1.71
2.....	5.25	3.90	2.34

TYPE 2005 — 2000 V.			
Cap.	Old List	New List	Your Cost
1.....	\$4.75	\$3.55	\$2.13
2.....	6.50	4.75	2.85

DATA Send for new 1936 catalog covering condensers and resistors. Also sample copy of Research Worker.



73 Washington St. Brooklyn, N. Y.

BOUND VOLUME XIX of QST (1935 Series)

WE have now a limited number of copies of Bound Volume XIX of QST. Vol. XIX comprises the entire 1935 series of QST. This volume is made up of two books or sections, each containing six issues of QST. This volume is handsomely bound in red cloth and with gold imprint. The complete volume is priced at \$5.00, postpaid.

Better act quickly — only a few copies available.

QST

38 LaSalle Road
West Hartford, Connecticut

parently the previous care in adjustment had been well worth while, for it was found that perfectly satisfactory signal characteristics could be obtained with fundamental output. The tuning of the plate tank circuit was found to be somewhat more critical, the best results being obtained with the plate circuit tuned slightly to the low-frequency side of resonance (capacitively reactive).

One or two additional suggestions may be in order. Generous by-passing of all power supply leads is quite necessary to prevent r.f. getting back into the power supply where it may be modulated, resulting in a poor note. While the unit has been operated with no shielding except that of the buffer-doubler tube, thorough shielding of both tubes and all coils is recommended, especially where the apparatus is to be mounted compactly. Such shielding also eliminated hand capacity effects in tuning and permitted visitors to walk past the transmitter without changing the transmitter frequency.

One problem remains to be solved. The pentode oscillator is quite sensitive to vibration. While plain cushioning of the entire unit goes a long way toward reducing the trouble, a neat and practical system of shock-proof mounting which permits panel mounting is a good design problem. Needless to say, all other pieces of equipment should be rigidly mounted and no opportunity left for vibration or change in wiring.

The described unit is at present used to drive the 830 at 100 watts input at 14 mc. with sufficient efficiency to excite a final push-pull 204-A amplifier to full 1-kw. input with good efficiency. It is also used with a second doubler to drive a separate final amplifier at 28 mc. Even at this frequency, where a 500-cycle shift in the oscillator frequency would cause a chirp of 4 kc. at the operating frequency, the stability is entirely satisfactory and no chirp is reported.

With regard to 'phone transmitters, one interesting point developed. The oscillator screen voltage for best keying characteristics was slightly different from that which would produce minimum frequency creep when the oscillator was operated constantly for long periods, as it would be in 'phone operation. The screen voltage should be set for minimum creep in the 'phone set, of course.

Summing up, the important points which it seems necessary to observe in obtaining results closely approaching those obtained with crystal controlled oscillators are as follows:

1. High-C grid-ground oscillator circuit.
2. Correct proportioning of plate, screen and suppressor voltages.
3. Light loading of the oscillator.
4. Liberal r.f. by-passing of power supply leads.
5. Well filtered oscillator power supply with good voltage regulation.
6. Correct adjustment of plate circuit tuning.
7. Good shielding.
8. Vibration-proof mounting.

To many, the care required in construction and adjustment may seem too great to make replacement of the crystal oscillator worthwhile. The

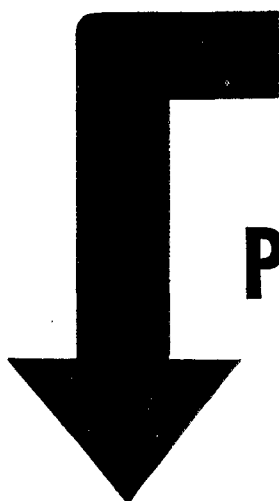

DOWN GO PRICES AS POPULARITY GOES UP!

COMPARE these prices—
see your savings on these famous types, each one of which now is available to you for less than ever before. At these new low prices you cannot afford to be without the assurance of reliable tube performance RCA gives you. Take advantage of these new prices and use RCA tubes in your transmitter.

RCA - 203 - A \$ **15.00**
formerly \$17.50. NOW

RCA - 211 \$ **15.00**
formerly \$17.50. NOW

RCA - 845 \$ **16.00**
formerly \$20.00. NOW

RCA - 838 \$ **16.00**
formerly \$18.00. NOW

RCA - 860 \$ **32.50**
formerly \$35.00. NOW

RCA - 866 - A \$ **4.00**
formerly \$5.00. NOW

RCA - 868 \$ **5.00**
formerly \$6.00. NOW

RCA - 918 \$ **5.00**
formerly \$6.00. NOW



AMATEUR RADIO SECTION

RCA Manufacturing Co., Inc., Camden, N. J.

A SERVICE OF THE RADIO CORPORATION OF AMERICA

Say You Saw It in QST — It Identifies You and Helps QST

NEW LOW PRICE METERS

D.C. VOLTMETERS AND MILLIAMMETERS

TYPE 531

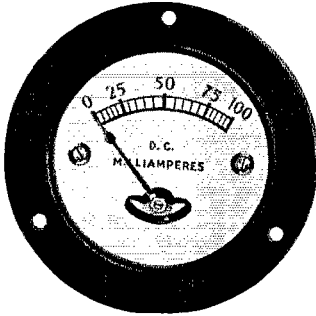

These new low priced instruments in their trim bakelite cases are offered to fill the amateur's need for meters which are ruggedly built, thoroughly dependable and inexpensively priced.

The air cushion damping of the movement controls the pointer action and brings it quickly and smoothly to rest. Milliammeter

scales are from 0-50 milliamperes and up. Voltmeters are from 0-3 to 0-25.

The modern flush bakelite cases measure 2 3/4 inches across the flange and mount through 2 1/8 inch hole. Dealer's price on these instruments is \$1.50.

D.C. Voltmeters with higher scales than those listed are available at slight extra cost. A complete line of A.C. Ammeters, milliammeters and voltmeters are available at slightly higher prices.

THE BURTON-ROGERS CO.

755 Boylston St. Boston, Mass.

Sales Division of the Hoyt Electrical Instrument Works

Gentlemen:

Find enclosed my remittance for of your Type 531 . . . D.C. Voltmeters . . . D.C. Milliammeters Range to be Kindly send more information on the other meters mentioned.

Name

State City Street

ASTATIC

dependability

THE AMATEURS' FAVORITE

The D-104 Astatic Grafoil Crystal Microphone is the choice of veteran amateurs because of its uniform quality performance—its constant dependability and ruggedness of construction. Fully guaranteed.

The
D-104
Made by
the
Pioneer
Manufacturers
of
**QUALITY
CRYSTAL
PRODUCTS**

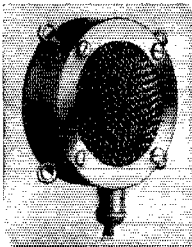

**GET
DETAILS
from
YOUR
JOBBER**

LIST PRICE
Only
\$2250

ASTATIC

Crystal Microphones and Pickups

Guaranteed instruments, known for their quality, dependability and ruggedness. Extensively used in both Professional and Amateur fields. Send for your literature today!
LICENSED UNDER BRUSH DEVELOPMENT COMPANY PATENTS

ASTATIC MICROPHONE LABORATORIES INC. + YOUNGSTOWN, OHIO

operating advantages gained, however, have been sufficient to lead us to return our borrowed crystals and cast free from crystal control—at least for the present. In case one feels that he must have crystal control in combination, he should build the e.c. oscillator as the permanent unit and add the crystal oscillator as an appendage, rather than the reverse. A completely separate oscillator tube and circuit should be used instead of attempting to plug the crystal into the same circuit.

To a Lady With Red Hair

(Continued from page 49)

and it was a desperate pull to shove it through, working into the early hours of Monday. The two-day respite gave the transmitting crew a chance to overhaul and make needed changes on the 14-megacycle gear. He himself had signed the work orders. To call for a five- or six-minute circuit right in the middle of a maintenance job! He could order the circuit, and get it, no matter what. He knew all that. But an order, once signed, was an order, and it was not the way to handle business to call for impractical things, or to force a change at the last minute.

He thought about it all that afternoon.

That night he went over to the North Tower quarters of Marcellus Gehring, Rollins Applewaite, and Pliny Fontaine, the trio who were in charge of transmitting equipment. The reputations which they bore with indifference made them primary objects of interest to visiting amateurs, who were usually much taken aback to discover that the Messrs. Gehring, Applewaite and Fontaine looked just about like anybody else. They were hard men to fool about radio transmission and quick to resort to mathematics, which they employed with a facility utterly staggering to those who could not follow along. But most of their success was due to plain common sense and unceasing attention to business.

Jug climbed the flights of stairs to the top floor, kicking open the door to avoid the necessity of turning the knob. The transmitting staff was at home, a very unusual situation.

"Here is Southgate!" announced Marcellus Gehring with alarm. "Lock up everything!" he added, scooping up a slide rule and throwing it hastily into a drawer of the study table.

"Throw Southgate out," murmured Pliny Fontaine, refilling the glass. "He is a harbinger of bad news."

Jug grinned.

"How about a circuit for five minutes on Number 4 tomorrow at two o'clock?" he asked Gehring.

"I knew it!" exclaimed Pliny Fontaine. "What did I tell you?"

"Who wants it?"

"I do."

Marcellus reached for the Maintenance Record. "Phone?"

"No, I'll key it."

"Automatic control's off Number 4," said Applewaite.

COMPLEX PROBLEMS

PROBLEM: HOW MANY TURNS ON A 1 1/2" DIAMETER FORM 1/2" LONG MUST I USE WITH A 25 μMFD CONDENSER TO TUNE TO 400 KC.?

$$L = \frac{10^8}{(2\pi f)^2 C} \text{ MICROHENRYS}$$

$f = 4 \times 10^5$
 $C = 25 \times 10^{-6}$

$$L = \frac{10^8}{(2\pi \times 4 \times 10^5)^2 (25 \times 10^{-6})}$$

$$= \frac{10^6}{15776 \times 634}$$

$$= 63.4 \text{ MICROHENRYS}$$

$N = \sqrt{\frac{3A + 9B}{0.2A^2}} \times L$
 $A = 1.5$
 $B = 0.5$
 $L = 63.4$

$$N = \sqrt{\frac{(3 \times 1.5) + (9 \times 0.5)}{(0.2)(1.5)^2}} \times 63.4$$

$$= \sqrt{\frac{36 \times 63.4}{1268}} = \sqrt{1818} = 42.6$$

= 35 TURNS ANS.

This Problem Quickly and Easily Solved with Type A Calculator

MADE EASY WITH

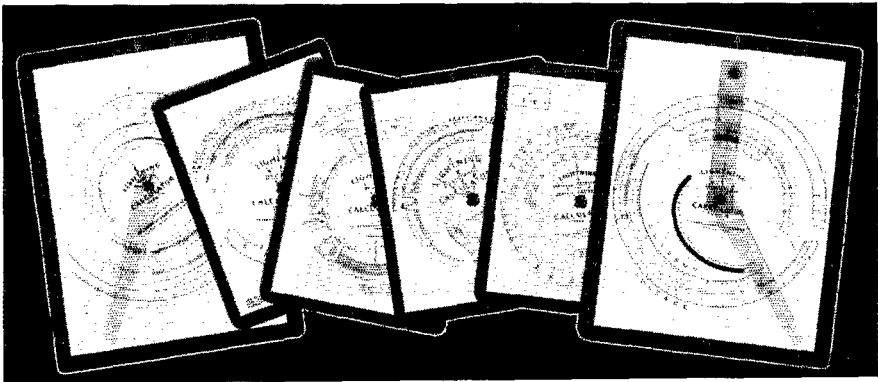

LIGHTNING CALCULATORS

Six Types Solve ALL Problems

TYPE A — For problems involving frequency, inductance and capacity, in design of radio frequency circuits. Direct reading answers for size of coils and condensers for any range between 400 kc. and 150 mc. Price, \$1, postpaid.

TYPE C — More information on electrical conductors than you could find in a book full of tables. Price, 50c, postpaid.

TYPE E — Direct reading total resistance of resistors connected in parallel, and total capacity of condensers connected in series. Price, 50c, postpaid.

TYPE B — Gives direct reading answers to calculations involving current, resistance, voltage and power with scale for resistance of copper wire and scale for calculating decibel gain or loss. Price, \$1, postpaid.

TYPE D — Gives decibel gain or loss when input and output voltages, currents or power are known. Price, 50c, postpaid.

TYPE F — Permits measurement of resistance, from 1 ohm to 1 megohm by use of a voltmeter. Makes an ohm-meter of your voltmeter. Price, 50c, postpaid.

AMERICAN RADIO RELAY LEAGUE, INC., West Hartford, Conn.

Say You Saw It in QST — It Identifies You and Helps QST

ARE YOU SICK OF "FLOWERY" ADJECTIVES



Model 24

Turner *skimps* on the "flowers" and shoots the wad on workmanship and materials. Thus Turner is enabled to *unconditionally* back every matter-of-fact claim.

SEE Radio Amateur's Handbook table on Crystal Microphone Output Levels on page 202 of 1936 edition.

Send for *KoLor Bulletin*

THE TURNER COMPANY
CEDAR RAPIDS, IOWA

Licensed under patents of the Brush Development Co.

EBY

Specializes in
Quality

Blinding Posts
Tip Jacks **Male Plugs**
Female Plugs
Low-Loss Sockets
A-C Switches
Tap Switches
Terminal Strips
Short Wave Switches
Moulded Sockets
Electric Eyes

Write for Latest Bulletin

HUGH H. EBY Inc.
2066 Hunting Park Ave.
PHILADELPHIA, PENNA.

"How much is down?" Gehring asked, turning the pages. "Sunday—Sunday the what?—eighteenth."

"Bias set's down for cleaning, and Number 12 and 14 are taken down."

Gehring studied the work sheet and scratched his elbow.

"Look," he said to Jug, pointing to the sheet. "Put interlock on Bias Relay No. 12. Set five seconds additional time delay on motor-operated switch No. 14. Re-check sequence of 14-megacycle control." Signed by Southgate, too, unless my eyes are seeing things," looking at Applewaite out of the corner of his eye.

Applewaite examined it.

Jug sat down on the corner of the table and reached for his pipe. "Can you get it back in service by then?"

"Sure, if you have to have it, but good Lord! For five minutes!" exclaimed Applewaite. "It's four hours' work getting that stuff back up. It's all in steel, you know, and it's right against the cam switches on the plate supply!"

"Have to work slow."

Jug examined the palm of his hand. It was unreasonable to ask for a circuit under such circumstances. He would just have to fail Ann. He would send a wire. Put it off til another time.

He hated that.

"What's it for?" asked Gehring. "Can't you use Number 3?"

Jug took a deep breath.

"No," he said. "Got to use twenty."

He thought a second.

"Listen," he said. "Here's why I want it."

The Messrs. Gehring, Applewaite, and Fontaine listened.

"One minute!" interrupted Rollins. "Is this woman good looking?"

"She is," said Jug.

"That is all I wanted to know!" said Rollins Applewaite. "Proceed."

Pliny Fontaine made an undulating motion with his hands, raising his eyebrows up and down.

"How capital!" cried Ned," murmured Pliny Fontaine.

Jug proceeded.

"I hate to let her down," he finished.

"Well—let's see," said Marcellus. "Where's the master drawing on Number 4 control, Jiggs? Over in the shack?"

"I pulled a couple of prints on it yesterday. Top of that drawer. No—here they are."

They bent over the diagram. It was hot in the room, and they began to bump their heads together, as they argued over which was better to do—jump around Number 17 and come in here to Number 11, or pick up the bias here at 8 and cut straight through to—

The blueprint was nearly white with leads running around in a labyrinth of resistors, relays, switches and terminal blocks, an appalling thing to delve into—but not to the Messrs. Gehring, Applewaite, and Fontaine. They knew it from stem to stern, having, at one time or another, argued over everything in it.

CARDWELL RECOMMENDS

FOR YOUR 500 WATT CLASS "C" FINAL RF AMPLIFIER

USING 50-T's, HF-200's, 852's, 838's, RK-28's

AND SIMILAR TUBES, EFFICIENCY MODULATED

FOR SINGLE-ENDERS

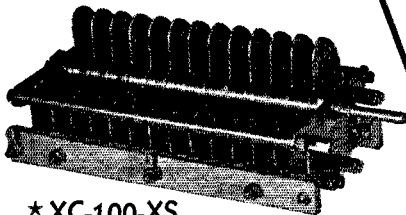

* XC-100-XS
\$6.90 Net to Hams

SPECIFICATIONS

6000 VOLT PEAK
.200" AIR-GAP
MYCALEX
INSULATION
BUFFED &
POLISHED
PLATE
EDGES



FOR PUSH-PULL

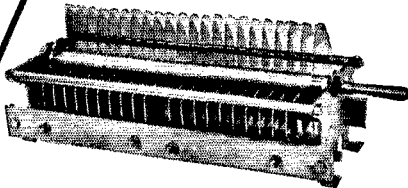

XC-75-XD*
\$10.20 Net to Hams

CARDWELL condensers are specified the world over by engineers, experimenters and amateurs!

There's a CARDWELL for every purpose — your dealer carries a complete line. The CARDWELL 1936 Catalogue, describing every condenser in the CARDWELL series is available — write for it.

THE ALLEN D. CARDWELL MANUFACTURING CORP'N
83 Prospect Street Brooklyn, New York

BIRNBACH

"STEATITE" INSULATORS



A transmitting antenna insulator of exceptional tensile strength — 1500 lbs. Glazed overall, high insulation value. No sharp edges in grooves or holes. For all power up to 1 KW. Priced only

470 — 6" \$.50 (list) 471 — 12" \$.70 (list)

PORCELAIN SPREADERS

462 — 2" \$.12 (list)

464 — 4" \$.15 (list)

469 — 7" \$.20 (list)

Write Dept. Q4 for Antenna Information

BIRNBACH RADIO CO., Inc.
145 HUDSON STREET NEW YORK CITY



*Ur sigs r FB
now, OM. I knew
the BC3 wud
clean-up ur note.*

BLILEY BC3 \$3.95
CRYSTAL UNITS and up
ACCURACY GUARANTEED

Radio Operator's
Course

Complete in
Telegraphy—
Telephony

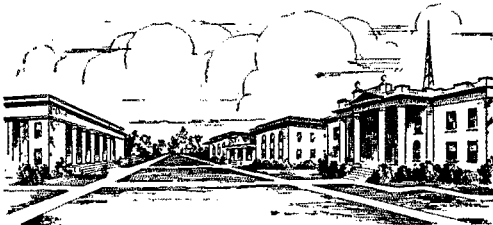

Practical
Experience
Studio—
Transmitter—
Announcing

P. A. C. is an endowed, educational institution — not privately owned, not operated for profit, college rank maintained. Course consists of maximum knowledge necessary to secure Commercial Telegraph Second-class, and Radio-telephone First-class government licenses. Course includes Wireless Code, Radiophone, Announcing, Microphone-Studio Technique, Service, Police, and Aeronautical Radio. We are authorized to teach RCA texts. At the completion of course you receive practical studio technique experience in our commercial broadcast studios located in the administration building, and experience as an operator on K P A C (500-Watt Commercial transmitter located on the campus, owned and operated by the college), and inter-departmental marine communication experience. If interested, write for Bulletin R.

PORT ARTHUR COLLEGE

Port Arthur (World-known port) Texas

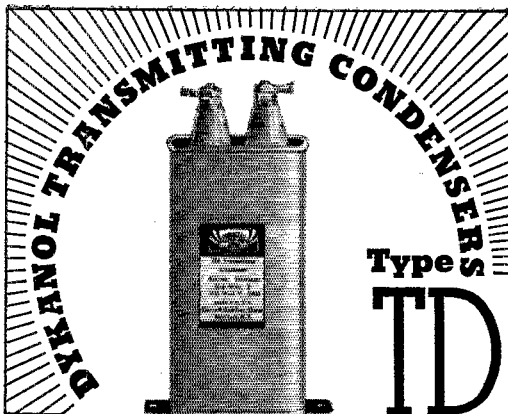

The accepted high voltage oil transmitting capacitor in the broadcast and amateur fields.

Check these features they speak for themselves
 ★ Non-inflammable and non-explosive. ★ Hermetically sealed in non-corrosive metal containers. ★ Considerably smaller than other types now available. ★ Can be operated at ambient temperatures destructive to ordinary oil condensers. ★ Can be operated continuously at voltages 10% above rating. ★ Available in a complete capacity range from 600 to 100,000 volts, D.C.

THE BEST CONDENSER EVER MADE FOR THE "HAM"

Write for latest catalog on the various applications of these and other C-D condensers. Free on request

CORNELL-DUBILIER
 CORPORATION
 4373 BRONX BOULEVARD
 NEW YORK

PEAK PRODUCTS IN MYCALEX



MYCALEX is the highest standard of insulation known for all Radio Frequency and electrical work. All your present insulation on Tuning Condensers, and other components can be fabricated in Mycalex.

Send your specifications for quotations
STANDARD MYCALEX INSULATORS: Acom tubesockets, Standard tube sockets, Antenna spreaders, Sheets, Stand-offs, RF choke coil forms, Rods, Strips.

Write today for descriptive literature on all Peak Products

Peak P-11 Pre-selector. Peak M-2 Aural Radiotelephone Monitor. Peak Q5 2½, 5, 10 meter super-het receiver. Peak X-4 56 mc. transmitter.

PEAK

EASTERN RADIO SPECIALTY CO.
 1845 BROADWAY **PRODUCTS** NEW YORK, N. Y.

"It's all right," said Marcellus, straightening up and looking around for the cigarettes. "We can fix it up."

The hands of the clock in the tower of the Engineering Building stood at two minutes to two. Jug glanced at the Western Union timepiece above the operating desk and typed: ". . . and tell daddy not to forget about my check—all my love—signed Henrietta AR BK BK QRX seven min for Nr. 847 AR"

"R," thundered the dynamic speaker.

Swinging around, he pressed the signal button on the control panel. The horn in the basement barked. Stand clear for change over! There was an interval. Safety switch open on one of the power enclosures.

"Close it! Close it!" Jug muttered, looking at the clock.

The operating room horn emitted a penetrating roar. Simultaneously, the automatic control sequence relay snapped shut, Jug grasped the brass handwheel protruding from the control panel and clicked it quickly from "3.5" to "14," his other hand tripping closed the automatic control master switch. With a whit the sequence control went into action. The 14-mc. filament pilots flashed red and the bias set down below could be heard whining in one quick leap into full speed, a prolonged volley of clicks sounding from the transmitter room. In the power enclosures, the plate supply cam switches rotated, came to a halt as the contactors closed in sequence with explosive force, humming faintly. The twelve rectifiers leaped into life as the contactors closed, the oil-filled reactors joining the inter-connected star neutrals, bursting into a 720 cycle song of increasing intensity.

The transmitting crew in the basement surveyed the action warily, watching for an ominous break in the sequence, but it followed through.

The pointer of the milliammeter on the Isochronometer started a leisurely pendulum motion. Jug closed in the dummy load, made a long dash on one of the Vibroplexes, and wrote in the log: "Input 950 freq. 14088. 12:00 p.m. Southgate V beam Nr. 1," and threw the antenna selector cam switch to the right.

The minute hand of the clock stood straight up.

Two deep reverberations sounded in the distance.

On the roof, the motor-driven air-break switch flashed as it swung upward in an arc to engage the twisted-line feeders of the V-beam on the hill, the long radiating arms of which encompassed the eastern horizon.

Setting the keying drive at 5 words a minute, Jug began to type. His eyes were expressionless as the perforations on the tape struck the keying rollers, but Jug was poker faced and only the firmer clamping of his teeth on the pipe stem indicated anything at all.

With cold fury, the 500's unleashed their might and fired it into the grey sky.

Ann waited. It was three o'clock. She could feel the seconds ticking by, and fright clutched her—

(Continued on page 108)

FOR MEASURING MODULATION

PRESENTING a well engineered fundamental circuit, the National Oscilloscope is ideally suited to measurement of percentage modulation either at the transmitter or receiver. Its remarkably low net price of \$17.70 (less tubes) makes it the ideal foundation for elaborate circuits as well.

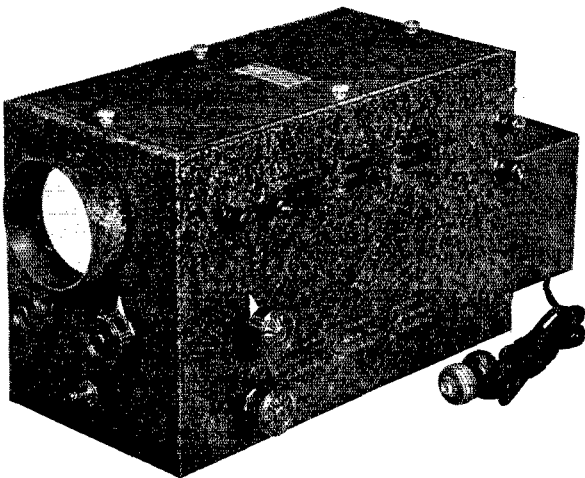

NATIONAL COMPANY, INC., MALDEN, MASS.

HIPOWER

AH cut — HIPOWER — crystals

LOW DRIFT—DEPENDABLE—ACTIVE

Why pay more, you cannot buy as good for less

Type	Frequency	Choice of Stock
AH10	1700-3500 Kc. Bands.....	\$2.35
AH10	7000-7300 Kc. Bands.....	\$3.90

Hipower crystals are sold by your dealer, or order direct

Write for literature

Zero temp. coef. crystals for
Broadcast and Commercial use

HIPOWER CRYSTAL CO.

2035-49 W. Charleston Street CHICAGO, ILLINOIS

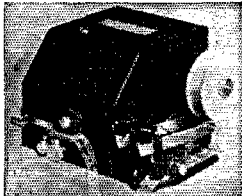

"QLZ - QLZ - QLZ"
OPERATORS
Save Your Fists
With the **AUTOMATIC**
ROBOT
RADIO KEY

Price
\$10

Postpaid
Patent
Pending

Repeats calls or messages indefinitely, automatically, by motor-driven endless paper tape, perforated, dot and dash, by attachment on key. Length tape unlimited. Speed adjustable. Induction-type motor. Furnished with two 100-foot rolls of tape. Complete unit. No additional equipment needed. A practical instrument. Answers long-felt want of amateurs.

GUARANTEED with Full Instructions

Made by Manufacturer of Electrical Instruments

Gardiner-Levering Co. Haddon Heights
New Jersey, U. S. A.

ECONOMY CODE MACHINE—\$12

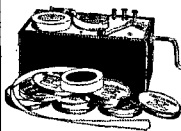

Learn code easily, at your convenience — and economically. Famous Instructograph principle. Complete with choice of 5 tapes, and Book of Instructions. Delivered postpaid anywhere in U. S. A. Send postcard for full details.

Instructograph Co., Dept. Q-42
912 Lakeside Place Chicago, Ill.

BUD IMPROVED MIDGET CONDENSERS

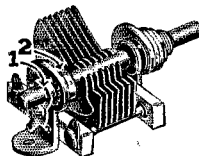

Note These Improved Features!

1. New Positive Wiping Contact on rotor shaft with adjusting screw, eliminates mechanical noise on high frequencies.
2. Close Fitting Bearings hold rotor calibration and smoothness of operation.

Insulated with ISOLANTITE. Soldered brass plate assemblies, and heavy aluminum end plates make a precision built, ruggedly constructed condenser.

No. 900 — Cap. 20 Mmfd.....	List \$1.15
No. 902 — Cap. 35 Mmfd.....	List 1.25
No. 903 — Cap. 50 Mmfd.....	List 1.35
No. 905 — Cap. 100 Mmfd.....	List 1.85
No. 906 — Cap. 140 Mmfd.....	List 2.00
No. 908 — Cap. 200 Mmfd.....	List 2.30
No. 909 — Cap. 250 Mmfd.....	List 2.45

Dual units and multiple space units in various capacities illustrated and described in our new catalog. Free upon request!

40% DISCOUNT TO AMATEURS

BUD RADIO, INC. 1937 E. 55th Street
Cleveland, Ohio

STATION ACTIVITIES

(Continued from page 78)

HUDSON DIVISION

EASTERN NEW YORK—SCM, Robert E. Haight, W2LU—EGF offers daily service to Canal Zone and connections with TL "P" and "C." FQG is new R.M. Congrats, Steve. LU reports Unit 1, N.C.R., receiving full uniform equipment, HYC reports much traffic for the month. GTW, Hudson Dist. A.A.R.S. net has real traffic net perking FB. GZF schedules PAQSD every Sat. on 3.5 mc. W80QG reports via radio. W2ATM is tuning up for that N.C.R. cruise. BLU is busy with A.A.R.S. schedules. FRU got his first card from 6th Dist. CQA, back from Bahamas, blew RK-20. CC handles 10 schedules per week. BLL, FWC, and CQA attend N.C.R. drill at NDB. CJP with 30 watts contacted OKIBC; he also QSP'd death notice to West Coast for Alaska. IYH worked his first ZS. IND is building 100-watt rig. IMR is trying to get rid of bad hum. HCM got Class A ticket and revamps for 'phone. GUW is on 7248 and 3854 kcs. GXL and BAC are rolling out on 1.75-mc. 'phone. GFT is rebuilding. LH has new PR-16 console and 3-stage crystal-controlled transmitter. CJS is on 14 mc. but makes better DX contacts on 3.5 mc. BJX reports for M.H.A.R.A. CJP is off the air due to theft of his entire station equipment! GWY on 14 mc. works all W's and DX. GFD moved to Poughkeepsie from Kingston. DOS is on 3.5 mc. CVT finds time from making "Go-Devils" to get on 3.5 and 7 mc. HES expects to be active on 56 mc. ODM is smacking the ether with an Eimac 150-T on 7 mc. BJX is on 7 mc. for club contest and League test. HVS has two rigs, one works on 7-mc. C.W., the other on 1.8-mc. 'phone. CGT is on 14 mc. with AGZ's transmitter. GXE is student at M.I.T. IXK is studying radio engineering at Harvard. ITK of Kingston reports activities. IUR has RK-20 working FB. HUM is keeping fit in Florida. JFE is working 1.75-mc. 'phone. HUB is out for high power. BDB is very FB traffic. HNR reports hot stuff on 7 mc. IVS has B.C. transmitter. HUK is burning out '45's. QY reports the passing of HBW of Walden, N. Y., Dr. Lowell Brown, one of best 56-mc. men. IMP of Pelham nearly had a relapse when he received two heard cards from U.S.S.R. GNI is now at IYK and his O.R.S. was transferred to Western Mass. Sect.

Traffic: W2EGF 1334 FQG 245 LU 240 HVC 301 GTW 173 GZF 123 W80QG 39 2BJA 39 ATM 35 FWC 36 BLU 32 CQA 18 CC 10 BLL 4 CJP 3 HCP 2 IYH 1.

NEW YORK CITY AND LONG ISLAND—SCM, Ed. L. Baunach, W2AZV—New O.R.S.: HBO and IHT. The Section is still in need of good O.R.S., but the applicants must have at least one schedule per week. EXR and HGO are out for O.R.S. ADW is N.C.R. R.M. for this Section and operates on 3570 kc. every evening. KI is member of Trunk Line "C" and can be heard daily on 3665 kc. R.M. EYQ wants all stations in Suffolk County interested in traffic to write him regarding a county traffic net. ECL, HMJ and HXT are on 14 mc. looking for traffic schedules. CHK is QRL work but manages to keep a high traffic total. HWS now operates JIP at school on 14,384 kc. GDF received his W.A.S. certificate. ING can be heard on 7-mc. traffic net. New station: JKN. PF operated portable on 3.5 mc. from Hotel Montclair, N. Y. C., on Feb. 11th for Veterans Wireless Operators Ass'n annual banquet and handled messages from other V.W.O.A. banquets via A.A.R.S. AYJ visited the gang in Phila. HJ is receiving plenty of S.W.L. cards from the foreigners. HVD was heard in England during recent tests on 3.5 mc. HHW is completing 28-mc. 'phone rig. Tu Boro R.C. call is JIQ. GVX is using an Eimac 150T in final with 300 watts input. IEK has 801 with 100 watts input. ILG is using link coupling from a 59 Tri-tet to '46's. IDX is too lazy to repair his antenna, which blew down in the snow storms. IHE is rebuilding rig to use a 2A5 crystal oscillator and '46's in parallel. ICO is building 28-mc. 'phone. AHC and DXO work HCAAE (Andes Amazon expedition) direct. DPQ is the expedition operator. CGD says it seems that most of the gang go in for flea power as he can't get rid of his '04A's and 851's. IBT is looking for traffic for Brooklyn and Queens. BGO is still after traffic. HAK found it too cold in his shack for comfortable working these past months. IOP is going places with his low-power rig using only 58 watts input. IPB is out for his Class A ticket. DOG schedules his home town in Pa. CSY works 'phone with his brother in Wisconsin. ZAV is getting out on 56 mc. using 58-58 job. On February 23d Unit Three of the N.C.R. in Hempstead, L. I., had a very FB Hamfest headed by

AA, ADW and CIT at their meeting place in the Hempstead Post Office. Any of gang who is interested should get in touch with any of the above-mentioned stations, who are always at the P.O. BPJ has gone in for amateur color photography. BAS is on 56 mc. exclusively. UN works for CBS. DOG's YL Jr. op weights 18 lbs. AZV's Jr. op is 23 lbs. BYL will soon be one of the Benedicts. EVA is looking for new QRA's. ASG and BKP QSO every Sunday morning on 3570 kc. Anyone who wants some snappy operating should call ASG at 10 a.m. E.S.T. JHB reports the following: IVL can't seem to run his '45 over 50 watts input without getting r.a.c. ELN is designing band pass filters. JHB, a newcomer, is going on 3.5 and 7 mc. with Jones '53-'46. Flatbush Transmitting Club invitation said, "Push the door bell down and hi de ho." We were promptly jolted by a spark coil with a mere 20 volts across it, hi. BTF has his automatic tape transmitter almost completed and an R.C.A. 136 is on the way.

Traffic: W2BGO 513 CHK 314 KI 241 EYQ 165 EXR 73 DXO 63 IBT 50 HGO 47 PF 37 AHC 29 AZV 26 ECL 23 CCD 18 BYL 16 HKO 16 HRA 13 ADW 12 HAK 8 HGO 14 GDF 6 IPB 6 IOP-IHT-BKP 5 CIT 6 GZS 5 EYS-BMM-DOG-FLD-HJ-ING-BPJ-HWS-JW-AA-FIP-HMJ 4 CP 3 HXT 2 ASG-IJZ 1.

NORTHERN NEW JERSEY—SCM, Chas. J. Hammer-sen, W2FOP—3ETX is back in traffic work in a big way. 2GGE says his '10's show signs of going west. GGW was busy listening on 14 mc. in HalliCrofter DX contest. Recent severe snow storm broke up HBQ's antenna mast. GAS has Navy tactical call of DC47. HZY worked G2PL and got FB report. GVZ got W.A.S. certificate number 60. IGM is rebuilding. HNP has new 150-watt 'phone rig on 3.9 mc. GSA is looking for cheap SW3. GQX is wondering how to invest fifteen bucks. CGG has worked 35 states on 3.5 mc. TX is having trouble keying '47 crystal osc. without chirps. IAMZ is working portable from Livingston while working in this Section. CJX has recently worked these countries on 14 mc.: VU, ZE, ZB, SU, ZF, PF, FB, OM! HGX worked 12 countries and 4 continents in past month. BJZ is looking for traffic schedules. AIF has 350 watts input to final. CIZ says his cold shack made his sending sound like a lid with gloves on. HRN worked D4NXR on 7 mc. for his second European QSO. GSX is getting ready for a try at 1.75-mc. 'phone. FZE has been appointed activities manager for U.C.A.R.A. for the summer. EUI is the only member of the U.C.A.R.A. not on 28 mc. ASC-4BDV is back in N.N.J. after a sojourn in Florida. CAY is working all bands from 56 to 1.75 mc. CQX can now be called Pop—it's a boy! HBQ is new R.M. in charge of Ocean and Monmouth counties. IAMZ, BT2, BJZ, FRF, IYS and HFT are new O.R.S. appointees. GQX has new O.B. appointment. IEQ says he is working a little DX around his back yard on 3.5 mc. IHK says his new super is FB. Plainfield Radiophone Ass'n meets every Friday night at the Plainfield City Hall and invites visitors. Orig. T.C.R.A. meets at the Rahway Y.M.C.A. and will welcome all who drop in on them. U.C.A.R.A. is keeping the locals informed about the schooner *Adventurer*. FFY is rebuilding r.f. portion of his rig. GZG has new exciter unit for 1.75-mc. 'phone. HLX is back on 1.75 mc. after several weeks' illness. IWU has B.C.L. trouble and confines operation to the "wee sma' hours." JDO is working 56 mc. IBZ is getting good DX with low-power 1.75-mc. rig. FLB has had attack of YLitis. BZC is back on 1.75 mc., quitting C.W. Low temperature in his cellar shack kept DAC off the air. HOZ gets quite a kick out of handling traffic. GYY is experimenting with vest pocket transmitters for 56 mc.

Traffic: W2BXC 2186 (WLNF 885) 3ETX 1182 2GGE 1026 GGW 863 HBQ 571 GAS 536 HZY 339 GVZ 325 ICM 265 HNP 176 GSA 75 GQX 59 HOZ 54 CGG 63 HTX 56 TX 25 FOP 39 IAMZ-BT2 25 2GMN 20 CJX 18 HFT 13 HGX 10 BJZ 9 AIF 8 ECO-CIZ 7 ICJ 2 HRN 3 (Jan.-Feb. GQX 100).

ROANOKE DIVISION

NORTH CAROLINA—SCM, H. S. Carter, W4OG—We want to thank the Raleigh gang for a big time at the Floating Club meeting held there February 2nd. These meetings are very enjoyable and the entire gang should get the habit of attending them. Raleigh: BRT has his intrastate schedules at noon. DW is still trying to get Utah for W.A.S. Tarboro: CCH says DX is on the upswing on 14 mc. Warren Plains: BHR is putting up a new antenna on a pair of 75-foot poles. Graham: CJP had a heart attack when six 30's went west in one day. AEH is increasing power. COC

has about completed his new 3.5-mc. rig. DCU is on 1.75 mc. and 3.5 mc. with a pair of 46's. CYN is back on 3.5-mc. C.W. after a try at 'phone, AYA is rebuilding. CLH is QRL work. Raeford: ANK is working portable at C.C.C. Camp with 2.5 watts input. Mt. Holly: CYY is working up a storm; he is new O.R.S. and has replaced DW on T.L. "C." Charlotte: BLN is working plenty of schedules, and is joining the A.A.R.S.; he is helping DCS rebuild. AH and DSY are on 28 mc. CXC is increasing power to 450 watts to final. The Club has moved to an uptown location and is rebuilding for 'phone and c.w. Wilmington: CPT kept his New Year's resolution by reporting from Washington, D. C.; he is helping in Cairo Survey. LA2X was a recent visitor, and made schedules with some of the fellows. FT has a new HRO. BPL is QRL broadcast station. DIE has 2nd class telegraph ticket to add to his collection of various licenses. US is now crystal-controlled, which makes Wilmington 100% crystal. EC is working all continents except Asia on 28 mc. Greensboro: MR is having auto QRM on 28 mc. ZH is rebuilding. AEL reports for the first time after being on the air 5 years. Winston-Salem: Activity at 4NC is very high at this time. CYA keeps schedules on 3.5 mc. ABT left his hat in Raleigh at the hamfest, but has it back now, thanks to CXF and OG. HI, BYA handles quite a bit of traffic. BOH is on the air. CKJ is heard regular on 3.5 mc. DKI is going places with his new PR16. Durham: CUB led the state in traffic this month. With the 'Phones: CXO has applied for O.P.S. AEN is getting good results with his crystal mike. BX wants some information on how to make his PR10 oscillate. DKB is having trouble with his 59 Tri-tet. DIS gets out FB when he is not pulling teeth. ALD is most consistent Charlotte 'phone on the air. BQE works 18 hours and sleeps 8, and is trying to find some way to be on the air more. CEI is on often. BV got the bugs out of his rig and is getting out FB now. CYB has about recovered from the trouble with his feet. CHX is putting 600 volts on a 59 Tri-tet which drives a '10 with 75 watts input fine. CEL has been seen around the hospital quite a bit, but the reports say he is not sick; a white uniform is the magnet. DSY is having good results on 28 mc. NP has a new velocity mike. BFB is QRL traveling. BNG is on the air plenty because the weather has been too bad to start his spring plowing. CLB is building a two stage preamplifier for his crystal mike.

Traffic: W4CUB 160 CYY 141 CXC 82 BLN 64 BRT 28 ABT 25 NC 17 ANK-CYA 12 BYA 10 CJP 5 CYB 4.

VIRGINIA—SCM, Charles M. Waft, Jr., W3UVA—EVN is at Lynchburg College. DYP was on 4-mc. 'phone while. DWE has no heat in shack. BNH uses 860 on 7 and 3.5 mc. EXW got on 14- and 3.9-mc. 'phone grid mod. 801's. BUR has moved. AMB wrote newspaper article on ham radio. CUV has FB new rig with P.P. '52's on 14-mc. 'phone and 7-mc. C.W. EZL insists that F.C.C. regulations be enforced better. FGW has 37 states towards W.A.S. on 3.5 mc. AAJ resigns as R.M. as he has irregular hours. BFW is building 'phone rig with P.P. RK20's. UVA schedules K6MXM (ex-3BHM at V.P.I.); worked VU2CQ for W.A.C. and W.B.E. EBK has YL-itis. BZE feels rebuilding time approaching. EMX is new O.P.S. BZ is working on 3.5, 7 and 28 mc. BIW is outstanding 28-mc. station. V.P.I. Club has applied for license. EBD was in O.R.S. party. AVR schedules 3BSY BT4 daily. ELN handled bunch of traffic from K4AAN. KU operates at WTAR. EMM has new rig with P.P. 838's; worked lots of DX on 28 mc. BYA and ANT (WLQT) make B.P.L. CA schedules W1ES, 3BZ, and 4BLN. CLJ let his license run out; took exam again. BRY is off due to lack of sky wire. FE is operating portable at Hampton. BSB hooked VU7AB on about 14,075 kc. FFD is using a '10 on 3.5 mc. EVV, portable at U. of Va., wants Va. schedules. CHE has new rig with P.P. '04A's and band switching. BYA was QRL with traffic from Florida Fair. AIJ hopes to get Va. 'phone net going. To BRY, the retiring S.C.M., may we express the feeling of the section when we say, "Thanks for a hard job well done." The S.C.M. wishes to express his appreciation of the support given him in the recent election. We will do our best to put Va. at the top and keep it there. To do this every ham must cooperate by reporting REGULARLY on the 16th of each and every month. Will you do your part? The Univ. of Va. Radio Club plans to hold the first 1936 meeting of the Va. Floating Club at Charlottesville on Sunday, April 19th. A good time is assured. There will be visits to Thornton Hall (new Engineering Building), Monticello, and Ash Lawn (homes of Jefferson and Madison).

Traffic: W8BYA 807 ANT 721 WLQT 819 ELN 122 FJ 84 DQB 47 EVN 28 BZE 25 EVV 18 CFL 25 EPS 15 UVA

10 KU 6 BUR-CFV-EBD 4 CYM 3 AAJ-EMM-EMX-FGW 2 AVR-BSE-CHE 1.

WEST VIRGINIA—SCM, Dr. Wm. H. Riheldaffer, W8KKG—The West Virginia 'phone net is organized with JWL, LBE, AHF, AFB, MOL and BDD. NMD won a 0-300 milliammeter in the Roanoke Division Contest. MCR rebuilt transmitter for 28 mc. HI rebuilt to modulate. BKI is the proud owner of three acorn tubes. MOL is first alternate N.C.S. of W. Va. A.A.R.S.' 'phone net. NFO needs Vermont for W.A.S. KKG worked VP9H on 3.5 mc. and is now W.A.C. on 28 mc. OKN paid ANU a visit. LNR is working in Elkns. NEP applies for O.R.S. and A.A.R.S. 3ZD visited HD and other Wheeling stations. HGA worked his 74th country. DPO, after making W.A.C. and W.A.S., sold his entire station. HD visited KKG, MZD, JRL, BOK, TI and IKN. NTV has new RK-20 Tri-tet going. The Grafton High School Radio Club station has been assigned 80FD. MJJ worked G2LB. EWM has a nice note with an e.c. 24. KSJ gets out nicely with his pair of ten's. CDV has an HRO to go with that 1 kw. NBH moved to Tampa, Fla. Traffic: W8OK 205 WLHB 160 MCR 140 AT 69 KKG 67 MJJ 29 HWT 61 AKQ 16 LII 22 KSJ 17 BOK 37 MZD 4 NFO 3 ANU-NEP-LXF 2 HD 5 NTV-EWM 1 LTC 2 WLHP 44.

NEW ENGLAND DIVISION

CONNECTICUT—SCM, Frederick Ellis, Jr., W1CTI—MK leads the Section with B.P.L. traffic. JHK keeps New London on the map. GME turns in fine total as usual. GVV worked his first VK. AMG stays on the job with Navy net. AMZ moved to Livingston, N. J., and had his O.R.S. transferred. QV reports for himself and the club station. JPE is working 14 mc. and lives with Ross Hull. BQS is warming up 56-mc. 'phone. AFB is now Conn. Trunk "C" operator. DLX got R8 from Germany. CTI is QRL but gets on the air when possible. BFB built himself a new relay rack using bedstead angle iron. GTX applies for O.O. appointment. IOV worked G, ON and HB on 3.5 mc. HLE worked ZL on 3.5 mc. DLL sends in a long list of 56-mc. stations heard along Long Island Sound between New Haven and Stamford. Sorry to hear that IKE is ill with an ear infection. Here is hoping for a speedy recovery. WICBA plans for a monster hamfest May 16th at Stamford. Reserve that date, gang, you won't want to miss this.

Traffic: W1AMK 729 JHK 150 GME 127 GVV 96 AMG 59 BDI 47 UE 36 QV 20 ABN 4 HPI 13 BQS 7 GTW 6 DOW-DLX-CTI 4 HYF-BFS 3 GTX-EWD 2 GKM 1.

MAINE—SCM, John W. Singleton, W1CDX—OR worked G2DQ on 1.75-mc. C.W. HSS is right up close to the top of the Message Pushers again this month. GKU assists GOJ in keeping up his very fine list of schedules. INW worked PAØSD on 3.5 mc. with 50 watts input. ALO is hard at work keeping the traffic routes perking. FAP is getting interested in 28 mc. BWR is getting his part of the Section lined up to route traffic. CDX may be heard on 3562 kc. almost any evening. IKC is out after W.A.S., W.A.C. and all. EBY's rig is perking FB. IDN is experimenting with Class B on 56 mc. DRZ has pair of 89s P.P. in final at 40 watts. IVP is going to give 14 mc. a try. Dfq's new Harvey 200R transmitter works FB. AQL visited the Penobscot Radio Club. ERB is getting his schedules lined up. BOR is heard consistently with FB signal. AKT has new R.C.A. receiver; he also has FB crystal transmitter. Maine amateurs were all deeply saddened upon learning of the passing of our beloved Hiram Percy Maxim—A Grand Old Man has passed on to his reward. We will all find it hard to go on without him.

Traffic: W1OR 463 HSS 319 GOJ 253 INW 230 ALO 162 FAP 144 BWR 116 HSE 55 CDX 45 CRP-IKC 8 EBY 2 IDN 3 DHH 1.

EASTERN MASSACHUSETTS—SCM, Albert N. Giddie, W1ABG—ABG won cigar from FRO in O.R.S. party! BEF is building new frequency checking apparatus. IGN has new 56-mc. rig for local traffic work. IWG is working DX on 7 mc. with 10 watts input. RE reports JRN new ham in Nee dham. JL worked six new sections in O.R.S. party. KH thanks Jim Lamb's new silencer is a wonder. QW is still trying to get N.C.R. stations to report. HRE is going crystal-controlled. ISM is trying for O.R.S. BR schedules K5AQ daily on 14-mc. 'phone. HXE says Reinarts' 56-mc. antenna has everything "stopped." BMW is doing fine O.O. and Cairo Survey work. IUQ worked seven states out of eight contacts. GEX is all "het up" over 'phone harmonic situation. BB is busy with Cairo Survey work and 1.75-mc.

(Continued on page 108)

EIMAC

PRESENTS the 35T

High frequency oscillator, r.f. amplifier, doubler, and Class "B" modulator.

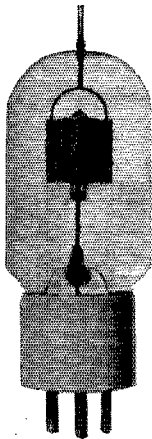

Class "C" output up to
112 watts

Class "B" output (2 tubes)
150 watts

● Tantalum grid and plate.
(no "getter")

● No internal insulators.

PRICE \$8.00 at leading
dealers after April 15th

EITEL-McCULLOUGH
INC.

SAN BRUNO, CALIF., U. S. A.
Cable "EIMAC"

EIMAC 35T

New — Improved

OHMITE R. F. CHOKES

4 Sizes

For use on 5
to 160 meter
transmitters

HANDBOOK
PAGES
[458-459]
CATALOG
SECTION

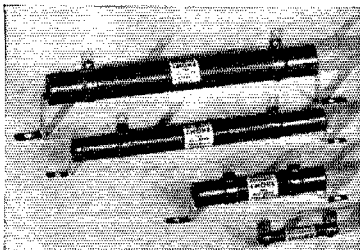

THESE OHMITE R. F. Chokes have many new features. They are single-layer wound on ceramic tubes, and coated with a moisture-resisting material which anchors the turns firmly in place. Ample space is allowed at the ends of the choke to prevent flash-over to ground when mounted by means of the mounting brackets furnished with the unit. They are described and their use fully discussed in a whole chapter of the new OHMITE Amateur Handbook. Get a copy from your dealer, or send 10c to:

OHMITE

MANUFACTURING CO.

4831 Flourney Street

Chicago, Illinois

cold, nervous fear. Her tightly-clasped hands felt her heart racing. The second hand on the tiny wrist watch marched inexorably on—on. Fifteen seconds past.

The din was horrible.

"Everybody on the band is right here," she whispered, pressing her hands to her forehead.

There was no use shifting the tuning. It was set where it should be, on the low-frequency side of the University's zero beat. She had checked it too often. It didn't vary the width of a pencil mark on over ten feet of dial spread.

Sudden doubt assailed her. Had she said three o'clock *his* time or *her* time?

"Oh, goodness!" she whispered. "What was it? I just know I said—"

Two new signals started up at that point calling PAOQL. Loud. Oh, so terribly loud!

"I just know I said *my* time."

And even if Jug was sending, could she hear him? The din was steady, a chorus of chirps, rattles, and pinging crystal notes, never ending and seemingly growing louder.

Thirty-five seconds past.

"He forgot," Ann murmured, a crushed feeling coming over her. Her throat began to ache—ache—each a stab that she was helpless to overcome.

"He forgot." Her lips formed the words, but no sound came.

The grandfather's clock on the landing of the stairs clucked with august majesty. It had seen many a clock come and go in its hundred-odd years of timekeeping and it knew a thing or two about keeping time that was not in the books. Its polished pendulum moved with stateliness and precision.

With calm solemnity it willed now to strike.

A mellow chord rang from it. Another. Another.

The top of the Duncan Phyfe table upon which Ann's elbows rested suddenly vibrated as a ringing, crystal signal with an organ-pipe undertone tore from the big dynamic. Behind it was the power equivalent to ten kilowatts and it shook the leaded window panes.

Ann's heart jerked.

She made a faint little sound. Desperate with excitement, she grasped the gold inlay pencil and began to scribble furiously:

"To a lady with red hair—this is Jug—I am proud of you—save the X for me—ARSK"

Ann caught the paper to her and hugged it fiercely. She closed her eyes in a slow sweep of the long lashes and her lips moved in what seemed to be a little prayer.

"Oh, Jug!" she whispered. "I will! I will!"

Laboratory Beat Oscillator and Signal Generator

(Continued from page 47)

A low-pass filter is provided in the plate circuit of the 53. It is essential that this filter be a good one, for if any of the fundamental oscillator component gets through to the power amplifier distortion will result. As it is, harmonic distortion is not detectable by ordinary means (such as in-

(Continued on page 110)



HAMS CALL IT "A Honey!"

● Meet Type 195 Bar and Filter Holder, a worthy member of the Premier Crystal family, and already an old friend to many interested in short wave radio. A Premier Crystal mounted in Type 195 holds the crystal on your incoming signal . . . single-signal reception assures a QSO of Gibraltar-like tenacity. Ease in crystal changing and dependability of frequency response renders Type 195 excellent for experimental work, for intermediate frequency filtering between 450 and 525 kc. in oscillator and superhet receivers. Type 195 also holds 100 kc. bars.

The holder is constructed of high quality Isolantite — the electrodes of heat treated nickel-silver, ground and hand lapped to a knife-edge, straight edge.

Spacer of low-loss Isolantite accurately ground plane parallel eliminates loose glass spacers, and guarantees satisfactory performance of crystal.

Crystal illustrated in square recess is a 465 kc. filter. Rectangular recess is for 100 kc. bar. Proper performance of holder assured by Isolantite spacer. Electrodes of constant characteristics and precision workmanship.

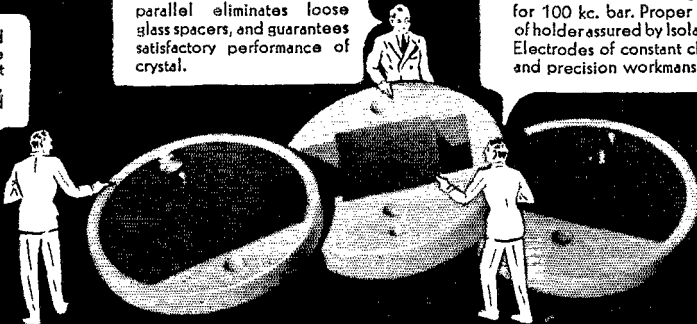

PREMIER CRYSTAL LABORATORIES, INC.
53-63 PARK ROW • NEW YORK • N. Y.

Utah
TRANSFORMERS and CHOKES

Send for complete Reference Guide of Better Transformer and Chokes for all Receiver and Transmitter Purposes.

UTAH RADIO PRODUCTS CO.
Orleans St., Chicago

Neon Oscilloscope Tube, tested, low striking voltage, long life—mirror, complete instructions \$1.75
Neon R.F. Wand, tracks down R.F., 8" \$.50
Neon R.F. Stick, internal electrodes, very sensitive to R.F., 12" \$1.00
Dress Up Your Station! Call letters in brilliant red or blue luminous tubing 3 1/4" high, with mounting, per letter \$1.00

Postpaid. Decorative displays for ham stations, prices on request
Commercialite Laboratories, Box 47, Omaha, Nebr., W9AQO

DON'T BE FOOLED!

Be sure to get a copy of my latest price list on all Receivers and Transmitters before you buy. You will find my terms more liberal and interest charges lower.

Flash! The New RCA-ACR175 RECEIVER
ONLY \$13.15 DOWN—Immediate Delivery
Balance in Nine Monthly Payments of Same Amount
NEW SUPER PROS IN STOCK

Attractive Terms and Prompt Delivery on National—Hammarlund—RME 69—Fobe—Skyrider—RCA—Harvey, etc., etc.

WILLARD S. WILSON W3DQ
DELAWARE RADIO SALES COMPANY
405 Delaware Avenue Wilmington, Delaware

Now The CODE TEACHER!

The NEW Master Teleplex

For beginners, experienced operators, and schoolroom. The sure easy way to learn code and to step up your speed. This amazing new instrument will record your own sending on double row perforated paper and repeat it back to you at any speed you desire. 10,000 words can be recorded on one tape.

No Batteries No Winding All Electric

It is the same in principle and in operation for this purpose it is equal to the Wheatstone Perforator and Transmitter, which cost over \$1,000.

Buy It or Rent It

Send for Folder Q4, which tells you how to get the use of this instrument without buying it. No obligation. We furnish complete course and personal instruction with a money-back guarantee. Low cost, easy terms. Write today for information.

TELEPLEX CO.
72 Cortlandt Street New York City
The New Master Teleplex, "The Choice of Those Who Know"

(Continued from page 106)

DX tests. 1QH is QSL Manager for M.V.A.R.C. WV added two more countries to his DX list. IZL continues to report from N.H. HXK is going crystal-controlled on 7 mc. JAF lacks one continent for W.A.C. EVJ, CKI and JMJ kept a 12-hour emergency radio watch during sleet storms which threatened to break the cable between the islands and the mainland. "The Yankee Network," ADM, AXP, BR, FR, MP and QM, is on 4-mc. 'phone every Saturday at 10.30 a.m. E.S.T. The M.V.A.R.C. is raffling off a B.C.L. set. It's about time we had some contests, or get-togethers, gang, so why not drop me a card and give me your ideas on what we ought to have. This means 'phones as well as C.W. stations. What d'ya say, are you still with me? The cards will tell! JIH is sporting a pair of 801's on 56 mc. JIQ is rebuilding for 28 and 56 mc. JGD is working portable. JRH is a new Lowell station. AKE, CIK, HKY and JID are rebuilding. GDU and JNP are on 7 mc. FCR and IIV have returned to 3.5 mc. We welcome 9RFW into our Section. AKS, ISM and HRE apply for O.R.S. AKS says 56-mc. net is working FB. HWE just missed B.P.L. ILL is building new 3.5-mc. rig.

Traffic: W1ABG 368 EVJ 345 BEF 271 FRO 253 IGN 239 DDE 191 IWC 180 RE 102 JL 86 HCH 67 KH 47 QW 42 (CEIC 36) AGA 40 HRE 31 HKY 24 AKB 22 ISM 19 BR 19 HXE 15 CIK 14 HWZ 10 BMW 8 GMD 6 IUQ 4 JCK-JID 3 GEX 1. The following A.A.R.S. reported traffic: AKE 1395 DCW 841 (WLJG 160) ZQ 657 (WLGQ 196) HWE 416 ILD 272 IHI 582 TY 535 INI 370 JPS 336 CKV 140 JBI 132 IXA 99 JKR 88 FZE 84 BDC 78 IVC 76 JDS 64 IKR 62 AGX 68 AAR 57 INA 47 IA0 43 AGR 37 CLN 33 EAU 30 AAU 28 CCL 26 HNR 26 GBW 21 IUP 17.

WESTERN MASSACHUSETTS—SCM, Percy C. Noble, W1BVR—JAH is running a fine bunch of schedules. AJD and JAH are keeping the West. Mass. O.R.S. channel hot. DDK very faithfully sends in the U.S.N.R. report each month—much appreciated. GZL is busy on 28-mc. 'phone. BNL is getting on 28-mc. C.W. EOB has new Hallcraft Super Skyriider. ISN has now worked all districts. IIP reports that someone is using AUM's call illegally. BKQ is now on 7294 kc. as well as on 3.5 mc. COI has 3.9-mc. 'phone using RK-20. IJR's father passed away during the month. Our deepest sympathy goes out to you, Ed. These monthly reports are mailed to A.R.R.L. Hq's on the 20th of each month. Your cards must be here by the 19th to be included. Please keep this fact in mind. Thank you. The entire Western Mass. Section mourns the passing of our beloved President, Hiram Percy Maxwell. Though he will never again participate in amateur radio, his memory will always be the guide of our actions as radio amateurs. A great man has been called to meet his Maker, and an unfillable void will forever remain in our ranks.

Traffic: W1BVG 405 (WLGE 127) BVR 160 (WLG 176) JAH 133 AJD 81 DDK 33 ASU 27 GZL-ICP 13 DIF-HNP 10 IFA-IYY 8 APP-ATK-JBU-NS 7 ABE 5 BNL-EOB-DJQ-IOT 4 ARH-INS 3 BPN-GUO-IIP 2 FXO 1.

NEW HAMPSHIRE—SCM, Robert Byron, W1AVJ—IDY reports 28 mc. working fine. FFL and IP are sure holding their places at the top in handling traffic. GHT is looking for schedule with some trunk line. FFZ is busy with A.A.R.S. work. IJB is now alternate S.C.S., also an O.B.S. APK is now an O.R.S.! JDF says not much doing there, but his traffic score says different. Congratulations to GOB, who announces the arrival of twin boys at his house. JES is on 3.5 mc. with ten in final stage. Saoc Valley Radio Club holds meetings every Friday at 8 p.m. with open house to hams. GMM is on in all his spare time. ILK has been busy with exams. ANS reports regularly. GOC keeps regular schedules with his brother, W4DSX. JEH, a new ham at Glenciff, says that the seed CCM sowed there is growing and in a short time there will be two more operators; at present there are three licensed hams there: JEH, HFX and LMB. JNC is reported as having very fine shack. CME is building new receiver. IP has position as time-keeper and paymaster where about a thousand women work. FTJ has the Monopoly game down to a science. EFE reports he got up early one morning (about ten), climbed up on the roof to discover his antenna buried deep in snow. TA has a chip on his shoulder and it is a good one; he wants to know why we do not tune the complete 3.5-mc. band after a CQ instead of just a few kcs. either side of our calling frequency, especially during daylight hours when there are so few on. JFW is active on 3.5 mc. JGI is working at Rye Beach. GOC is planning emergency rig. TA has a hundred-watt rig on the air. BCT

bought ABY's 'phone and is now on 1.75-mc. band with a wallop. IGI has been sick but is back on the job now. IXY has a pair of ten's going places. AFD is active on 28 mc. FGC is on 7 mc. HSS is working plenty of DX on 1.75 mc. DUK is now after everything on 28 mc. Congratulations to BFT, who we understand won the last W-VE contest with a peach of a score and a lot of hard work. HOV had misfortune with his RK-20. HOU is on 28 and 14 mc. JCA has pair of ten's in final.

Traffic: W1FFL 2267 (WLGB 64) IP 1058 JDF 418 IJB 384 GHT 260 FFZ 163 TA 151 EFE 121 EAL 45 FCI 31 GMM 19 ILK 8 IDY 5 GOC 2 BFT 151.

RHODE ISLAND—SCM, Clayton C. Gordon, W1HRC IEG got his receiver working on 28 mc. IZO has new "Mac-Key." IPU has long list of calls heard on 28 mc., including several foreigners. 9SCY (at Newport) received Class A ticket. GTN observed another "fade-out" on Feb. 16th between 11.00 and 11.30 a.m., for a period of about 15 minutes, at which time the C.A. Net of the A.A.R.S. went out completely. ISR is RM3C in U.S.N.R. now. IEX has new rig with 32 watts on 7 mc.; first QSO was EA4AP. HEEH has new QST noise-eliminator working FB. It is reported JRO and JRM, if giving Providence as QRA, are bootleggers—anyone having definite information please advise O.O. DDY or O.O. ZS. EJ is working in Hartford but gets home week-ends, etc., and is on 56 mc. then. HRZ and ETD are on 28 mc. experimentally. HRZ is the "Big-Shot" in the 56-mc. gang which is composed of AKA, BGA, AVH, HQR, AAD, AMD, AOP and JAR. DYB is showing up at AQ again after long absence. The R.L. gang on 7 mc. contains the following: HTB, AWG, BVI, HPE (also on 28 mc. some), IWZ, JIK. BLS worked two VK's, a ZL and an OK with his RK-20 on 14 mc. all during the same week, two different mornings. JFF on 3.5 mc. with low power is working out well—wonder if he can beat the "7" HRC worked a couple of weeks ago who was using a '24A. The Prov. Radio Ass'n held a DX contest on 3.5 mc. from 11 p.m., Feb. 8th, to 7 a.m., Feb. 9th. JGE has new Tobe receiver. JSB is new ham in Newport. The Newport 56-mc. gang thought they were working DX when they hooked K6JKU (portable-mobile) until they found he was stationed at Radio Compass Station at Brenton's Point. JPJ (handling A.A.R.S. traffic) and DIL BT1 are also 3.5-mc. men at Newport. BJA has 110 watts on his 830 final now on 3.5 mc. and has resumed his schedules with BEF. JRY is latest J call known to be assigned in Providence.

Traffic: W1IEG 1004 (WLGK 246) IZO 654 IPU 61 IAV 20 DDY 17 GTN 16 ISR 6 IEX 3.

VERMONT—SCM, Forrest D. Drew, W1BJP—Thanks for the nice increase in traffic, gang. BNS leads and makes the B.P.L. BJP is rallying from an attack of gripe. AVP was active in O.P.S. party and wants more Vt. QSO's on 'phone. FPS needs only three states for W.A.S. IQG has a new Collins network. AOO reports activity on three bands with a new 2A5 Tri-tet. AXN has a new rack and Collins network for the transmitter. FSV has a new rig, also new receiver and is applying for O.R.S. GAZ is in for some DX on 14 mc. GAN is hard on '10's, having blown five of them lately. GNF and AHN gave a radio demonstration and talk at the Windsor Rotary Club. Fine work, boys, and more power to you. DQK is having fine results on 28-mc. 'phone and reports visits from 1GZL, VE2JJ, VE2HV and VE2JE. GAE has been sick for several weeks and we hope for his speedy recovery.

Traffic: W1BJP 21 GAE 2 DQK 7 GNF 9 AXN 76 (WLGK 65) AOO 15 IQG 8 BNS 440 FSV 4.

ATLANTIC DIVISION

EASTERN PENNSYLVANIA—SCM, James M. Bruning, W3EZ—R.M.'s: 3AKB, 3AQN, 3EOP, 3ASW, P.A.M.: 3EOZ. Attention 'Phone Men: The O.R.S. sign after a C.W. call indicates one who measures up to definite standards. Similarly, the words "Official Phone Station" (O.P.S.) indicates that you "measure up"—that you sincerely try to operate your station with correct adjustment and proper procedure. 'Phone men with quality signals and operating experience are requested to write the S.C.M. Thanks. Brasspounders this month: WLQA (30K), W3EZ, WLQB (3EOP), 3AQN has a complete five-year message file. 3BES worked his 90th country! 3BRZ and 8ITS applied for O.P.S. 3BGD enquires about O.B.S. 3BZP has 45 of 48 states needed for W.A.S. 3CHH says 802's in parallel "won't talk." 3DEJ is interested in O.P.S. work. 3DMQ worked the rare stations FR8VX, VU2PX and ZE1JS.

3DNZ is completing new high power 'phone set. 3EBP is busy with A.A.R.S. 3ECA, 3EJW and 8MDA are in line for ORS soon. 3EOP has new 28-, 14-, 3.5-mc. rig. 3EOZ is new 'Phone Activity Manager (P.A.M.) for our section; Tom has brought his station up to date with 1 kw. input and has installed the latest send/receive monitoring equipment. 3EUP has new 100 watt rig on 14, 7 and 3.5 mc. 3EZ sends an SOS for old timers 3BNS, 3CL and others. The newer crop of O.R.S. are smashing your records. 3EYO, 3FKJ and 8DIG are new O.R.S. 3FUH has new RK-20 rig. 3FXZ (Mrs. 3MG) is fast becoming known on the 3.5-mc. C.W. band; handles traffic too. 3GS is now experimenting on 28 mc. 3MG wants Africa for W.A.C. 8BFF has trouble mixing night work and radio. Ditto for 3ADE, 3EZ and 8EKG. 8DIG (one of our Observers) calls attention to the growth of a.c. notes on 3.5 mc. lately. 8EU installed new antenna. 8ITS has Broadcast license. 8MRQ sends first report. 8NNC is now using 35 watts with fine results. We have received two requests for East Penna. QSO party. Send your opinion to S.C.M.

Traffic: W8EZ 580 3EOP 395 (WLQB 521) BZP 374 EBP 364 AKB 170 ECA 146 BVS 137 EYO 124 EPJ 94 AQN 79 EDA 54 ADE 47 VR 20 EWJ 11 BES 10 EUP 9 EOZ 4 CHF 2 DMQ 1 BGD 1 BOK (WLQA 687) 8ASW 160 8DIG 76 8OML 54 8NNC 34 8MRQ 30 8DMA 13.

MARYLAND-DELAWARE-DISTRICT OF COLUMBIA—SCM, Edgar L. Hudson, W3BAK—W3CQS, W3EOU, W3CXL, R.M.'s. W3BWT, Chief R. M. Sgt. Ed. Day, who has been confined to the hospital for several months, is now able to handle some traffic. Good luck, Ed. EZN joined the Army net. CDG is putting an RK-20 in the buffer stage. ABA had to drop A.A.R.S. due to being QRL work. FSP has fine rig on 7 mc. Washington Central High School Club station WZ is coming back on the air with P.P. '52's. GAD is a new ham in Washington. FQB has trouble with the B.C.L.'s. FGD won HRO receiver at Hamfest in Baltimore. FRB is building a six stage transmitter. BHE has built QST '34 frequency monitor. CDQ attended the Baltimore Hamfest and won a Bliley crystal. CWE attending college in Michigan is building new rack and panel 'phone rig. Keep your ears open, fellows. FRV has been rebuilding for March DX contest. FQL got married. BFX has been in hospital, but is back on the air. FEG is moving to new quarters. EUK has a new Breting 12 receiver. FZH is a new ham in Rehoboth, Del. DTO, portable, is now in San Diego, Calif., making arrangements for schedules on 7 mc. with Henlopen A.R.C. members. FJK is active on the air. CQS, Ed Thompson, recently had several narrow escapes. On his trip to the Trenton Hamfest he and his XYL were in an auto accident which wrecked Ed's car and placed Mrs. Thompson in a hospital for several days with some broken ribs. During the extreme cold weather while the residents of Smith's Island were isolated on account of ice, Ed, and several others in a rescue party were attempting to cross the ice when Ed fell thru the ice in zero weather. He shortly lost consciousness and later woke up in a hospital. Ed had his portable radio station along. He had hoped to get it up on the island. Sgt. Hunter of the Md. State police, a member of the party, lost his life due to exposure. We understand Ed got along OK.

Traffic: W3BWT 754 CIZ 633 CXL 582 (WLM 2763) ASO 204 BKZ 82 FFF 80 FZN 25 CDG 23 BAK 11 ABA 10 EPD 26 BR8 2 FUW 1 EPN 2.

SOUTHERN NEW JERSEY—SCM, Carroll D. Kentner, W3ZX—The Southern New Jersey Traffic Net has undergone major changes in operating procedure. It will be spot frequency on 3700 kc. and sessions will be held three times weekly at 7.15 p.m. A snappy routine has been worked up and the Net should prove to be a great aid in clearing state traffic. Watch our smoke! FTK tops the section this month with a grand total of 1171. FBM has joined A.A.R.S. and enjoyed participating in his first O.R.S. party. EWF is sporting a new 50T in the final. COT reads O.B.S. on 'phone to ZU6P and reports 28 mc. 'phone rig is coming up. BO is re-appointed N.C.S. in A.A.R.S. FOS is having storm and B.C.L. troubles but is coming up for O.R.S. soon. FFE is a new reporter, BIR is active on 14 mc. C.W. and 3.9 mc. phone. AEJ goes in for chess games with EPJ in his spare time. APV blew both '66's! DNU is changing QRA. DQV is new reporter; he is on 7 mc. with 38 watts. DOR wants O.R.S. EKL is slipping—to "five meters." ZI turns in his usual good total. EFM goes to town with a nice total. DSC had landed on TL "M". NF is pressed for time to get on the air. BEL manages to find one off-frequency station to report.

ZX is too busy with Net reorganization to pound much brass.

Traffic: W8FTK 1171 EFM 713 (WLNJ 123) ZI 379 APV 437 VE 333 (WLNJ 10) DSC 322 FBM 33 EWF 3 COT 6 BO 82 FOS 40 FFE 23 AVJ 14 BIR 9 AEJ 4 EKL 146 NF 61 (WLM 194) BEI 33 ZX 32 DQV 2.

WESTERN NEW YORK—SCM, Charles Smith, W8DSS—C.R.M.'s: 8JTT, R.M.'s: 8BJO, 8AQE—JTT again leads with a smart total and makes the B.P.L. Nice work, Roger. CSE, MQX, KJW and MBI are all new O.R.S. starting off on the right foot with very nice totals. BJO is doing a fine job as R.M. JQE nearly made the B.P.L. FCG, CDK and GWT are helping out in the Southern Tier with MQJ also getting interested. BWY, LVZ, EQJ and CJJ are handling some traffic with the latter keeping schedule with HJ2B. GWY is doing plenty of work as "O.O.". LWD passed O.R.S. test, Congrats. LQC, DLK and LJD should apply for O.R.S. DBX keeps only A.A.R.S. schedule as he is QRL. JOT was appointed Lieut. in C. G. radio net. BEN makes "W.A.S." at last. BEK is rebuilding shack. BR, EUY and AAR report. PBO is new ham in Baldwinsville. LGV's brother is now PDO in Iliion. MYS, NNW and BGO make first report. NWT works nice DX on 3.5 mc. and reports formation of Cayadutta Amateur Radio Ass'n. in Johnstown. OXI reports for the Saratoga Springs gang. AWG is opping at WLF1, Phila. CQW is QRL in Buffalo. PCI is getting out FB. GPS wants HRO receiver. AWM sends in usual FB report on Jamestown Club and station activities. NNJ using 9 watts input on 3.5 mc. C.W. was heard in Danzig Free State. CGU wants O.P.S. The Oneida Radio Club tendered a testimonial dinner to the resident S.C.M. and presented him among other "things" an FB A.R.R.L. S.C.M. lapel pin. Thanks, boys, and here's hoping that I can conduct this office in such a manner that you will all be proud of your choice. CPJ and NTY are active on 7 mc. FPC, LGS and OCH are building. NNW, BGN and JTT are experimenting on 56 and 28 mc. NWK, FMX, LGR and DES are working some DX. Our old friends, Jack, DSA and Marge, DEJ, are working at WHDL, Olean, as announcer and stenographer respectively. The gang wishes you both all kinds of success and happiness in your new positions. This Section needs a good slogan and the S.C.M. is open to suggestions. There will be a prize for the winner so let's hear from you. Everybody is eligible. CO has a '52 in the final and is using a pair of 800's in Class B to modulate the rig on 14, 3.9 and 28 mc. 73.

Traffic: W8JTT 1222 JQE 445 DSS 440 CSE 394 MQX 310 BJO 286 LJD 188 MBI 180 KJW 112 JE 106 FCG 57 GWT 46 BWY 45 LVZ 41 GWY 39 CJJ 27 CDK 20 BGO 12 PBO 12 EQJ 11 OXT 10 JOT 9 BEN-NWW 8 MNW 6 BEK 5 LGV-EUY 2.

WESTERN PENNSYLVANIA—SCM, C. H. Grossarth, W8CUG—KUN needs Louisiana for his W.A.S. KWA had two RK-20's up at one crack! OFO was appointed L.N.C.S. of PA55. UK is kept busy as D.N.C.-2 of Penna. district 5 in the A.A.R.S. KNB has been hearing some DX on 28 mc. CUG is looking longingly at 28 mc. LOQ blew up the RK18 messing on 56 mc. MOT has a new Skyriider with crystal filter. KBM says break in works swell. YA has direct contact with the Canal Zone and P.I. MHE sends his usual spasm sheet about the Allegheny Valley gang. KOB hooked EA7AD for his first European contact. IOH is trying hard for a W.A.S. certificate. CMP still has 28 mc. hopes. LOR says AJE will be ready to go again soon and NFX is set to take the class "A" exam. DGL is spending most of his time on the Cairo Survey; he is a newly appointed Official Observer. UR is looking for an '03A. OWC sends his first report. OTM built a new rig. OUI is active. GLA enjoys O.P.S. parties. OIZ put up a new sky wire. PAQ rebuilt his final using an RK 20. OKP says "MYM is active on 56. OUH is a DXer on 3.5 mc. LNH has an 861-welcome to OWH who moved in from the 4th district. PGV and PDT are new hams. OKP is active on 7 mc." LIG reports new ham, PEO, in Warren. After checking the report cards I find that only two have made it known they wanted a contest. Twenty-eight reports and only two stating a desire for a contest leaves no doubt in my mind as to the wishes of the gang. By the almost unanimous lack of interest in a contest the vote stands—NO CONTEST.

Traffic: W8ADY 508 KUN 388 KWA 305 OFO 248 UK 220 KNB 200 CUG 137 LOQ 141 MOT 125 KBM 123 YA 123 (WLM 250) MHE 74 KOB 29 AXD 27 IOH 15 GUF 13 FIP 13 CMP 66 LOR 4 RG 2 LIG 11 EFA 202.

Announcing —

50s PORTABLE TRANSMITTER

Output: 50 watts CW
15 watts PHONE

Input: 12 or 32 volts dc

- CRYSTAL CONTROL
- BAND SWITCHING
- 3 FREQUENCIES
- ANTENNA MATCHING CIRCUIT

Write for full technical data

HARVEY
RADIO LABORATORIES, INC.

12 Boylston Street

Brookline, Mass.

(Continued from page 108)

spection on a cathode ray oscilloscope) except at the very low frequencies, and even there the wave shape is very close to the sinusoidal.

High-quality transformers are used for coupling into and out of the power amplifier stage. These transformers and the General Radio tuning condenser are the major "luxury" components in the unit, and between them constitute a goodly part of the cost. For this reason, it may be pointed out that cheaper parts can be used, reasons of economy dictating, and actual performance will not suffer greatly. The principal loss will be in operating ease. It will be more difficult to accurately calibrate the low audio-frequency range, and the over-all output variation with frequency change will be increased. But, provided a stable receiving-type condenser and moderately good audio transformers without hysteresis distortion due to d.c. loading are used, the thing will work and the pocketbook will suffer less.

Careful matching of the 2A3 output tubes is essential or the frequency characteristic will make a sharp rise at 60 cycles and little 60-cycle serrations will show around the edges of the higher frequency waves. This is accomplished by separate adjustable legs in the voltage divider, providing individual grid bias to each tube. The potentiometers should be adjusted so that plate currents are equal (40 ma. each), a pair of headphones or an oscilloscope being connected across the output meanwhile to make sure that this point coincides with minimum hum level.

In this instrument, the output potentiometer is a 1000-ohm affair, and is connected across the paralleled secondary windings in the output transformer to reflect the proper load impedance (5000 ohms) to the 2A3 plates. If higher output voltages are required, a 4000-ohm potentiometer can be used across the windings connected in series. Other types of transformers should of course be chosen with this point in mind.

In any event, the potentiometer must be capable of absorbing the maximum output of the unit, in this case about 1.5 watts. A copper-oxide rectifier is used in connection with the plug-in milliammeter to check output voltage. (Incidentally, it has been found that little faith can be placed in the calibration curves accompanying these devices; it is best to run an accurate curve when the b.f.o. is completed, comparing readings with a reliable a.c. voltmeter with a negligible or compensated frequency characteristic.) A double-pole double-throw switch is provided for switching the audio output from the output terminals to the suppressor-grid circuit of the signal generator unit, for modulation purposes.

CALIBRATION METHODS

The most convenient method of calibration is direct comparison with a reliable source, matching tones aurally if necessary or, preferably, on an oscilloscope. Such a source should preferably be variable, of course, but if a reliable 1000-cycle oscillator and an oscilloscope are available, a decent calibration of the higher frequencies can be

"Pleased" with
the Hi-Fidelity of the Model 1750
... the Reproducer with the New



It's what OTHERS say that COUNTS!

Read the following letter:

Pass Christian, Miss.,
Oct. 14, 1935

"Gentlemen:
Recently I received one of your new No. 1750 Para-Curve Reproducers and I am more than pleased with its Hi-Fidelity performance. Please rush 1 Model 1750 to match a new Philco Model 650X."
Eldridge A. Helwick

\$17.50 LIST

Write for complete catalog, dealer's discount and name of nearest distributor. Wright-Decoster distributors are always anxious to cooperate with you.

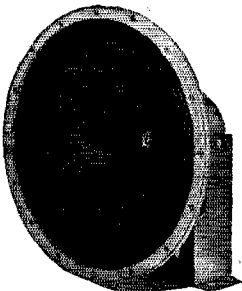

Model 1750 12" Reproducer

WRIGHT-DECOSTER, Inc.

2259 University Ave.

St. Paul, Minn.

Leeds Leads Again with the "SILENT CAN"

An amazingly versatile unit both electrically and mechanically, employing the basic Lamb silencing circuit, the unit is designed to function on a wide variety of super hets employing one i.f. stage. The can may be mounted in any position inside, or outside, of the receiver. The chassis is then slid into place and fastened by two screws. Overall dimensions, less tubes, $3\frac{1}{4}'' \times 6\frac{1}{2}'' \times 2''$ high. A 6K7 i.f. stage is followed by a 6J7-6H6 and a 6L7. The latter operating at low gain. Excellent stability — slight mis-alignment of the receiver i.f. transformers — a.v. c. circuit undisturbed — series filaments operating through a line cord — receptacle for the receiver line cord — frequency range 430-520 Kc. The "Silent Can" may be used on Browning 35's, Tobe Communication Receiver, ACR-136, Sky-Rider S-9, and a host of all-wave sets. The "Silent Can" wired and tested with instructions and a set of RCA tubes sells at..... **\$10.95**

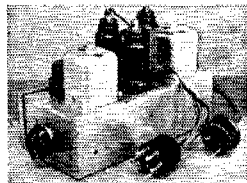

Shipping weight, 5 lbs.

Please give name and model number of receiver when ordering.
If your nearest dealer cannot supply you, order direct from

LEEDS RADIO COMPANY

45 VESEY STREET

+

NEW YORK CITY

BEGINNER OR OLD TIMER. TO BE
A GOOD OPERATOR, YOU NEED:

MAC KEY @ \$7.95, fine semi-automatic key. JUNIOR
MODEL @ \$4.95, a low priced "speed key" guaranteed.
MAC OSCILLATOR @ \$3.95, a.c./d.c. 1,000 cycles code
practice.

"Mac" items sold with emphatic money back guarantee.
See my full page in new ARRL Handbook.

T. R. McELROY, 23 Bayside St., BOSTON, MASS.
If u hv a Mac Key wrt me now for smy tip & dsrb inf. Ix
tmxy tip & free, so be sure to wrt & pass t wd to otrs

CODE TEACHER



It's easy to learn the code with the Instructograph. Book of Instructions shows you how to study to best advantage. You can rent Instructograph on very attractive terms and rental may be applied on purchase price. A postcard will bring you full details.

INSTRUCTOGRAPH COMPANY, Dept. Q-4
912 Lakeside Place Chicago, Ill.

Representatives for Canada Toronto
Radio College of Canada, Ltd., 863 Bay St.

TIME-SAVERS

... FOR ...

Amateurs
Engineers
Experimenters
Servicemen

SEE PAGE 99

PRECISION CRYSTALS

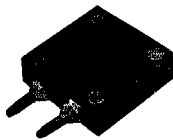

Crystal Holder

Highest quality crystals one-inch square, carefully ground for frequency stability and maximum output. Be sure of your transmitter frequency — use PRECISION CRYSTALS.

'X' cut PRECISION Crystals carefully ground for maximum power supplied within 0.1% of your specified frequency and calibrated to within 0.03% are priced as follows: 1750, 3500 and 7000 kc. bands — \$3.00 each. Add \$1.00 to above price if plugin, dustproof holder is desired. (Holder as illustrated to fit G.R. jacks or round holder to plug into a tube socket can be furnished) G.R. jacks to plug illustrated holder into — \$1.50 pair.

Low frequency drift crystals (Type LTC) having a drift of less than 5 cycles per million per degree C. are supplied at the following prices: 1750 and 3500 kc. bands — \$3.50 each; 7000 kc. band — \$4.00 each. Holder \$1.00.

'AT' cut crystals for commercial use quoted on at your request. When ordering our product you are assured of the finest obtainable. Now in our sixth year of business.

PRECISION PIEZO SERVICE

427 Asia Street

Baton Rouge, La.

**\$65 puts
YOU on the Air!**

— with the "PROGRESSIVE" Universal Exciter and low power unit — a real "he man" crystal controlled, all band Xmitter with enough extra power supply for the next step (P.P. 865's). Simply follow the easy-to-understand diagrams in the "PROGRESSIVE GUIDE." The 865 step adds only \$35.00.

THE NEW 803 TUBE

— foretold over a year ago in the "PROGRESSIVE TRANSMITTER GUIDE" — is now embodied in the "PROGRESSIVE."

Before building or remodelling your station rack and panel fashion write for FREE "Progressive Transmitter Bulletin"—Form 20B. Simply address

GENERAL TRANSFORMER CORP.

518 S. Throop Street, Chicago

"The Crystal Specialists Since 1925"

PIEZO-ELECTRIC CRYSTALS

Guaranteed Accurate to BETTER than .01%

SCIENTIFIC RADIO SERVICE

UNIVERSITY PARK, HYATTSVILLE, MD.

Get Your NEW

MARTIN VIBROPLEX

**JUNIOR
ONLY**

NOW!

\$10

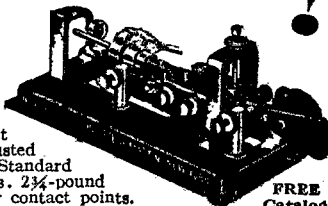

FREE
Catalog

The BUG that satisfies the world's finest operators—can be trusted to satisfy you. All Standard Vibroplex features. 2 3/4-pound japanned base. Heavy contact points. The only difference is in size. Just what you need to develop a good fist. A bargain at this low price.

OTHER VIBROPLEX MODELS

Famous Improved Vibroplex, Black or Colored, \$17; Nickel-Plated, \$19. Newest Model Vibroplex, No. 6, Black or Colored, \$17; Nickel-Plated, \$19.

Remit by money order or registered mail

THE VIBROPLEX CO., INC.

832 Broadway

New York, N. Y.

secured by application of Lissajou's figures.² The low frequencies can be compared with 60 cycles from the oscilloscope sweep circuit; since this frequency is taken direct from the a.c. mains, it can be relied upon to be perfectly synchronized. By this method an accurate calibration up to 1000 cycles or so can be secured without too great difficulty, if a little patience is used and results are double-checked.

This is the only satisfactory method of calibrating the low audio frequency range without use of an auxiliary standard that it has yet been possible to devise. An alternative method of calibrating the high frequency range that requires only a broadcast receiver as additional apparatus has been suggested by J. J. Lamb, however. The procedure is as follows: Tune the broadcast receiver, preferably a t.r.f. set with good gain, to a b.c. station operating on 1100 kc. Couple its antenna circuit to the grid circuit of the fixed frequency oscillator, removing the grid cap from the variable-frequency oscillator tube meanwhile. The 10th harmonic of 110 kc. is 1100 kc., so if the trimmers in the fixed frequency oscillator are adjusted to zero beat with the b.c. station, the frequency of the oscillator will be precisely 110 kc. Next, replace the grid cap of the variable-frequency oscillator, couple it to the b.c. set in the same fashion, and in turn adjust it to zero beat, with the main tuning condenser at minimum capacity and the zero-beat adjustment at mid-scale. With zero-beat achieved all around, the fixed frequency oscillator can now be disregarded. The b.c. set should next be to a station operating on 1090 kc. The b.f.o. dial is then rotated until the variable-frequency oscillator is in zero beat with this station, and the exact adjustment recorded. This is the 1000-cycle point on the calibration scale. The b.c. set is tuned to a station on 1080 kc., zero beat again found, the dial setting again noted, and the 2000-cycle point is determined. This is continued until a station on 1000 kc. has been checked and the 10,000 cycle point on the b.f.o. reached. With these 11 points, an accurate calibration curve can be drawn between 1000 and 10,000 cycles—accurate, that is to say, to a probable 5 cycles, since the b.c. stations are not allowed to vary more than 50 cycles.

Such accuracy is rather more than can be maintained in practice, unless an auxiliary checking method is used for zero-beat resetting. The simplest method is to use an oscilloscope with 60-cycle sweep for resetting. Another, requiring a few moments and some care, is to count cycles against the second hand on a watch. This will enable resetting to better than a cycle, but takes a few minutes and is pointless unless stabilized power supply is used. A tuned reed can also be employed; but this becomes a more elaborate proposition than was originally contemplated. Anyway, what's a cycle or two in routine work? Percentages are more important than exact values and this unit can be relied upon to preserve

² Cathode Ray Tubes at Work, by John F. Rider; RCA Instruction Manual, or other cathode-ray oscilloscope instruction book.

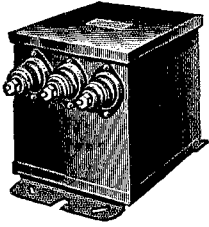

FIRST *with the* LATEST! ADDITIONS **THORDARSON** TO THE TRANSMITTING LINE

HERE are some new and timely items that will be of vital interest to every ham operator. What are *your* requirements?

Class B Output Modulation Transformers

Type	Application	Secondary		Mfg. Fig.	H.	Dimensions		D.	Wt. Lbs.	List Price
		R.F. Load Ohms	D.C. M.A.			W.	W.			
T-8208	Plates of Eimac 50T's (100 watts audio power) to R.F. load	5,000	200	2Q	6½	5¾		8	17	\$16.00
T-8209	Plates of Eimac 50T's (250 watts audio) to R.F. load	2,500	400	2Q	7¾	5¾		9½	22	24.00
T-8210	Plates of Eimac 150T's (500 watts audio) to R.F. load	10,000	200	2Q	9¾	7¾		7¾	38	50.00
T-8225	Plates of H.D. 203A's (500 watts audio) to R.F. load	4,000	500	2K	8	6¾		8	40	50.00

AUTO TRANSFORMERS can be used for increasing low line voltages or for power reduction during transmitter adjustment. Tapped at 60-80-90-100-110-120-125 volts.

Type	Capacity V.A.	H.	Dimensions W.	D.	Mfg. Fig.	Wt. Lbs.	List Price
T-8211	500	6¾	4½	7	2M	13	\$10.00
T-8212	1000	6¾	5½	7½	2M	18¾	15.00
T-8213	2000	7½	6¾	7¾	2M	36	20.00

[See your Supplier for these and many other items of the THORDARSON Line]

THORDARSON ELECTRIC MANUFACTURING CO.
Transformer Specialists Since 1895
 500 West Huron St. Chicago, U.S.A.

*How to
 Become*

A RADIO AMATEUR

Published by the AMERICAN RADIO RELAY LEAGUE, INC. • West Hartford, Connecticut



Fourth Edition
 Price 25 Cents

Price 25¢ postpaid
 (no stamps, please)

AMERICAN RADIO RELAY LEAGUE
 WEST HARTFORD, CONNECTICUT

*Universally recognized as the
 standard elementary guide for
 the prospective amateur*

HOW TO BECOME A RADIO AMATEUR

describes, in clear understandable language, apparatus incorporating features hitherto confined to more advanced stations. Although completely modernized, the station can still be built at a minimum of expense, and the designs have been made flexible so that parts out of the junk box readily can be substituted. While easy to build, the performance of the equipment is such that any amateur can own and operate it with satisfaction and pleasure. Complete operating instructions and references to sources of detailed information on licensing procedure are given, as well as a highly absorbing narrative account of just what amateur radio is and does.

CANDLER SYSTEM

Taught at
Harvard and
Mass. Tech.,
by
Champion
McELROY



"IF THERE WERE A BETTER WAY than CANDLER Home Training in Code, in High-Speed Telegraphing and in Touch Typewriting, I would know it." — McELROY.

CANDLER SYSTEM — for 25 years the dominant source of Sound Telegraphic Technique. An impressive alumni of skilled Amateurs and Com'l Operators, the wide confidence of the profession and Communications Companies.

FREE — 1936 Book of Facts — Describes Home Training for beginners, for Amateurs who want their com'l licenses, for Com'l ops who want to prepare for better jobs. Contains McElroy's Personal Experiences and other helpful information. Send for it. No obligation.

CANDLER SYSTEM CO.

Dept. Q-4

ASHEVILLE, N. C.

RADIO COURSES

RADIO OPERATING: Prepare for Gov't License Exam. ● **RADIO SERVICING:** Including Short Wave ● **AMATEUR CODE** ● New Course in **ELECTRONICS.**

Day and Evening classes—Booklet upon Request

NEW YORK YMCA SCHOOLS

4 West 63rd Street, New York City

BRUSH Headphones

● Meet every headphone requirement. They bring in weak signals strong and clear and will handle excessive volume without overloading. Response 60 to 10,000 cycles. No magnets to cause diaphragm chatter. Specially designed cases minimize breakage. Light in weight. Only 6 oz., complete with headband and cords. A quality product at a low price. Details, Data Sheet No. 10. Copies on request. Send for one.

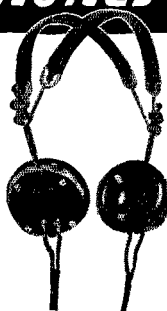

The **BRUSH** DEVELOPMENT COMPANY
1002 E. 40th St. CLEVELAND, O.
PIEZO ELECTRIC
MICROPHONES • MIKE STANDS • TWEETERS • HEAD PHONES • LOUD SPEAKERS

reliable percentage ratios. In this connection, it may be mentioned that, while it is very difficult to secure high frequency stability in a b.f.o. owing to the fact that a very small percentage change at 100 kc. becomes a very large percentage change at 100 cycles (.1 per cent becomes 100 per cent, for example), this unit, once properly warmed up, can be depended upon to hang very close to a mean value of 4 or 5 cycles over an appreciable length of time, even without a compensated power supply. It will oscillate around the mean frequency by that amount, that is to say, due to line vagaries, but it will not drift appreciably. This is due, of course, to the careful attention to both electrical and mechanical details affecting stability, and the fact that the oscillators are made as nearly identical as possible, so that drift in any direction will be approximately equal.

So much for the beat-frequency audio oscillator. The signal generator will be described in Part II, for that is definitely a story by itself.

Cathode-Ray Monitoring of Received Signals

(Continued from page 35)

In general it is not practical to attempt to use a single c.r. tube for both receiver and transmitter. A switching arrangement could possibly be worked out, but this article will not involve itself with that. It is not unlikely that means could be worked out in some cases whereby monitoring of one's own transmission could be done in the station receiver so that the one c.r. installation could serve all purposes. This, however, is a problem whose solution depends on

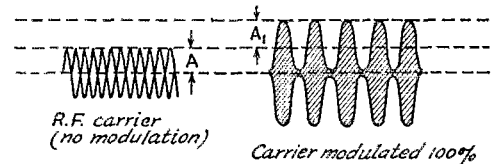

FIG. 2—TYPES OF PATTERNS OBTAINED ON 'PHONE SIGNALS

The values indicated are used in determining percentage modulation by the formula given in the text.

being able to run the receiver at the same time the transmitter is on, without overloading the receiver.

Fig. 1 shows the method of cutting out a.v.c. on the Pfanstiehl, in order to increase deflection sensitivity. A short lead from the second i.f. tube plate is recommended. Capacity of this connection will have to be compensated for by re-adjustment of trimmer on the secondary of the second i.f. transformer.

It is necessary to stress the importance of linearity on the part of the receiver (up to the point where the c.r. tube is connected). Without linearity the results obtained can only be regarded as highly questionable and of no accurate quantitative value. About the best way of determining linearity in the receiver is to get a good

(Continued on page 118)

Where to buy it

A directory of suppliers who carry in stock the products of these dependable manufacturers.

ASTATIC
Crystal Microphones and Pickups
ASTATIC MICROPHONE LABORATORY, Inc. YOUNGSTOWN, O.
Pioneer Manufacturers of Quality Crystal Products

- JAMAICA, L. I., N. Y.** 92-26 Merrick Rd.
 Federated Purchaser, Inc.
- NEWARK, N. J.** Federated Purchaser, Inc. 230 Central Ave.
- NEWARK, N. J.** 219 Central Ave.
 Wholesale Radio Service Co., Inc.
- NEW YORK, N. Y.** 25 Park Place
 Federated Purchaser, Inc.
- NEW YORK, N. Y.** 103 W. 43rd St.
 Harvey's Radio Shop
- NEW YORK, N. Y.** 100 Sixth Ave.
 Wholesale Radio Service Co., Inc.
- NEW YORK, N. Y. (BRONX)** 542 East Fordham Rd.
 Wholesale Radio Service Co., Inc.
- PITTSBURGH, PENN.** 343 Blvd. of the Allies
 Federated Purchaser, Inc.

BURGESS BATTERY COMPANY
"Chrome" protected
RADIO BATTERIES
 Look for the Black and White Stripes
 FREEPORT, ILLINOIS

- ALBANY, N. Y.** Uncle Dave's Radio Shack 356 Broadway
- BALTIMORE, MD.** Radio Electric Service Co. 303 W. Baltimore St.
- BOSTON, MASS.** Radio Shack 46 Brattle Street
- HARTFORD, CONN.** 210 Chapel Street
 Stern & Company, Inc.
- JAMAICA, L. I., N. Y.** 92-26 Merrick Rd.
 Federated Purchaser, Inc.
- MANCHESTER, N. H.** 1008 Elm Street
 Radio Service Lab. of N. H.
- MONTREAL, CANADA** 285 Craig Street, West
 Canadian Electrical Supply Co., Ltd.
- NEWARK, N. J.** Wholesale Radio Service Company 219 Central Ave.
- NEWARK, N. J.** 230 Central Avenue
 Federated Purchaser, Inc.
- NEW YORK, N. Y.** 25 Park Place
 Federated Purchaser, Inc.

- NEW YORK, N. Y.** Harrison Radio Company 12 West Broadway
- NEW YORK, N. Y. (BRONX)** 542 E. Fordham Rd.
 Wholesale Radio Service Company
- NEW YORK, N. Y.** 100 Sixth Avenue
 Wholesale Radio Service Company
- PITTSBURGH, PENN.** 343 Blvd. of the Allies
 Federated Purchaser, Inc.
- PITTSBURGH, PENN.** 403 Penn Avenue
 Tri-State Radio Equipment Co.
- READING, PENN.** 404 Walnut Street
 George D. Barbey Company
- SPRINGFIELD, MASS.** 349 Worthington St.
 T. F. Cushing

Super SKYRIDER

 the hallicrafters

- ALBANY, N. Y.** Uncle Dave's Radio Shack 356 Broadway
- BALTIMORE, MD.** 303 W. Baltimore Street
 Radio Electric Service Company
- BOSTON, MASS.** Radio Shack 46 Brattle Street
- GLOVERSVILLE, N. Y.** 40 Clyde St.
 Adirondack Radio Service
- HARTFORD, CONN.** 227 Asylum Street
 Radio Inspection Service Co.
- MANCHESTER, N. H.** 1008 Elm Street
 Radio Service Lab. of N. H.
- NEWARK, N. J.** 219 Central Ave.
 Wholesale Radio Service Co., Inc.
- NEW HAVEN, CONN.** 86 Meadow Street
 Hatry & Young
- NEW YORK, N. Y.** 51 Vesey St.
 Gross Radio, Inc.
- NEW YORK, N. Y.** 103 W. 43rd St.
 Harvey's Radio Shop
- NEW YORK, N. Y. (BRONX)** 542 East Fordham Rd.
 Wholesale Radio Service Co., Inc.
- NEW YORK, N. Y.** 100 Sixth Ave.
 Wholesale Radio Service Co., Inc.
- PITTSBURGH, PENN.** 403 Penn. Ave.
 Tri-State Radio Equipment Co.
- PITTSBURGH, PENN.** Tydings Company 620 Grant St.
- RICHMOND HILL, NEW YORK** 124-11 101st Ave.
 Marine Radio Company
- SPRINGFIELD, MASS.** T. F. Cushing 349 Worthington St.

Where to buy it

A directory of suppliers who carry in stock the products of these dependable manufacturers.



JAMAICA, L. I., N. Y. 92-26 Merrick Rd.
Federated Purchaser, Inc.

MONTREAL, CANADA 285 Craig Street, West
Canadian Electrical Supply Co., Ltd.

NEWARK, N. J. 230 Central Avenue
Federated Purchaser, Inc.

NEWARK, N. J. 219 Central Ave.
Wholesale Radio Service Company

NEW YORK, N. Y. 25 Park Place
Federated Purchaser, Inc.

NEW YORK, N. Y. 12 West Broadway
Harrison Radio Company

NEW YORK, N. Y. (BRONX) 542 E. Fordham Rd.
Wholesale Radio Service Company

NEW YORK, N. Y. 100 Sixth Avenue
Wholesale Radio Service Company

PITTSBURGH, PENN. 603 Grant Street
Cameradio Company

PITTSBURGH, PENN. 343 Blvd. of the Allies
Federated Purchaser, Inc.

PITTSBURGH, PENN. 403 Penn Avenue
Tri-State Radio Equipment Co.

READING, PENN. 404 Walnut Street
George D. Barbey Company



ALBANY, NEW YORK 356 Broadway
Uncle Dave's Radio Shack

BOSTON, MASS. 588 Commonwealth Ave.
Littlefield-Greene Corporation

BOSTON, MASS. The Radio Shack 46 Brattle Street

BOSTON, MASS. Selden Radio Company 28 Brattle Street

BUFFALO, NEW YORK 326 Elm Street
Radio Equipment Corp.

CONCORD, NEW HAMPSHIRE 80 N. State Street
Carl B. Evans

JAMAICA, L. I., N. Y. 92-26 Merrick Rd.
Federated Purchaser, Inc.

NEWARK, NEW JERSEY 230 Central Avenue
Federated Purchaser, Inc.

NEWARK, NEW JERSEY 219 Central Street
Wholesale Radio Service Co.

NEW YORK, N. Y. 25 Park Place
Federated Purchaser, Inc.

NEW YORK, N. Y. 12 West Broadway
Harrison Radio Company

NEW YORK, N. Y. Harvey's Radio Shop 103 W. 43rd St

NEW YORK, N. Y. Wholesale Radio Service Co. 100 Sixth Avenue

PITTSBURGH, PENN. 343 Blvd. of the Allies
Federated Purchaser, Inc.



ALBANY, N. Y. 31 Hudson Avenue
Havens Electric Company, Inc.

ALBANY, N. Y. Uncle Dave's Radio Shack 356 Broadway

BALTIMORE, MD. 303 W. Baltimore St
Radio Electric Service Company

BOSTON, MASS. H. Jappe Company 46 Cornhill

BOSTON, MASS. Radio Shack 46 Brattle Street

CHARLESTON, W. VA. Virginian Electric, Inc.

HARTFORD, CONN. 203 Ann Street
Hatry & Young

JAMAICA, L. I., N. Y. 92-26 Merrick Rd.
Federated Purchaser, Inc.

NEWARK, NEW JERSEY 230 Central Avenue
Federated Purchaser, Inc.

NEWARK, N. J. 219 Central Avenue
Wholesale Radio Service Co.

NEW HAVEN, CONN. 86 Meadow Street
Hatry & Young

NEW YORK, N. Y. Bruno-New York, Inc. 460 W. 34th St

NEW YORK, N. Y. 25 Park Place
Federated Purchaser, Inc.

NEW YORK, N. Y. 16 West 22nd Street
Royal-Eastern Electrical Supply Co.

NEW YORK, N. Y. 136 Liberty Street
Sanford Samuel Corp.

NEW YORK, N. Y. (BRONX) 542 E. Fordham Rd
Wholesale Radio Service Co.

NEW YORK, N. Y. 100 Sixth Avenue
Wholesale Radio Service Co.

NEW YORK, NEW YORK 12 West Broadway
Harrison Radio Company

PHILADELPHIA, PENN. 10 S. 10th Street
Eugene G. Wile

PHILADELPHIA, PENN. 117 North 7th St
Raymond Rosen & Company

PHILADELPHIA, PENN. 512 Market Street
M & H Sporting Goods Company

PITTSBURGH, PENN. 343 Blvd. of the Allies
Federated Purchaser, Inc.

PITTSBURGH, PENN. 603 Grant Street
Cameradio Company

READING, PENN. Bright & Company 8th & Elm Street

SPRINGFIELD, MASS. T. F. Cushing 349 Worthington Street

WASHINGTON, D. C. 938 F Street, N. W.
Sun Radio & Service Supply Co.

Where to buy it

A directory of suppliers who carry in stock the products of these dependable manufacturers.



**AMATEUR
RADIO
EQUIPMENT**
RCA Victor Division of RCA Manufacturing Co., Inc.

ALBANY, N. Y. Uncle Dave's Radio Shack 356 Broadway
BOSTON, MASS. H. Jappe Company 46 Cornhill
BOSTON, MASS. Radio Shack 46 Brattle Street
CAMDEN, N. J. Radio Electric Service Company 811 Federal Street
ERIE, PENN. J. V. Duncombe Company 1011 West 8th St.
GREENWICH, CONN. Mead Stationery Company 252 Greenwich Ave.
HARTFORD, CONN. Hatry & Young 203 Ann Street
HARTFORD, CONN. Radio Inspection Service Co. 227 Asylum Street
MONTREAL, CANADA Canadian Electrical Supply Co., Ltd. 285 Craig Street, West
NEWARK, N. J. Wholesale Radio Service Company 219 Central Avenue
NEW HAVEN, CONN. Hatry & Young 86 Meadow Street
NEW YORK, N. Y. Bruno-New York, Inc. 460 W. 34th St.
NEW YORK, N. Y. Sanford Samuel Co. 136 Liberty Street
NEW YORK, NEW YORK Grand Central Radio, Inc. 124 E. 44th Street
NEW YORK, N. Y. (BRONX) Wholesale Radio Service Co. 542 E. Fordham Rd.
NEW YORK, N. Y. Wholesale Radio Service Company 100 Sixth Avenue
PHILADELPHIA, PENN. Radio Electric Service Company 3145 N. Broad Street
PHILADELPHIA, PENN. Radio Electric Service Company N. E. Cor. 7th & Arch Streets
PHILADELPHIA, PENN. M & H Sporting Goods Co. 512 Market Street
PITTSBURGH, PENN. Cameradio Company 603 Grant Street
RICHMOND HILL, N. Y. Marine Radio Company 124-11 101st Ave.

Use **SHURE**
MICROPHONES
Microphone Headquarters

ALBANY, N. Y. Uncle Dave's Radio Shack 356 Broadway
BOSTON, MASS. H. Jappe Company 46 Cornhill
BUFFALO, N. Y. Radio Equipment Corporation 326 Elm St.
GLOVERSVILLE, N. Y. Adirondack Radio Service 40 Clyde St.

JAMAICA, L. I., N. Y. Federated Purchaser, Inc. 92-26 Merrick Rd.
NEWARK, NEW JERSEY Federated Purchaser, Inc. 230 Central Avenue
NEWARK, N. J. Wholesale Radio Service Company 219 Central Avenue
NEW YORK, N. Y. Wholesale Radio Service Company 542 E. Fordham Rd.
NEW YORK, N. Y. Wholesale Radio Service Company 100 Sixth Avenue
NEW YORK, N. Y. Sun Radio Company 227 Fulton Street
NEW YORK, N. Y. Federated Purchaser, Inc. 25 Park Place
PITTSBURGH, PENN. Federated Purchaser, Inc. 343 Blvd. of the Allies
PITTSBURGH, PENN. Tri-State Radio Equipment Co. 403 Penn Avenue
PITTSBURGH, PENN. Tydings Company 620 Grant Street
READING, PENN. George D. Barbey Company 404 Walnut Street
SPRINGFIELD, MASS. T. F. Cushing 349 Worthington Street



**TRIPLET
INSTRUMENTS**

ALBANY, N. Y. Uncle Dave's Radio Shack 356 Broadway
BOSTON, MASS. Radio Shack 46 Brattle Street
BOSTON, MASS. Selden Radio Company 28 Brattle St.
HARTFORD, CONN. Hatry & Young 203 Ann Street
JAMAICA, L. I., N. Y. Federated Purchaser, Inc. 92-26 Merrick Rd.
MONTREAL, CANADA Canadian Electrical Supply Co., Ltd. 285 Craig Street, West
NEWARK, NEW JERSEY Federated Purchaser, Inc. 230 Central Avenue
NEWARK, N. J. Wholesale Radio Service Company 219 Central Ave.
NEW HAVEN, CONN. Hatry & Young 86 Meadow Street
NEW YORK, N. Y. Federated Purchaser, Inc. 25 Park Place
NEW YORK, N. Y. Wholesale Radio Service Company 542 E. Fordham Rd.
NEW YORK, N. Y. Wholesale Radio Service Company 100 Sixth Avenue
PITTSBURGH, PENN. Cameradio Company 603 Grant Street
PITTSBURGH, PENN. Tydings Company 620 Grant St.
PITTSBURGH, PENN. Federated Purchaser, Inc. 343 Blvd. of the Allies
READING, PENN. George D. Barbey Company 404 Walnut Street

Help

For the AMATEUR

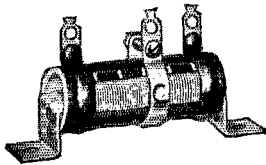

USE Electrad "Variohm" Dividers and get exactly the right plate, screen and suppressor voltages for those new pentodes. Five sizes from 25 to 200 watts to suit all power packs. 85c to \$3.75 each list.

Write Dept. Q-4 for Complete 1936 Catalog of Resistors for All Purposes



"HAM" SPECIAL Standard Teleplex
A highly efficient code teacher using heavy specially prepared waxed paper tape, having two rows of perforations. Write for Free folder Q.1. DEALERS — Correspondence invited with dealers for protected territories.

We are the originators of this type instrument
TELEPLEX CO.
72 Cortlandt St., New York City

Instrument with tapes prepared by expert and complete course of lessons; all for \$11.95

IMMEDIATE DELIVERY

from amateur headquarters

The New RCA ACR-175 complete.....	\$119.50
PR-16s complete prepaid.....	95.70
PR-16Cs complete with crystal prepaid....	101.70
National HRO Jrs.....	99.00
RME-69s.....	118.80
National HROs.....	167.70
Bretting 12s complete prepaid.....	93.00
Super Skyriders complete.....	79.50
ACR-136s complete.....	69.50
Silver 5Ds complete prepaid.....	109.80
Super Pros complete.....	194.04

The new All Star and Radio-Silver transmitter kits

COLLINS, RCA, AND RME TRANSMITTERS
TRADE IN YOUR RECEIVER and TRANSMITTER

Consider these reasons why it is genuinely to your benefit to deal with W9ARA. I sell amateur apparatus exclusively and am jobber for every line. Besides guaranteeing to sell to you at lowest prices and to see that you are 100% satisfied with everything you buy from me, I take in trade your used apparatus and furnish technical help free. I sell on time payments. Write to W9ARA about any apparatus.

HENRY RADIO SHOP

211-215 North Main Street Butler, Missouri

'phone station which is equipped with a c.r. tube to transmit at various levels of modulation using tone (60 cycles is OK, although a somewhat higher frequency would be more suitable). I suggest test transmissions at 25, 50, 75 and 100 per cent modulation. These transmissions should be repeated with low, medium and high power. In the receiver in use here no adjustments for linearity were found necessary. However, allow the writer to quote from the article by W. C. Lent, *QST* for Aug., 1935:

"Linearity in a receiver can be obtained if the following requirements are met: (1) The dynamic output characteristics of all the radio stages, whether they be working at high or intermediate frequency, must be entirely linear over the range of the signal grid-swing. This requires a proper choice of tubes together with the adjustment of the load impedance into which each tube works. (2) If the receiver is of the superheterodyne type, the relation between translation gain and signal input of the first detector must be a straight line when plotted. This can be obtained by a proper adjustment of the first detector bias and the input to the first detector from the high frequency heterodyning oscillator."

Several previous issues of *QST* and the A.R.R.L. *Handbook* have covered the processes of modulation completely and there is no need of repetition here. In work of this kind, however, there are several things which should be borne in mind. First, a fully modulated wave contains 50 per cent more power than when unmodulated, in the case of modulation by a pure sine wave. A carrier 100 per cent modulated with voice contains less than this amount of additional power, a considerably lower increase in effective antenna current than the familiar 22.6 per cent showing 100 per cent modulation on voice peaks. It is here that the c.r. tube really shows its usefulness because it indicates *amplitude*, and responds accurately and instantaneously without regard to waveshape. A completely modulated wave varies in terms of amplitude involved, from its carrier amplitude to a value twice as great and to zero. It is in terms of voltage *amplitude* that the cathode ray tube defects. It is independent of power or effective current.

By use of the marked celluloid scale previously referred to in this article and the formula,

$$\frac{A_1}{A} \times 100 = \% \text{ modulation,}$$

the percentage of modulation can be determined from patterns of the type shown in Fig. 2.



Interested in a 271-foot mast? W6AM has one that supports any number of beam antennas. Among some of the items in use on that mast are the following: 3 1/2-mile coils of 1/2-inch tarred rope; 4 1-mile coils of guy wire; 200 pounds of No. 14 copper wire; 5000 feet of No. 12 wire; several hundred strain insulators of various lengths up to 18 inches and 2000 spacer bars and transposition blocks.

NEW ECONOMY! MICROPHONE

by "Microphone Headquarters"

The SHURE 3B (Two-Button Type)

There are no "short cuts" to highest quality performance, but advanced engineering and accurately controlled quantity production have made possible the new Shure Model 3B — a two-button microphone with quality performance never before available at such low cost!

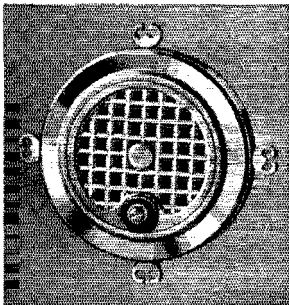

The 3B is a full-size two-button microphone with rugged cast frames and built-in protective grill, finished in bright nickel plate overall. Carries the full Shure Guarantee. **\$5.50**
List price, only.....

(Hand Models, with and without automatic switch, also available.)

Ask your Jobber, or Write

HANDBOOK
[451]
CATALOG
SECTION

SHURE MICROPHONES
SHURE BROTHERS • MICROPHONE HEADQUARTERS
215 WEST HURON STREET • CHICAGO, U. S. A.

GULF RADIO SCHOOL

Radiotelegraphy Radiotelephony
Radio Servicing

SECOND PORT } 1007 Carondelet Street
U. S. A. } NEW ORLEANS, LA.

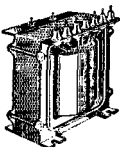

POWER TRANSFORMERS

Each Side	Pri. Volt	Wt. Lbs.	Price
1000-750 V	300	25	\$6.00
1500-1350-850	400	31	7.50
1500-1350-850	750	44	11.00
2000-1500	750	43	10.50
2000-1500	1000	52	15.00

Prices are net, 20% deposit on C. O. D. orders.
Write for quotations on special jobs or rebuilding service

SPEAR MANUFACTURING CO.
Waterville, Ohio

New RCA Receiver \$119.50 ACR 175

RCA Amateur Receiver, with four times the band spread of the ACR 136. 5 to 600 meters. Crystal filter. Iron core I. F. Transformers. 10 metal tubes.

M. & H. SPORTING GOODS CO.

Philadelphia, Pa. 512 Market Street
Atlantic City, N. J. 1709 Atlantic Avenue

PYRANOL CONDENSERS

2 mfd. 2000 volt
trans. condensers **\$2.90**

Impregnated and filled with Pyranol. We rate these at 2000 volts working and we know of cases where they are in use at a 50-75% overload. Made by one of the world's largest manufacturers of electrical apparatus.

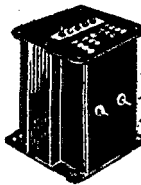
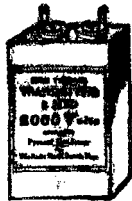

INTERNATIONAL PLATE TRANSFORMERS

Outstanding for Value. 750 and 1000 volts each side of c.t. at 300 mills. Cased completely in steel, crackle finish.
Model 2000.....\$5.95
Model 3000 — Same in appearance, 750-1000-1500 each side of c.t. 300 mills. \$8.95
We know of nothing that equals the value received in these two items

INTERNATIONAL CHOKES

SMOOTHING — SWINGING — CASÉD

12H — 200MILL.....	\$2.50	5/25H.....	\$2.50
12H — 300MILL.....	3.75	5/25H.....	3.75
12H — 500MILL.....	6.50	5/25H.....	6.50

INTERNATIONAL RELAY RACKS \$13.50

Another Outstanding Value

This rack is standard construction, according to WE. specification. See January QST for details.

866
TUBES
H.D. —
Isolantite
Tops
\$1.00

Mail Orders Filled — Include Postage

THE RADIO SHACK
46 Brattle St. Boston, Mass.

2.5V-12A
866
Trans
Cased
\$1.50

TO MATCH—

A 599x signal An effective transmitter
A WAC certificate A swell layout
An efficient receiver A well-operated station

YOU WANT—

The swanky BUCKRAM-BOUND edition of the
HANDBOOK
See page 87 this issue **\$2.50 postpaid**

AMERICAN RADIO RELAY LEAGUE
West Hartford, Conn., U. S. A.

VALPEY CRYSTALS

STEP BY STEP PRECISION MADE

Type VM2. Mounted crystal within 5 Kc of specified frequency 1.7, 3.5, 7 Mc Bands.....\$3.00
Type VG2. Unmounted x cut within 5 Kc 1.7, 3.5, 7 Mc Bands.....\$2.25
Type VC2 in 1.7, 3.5 Bands only. Plus or minus 20 Kc.....\$1.50
Type VM2A. AT cut mounted. Drift less than 4 cycles per Mc per degree C 1.7, 3.5, 7 Mc Bands.....\$4.50
Type VC2A. AT cut unmounted drift less than 4 cycles 1.7, 3.5, 7, Mc Bands.....\$5.50

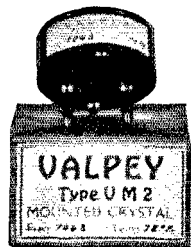

The Valpey Crystals
377 Summer Street, Medway, Mass.

Crystals for All Requirements. At Your Dealer's or Order Direct.

32%

OF THE APPLICANTS FOR AMATEUR LICENSE PRIVILEGES FAIL THE EXAMINATION

Why?

Inadequate technical background? Perhaps.

Lack of practical operating experience? Very likely.

Code incompetency? Yes.

Insufficient background of general information? Unquestionably.

A major step toward making certain that *you* will not fail is thorough study of

THE RADIO AMATEUR'S LICENSE MANUAL

Includes:

Corrected text of the amateur regulations up to date.

Corrected answers to typical examination questions relating to regulations, where the same are changed by the amendments to regulations.

Corrections in the text concerning permissible 'phone bands and portable privileges, under new regulations.

Additions to the text about licensing, to incorporate the existing arrangements in Alaska, Puerto Rico and Hawaii, the right to have code tests administered by government radiotelegraph operators; and a similar paragraph extending to cripples the right to have their material dictated or typewritten.

Several notable changes in the way of improved answers to questions in the Class-A 'phone examination, bringing them in line with the modern engineering concept of modulation.

Several other improved answers to questions appearing in the Class-B-C examinations.

UP TO DATE IN EVERY RESPECT. VALUABLE ALIKE
TO THE BEGINNER AND THE ALREADY-LICENSED

25 CENTS POSTPAID . . . (No stamps, please)

[No. 9 in the series entitled
The Radio Amateur's Library]

THE AMERICAN RADIO RELAY LEAGUE

WEST HARTFORD, CONNECTICUT

W8XWJ—31.6 mc.

W8XWJ, high-frequency station of the Detroit Free Press, WWJ, has 100 watts, 100% modulated, on 31.6 mc. A new antenna, now under construction, will be 625 feet above the ground—atop the Penobscot Bldg. in Detroit. Code practice is being broadcast Sundays from 7:30 to 7:45 p.m. and Tuesdays and Thursdays from 7:15 to 7:30 p.m. A broadcast to hams is being inaugurated on Tuesdays, 7:00 to 7:15 p.m. A technical series is broadcast each Thursday, 7:00 to 7:15 p.m., as well as a talk on everyday technical matters from 7:15 to 7:30 p.m., Wednesdays. All E.S.T. reports on signals and comments on the programs are requested, and should be addressed to Carl Wesser, W8ND, 4465 Penobscot Bldg., Detroit, Mich.

1.75-mc. Tests

Preliminary reports on the 1936 series of 1.75-mc. trans-Atlantic tests have been received from W1BB, W8BDV, W1GBD and W1ADF. Several two-way contacts have been established, W1BB being particularly outstanding. He has had QSO's with G2II, G2DQ, G6WQ, G6PF, G6VQ, G5GL, G6GL, G2IN, and on February 23rd snagged FA8BG in Algeria! FA8BG was on 1753 kc., RST 359, time 0500-0600 GT. Remember, this is all on "160 meters"! FB, W1BB. Contacts with G2II, G2IN, G2DQ and G6WQ are reported for W2UK. G2DQ was also worked by W8UV, W1OR and W8OKG. W1GBD reports a contact with G2II, and also hearing G2IN, G2DQ and G6WQ calling him. W8BDV has to his credit QSO's with G2DQ (1:45 a.m. EST, Feb. 1st) and G2II (2:10 a.m. EST, Feb. 1st); he reports G2DQ S6-7 and G2II S5-6. W2BFA has logged G2II, G2DQ, G2IN and G6WQ. W8UV logged G2IN. W2UK heard G2XC. On March 1st, W1ADF exchanged reports with G2DQ through the respective "G" and "W" transmitting periods. W1BB is making a tabulation of results in these 1.75-mc. tests and would appreciate a post card from W/VE participants, listing stations heard or worked, RST Max-Av-Min, W, K, Condr, Fcy, and any other pertinent remarks. Address W1BB, 36 Pleasant St., Winthrop, Mass.

Attention, 56-mc. gang: G6PU advises that he is on 56 mc. every Wednesday from 1030 to 1100 GT, and would appreciate the cooperation of United States amateurs in watching for his signals.

The Stuyvesant High School, the only Science High School in New York City and possibly in the east, offers advanced courses in Physics, including one term in Electron Physics. This course covers the fundamentals of Electronics, including Radio, Sound Pictures, Television, Telephotography and Photo-electricity. A number of students are engaged in individual research work in Electronics. The A.R.R.L. Handbook proves highly valuable to the students of these various courses and is used as one of the textbooks.

Have you heard the call "CQ PBN" on the air? It is used by members of the Progressive Beginners' Net, which was mentioned in March QST, page 43. Anyone interested can obtain complete details from E. P. Clark, W2IHT, 28 Pierrepont St., Brooklyn, N. Y.

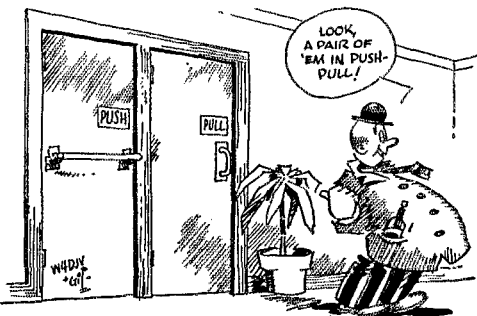

MR. E. H. RIETZKE

PRES. OF CREI



CREI TECHNICAL TRAINING IS "JOB INSURANCE" . . .

Don't sit back and watch the other fellow get ahead. Radio plays no "favorites." The GOOD men get the GOOD jobs. TECHNICAL TRAINING makes it possible for YOU to get ahead to a better job and better pay. Preparing yourself today is the best insurance for a better job tomorrow. We can help you get ahead, as we have done for hundreds of others.

You Can Become a Radio Engineer and Enjoy a Bright Future in a Field Where Training Pays!

CREI courses are planned for EXPERIENCED radiomen who want to become ENGINEERS. Every phase of radio engineering is covered in three forms of study—home study, residence or combination of both.

WRITE FOR FREE CATALOG

CAPITOL RADIO ENGINEERING INSTITUTE

14th and Park Road Dept. Q-4 WASHINGTON, D. C.

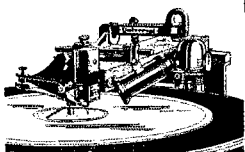

UNIVERSAL Professional Recording Machine

Designed and built to insure Highest Class Results. Solid, heavy, dependable—Precision machined thru-out—16 in. distortion-proof turntable disc—Constant speed rim drive without "waver" or "wow"—110 volt A.C. 100% synchronous, reversible motor—Solid steel bar slide—Special Universal power cutter with four adjustments for damping—Engineered by Universal to provide the best in instantaneous recording equipment.

Write for detailed description

UNIVERSAL MICROPHONE CO., Ltd.
424 Warren Lane Inglewood, Calif., U. S. A.

● DUPLEX TRANSMITTER-RECEIVER

A complete 5-meter station employing 7 tubes . . . including our new 6E6 PUSH-PULL oscillator.

● TYPE TR-6A6-F.O.B. factory **\$3975**

● SPECIAL EQUIPMENT FOR ALL REQUIREMENTS

RADIO TRANSCIVER LABORATORIES
General Offices and Plant Richmond Hill, N. Y.

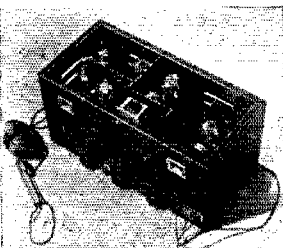

RADIO ENGINEERING

RCA Institutes offers an intensive course of high standard embracing all phases of Radio. Practical training with modern equipment at New York and Chicago schools. Also specialized courses and Home Study Courses under "No obligation" plan.

Illustrated Catalog on request

RCA INSTITUTES, INC. Dept. ST-36
75 Varick St., New York 1154 Merchandise Mart, Chicago
Recognized Standard in Radio Instruction Since 1909

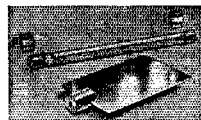

Oscilloscope Kit

Make This OSCILLOSCOPE

Low cost, easily constructed kit for amateurs and experimenters. With it view and demonstrate wave form! Use it for making resonance and r.f. indicators and audio oscillators. Comes with an improved brilliant tube having unexcelled fidelity response and long life. Now better adapted to r.f. operation. Nothing like it for accuracy and performance. Definition of wave form clean-cut and clear.

\$2.00 Net

Prepaid with Improved Tube, Clips, Mirror and Motor Adapter. "Tube only, \$1.50"

See at your jobber or order direct at this low price.

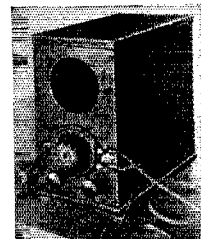

The Finished Job!

SUNDT ENGINEERING CO.

4246 LINCOLN AVENUE CHICAGO, ILLINOIS

(Affiliate of Littellfuse Labs. — Makers of Instrument Fuses — Radio and Auto Fuses — High Voltage Fuses — Aircraft Fuses — Fuse Mountings Neon Potential Fuses and Indicators)

As much Current
as you want—

with

WARD LEONARD Ring Type RHEOSTATS

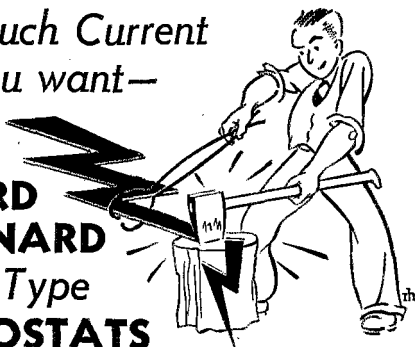

These power rheostats provide a fine continuous adjustment. No steps to consider. The contact arm travels smoothly around the windings providing as much or as little resistance as desired. These and other Ward Leonard rheostats, resistors and relays for the amateur are shown in the new Bulletins 507 and 507B. Send for it today.

WARD LEONARD ELECTRIC CO.

41 South Street, Mount Vernon, N. Y.

Please send me bulletins 507 and 507B.

Name.....

Address.....

City.....State.....

Call Signal.....Q

LEARN RADIO

New Classes Now
Forming! Send for 40-
page catalog, explains

fully, 300 licensed graduates placed in past 4½ years in broadcasting, shipping, police radio, aviation, etc. We teach all branches. Oldest, largest and best equipped school in New England. Equipped with Western Electric sound and broadcasting equipment and RCA marine transmitter. Course prepares for United States Government telegraph or telephone license.

MASS. RADIO SCHOOL, 18 Boylston Street, BOSTON

AMPERITE HIGH LEVEL VELOCITY

(HIGH IMPEDANCE—2000 OHMS)
OPERATES WITHOUT PRE-AMP

THIS MICROPHONE IS HIGH ENOUGH IN IMPEDANCE TO OPERATE DIRECTLY INTO GRID . . . BUT NOT HIGH ENOUGH (ONLY 2000 OHMS) TO INTRODUCE SERIOUS LOSSES IN LINE UP TO 200'.

Replaces condenser and crystal mikes. No changes necessary. Eliminates input transformer and its losses. Eliminates hum trouble and feedback. EXCELLENT FOR CLOSE TALKING.



New! POSITIVE-AND-SMOOTH-ACTION STANDS

Positive, non-sliding, ball-bearing clutch! Will never wear out . . . never require adjustment. WILL NOT "CREEP". Tightens with only ¼ turn of clutch. Mike can be rotated without loosening clutch. SMOOTH, PNEUMATIC-LIKE ACTION up and down. A model for every purpose. WRITE FOR ILLUSTRATED BULLETIN S.

AMPERITE Company, 561 BROADWAY NEW YORK

AMPERITE 3 POINT Velocity MICROPHONE

ELIMINATES HUM TROUBLE

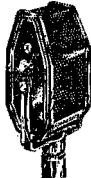

MODEL 3E-H for speech and music. List \$12.00 with coupling.
MODEL 3E-M for speech. List \$12.00 with coupling.
WRITE FOR BULLETIN H.

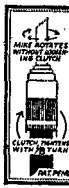

CLUTCH PULLS WITH ¼ TURN

The 836

(Continued from page 90)

standard four-prong base, and has the plate connection coming out to a top cap.

Ratings on the 836 are as follows:

Heater voltage.....	2.5 volts
Heater current.....	5.0 amps.
Peak inverse voltage.....	5000 volts
Peak plate current.....	1.0 amp.
Average plate current.....	250 ma.

A pair of the tubes in the full-wave rectifier circuit should be good for 500 milliamperes at 2000 volts d.c.—a full kilowatt. Under normal operating conditions the tube drop at full load current is about 55 volts.

The 35T

Eitel-McCullough, Inc., have just announced a new type to be known as the 35T—the number meaning, in conformity with previous Eimac designations, that the safe plate dissipation is 35 watts. The new tube has the features which have distinguished forerunning Eimac types—low interelectrode capacitances, rugged filament and tantalum electrodes. The tube is quite small in size, considering the power rating, making it especially suitable for compact transmitters. Characteristics and ratings are as follows:

Filament voltage.....	5.0 volts
Filament current.....	4.0 amps.
Amplification factor.....	30

Interelectrode capacitances:

Grid-plate.....	2 μ fd.
Grid-filament.....	2.5 μ fd.
Plate-filament.....	0.3 μ fd.
Max. plate voltage.....	1500 volts
Max. plate current.....	100 ma.
Max. grid current.....	20 ma.
Max. plate dissipation.....	35 watts

The 35T need not be used at maximum plate voltage, being capable of an output of 38 watts at 500 volts (with 75% efficiency) and correspondingly greater outputs at intermediate voltages, as a Class-C amplifier. More than 100 watts output can be secured at maximum ratings. A pair of 35T's in Class B audio will give outputs ranging from 60 watts at 500 volts to 150 watts at 1500 volts. We hope to have more information on operating the tubes in our next issue.

Los Angeles Emergency Committee

A group of Los Angeles amateurs have organized for the express purpose of providing emergency communication in time of disaster. The group is known as the Amateur Radio Communication Committee, a subcommittee of the Communication Committee of the Los Angeles Major Disaster Council. The Disaster Council is organized to cover all phases of relief work in time of emergency. The work of the Amateur Radio Committee is to provide communication between Headquarters and the various district concentration centers, which number fifteen.

The Committee organization consists of a Chairman, Dr. W. C. Vance, W6KJJ; Vice-Chairman, W. W. Matney, W6EQM; Secretary, E. C. Ward, W6ETX; three Area Commanders, W. E. Johnson, W6AYF, H. Bacon, W6JPH, and W. M. Ketteringham, W6HMH; District Chiefs and necessary personnel, including Technical Adviser, Finance Officer, etc.

HAM-ADS

(1) Advertising shall pertain to radio and shall be of nature of interest to radio amateurs or experimenters in their pursuit of the art.

(2) No display of any character will be accepted, nor can any special typographical arrangement, such as all or part capital letters be used which would tend to make one advertisement stand out from the others.

(3) The Ham-Ad rate is 15¢ per word, except as noted in paragraph (6) below.

(4) Remittance in full must accompany copy. No cash or contract discount or agency commission will be allowed.

(5) Closing date for Ham-Ads is the 25th of the second month preceding publication date.

(6) A special rate of 7¢ per word will apply to advertising which, in our judgment, is obviously non-commercial in nature and is placed and signed by a member of the American Radio Relay League. Thus, advertising of bona fide surplus equipment owned, used and for sale by an individual or apparatus offered for exchange or advertising inquiring for special equipment, if by a member of the American Radio Relay League takes the 7¢ rate. An attempt to deal in apparatus in quantity for profit, even if by an individual, is commercial and takes the 15¢ rate. Provisions of paragraphs (1), (2), (4) and (5) apply to all advertising in this column regardless of which rate may apply.

Having made no investigation of the advertisers in the classified columns, the publishers of *QST* are unable to vouch for their integrity or for the grade or character of the products advertised.

QUARTZ—direct importers from Brazil of best quality pure quartz suitable for making piezo-electric crystals. Diamond Drill Carbon Co., 719 World Bldg., New York City.

RADIO engineering, broadcasting, aviation and police radio, servicing, marine and Morse telegraphy taught thoroughly. All expenses low. Catalog free. Dodge's Institute, Byrd St., Valparaiso, Ind.

NATIONAL—Hammarlund, Patterson used sets, 60% off list. W3DQ, 405 Delaware Ave., Wilmington, Del.

CLASS B transformers—Universal for two or four 46s, 210s, 800s, RK18s, etc., \$7.75 pair postpaid. 70 watts audio from 46s, 100 watts from 10s. Write for details. W8UD, Douglas, Mich.

RECEIVERS—new and used, sold and traded in. Hammarlunds, Nationals, RME69, Skyriider. Schwarz Radio Service, 15 Lawrence Ave., Dumont, N. J.

FOR sale. Six 750 volt, 150 watt generators, \$11. each. Also a few other generators and motors. Wilnot Auto Supply Company, 1970 Wilnot St., Chicago.

QSL cards, two color, cartoons, message blanks, stationery. Snappy service. Write for free samples to-day. WIBEF, 16 Stockbridge Ave., Lowell, Mass.

CALLBOOKS—new DX calls, new prefixes, thousands of new W and VE calls, in the SPRING 1936 Radio Amateur Call Book. Sent postpaid \$1.25, or a whole year (four issues) for \$4. (In foreign countries \$1.35 and \$4.35.) Your call and QRA printed in large type, \$1. per year. W9FO-610 S. Dearborn, Chicago.

INTRODUCTORY offer. One order to an individual. Send \$1. and call letters for 100 two color modern QSL cards (not filled with advertising—send for sample) and six F.M.C. porcelain case mica low loss transmitting and receiving condensers. Any capacity up to .006 mfd. 5% capacity tolerance 2,000 volt test. Actually a \$7.50 value for \$1. Capacity color chart included. Filtermatic Mfg. Co., Tacony, Phila., Pa.

SKYRIDERS cheap—sell or trade. Also can use cameras, binoculars, etc. Wells-Smith Radio Corp., 26 North Wells St., Chicago.

QSLs! SWLs! Samples. W9UII.

SWAP crystals for meters, tubes, parts, W9ERU.

DRESS up. Give your station that million dollar look. Most complete line of all-welded relay racks, chassis, panels, Hi-Power equipment. \$5 balance-choke gets 1 amp from 60s. Rectifier Engineering Service, 4337 Rockwood Road, Cleveland, Ohio.

WANTED Collins 30 FXB transmitter complete. Cash for bargain. W4BPF, Albany, Ga.

HAM apparatus wanted—sell-trade. RCA. 851 new \$75. Amateur Exchange, 6341 Broadway, Chicago.

AMATEURS modernize your station with one of our chromium plated microphone stands. Joseph Fairhall, Jr., Danville, Illinois.

SELL pair 276A's, Johnson sockets, Cardwell 551B's, 1200V-400W power supply complete. Excellent condition cost \$80. Trade for receiver. W2DYT

ACSW3 new complete, power supply, 20, 40-80-160 coils, \$25. WILFK

SPECIALIZED machine work. Let me make those pieces that require a lathe. W9TGC.

GENERAL Electric Dynamotors 24/750 volts 200 mills ball bearing with filters \$25. Two machines for 1500 volts \$40. Westinghouse 27 1/2/350 volt; \$10. Generators 6-15 volt 500 watts \$10. 500 watt 500 cycle \$10. List Henry Kienzie, 215 Hart Blvd., Staten Island, New York.

SELLING out P.A. Electrad parallel push pull fifty's \$20. Four racon giants, fifteen and five. Four 3 1/2 foot trumpets, six dollars, four at 2 dollars. Meters, Microphones, long list, free. John Stiles, Potsdam, New York.

MOTOR-Generator bargain. 110 d.c. to 110 a.c. 60 cycles 300 watts out put. Complete with line filter, regulator, etc. good job. Bargain \$25. Westinghouse 110 d.c. motor 1/2 H.P. compound \$5. Want 15000 volts mica transmitting condensers, typewriter, ham goods. Menier, 563 West 184th Street, New York.

HAVE Electric Specialty Co. 1,000 volt generator, Radio Supply Co. 500 volt generator, want typewriter, saxophone, microscope or ? Harold Long, 912 Indiana Ave., LaPorte, Ind.

ACSW3 receiver 10, 20, 40, 80 bandspread coils \$22. All band rack transmitter. W1EWD, 230 Kelsey St., New Britain, Conn.

SWAP station, fifty dollars or 54 Hornet and tolls, binoculars Pro. W3EIM.

SELL—3 tube ac ham receiver, complete-coils, tubes, power supply. \$12.50 postpaid. W2GWY

QSLs. Free samples, Printer, Corwith, Iowa.

CRYSTALS 80 and 160 meter bands 95%. A stock of 1,000 crystals insures you prompt delivery. New type shielded holder 60¢. Fits five or seven prong socket. Specify type. White Radio Laboratory, Sandpoint, Idaho.

I National FB-7A. Short wave receiver. 1 5897-AB National power unit. National coils FB-B, FB-C, FB-D, FB-E, FB-F. Band spread coil 1.7-2.0 MC. Leon A. Alley, South Main Street, Middleboro, Mass.

SPECIAL rubber stamp—your call letters, street and city—3 lines 35¢. Bruce Wilson, Brookville, Pa.

VELOCITY microphone, Bruno, shielded, with Thordarson transformer to grid. Both \$7. W5BTX, Fayetteville, Ark.

SYLVANIA graphite plate tubes. Never used. Pair 211B \$20. FOB. W2GOJ.

FIRST \$50. takes complete station. Collins xmtr type 4-A with 80, 160 coils, three crystals, two keys, mike and modulator. National SW-3 with three sets coils, pwr supply. Equipment in A-1 condition. Must have cash. W9PXY, Lancaster, Wisconsin.

SELL or trade 400 watt 1600 volt 250 mil power trans; 750 volt 150 mil pdc power supply; 350 volt 100 mil pdc supply; vibroplex; 2 tube acdc sw receiver; xtals; meters; misc. Want movie camera. Ralph Senechal, W9HNW, Anamossee, N. Dak.

SW3 (10 coils) power pack, "SRR", extras. Write best offer for information 2320 So. 22nd St., Phila., Pa.

HC quality crystals now furnished mounted in bakelite holders. "V", "AT" and "X" cuts. Mounted "X", \$2.55. Unmounted "V" cuts, four cycle coefficient, \$3.25. 80M "X", \$1.95. Guaranteed. Request catalogue. Ham Crystals, 1104 Lincoln Place, Brooklyn, N. Y.

MIMEOGRAPH, Dick model 30. New. All accessories, \$20. Nebel, 1104 Lincoln Place, Brooklyn, N. Y.

WANTED old radio sets or parts for Ham antique collection. All letters answered. W6LMM

CLASS "B"-4-46's, all Thordarson, Triplett, 70 watts. Complete tubes, power supplies \$50. Write W9VTP, 4911 Farnam, Omaha, Nebraska.

QSLs, 300 one color cards \$1. Samples, 2143 Indiana Avenue, Columbus, Ohio.

CRYSTALS: zero cut. Guaranteed to compensate at near zero without oven control. Your approximate frequency, 80 or 160 meters \$1.85. Ordinary zero cuts \$1.35 postpaid. Blanks 65¢. Plug-in Holders 75¢. Dozen \$6. Crystal Quartz, will cut twelve crystals \$1. Fisher Laboratory, 4522 Norwood Street, San Diego, California.

ALTERNATOR 60 CY. for sale. 110 v. 10 a. single phase, practically new. C. C. Farnam, 212 W. Michigan, Jackson, Michigan.

SELL QST file, March 1917 to date. Ross Moorhead, Route 1, Findlay, Ohio

MUST sell new HRO complete in original packing. W9COJ

SPECIAL 250 one color QSLs \$1. Samples. W5AIA

QSLs, 2 colors, quality Buff card, \$1. hundred: \$1.50-200. Samples on request. W8NOS.

FOR sale seven tube auto radio want 1 H.P.A.C. motor or reciprocating water pump. Particulars on request. Arlo Weld, Sugargrove, Penna.

REBUILT Vibroplexes \$5-\$7. New large base bugs \$8.50. Lydeard, 28 Circuit, Roxbury, Mass.

NEW RCA 852 \$15. W8ANT

CRYSTALS—1750 to 2000 kilocycles; 3500 to 4000 kilocycles; X or Y. 1" square, ground to your specified frequency \$2.75. Approximately 1", within seven kilocycles of specified frequency \$1.75. Less than 1", within fifteen kilocycles of specified frequency, \$1.35. Exact frequency marked on each crystal. Oscillating blanks 85¢. Rough-cut blanks 60¢. Small irregular shaped blanks, five for \$1.00. Dustproof plug-in holders, 85¢. William Throm, W8FN, 4021 Davis Avenue, Cheviot, Ohio.

WANTED: complete 1935 files of "QST", both Western and Southern editions. Also single copies or complete yearly files of "Proceedings, I.R.E." for 1913, 1914 and 1915. Sumner B. Young, "Maplewoods", Wayzata, Minn.

TRADE-SW3, five sets coils, for good set analyzer. State voltages. "Smith"-W8ANC, Charleroi, Pa.

QSL's samples W8LQM, 942 Linwood Avenue, Columbus, Ohio.

QSL cards. Two color, 75¢-100¢—\$1.75-300. Send for samples. H. Goranson, 1543 Highland Ave., Chicago, Illinois.

CRYSTALS: new zero coefficient "V" cuts, 160-80 meters your approximate frequency \$1.85, AT \$1.50, X \$1.25. Exact specified frequency \$2.70-\$2.60-\$1.95. Calibration accuracy 99.99%. Holders \$1.—Blanks, Southwest Piezo Service, Box 792, Abilene, Texas.

"W9ADN crystals. Custom made at mass production prices because sold direct. 40 to 160. \$2.50 to \$4. See last Hamad.

USED RCA 860—\$12.50. W8ANT

QSL's. Mile-Hi quality 300 2 color \$2. W9TOS

CRYSTALS guaranteed excellent oscillators, approximately one inch square. 80-160 meter bands, within 5 kc. Y cut. \$1. X cut, \$1.50. Postpaid. Herbert Addington, 2252 North LeClaire Avenue, Chicago.

"BLILEY crystalize" your transmitter! Descriptive folder free! Write your questions, desires to W8DED

QSL's! Unbeatable! Samples? (stamps), W8DED, Holland, Mich.

RME-69's! Patronize W8DED

BLANKS 50¢ Faberadio

LATHE metal turning. Six inch swing. Compound tool rest with power feed. Weight 35 lbs. At Ham price, \$10.95. W6ELA, 105 1/2 East Ave. 38, Los Angeles.

203A class B transformers \$10. pair. Trade. Satisfaction guaranteed. W2GZL, Elizabeth, New Jersey.

QSL's. Finest quality. Lowest prices. Samples free. Maleco, 1512 Eastern Parkway, Brooklyn, New York.

MOVING, 800 xmtr, 300 w. power—\$60; 210 xtal xmtr \$30; bandspread receiver (tubes, batteries) \$15; monitor (tube, batteries) \$6; Super Skyriver, W7FLU-W9FG, Hawk Springs, Wyo.

SELL: silver Marshall receiver. Superhet. Cash or terms. 1528 48th, Des Moines, Iowa.

"T-9" 40 meter crystals as low as \$1.50, also 80's; see March QST Ham-ads. None better. "Eidson's", Temple, Texas

QSL's—150 two colors \$1. Samples? stamp! W3PJ, Elmer, N. J.

RK-28 under 2 hours \$20. FBXA, tubes, power B.S. Coils 40 & 20 \$38. Thordarson 6283, 6408, 6315 (trans., swing, smooth. 2000v 250 ma) \$25. ACME AD31, AD21 \$12. 2-Collins Hi-Fidelity 306, 1-721 transformers for speech coupling \$12. Wanted: Kleinschmidt perforator. Thompson, 1301 Findlay Ave., New York City.

USED 852's \$6. up. W8ANT

TRANSMITTERS: special apparatus, to order. Superior workmanship. Howard Radio, 154 Pine Avenue, Chicago.

TELEPLEXES, omnigraphs, vibroplexes, receivers, meters, bought, sold, traded. Ryan Radio Co., Hannibal, Mo.

CRYSTALS \$1.50. Faberadio.

SPECIAL guaranteed Y cut crystals. within 10 kc. \$1. Norman Edwards, 69 Condon, Buffalo, N.Y.

MILLIAMMETERS—brand new triple range Jewells, 40-80-200 mls, \$2.75 (allow postage insurance 2 lbs) W9SXF, 1139 North 23, Lincoln, Nebraska

1000 watt Thordarson transformer 1500-2000 volts, 5 volts 20 amperes C.T. Thordarson filament transformer, 7.5 volt 150 watt C.T. Thordarson filament transformer with Super Power primary clacostat, 30 Henry 500 mil Thordarson Filter choke, 4 mid. 2000 volts and 2 mid. 1500 volts Fleetheim filter condensers, 30,000 ohm 200 watt bleeder, 2-866s. All for \$40. Jewell model 88 D.C. voltmeter 0-3000 volts with external shunt list \$49. sell for \$15. Brand new Baldwin type C phones \$2.50 Slightly used \$2. Type E \$2.50. Many other bargains. Write for list. W2HO, 75 Munro Blvd., Valley Stream, N.Y.

MOUNTED 40 meter crystals. \$3. W8ANT

CT-60 transmitters—three model B-80-40-20, one Model A-160-80-40. All same as latest model but with only one crystal mounting. Regular \$38. your price \$22. each. CT-30 transmitter—30 watts phone and CW; cabinet mounted with all tubes and coils for 180-80-40 meters \$50. Harvey Radio Laboratories, 12 Boylston St., Brookline, Mass.

COMPLETE training amateur licenses; \$1.50 weekly. Resident and correspondence courses. Booklet. New York Wireless School, 1123 Broadway, New York.

ALLSTAR SR. \$30. W1DEC.

QSL cards—attractive—different. Stamp for samples. W8DDS, 2156 West 80th Street, Cleveland, Ohio.

QSL's! The finest obtainable, at the lowest price. Free samples to Hams. W2FJE, 145 Lafayette Avenue, Brooklyn, N. Y.

CRYSTAL comet pro complete \$60. silver 6B complete with crystal \$35., FB7 with tubes \$22., Peak preselector \$12.50, complete 200 watt transmitter using two RK-20s in final \$95. W9ARA, Butler, Mo.

CANADIANS write VE3SP for your receiver needs. Peak preselector \$22.

AIR-WOUND coils W8ANT

QUARTZ \$2. lb. Faberadio, Sandwich, Illinois

RELAY racks at prices you can afford. Radio Headquarters, Ft. Wayne, Indiana.

QSL's that are different. Radio Headquarters, Ft. Wayne, Indiana

5 ft. panel with 4 shelves, 3 power supplies Weston 0-50 meter, 47 xtal and 41 buffer including RCA tubes wired and installed. Have most of unfinished final parts \$25.00. New Barr transceiver complete \$12. 210 Xmitter including tube power & filament supplies \$10. Blum, 895 Ebner, Columbus, Ohio.

HOLDERS \$1. Faberadio

COLLINS 30FXB's, 30FX and other transmitters taken in trade. All first class condition. Marine Radio Company, 124-11 101st Avenue, Richmond Hill, N.Y.

SELL—two weeks old Royal PR6 complete. Six metal tubes power supply band spread 9-550 meters. Perfect condition. W5BB.

METERS repaired—reasonable prices. Braden & Apple Co., 305 Park Drive, Dayton, Ohio

QSLs, listener cards. Best reply getters. Samples (stamps) W8ESN, 1827 Cone, Toledo, Ohio

FOR sale—three new receivers at reduced prices ACR-136 \$59.50—Sargent \$59.50 SW3—coils—power pack—tubes \$30. Write Jos. N. Davies, W8ANT, Southern Ohio's only amateur owned amateur business, Box 602, R.R.9, North Bend Road, Mt. Airy, Cincinnati, Ohio

FREE folder. Faberadio, Sandwich, Illinois

CUSTOMBUILDERS offers you a new service any radio equipment built to your specifications no charge for quotations. Custombuilders, Dept. C 113 West 57th, New York City.

FLORIDA hams 40% discount on Hammarlund, Thordarson, Biley, Cardwell, etc. Rush service. W4QN, Radio Accessories, Orlando.

OLD W9DQ is still at it, the best place to buy a new receiver or trade in an old one, also ham parts, transmitters, etc. Falmer's Trading Post, Route 1, Duluth, Minn.

TRADE Teleplex, Condenser, Analyzer, Transceiver, for Pre-selector, Freqmeter, Monitor, Fan, Vacuum Cleaner—W8CMJ

TRANSFORMERS—1200 watt 1200-2200-3200 each side \$24. Polyphase, 25 cycle transformers. Frank Greben, W9CES, 1533 S. Sawyer Ave., Chicago, Ill.

VERTICAL antenna—spring temper copper tubing. See page 27 March QST. Telescoping section matches transmitting frequency. Wholesalers write for details. 20-meter kit, \$12. 10-meter kit, \$7. Foltz Radio Mfg., 1712 E. First, Sterling, Ill.



The Superiority of Our
DYNAMIC MICROPHONE
Over Other Types Is
Mainly in Its Sensitivity

No high gain preamplification required. No background noise. No Power Supply. And the price... \$50

SPECIAL PRICE TO AMATEURS.....net \$17.40

U. S. PATENTS PENDING

Send for Bulletin 3011

RADIO RECEPTOR CO., INC.
110 Seventh Ave., New York City

Your Nearest Dealer Is Your Best Friend

Your nearest dealer is entitled to your patronage. You can trust him. He is equipped with a knowledge and understanding of amateur radio. He is your logical and safe source of advice and counsel on what equipment you should buy. His stock is complete. He can supply your needs without delay. His prices are fair and consistent with the high quality of the goods he carries. He is responsible to you and interested in you.

Patronize the dealer nearest you — You can have confidence in him

<p>ALLENTOWN, PENNSYLVANIA Radio Electric Service Co. 1024 Hamilton Street Complete stocks transmitting equipment</p>	<p>PHILADELPHIA, PENNSYLVANIA Eugene G. Wile 10 S. Tenth Street Complete Stock of Quality Merchandise</p>
<p>BALTIMORE, MARYLAND Radio Electric Service Co. 303 W. Baltimore Street Everything for the amateur</p>	<p>PROVIDENCE, RHODE ISLAND W. H. Edwards Co. 32 Broadway National — Hammarlund — RCA — and other leaders</p>
<p>BIRMINGHAM, ENGLAND Radio Mart 19 John Bright Street Drop in and meet Bill Nightingale—G5NI</p>	<p>PROVIDENCE, RHODE ISLAND Kraus & Company 89 Broadway Everything for the amateur and serviceman</p>
<p>BUFFALO, NEW YORK Dymac Radio 216 E. Genesee St. — Tel. Cl. 2080 Complete Stock Amateur Parts — Standard Discounts — W8AWK</p>	<p>ROCHESTER, NEW YORK Radio Service Shop 244 Clinton Avenue, North Complete stock amateur-BCL parts. Standard discounts. W8NUC</p>
<p>BUFFALO, NEW YORK Radio Equipment Corp. 326 Elm Street Ham, service and sound equipment</p>	<p>SYRACUSE, NEW YORK Roy C. Stage, W8IGF Complete stock of standard Ham & BCL parts Standard Discounts. Free technical service</p>
<p>MANCHESTER, NEW HAMPSHIRE Radio Service Lab. of N. H. 1008 Elm Street — Tel. 218-W Branches — Portland, Me. and Barre, Vt.</p>	<p>SPRINGFIELD, MASS. S. S. Kresge Company 1540 Main Street Standard discounts on standard lines. Advisory service: W1JQ, W1FOF</p>
<p>MONTREAL, CANADA Canadian Elec. Supply Co., Ltd. 285 Craig St., W. Quality parts and equipment for discriminating buyers</p>	<p>PHILADELPHIA, PENNSYLVANIA Consolidated Radio Corp. 612 Arch Street Ham receivers, Transmitting tubes, Collins transmitters, etc.</p>
<p>PHILADELPHIA, PENNSYLVANIA Radio Electric Service Co., Inc. N. E. Cor. Seventh & Arch Sts. All nationally-advertised lines in stock</p>	<p>WASHINGTON, D. C. George's Radio Co. 816 F Street, N.W. Washington's largest distributor of radio parts</p>
<p>PITTSBURGH, PENNSYLVANIA Cameradio Company 601-3 Grant Street "Ham" Headquarters for Pennsylvania-Ohio-W. Virginia</p>	<p>WHEELING, WEST VIRGINIA Cameradio Company 30 Twelfth Street Complete stock of amateur Equipment at standard discounts</p>

You Are Protected When You Buy From QST Advertisers

“Advertising for QST is accepted only from firms who, in the publisher’s opinion, are of established integrity and whose products secure the approval of the technical staff of the American Radio Relay League.”

Quoted from QST’s advertising rate card.

Every conceivable need of a radio amateur can be supplied by the advertisers in QST. And you will know the product has the approval of the League’s technical staff.

For Your Convenience

QST'S INDEX TO ADVERTISERS IN THIS ISSUE

Aerovox Corporation.....	96
Amperex Electronic Products.....	90
Amperite Corporation.....	122
Astatic Microphone Company.....	98
A.R.R.L. Binders.....	94
Calculators.....	99
Handbook.....	91, 92
Supplies.....	87
Birnbach Radio Company, Inc.....	101
Bliley Electric Company.....	77, 101
Brush Development Company.....	114
Bud Radio, Inc.....	103
Burgess Battery Company.....	1
Burton-Rogers Company.....	98
Candler System Company.....	114
Capitol Radio Engineering Institute.....	121
Cardwell Mfg. Corp., Allen D.....	101
Central Radio Laboratories.....	88
Cohen's Sons, I. S.....	113
Collins Radio Company.....	Cov. 2
Commercialite Laboratories.....	107
Cornell-Dubilier Corporation.....	102
Delaware Radio Sales Co.....	107
Delco-Remy Corporation.....	85
Eastern Radio Specialty Co.....	102
Eby Inc., Hugh H.....	106
Eitel-McCullough, Inc.....	108
Electrad, Inc.....	118
Gardiner-Levering Company.....	103
General Electric Company.....	80
General Radio Company.....	86
General Transformer Company.....	112
Gross Radio, Inc.....	81
Gulf Radio School.....	119
Hallcrafters, Inc., The.....	79
Hammarslund Mfg. Company.....	4
Harvey Radio Laboratories.....	110
Henry Radio Shop.....	118
Hipower Crystal Company.....	103
Instructograph Company.....	103, 111
Leeds.....	95, 111
M & H Sporting Goods Co.....	119
Marine Radio Company.....	2
Massachusetts Radio School.....	122
McElroy, T. R.....	111
McGraw-Hill Book Company.....	84
National Company, Inc.....	75, 83, 103, Cov. 3
Newark Electric Company.....	93
New York V.M.C.A. Schools.....	114
Northern Ohio Laboratories.....	113
Ohmite Mfg. Company.....	106
Port Arthur College.....	101
Precision Piezo Service.....	111
Premier Crystal Laboratories.....	107
Radio Mfg. Engineers.....	82
Radio Receptor Corp.....	124
Radio Shack.....	119
Radio Specialties, Inc.....	120
Radio Supply Company.....	115
Radio Transceiver Laboratories.....	121
RCA Institutes, Inc.....	121
RCA Manufacturing Company.....	97, 127, Cov. 4
Raytheon Production Corporation.....	80
Scientific Radio Service.....	112
Shure Brothers Company.....	119
Signal Electric Mfg. Company.....	121
Spear Manufacturing Company.....	119
Standard Transformer Corp.....	78
Sundt Engineering Laboratories.....	121
Teleplex Company.....	107, 118
Thordarson Electric Mfg. Co.....	113
Triplett Electrical Instrument Corp.....	76
Turner Company.....	100
United Transformer Company.....	128
Universal Microphone Company.....	121
Utah Radio Products.....	107
Valpey Crystals.....	119
Vibroplex Company.....	112
Ward Leonard Electric Company.....	122
Wright-DeCoster, Inc.....	110

NEW RCA TUBES

of 2 Popular Types

RCA-805 125 watts plate dissipation

\$18.00 amateur's net price

You liked the RCA-838 so well that we decided to bring out another tube of the same general family. So we designed the RCA-805, which has the plate lead brought out of the top, and is extra-well insulated to stand higher voltages. Like the 838, the new tube is especially attractive in Class C r-f service with grid leak bias, since the plate current drops to a safe value if grid excitation is accidentally removed. The 805 is also particularly useful as a Class B modulator. This new tube may be operated with full inputs at frequencies up to 30 megacycles.

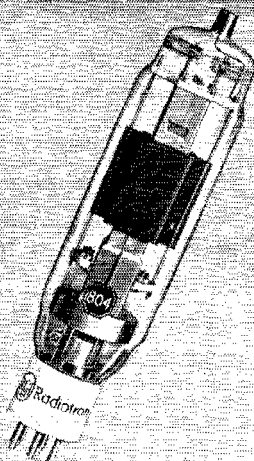
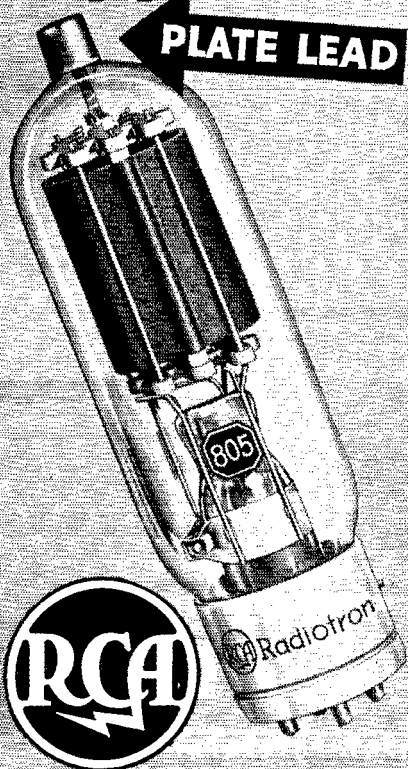

RCA-804 **\$15.00** amateur's net price

As a Class C r-f amplifier pentode, RCA-804 is capable of delivering power outputs up to 80 watts with less than one watt of driving power. The RCA-804 is also well adapted for use as a high-power crystal oscillator. It requires no neutralization in well-shielded circuits. Plate dissipation is 40 watts in most services. The RCA-804 is also useful in grid or suppressor-grid modulated applications.

AMATEUR RADIO SECTION

RCA Manufacturing Company, Inc., Camden, N. J.

An RCA Service

WILL YOU WIN THIS TRANSMITTER PHONE and CW KIT, FULLY MOUNTED . . . Ready-to-Wire

Variactor Carrier Control modulation is now being used by many amateurs in their own phone rigs. These new Ready-to-Wire transmitter kits employ the Variactor system exclusively. A 50 watt kit in cabinet (back view illustrated) will be given away FREE to the amateur who suggests a NAME that will best describe this series of transmitter kits using Variactor Carrier Control.

Contest closes July 1st, 1936. Judges are: Robert Kruse, Frank Jones, and L. M. Cockaday, three nationally known radio editors. Mail suggested names direct to UTC.

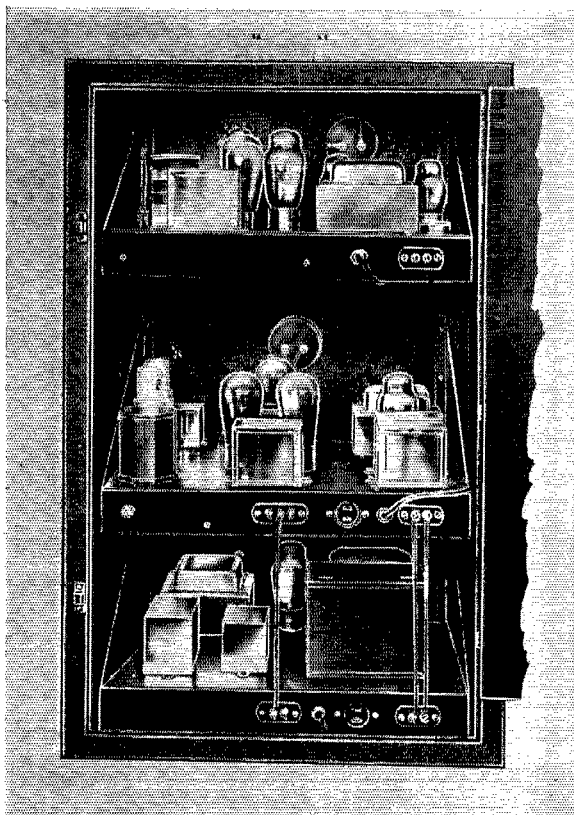
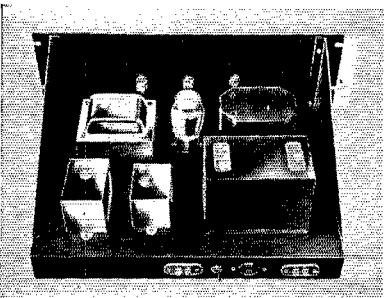
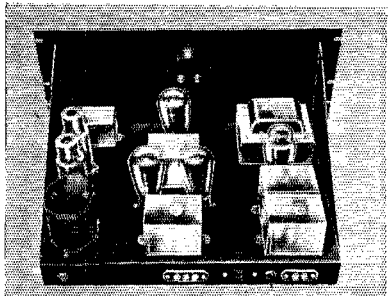
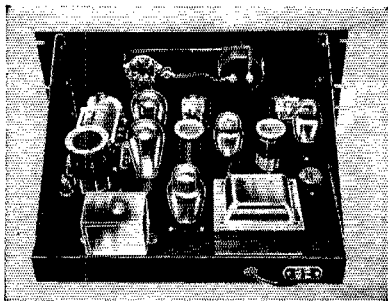

REAR VIEW SHOWING CONSTRUCTION AND PARTS

SECTION ONE

50 watt RF unit. Consists of crystal-controlled pentode oscillator, pentode buffer-doubler, push pull final amplifier and choke input mercury vapour rectifier system having a regulation better than 5%. Readings on 5 circuits instantaneously through one meter. Used by itself this unit is a highly efficient 50 watt CW transmitter.

SECTION TWO

Consists of a high gain speech amplifier and Class B modulating stage. It has an output of 30 watts, and when used to modulate the RF amplifier at 100% modulation, the distortion level is less than 5%. This amplifier is designed for use with high level crystal microphones and will operate with any of the carbon type.

SECTION THREE

VARIACTOR Controlled Carrier Unit. Has a separate power supply for 50 watt class C stage and Variactor units for carrier control. Instantaneous switchover provided from carrier control to constant carrier. When used with 500 watt class B Linear stage DX coverage is increased, efficiency of the Linear stage is easily doubled. Reduces interference between stations tremendously.

These new units represent the last word in transmitter KIT design. Nothing has been overlooked to obtain maximum performance and efficiency, and yet the kits are PRICED WITHIN REACH OF EVERY AMATEUR.

A list of the manufacturers whose parts are used in these assemblies reads like the blue book of Ham Radio: UTC, Cardwell, Cornell Dubilier, Hammarlund, Isolantite, Aerovox, IRC, Triplett, Yaxley, Johnson, Electrad, etc. . . . Tubes by RCA.

The units are furnished completely assembled and mounted on black enamel chassis with front rack panels and etched silvered overall plates. All you have to do is wire them . . . even the wire is furnished. Full working prints accompany each assembly.

Begin with a 50 watt CW unit and later use it to excite a 750 watt CW Class B Linear Stage or start with the 50 watt VARIACTOR controlled carrier phone rig and use it later to excite a 500 watt phone Class B Linear Stage. Units may be purchased separately and are complete in themselves.

Full Scale Working Print Brochure covering all constructional plans for the 50 watt, 500 watt and 750 watt units may be purchased from your distributor or direct for 25c. Free with purchase of each sectional unit.

UNITED TRANSFORMER CORP.

76 SPRING STREET

NEW YORK, N. Y.

EXPORT DIVISION - 15 LAIGHT STREET, NEW YORK, N. Y.

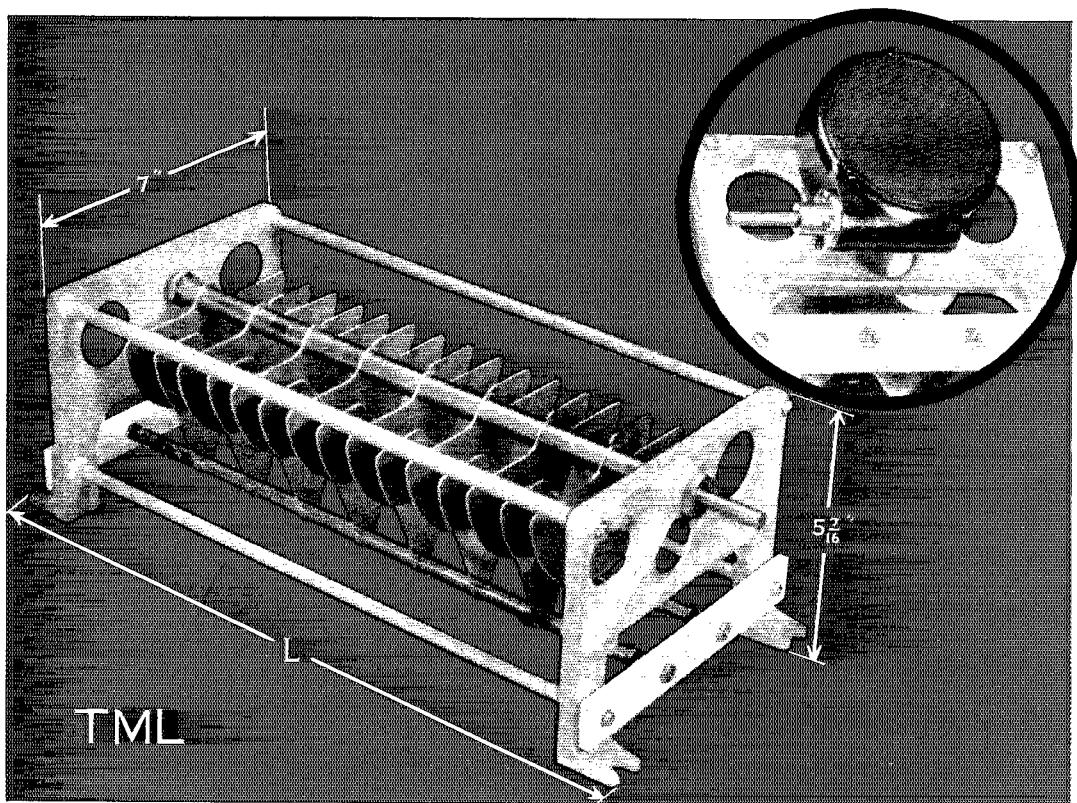

BIG PLATES AND LOW PRICE

The first thing one notices about the TML is that it is big without being clumsy, for its oversize plates permit high voltage ratings without excessive length. The second surprise is the price, for the TML is built in the same sized production lots as midget condensers. In short, it provides performance without a price penalty. It is the ideal unit for the high level modulation 1 kw job.

Type TML has the further distinction of being the first transmitting condenser to be available with the PW type precision worm drive, self-locking, and permitting mounting parallel to the panel.

A few popular sizes are listed below and intermediate sizes are available at proportionate prices. Split-stator models are available. Though not listed, approximate prices and sizes may be judged by the fact that each section of a split-stator condenser has about 40% of the capacity of a single section in the same frame.

NATIONAL COMPANY, INC., MALDEN, MASS.

Capacity	Peak V	Length	Plates	Cat. Symbol	Net Price
75 Mmf	20,000	18 $\frac{1}{2}$ "	17	TML-80E	\$14.10
50 Mmf	15,000	8 $\frac{3}{4}$ "	9	TML-50D	9.90
150 Mmf	15,000	18 $\frac{1}{2}$ "	27	TML-150D	14.55
75 Mmf	10,000	8 $\frac{3}{4}$ "	11	TML-75B+	9.90
245 Mmf	10,000	18 $\frac{1}{2}$ "	35	TML-250B+	15.75
500 Mmf	7,500	18 $\frac{1}{2}$ "	49	TML-500A+	19.50

Precision worm drive unit, 20 to 1 ratio, Net Price, extra \$5.70. Catalogue symbol of drive: PWL

RCA proudly presents the ACR-175

This new RCA amateur receiver incorporates every desirable feature of design, construction and operation, including several remarkable new developments.



\$119.50
net
f. o. b. factory

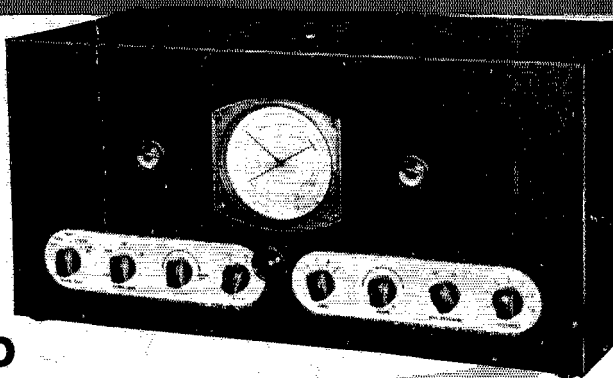

Translate these features into performance

1. 5 to 600 meters, continuous
2. Ultra-selective crystal filter
3. "Magic Eye" tuning and signal strength indicator
4. Actual signal input read directly in microvolts
5. Iron Core i-f Transformers (permanent alignment, high gain)
6. Metal Tubes
7. 11 tubes, 2 I. F. stages
8. Increased sensitivity
9. Greater selectivity with or without crystal
10. Improved signal-to-noise ratio
11. Improved a. v. c.
12. Greater band spread
13. Separate dynamic speaker
14. Pre-selection
15. Band change by switch
16. Individual coils for each band
17. Unusual stability
18. Iron-core heterodyne oscillator calibrated in cycles
19. Audio tone control
20. Unique stand-by pilot light
21. Handsome, rugged metal cabinet
22. Improved velvet drive tuning control—no back lash
23. Direct-reading, calibrated dial
24. Single-control tuning
25. Convenient and accurate logging
26. Two-speed, positive dial drive
27. All controls on front panel
28. Controls conveniently located low on panel
29. Headphone jack
30. Built-in power supply
31. Power transformer operates on 25 to 60 cycles
32. And the price, complete with tubes, crystal, speaker—only \$119.50 net, f. o. b. factory

Available for immediate delivery

AMATEUR RADIO SECTION
RCA MANUFACTURING COMPANY, INC.
CAMDEN, NEW JERSEY A Service of the Radio Corporation of America