

QST

March, 1938
25 cents

devoted entirely to

amateur radio

In this Issue —
**How to Get
Maximum
Performance
From Noise
Silencers**



W6FQY

First Station to Work All Continents on 28 mc. Phone

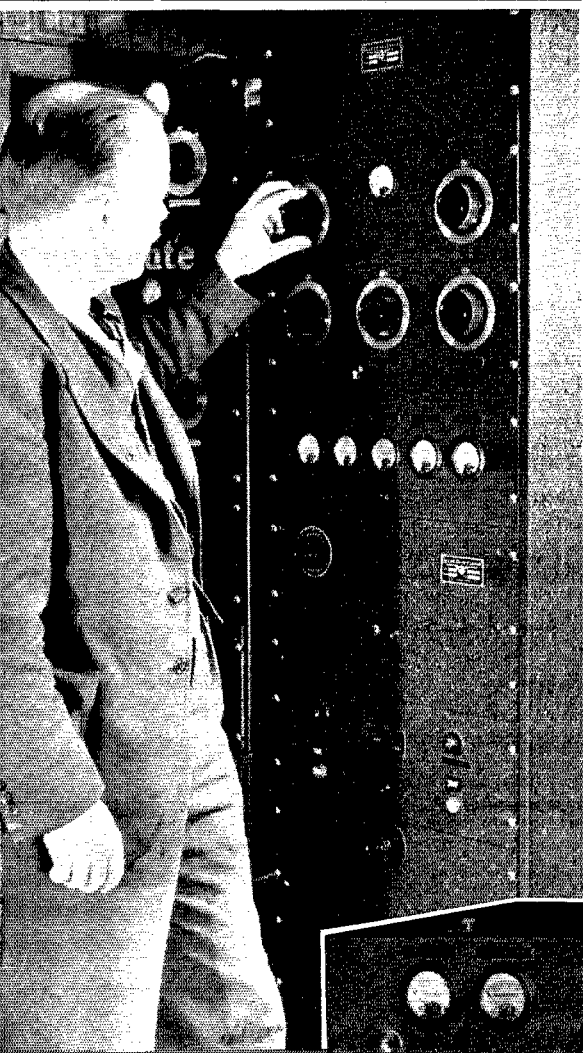

HERE IS HIS LOG:

Nov. 13, 1935			
4:00 P. M.	ZL2KK	CW	Q5R8
4:25 P. M.	K6KSI	CW	Q5R8
Nov. 14, 1935			
9:22 A.M.	ZSIH	CW	Q4R6
3:18 P. M.	J2HJ	Fone	Q5R8
3:24 P. M.	J2IS	Fone	Q5R9
Nov. 15, 1935			
9:14 A.M.	ZU6P	Fone	Q4R6
2:40 P. M.	VK2HZ	Fone	Q4R4
9:15 P. M.	LU9AX	Fone	Q4R8
Nov. 16, 1935			
10:10 A.M.	LU1EP	Fone	Q4R6/7
Nov. 20, 1935			
8:35 A.M.	G6LK	Fone	Q5R6
2:24 P. M.	VK4EI	Fone	Q4R5

Equipment used was a COLLINS 150C with special 10 meter coils. W6FQY has also worked all sorts of dx on the other bands, but this record is of special importance because of the present activity on 28 mc.

There are hundreds of other amateurs who are really doing things with their COLLINS transmitters. COLLINS transmitters have established a reputation for outstanding performance that has never been equalled.

Above:

Dr. Frank E. Breene,
W6 FQY, and His
Record-breaking
Collins 150C.



THE 45A

A NEW COLLINS
DX-GETTER

Collins Radio Company

CEDAR RAPIDS

New York
11 West 42nd St.



IOWA, U. S. A.

Mexico City
Edificio "La Nacional"

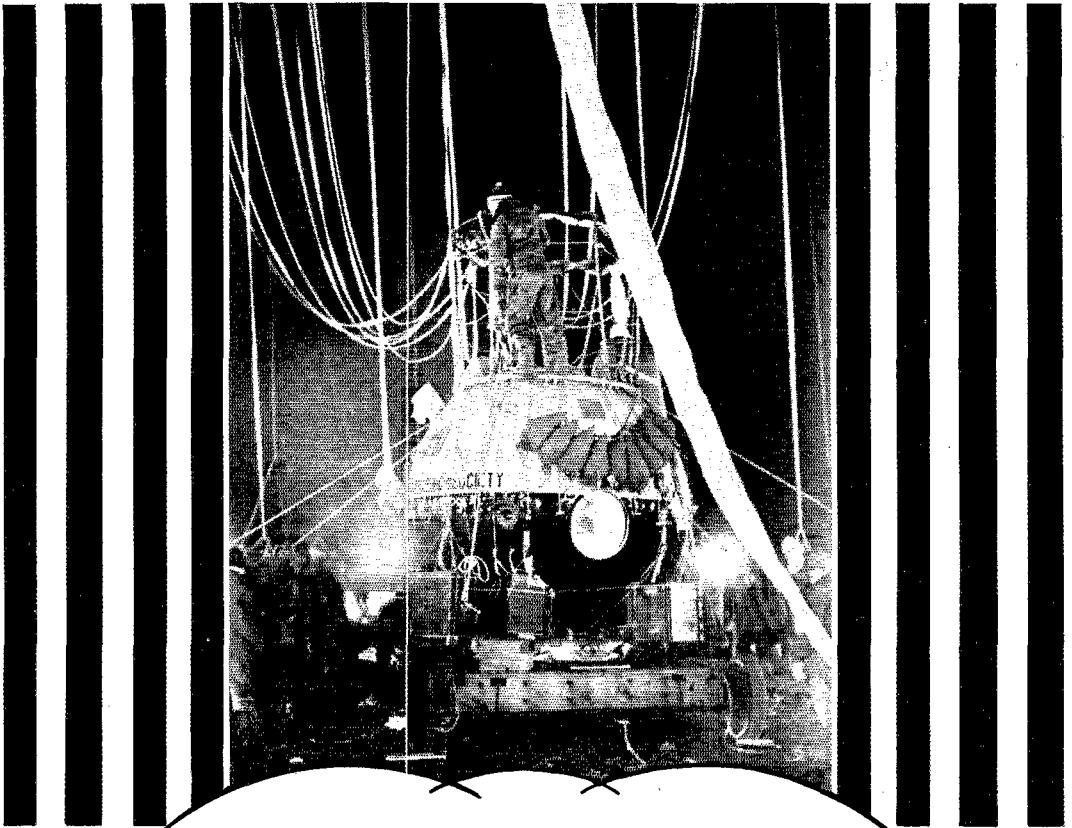

COURTESY N B C

STRATOSPHERE BALLOON used **BURGESS BATTERIES**

The gondola of the United States Army-National Geographic Society stratosphere balloon being made ready for its record making ascension. Burgess Batteries served portable power for operation of cosmic ray equipment, communication, and broadcasting, which was successfully re-broadcast by N B C.

Parachutes attached to battery boxes hanging outside of the gondola were used to drop discharged batteries during the flight.

Use Burgess Batteries in your own experimental work and avail yourself of the same economical, dependable, portable power.

Burgess Battery Co., Freeport, Ill.

BURGESS

Say You Saw It in *QST* — It Identifies You and Helps *QST*

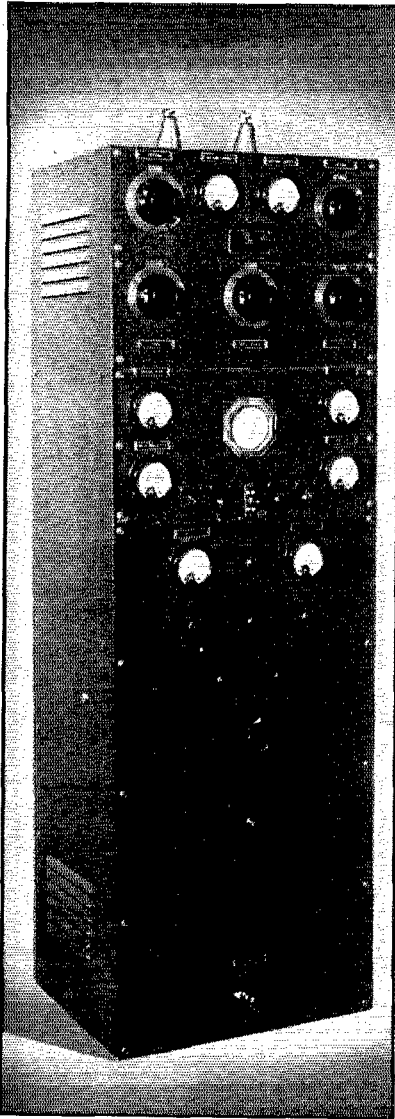

COMPARE!

MARINE 140C



Nominal output rating 175 watts phone and C.W. (Actual measured output more than 200 watts.)

Incorporating the latest developments of modern engineering design, the Marine 140C is released from our laboratories, after many months of research, and we feel confident that its introduction meets with all the rigid requirements of present day practices —

Check these exclusive outstanding features of the Marine 140C

- ✓ Visual Oscilloscopic modulation control.
- ✓ Variable panel switch for line voltage control. Range 90 to 135 volts, A.C.
- ✓ Eight three inch meters. Separate metering of all stages plus two antenna ammeters and filament voltmeter.
- ✓ Complete overload relay protection — including protective rear door cut-out switch.

Other important Marine characteristics of this ultra-modern transmitter are as follows:

- ★ Four R.F. stages incorporating the newly developed "MARINE" two stage single control exciter unit.
- ★ Pilot light indicators on front panel.
- ★ Provision for panel and remote control operation.
- ★ Frequency range: 30,000 to 1500 kc.
- ★ High fidelity audio channel, frequency response of 30 to 10,000 cycles — 1.5 db with a gain of 125 db.
- ★ Break in keying system.
- ★ Three separate heavy duty power supplies, providing complete A.C. operation. No bias batteries required.
- ★ Universal antenna matching network.
- ★ Unconditional one year guarantee.

★ INQUIRE REGARDING OUR DEFERRED PAYMENT PLAN ★

*Write today for the details.
Photographic illustrations
supplied on request.*

MARINE

General Offices and Plant:
124-11 101ST AVENUE
RICHMOND HILL, N. Y.



Radio Company

QST

Published monthly, as its official organ, by the American Radio Relay League, Inc., at West Hartford, Conn., U. S. A.; Official Organ of the International Amateur Radio Union

devoted entirely to

AMATEUR RADIO

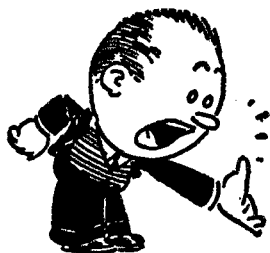

Editorials	9
International DX Contest Announcement	10
Pointers on Noise Silencing Circuits <i>George Grammer</i>	11
A Low Cost Crystal Transmitter <i>Vernon Chambers</i>	13
Results — 3500-Kc. Transoceanic Tests	16
Transmitter Band-Switching Systems <i>George Grammer</i>	17
An Improved Speech Preamplifier <i>Cyrus H. Fraser, W8BBK</i>	20
High Voltage from 32 Volts D.C. <i>Wilbur J. Tabor, W9KUI</i>	21
"Fists" I Have Seen <i>F. H. Schnell, W9UZ</i>	22
Oakland Radio Club Announces Cairo Plaque	24
R.S.G.B. 28-Mc. Contest	24
What the League Is Doing	25
Peace On Earth <i>Keith Williams, W6DTY</i>	26
The Canada-U.S.A. Contact Contest, 1935	28
Pentodes as Class-AB Amplifiers	29
New Receiving Tubes	29
Art-Metal Finish <i>Paul E. Millington, W9KSW and Roger Zaun, W9UVV</i>	30
Connecticut State Convention	30
Transmission-Line Loading for Short Antennas <i>H. S. Keen, W2CTK</i>	31
Experimenters' Section	32
An Unorthodox Antenna — The 6E5 for Checking Overmodulation — Adapting the Patterson PR-10 for 10 Meters — Adapting the QST Three Tube Transmitter to Ten Meters — Crystal Oscillator Keying — Code Practice Set for Eliminating Clicks	
I.A.R.U. News	35
Operating News	37
Correspondence Department	45
Book Review	64
830-B and 834 Transmitting Tubes Announced	86
Club Notes	90
QST's Index of Advertisers	94

**March
1936**

**VOLUME XX
NUMBER 3**

Kenneth B. Warner (Secretary, A.R.R.L.), *Editor-in-Chief and Business Manager*; **Ross A. Hull**, *Associate Editor*; **James J. Lamb**, *Technical Editor*; **George Grammer**, *Assistant Technical Editor*; **Clark C. Rodimon**, *Managing Editor*; **David H. Houghton**, *Circulation Manager*; **F. Cheyney Beekley**, *Advertising Manager*; **Ursula M. Chamberlain**, *Assistant Advertising Manager*.

Editorial and Advertising Offices
38 La Salle Road, West Hartford, Conn.

Subscription rate in United States and Possessions and Canada, \$2.50 per year, postpaid; all other countries, \$3.00 per year, postpaid. Single copies, 25 cents. Foreign remittances should be by international postal or express money order or bank draft negotiable in the U. S. and for an equivalent amount in U. S. funds.

Entered as second-class matter May 29, 1919, at the post office at Hartford, Connecticut, under the Act of March 3, 1879. Acceptance for mailing at special rate of postage provided for in section 1103, Act of October 3, 1917, authorized September 9, 1922. Additional entry at Concord, N. H., authorized February 21, 1929, under the Act of February 28, 1925.

Additional second-class entries to cover sectional editions authorized March 20, 1935

Copyright 1936 by the American Radio Relay League, Inc.
Title registered at United States Patent Office.

HAMMARLUND

Announces



A PERSONAL WORD TO
RADIO AMATEURS FROM
LLOYD HAMMARLUND

THE "SUPER-PRO" Receiver, like most other worth-while developments, has been a long time coming. We aimed too high for speed. Speed in radio production too often demands shallow thinking and lack of precision.

Hammarlund's traditional policy has been—"Take time to do it RIGHT!" Now, it is ready—the finest receiver ever to bear the Hammarlund name—a receiver that will out-perform all preceding standards—a receiver worth waiting for.

The "SUPER-PRO," in addition to setting new high levels of sensitivity, selectivity and tone, offers refinements of control and adjustment never before embodied in any receiver. Read about them on the facing page.

We, here at Hammarlund's, are as proud of this accomplishment as we know you will feel proud in its ownership.

Lloyd Hammarlund

HAMMARLUND MANUFACTURING CO.

424-438 W. 33rd Street, New York

The "SUPER-PRO"

AMATEUR-PROFESSIONAL RECEIVER

THE new Hammarlund "Super-Pro" Receiver more than fulfills the exacting demands of the seasoned professional and amateur operator. It fairly bristles with distinctive features. Among these are: Electrostatically shielded input; two stages of tuned R.F. on all bands; four air-tuned I.F. transformers; continuously variable selectivity; three audio stages; silver-plated five-band switch; visible tuning meter; separate power supply unit; separate grid bias supply; send-receive switch; speaker-phone switch; A.V.C.-Manual switch; C.W.-Modulation switch; standard and rack type panels and heavy gauge cadmium-plated steel chassis.



CONTROL PANEL

The precision controls include: accurately calibrated tuning dial in kilocycles and megacycles; band spread tuning dial (both illuminated); five-band switch; audiofrequency gain; radio frequency gain; intermediate frequency gain; selectivity; beat frequency and tone control. The main tuning dial is accurately calibrated in ranges of 2.5 to 5; 5 to 10; and 10 to 20, and in kilocycles from 540 to 1160 and 1160 to 2500. This dial is equipped with an ingenious mechanical shutter which operates in conjunction with the band change switch, making visible only the frequency band in actual use. The high frequency ranges each have a two-to-one frequency range, which puts the three amateur bands at the same setting of the main tuning dial.

TUNING UNIT

The tuning unit, illustrated at the right, is an engineering triumph of compactness and precision. It includes the main tuning and band spread condensers and their respective dial assemblies, the band change switch, and all antenna coupling, R.F. and H.F. oscillator coil assemblies. Only 8 leads from this unit to chassis assembly

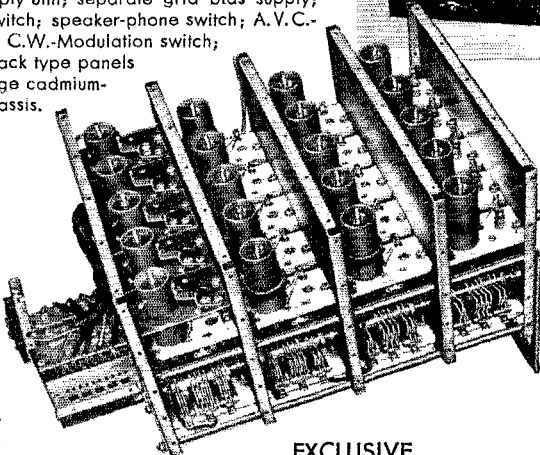

EXCLUSIVE BAND-CHANGING SWITCH

The band-changing switch is a radical departure from switches commonly used for this purpose. Its design incorporates the well-known knife switch principle actuated by eccentric cams. Specially designed bakelite sections with silver-plated phosphor bronze knife blades, gradually slide into silver-plated phosphor bronze spring clips forming a 6-point positive contact. This switch operates backward or forward and not only controls the tuning coverage of the 20 mc. to 540 kc. range in five bands, but also automatically connects the proper band spread condensers to each of the three high frequency circuits and short circuits all coils not actually in use.

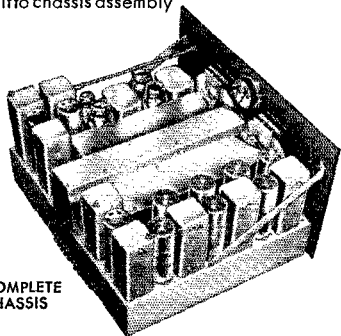

COMPLETE CHASSIS

Write Dept. Q-3 for Complete Details

HAMMARLUND MANUFACTURING CO.

424-438 W. 33rd Street, New York



Progressive

(TRADE MARK)



TRANSMITTER UNITS FOR RADIO AMATEURS

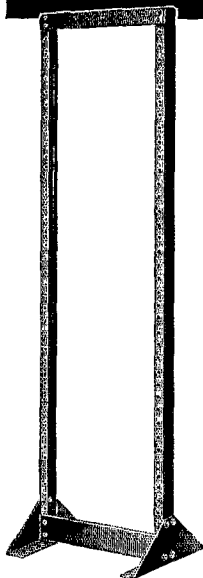

The Start

STEP BY EASY STEP
From the Start to the Finish

ANNOUNCED MARCH, 1935

at the I. R. S. M. CONVENTION and in the
PROGRESSIVE TRANSMITTER GUIDE
published by the Amateur Press, Chicago

The Progressive Transmitter at W9THL has been working all sections of the world nearly every night for the past year. Build a PROGRESSIVE outfit yourself! Get on the air! You can build your own CW 15-Watt Outfit for less than \$100 or a 65-Watt Outfit for only \$150!

Add up in easy steps to that greatest thrill of amateur radio—the complete 800-Watt Rig—CW and Fone for \$400. And what's more you build this rack and panel "amateur station" yourself. Simply follow the "PROGRESSIVE GUIDE" and the easy-to-understand directions.

With the PROGRESSIVE way you build to this final stage in easy steps—as rapidly or gradually as you choose—right up to the commercial broadcast level without scrapping ten dollars worth of equipment in the entire outfit.

The complete unit illustrated above—is the Progressive Transmitter used at W9THL. In its wanderings over the world it has among its transocean stations worked recordings at Argentina, Belgium Canal Zone, Cuba, England, France, Germany, Scotland and Spain.

The heart of your transmitter is your transformer. GENERAL now employs Highest Efficiency PULL-PUSH Moisture-Proofing on all transformers—most perfect modern method known. GENERAL furnishes a complete line of power supply units designed especially to bring amateur transmitting equipment to the commercial broadcast level of quality (described in the "PROGRESSIVE" TRANSMITTER GUIDE for Amateurs).

SENSATIONAL BOOK YOU NEED

THE "PROGRESSIVE" TRANSMITTER GUIDE for radio Amateurs, telling you just how to build a real high power transmitter—outlines each progressive step in simple, easily-followed fashion. Published by the Amateur Press, 1300 W. Harrison, Chicago. 28 pages, 12 illustrations, 14 Circuit Diagrams. 25c (U.S.) postpaid. Send International Postal Money Order.

Listen to the PROGRESSIVE TRANSMITTER — W9THL frequency 7112-7035 (42 meters) usually Fridays 12 P.M. to 3 A.M. or Saturdays 12 P.M. to 2 A.M.—occasionally 8 P.M. to 12 P.M.—also on 20, 40, 80, 160 meter bands.

Free for the Asking!

Send for FREE Bulletin, Form 20—"PROGRESSIVE" TRANSMITTER and a complete line of Amateur Transmitting power supply units, audio inputs, outputs and chokes.

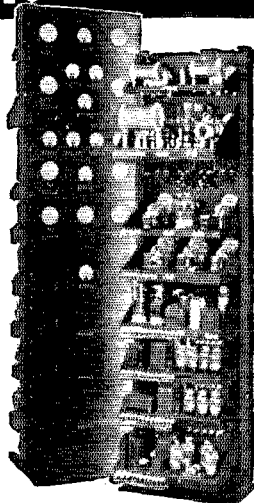

The Finish

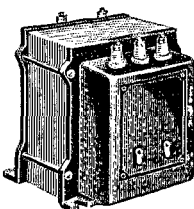

Type "F" Deluxe
A sturdy fully shielded cast iron mounting for high voltage transmitter transformers.

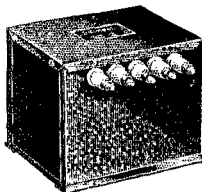

Type "D"
The Progressive Transmitter Deluxe Mounting.

GENERAL TRANSFORMER CORPORATION

518 S. THROOP ST., CHICAGO, ILLINOIS

Say You Saw It in QST — It Identifies You and Helps QST

Section Communications Managers of the A.R.R.L. Communications Department

All appointments in the League's field organization are made by the proper S.C.M., elected by members in each Section listed. Mail your S.C.M. (on the 10th of each month) a postal covering your radio activities for the previous 30 days. Tell him your DX, plans for experimenting, results in phone and traffic. He is interested, whether you are an A.R.R.L. member or get your QST at the newsstands; he wants a report from every active ham. If interested and qualified for O.R.S., O.P.S. or other appointments he can tell you about them, too.

Eastern Pennsylvania
Maryland-Delaware-District
of Columbia
Southern New Jersey
Western New York
Western Pennsylvania

W3EZ
W3BAK
W3ZX
W8DSS
W8CUG

Illinois
Indiana
Kentucky
Michigan
Ohio
Wisconsin

W9WR
W9TE
W9AUH
W8DVH
W8CIG
W9ATO

North Dakota
South Dakota
Northern Minnesota
Southern Minnesota

W9OEL
W9PFI
W9OWU
W9DEI

Arkansas
Louisiana
Mississippi
Tennessee

W5ABI
W5DWW
W5CWO
W4BBT

Eastern New York
N. Y. C. & Long Island
Northern New Jersey

W2LU
W2AZV
W2FOP

Iowa
Kansas
Missouri
Nebraska

W9LEZ
W9FVZ
W9CJR
W9FAM

Connecticut
Maine
Eastern Massachusetts
Western Massachusetts
New Hampshire
Rhode Island
Vermont

W1CTI
W1CDX
W1ABG
W1BVR
W1AVJ
W1HRC
W1BJP

Alaska
Idaho
Montana
Oregon
Washington*

K7PQ
W7NH
W7AAT
W7AMF
W7WY

Hawaii
Nevada
Santa Clara Valley
East Bay
San Francisco
Sacramento Valley
Philippines
San Joaquin Valley

K6EWQ
W6BIC
W6BMW
W6JTV
W6SG
W6DVE
KA1XA
W6CRF

North Carolina
Virginia
West Virginia

W4QG
W3UVA
W8KKG

Colorado
Utah-Wyoming

W9FA
W6GQC

Alabama
Eastern Florida
Western Florida
Georgia-So. Carolina-Cuba-
Isle-of-Pines-Porto Rico-
Virgin Islands

W4DGS
W4BCZ
W4MS

W4CE

Los Angeles
Arizona
San Diego

W6BPU
W6LVG
W6EOP

Northern Texas
Oklahoma
Southern Texas
New Mexico

W5BII
W5CEZ
W5BDI
W5CGJ

Maritime

VE1DQ

Ontario

VE3QK

Quebec

VE2EE

Alberta
British Columbia

VE4GD
VE5EP

Manitoba
Saskatchewan

VE4BG
VE4EL

ATLANTIC DIVISION

James M. Bruning
339 W. Lancaster Ave.
Haverford

Edgar L. Hudson
Carroll D. Kentner
Charles Smith
C. H. Grossarth

1107 Park Ave.
310 E. Walnut St.
261 N. Balph Ave.

Laurel, Delaware
Collingswood
Oneida
Bellevue

CENTRAL DIVISION

Fred J. Hinds
Arthur L. Braun
G. W. Mossbarger
Kenneth F. Conroy
Robert P. Irvine
E. A. Cary

6618 West 34th St.
530 East Morris St.
Box 177
18030 Waltham Ave.
5308 Northliffe Ave.
3922 No. 19th Pl.

Berwyn
Indianapolis
Camp Taylor
Detroit
Cleveland
Milwaukee

DAKOTA DIVISION

Hartwell B. Burner
Mike Strahon
Leonard Hoistad
Francis C. Kramer

601 S. Grange Ave.
W. Bluff St.

Hope
Sioux Falls
Elbow Lake
St. Charles

DELTA DIVISION

H. E. Velte
W. J. Wilkinson, Jr.
J. H. Weems, Jr.
Merrill B. Parker, Jr.

2918 West 15th St.
1523 Laurel St.
P. O. Box 244
1912 Oak St.

Little Rock
Shreveport
State College
Chattanooga

HUDSON DIVISION

Robert E. Haight
E. L. Baunach
Charles J. Hammersen

511 South Holmes St.
7823 10th Ave.
92 Claremont Ave.

Scotia
Brooklyn
Verona

MIDWEST DIVISION

Phil D. Boardman
O. J. Smetter
J. Dewey Mills
Samuel C. Wallace

325 Kirkwood Blvd.
305 Western Ave.
Box 205
Green St.

Davenport
Topeka
Mount Vernon
Clarks

NEW ENGLAND DIVISION

Frederick Ellis, Jr.
John W. Singleton
Albert N. Giddis
Percy C. Noble
Robert Byron
Clayton C. Gordon
Forrest D. Drew

19 Merrill Rd.
73 Allen St.
128 Crawford St.
37 Broad St.
12 Humphrey St.
206 California Ave.
947 E. Main St.

Norwalk
Wilton
Lowell
Westfield
Concord
Providence
Newport

NORTHWESTERN DIVISION

Richard J. Fox
Nellie H. Hart
O. W. Viers
Frank L. Black
Robert H. Votaw

Box 301
Box 6
Box 265
1822 McPherson St.
Route 1, Box 398

Ketchikan
Twin Falls
Red Lodge
North Bend
Vancouver

PACIFIC DIVISION

Atlas O. Adams
Edward W. Heim
Charles J. Gaur
Harold J. Burchfield
Alan D. Whittaker, Jr.
Geo. L. Woodington
Newton E. Thompson
Vernon C. Edgar

21st Infantry Brigade
716 West Sixth St.
318 Hawthorne Ave.
2940 106th Ave.
79 Elinor Ave.
716 Redwood Ave.
P. O. Box 849
732 Blackstone Ave.

Schofield Barracks
Beno
Palo Alto
Oakland
Mill Valley
North Sacramento
Manila, P. I.
Fresno

ROANOKE DIVISION

H. S. Carter
Charles M. Waff, Jr.
Dr. Wm. H. Riheladaffer

115 Crafton St.
P. O. Box 1212

Winston-Salem
Univ., Charlottesville
Lost Creek

ROCKY MOUNTAIN DIVISION

Glen Glasscock
Arty W. Clark

2160 South Josephine St.
260 So. 9th West

Denver
Salt Lake City, Utah

SOUTHEASTERN DIVISION

James F. Thompson
Philip A. McMasters
Edward J. Collins

2248 S. Arlington Ave.
731 Arlington Ave.
1517 East Brainard St.

Birmingham
St. Petersburg
Pensacola

Bannie L. Stewart
SC-P53,
C.C.C. Camp Lawrence

Effingham, S. C.

SOUTHWESTERN DIVISION

Howell C. Brown
C. C. Day
Harry A. Ambler

120 N. El Molino Ave.
"La Posta Quemada"
4101 Hamilton St.

Pasadena
Vail
San Diego

WEST GULF DIVISION

Richard M. Cobb
Carter L. Simpson
Ammon O. Young
Joseph M. Eldodt

Box 185
2010 So. 4th St.
4803 43rd St.

Dodd City
Ponca City
Houston
Chamita

MARITIME DIVISION

A. M. Crowell

69 Dublin St.

Halifax, N. S.

ONTARIO DIVISION

John Perdue

229 Askin Boulevard

Windsor, Ont.

QUEBEC DIVISION

Stan Comach

780 Brault Ave.

Verdun, P. Q.

VANALTA DIVISION

J. Smalley, Jr.
D. R. Vaughan-Smith

611 1st Ave., N. W.
1221 Burnaby St.

Calgary
Vancouver

PRAIRIE DIVISION

A. J. R. Simpson
Wilfred Skaife

71 Thelmo Mansions
2040 McTavish St.

Winnipeg
Regina

* Officials appointed to act until the membership of the Section choose permanent S.C.M.'s by nomination and election.

The American Radio Relay League



DIRECTORS

<i>President</i>	
HIRAM PERCY MAXIM.....	W1AW
Box 216, Hartford, Conn.	
<i>Vice-President</i>	
CHARLES H. STEWART.....	W3ZS
St. David's, Pa.	
<i>Canadian General Manager</i>	
ALEX REID.....	VE2BE
169 Logan Ave., St. Lambert, P. Q.	
<i>Atlantic Division</i>	
EUGENE C. WOODRUFF.....	W8CMP
234 W. Fairmount Ave., State College, Pa.	
<i>Central Division</i>	
EDWARD A. ROBERTS.....	W8HC
2699 Endicott Rd., Shaker Heights, Cleveland	
<i>Dakota Division</i>	
CARL L. JABS.....	W9BVH
1822 James St., St. Paul, Minn.	
<i>Delta Division</i>	
E. RAY ARLEDGE.....	W5SI
P. O. Box 286, Pine Bluff, Ark.	
<i>Hudson Division</i>	
KENNETH T. HILL.....	W2AHC
115 Willow St., Douglaston, L. I., N. Y.	
<i>Midwest Division</i>	
FLOYD E. NORWINE, JR.....	W9EFC
120 South Fourth St., St. Louis, Mo.	
<i>New England Division</i>	
G. W. BAILEY.....	W1KH
74 Webster Road, Weston, Mass.	
<i>Northwestern Division</i>	
RALPH J. GIBBONS.....	W7KV
c/o United Air Lines, Pendleton, Ore.	
<i>Pacific Division</i>	
S. G. CULVER.....	W6AN
2962 Russell St., Berkeley, Calif.	
<i>Roanoke Division</i>	
H. L. CAVENESS.....	W4DW
State College Station, Raleigh, N. C.	
<i>Rocky Mountain Division</i>	
RUSSELL I. ANDREWS.....	W9AAB
1867 So. Lafayette St., Denver, Colo.	
<i>Southeastern Division</i>	
BENNETT R. ADAMS, JR.....	W4APU
1512 Grove Place, Homewood, Ala.	
<i>Southwestern Division</i>	
CHARLES E. BLALACK.....	W6GG
P. O. Box 55, Yuma, Ariz.	
<i>West Gulf Division</i>	
WAYLAND M. GROVES.....	W5NW
c/o Humble Pipe Line Co., Neches, Texas	

• **T**HE AMERICAN RADIO RELAY LEAGUE, INC., is a non-commercial association of radio amateurs, bonded for the promotion of interest in amateur radio communication and experimentation, for the relaying of messages by radio, for the advancement of the radio art and of the public welfare, for the representation of the radio amateur in legislative matters, and for the maintenance of fraternalism and a high standard of conduct.

It is an incorporated association without capital stock, chartered under the laws of Connecticut. Its affairs are governed by a Board of Directors, elected every two years by the general membership. The officers are elected or appointed by the Directors. The League is non-commercial and no one commercially engaged in the manufacture, sale or rental of radio apparatus is eligible to membership on its board.

"Of, by and for the amateur," it numbers within its ranks practically every worth-while amateur in the nation and has a history of glorious achievement as the standard-bearer in amateur affairs.

Inquiries regarding membership are solicited. A bona fide interest in amateur radio is the only essential qualification; ownership of a transmitting station and knowledge of the code are not prerequisite. Correspondence should be addressed to the Secretary.

OFFICERS

<i>President</i>	HIRAM PERCY MAXIM, W1AW
Hartford, Connecticut	
<i>Vice-President</i>	CHARLES H. STEWART, W3ZS
St. David's, Pennsylvania	
<i>Secretary</i>	KENNETH B. WARNER, W1EH
West Hartford, Connecticut	
<i>Treasurer</i>	ARTHUR A. HEBERT, W1ES
West Hartford, Connecticut	
<i>Communications Mgr.</i>	F. EDWARD HANDY, W1BDI
West Hartford, Connecticut	
◆	
<i>General Counsel</i>	PAUL M. SEGAL, W3EEA
1010 Shoreham Building, Washington, D. C.	
◆	

Address all general correspondence to the executive headquarters at West Hartford, Connecticut



THE EDITOR'S MILL

ONE of the saddest objects in the radio world is an amateur who can't make conversation. (Prize for the very saddest object goes to the bird caught up by a chap who can't *stop* conversing! It was this situation which called forth the invention "Well, I won't keep you any longer, OM!") But we're talking about those who have trouble making conversation, in a game the very foundation of which is personal contact.

One of the largest appeals of amateur radio is the diversified contacts it provides. The next station worked may be a school lad or a retired merchant or a housewife or an auditor, a tennis star or a truck driver, a yacht designer or a dentist. The naturally gregarious flourish in such a profusion of possibilities but the introspective have difficulty in breaking down the barriers of reserve. On this very page we have smiled, perhaps scornfully, at the "formula QSO" we hear so often: "GE tnx OM fr FB call ur FB sigs RST 579x hr in Spittoon wx hr cold es cldy pwr hr 60 watts wl wtsa OM? ar," and its companion reply: "R GE tnx OM fr FB rpt ur FB sigs RST 589x hr in Peruna wx hr cldy es cold pwr hr 70 watts wl wtsa OM? ar." But we must admit that this humble device arose spontaneously, to fill a very real need. It is "openers," a thing to break ice, and from just so inauspicious a beginning many firm radio friendships have flowered.

The difficulty that the reticent seem to find is their inability to go past this point—the stereotype ends here except for the formula conclusions, equally well known. To get past this hurdle and really begin to know the other fellow, the amateur is on his own, he must commence to make his own conversation. Sometimes it is a hard job. We met a man on the air the other night who gave us a good lesson in breaking the ice. The QSO was on the 7-mc. band and so got off to the usual formula start. It didn't look any too bright. Then our correspondent said, "Well, now, let's know each other better. I'm 44 years old; I own a garage in this town of 500 people; I also do electric welding. Have two children. What do you do, and how old are you?" That was his particular ice-breaker and it worked splendidly. It led to an enjoyable 40-minute chat. We know something about that man now, we like him, and we're looking forward to meeting him again.

Let the timid, then, devise a few ice-breakers for themselves. Jot down a few things to talk

about. We don't have to pry into each other's souls but each new QSO offers warm human possibilities that far transcend mere shop-talk about gear and circuit conditions. First step in learning to visit over the air is to be prepared to do your part of the conversing, by arming yourself with a few openers.

Another suggestion: It is difficult to remember the things the other fellow talked about, the questions he asked. If the contact is to go on, its thread must not be lost. When interference conditions are good and a smooth fist spins out the words at the other end, one does not need to copy; one simply listens. It is then easy to jot down "topics," thoughts generated by the other chap's remarks, the things he asked about. When interference is bad it is better to copy, for a few letters in random words often show by examination what was said even though most of the words were lost. If one is copying, a useful device is to underscore the questions asked, the key words that represent ideas to be commented upon. By either of these methods one is prepared for a quick come-back and the execution of his part in sustaining the conversation.

One final cliché needs ripping into: "Hpe cu agn sn OM." When you've met a fellow you like well enough to want to know better, why not make a schedule to see him again? Many a splendid possibility is passed by in overlooking this workable way to another contact. Without it, you're likely never to "c him agn." When you meet again as the result of a schedule you'll feel like old friends, both of you. In fact, you're on the way, for you have something now in common—your previous QSO. It's much more satisfying than the restless flitting from call to call, never progressing beyond the formula stage.

Radio is a tool, we its master—ours to use for human ends as well as technical ones.

THE recent remarkable performance of the 28-megacycle band naturally has attracted a considerable number of new-comers. That is splendid, for there is still plenty of room and a good time is being had by all. But amongst the new arrivals are quite a few whose signals do not meet the standard set for that band by regulations. Attracted by the possibilities of easy worldwide DX, a number of 56-mc. fellows have hurriedly made up larger coils for the 28-mc. band

and endeavored to join the parade, with a resultant rather atrocious messing-up of things in general; and concerning this state of affairs we'd like to say a few words.

The 28-mc. band, it seems to us, is to be approached only as an extension of the technique of the lower frequencies. The practices of the 56-mc. band cannot be applied to it. It is not an easier 5-meter band; it is a harder 20-meter band. The very fact that 28 mcs. is good for world DX at favorable times in the solar cycle, as at present, resulted in the decision a year or so ago to extend it to the regulations which govern all the lower-frequency bands. Thus there is required for it stability of carrier, pureness of supply, control of modulation and freedom from wobulation precisely to the same extent as in the bands below 14.4 mc.

Five-meter technique is still developing; it is not yet crystallized. The band is wide open for all forms of experimental work and, so far as

regulations themselves are concerned, anything goes. But it is improper to invade "ten" with these same practices. Modulated self-excited oscillators may be tolerated at local ranges on 56 mc., and indeed the superregen receivers of that band receive such signals very well. But when such equipment is put on 28 mc. the result is painful for all concerned. The signals are simply smears, the receivers customarily used in that band can't accept them, the superregen receivers themselves radiate all over the place, and nobody gets anywhere. We would like to point out to these OM's that this is all wrong, both technically and from the standpoint of regulations. "Ten" is not part of the u.h.f. family, and the requirements of F.C.C. regulations are to be met only by extending to it the methods of our lower-frequency bands. Please give ear, fellows: let us put in the 28-mc. band only signals that stand still when they're modulated by mike or key.

K. B. W.

The Eighth International DX Competition

March 14th-22nd

ALL Hams, the world around, are invited to take part in A.R.R.L.'s Annual DX Contest. The four major features of contest operation are:

(1) *The exchange* of a six figure serial number group, between W/VE and DX stations, counting both parties to the QSO three points if an exchange is completed in both directions. Numbers consist of the three-figure report on the station you are working plus three self-assigned numerals that stay the same throughout the contest.

(2) A *multiplier* for the total of points made through such exchanges by either the number of countries (by I.A.R.U. prefix list) or the number of W and VE licensing areas with which successful exchanges have been made.

(3) Operation in *different frequency bands* is credited by the fact that the number of countries or areas for multiplier shall consist of those worked in band one, plus those worked in band two, plus those worked in band three, etc.

(4) A *total time of operation* period—90 hours at any time in the nine-day contest period with no penalty. (A contestant can work as many additional hours as he pleases in the nine days, but scores are reduced in proportion to the *excess* hours for all time over 90 hours.)

(5) For W/VE's a "quota system" makes the maximum number of stations that can be worked in any one country *three* (for each band). There is no limit for others than W/VE.

See February *QST* for rules and announcement in full detail, with which various suggestions to assist in successful and pleasurable DX operation have been incorporated. Mark your calendar now and plan to take part with amateur operators everywhere in . . . The Eighth International DX Competition.

Operating Noise-Silencing Units

Practical Hints for the Best Silencing Results

By George Grammer*

WHILE the ideal way of incorporating the noise-silencing circuit described in February *QST*¹ in a receiver is to make it an integral part of the set, naturally enough most amateurs have shown great interest in the separate-unit idea because it can be applied to existing superhet receivers, many of which do not have the extra chassis room necessary for the installation of two additional tubes and a diode transformer. Experience of the past few weeks, both here and on the part of amateurs in the field, has shown that certain special problems are likely to be encountered in getting such units to work properly, these depending principally upon the particular receiver used and the method of making connections between receiver and noise-silencing unit.

Probably the most prevalent complaint is that of loss of receiver gain when one of the i.f. tubes in the receiver is replaced. This, of course, has nothing to do with the silencing circuit; it is simply a matter of successfully substituting the 6L7 for the existing i.f. tube. Since the 6L7 is capable of giving about the same gain in i.f. circuits as any of the tubes normally used for that purpose, the logical deduction is that there is something wrong with the method of connection if the receiver gain is greatly reduced.

One point which was immediately discovered by several workers is that ordinary rubber-covered shielded wire is entirely unsatisfactory for

making the r.f. connections between the i.f. input and output circuits and the 6L7. Not only does such wire have quite high capacity, even in short lengths, but the losses in the rubber insulation employed also appear to be unduly high. The latter will cause a reduction in signal strength; the former may make retuning the i.f. circuits of the affected stage impossible. The material to use is the type of shielded cable measuring about a half-inch in diameter, having a small rubber insulated wire at the center, the intervening space being filled with cord. This has considerably lower losses and much less capacity than the ordinary shielded wire.

At that, it will pay to be very sparing in the use of even the large cable. The shorter the r.f. connecting leads the better. This is particularly important not only from the loss standpoint but also because the leeway in i.f. transformer adjustment varies considerably with some receivers. It *must* be possible to retune the i.f. circuits to resonance if the amplifier is to work. If it happens that in the particular receiver used the i.f. trimmers are normally working near minimum capacity, even a short length of shielded lead may add enough to the circuit to make exact retuning impossible. With air condensers having stops, this condition will be evident if the end of the condenser scale is reached before the resonance peak is passed through. With condensers which do not have stops, however, an apparent peak—which may be quite far from actual resonance—may be obtained at the minimum capacity setting. This will

* Assistant Technical Editor.

¹ Lamb, "A Noise-Silencing I.F. Circuit for Superhet Receivers," *QST*, February, 1936.

Noise About Noise

At last we know just how to crash the newspapers and news magazines of the country. All you need is to develop a successful noise silencer for radio receivers and write a quiet, conservative QST article about it. Of course it takes a few years of persistent laboratory work and original thinking to make the silencer a possibility, but from then on, no effort is necessary.

The publicity given us by the press at large is, of course, deeply appreciated. We are human enough to enjoy seeing a fellow like Jim Lamb get the credit that is due him. We get somewhat griped, though, at the way in which a certain fringe of the papers and magazines cleanly violate all the ethics of the game—not to speak of the copyright law—in crude attempts to turn some of the credit in their own direction. Already the development presented by QST is being adopted by new and strange parents. Before long there will surely be a host of "Smith Noise Eliminators," "Brown Static Quenchers" and the like bursting into print. It is obviously futile to hope that this most recent QST development will fail to butter the bread of the same aspiring radio re-inventors who have done so well by us in the past.

April QST will contain a further wad of authentic dope on the new development with particular emphasis on the many variations necessary for completely effective silencer action under the different conditions found in different receivers.—EDITOR.

result in reduced gain and decreased selectivity. It all boils down to the fact that the r.f. leads should be as short as the layout of the receiver will permit.

Since capacity to ground is of little consequence in the cathode lead, ordinary shielded wire may be used for this connection.

A second point to be watched is that of the tuning range of the diode transformer used. It is essential, of course, that its frequency be adjustable

net in close proximity to the socket of the i.f. tube to be replaced. The necessary r.f. and d.c. leads can then be run through appropriate holes drilled in the receiver cabinet, making short connections. An even more desirable method is to substitute a metal tube socket for the one in the set and install the 6L7 right in the receiver. The plug-in type unit shown in last month's *QST* generally will require a greater r.f. lead length and may result in some reduction in receiver gain, even though the silencing action is entirely satisfactory. This can be tolerated if the receiver has more than enough gain in the first place, but at best represents a makeshift method of doing the job.

A FEW NOTES ON OPERATION

A résumé of the tuning of the silencer unit should be of some benefit. With the unit wired in place, the first step is that of readjusting the i.f. circuits affected by the tube substitution; these are two only: the grid trimmer of the input transformer and the plate trimmer of the output transformer. The adjustment may be made on a steady incoming signal using the set's tuning meter, if there is one, as an indicator. In the absence of any measuring device the adjustment can be made on set noise or on a steady modulated signal, preferably with the beat oscillator off. This first lining up may be done with the grid cap disconnected from the noise amplifier, whose grid is in parallel with that of the 6L7. Familiarity with the receiver will show whether or not the gain is adversely affected by the substitution of the 6L7 for the regular i.f. tube. If there is a marked reduction in gain one of the reasons previously cited probably will be the cause and steps should be taken to overcome the defect.

Assuming that the gain is found to be satisfactory, the grid cap may be replaced on the noise amplifier tube and the grid circuit i.f. trimmer once more readjusted to compensate for the extra capacity added to the circuit when the noise amplifier is cut in. The threshold control, R_{24} in Fig. 1,¹ should be in the "off" position (all resistance in circuit). When the grid trimmer is readjusted the gain should be the same as before. It will not be necessary to touch the plate trimmer.

The next step is to turn the noise control down slowly from maximum resistance until a point is reached where there is a sudden reduction in background. At this setting the bias on the noise amplifier and rectifier has been reduced to the point where these two tubes start to work, with the result that negative bias is being applied to the No. 3 grid of the 6L7, reducing its gain. With the control set just on the edge of this condition, tune in a weak signal and adjust the trimmer on the diode transformer to resonance, indicated by a *reduction* in signal strength. Signals of average strength should cut themselves off completely when the diode transformer is adjusted properly. Moving

(Continued on page 78)

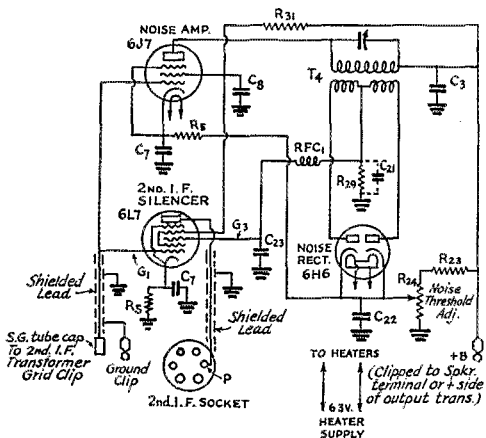

FIG. 1—ALTERNATIVE CIRCUIT OF THE SILENCER SECTION FOR RECEIVERS HAVING TWO I.F. STAGES

The silencer tube has a fixed cathode resistor in this instance. The grid and plate connecting leads to the receiver should be of the low-capacitance low-loss type, as described in the text. Typical component values are as follows:

- C_3 —0.01- to 0.1- μ fd. plate by-pass condensers, 400-volt tubular.
- C_7 —0.1- μ fd. cathode by-pass condensers, 200-volt tubular.
- C_8 —0.01- to 0.1- μ fd. silencer by-pass condensers, 400-volt tubular.
- C_{21} —0- to 250- μ fd. noise rectifier load by-pass (use minimum value permissible for r.f. filtering).
- C_{22} —0.1- μ fd. threshold resistor by-pass, 200-volt tubular.
- C_{23} —50- μ fd. silencer grid by-pass, mica midget.
- R_5 —350- to 1000-ohm cathode resistors, $\frac{1}{2}$ -watt.
- R_{23} —20,000- to 50,000-ohm threshold bleeder resistor, 1-watt.
- R_{24} —5000-ohm threshold control resistor, volume-control type.
- R_{29} —100,000-ohm noise rectifier load resistor, $\frac{1}{2}$ watt.
- R_{31} —50,000-ohm screen voltage dropping resistor (see Feb. *QST*).
- RFC—20-millihenry r.f. choke.
- T_4 —Single air-tuned full-wave diode coupling transformer (Sickles, National, Tobe, etc.).

to that of the intermediate frequency used in the receiver. Nearly all diode transformers can be adjusted to 456 kc., the i.f. almost universally used in the newer receivers, but it may not be possible to tune some of them to the 500-kc. i.f.'s used in some of the older amateur-band receivers. If there is no definite sign of resonance in the tuning of this transformer it will not be possible to get the most out of the silencing unit.

The most satisfactory way of constructing a noise-silencing unit is to build it on a small metal chassis which can be bolted to the receiver cabi-

A Low-Cost Crystal Transmitter

Complete Details of a Simple Outfit Using Receiving Tubes

By Vernon Chambers,* WIJEQ

THIS relatively simple transmitter certainly delivers the goods and is capable of operation on four bands. RST 449 sigs were banged over into England during the R.S.G.B. 80-meter tests. Receiving tubes are used in the interest of low cost but at that, a good ten watts of output are available. Although designed to operate with a separate crystal for each band, doubling can be accomplished with some reduction in power. A separate crystal for each band, down to 40 meters (then doubling for 20 meters) eliminates the usual expensive and complicated doublers.

This is the type of unit which will serve admirably as the basis for progress into the realm of high power.

condensers, respectively. High voltage is applied to the ground end of the tank circuit L_1, C_1 . In all cases the negative high-voltage lead is considered as "ground." The plate goes to the ungrounded end of circuit L_1, C_1 , and the stator plates of C_4 .

THE AMPLIFIER

The grids of the two amplifier tubes are capacity-coupled to the oscillator by condenser C_4 . All terminals on the two amplifier sockets are connected in parallel. Resistor R_2 and RFC_2 serve the same purpose as R_1 and RFC_1 in the oscillator. The tube plates are tied to one end of the tank circuit C_2, L_2 . The other end of the circuit is connected to the grids through the neutralizing condenser C_3 . The rotary plates of C_2 are grounded

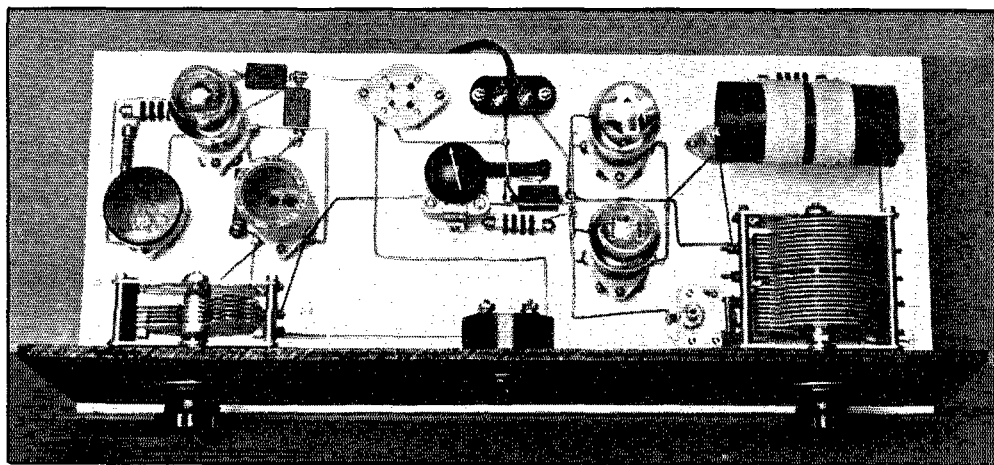

A PLAN VIEW OF THE SIMPLE TRANSMITTER

The crystal oscillator group is at the extreme left. The tube, crystal, coil and tuning condenser can be identified readily. Along the rear edge of the base is the four-pin cable socket and the two terminals for the key. Remaining items of importance are the coupling condenser (fitted with a knob) very near the center of the base and the neutralizing condenser sitting alongside the amplifier tuning condenser.

THE OSCILLATOR CIRCUIT

Fig. 1 shows us two familiar circuits, the pentode crystal oscillator and an amplifier with two tubes in parallel. Both circuits use 2A5's. In the oscillator we find the crystal hooked between grid and cathode. Resistor R_1 furnishes grid bias and RFC_1 prevents the flow of r.f. current through the leak. The high-voltage is dropped to a value suitable for the screen grid through resistor R_3 . Condensers C_5 and C_6 are screen and plate by-pass

*QST Laboratory Assistant.

Positive high voltage is applied to the tank coil center tap through RFC_3 . Link coupling is used between L_2 and the antenna tuning unit.

CONSTRUCTIONAL DETAILS

A front view of the transmitter shows the oscillator at the left side, the amplifier at the right. In the oscillator unit, a five-prong socket serves as a crystal mount. Centered about $3\frac{1}{4}$ inches to the right is a four-prong socket for the oscillator coil. Slightly to the rear of these two sockets is the six prong 2A5 socket. Condensers C_1 and C_2 , together

with the plate current meter, are mounted on the panel.

Eight inches in from the right end of the board and centered between the front and back, the two amplifier tube sockets are mounted. The amplifier tank coil is located behind condenser C_3 . This coil is set up on two Johnson 20J stand-off insulators equipped with G.R. jacks. A small piece of brass is drilled to fit the stator terminals of one section of C_3 , and to this the Cardwell Trim-Air neutralizing condenser is fastened.

Centered between these two circuits, and in the

eight-wire cable. The filament voltage drop was excessive in the ordinary four-wire cable, hence the suggestion of an eight-wire cable. Two wires can be used for high-voltage leads, the remaining six being divided into two groups of three each, thus giving three parallel wires for each filament lead. One side of the key terminal strip is connected to negative plate voltage and the other to the amplifier cathode. The two amplifier tube sockets are tied in parallel, the corresponding connections of each socket connected together. When making grid, plate and cathode connections, try

to do so at points midway between the sockets. The ground connection to the rotary plates of C_2 should be as short as possible.

COILS

The most efficient way of operating the transmitter is with a separate oscillator and amplifier coil and a separate crystal for each band. In this way, maximum output can be had. If amplifier doubling is desired, the crystal circuit is adjusted and equipped to operate on one band and a coil for the next lower band is placed in the amplifier. The rig then is put through the usual tuning procedure and the output will be on the second harmonic of the oscillator and, of course, one band higher in frequency. Doubling can also be had with the crystal and both

coils designed for one band, by decreasing the amplifier tank capacity until the second harmonic is reached. In any case, doubling will show quite a decrease in output, and with crystals as inexpensive as they are, the business of doubling in a transmitter of this type is hardly justified.

The oscillator coils for 160, 80 and 40 meters are wound on Hammarlund four-prong coil forms. These forms have a diameter of $1\frac{1}{2}$ inches and a winding length of $2\frac{1}{4}$ inches. All coils are of 18 d.c.c. wire. The number of turns for the three oscillator coils are as follows: 160 meters, 43 turns close wound; 80 meters, 22 turns; and 40 meters, 14 turns. The windings of the 80- and 40-meter coils are spaced the diameter of the wire. There is no 20-meter coil for the oscillator, as 20 meters is reached by doubling in the amplifier.

All amplifier coils are wound on $4\frac{1}{4}$ -inch pieces of 2-inch diameter bakelite tubing. These coils are mounted on stand-off insulators as previously explained. A soldering lug under each jack serves as a wire connecting point. A third plug in the exact

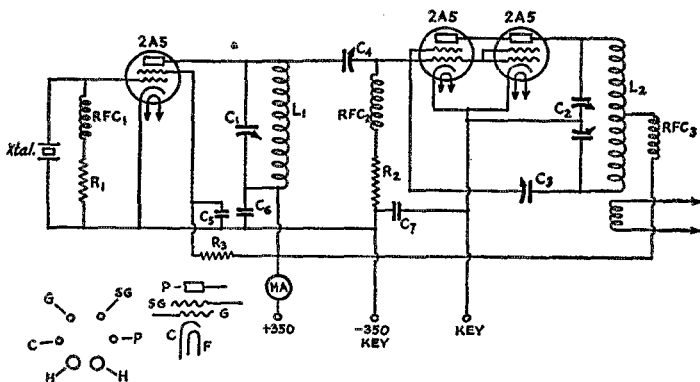

FIG. 1

- C_1 —250- μ fd. (Cardwell XR-250-PS).
- C_2 —500- μ fd. split-stator (Cardwell XR-500-PD).
- C_3 —25- μ fd. variable Trimair (Cardwell ZR-25-AS).
- C_4 —75- μ fd. variable midget (Hammarlund MC-75M).
- $C_5, 6, 7$ —005-mica (Cornell Dubilier).
- R_1 —7500-ohm 1-watt (IRC).
- R_2 —1250-ohm 10-watt (IRC).
- R_3 —50,000-ohm 2-watt (IRC).
- 3—Six-prong sockets (National).
- 1—Five-prong sockets (National).
- 2—Four-prong sockets (National).
- 1—3-screw input strip.
- 2—Standoff insulators (Johnson 20J) with jacks.
- 3—Four-prong coil forms (Hammarlund SWF-4).
- 14 inches 2" bakelite tubing.
- 1—Four-prong cable plug.
- 6 feet 8-wire cable.
- 1—0-200-ma. meter.
- $\frac{1}{4}$ -lb. No. 18 d.c.c. wire.
- 1 roll No. 14 tin wire.
- 1—battery clip (Mueller type 45).
- 12—G.R. plugs.

middle of the board, the coupling condenser C_3 is mounted in an upright position with the aid of a small angle bracket. Behind C_3 , is a four-prong socket serving as a terminal for plate and filament leads. To the right of this socket is a small two-screw input strip for the key terminals.

The baseboard measures 9 by 21 inches. It was given a couple of coats of duco white enamel for appearance's sake only. The panel is a $7\frac{1}{2}$ by 21-inch piece of crackle-finished pressed-wood (tempered Masonite).

WIRING

Although most of the wiring can be seen in the picture, perhaps a few suggestions will be helpful. When wiring the tank circuits try to make all connections short and direct. The only wires beneath the base are those hooking the tube filaments in parallel and transferring positive high voltage from the oscillator tank circuit to the amplifier tank coil center-tap. Power leads are brought to the socket mounted for that purpose through an

center of the coil provides the center tap at which high voltage is connected.

A handy way to wind the amplifier coils is to start at the center tap and wind out. All coils require the same winding space. The windings are spaced $\frac{1}{4}$ -inch apart at the center to clear the G.R. plug located there.

These coils have the following turns: 160 meters, 36; 80 meters, 20; 40 meters, 10; 20 meters, 6. These windings are, of course, all center-tapped. The 160-meter coil turns are wound without spacing. Turns on the other coils are spaced to occupy the same length as that of the 160-meter coil.

TUNING AND ADJUSTMENT

Crystal oscillation is the first thing to obtain. With C_2 at a low capacity setting and high voltage off the final, the oscillator is tuned to resonance (plate current dip or glow in neon bulb held against the plate lead). If the neon bulb is used, its brightest glow indicates when the crystal is functioning the most efficiently. Five mils or so above minimum is probably the best setting for plate current, if the meter only is used for adjustment.

Neutralizing comes next. This is accomplished by holding the neon bulb against the oscillator plate lead and tuning the amplifier to resonance. If during this procedure the neon bulb should flicker, the final is not neutralized. C_4 is then

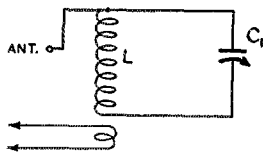

FIG. 2

C_1 —150- μ fd. (Cardwell MR-150-BS).
L—See text.

tuned in slow stages until the amplifier can be tuned through resonance without the flicker. High voltage is disconnected from the tank during these adjustments.

Now that we are ready to apply the oscillator excitation

to the amplifier grids, it is a good idea to fix up a gadget to help us estimate the amount of output that can be obtained from the rig. A ten-watt light bulb connected to five or six turns of insulated No. 20 or so wire makes such a gadget.

With no load on the final (and the key closed) it is tuned to resonance. If a load is now coupled on (light bulb, neon bulb or antenna) the plate current will increase appreciably. If either of the two bulbs constitute the load, maximum glow indicates maximum output. The brightest glow with the least plate current is the proper adjustment. Increasing the capacity of C_2 , at this time, may result in an increase of output. This increased capacity may stop crystal oscillation, however. Should this happen, the amplifier need not be touched again; it is only necessary to reset C_2 and possibly retune the crystal slightly.

If at 160 meters trouble is encountered in making the oscillator work, this is because in pentode circuits the only method of feedback is through the rather small grid-plate capacity of the tube. This feedback occasionally is not great enough to

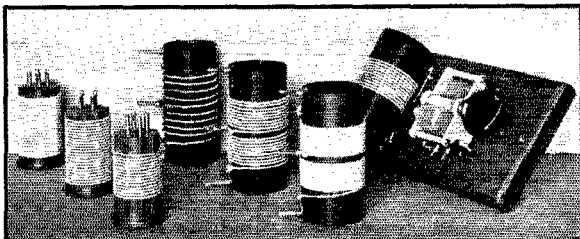

COILS FOR THE LOW-COST TRANSMITTER AND THE ANTENNA TUNING UNIT

At the left are the three coils for the crystal oscillator (160, 80 and 40 meters). The three amplifier coils are in the middle, that at the rear serving for both 40 and 20 meters. Coil data are given in the text.

permit crystal oscillation. This trouble, if run across, can be eliminated by soldering a piece of insulated wire to the tube plate and bending it around to a position near the grid. Usually clipping it under one of the grid wires does the trick. A little experimenting with its nearness to the grid will decide a correct point.

ANTENNA TUNER

Fig. 2 shows the antenna tuning unit. This tuner has been used with a voltage-fed antenna, cut to a half wave for 3.5 mc. The antenna in this case is 132 feet long. Other types of antennas and tuners can be used, of course. Reference to the Antenna Chapter of the A.R.R.L. *Handbook* will show any number of schemes adaptable to the rig. Care should be taken to cut a half-wave antenna for your lowest frequency ($\frac{468,000}{\text{Freq. (kc)}}$) feet.

The mount board for the tuner is $4\frac{1}{2}$ by 8 inches. Holes are drilled for two G.R. jacks spaced 3 inches between centers. The condenser is mounted on two small angle brackets. A Fahnestock clip at the coil end serves as an antenna terminal.

The coil is in parallel with the condenser. A wire is connected from the Fahnestock clip to one G.R. jack and then to the condensers stator plates. The rotary plates go to the other G.R. jack.

Tuner coils are wound on $3\frac{1}{2}$ -inch long by 2-inch diameter pieces of bakelite tube. No. 18 d.c.c. wire is used for all coils. G.R. plugs, 3 inches between centers, serve as winding terminals and in turn plug in the jacks on the baseboard. The number of turns are as follows: 160 meters, 58 (close-wound); 80 meters, 21 (spaced diameter of wire); 40 meters, 12 (s.d.w.); 20 meters, 5 (s.d.w.).

Five or six turns of insulated wire (ordinary "push-back" wire is suitable) wound around this tuner coil and likewise around the amplifier coil,

(Continued on page 27)

Results—3500-Kc. Transoceanic Tests

THE 3500-kc. transoceanic tests held by the R.S.G.B. during December, with the co-operation of European societies and A.R.R.L., were reasonably successful with a good number of contacts being established, and scores of calls heard. The one regrettable feature was the seeming disregard of, or carelessness in not observing, the "Silent Periods" by many amateurs on this side of the "pond." By sending "Test RSGB," "CQ DX," etc., during periods specifically set aside for listening, these amateurs through their thoughtless transmissions not only spoiled many an operator's chances of pulling through a DX signal, but also wasted their own

Mr. H. J. Powditch, G5VL, under whose guidance the tests were arranged, writes as follows:

"Outstanding was the work of G2ZQ (C.W.). With 120 watts he averaged a contact every five or six minutes while on the air. Among the low-power fellows, G2DQ got across to VE1EI on 'phone with an input of just 7½ watts! G5KG with 10 watts had some 18 contacts, 9 on 'phone. I think the tests have demonstrated:

"(1) That 80 meters is exceedingly good for trans-Atlantic working, powers of 50 watts being quite reliable. Several stations here comment that reports received are higher QRK than on higher frequencies.

"(2) That, even on low powers, contacts are quite possible.

"(3) That, given schedule working and known frequencies, regular working is quite possible.

"(4) That American and Canadian stations, on their present powers, are receivable almost any night here. The general opinion is that your stations do not expect calls from Europe and do not appreciate their strength and consistency here.

"(5) That more schedule working is called for."

G2ZQ made a total of 49 contacts during both periods of the tests. G6PF with a power of 48 watts made 40 contacts, and PAØASD 36. G5VL, using 'phone, made 18 QSO's. G6LL, 'phone, made 8 contacts.

In the lists of stations logged asterisks are used to indicate the number of different stations reporting reception, as follows:

No asterisk.....Reported by 1 station only.
 *.....Reported by 2 or 3 stations.
 **.....Reported by 4 or 5 stations.
 ***.....Reported by 6, 7, 8, 9 or 10.
 ****.....Reported by 11, 12, 13, 14 or 15

'Phone stations are indicated by an (f) after their calls. In the "Stations Worked" lists a figure in parenthesis after a call indicates the number of contacts made with that station during the period in question. The various lists follow. We hope your call is among them!

—E. I. B.

LOGGED IN NETHERLANDS

(Includes both Periods)

W1ADM(f) ADR* AKR AMP* APK AQW AVJ BDI
 BES(f) BFI BFT BJP BKL* CAB CDX CJP COX CPM
 CTG CTZ DES DIA DLD DQ* DZT EER* EF
 EXR EZ* FTY FVK FXQ GC GKJ GOJ GQB GTS GUY
 GVH* HJI HNP* HNU HRS HWZ HZ IBR IDX IEO

(Continued on page 58)

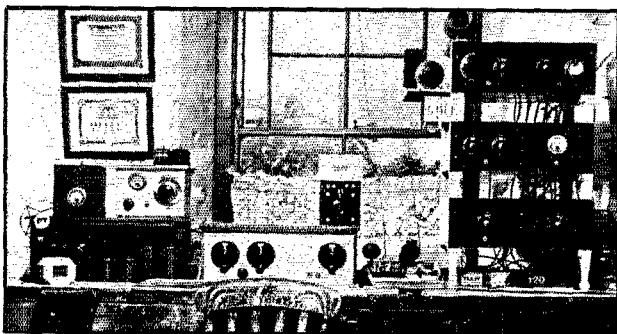

G6PF, ONE OF MOST CONSISTENT EUROPEANS, USED LESS THAN 50 WATTS

time and power by sending when no DX operators were listening for them!

In spite of the lack of coöperation of so many careless fellows, however, some good DX was pulled through and we are able to present a good-sized list of "calls logged." The lists of stations logged and worked will speak for themselves. Outstanding among the United States C.W. operators was W1SZ, who made 9 contacts with 8 different stations during the First Period (Dec. 15th-18th, 2345-0020 GMT each night), and 28 contacts with 15 different stations during the Second Period (Dec. 19-22, 0500-0800 GMT each night). W1SZ worked stations in Great Britain, Germany, France, Switzerland, Norway and Netherlands. W8FIP worked 11 different stations. W1BKL, W1ME and W1TS each worked 9 different stations.

The outstandingly successful 'phone operator among the W/VE group was VE1EI, who made 14 contacts with 5 different British stations: G2DQ, G2IN, G5KG, G5VL and G6LL. A good number of 'phone stations were logged in Great Britain, the number being especially high since numerous British Receiving Stations were active in the tests.

Transmitter Band-Switching Systems

A Survey of Practical Circuit Arrangements

By George Grammer, Assistant Technical Editor

FUNDAMENTAL to a discussion of transmitter band-switching is an appreciation of the end to be achieved by its use. Just what sort of picture is conjured up in the mind of the amateur who thinks about band-switching? A single knob affair, so rapid in operation that if one should hear a CQ on some band other than that to which the transmitter is tuned a flip of the wrist would put the set there in time to pound out an answer? Or is it something which merely changes the inductances in the various stages so that the circuits are *capable* of being tuned for output on the band desired? There's a vast difference between the two, and the solution of the first is much the simpler—all it requires is separate transmitters and separate antennas for each band. Naturally it's expensive, especially when any power is involved.

However, we rather believe that most amateurs think of band-switching as something applied to one transmitter. In that case the one-knob business, while not beyond attainment, is certainly not simple of solution nor is it likely to be inexpensive. The transmitter switching problem is not readily comparable to that in receivers. Not only is there an infinite variety of transmitting circuits, as compared to the quite standardized receiver input arrangement, but the greater physical size of the transmitter, the necessity for more accurate tuning because of the power handled, the required provision for antenna coupling, and the large number of antenna systems in use, each with its different tuning requirements, all introduce complications which simply are not considered in receiver switching design.

If in an attempt to duplicate the easy switching which characterizes commercial receivers the same technique is adopted, it would be found that except for tube cost, the total cost would be almost the same as for individual transmitters for each band. Receiver switching as commonly practiced involves the use of separate coil sets for each band, individually adjusted by trimmer condensers. The corresponding transmitter set-up would require not only separate coils, but the separate trimmers would have to be regular transmitting condensers, since there are no cheap transmitting "trimmers." Nevertheless this principle can be applied with some benefit, although its application is necessarily limited if the cost is to be kept down. With pre-tuned separate circuits, however, the ideal of one-flip band-change can very nearly be realized.

Because so few amateur transmitters are exactly alike it is difficult to discuss band-switching except in terms of a single stage. We propose here to look over the various methods of stage switching which have been described from time to time, necessarily leaving complete transmitter design to the individual concerned.

SWITCHING TANKS

One of the first systems that comes to mind is that of switching complete tank circuits, already mentioned. A representative arrangement is shown in Fig. 1, coupling between two stages being indicated. Parallel feed is shown for both plate of driver and grid of amplifier, although series feed readily could be used on either one

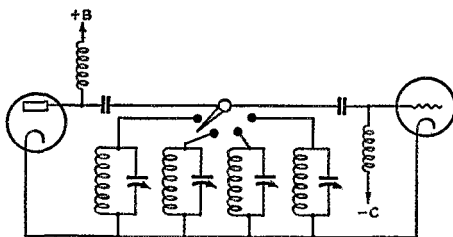

FIG. 1—ONE METHOD OF BAND-CHANGING—TANK SWITCHING

This system offers about the maximum of speed and convenience, but is relatively expensive since separate tank circuits are required for each band to be covered.

simply by joining the lower ends of the various tank circuits together and inserting a by-pass condenser between the junction and ground.

This system is not wholly impractical from the expense standpoint when applied to a low-power stage, since midget condensers are relatively inexpensive and coils are easy to make. The switch should have good insulation and fairly low capacity between contacts to avoid stray excitation of unused tanks and possible resultant power loss. The coils should be arranged for minimum coupling; shielding is not necessary, although desirable. Shielded tanks of the type built up by W9DRD¹ are excellent for low-power stages handling up to 20 watts or so; special units for the purpose are now commercially available.

If the switching is to be kept simple, it is necessary that the amplifier tube be of a type

¹ Hollister, "A Four-Band Exciter," *QST*, July, 1935.

which can be driven directly from the plate end of the tank circuit and not require tapping down on the coil for maximum power transfer. If tapping is required, it will be necessary to gang two switches so that the proper tap is selected along with the desired tank circuit. Alternatively, if the tube combination is not suitable for straight-through coupling the load on the driver stage can be adjusted through the use of a suitably small grid coupling condenser. This generally entails some sacrifice of excitation power, however.

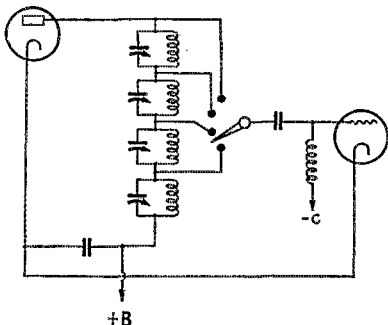

FIG. 2—SERIES TANK CIRCUITS FOR BAND-SWITCHING

In some cases this simplifies the switching problem introduced when separate tanks are used, as discussed in the text.

It is hardly necessary to provide for shorting out the unused tanks, since the operating conditions are not comparable to those in receivers, where extra coils often must be shorted to avoid dead spots. Such shorting would require a special switch and introduce the very complications which we want to avoid. The simpler the r.f. circuit, the better.

TANKS IN SERIES

Another method of switching separate tanks, proposed by W6ZH,² is shown in Fig. 2. In this case four separate tanks, one for each band, are in series, excitation being picked off at the desired frequency by the four-point switch. Providing suitable $L-C$ ratios are used, the tanks resonating on bands other than that in use will offer negligible impedance at the operating frequency. In effect, then, only the desired tank is in circuit. The one precaution to be observed is that the $L-C$ ratio should not be too high; if each tank consists of mostly coil and little condenser the impedance on other bands may be great enough to affect the operation of the circuit. The optimum $L-C$ ratios as given by Robinson³ should be satisfactory.

When the driver tube is used as a doubler, the

² Millen, "A Quick-Switch 'Phone Transmitter for Two-Band Operation," *QST*, November, 1935.

³ Robinson, "The Operation of R. F. Power Amplifiers," Part II, *QST*, April, 1934.

fact that a tank circuit tuned to the fundamental frequency is present should improve the efficiency without lowering the output on the second harmonic. Obviously the tube must either be neutralized or of the screen-grid type to prevent self-oscillation.

This type of switching offers an advantage over the arrangement of Fig. 1 in that a second switch is not necessary should it be desirable to take the excitation from taps on the coils instead of across each circuit as a whole. It should be readily apparent that all four of the taps could be on the coils just as well as between the tank circuits, as shown in the diagram.

TAPPED COILS

The separate tank method is, as we have already pointed out, relatively expensive and bulky except for low-power stages. For stages handling more than a few watts, it would seem to be more practical to use a tapped inductance, keeping the same tuning condenser for all bands.

A question which arises immediately in consideration of tapped coils is that of efficiency—or rather the extent of such losses as may be introduced by using only part of a large inductance, since the unused section is usually intimately coupled to the active section. Long ago it was found that "dead-end" effects were greatly lessened when the unused section of the coil was short-circuited instead of simply being allowed to float. Shorting, rather than tapping, is therefore the method of switching commonly employed. Typical circuits are given in Fig. 3. Splitting the inductance into two parts with coupling between the two sections minimized, as indicated in the lower diagram, will be of some help in reducing losses, especially when four or more bands are to be covered. If the range to be covered is from 3.5 to 28 mc., for instance, one coil would take care of the 14 and 28 mc. bands and the other the 7- and 3.5-mc. bands, allowance being made for the fact that the smaller of the two coils is always in the circuit on these two lower-frequency bands.

There are two points to observe in shorting coils. The switch contact resistance and resistance of tap connections must be as low as possible. Considerable power loss will result if these resistances are not low, since the r.f. current flowing in the shorted section may be quite large. In stages handling several hundred watts, the current-carrying capacity of the switch becomes an important factor, not only because of this "idle" current but also because the regular tank current flows through the switch as well. Since the magnitude of both currents depends greatly on the loading of the circuit, being much less when power is being delivered to an external load, it is highly advisable to make all adjustments with the amplifier loaded, if possible. If it is necessary to operate the amplifier without load,

the plate voltage should be reduced to lessen the danger of burning out the switch. Switches now on the market will do a satisfactory job of shorting in kilowatt transmitters so long as the amplifier is loaded, but a few minutes operation at full plate voltage without load may spell the end of the shorting switch. This, despite the fact that the switch made by at least one manufacturer is capable of carrying around 75 amperes without damage!

The second point, established by some measurements made recently in the *QST* laboratory, is that shorting should always be from the low-potential or "cold" end of the tank, especially when three or more bands are to be covered. No observable loss is introduced so long as this rule is followed, even when a single coil is made to serve for four bands. If the shorting is from the "hot" end of the tank, the losses are negligible when two adjacent bands are to be covered, but are apparent, although not unduly high, when the third band is attempted.

Covering four bands with one coil appears to be completely impracticable if shorting is done from the high-potential end of the coil.

A good check of the efficiency of a shorting system can be obtained after a few minutes continuous operation of the amplifier. If any heat at all shows up in the tank, the active turns should be warmer than the shorted turns. Reversal of this condition indicates loss in the shorted section, in most cases traceable to relatively high resistance in the shorting mechanism.

On large coils where most of the turns are shorted for high-frequency operation (for instance, a 160-meter coil operated at 20 meters) it is not unusual for a potential gradient to develop along the shorted section. A neon bulb slid along the coil will readily show such a condition. Additional shorting at several points along a long coil would seem to be indicated in such a case. However, we were unable to measure any difference in losses whether the coil was shorted in several spots or simply as a whole; losses were negligible in either case so long as the shorting was done from the cold end.

SWITCHING BALANCED CIRCUITS

When balanced circuits—push-pull, or balanced circuits used for neutralized amplifiers—are switched, the same principles apply. Since the center of a balanced coil is the low-potential part, it is desirable to short outward from the center, as shown in Fig. 4. If more than two bands

are to be covered, this means that two switches must be used; they may be ganged, of course. Two switches are likewise required if shorting is done from the high-potential ends inward, although as already pointed out this method preferably should not be used for covering more than two bands. In this case it is necessary that the switch arms be well insulated from each other and from ground, since the full tank voltage appears across the switches.

If circuit balance is to be maintained from one band to the next, it is necessary that the switching system be symmetrical. Care should be taken in mounting switches so that both will have the same capacity to ground, especially when the amplifier is mounted on metal.

OUTPUT COUPLING

So far the discussion has been confined to circuits considered simply by themselves, or simply coupled by the usual capacity method to a following stage. When it is necessary to couple out of the circuit by any other

means the problem starts to become complicated, from both electrical and mechanical standpoints.

It is difficult, for instance, to use a single link for link-coupling to a following stage or to an antenna-tuning unit. A link which gives the proper coupling on one band is fairly certain to give too much or too little coupling on others. Too, it is necessary to put the link at the hot end of the coil if shorting is from the other end. Coupling to the cold end is desirable for reasons which have been discussed many times before in these pages; however, with coil shorting there is no choice in the matter because it is practically impossible to couple a link to shorted turns. Assuming a satisfactory solution of the number of link turns for various bands can be worked out, an additional switch is likely to be needed, in turn requiring more space and introducing mechanical problems, especially if the switches are to be ganged.

If the coupling is to be direct, through a tap on the tank coil, the situation is about the same as with link coupling—an additional switch, with an extra set of taps, is required. Taking the relatively simple case of a screen-grid output amplifier working into a pi-section antenna filter, this means that on top of a switching arrangement similar to that in Fig. 3 an additional switch with four extra coil taps will have to be installed—a total of two switches and seven taps to cover four bands. This arrangement was used for three

(Continued on page 82)

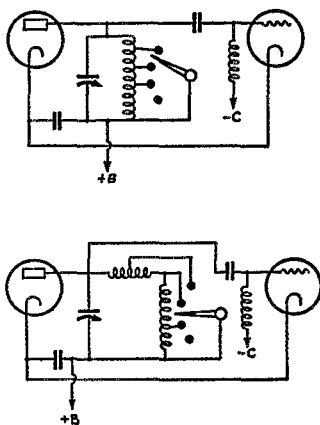

FIG. 3—SUGGESTED COIL-SHORTING ARRANGEMENTS
The lower diagram sectionalizes the inductance to reduce losses when several bands are to be covered.

An Improved Speech Preamplifier

Details of a Flexible, High-Fidelity Unit

By Cyrus H. Fraser,* W8BBK

THIS article describes an improved preamplifier circuit in which the cost of construction has been reduced by the use of a resistance network used to connect the double button carbon microphone to the amplifier circuit thus eliminating the input transformer, and also shows a plate circuit having two tuned networks designed to increase the amplification at the high and the low frequencies. This type of amplifier may be used to compensate for the deficiency of the dynamic speaker at the high and low frequencies, as in public address systems, or it may be used to compensate for the falling off of the

ticeable hum was eliminated and the frequency response of the amplifier was improved. With this input arrangement it may be necessary to use more than six volts of microphone battery to obtain normal microphone current, depending upon the type of double-button microphone used.

Briefly, from Fig. 1, the theory of the input circuit is as follows: As the diaphragm swings in direction A by the action of a sound wave the carbon granules are compressed on this side causing a decrease in resistance and an increase in current in side A, the current in side B decreasing at the same instant by a decrease in the pressure on

the granules on this side. If the microphone is balanced, the current in side A will equal the current in side B. The voltage at any instant impressed on the grid of the first amplifier tube will be the IR drop across $R1$ equaling the voltage across $R2$, $R3$ and $R4$. If the microphone is not balanced, the wave form will be distorted by unequal voltage drops across $R3$ and $R4$. This input circuit has less gain than one with an input

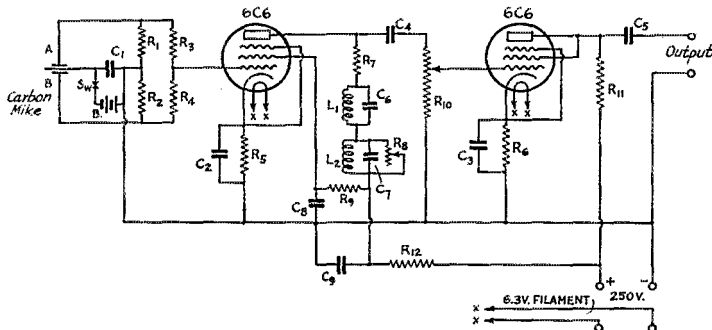

FIG. 1

- | | |
|------------------------------------|---------------------------|
| L_1 — $\frac{1}{4}$ henry. | R_8, R_4 —15,000 ohms. |
| L_2 —200 henrys. | R_5, R_6 —1000 ohms. |
| C_1 —0.1 μ fd. | R_7 —30,000 ohms. |
| C_2, C_3 —2 μ fd., 25 volts. | R_8 —500,000 ohms. |
| C_4 —0.25 μ fd. | R_9 —300,000 ohms. |
| C_5 —0.1 μ fd. | R_{10} —500,000 ohms. |
| C_6 —0.0005 μ fd. | R_{11} —100,000 ohms. |
| C_7 —0.035 μ fd. | R_{12} —10,000 ohms. |
| C_8 —0.1 μ fd. | B—6 volts or more depend- |
| C_9 —8 μ fd. | ing on microphone. |
| R_1, R_2 —200 ohms. | |

high and low frequencies in the later stages of the transformer-coupled power amplifier or modulator.

In the original preamplifier with conventional input transformer, considerable hum was encountered and it was discovered that after all hum was eliminated in the plate supply there was still an annoying amount originating in the input transformer and in the leads to the volume control which had been placed on the secondary side of the input transformer. By changing the volume control to the grid circuit of the second preamplifier tube, as shown, and by using a resistance network instead of the input transformer, all no-

iseable hum was eliminated and the frequency response of the amplifier was improved. With this input arrangement it may be necessary to use more than six volts of microphone battery to obtain normal microphone current, depending upon the type of double-button microphone used. Briefly, from Fig. 1, the theory of the input circuit is as follows: As the diaphragm swings in direction A by the action of a sound wave the carbon granules are compressed on this side causing a decrease in resistance and an increase in current in side A, the current in side B decreasing at the same instant by a decrease in the pressure on the granules on this side. If the microphone is balanced, the current in side A will equal the current in side B. The voltage at any instant impressed on the grid of the first amplifier tube will be the IR drop across $R1$ equaling the voltage across $R2$, $R3$ and $R4$. If the microphone is not balanced, the wave form will be distorted by unequal voltage drops across $R3$ and $R4$. This input circuit has less gain than one with an input transformer. If necessary this may be remedied by adding one more stage of resistance-coupled amplification to the succeeding circuit usually used with the preamplifier. This additional stage will be found cheaper than a high-grade input transformer, will have less loss at high and low frequencies, will take up less space than a high-grade input transformer which is necessarily large, and the additional stage is lighter and does not increase the hum level to any noticeable extent.

There has been some controversy regarding the advisability of increasing the amplitude of the higher audio frequencies on radiotelephone transmitters due to side band interference, but it is now generally conceded that when the station is used for voice only the amplitude of the higher frequencies of the voice is so small that no interference is noticeable. It is these higher frequencies or harmonics that make the speaker sound natural.

The plate circuit described here is composed of two tuned circuits resonant at 60 and 14,000 cycles. At the resonant frequency the impedance of the plate circuit is increased and consequently

* 48 Glenwood Avenue, Buffalo, N. Y.

the overall amplification of the amplifier is increased. It can be seen that as the tube plate resistance increases, the amplification of the tube increases. In the case of resistance-coupled amplifiers one might wonder why we do not increase the plate load resistance indefinitely, to the end that the voltage amplification would equal the amplification factor of the tube. But if the plate resistance is increased to a large value we have an unstable plate circuit and the drop in voltage through the resistance becomes so great that an increased plate supply voltage is necessary to make up for the additional drop in the plate load resistance. We can increase the applied plate voltage but this increases the size and expense of the power supply with not enough increase in voltage amplification to war-

rant it.

The direct current resistance of the 200-henry choke should not be higher than 3000 ohms, and the $\frac{1}{4}$ -henry choke should not be over 400 ohms for efficient results. The lower the resistance the more gain will be obtained at the resonant frequencies; but if too low a resistance is used the amplification will be peaked at these two frequencies only, and the overall curve for the amplifier will be undesirable. At any other frequency than the resonant frequencies the plate load impedance will be lower and therefore the amplification will be lower. By using a 30,000-ohm resistance in series with the resonant circuits the amplification on frequencies between 60 and 14,000 is maintained at a slightly lower value than the amplifi-

(Continued on page 68)

High Voltage from 32 Volts D.C.

By Wilbur J. Tabor,* W9KUI

HAMS without access to commercial power but having 32 volts d.c. available will be interested in the power supply used at W9KUI. The set-up described is the result of a couple years spent experimenting on various types of power supplies for 32-volt systems. Among others, a home-grown motor-generator was tried, but its efficiency was terrible.

The supply used now is relatively efficient, easy to build and is entirely satisfactory. It supplies 35 watts to a pair of 45's with 375 volts at 95 mls. This supply consistently brings better QRI reports to the same transmitter than my previous supply which had 24 mikes and 3 chokes. In 31 contacts on 80-meter c.w., not counting two contacts made with the choke shorted out, tone has been reported as T8 once, at all other times T9, sixteen of which were T9X.

The lay-out consists mainly of an altered Stancor ten-tube transformer P949, having a 110-volt primary, 700-volt 120-ma. center-tapped secondary, 6.3-volt secondary and a 5-volt secondary. The idea is to change the 110-volt primary to adapt it to 32 volts. The fiber mount carrying the soldering lugs is removed, also the half shell. Without removing the laminations, cut the wire in the two low-voltage secondaries and remove them, being careful not to damage the 110-volt primary which is underneath. Remove three layers of the primary and about 10 turns of the fourth. Remove a little of the insulation under these ten turns exposing the fifth layer. This gives you three taps on your primary, one at the end of the coil, another at edge of the fourth layer where wire goes to fifth layer, and the

third tap is where the fifth layer was uncovered by removing those ten turns. Experiment to find which tap works best. Using too few turns in the primary causes excessive sparking at the vibrator points. I use the middle tap. This primary is put in series with a Ford coil. The high-voltage terminal of the coil is not used. The success of this supply depends largely on the buzzer adjustments. Put a toothpick under the brass reed of the stationary contact. Connect your transmitter to the set-up for a load. A high-range voltmeter or other means of noting results is necessary. With the buzzer running, voltage will probably be about 150. Now, take another toothpick, place it between the core and the vibrating reed and gently push the reed toward the stationary con-

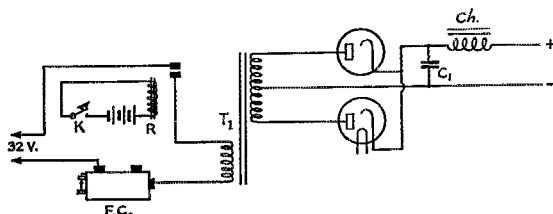

FIG. 1—COMPONENTS ARE DESCRIBED IN THE TEXT

tact. The voltage will rise sharply. This second toothpick is only temporary, to show what results may be expected. To make the permanent spacer, cut strips of thin QSLs about 1 inch by $1\frac{1}{2}$ inches and place them between core ending and vibrator. The idea is to dampen the vibrations so as to increase the period of time that current flows during each cycle. I use two strips and get a fine

*Spring Valley, Minn.

adjustment by sliding a smaller third strip up and down between the two. There should be very little sparking at the points. The vibrator should give out a vigorous buzz. It will pay to spend plenty of time experimenting with different thicknesses of paper and adjustments of the thumb screw. A fraction of a turn from where it works best, the points start arcing. You must have good points. They cost only a nickel a pair so have some spares. A little arcing usually spoils them in short order.

I have taken 40 watts from this outfit, but it is more stable at 35. I use 36 volts input, usually, sometimes only 30, which gives 30 watts output from the supply.

The keying relay is a Ford cut-out, stripped of wire and rewound full of No. 32 d.c.c. wire. A 1- μ f. condenser across the keying points may be advisable. The rectifiers are a pair of Type 1s. Full-wave rectification is used. Half-wave rectification didn't work at all. The filter consists of a

(Continued on page 64)

"Fists" I Have Seen

By F. H. Schnell, W9UZ*

Fred Schnell has built himself a tape recorder and is having a lot of fun examining "fist-prints." One of the chief things disclosed is that our ears are remarkable mechanisms to make anything out of some of the mangled sending on the air. Some of it is pretty good but subject to easy improvement. The records reproduced in this article were made at random in the 7-mc. band. The recorder itself is inexpensive and can be made by any clever amateur. We shall have a description of it in an early issue.—EDITOR.

FULLY aware of the risk of severe "panning" for criticizing the other fellow's "fist," it is being done here with comments that seem pertinent towards correcting the mechanical faults. It is hoped that these comments will be accepted in the spirit in which they are offered. Much tinkering with the Mac key at W9UZ, making numerous adjustments to duplicate some of the typical errors, has been productive of results and some corrective suggestions are submitted. The business of recording is still too new and there is much to be learned about what the recorder reveals. Therefore, no definite statements can be made one way or the other in some instances. However, it is clearly evident that a great deal of room remains for improvement in "manipulation."

Running down the list: W2AYN: mechanically perfect with his automatic transmitter at 35 w.p.m.—that's the pattern! W3BPD: needs a wee bit better spacing, otherwise one of the best. W3BES: dashes too short and choppy. W9GMV: clipping it off at a pretty good rate but not enough spacing between words. W9MIK: not enough spacing, dashes of irregular length, but good adjustment on the dots. W3AJO: dot adjustment too light. W5CVA: improper construction of the letter "C," too much spacing between the three dots and the dash of the letter "V" which makes it sound like "ST," 6 dots for the figure "5"—slow down the dots. W2DPB: dot contacts too close. W9DO: practically the same as W9GMV, although both of these operators clip it off at a merry rate. W9TLY: dashes too short. W3BM: dot contacts too close. W2HRA and W3HC:

well-made characters with good adjustment on the bugs. W9MWH: dots too choppy, probably caused by too much spacing between contacts. W2FIS: a good example of "packed" manipulation—rather difficult except for one who knows how to do it and still retain character details. W1YL: improper spacing between letters. W8GQZ: "CQ" run together with practically no spacing. W1EH: well-defined characters, very good bug adjustment, very slight tendency to run the last dash of "1" and the "E" together in the call "W1EH"; otherwise the best approach to the auto of W2AYN and the best record thus far for uniformity and balance.

It must be remembered that one adjustment of the contacts, weights and springs of the bug will adapt it to only one speed of so-called mechanical perfection. It is possible to vary from the speed by "packing" as W2FIS does it, but this requires skill and operating ability. W9GMV and W9DO "pack" it but more spacing between words could be tolerated.

You've heard "fists" on the air and you've heard some of the same gang blowing whistles at a convention and noticed the whistles maintain the same characteristics. Now the automatic recorder discloses those things which make individualistic "manipulators" and perhaps some of them are not quite as snappy as the owner thinks they are. For instance, notice the tendency for the long third dash in the numeral "8"—dah dah daaahh dit dit. That is nothing more than a bad habit acquired from having it pounded at the eardrum by some operator who, in all probability, picked it up the same way without realizing it.

*4915 No. Sawyer Ave., Chicago.

Signals Picked at Random in the 7-mc. Band

W2AYN
W3BPD
W3BES
W8FAR
W9GMV
W9KZZ
W9KXE
W9MIK
W3ZD
W3AJO
WIGBY
W5CVA
W9TWC
W6KWA
W8VW
W2DPB
W9DO
W2EQQ
W9MXX
W9TLY
W9RNW
W8JYP
W3BM
W9MXX
W9TFX
W9VVL
W8DFH
W2HRA
W3HC
W9MWH
W2FIS
WIFTR
W1YL
WIAOO
W8GQZ
W1EH

Oakland Radio Club Votes Plaque

To Be Awarded in A.R.R.L.'s Cairo Commercial Occupancy 1936-1937 Survey

AT A recent meeting of the Oakland Radio Club, of Oakland, Calif., it was voted that a suitable award be made to the individual amateur showing the most outstanding work in the Cairo Survey.

To this end a silver wall plaque is on display at the club rooms of The Oakland Radio Club. The plaque is to be awarded to the individual, chosen from results turned in to headquarters of the American Radio Relay League at Hartford for the year beginning March 1, 1936, to March 1, 1937. The plaque is to be known as the "Col. Claire Foster Award," and at the time of presentation will be suitably engraved with the name of the amateur making the best showing.

The plaque itself is eleven and a quarter inches, by fourteen inches overall, ebony base and polished silver insert. A picture of the plaque is presented herewith.

Rules are of the simplest. Competitors must show in submitting Cairo Preparatory Commercial Occupancy Survey log sheets the individual who is the actual observer. Club surveys will not in themselves count on individual scores except as reports are submitted in duplicate by *individuals* (one to Hq., one to the group control) or a written memorandum covering Rule 4 (a, b, c) submitted to Hartford monthly or oftener, making possible a correct and continuous summary of individual activity as counting toward the award. The word of the A.R.R.L. Cairo Award Committee will be final.

Survey information may be obtained from League Headquarters or from the secretary of The Oakland Radio Club, W6QW, 849 Milton Street, Oakland, Calif.

Cairo Survey Rules for Award of Plaque

1. All Cairo survey logging reported must take place in the period March 1, 1936 to March 1, 1937.
2. All logs should follow the form¹ or forms approved by the Cairo Committee and show the identity of stations, character of transmitted

¹ A.R.R.L. Headquarters will provide approved log forms for this work to any amateur working in the Cairo preparatory survey on receipt of postal card request for same. Write for your blanks! Get going to win this silver plaque!

material, the time, duration and frequency of transmissions as accurately as possible.

3. Equal credit will be given for reports on either the 4-4½ mc. or 6-8 mc. ranges prescribed for survey examination.

4. The "most outstanding work of any individual" will be considered as depending on (a) the number of different stations logged with complete details, (b) the time or duration of total observations reported, and (c) the regularity and number of weekly reports received in the one year period.

5. Work by an observer cooperating in "group" surveys shall count for an individual only where the *individual* work is separately reported making a correct and continuous summary of individual activities in the survey available to the judges.

6. All logs will be examined after analysis by an A.R.R.L. Award Committee whose decision shall be final.

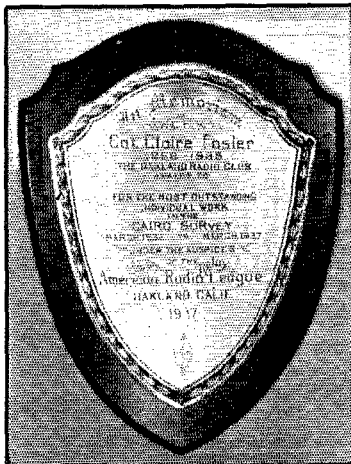

R.S.G.B.'s "First International" 28-mc. Contest

THE results of A.R.R.L.'s one-year 28-mc. contest appeared in the January issue of *QST* (page 19), with details on the national highs and W9NY's excellent work, which won him the watch charm award.

Covering the same period, R.S.G.B. held a world wide 28-mc. contest. We are taking the liberty to report the highlights from data given in the January, 1936 *T. & E. Bulletin*: "Mr. B. J. Kroger, X1AY, has been adjudged world winner, and becomes the permanent holder of the very valuable silver trophy presented by the R.S.G.B. Mr. Kroger ran up the very high score of 4542 points with an input of between 40 and 80 watts. His transmitter used two '10's in push-pull.

"Close behind Mr. Kroger came Mr. Con. Bischoff, VK2LZ, who piled up 4071 points. VK's and one ZL account for his first 39 contacts made up to January 27th, then followed QSO's with W9NY and W2TP on March 23rd after a two months' break. J2HJ was worked on the 24th, whilst X1AY provided the big thrill just a week later. On this day, the 31st, 10 W6's were also worked, as well as W4TZ, VK6SA and J2HJ.

"Third place was taken by Mr. J. T. Dixon, W4AJY, who scored 2399 points, mostly from U.S.A. contacts. He had 75 such QSO's during June and 74 during July. In September OA4J, LU9BV, IEP, 3DD, 3DH, X1AY and VK4BB were worked.

"The most remarkable log submitted was that from Mr. Wareing, W9NY, who finished fourth with 2260 points. This gave a complete record of every 28-mc. call transmitted during the contest, and ran to 47 foolscap sheets. A truly remarkable effort. We commend to the attention of all

(Continued on page 64)

What the League Is Doing

League Activities, Washington Notes, Board Actions—For Your Information

Fees? The F.C.C. and Congress are again talking about fees for licenses for radio stations and operators. The Commission has nearly five hundred people in its staff now, and the idea is to pass on the expense of this administration to the services which benefit from it. Broadcasting would inherit most of the radio expense, of course, and the amount charged us would seem insignificant by comparison. But the A.R.R.L. is opposed to any fees whatever for amateur operation, believing that that would be very short-sighted national policy. We can put up a swell argument, too. The League is therefore expressing itself on the subject to the Commission and will do everything possible to save us from this unnecessary and undesirable expense. The Commission won't get enough out of us to amount to a drop in the bucket, but as individuals it would hurt many of us like sixty. This subject has been up several times in recent years and so far this time it is still in the preliminary stages, but QRX for a possible call for membership assistance.

Blind Transmissions The recent exorcism of miniature broadcasting by some amateur 'phones has put the F.C.C. monitoring force on the warpath against all one-way transmissions by amateurs. We think that the amateur should have the right to engage in a one-way communication to an individual equipped only with a receiver, provided the communication is of the type normal to an amateur. The League has had this question up at the F.C.C. and is promised a ruling which will permit blind communications to a particular receiving point, provided the communications are of the usual amateur type and in no sense broadcasting.

Music Testing The F.C.C. has decided that the number of abuses of the privilege of transmitting music for test purposes scarcely warrants a rescinding of that provision in our rules. They are going to concentrate, instead, upon pinching the offenders. Most of the violations take the form of trying to entertain either an individual amateur listener or a group of short-wave listeners. This is the broadcasting of entertainment, not amateur communication, and it is prohibited to amateur stations. The monitoring stations are therefore being instructed to go after the violators. Our regulation permits the transmission of music only for brief tests, not by

the half-hour, and for bona fide experimental work, not the entertainment of an audience.

F.C.C. Notes Change of address, even to the house next door, requires modification of amateur licenses. It is not sufficient to notify the Inspector. Upon receipt of such notification the inspector sends an application blank. Sometimes a member writes us, demurring about filling out a long form and wondering if it is necessary. The answer is yes. Proper procedure is to write the inspector for an application form, fill it out and mark the heading for "modification," and send it direct to the F.C.C. at Washington, returning your license. Return both licenses, if you still have separate ones. The new license, by the way, will be for a period of three years from date of modification. Proof of activity is not necessary. After having filed for modification you may operate at the new address in portable status, filing monthly notice thereof with your district inspector and remembering to sign the portable indication, until your modified licenses are returned.

We would like to point out an error in nomenclature commonly made by amateurs, in confusing "districts" and "call areas." For example, the region where W6 calls are used is not the sixth district. It used to be, but all that was changed years ago. That region is now simply the sixth amateur call area. The sixth district, or District No. 6 as it is officially known, is something quite different, being the area served by the inspector at Atlanta.

Dig down your copy of the F.C.C. regulations and note the following amendment:

411. Eligibility for reexamination. An applicant who fails examination for amateur privileges may not take another examination for such privileges within ninety days, except that this rule shall not apply to successive examinations at a point named in Rule 30-A.

The examinations in the cities other than the district headquarters are substantially ninety days apart but sometimes only eighty-eight or eighty-nine days, and this amendment permits an amateur who fails the examination at one such city to take it at that same city when the inspector next visits it, even though the elapsed time is not quite ninety days.

Diathermy QRM The Commission is aroused over the disclosures regarding diathermy QRM, "The Shadow." They may seek some amendment to the Com-

(Continued on page 62)

Peace On Earth

Experiences in a DX Contest—Sad but True

Keith Williams,* W6DTY

G'MORNING, oaf," greeted Wilburforce, as he heaved himself into Charlie's guest chair and helped himself to a cigarette. "Don't tell me you're not going to enter the DX contest, which same begins tomorrow night."

"I won't tell you any such a thing, lid. I'm going to enter and use up my two weeks' vacation by making W.A.C. three times a day."

Wilburforce sighed. Charlie *should* make W.A.C. three times a day he thought as he gazed with envy on the rack and panel all decorated with meters and gadgets and a pair of '04A's—and the Single Signal super. Another sigh.

"Well, Charlie, it'll be a great contest. It'll create plenty of good will in these troubled times, huh? Friendliness and brotherly love among the hams will do a lot and go a long way and all that sort of thing. I'm going to do my part with my noble pair of ten's and my snazzy t.r.f."

Charlie looked benign and fraternal as the dickens. "That's the spirit, Wilburforce, my friend. Brotherly love and good will created by a contest like this will do a lot in days like these. You and I will have to sort of cooperate and so forth. I'll give you a chance and you give me a chance, and we'll work plenty of DX, fella."

"Okay, mud turkle, my pal. And when your gozgle gets rough and your arm gets that glassy feeling, come over and refresh yourself from my private stock and watch my ten's run cold at 120 watts."

Charlie beamed. Drinks were produced and toasts were toasted and the two bosom pals parted with nothing but love and kindness surging about in their hearts.

Promptly on the minute, at the very GT, Charlie turned on his receiver and draped the cans over his head and lit a cigarette and twiddled the dial. Ah, what a life! Signals just dripping all over, right out of the clouds and now to start off with a nice, zippy, friendly call to ZT6K. An immediate QSO. Number here, number there, please, QRK? Lovely! 73 and CUL diddle-de-dar-de-dar! Just like that. The first points and the first continent. Now for another. Well, how elegant . . . HC1FG rolling in nice as anything. A nice, zippy, friendly call. Hot dog! There she be . . . "R OK ES TNX BT NR HR BLURPETY BLURPETY BLURPETY BLOOP CLONK," etc., for three minutes. Charlie turned purple. That blighted germanium Wilburforce

must be clattering around with his ten's! (Profanity!)

Ah! There, the air was clear again. That was Wilburforce calling a CM2. Ah well. He didn't intend to do that. Give him a little call in a minute and remind him to fix the key clicks.

Wilburforce tuned up his crystal and his doubler and his push-pull ten's and pushed the watts around. The plates were slightly pink, but what matter a bit of pink here and there. The key was twiddled experimentally, the monitor listened to. Magnificent! A bit of listening at the receiver. Perfect night! A CM2 calling "CQ TEST W-VE." Okay, big boy, wait a minute. The key was attacked with vim and vigor. Well, blow me down! A QSO right off the bat, just like that, by golly. Number here, number there. All okay and "TNX 73 SK." First points, first CM. Mmmm!

Well, well, well! There was YV3LO smacking out a CQ. Another vimous and vigorous call. Blast my timbers, he came back! "R OK HR NR CLUNK BLA-A-A-A-A-A-AH-AH BLAH BLAH BLAH!" Horrors! That's Charlie pushing a kilowatt right through my head! Ah well, I'll just have to drop over and see him.

"Hello, that you Wilburforce? This is Charlie. Say, old man, you have some pretty nice key clicks over my way and it sort of smears me up a bit. Have you got a filter on your key? Oh, you don't need any? You are keying in the grid circuit of the final? I see. Oh, yes. Well, I'd appreciate it if you'd experiment a bit with a filter anyway. Not kicking, you know, heh-heh-heh, but just thought I'd let you know. Well, good luck and so long."

Knock, knock, knock!

"Hiyu, Charlie. Just thought I'd drop around and see you for a minute or so. Worked much? Oh, W.A.C. already this early in the morning? Fine business. Oh, I've worked a few sundry CM's and a Mexican and a couple South Americans or so. By the way, your old kilowatt certainly does put a blanket on my receiver. When you have the key down I can't hear anything at all. Do you suppose you could lower your power or change your antenna or something? I'm not kicking, you understand, but just thought I'd let you know how things were. You say I ought to have a super? Well I haven't. And I haven't got a kilowatt, either. Well, be seeing you. So long, pal."

*RFD No. 2, Box 24F, Ventura, Calif.

Charlie was vexed beyond words. Every time he'd get a QSO and about half of one number, Wilburforce's key clicks settled his hash for him. Doggone that guy, anyway! Nice fellow and all, but he ought to have a bit more decency about him!

Wilburforce was getting mad. Each time he'd snag a DX station out of the QRM, Charlie would start banging away and hurt his ears and smear everything on the t.r.f. Nice guy and all, but no milk of good old human kindness. Something should be done to a fellow like that.

"Say, listen, Wilburforce, this is Charlie again. You better fix those clicks if you know what's good for you. I'm not taking a two weeks' vacation and going without sleep and everything, and burning up a few kilowatts of juice just to sit here and be entertained by a squad of beastly clicks like you're turning out!"

Knock, knock, knock!

"Hiyu, Charlie. Boy you're sure knocking the devil out of things for me with your blasting over here. I know it's fun to draw an eight-inch spark off the feeders with a pencil, but couldn't you do pretty well and have a lot more fun with lower power or something? No? Well, I'm getting pretty mad about it myself. You better watch out, mister!"

Slam! Stomp, stomp, stomp!

A period of siege ensued. Charlie put a paper weight on his key and sat back and gloated. Wilburforce put his key in the positive lead to the ten's and manufactured a slip wheel out of a clock, and let her rip out dots for Charlie's entertainment.

It was pretty dark. And the fog was blowing in and it was getting cool. Charlie was walking along the street toward Wilburforce's house. Suddenly he met Wilburforce.

"Hello, where you going? I thought I still heard that infernal machine of yours clacking away when I left the house. And what's that you've got in your hand?"

"Oh, hello, Charlie. Well, as a matter of fact, I was headed for your place. I thought I heard your sawmill still putting out steady when I left my house. And this is a baseball bat that I got for my kid last Christmas."

"Oh, I see, Wilburforce. You intend to get nasty about things, huh? Well, as a matter of information, I've got a hammer here I got as a present for my brother-in-law, who's a carpenter, but I'm going to let you have it!"

"Ah, yes, I see. Well, Charlie, this baseball bat I was bringing over to your house you can have right now."

Wham! Pow! Whop! Smack! Clunk!

"That'll teach you to have key clicks!"

"This'll show you how to push a kilowatt around. . . Oof!"

And so ended the good-will DX contest as far as Wilburforce and Charlie were concerned. The world, in its troubled and hectic days, with war brewing everywhere, was a great deal better off. Good will and brotherly love pervaded. The old ham spirit was triumphant. Wonderful fraternalism among the hams. Ah, radio! Oh, ether Gods! Lovely.

Strays

Reception reports from stations located in Virginia, the Carolinas, Florida, Texas, Arizona, New Mexico, Oregon, Colorado, Nevada, the Dakotas and Minnesota are requested on the 20-meter 'phone signals of W9YAB, the station of Fred Q. Gemmill at the University of Kansas, Lawrence, Kansas, in connection with thesis work on directional antenna systems. These areas lie in the null regions of the antenna in use at present, and signal reports will be especially valuable. The station is on the air for at least an hour each morning, and longer periods on weekends.

Fellows who incline to vertical antennas for 20-meter work will be interested in a rig being marketed by W9GBT, Robert Foltz of Sterling, Illinois. It consists of a two-section tube of a new type of spring-tempered one-inch copper tubing, capable of standing up with only three guy ropes. The usual types of copper tubing are not satisfactory because of lack of rigidity.

A Low-Cost Crystal Transmitter

(Continued from page 16)

transfer power to the antenna. The "link" connecting these two coils may also be a pair of "push-back" wires twisted together. When the antenna circuit is hooked to the transmitter, a rise in plate current will take place. The amplifier is then tuned to minimum plate current.

The antenna tuner condenser is now tuned to give the highest amplifier plate current and the amplifier is again trimmed for resonance. These adjustments, together with adjustment of the coupling link between amplifier and antenna, enable one to set the amplifier plate current at a reasonable operating value (between 50 and 60 ma.). It must be remembered that the meter is connected to read the total of oscillator and amplifier plate current and that the oscillator value must be subtracted from the total to give the amplifier input.

Two months of operation under normal ham conditions have shown this rig to be an efficient and practical piece of gear. Don't let 'em kid you—high power isn't everything in this ham hobby.

The Canada-U. S. A. Contact Contest, 1935

By F. H. B. Saxon, VE3SG and S. B. Trainer, Jr., VE3GT

THE third A.R.R.L. Canada-U. S. A. Contact Contest, held from November 8th (6 p.m.) to November 10th (midnight) was thoroughly enjoyed by all who were able to participate. In the contest, each W/VE contact had the basic count of one point, with an additional two points being given for "the handling of any traffic regardless of the amount." A number of contestants misinterpreted "the handling of any traffic" as meaning that messages had to be exchanged as in SS contests, and thereby lost some valuable time while on the air. Congratulations are particularly due to those making the highest ten scores in the United States and Canada. Certificates have been sent to each of the Section winners, signed in full by the committee who sponsored the contest as well as the Canadian General Manager.

THE TEN HIGHEST

Canada

VE4QZ	23,431	VE4KA	20,358
VE2DG	22,732	VE3TD	19,152
VE5HQ	21,995	VE2JK	17,370
VE3QD	21,840	VE1GE	15,651
VE3DJ	20,741	VE4PH	15,219

U. S. A.

W1BFT	15,120	W8JIN	11,018
W9TYF	13,135	W8FIP	10,899
W3DMQ	12,285	W6KRI	9,639
W1EZ	11,655	W9DQH	8,789
W2GKR	11,277	W9PTE	8,600

VE4QZ successfully took VE5HQ's place as the top VE this year by working 128 W stations in 41 A.R.R.L. Sections with an input to the final stage of 45 watts. VE3QD worked the most W's, 188, while VE5HQ again worked the most W Sections, 43, two less than in 1934. Seven VE's worked more than 120 W's during the short period of the Contest, VE2DG "bagging" 151, and VE3DJ 145. VE1EP's score of 18,921 was made by two operators, VE1EP and VE1HG, and is therefore not listed with the "ten highest."

W1BFT took undisputed lead of the W's by contacting and handling contest traffic with 80 VE's in all VE Sections!!!! W9GBJ, 1934 winner, worked 50 VE's. W8JIN "hooked" 68 VE's, W3DMQ 67, W1EZ and W2GKR 63, and W8FIP 59. In 1932 no W worked all VE Sections, and in 1934 five W's worked all VE Sections, while in 1935 36 different W's worked all seven VE Sections!!!! Every reporting station from Indiana accomplished this feat, and W1's, W2's, W3's, W6's and W7's, all did it without difficulty. It is worthy of note that among the leaders nearly every section of the country is represented. The first twelve W8's scored higher than the 1934

winner, while only two VE's were able to do it. Many W's worked that elusive VE Section for the first time and many VE's were able to add the 48th State to their list of QSO's. Many W's worked all Canadian Sections several times over.

VE4QZ, the leading VE, wins the handsome cup presented by the Wholesale Radio Co. Limited, of Toronto, as well as a Hammarlund transmitting condenser, donated by White Radio Co. of Hamilton, Ont. VE2DG, won second prize, a Hammond Transformer donated by Hammond Mfg. Co. of Canada Limited. The Johnson Mfg. Co. presented a 14-mc. "Q" Antenna to VE5HQ, as third prize. Fourth prize went to VE3QD, two high voltage filter condensers, presented by Polymet of Canada Limited, and fifth prize, two Band Switches were presented to VE3DJ, the winner of fifth prize, by the Ohmite Mfg. Co.

W3DMQ wrote: "Attribute my score to judicious use of twelve crystals and the use of three bands. Broke sleep-losing record. Started contest aged 15, and was aged 16 when it ended, my birthday being November 11th." W9RH forgot the contest until the last hour and then worked four VE's in four VE Sections. W9RIA was sorry he didn't work his brother VE5LP, although his sister, W9TSV, was heard working plenty of VE's, and said, "The contest was great, creating new friends, bringing old ones closer together." W5EZA worked all VE Sections and his first VE1 with less than 8 watts input.

W1EZ offered an excellent suggestion, "that in future VE/W contests VE stations in the middle of the bands might well use the familiar DX 'Q' signals, indicating the portion of the bands they intend to cover, which would also tend to reduce QRM from stations in the remote section of the bands." W6KRI worked more VE's in the Contest than he had ever worked before!!! W9EGP had 10,000 points of fun. VE4QZ worked an XYL with his 88th message! VE3QB, with less than ten watts input worked 28 W's in 11 Sections. VE2DG started six hours after the Contest opened and nearly landed in first place among the VE's.

3, 5, 7 and 14 mc. were the most popular bands, with successful QSO's being about evenly distributed among the three bands. Many stations reported unusually poor conditions during the contest in some parts of the continent. Seventy-three per cent of the VE's used less than 50 watts input to the last stage, which shows fully what can be accomplished with comparatively low power. Only twenty-nine per cent of the W's used less than 50 watts.

Several VE's worked K6, while three W's worked the Northwest Territories of Canada, which comes under VE5. W8JIT, W9FOQ, W5CPT, VE5HQ and VE4KX all won in their respective Sections for the second successive time.

Each year's contest has seen an increase in activity, and it is hoped that next time more of the participating stations will send in their logs to aid the Committee in checking logs, and so that those who did not take part will really observe something they have missed. Those who were in this contest "eagerly await the next." The Contest Committee wishes to thank all those who took such pains to prepare neat logs, and for the fine cooperation by many who did not "actively participate." It is planned to make this Contest an annual affair, and your continued enthusiasm and support is requested by the Committee.

(Continued on page 68)

Pentodes as Class-AB Amplifiers

IN OPERATING pentode-type tubes in high-power audio stages of the Class-AB type it has been customary to use the tubes not as pentodes but as triodes, the screen being connected directly to the plate in each tube. This method of connection does not retain the characteristic high power-sensitivity of the pentode-connected tube, however. On the other hand the regular pentode connections, with screen at the same d.c. potential as the plate but grounded for audio, cannot be used in Class-AB amplifiers because the plate potentials required for high power outputs (of the order of 350 volts) would cause the power dissipated in the screen to be far beyond the safe value. If, however, the screen voltage is kept down to its normal value for Class-A service—about 250 volts—the plate potential may be increased without damage to the tube.

The advantages of using the pentode connection in Class-AB service are greater power sensitivity—less grid voltage swing required and less power taken from the driver—than for triode operation, generally greater output, especially with self-biased circuits, and lower total distortion at maximum output. The following information on operating 6F6 tubes as pentode Class-AB amplifiers is taken from an *Application Note* published by RCA Manufacturing Company, Inc.

A typical circuit for 6F6 pentodes as Class-AB amplifiers driven by a single 6F6 triode-connected is given in Fig. 1. Recommended values of cathode resistor for both stages are given in the diagram; these should be by-passed by large-capacity condensers in the usual way. It will be noted that this circuit differs from the regular push-pull amplifier circuit only in that the screens are operated at a lower potential than the plates. If fixed bias is to be used on the power stage, the negative high-voltage return should be made to the cathodes, a source of fixed bias being inserted in place of the cathode resistor indicated.

Tests have shown that the optimum plate-to-plate load is substantially independent of the voltage regulation of the power supply (this factor must be considered, since the current varies with the signal) and likewise of the voltage regulation in the screen circuit. It is also independent of the bias system used, being a function of the power output desired, the permissible distortion, and the allowable plate and screen dissipation. Plate and screen voltage regulation is a factor in the determination of the optimum input transformer ratio, however, and the biasing method also is found to influence the input transformer design. Optimum operating data are given in the following table for both fixed and self bias.

TABLE I

Driver—6F6	Fixed Bias*	Self Bias
Input signal, r.m.s.	10.1	10.3 volts
Plate load resistance	21,800	33,100 ohms
Max. power output	288	261 mw.
Interstage transformer		
Turns ratio, pri. to 1/2 sec.	1.54:1	1.74:1
Peak power efficiency	73.5	64.4%
Output stage—two 6F6's		
Peak grid input power	210	168 mw.
Peak grid input voltage (per tube)	47.4	50.5 volts
D.c. grid current (per tube)	1.2	1.0 ma.
Zero-signal plate current (per tube)	17	27 ma.
Max. signal plate current (per tube)	39.5	37.5 ma.
Zero-signal screen current (per tube)	2.5	4.0 ma.
Max. signal screen current (per tube)	8.0	7.5 ma.
Plate-to-plate load	10,000	10,000 ohms
Power output (two tubes)	18.5	17.1 watts
Total harmonic distortion, percent	5.1	5.0

* Fixed bias, -26 volts.

In the above table, the voltage regulation of the plate supply is assumed to be equivalent to 1000 ohms in series with the plate and an additional 2000 ohms in series with the screen from a plate supply with perfect regulation, on the assumption

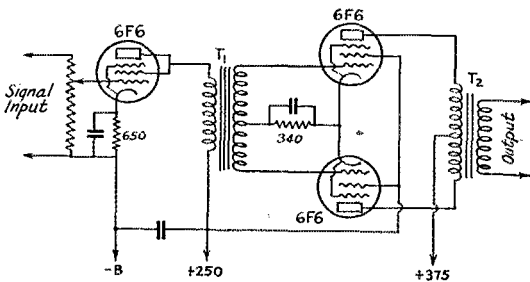

FIG. 1

that in an actual receiver or amplifier the plate voltage would be obtained directly from the first filter condenser while the screen voltage would be secured from a point on the voltage divider or through the drop in a speaker field coil. These figures probably represent average conditions.

(Continued on page 68)

New Receiving Tubes

A NEW duplex-diode triode, to be known as the 6R7, has been added to the metal tube series, according to announcements from Raytheon and RCA-Radiotron. The triode section of the 6R7 is a medium- μ affair, designed to give

(Continued on page 70)

Art-Metal Finish

The Application and Treatment of Crackle Enamel

By Paul E. Millington,* W9KSW and Roger Zaun,** W9UVV

ADURABLE and handsome one-coat finish for laboratory and radio equipment is now available through the development of a so-called crackle enamel or paint, known commercially as "art-metal finish."¹ The product is manufactured in a variety of colors, of which the easiest to apply and generally the most satisfactory for amateur use is plain black. Besides having a high viscosity, its application and treatment differ considerably from the more familiar types of metal finishes.

Either one of two general methods for the actual application may be used. The best, probably, is the use of a power sprayer capable of handling the heavy liquid full body. A hand sprayer with an adjustable nozzle is satisfactory, although the difficulties encountered with such an apparatus are not appreciated until its use is attempted. In either case, the paint spurts as it issues from the nozzle. However, this effect is entirely normal and necessary in building up a moderately heavy even coat. The paint may be applied successfully also by means of a soft brush, undoubtedly a more convenient method for most amateurs. Brushing should be light and continued only long enough to insure an even application. The resulting coating of material must be normally heavier than an ordinary paint, although very thick applications are to be avoided. As a rule, a few small bubbles will remain distributed over the surface after brushing. While these are not particularly harmful, the larger ones may be pricked open with a sharp wire. The effects of spurting from the sprayer, or brush marks, in case the second method has been elected, soon disappear, the final surface presenting a smooth glistening appearance. Suspiciously thin places may be covered further by allowing a fine stream of the paint to flow in from a stick, or the brush, held above the surface. Panels should be supported horizontally to obviate running, while articles of irregular shape must be covered less thickly, some practice being necessary before the optimum thickness of paint can be secured.

Once the piece is covered satisfactorily, it should be allowed to air dry under comparatively dust-free conditions for a period of one-half to two hours, and then heated for one hour or more

at a temperature of 200° to 250° F., measured by an accurate thermometer. The baking can be accomplished on an ordinary gas stove oven large enough to hold the piece. Panels should lie flat, usually supported on one of the removable grills. If the oven is small the door may be left open, the article allowed to extend outside and the front boxed in with cardboard. In such cases, the object must be reversed during the baking to insure proper heat treatment. Temperatures must not exceed 250° F., otherwise blistering occurs. Over a limited area blisters can be pricked open, patted down and the article returned to the oven. The longer the heating, the harder the finish, although an hour and one-half is amply sufficient for most purposes.

The paint, due to its asphalt-like character, is soft while hot, even at the end of the heat treatment. Hence great care must be exercised in moving the finished articles before they are cold. Articles previously painted with an ordinary paint or enamel can be treated directly providing the old finish does not blister or crack off at 250° F. Should this occur on preliminary test, the old material must be removed completely before the art-metal finish is applied.

Bakelite can be handled as metal except that some provision must be made to support large panels at several points, since bakelite softens appreciably at the baking temperature.

Sprayers and brushes are cleaned readily by the use of toluene, xylene, or even acetone, which are available at many large paint stores and at all chemical supply houses. Turpentine, gasoline, and naphtha have proved to be ineffective.

As a rule, the texture of the finish will vary from article to article, since amateurs find it difficult to control conditions exactly. Then, too, graining of a surface sometimes occurs, probably due to slightly uneven application. However, these variations are pleasing to most people rather than otherwise.

Connecticut State Convention

(New England Division)

April 4-5, 1936

Place: Bridgeport, Conn.

Hotel: Stratfield Hotel.

Auspices: Bridgeport Amateur Radio Association.

A good program has been prepared. Watch for the publicity.

* University Extension Division, 623 W. State St., Milwaukee, Wisconsin.

** 2914 North 46th Street, Milwaukee, Wisconsin.

¹ The Sherwin-Williams Company.

Transmission-Line Loading for Short Antennas

By Henry S. Keen, W2CTK*

PROBABLY one of the biggest ham problems is that of putting up the best antenna system that the location will permit. Nearly any amateur will admit that a good antenna system is half the battle, yet the time and effort spent on the sky wire is far from being in proportion to the importance of that unit.

localities. If we only could remove the radiating portion of the antenna from surrounding objects, this problem would be considerably simplified. But how to get a half wave flat-top for 160-meter 'phone or c.w. on the top of a small apartment house? It's quite a job! (Fig. 1).

The usual device for lowering the fundamental frequency of an antenna is well known. It is our old friend the loading coil, and was very widely used in the old days. It behaves best when inserted at a voltage node. Our 160-meter flat-top can be brought into step by putting the proper value of loading coil in the center, as in

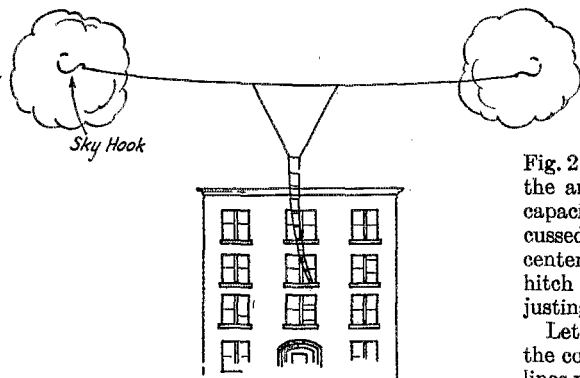

FIG. 1

"... 160-METER FLAT TOP ON A SMALL APARTMENT BUILDING? IT'S QUITE A JOB!"

Fig. 2. Loading coils can also be put at the ends of the antenna, but here they operate partly as a capacity load at the ends, and will not be discussed now. That leaves the loading coil in the center as the alternative. However, there is a hitch to this proposition, that of making, adjusting and weatherproofing the coil.

Let us consider an equivalent circuit to replace the coil. A pair of closed or shorted transmission lines possesses inductive reactance, providing the length is less than one-quarter wave. Conversely, a pair of open transmission lines less than a

(Continued on page 78)

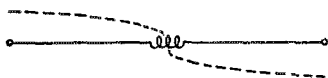

FIG. 2

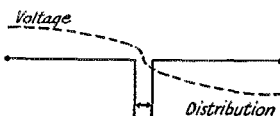

FIG. 4

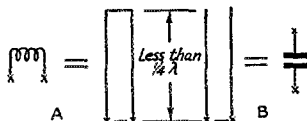

FIG. 3

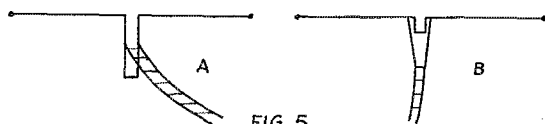

FIG. 5

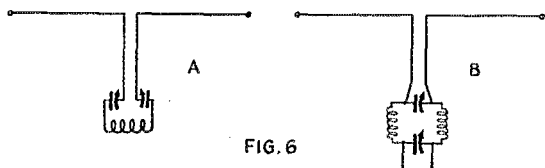

FIG. 6

Most of us—particularly those living in the cities—are cramped for the necessary space in which to hang the antenna, and as a result take a questionable refuge on the higher frequencies. Probably lack of room has kept many a ham from enjoying the relatively open spaces on the lower frequencies, particularly 1.7 mc. There is also the problem of b.c.l. QRM in crowded

* 1330 East 28th St., Brooklyn, N. Y.



An Unorthodox Antenna

By Yardley Beers,* W3AWH

MANY antenna systems, though theoretically good radiators, have the weakness of radiating at angles often not effective for communication. In addition, theory cannot provide sufficiently for the presence of objects such as metal roofs, gutter pipes, BCL antennas and the like, which usually exist on the premises of most amateurs. Hence an antenna which is designed from experiment rather than theory would seem to be justified.

Such an antenna has been designed by the writer's friend, Mr. H. J. Siegel, W3EDP.¹ On first coming on the air two years ago, though he consumed over a thousand feet of wire in experimenting with antennas of the usual types, W3EDP failed to get satisfactory results. His goal was an antenna which could be operated efficiently on all bands, so he set about to design a new antenna, trying to find the best compromise between radiating angle and theoretical efficiency. The radiating angle of an antenna depends not only on the height above ground and the orientation with respect to the horizontal but also on the length. Being unable to alter the first two factors, W3EDP varied the third.

A one-hundred-foot roll of wire was hung up to his mast and tried out for several weeks on 7 mc. The results were carefully tabulated, with due allowance being made for adverse conditions. Four feet of wire was then cut off and this process repeated. Almost every reasonable antenna length was tried, and then the entire process was repeated several times. When all the tabulations were complete, a length of 84 feet seemed to stand out as being the best of all the combinations tried. It may be apropos here to state that the antenna in all cases was inductively coupled to the final power amplifier by a parallel-

tuned tank circuit on all bands. This parallel-tuned circuit was arranged for variable coupling to the final power amplifier tank coil so that it could be adjusted for maximum efficiency and so that the load on the final amplifier could be controlled. It is important to mention here that low *C* in the antenna circuit gave by far the best efficiency. High *C* caused a high circulating current and looked very nice on the thermocouple ammeter but was nil for results.

Not liking entirely the idea of an end-fed single wire antenna, W3EDP set about to find a counterpoise for the best results with his 84-foot antenna. Going through a pruning process similar to that with the antenna itself produced a counterpoise length of 17 feet as the one working best in combination with the antenna. This combination seemed to work excellently on 160, 80, 40 and 10 meters, but on 20 meters a counterpoise length of 6½ feet seemed to outshine all others. The parallel tuning arrangement remains untouched for operation on all bands. W3EDP was a bit skeptical about the operation of this system on 10 meters, so he put his transmitter down there to find out. Results were about equal operating with the 17-foot counterpoise and in operating without any counterpoise at all. The antenna is about 20 feet from the ground and the counterpoises are strung in the room near the ceiling of the first floor of his house. No lead-in arrangement was found necessary, the antenna and counterpoise both being brought directly to the antenna coil. The antenna and counterpoise are at right angles to each other.

Like most antennas, this one has its directional properties, though it is a bit difficult to say just what they are, for at most times it gives excellent results in all directions. Recently we have been getting VK, ZL and ZS stations twice daily on 14 mc., apparently by different paths; VK and ZL have been worked in the early and late mornings, early afternoon and evening and again at midnight; ZS stations at early afternoon and again

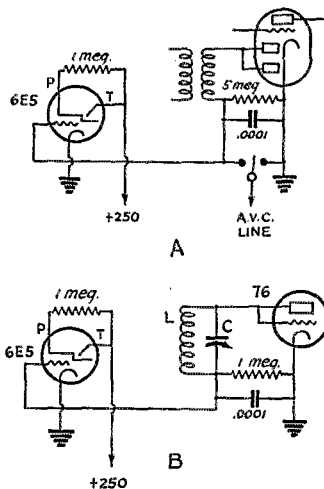

FIG. 1—CIRCUITS FOR USING THE 6ES FOR CHECKING OVER-MODULATION

A typical application to an AVC-equipped superhet receiver is shown at A. An overmodulation indicator for transmitting is given at B.

¹ 120 Renfrew Ave., Trenton, N. J.

just before midnight. Roughly speaking, the antenna seems to give best results in a direction at right angles to its length. It also has the unusual property of emitting a very weak ground wave. On 7 mc. W3EDP's signals have been barely audible across town, when at the same time he was QSO the west coast and getting an R8-9 report.

Though this antenna may seem unorthodox to many, the results obtained with it should justify it fully. Using a pair of 46's with 50 watts input to the final P.A., W3EDP has consistently received R7-8 reports on 7 and 14 mc. from five continents. In addition he has worked 75 countries in all continents within two years with this little rig from an average DX location, a record not duplicated by many using higher power. W3EDP has used his antenna system at two different locations with equal results. In addition the writer has used this antenna in a badly screened location, between two houses and under several trees, yet without altering the dimensions from those given him by W3EDP he has obtained excellent results on 3.5 mc., having worked Europe several times with a pair of '10's.

This antenna is not offered to the reader as a cure-all for his antenna troubles. To discover its true value it will have to be tested at more locations of different characteristics. The dimensions may have to be altered slightly in some locations for maximum efficiency. It is the writer's belief that the design of this antenna perhaps may be the basis of further antenna experiments.

The 6E5 for Checking Overmodulation

A method for checking overmodulation by the use of the new electron ray tube—the "magic eye"—is suggested by Clarence C. Moore, W9LZX. Overmodulation in either the upward or downward direction can be detected, and the gadget can be used to check incoming signals as well as one's own transmitter.

Typical circuits for both receiving and transmitting are indicated in Fig. 1. Circuit A shows how the 6E5 can be connected into a superhet receiver using a diode rectifier. The grid of the 6E5 is connected to the a.v.c. side of the rectifier load resistor. Audio coupling is omitted in the interests of simplification although the connections in the receiver would not be disturbed. The width of the shaded area on the target is dependent upon the voltage developed across the diode load resistor and hence upon the received signal strength. On the method of using the tube W9LZX writes: "The 'magic eye,' when nearly closed on a strong carrier, has light yellowish-green edges on the two sides of the opening. With modulation there is a fuzzy appearance between these edges, but with overmodulation the two bright edges themselves will shift closer together. With downward modulation the opposite occurs. The most accurate reading is obtained when the eye is open

about 40 degrees. The a.v.c. on the super cannot be used at the same time because it would compensate for any carrier shift. The audio gain control may need to be turned down while the i.f. gain is brought up high enough to get proper readings on weak stations."

Incidentally, the 6E5 can be used as a tuning meter when the a.v.c. is connected in.

For transmitting, the circuit shown at Fig. 1-B is suggested. It is equivalent to that at A except that a triode with grid and plate connected together is used as a rectifier. The tuned circuit is adjusted to resonance at the transmitting frequency. The circuit must be well shielded so that the only signal pickup is through the tuned circuit.

Adapting the Patterson PR-10 for 10 Meters

Since the 10-meter band has opened up many amateurs owning Patterson receivers would like to listen on that band but are unable to do so, because the PR-10 and smaller Patterson sets will only tune down to 16 meters. However by means of an adapter we have been using our Patterson PR-10 with excellent results on the 10- to 8-meter band.

The adapter consists of a 10-meter grid coil of the dimensions given in Fig. 2, tuned by a midget of 100 to 250- μ fd. capacity. The grid coil is mounted on the condenser. The rotor side of the condenser is grounded by mounting it on a bracket which is screwed to the chassis, which, of course, is already grounded. A short grid lead passes through a ventilator slot on the side of the receiver. The 10-meter grid lead clips on the grid cap of the first detector tube after removing the usual grid-cap connection. The antenna is then removed from the antenna post on the receiver and clipped on a small antenna coil of 2 or 3 turns coupled to the 10-meter grid coil. We have our antenna coil mounted on the end of the grid coil. If a doublet is to be used it may be coupled to the grid coil by a turn or two.

To tune on the 10-meter band first place the band selector switch to the 20-meter band. Then set the main dial at approximately 50 and proceed to tune with the band spread dial if a PR-10 model is used. If not, then all tuning is done with the one tuning dial on the receiver. After setting

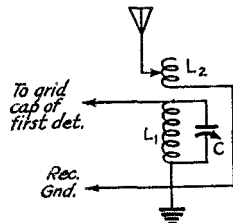

FIG. 2—A TEN-METER ADAPTER FOR PR-10 AND SIMILAR RECEIVERS WITHOUT THE TEN-METER RANGE

The circuit replaces the first-detector tuned circuit and employs the second harmonic of the set oscillator.

C—Midget variable condenser, 100 to 250 μ fd.

L1—Grid coil, 6 turns No. 14 wire, spaced $\frac{1}{4}$ inch between turns; coil diameter $1\frac{1}{2}$ inches.

L2—Antenna coil, same construction as L1, but 2 or 3 turns.

the main dial to the frequency the grid condenser, C_1 , should be adjusted for maximum noise level.

The receiver in this fashion is working off the harmonic of the 20-meter oscillator. The output is nearly as good as on 20 meters.

—Malcolm P. Mobley, W6JYH

Adapting the QST Three-Tube Transmitter to Ten Meters

The transmitter using a 47 crystal oscillator, 10 buffer-doubler and 203-A final described in February, 1934, *QST* can very easily be changed to work on 28 mc. Using a 7-mc. crystal the coil L_1 in the crystal plate circuit should be changed to $8\frac{1}{2}$ turns of No. 12 enamelled wire, close wound on a two-inch form. Coil L_2 in the doubler plate circuit becomes 4 turns of No. 12 enamelled wire, spaced the diameter of the wire; the neutralizing winding consists of $4\frac{1}{2}$ turns close wound one-quarter inch from tank coil. Coil L_3 in the plate circuit of the final stage is changed to 2 turns of quarter-inch copper tubing spaced about $\frac{1}{2}$ inch, the diameter remaining the same.

With this size buffer-doubler coil the rig can be worked on 7 mc. using the 10 stage as a buffer.

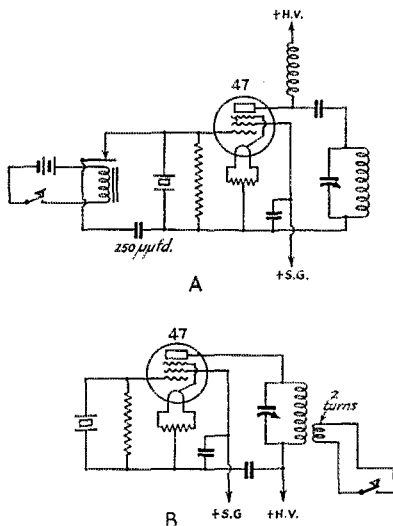

FIG. 3—CLICKLESS CRYSTAL KEYING CIRCUITS

That at A operates by grounding the grid (for r.f.) with the key open. In B the plate circuit is detuned with the key open.

The condenser readings should be around 85 for 7 mc. and around 5 for 14 mc. when doubling. With 500 volts on the plate of the 10, the tube should draw 80 mils. The 203-A grid bias resistor should be reduced to 5000 ohms and the grid mils will read 15. With load on the final the grid mils will read 12. With the 203-A being used as a doubler to 28 mc. the minimum plate current will be about 10 ma. with no load.

Have used this arrangement for about a week off and on and have reports of R5 to R9 from the West Coast and Europe.

—A. W. Kovatch, W8BYM

Crystal Oscillator Keying

Fig. 3 shows two crystal keying circuits which operate entirely on the r.f. portion of the circuit and break no d.c. contacts. That shown at A is used by Nat C. Smith, W9UJ-W2CZU, who writes:

"This method eliminates the key clicks so that it is impossible to tell when the transmitter is keyed when listening to the receiver; no clicks, just a shushing sound, is the result.

"A relay is required. The contacts need not be very husky as no sparking is evident. The back contact of a s.p.d.t. relay is used.

"Pressing the key removes the ground from the crystal and the plate milliammeter will show normal current for the crystal in oscillation. When the key is released, the relay grounds the crystal and plate current rises about 25%. My oscillator with 375 volts on the plate has the following currents:

Crystal grounded—40 ma.

Crystal oscillating—25 ma.

"Naturally the stages following the crystal must be biased to practically cut off to prevent tube damage when excitation is removed."

A system operating on much the same principle is shown in Fig. 3-B. In this case a keyed loop coupled to the plate tank is used to detune the circuit and thus control oscillation. This arrangement is suggested by S. G. Read, W8JUQ. It has been his experience also that key clicks are completely absent on a receiver in the same room.

The keying loop need have only about two turns, closely coupled to the plate coil. To tune, close the key and adjust the plate tuning for oscillation, tuning far enough on the high-frequency side of resonance to give clean-cut keying. When the key is opened the circuit is detuned and oscillations cease.

Code Practice Set for Eliminating Clicks

Low-power stations using the key from an old code practice set on the transmitter can eliminate key clicks very simply. Connect the key leads from the transmitter to the outside terminals on the buzzer set (as if connecting batteries for code practice). Hook a condenser of about one μ f.

(Continued on page 52)

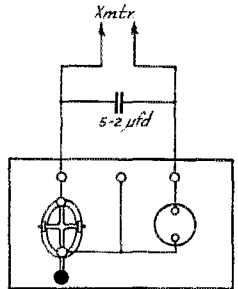

FIG. 4—USING THE CODE PRACTICE BUZZER IN A KEY-THUMP ELIMINATOR

● I. A. R. U. NEWS ●

Devoted to the interests and activities of the

INTERNATIONAL AMATEUR RADIO UNION

President: H. P. MAXIM

Vice-President: C. H. STEWART

Secretary: K. B. WARNER

Headquarters Society: THE AMERICAN RADIO RELAY LEAGUE, West Hartford, Conn.

MEMBER SOCIETIES

American Radio Relay League
Associazione Radiotecnica Italiana
Canadian Section, A.R.R.L.
Československá Amatérská Vysílací
Deutscher Amateur Sende-und-Empfangs
Dienst
Experimenterende Danske Radioamatører
Irish Radio Transmitters Society
日本アマチュア無線聯盟
Liga Colombiana de Radio Aficionados

Liga Mexicana de Radio Experimentadores
Nederlandse Vereniging voor Internationaal Radioamateurisme
Nederlandsch-Indische Vereniging voor Internationaal Radioamateurisme
New Zealand Association of Radio Transmitters
Norsk Radio Relæ Liga
Österreichischer Versuchssenderverband
Polski Związek Krotkofalowcow

Radio Society of Great Britain
Rede dos Emissores Portugueses
Reseau Belge
Reseau des Emetteurs Français
South African Radio Relay League
Suomen Radioamatööriyhdistys r.y.
Sveriges Sandareamatörer
Unión de Radioemisores Españoles
Union Schweiz Kurzwellen Amateurs
Wireless Institute of Australia

Conducted by Clinton B. DeSoto

Tone:

Commenting on the RST system, the D.A.S.D. recalls to mind the T-scale suggested some years ago by J. Fuchs, OE1JF, and reproduced at that time in *QST*. This system has achieved almost universal adoption in Germany and widespread use amongst other European amateurs, although it is not generally employed through the rest of the world. It is suggested that this may be due to lack of information concerning the scale, and that this situation be remedied through adequate publicity. This we are glad to provide.

The principal advantage of the Fuchs' scale, which is reproduced immediately following, is that it takes into consideration the stability of the received signal, and provides unmistakable definitions of quality. Freely translated, the definitions are:

- T1—Plates fed by raw a.c., 50 to 60 cycles.
- T2—Plates fed by a.c. or r.a.c. of musical frequency.
- T3—Plates fed by r.a.c. without filter.
- T4—Plates fed by r.a.c., smoothly filtered, stable.
- T5—Plates fed by r.a.c., well-filtered but unstable.
- T6—Plates fed by r.a.c., well-filtered, very stable.
- T7—Plates fed by d.c., unstable (i.e., chirps, etc.).
- T8—Plates fed by d.c., stable, but clicks, spurious radiations.
- T9—Plates fed by d.c., perfectly stable.

This system, by the way, represents the T-scale in the well-known European W-R-T reporting system.

Prefixes:

We have a variety of new prefixes to report this month. Under British jurisdiction, the following changes have been made: Ascension Islands are now ZD8, St. Helena is ZD7, and Mauritius has been assigned VQ8.

Mexico, as almost everyone must know by now, has used XE since January 1st.

The anomalous situation with regard to Greenland and The Faeroes has been cleared up by the assignment by the Danish government of OX to Greenland and OY to The Faeroes. The latter, by the way, are considered part of Denmark, whereas Greenland is a Danish colony.

TBTOC:

Opening up of the 28-mc. band has lent renewed impetus to the number of claimants for the TBTOC (Three-Band Trans-Oceanic Club) classification. Among the newcomers:

W9MIN, with D4ARR
VE3WA, with VK3YP
LU1EP, with ON4AU
VK3MR, with W8CRA
VK5HG, with W8CRA
VK3KX, with W6JJU
J2LK, with W6JJU
J2LU, with W6JJU
EI8B, with W1AF
ON4LX, with W1AF

Pa0FX with W1SZ, D4ARR with W1SZ have graduated to the FBTOC, doing the job on 28, 14, 7 and 3.5 mc. W6JJU, is close to a TBTOC WAC, which would indeed be something.

In this connection, it should be pointed out that at present *no certificate* is being issued in

connection with TBTOC. In the December, 1934, issue of *QST*, on page 49, a suggestion by W6FFP that certificates be provided to those qualificants willing to pay a nominal sum was presented. The response to the suggestion at that time was negligible. Perhaps now, with a larger number of TBTOC members, and with all this new-found prosperity we are hearing about on the b.c. chains, the answer is a different one. How many TBTOC-er's would be willing to pay a certain amount, probably a dollar or so each (less if enough wanted them), for a unique and distinctive coöperatively-financed certificate establishing their honored place in the highest existent DX category (hi!)? Let's have a showing of hands.

National:

The month's budget of news: *Bolivia*: H. E. J. Smith, ex-CT2BK, writes that none of the Bolivian calls now listed are effective, licenses having been cancelled for more than two years because of the war with Paraguay. Until this is finally concluded there won't be any amateur radio in this country; and in any event, the authorities don't



MISS NELLY CORRY, G2YL, HOLDER OF FIRST 28-MC. WBE AND ONE OF THE FIRST 28-MC. WACS

care a whole lot for amateurs, although there are some genuinely interested experimenters. Receivers are generally permitted, however, and, except in the city of La Paz itself, which is in a hole, conditions are quite good. *Brazil*: Vasco Abreu, PY1AW, tells us that during the last week of November a small rebellion burst out in a few places in Brazil. It was promptly overcome, but meantime PY stations were instructed to stop their activities until orders to the contrary were issued. Last word is that this order is still being strictly observed. PY1AW reports an average QSL rate of 54% on the part of W stations, the 3rd district being high with 70% and the 2nd district low with 40%. *Denmark*: H. T. Petersen, OZ7Z, reports among other things, that OZ9WB/9Q has worked all Australian and New Zealand districts, a record. OZ2M worked all U. S. districts and four Canadian last October. *France*: On last November 1st André Auger,

F8EF, long and favorably known as the constructively active president of the R.E.F., was forced to resign his position due to the pressure of personal affairs. He is succeeded by Georges Barba, F8LA, an old-time amateur whose call will be familiar to many, and who gives assurance of leading the R.E.F. in the same successful paths as M. Auger. The latter will continue actively in charge of foreign relations, including I.A.R.U. matters, at the request of the Council. Another report from France gives the American winners in the 1935 "Coupe du REF" competition. W8MAH took first U. S. Honors, followed by W8GQB and W8KOL, who were paired for second place, and W8KWJ, W9TBX, W8ERZ, W1FPP and W8UVA, all of whom were tied for third place. In Canada the winners were VE1ET and VE3HF. Both W8MAH and VE1ET will receive special certificates in recognition of their work. *India*: B. M. Tanna, Hon. Secretary of the Indian Radio Amateurs' League, sends us the following information concerning the radio regulations in India: All Madrid bands are allowed, except that the 3.5-mc. band is restricted to 3750-4000 kc. 'Phone is allowed on all bands. Except in special cases the maximum power allowed is 10 watts input to the aerial (actually, 10 watts output). Third-party traffic, although not legally allowed, is tolerated. There are about 115 licensed amateurs in India, of which about 25 are active on the air. The I.R.A.L. has a membership of about 300. *Kenya*: The contest held by the Radio Society of East Africa early last year was won by R. J. Fittall of Nairobi, the runner-up being D. C. Hardinge, also of Nairobi. *Norway*: At the annual general meeting of the N.R.R.J. the following new members of the board were elected: President, Bjarne Barkbu, LA4A; vice-president, Ahlert Horn, LA2Q; secretary, O. Johannesen, LA4K; members, A. Nybro, LA3I, and Chr. Becker, LA3J; alternates, G. H. Petersen, LA1D, and B. Th. Fjeld, LA1Y. *Rhodesia*: R. A. Jubb, ZE1JN, writes: "The regulations over here are stiff but excellent; 50 watts is the limit to the final amplifier; crystal control is compulsory on the 14- and 7-mc. bands; all the amateur bands are available; key filters compulsory; overmodulation is illegal and numerous other items which are for the benefit of the BCL as well as giving all of us a fair share of the band to work in.

"ZE1JV, ZE1JX and ZE1JC are all QRP, not more than ten watts input is used by any of these stations. ZE1JM, ZE1JN, ZE1JO, ZE1JS, ZE1JT, ZE1JY, and in a few weeks ZE1JJ, can all be considered in the 40-watt class. All of them use two type 46 tubes in their final amplifiers; some use push-pull, some don't, but although the crystal oscillators and frequency doublers are of various design, the tube used in the finals of all these stations is the good old 46. The 802's ordered ten months ago have not arrived in this country

(Continued on page 54)



OPERATING NEWS



Conducted by the Communications Department

F. E. Handy, Communications Manager

E. L. Battey, Asst. Communications Manager

ACTIVITY REPORTS were "up" this month and general amateur operating in all fields near the seasonal peak for the year. Traffic figures were bettered due to holiday traffic and to the A.A.R.S. traffic contest in which there was a high degree of amateur interest. New plans for spot frequency nets are announced for Central California, and in the Wisconsin and Washington Sections. The Virginia Net frequency has been changed to 3659 kc.

The "DX" fraternity looks forward to the annual A.R.R.L. tests as a high point of the season, and we are glad to say that W6CUH predicts fine DX conditions for the dates announced. He has been keeping a cyclical record of ups and downs in the DX conditions for the last several months. The "quota" plan (for W/VE participants only) which developed from the published letters of W4EG, W5NW, W9FM, etc., will have its first test in this year's A.R.R.L. DX Competition. Depending on the majority reaction of participants to this feature this may be stiffened, or relaxed, or eliminated altogether in the future. All comments are carefully analyzed each year so the generally desired trends may be written into future rules of all activities. As always, the amateurs of each country or A.R.R.L. Section compete directly only with hams of their immediate Section, where conditions for making an Award are substantially the same. The Rules for a given locality apply in the same way to everybody insuring fairness to each who takes part. Good operating fun and DX are always available in our March tests. We hope all readers will take part and get their share. All reports, large and small, and your general remarks on "the best thing" and "the worst thing" that happened in the Contest will be appreciated.

Interest in W.A.S. achievement is extremely high. Many report needing but a few more cards to qualify for the certificate. A few hours working on almost any band and you find stations looking for their additional states for W.A.S. In *Marin Amateur's QSA-5* W6BJM says (about W.A.S.), "It stimulates continental QSOs where consistent communication may be held, and anybody holding it will at least have worked a few stations. . . . Probably one or two WAC's will find they can't qualify, and will suddenly take a new interest in signals beginning with 'W.' Methinks it is a far more worthy goal than WAC, if one must have an alphabetical ultimate. It is just possible it will revive the ancient practice of QSL. . . ." A lot of us find that after all we can't locate the card we just knew we had from a contact made some time ago with far away Nevada or Vermont. Well, establishing a new contact there *right away* and getting that necessary acknowledgment to submit under W.A.S. rulings makes an interesting problem that adds point to our time spent on the air. Perhaps it encourages us to build crystal-switching or band-switching into the "heap." At any rate it sharpens our perceptions in tuning the band over in looking for the elusive station, and therefore makes us better equipped to tackle a particular communication job (of locating stations and getting them to answer) when a wire tie-up or flood emergency develops unexpectedly one of these fine days. A.R.R.L. members are bonded together in an organization dedicated among other things to the *maintenance of fraternity, and a high standard of conduct.* It is entirely in keeping with that purpose that we devote regular time conversing by amateur radio with each other over this whole great country; that we cement the bond of friendship by exchanging some memento or record of our contact. The time-honored QSL-card is perhaps the most simple and practical means of swapping this additional token of a new or renewed radio friendship, giving equipment details and data

on the signal for purposes of record that may have great value. Many old-timers (along with amateurs boasting brand-new tickets) find it again a heart-warming experience to greet the mailman with outstretched hand for the hazy tokens of the amateur brotherhood that also serve as stepping stones to W.A.S.

QSL—QSP ALWAYS

Familiar slogans, those! Many a card has carried one or both. The feeling behind the words is really indicative, we think, of the true spirit of amateur brotherhood. The marks are those of fraternity and equality. Are you, brother ham, always ready to QSP or QSL? Will you always do your best to take a message and put it through for your brother amateur, or for the public welfare? Do you know A.R.R.L. message form? How to check a message? Will you take a moment to talk to your brother ham, or help him test his transmitter or is yours one of those "robot stations" they tell about! Will you slow down for the man who says, "QRS"? Are you tolerant and understanding of other big branches of amateur radio beyond your own special interests? DO you always come through with a card (QSL) when requested? In short are you a good fraternity brother? Can you be *dependen on* in every day hamming or in a pinch? Long may the slogans live. Much more can be said on "real fraternalism" as applied to our amateur radio. It is all brought to mind by those excellent expressions that say so much! QSL—QSP ALWAYS.

—F. E. H.

W.A.S.

Complete rules for membership in the new Worked All States Club appeared on page 33, January *QST*. Attention is called to Rule 2, which reads, "Contacts with all forty-eight states must be made from the same location." The "same location" has been defined so as to permit normal moving about of amateurs within one general locality. No two street addresses where you radio work (represented in letters or QSL-card acknowledgments from the 48 states) has been accomplished can be more than 25 miles apart and count for W.A.S. Club membership.

Have you checked up on your contacts and QSL's to see how you place towards WAS? The list of Charter Members will appear in April *QST*. Will *your* call be among them? Send in your cards NOW!

Does anybody need NEVADA for WAS?! W6BIC, Nevada SCM, advises that W6BTJ, W6LOD, W6KBZ, W6MVP and W6AJP (all Nevada stations) are trying for WAS on 3.5 mc. every morning from 1:30 a.m. PST on. Here are the frequencies of several Nevada stations: W6UO 3846.2 kc., W6KJQ 7150, W6GGO 3658, W6AJP 3658, W6LCJ 14,032 and 14,224, W6BTJ 3658, W6BIC 3546 e.w. and 3924 and 3960 'phone.

New England Division Director Bailey, W1KH, suggests a W.A.S.B.N.C. Club (Worked All States But No Cards)! He says the club symbol would be a LYRE!!

A message recently received following the announcement of the WAS Club reads as follows: "Please issue me a WABTSARCFASBNC certificate." Investigations with the aid of our chief cryptographer disclosed that the mysterious letters stand for "Worked All But Three States And Received Cards From All States But Nine Club"!!! How do you stand? Hi!

56-mc. DX Contest

The Milwaukee Radio Amateurs' Club "56-mc. International Contest" is getting under way. If you missed the announcement, see January *QST*, page 27, and start reporting weekly to assure yourself credit towards the beautiful 16-inch loving cup!

W9NPS has a transmitter on "five," crystal-controlled using a pair of '52's, input about 400 watts. He is on daily in the morning and in the late afternoon and evening. W6HJN (San Francisco) reports his activity centers on making field strength tests on beam radiators at the moment.

W9NY and W9GHN are getting on "5" and are building a suitable receiver to pull in DX signals. They suggest that the gang sending DX tests on 56 mc, use or concentrate on the 56-56.5 mc. part of the band. Also they request local 'phones everywhere to kindly refrain from using this part of the band for duplex or local rag chewing.

It is suggested that all 56-mc. hams drop a line to W9NY or W9RH in Milwaukee to line up some schedules for transmitting and listening, since these will doubtless develop into the first DX contacts to be reported towards this M.R.A.C.-A.R.R.L. Cup Award.

Each year the Adaman Club of Colorado climbs Pike's Peak, regardless of weather, and as the New Year breaks, sets off fireworks. The Pike's Peak Amateur Radio Association members have worked with Joe Rohrer, W9EYN (of KOA), in experimental work leading up to a broadcast of the event this year. While the broadcast was being put on, the amateur members of the party, W9GLI, Archie Haase, and W9LFI, Tom Hoark, were operating the five-meter rig handling the Adaman communication with the Springs. In addition, they were testing for possible contacts with Denver, 75 miles away, and finally hooked up for a short two-way QSO with W9DSB of Denver. The boys on the Peak also heard W9ESA and W9GBQ, both of Denver. In Denver, the Peak outfit was heard by W9DSB, W9ESA, W9FCX, W9VXX, W9MBF, and W9FA and W9FXM, who were at W9DSB's place. This success marks the culmination of three years of effort toward this end, and has hopped interest up to fever heat.

Next objective . . . signals between Denver and the Springs, straight over the Palmer Lake Ridge! We are putting a 200-watt Class B modulated set here next week with a beam toward Denver. W9NY has started something, and I can think of nothing to give me more pleasure than a five-meter QSO with him from here one day.

W9KNZ's transceiver on the Peak (27 pounds) utilized a 49-30-19 and another 30. A telescoping aluminum quarter-wave rod antenna, 4 feet 1 inch long, worked against the operator's body as ground. Input to the oscillator was 2½ watts from B batteries. We had a chance for a real study of conditions. We have had five trips up this peak and on all, conspicuous fading. When signals were weak at one point, they would be strong at another, and steady contact with the expedition was only maintained through our having several points here in town. The signals in Denver, 75 miles away, were generally better than they were in the Springs, only about 14 miles away. Contacts with the Peak were maintained from W9HDU's after 7 p.m. and the signal strength varied several times through fading cycles during which it rose to R-8 and sunk to barely readable.

The old standbys here have been W9ESA, W9GBQ, in Denver, and W9HDU, W9NRZ and W9KNZ in the Springs. These few have stuck to five-meter work consistently. Data collected on more than a dozen fruitless trips up the Peak will now be put to use in a concerted effort to break down the Palmer Lake Ridge barrier between the two towns. This is our first milestone toward our ultimate objective, five-meter DX. The better part of next year will bespent on high-power five-meter work. The location is most strategic, both from the standpoint of advantages and difficulties. If we fellows are to get most fun out of it, we've GOT to make it a DX band. THAT'S WHAT WE'RE GOING TO DO THIS YEAR. (COME ON, MILWAUKEE! HI.)

—W9KNZ

OBSERVERS' HONOR ROLL

Cairo Commercial Occupancy Survey

6000-8000 kcs.

W1GTN	W3DRO	Jas. C. Hayes	W5NW
W1DZT	W6AF	Ed Hutchinson	W6AKI
W1EZV	W7AAN-DRF	W. S. Jackson, Jr.	W6BUZ
W1IEG	W9DIB	W1ASB	W6CLY
W1IQF	VE3AHK	W1BDI	W7CJN
W1HRC	W1ABG	W1BNL	W7FDZ
W1DDY	W1IDH	W1DSZ	W8CNZ
W6JVE-7	W1LKC	W1FAH	W8HGG
W8NQ	W1LRJ	W1IJL	W8IGQ
VE3GG	W1JAC	W1LZL	W8ISK
W3FCQ	W1JGY	W1JBQ	W8KPL
W. R. Faries	W1MKE	W1JLH	W8LVH
W1BGJ	W2HLK	W2CPZ	W8OIC
W1HEH	W2HYK	W2DWW	W9ASZ
W1LR	W3EZ	W2GTA	W9CVL
W3CWE	W5CVO	W2EJF	W9DCM
W6RB	W6DFO	W2LXQ	W9LDH
W9GPL	W7ALH	W3ALB	W9LHV
W8XL	W7CHV	W3BES	W9NPY
W3EQP	W8CIK	W3DMQ	W9NXG
W4CYY	W8KNT	W3FHS	W9RTD
W7DYH	W9DOU	W3FLD	Z1ZOD
W9EFK	W9HQT	W4DNA	H. Balter
W1BLV	W9MGN	W5AIR	D. R. Bittner
W1IOA-3	VE4UN	W5DWW	W. Kopecky
W2HNX	VO1C	W5ESP	H. Kuper

4000-4500 kcs.

W3EQP	W1IPU	W1BDI	W9CVL
H. Kuper	W1IZO	W1BNL	W9GPL
W1AQF	W1JAC	W2CPZ	VE3BZ
W1AXS	W1JCN	W2HLK	VE3GG
W1CAB	W7COH	W6AKI	Russell Green
W1GTS	W1ABG	W7FDZ	Jas. C. Hayes

Director Groves suggested it, the Cairo Committee approves, and we are happy to present above the Honor Roll of amateurs who have submitted reports and are continuing to submit logs of "commercial occupancy" in the Cairo Preparatory Survey. These are men who are doing something more than "talk about" more frequencies. They are amateurs who are giving unselfishly of their time that your amateur representatives at Cairo and the conferences that precede it may be provided with vital facts, knowledge and practical information, with which to work in our common interest.

The above Honor Roll includes all Cairo survey work reported to A.R.R.L. Headquarters to date. The listing of calls or names has been made as closely in the order of the volume of survey work performed by each individual as possible. Starting in April *QST* a monthly Honor Roll will be published.

Are you doing your part? Every true amateur should be in on this effort and able, with these observers, to wear the special A.R.R.L. button (¾ inch size) which is restricted to those who actually submit logs. Note also the announcement elsewhere in this issue of a silver plaque award for the most valuable and consistent individual observing effort between March 1, 1936 and the same date in 1937.

The Cairo survey blanks are available to every W or VE ham who wants more frequencies for operating work and is willing to put in some time making observations in the 4000-4500 kc. or 6000-8000 kc. range. Any receiver with a beat oscillator that will cover these ranges or even a substantial part of one range, can be used. A card or message will bring you details.



Winter Brings Emergencies! QRV?

By Benton White, W4PL*

It is reversing the usual order to have an ice storm in Central Georgia. \$2,000,000 worth of damage was reported in Atlanta alone. Trees, wires and poles crashed. For several days the only power available was from a few underground cables. The writer, 125 miles north of Atlanta, was icebound for five days. In spite of feeder lines and antennas carrying loads of an inch or two of ice, amateurs were on the job to cover the existing communications emergency. Mr. White tells of the work of Monroe hams who with customary modesty he says, have not told the story themselves.

—EDITOR

MONROE, Ga., is a pleasant county seat of some 5000 population, situated on Highway No. 10, fifty miles east of Atlanta.

On the night of December 29th when the last wire and cable into town, swollen to the size of a baseball bat by its ever increasing coat of ice, snapped and fell, the distracted telephone co. remembered W4APX and sent a car hurrying to his home, two miles out of town. Could he move his station to the city? Could he establish communication with the outside world? Yes, he thought he could, and he was certainly game to try.

Half a mile back towards town and the car went into the ditch. Brother Hams, did you ever, at the graveyard hour of 3 a.m., set out to carry a regular—not a portable—transmitter, a power supply and a receiver for a mile and a half along a road that approximated a solid sheet of ice, a road so slippery that four chains couldn't hold a car on it? In a driving mixture of rain and sleet that froze instantly to everything it touched? Did you ever try to put up an emergency antenna in the dark with every tree, post, roof and window ledge sheathed in slippery ice? Well, W4APX, assisted by W4DOH and W4BAG, did all of this, and he was on the air and had outside contact established by 5 a.m.

Eighty meter c.w. was used and the set-up was made on the second floor of the Court House. The first antenna was a piece of insulated wire tied between two trees in the Court House yard, as high up as a man could reach in the slippery darkness. No insulators were available and the feeders went out the window and down to the flat top!

Indoor antennas were later tried, and the one that ran from the jury box to the clerk's office and down the hall worked better than the one that was tied to the judge's chair and went, via the sheriff's room, to the clerk and master's office. But the outside antenna, raised to twelve feet, got the best reports and was in use at the end.

Message blanks were left at the hotels, post office, telephone and telegraph offices, and drug stores. Regular collections were made and for three days W4APX and W4DOH, one or the other on duty hourly, kept 5000 people in touch with the outside world.

The traffic file presents a queer cross-section of human affairs. Here is one from one of the commercial communication companies; "All lines out at midnight . . . ice getting heavier . . . rush crew cable men and 50 pairs cables." Stern stuff, that one, and the receiving station must hurry it to its destination by radio, or Western Union, or long distance or what have you, and hang the expense.

Well, well; over in Augusta somebody must have been tossing a notable New Year's party, for here are a whole bunch of "regrets" from Monroe's fairest. ". . . roads impassable . . . can't come . . . simply desolated . . . had a new dress and a permanent too . . . etc."

Some were sent from stranded auto tourists en route to Florida. What they think of the Sunny South can't be put on the radio, but their friends ahead and behind are going to be mighty glad to know why they haven't shown up, and that they are not lying unidentified in some hospital.

* A.R.R.L. O.R.S., Shepherd, Tennessee.

Does this one sound like it originated in central Georgia, where snow is almost a novelty? ". . . and my roof has caved in from the weight of ice." Most incongruously it ends with "Happy New Year." . . . Sure sounds like he was having it.

Here is one to wipe the smile off your face, a pitifully anxious inquiry as to the condition of two emergency cases in one of Atlanta's big hospitals. (Got an answer to that one . . . both patients doing well.

Here is one from a preacher who regrets that he cannot officiate at a wedding: ". . . roads a solid sheet of ice . . . get some other minister," he says. Well, that's not as bad as if the groom hadn't shown up.

And here are four YLS who, probably with much less regret, advise the dean of women that they will be late returning to school.

And whadda you know about this one! A young buck from Atlanta and his YL out for a little spin, and here they are in Monroe with the engine frozen under the hood, and the wheels frozen to the ground. From his anxiety to contact Atlanta we judge that his YL's OM must own the biggest shotgun in the state of Georgia.

It is the holiday season and lots of movement, and suddenly everything is halted, and communication is gone. In



W4PL IN THE "SUNNY SOUTH"

the town are travellers caught enroute; local people who have planned to go somewhere—and can't; people expecting visitors—who ought not now try to come; matters of health and business and pleasure at loose ends. All are served by the magic of coil and condenser and vacuum tube, plus the spirit and training of the amateur.

If opportunity—and emergency—knocks at your door at 3 a.m. some morning, can you do as good a job? Have you a transmitter that you can move with reasonable ease, or is it portable by Mack Truck only? Do you know the standard form and procedure for handling traffic? Do you know the Q signals and the abbreviations in ordinary use that will help the operator at the other end, straining his ears at weak and wavering signals, to make perfect copy?

If so, fine! If not, then NOW is the best time to prepare!

World's Largest Ham?

W9TLQ, 327 lbs., president of the 1.75-mc. "Eighth of a Ton Club," is suggested as the "world's largest ham." Any competition? W9ONR, 280 lbs., is vice-president of the club, and there are several "scrub-team" members (those between 200-250 lbs.), namely W9PEH, W9SRO, W9AAJ, W9LXI, and W8KKH.

Skip is often responsible for unusual routing of DX traffic. Here's an example: A message from ZS6AM to W2EDW traveled ZS6AM-W8AZI-W6LFL-W2CTO-W2EDW. The reply was routed through W2CTO-W6LFL-W8AZI-W3CHG-ZS6AM.

Mr. Campbell's article wins the C.D. article contest prize for this month. Each month we print the most interesting and valuable article submitted in connection with the article-contest. Contributions may be on any phase of amateur operating or communication activity which adds constructively to amateur organization work. Contributions should run about 500 words. Prize winners may select a 1936 Handbook, six logs, six message files, six pads blanks, or equivalent credit toward a combination of A. R. H. L. supplies. Let's have your article. Mark it "for the C.D. contest," please.
—F. E. H.

CQ DX, or Duck Soup for All

By M. R. Campbell, VK3MR* via W2GOX

I READ with interest VE3IG's letter, "CQ DX," in *QST*, November, 1934, and a reply by W6YL in *QST*, February, 1935.

Having managed to sneak in a few DX contacts between "W" QSO's, am in a position to offer a few remarks and a suggestion or two on this DX racket. VE3IG remarked, "what is duck soup for one ham, may be poison for another," but this is duck soup for all who may need it.

VE3IG claims that he gets more DX by calling "CQ DX", while G6YL gets hers by calling the DX stations. G6YL mentioned the number of countries she had worked with her method with 8 to 10 watts, and our friend from VE went into a lot of mathematical calculations to prove his system. My own system is a combination of both with special regard to the position on the band, which is most important and depends on whether you are calling "CQ" or an individual station. There are a few chaps in locations that are not the best for DX and, again, there are many in excellent positions but do not take advantage of it.

Before there is any desire to work DX, one has to hear it, which necessitates a good receiver and the ability to handle it under all conditions and also to understand conditions. Also you have to know the capabilities of the antenna, and realize its strong and weak points, regarding radiation pattern, etc. Then again, you have to see that the transmitter is delivering the maximum amount of RF to the antenna via the feeders. If you can say "Yes" to these questions, the working of DX becomes quite simple, providing certain things are kept in mind.

You will often notice that some hams can work DX in fine style and get big reports up to R-8/9 from countries many thousands of miles away and another chap, a few miles away, with less power, may get only R-4/6 from these same stations, but when it comes to a DX Test, the low power man romps home; not because he is in a better location. It's simply because he has what we might call "Radio DX Sense," and can be likened to road sense in motor car driving. That little something called "judgment," that makes some people stand out from the rest. This judgment can not be taught. It can only be acquired by experience, the time taken depending on the individual.

Here is some good advice. There is no reason why anyone should call long CQ's. Every ham knows what CQ means. When he hears it, he wants to know who is calling. Is it a DX station or a local in the skip? If it's DX that he wants to work, he will hang on to the signal and try his luck when the call has finished, even if it's a long call.

So much for the chap listening to you. For your own gain, you want to tell the world you're on the air calling "CQ" and desiring a QSO with some distant ham and that distant ham is the chap mentioned above. So cut out the long CQ's. Send as follows—it's good practice: "CQ CQ CQ DX de XYZ. CQ CQ CQ DX de XYZ" for one, two or three minutes, depending on circumstances, and sign off with your own call three times. Long CQ's and long calls make the average ham mutter rude things in his beard.

If your frequency is near the HF end of the band, always tune from that end and the same applies to the LF end. If you are exactly in the middle of the band, tune from the LF end, and if a few Kcs. higher in frequency than the middle of the band, tune from the HF end. If this practice was used

by all hams, there would be less use for head-ache powders.

It's quite a simple matter to sit in a conspicuous place in the band and call "CQ DX" for ten minutes and then listen to see how many stations are calling you. With this method, you will work a lot of DX in a long time. This method is OK for stations in other countries during "W" tests. The idea is to work a lot of DX different countries in a short time, and that can be done by listening more and calling the DX stations. It's not much use calling these stations if you don't take into consideration your position in the band, with respect to the station you intend to call.

The whole secret is to put your signal under the nose of this DX station so he will hear you as soon as he starts to tune down or up the band, whichever the case may be. If he always tunes from the end that his signal is on, it's a simple matter. Even if you find that he tunes from the other end, you simply QSY there and if you can't get him and others are, it's ten to one you're not getting there or your signals are being QRMD. If you are not getting there, and you can work stations just as far or farther in other directions, it seems to indicate that your antenna is not good for that direction.

While on the subject, I'd like to say that it's the antenna that gets you there. Power helps once your antenna has put your signals over. There are three kinds of antennas. One that puts the signals with a bang to that DX station; one that just gets you there, and the other that doesn't. Under good conditions, the third antenna may get there but under real bad conditions, it's the first antenna that does the trick.

Another point that saves time and headaches is to use judgment when calling a station. If the station being called tunes from the HF end or the LF end and your frequency is about 2 kc. in from the edge, don't call for five minutes. Two or three calls will be OK. The farther you are in from the edge, the longer you should call—but use judgment.

I will finish here with a true yarn regarding the above. During the last "W" tests, using 7285 kc., I called CQ and worked W9FM. He called me twice, snapped over and received his number OK, listened again and heard a hopeful W just finishing calling me on the same CQ.

DX Notes

At 6:30 a.m. P.S.T., December 23rd, W6LHZ worked YN1AA, who said it was his first W6 contact. W6GPQ reports SU5NK, Cairo, coming through remarkably well, 14,280, T9X; others heard at GPQ—F88AA (old FB8IA) 14,315, T9X, FB8AB (old FB8C) about 14,280, n.d.c., I1WW 14,320-14,295, n.d.c. W1GJQ worked VU7FY on November 21st, '35, at 7:45 a.m., thereby beating W1DZE, who worked 7FY on December 3rd. The QSO made W1GJQ W.B.E. On December 17th W6GAL snagged what he calls "a honey": CL3AC, 14,380 kc., chirpy d.c. (self-excited); QTH was given as Timor. GAL is wondering if this is the first W/Timor contact. Has anyone any information?

W4DRZ, Fort Lauderdale, Fla., reports 7 mc. hot for DX during December. Among the consistent signals he lists: Between 6:00-9:00 a.m. E.S.T.: K6CJG, 7100; K6MTE, 7120. Between 6:00-8:00 a.m. E.S.T.: VK2SS, 7100; VK5MK, 7080; YK6KB, 7110; KA1HR, 7100. Between 5:00-9:00 p.m. E.S.T.: EA7AV, 7105; EA4AB, 7120. Between 7:00-9:00 p.m. E.S.T.: EA8AF, 7090; FT4AA, 7105. Between 5:00-8:00 p.m. E.S.T.: SP1FI, 7115. All these stations average S6 or better. W2ALW QSOed J2KJ (7070 kc.) on January 24th, 4:50 p.m. E.S.T.; he received S7; J2KJ was S6. W4CEN, North Carolina, lists some more or less rare ones in the "Tarheel Ham," which we reproduce here: EA8AL, 7130 kc., 9 p.m.; EA8AF, 7100, 9:25 p.m.; LU5CZ, 7150, 12:40 a.m.; SP1DE, 7025, 9:40 p.m.; SP1IA, 7040, 10:35 p.m.; YR5NP, 7140, 1:40 a.m.; HJ4ABG, 7150, 9:05 p.m.; YM4AA, 7035, 2:10 a.m.; LU1AD, 7170, 12:25 a.m.; SP1FI, 7150, 11:05 p.m.; CP1AC, 14,380, 5:50 p.m.; ZS6AM, 14,360, 4:50 p.m. These were all worked or heard during December.

A battle royal is in progress for the presidency of the "210 DX Club" between W8DVS, W8BSF and W8DWV. W8DWV holds the honor at present with 89 countries in his credit with his '10s. The club now has members in all districts except W2 and W7. ON4CC reports that ON4AC has

* 194 O'Heas Road, Coburg West, N. 13, Vic. Australia.

BRASS POUNDERS' LEAGUE

(December 16th-January 15th)

Call	Orig.	Del.	Rel.	Total	Call	Orig.	Del.	Rel.	Total
WBFLA	2000	14	3000	5014	W1MK	106	220	447	773
W1FFL	176	384	4401	4961	W6CXX	395	375	2	772
W2BCX	129	64	4489	4682	W9SGP	81	79	599	769
W3OK	1071	93	1794	2957	W3BZP	130	142	490	762
W8MOT	262	52	2409	2723	W3BEP	22	26	675	723
Y2EGF	150	69	1975	2194	W8BFA	74	20	619	713
W1ICS	524	152	1508	2184	W1JFS	115	44	536	695
W8GUF	208	163	1801	2172	KALEE	142	24	524	690
W3EOP	234	123	1656	2013	W1GKY	248	98	306	662
W8JE	888	119	748	1755	W6BPU	54	202	393	649
W8ADY	66	50	1598	1714	W9AZR	—	—	638	638
W1JDF	817	196	676	1689	W3FBM	2	5	616	623
W8LEZ	100	68	1291	1459	W5DXA	225	187	208	620
W8JID	—	—	1408	1408	W3BWT	127	101	392	620
W1AKS	270	121	974	1365	W9HUO	29	7	576	612
W2GGE	47	67	1245	1359	W9POB	178	36	396	610
W3EFM	91	4	1222	1327	W2HBQ	115	33	462	610
W9ESA	42	140	1118	1300	W9OUD	79	39	476	594
W9AJJ	180	102	1002	1284	W9OLG	50	10	530	590
W8MNN	211	520	547	1278	W9RJJ	133	109	345	587
W1IP	26	43	1196	1265	W6CDD	120	494	68	582
W3JTT	77	115	1056	1248	W9RIZ	31	32	512	575
W8CEZ	205	189	830	1224	W9HJC	—	—	575	575
W1ZQ	19	236	922	1177	W9KZL	101	106	353	559
W8CUU	139	289	706	1134	W8OQG	23	34	502	559
W3ANT	31	56	1040	1127	W8KWA	11	75	470	556
W8FAM	51	35	1015	1101	W2HBS	33	68	454	555
W2BGO	81	107	914	1082	W8LSP	62	33	456	551
W1IEG	8	100	963	1071	W8CJO	3	57	487	547
W4IR	23	152	880	1055	W2HZJ	187	133	226	546
W9KG	72	208	746	1026	VE3QK	38	66	438	542
W9FLG	33	115	840	988	W3ZT	139	114	288	541
W1TY	38	60	864	962	W8LMD	22	28	490	540
W1IB	700	143	104	952	W6JTV	37	61	437	535
R8NDH	399	176	292	867	W2GAS	135	41	356	532
KALLG	255	323	280	858	KALDS	118	62	350	530
K6FKB	210	190	456	856	W9ALJ*	78	42	406	526
W2GGW	56	80	720	856	VE3ABW	78	93	353	524
W9TGN	61	94	692	847	W1BVR	5	36	478	519
W3FTK	30	53	772	855	W3LDM	2	30	487	519
W1EWE	226	116	484	826	W3CDG	288	41	180	509
W8MQX	196	200	422	818	W3APV	48	24	436	508
W6BMC	20	43	749	812	W3VE	90	85	332	507
W1LXC	122	56	602	780	W3BYA**	23	34	448	505

MORE-THAN-ONE-OPERATOR STATIONS

Call	Orig.	Del.	Rel.	Total
WBNT	628	1422	2031	4081
W3SN	1390	521	1601	3512
KAIHR	1295	740	1032	3067
W3EOU	811	217	1334	2362
W1DCW	—	4	1527	1531
W3CXL	37	45	763	845
W4BBV	61	27	454	542
W4ABS	300	175	63	538

These stations "make" the B.P.L. with totals of 500 or over. Many "rate" extra credit for one hundred or more deliveries. The following one-operator stations make the B.P.L. for delivering 100 or more messages; the number of deliveries is as follows: Deliveries count!

W1FEZ, 220	W1EFE, 191	W7APS, 107
W1GHT, 211	W1BFT, 155	W9KJY, 104
W1FO, 210	W1AQW, 150	W5AMT, 103
W6CHD, 210	W5BXA, 128	W2GVZ, 102
	W3ZD, 117	

A.A.R.S. STATIONS

Call	Orig.	Del.	Rel.	Total
WLQA (W3OK)	—	—	1835	1835
WLVB (W6BMC)	14	35	1658	1707
WLQT	62	4	1322	1388
WLMI (W6GXM)	135	370	810	1315
WLNF (W2BCX)	60	14	1002	1076
WLUD (W9LEZ)	37	19	506	661
WLMF (W5EEW)	25	34	468	527
WLTJ (W9DDE)	72	91	344	507

A total of 500 or more, or just 100 or more deliveries will put you in line for a place in the B.P.L.

* November-December.

** October-November.

gone to Persia, where he will stay several months. It is expected that he will be on the air while there, so watch for a "new one"! As proof that DX can be worked consistently with moderate power, W8MAH submits the following statistics for his station for the year 1935: Power input to final — 100 watts; foreign QSO's (excluding VE)—584; different foreign stations worked—365; WAC—once; countries worked—68; frequency bands used—28, 14, 7 and 3.5 mcs.

In connection with the silent period observed on Sunday, January 26th, by British Empire stations in respect to the memory of the late King George, R.S.G.B. sent a message to A.R.R.L. advising of same so that word could be passed along. This message arrived at A.R.R.L. Hq. from several different sources, namely: By mail from W2CTC, who received from G6NJ; W2DVV, who received from G6VP; W1AQH, who received from G2TM; W8LEC, who received from G6WY; and W1DTJ.

W2CTC (ex-OH6AXW) reported on January 23rd that during the past month he had made about 250 foreign contacts in 33 countries and all continents! W9KA has been working a few of the rare ones: CPIAC, Bolivia; ZP2AC, Paraguay; YN1AA, Nicaragua; HJ22, Colombia; K7UA,

Alaska; all 14 mc. He worked J2LL recently at 0200 G.T. Inside of one hour W6GAL had two very FB contacts with VQ8AC and VQ8AF in Mauritius. He maintained daily schedule with VQ8AC. VQ8AF is "screechy d.c." about 14,350 kc., VQ8AC either 14,360 or 14,270, also a "screechy" note. The best times for west coast VQ8 contacts seems to be around 1600 G.T., reports 6GAL. GAL also says that TGIAF, broad r.a.c., 7015 kc., has been coming through lately. VU7FY, 14,386, and VU2CQ, 14,300, are consistent every morning from 7:15 to about 9:00 a.m., says W2AIW. His first contact with VU7FY made him WAC after more than 13 years on the air. W8BKP lists a few frequencies: SPIIH, 7150; YR5NP, T6, 7125; FB8AA, T9, 14,300; FM8D, T9, 14,280; SM5WZ, T8, 7200; OK1ZB, T9, 7150; SU1SS, T8, 14,350; CE4AD, T7, 14,400. W8BKP reports QSO with FQ8VB, January 4th, 3 a.m., 7 mc.

W1DUJ, Warren, Maine, sends some interesting items: Van, operator of NY1AB fame, is now working under call of W6GCX at Long Beach, Calif. ZS1AH is the chief of the Capetown Fire Department (according to ZS1AL). On January 25th, W1DUJ heard, identified, called and worked VK2RB, Sydney, a 'phone station. It is believed to be the

first Maine-VK 'phone contact. On January 26th, 1DUJ worked VK5LB, who changed to 'phone after contact was established, with fair results. The VK2RB QSO was most satisfactory, his 'phone being S7, readability 3-4, at WIDUJ. SX3A was logged at 2:27 a.m., January 28th, about 14,375 kc. WIDUJ reports a schedule with J3CR on about 14,300 kc, every evening at 0100 G. T. K4DRN, Virgin Islands, can be heard nearly every evening at about 5 p.m. E.S.T., near 14,350 kc. Next DX station hooked by DUJ after finishing with J3CR one night was CE3CR. HI, Signals from LU, CE, K5, ZL, ZT6 may be heard on 14 mc. between 11:30 p.m. and 2:00 a.m. E.S.T. for about two weeks of each month. WIDUJ has also heard K6, ZBI, ZEI and several Europeans at this time.

The usual quota of "ship QSO's" and "ships heard" are reported this month. WIDUJ heard XESM, while off the Brazilian coast, near high frequency and of 14-mc. band. W9MLF worked GTCP, the S.S. *Thistle Glenn*, on January 12th, 2:48-3:18 a.m.; this ship was outside the high-frequency end of the 7-mc. band, very rough note. 9MLF inquires whether any other hams have worked GTCP, and if so, how to send QSL's. W6LCD reports QSO with XESM, off Mexican coast, u.c. note. W1GBD on January 26th at 7:45 a.m. logged a station signing NR2BO on the 3500-kc. band and working W7BSU. NR2BO said he was on a ship 60 miles from Eureka, Calif. Has anyone any dope on such a station?

W3BZP believes in "service to his fellow ham"; when he hears a good bit of DX he passes the dope along. Logging F8IH RST 579 on 3545 kc. recently, he gave him a call, interspersing at regular intervals during the call F8IH's frequency for the information of others who might be trying to locate him! FB. From the Fifth District W5EHM sends some notes: Heard January 2nd—A CIAN, T9, 14,300 kc.; ZD8A, T9, 14,325. Among others coming through on 14 mc. between noon and 4:00 p.m. he lists FB8AA, T9, 14,300; FM8D, T9, 14,300; ZS6AF, ZS1AL, ZT6W and ZS6AL. EHM reports 7 mc. hot in early January, the 7th being the best night. Among those heard were F8PK, D4NXR, F8NE, G6RV, ON4GU, G6JZ, G6UF, PA0ZP, SM7RV (ship in Caribbean Sea). SPIFI and SPIDE came through FB nightly during the Spanish tests. W2HHF sends some helpful dope: South Africans FB in afternoon from 2:00 to 6:00; frequencies: ZU6B, 14,380; ZS6AL, 14,360; ZS1D, 14,340; ZS1AH, ZU1T, 14,280; ZT6Y, 14,300. VK's FB from 2:30 to 5:00 p.m.: HEF worked VK5GW, 5MD, 3MR, 3CN, 3RX, etc. VU2CQ coming through every morning about 9:00 on 14,265. T9, J2LL on 14,340 puts in FB signals; ZD8A (old VQ8A) puts in S7-8 signal on 14,310; CP1AC, r.a.c., 14,390, is old W2CDA. W2HHF worked U2NE, 7060 kc., T9, at 2:00 a.m. E.S.T. Europe comes through well at that time. Others heard by HEF: CE3EL CE3CR, r.a.c., 14,390; XU3CU, T8, 8:00 p.m., 14,050; TF3AG, T9, 14,295, 9:00 a.m.; ZT1Z ZT1R ZS6Y ZT6AK ZT6Q also FB on 14 mc.. EA8AC 7045 kc.

W4BCR worked VS6AC, 14,300 kc., January 2nd, 7:45 a.m., and is looking for his QTH. He also worked OM2RX, January 7th, about 7140 kc.; U2NE, January 3rd, 7100 kc.; and VU2CQ on December 7th and 12th, 14,260 kc. W9JEQ reports that he worked ZU6P and ZL1AK at about 12:30 a.m. C.S.T., January 24th (14 mc.), an unusual time to hear either of those parts of the world. Conditions were not normal that night. ZL's and VK's were coming in along with ZS and ZUs, at the same time OK4AA was tearing in, all S8; every signal heard by W9JEQ was DX; it was like a "ham's dream," he says. W6GAL worked VU2BG on December 24th at 0130 G.T. (14,405 kc.), a very unusual night; at 8:00 p.m. P.S.T. the same night he worked FB8AB! To start the New Year right W6GAL snagged VQ4CRO at 1600 G.T., January 1st; he was T9, 14,130 kc., and it was his first W6 QSO. W6GAL has been hearing ES1C on 14,020 kc., r.a.c., self-exc., 6GAL worked SPIDE for his 80th country with his '10s!! He worked ON4CJJ, about 13,390 kc., T9, and reports best time for reception and QSO on the west coast from 2100 to 2200 G.T.

O.B.S.

The following is a supplement to the list of A.R.R.L. Official Broadcasting Stations in November QST (page 60):

W1BFT, W2IYH, W3VE, W4DHG, W8EEQ, W8LUD, W9RPA.

3873-Kc. Club

The 3873-kc. Club, or "73 Club" as it is more familiarly known, was organized a short time ago, and up to February 3rd numbers 63 hams. The purpose of the club is to bond together in "good fellowship" those c.w. amateurs operating between 3850-3900 kc., to make possible better friendships between telegraphing amateurs in that band, and to encourage better occupancy of the 3900-kc. end of the 3500-kc. band. The prime activity of the club is rag-chewing. There are no dues, nor any formality about meetings. All that is asked of members is that they operate between 3850-3900 kc. as much as possible, especially during club periods: 7:00 to 10:00 p.m. (local time) each night. If your frequency lies within the club band, you are invited to join. Call "CQ 73" to raise club members. Just drop a post card, or send a message to W8JTT, 124 Temple St., Fredonia, N. Y., requesting membership, giving your favorite nickname and a brief description of your transmitter. Dope on your occupation is appreciated also. For more information contact any of these club members: W1CJD CJZ CKD EZ GKM GME GVV HYF IMY IWC JHK QV TS UE W2AMN CCZ CGG EGF FT'L HHH HNJ HXX HZY W3AKB BKZ EDC NF W6DNE W6FQU W8AIN BYM EUY GUF GXY HCS HKR JKG JQE JTT KWA LQC LWD MQC NJC NVJ NYY W9CCP KFI MZB PDE PSD PVZ SGP TIU VE3QK TM WX ZV W8KUN W9POB VE3AEM W1AFB W8DLK.

A 7-mc. Club, similar to the 3873-kc. Club, has been previously reported in QST—The 7294-kc. Club. This club is also dedicated to "good fellowship," and rag-chewing is the major activity. Any ham operating between 7200 and 7300 kc. is eligible to membership. Meetings are held daily at 7:00 p.m. and Sundays at 9:30 a.m., PST. The 7294-kc. Club now numbers close to 100 amateurs. For further details get in touch with W6ZX, 1821 Chestnut St., Berkeley, Calif.

The A.R.R.L. Emergency Corps New Members

THE following have recently qualified for membership in the A.R.R.L. Emergency Corps: W1FL W2BLU W2HOC W2JDO W3CX/L/WLM W4BTC W4BXL/BXM W4DSW W5EHK W6AZP W6BPU W6GTM W6IHK W7APN W8GWY W8HGG W8LAJ W8LLH W8MJJ W8NAW W8NCX W8OXI W9BSF W9CSJ W9GQN W9JQM W9KHC W9NQJ W9POB W9TYF W9URX W9PKB W9NIU XE1C VEZHE D.T.R.I. Radio Club (W98AL); Holyoke (Mass.) Amateur Radio Club.

At this writing membership in the A.R.R.L. Emergency Corps totals 153. The Corps comprises those amateurs and amateur organizations possessing equipment (transmitter, receiver and auxiliary power) suitable for operation in an emergency when regular power and communication facilities are disrupted. All amateurs having such equipment are invited to enlist in the organization. Simply send a post card to the Communications Department, A.R.R.L., West Hartford, Conn., listing in detail what emergency gear you have, including data on what frequency bands it works, etc., and stating especially what form of auxiliary power is available. A membership card, which also serves as a card of introduction, is furnished every A.E.C. member. See page 59, November '35 QST for complete details.

Briefs

The winter graduating class at the Benjamin Franklin High School, Los Angeles, has among its members five hams: W6KHZ, W6LHZ, W6LHY, W6LHW and W6MZA.

CLUBS! Many groups are getting started in earnest on an organized observing program in connection with the preparatory survey. You are cordially invited to drop a line to Hq. for full information and details, and log forms for those of your members who will help. In the Northwest Division

W. L. Miller, W7AAN, is doing an outstanding organizing job in the 8 mc. survey following out a 14-week program. In the Rhode Island Section, S. W. Atkinson, W1AFO, is progressing with a similarly successful 4-mc. survey.

Beginners Net

W2IHT is establishing a net on the 3500-kc. band for beginners using low or moderate power and sending at a speed newcomers can copy. This net is to cover the Second District and parts of the First and Third Districts. The net is intended to stimulate an interest in traffic handling among new hams and to bond together those fellows who are just starting in the game. Further information communicate with W2IHT, 26 Pierrepont St., Brooklyn, N. Y.

American Museum Expedition to New Guinea

Mr. Ewing Julstedt, W2IVN, is the radio operator of the American Museum of Natural History's Expedition to New Guinea. The purpose of the expedition is to collect specimens of birds, animals and plant life in a section of New Guinea hitherto unexplored. The expedition, consisting of a ground party and an air party, will be based at Daru, Papua, flying to Daru from Brisbane, a coastal trip of about 1500 miles. Several air trips are to be made over the territory to be explored, some of which is mountainous, ranging as high as 12,000 to 16,000 feet. The ground party is to be taken into the interior and left, with supplies to be furnished by the air party. The two groups will be kept in radio communication, the expedition having three complete transmitting sets.

KHAHX is the call assigned to the Fairchild amphibian plane. W2IVN advises that contact with amateur stations is contemplated from New Guinea. The party expects to be in that section for at least a year. Any amateur making contact with this expedition is requested to send details to A.R.R.L. for reporting in *QST*. Details of frequencies on which contact is established will be especially appreciated.

Station Activities

CANADA

MARITIME DIVISION

MARITIME—SCM, A. M. Crowell, VE1DQ—NOVA SCOTIA: VE1ER tops the list this month with the finest total in months, result of regular schedules well kept. GL, R.M. Bill Horne, says all who have not received the club circular re. the new nets, write in for copy giving complete address. HH has regular schedules with ER, GS and W1ESL. IV is on 3.5 and 7 mc. GB is active on 7 and 14 mc. EP and HG are trying 7 mc. for DX. New arrivals on 14-mc. 'phone: AW, AX, GR and ET, FO, GL and CP taking physical "jerks" at the "Y." FQ gets out well with his 1.75-mc. 'phone. BV and DW are on 3.9-mc. 'phone. HN is pleased with the results of his 'phone rig on 1.75 mc. BI will be on 3.9 mc. soon. CV is new man in Yarmouth. DN is remote-controlled—3.9-mc. 'phone, 3.5- and 7-mc. c.w. HJ is adding an 800, GV is QRL studies. CP rebuilt with metal tube in crystal stage. GC is going strong on 14 mc. IA is now located in Halifax with M.T. & T. IX and IL visited GL. GE has QSO'd 25 countries with his single '45. Following are working good DX on 28 mc.: DC, CO, EA and EH. CD is rebuilding Tri-tet. CE was transferred from Windsor to St. John, N. B. FE is crystal-controlled in 3.85-mc. 'phone band. EL has nice 3.9-mc. 'phone. GD is active on 3.9 mc. BT grid modulates 59's on 3.9-mc. 'phone. IM works lots of VE1's and 2's on 3.9-mc. c.w. DW, 8-watt 3.9-mc. 'phone, has new D.B. mike. HN gets out fine with his 5-watt 1.75-mc. 'phone. AR is installing crystal on 1.75 mc. IH is using series modulation and low power. HQ at Hebbville shows what can be done with '45's on 1.75-mc. 'phone. GR is going to install crystal for 14-mc. 'phone. EQ is rebuilding his 'phone. GK has new crystal rig. GF is new Truro ham. CU is new man in Yarmouth. FR is only active 3.5-mc. man in Summerside. P.E.L. AP is building super and rebuilding transmitter. BD and AF are rebuilding. BE is experimenting on 1.75-mc. 'phone. CV is back on 1.75 and 3.9 mc. again.

IU works plenty of "W's" on 3.5 mc. JB, North Minto, N. B., uses four '45's P.P. par. with 50 watts input on 3.5, 7 and 14 mc. GU blew his filter condensers. GN is still working on his 1.75-mc. 'phone. CJ (exGM) is QRL work. EC of the Radio Division R.C.M.P. has "cool" type antenna—one end attached to ice house. BL is getting out very well on 7 and 14 mc. BZ has been confined to bed with rheumatic fever. Very sorry, OM. HX is doing a bit of service work. EY has new rig—'47, 59, pair of '46's; he schedules W1AJS and is in line for O.R.S. It is our sad duty to record the deaths of two Maritime hams, VE1AO, who was electrocuted while at work on the transmitter at CFNB, and VE1II, who was killed by a fall of rock in the mine at Joggins. Our deepest sympathy is extended to their families. Newfoundland: VO4Y is first to work 28 mc. outside Newfoundland. 1G is new man with 30 watts to a '10 'phone and c.w. 1L is working "W's" in the wee hours of the a.m. on 3.5 mc. 1H is active on 7 mc. 1C has new Skyrider. 1P has '59—RK20 rig on 'phone and c.w. 1I, most outstanding VO 'phone, is now using remote control, working duplex 14-mc. 'phone with G5ML regularly. 1V, 3FM and 2Z are quite active. 1W is looking for bi-weekly schedules on Sundays—Weds. around midnight A.S.T. (attention, VE1GL). The Newfoundland Amateur Radio Association holds weekly meetings Monday nights at the homes of members. The committee elected on Nov. 11th was pres., VO1P; vice-pres., VO4Y; secy.-treas., VO1H. 1H is doing Cairo Survey work.

Traffic: VE1ER 189 GL 143 EA 1 HH 22 IV-GB 4.

ONTARIO DIVISION

ONTARIO—SCM, John V. Perdue, VE3QK—R.M.'s: 3GT, SRK, 3GG, 3DU, 3WX, 3TM, 3QK, 3SG. ABW makes Brasspounder's League. Congrats, Jeff VD hints at interest in 7-mc. traffic schedules. JT continues to work fine DX on 3.5 mc.; a VO, three ZL's, three G's, an HB and a K7 are his boasts in the past month's operation. IB manages to handle some traffic along with keeping chummy with his cronies on the higher frequencies. GT is looking for schedules on 3503 kc. between 7 and 7:15 a.m. JT is charter-member No. 9 in W.A.S. Club. ZE can't even hear four states for W.A.S. and is bound for 28 mc. for another try. AU is heard on 3.9-mc. 'phone and is interested in O.P.S. ER while operating on 3.9- and 14-mc. 'phone handles some fine traffic. CG earns the orchids for arousing DW and the Mrs. to the point of honest-to-goodness schedules once more. Congrats to you, Ken! WK continues FB on the Great Lakes Route (3TM, 3DU, 3VZ, 3WK and 2BU), which seriously challenges T.L. "I" for Ontario Trunk supremacy. 9AL wants a truck and fourteen men to move his new rig into his shack. The Hamilton gang scoffs at those who say Tigertown is asleep with fourteen reporters. QB is back in harness again, as is KM, whom Mr. "X" terms as "the modulated power leak." VZ and AEM hold down good schedules. DO has forgotten the code. ADF is going higher in the power range along with QU. PO sticks to 28 mc. QE, TO and OJ are QRL work. AFV is QRT while QSYing to new QRA. DU, besides doing fine traffic business, snoops on the London gang and tells us that: ACO is going great guns on his new rig, GC and HZ are on 3.8-mc. 'phone most of the time and on 1.75-mc. 'phone he hears ADC and AEV gabbling along and that the 7-mc. band feels the presence of KC, PA and TN . . . the Windsor gang was strengthened by the arrival of IK, who boasts of the latest design in ham shacks, and of ALL things, in Windsor's swellest hostelry. AHL and WA continue on 14 mc. AHE, CP, MY and ZV are all remodelling rigs. OH is heard occasionally from the sticks. AHN attended rummage sale at 9AG's and battled with the S.C.M. for items on the "free list." 9AG has gone Television on us in a big way when he and XA, FJ, FO and 9BW aren't guiding the destinies of CKLW and CRCW. Congrats to Ted and Bill, 9BW, on the arrival of Nancy Joy! TM plugs along with QK on TL "M" when not admiring his new license plates, which fairly scream "BY-88" and look pretty chummy alongside QK who has "BX-73"; RO and WJ fly "W-73" and "BY-73" respectively not to overlook WX who goes all one better with "7388"; all are members of the Essex County Brasspounder's League; and visit TM at 73 Talbot St., Leamington! MIM. And believe

it or not, all are members of the newly organized "73 Club" . . . tie that one! NX is enjoying 3.8-mc. 'phone along with GO and BF. BZ is QRL Cairo Survey work, FB, George! Wish we could say this about more of you. St. Thomas comes forth with a host of activity on 56 and 112 mc., the exponents of which are BM, ACK, NI who all watched 1935 do a "fadeout" in AFP's shack in a big way while HG pondered over how to acquire power for a pair of 211E's. From Kirklund Lakes comes a dandy letter authored by AGM who sees a pair '03A's ask questions that are answered through an HRO, and he tells us that AGG, who was VE2JI at one time, works FB DX on 7 mc. with 211D, that AFR runs up alleys and hides behind mine hoists when HCL's go on the rampage over his RK-20's, and all this time VN tries to dope out ways and means of holding the juice in his antenna condensers from a pair of '03A's and he, of course, would have to keep apace with a Comet Pro. AGI is after W.A.S. GG and ADP have a lot of fun trying to work each other on 'phone and keeping the dints out of Brass Hats when not handling a lion's share of Trans-Canadian Traffic. AA says that the "twin" business is kinda slow in Twin Falls; sorta Crumby, say we! PL is taking over RK's schedules and tells us that JL, MX and LC are Ottawa's 'phone delegates to the 3.8-mc. conference. Thanks for the host of reports, gang. Keep up the good work and the middle valve down so's we can continue going "round and 'round" other years of Ontario activity. 73. BCNU.

Traffic: VE3QK 542 ABW 524 G3 302 ER 142 TM 105 WX 77 AEM 75 WK 53 IB 42 DU 31 AU 24 CG 22 GT 8 VD 7 AGM-CP-ZE 5 AHE-QB 2 PL 1. VE9AL 37.

QUEBEC DIVISION

QUEBEC—SCM, Stan Comach, VE2EE—Winter activity is at its peak, blown-down antennas have been re-hung and the gang is on in full strength. To the newcomers, welcome. 2YL is a YL in old Quebec; LM has handled her first message. BU reports AX active again. AR is back in town. x2BO is also back in Montreal. DD is using a 211E final. IJ is tinkering around that '03A final. IQ can't decide what tubes to use. IY is on consistently, a hefty signal from low power. HF, HP, GD and ER are new 14-mc. 'phones. AB and EV are trying 28 mc. BO is thinking of a 14-mc. crystal to permit operation on 28 mc. LV is a newcomer, operating on three bands. JK is new O.R.S. EC is handling plenty of traffic. CO has rebuilt the transmitter. LQ is heard consistently from up North. Occasionally CU and GZ are heard. IO mistook a '47 for a '10, goodbye '47. GO has new transmitters. GM reports working a G6 on 7 mc. Our Hungarian Consul is HAF8B. HH had visit from KN and CS.3CA was a visitor in Montreal. Anybody wanting dope on crystal grinding ask LJ. BB schedules AP, EC, JK, KF, and IY. KK is still building. CR is trying 'phone again. DQ and IN are on 7 mc. exclusively. JT gets out well on 3.5 mc. AY is rebuilding. FG had his receiver overhauled, getting ready for the DX tests. DR is still busy with the usual schedules. AB has invested in an R.M.E. 69. BE paid a visit to Ottawa. How about some news, gang. Look elsewhere in QST for advance notices on the forthcoming Convention. Let's see you there.

Traffic: VE2DG 352 DR 319 EC 101 BG-BU 45 CO 67 HT 44 JK 18 GO 13 FG-HH 5 LV-LM 1 AP 51 EE 10.

VANALTA DIVISION

ALBERTA—SCM, Jim Smalley, Jr., VE4GD—LX worked so hard on traffic the dust got thick on his 'phone rig. BZ comes through with a nice total. The QK-GE schedule continues to click FB. YD sends the first report from Peace River. UY reports working lots of W stations on 28 mc. LA had his garage business go up in smoke and lost some radio equipment. If JJ and the Breakfast Club continue at their present rate they will be getting a sponsor for their programme. OD, AW and GD hold the long distance record for B.C.L. complaints with a distance of 85 miles! IO and NV are Calgary's first 1.75-mc. 'phones in some years. JK has come back to Calgary. BW has a new rig. GY is heard on 'phone. HM is still the most reliable station in Edmonton. DI was a Christmas visitor in Calgary. FI Junior has been missing University and ham radio both due to sickness. DR likes his Kea Klux. DX is now located in

Vancouver. FG has an antenna at last. IN has a good signal on both 3.9 and 1.75 mc. LM is heard on 14, 3.9 and 1.75 mc. OG is once more going strong. TM is going 'phone. XR and XS add their two cents worth to the 7-mc. QRM.

Traffic: VE4LX 259 BZ 77 QK 36 GE 24 UY 10 SD 4.

BRITISH COLUMBIA—SCM, Don Vaughan-Smith, VE5EP—How about an O.R.S. or O.P.S. appointment? If you can qualify, let's hear from you. Plans are going ahead for a Vanalta Convention to mark Vancouver's Jubilee year. Any suggestions that would contribute to its success are always in order. The whole VE5 gang it seems are behind the Amachever according to the response after that appeal in the Nov. issue! What, no W.A.S. (Worked All States)? 5GI reports European DX very consistent during last three months; Frank worked over 200 Europeans in this time on 14 mc. We take pleasure in announcing the appointment of B. W. Naylor, 5BI, as Official Observer. 5DG, way up in Pouce Coupe, handled traffic for Pilot McLaren on his Xmas flying trip to Liard River. FB and one up for the amateur! 5PT is using a pair of '10's, 50 watts, and has worked nearly all U. S. and Canadian districts.

Traffic: VE5CC 23 DG 4 FG 25 AV 100 BR 47 MK 26 OK 9 JL 29 NG 1 EP 55 GI 34.

PRAIRIE DIVISION

MANITOBA—SCM, A. J. R. Simpson, VE4BG—TO is heard consistently working DX on 7 mc. TJ is busy working ZL's and VK's. MW is very active on 7 mc. RO has pair of 880's in second transmitter. DU spends considerable time on 28 mc. QY is heard regularly on 14 mc., and tries 'phone occasionally. KX keeps busy on 14 and 7 mc. MY has migrated to 3.5 mc. QF has new transformer in high power supply. NI keeps busy on 14- and 28-mc. 'phone. QC is still using lock system on 211 final. VG is handling the rural schedules now in place of TV, who expects to leave Winnipeg shortly. MJ and SV keep busy on 3.5 mc. IP is heard consistently on 14-mc. 'phone. SS is causing plenty QRM on 1.75-mc. 'phone along with VD, ZL and VF. EK has a pair of RK20's working FB on 1.75-mc. 'phone. ZK is heard regularly on 7- and 14-mc. c.w. LL is having trouble getting enough excitation. NM is putting out a strong signal on 7 mc. Trunk Line station AG leads as usual with high traffic score.

Traffic: VE4AG 337.

SASKATCHEWAN—SCM, Wilfred Skaife, VE4EL—This month I want to voice my appreciation of the Trunk Line work. I have listened in to this line on 3690 kos. many times, and the way the traffic is passed along is a credit to this and the adjacent Sections and the A.R.R.L. If you are interested, listen in some night at 6:30 and see if you do not agree with me. XL is operating at Dundurn Camp. XM has an FB new monitor. WO has new t.r.f. receiver. BD tried 28 mc. with a little success. EB makes record of incoming QSO and re-transmits to the astonishment of the sender. YM is using a '10 and reports some DX. FY helps XM get bugs out of receiver. OH built new stage speech amp. LU plans 1.75-mc. 'phone. CM is still blowing junk. KM built new exciter unit. DB is getting FB results with new rig. OR rearranged station. UZ is having key click trouble. ES is getting good results on 14-mc. 'phone. OC plans P.P. '10's in final. VQ is collecting junk for new receiver. KA is going on 28 mc.; says it's FB. JU got the itch from the 28-mc. bug. PG finds '47 and 56 are not interchangeable. HI. JV hears lots of S. Africans on 14 mc. FW has new rig perking FB. OM will be on soon with new rig. RE is building 'phone outfit. IG gets very FB reports on 28 mc. with low power. KS is awaiting crystal. ZB, ZC and IV are new hams at Moose Jaw. Give them a call, fellas. KJ is still doing well on 'phone or c.w. with 3 to 4 watts input. WF sends in first report; his rig is '47 c.c. osc. and '46 buffer. TK booked a CM. GO is planning '47 c.c. osc., '10 buffer and P.P. 801's in final. FI has new rig, '47 c.c. osc. into '46 into P.P. '46's. MZ is heard by VK and EI. UR has trouble with his RK25; he gets out fine on 7 mc. when tuned to 3.5 mc. HI. RZ gets out well with 7 watts input. EM is new ham at Sovereign with '45 and '46. UL has two rigs: 33 c.c. osc. and P.P. '30's for local and 42 c.c. osc. and P.P. '45's for DX.

Traffic: VE4CM 284 MH 17 WF 10 EL 9 HI-UL 7 XM 5.

(Continued on page 76)

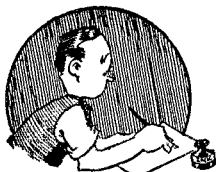

CORRESPONDENCE

The Publishers of QST assume no responsibility for statements made herein by correspondents

The Cairo Survey

Route 1, Box 257, Scappoose, Ore.

Editor, QST:

Please slip me the dope on the Cairo Survey. I have been rather hesitant about volunteering for this work because of my limited equipment, but I guess maybe I can be of some assistance. It looks like the League needs me and I'll be damned if I'll be a quitter, anyway! . . .

—Gordon A. Leap, W7BYQ

1015 College Ave., Iowa Falls, Iowa

Editor, QST:

VE3GG certainly hit the nail on the head. After reading his letter in January QST, I felt that I was sort of shirking, to say the least, in not taking part in the Cairo Survey. So even though I'm still in my last year of high school, I want to do my part in the Survey. Send me the dope right away.

—Harrison Lehmann, W9SQK

Alhambra, Calif.

Editor, QST:

The nature of my work makes it impossible for me to have any fixed hours on the air, but nevertheless I do have quite a bit of available time, and if I can be of any service in the Cairo Survey work would be more than glad to do so. . . . I visit most of the radio clubs in Southern California and . . . will be glad to give the boys a little pep talk and see if we can get some cooperation.

—V. G. Wiley, W6FGS

104 Logan Court, Raleigh, N. C.

Editor, QST:

. . . I would like to take part in the Survey. . . . I have listened for hours on end to commercial stations sending a series of V's de WBUNK de WBUNK V V V . . . I see no reason why amateurs should be crowded into narrow bands when between the amateur bands I have found blank spaces 300 kc. wide without so much as one signal.

I have been told by fellows at college that boys in school have no time for amateur radio. That may be true, but still I think I could find a few hours a day, and a few minutes to fill out a blank,

if I could have a part in obtaining new amateur frequencies. —Everett D. Thomas, W4DKM

EDITOR'S NOTE.—Since publication of January QST, 134 new Cairo Surveyors have volunteered, some representing groups which bring the total number of new volunteers to well over 200. A good percentage of these show that they were inspired by VE3GG's plea. How about you? Are you doing *your* part?

"AN OPEN LETTER TO ALL RADIO AMATEURS"

EDITOR'S NOTE.—Owing to space limitations, several portions of VE3GG's letter in January's "Correspondence" section under the heading "Cairo Survey" were necessarily deleted. These sections, indicated by dotted spaces in the January letter, follow:

Hydro, Ontario

Editor, QST:

. . . [Speaking of the type of man engaged in Cairo Survey work] It is then when he silently contemplates a situation where he has spent half a life time and thousands of dollars of his hard-earned income on his radio hobby, and compares it with his golf, which did not cost him one tenth of the outlay. His life membership in the golf club from its early inception, when three pioneers first broke the ground for the course, now assures him at least, that when he wants to use his clubs, he can, without having to choose between standing on the side lines, or scrambling through a horde of yelling youngsters chewing up the green with everything from a hockey stick to a claw hammer.

In spite of the fact that he knows statistics will show the bulk of our radio amateurs to be under 20 years old, that the majority of these are of high school age, that a large percentage of the radio licenses issued each year are taken out by boys who drop the game for good after the second or third year or earlier, depending upon the changes necessary when preparing for their career in life, and the natural susceptibility to YLitis, in spite of all this, I say, we find our bald-headed Cairo Survey man swinging his dial back to the job of logging the commercials and compiling his lists for Headquarters.

He realizes full well that each year a new swarm of transient and generally irresponsible youths are turned loose all over the precious amateur frequencies, coming and going annually like a blight, often crippling and rendering the bands useless half the time. He knows that any child of

sixteen years can, with three or four dollars put even Mr. Maxim himself off any sked he cares to make, and furthermore KEEP him OFF for as long as he wants, and, should Mr. Maxim, in a spirit of coöperation, try to work the child, HE himself is driven down to a sending speed which is the basis stem of half the QRM.

What guarantee has our friend of the Cairo Survey that even if his work helped to win new frequencies, that the same conditions will not prevail on the new assignments as prevails now on the present bands? None whatever! The new frequencies (if they ever come) are doomed to devastation already by the present system of licensing, and allotment of frequencies which allows any irresponsible kid who swears he can send at 10 per minute and get someone to draw him a diagram, to wallow around on ANY amateur band at will. An editorial some time ago in *QST* where an amateur was charged with perjury for "assisting" eight applicants to secure licenses gives an accurate cross-section of the intolerable situation in this respect. . . .

To the member of our organization who has the welfare of the A.R.R.L. the above paragraph will sound an ominous warning; on the other hand thousands of "transient amateurs" will not even bother to finish this article. Then, why in Heaven's name, should we persist in a policy which defeats our own ends by granting every Tom, Dick and Harry the same amateur status as your Cairo Survey men, right off the bat!

The situation has now developed to a stage where the following changes should go into effect at once:

(1) Forbid the issue of any more amateur license, until further notice from the A.R.R.L.

(2) Set a definite LIMIT on the strength of the amateur army, and keep the army up to strength by the re-issue of cancelled or abandoned licenses to new applicants. No new call to be issued on any account.

(3) Cancel all licenses held by persons under 18 years old, or any license held by a person with less than TWO years activity on the air, with promise of renewal if the Cairo Survey is successful in obtaining more frequencies for amateur use.

(4) No license to be issued in future to any applicant under 21 years old, on the grounds that a radio license for amateur work demands something more from the applicant besides a dubious 10 words per minute, and the scrawled copy of a radio circuit. It demands mental stability and sufficient intelligence to appreciate the serious responsibilities involved in becoming a member of the most remarkable organization the world has ever known.

(5) All newcomers to be assigned to a probationary band, other than the regular amateur bands. If new frequencies are not immediately available for this purpose, then—assign 10 kc. on each of the present bands exclusively to probationers giving them a "P" prefix until such times as they can pass a stiff examination on the "Q" list along with send and receive at not less than 20 words per minute. Frequency violation of a "P" station to cancel his license forever. We do not have to tolerate violators. The idea is to put an amateur license at a premium, where it rightly belongs, instead of something you can find in any ashcan.

(6) All "P" stations to report once a year by arranged sked with A.R.R.L. inspector for examination as to progress made towards minimum standards set by the A.R.R.L. Sub-standard performance in comparison to time license has been in force to be sufficient cause for the recommendation of cancellation. Inspectors to be appointed within reasonable operating range in every district from the staffs of the Q.R.S. or from the ranks of competent volunteers for such work.

(7) Two observations, not less than seven days apart, by an appointed A.R.R.L. observer of ANY station using a note other than xtal, or pure d.c. to be sufficient cause for cancellation. The seven day period between checks to be allowed as sufficient time for the operator of the offending station to have received reports from stations worked in regard to his note and same remedied. Station testing will not count as an observation; an actual QSO must be in progress before the Observer will record any infraction of this rule.

(8) All "P" stations to be silent from 24.00 o'clock local time every Sunday to 00.01 the following Tuesday, local time. . . .

—"Mike" Caveney, VE3GG

Cairo Suggestion

730 N. 6th St., Grand Junction, Colo.

Editor, *QST*:

In view of the fact that any demands by amateurs for additional frequencies at the Cairo conference are likely not to meet with over-enthusiastic response from commercial and other interests, it has occurred to me that it might perhaps be the part of wisdom for the amateur proposals to involve the ceding of portions of the existing amateur frequency assignments, in exchange for other more desirable allotments.

In this connection, I should appreciate hearing from you as to your reaction to the following system of amateur frequency assignments:

5 meters—56,000-60,000 kc.
10 meters—24,000-30,000 kc.
20 meters—14,000-15,000 kc.
40 meters—7,000-7,500 kc.
80 meters—3,500-3,750 kc.
160 meters—1,750-1,875 kc.

The advantages and disadvantages of such a system are of course immediately obvious, and I shall not discuss them further. They simply involve bargaining away some less needed for some more needed territory, and, while I am not very familiar with the actual process of reaching agreements at these conferences, I feel quite sure that such a plan of offering concessions in return for advantages desired would be more likely of success than would a plan of demanding favors while offering nothing in return. . . .

—Duane Magill, W9DQD

Hey, You "Ten"-Meter Gang!

Weyburn, Sask., Canada

Editor, *QST*:

This afternoon I was listening in on 28 mc. and found it to be quite active, with lots of 'phones coming through very well. On changing my receiving coils to go up to 20 meters, I was surprised to hear a large group of signals coming through in a new place. Knowing my 20-meter coils would not bring in 10 meters, and hearing a local on 20 putting a strong harmonic in the band, I wondered if all the other signals I could hear could be harmonics also. Imagine my surprise, however, when I heard W7—calling "CQ ten."

The point is that a large number of hams have their rigs and receivers working on the wrong harmonic [presumably the 3rd harmonic of 40-meter crystals.—EdRROR] and are working each other in a band supposed by them to be 10 but which actually is not. A check with my absorption frequency meter showed this. . . . How many ten-meter bands have we?

The new band was very well inhabited. [VE4UN lists some fifteen calls heard there.—EdRROR.] These fellows simply don't know any better. I hear them say "No DX" and "No 'phones." Well, they will find both on ten!

This matter appears to me to be of great importance and should be looked into at once.

—W. J. Mertz, VE4UN

January Editorial: Getting QSO

1928 Lewis Ave., Long Beach, Calif.

Editor, *QST*:

It was with somewhat mixed emotions that I read your contribution to the "The Editor's Mill" in the January 1936 *QST*, concerning calling and CQ'ing procedure; for right there before my eyes a supposedly-futile brain-child of mine was being dragged out of the moth-balls in which it had lain for five full years!

(Continued on page 48)

On Measuring Modulation at the Receiver

(Number Twenty-five of a Series)

WE HAVE received so many letters requesting information on how to measure the percentage modulation of received signals, that we can hardly do better than to start our third year of this series with a subject of such general interest.

Such measurements are by no means as difficult as is generally supposed. The connections are made as shown in the illustration at the right. The common terminal of the horizontal and vertical deflection plates is tied to the receiver chassis. The free terminal of the horizontal deflection plates is tied to the plate of the last I.F. tube in the receiver through a .5 mfd. blocking condenser, and also connected through a twenty thousand ohm resistor to the free terminal of the vertical deflection plates.

These simple connections are all that are required, but in making them certain precautions must be observed. Since this system is tied to the plate of the last I.F. tube, the wiring should be carefully made to have minimum capacity to ground, and the last I.F. transformer should be retuned after the connections are made.

The principle of operation is not complicated either. The signal is impressed directly on the horizontal deflection plates, causing a horizontal trace. At the same time, the signal is also impressed on the vertical deflection plates, but because of the 20,000 ohm resistor, the vertical trace is out of phase with the horizontal and an elliptical pattern results.

Three typical patterns are illustrated at the left, all reproduced from unretouched photographs. A National CRO Oscilloscope was employed, connected to an HRO receiver. The top picture represents an unmodulated signal. It is a single, sharp oval line.

If the signal is now modulated, the trace will be seen to widen to a ribbon, as shown in the second picture. It should be noted that this widening occurs in "both directions"; that is, the outside length of the oval increases, while the length of the inside dark area decreases. If these two dimensions are called D_1 and D_2 , respectively, the percentage modulation can be calculated from the well-known formula:

$$\text{Modulation} = \frac{D_1 - D_2}{D_1 + D_2} \times 100 \text{ (per cent)}$$

As might be expected, for 100% modulation, the dark area in the center of the pattern decreases to zero. This point can be determined quite accurately. If the signal be over-modulated, the illuminated area increases still further, and a bright spot appears in the middle of the figure. Such a pattern is shown in the lowest illustration. This last pattern is quite unmistakable, and looks for all the world like the revolving turntable of a phonograph with a record in place. The exact amount of over-modulation cannot be calculated, but this is not particularly important since all percentages of over-modulation are equally illegal under the regulations.

One or two precautions must be observed in interpreting the signals. The most important thing to remember is that the device measures modulation at the second detector of the receiver, not necessarily at the transmitter. Errors can be due to two sources. Defects in the receiver, such as cross-modulation, poor frequency characteristic and improper coupling of the H.F. oscillator, can all affect the apparent modulation. In a well-designed receiver the resulting error is quite small, and in any case, results can be readily checked by tuning in a transmitter whose modulation is known. Such a test can usually be arranged without any difficulty, since a large number of transmitters are equipped with oscilloscopes these days.

The second source of error is more of a variable. Static, heterodynes and similar disturbances appear at the second detector as a modulation of the carrier (since otherwise they could not ride through the receiver). Since these extraneous signals are superimposed on the regular modulation, they will make the signal appear to have a higher percentage modulation than is really the case. Therefore, in order to make measurements it will be necessary to have the signal out in the clear. Even when conditions are very bad, it will usually be found that there are moments when the signal is clear and a moment is enough when one is watchful.

We recommend that you try it out. In addition to being easy to rig, and fascinating to watch, a very useful monitoring service is performed. Unfortunately, many amateurs have not found it possible to equip their stations with oscilloscopes or equivalent equipment and measurements at the receiving end seem the best way to keep the air free from over-modulation interference.

JAMES MILLEN

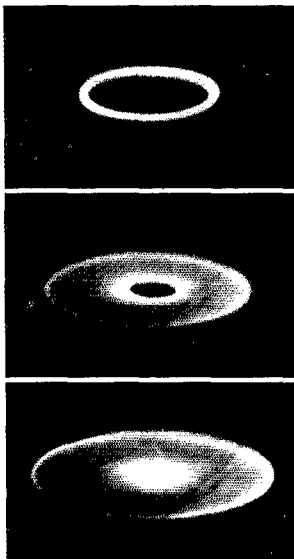
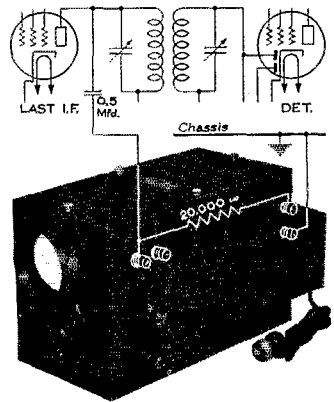

(Continued from page 48)

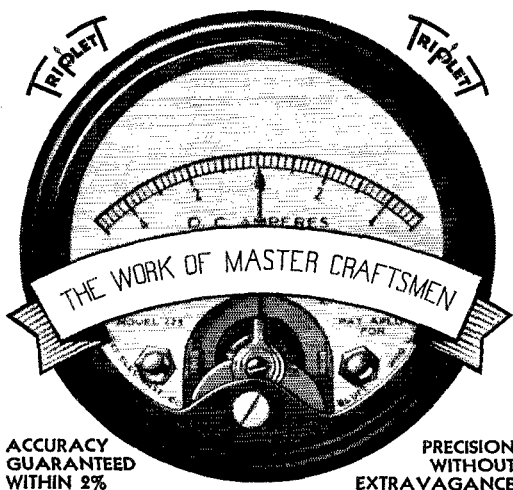

MODEL 223 D.C.

5-0-5 Ammeter

Here is shown a 2" metal case clamp-on type Ammeter—just one of Triplett's large line of Instruments. Made in Bakelite and metal cases. D.C. instruments are the D'Arsonval moving coil type, A.C. are the movable iron repulsion type with an outstanding design.

TRIPLETT MANUFACTURES

a complete line of all sizes and styles electrical measuring instruments for radio, electrical and general industrial purposes both standard and custom built. If you have an electrical instrument problem write to TRIPLETT.



MAIL THIS COUPON!

Triplett Electrical Instrument Company

253 Harmon Drive, Bluffton, Ohio

Please send me your new 1936 Catalogue.....

Name.....

Address.....

City.....State.....

I made a dash for my file of *QST*, and after thumbing through some ten ancient and dog-eared copies, I found what I was seeking. There, on page 56 of the December 1930 *QST*, was a letter I had sent in concerning the CQ-answering problem. At the time this letter appeared, the bands were crowded, but compared to present conditions, they were relatively unpopulated. The whole idea was to cut down the necessary calling time and to raise our batting average in contacts established. However, the addition of a couple of letters at the end of a CQ to indicate at which end of the band the CQer would start listening constituted superfluous signals in the minds of certain members of the amateur fraternity, and after a slight flurry of interest, the whole subject was laid on the table. Now, after five years, the subject has again been brought up in an improved and more comprehensive form, and the headquarters staff has indicated interest, so what is to prevent the idea from being developed to its fullest right now? If an idea has merit the amateurs will not hesitate to adopt it, once it is placed before them and its advantages pointed out. Let's keep after this thing until we arrive at something which will be acceptable to all concerned, and which will eliminate these five minute (or longer!) answers to a snappy 3 times 3 CQ!

—Orin C. Lewis, W6DZK

3959 Marathon St., Los Angeles, Calif.

Editor, *QST*:

Regarding your editorial in January *QST*, I can suggest one thing in this connection and that is that hams try electron-coupled oscillators as I have done and as several amateurs with whom I am acquainted are doing. It is very convenient to change to other frequencies in the same band quickly and accurately.

The e.o.-exciter unit is the most convenient and useful unit I have ever come across. In this connection, let me state that I have found it much more stable than crystal control unless an elaborate and expensive crystal oven is used. In fact, I don't care to ever go back to crystal control after using the electron-coupled oscillator.

I have done some extensive experimenting with electron-coupled frequency meter-monitors and the one I now have has never had to be re-calibrated but once since I built it and that was when I drove some nails into my receiver table without removing the frequency meter. Anybody that will do a trick like that ought not have a good instrument (hah). It was built late in 1934 and held its calibration to 100 cycles for ten months until the above incident occurred, and when I re-calibrated it, it held its calibration up to the present day. I have no doubt it is closer than 100 cycles but the curve I have won't show any closer than that. At present I am not on 'phone, but on c.w. the ability to change from one frequency to another is mighty convenient. . . .

—Leland R. Ford, W6GXN

825 West End Ave., New York City

Editor, *QST*:

. . . On the difficulty of getting QSO, I believe you have overlooked the more important points of the question.

Most hams, nowadays, have much better receivers than they had a few years ago. They bring in more signals that can be copied, so that besides the greater number of signals of good intensity we can also bring in a larger number of weaker signals. Therefore it takes much longer to tune across the band after a CQ. Also the fellows are making their answering calls shorter (in most cases a good idea) due to your insistence on calling 3 times 3, so that there isn't much use in looking over more than one-third of the band after a CQ.

It seems to me that the solution to the problem you have mentioned lies in the general adoption of "break-in." If that were done, a fellow who had sent out a CQ would know that he was going to be called until he answered someone, and therefore he would be able to tune over the whole band. It would mean longer calls and, in one way, more QRM, but that would be offset by the fact that everyone would stop calling as soon as our CQer pressed his key again. To prevent the continuation of calls from fellows who might not have been heard, the ham who sent CQ and heard no reply, if he elected not to send another CQ, could send TEST once or

Start with This!

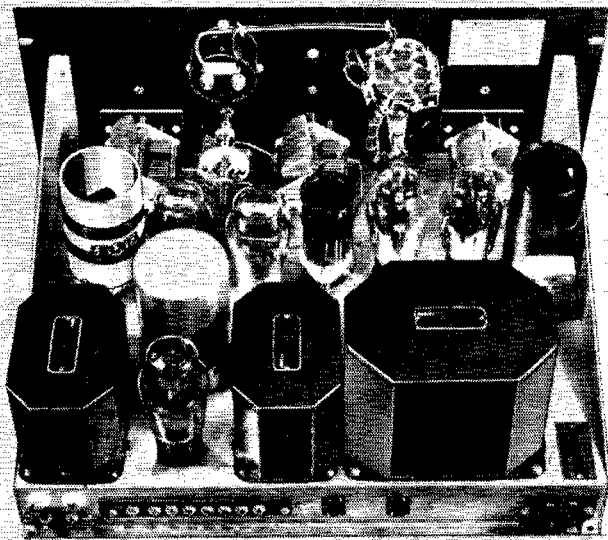

ACT-40-R, the r-f unit of the 40-watt RCA amateur transmitter. Net price to amateurs, \$110, f.o.b. Camden, with one set of coils but less crystal and tubes.

AMATEURS who wish to acquire complete RCA factory-built and factory-tested transmitter equipment recently announced may begin with the RCA ACT-40-R. This is a complete r-f unit, including power supply. With a minimum of accessories it can be used as a 40-watt C-W transmitter, giving you in every respect the highest standards of quality and performance. The ACT-40-R is particularly useful as an exciter unit for high-power stages, eliminating the necessity of building your own multi-band exciter unit. The unit may also be used as

the power stage in association with your present modulator and antenna coupling units, if desired . . . Plug-in coils permit operation on 160, 80, 40 and 20 meters. No change in neutralization is usually required when shifting to adjacent bands . . . This rugged, convenient unit permits you to go on the air at once with RCA dependability. Later, other RCA units may be added for operation on phone as well as C-W, with 40 or 200 watts. Thus the RCA unit plan of construction again demonstrates its great advantages to you. Write for complete details.

AMATEUR RADIO SECTION



RCA Manufacturing Co., Inc.

Camden, N. J., a subsidiary of the Radio Corporation of America

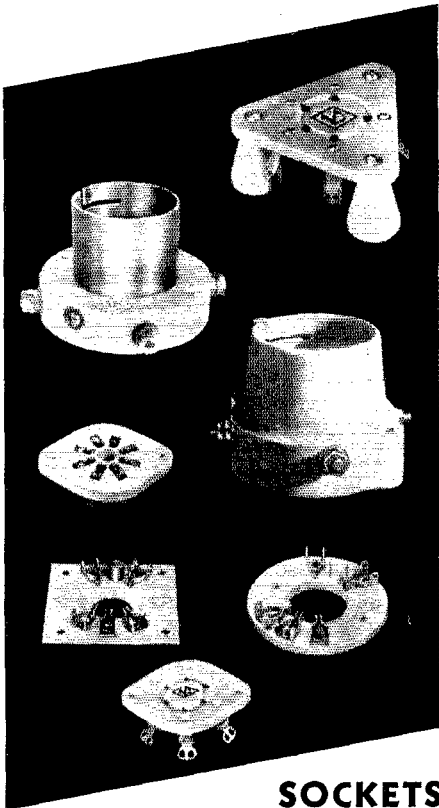

SOCKETS

■ National has a socket for every amateur need. A few are pictured above. At the top right is the big JX-100, a wafer-type low-loss socket for power pentodes such as the RK-28 and RCA-803. Below it are two fifty-watt sockets with sturdy side wipe contacts. Type XC-50 is entirely of low-loss Steatite, while type XM-50 employs the more conventional metal shell and is lower in price. Next comes the Isolantite wafer socket for Octal (metal) tubes, followed by two sockets for acorn tubes. The acorn pentode socket is assembled on a square copper base and has built-in by-pass condensers for stable high frequency operation. The Acorn triode socket has an Isolantite base. And last, but by no means least, is the amateur's favorite receiving tube socket.

NATIONAL COMPANY, INC.
MALDEN, MASS.

twice and sign to stop everyone from calling him. Or some other signal could be devised to signify that a fellow had heard no answer to his CQ and was going to look for CQ's himself.

Certainly the use of "break-in" is a great source of pleasure and it should not be hard to sell the idea to hounds. They should be told again how it lessens QRM by saving unnecessary talk on the air; i.e., preventing the full repetition of a long description which is the inevitable result of QRM, QSB, or some misunderstanding; facilitating the handling of traffic, etc. . . .

—S. P. Mainthou, W2DVO

131 Washington Ave., Oakmont, Pa.

Editor, *QST*:

Consideration of the third subject in your editorial in January *QST* brings to mind a scheme used here several years ago to adjust the transmitter frequency rather quickly to any point in the band. A description of the outfit appeared in July 1929 *QST*. It may be that, with the stable oscillators now possible, such a device could be constructed having a practical degree of stability, while at the same time being capable of rapid adjustment to any desired frequency.

One thing is certain. If it were possible to place one's transmitter frequency exactly in accord with that of a station just in the act of signing off, the station with whom he was communicating could easily be raised with a short call.

It would seem that if we can make our receivers stable, and at the same time readily adjustable, the same thing could be done with our transmitters. Of course, a number of factors immediately present themselves for consideration. Antenna efficiency, methods of feed and coupling, rapid monitoring, and frequency stability with changes in temperature, are a few. Possibly others would develop.

I have many times stated my conviction that the crystal, as a means of frequency control, is a makeshift, locking a transmitter to a certain frequency, and sooner or later will have to give way to some other method of control which will also lock the frequency but allow adjustment as well.

Perhaps this problem is just one more of the supposedly tough ones that come along for the amateur and which, under the spur of necessity, he just naturally goes ahead and works out.

—A. W. McAuly, W3CEO

January Editorial: 'Phone

Zanesville, Ohio

Editor, *QST*:

I read with considerable interest your editorial in the January issue. I agree with it for the most part, but wish to take exception to one part. I heartily agree with your stand on broadcasting for entertainment purposes. It is not only unsportsmanlike but illegal. So much for that. But why can't we acknowledge SWL cards? I average about two SWL cards a day and have always answered them all. It has cost me a little but so has my interest in amateur radio; in fact, my chief hobby is amateur radio. You certainly admit that it is not necessary to have a station to be an amateur. I don't mean that you can transmit without a station, but transmitting is only one half of radio, the other half is listening. It is highly probable that a sizable bunch of folk are interested in transmitting who will never own a transmitter; but still they are very much interested. Now why can't these folks take an interest in things that are going on in radio to the utmost of their ability without being ignored by folks that are in a more fortunate position as regards to transmitting? Some of our good musicians are not players of instruments, they are listeners. I'll venture that quite a sizable number of readers of *QST* are not possessors of transmitters. They may join the relay league without ever pounding brass or stuttering over a mike; just an interest is all that is required. Did you ever consider, which you no doubt have or you would never have mentioned it, that these folks who send SWL cards are actively interested in ham radio? They show that or they would never take the trouble to send a card. I hear someone say, "Well, I like to get DX SWL cards, but I don't care for cards from locals and short distances." Don't you realize that some very good friends can be made around your own town by taking an interest in these SWL? Also a good feeling can be cultivated by being courteous and replying to these cards. Some of my very best

COMPLEX PROBLEMS

PROBLEM: How many turns on a 1 1/2" diameter form 1/2" long must I use with a 25 μmfd condenser to tune to 4000 kc.?

$$L = \frac{10^8}{(2\pi f)^2 C} \text{ MICROHENRYS}$$

$$f = 4 \times 10^6 \quad C = 25 \times 10^{-6}$$

$$L = \frac{10^8}{(2\pi \times 4 \times 10^6)^2 (25 \times 10^{-6})}$$

15776	1000000.0
	94656
	53440
	47328
	61120
← 63.4 MICROHENRYS	

$$N = \sqrt{\frac{3A + 9B}{0.2A^2} \times L}$$

$$A = 1.5 \quad B = 0.5 \quad L = 63.4$$

$$N = \sqrt{\frac{(3 \times 1.5) + (9 \times 0.5)}{(0.2)(1.5)^2} \times 63.4}$$

$$= \sqrt{36 \times 63.4}$$

$$= \sqrt{1266}$$

$$= 35 \text{ TURNS}$$

ANS.

1.5	1.5	1.5	1.5	1.5	1.5
1.5	1.5	1.5	1.5	1.5	1.5
2.25	2.25	2.25	2.25	2.25	2.25
0.75	0.75	0.75	0.75	0.75	0.75
0.450	0.450	0.450	0.450	0.450	0.450

20	20	20	20	20	20
1000	1000	1000	1000	1000	1000
25	25	25	25	25	25
150	150	150	150	150	150
63.4	63.4	63.4	63.4	63.4	63.4
17670	17670	17670	17670	17670	17670

become simple with

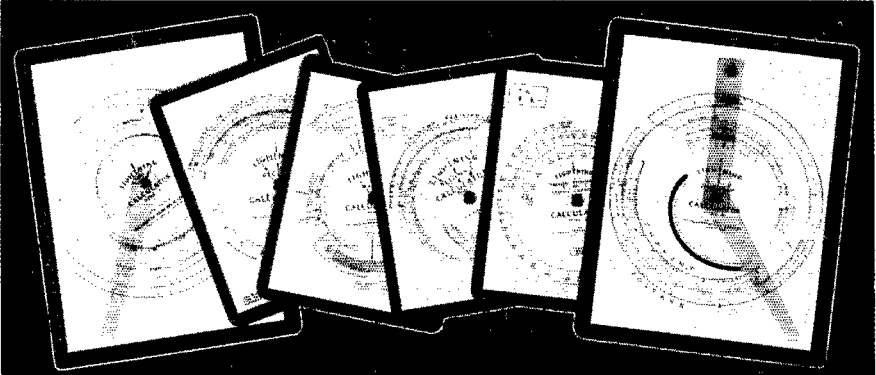

LIGHTNING CALCULATORS

SIX Types to Cover ALL Problems

TYPE A — For problems involving frequency, inductance and capacity, in design of radio frequency circuits. Direct reading answers for size of coils and condensers for any range between 400 kc. and 150 mc. Price, \$1, postpaid.

TYPE B — Gives direct reading answers to calculations involving current, resistance, voltage and power with scale for resistance of copper wire and scale for calculating decibel gain or loss. Price, \$1, postpaid.

TYPE C — More information on electrical conductors than you could find in a book full of tables. Price, 50c, postpaid.

TYPE D — Gives decibel gain or loss when input and output voltages, currents or power are known. Price, 50c, postpaid.

TYPE E — Direct reading total resistance of resistors connected in parallel, and total capacity of condensers connected in series. Price, 50c, postpaid.

TYPE F — Permits measurement of resistance, from 1 ohm to 1 megohm by use of a voltmeter. Makes an ohm-meter of your voltmeter. Price, 50c, postpaid.

AMERICAN RADIO RELAY LEAGUE, INC.
WEST HARTFORD, CONNECTICUT

EVEREADY

PLUG-IN

RADIO BATTERIES



Simplifies Battery Connections. Socket firmly embedded in the battery seal. Can't come loose.

Adapter furnished with each battery. Connect up once to adapter. When replacing batteries, remove adapter from old battery and place in socket of new battery. Prevents mistakes in connecting up.

"Sealed Socket" construction now available on all popular types of Eveready "B" and "C" batteries.

Headquarters for Battery Information

NATIONAL CARBON COMPANY, INC.

General Offices: New York, N. Y.

Branches: Chicago, San Francisco



Unit of Union Carbide and Carbon Corporation

friends in radio have been made in this way. From my letter you may get the idea that I am a newcomer in radio. This is far from the facts. I have been interested in radio since 1912 when I had my first receiver, one of the old Navy tuners with a loading coil that was quite long. I forget just how long, but it was plenty big. Then in 1920 I became interested in radio from a broadcasting angle, as a lot of other experimenters did. I was content to listen and experiment until 1932, when I obtained my transmitting license, and have been on the air ever since. I know it sounds sophisticated to grumble about SWL cards, etc., but I don't think it reflects the spirit of ham radio and wish to take this opportunity to express my disapproval. . . .

—Chas. W. Cover, W8KVJ

EDITOR'S NOTE.—The editorial in question objected not to acknowledging SWL cards by means of QSL cards or letters, but to their acknowledgment *over the air, à la* early broadcasting stations and their fan mail. Discouragement of short-wave listeners is certainly not *QST's* policy; preservation of amateur radiotelephone as a two-way communicating medium, as opposed to illegal and unethical private broadcasting, most assuredly is.

207 N. Arden Drive, Beverly Hills, Calif.

Editor, *QST*:

I certainly agree with the editorial in this month's *QST* about 'phone procedure, especially the entertainment part. After hearing a certain W6 last night I am so mad I can't see straight! His transmission was something like this:

He talked for a minute or so to the fellow he had the QSO with, and then began strumming on a guitar and singing slightly off key. After a few songs he said, "W6— has just completed a modulation test and is not broadcasting for entertainment purposes." There was a little more talk and then he said, "And here's a modulation test for so-and-so," and again burst into song. He made several "modulation tests" for various friends, in the meantime cluttering up the air while someone with a message may have been QRM'ed and many persons were undoubtedly annoyed.

The ham bands are overcrowded with good operators and we don't need these fakes who not only break the F.C.C. rules but destroy the amateur spirit.

I wish that the League would start a drive against these fellows. With all the fine hams on the air we could get rid of the offenders easily if we got down to business. How about it?

—Irene Kahn

Pentodes as Class-AB Amplifiers

(Continued from page 29)

The type of distortion present depends upon the signal level. At low levels only the second and third harmonics are present, the second harmonic being attributable to the driver stage. Higher-order harmonics do not appear until the output is about eight watts (at this level the total distortion is approximately 2%) after which the fifth, seventh, ninth, and eleventh harmonics appear. These harmonics represent an appreciable part of the distortion at maximum output.

The input transformer efficiencies given above are average for the type of transformer. The leakage inductance should be small. Any serious deviation from the ratios specified will result in either lower power output or increased distortion.

Experimenters' Section

(Continued from page 34)

across them. Screw down the adjustment screw on the buzzer so that it clicks instead of buzzing.

The clicks will stay in the buzzer and out of BCL sets. At W3EEK all interference with the family b.c. set is stopped although the transmitting aerial runs not five feet from the b.c.

THE ALL-STAR BUILD-IT-YOURSELF TRANSMITTER

See page 83, Feb., 1936, *QST*, then send for circular which gives full details. A high power job (400 watts input) composed of finest parts such as Thordarson, Hammarlund, etc. All chassis and panels are punched, chassis being cadmium finish, panels black crackle finish. Save by building it yourself.

	<i>Less Tubes</i>	<i>With Tubes</i>
40 Watt RF Unit.....	\$37.90	\$50.12
Low Voltage Power Supply.....	29.90	30.42
RF Amplifier.....	46.24	82.24
High Voltage Power Supply.....	52.75	57.25
Two Hundred Watt Modulator.....	27.78	63.78
Speech Amplifier and Power Supply..	35.38	39.54

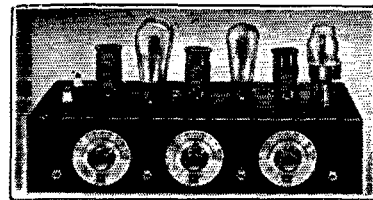

'47 as crystal oscillator, one '46 as buffer or doubler and two '46's in the amplifier stage, set of three coils supplied with kit for 20, 40, 80 or 160 band. Additional coils 75c each.

Complete kit, less tubes and crystal.....

GROSS C C TRANSMITTER — OUTPUT 25-30 WATTS

The "CW-25" transmitter kit due to its low cost makes it possible for anyone to own a modern crystal controlled station. A schematic hook-up and parts layout sheet as well as tuning instructions are furnished, thus enabling the most inexperienced operator to wire and put the set on the air, for real results. The "CW-25" is supplied with a shrivel finished sturdy metal chassis under which all parts are mounted, making the wiring and components dust-proof. A plug-in crystal holder is furnished with the kit. Only one milliammeter is required for tuning the transmitter and each stage is provided with a jack for this purpose. The "CW-25" uses one

milliammeter is required for tuning the transmitter and each stage is provided with a jack for this purpose. The "CW-25" uses one

\$14.95

P-25 POWER SUPPLY — for CW-25 transmitter with matching chassis — \$11
450 volts at 200 MA, choke input — complete kit, less tube.....

OUTSTANDING !!

Gross Crystal Holder

WHITE CERAMIC commercial type crystal holder — priced at less than ordinary holders. Adjustable pressure, dust proof, no tools required to open. Takes crystal to 1 1/4" square. Plugs standard 3/4" spacing. Most efficient job yet..... **\$1.00**

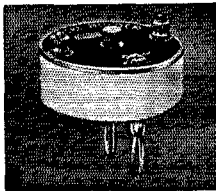

THORDARSON [CASED] TRANSFORMER

600 volts each side of C.T. 200 MA 2 1/2 V. 10 amps. C.T., 5 V. 3 amps. 7 1/2 V. 3 amps. C.T.....

\$2.45

THORD. CHOKE 12 H 250 MA..... **\$1.95**
THORD. 15 H 250 MA CHOKES..... **\$2.95**

MAC-KEY Semi-Automatic and Straight Junior Model..... **\$7.95**

BARR DB3 TRANSCEIVER

less tubes, batteries and accessories. Bulletin on request. **\$16.20**

Cased Combination Filament Transformers
2 1/2 V. C.T. 10 amps. for 866's.
10 V. C.T. 7 amps. for '50's or '52's.
10,000 Volt Insulation..... **\$3.25**

GROSS CASED POWER TRANSFORMERS

650 v. ea. side C.T. 350 ma. fila. 2-7 1/4 v C.T. and 1-5 v will give 500 v with choke input using 83 or 5Z3 tubes. You can run your entire R.F. and class B off this trans..... **\$5.50**
750 v. ea. side C.T. 300 ma. fila. 2-7 1/4 v C.T. and 1-5 v..... **\$5.65**
750-1000 v. ea. side of C.T. 300 watts. **\$6.65**
850-1350-1500 v. ea. side of C.T. 400 watts..... **\$8.75**
(The ideal job to give 750-1000-1250 v D.C. with choke input)
850-1350-1500 v. ea. side of C.T. 550 ma..... **\$12.50**
1500-2000 v. ea. side of C.T. 800 watts. **\$11.70**

BLILEY CRYSTALS

Largest stock in New York

HF2-20 M Mounted Crystals... **\$7.50**
BC2 Crystal Holders..... **\$1.00**
BC3-40-80 M Mounted Crystals. **3.95**
LD2-40-80-160 M Mounted Crystals. **\$4.80**

Exact Freq. if in stock or within 10 KC

NEW!! HOYT BAKELITE CASE HOT WIRE ANTENNA METER

3 3/4" Across Flange, Mounts through 2 1/2" hole. Scale Length 1 1/4". Ranges: 0/1.5; 0/3; 0/5 Amps. **\$3.50**

TAYLOR TRANSMITTING TUBES

866 Heavy Duty..... **\$1.65**
825 Carbon Plate 40 Watts 750 V. **4.95**
203-A Carbon Plate..... **12.50**
203-B Metal Plate..... **7.50**
HD203-A Carbon Plate — out of top. **\$17.50**

GUARANTEED TUBES ISOLANTITE TOPS

800 Carbon Plate..... **\$5.35**
866-A 10,000 volts inverse Peak... **1.85**
203-A Carbon Plate..... **8.45**

FARADON ALUMINUM CASE PYREX INSULATED MICA CONDENSERS

Capacity .01, 5000 v. working voltage. 20 amps at 1000 K.C. Spec..... **\$3.95**
Type WC2267-A (Regular \$15.00)

HALLICRAFTERS SUPER-SKYRIDER

Complete with 9 Metal Tubes... **\$79.50**
Same as above. With Crystal... **89.50**
See Technical Article P. 36 Aug. *QST*.

EIMAC UNSURPASSED TRANSMITTING TUBES!

Performance — Ruggedness — Power — Price
50-T Output 75 to 250 watts... **\$13.50**
150-T Output 150 to 450 watts... **24.50**
300-T Output 350-700 watts... **60.00**

TRANSMITTING FILTER CONDENSERS

Compact, cased, with standoff insulators
Working Voltage
1000 V. 1500 V. 2000 V.
1 mfd..... **\$1.10 \$1.45 \$1.75**
2 mfd..... **1.45 2.00 2.45**

20% DEPOSIT WITH ALL C. O. D. ORDERS

REMIT BY M. O. INCLUDE POSTAGE

Cable Address: GROSSINC

GROSS RADIO, INC., 51 VESEY STREET, NEW YORK CITY

FOR ALL BANDS

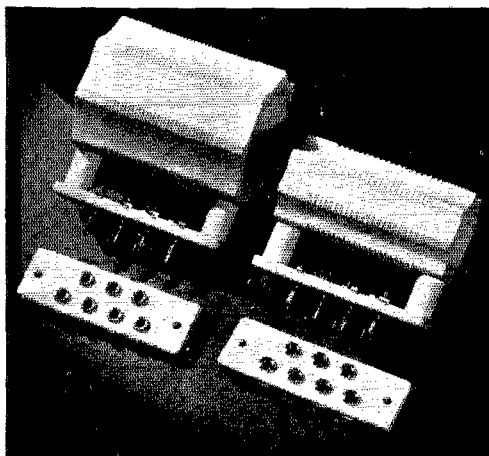

Type 677-Y

Type 677-U

MANY thousands of amateurs are using the General Radio Type 677 Coil Form, in preference to more expensive forms, in oscillator and low-power amplifier stages. These forms are entirely adequate for such use with power up to 50 watts.

The Type 677 Form may be used with or without the plug-in features. The plug and jack bases are sold only with plugs and jacks.

SPECIFICATIONS

	Type 677-Y	Type 677-U
Length.....	4 $\frac{5}{8}$ inches	4 $\frac{5}{8}$ inches
Diameter.....	3 $\frac{7}{8}$ inches	2 $\frac{7}{8}$ inches
Threads.....	30	21
For Use On.....	160 and 80 m	80, 40 and 20 m
Maximum Wire Size	12 B and S	10 B and S
Price (form only)...	75 cents	50 cents
Type 677-PI Spacers: 30 cents per pair		
Type 678-P Plug Base (with 7 plugs): 70 cents		
Type 678-J Jack Base (with 7 jacks): 65 cents		

Order direct from this advertisement, including remittance, and we ship prepaid anywhere in the United States

For catalog of many other amateur parts ask for Bulletin 936

General Radio Company

Cambridge, Massachusetts

set's antenna. Care must be taken, however, that the buzzer does not "buzz" or the signal will be modulated or sound chirpy.

—D. Kaufmann, W3EEK

A Monitoring Kink

Owners of superhet receivers will be interested in this simple method of using their receivers as monitors. It is suggested by John N. Montgomery, 3rd, W8HWU, who writes:

"Here is a very simple monitor which costs nothing to build. Just place the send-receive switch in the lead from the first detector and r.f. tube cathode resistors to ground. When this circuit is broken the oscillator tube acts as a frequency meter-monitor when tuned to the local transmitter. This has worked on every super which we have tried it on, including several commercial receivers. It was tried originally to prevent r.f. in the antenna from burning out the r.f. gain control, but has worked so well as a monitor that I would not be without it. The only disadvantage is that the set has to be tuned to the transmitter in order that the signal may be heard on each transmission, which means that it must be retuned on each transmission during a QSO."

I.A.R.U. News

(Continued from page 36)

yet! Then come the 50-watt stations, ZE1JB, ZE1JE, ZE1JF, ZE1JR and ZE1JU. ZE1JB uses a T61D, ZE1JE and ZE1JF use RK20's, ZE1JR uses a Collins commercially-made transmitter with a 203A in the final, and ZE1JU a DET1.

"There are not many stations in the country and so there is not too much QRM; at times it is absolutely nil. ZE1JM and ZE1JR are both WAC on 'phone, ZE1JM being also WAC on c.w. ZE1JB, ZE1JJ, have WAC certificates, ZE1JN, JS and JU have applied for their certificates. One evening ZE1JN got WAC in 3 hours, 20 minutes, ZE1JS 3 hours, 45 minutes. ZE1JU has been very successful on 10 metres with numerous contacts. ZE1JN has four countries to his credit on 10 metres. Both these stations have called numerous American stations on 10 metres but with no luck.

"That is all there is to it. I have given the tube used so that the stations can be classified. Some, of course, are not using the maximum input to the tube, but we are not bluffing when we say that our power is around about 50 watts. The difference in signal strength may be the difference in the S. S. superhet you use in America and the battery driven TRF-D-LF receiver used over here."

A.R.R.L. QSL Bureau

FOR the convenience of its members, the League maintains a QSL-card forwarding system which operates through volunteer "District QSL Managers" in each of the nine U. S. and five Canadian districts. In order to secure such foreign cards as may be received for you, send your district manager a standard No. 8 stamped

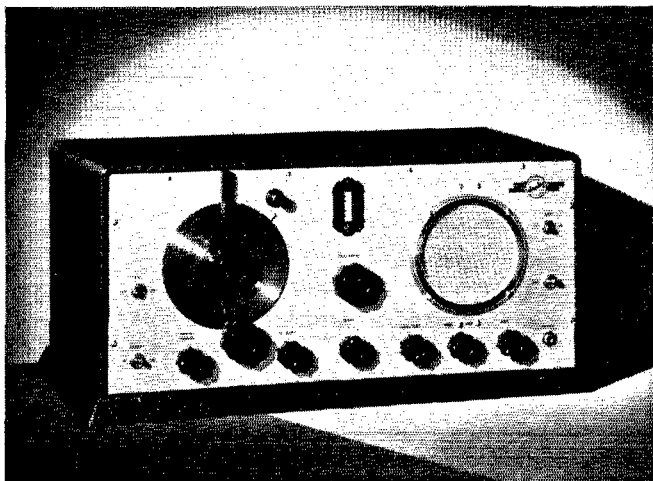

the
**SUPER
 SKYRIDER**
 is
COMPLETE!

THE HAM that buys a Super Skyrider with Crystal Filter at \$89.50 is buying all that he needs for short wave reception. Here is a receiver that covers the radio spectrum with unsurpassed efficiency, including the standard broadcast band and the 10 meter band, so active of late. Recent Hallicrafters' laboratory developments have greatly increased the Super Skyrider efficiency on this particular band.

It's complete, without a single extra to buy, with a convenient band switch (no cumbersome plug-in coils), controlled Crystal Filter Circuit (an absolute necessity on any receiver because of amateur band congestion), 9 Metal Tubes with their superior performance characteristics, Iron Core I. F. System (first used on the Super Skyrider) and a dozen other exclusive Hallicrafter developments.

Think of these features when you're buying short wave reception, and see the Super Skyrider at your jobbers today. It's supreme for short wave reception and complete at a single moderate price.

- **9 Metal Tubes** — Dovetail perfectly with our efforts to improve signal to noise ratio — eliminate noisy tube shields — reduced inter-electrode capacities and shorter leads afford greater gain.
- **Iron Core I. F. System** — greatly increased sensitivity and a signal to noise ratio unattainable with an air core system.
- **Duo-Micro-Vernier Band Spread** — provide improved logging accuracy; — provides electrical band spreading and micro-vernier tuning in an exclusive and distinctive dial.

- **More efficient Crystal Filter Circuit**, controlled by variable knob on front of set gives one signal selectivity — without reducing sensitivity.
- **Beat Oscillator** with continuous range.
- **Modern Band Changing System** — any desired bands in the short wave spectrum with the turn of an exact positive switch — no cumbersome plug-in coils.
- **Compact** — all completely enclosed in one convenient and efficient cabinet 19 1/4" x 10" x 10".

**Hallicrafters
 Mileage
 Marathon**

The judges are swamped with reception reports from busy hams working the world to win the Mileage Marathon. It's the biggest event short wave radio has ever known. We tried, in vain, to check these reports as they came in but we're way behind. However, we are working night and day and hope to announce the winner in next month's QST.

SEE YOUR JOBBER TODAY OR WRITE FOR COMPLETE DETAILS



the hallicrafters

3001-Z Southport Avenue, Chicago, Illinois, U. S. A.

Cable Address: "LIKEX — New York"

Say You Saw It in QST — It Identifies You and Helps QST



when Trouble 'hears' its ugly head'

and the customer starts talking in three-letter words it's time you got wise to yourself and changed to CENTRALAB.

Noisy, nerve-teasing reception can very often be permanently cured with a dose of "One Centralab Radiohm to one Radio."

It works miraculous cures. Try it next time you're out Trouble shootin'.

— and a mere handful service practically any set made — better than ever before.

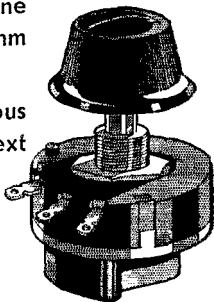

Every Radio Service Man should be a member of the Institute of Radio Service Men

Centralab

MILWAUKEE, WISC.

**RADIOHMS SUPPRESSORS
FIXED RESISTORS**

envelope. If you have reason to expect a considerable number of cards, put on an extra stamp so that it has a total of six-cents postage. Your own name and address go in the customary place on the face, and *your station call should be printed prominently in the upper left-hand corner.*

- W1—J. T. Steiger, W1BGY, 35 Call Street, Willimansett, Mass.
 W2—H. W. Yahnel, W2SN, Lake Ave., Helmetta, N. J.
 W3—R. E. Macomber, W3CZE, 418 10th St., N. W., Washington, D. C.
 W4—B. W. Benning, W4CBY, 520 Whiteford Ave., Atlanta, Ga.
 W5—E. H. Treadaway, W5DKR, 2749 Myrtle St., New Orleans, La.
 W6—D. Casson Mast, W6KHV, 423 East E Street, Ontario, Calif.
 W7—L. Q. Kelly, W7BPC, 4919 So. Prospect St., Tacoma, Wash.
 W8—F. W. Allen, W8GER, 324 Richmond Ave., Dayton, Ohio
 W9—George Dammann, W9JO, 319 Sherman Ave., Evanston, Ill.
 VE1—J. E. Roue, VE1FB, 84 Spring Garden Rd., Halifax, N. S.
 VE2—W. H. Oke, VE2AH, 5184 Mountain Sights Ave., N. D. G., Montreal, P. Q.
 VE3—Bert Knowles, VE3QB, Lanark, Ont.
 VE4—Dr. J. J. Dobry, VE4DR, Killam, Alberta.
 VE5—E. H. Cooper, VE5EC, 2024 Carnarvon St., Victoria, B. C.
 K4—F. McCown, K4RJ, Family Court 7, San-turce, Puerto Rico.
 K7—Frank P. Barnes, K7DVF, Box 297, Wrangell, Alaska.

Results—3500-Kc. Transoceanic Tests

(Continued on page 16)

INU IRT IXP IYW JDA JN JNB* LI(f) ME MK* QV
 SZ* TA TS* UE ZL W2AIZ* AMF AMP ATM AYJ CIA
 DJ DJP DYF EVI FQV GZF HEG HXM ICM IUX KQ
 W3ADE BJT BRT BSB BYM(f) CDG CMR CVL DD*
 DQ DSN DUE EFS(f) EG EHY(f) EOP EXB* GS HBS
 HC NF TY W4NC W8AAC AQS CAX CUO FIP GBK
 GZW IZJ JTW KWA MQ MQX MXR YA W9PNH
 VEICD CE EI* GL GU GZ VE3IG VOIC IP

LOGGED IN GREAT BRITAIN

(First Period—December 15-18, 1935)

W1ADM(f)*** ADR*** AEF AF AFB AGL(f) AJA
 AKE AMP* APK** ARB ARH AY(f) BCN(f) BCP(f)
 BDI BEF BEF(f)* BES(f)** BFT** BHI BJP BKL*
 BMT(f)* BO(f) BQT BQU BR(f) CAB CDX* CIW(f)
 CJD CPE(f) CPM* CQX(f) CRW(f)* CSC CTG* CTS
 CTX(f) CWH(f)** DBM(f)** DCF(f) DEO DHE DHH*
 DIA DQ* EE EER* EF** EH EVJ* EWF(f) EZ* FAH(f)?
 FCE(f)* FGM(f) FJA FPM FVH FVK GKJ GOJ* GOO
 GTS** GVH** GXV* HDV HJI HNF HNU* HPV HSB
 HWZ* HYX IEM IHX IXY* IYW JN JNB* JQ KH*
 LI(f)*** ME** MK OR* QR* QU(f) SZ* TA TS* YK*
 W3AEP* AFD(f) AIW AIZ AMP* ARV ATM* AU(f)*
 AYJ* AYM(f) BMM* BVM(f) BW BY(f) BYE(f) BYF(f)
 BYM(f)* BYR(f) CAY DEN* DLM DLO DLY(f)*
 DQV DRO DUP DYM DYO* EAR ELD** EOY EUV
 EVI* EWD FFN* FOA FQV* GCE GDF GFF* GKR
 GVZ* HC HCS HS(f)* HVO HZY US W3AWH* BBG
 BDI BDU BEC BEZ* BOS(f) BPT(f) BSB CES CHH
 CPG CWG(f)* DD* DDU DQ(f)*** DQE DT DU(f)
 DUE DVE EBP EFK(f) EFS(f)* EFY(f) EHY(f)***
 EKO(f) EOB EOP EOY** ESY(f) EXB** FD FDY

Build
Your
Own

ALL-STAR TRANSMITTER

Below — Rear view of
400-watt Phone Trans-
mitter.

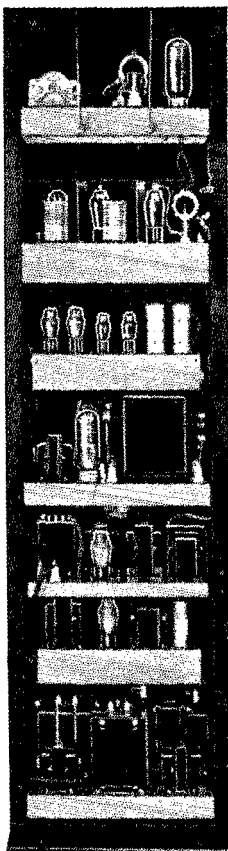

At right — Bot-
tom view of 40-
watt R.F. Unit.

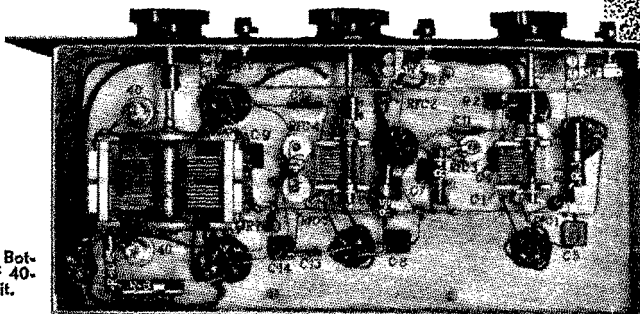

ALL you need to build this professional-looking ALL-STAR TRANSMITTER is a soldering iron, screw driver and a pair of pliers. Drilled chassis and detailed instructions, including photographs, enable you to duplicate the laboratory results. No laborious drilling or machining. Instructions are so explicit and complete the job can be done without using the schematic drawings. Yet, efficiency has not been sacrificed to simplify construction.

Photographs and Diagrams Accurately Guide You

Instruction Sheet, which is provided with each foundation unit, contains 21 photographs showing in detail the standard parts used. Each part is identified by a key-number for quick, easy identification. Besides the photographs, there are eight diagrams, one for each unit and one for the complete unit.

Nothing Discarded!

Build step by step the various units without discarding anything from previous stages. If you own a suitable low-power unit, you can add the ALL-STAR High Power stages and complete the 400 or 500-watt jobs. Or if you already have a CW transmitter, the speech amplifier and modulator can be added for phone operation.

Sponsor

Manufacturers

THORDARSON ELEC.

MFG. CO.

500 W. Huron St.

Chicago

HAMMARLUND

MFG. CO.

494 W. 33d St., New York

CORNELL-DUBILIER

CORP.

4377 Bronx Blvd.

New York

TRIPLETT ELEC. INST.

CO.

Bluffton, O.

OHMITE MFG. CO.

4829 W. Flournoy St.

Chicago

E. F. JOHNSON CO.

Waseca, Minn.

CROWE NAME PLATE

MFG. CO.

1749 Grace St., Chicago

★ BUILD YOUR OWN ★
ALL-STAR
TRANSMITTER

Build in Easy Steps Save \$200 to \$300

Complete 40-watt CW transmitter — 40-watt phone transmitter — 500-watt CW transmitter — or 400-watt phone — can be built at savings up to \$300 over a factory-built transmitter of equal appearance and performance.

Foundation units and all the STANDARD parts required to build any or all ALL-STAR TRANSMITTER units are stocked by local supply dealers. Complete constructional data and diagrams, 25¢ postpaid, or FREE with foundation units.

See Your Jobber or Write to any of the sponsor-manufacturers listed, or to ALL-STAR HEADQUARTERS, 222 W. Adams St., Chicago.

Say You Saw It in QST — It Identifies You and Helps QST

RAYTHEON FAMILY

There is a RAYTHEON (4-Pillar Glass; All-metal; or Amateur) Tube for every purpose.

RK-28—The RK-28 represents the ultimate in RF pentode design at the present time. Filament emission (10 volts, 5 amperes) is ample to provide long life at full rated power input. CW output of 200 watts is obtained with only 1.8 watts driving power.

	CW	Suppressor Mod. 3Phone
PLATE VOLTAGE	2000	2000 Volts
PLATE CURRENT	140	80 M.A.
SCREEN VOLTAGE	400	400 Volts
SCREEN CURRENT	60	85 M.A.
SUPPRESSOR VOLTAGE	plus 45	-50 Volts
REQUIRED RF INPUT POWER	1.8	2.7 Watts
REQUIRED MOD. POWER	-	1.2 Watts
OUTPUT	200	60 Watts

Base—Jumbo 5 Prong Isolantite
Overall dimensions—9 1/2" Long x 2 1/2" Diameter

RK-34—Type RK-34 is intended for service on the five and ten meter bands. Complete isolation of the plates in this dual mode tube, with plate connections brought out on top of the bulb, raises efficiency to a high level. The base is Isolantite.

HEATER VOLTAGE	6.3 Volts
HEATER CURRENT	0.8 Amp.
Class C Operating Conditions	
PLATE VOLTAGE	300 Volts
GRID BIAS	-40 Volts
PLATE CURRENT	80 M.A.
POWER OUTPUT	75 Watts

Base—Large 7 Prong Isolantite
Overall Dimensions—5 1/2" Long x 1 1/2" Diameter

RAYTHEON

AMATEUR TUBES

Easy to Drive

RAYTHEON PRODUCTION CORP.

30 E. 42nd St., N. Y. 55 Chapel St., Newton, Mass.
445 Lake Shore Drive, Chicago, Illinois
555 Howard Street, San Francisco, California
415 Peachtree Street N. E., Atlanta, Georgia

FJU(f) FSJ(f) FTK* FYF LJ(f) NF* SL(f) UD(f) ZI
W4ABS ACV(f)* ACZ(f) BRT BYY(f)* CBQ(f) CL(f)
CPX CVQ(f)* CZP DAY DU(f) DW EJB KDV(f)? SY
W8ABX ASW* AVK BSV CNC FCB* FIP* FL(f) ION
KNB MAH* MOT MYD PK WBT W9AEH ENQ NN
VE1BF* CA(f)* DZ FI(f)**** EL* ER** EW(f) GL*
VE2CX HE(f) VE3JT VO1H** 4J 4Y*** H15X(f)**

LOGGED IN GREAT BRITAIN

(Second Period—December 19–22, 1935)

W1ABL(f) ADR* ADM(f)** AFB* AMP* ANU APK*
ARB ARH* AVJ* BFT BJP* BKL* CAV* CDX* CIU
CJD* CJP* CNT CPM CR(f) CW(f)* DCE DHE*
DLD* DPW DQ* EF ER EVK EWD* EXR EZ FJA
FOZ* FR(f) FVK* FXO FY GJK GOJ GTS GUY(f)
GVH** GWE GY* HIS HJI HLE HNU* HNV HPZ HRU
HXT IEO IJ(f) IKO IXP JAV* JBO JEQ ME** MK**
NN OR QJ(f) SZ** TS** VV YK* ZK ZL* W2ADY(f)
AFU AGX* AIZ AYJ BB(f) BCX* BKV BMM* BWR(f)*
BYM(f)* BYR(f) CA CAY** CMS CUE CUI* CZX DLO*
DMM* DYF* DYO** DYR(f) EHY(f) EQS EVI** EVJ
FFN* FTH GBF GCE GDA GDF* GFD* GGW GMS
GQA GQX GZF* HBS HEG HVE IEO HEV HR(f) HS(f)*
HUD HWI HWO HXP(f) IBC(f) IEO JEG KR(f)* MO(f)
MQ QK QL QY(f) W8ADE AFY(f) AHR(f)** AHY
AQR(f)* AWH AWR(f) BJU* BSB* BW BYM(f) BZW
CDG* CMR CNZ DD* DGO DKX(f) DQ(f)* DQM
DRF(f) DRY(f)* DUE ECG EDP EFS(f)* EHY(f)**
EOM EOP* EZL FAX* FTK NF* NO VR ZX W4ABS
BRT* CPX CZP DAY(f) SY W6CSN W8AQS AY(f) BAS
BHK* BPH BQ BWL CAX** CNC** CNE CPN(f)
CWS(f) DUIDYY DZN** EUY FIP** FNX GGD GKG
HBG HGG JE* JKS(f) JTT JXM KIR(f) KWA LDA*
LMI MEV MFF MFV* MJT MOT* MQ MQO* MRV
NYY OR OVA OZU RG UV** W9AEH** EAF ENQ
IQB JDO(f) KGL NNZ RCQ RKW SPE VE1BO(f) DA
EI(f)*** EO(f) ER GO(f) GR(f) GW QU VE2BD CX DR
DS GV JK* VK VE3AR? CQ JT LC XS VO1L 1P**
H15X(f)

FIRST PERIOD—December 15–18, 1935

(2345–0020 GMT each night)

Logged in U. S. First District (W1)

D4ARR*** CSA*** JZI PIU E14J*** F8IL G2DQ**
IC* PL** ZF ZQ*** G5BD* FV*** GB GV JU* KF
KG*** PL(f) RB RV** VL(f)** G6BH GH MD* PF***
RB*** RH WY HB9AQ*** 9AS 9B 9BC** 9H ON4AU*
CS JO PA0ASD** AZ DC* FX*** HR* NB PN* UX
WA* ZMT ZQ SP1IC.

Logged in U. S. Second District (W2)

D4ARR** CSA* E14J* G2DQ* ZQ** G5BD* FV* JU
KG*** VL(f) G6LL(f) PF* RB** G16TK HB9AQ** 9BG
9J* NY2AB PA0ASD* FX* PN.

Logged in U. S. Third District (W3)

D4ARR G2BQ DQ PO ZQ* G5FV JF KG G6PF HB9AQ*
9J.

Logged in U. S. Eighth District (W8)

D4AKN ARR* CSA* F8QG G2AI DO DQ ZQ** G5FV**
KG G6KJ PF RB* HB9AQ PA0ASD PN.

Logged in Canadian First District (VE1)

G2IN G5KG VL(f) G6LL ON4ZA

Logged in Canadian Second District (VE2)

D4ARR G2LQ PR G6MD RB PA0XF

Logged in Canadian Third District (VE3)

G2ZQ G5FV HB9BG

SECOND PERIOD—December 19–22, 1935

(0500–0800 GMT each night)

Logged in U. S. First District (W1)

D4ARR*** CSA*** SMP SNP* TFL* F3AM F8EX* QB
QG*** TV** G2DF DQ**** DQ(f) PL*** SA ZP* ZQ***
G5BD** JZ KG* RB* VL(f)* G6CL* DE JF KI* LL(f)
PF*** RB*** RG HB9AB 9AK 9AD 9AQ*** 9AS 9B
9C 9I* 9K LA2W LA4U OE3AH* OK3VA ON4NC
PA0AQ* ASD** HL HR* PB PK* PX QQ** WA*

LEEDS LEADS AGAIN

OF COURSE the "NOISE SILENCER" is the greatest aid to radio reception in years.

OF COURSE our engineering staff was immediately alive to the vast field of application of a small adapter to thousands of superhets, both amateur and B C L.

Soooo we developed the LEEDS "QUIET CAN" an amazingly compact dingus housing all the necessary parts and tubes. Just bolt the Quiet Can on the cabinet or chassis, make three connections, observe a few precautions as outlined in the instructions, and say Goodbye to noise.

On the left we have an inside view of the Quiet Can measuring only 2½ x 5¼ x 6¼ overall with cover. Filament supply is ingeniously obtained by the use of a resistance type line cord with the tube heaters in series, eliminating the bulk and hum producing possibilities of a filament transformer.

On the right we picture the Quiet Can mounted on an FBXA with noise control conveniently located near the crystal controls. A hole in the chassis is provided, so that the potentiometer may be turned at right angles, the shaft extended and brought out of the front panel.

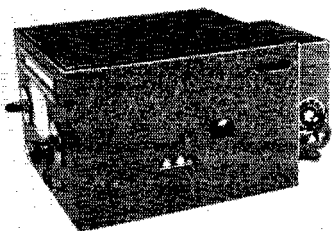
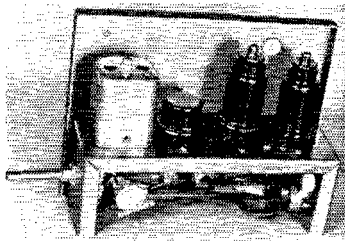

You bet we figured on thin pocketbooks and quantity sales. By buying large stocks of material we are able to pass on a considerable saving to you

The complete kit of parts with 3 tested RCA or Sylvania metal tubes... **\$6.55** The Quiet Can wired and tested with RCA or Sylvania metal tubes. IF aligned to your IF frequency... **\$8.55**

Shipping weight 5 lbs. Like all Leeds products the "Quiet Can" is unconditionally guaranteed

THORDARSON TRANSFORMER special, 1200 volts CT 200 ma, 5 v. 3 amp, 7½ v. 3 amp, 2½ v. 10 amp, a quality cased job... **\$2.45**

Thordarson 12 henry 250 ma choke, 1.95
Thordarson cased class B transformers input and output.

For 46's. Per pair... **\$6.17**
For 210. Per pair... **8.23**
For 203-A. Per pair... **17.64**

TRANSFORMER SPECIAL G. R. uncased transformers, 220 volts each side of center tap at 100 mils, two 5-volt filament windings. Ideal for "C" bias supplies. Each... **\$4.49**

The record is 100% perfect. Thousands of microfarads of Leeds oil filled Condensers are in use without one case of failure.

1 M F	1000 v.	\$1.10
2 M F	1000 v.	1.45
1 M F	1500 v.	1.45
2 M F	1500 v.	1.95
1 M F	2000 v.	1.75
2 M F	2000 v.	2.45

WESTINGHOUSE and **SANGAMO** watt hour meters, illustrated last month; 110-120 volt, 60 cycle, 2-wire meters; 5-10-25 and 50 ampere capacity... **\$3.50**
Shipping weight 15 lbs.

LEEDS offers outstanding values in quality transmitting TUBES, backed by our name and guarantee.

*203-A...	\$8.45	†*830-B...	\$7.25
†210-HF...	1.75	*838...	11.75
866...	1.50	†*841...	2.95
304-A-UHF	9.45	*852...	11.50
†*801...	2.95	866-A...	1.95

*Graphite Anode Tubes
†Isolantite Base

Tubes Shipped by Express Only



LEADS THE FIELD

World Wide Service to Amateurs

45 Vesey Street
New York City

Tel. COlandt 7-2612

Cable Address: "RADLEEDS"

LEEDS Unconditionally Guaranteed Crystals

X-cut 160 and 80 meters... **\$2.25**
X-cut 40 meter... **3.25**

Moulded bakelite holder... **\$1.00**
Hill all brass adjustable holder... **1.65**

PIEZO astatic crystal pickup 8" arm; \$15.00 list, special... **\$6.75**

ROLA G-12 high fidelity speakers; D. C. models 12" cone; 8 ohm v. c. 6 volt, 1000 or 2500 ohm field... **\$8.95**
A. C. model... **14.95**

New **ROLA** K-12 D.C. speaker 12" cone; 8 ohm v. c.; 6 volt, 1000 or 2500 ohm model... **\$5.95**

TRIMM 2000 ohm phones **\$1.80**.
4000 ohm... **\$2.25**

FROST TRIMM featherweight **\$5.88**.
2000 ohm... **\$1.45**

FROST 3000 ohm **\$1.65**.
DX 20,000 ohm imp... **\$2.65**

WESTERN ELECTRIC type P-11. **3.95**

LEEDS Leads as the only distributor in the country, handling G.R. Amateur accessories and laboratory apparatus. Bulletin No. 936 mailed on request.

GENERAL RADIO coil forms type 677-U price 50c; type 677-Y price 75c. G.R. amateur accessories always in stock.

G. R. dials, with fluted knobs 4" — **\$1.50**; 3¼" — **\$1.25**; 2¾" — **\$1.00**.

THESE SPLENDID BOOKS FREE!



THINK OF IT! 2 books full of invaluable information, to be had for just the mailing costs! One with 20 complete transmitter designs including 12 tested transmitter RF section designs and 8 modulator and speech amplifier designs. Circuits, complete parts specifications, inductances, etc. all included. Outputs ranging from a little fellow all the way up to the big ones comparable to the best broadcasters.

Ten complete designs for public address amplifiers in the other book. It includes one for every purpose, from 3 Watts to 30 Watts output, tried and tested designs that you can build, with complete parts lists for each.

These books should be in every amateur's technical library. Just 22 cents in stamps, to cover postage, brings them both to you, or get them from any Standard Distributor. Send for your copies today.

STANDARD TRANSFORMER CORPORATION

856 Blackhawk Street, Chicago, Illinois

MAIL THIS COUPON!

STANDARD TRANSFORMER CORPORATION

Dept. A, 856 Blackhawk St., Chicago, Ill.

I am enclosing 12c for Transmitter Manual

I am enclosing 10c for Amplifier Manual

Name.....Address.....

City.....State.....

Logged in U. S. Second District (W2)

D4ARR** CSA** F8QG* G2DQ* PL ZQ** G5BD* KG VL(f) G6LL(f) PF** RB* WF HB9AB 9AN 9AQ** 9AT 9J 9Y OE1CM OE3FM ON4NC VO PA0ASD QQ WA* VO1L 1P

Logged in U. S. Third District (W3)

D4ARR* SXR F8TV* G2DQ** PL ZQ* G5BD G6PF* RB* HB9A 9AQ* HH9X PA0HR WA

Logged in U. S. Fourth District (W4)

G6PF RB HB9AQ

Logged in U. S. Seventh District (W7)

G2ZQ G6PF

Logged in U. S. Eighth District (W8)

D4ARR* CSA VRR F3AM F8EX QG* TV* G2DQ** PL* RB ZP ZQ** G5BD* KG* VL(f) G6CJ GF FT*** RB HB9AO 9AQ** 9J K6LHK LA2W* NY1AA OE3AH PA0ASD* FA HR* WA VO1L 1P YP5BC

Logged in U. S. Ninth District (W9)

D4ARR F8QG G2DQ* ZQ* G5BD* MP VL(f) G6PF* RB* HB9AQ** LA2W

Logged in Canadian First District (VE1)

F8TV G2DQ G5KG VL(f) G6LL

Logged in Canadian Second District (VE2)

G2ZQ G6PF HB9AQ PA0WA

Logged in Canadian Third District (VE3)

D4ARR F8TV G2PL G5BD G6PF HB9AQ 9G

PERIOD NOT INDICATED—Includes Both

Logged in U. S. First District (W1)

D4ARR** CSA** F8EX QG* TV* G2DQ** PF PL* RB ZQ** G5BD* FV** JU KG* OG G6JU PF*** PH RA RB** WY* ZC HB9AQ*** 9BB 9BG* 9H 9J OE3AH* ON4AU* PA0AD AQ AS ASD* DC FX** HR* PK PN QQ* WA** SP1DQ VK3HG ZL2GN

Logged in U. S. Third District (W3)

D4ARR* CSA EA9LV F8GQ TV G2AX DQ PL ZQ* G5BD FV* G6LL(f) PF RB* HB9AQ 9BG PA0AP ASD PN QQ WA VO1L 1P ZL3BJ

Logged in U. S. Eighth District (W8)

D4ARR* CSA F8EX QG* G2DQ* PL* ZQ* G5BD JZ(f) KI VF G6PF* RB* HB9AM 9AQ* 9AS 9J 9Q LA4U ON4WR PA0AQ ASD* LN

STATIONS WORKED IN FIRST PERIOD

(By W/VE Stations)

WIARB: G2ZQ WIARH: G2ZQ W1CJP: G6RB-PA0DC W1CSC: G2ZQ-G6RB W1DBM(f): G5VL W1DHH: D4CSA W1DQ: G2ZQ W1EF: G5KG-G6RB-PA0ASD W1EJ1: G5FV-G5KG-PA0ASD W1HNU: G5FV-G6RB W1ME: G2ZQ W1OR: G2ZQ W1SZ: G2ZQ-G5BD(2)-G6PF-G6RB-D4ARR-F8IL-PA0DC-PA0FX W1TS: G2ZQ(2)-G5KG-G6RB(2)-PA0ASD W1ZL: G6RB-HB9AS W2AEP: G2ZQ-G5BD-G6PF-D4CSA W2CAY: D4CSA W2DYR(f): G5VL W2GFF: G2ZQ-G5BD-G6RB-D4ARR W3BSB: G2ZQ-D4ARR W8AVK: G2ZQ W9NNZ: G2ZQ VE1E1(f): G2IN-G5KG-G5VL(4) VE3JT: G2ZQ-ZL3FC-ZL3PF-ZL2GN-VO1P

STATIONS WORKED IN SECOND PERIOD

(By W/VE Stations)

WIARH: G2PL-G6PF-G6RB-HB9AQ W1CJP: G6PF-HB9AQ-PA0ASD-PA0QQ W1DHH: D4ARR-G6RG-OK3VA W1DL: D4ARR-G2ZQ-G6RB W1DQ: D4ARR-G2DQ-G6PF(2)-G6RB-HB9AQ-PA0HR W1ZK: G2PL W1ME: D4ARR-G2PL-G2ZQ-G6KI-G6RB-G6PF(2)-F8QG-HB9AQ(2)-PA0QQ W1OR: G2ZQ-G6PF(2)-G6RB W1SZ: D4ARR-G2DQ-G2PL(4)-G2ZF-G5BD-G6CL-G6KI(3)-G6PF(4)-G6RB(2)-F8QG-HB9AQ(4)-HB9AS-HB9AK-LA4U-PA0QQ(2) W1TS: D4ARR-G2PL(2)-G2ZQ-G6PF(3)-F8QG(2)-HB9AQ(2)-PA0MSD W1UE: PA0ASD W1ZL: G2PL-G2ZQ-D4ARR-G6RB(2)-HB9AQ W2CAY: G2PL-G6PF-G2ZQ-HB9AB-PA0QQ-VO1L

It's a wow!

EVERYWHERE WE HEAR THE MOST ENTHUSIASTIC PRAISE OF OUR NEW MANUAL OF AMATEUR COMMUNICATION,

The Radio Amateur's Handbook

In the second month after publication we have sold and shipped 40 tons of copies, not only in the United States and Canada but in every land where there are amateurs. Why? Because the A.R.R.L.'s Handbook is the standard manual of amateur practice, known for ten years to be written by expert amateurs who know their stuff and can explain it so you may employ their knowledge.

The new 1936 edition is nearly twice as big as its famous predecessors. Written by the amateur technicians who have made *QST* famed and *reliable*: It's an extraordinary piece of work — even if we do say so ourselves. Jim Lamb, George Grammer, Ross Hull, Clint deSoto, and others. Communicating dope by Handy, background stuff by Budlong. C.W. and 'phone. All the way from 160-meters to 11¼. Simple and complete. Theory, principles and constructional specifications. Transmitters and receivers, antennas and feeders, power supplies and monitors. Some for every need, every purse. Lavishly illustrated both with photos and diagrams. Dozens of copyrighted original tables of tube dope and charts. Not only technical questions but operating ones, legal ones. And a profusely-illustrated advertising section which is a handy catalog of the best gear in America, right where you want it. The complete answer to the ham's prayer.

480 pages, 6½ x 9½, in the familiar *QST* format, heavy dirt-rejecting cover. Unquestionably more words of technical advice, and sounder and more interesting and reliable advice, than has ever been sold before for a measly Bucks 1. Printed in the usual textbook form, this book would be two heavy volumes for about nine good Iron Men plus another for postage. It's the world's best buy in amateur radio literature.

When you buy a Handbook, see that it carries the A.R.R.L. emblem. Only then will you have the reliable and original Handbook created by the Headquarters Staff of the A.R.R.L.



\$ 1.00 POSTPAID IN
CONTINENTAL U. S. A.

\$ 1.15 POSTPAID
ELSEWHERE

\$ 2.50 POSTPAID, IN
BUCKRAM BOARDS

FOR BEST RESULTS IN AMATEUR
RADIO, ORDER YOURS TO-DAY!

American Radio Relay League, Inc.
West Hartford, Connecticut

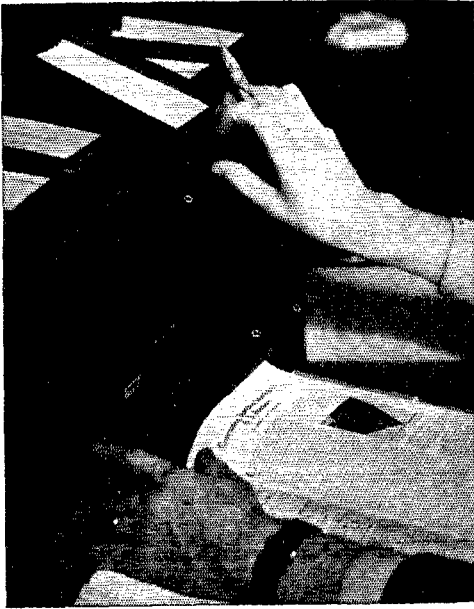

QST

YEARLY BINDERS

Those who take pride in the appearance of their lay-out and wish to keep their reference file of *QST*'s in a presentable manner, appreciate the *QST* binder. It is stiff-covered, finished in beautiful and practical maroon fabrikoid. Cleverly designed to take each issue as received and hold it firmly without mutilation, it permits removal of any desired issue without disturbing the rest of the file. It accommodates 12 copies of *QST* and the yearly index. Opens flat at any page of any issue.

With each Binder is furnished a sheet of gold and black gummed labels for years 1919 through 1938. The proper one can be cut from the sheet and pasted in the space provided for it on the back of the binder.

A file of several years of *QST*, kept in order in binders, is a most valuable reference library for any Radio Amateur.

Price **\$1.50** postpaid

Available only in United States and possessions

THE AMERICAN RADIO RELAY LEAGUE

WEST HARTFORD

CONNECTICUT

62

See You Saw It in *QST* — It Identifies You and Helps *QST*

VO1P **W2DYR(1)**: G5KG-G5VL **W2GGW**: G2ZQ **W2GQX**: G2ZQ **W3BSB**: G2PL-G6PF-D4SXR **W3BVO**: F8TV **W8BQ**: F8EX **W8GKG**: HB9AQ **W8KWA**: PA0ASD **W8LDA**: D4ARR-G2PL **W8UUV**: G2ZQ-G5KG-G6PF-G6RB-F8QG-D4ARR-HB9J **W9AEH**: D4ARR-G2DQ-G2ZQ-G6PF-HB9AQ **W9NNZ**: G2ZQ **VE1EI(1)**: G2DQ-G5KG(3)-G5VL(2)-G6LL(2)

STATIONS WORKED—PERIOD NOT INDICATED

(By W/VE Stations)

W1BJP: G2DQ-G2ZQ-G5JU-HB9AQ **W1BKL**: G2PL-G2ZQ-G5BD-G6PF-G6RB-HB9AQ-PA00Q-PA0HR-F8QG **W1CDX**: G2DQ-G6PF-G2ZQ-HB9AQ-PA0ASD **W1EVJ**: G2DQ-G2ZQ-G5BD-G6RB-PA0DC-D4CSA-HB9AQ **W1IYW**: G5KG-PA0ASD **W3AWH**: G2ZQ-G5BD-G6PF-G6RB-HB9AQ **W8FIP**: G2DQ-G2ZQ-G2PL-G5BD-G6PF-G6RB-HB9AS-HB9AQ-PA0ASD-F8EX-D4ARR **W8MAH**: G2ZQ **W8MQX**: G2PL-PA0ASD

STATIONS WORKED IN FIRST PERIOD

(By G/PA Stations)

G2IN: VE1EI(f) **G2ZQ**: W1DQ ARB ARH OR TS(2) BKL BJP EZ SZ CSC EVJ ME W2DYO AEP BMM HZY GFF DUP W3EOP BSB AWH W8AVK KNB MAH MOT VE3JT **G5BD**: W1BKL SZ(2) DHE FVK EVJ W2AEP GFF AMP W3AWH EBP **G5KG**: W1EF BFT 1Y W HJI GVH TS VE1EI(f) **G5VL**: All 'phone—W1DBM CWH CRW W2BYM BYR HS W3SL UD W4ACZ(2) CVQ BYY VE1EI(3) **G6PF**: W1BFT CDX SZ W2AEP DLO W8FIP **PA0ASD**: W1BFT GOJ TS EF GVH EZ JN FXQ HNU HJI IYW EXR W2GZF HXM W8MQ **PA0FX**: WIADR SZ

STATIONS WORKED IN SECOND PERIOD

(By G/PA Stations)

G2DQ: W1CDX SZ BJP EVJ IKJ DQ TS W3EDP W8FIP(2) W9AEH VE1EI(f) **G2ZP**: W1SZ W8CNC VO1P **G2ZQ**: W1ZL EWD ME DLD TS CDX OR W2CAY GQX GGW HBS EVI W3VR W8UUV GKG LMI BHK FIP W9ENQ NNZ AEH VE2JK **G5BD**: W1SZ CIU BKL HXT W2DLO W8JE FIP W9AEH VE2GV **G5KG**: W1GTS ADR W8UUV Phone—W1CRW W2KR DYR BYM W3AHR VE1EI(3) **G5VL**: All phone—W1GUY W3DRY VE1EI **G6LL**: 'All phone—W1ADM CRW W2BYM BYR W3AQR VE1EI(3) **G6PF**: W1SZ(4) ME(2) TS(3) OR(2) AFB BKL ARH DHE DQ HLE CJP W2CAY EVI GZF DLO W3AWH BSB W8UUV BAS EUY CNC JE MOT W9AEH VE2JK VO1P(2) **PA0ASD**: W1GVH JNB TS CJP HNU CDX AKR GUY UE W2AMP(2) GZF W3DD(2) W8FIP MQX AQS KWA IZJ VE3IG VO1P(2)

What the League is Doing

(Continued from page 25)

munications Act to extend their authority over apparatus capable of such interfering radiation. More effective technological collaboration with manufacturers of equipment is planned. What with diathermy and automobile ignition interference, there is plenty of room for some effective cooperation.

Ratifications Great Britain on August 23rd last bound herself and North Ireland and Newfoundland to the terms of the Madrid convention and its radio regulations. The acceptance also applies for all British territories except the colony and protectorate of Kenya. The radio regulations not having been accepted on behalf of Kenya, a binding treaty relation does not exist with it and third-party traffic is still OK.

Southern Rhodesia has also ratified.

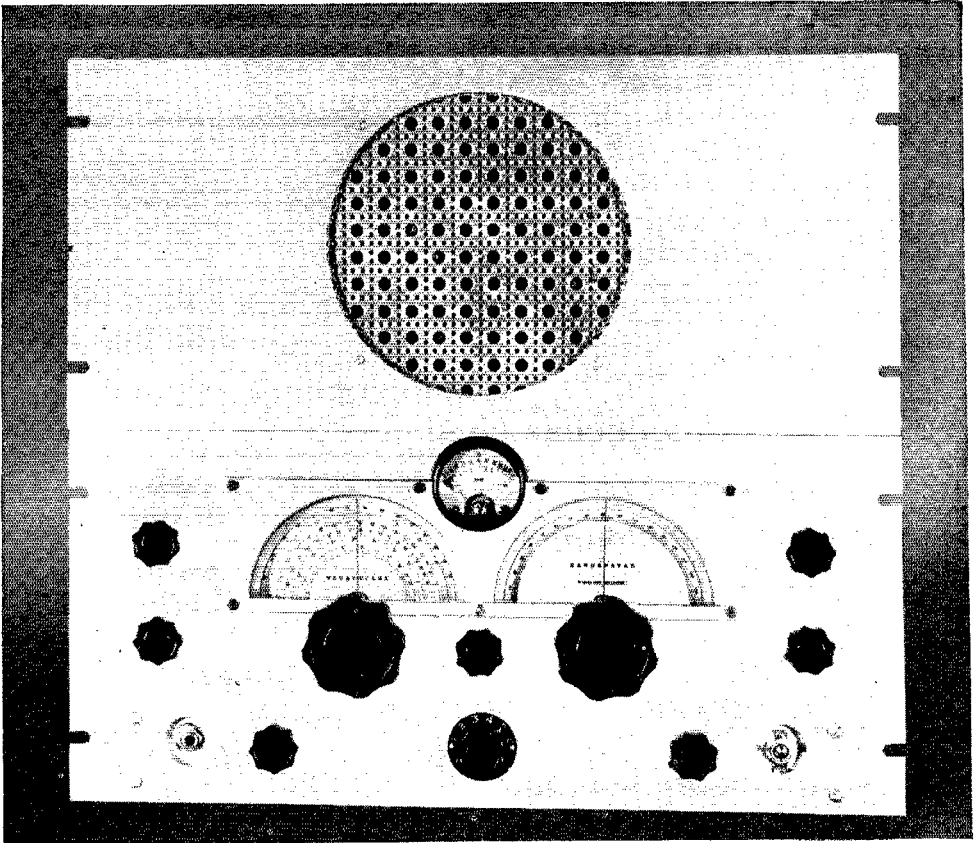

SINGLE SIGNAL R M E SUPER RECEIVER

In special satin finish relay rack mounting. A dust and shield cover, fully ventilated, may be had to protect the receiver proper. This combination unit is but another example of typical RME design and engineering.

Bulletin 69 will give you full details

RADIO MFG. ENGINEERS, Inc., 306 First Ave., PEORIA, ILL.

*Radio Operator's
Course*

*Complete in
Telegraphy—
Telephony*



*Practical
Experience
Studio—
Transmitter—
Announcing*

P. A. C. is an endowed, educational institution — not privately owned, not operated for profit, college rank maintained. Course consists of maximum knowledge necessary to secure Commercial Telegraph Second-class, and Radio-telephone First-class government license. Course includes Wireless Code, Radiophone, Announcing, Microphone-Studio Technique, Service, Police, and Aeronautical Radio. We are authorized to teach RCA texts. At the completion of course you receive practical studio technique experience in our commercial broadcast studios located in the administration building, and experience as an operator on K P A C (500-Watt Commercial transmitter located on the campus, owned and operated by the college), and inter-departmental marine communication experience. If interested, write for Bulletin R.

PORT ARTHUR COLLEGE

Port Arthur (World-known port) Texas

... NEVER BEFORE HAS THERE BEEN SUCH A BOOK VALUE!

More than 256,000 words—
over 500 diagrams, charts and
photographic illustrations,
53 basic design formulas,
42 charts and tables
in the NEW

TWICE-AS-BIG 480-PAGE 1936 HANDBOOK

It's the equal of a two-
volume \$7.00 textbook
It's EASY to get one, too—
use the coupon below

• • • • •
A.R.R.L.
West Hartford, Conn., U. S. A.
Your statistics overwhelm me.
Here's my dollar—(or \$1.15; I live outside of U. S. A.
proper).

Please send to:

Name _____

Address _____

(Continued from page 22)

1- μ d. electrolytic and an overloaded 30-henry choke. At first thought, this would seem inadequate, but the high-frequency supply filters very easily.

A single 6Z4 was used for a while, but it gave considerably less output. The regulation was poor and it was necessary to have sufficient load on it to hold the voltage down.

The vibrator adjustment makes a lot of difference about the chirp, too. This rig draws not more than 2½ amperes when key is pressed and, of course, none when key is up so its average efficiency is quite high. It will handle 25 w.p.m. okay. Break-in can be worked with it also. I have my Type 45 filaments in series and heat them with five volts d.c. The 6-volt battery for the keying relay heats the rectifier tubes which are in parallel. Very likely, an excellent portable power supply could be built up like this, using No. 6 dry cells.

BOOK REVIEW

Police Radio Operator's Manual, by the General Electric Co., Radio Department. 64 pages, 4 illustrations, 17 diagrams. Published by General Electric, Radio Department, Schenectady, N. Y. Price, \$1.00.

The secretary's office of the A.R.R.L. Hq. establishment, which is also the license and laws information service, welcomes this book, for it provides the answer to the questions concerning police radio operation which are constantly being asked. The Manual provides sufficient information to enable passage of the radiotelephone operator's examination, third class. It deals with the following general topics: radiotelephone transmitters, receivers, general principles of electricity, operation and care of storage batteries, power supply apparatus, and radio communication laws and regulations, providing a comprehensive digest of these inclusive topics.

—C. B. D.

R. S. G. B. 28-Mc. Contest

(Continued from page 24)

serious 28-mc. workers an examination of Mr. Wareing's log. As an illustration of thoroughness and neatness we consider it to be of the highest order, whilst as evidence of sublime patience it has few equals, for on occasions W9NY shows making over 100 calls in succession without receiving a reply.

"Fifth position was taken by Mr. K. Shiba, J2HJ, with 25 contacts, most of which were with VK or W6. His total was 1401 points. That indefatigable South African ZS1H finished sixth with 1067 points. His first contest QSO was with G2HG on September 7, 1935. In the remaining few days of the contest he worked 3 G's, 2 ON's, 3 F's, 2 LU's, 2 D's, 2 FA's, 2 W9's and a PA.

"Mr. E. H. Conklin, W9FM, and Mr. M. R. Carlson, W9FFQ, made seventh and eight places, respectively."

The *T. & R. Bulletin* goes on to list the participants, in the "order of merit," as follows: X1AY-4542, VK2LZ-4017, W4AJY-2399, W9NY-2260, J2HJ-1401, ZS1H-1067, W9FM-929, W9FFQ-876, G2YL-779, F8OZ-702, G2HG-698, J2IS-683, D4BMJ/KJP-659, ZL3AJ-658, VE2HY-658, OK1AW-556, PAOQQ-418, W9EGE-240, G5LA-204, VK4EI-183, G5OJ-144, D4OON-102, G6WN-90, VK4GK-75. Late entries were received from VK4BB-1627, VK3JJ-440 and ZL1BA-698. Certificates of Merit have been awarded to the first 10 stations.

In the A.R.R.L. Contest ten W/VE leaders placed in the order W9NY, W4AJY, W4TZ, W4AGP, W6CAL, W9FFQ, W9GPF, W1ZB, W9FM, W1CUN. The reason the order of merit in the two contests differs is that in A.R.R.L.'s contest greater weight was given the factors of "regular reporting" and the submission of experimental data and station description. The League's contest was open only to U.S.A. and Canadian amateurs.

RADIOLAB FASTEST MAIL ORDER SERVICE IN THE WORLD

Atlas Metal Boxes

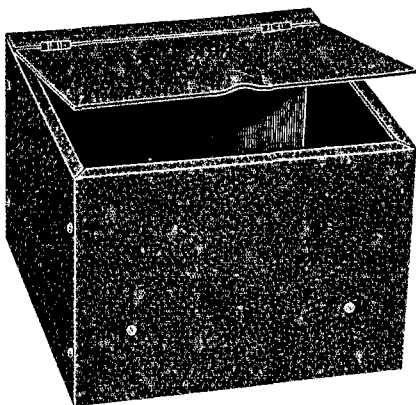

The original cabinet of the knock-down type and the best. Greatly simplifies receiver assembly and makes repair or change of the enclosed unit much easier since the top, bottom or any side can be removed in a moment.

Every Atlas box is finished in genuine baked on wrinkle enamel, no crystalline lacquer being used whatsoever on either the screw top or hinged lid type. Another important point of superiority is the fact that all boxes except the two smallest, No. 1601 and 1801, have subchassis as an integral part of the box. No extra cost for a chassis — no tedious job of fastening in a makeshift chassis. In Atlas you have a complete box, intelligently designed, ready to use.

No.	H.	W.	D.	Screw Lid	Hinge Lid
1601	7"	6"	6"	\$1.05	\$ —
1602	7"	10"	6"	1.45	1.70
1603	7"	12"	6"	1.63	1.80
1801	7"	6"	8"	1.14	—
1802	7"	10"	8"	1.60	1.85
1803	7"	12"	8"	1.78	1.94
1804	7"	14"	8"	2.08	2.35
1805	7"	18"	8"	2.55	2.82
1204	9"	18"	12"	3.00	3.40
1205	9"	21"	12"	3.37	3.58
1206	9"	24"	12"	—	3.98

SOLID COPPER PEE WEE CLIP



An inductance clip that will not heat in strong R.F. circuits. Overall length, 1 1/2". Jaws open to 3/4". A Mueller product, long needed, never before available. No. 45 OS.

Your cost **7c** Each
Ten for **60c**

VOLTAGE REGULATED PLATE TRANSFORMER

Made to order for class B 210's. Gives steady 510 Volts DC at loads from 30 MA. to 200 MA. Made to sell at nearly \$12 by a manufacturer known for quality for over 40 years. Name can not be used at this deep cut price. Fully cased. Weight 28 lbs.

Limited quantity
Order now, only **\$6.95**

Here It Is! Ready to Use!

THE NOISE SILENCER

Read R2 signals thru R9 noise!

A completely built unit to plug in your super. Uses three metal tubes and has its own filament transformer. Neat crackle finish cabinet 10" x 5" x 6". The greatest advance in the radio art in 20 years but it costs only.... **\$13.75**

Set of RCA tubes, one 6J7, one 6L7, one 6H6.
Your cost **\$2.57**

Bliley 20-Meter Crystals

Delivery scheduled for Feb. 25th. Mounted in Victron holder with plugs for standard 5-prong tube socket. Output up to 5 watts in conventional circuits with a 47 tube. Drift 20 cycles per meg. per degree Centigrade. Furnished from 14,000 K.C. to 15,000 K.C.

Within .2% Within .1% Within .05%
Cost. **\$7.50** Cost. **\$11.00** Cost. **\$15.00**

National HRO Junior

This new remarkable receiver in stock for immediate delivery.

Amateur's
net cost

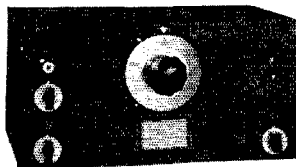

\$99.00

RADIOLAB AIR DERBY

W5JC won the HRO, W9AFN the RME-9DS, W9EDK the 300T. The rest of the 58 prize winners finished in this order: W9OX, W9MXY, W9OGT, W9RQX, W9TAM, W5GEZ, W9RSO, W5BSG, W8KAY, W9PAZ, W5ETT, W5DQ, W9GCG, W7BSU, W5FB, W9HSH, W9PLG, W5ASG, W7EOI, W5ELE, W5AMO, W9NVX, W9KEO, W9GET, W4CVS, W9KJB, W9DMA, W8IM, W9VKF, W5EBT, W4COR, W6CUZ, W9ISR, W9TKX, W5AIT, W9UBS, W5AG, W5DPE, W9MLN, W4BOL, W9LFE, W8EJ, W5AQ, W5DCR, W7COX, W9AIA, W9RQR, W5DOD, W4BEI, W9MZD, W9FOD, W9RIZ, W9NWX, W9SEC, W5DQV.

Due to the fact that the judging was completed at a very poor time for early publication in QST it was deemed advisable to mail out announcements at once, which was done the last of January. Complete results were sent to all participating stations whose calls appeared on the entries even though that station did not send in an entry. If you did not receive this announcement and would like to have it, it is yours for the asking. It contains a complete list of prizes, winners, pictures of the first three, and a statement by the Francis E. Teel Co., Certified Public Accountants, guaranteeing accuracy of results.

The DERBY is over, it was a lot of fun, a lot of work, and, we hope, an enjoyable amateur activity, if you enjoyed it remember the 27 manufacturers who made it possible. They deserve your patronage and we of course would like to handle your orders.

RADIOLAB 1515 GRAND AVE. KANSAS CITY, MO.

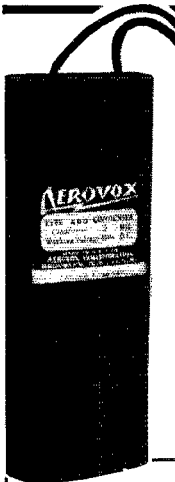

For that
Condenser
Bank . . .



UNCASED PAPER CONDENSERS

Handy, inexpensive, non-inductively wound paper sections. Neat shape Black varnished paper cover. Pitch-sealed ends. Pigtail leads. • Same sections as used in standard AEROVOX metal-cased units. • For new assemblies. Or as replacements. • You can't beat them!

Available in short (SU), Medium (MU) and Long (LU) sizes.

In 200, 400, 600 and 1000 volt ratings. 1 to 4 mfd.

Low in price. You save container cost. The most paper capacity for least money.

DATA Send for 1936 Catalog covering complete condenser and resistor line. Also sample copy of monthly Research Worker.



73 Washington St. Brooklyn, N. Y.



MR. E. H. RIETZKE

PRES. OF CREI

Here's How YOU Can Become a RADIO ENGINEER!

CREI training is open to every ambitious man who realizes that TECHNICAL TRAINING is the "short cut" to Success! Constant new developments make Radio a profession of specialists . . . and offers the Radio Engineer a great opportunity to get ahead. CREI can help YOU as we have helped others out of routine jobs into well-paying jobs with a definite future.

See Actual Movie
Films of Our School

"A Trip Through The Capitol Radio Engineering Institute" is an interesting half-hour motion picture of our school, students, equipment, and faculty. We will be pleased to show it to you individually or as a group. Write or call in NEW YORK — Mr. M. Schatt, 29 Broadway — in CALIFORNIA — Mr. E. H. Guilford, 1087 W. Ocean Ave., Long Beach.

WRITE FOR
FREE
CATALOG

Completely illustrated. Gives all details about courses, prices, terms, etc.

**CAPITOL RADIO
ENGINEERING INSTITUTE**
14th and Park Road Dept. Q-3
WASHINGTON, D. C.



VE-W Contest Scores

(Continued from page 28)

VE SCORES—VE/W CONTEST, 1935

Maritime			Ontario (Continued)		
VE1EP	18,921	134 34	VE3PL	1,824	38 19
VE1EF	15,651	94 37	VE3AE	1,512	24 14
VE1EK	7,857	70 28	VE3OF	1,056	28 11
VE1EV	7,893	78 22	VE3AT	864	20 12
Quebec			VE3SS	776	17 11
VE2DG	22,732	151 35	VE3JT	570	14 10
VE2JK	17,370	134 30	VE3AD	270	10 9
VE2DR	13,239	145 37	VE3ADP	242	9 7
VE2EF	11,359	115 37	VE3O	180	10 6
VE2FG	9,472	105 32	VE3TO	113	5 5
VE2HG	5,133	61 29	Manitoba		
VE2HP	5,076	49 24	VE4KX	6,090	74 29
VE2IN	4,644	66 18	VE4TR	5,412	62 22
VE2CS	3,240	60 20	VE4SF	2,352	31 16
VE2AA	2,931	45 28	VE4YO	792	16 16
VE2JZ	2,441	35 21	VE4TV	756	18 14
VE2BO	2,882	21 14	VE4SO	171	7 6
VE2JJ	705	17 10	Saskatchewan		
Ontario			VE4QZ	23,431	128 41
VE3QD	21,840	188 40	VE4CA	20,358	120 39
VE3DJ	20,741	145 33	VE4IG	9,016	38 18
VE3ED	19,152	113 38	VE4QS	1,716	37 22
VE3GT	10,913	96 25	VE4UN	1,267	23 13
VE3ACS	7,980	66 28	Alberta		
VE3DU	7,011	57 28	VE4PH	15,219	89 38
VE3EM	6,646	79 21	VE4S	4,504	42 21
VE3ZE	5,550	52 26	VE4UY	160	9 4
VE3CM	5,320	63 28	British Columbia		
VE3CG	4,140	48 20	VE5EQ	21,995	124 43
VE3AEJ	4,047	33 19	VE5EG	13,974	100 34
VE3QK	3,960	60 22	VE5RO	10,096	94 33
VE3GZ	3,270	43 20	VE5JC	4,347	63 27
VE3ZV	3,150	35 10	W SCORES—VE/W CONTEST, 1935		
VE3LV	2,080	24 13	Eastern Pennsylvania		

Indiana			Kentucky		
W8TYF	13,135	47 7	W9OMW	126	6 1
W9EGP	7,466	33 7	Michigan		
W9IU	6,887	36 7	W8GQB	5,103	27 7
W9RGB	6,111	33 7	W8ITK	2,322	15 6
W9AB	3,402	18 7	W8MPT	1,134	10 3
Ohio			W8NUV	405	5 2
W8JIN	11,016	68 6	W8HA	27	1 1
W8BYM	5,544	30 7	Southern New Jersey		
W8DQZ	2,916	20 6	W3DBD	6,552	38 7
W8BOF	1,035	12 5	W3FBM	513	7 2
W8CIB	1,008	10 4	Western New York		
W8KZO	810	6 4	W8JTT	7,560	39 5
W8CBI	162	3 2	W8NUY	4,968	24 5
W8MMF	162	2 2	W8GWT	3,321	15 6
Wisconsin			W8FUG	2,475	19 5
W9PTE	8,600	31 7	W8JW	1,620	15 5
W9RQM	6,821	23 7	W8MQX	1,539	19 2
W9EJ	756	7 4	W8NWT	1,539	18 3
W9RH	432	4 4	W8EMW	1,485	11 5
W9MRW	54	2 2	W8MBI	1,296	6 2
South Dakota			W8MKA	1,080	6 2
W9FOQ	270	4 3	W8AQF	627	6 2
Northern Minnesota			W8JQE	486	6 2
W9RIA	1,674	11 4	Western Pennsylvania		
W9KUI	41	1 1	W8FTP	10,899	59 7
Southern Minnesota			W8LBD	2,790	22 5
W9VKF	6,614	34 5	W8KUN	2,052	25 3
Arkansas			W8NSF	1,845	15 5
W5BDW	6,489	35 7	W8MKJ	1,215	15 2
W5ASG	2,709	15 7	Illinois		
Louisiana			W9DQH	8,789	33 7
W5DAW	729	9 3	W9MUX	5,346	22 6
W5BZR	216	4 2	W9ACM	4,347	15 7
Mississippi			W9TBY	1,665	13 5
W5EZA	5,103	20 7	W9CEO	1,116	12 4
N. Y. C. & Long Island			W9LIG	954	19 2
W9GKR	11,277	63 7	W9OQW	891	11 3
W2DHI	6,237	34 7	W9M	828	8 2
W2EYS	2,875	25 3	W3TAY	324	3 2
W2GQ	1,656	16 4	W9LL	162	3 2
W2GKW	1,580	13 3	W9GMT	162	3 2
W2HBO	540	10 2	W9SGZ	108	2 2
W2IMP	513	7 2	W9AND	81	3 1
			W9WR	27	1 1

(Continued on page 68)

**20
10-5
METER
BANDS**

Simplified Crystal Control

with the **BLILEY HF 2 UNIT**

The new Bliley HF 2 Crystal Unit brings added possibilities to the 20, 10 and 5 meter bands. You can now have that clean-cut crystal control note at these higher frequencies with a real saving in transmitter cost. Expensive, inefficient doubler stages are reduced to a minimum . . . overall efficiency is greater . . . power output for a given number of tubes is increased.

Supplied within 0.2% of your specified frequency between 14.0 and 15.0 MC., or choice from dealer's stock for ..\$7.50.

Ask your dealer for your copy of the new Bliley Catalog G-8. Bliley Electric Company, Erie, Pa:



BLILEY HF-2 CRYSTAL UNIT

INTERNATIONAL RELAY RACKS \$13.50
Another Outstanding Value
This rack is standard construction, according to WE, specification. See January QST for details.

866 TUBES . . . \$1.00
H.D. — ISOLANTITE TOPS

WE ARE PROUD TO PRESENT THE RME-69
The RME-69 S.S. Super is a precision instrument, custom built, coming under the class of model laboratory equipment; it is offered to those amateurs, experimenters, and engineers who desire the most up-to-date H.F. Receiver.
Complete with xtal Tubes . . . \$123.80
Speaker mounted in Cabinet . . . 11.10

SICKLES I.F. TRANS. for Jim Lamb's noise silencer . . . \$1.85

TOBE OIL CONDENSERS
2 M.F.D. — 2000 V. \$2.50
1 M.F.D. — 2000 V. 1.70

110 V. AC. operated single circuit primary keying or circuit relay. Conservatively rated 220 V. at 15 amps AC. \$2.95

Eimac 50T — \$13.50 — 150T . . . \$24.50
H-K 354 Gammatron 24.50

The SUPER-SKY-RIDER
Acclaimed by amateurs as the outstanding set of the year.
Model SX-9 (with xtal) . . . \$89.50
Less crystal. 79.50
IMMEDIATE DELIVERIES

THE SUPER-SEVEN \$49.50
Seven-tube Super

THE RADIO SHACK

INTERNATIONAL Plate Transformers
Fully Cased
Model 2000 — 750-1000 each side — 300 Mills. . \$5.95
Model 3000 — 750-1000-1500 each side — 300 Mills. . \$8.95

UNEQUALLED FOR VALUE

INTERNATIONAL CHOKES
Smoothing — Swinging — Cased
12H — 200Mill. \$2.50 5/25H. . . \$2.50
12H — 300Mill. 3.75 5/25H. . . 3.75
12H — 500Mill. 6.50 5/25H. . . 6.50

10 Volt — 6.5A Fil-Trans. — Cased \$2.10

Thordarson T6878 Transformer
600-0-600-2.5V-10A-5V-3A-7.5V-3A
200Mill. \$2.75

Valpey Mfd. Crystal.	Bliley BC3 Crystals. \$3.90
40-80 — 160M. . \$3.00	Bliley LD. 4.80
Valpey unmounted.	Bliley 20M xtals. 7.50
80-160M X Cut. \$1.50	

BALDWIN TYPE C PHONES \$2.50

2.5V-12A Trans. for 866's. \$1.25	Brush Crystal Phones \$5.40
---	---------------------------------------

ASTATIC CRYSTAL MIKE \$13.50

THE MAC-KEY \$7.50
You can send better with it

RAYTHEON RK20 15.00

Mail Orders Filled — Send M.O.

THE RADIO SHACK
46 BRATTLE STREET, BOSTON, MASS.

The largest stock of Gear in N. E. at your call

PYRANOL CONDENSERS
2 Mfd. — 2000 Volts **\$2.90**

In two years we have not been called upon to replace one condenser due to failure in service. This is the best reason why you should decide on the PYRANOL. Pyranol is your guarantee.

Used Tubes RCA 860 . \$9.00 RCA 852 . 9.00 RCA 204A 20.00 RCA 849 . 30.00 All guaranteed	Antenna Wire 100 ft. enamelled No. 12. 60c 100 ft. enamelled No. 14. 49c
--	---

JOHNSON 5M — O. Ant. \$3.90
Desk Mike Stand. Chrome finish. . . . \$1.65

Ohmite Band ch. Switch . . . \$1.80

E.O.I. Cable 6c per foot

Resonant Choke — will handle one 1K.W. \$3.60

Complete Stock Triplett Meters

Pioneer G.E. Motor \$10.80

R.C.A. Transceiver \$19.95

International D.B. Microphone an outstanding value — money back after a week's trial \$3.25

Complete stock of Ohmite Resistors

Play Safe! Use CARDWELL Complete Stock on Hand

Alladin Iron Core I.F. Trans. . . \$1.80

Dunco Keying Relay AC or DC type \$2.00

Johnson 10 MQ Antenna . . . \$3.50

UTC COMPONENTS
Linear standard — PA — chrome and replacement transformers. Complete stock all types. Catalogue on request.



Be Wise

Cornell-Dubilier, long the leader in the condenser industry, brings now to the 'HAM' the TF line of Dykanol filter capacitors.

High fidelity amplifier, transceiver and transmitter operation demands condensers of the finest electrical characteristics.



Minimum power factor — extremely high insulation resistance — constant non-inductive capacity — stable electrical characteristics under abnormal temperature and humidity conditions. These are only a few of the salient intrinsic features of the TF series.

Catalog No. 127-A contains a full description. A copy is yours for the asking.

CORNELL-DUBILIER

CORPORATION

4373 BRONX BOULEVARD
NEW YORK

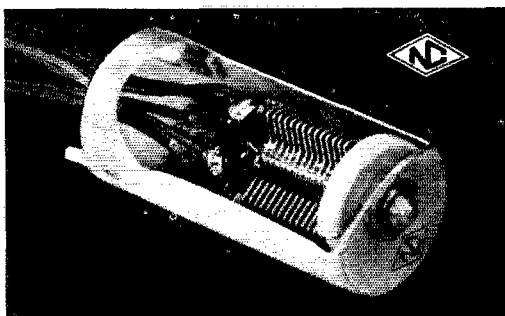

TWIN DIODE TRANSFORMER

■ NATIONAL announces a new I.F. transformer designed for operating into a diode detector. Though of the same high quality as National interstage I.F. transformers, it differs from them principally in having a closely-coupled, untuned, push-pull secondary, and is particularly suitable for use in noise suppression circuits as well as in detector and AVC circuits. Type IFD 175 or 450 to 550 k.c.

List Price **\$3.50**

USUAL AMATEUR DISCOUNTS APPLY

NATIONAL COMPANY, INC.

MALDEN, MASS.

N. Y. C. & Long Island (Continued)			Montana		
W2BGO	486	6 2	W7EUBO	41	1 1
W2HAY	216	9 2	W7EXM	27	1 1
W2ING	162	2 2	Washington		
W2EYG	27	1 1	W7ECC	2,309	23 3
Northern New Jersey			W7EYD	1,080	18 3
W2GUM	3,015	23 5	W7E	81	3 1
W2GON	2,673	22 3	W7BHW	27	1 1
W2BWW	1,944	18 3	Santa Clara Valley		
W2GQX	1,647	21 3	W6DQH	81	2 1
W2HXI	1,206	16 2	East Bay		
W2CW	1,116	13 4	W6IGA	848	6 3
W2CJX	936	6 6	W6LMZ	405	5 3
W2GVZ	270	5 2	San Francisco		
W2CPJ	216	4 2	W6CIS	2,981	17 7
Lotca			W6JMR	324	4 3
W9DIB	648	8 3	W6JHA	54	2 1
Missouri			Sacramento		
W9RSO	7,182	42 7	W6MZH	41	1 1
W9BBJ	6,489	35 7	San Joaquin		
W9NNZ	4,725	25 7	W6MYK	324	4 3
W9RJP	4,617	21 6	San Diego		
W9KEI	3,402	21 6	W6GTM	5,508	34 6
W9RGR	2,828	23 5	W6EPZ	2,538	19 6
W9UAZ	2,070	16 5	Colorado		
Nebraska			W9DQD	108	2 2
W9DMY	2,970	19 6	Utah		
W9KJP	621	8 3	W6FRN	2,308	18 6
W9TBD	468	6 3	Alabama		
Connecticut			W4AG	6,048	32 7
W1FRK	6,318	30 5	W4CJG	3,132	22 6
W1TS	3,825	29 6	W4APU	944	10 4
W1GME	558	11 2	W4BJA	162	4 1
W1GEM	432	8 2	Los Angeles		
Maine			W6KRI	9,639	51 7
W1GJZ	6,993	26 7	W6CAL	8,505	47 7
W1GKJ	1,935	15 5	W6EXQ	8,505	47 7
Eastern Massachusetts			W6CEM	3,591	21 7
W1ABG	2,430	20 3	W6ACL	2,646	17 6
W1ESI	2,065	17 3	W6CPG	27	1 1
W1IDU	1,260	13 4	Northern Texas		
Western Massachusetts			W5CPT	1,080	6 5
W1DLD	2,880	23 5	W5CPB	810	6 5
W1HOZ	756	12 3	Oklahoma		
W1AJ	108	2 2	W5DQB	27	2 1
New Hampshire			Southern Texas		
W1BFT	15,120	80 7	W5BEX	1,350	9 4
W1ILA	486	6 3	W5ARO	1,170	10 5
W1IZL	90	4 2	W5BKE	756	7 4
Rhode Island			W5BDI	648	8 3
W1BBN	5,796	32 7	W5DMB	81	3 1
W1BLV	2,430	20 3	Vermont		
W1LIMY	1,038	13 2	W1EZ	11,655	63 7
Vermont			W1AXN	432	8 2
W1GNT	143	3 2	W1GNT	143	3 2

An Improved Speech Preamplifier

(Continued from page 81)

ation curve is given in Fig. 2 as a function of the deviation from the 1000-cycle gain in decibels.

Where the preamplifier is three or four feet away from the filament and plate voltage trans-

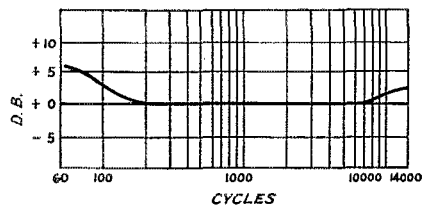
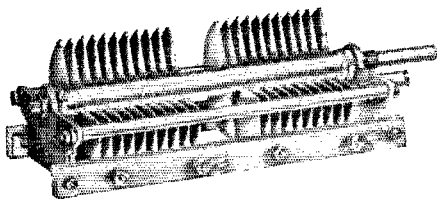

FIG. 2

former, which is advisable because of hum pickup, it is an advantage to use the 6-volt type tube (6C) due to the lower drop in voltage in the filament supply cable because of the lower filament current taken by these tubes.

Condenser C9 and resistance R12 act as a filter,

ONLY ONE CARDWELL QUALITY, "THE FINEST!"



★ TYPE MT-100-GD ★

FOR USE IN BUFFER STAGES, 700 to 1000 volts, USING 211—50T—150—35Y—203A TUBES

- ★ PLATE EDGES ROUNDED AND BUFFED
- ★ MYCALEX INSULATION
- ★ 100 MMF. PER SECTION

AMATEURS: Note the number of times that CARDWELL Condensers are specified in circuit diagrams published for your use. Ask the leading Amateurs in your district and learn that they, too, prefer CARDWELLS.

ENGINEERS: In leading Laboratories throughout the world, CARDWELL Condensers are invariably used for circuit designing, resulting in the use of CARDWELLS in Land Stations, Marine Stations, Airplanes, Medical Therapy and wherever variable condensers are used.

THE ALLEN D. CARDWELL MFG. CORP., 83 PROSPECT ST., BROOKLYN, NEW YORK

CARDWELL ★ CONDENSERS

NORTHERN OHIO LABORATORIES



National HRO JR. Receiver
NET \$99.00
Includes tubes, and 10 to 20 meter coils. Immediate shipment. 5897 Power pack. Net \$15.90. See National Company ad this QST for full specifications.

Filter Condensers W8BAH Specials

2 mfd. 1000v working..... \$1.98
2 mfd. 1500v working..... 3.00
2 mfd. 2000v working..... 3.90

CONDENSERS ARE OIL AND PAPER TYPE Unconditional Guarantee

Relay Rack Panels Crackle Finish T.M. Type

19" x 7"..... .48c
19" x 8 3/4"..... .58c
19" x 10 1/2"..... .69c

Panel 1/4" thick. Beautiful finish. Money back if you don't like them

SUPER
SKYRIDER
NET \$79.50

New Mac-Key
\$7.95
Speed-x bug
\$5.70

Branches in following Ohio cities—
CAMBRIDGE, SPRINGFIELD

RCA
TYPE
ACR-136
RECEIVER
NOW
\$69.50

WARREN AND
SHELBY
NOL

RCA
TYPE
ATR-219
TRANSCIVER
NOW
\$19.95

No. 73

Catalog Folder

New Edition Now Ready

WRITE FOR YOUR COPY TODAY

Postpaid Cash or Stamps, 25c

FOR THAT NEW 10-METER TRANSMITTER
BLILEY NEW 20-METER MOUNTED
HF2 CRYSTAL UNIT
NET EACH
\$7.50

TYPE
HRO
NATIONAL
RECEIVER
NOW
\$167.70

PEAK
2 STAGE
PRESELECTOR
NOW
\$19.80

10-
METER
BANDSPREAD COILS
For National Receivers. Net per pair
FB7A \$7.20 SW3 \$3.00

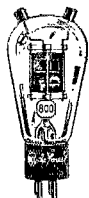

RCA IN STOCK

800.....	\$10.00
801.....	4.50
802.....	3.90
803.....	38.50
203A.....	17.50
211.....	17.50
838.....	18.00
841.....	3.25
845.....	20.00
866.....	2.25
866A.....	5.00
852.....	16.40
860.....	35.00
865.....	12.75
885.....	2.00
906.....	18.00
954.....	5.80
955.....	3.75

BETTER HURRY! ONLY A FEW LEFT Power Transformer

600 volts each side of C.T. 200
MA 2 1/2 V. 10 amps. C.T., 5 V.
3 amps., 7 1/2 V. 3 amps. C.T.
Only \$2.35 each

RME
69
RECEIVER

WHAT'S
A
MUGAWUG?

RCA 803
NET \$38.50

NORTHERN OHIO LABORATORIES
2073 WEST 85th STREET, CLEVELAND, OHIO

RCA 852
NET \$16.40

EIMAC

TRANSMITTING TUBES

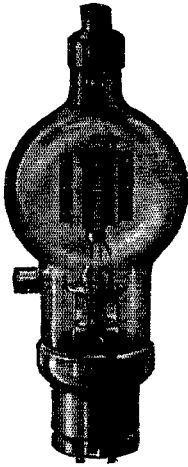

EIMAC 150T

WHEN YOU
THINK OF DX—
REMEMBER AT
ANY PLATE
VOLTAGE AND
AT ANY FRE-
QUENCY EIMAC
TUBES DO A
BETTER JOB!

Now available with
following plate dis-
sipation ratings

- 75 WATT
- 150 WATT
- 300 WATT
- 500 WATT

EITEL-McCULLOUGH, INC.
SAN BRUNO, CALIF., U. S. A.
Cable "EIMAC"

RADIO COURSES

RADIO OPERATING: Prepare for Gov't License Exam. ●
RADIO SERVICING: Including Short Wave ● AMATEUR
CODE ● New Course in ELECTRONICS.

Day and Evening classes—Booklet upon Request
NEW YORK YMCA SCHOOLS
4 West 63rd Street, New York City

Get Your NEW

MARTIN VIBROPLEX

JUNIOR

ONLY

\$10

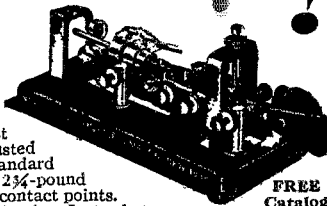

The BUG that satisfies the world's finest operators—can be trusted to satisfy you. All Standard Vibroplex features. 2 3/4-pound japanned base. Heavy contact points. The only difference is in size. Just what you need to develop a good fist. A bargain at this low price.

FREE
Catalog

OTHER VIBROPLEX MODELS

Famous Improved Vibroplex, Black or Colored, \$17; Nickel-Plated, \$19. Newest Model Vibroplex, No. 6, Black or Colored, \$17; Nickel-Plated, \$19.

Remit by money order or registered mail

THE VIBROPLEX CO., INC.
832 Broadway New York, N. Y.

in addition to that in the plate voltage power supply, to reduce hum in the plate voltage power supply to the first tube. Further increase in gain on the higher frequencies may be obtained in the succeeding power amplifier stages if used, by placing a condenser across the secondary of one of the interstage transformers. As the size of these condensers depends upon the design of the transformer, no definite values can be given although they generally are in the neighborhood of 500 to 750 μfd . if the transformer is designed for Class-A amplification. For a single secondary, one condenser is used, and two in series of the same value with their midpoint grounded, if the transformer has push-pull secondaries.

Two 100-henry chokes of standard make were used in the author's amplifier. The amount of bass can be reduced by varying the amount of resistance in the variable resistance across L_2 C_7 . The amount bass desirable in the amplifier will depend upon the type of equipment with which it is used. For example, if used with a public-address system which has the large type dynamic speakers which in themselves favor the low frequencies, it might be advisable to omit circuit R_8 , L_2 , C_7 and replace it with an additional 25,000-ohm resistor.

Strays

W2HFO tells of the ham who absent-mindedly wrote "hrs mi crd, where's urs?" on all the Christmas greeting cards he sent out!

Another coincidence: W6CAL, moving to the East Coast, was assigned the call W1JPE. His first W contact, made on a "CQ SF," was with a San Francisco station, W6JPE!

New Receiving Tubes

(Continued from page 29)

fairly high voltage-amplification and at the same time permit transformer coupling to the following audio power stage. It is capable of an audio output of approximately one-fourth watt and is therefore suitable for driving triode power amplifiers taking appreciable grid power. It is especially suitable for use in high-fidelity receivers.

Tentative characteristics of the 6R7 are as follows:

Heater voltage.....	6.3 volts
Heater current.....	0.3 amp.
Plate voltage.....	250 volts
Grid voltage.....	-9 volts
Amplification factor.....	16
Plate resistance.....	8500 ohms
Mutual conductance.....	1900 micromhos
Plate current.....	9.5 ma.

The tube has the usual octal base with 7 pins and top cap. Pin connections are as follows (see 1936 A.R.R.L. Handbook for numbering system): 1, shell; 2, heater; 3, triode plate; 4, diode plate; 5, diode plate; 7, heater; 8, cathode; cap, grid.

RCA-Radiotron also announces two new glass types, the 1A4 and 1B4, both screen-grid tetrodes for battery receivers. The 1A4 is of the variable- μ

MARCONI

Announces

A Commercial Service Type Receiver for **AMATEUR** Use

Metal tubes with maximum gain R.F. stages. Automatic and Manual sensitivity control. Calibration always visible; No loose charts. Continuous frequency range with band spread. Range 1.5 to 22 m.c. Selectivity switching: No plug-in coils. C.W. beat note switching without de-tuning input circuits. Operates from P.U. or battery supply. Sensitivity minimum $\frac{1}{2}$ microvolt per meter, 400 cycle 30% modulation for 100 milliwatts output. Continuous fidelity within 3 D B to 5000 c.p.s. Model CSR2, receiver complete with tubes. F.O.B. Montreal \$195.00. Address Dept. T.R. for further information.

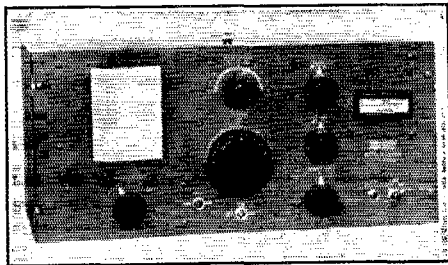

MARCONI MODEL CSR2 RECEIVER

CANADIAN MARCONI COMPANY

Vancouver

Toronto

MONTREAL

Halifax

St. John's, Nfld.

There is only ONE

*TRIMM FEATHERWEIGHT
headset. EXPERIENCE is one of
the unseen factors in their manufac-
ture. You can secure them at your
favorite jobber.*

TRIMM RADIO MFG. CO.
1770 W. Berteau Ave.
Chicago, Ill.

OHMITE BAND-SWITCH

(PATENT PENDING)

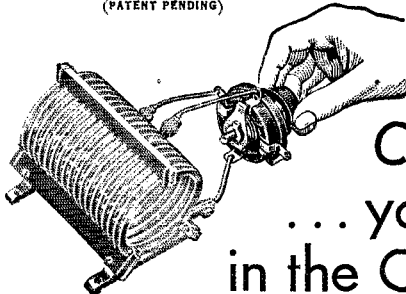

Click!
... you're
in the Clear!

HANDBOOK
PAGES
[458-459]
CATALOG
SECTION

DON'T fuss and fume when interference chokes your wave band. Don't waste valuable operating hours changing coils and retuning. Snap the OHMITE Band-Switch mounted on your control panel for instant QSY (frequency change). It's the modern way! Ask your dealer, or write for Bulletin 104 which contains diagrams for most basic circuits.

OHMITE MANUFACTURING COMPANY
4831 Flournoy Street, Chicago, Illinois

RADIO METERS by HOYT

MOVING COIL TYPE ACCURATE
REASONABLY PRICED

A complete line of panel mounting meters for the radio amateur. Available in 2 $\frac{1}{4}$ ", 3 $\frac{1}{4}$ " and 4 $\frac{1}{4}$ " styles. New line of 2" meters now ready. Full information gladly sent on request.

BURTON-ROGERS CO.
755 BOYLSTON STREET, BOSTON, MASS.

Sales Division of The Hoyt Electrical Instrument Works

It's True!

It is to your advantage to buy from me. Your inquiry about any amateur apparatus will prove that to you. I give you specialized personal service of genuine value that is not available from other jobbers.

I take in trade used apparatus. I sell on time payments.

I stock at lowest prices all amateur apparatus.

I am jobber for Collins, RCA, RME, Marine transmitters. Trade in your transmitter. Buy on time. Write for information.

I have in stock the new All Star transmitter kits. Supplied assembled at nominal cost. Also Radio-Silver transmitters.

I ship all receivers on ten-day trial. You need send but \$5.00 with order.

FLASH-W9ARA can supply rotary beam antennas for 20, 10, and 5 meters.

TRADE IN YOUR TRANSMITTER OR RECEIVER

PR-16s complete prepaid	\$95.70
National HRO Jrs	99.00
Super Pros complete	194.04
RME-69s	118.80
National HROs	167.70
Breting 12s complete prepaid	93.00
Super Skyriders complete prepaid	79.50
Silver 5Ds complete prepaid	109.80
RCA ACR-136s complete	69.50

Every inquiry and order is personally attended to by Robert Henry, W9ARA; an active amateur for eleven years; graduate E.E. from M.I.T.; and owner of Henry Radio Shop selling amateur apparatus for seven years. You can reach me by letter, telegram, or phone call 24 hours a day, 365 days a year. When in a hurry order from W9ARA. Write for any information.

HENRY RADIO SHOP

211-215 North Main Street Butler, Missouri

RADIO ENGINEERING

RCA Institutes offers an intensive course of high standard embracing all phases of Radio. Practical training with modern equipment at New York and Chicago schools. Also specialized courses and Home Study Courses under "No obligation" plan.

Illustrated Catalog on request.

RCA INSTITUTES, INC. Dept. ST-36

75 Varick St., New York 1154 Merchandise Mart, Chicago
Recognized Standard in Radio Instruction Since 1909

USE A

MODULATION MONITOR

TO COMPLY WITH FCC RULE 381

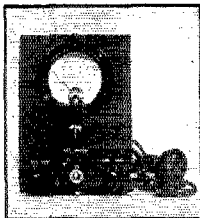

This modulation monitor reads directly percentage modulation on either positive or negative peaks and indicates carrier shift during modulation. May be used on frequencies from 500 to 30,000 kc.

A simplified version of the type of monitor required by the FCC in all broadcast stations by November 1, 1936. Requires no changes in your "rig."

NET PRICE \$20.00

DOOLITTLE & FALKNOR, Inc.
7421 SOUTH LOOMIS BOULEVARD
CHICAGO, ILLINOIS

or "super-control" type, while the 1B4 is a sharp cut-off tube.

Following are the characteristics of the 1A4:

Filament voltage	2.0 volts
Filament current	0.06 amp.
Plate voltage	180 volts
Screen voltage	67.5 volts
Grid voltage	-3 volts min.
Plate current	2.3 ma.
Screen current (app.)	0.7 ma.
Plate resistance	960,000 ohms
Amplification factor	720
Mutual conductance	750 micromhos
Grid-plate capacitance (with shield)	.007 μ fd.
Input capacitance	4.6 μ fd.
Output capacitance	11 μ fd.

The 1B4 has the following characteristics:

Filament voltage	2.0 volts
Filament current	0.06 amp.
Plate voltage	180 volts
Screen voltage	67.5 volts
Grid voltage	-3 volts
Plate current	1.7 ma.
Screen current (app.)	0.4 ma.
Plate resistance	1.2 megohms
Amplification factor	780
Mutual conductance	650 micromhos
Grid-plate capacitance (with shield)	.007 μ fd.
Input capacitance	4.6 μ fd.
Output capacitance	11 μ fd.

Both tubes have four-prong bases with top caps, the connections being as follows (RMA system): pins 1 and 4, filament; 2, plate; 3, screen; top cap, grid.

Characteristics of the 1B4 are identical with those of the 32. The grid-plate capacitance of the new tube is lower than that of the 32, however. The 1A4, which replaces the 34, is likewise lower in grid-plate capacitance, and has higher mutual conductance. The plate and screen currents are slightly lower than with the 34. Both the new tubes are of the type requiring a close-fitting shield for realization of the low grid-plate capacitance.

The construction of the 5Z4, the metal-tube rectifier, has been changed to use a solid metal shell comparable in size to that used on the metal audio power tubes. This replaces the old tall "ventilated" shell.

Operating Noise-Silencing Units

(Continued from page 12)

the noise control toward the "off" position will bring the signal back unchanged in strength; the stronger the signal the farther will the control have to be moved from the critical position to bring back the original strength.

If a good husky noise comes along, a final adjustment can be made by setting the control at the critical point and adjusting the diode trimmer for minimum noise. The correct setting will be unmistakable, and the tuning should be fairly sharp.

Occasionally, tuning the diode transformer to resonance will cause regeneration and, in some cases, even may cause the i.f. amplifier to oscillate. This should not happen with an i.f. amplifier normally stable when all circuits are properly

Thordarson Special Cased Transformer

600 volts each side center, 200 MA. **ONLY \$2.45**
 2 1/2 v @ 10 amp.
 5 v @ 3 amp.
 7 1/2 v @ 3 amp.



NATIONAL 1-10 RECEIVER

Here's the latest NATIONAL ultra short wave receiver. Covers everything from one to ten meters. Super-regenerative circuit with high signal to noise ratio. Stage of RF built in. Uses one 954, one 955, one 6C5 and one 6F6 tube. Ideal for mobile use. Calibration curves included. Net price with coils, less tubes and power supply.

\$28.50
NET

BLILEY XTALS LD-2 \$4.80
New 20 Meter now ready HF-2 \$7.50

New All Star Xmitter
Write for Big Bulletin and News Sheet!

171 E. JEFFERSON ST., DETROIT, MICH.
W8JDG - 8GDT - 88NG - 8JT

QST SUPPLIES (Postpaid)
 Handbook \$1.00
 Logbook49
 Binders 1.50
 License Manual25
 Hints & Kinks50

Sylvania Tubes

Type	Price (Net)
27	\$.39
26	\$.34
45	\$.39
47	\$.51
80	\$.34
86	\$.39
88	\$.31
10	1.14
50	1.42
81	1.14
Special: 10 with isolantite base thoriated filament only	\$1.57

Special Xmitting Tubes
 Raytheon RK-23 \$4.50
 Raytheon RK-25 \$4.50
 Raytheon RK-20 \$15.00
 Eimac 50T .. 13.50
 Eimac 150T .. 24.50
 Eimac 300T .. 60.00
 Taylor 866's .. 1.65

G. E. PYRANOLS
 1000
 2MF \$2.67
 4MF 4.16
 1500
 2MF \$3.71
 4MF 5.25
 3000
 2MF \$4.75
 4MF 6.53
They Stand Up!

NEW 1936 RECEIVERS

Model	Price
RCA-ACR 136...	\$69.50
National HRO	167.70
National HRO Jr.	99.00
PR-16	95.70
With Crystal	101.70
RME-69 "SSS"	118.80

VIBROPLEX JR. KEY
 Exact duplicate of famous Vibroplex in Jr. size
\$10.00

ALL R. C. A. TUBES IN STOCK

RCA-852	16.40
RCA-866	2.25
RCA-800	10.00
RCA-801	4.50
RCA-802	3.90
RCA-803	38.50
RCA-866A	5.00
RCA-954	5.80
RCA-955	3.75

All metal tubes in stock Shipped same day order is received

TRIMM HEADSETS
 Built for hams. Weight 4 ounces. 24,000 ohms impedance only.
\$5.88 Other models from \$1.88 up.

FAMOUS B. C. L. HUSH BOX
 Here's what you've been looking for. Sensational success wherever tried. Solves the B.C.L. problem. A shielded wave trap with one or two band tuning. Easily installed. Money back guarantee. Order Now!
ONE BAND TWO BAND \$1.20 \$1.35

SAVE PARCEL POST — BUY IN MICHIGAN

For Complete Catalog of
NATIONAL RADIO PRODUCTS
 see the new
A.R.R.L. HANDBOOK
 pages 385 to 400 incl.

"The Crystal Specialists Since 1925"
PIEZO-ELECTRIC CRYSTALS
 Guaranteed Accurate to BETTER than .01%
SCIENTIFIC RADIO SERVICE
 UNIVERSITY PARK, HYATTSVILLE, MD.

Birnbach JACKS & PLUGS

No. 401 8 Amp List Price 7¢
 No. 400 8 Amp List Price 7¢
 No. 399 25 Amp List Price 25¢
 No. 403 8 Amp List Price 6¢
 No. 396-25 Amp. 10-32 Thread List Price 25¢
 No. 397-25 Amp. 1/4-20 Thread List Price 25¢
 No. 398-25 Amp. List Price 25¢

Large area of contact is an outstanding feature of Birnbach jacks and plugs. Low resistant phosphor bronze springs secured over solid brass center pins make these plugs non-collapsible. Jacks and Plugs milled of solid brass, nickel plated, complete with nut and lug. Nos. 396 and 397 are ideal for use with ceramic coil forms. Special plugs utilizing the Birnbach spring available to order.

BIRNBACH RADIO CO., Inc. Write Dept. Q3 for latest catalog
 145 HUDSON STREET NEW YORK CITY

High Quality Wireless Key
 This SIGNAL standard wireless key is designed to carry heavy currents. Furnished with either 3/16", 1/4", or 1/8" coin silver contacts. Equipped with navy type key lever knob and has lacquer finish over brass construction.
 Priced from \$3.85 to \$4.25 list.
 SIGNAL's line of Wireless Keys, Telegraph Instruments and Wireless Practice Sets is complete. Send for our bulletin.
SIGNAL ELECTRIC MFG. CO.
 Menominee, Michigan, U. S. A.

SIGNAL
 MANUFACTURERS OF ELECTRICAL PRODUCTS

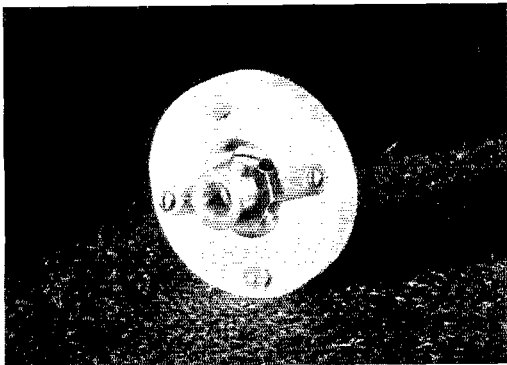

COUPLING: Extremely practical where space is limited, this coupling has Isolantite insulation that will not char under flash over and does not absorb moisture. Equally important, it possesses high electrical efficiency as well as the mechanical rigidity so lacking in couplings of the fibre disk type. Catalog Symbol TX-9.

Net Price \$5.60

NATIONAL COMPANY, INC.
MALDEN, MASS.



**UNIVERSAL
POWER TRANSFORMER**

In Alloy Hum-Proof Casting. 420-350-0-350-420V at 125 M.A. 5V 3A, 6V 6A, c.t. and El. shield. Code: ALPTA. Net price \$4.50. Chooses its Alloy Hum-Free cases. Each \$1.75. 30-13,000 cycles plus or minus 1 d.b. Multiple coil, Hum-Free, balanced construction, audio transformers in Hum-Proof Cases. Each, net \$3.75. Hum-Proof Alloy Cases No. 1 or 2. Each \$0.75.
AALLOY TRANSFORMER COMPANY, INC.
135-Q Liberty St. New York City

BRUSH
Headphones

● Meet every headphone requirement. They bring in weak signals strong and clear and will handle excessive volume without overloading. Response 60 to 10,000 cycles. No magnets to cause diaphragm chatter. Specially designed cases minimize breakage. Light in weight. Only 6 oz., complete with headband and cords. A quality product at a low price. Details, Data Sheet No. 10. Copies on request. Send for one.

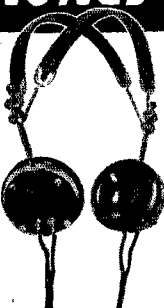

The **BRUSH** DEVELOPMENT COMPANY
1813 E. 40th St. CLEVELAND, O.
PIEZO ELECTRIC
MICROPHONES • MIKE STANDS • TWEETERS • HEAD PHONES • LOUD SPEAKERS

tuned and the gain is at maximum. Regeneration without oscillation will be evidenced by increased sharpness in the tuning, particularly noticeable in c.w. reception, and possibly by an increase instead of decrease in set noise as the noise control is turned down toward the critical point. Needless to say, regeneration is undesirable. Good shielding and proper by-passing should cure it.

As is usually the case with any new system, a short period of familiarization with the operation and capabilities of the device is necessary for full realization of its possibilities. In general, the greatest reduction of noise for a given signal will be obtained when the noise threshold control is advanced as nearly as possible to the point where the signal starts to cut itself off. In c.w. reception it is possible to go beyond this point and obtain a further improvement in signal-to-noise ratio, even though the actual signal strength is reduced. Since the control can be advanced farther on weak signals than on strong before the cut-off point occurs, the actual noise volume on weak signals can be reduced to greater extent than on strong ones. *In any case, when the device is working properly it should be possible to reduce the noise to such an extent that a weak signal is just as readable as it would be were the noise not present under normal receiver operation.* It may be possible to hear some of the noise components in the background, but their strength will be down far enough so that the readability of the signal is not impaired. With the control set for full strength on strong signals, the noise background may be somewhat louder, but the readability is of course unaffected.

It is not possible to go quite as far in noise silencing action on 'phone signals, although the device does make fairly weak signals, completely drowned out by the noise in normal reception, perfectly readable. Adjustment of the noise threshold control is considerably more critical for maximum results than with c.w. reception. If the control is advanced too far, the carrier will block itself off, leaving only a few sidebands to break through. These are of course unintelligible. Furthermore, the control cannot be advanced quite to the point of cut-off, as in c.w. reception, because doing so would cause the up-modulation peaks to be cut off, resulting in lop-sided modulation and distortion. Hence the residual noise may be slightly louder when the control is correctly adjusted for 'phone reception than for c.w. reception of a carrier of equal strength. A properly-modulated 'phone signal comes out better under these conditions than one badly over-modulated, since the control can be advanced farther before peaks are chopped off.

If the unit is to operate properly it is essential that the signal level at the grid of the noise amplifier tube be high enough to make possible cut-off of both signal and noise after passing through the noise amplifier and rectifier. This condition generally will be met when the 6L7 is substituted for the second i.f. tube in the receiver. An additional noise amplifying stage will be advisable should the receiver have only one i.f. stage. The opera-

(Continued on page 78)

MARCH OF THE CHAMPIONS!



TED R. McELROY, Official Champion of the World, Class A. Speed 69 wpm.

CANDLER SYSTEM taught at HARVARD and Massachusetts Institute of Technology in their course "The Art of Radio Communication," conducted by our famous student, Champion McElroy.

Get Your Code Training and Technique Where They Got Theirs!
Twenty-fifth Anniversary of
THE CANDLER SYSTEM

This famous SYSTEM is backed by a Quarter Century of Success in training Amateurs and Commercial Operators who could be satisfied only with the best!

You Can Learn Code RIGHT, from the Beginning or obtain your commercial license and qualify for a good job by taking CANDLER TRAINING in your own home, as McElroy, Jean Hudson and many others have done and are doing. It is surprisingly easy and inexpensive.



JEAN HUDSON, W3BAK, Official Champion of the World in Class E.

Jean obtained her ham license at the age of 8, and two months after she began Candler SCIENTIFIC CODE and Touch Typewriting Courses, could copy 30 wpm on her "mill." At the age of 9 she won official championship in Class E, against rigid competition.

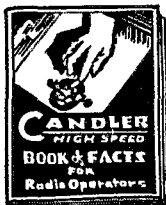

FREE—1936 Book of FACTS

Contains McElroy's own story, "How I Learned to Read Code, and What Candler Training Has Meant to Me," also little Jean's story and other valuable information. Whether you want to learn code or increase your speed, this book will help you. A card will bring it. No obligation.

CANDLER SYSTEM CO.

Dept. Q-3 ASHEVILLE, NORTH CAROLINA

Beginner or old timer, to be a good operator, you need:

MAC KEY @ \$7.95 finest semi-automatic key built. Or JUNIOR MODEL @ \$4.95 a low priced "speed key" guaranteed; MAC OSCILLATOR @ \$3.95 AC/DC 1,000 cycles code practice. "Mac" items sold with emphatic money back guarantee. See my full page in new QST handbook.

T. R. McELROY, 23 Bayside Street, Boston, Mass.

I have an extremely important message for all owners of my keys. Won't cost you anything to write me on this and it will mean a great deal to you. MAC.

LEARN RADIO

New Classes Now Forming! Send for 40-page catalog, explains

fully. 300 licensed graduates placed in past 4½ years in broadcasting, shipping, police radio, aviation, etc. We teach all branches. Oldest, largest and best equipped school in New England. Equipped with Western Electric sound and broadcasting equipment and RCA marine transmitter. Course prepares for United States Government telegraph or telephone license.

MASS. RADIO SCHOOL, 18 Boylston Street, BOSTON

• DUPLEX TRANSMITTER-RECEIVER

HANDBOOK
Page
446
Catalog
Section

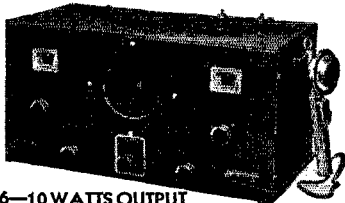

Fixed or
Mobile

• TYPE TR-6A6—10 WATTS OUTPUT

Employing new 6E6 UNITY COUPLED P.P. oscillator, 6A6 Class B, 6A6 Class A. Phone or I.C.W. without external batteries. Four tube non-radiating receiver. **\$39.75**
7½" x 15" x 8"

SPECIAL EQUIPMENT FOR ALL REQUIREMENTS
RADIO TRANSCIEVER LABORATORIES
General Offices and Plant Richmond Hill, N. Y.

Specially Designed for 'Phone Work!

The SHURE 70S is not "just another crystal microphone," but a specially designed instrument for high-efficiency speech transmission. Definitely increases effective side-band power.

For clear, crisp 'phone signals with a real "punch", install a 70S now! The cost is low . . . only \$25 list, complete with desk mount and cable.

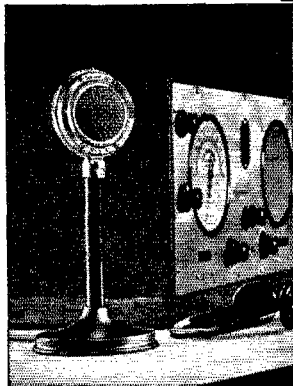

Ask your jobber for complete information, or write for Bulletin 137Q. Licensed under patents of the Brush Development Company.

HANDBOOK
451
CATALOG
SECTION

SHURE MICROPHONES
SHURE BROTHERS • MICROPHONE HEADQUARTERS
215 WEST HURON STREET • CHICAGO, U. S. A.

STATION ACTIVITIES

(Continued from page 44)

DAKOTA DIVISION

NORTH DAKOTA—SCM, Hartwell B. Burner, W9OEL—Assistant SCM, W. O. Morris, W9JZJ. DGS has an 89-802 line-up for 28 mc. EOZ has a Gamatron in final with a real sock. DYA has a new generator. DM is making wood call letters for the boys. OEL is kept away from home because of snow blocked roads. JZJ is acting S.C.M. this month. JAR reports 20 below zero in his shack. Brrr. TFC has 830 in RPT on 14 and 28 mc. KZL is up to his ears in schedules. TQZ is a brother of CRL, who is now at WDAY. IBQ has new a.c. receiver. USY has worked 35 states and is trying hard for W.A.S. MGR rebuilt in steel rack. PVA keeps the air busy at noon with Army net. SEQ's father, who is a railway engineer, took code test. The North Dakota gang has what is known as the Ancient and Honorable Order of Radio Dum Doras. Officers are: Grand All Highest Most Majestic Dum Dora: KZL; All Highest Most Majestic Dum Dora: RII; Most Majestic Dum Dora: PVA; Grand Counsel on Dum Stunts: SEQ; Grand Custodian of Dum Stunts: DGS; Chairman of Board of Governors: STT; Board of Governors: DM, OEL, MGR, STJ, NUM; Grand Tossor of Ink: JZJ. The No. Dak. QSO Party will be held March 15th from 10 a.m. to 5 p.m. Prizes will be awarded. BTJ has a new McMurdo Silver Masterpiece receiver.

Traffic: W9SWC 352 HJC 575 DGS 141 DYA 43 DM 6 OEL 381 JAR 20 TFC 140 KZL 559 TQZ 3 USY 8 PVA 340.

SOUTH DAKOTA—SCM, Mike G. Strahon, W9PFI—The South Dakota State Convention will be held at Rapid City, sometime in August. The Miller boys are for it 100%. Miller Amateur Radio Club elected new officers: PPR, pres.; OED, vice-pres.; PGV, sec.-treas.; P. F. Burke, activities mgr.; E. A. Andersen, news reporter. PGV and OED are building new rigs. LDU is building a new 'phone job. KPQ is building a portable rig. PPR is on 3.5-mc. C.W. with two '45's. SGI is building a new rig. DIS is trying 56 mc. SMV is on 3.5 and 7 mc. with an FB rig. SOB is school teacher and has portable on 3.5 mc. IQZ is on at Yankton with FB sigs. MBA has new 211D and is going to rebuild. DYM reports new ham at Wolsey. TY is trying all bands. IQD is rebuilding. PPR has '45's in P.P. on 3.5 mc. TOP at Rapid City gets out FB with one 2B6. ADJ has new rig. CJC is rebuilding for 1.75-mc. 'phone. FOQ was on 3.5 mc. for Dak. Div. Contest. SMK is on 3.5 mc. GQH puts out a nice 'phone sig. OXC has spider QRM. OED is building crystal rig. PHD is trying 1.75-mc. 'phone. MZJ is putting out nice sigs. on 3.5 mc. SEB is on every Sun. a.m. on 3.5 mc. B.A.R.K. is now going strong (Brookings Amateur Radio Club). The Miller Radio Club visited the Platte gang and had an FB time. SCB is back from the coast. GRJ, PGV and RNH are movie ops. JBT still pounds in on his FB 1.75-mc. 'phone. LAM is putting up new ant. SMS will be on soon with new rig. GYG gets out nicely on 7 mc. DTS has nice rig on 3.9-mc. 'phone. FJR works lots of J's with new long ant., getting R7 to 8 reports. KPQ reports new job is FB. HAT was visiting at Yankton. USE and USI are going strong. FEM says new ham at Howard. TBI works 3.5-mc. C.W. with nice sig. Forty attended the annual Sioux Falls Radio Club banquet, January 21st. PFI moved to Y.M.C.A. and now uses a portable 'phone and C.W. rig. RWE still has hopes of getting rig on air if weather will permit. ALO is doing lots of 28-mc. work with plenty of results.

Traffic: W9AZR 638 OQV 464 ALO 39 MBA 85 SMV 31.

NORTHERN MINNESOTA—SCM, Leonard Hofstad, W9OWU—Howdy, gang! Thanks for all the swell reports. Things are clicking FB in the Section. Two stations make the B.P.L. this month, JID and RJF. OML is in C.C.C. camp. OMI just got back from C.C.C. at Rochester. OOO is building new rig for PIE. VEU has new ACB-136 receiver and is on 1.75-mc. 'phone. UJZ is active as O.O. and has 825 working FB. PUB has trouble with 1.75-mc. 'phone. RJF has 59 e.c. osc. He wants to thank all A.A.R.S. for coop in first message contest. JIE and BMX are working 1X on "ten." BVH has 28-mc. fever, too. OOO schedules WUCY, UJZ and VHU. RJF schedules OZG, PTU, IGZ, FTJ, OWU and JID. Dak. Div. S.C.M.'s, R.M.'s and the Director work on spot freq. 3800 kc., Sunday a.m.'s. IGZ uses 250-volt generator for plate supply. VVN and VYP are new hams at La Porte. LSC has new speech amp. and crystal mike. FEP sold receiver and is building new one. HEO uses P.P. tens with 165 watts input, also has SW3

and new antenna, 264 ft. long, 64 ft. feeders. OTW is on 3525 kc. Your S.C.M. schedules RJF, OVB, OZG and YC. OOV attends U. of M. St. Paul Radio Club will have banquet in Hotel Lowry in February. BBL made address on radio from its beginning at the Jan. meeting of St. Paul Club. Min.-Dak. still has its meetings every Tues. night on 1.75-mc. c.w. PTU spends all his time on the air with A.A.R.S. OZG, IGZ, HEO and OVB have applied for O.R.S. We need a couple of O.B.S. What say, somebody? We need some O.P.S., too.

Traffic: W9HEO 46 IGZ 106 PTU 175 OZG 132 RJF 587 JID 1408 UJZ 2 000 5 OWU 60 OVB 4.

SOUTHERN MINNESOTA—SCM, Francis C. Kramer, W9DEI—BN, DEI and KUI are the only traffic reporters this month. After working his 72nd country BTW leaves So. Minn. to join the Research Div. of R.C.A. We wish you luck, Lowell, and more DX. IJN made the highest score in the Dakota Div. QSO party. JEQ is DX-ing on 14 mc. KAV is striving to get quality for his 'phone. AGO is looking for an African 'phone contact for W.A.C. on 'phone. RHT is attending R.C.A. school in Chicago. KUI is "un-bugging" a Tri-tet! OEV has a new Skyriider. BTW/ELA had over 500 DX QSO's in 1935. BKK won a letter for showing highest copying ability in A.R.R.L. Navy Day competition in this Naval District—Congratulations. FMA pounds brass at 7FM. FCS likes to draw sparks from antenna of KROC. IDF and SJH are QRL college. LXC of Wis. is attending Carleton. KDI worked K7VF on 3.9-mc. 'phone with 65 watts input. GLE finds plenty of bugs still left in the rig. RAU has a fine sounding 3.9-mc. 'phone at college in Sioux Falls. MXW worked Africa on 14 mc. GFA spends most of his time on 7 mc. listening to stations calling DX! PEV operated rig from bed while sick with flu. FNK doesn't believe there is any DX. WAA is new station in Rochester. ACB, South High School of Mpls., is looking for schedules on 7 mc. NNO is rebuilding. The following officers were elected at the annual meeting of the Mpls. Radio Club: pres., BHB; vice-pres., IOG; secy.-treas., RTE. TQW works DX with 35 watts input on 28 mc. IJN is going down on 28 mc. RSM affiliates himself with theory of relativity by Einstein. TDE, station of the North High School, is on 14-mc. C.W. TAT, UMO, VEH, VGB, VJA, VPH, VPY and VXH are members of South High Radio Club. LVG swallowed his mike and is now in the market for a new one. BP smoked a ham with the village council. NYB is attending Dunwoody. PAT ground some 7-mc. rocks. SNW is rebuilding, this time using a 825 final. SKW has a pair of 801's going strong. It is reported JDO was heard by Mummies in Egypt? PXI expected a tie from his YL for Xmas, but got her picture. PLE prefers roller skating to ham radio. SGS is QRL school. NYO is back in Mpls. again. NVQ and NZM work in a radio factory in Chicago. TAT thinks X1ED must have paid \$4 a hundred for his QSL's! DGE is building a low-powered 'phone rig. DHP's double chin is a deficit in 'phone work. It is rumored that DGH, TEM and YC have key clicks? TAT uses cores off flashlight batteries, and toilet paper rolls for ten-meter forms! And then there is the fellow who wound a coil on a rolling pin, and couldn't get it off @!@!—\$ PBH suggests the forming of a Paul Bunion club with him as President. HFF says an RK20 will push a pair of '52's. LEB has a pair of 825's on 7 mc. The bootleg station using LIP's call may receive DX cards by seeing Rex Munger! RYM's rig draws plate current with juice turned off. GTE mounts his crystal on a spring. TYE is trying to get down to 14 mc. EGG gets back to Minn. once in a while. DEI contacted VU2CX for W.A.C. on 14 mc. It's time to select a new S.C.M. Nominations must be in the office of A.R.R.L. HQ's by April 10th. Your present S.C.M. will be unable to run for the office because of increased business, and business worries!

Traffic: W9DEI 14 BN 10 KUI 2.

CENTRAL DIVISION

ILLINOIS—SCM, Fred J. Hinds, W9WR/W9APY—R.M.'s: 9AND, 9ILH, 9KJY. P.A.M.: 9WC. Our sincerest sympathy to Mr. and Mrs. Haller (9HPG) in their loss of a baby boy. BPU made T.B.T.O.C. with VK2EO. ANQ wants to work Chicago on 56 mc. At least two bootleggers have been heard using ONR's call. TWL is building a crystal rig. Traffic not much at SSC, but he's on the air. NUF has been on 14-mc. 'phone with a new Class B modulator. Listen for HQH's 1:30 a.m. QST's. ATS wishes his work wouldn't keep him from operating in contests. W.A.S. certificate Nr. 12 went to KA. ENQ worked Europe

and heard lots more in 3.5-mc. tests. KJY needs confirmation of a Nevada contact for W.A.S. 801 is new transmitter at NIU's. SKF's pastime is a two-hour ragchew about tube characteristics. PCI is contemplating new 50-wattier. New Super Seven at SLU and TAY. NMZ's new bug doesn't seem to raise the boys just right. VNV needs two states for W.A.S. and one continent for W.A.C. DBO's first 1936 QSO took place just a few minutes past midnight. A.A.R.S. attracts TBZ. The '03A feeding the 7-mc. Zepp (on 3.5 mc.) at EAF brings nice reports from DX—and good traffic totals. CUH is still trying to get back on the air, even with all the breaks against him. OIU is scheduling RCG, whose YL is a nurse at a hospital near OIU's. TXQ is going to Washington U. No QSP's on 56 mc., reports VCB. ACU has new Shure crystal mike. SCT is keeping his eye open for traffic he can deliver. New HRO is marvelous, thinks AA. IYA traded his t.r.f. in on an FBXA. JVJ is still working on his half-KW 14-mc. 'phone. Antenna at VIP works best when it is on the ground. SIY sends in his first report. PNE is giving 28 mc. a whirl. DOU, writing from Penna., tells us he misses brasspounding, but keeps in practice by virtue of an audio osc. and bug he has with him. NPM is building 8G a transmitter. MLF likes his new RME69. OW gave HUX new mike for Xmas! EWN operates ANR for the Army, and would like to hear from other hams who are soldiers. '03A in final at LGT. ILH is keeping things humming. RAQ finds, to his dismay, that crystals do not bounce on cement floors. UPW worked a W8 and then discovered his antenna switch was thrown to ground. VCG snagged a 50-T for Xmas and KHG got a 211. KHD is contemplating a bridge rectifier for 3000 volts. DDE handled all the traffic at WLTJ. The only signal STG is putting out at present is one from a clarinet. RWS is planning big things in DX schedules. UZG uses his bedspring for a counterpoise. A receiver should be judged by the way it works on 14-mc. 'phone, thinks COW. WC is keeping 'phone bands alive. INY is only on in the daytime. OXA is working west coast on 3.5 mc. in early mornings. MRH applies for O.P.S. RNW is gathering parts for an '03A final. A free course in Amateur Radio has been started in Downers Grove. Classes are held in both theory and code under George Wernett. Registration may be made at the Community Club, 1100 Grove Street.

Traffic: W9KJY 480 (WLTK 75) PLL 369 RMN 277 FEN 168 ULO 149 RAQ 126 CGV 110 (WLTG 22) ILH 103 ANR-HPG 92 EAF 81 AND 71 DBO 68 (WLTJ 13) FM 65 BJH 49 NXG 45 NGG 44 TBZ 43 NMZ 34 DDO-NXG-OQ 32 L0L 28 KBH 24 SKF 19 NIU 18 VNV 15 ENQ 14 FTX 13 KA 9 ATS-FO-HQH 8 NUF-RWS 7 TAY 6 JO 5 ONR-SSC 4 AU-ANQ-TWL-BPU 3 CEO-KHD-UPW-RCQ 2 NHF-OQW 1. W9DDE (WLTJ 507).

INDIANA—SCM, Arthur L. Braun, W9TE—HBK wants more power. EGQ has his super perking FB. HSF is rebuilding to portable 'phone and c.w. UT traded his super for an SW3. FXM is active on 1.75-mc. 'phone. AGZ and HKZ have new Super Skyriders. JIW likes W.A.S. idea and has 42 now. LLY is trying to line up QSO party. OEC likes rag chews on 'phone. SFG is trying new antennas on his rig. LKI is experimenting on his rig. CB is doing fine in N.C.R. activities. TTA is getting out fine on 1.75 mc. UIX is DXing on 7 and 14 mc. FQ is oping at SAL with new rig. HUO leads state in traffic. HUF is assigned WLVH now. DHJ ops on 7 and 3.5 mc., DX and traffic. AXH is thinking about 14 mc. UM is giving 14 mc. a try. TRN is planning 28-mc. rig. NTP is trying for W.A.S. on 1.75-mc. 'phone. CZD and PHV are oping 1.75-mc. 'phone. MBL built Class B mod. HUB is DXing on 28 mc. TYF likes DX on 7 and 14 mc. TBM wants to install BK-in. JRO wants O.R.S. KHC ops at home from IDZ. ODH is QRL A.A.R.S. schedules. TGC had an FB O.R.S. QSO party for Ind. O.R.S. DET is playing basketball. JST is having trouble with his antenna. IU likes to win O.R.S. parties. SVH has mod. perking FB. SNQ has new bug. PIL worked G5 for DX this month. FHM ops on Monday for N.C.R. schedules. HPQ is planning 56-mc. rig. WBI is ex 9FB back on the air. EOC worked K5, KP, HH for DX this month. UYP is building new receiver. VVJ is new at South Bend. NGJ wants high power. SRV sold his '03A. VNZ is planning a honeymoon. TE is QRL as Unit. Comdr. in N.C.R.

Traffic: W9HBK 29 EGQ 5 CB 87 TTA 4 UIX 6 FQ 2 HUO 612 HUF 20 DHJ 26 AXH 6 MBL-HUV-TYF 1 TBM 159 JRO 21 ODH 29 TGC 129 IU 61 SNQ 3 FHM 5 HPQ 36 UYP 16.

KENTUCKY—SCM, G. W. Mossbarger, W9AUH—Lexington, Ky., enjoyed one of the most successful ham

gatherings ever held there on January 11th, Louisville A.R.T.S. holding its regular meeting there on that date. Forty-one amateurs from all over the state attended. FZV has new 300-watt rig. ARU is honestly active. EDQ schedules west coast on Trunk "B." HBQ has usual fine total. TLZ reports AGAIN. JL as usual is rebuilding. KOX likes Ky. contests. OMW is getting contestitis. CDA fondles 50T. TKP is now quick band-changer with new rig. PAZ postals can now handle "KYN" traffic. BWJ also wants traffic. Ray! for Owensboro. RBV and SDC, Purdue twins, report faithfully. IFM champions "KYN." OX is QRL B.C.L. repairs; one way of keeping 'em quiet. BAZ flies home from Texas to report; there's a man for youse gals. HAX is jubilant over Xmas traffic. NKD cleans up note. Whoopy! IXN and EDV have 'phone schedules going in fine shape. NGZ, PZL and SZK all keep mikes busy. ETT, EOM, KCZ and CMB can drink more likker, . . . no, no, no, what I mean is, they visited Lexington gathering, GOSH!, nearly committed a "fa paw." I dread to say so, however, ELL is now modulating the mess on 3.9 mc. MN, tall, handsome U.S.N.R. officer, gold braid and all, skipped home for Xmas and gave the YL's a treat. KMR's 'phone is kept hot by Y.M.C.A. class. KKG bought an RK28. Gentlemen, make this your special reporting month! 73.

Traffic: W9BCA 3 AUH 5 ELL 8 SDC 38 HAX 113 BAZ 78 OX 57 IFM 32 RBV 42 BWJ 53 PAZ 30 TKP 31 CDA 50 OMW 20 KOX 12 TLZ 3 HBQ 111 EDQ 117 ARU 15 FZV 7.

MICHIGAN—SCM, Kenneth F. Conroy, W8DYH, 18030 Waltham, Detroit—Assistant S.C.M.'s: H. C. Bird, SDPE, R.F.D. No. 2, Pontiac, and J. Lessard, 9PDE, Box 223, Munising. R.M.'s: 8LSF, 8ICM, 9ADY, 9RHM. MICHIGAN NINES: Last QSO Party was a wow! 9SSQ with score of 517 won the crystal and holder donated by ADY. Those attending: 9SSQ, PFK, PDE, UAS, TQT, PCU, YX, CE, OWM, EQV, SVB, TTY, VQT, CWR, ADY, CEX, CGP, CWD, EVI, GBH, HK, KPW, LLD, LUU, OWG, OZG, OZM, PAF, YJZ, POC, PWW, RQP, TGE, THD, TXI, VIF, VJJ and VUI—38 in all! NEWS FOR U. P. GANG: QSO Party First Sunday each month during January, February, March, April and May, 9 a.m. to 4 p.m. C.S.T. 2 points—stations worked. 1 point—each station heard, not worked. Multiply by number of counties worked. Multiply by the following handicap: Inputs 69 watts or less by 1.5; inputs 70 watts or more by 1. This total making the final score. Send claimed scores to Assistant S.C.M. 9PDE monthly and also after the May QSO Party to see who is "Big Chief QSO Partyman"—or sumpin'. One-spot net (3630 kc. in U.P.) working FB 6:30 to 7:30 p.m. C.S.T. PDE reports XYL's GJX and URB put out monthly "Roast Ham" Bulletin—50¢ a year. FB, CWR, the most western Michigan station hoorsays for FB A.S.C.M. KDE is a one-spotter. RIT reports IOV back from N. Y. and intends pounding brass again. Yea, Ray, HK, reports again! OZG reports. HSQ hooks one-spot net and is also going in for A.A.R.S. UAS reports snow so deep that just top of 40-footor is in clear! TGE has trouble with feeders stretching. VUI is working out on 28 mc. VQT is keeping nice schedules and is on the way up. FB.—he is at C.C.C., Germfask, Mich. PCU send in nice total via A.S.C.M. PDE. MICHIGAN EIGHTS: 8LTD has 801 in final and the bed-springs are the antenna—but the signals, like most hams, stick to their bed! ARR built himself an all-wave transmitter—No, Baxter, it is not a spark transmitter! Guess we'll take R.M. ICM out in back of the barn—he just missed the B.P.L. by a hair! He is looking for a job. Got? KEY handles ICM's deliveries while Roy is vacationing (unemployed to you!) KEY misses the B.P.L. by 18 messages! JKO says he'll handle 1000 messages per month if we won't mention that the YL's have given him the go-by! Okay, Stew, we won't. LTT, newest O.R.S., is after A.M. schedules. NNE reports QRM and QRN too much for him—especially YL QRM! ALL STATIONS: QSL Mgr. 8GER, Dayton, Ohio reports Michigan slipping re QSL cards—he has 15,000 QSL's! Send for yours—let's see if we can clean him out. W. Va. is always better than 90% clear! The gang at WXYZ report on one card to save shekels! ATO is rebuilding. HAC is on 7 and 14 mc. PQ is back again. LYT is also rebuilding—what! no report from RF? HL ODN has automatic keyer ready for transmitter. Swell! KXX is practically off the air. LTH: Sorry your 56-mc. contest rules too late for Bulletin and QST—let's have them just a week or so earlier next time. LHH wants to know where the Nev., Utah, Ariz., N. Mex., and Miss. hams are on 3.5 mc. He's after W.A.S. DSQ schedules DPE daily

(Continued on page 80)

NEWARK'S SETS FOR EVERY AMATEUR

Newark's deferred payment plan, available to everyone in the U.S.A. makes it easy for you to own a

NATIONAL H. R. O.
NATIONAL H. R. O. JR.
R. M. E. 69
R. C. A. AGR-136
S9-SUPER SKYRIDER-SX9
HAMMARLUND SUPER PRO
PATTERSON PR-16C

Write for Catalogue Describing Payment Plan on Receivers

NEWARK Oil filled — Oil impregnated Filter Condensers	
2 mfd. 2000 V. DC.....	\$1.50
4 mfd. 2000 V. DC.....	\$2.25
8 mfd. 2000 V. DC.....	\$2.75
9 mfd. 3000 V. DC.....	\$7.25
NEWARK PAPER FILTER CONDENSERS	
1 mfd. 1000 V. DC.....	56c
1 mfd. 1500 V. DC.....	66c
THORDARSON No. T6878 Plate and Fil. Transformer, 600-0-600 V. at 200 M. A. 2½ V. at 10 amp., 5 V. at 3 amp., 7½ V. at 3 amp.....	
	\$2.45
THORDARSON No. T6877 Heavy Duty choke, 15 henries at 250 M. A.....	
	\$1.95

SEE OUR FEBRUARY QST AD!

NEWARK ELECTRIC COMPANY
"FASTER SERVICE—BETTER BARGAINS"
226 W. Madison Street, Chicago, Illinois

LICK BCL INTERFERENCE DXR Interference Filter does the job!

Compact, shielded unit that may be used as wave-trap or low pass filter — now offered to amateurs for the first time.
Type A — any one band or frequency.....\$1.20 net
Type B — any two bands or frequencies.....\$1.35 net

Order direct from this ad or from your nearest dealer
DXR RADIO PRODUCTS
3455 W. Chicago Blvd., Detroit, Michigan

NEW! TOBE MICRANOL Transmitting Condensers PROCESSED IN OIL!

Special Low Prices!



Processed in Micranol — These condensers will withstand peak surges of thousands of volts and will give long faithful service under hard working conditions. Positively sealed against moisture absorption. Housed in round aluminum containers with porcelain insulator supported terminals. Ring clamp for easy mounting.

Even for low power transmitters or PA power supplies these condensers are so low in price it is economy to buy them. Each condenser bears this famous TOBE trade-mark of highest quality technical apparatus. Note the small compact sizes.

WORKING VOLTS 2000 D.C. Tested at 6000 volts D.C.
TC-1 1.0 Mfd. Container size 3¼" x 2¼" Diameter. \$1.70
Your Cost.....

TC-2 2.0 Mfd. Container size 3¼" x 3¼" Diameter. \$2.50
Your Cost.....

IN STOCK AT ALL HAM SUPPLY DISTRIBUTORS
or order direct. (Include postage.)

TOBE DEUTSCHMANN CORPORATION
CANTON, MASS.

(Continued from page 74)

tion of so many i.f. stages in close proximity may lead to oscillation troubles, however. Should the additional noise stage be tried and found to oscillate, one of the noise amplifier tuned circuits can be loaded down with resistance (50,000 to 100,000 ohms) to stabilize its operation; while this may result in lowered gain in the noise circuit, there still should be ample voltage available for noise suppression. Unless the cutting-off action as described above is obtained, whatever the arrangement used, full realization of the noise-reducing possibilities of the device cannot be secured.

Transmission-Line Loading for Short Antennas

(Continued from page 31)

quarter wave in length possesses capacitive reactance. This is indicated in Fig. 3. A shorted line one-fourth wave long is equivalent to a parallel resonant circuit. Incidentally the L_2/C ratio of such a "tank" may be changed at will by moving the two voltage points from one end to the other of the quarter-wave line. The open end of the line (capacity) may be considered as paralleled to the shorted end of the line (inductance). Therefore we can replace the loading coil of Fig. 2 by a closed transmission line. For adjustment of the system a sliding bridge is suggested as shown in Fig. 4. Feeders can be attached to the loading line at an appropriate point (5-A) to permit feeding the set-up from a matched-impedance line. If the loading line is only a few feet long, the feeders will have to be attached to appropriate points on the flat top on either side of the center of the loading line, Fig. 5-B.

If the loading line is long enough to be brought into the window of the operating room, two systems of feeding are feasible. The customary pick-up coil can be used with series condensers for fundamental and shunt tuning for harmonic operation, as shown in Fig. 6-A, or a Collins type impedance-matching network may be used to cover all bands, with appropriate coil and condenser changes, as at Fig. 6-B.

Of course the popular Zepp feed system may be used if the operating room is properly located, and the operator prefers it.

If the matched impedance feeders are desired, the loading line should preferably be cut to the exact length for resonance. For operation at the even harmonics the short, or bridge, across the loading line should be removed. The point at which the feeders are attached will be different for each band, but will not be difficult to locate.

Strays

When making plug-in coils on tube bases, if the base is too short for the required winding a piece of an old three-cell flashlight case of the fibre type will just slip over the base, thus extending the available winding length.

—Ray Howdeshell, Minong, Wis.

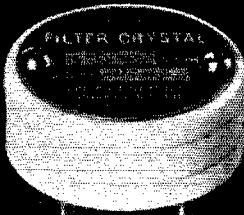

ENGINEERED FOR COMMERCIAL ACCURACY

The Type 195 Bar and Filter Holder engineered for micrometer accuracy and constructed as only can be produced by precision craftsmanship.

The Holder, constructed of Isolantite, is extremely rugged and impervious to the most severe humidity conditions. The highly glazed surface (leakage resistivity 10^{14} ohms per sq. CM), low loss and stable characteristics (thermal expansion 7 parts per million per degree C at 20° C), make Isolantite the ideal ceramic insulation.

ACCOMMODATES 100 kc BARS and FILTER CRYSTALS from 450 to 525 kc.

Write today for Bulletin 103 describing in detail Premier Crystals, Isolantite Holders, etc.

ELECTRODES OF HEAT TREATED NICKEL SILVER, GROUND AND HAND LAPPED, FIRMLY ANCHORED TO ISOLANTITE BASE.

Spacer of low-loss Isolantite accurately ground, to precise thickness and planes parallel, eliminates loose glass spacers, and guarantees satisfactory performance of crystal.

Crystal illustrated in square recess is a 465 kc filter. Rectangular recess is for 100 kc bar. Proper performance of holder assured by isolantite spacer, Electrodes of constant characteristics and precision workmanship.

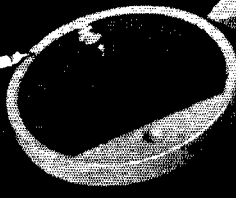

PREMIER CRYSTAL LABORATORIES, INC.
53-63 PARK ROW - NEW YORK - N. Y.

ECONOMY CODE MACHINE—\$12

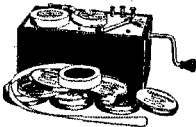

Learn code easily, at your convenience—and economically. Famous instructograph principle. Complete with choice of 5 tapes, and Book of Instructions. Delivered postpaid anywhere in U. S. A. Send postcard for full details.

Instructograph Co., Dept. Q-31
912 Lakeside Place Chicago, Ill.
Representatives for Canada

Radio College of Canada, Ltd., 863 Bay St., Toronto



New Multiple 5 in 1 Sheet Metal Punch—

Radio, Tinsmith and Sheet Metal Workers

Cut those holes quickly and efficiently with this patented Punch and a hammer—nothing else needed. Holes sizes 8/16, 12/16, 15/16, 13/16, 17/16. Price \$3.95. Shipping weight 3 lbs.

LIVERMORE 5 IN 1 PUNCH CO.

119 So. Broon Street Madison, Wisconsin

BUILD IT YOURSELF!

★ BUILD YOUR OWN ★

ALL-STAR TRANSMITTER

BY Thordarson
Hammarlund
Cornell-Dubilier, Etc.

Write for Free Circuits Diagram and Literature

M. & H. SPORTING GOODS CO.
Philadelphia, Pa. 512 Market Street
Atlantic City, N. J. 1709 Atlantic Avenue

5 RELAYS

both Economical and Hardy . . .

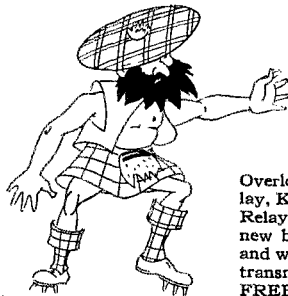

Overload, Underload, Time Delay, Keying and Remote Control Relays are all described in the new bulletin 507B. It tells how and where to apply them in your transmitter. Send for your FREE copy . . . NOW.

WARD LEONARD ELECTRIC CO.

41 South Street, Mount Vernon, N. Y.
Please send me a FREE copy of 507B.

Name

Street

City and State

Call Signal Q

(Continued from page 77)

for C.W.C. traffic. Even ol' man Walt, BRS, says that traffic handled properly is really great fun. He claims he has a 1940 model guzouter! NIT is new reporter from Walled Lake. NVP is still trying for DX—maybe somebody stuck a metal bar across your feeders—like DEN and RX did to us once! OGY reports AIN has comm'l license and is on the market for a job—if he can get an audition with the FB fist of his—he shouldn't have any trouble! MZH is trying 56 meggies. LSF is in the B.P.L. for first time—congrats and keep up the nice work, Bob. KMH and NJG have consolidated. FWU, another new O.R.S., says we sure picked a regular guy for Assistant S.C.M. JUQ runs a pole setting machine for a living—anytime you're around this way, OM, we'd be more than pleased to see you—you can even bring your contraption along! JTK reports following: NVX going strong . . . LLL and DWI have 50T's . . . CPY has the '04A going strong. NJC has 45 states, 1365 QSO's under his belt using '46 on 3.5 mc. FB. One-spot L.P. Net 3656-ke. crystals are available thru D.A.R.A. Secy., 3KSY, at \$1.50 each—X-cuts or A-cuts at \$2.25 each. LYS is working and night-schooling-QRL. DPE tells us the C.C.C. will operate on 4300 kc. using Army calls and also in the ham bands! FB. ONK is working for O.R.S. PBQ is after one also. FX continues his organization known as "The Non-political Political Club." NGC is doing fine work on 3590 and 3835 kc.—is Chair Warmer's Club member. OOR claims he has a good-looking sister—NKK claims he sold car to get enough junk to get on air—thru his QSO with OOR met OOR's sister and now needs car, again—so what? Let's wait till next month! Hi. JYP sends in the following stray: A local (Flint) 56-mc. bootlegger is griping because some other bootlegger was bootlegging his bootleg call! Oh, my! OGU (who got license thru Mrs. DYH's code practice) pops up with a wow of a total! FB, Bill! OCA is building 59-59-'10 P.P. '10's rig. DED wants to know who got the crystal for first out-state QSO on 28 mc.—he's working both coasts there. NIZ is settling down to operating. CU is now at 3471 Bedford and says the Mrs. is brushing up on code. Our good O.O., NQ, needs 5 states for W.A.S. KSY and AKN report a reorganization of the Detroit Amateur Radio Association to a "Traffic" club—interested parties get in touch with them. MCV keeps nice schedules. OHM reports NOB left 3.5 for the wilds of 7 mc. NAP is rebuilding and expects to be back next July! RX is almost on, again! Mrs. DYH has the bug again—it's gonna be kinda hard on Paty, doing all the housework! But she's a tough Irishman! Reports must be received before the 20th of each month for QST, or before 27th for D.A.R.A. Bulletin write-up. Copies of Bulletin mailed free to all stations reporting—new stations, please include address. AIJ is still on 14 mc. ECI is after a Class "A." KAA and NUL are rebuilding. GQS wonders where DZ keeps himself. 9CE runs up nice total on one spot net. 9EQV reports "9CEX claims the OZM-TQT romance is only 'puppy love,' hi." 9TTY, using '47 crystal, 8 watts input, runs up total of 1311 FB. They use loop-keying and say it's okay. 9TGE wonders if F.C.C. checks on poor notes—claims a lot of 'em around there.

Traffic: W8LSF 551 ICM 444 DPE 246 BMZ 176 OGU 103 KEY 87 BRS 76 LYS 72 NGC 59 DSQ 50 LTT 40 ONK 28 JYP 23 DED-NYV 16 ARR 14 FWU 12 FX 11 LFA 10 GQS-HUD 8 JTK 6 NIT-NIZ 4 AIJ-LHH 3 JKO-OCA-PBQ 2 ECI-KSY-MCV-NQ-NVP-OKK-MV 1 W9PCU 202 PDE 177 TTY 131 CE 27 CWR 26 KDE 21 VQT 12 HK 11 HSQ 8 RIT 7 UAS 3.

OHIO—SCM, Robert P. Irvine, W8CIO—RN says Ohio Regulars are keeping his busy. UW reports by radio. HMH was QSO with VK3HG on the morning of Dec. 16th on 3.5 mc. and the next morning VK3HG answered his CQ. MQO says his 5-Z-3 wouldn't stand 1500 volts. WE is busy with his job. ITR got a dandy write-up in local newspaper for handling death message. IET handled QRR message from Georgia via 4PL and got good write-up in newspaper. DVL wants O.R.S. again. EEQ claims his family is the champion radio family—EEQ, NIZ, and EBG all in the same family. APC is still reporting via "Ye Ole Hen." NAL is nicknamed "General." FFK lost his commercial ticket because he was seven days late renewing it; take warning, fellows! NGZ says his '46's in the final with 120 watts input don't get VERY red. AQ needs only one state for W.A.S. ticket. BYM is working on 28 mc. MQC got new ToBe receiver for Xmas. KEV is holding down Toledo position for Ohio regulars. ISK is new Alternate Corps Area Net Control station for Fifth C.A. A.A.R.S. GSO reports OVA and OXF new hams in Lancaster. LAU will have crys-

tal-controlled transmitter on the air soon. FKW is trying hard to get on 28 mc. KLN is new reporter from Columbus. LY is an old-timer but a new reporter. JDD is back on the air with new final amplifier and Class "B" modulator. KLP is busy observing on the Cairo Survey. NJJ is building new crystal-controlled 1.75-mc. 'phone rig. LJJ works out well on 3.5-mc. c.w. LZA is QRL work. GLG is operating on 7 mc. ORM is new reporter from Cleveland and wants O.R.S. BKM cracked his 7-mc. crystal trying to get on 28 mc. ODB worked an EA-7 and a G-6 using a single '10 with 40 watts input. FNX is trying 7 mc. for a change. MMH is after DX on 28 mc. JOU is still looking for DX. NAF will be on 28 mc. soon. IRA, an old-timer, is a new reporter from Mt. Vernon. FGC received confirmation of his signals being heard in Germany. 'Phone report from Chief P.A.M., 8DXB: IAI has worked all U.S.A. and Canadian districts on 1.75-mc. 'phone. EDR confines his activity principally to 28 and 14 mc. JLQ and BIQ are working out FB on 28 mc. HFR has lots of schedules on 3946 kc. CDR has a fine 'phone on 3.9 mc. EMV has been bit by the 28-mc. bug. JTI is editor of the "Aerial," Akron hamsheet. BYF carries on, on 1.75-mc. 'phone; they all know "Doc." JTW runs the Zoo at Columbus, and a good ham station, too. ODI and OGK are good reporters from Cleveland. KNF enjoys working with candles daytime, but it's radio at night. JJM is not a bad parson to talk to; many enjoy his QSO's. JFC has a popular call, January-Florida-California. BCA shut down Galion Park for the winter; more time for ham radio. DXB would like schedules on Wed. and Sat. evenings, also Sun. p.m. Medina County Radio Club is fortunate to have SAQ as its Pres., ERE, Vice-Pres.; LAV, Secy.-Treas.

Traffic: W8CIO 547 (WLHC 143) RN 443 UW 297 (WLHI 47) HMH 288 MQO 243 WE 189 GSO 169 ITR 130 IET 116 AVB 100 DVL 72 EEQ 70 LZK 67 BBH 64 (WLHA 85) APC 52 NAL 46 FFK 41 NGZ 40 LCY 33 AQ 30 BYM 29 MQC 19 IAW 18 KEV 16 ISK 15 LZE 14 GSO 13 MUR 8 LAU 5 MHH 4 FKW 2 KLN-LY 1.

WISCONSIN—SCM, E. A. Cary, W9ATO—We are starting a state traffic net on 3775 kc. to be on between 4 and 5 p.m. and 6:30 to 7 p.m. six days per week. We hope to have it working by the time this comes out in print. If you have traffic for Wis., watch for stations on this freq. Why is it that there are no 'phone men reporting? Are they such retiring fellers, or are they afraid a B.C.L. will get hold of QST? How about dropping me a line, you 'phone men? PFQ is putting in high power. TSC is vacationing in Florida. OXP has new rig using '47-'10-276A. EWY is responsible for the big traffic total at ZY. HSK is handling plenty of A.A.R.S. traffic. UGE is rebuilding and going after traffic in a big way. UIT reports for first time in years! He is x9ELD from way back when. RSR has been appointed O.R.S. JAW is experimenting on 28 mc.; he also wants O.R.S. RKP has new rig going. AKT is taking haywire out of the rig—TJ spends 50% of his time rag chewing. 8KNP worked six districts on 7 mc. with 4 watts input. OTL is trying to get gang going on 56 mc. TFS had his antenna stolen, mast and all! FJJ is at U. of Wis. KPG is working on 1.75-mc. 'phone rig. REQ builds his own a.c. generators and lights up the farm. MUI has a new male Junior op. TDN has new 211D in final. URM, BAS, JLM and FVX are having lots of fun on 1.75-mc. 'phone with round table. AJM is working 1.75 mc. SST has parasites. AKT recommends flea power. RZL has new 3.9-mc. antenna. NPU wants more men on 28 mc. DCU put 6L7 and iron core i.f. transformers in receiver, and it works FB. He is teaching Y.M.C.A. Radio Club boys to build receivers. Madison gang on 28 mc. is NPU, HBH and DCU. JLM has new ToBe receiver. RNU has composed ham song to music of "Round and Round." AKT found a swap editor for F.L. R.C. News; John Raynowa is the man. BOP reports for first time; he is going to U. of Wis. and operating portable. UMP is still working stations on north side of Milwaukee with 56-mc. transceiver. TXF has 930B with quarter k.w. input. VDL is rebuilding transmitter for 7 mc., 150 watts into a '10. UJN is rebuilding rig with 211 final for 14, 7, 3.5 and 1.75 mc. UVV and FEO are building 1.75-mc. 'phone. VKC is working big DX on 3.5 mc. with '45 self-excited. TME, THN, ESE, PYM and JWN are working portable 56-mc. 'phone. EQP was elected President of the Kilocyte Club of Milwaukee; he is building 300-watt 14-mc. 'phone. LFK is QRL new Junior op, male for the mail man. RSA is rebuilding again. Jones exciter into an 802 into a pair of 802's. ONI applies for O.R.S. ONF and DEK are on 7 mc. VVZ is new ham in La. Cross. EXH is proud papa of new male Junior op. All men these days! LED is getting new receiver. CFT sold pair of '52's to VBC who is going to put

one k.w. on 1.75-mc. 'phone. LWX has new 2000-volt 500-m.a. transformer and is looking for Eimac 150. PRM has pair of 211E's; he is getting out swell on 3.9-mc. 'phone. Wausau Club has ten members and invites hams in the vicinity to join. SZL is working with Naval Reserves and applies for O.R.S.

Traffic: W9OXP 136 ZY 82 HSK 55 SES 35 UGE-UIT-RSR 17 JAW 15 AKT 14 RKP 13 TJI-OTL 3 TXR 1. W9KNP-9 3.

MIDWEST DIVISION

IOWA—SCM, Phil D. Boardman, W9LEZ/WLUD—R.M.'s: 9CWG, 9LXC, 9HCH, 9NNM. P.A.M.: 9AED. In keeping with the policy recently announced additional O.R.S. appointments have been cancelled. There is no such thing as an inactive O.R.S.! New appointments: O.O.—9LDE, O.B.S.—9RPA. Appointments cancelled: R.M.—9ABE, 9HMM. O.R.S.—9HMM, 9DFZ, 9DZW, 9DNU. LEZ/WLUD sets new traffic record with 2120 messages. AWH wants west schedules at 5:00 and 5:30 a.m. CST. Help. PGG finds new job in cutting in on radio time. CWG is the modest young man who won't let us forget that VK on eighty. VTD (ex-5MU) is looking for his old gang in Arkansas. MEB, ex-9HPA, ex-R.M., is back on the air. ACL has schedule with Honduras on 3.5 mc. AEP is lining up state schedules. FYC has new Class A ticket, and receiver, but no 'phone rig; tough. AJA says life is full of ups and downs, meaning antennas. SKM has new receiver. TNX is going strong on 3.5 mc. with new rig. FLK is taking a fling at 28 mc. KOY had license expire. PND has new radio shop. PAH moved to Guthrie Center. VHL and VQI are new hams in Council Bluffs. GFQ is back on 3.9-mc. 'phone after two years. COY is having fun with oscillograph. BJP hopes to be back on the air soon. SQL finds work and radio don't mix very well. DEA is wishing he could work 3.5 mc. again. LCX is soon to have new rig with higher power.

Traffic: W9LEZ 1459 (WLUD 661) AWH 271 PGG-CWG 60 VTD 19 MEB 10 ACL 7 AEP 4 FYC 3 AJA 1 LCX 780.

KANSAS—SCM, O. J. Spetter, W9FLG—9KG and 9RIZ, R.M.'s. TVU is using fifty-watt rig on forty. NL, IEH, PET and OFR are on 1.75-mc. 'phone. IFF is now in Atchison and on 1.75-mc. 'phone. UIZ is new reporter on 3.5 mc. RAT is rebuilding contemplating 28 and 14-mc. 'phone. GXV had antenna tied to chimney and snow pulled chimney through roof at 3:00 a.m. SJV has new 50T in final and Super Skyriders receiver. APF has new three-band exciter. LRR has new Skyriders and '03A with carbon plate. BO has pair of new 838's. CNW is suffering YLitis. BJV is reported getting the bug again. VRZ is new on 1.75-mc. 'phone. VZL and WBJ are new calls at Hazelton, on 3.5-mc. C.W. CVN and BEZ are working DX on 28-mc. 'phone. DMF has new rig with '03A final and 830-B modulators. VVR and VXA are new calls in Wichita. FZU is on the air again. UFC has new rig on 7 mc. CVN, UNQ and DMF have new Breting Supers. TTU is on 1.75-mc. 'phone with '03A final. SIL and SOD are working 56 mc. ABJ is planning 1.75-mc. 'phone. TBR is using 802 crystal osc. on the air. AWP has new final and reports it very FB; he also reports lots of 28-mc. activity in Wichita. W.A.R.C. elects for 1936: AWP, pres.; DMF, vice-pres.; UFC, secy-treas.; TJQ, editor; NLZ, sgt.-at-arms; Earl Graves, assoc. representative. K.V.R.C. election: DEB, pres.; ICV, vice-pres.-treasurer; KXB, secy. H.A.R.C. election: GXV, pres.; PIW, vice-pres.; PB, secy.; RQE, treas.; IQI, activity mgr. New club formed at Great Bend, no dope on name yet. FB report, gang, let's keep it going. Thanks. T.R.A.A. elected committee consisting of LJN, BNZ, GRA, LJJ and KCR to conduct business for the coming year.

Traffic: W9KG 1026 FLG 988 RIZ 575 RAT 296 FMX 119 EYY 114 OZN 97 UIZ 14 SJV 11 PB 10 OFR 8 AWP 7 TVU 2.

MISSOURI—SCM, J. Dewey Mills, W9CJR—Five Missouri hams make the B.P.L. this month, with AIJ leading the gang. TGN worked 6 new Europeans on 28 mc. SGP is new R.M. Miss OUD says it surprises herself to make B.P.L. OLC is operating portable in Chicago. MZD is rebuilding again. IGW works J2 for W.A.C. but still lacks the cards. DI says A.A.R.S. gets 80% of the traffic. KEI says Trunk Line "E" is going fine but needs some reliable traffic. RPC is after DX. NNZ worked 3 "G" stations few days after tests! KCG is QRL farm work. RSO, a first reporter, made W.A.C. on Xmas day. EDK worked South Africa twice with 45 watts. SIP went to 14 from 7 mc. KEF worked K7 with 40-watt carrier on 3.9-mc. 'phone. PXH wants schedules near Amherst, Mass. HUG

is active again after moving to farm. CCZ is going on 14-mc. 'phone. VEE is QRL much work in store. SHV is trying 28 mc. BTD is improving antenna. LVA wants to do same. AZL is on 7 mc. now. PVW has been tied down with pneumonia. HUN is coming on the air again. AWC is attending school in Utah. OWQ is working on new antenna system. ISB and UVO are on 1.75-mc. 'phone. AXL is on 1.75-mc. 'phone with low power. HHT is on 7-mc. c.w. OMG reports for Poplar Bluff hams. MUT, RJP, TPK, PYF and KIV report by radio. The S.C.M. is very pleased to have a very good Missouri traffic report this month. Keep 'em coming, gang, and let's set Missouri out in FRONT. CJR is active on 3860 and 3775 kcs.

Traffic: W9AJJ 1284 TGN 847 SGP 769 OUD 594 OLG 590 KIV 248 MZD 228 PYF 225 IGW 203 TPK 146 DI 122 KEI 56 RPC 51 RJP 40 NNZ 32 KCG 25 RSO 22 MUT 21 EDK 13 SIP 4 KEF-PXH 3 GBJ 2 CJR 21 OVO 3 (WUCE 51) ENF 19 DEN-UXA 2. (Nov.-Dec. W9AJJ 526)

NEBRASKA—SCM, Samuel C. Wallace, W9FAM—BNT cops the honors in volume of traffic as per usual. FAM is battling second this month due to A.A.R.S. and Xmas and New Year's Greetings traffic. Thanks to R.M. RUJ for his efforts and to all the District net control stations for their fine work in keeping the gang lined up. POB holds third place this time due to a lot of Holiday greetings traffic. EHW had some sickness at his place. RUJ is busy lining up schedules for the gang on C.W. or 'phone; he has a nice 'phone net organized over the state and things are moving along nicely. DGL sends in his Observers report with a couple of offenders on it. TBF reports Northeastern Nebraska Radio Club met at Pender, December 22nd, with 14 present. TBD, RWN and FYP came in as new members. UOU is a real 'phone traffic handler keeping a bunch of good reliable schedules every day; he relayed 31 messages from OLCX portable at Pet and Hobbie Show, Jan. 1st, at Y.M.C.A., Lincoln. They got a lot of publicity for their work. INR is trying to get a western Nebraska net organized. TBD is building 1.75-mc. 'phone and is going to work both C.W. and 'phone to connect the gang up so traffic can be handled more efficiently. DMY is keeping a bunch of schedules. KJP is working a little DX. BQR is still working A.A.R.S. schedules. DLK holds the championship for originating messages. HI. UDH joined the A.A.R.S. and sure did do his stuff during Holidays in originating a bunch of traffic. TKK is doing his stuff in the A.A.R.S. net. PDH is keeping things moving out his way. THF had some sickness at his home. KLD is new member of the A.A.R.S. KVB is having trouble hunting bugs in his new transmitter.

Traffic: W9BNT 4081 FAM 1101 POB 610 EHW 223 TBD 201 RUJ 165 DMY 62 UOU 145 KJP 11 INR 1 DGL 2 TBF 7 BQR 11 DLK 7 UDH 195 TKK 71 PDH 24 THF 42 KLD 8 KVB 37 PLO 20.

WEST GULF DIVISION

NORTHERN TEXAS—SCM, Richard M. Cobb, W5BII—DXA has been appointed Route Manager and makes the B.P.L. this month. EFO is new A.A.R.S. member and is active on 3.5 mc. EEW handles most of his traffic on A.A.R.S. special frequencies. AZB will soon be an O.R.S. EES is working for an O.R.S. appointment. NW, our Director, has been running schedules with A.R. R.L. Hdqtrs. He requests that we get more activity on the Cairo Survey. DUR is also active. DNE is now T.L.S. on Trunk "D." ZD is on regularly with an FB bunch of schedules. DVD reports from Plainview, Tex. ARS hopes to be able to resume schedules soon. APW has been rebuilding. COK wants more traffic. CPB has been doing a little work on 28 mc. EMG has '03A on now. FBQ worked the yacht *Orinoco* at sea and other FB DX. He is now trying for W.A.S. using less than 16 watts input. CPT has worked all W's on 28 mc. with 5 watts and says it sure is a swell band. AID had more QSO's during the year 1935 than the previous four years put together; he is really on the air! AL lets the ex-YL listen to hams on his Skyriders for entertainment while she is recovering from an operation in the hospital. QU is active on 7 mc. EJJ is pounding brass at AQY at A. & M. College. Friends of DHH should ask him about the fire at his shack!!

Traffic: W5DXA 620 EEW 5 (WLMF 527) AZB 345 EES 291 DNE 279 BXA 278 ZD 261 DVD 77 DMA 72 ARS 2 COK 40 CPB 29 EMG 9 FBQ-CPT 11 AID 10 ARV 5 BII 22.

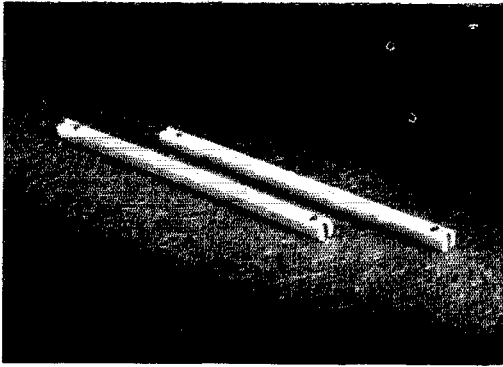

SPREADER: Light in weight as well as exceptionally efficient, these Steatite spreaders offer unusual advantages. The material is non-hygroscopic and weatherproof. The slender shape minimizes surface leakage. The power factor is of the order of 0.15%. The weight is but one ounce each. Catalog Symbol AA-3.

Net Price \$1.18

NATIONAL COMPANY, INC.
MALDEN, MASS.



"HAM" SPECIAL Standard Teleplex
A highly efficient code teacher using heavy specially prepared waxed paper tape, having two rows of perforations. Write for Free folder Q.T. DEALERS — Correspondence invited with dealers for protected territories.

We are the originators of this type instrument
TELEPLEX CO.
72 Cortlandt St., New York City

Instrument with tapes prepared by expert and complete course of lessons: all for \$11.95



IMPROVED

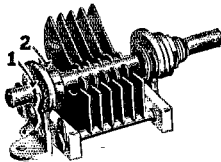

Neutralizing CONDENSERS

for neutralizing tube capacities of XMITTER tubes. Also, ideal as tuning condensers on high and ultra high frequency receivers. Note these improved features.

1. New positive wiping contact on rotor shaft with adjusting screws eliminates noise on high frequencies.
2. Close fitting bearings hold to calibration. Insulated with ISOLANTITE. Soldered brass plate assemblies and heavy aluminum end plates make a rigidly constructed "fool-proof" job.

No. 567 — Max. Cap. — 4 MMFD. Spacing .200" — List \$1.40
No. 564 — Max. Cap. — 8 MMFD. Spacing .130" — List \$1.50
No. 565 — Max. Cap. — 15 MMFD. Spacing .060" — List \$1.50
No. 566 — Max. Cap. — 35 MMFD. Spacing .095" — List \$2.00
No. 897 — Max. Cap. — 35 MMFD. Spacing .060" — List \$1.55

40% DISCOUNT TO AMATEURS

BUD RADIO, INC. 1937 E. 55th Street
Cleveland, Ohio

Notes on Band-Switching

(Continued from page 19)

bands in the 803 amplifier described in the current *Handbook*.

While this situation is bad enough from a constructional standpoint, consider what happens when a balanced circuit has to be used. Instead of two switches for shorting and coupling adjustment, four are required; instead of seven taps we have fourteen! All this on one circuit alone. If the output amplifier is push-pull with link coupling

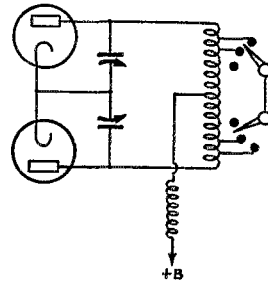

FIG. 4—PREFERRED METHOD OF COIL-SHORTING IN BALANCED CIRCUITS

Losses are reduced when "cold" turns are shorted, as pointed out in the text.

to the driver, a highly popular arrangement, then the switching arrangement of the plate circuit will have to be duplicated for the grid. Thus we end up with a total of seven or eight switches and innumerable taps for but one stage of the transmitter. When exciters and antenna equipment are added on it is not hard to perceive that the thing begins to resemble one of Rube Goldberg's contraptions.

Neutralized circuits are just about as bad as push-pull, since the same necessity for maintaining balance exists.

Some simplification of the switching of a balanced circuit can be brought about by the use of a split-stator condenser for getting circuit balance and shorting from one end of the coil, since the ground point on the coil will automatically shift to the center of the active portion. However, this method is not wholly desirable for three reasons: the number of bands that can be covered is limited because of the losses introduced with shorting from a high-potential end, electrical symmetry of circuits cannot be maintained, and parallel d. c. feed becomes necessary. Furthermore, while this saves one shorting switch, it does not in the least simplify switching of the output coupling.

TAKING STOCK

All in all, shorting out coil sections for band changing does not seem to be the whole answer to the band-switching problem. In the final analysis, all that is saved is the difference in time required between the operations of turning a switch and plugging in a coil, plus the elimination of a stock of plug-in coils. The retuning operations, which usually consume much the greater proportion of the time required for band-changing, are whittled down not one bit by coil shorting. And, as a little thought will show, the more complicated the transmitter the less time, proportionately, is saved by coil shorting. Of course that is not the whole story. Coil switching may be decidedly convenient if the transmitter is built in the metal enclosures now available in several styles, since

HITTING THE STOPS 1,250,000 TIMES

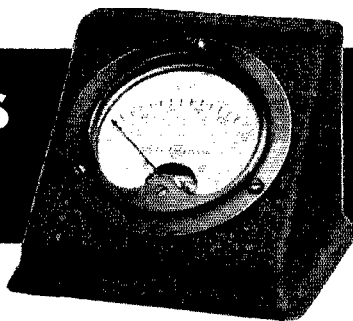

Back and forth 1,250,000 times zipped the pointer of a G-E panel instrument—one moment hitting the stop below zero—the next, far above scale. The punishment was terrific—yet the instrument stood up. Every part was in good operating condition.

Your rig deserves panel instruments manufactured by General Electric. Their accuracy and sturdy construction will give you that extra performance so essential for the complete enjoyment of your transmitter.

Pictured is a standard panel instrument mounted in a portable stand. Have your dealer show you a 100-ma d-c instrument for vertical panel mounting. You'll like it.

Write to Department 6A-201, Schenectady, N. Y. for a free copy of Bulletin GEA-1239, "Small Panel Instruments."

430-61

GENERAL ELECTRIC

GULF RADIO SCHOOL

Radiotelegraphy

Radiotelephony

Radio Servicing

SECOND FLOOR } 1007 Carondelet Street
U. S. A. } NEW ORLEANS, LA.

the
first



MICROMETER FREQUENCY METER sold over two years ago, is rendering accurate, dependable service. Today's MFM is even better—with precision sufficient for many commercial jobs. Amateur range 1.7-2.0 MC, AC operated, nominal accuracy 0.02%, price \$54.00 net. ● The MIXER MONITOR checks keying on CW, fidelity and carrier shift on phone—output audio mixes with receiver output—uses 6A6 tube—price \$9.90 net. ● Catalog sheets on both instruments can be had for the asking. ● Shipments prepaid in U. S. A. on cash orders. ●

LAMPKIN LABORATORIES

Bradenton, Fla.

VALPEY CRYSTALS

A Complete Line Available to You

Type VM2—1.7—3.5—7 MC Bands. Completely Mounted within 5 KC... **\$3.00**

Type VM2SS—465—500—525 KC. SS Filters, mounted..... **\$4.60**

Type VM2100—100 KC Standard. Frequency bar, mounted..... **\$7.50**

We are equipped to supply crystals for general communication use
Special cut crystals for experimental use

See Your Dealer or Order Direct

The Valpey Crystals

377 Summer St., Medway, Mass.

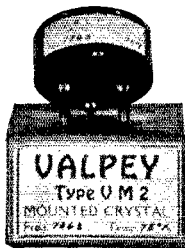

1.7—3.5—7 MC Bands... **\$3.00**

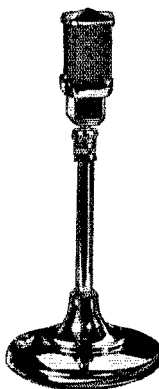

JUST ONE ITEM

in a complete line by TURNER, the only manufacturer of both crystal microphones and amplifiers.

SPECIFICATIONS:

Model 38 — high fidelity single crystal flat from 500 to 7000 cycles with rising low frequency characteristic of approx. 5 DB at 50 cycles. Output—60 DB. Non-directional, unaffected by wind or temperature changes.

MODEL 38
LIST \$22.50
Less Stand

For information write

THE TURNER COMPANY
CEDAR RAPIDS, IOWA, U. S. A.

Licensed under patents of the Brush Development Co.

Yes the IMPOSSIBLE
is a REALITY—
the Amazing
WRIGHT-DECOSTER
NOKOIL
DYNAMIC REPRODUCER

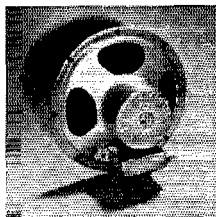

"All that the
name implies"

➔ NO FIELD
COIL OR
CURRENT ←

- Performs like an electro-dynamic reproducer
- Requires less space than an electro-dynamic speaker
- Priced to compete with electro-dynamic reproducers
- The answer to the demand for a compact permanent magnet dynamic speaker
- Available in 6" and 8" models

Write for complete catalog, prices and name of nearest distributor. Wright-Decoster distributors are always anxious to cooperate.

WRIGHT-DECOSTER, Inc.

2259 University Ave. St. Paul, Minn.
Export Dept.: M. Simons & Sons Co., New York
Cable Address: "Simontrice"
Canadian Office: A. M. Flechthelm & Co., Guelph, Ont.

CODE TEACHER



It's easy to learn the code with the Instructograph. Book of Instructions shows you how to study to best advantage. You can rent Instructograph on very attractive terms and rental may be applied on purchase price. A postcard will bring you full details.

INSTRUCTOGRAPH COMPANY, Dept. G-3
912 Lakeside Place Chicago, Ill.

Representatives for Canada Toronto
Radio College of Canada, Ltd., 863 Bay St.

PRECISION CRYSTALS



Crystal Holder

'X' and 'AT' cut crystals one inch square carefully ground for frequency stability and maximum output. Be sure of your transmitter frequency—use **PRECISION CRYSTALS**. Guaranteed to be the highest quality obtainable.

'X' cut **PRECISION Crystals** carefully ground for maximum power supplied to your specified frequency accurate to 0.1% and calibrated to within 0.03% are priced as follows:

1750 and 3500 kc. bands — \$3.00 each. 7000 kc. band — \$3.50. Add \$1.00 to above prices if plug-in, dustproof holder is desired. (Holder as illustrated to fit G, R, type jacks or round holder to plug into tube socket can be furnished) G, R, jacks to plug illustrated holder into — \$1.15 pair.

The 'AT' cut crystal recently developed has a temperature coefficient of practically zero and will handle more power than ordinary crystals. 'AT' cut crystals ground to your specified frequency accurate to 0.1% and calibrated to within 0.03% are priced as follows: 1750 and 3500 kc. bands — \$6.00 each. Crystal holder — \$1.00. Jacks for holder \$1.15 pair.

Crystals and ovens for commercial use quoted on at your request. When ordering our product you are assured of the finest obtainable. Now in our sixth year of business.

PRECISION PIEZO SERVICE

427 Asia Street Baton Rouge, La.

the nuisance factor of having to open doors or take off dust covers to change coils is appreciable. However, we still run up against the inevitable conclusion that to get transmitter band-changing at all comparable in convenience and speed to that available in modern receivers just about requires a separate transmitter for each band.

Nevertheless a lot can be done to make transmitter operation more convenient, even though we don't try to go the whole way and make band-changing purely a one-knob affair. There is no reason why, for instance, switching cannot be applied to exciter circuits, even though coils may be changed in one or more high-power stages. An exciter of the type described by W9DRD will save a great deal of time and energy in band-changing. The fixed-tune tanks may not result in optimum performance from all tubes in the exciter over a whole band, but if the transmitter is designed with ample excitation the slight inefficiency can be written off as one of the prices of convenient operation. A high-power Tri-tet oscillator using an RK-20 and having switching of plate and cathode coils will provide, with suitable crystals, enough excitation for a fairly high-power amplifier, and since the usual string of low-power exciter tubes is eliminated will be found to save considerable time both in switching and retuning. In fact, the logical extension of this thought is that the really practical band-switching transmitter will have to be one designed primarily with band-switching in mind, and that band-switching is not to be considered as something which can be applied effectively to any transmitter design the builder may fancy.

The requirements to be fulfilled in such a transmitter can be stated quite simply. First, the power gain in each stage must be as high as possible so that the number of stages, and hence the number of necessary switching operations, can be reduced to a minimum. This can be modified somewhat by permitting as many low-level separate-band exciter tubes, operating with non-critical tuning, as may be desired, the large power gains being secured in the succeeding stages. Second, in the interests of practicable switching arrangements, balanced circuits should be avoided. This of course lets out neutralized amplifiers—in fact, the two requirements practically impose the condition that screen-grid pentode power tubes must be used. There is small comfort in this for those who like neutralized triodes with a driver nearly as big as the final, but transmitters of that type are not readily conquered by simple methods—at least not by the methods now in use or on the horizon.



Remember that cartoon on page 84 of the January issue? Well, Decatur, Ill., and Piedmont, Calif., have one leg on that certificate, according to a newspaper clipping sent in by W9QQ. They QSO'd on the afternoon of December 29th, probably the first u.h.f. DX police contact!

TRY SPRAGUES ...

and note the difference

Treat your Xmitter to the best! Try the famous Sprague "600 Line" OIL IMPREGNATED TRANSMITTING CONDENSERS —ALWAYS THE BEST AND NOW PRICED LOWER THAN EVER BEFORE.

... Or, for an inexpensive and ideal replacement in many circuits try Sprague Short Wave High Frequency Oil Impregnated Condensers.

It always pays to use the best! Spragues are made in a complete line for EVERY service and amateur need. Featured by leading jobbers. Write for catalog.

SPRAGUE PRODUCTS CO.
North Adams, Massachusetts

SPRAGUE SPRAGUE 600 LINE CONDENSERS

AMERICA'S FINEST LINE OF QUALITY UNITS

STERN WHOLESALE RADIO PARTS INCORPORATED

210 CHAPEL STREET, HARTFORD, CONNECTICUT

A ten-year-old radio distributor announces the opening of a well-stocked amateur department.

24-hour service on mail orders

TWO INTRODUCTORY SPECIALS!

Noise Silencer Kit (Feb. 1936 *QST*, page 11). Complete kit, all highest quality standard parts, exactly as specified in *QST*.

Without tubes..... \$5.00
With three tubes 8.00

10-Meter Converter Kit (Feb. 1936 *QST*, page 39).

All parts complete exactly as specified in *QST*..... \$9.25

EITHER KIT SHIPPED POSTPAID

Send for free R-S-T System Chart

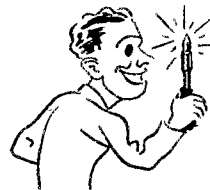

TAKE A HOT TIP FROM
ME GANG —

FOR A GOOD SOLDER
JOB . . . GET ESICO

Esico irons guarantee hot, clean solder joints, day in and day out. A complete range of irons for every purpose, displayed at all Esico distributors.

ELECTRIC
SOLDERING
IRON CO., INC.
342 West 14th St.
New York, N.Y.



EBY

Specializes in
Quality

Binding Posts
Tip Jacks **Male Plugs**
Female Plugs
Low-Loss Sockets
A-C Switches
Tap Switches
Terminal Strips
Short Wave Switches
Moulded Sockets
Electric Eyes

Write for Latest Bulletin

HUGH H. EBY Inc.
2066 Hunting Park Ave.
PHILADELPHIA, PENNA.

60-T TRANSMITTER

—BAND SWITCHING

—CRYSTAL SELECTION

—50 WATTS CW

—15 WATTS PHONE

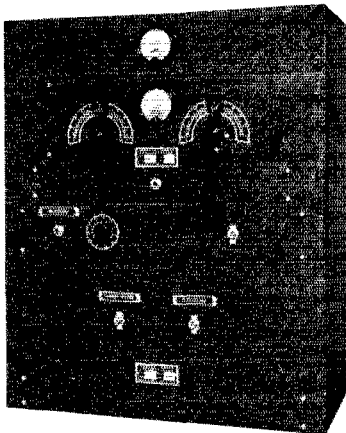

60-T FOR PHONE AND CW — \$88.20

60-T FOR CW ONLY — 69.00

Above Prices are Less Tubes and Accessories

WRITE FOR CIRCULARS AND PRICES
ON THE 60-T AND 200-R

Time Payments Available

HARVEY RADIO LABORATORIES

12 BOYLSTON STREET, BROOKLINE, MASS.

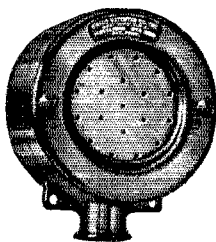

The Superiority of Our
DYNAMIC MICROPHONE

*Over Other Types Is
Mainly in Its Sensitivity*

No high gain preamplification required. No background noise. No Power Supply. And the price..\$30
SPECIAL PRICE TO AMATEURS....net \$18

U. S. PATENTS PENDING

Send for Bulletin 3011

RADIO RECEPTOR CO., INC.

110 Seventh Ave., New York City

I can't afford much for a crystal

Get a BC3 they're cheaper in the long run

BLILEY BC3 \$3.95
CRYSTAL UNITS and up
THOUSANDS ARE IN USE

830-B and 834 Transmitting Tubes Announced

TWO new tube types, known as the 830-B and 834 and corresponding quite closely to types previously available from other manufacturers, have been added to the RCA-Radiotron transmitting line. The 830-B is very similar to the well-known tube bearing the same number, but in addition to its audio ratings now also carries r.f. ratings for frequencies as high as 60 megacycles. Since the characteristics differ slightly from those of the old 830-B we list them below:

Tentative Characteristics, 830-B

Filament voltage.....	10 volts
Filament current.....	2 amps.
Amplification factor.....	25
Direct interelectrode capacitances:	
Grid-plate.....	11 μ fd.
Grid-filament.....	5 μ fd.
Plate-filament.....	1.8 μ fd.

Maximum ratings are as follows:

Plate voltage.....	1000 volts
Plate current.....	150 ma.
Plate dissipation.....	60 watts

Typical operating conditions:

As Class-B Modulator (2 tubes)

Plate voltage.....	1000 volts
Grid voltage.....	-35 volts
Peak driving voltage (grid to grid).....	270 volts
Zero-signal plate current.....	20 ma.
Max.-signal plate current (sine wave).....	280 ma.
Load resistance (plate-to-plate).....	7600 ohms
Driving power, approx.....	6 watts
Power output.....	175 watts

As Class-B R.F. Amplifier

Plate voltage.....	1000 volts
Grid voltage.....	-35 volts
Peak r.f. grid voltage.....	85 volts
Plate current.....	85 ma.
Grid current.....	6 ma.
Driving power, approx.....	6 watts
Power output.....	26 watts

As Plate-Modulated Class-C Amplifier

Plate voltage.....	800 volts
Grid voltage.....	-150 volts
Peak r.f. grid voltage.....	285 volts
Plate current.....	95 ma.
Grid current.....	20 ma.
Driving power, approx.....	5 watts
Power output.....	50 watts

C.W. Power Amplifier or Oscillator

Plate voltage.....	1000 volts
Grid voltage.....	-110 volts
Peak r.f. grid voltage.....	250 volts
Plate current.....	140 ma.
Grid current.....	30 ma.
Driving power, approx.....	7 watts
Power output.....	90 watts

The operating data for modulated service are for carrier conditions, based on 100% modulation capability. Recommended grid-leak resistance for r.f. service is 5000 ohms. The tube may be operated at full ratings at frequencies up to 15 mc. At 30 mc. both plate voltage and plate input should be reduced to 75% of the ratings in the tables above; at 60 mc. the reduction factor should be 50%. The tube resembles the previous 830-B physically, having graphite-plate construction with the plate connection to a top cap, with grid and filament leads brought out to a medium 4-prong base.

THE 834

The 834 is closely equivalent to the W.E.

Where to buy it

A directory of suppliers who carry in stock the products of these dependable manufacturers.

ASTATIC
Crystal Microphones and Pickups
 ASTATIC MICROPHONE LABORATORY, Inc. YOUNGSTOWN, O.
Pioneer Manufacturers of Quality Crystal Products

CHICAGO, ILL. 833 West Jackson Blvd.
 Allied Radio Corporation

CHICAGO, ILL. 601 W. Randolph St.
 Pioneer Automotive Supply Co.

CHICAGO, ILL. 1331 So. Michigan Ave.
 Federated Purchaser, Inc.

CHICAGO, ILLINOIS 520 S. State Street
 Mid-West Radio Mart

CHICAGO, ILLINOIS 926 W. Madison Street
 Newark Electric Company

CHICAGO, ILL. 901-911 W. Jackson Blvd.
 Wholesale Radio Service Company, Inc.

KANSAS CITY, MO. 1012-14 McGee St.
 Burstein-Applebee Company

Super SKYRIDER
 the hallicrafters

CHICAGO, ILL. 841 E. 63rd St.
 Arey-Wilcox Radio Co.

CHICAGO, ILL. 833 W. Jackson Blvd.
 Allied Radio Corp.

CHICAGO, ILLINOIS 415 S. Dearborn Street
 Chicago Radio Apparatus Company

CHICAGO, ILLINOIS 19 S. Wells St.
 Hinds & Edgerton

CHICAGO, ILLINOIS 520 S. State Street
 Midwest Radio Mart

CHICAGO, ILLINOIS 926 W. Madison Street
 Newark Electric Company

CHICAGO, ILL. 901-911 W. Jackson Blvd.
 Wholesale Radio Service Company, Inc.

CINCINNATI, OHIO 633 Walnut St.
 Steinberg's, Inc.

COLUMBUS, OHIO 61 E. Goodale St.
 Bell Radio Parts Co.

DULUTH, MINN. 109 E. 1st St.
 Northwest Radio

FARGO, N. D. 123 Broadway
 Dakota Electric Supply Company

HANNIBAL, MISSOURI 1204 Broadway
 Modern Radio Company

INDIANAPOLIS, IND. 34 W. Ohio St.
 Van Sickle Radio Shop

KANSAS CITY, MO. 1012 McGee Street
 Burstein-Applebee Company

OMAHA, NEBRASKA 2855 Farnam St.
 Radio Accessories Company

ST. LOUIS, MO. 927 Pine Street
 Gordon Radio Company

THE PAS, MANITOBA CANADA
 L. J. Hamers & Company

E.F. JOHNSON COMPANY
 MANUFACTURERS OF
RADIO
 TRANSMITTING EQUIPMENT
 WASECA, MINN.
 U.S.A.

CHICAGO, ILLINOIS 926 W. Madison Street
 Newark Electric Company

CHICAGO, ILL. 520 S. State Street
 Midwest Radio Mart

CHICAGO, ILL. 901-911 W. Jackson Blvd.
 Wholesale Radio Service Company, Inc.

CHICAGO, ILLINOIS 1331 So. Michigan Ave.
 Federated Purchaser, Inc.

DETROIT, MICHIGAN 5031 Hamilton Street
 Rissi Brothers

Where to buy it

A directory of suppliers who carry in stock the products of these dependable manufacturers.



- CHICAGO, ILLINOIS** 1331 So. Michigan Ave.
Federated Purchaser, Inc.
- CHICAGO, ILLINOIS** 226 W. Madison Street
Newark Electric Company
- CINCINNATI, OHIO** 633 Walnut Street
Steinberg's, Inc.
- CLEVELAND, OHIO** 2073 West 85th Street
Northern Ohio Laboratories
- FARGO, NO. DAKOTA** 123 Broadway
Dakota Electric Supply Co.



- BUTLER, MO.** Henry Radio Shop 211 N. Main St.
- CHICAGO, ILL.** Newark Electric Company 226 W. Madison Street
- CHICAGO, ILL.** Allied Radio Corporation 833 W. Jackson Blvd.
- CHICAGO, ILL.** Midwest Radio Mart 520 S. State Street
- CHICAGO, ILL.** Wholesale Radio Service Company, Inc. 901-911 W. Jackson Blvd.
- CINCINNATI, OHIO** Steinberg's, Inc. 633 Walnut Street
- CLEVELAND, OHIO** Northern Ohio Laboratories 2073 West 85 Street
- CLEVELAND, OHIO** Cleveland Distributing Co. 1301 Superior Avenue

- DETROIT, MICH.** Radio Specialties Co. 171 E. Jefferson Ave.
- FLINT, MICH.** Shand Radio Specialties 203 W. Kearsley St.
- KANSAS CITY, MO.** Burstein-Applebee Company 1012 McGee St.
- PEORIA, ILL.** Klaus Radio & Electric Company 707 Main Street
- TORONTO, CANADA** Wholesale Radio Company, Ltd. 1137 Bay St.



- CHICAGO, ILL.** Midwest Radio Mart 520 S. State Street
- CHICAGO, ILL.** Newark Electric Company 226 W. Madison Street
- CHICAGO, ILLINOIS** Allied Radio Corporation 833 W. Jackson Blvd.
- CHICAGO, ILLINOIS** Chicago Radio Apparatus Company 415 S. Dearborn Street
- CHICAGO, ILL.** Wholesale Radio Service Company, Inc. 901-911 W. Jackson Blvd.
- CHICAGO, ILLINOIS** Federated Purchaser, Inc. 1331 So. Michigan Ave.
- CINCINNATI, OHIO** Steinberg's, Inc. 633 Walnut St.
- CINCINNATI, OHIO** Krauss Radio Stores, Inc. 111 East 5th Street
- CLEVELAND, OHIO** Northern Ohio Laboratories 2073 West 85 Street
- CLEVELAND, OHIO** Goldhamer, Inc. 610 Huron Road
- COLUMBUS, OHIO** Hughes-Peters Electric Corp. 178 N. 3rd Street

Where to buy it

A directory of suppliers who carry in stock the products of these dependable manufacturers.

DAYTON, OHIO Burns Radio Company 140 E. 3rd Street

DES MOINES, IOWA Iowa Radio Corporation 1212 Grand Avenue

DETROIT, MICH. Radio Specialties Co. 171 E. Jefferson Ave.

FARGO, N. D. Dakota Electric Supply Company 123 Broadway

PEORIA, ILL. Klaus Radio & Electric Company 707 Main Street

YOUNGSTOWN, OHIO Ross Radio Company 325 West Federal Street



CHICAGO, ILLINOIS Federated Purchaser, Inc. 1331 So. Michigan Ave.

CHICAGO, ILL. Midwest Radio Mart 520 S. State Street

CHICAGO, ILL. Newark Electric Company 226 W. Madison Street

CHICAGO, ILL. Allied Radio Corp. 833 W. Jackson Blvd.

CHICAGO, ILL. Wholesale Radio Service Company, Inc. 901-911 W. Jackson Blvd.

CLEVELAND, OHIO Goldhamer, Inc. 610 Huron Road

DES MOINES, IOWA Iowa Radio Corporation 1212 Grand Ave.

DETROIT, MICH. Rissi Bros. 5027 Hamilton Ave.

DETROIT, MICH. Radio Specialties Co. 171 E. Jefferson Ave.

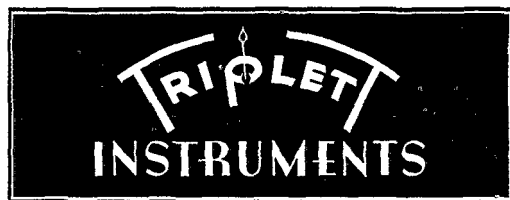

CHICAGO, ILL. Allied Radio Corporation 833 W. Jackson Blvd.

CHICAGO, ILL. Newark Electric Company 226 W. Madison Street

CHICAGO, ILL. Midwest Radio Mart 520 S. State Street

CHICAGO, ILL. Wholesale Radio Service Company, Inc. 901-911 W. Jackson Blvd.

CHICAGO, ILLINOIS Federated Purchaser, Inc. 1331 So. Michigan Avenue

CINCINNATI, OHIO Steinberg's, Inc. 633 Walnut Street

CLEVELAND, OHIO Goldhamer, Inc. 610 Huron Road

DETROIT, MICH. Rissi Bros. 5027 Hamilton Ave.

FARGO, N. D. Dakota Electric Supply Co. 123 Broadway

TORONTO, CANADA Wholesale Radio Company, Ltd. 1133-1137 Bay St.



CHICAGO, ILL. Newark Electric Co. 226 W. Madison St.

CHICAGO, ILL. Midwest Radio Mart 520 S. State St.

INDIANAPOLIS, IND. Van Sickle Radio Shop 34 W. Ohio St.

HIPOWER

AH cut—HIPOWER—crystals
LOW DRIFT—DEPENDABLE—ACTIVE
 Why pay more, you cannot buy as good for less

Type	Frequency	Choice of Stock
AH10	1700-3500 Kc. Band	\$2.35
AH10	7000-7300 Kc. Band	\$3.90

Hipower crystals are sold at your dealer,
 or order direct



Type M Holder \$1.00
 Molded Bakelite, plugs into
 tube socket.

FREE plug-in mounting

Write for literature

Zero temp. coef. crystals for
 BROADCAST and COMMERCIAL use

HIPOWER CRYSTAL CO.

2035-49 W. Charleston Street
 CHICAGO, ILL.

RADIO

ENGINEERING, broadcasting, aviation and
 police radio, servicing, marine
 radio telegraphy and telephony. Morse telegraphy and railway
 accounting taught thoroughly. Engineering course of nine
 months' duration equivalent to three years of college radio
 work. School established 1874. All expenses low. Catalog free.
DODGE'S INSTITUTE, Day Street, Valparaiso, Indiana

At Last! A New!
CODE TEACHER
THE NEW MASTER TELEPLEX

for beginners, experienced operators, and schoolroom
 No Batteries No Winding

ALL ELECTRIC
JUST PLUG IN AND LET HER GO

The new Easy way to learn code and speed up wpm. This new
 instrument will record your own sending on double row per-
 forated paper and repeat it back to you at any speed. 10,000
 words can be recorded on one tape.

This New Machine Is Remarkable

It is the same in principle, and in operation for this purpose is
 equal to the Wheatstone Transmitter and Perforator, which
 would cost over \$1000.

BUY IT OR RENT IT

Send for Folder Q, 3, which tells you how to get the use of this
 instrument without buying it. No obligation. We furnish
 complete course and personal instruction. Low cost, easy
 terms. Write today for information.

TELEPLEX CO.

72 Cortlandt Street New York City
THE NEW MASTER TELEPLEX
 "The Choice of Those Who Know"

304-A both in ratings and structure, having sepa-
 rate wire grid and plate leads brought out the top
 of the bulb, with filament leads through the me-
 dium 4-prong base. Tentative characteristics are
 as follows:

834

Filament voltage	7.5 volts
Filament current	3.25 amps.
Amplification factor	10.5
Max. plate dissipation	50 watts
Direct interelectrode capacitances:	
Grid-plate	2.6 μ fd.
Grid-filament	2.2 μ fd.
Plate-filament	0.6 μ fd.
Maximum operating conditions, with typical ratings, are listed below:	

Class-B R.F. Amplifier

Plate voltage	1250 volts
Grid voltage	-115 volts
Peak r.f. grid voltage	115 volts
Plate current	50 ma.
Grid current	0 ma.
Driving power, approx.	3 watts
Power output	20 watts

Plate-Modulated Class-C Amplifier

Plate voltage	1000 volts
Grid voltage	-310 volts
Peak r.f. grid voltage	435 volts
Plate current	90 ma.
Grid current	17.5 ma.
Driving power, approx.	6.5 watts
Power output	58 watts

C.W. Power Amplifier or Oscillator

Plate voltage	1250 volts
Grid voltage	-225 volts
Peak r.f. grid voltage	350 volts
Plate current	90 ma.
Grid current	15 ma.
Driving power, approx.	4.5 watts
Power output	75 watts

Operating conditions for modulated service refer to carrier,
 for use with 100% modulation. The 834 may be used at full
 ratings up to 100 megacycles.

Strays

W4CDE, who lives kinda out in the country,
 sez he manufactures his own lexticity. Sorta
 ohm talent, as it were!

—W4ACB

Celebration, Pittsburgh, Pa.

The Amateur Transmitters Association of
 Western Pennsylvania is ten years old in Febru-
 ary, 1936, and in celebration of the occasion is
 holding a banquet Saturday evening, February
 29th, at the Hotel Mayfaire, Penn Avenue, Pitts-
 burgh, Pa. Tickets are \$1.50. All amateurs are in-
 vited. Complete details may be obtained from
 the club secretary, R. M. Francis, 3577 Elmhurst
 Street, Pittsburgh.

According to W6ALO, W6LDJ lost a couple of
 nights sleep worrying about gas in a new bottle,
 only to find the cause was a blue QSL card tacked
 on the wall behind the rig!

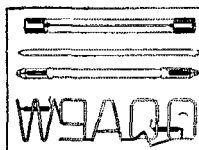

Neon Oscilloscope Tube, tested, low
 striking voltage, long life—mirror
 complete in structions. \$1.75
 Neon R.F. Wand, tracks down R.F.
 8" \$5.00
 Neon R.F. Stick, internal electrodes,
 very sensitive to R.F., 12" \$1.00
Dress Up Your Station! Call letters
 in brilliant red or blue luminous
 tubing 3/4" high, with mounting
 per letter \$1.00

Postpaid. Decorative displays for ham stations, prices on request.
 Commercialite Laboratories, Box 47, Omaha, Nebr., W9AQQ

HAM-ADS

(1) Advertising shall pertain to radio and shall be of nature of interest to radio amateurs or experimenters in their pursuit of the art.

(2) No display of any character will be accepted, nor can any special typographical arrangement, such as all or part capital letters be used which would tend to make one advertisement stand out from the others.

(3) The Ham-Ad rate is 15c per word, except as noted in paragraph (6) below.

(4) Remittance in full must accompany copy. No cash or contract discount or agency commission will be allowed.

(5) Closing date for Ham-Ads is the 25th of the second month preceding publication date.

(6) A special rate of 7c per word will apply to advertising which, in our judgment, is obviously non-commercial in nature and is placed and signed by a member of the American Radio Relay League. Thus, advertising of bona fide surplus equipment owned, used and for sale by an individual or apparatus offered for exchange or advertising inquiring for special equipment, if by a member of the American Radio Relay League takes the 7c rate. An attempt to deal in apparatus in quantity for profit, even if by an individual, is commercial and takes the 15c rate. Provisions of paragraphs (1), (2), (3) and (5) apply to all advertising in this column regardless of which rate may apply.

Having made no investigation of the advertisers in the classified columns, the publishers of *QST* are unable to vouch for their integrity or for the grade or character of the products advertised.

QUARTZ—direct importers from Brazil of best quality pure quartz suitable for making piezo-electric crystals. Diamond Drill Carbon Co., 719 World Bldg., New York City.

RADIO engineering, broadcasting, aviation and police radio, servicing, marine and Morse telegraphy taught thoroughly. All expenses low. Catalog free. Dodge's Institute, Byrd St., Valparaiso, Ind.

NATIONAL—Hammarlund, Patterson used sets, 60% off list. W3DQ, 405 Delaware Ave., Wilmington, Del.

QLSs, SWLs, modern, neat. Quality stock. Priced right. Samples? Stamps. W8ESN, Toledo, Ohio.

1000W General Electric transformers, 1100-2200-4400 each side center on 110. Sold hams eight years. \$13.50. Dawson, 5740 Woodrow, Detroit.

CLASS B transformers—Universal for two or four 46s, 210s, 800s, RK18s, etc., \$7.75 pair postpaid. 70 watts audio from 46s, 100 watts from 10s. Write for details. W8UD, Douglas, Mich.

150 2-color QSL's \$1. W5A1A

SELL—All-Star. W3BBV

RACKS—38 units GR type, tapped, 100 pounds net, \$12.50 prepaid U. S. A. 1/2" crackle lacerated insulating panels, slotted, extremely rigid, all standard sizes prepaid. 52¢ square foot. Stamp for particulars. W1JBR, Storrs & Cooley, 11 Olds Place, Hartford, Conn.

RECEIVERS—new and used, sold and traded in. Hammarlunds, Nationals, RME69, Skyriider. Schwarz Radio Service, 15 Lawrence Ave., Dumont, N. J.

INTRODUCTORY offer. One order to an individual. Send \$1. and call letters for 100 two color modern QSL cards (not filled with advertising—send for sample) and six F.M.C. porcelain case mica low loss transmitting and receiving condensers. Any capacity up to .006 mfd. 5% capacity tolerance 2,000 volt test. Actually a \$7.50 value for \$1. Capacity color chart included. Filtermatic Mfg. Co., Tacony, Phila., Pa.

PHONE hams—a brand new outstanding combination over-modulation, carrier shift and field strength indicator. Fifteen dollars, complete. Custombuilders, 113 West 57, New York City.

FOR sale. Six 750 volt, 150 watt generators, \$11. each. Also a few other generators and motors. Wilmot Auto Supply Company, 1970 Wilmot St., Chicago.

THERMOCOUPLE ammeters repaired \$2.50. W9GIN, 412 Argyle Bldg., Kansas City, Mo.

CRYSTALS—request our catalog. "X", eighty meters, \$1.95. "V" cut, low-drift, 80-160; Ten cycle, \$2.25. Four cycle, \$3.25. Low priced mounted crystals. Holders. Ham Crystals, 1104 Lincoln Place, Brooklyn, N. Y.

THEY give you station that million dollar look—the new all-welded relay racks, chassis, panels. Sure-fire performance if it's equipped with super-power transformer, reactors. Rectifier Engineering Service, 4837 Rockwood Rd., Cleveland, Ohio.

QSLs. 5-Meter Print, Escanaba, Mich.

SNAPPY QSL's, Samples? W9SIF, Spring Road, Hinsdale, Illinois.

CASH for FB-XA. W9JUN

SELL DCSW3. Tubes, coils 20, 40, 80, 160, \$18. W2HRM.

QSL's. Free samples. Printer, Corwith, Iowa.

NATIONAL ultra high frequency converter. Never used, \$10. W1BFJ.

HAMMARLUND, National, Sargent, RME, Hallicrafter, Paterson and others. Best place to trade your old receiver or buy parts. Palmers Trading Post, Route 1, Duluth, Minnesota.

SELL—month old metal tube S9 Super Skyriider with xtal. Also slightly used 204A. Want Peak preselector. W2AYJ, Oyster Bay, N. Y.

PHONE transmitter for sale. Low power, finest parts, beautiful custom made rack. Prefer selling to Chicago ham. W9NHF, Ravenswood 0641.

SELL or swap for superhet rectifier. Course with I. C. S. school. Cash preferred. W1ISN.

CASH for HRO, AGSX, or FBXA complete. State age, lowest price accepted. A. M. Horn, 33-35 Suffolk St., N. Y. C.

AUTOMOBILE call letter plates, 85c pair. W9AIN, Evansville, Ind.

SELL crystal control transmitter complete, \$35. 5 Meter station, \$12.50. Penney, 35 Eutaw St., Boston, Mass.

SELL—Universal exciter, complete, tubes, crystal, coils. Relay rack construction. Write W9UCM

TWO ninety-foot galvanized steel radio towers cheap. Donald Applegate, Park Hotel, Columbus, Ohio.

CALLBOOKS (Spring-W9FO). \$1.25 from W8DED

QSL's! No cheap trash! Samples? (Stamp) W8DED, Holland, Mich.

DANGER! High-voltage card 10¢! W8DED.

BLILEY crystals?? Write W8DED.

SKYRIDERS cheap—sell or trade. Also can use cameras, binoculars, etc. Wells-Smith Radio Corp., 26 North Wells St., Chicago.

SELL FBXA BS coils all bands, Peak Preselector, power supply. All A1 shape. Sixty dollars cash. W3ESY, Hellam, Pa.

QSL cards, two color, cartoons, message blanks, stationery. Snappy service. Write for free samples to-day. W1BEF, 16 Stockbridge Ave., Lowell, Mass.

NATIONAL AGSX Communication Receiver, relay rack mounting with double power pack, speaker, two coil racks, and special wood cabinet. Value \$465. Sale price \$225. F.O.B. Augusta, Georgia. Receiver in perfect condition. Write W. C. Fleming, 214 Leonard Bldg., Augusta, Ga.

AAA-1 Supreme Diagnetometer \$50. Supreme 85 tubetester \$20. W2CBS-Joseph Tucker, 715 East 4th St., Brooklyn, N. Y.

SW3 general coverage coils numbers 60, 61, 64, 65, 66, 67, 68. Best offer takes them. W5BB.

SELL FBXA tubes, coils, power pack—\$45. W2HFF.

W1AAX for sale—RK18 rack panel job, RK20 job as in Aug. '35 *QST*. Receivers, tubes, and hundreds of parts. *QST's* from Nov. 1919. 275-5th St., South Boston, Mass. Fee enclose stamp for photo.

1 #4 WE212D, 1 #2 WE212D, 1 #3 WE212D, good shape, \$8. each. 1 #4 WE212D which is O.K. except plate lead burned off, \$5. 2 WE sockets 212D's—\$2.50 each. Filament transformer 2-212D's \$4. Filament transformer 22 volts, water cooled tube \$8. Ball bearing Escro 3 Unit Motor Generator. Filament and generator and plate 1000 @ 350 mls, tapped. 110 volt single phase motor cost \$220. @ \$35. Filament transformer, three separate secondaries for 210's @ \$3. W9MM.

QSL's. Finest at lowest prices. Samples. Maleco, 1512 Eastern Parkway, Brooklyn, New York.

BARGAIN. Used xmtr equipment. W9HWZ

USED receivers—RME9D's, Comet Pros, National, Patterson. Satisfaction guaranteed. Mims Radio Company, Texarkana, Ark.

FOUR stage 250 watt CW transmitter. Three power supplies, complete eight meters and tubes \$100. W5BDB

W9ADN crystals for individual attention. Temperature coefficient 0.000004—"B"—40-80—\$3.75; 80—"AT50"—0.000009—\$2.50; 0.000002—\$4. Holders \$1. Lockport, Illinois.

THREE Westinghouse oil filter condensers, 3.2 mfd. 3500 volt (good for 5000). \$10. each—W1BZ

CRYSTALS \$1. postpaid. Y cut, guaranteed no jump oscillators. Approximately 1 inch square, 80-160 meter bands. Herbert Addington, 2252 North LeClaire Avenue, Chicago.

SELLING out—everything goes. Write for bargain list. W4CGW, 601 Penna. Ave., Clearwater, Fla.

CRYSTALS: Zero cut. Guaranteed to compensate at near zero without oven control. Your approximate frequency, 80 or 160 meters, \$1.85. Ordinary zero cuts \$1.35 postpaid. Blanks 65¢. Plug-in holders 75¢; dozen \$6. Fisher Laboratory, 4522 Norwood Street, San Diego, California.

CRYSTALS—New zero coefficient "V" cuts. 80 or 160 meters your approximate frequency \$1.85—AT \$1.50—X \$1.25. Calibration accuracy 99.99%. Southwest Piezo Service, Box 792, Abilene, Texas.

SELL or trade Esco 2000 volt motor-generator. W5KD

TRANSMITTING tubes—slightly used and new 203A'S, 211's, 503A'S 212D'S and other types. \$6. and up. Write for list. Mims Radio, Texarkana.

GROSS CB100 transmitter complete everything \$250. Mims Radio, Texarkana, Ark.

SELL, used 204A, sockets, perfect condition. Best offer. W9BOH

VIBROPLEXES, rebuilds \$5. to \$7. New bugs \$9. Lydeard, 28 Circuit, Roxbury, Mass.

WANTED—high voltage generator and good battery receiver. W9ARJ, Henry Langdell, Eau Claire, Wis.

SELL two transceivers; also 50 watt rig complete—W9OSM

WANTED—Cathode Ray tube—W7ERD

QSL's, QSL's. Samples. Prices on request. W2AEY

CRYSTALS 1" Sq. X cut 80-180 meters \$1.40, 40 meters \$2.50, within 3 Kc. of desired freq. Guaranteed the very best. The Ransom Lab., North Syracuse, N. Y.

203A Class B transformers \$10. pair. Ribbon microphones, \$10. Trade for transmitting equipment. W2GZL, Elizabeth, New Jersey.

SACRIFICE—Pacifi Electric Co. transformer, 3600V each side 3000 d.c. with choke input. Air cooled, mounted, new—beautiful job. Ideal for 150T or 852. First \$15. takes it. W5AMK

BACK again fellers—"T-9" dependable X cut 40 meter crystals, \$1.50 within 10 kilocycles, \$2. within 5 kilocycles, \$2.50 for exact frequency, postpaid. Now 80 meters also, at same prices. Skeptical?—repeat orders and testimonials tell the story. Fully guaranteed—you must be pleased. "Eidson's", Temple, Texas.

SELL: one HP 110 volt single phase century motor \$25, 500 watt 500 cycle Crocker-Wheeler motor-generator \$10. Want Photophone speakers. W9DWK.

SELL: Breting, Super Skyrider receivers. Easy terms. Trades accepted. W8IV, Argyle, New York.

TRANSFORMERS—1200 watt 1200-2200-3200 each side \$24. Quotations given. Frank Greben—W9CES, 1533 S. Sawyer Ave., Chicago, Ill.

SALE FBXA, 5897 power-supply, coils AB-20, AB-80, FB-C, FB-P, AB-40 or FB-B, excellent condition \$50. Ballantine, 1809 Cheltenham Ave., Philadelphia.

20 watt speech amplifier, two meters, power supply, input transformer to 211's. \$25. takes it. M. B. Strickland, Ashland, Mass.

W8HNY selling out. 200 watt class B phone, beautiful rack job complete; National FB7A complete, 20, 40, 80 coils. Whole station ready to run, for \$175; or sell separately. Yates M. Hoag, 277 South, Utica, N. Y.

TELEPLEXES, Omnigraphs, Vibroplexes, meters, receivers. Bought, sold, traded. Ryan Radio Co., Hannibal, Mo.

CRYSTALS—1750 to 2000 kilocycles; 3500 to 4000 kilocycles; X or Y. 1" square, ground to your specified frequency \$2.75. Approximately 1", within seven kilocycles of specified frequency, \$1.75. Less than 1", within fifteen kilocycles of specified frequency, \$1.35. Exact frequency marked on each crystal. Oscillating blanks, 85¢. Doughton blanks, 60¢. Small irregular shaped blanks, five for \$1. Rustproof, plug-in holders, 85¢. Wm. Thram, W8FN, 4021 Davis Ave., Cheviot, Ohio.

SELL slightly used Instructograph code machine, ten tapes, oscillator, instructions. Perfect condition. \$20. Money order only. W9CLP, Chicago.

AMATEUR licenses, complete training, \$1.50 weekly. Resident and correspondence courses. Students licensed this month: W2JAN, W2JBD, W2JCU, W2JJD, W2JDQ, W2JDE, W2JGS, W2JGV, W2JGX, W2JGY, W2JHF, W2JHV, W2JIE, W2JII. New York Wireless School, 1123 Broadway, New York.

RCA 861s-\$45.; 851s-\$40.; 849s-\$30.; 860s-\$9.; 852s-\$9. New Ewing 866As-\$2.50; 212Ds-\$10. Ewing, 1057 Pratt, Chicago.

TRADE, 32-power spotting scope, for radio apparatus. Make offer. Arthur T. Adams, W8LYL, Merced, Calif.

RAW quartz \$2. pound, blanks 50¢, holders 50¢. Faberadio, Sandwich, Illinois.

BARGAINS, Class B and power transformers, modulator units, transmitters, receivers, good used 849 tube. Write Radio, 314½ West Lincoln, Blackwell, Okla.

QSL's! The finest obtainable at the lowest price. Free samples to hams. W2FJE, 145 Lafayette Ave., Brooklyn, N. Y.

TRANSMITTER—W3DD 210 very neat—rack form—XPDC 850v power supply included. Guaranteed satisfaction—First M.O. for \$21. takes all. Write W3EKS, Ardmore, Pa.

RECEIVER—Fb like ACSW5, coils, tubes—(58s), power supply. Best offer, W3EKS.

212Ds trade for transceiver, P. A. equipment, converter, receiver, parts. 4AXL.

CALL letters, black and silver 1" high gummed Metalettes, 25¢ set. J. F. Satterthwaite, Toledo, Ohio.

SELL 300 volt Edison "B" power supply \$10; Jannette 32 dc/110 ac 150 watt converter \$25; standard micrograph \$15; 250 volt powerpack \$1. W9AIR, Sleepy Eye, Minnesota.

TRANSMITTERS—built to order. Save 35%. Write Howard Radio, 154 Pine Ave., Chicago.

WANTED—Good ham receiver. W9GLR.

CALLBOOKS—new DX calls, new prefixes, thousands of new W and VE calls, in the SPRING 1936 Radio Amateur Call Book. Sent postpaid \$1.25, or a whole year (four issues) for \$4. (In foreign countries \$1.35 and \$4.35.) Your call and QRA printed in large type, \$1. per year. W9FO-610 S. Dearborn, Chicago.

200 watt phone, commercial style, hear it on 14 MC. complete \$130. FB-7X all bands, supplies, speaker \$35. W3ARA, 236 Landis Ave., Vineland, N. J.

FOR sale—new and used receivers—transmitting tubes—condensers—meters—microphones—vibroplexes relay racks—Jos. N. Davies, WBANT, Box 602, R. R. 9, N. Bend Rd., Mt. Airy, Cincinnati, Ohio.

SELLING out WIFYN, Rack transmitter, Weston meters, new high quality parts. Real bargains. List.

TIME payments to Connecticut hams on receivers, parts, tubes. New Haven and Hartford stores. Hatry & Young.

242 tubes, new, unused, fully guaranteed, \$4.95; equivalent to 203-A but 12 mu. Fine R. F. amplifier, B or C. Hatry & Young, Hartford, Conn.

LAMB'S noise reducer built for any receiver. Hatry & Young, Hartford, Conn.

SELL Peak Q5 UHF receiver and Peak 5 meter X4 transmitter both complete with tubes \$65. cost \$86.50. W2BRE

Utah
TRANSFORMERS and CHOKES
Send for complete catalog. Includes a wide variety of Battery Transformers and Chokes for all Receivers and Transmitting Devices.
UTAH RADIO PRODUCTS CO.
Orleans St., Chicago

NEON OSCILLOSCOPE KIT

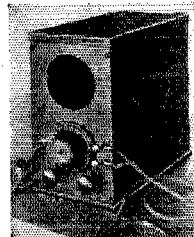

The Finished Job!

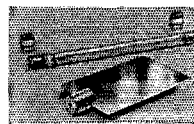

Oscilloscope Kit

Radio amateurs — Experimenters will want this for viewing and demonstrating wave form, for making resonance and r.f. indicators and audio oscillators. Many other uses too. Neon oscilloscope tube is brilliant and has long life. Complete kit only \$2.00 includes tube, clips, mirror and motor shaft adapter.

\$2.00 Net
Prepaid with Tube, Clips, Mirror and Motor Adapter

Write for folder or see at your jobber — or order now from —

SUNDT ENGINEERING CO.

4246 Lincoln Avenue

Chicago, Illinois

(Affiliate of Littelfuse Labs. Makers of Instrument Fuses — Radio and Auto Fuses — High Voltage Fuses — Aircraft Fuses — Fuse Mountings.)

Your Nearest Dealer Is Your Best Friend

Your nearest dealer is entitled to your patronage. You can trust him. He is equipped with a knowledge and understanding of amateur radio. He is your logical and safe source of advice and counsel on what equipment you should buy. His stock is complete. He can supply your needs without delay. His prices are fair and consistent with the high quality of the goods he carries. He is responsible to you and interested in you.

Patronize the dealer nearest you — You can have confidence in him

CHICAGO, ILLINOIS

Allied Radio Corporation
833 West Jackson Blvd.

Complete standard lines always in stock—W9NRV—W9IBC—W9RZI

CHICAGO, ILLINOIS

Chicago Radio Apparatus Company
415 South Dearborn Street (Est. 1921)

W9RA and W9PST — Amateurs since 1909

CHICAGO, ILLINOIS

Mid-West Radio Mart
520 S. State Street
All standard lines carried in stock

DENVER, COLORADO

Inter-State Radio & Supply Co.
1639 Tremont Place
Amateur Radio Headquarters in the Rocky Mountain Region

DETROIT, MICHIGAN

Radio Equipment Sales Co.
14036 Woodward Ave., Highland Park
A complete stock of amateur, shortwave and service parts

DETROIT, MICHIGAN

Radio Specialties Company
171 E. Jefferson Avenue
Ham Supplies — National & Hammarlund Sets and Parts

DETROIT, MICHIGAN

Rissi Brothers
5027-31 Hamilton Ave. at Warren
W8KXK Manager Amateur Department

FRESNO, CALIFORNIA

Ports Manufacturing Co.
3265 E. Belmont Ave.
Wholesale: RCA-Thordarson-Biley. All Standard Lines

KANSAS CITY, MISSOURI

Burstein-Applebee Company
1012-14 McGee Street
"Specialists" in supplies for the Amateur and Serviceman

KANSAS CITY, MISSOURI

Radio Laboratories
1515 Grand Avenue
Amateur Headquarters in Kansas City

MILWAUKEE, WISCONSIN

Radio Parts Company, Inc.
332 West State Street
Complete stock Nationally Known products

MINNEAPOLIS, MINNESOTA

Lew Bonn Company
1124 Harmon Place
Rex L. Munger, W9LIP, Sales Engineer
Radio Wholesaler Complete Stock

MINNEAPOLIS, MINNESOTA

Electric City
1607 Hennepin Street
Headquarters for standard lines of amateur and servicemen parts

SALT LAKE CITY, UTAH

Felt Radio Company
150 South Main Street
W6IAL Intermountain Radio Headquarters W6GTQ

SAN FRANCISCO, CALIFORNIA

Offenbach Electric Company, Ltd.
1452 Market Street
"The House of a Million Radio Parts"

TORONTO, CANADA

A & A Radio Service Supply
101 Queen Street, West
Canada's foremost radio supply house

You Are Protected When You Buy From QST Advertisers

“Advertising for QST is accepted only from firms who, in the publisher’s opinion, are of established integrity and whose products secure the approval of the technical staff of the American Radio Relay League.”

Quoted from QST’s advertising rate card.

Every conceivable need of a radio amateur can be supplied by the advertisers in QST. And you will know the product has the approval of the League’s technical staff.

For Your Convenience QST'S INDEX TO ADVERTISERS IN THIS ISSUE

Alloy Transformer Company	74
Aerovox Corporation	66
All Star Headquarters	57
A.R.K.L. Binders	62
Calculators	51
Handbook	61, 64, 69
Hints & Kinks	69
License Manual	73
Supplies	65
Birnbach Radio Company, Inc.	73
Bliley Electric Company	67, 86
Brush Development Company	74
Bud Radio, Inc.	82
Burgess Battery Company	71
Burton-Rogers Company	71
Canadian Marconi Company	71
Candler System Company	71
Capitol Radio Engineering Institute	66
Cardwell Mfg. Corp., Allen D.	69
Central Radio Laboratories	56
Cohen's Sons, I. S.	73
Collins Radio Company	Cov. 2
Commercialite Laboratories	90
Cornell-Dubilier Corp.	68
Delaware Radio Sales Co.	69
Deutschmann Corp., Tobe	78
Dodge's Institute	90
Doolittle & Falknor, Inc.	72
DXR Radio Products	78
Eby Inc., Hugh H.	85
Eitel-McCullough, Inc.	70
Electric Soldering Iron Company	85
General Electric Company	83, 95
General Radio Company	53
General Transformer Company	6
Gross Radio, Inc.	53
Gulf Radio School	83
Hallcrafters, Inc., The	55
Hammarlund Mfg. Company	4, 5
Harvey Radio Laboratories	86
Henry Radio Shop	72
Hipower Crystal Company	90
Instructograph Company	79, 84
Lampkin Laboratories	83
Leeds	59
Livermore 5 in 1 Punch Company	79
M & H Sporting Goods Company	79
Marine Radio Company	72
Massachusetts Radio School	75
McElroy, T. R.	75
National Carbon Company	52
National Company, Inc.	47, 50, 68, 73, 74, 82, Cov. 3
Newark Electric Company	78
New York V.M.C.A. Schools	70
Northern Ohio Laboratories	69
Ohmite Mfg. Company	71
Port Arthur College	63
Precision Piezo Service	84
Premier Crystal Laboratories	79
Radio Laboratories	65
Radio Mfg. Engineers	63
Radio Receptor Corp.	86
Radio Shack	67
Radio Specialties, Inc.	73
Radio Supply Company	69
Radio Transceiver Laboratories	75
RCA Institutes, Inc.	72
RCA Manufacturing Company	49, Cov. 4
Raytheon Production Corp.	58
Scientific Radio Service	73
Shure Brothers Company	75
Signal Electric Mfg. Company	73
Sprague Products Company	85
Standard Transformer Corp.	60
Stern Wholesale Parts, Inc.	85
Sundt Engineering Labs.	92
Teleplex Company	82, 90
Trimm Radio Mfg. Company	71
Triplet Electrical Instrument Corp.	48
Turner Company	83
United Transformer Company	96
Utah Radio Products	92
Valpey Crystals	83
Vibroplex Company	70
Ward Leonard Electric Company	79
Wright-DeCoster, Inc.	84

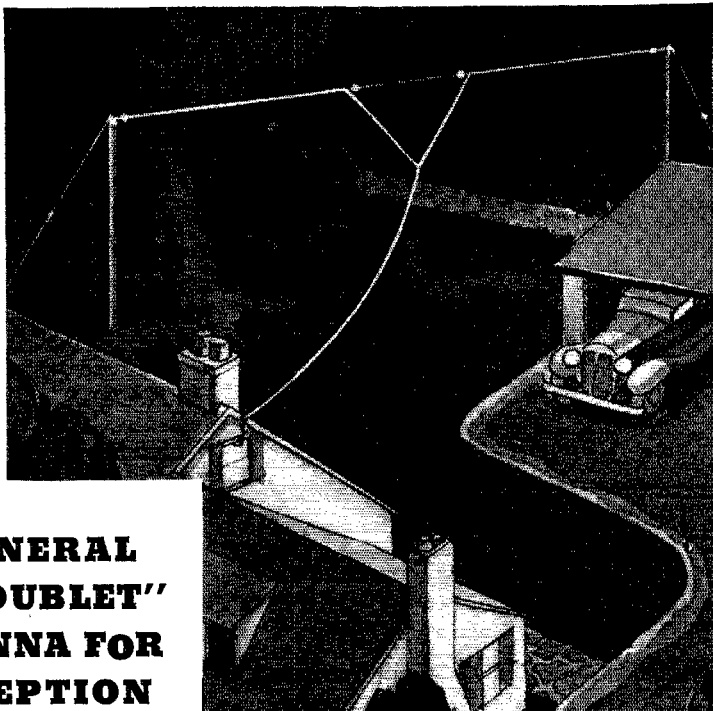

INSTALL A GENERAL ELECTRIC "V-DOUBLET" ALL-WAVE ANTENNA FOR SUPERIOR RECEPTION

DIRECTIONAL CHARACTERISTICS

The "V-doublet" Antenna System is ideally suited to take full advantage of directional effects. When the antenna system is placed at right angles to the direction of the incoming signal, the signal will come through at maximum energy. When the antenna span points towards a known source of local interference, it decreases the pick-up of noise from that source.

EXCELLENT SENSITIVITY ON ALL SHORT-WAVE FREQUENCIES

The "V-doublet" is very broadly peaked in the short-wave band. The tapered "V" section couples the antenna to the transmission line in a manner that permits the transfer of signal energy over a wide frequency range, without favoring any particular short-wave frequency.

A specially constructed receiver-coupling transformer affords proper *electrical matching* for modern radio receivers equipped with antenna coils having a relatively large number of turns in the primary circuit.

BALANCED TRANSMISSION LINE

Short-wave signals intercepted by the "V-doublet" are fed to the receiver through a balanced, twisted-pair, transmission line. Since the transmission line serves only to transfer signals from the doublet to the receiver it minimizes "man-made" static which originates from the house wiring system and external electrical apparatus, including even ignition systems of passing automobiles.

DOUBLET FOR SHORT-WAVE— T TYPE FOR BROADCAST

In the reception of standard broadcasts, the

G-E "V-doublet" Antenna System is automatically converted from its "V-doublet" form to one approximating the conventional "T" type arrangement. This change-over is accomplished automatically by the special circuit employed in the receiver-coupling transformer.

EASY TO INSTALL

The "V-doublet" All-wave Antenna Kit, consisting of the doublet wires, glass strain insulators, and transmission line is assembled and packed ready for installation. It's easy to install, requiring only two points of suspension over a 50-foot span.

PRICE . . . Model KV-100 . . . \$5.00

Available at your local
General Electric Radio Dealer



GENERAL ELECTRIC

THE ORIGINAL METAL-TUBE RADIO

APPLIANCE AND MERCHANDISE DEPT.
GENERAL ELECTRIC COMPANY

BRIDGEPORT CONNECTICUT

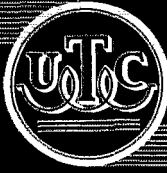

*Most Complete Transformer
Line in the World*

QUALITY • RELIABILITY

A Universal Modulation Output Choke for Every Purpose

The Answer to Your Audio Modulation Problem

Broadcast and phone men who want an output audio unit that will match all possible tube impedance combinations to the R F Stage cannot afford to be without the new UTC Universal Modulation Output Chokes.

TYPE OUTPUT CHOKE	INPUT		OUTPUT	LIST PRICE	NET PRICE
	CLASS B	A PRIME	R F TUBES		
HUC-20 will handle 30 watts audio peak	46-59-53-6A6 etc...	45's-42's 2A3's	46's-210's-801's 211-50T-etc...254A's- etc...	\$ 7.00	\$ 4.20
HUC-50 will handle 60 watts audio peak	210's-801's-830's 841's, etc...	P.P. Parallel 250's-45's 2A3's	RK 20-203A-838-860 211-50T-etc...254A's- 210's-801's-830's	\$12.50	\$ 7.50
HUC-100 will handle 125 watts audio peak	800's-211 E's 50 T's	845's-284's etc...	852-203A-242A-211 50T-RK 18's-RK 20's 860's-282A's-etc...	\$20.00	\$12.00
HUC-200 will handle 250 watts audio peak	203 A's-838's 50 T's-etc...	P.P. Parallel 845's-284 A's 800's-etc...	203 A's-838's-50 T's 860's-803-etc... HF 200's	\$32.50	\$19.50
HUC-500 will handle 650 watts audio peak	204 A's-150 T's HK 354's-HF 200's	849's-150 T's 212 D's	150 T's-204 A's-849's HF 200's-HF 300's	\$80.00	\$48.00

What This Universal Modulation Choke Will Do:

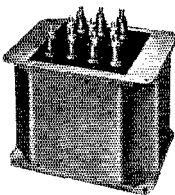

The choke may be used to match the output audio stage to an R F Pentode stage for screen plate modulation.

It is tapped so that it can be used as an autotransformer coupler from Class B to Class C stages, various impedance taps are available, so that each choke will readily accommodate push pull

Class A — Prime or Class B Modulators, single ended Class A Modulator with the DC adding, or single ended Class A Modulator with the DC bucking.

The chokes are huskily constructed and air gaps are arranged to take care of the maximum currents.

Included with each choke is our data sheet 112 which indicates the application of each unit for different tubes and circuits.

BALANCE COILS

The new UTC development which permits paralleling mercury vapor rectifier tubes with equal current distribution.

List Net

PA 10B

Center tapped choke to equalize the load between two 80's, 81's, 82's, 5Z3's, 83's, etc.

\$ 5.00 \$3.00

PA 11B

Center tapped choke to equalize the load between two 866's, 866A's

10.00 6.00

PA 12B

Center tapped choke to equalize the load between two 872's, 872 A's

25.00 15.00

UNITED TRANSFORMER CORP.

76 SPRING STREET

NEW YORK, N. Y.

EXPORT DIVISION — 15 LAIGHT STREET, NEW YORK, N. Y.

DIFFERENT ONLY IN VERSATILITY AND IN PRICE

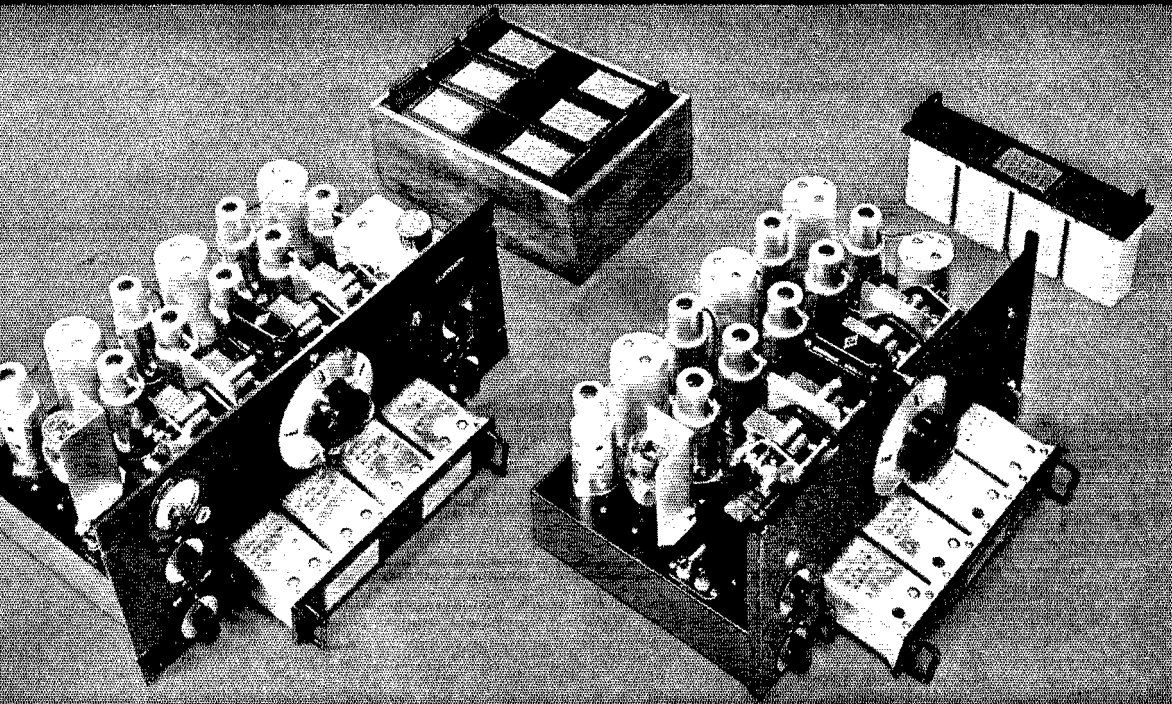

THE STANDARD HRO :: THE HRO JUNIOR

ANY night on the amateur bands you will hear a better advertisement of the Standard HRO than we could write. The unqualified enthusiasm of men who have spent years mastering the fine points of high frequency communication counts for more than a long list of unusual details, even though those details include such items as the PW Precision Condenser, calibrated band spread and a crystal filter as effective on phone as c.w. The demands of modern radio are rigorous, and the proof of the pudding is in the eating.

THE attractively priced HRO Junior is the Standard HRO stripped down to its straight superheterodyne circuit by omission of the calibrated S-meter (and associated circuit), the single-signal crystal filter, the extreme electrical band spread, and the engraved aluminum relay rack panel. The chassis, all other parts, and the fundamental circuit are identical. The general performance of the HRO Junior is in every way equal to the magnificent performance of the HRO. The crystal filter and the S-meter, may be added at any time.

An illustrated folder describing both receivers will be mailed on request

NATIONAL



COMPANY

RCA ANNOUNCES TWO NEW TYPE

RCA 834

The RCA 834 is designed primarily for use at ultra-high frequencies and can be operated with maximum rated input at frequencies up to 100 megacycles. With reduced input, this new RCA type may be operated at frequencies as high as 350 megacycles. Rated at 50 watts plate dissipation for Class C telegraph service, the RCA 834 is capable of real output in conventional circuits at ultra-high frequencies. Amateur's Net Price \$12.50.

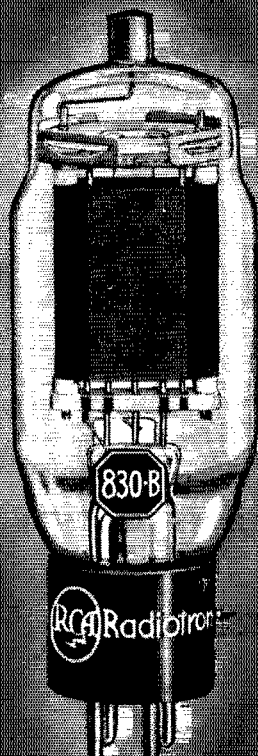

RCA 830-B

RCA 830-B is rated at 60 watts plate dissipation for Class C telegraph and Class B service. Maximum plate voltage is 1000 volts. This tube is particularly good as a Class B modulator: Two tubes will deliver 175 watts of audio power. The RCA 830-B is also useful as an r-f amplifier. Power output in Class C telegraph service is approximately 90 watts. Amateur's Net Price \$10.00.

The RCA 834 and RCA 830-B are available for immediate delivery from your supplier.

AMATEUR RADIO SECTION

RCA MANUFACTURING COMPANY, INC.

Camden, New Jersey · A subsidiary of the Radio Corporation of America