

**QST** 

February, 1936  
25 cents

devoted exclusively to

# amateur radio

in this issue—  
successful  
tube-  
testing  
tricks

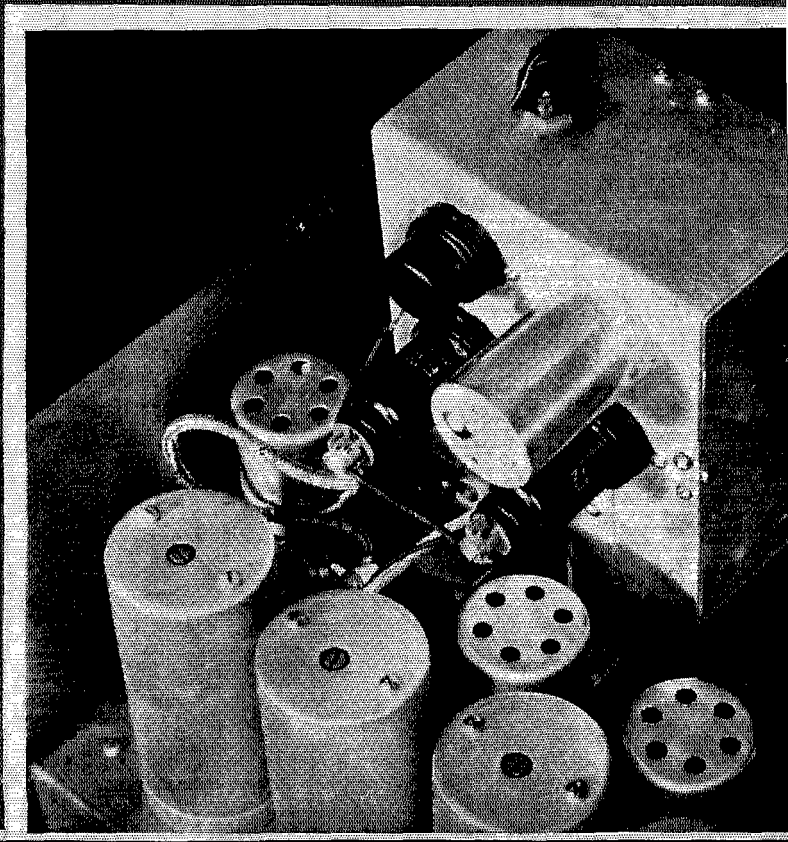

# Worthy Successor..

## .. 30FXC

THE 30FXB is an old friend, familiar to almost everyone interested in short wave radio. We have hesitated to make any changes in this model until it was possible to accomplish something really worthwhile by a new design. Several months have been spent in the development of the 30FXC, a worthy successor to the 30FXB.

Most important accomplishment is the increase in rated output from 100 watts to 175 watts (actual output is over 200 watts). Other additions include the C100 oscillator, inductive neutralization, two buffer stages, unit frequency shift, new flush dials and panel power controls. The power supply has been increased in capacity to permit the highest safe output consistent with the use of 866A rectifiers. Of unusual interest is the L section antenna network which is even more efficient and convenient than the pi section network.

Most appreciated feature is the moderate price which makes the decision to buy the best an easy one. • • • •



175 Watts  
TELEGRAPH-TELEPHONY

## Collins Radio Company

CEDAR RAPIDS  
New York  
11 West 42nd St.



IOWA, U. S. A.  
Mexico City  
Edificio "La Nacional"

# TRIPLETT INSTRUMENTS ARE *Distinctive*

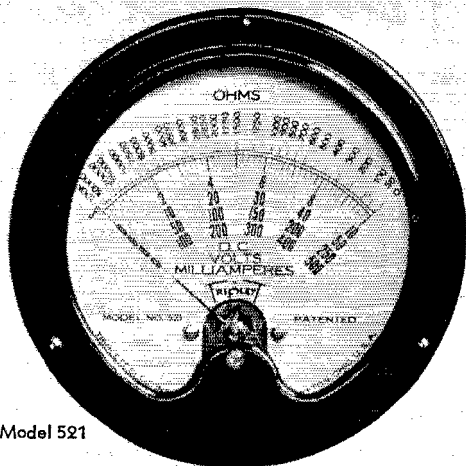

Model 521

**MODERN  
EXTERNALLY**

**PRECISION BUILT  
INTERNALLY**

## Precision without Extravagance

Model 521 Volt-Ohm-Milliammeter  
Dealer Net Price..... **\$7.00**

Body 4 $\frac{3}{8}$ "", Flange 5 $\frac{1}{4}$ "", Body depth 1 $\frac{1}{2}$ "",  
Scales 3 $\frac{1}{8}$ " in length Knife edge pointers.  
Molded bakelite case. Flush mounting. Beautiful  
in appearance yet accuracy is guaranteed within  
1%.

An extra large Foundation Instrument. Has long  
visible scale. An instrument that stands out on  
your test panel. Can be used to handle practically  
any values by using proper shunts and multi-  
pliers. Available also in projection mounting.

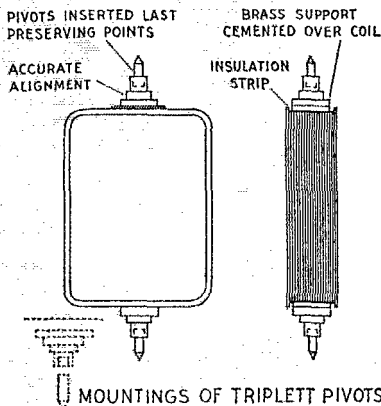

**Why Accuracy Can Be  
Guaranteed within 2%  
or less**

Triplett's Method as illustrated insures true alignment of  
moving element without strain and with maximum insulation  
against breakdowns. The pivot points are protected  
perfectly by the method of assembly — attaching them  
just before inserting in their sapphire jewel bearings.

### TRIPLETT MANUFACTURES

a complete line of electrical instruments for radio,  
electrical and general industrial purposes — both  
standard and custom built. Write for Catalogue. See  
them at your jobbers.

**SEE YOUR JOBBER!**

**MAIL COUPON FOR  
FULL INFORMATION**

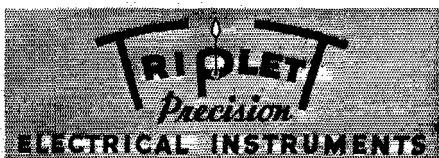

Triplett Electrical Instrument Co.  
252 Harmon Drive, Bluffton, Ohio

Please send information on  
Model 521..... Send 1936 Catalogue.....

Name.....

Address.....

City.....State.....

Say You Saw It in *QST* — It Identifies You and Helps *QST*



# MARINE *Engineers* ON THE JOB!

In keeping in step with the demands of the amateur fraternity, Marine engineers from time to time have redesigned their equipment, to incorporate all the latest developments of the times. Now Marine engineers are proud to introduce to the "ham" two new rigs. Close adherence to the Marine standard of "Quality First" a characteristic of all Marine equipment, is the keynote of these models.

## MARINE 140C

An ultra-modern 175 watt Phone and C.W. rig utilizing "Visual Oscilloscopic Modulation Control." A rig any "ham" would be proud of, but also gives the "shack" a real professional appearance.

*Here are a few of the salient features of this "XMTR" — give them the once-over and convince yourself.*

Power output ● Conservatively rated at 175 watts Phone and C.W. Frequency Range: 30,000 to 1500 Kcs. Modulation Control ● Built in Cathode Ray Oscilloscope ● Permanent Neutralization ● All "XMTR's" are permanently neutralized at factory, Changing bands or different antennas have no effect upon the characteristics of the unit ● High Fidelity Audio Channel ● Frequency response of 1.5 db with a gain of 195 db. Antenna Matching Network ● Capable of efficiently matching any type antenna in general use ● Dimensions: 60" long x 19½" wide x 15" deep.

## MARINE 18A

The model 18A was developed in consideration of the great demand for a transmitter of low power, reliability, low original and operating costs. In consideration of the space allowed, we are unable to enlarge upon the many favorable features of this unit. Therefore we are listing only a few of these characteristics, so as to give you some idea of this most remarkable unit. Output: 50 watts Phone — 125 watts C.W. Frequency Range 1500 to 30,000 Kcs.

*Automatic relays afford ample protection to both the operator and equipment ● Ruggedly constructed to withstand the most severe abuse ● 100% modulation.*

All Marine Transmitters are equipped with over modulation indicators or Cathode Ray Oscilloscopes.

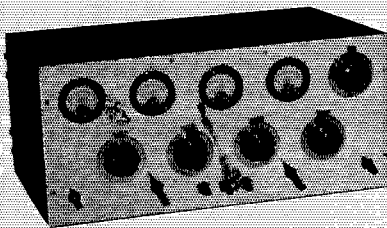
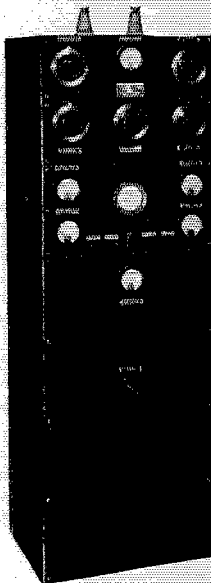

### *Efficient operation on 10 meters with Marine Transmitters*

- 22BP 15 watts Phone and C.W.
- 35B 40 watts Phone and C.W.
- 83B 50 watts Phone and C.W.
- 18A 50 watts Phone and 125 C.W.
- 60G 60 watts Phone and 200 watts C.W.
- 140B 100 watts Phone and C.W.
- 140C 175 watts Phone and C.W.

- 270B— 300 watts Phone and C.W.
- 750B 750 watts Phone and C.W.

Also a series of broadcast and special purpose transmitters with rated outputs up to 90,000 watts.

You are assured of complete satisfaction and uninterrupted operation with all Marine Radio apparatus. The Marine Radio ironclad unconditional guarantee absolutely protects you.

So that you may enjoy the use of equipment that heretofore was out of your reach, Marine Radio introduces the convenient "Deferred Payment Plan." Now! you can enjoy the use of Marine equipment while paying for it. Why not enquire into the attractive terms offered? Information forwarded without obligation to you.

*Illustrated descriptive catalogs and photographs will gladly be furnished upon request.*

# MARINE

General Offices and Plant  
124-11 101ST AVENUE  
RICHMOND HILL, N. Y.

# *Radio Company*



# QST

Published monthly, as its official organ, by the American Radio Relay League, Inc., at West Hartford, Conn., U. S. A.; Official Organ of the International Amateur Radio Union

devoted entirely to

# AMATEUR RADIO

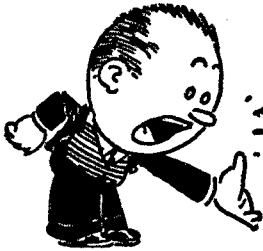

Editorials . . . . .	9
Armistice Day Message — 1935 . . . . .	10
A Noise-Silencing I. F. Circuit . . . . . <i>James J. Lamb</i>	11
A Simple Regenerative Receiver with Separate Beat Oscillator . . . . . <i>Robert J. Talbert, W9SHC</i>	15
200-Watt C. W., 75-Watt 'Phone . . . . . <i>Frank Gow, W1AF</i>	16
An Unconventional Receiver for the U.H.F. . . . .	21
What the League Is Doing . . . . .	24
A Few Random Remarks . . . . . <i>The Old Man</i>	26
Audio Output Limiters for Improving the Signal-to-Noise Ratio in Reception . . . . . <i>H. A. Robinson, W3LW</i>	27
28 Mc. . . . .	30
Ingang, B.E.R.U. and All That! . . . . . <i>Yardley Beers, W3AWH</i>	31
A.R.R.L. Eighth International DX Competition . . . . . <i>F. E. Handy</i>	35
A Ten-Meter Converter . . . . . <i>George Grammer</i>	39
How to Read and Use Your QST . . . . .	42
A Detector Circuit for Reducing Noise Interference in 'Phone Reception . . . . . <i>Leland E. Thompson</i>	44
1935 Navy Day Competition . . . . .	46
Using the 6L7 to Improve Superhet Performance . . . . .	48
The Love of Hazel. . . . . <i>Lewis B. Coe, W9CNY</i>	50
Neon Bulb Audio Oscillators . . . . . <i>F. H. Schnell, W9UZ</i>	52
Types of Distortion in 'Phone Transmitters <i>Durwood J. Tucker, W5VU</i>	53
Amateur Radio Stations . . . . . <i>W2BSD, W3CZO, N2LA, W3KQQ</i>	56
For the Experimenter . . . . .	58
Grid Leak Modulation — Spotting Frequencies — Oscillator Keying with Grid Leak Bias on Amplifiers — Revised Transceiver Circuit — Combined Plate and Bias Pack — More on the 6A7 Transmitter — Quick Shift for Amplifiers or Doublers . . . . .	
I.A.R.U. News . . . . .	61
Operating News . . . . .	63
Correspondence Department . . . . .	71
A.R.R.L. QSL Bureau . . . . .	122
Silent Keys . . . . .	122
QST's Index of Advertisers . . . . .	126

February  
1936

VOLUME XX  
NUMBER 2

Kenneth B. Warner (Secretary, A.R.R.L.), *Editor-in-Chief and Business Manager*; Ross A. Hull, *Associate Editor*; James J. Lamb, *Technical Editor*; George Grammer, *Assistant Technical Editor*; Clark C. Rodimon, *Managing Editor*; David H. Houghton, *Circulation Manager*; F. Cheyney Beekley, *Advertising Manager*; Ursula M. Chamberlain, *Assistant Advertising Manager*.

*Editorial and Advertising Offices*  
38 La Salle Road, West Hartford, Conn.

Subscription rate in United States and Possessions and Canada, \$2.50 per year, postpaid; all other countries, \$3.00 per year, postpaid. Single copies, 25 cents. Foreign remittances should be by international postal or express money order or bank draft negotiable in the U. S. and for an equivalent amount in U. S. funds.

Entered as second-class matter May 29, 1919, at the post office at Hartford, Connecticut, under the Act of March 3, 1879. Acceptance for mailing at special rate of postage provided for in section 1103, Act of October 3, 1917, authorized September 9, 1922. Additional entry at Concord, N. H., authorized February 21, 1929, under the Act of February 28, 1925.

Additional second-class entries to cover sectional editions authorized March 20, 1935

Copyright 1936 by the American Radio Relay League, Inc.  
Title registered at United States Patent Office.

# Register for today for the hallicrafters MILEAGE MARATHON!

at any of the following DEALERS:

- |                             |  |  |   |   |
|-----------------------------|--|--|---|---|
| <b>CALIFORNIA</b>           |  | <b>IOWA</b>  | <b>Manchester</b>   | <b>PENNSYLVANIA</b>   |
| Long Beach                  | Scott Wholesale Radio<br>222 E. 4th St.          | Ft. Dodge<br>Warehouse Sales Co.<br>Warren Elec. Co.<br>3105 Elm St. | Radio Serv. Lab. of<br>N. H.                              | Allentown<br>Radio Elec. Serv.<br>1824 Hamilton St.   |
| Los Angeles                 | Radio Television Sup.<br>Co. 1791 Grand          | Des Moines<br>Iowa Radio Corp.<br>647 Water St.                      | <b>NEW JERSEY</b>   | New Castle<br>Rapson-Peterson &<br>Shields 19 E. North<br>M. & H. Surg. Goods<br>512 Market St. |
| Los Angeles                 | Pacific Radio Eng. Inc.<br>729 S. Main St.       | Indianapolis<br>State Radio Co.<br>314 N. Illinois St.               | Manasquan<br>Paramount Radio Serv.<br>155 Main St.        | Philadelphia<br>M. & H. Surg. Goods<br>512 Market St.   |
| Los Angeles                 | Radio Supply Co.<br>914 S. Broadway              | Indianapolis<br>Van Sickle Radio<br>34 W. Ohio                       | Newark<br>Radio Apparatus Co.<br>249 Central Ave.         | Philadelphia<br>Consolidated Radio<br>Corp. 412 Arch<br>Herbach & Rademan<br>Co. 438 Market     |
| Los Angeles                 | Western Auto Sup. Co.<br>1108 S. Grand Ave.      | Richmond<br>Rodefelo Co.<br>1008 S. Broadway                         | <b>NEW MEXICO</b>   | Philadelphia<br>Radio Elec. Serv. Co.<br>Cor. 7th & Arch  |
| Los Angeles                 | Zack Radio Sup. Co.<br>1439 E. Colorado          | New Orleans<br>Louisiana<br>Shuler Supply Co.<br>Box 237             | Albuquerque<br>Wm. H. Allen Co.<br>812 S. Walter St.      | Philadelphia<br>Radio Elec. Serv. Co.<br>Cor. 7th & Arch  |
| Pasadena                    | Dow Radio Supply Co.<br>1278 Anacapa             | Portland<br>Maine<br>Frank M. Brown Co.<br>8-16 Free St.             | <b>NORTH CAROLINA</b>                                     | Pittsburgh<br>Hamburg Radio<br>963 Liberty Ave.   |
| Santa Barbara               | Lamb Elec. Co.<br>1278 Anacapa                   | Portland<br>Radio Serv. Lab. of Me.<br>5744 Congress                 | Charlotte<br>Radio Sup. Co. Inc.<br>218 W. Fourth St.     | Pittsburgh<br>E. J. Tydings<br>628 Grant St.  |
| San Diego                   | Coast Elec. Co.<br>744 G. St.                    | Baltimore<br>Maryland<br>Wholesale Radio Parts<br>282 W. Pratt       | Statesville<br>H. P. Woodward<br>187A Center              | Pittsburgh<br>Tri-State Radio<br>463 Penn Ave.  |
| San Francisco               | I. S. Cohen & Son<br>1925 Market St.             | Baltimore<br>Radio Elec. Serv. Co.<br>393 W. Baltimore               | <b>NORTH DAKOTA</b>                                       | <b>RHODE ISLAND</b>   |
| San Francisco               | Offenbach Elec. Co.<br>Ltd. 1452 Market St.      | Boston<br>Massachusetts<br>H. Jappe Co.<br>46 Cornhill               | Fargo<br>Dakota Elec. Sup. Co.<br>123 Broadway            | Providence<br>W. H. Edwards & Co.<br>32 Broadway  |
| San Francisco               | San Francisco Radio<br>Co. 1284 Market St.       | Boston<br>The Radio Shack Inc.<br>46 Brattle St.                     | <b>NEW YORK</b>   | <b>SOUTH CAROLINA</b>   |
| San Jose                    | Radio Specialties Co.<br>154 W. San Fernando St. | Boston<br>Sager Elec. Sup. Co.<br>281 Congress St.                   | Albany<br>Ft. Orange Radio Dist.<br>Co. 154 Broadway      | Columbia<br>Dixie Radio<br>1714 Main St.  |
| Modesto                     | Wholesale Radio Serv.<br>915 Jay St.             | Springfield<br>T. F. Cushing<br>349 Worthington                      | Buffalo<br>Kronson Serv. Co.<br>423 E. Genesee St.        | <b>TENNESSEE</b>  |
| Oakland                     | Electric Sup. Co.<br>12th & Fallon St.           | Brookton<br>Ware Radio & Sup. Co.<br>915 Centre St.                  | New York<br>Davega City Radio<br>62 Corlandt St.          | Bristol<br>Interstate Hardware<br>Armstrong Furn. Co.<br>44 N. Main St.                         |
| <b>COLORADO</b>             | The Auto Equip. Co.<br>14th at Lawrence          | Worcester<br>Mechanic St.<br>37                                      | New York<br>Gross Radio Inc.<br>81 Vesey St.              | Memphis<br>Armstrong Furn. Co.<br>44 N. Main St.  |
| <b>CONNECTICUT</b>          | D'Elia Elec. Co.<br>1338 Fairfield Ave.          | Ann Arbor<br>Michigan<br>Dick & Purchase<br>331 S. Main St.          | New York<br>Harvey's Radio Shop<br>193 W. 43rd St.        | Dallas<br>Wilkinson Bros.<br>2581 Commerce St.  |
| Hartford                    | Radio Inspection Serv.<br>Co. 227 Asylum St.     | Flint<br>Wilke & Sessions<br>711 1/2 W. Dayton                       | New York<br>Wholesale Radio Co.<br>189-4th Ave.           | Ft. Worth<br>Amateur Supply Co.<br>1808 St. Louis Ave.  |
| New Haven                   | Hatry & Young<br>86 Meadow St.                   | Lansing<br>Norge Sales & Serv.<br>2099 E. Michigan Ave.              | Rochester<br>Howe & Rogers Co.<br>68-78 Stone St.         | Everett<br>Fringling Radio Co.<br>2516 Colby Ave.   |
| Waterbury                   | Mac's Radio<br>208 Bank St.                      | Detroit<br>Missouri<br>Henry's Radio Shop<br>211 N. Main St.         | Rochester<br>Beaucaire, Inc.<br>228-236 Broadway          | Seattle<br>Seattle Radio Sup. Co.<br>2319 Second St.  |
| <b>DELAWARE</b>             | Delaware Radio Sales<br>Co. 465 Delaware St.     | Hannibal<br>Modern Radio Co.<br>819 Broadway                         | Richmond Hill<br>Marine Radio Co.<br>124-11-101st St.     | Spokane<br>Spokane Radio<br>611 First St.   |
| <b>GEORGIA</b>              | Wholesale Radio Serv.<br>418 Peachtree St. N. W. | Kansas City<br>Burststein-Appelbe Co.<br>1812 McGee                  | Schenectady<br>M. Schwartz & Sons<br>712 Broadway         | Tacoma<br>C. & G. Radio Sup.<br>714 St. Helena Ave.   |
| <b>DISTRICT OF COLUMBIA</b> | George's Radio Co.<br>816 "F" St. N. W.          | Kansas City<br>Boppert's<br>1226 Main St.                            | <b>OHIO</b>   | <b>WEST VIRGINIA</b>  |
| <b>FLORIDA</b>              | Watkins Radio Co.<br>112 N. Second               | St. Louis<br>Gordon Radio Co.<br>18th & Pine St.                     | Akron<br>Brighton Sptg. Goods<br>118 E. Market St.        | Wheeling<br>Radio Serv. Lab.<br>1421 Main St.   |
| Ft. Pierce                  | Glover Weiss Co.<br>2 E. Bay St.                 | Kansas City<br>Radio Labs.<br>1515 Grand Ave.                        | Cincinnati<br>Krausz Radio Stores,<br>Inc. 111 E. 5th St. | <b>WISCONSIN</b>  |
| Jacksonville                | Idaho<br>Walker Elec. Co.<br>121 S. 16th St.     | Duluth<br>Minnesota<br>Northwest Radio<br>109 E. First               | Cincinnati<br>Steinberg's Inc.<br>433 Walnut St.          | Madison<br>Radio Parts Co.<br>332 W. State St.  |
| <b>IDAHO</b>                | Walker Elec. Co.<br>121 S. 16th St.              | St. Paul<br>Lew Bonn Co.<br>596 Robert St.                           | Cleveland<br>Progressive Elec. Co.<br>6207-69 Broadway    | <b>CANADA</b>   |
| <b>ILLINOIS</b>             | Allied Radio Corp.<br>833 W. Jackson             | Omaha<br>Nebraska<br>Radio Accessories<br>2855-Farnam St.            | Columbus<br>Bell Radio Parts, Inc.<br>41 E. Goodale St.   | The Pas, Man. L. J. Hamers & Co.<br>Box 29  |
| Chicago                     | Chicago Radio App.<br>Co. 415 S. Dearborn        | Dover<br>New Hampshire<br>H. Jappe Co.<br>459 Central Ave.           | Dayton<br>The Burns Radio Sup.<br>148 E. 3rd St.          | Vancouver B.C. Vancouver Radio Eng.<br>1911 Robson St.  |
| Chicago                     | Hinds & Edgerton Inc.<br>19 S. Wells             | <b>NEBRASKA</b>  | Toledo<br>Toledo Radio Elec.<br>317-18th St.              | Winnipeg Man. Wholesale Radio Sup.<br>185 Donald St.  |
| Chicago                     | Midwest Radio Mart<br>529 S. State               | <b>NEW HAMPSHIRE</b>   | Cleveland<br>Radio Serviceman's<br>Sup. 628 Prospect St.  | Toronto Ont. Rogers Majestic Ltd.   |
| Chicago                     | Wholesale Radio Co.<br>911 W. Jackson            | <b>NEBRASKA</b>  | <b>OKLAHOMA</b>   |   |
| Chicago                     | Newark Elec.<br>224 W. Madison                   | <b>NEBRASKA</b>  | Oklahoma City Southern Sales Co.<br>138 W. 3rd St.        |   |
| Moline                      | Loggren's 101-5th Ave.                           | <b>NEBRASKA</b>  | Tulsa<br>Radio, Inc.<br>Box 36-219 S. Boulder             |   |

HANDBOOK  
423-429  
[CATALOG  
SECTION]

PRIZES TOTALLING \$500.00

*Come  
on, Hams!*

make those midnight hours pay DIVIDENDS

**the hallicrafters**

All Amateur and Short  
Wave Listeners eligible re-  
gardless of make of receiver!

# MILEAGE MARATHON

Starts Feb. 5th

**\$500<sup>00</sup>**

**IN PRIZES!**

*It's as simple as this!*

We can't give you the complete rules, we haven't room, but here's a hint. Every DX reception you get will help you along toward one of the prizes, and the farther away it is the more it counts. We're going to keep accurate score on everybody. To get the complete rules stop at your nearest Hallicrafters' jobber. To get in you'll have to fill out an entry blank and register as a contestant. There's no charge for entry nor is registration contingent upon your making any purchases. The contest starts Feb. 5th and ends Feb. 29th, 1936, so get ready, hams, see or write your jobber today and get your entry blank.

The following committee is in charge of the Hallicrafters Mileage Marathon. Their decisions are final:

Roy C. Corderman W3ZD  
Walter Bradley Martin W3QV  
Don Wallace W6AM  
Lt. Comdr. R. H. G. Mathews, U. S. N. R. W9ZN  
W. J. Halligan Ex 1UL

Here's something for every ham and short wave listener in the country to shoot at! A marvelous contest that's open to everybody, with \$500.00 worth of cash and merchandise prizes for the most industrious and cleverest DX listeners. A first prize of \$200.00, second prize of \$100.00, third prize of a Hallicrafters Super Skyrider and eleven other worth while prizes are waiting the winners. Everybody with a short wave receiver of any kind is eligible for this contest, which is new and novel in conception and will give you a whole month of fun and excitement.

You're not required to purchase a thing, just go to your nearest Hallicrafters' jobber (he's listed on the opposite page) and register as a contestant or write him for the complete details. Act quickly, the contest starts Feb. 5th, 1936 and every day's delay lessens your chances of winning. Get all ready to start for a big month of fun and profit. Stop at your jobber's for your entry blank today or write him for full details of the contest.

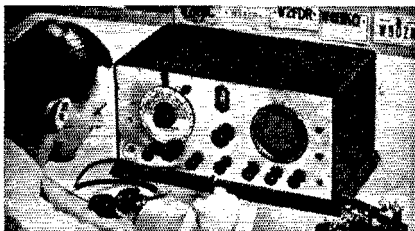

**the hallicrafters**  
301 Southport Avenue  
CHICAGO, ILLINOIS  
U. S. A.

FOR BETTER RADIO

Use

Hammarlund

SOCKETS

- 1 MADE OF ISOLANTITE—  
LOWEST LOSSES
- 2 REINFORCED SIDE  
GRIPPING CONTACTS—  
RUST PROOFED
- 3 CONSTANT RESISTIVITY—  
MAXIMUM EFFICIENCY
- 4 UNAFFECTED BY  
TEMPERATURE OR  
HUMIDITY
- 5 SUB PANEL OR BASE  
MOUNTING—TUBE  
LOCATING GROOVE—
- 6 4, 5, 6, AND 7 PRONGS

WRITE DEPT. Q-2 FOR  
GENERAL CATALOG

HAMMARLUND MANUFACTURING CO.

424-438 West 33rd Street, New York

CANADIAN OFFICE: 41 WEST AVENUE NORTH. HAMILTON. ONTARIO  
6

Say You Saw It in *QST* — It Identifies You and Helps *QST*

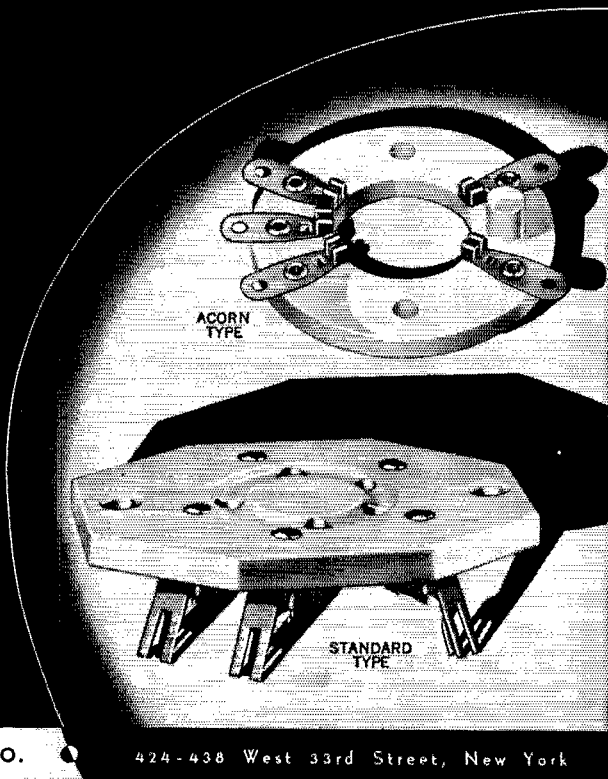

## Section Communications Managers of the A.R.R.L. Communications Department

All appointments in the League's field organization are made by the proper S.C.M., elected by members in each Section listed. Mail your S.C.M. (on the 16th of each month) a postal covering your radio activities for the previous 30 days. Tell him your DX, plans for experimenting, results in phone and traffic. He is interested, whether you are an A.R.R.L. member or get your QST at the newsstands; he wants a report from every active ham. If interested and qualified for O.R.S., O.P.S. or other appointments he can tell you about them, too.

Eastern Pennsylvania Maryland-Delaware-District of Columbia Southern New Jersey Western New York Western Pennsylvania	W3EZ  W3BAK W3ZX W8DSS W8CUG	<b>ATLANTIC DIVISION</b> James M. Bruning  Edgar L. Hudson Carroll D. Kentner Charles Smith C. H. Grossarth	339 W. Lancaster Ave.  1107 Park Ave. 310 E. Walnut St. 261 N. Balph Ave.	Haverford  Laurel, Delaware Collingswood Oneda Bellevue
Illinois Indiana Kentucky Michigan Ohio Wisconsin	W9WR W9TE W9AUH W8DYH W9ATO	<b>CENTRAL DIVISION</b> Fred J. Hinds Arthur L. Braun G. W. Mossbarger Kenneth F. Conroy Robert P. Irvine E. A. Cary	6618 West 34th St. 530 East Morris St. Box 177 18030 Waltham Ave. 208 N. Hitchhike Ave. 3922 No. 19th Pl.	Berwyn Indianapolis Camp Taylor Detroit Cleveland Milwaukee
North Dakota South Dakota Northern Minnesota Southern Minnesota	W9OEL W9PFI W9OWU W9DEI	<b>DAKOTA DIVISION</b> Hartwell B. Burner Mike G. Strahan Robert P. Gietas Francis C. Kramer	601 S. Grange Ave.  W. Bluff St.	Hope Sioux Falls Lake Mike St. Charles
Arkansas Louisiana Mississippi Tennessee	W5ABI W5DWV W5CWO W4BBT	<b>DELTA DIVISION</b> H. E. Velte W. J. Wilkinson, Jr. J. H. Weems, Jr. Merrill B. Parker, Jr.	2918 West 15th St. 1523 Laurel St. P. O. Box 244 1912 Oak St.	Little Rock Shreveport State College Chattanooga
Eastern New York N. Y. C. & Long Island Northern New Jersey	W2LU W2AZV W2FOP	<b>HUDSON DIVISION</b> Robert E. Haight E. L. Baum Charles J. Hammersen	511 South Holmes St. 7823 10th Ave. 92 Claremont Ave.	Scotia Brooklyn Verona
Iowa Kansas Missouri Nebraska	W9LEZ W9FLG W8CJO W9FAM	<b>MIDWEST DIVISION</b> Phil D. Boardman O. J. Spetter L. Dewey Mills Samuel C. Wallace	325 Kirkwood Blvd. 305 Western Ave. 308 N. Hills Green St.	Davenport Topeka Mount Vernon Clarks
Connecticut Maine Eastern Massachusetts Western Massachusetts New Hampshire Rhode Island Vermont	W1CTI W1CDX W1BGC W1BVR W1AVJ W1HRC W1BJP	<b>NEW ENGLAND DIVISION</b> Frederick Ellis, Jr. John W. Singleton Leon N. Gietas Percy C. Noble Robert Byron Clayton C. Gordon Forrest D. Drew	19 Merrill Rd. 73 Allen St. 138 Crawford St. 37 Broad St. 12 Humphrey St. 206 Clapham Ave. 947 E. Main St.	Norwalk Wilton Lowell Westfield Concord Providence Newport
Alaska Idaho Montana Oregon Washington*	K7PO W7NH W7AAT W7AMF W7WY	<b>NORTHWESTERN DIVISION</b> Richard J. Fox Nellie H. Hart O. W. Viers Frank L. Black Robert H. Votaw	Box 301 Box 6 Box 265 1502 McPherson St. Route 1, Box 398	Ketchikan Twin Falls Red Lodge North Bend Vancouver
Hawaii Nevada Santa Clara Valley East Bay San Francisco Sacramento Valley Philippines San Joaquin Valley	K6EWO W6BIC W6BMW W6TIV W6SG W6DVE KA1XA W6CRF	<b>PACIFIC DIVISION</b> Atlas O. Adams Edward W. Heim Charles J. Camp Harold J. Burchfield Alan D. Whitaker, Jr. Geo. L. Woodington Newton E. Thompson Vernon C. Edgar	21st Infantry Brigade 716 West Sixth St. 318 Hawthorne Ave. 2940 106th Ave. 79 Elmor Ave. 716 Redwood Ave. P. O. Box 849 732 Blackstone Ave.	Schofield Barracks Reno Palo Alto Oakland Mill Valley North Sacramento Manila, P. I. Fresno
North Carolina Virginia West Virginia	W4OG W3BRY W8KKG	<b>ROANOKE DIVISION</b> H. S. Carter Neil E. Henry Dr. Wm. H. Riheldaffer	115 Crafton St. 1017 Knight St.	Winston-Salem Lynchburg Lost Creek
Colorado Utah-Wyoming	W9FA W6GQC	<b>ROCKY MOUNTAIN DIVISION</b> Glen Glasscock Arty W. Clark	1171 Detroit St. 260 So. 9th West	Denver Salt Lake City, Utah
Alabama* Eastern Florida Western Florida Georgia-So. Carolina-Cuba- Isle-of-Pines-Porto Rico- Virgin Islands	W4DS W4BCZ W4MS  W4CE	<b>SOUTHEASTERN DIVISION</b> J. Wesley Davis Philip A. McMasters Edward J. Collins  Bannie L. Stewart	835 Young St. 731 Arlington Ave. 1517 East Brainard St.  SC-P53, C.C.C. Camp Lawrence	Selma St. Petersburg Pensacola  Effingham, S. C.
Los Angeles Arizona San Diego	W6BPU W6LVG W6EOP	<b>SOUTHWESTERN DIVISION</b> Howell C. Brown C. C. Day Harry A. Ambler	120 N. El Molino Ave. "La Posta Quemada" 4101 Hamilton St.	Pasadena Vail San Diego
Northern Texas Oklahoma Southern Texas New Mexico	W5BII W5CEZ W5BDI W5CGJ	<b>WEST GULF DIVISION</b> Richard M. Cobb Carter L. Simpson Ammon O. Young Joseph M. Eldott	Box 185 2010 S. 4th St. 4803 Eli St.	Dodd City Bartlesville Houston Chamita
Maritime	VE1DQ	<b>MARITIME DIVISION</b> A. M. Crowell	69 Dublin St.	Halifax, N. S.
Ontario	VE3QK	<b>ONTARIO DIVISION</b> John Perdue	229 Askin Boulevard	Windsor, Ont.
Quebec	VE2EE	<b>QUEBEC DIVISION</b> Stan Comach	780 Brault Ave.	Verdun, P. Q.
Alberta British Columbia	VE4GD VE5EP	<b>VANALTA DIVISION</b> J. Smalley, Jr. D. R. Vaughan-Smith	611 1st Ave., N. W. 1221 Burnaby St.	Calgary Vancouver
Manitoba Saskatchewan	VE4BG VE4EL	<b>PRAIRIE DIVISION</b> A. J. R. Simpson Wilfred Skaffe	71 Thelmo Mansions 2040 McTavish St.	Winnipeg Regina

\* Officials appointed to act until the membership of the Section choose permanent S.C.M.'s by nomination and election.



# The American Radio Relay League



• **T**HE AMERICAN RADIO RELAY LEAGUE, INC., is a non-commercial association of radio amateurs, bonded for the promotion of interest in amateur radio communication and experimentation, for the relaying of messages by radio, for the advancement of the radio art and of the public welfare, for the representation of the radio amateur in legislative matters, and for the maintenance of fraternalism and a high standard of conduct.

It is an incorporated association without capital stock, chartered under the laws of Connecticut. Its affairs are governed by a Board of Directors, elected every two years by the general membership. The officers are elected or appointed by the Directors. The League is non-commercial and no one commercially engaged in the manufacture, sale or rental of radio apparatus is eligible to membership on its board.

"Of, by and for the amateur," it numbers within its ranks practically every worth-while amateur in the nation and has a history of glorious achievement as the standard-bearer in amateur affairs.

Inquiries regarding membership are solicited. A bona fide interest in amateur radio is the only essential qualification; ownership of a transmitting station and knowledge of the code are not prerequisite. Correspondence should be addressed to the Secretary.

## DIRECTORS

*President*  
HIRAM PERCY MAXIM.....W1AW  
Box 216, Hartford, Conn.

*Vice-President*  
CHARLES H. STEWART.....W3ZS  
St. David's, Pa.

*Canadian General Manager*  
ALEX REID.....VE2BE  
169 Logan Ave., St. Lambert, P. Q.

*Atlantic Division*  
EUGENE C. WOODRUFF.....W8CMP  
234 W. Fairmount Ave., State College, Pa.

*Central Division*  
EDWARD A. ROBERTS.....W8HC  
2699 Endicott Rd., Shaker Heights, Cleveland

*Dakota Division*  
CARL L. JABS.....W9BVIH  
1822 James St., St. Paul, Minn.

*Delta Division*  
E. RAY ARLEDGE.....W5SI  
P. O. Box 286, Pine Bluff, Ark.

*Hudson Division*  
KENNETH T. HILL.....W2AHC  
115 Willow St., Douglaston, L. I., N. Y.

*Midwest Division*  
FLOYD E. NORWINE, JR.....W9EFC  
120 South Fourth St., St. Louis, Mo.

*New England Division*  
G. W. BAILEY.....W1KH  
74 Webster Road, Weston, Mass.

*Northwestern Division*  
RALPH J. GIBBONS.....W7KV  
c/o United Air Lines, Pendleton, Ore.

*Pacific Division*  
S. G. CULVER.....W6AN  
2962 Russell St., Berkeley, Calif.

*Roanoke Division*  
H. L. CAVENESS.....W4DW  
State College Station, Raleigh, N. C.

*Rocky Mountain Division*  
RUSSELL J. ANDREWS.....W9AAB  
1867 So. Lafayette St., Denver, Colo.

*Southeastern Division*  
BENNETT R. ADAMS, JR.....W4APU  
1512 Grove Place, Homewood, Ala.

*Southwestern Division*  
CHARLES E. BLALACK.....W6GG  
P. O. Box 55, Yuma, Ariz.

*West Gulf Division*  
WAYLAND M. GROVES.....W5NW  
c/o Humble Pipe Line Co., Neches, Texas

## OFFICERS

*President*.....HIRAM PERCY MAXIM, W1AW  
Hartford, Connecticut

*Vice-President*.....CHARLES H. STEWART, W3ZS  
St. David's, Pennsylvania

*Secretary*.....KENNETH B. WARNER, W1EH  
West Hartford, Connecticut

*Treasurer*.....ARTHUR A. HEBERT, W1ES  
West Hartford, Connecticut

*Communications Mgr.*...F. EDWARD HANDY, W1BDI  
West Hartford, Connecticut

*General Counsel*.....PAUL M. SEGAL, W3EEA  
1010 Shoreham Building, Washington, D. C.

Address all general correspondence to the executive headquarters at West Hartford, Connecticut



# THE EDITOR'S MILL

THE eleven-weeks' life of "The Shadow," the recent mysterious radio interference, constitutes a fascinating chapter in modern radio. With no particular moral it is still worth recounting. Starting the first week in October, many radio services were bothered by a gargly a.c. signal which would park itself for a half an hour or so on some particularly inconvenient frequency, then move a few hundred kilocycles and repeat the performance. Up and down the high-frequency spectrum it coursed, from about 9 o'clock in the morning until it skipped out at night. It bothered the Navy and the R.C.A. and the telephone company and one day it interrupted communication with ships at Cape Cod. It was heard on the West Coast and in England, and the British communications system reported it similarly in Egypt, India and Australia. Countless amateurs found it squirming its way through their bands.

What was it? Was it some anti-social crank out of fanciful fiction, with a "mystery station" somewhere in the wilderness from which he was endeavoring to blast the communications of civilization? Was it of accidental industrial origin? The radio world buckled down to the job of locating the source and unraveling the mystery. Physicists undertook to determine the approximate location by an examination of the time at which the various frequencies skipped out, but the results were confusing. Countless direction-finders were swung into action but the bearings were greatly varied. Innumerable oscilloscopes were brought into play, only to find that "The Shadow" varied from observer to observer in phase and wave form. Many were the hypotheses advanced. An unusually powerful new smoke precipitator? New tube bombarding equipment? The new generating station at Hoover Dam? Could it possibly be of cosmic origin? The latter was a particularly disturbing thought. What with Dellinger Effects, the unusual performance of ten meters, whistles from outer space and recent unusual solar activity, it did not seem an impossible idea. What if some nova had suddenly decided to burst over the next thousand years with a loud frying noise! Was this possibly just the first of numerous celestial invasions which finally would make radio communication impossible on this sphere? We even decided that it was a little remarkable that radio

had got along so well the past thirty-five years.

And now for the unraveling. Amongst the groups which went to work on this problem was the Naval Communications Reserve, who made it their job from the very first week, and to whom we are largely indebted for the success now reached. All over the country these fellows were busy, making observations and exchanging notes. Gradually the field narrowed down. In Boston, the N.C.R. group enlisted the aid of Harvard's Cruft Laboratory and its radio truck, under the direction of W9DOE. Three days of concentrated observations on oscilloscopes showed that there was not a single "Shadow" but many, only one identifiable in phase and wave shape as supplied with Boston "juice." Who it was who first suspected these newfangled "diathermy" machines we do not know but eventually suspicion centered on them. Momentarily at a loss when no Boston hospitals reported owning such devices, the brute was finally traced to earth at an athletic club. At about the same time, similar discoveries were made by N.C.R. personnel in Seattle and in Charlotte, N. C. The installation at Boston was keyed with a CQ wheel and was promptly reported from Philadelphia, Norfolk, Washington, Bellevue and Great Lakes, even though no antenna was used and the radiation was largely from r.f. which got back into the power wiring.

And so "The Shadow" was found to be a considerable number of these new "diathermy" or "inductotherm" machines which have lately come into vogue for heat therapy. The ones which have caused most of the trouble have an input of half a kilowatt and apply unrectified a.c. directly to the plates of a high-frequency oscillator in a parallel-fed circuit. In many of them the tank circuit consists only of twelve feet of flexible insulated cable which is wrapped around the arm or leg of the patient so as to enclose the injured spot in a high-frequency field. Many athletic clubs are possessed of these devices and, with the coming of the football season, the merry QRM commenced and mounted. Now we can see why direction-finders and oscilloscopes yielded differing data and why the note was a gargle and why the frequency meandered through the spectrum as the cable was coiled around bruises and sprains of various dimensions. Hi—but what a mess!

Thus "The Shadow," which baffled the whole communication world for weeks, is now laid, thanks largely to the N.C.R. and Cruft. Gone is the spectre, and with it the melodrama of chase. Remains the difficult practical job of applying

technical remedies to all these installations. Let us hope that the authorities will hop promptly to the job, and not let it get as far beyond them as has automobile ignition interference.

K. B. W.

## Armistice Day Message—1935

**T**HE Seventh Annual Armistice Day Message from the chief signal officer of the Army to all members of the Army Amateur Radio System was transmitted on the night of November 11, 1935 from WLM-W3CXL, the Army Net Control Station of the A.A.R.S., located at the War Department in Washington, D. C.

In accordance with established practice the reception of this message was made a competition for the nine corps area organizations of the A.A.R.S. Each Army Amateur was requested to copy the message and mail the copy to his corps area signal officer to be checked. Each corps area was scored on the percentage and the total number of active stations copying and submitting a copy of the message.

The message was transmitted at the regular broadcast periods of 7:00 p.m. and 10:00 p.m., E.S.T., on the special A.A.R.S. frequencies of 3497.5 and 6990 kcs. simultaneously. Most of the corps area net control stations rebroadcast this message once or twice to assist members who were unable to hear WLM-W3CXL.

The Chief Signal Officer's message was as follows:

"TO ALL ARMY AMATEURS—  
SEVENTEEN YEARS AGO TODAY MARKED THE END OF A CONFLAGRATION THAT HAD SWEEPED OVER THE WORLD LEAVING MUCH UNTOLD SUFFERING AND SORROW IN ITS WAKE STOP WE HOPE THIS DISASTER WHICH WAS CAUSED BY MAN WILL NEVER BE REPEATED STOP HOWEVER EACH YEAR FINDS THIS COUNTRY FACED WITH A NUMBER OF EMERGENCIES AND DISASTERS SUCH AS FLOODS AND HURRICANES IN

WHICH MANY ORGANIZATIONS ARE CALLED UPON TO HELP STOP THE ARMY AMATEUR RADIO SYSTEM IS ORGANIZED TO HELP FURNISH EMERGENCY COMMUNICATION WHEN OTHER FORMS FAIL STOP YOU MEMBERS WHO TRAIN AND HOLD YOURSELF IN READINESS TO PERFORM THIS VALUABLE PUBLIC SERVICE I AM HAPPY TO COMMEND AND TO EXPRESS TO YOU MY APPRECIATION ON BEHALF OF THE ARMY

J B ALLISON  
MAJOR GENERAL  
CHIEF SIGNAL OFFICER OF THE ARMY"

In response to this message 1017 copies were received. 866 of these messages were from the 1088 members who were carried as active on that date, giving a total of 80% of active members having copied the message.



E. D. HARTMAN,  
WsOK

To the Fifth Corps Area went the honors for having the highest percentage of active stations copy the message and to the Third Corps Area the honor of having the greatest number of active stations copy the message.

The Fifth Corps Area, comprised of the states of Indiana, Kentucky, Ohio and West Virginia, has its Army Amateur Radio System under the guidance of Lt. Colonel Clyde L. Eastman, Corps Area Signal Officer; Staff Sergeant Richard W. Martin, A.A.R.S.

(Continued on page 80)

Relative Order	Corps Area	No. of Active Stations Nov. 4, '35	Corps Area	No. of Active Stations Copying Message	Corps Area	Percent of Active Stations Copying	Corps Area	Total No. of All Stations Copying Active, Inactive, Etc.
1	III-IX	181	III	164	V	99	III	202
2		181	IX	129	VII	98	VII	152
3	VII	129	VII	126	III	91	IX	139
4	IV	120	V	104	II	87	IV	117
5	VIII	116	IV	100	IV	83	V	108
6	V	105	VIII	85	VIII	73	II	95
7	I	102	II	80	IX	71	VIII	87
8	II	69	I	56	VI	59	I	56
9	VI	61	VI	36	I	55	VI	55
10	OCSigO	13	OCSigO	4			OCSigO	4
11	Panama Dept.	11	Panama Dept.	2			Panama Dept.	2
<b>Totals</b>		<b>1088</b>		<b>866</b>		<b>Av. % 80</b>		<b>1017</b>

# A Noise-Silencing I.F. Circuit for Superhet Receivers

An Effective Method of Coping With Auto Ignition and Other Electrical Interference in C.W. and 'Phone Reception

By James J. Lamb\*

*Here is another development of Jim Lamb's: And darned if we don't think it destined to the same wide-spread application in amateur and commercial radio as is now given his "Single-Signal" development. The new scheme is, without doubt, a second solid whack at the interference problem. Too bad that we can't ship out a receiver test booth or at least some moving cathode-ray tube pictures to establish once and for all that the scheme really works—but it certainly does.—EDITOR*

THE problem of noise interference from electrical equipment in radio reception is one that becomes increasingly acute as we expand our use of the radio spectrum farther in the high and ultra-high frequencies and, simultaneously, electrical equipment capable of causing interference becomes more widely used. It is not so long ago that the only kind of QRN which really bothered was just plain natural static. But now, at least on our higher frequencies, the interference from atmospherics is practically negligible, while that from automobile ignition and oil burner systems, domestic and industrial equipment in infinite variety, is really disastrous. Admittedly this kind of interference is controllable at the source—provided all the manufacturers and all the users of the offending devices could be persuaded forthwith to take the necessary steps with the individual equipments. This utopian state may some day arrive, of course. But what about the immediate situation? Is there anything like a generally applicable shot in the arm that we individually can give our receivers to immunize them, more or less, from the electrical noise epidemic? We now believe that at least several more or less effective solutions are not just possible but, better still, have been developed to the practical stage. These are methods applicable to our present system of communication with amplitude modulated waves

and adaptable as supplements to existing types of receivers, to be used within the receiver itself without compromising its normal characteristics. In addition to the one which is the subject of this article, descriptions of several others will be

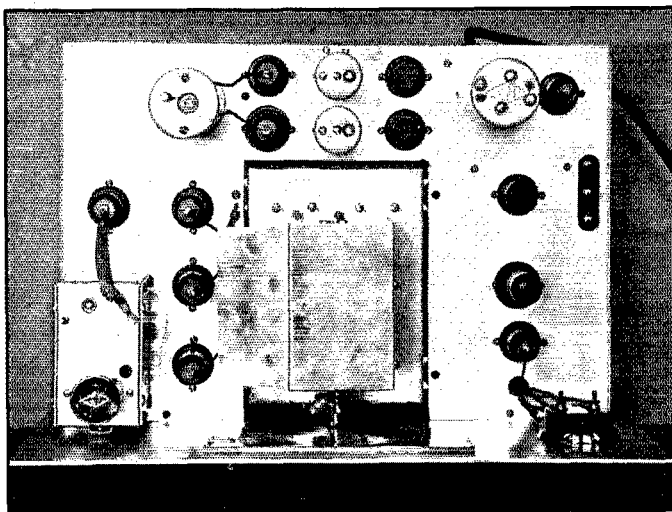

TOP VIEW OF THE METAL-TUBE RECEIVER USING THE NEW NOISE-SILENCER CIRCUIT

The receiver is completely described, except for this feature, in Chapter Seven of the 1936 A.R.R.L. Handbook. From left to right, behind the tuner unit and to the right of the second i.f. transformer, are the i.f. silencer-amplifier tube, the second detector coupling transformer and the diode second detector. Behind these, in corresponding positions, are the noise amplifier tube, coupling transformer and noise rectifier.

found in this and recent issues of *QST*.<sup>1</sup> Truly, we are getting somewhere.

\* Technical Editor, *QST*.

<sup>1</sup> Thompson, "Detector Circuit For Reducing Noise Interference," April, 1935; Hull, "A New Receiving System for the Ultra-High Frequencies," Nov. and Dec., 1935; Robinson, "Output Limiters," this issue; and Thompson, "Detector Circuit For 'Phone," this issue.

SOME CHARACTERISTICS AND EFFECTS  
OF ELECTRICAL INTERFERENCE

From the experience of others, and from our own observations during work on the present

show up on the oscillograph as distinctly separated and more or less uniform pulses, each of extremely short duration (one-thousandth second or less). Before they ruin intelligible reception, they may have an amplitude as great as twice that of the desired signal. But more often than not their amplitude runs 20 or more times that of the desired signal, so that they can even overload circuits (drive grids positive) and cause secondary effects which demand special consideration, as will be explained farther on. The main pulse of small duration may be accompanied by subsidiary "whiskers," as when the spark occurs with 60-cycle mains supply. The omnipresent auto ignition pulse, however, is characteristically clean and relatively free from "whiskers."

The commutator-type interference is considerably more complicated in form. A d.c. series motor gives prominent pulses of commutation frequency, more or less uniform in amplitude, with an almost solid intervening "whisker" accompaniment of considerably smaller but non-uniform amplitude. A series (universal) motor operating on a.c. has the commutation-frequency pulses superimposed on a supply-frequency superimposed on a supply-frequency superimposed on a supply-frequency component (and the "whiskers" as well), making the picture still more complex. In both cases, the principal noise component heard is the commutation-frequency rattle, filled in with hash from the "whiskers." As compared to the spark-gap type, which has effective value relatively small compared to amplitude, the commutator-type interference is of more solid wave form and has greater effective value in proportion to its peak amplitude. Amplitude operated limiting and silencing systems

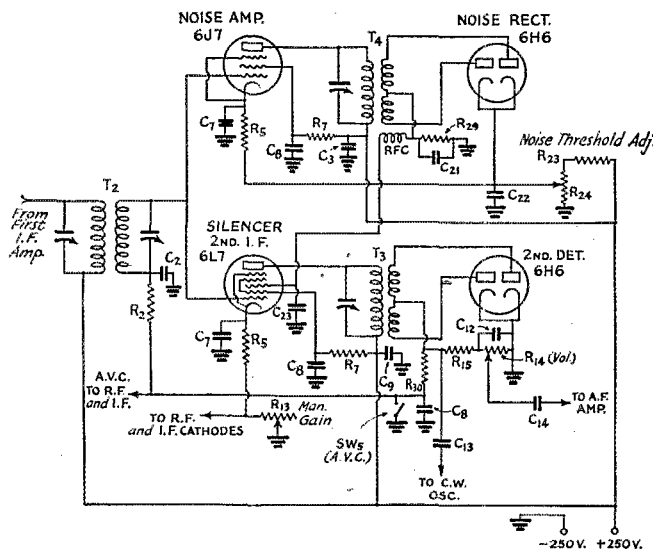

FIG. 1—CIRCUIT OF THE SILENCER SECTION ADAPTED TO THE 1936 A.R.R.L. HANDBOOK METAL-TUBE SUPERHET

Components are designated to correspond with the description given in the Handbook, to which the reader may refer for other circuit details.

- C<sub>2</sub>—0.01- $\mu$ fd. grid by-pass condensers, 200-volt tubular.
- C<sub>3</sub>—0.01- to 0.1- $\mu$ fd. plate by-pass condensers, 400-volt tubular.
- C<sub>7</sub>—0.1- $\mu$ fd. cathode by-pass condensers, 200-volt tubular.
- C<sub>8</sub>—0.01- to 0.1- $\mu$ fd. screen by-pass condensers, 400-volt tubular.
- C<sub>9</sub>—0.25- $\mu$ fd. main by-pass condenser, 600-volt tubular.
- C<sub>12</sub>—50- $\mu$ fd. detector load by-pass, mica midget.
- C<sub>13</sub>—50- $\mu$ fd. beat osc. coupling condenser, mica midget.
- C<sub>14</sub>—0.1- $\mu$ fd. detector output coupling condenser, 200-volt tubular
- C<sub>21</sub>—0- to 250- $\mu$ fd. noise rectifier load by-pass, mica midget.
- C<sub>22</sub>—0.1- $\mu$ fd. threshold resistor by-pass, 200-volt tubular.
- C<sub>23</sub>—50- $\mu$ fd. silencer r.f. by-pass, mica midget.
- R<sub>2</sub>—100,000-ohm grid filtering resistor, 1/2-watt.
- R<sub>5</sub>—350- to 1000-ohm cathode resistors, 1/2-watt.
- R<sub>7</sub>—100,000-ohm screen-voltage dropping resistors, 1/2-watt.
- R<sub>13</sub>—5000-ohm manual r.f. gain control.
- R<sub>14</sub>—1-megohm volume control.
- R<sub>15</sub>—50,000-ohm detector load resistor, 1/2-watt.
- R<sub>22</sub>—20,000-ohm threshold bleeder resistor, 1-watt.
- R<sub>24</sub>—5000-ohm threshold control potentiometer, volume-control type.
- R<sub>26</sub>—100,000-ohm noise rectifier load resistor, 1/2-watt (see text).
- R<sub>30</sub>—1-megohm a.v.c. filter resistor, 1/2-watt.
- RFC—20-millihenry r.f. choke.
- T<sub>2</sub>—Double air-tuned i.f. transformer (Hammarlund ATT-465).
- T<sub>3</sub>—Single air-tuned full-wave diode coupling transformer (Sickles 456-kc.) (see text).
- T<sub>4</sub>—Same as T<sub>3</sub>.

development, it appears that ordinary electrical disturbances affect the receiver circuits as highly damped waves and may be classified generally as of two basic types. One is the "pistol shot" or "machine gun" variety, usually resulting from a spark discharge across a gap. Ignition systems, light switches, key clicks, power leaks, "violet ray" gadgets and the like are common sources. The other is the "hash" type identified with d.c. and a.c. series motors.

The disturbances of the first (spark-gap) type

accordingly find it much more difficult to handle. Fortunately interference of this type is considerably less prevalent than the jump-spark type; and, unlike the machine-gun variety, it is effectively disposed of by selective circuits such as the i.f. crystal filter.

Besides these two main types, several others which we have encountered also might be classified. Some have characteristics not unlike natural static—that from a faulty high-tension transformer which was having internal trouble being



one case. Such disturbances are generally non-uniform in amplitude and in duration, although frequently of high amplitude relative to the radio signal, and may result in receiver noise output of a "plunky" character. Still another type of more or less common interference is that peculiar to old and faulty incandescent lamps. But these types usually represent the dying rattle of sick equipment and end shortly with its demise. The degree to which these miscellaneous interferences can be silenced in the receiver depends on their wave form. If in the form of short-time discrete pulses, then they are most readily handled; if in the form of a more or less solid envelope, then they are less tractable. Interference effects of all types, however, have been found reducible by the system described, the amount of reduction ranging up to practically total elimination for ignition noise, clicks and similar types.

In view of the characteristically ultra-short duration and relatively large separation of the

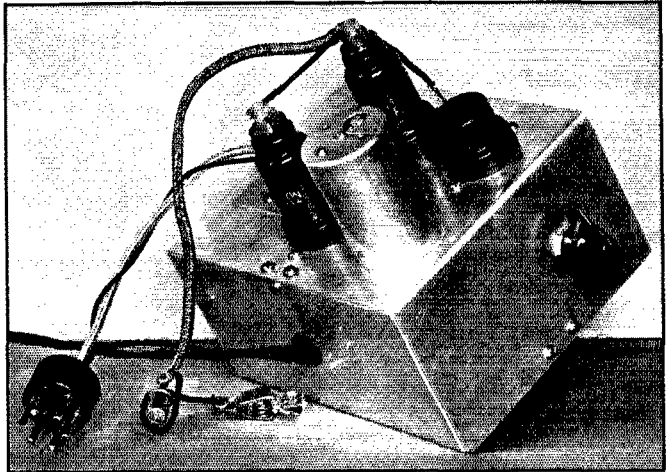

THE SILENCER ADAPTER UNIT FOR USE WITH STANDARD SUPERHET RECEIVERS, AS DESCRIBED AT THE END OF THIS ARTICLE

From left to right, grouped around the diode coupling transformer, are the 6J7 noise amplifier, the 6L7 i.f. silencer-amplifier and the 6H6 noise rectifier. The knob on the side controls the noise threshold adjusting resistor.

But the ear is supposed to be insensible to acoustical impulses so widely separated and of such short duration. Obviously something is occurring to increase the effective length of each pulse before it reaches our ears so as to give it a character it did not have originally. One element of the receiving system which certainly is capable of accomplishing this change in character is the telephone receiver or loud speaker. By its very nature it responds with a reverberating crack or a boom to the shortest high-amplitude impulse, vibrating at some natural period of its own long after the original electrical jolt. Then also the pulses can be given appreciably increased electrical duration in audio-frequency circuits and even in radio-frequency stages of the receiver. This is especially likely if their amplitude becomes sufficient to drive a grid positive in any r.f. or audio stage. When this occurs, grid current representing the rectified envelope of the pulse flows through the input return circuit of the afflicted stage, which may include resistance-capacitance networks of relatively large time constant in addition to the coupling circuits and bias source. This gives rise to the secondary effects of cross-modulation and blocking.

With r.f. or i.f. circuits of high selectivity and low decrement, particularly with a crystal filter, shock excitation from high-amplitude pulses results in prolonged wave trains of relatively small damping. In a typical instance, spark

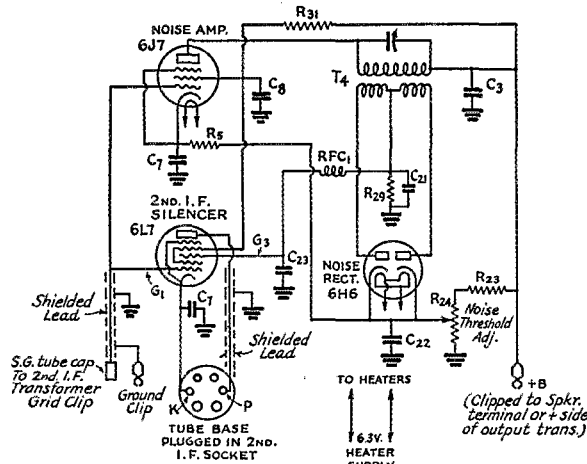

FIG. 2—CIRCUIT OF THE SILENCER ADAPTER UNIT

Components are the same as for corresponding designations in Fig. 1, excepting R<sub>31</sub> which is a 50,000-ohm screen-voltage dropping resistor. Two separate 100,000-ohm resistors may be used, as in Fig. 1.

electrical pulses principally responsible for noise interference, it might be wondered how they can be so devastating in effect. The electrical pulses individually may be of less than one-thousandth second duration, as previously mentioned, and in a typical case may occur 120 times per second.

interference wave trains of approximately a thousandth-second duration with a straight transformer-coupled two-stage i.f. superhet have been

Why not amplify the noise peaks extending above the desired signal amplitude at radio frequency, rectify them and use the rectified voltage to control the gain of a subsequent radio-frequency stage, automatically and instantaneously?

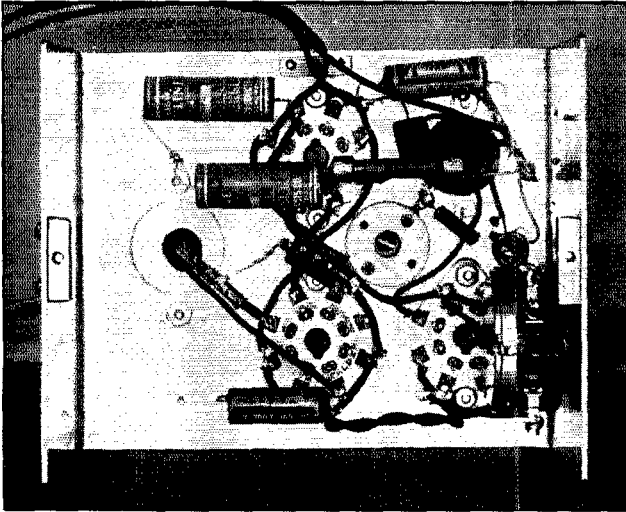

**BOTTOM VIEW OF THE ADAPTER UNIT**

To the left of the threshold adjusting resistor are the noise rectifier and i.f. silencer-amplifier tube sockets, the noise amplifier socket being above the latter. The r.f. filter choke is mounted centrally, other components being placed to give short leads and minimum stray r.f. coupling.

observed to increase to over one-hundredth second duration with the crystal filter switched in. In c.w. reception with the receiver's beat oscillator on, the aural effect on switching in the crystal is conversion of machine-gun rattling to continuous "pinging" and ringing at beat-note frequency—from which the signal cannot be distinguished.

With these characteristics and peculiarities of the most common types of electrical interference in mind, it appears entirely reasonable that something in the nature of eliminating their effects should be possible. They are inherently of short duration until prolonged in effect by some element of the receiving system. They generally cause only objectionable background so long as their amplitude does not exceed the desired signal amplitude at the output of the receiver. Advantage of these characteristics have been taken in devising output limiting circuits of various types, several of which are described elsewhere in this issue. But these can only cut off the peaks of interference which extend above the desired-signal level in amplitude, and leave the earlier circuits of the receiver without protection from the secondary effects of overloading. Why not go farther? Why not try to bring the amplitude of the interference below the desired-signal level, and do the job in an earlier circuit of the receiver before the stages most susceptible to overloading and cross-modulation are reached?

#### THE SILENCER CIRCUIT

The essential circuit of a typical example of this method of noise peak silencing applied in the i.f. amplifier of a superhet is shown in Fig. 1, the receiver being the metal-tube superhet described in the 1936 A.R.R.L. *Handbook*. This receiver originally used a separate a.v.c. amplifier and rectifier, which section was adapted to serve as the noise amplifier and rectifier in the present arrangement. The same silencer circuit is, of course, readily adaptable to other superhet designs.

As shown in the diagram, the control grids of the noise amplifier and second i.f. amplifier are fed in parallel from the secondary of the conventional tuned i.f. transformer. The output circuit of the noise amplifier is coupled to the

full-wave diode noise rectifier by means of transformer  $T_4$ , which is also tuned to the intermediate frequency (456 kc. in this case). The cathodes of both the noise amplifier and noise rectifier are connected to the movable contact on the resistor  $R_{24}$  so that the control grid of the noise amplifier and the diode plates of the rectifier can be biased negative with respect to the cathodes of these tubes. This bias determines the input amplitude at which rectification starts in the diode, being normally set so that action begins for noise peaks extending above the desired signal level. For 'phone reception with automatic gain control, the bias developed in the a.v.c. circuit of the receiver is also applied to the control grid of the noise amplifier, augmenting the fixed bias developed across  $R_{24}$  and automatically maintaining the proper noise threshold level over the range of signal strength normally encountered with fading.

The rectified noise voltage developed across the diode load resistor  $R_{23}$  is applied to the No. 3 grid of the 6L7, biasing this grid negative in proportion to the amplitude of the noise pulse and, accordingly, reducing the gain of this i.f. stage for the i.f. components of the same noise pulse on the grid of the i.f. amplifier tube. The object is, in effect, to make the noise commit suicide in the final i.f. stage by partly or wholly blocking this amplifier during the noise pulse.

(Continued on page 58)

# The Simple Regenerative Receiver with Separate Beat Oscillator

An Improvement Giving Greater Selectivity, Stability and Sensitivity

By Robert J. Talbert,\* W9SHC

FROM time to time *QST* has published articles<sup>1</sup> on using a separate beat oscillator for c.w. reception with a regenerative receiver, pointing out the theoretical gain in sensitivity which is possible and suggested layouts have been described. After trying the suggested methods, with various types of beat oscillators and arrangements for coupling the oscillator output to the detector, a successful practical receiver was finally achieved.

Essentially it consists of an electron-coupled type regenerative screen-grid detector and a pentode audio stage with an electron-coupled beat oscillator coupled to the detector suppressor grid and operating at one-half the received signal frequency; when receiving on 7 mc., for instance, the oscillator is on 3.5 mc. Thus the second harmonic of the oscillator fundamental frequency corresponds with the incoming signal frequency. This is emphasized right at the start because it is absolutely necessary that the local oscillator input to the detector should not only be small but also should be under complete control.

Moreover, care should be taken that the oscillator voltage reaches only the suppressor grid of the

detector. It must be prevented from overloading the signal input circuit. If both oscillator and detector were tuned to the same frequency, it would be practically impossible to shield the oscillator circuit sufficiently to prevent pick-up through the wiring and input to the detector in the wrong part of the circuit.

This was immediately made evident in pre-

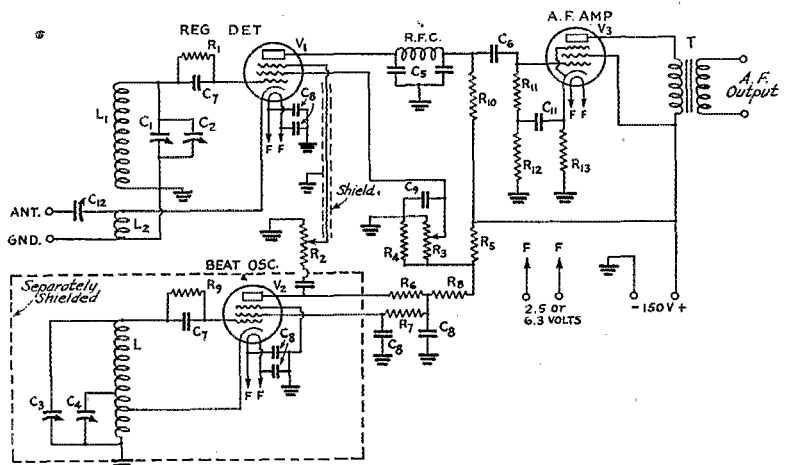

FIG. 1—CIRCUIT OF THE REGENERATIVE RECEIVER WITH SEPARATE BEAT OSCILLATOR

- L1, L2, L3—Usual coils for frequency ranges to be covered (see A.R.R.L. Handbook).
- C1, C2, C3, C4—Usual tuning condensers.
- C5—250- $\mu$ fd. plate by-passes.
- C6—0.03- $\mu$ fd. grid coupling condenser.
- C7—100- $\mu$ fd. grid condensers.
- C8—0.01- $\mu$ fd. by-passes.
- C9—1- $\mu$ fd. screen-grid by-pass.
- C10—50- $\mu$ fd. oscillator coupling condenser.
- C11—0.1- $\mu$ fd. audio filter resistor.
- C12—50- $\mu$ fd. antenna coupling condenser.
- R1—5-megohm detector grid leak.
- R2—50,000-ohm oscillator output potentiometer.
- R3—50,000-ohm screen-grid potentiometer (reg. control).
- R4—10,000-ohm divider resistor.
- R5—25,000-ohm divider resistor.
- R6—50,000-ohm oscillator plate resistor.
- R7—150,000-ohm oscillator screen-grid resistor.
- R8—50,000-ohm oscillator plate drop resistor.
- R9—50,000-ohm oscillator grid leak.
- R10—150,000-ohm detector plate coupling resistor.
- R11—250,000-ohm audio grid coupling resistor.
- R12—100,000-ohm audio filter resistor.
- R13—650-ohm audio cathode resistor.
- R.F.C.—Detector plate r.f. choke (2.5 mh.).
- T—Pentode output transformer.

- The oscillator should be thoroughly shielded from the detector circuit, as explained in the text. If a stable electron-coupled type heterodyne frequency meter is available, it may be adapted to use as the separate beat oscillator.

liminary tests. It was found that when a signal was tuned in with the detector oscillating and the local oscillator tuned to the same frequency, the strong local oscillation would lock into synchronism or "pull in" the detector. This discouraged

(Continued on page 98)

\* 7823 Colfax Ave., Chicago, Ill.  
<sup>1</sup> Robinson, "Regenerative Detectors," *QST*, Feb., 1933;  
 De Cola, "Increased Sensitivity With the Regenerative Detector," *QST*, Dec., 1934.

# 200 Watts C.W., 75 Watts 'Phone

## A Three-Band Transmitter Using Only Two Tubes

By Frank Gow, W1AF\*

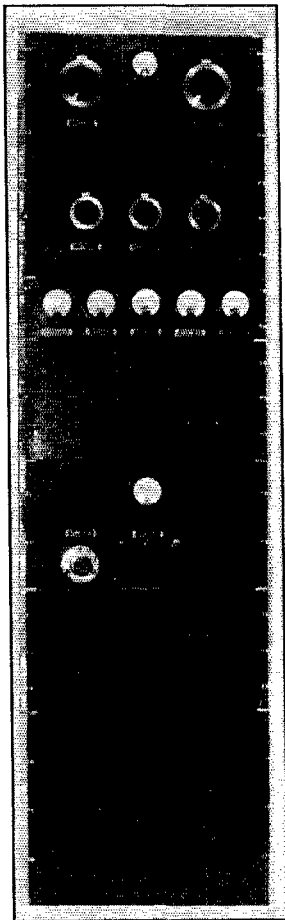

THE COMPLETE TRANSMITTER, FROM POWER SUPPLIES TO ANTENNA TUNING EQUIPMENT, IS MOUNTED ON THIS RACK

The r.f. unit, consisting of only two tubes, occupies the second panel from the top. The rack provides ample room for all the transmitter essentials and accessories without crowding.

deliver close to 15% more output with the same input.

The new transmitter is all in one assembly, rack-mounted. The rack was constructed by a local

IT IS inevitable that one who has enjoyed the simplicity and operating convenience of the RK20 pentode should turn to its big brother, the RK28, for increased power. The transmitter at W1AF, described in August, 1935, *QST*, was recently replaced with a new rig employing the larger pentode. Results have been most gratifying. While signal strength reports on the new rig are not noticeably greater it has been evident that the higher power gets through with more consistency.

The circuit, like that of the RK20 transmitter, is extremely simple. Two tubes, an RK23 and an RK28, comprise the r.f. portion. The old stand-by, the 59 Tri-tet, will excite the 28 sufficiently if 400 to 500 volts plate potential is used. However, for conservative operation the RK23 was selected. The RK23 will de-

steel company for the modest sum of \$10. They cut and welded the channel iron into a complete unit in less time than it takes to tell. In getting such a rack fabricated it is a good idea to have the uprights drilled for the panel bolts, unless you are fortunate enough to own a large power drill press. You may tap the holes at your own leisure and save considerably on labor charges. The rack is not of standard proportions or construction, being built expressly for its particular purpose. It is 6 feet 3 inches in height, 21 inches wide and has an over-all depth of 18 inches. For pleasing contrast to the black panels, the rack is painted with aluminum Duco. Two 3- by 1/4-inch steel straps are welded across the under side of the base, front and back, and four 1 1/2-inch rubber-tired casters are bolted to these straps. The same concern

formed a sturdy steel chassis for the high-voltage power supply. This chassis measures 18 by 15 inches, is 4 inches deep, and carries along its 15-inch sides two 1 1/2-inch fins, which support the

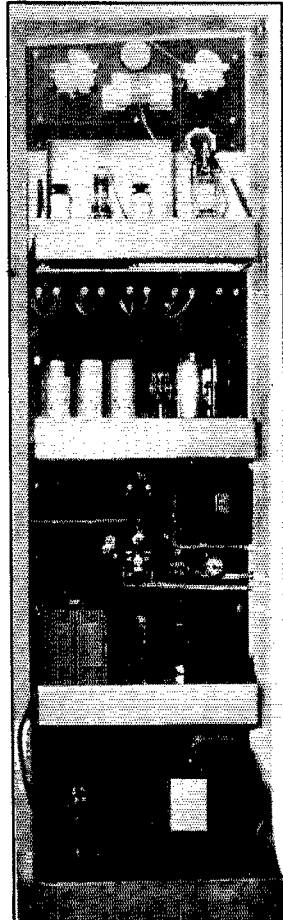

IN THIS REAR VIEW, THE CONSTRUCTION OF THE VARIOUS TRANSMITTER SECTIONS IS CLEARLY SHOWN

Antenna-tuning unit at the top, followed by the exciter-amplifier, meter panel, speech amplifier and modulator, panel for accessories, low-voltage power supply and high-voltage power supply.

\*3 Water Street Court, Medford, Mass.

chassis when bolted to the rack's base. All panels are  $\frac{1}{4}$ -inch Tempered Masonite, finished with air-dry crackle paint. Tempered Masonite is rugged, very easy to work, and is inexpensive.

the first is the antenna unit. This panel is 20 by  $10\frac{1}{2}$  inches ( $1\frac{1}{2}$  inches remaining at the top of the rack is occupied by a  $1\frac{1}{2}$ -inch steel strap connecting the two uprights) and carries a bake-

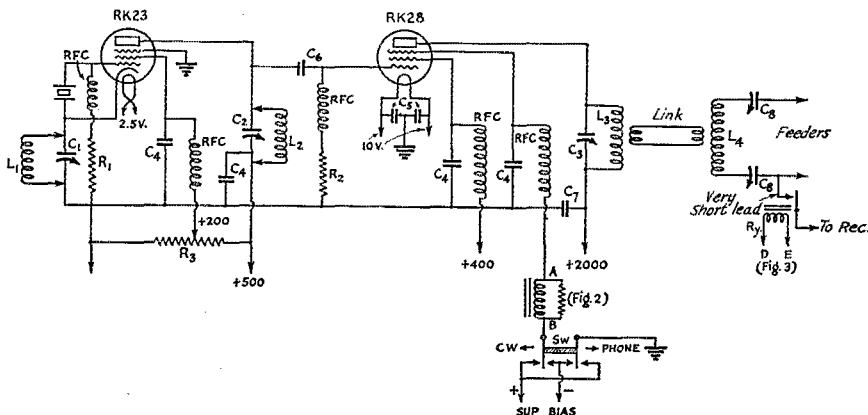

FIG. 1—CIRCUIT DIAGRAM OF THE RK23 TRI-TET EXCITER AND RK28 AMPLIFIER

- C<sub>1</sub>—250- $\mu$ fd. variable (National TMS-250).
- C<sub>2</sub>—100- $\mu$ fd. variable (National TMS-100).
- C<sub>3</sub>—50- $\mu$ fd. high voltage variable (National TMA-50A).
- C<sub>4</sub>—.002- $\mu$ fd. mica, receiving type (Sangamo).
- C<sub>5</sub>—.004- $\mu$ fd. mica, receiving type (Sangamo).
- C<sub>6</sub>—100- $\mu$ fd. mica, receiving type (Sangamo).
- C<sub>7</sub>—.002- $\mu$ fd. mica, 5000-volt (Sangamo).
- C<sub>8</sub>—Antenna Series condensers.
- R<sub>1</sub>—50,000 ohms, 2-watt.
- RFC—Universal wound chokes (National 100).
- Sw—D.P.D.T. jack-switch (Yaxley 760).
- Ry—S.P.S.T. relay (Dunco RA-1).
- L<sub>4</sub>—10 turns No. 12 on G.R. Type 677U coil form.

Band	Operation			Crystal Frequency
	Coil at L <sub>1</sub>	Coil at L <sub>2</sub>	Coil at L <sub>3</sub>	
3.5 mc.	B	A	E	3.5 mc.
7 mc.	D	B	F	7 mc.
14 mc.	C	D	G	7 mc.

Coil	Coil Data		
	Turns	Length of Winding	Wire Size
A	35	$1\frac{1}{4}$	18
B	15	$1\frac{1}{4}$	18
C	7	$\frac{1}{2}$	18
D	6	$\frac{3}{8}$	18
E	22	*	10
F	15	†	10
G	8	‡	10

- \* Wound in grooves on G.R. Type 677U coil form.
  - † Wound in grooves on G.R. Type 667U coil form.
  - ‡ Wound in alternate grooves on G.R. Type 677U coil form.
- Coils A, B, C and D wound on Hammarlund Isolantite coil forms (diameter  $1\frac{1}{4}$  inches)

$\frac{1}{4}$ -inch round-head machine screws are used for panel bolts. Three standard steel chassis, measuring 17 by 10 by 3 inches, are employed; these are bolted to their respective panels with six 6/32 flat-head machine screws spaced to distribute the chassis weight evenly. Brackets formed by  $\frac{1}{4}$ -inch steel strips, bolted from the rear corners of the chassis to a point about 8 inches up from the bottoms of the panels, lend no small amount of rigidity. The panels support plenty of weight with no sign of stress or warping when the unit is finally bolted to the rack. This type of construction permits the units to be easily removed from the front of the rack.

#### RACK LAYOUT

Taking the panels in order from the top down,

lite sub-panel 17 by 6 by  $\frac{1}{4}$  inches, mounted parallel to the main panel. This sub-panel is supported and stood off  $\frac{3}{4}$  inches by short lengths of brass tubing, through which pass long machine screws at each corner. The bakelite insulation, for mounting the antenna condensers, precludes the possibility of r.f. leakage through the Masonite. The r.f. ammeter, not a bakelite case, was sub-mounted on bakelite for the same reason. The antenna coil, which feeds a Zepp antenna, is link coupled to the amplifier. The G.R. coil form is fitted with plugs and is plugged into two stand-off insulators which are in turn fitted with jacks. The system can be converted in a few moments to a single pi Collins network. This unit also carries the antenna send-receive relay. The transmitting antenna here proved superior to other types of special receiving antennas, hence the relay.

#### THE EXCITER-AMPLIFIER

The next panel is the exciter-amplifier, mounted on a standard chassis, with a 20- by 10-inch panel. The circuit line-up, mentioned earlier, is essentially an RK23 Tri-tet oscillator followed by a conventional pentode amplifier circuit for the RK28. The input and output circuits of the RK28 are shielded by the same method used for the RK20 set described in August *QST*. The tube base shield box measures a depth of  $2\frac{1}{4}$  inches from the top of the chassis to the tube socket.



At this depth, the bottom of the internal shield of the RK28 will line up flush with the top surface of the chassis. The Masonite panel of the unit is "backed-up" with a piece of No. 22 gauge gal-

socket, tuned to the crystal frequency, and coil B inserted in the plate circuit and also tuned to the crystal frequency. Similar procedure is followed on 80 meters. Reference to the coil table will

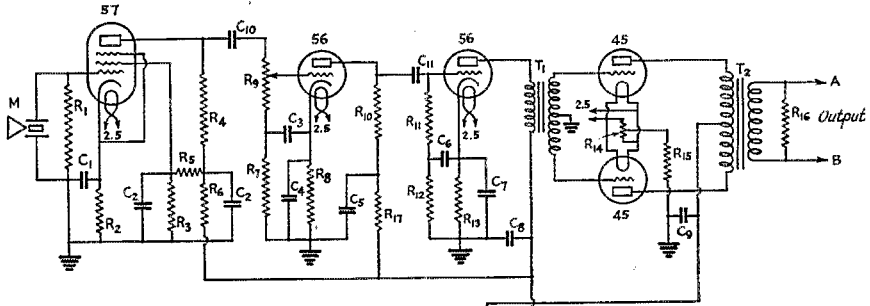
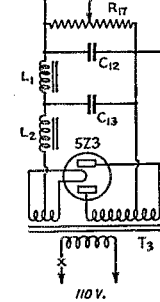

FIG. 2—SPEECH AMPLIFIER AND SUPPRESSOR-GRID MODULATOR DIAGRAM

- R<sub>1</sub>—5 megohms, 1-watt.
- R<sub>2</sub>—3500 ohms, 1-watt.
- R<sub>3</sub>—50,000 ohms, 1-watt.
- R<sub>4</sub>—.25 megohm, 1-watt.
- R<sub>5</sub>—.1 megohm, 1-watt.
- R<sub>6</sub>—50,000 ohms, 1-watt.
- R<sub>7</sub>—.1 megohm, 1-watt.
- R<sub>8</sub>—4500 ohms, 1-watt.
- R<sub>9</sub>—.5 megohm variable.
- R<sub>10</sub>—50,000 ohms, 1-watt.
- R<sub>11</sub>—.5 megohm, 1-watt.
- R<sub>12</sub>—.1 megohm, 1-watt.
- R<sub>13</sub>—2700 ohms, 1-watt.
- R<sub>14</sub>—20-ohm center-tap resistor.
- R<sub>15</sub>—750 ohms, 5-watt.
- R<sub>16</sub>—5000 ohms, 10-watt.
- R<sub>17</sub>—10,000 ohms, 1-watt.
- R<sub>18</sub>—15,000 ohms, 100-watt bleeder (Ohmite)
- C<sub>1</sub> to C<sub>9</sub>—2 μfd.
- C<sub>10</sub>, C<sub>11</sub>—.1 μfd.
- C<sub>12</sub>, C<sub>13</sub>—8-μfd. electrolytics.



- L<sub>1</sub>, L<sub>2</sub>—30 henry, 100-ma. chokes (commercial rating).
- T<sub>1</sub>—Push-pull input transformer (Delta AD91).
- T<sub>2</sub>—Push-pull output transformer, 1:1 (Delta AD75).
- T<sub>3</sub>—Power transformer (Thordarson T-5822)

vanized sheet iron 20 by 10 inches. This, plus a simple three sided form of the same material, 6 inches high and 10 inches long, shown in the photograph, practically encloses the oscillator equipment. It was not found necessary to close up the back of this unit. The amplifier tank coil is fitted with plugs and is supported on a strip of Victron which is mounted directly on the tank condenser by means of small aluminum brackets. Incidentally, don't use bakelite for this strip, because it will blister and burn within a few minutes. Birnbach Company is now manufacturing a new type of plug expressly for coil form mounting. This solves a problem of long standing for the amateur who is not a machinist.

The RK23, because of its internal shielding, as a rule will not oscillate with straight pentode connection unless some feedback is introduced from plate to grid. Therefore, for convenience, the cathode circuit as well as the plate is tuned on all frequencies. Fortunately, this does not require additional coils. For example; operating on 20 meters with a 40-meter crystal, the cathode circuit is tuned to the crystal frequency with coil C (see Fig. 1) and the plate circuit to its second harmonic with coil D. On 40 meters with the same crystal, the same cathode coil C is left in its

indicate the proper coil and its respective position. The amplifier coils are of course changed for each band. Because of the RK23's excellent shielding, feedback does not cause an increase in crystal current with subsequent heating and drift.

The RK23 is operated with 500 volts on the plate and 200 on the screen. These values supply ample excitation to the RK28; grid current, through a 15,000-ohm grid leak, averages 16 to 20 mils at all frequencies. With 2200 volts on the plate, the RK28 handles 350 to 400 watts input on c.w. without a trace of plate color. On 'phone, with negative suppressor bias, the tube's efficiency is lowered considerably, and the plate is called upon to dissipate power somewhere near its normal rating of 100 watts. Consequently, the plate does run a cherry red, although it is nothing to become alarmed about. At 2000 volts, the 28 is rated to produce a 60- to 65-watt carrier. With the increased plate voltage, 2200, the output is somewhat increased and an estimated carrier of 75 to 80 watts may be expected.

#### METERS

The meter panel, which is 20 by 5 inches, carries five instruments. From right to left in the front view, these read oscillator plate current,

amplifier control grid current, amplifier plate current, amplifier screen grid current and amplifier suppressor grid current.

### SPEECH-AMPLIFIER MODULATOR

Immediately below the meter panel is the speech amplifier and modulator unit. It is prac-

filament transformer, filament primary rheostat, filament voltmeter, remote-control relay, transmit-receive switch, suppressor bias voltage-reversing switch, and a switch to short out the keying filter. There still remains a fair space upon which other gadgets such as signal lights can be mounted.

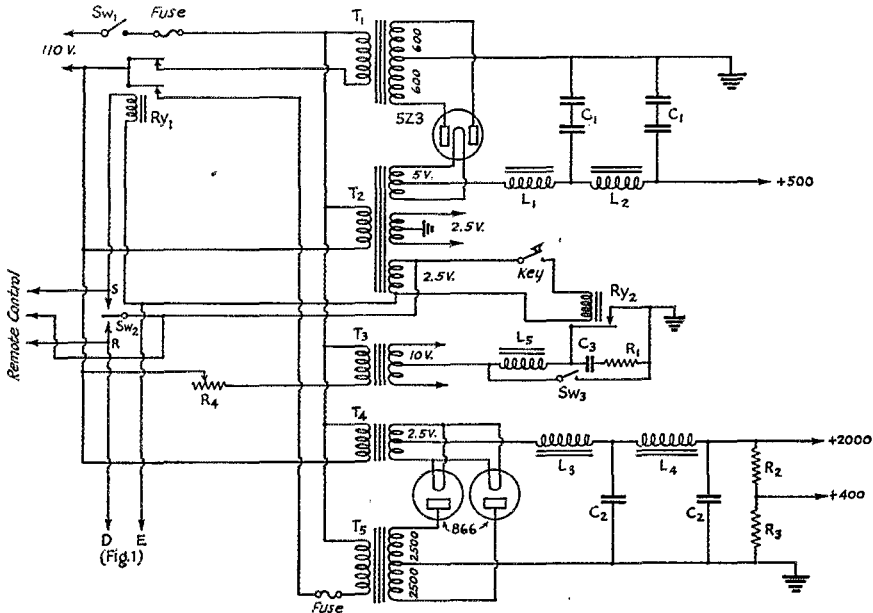

FIG. 3—R.F. POWER-SUPPLY DIAGRAM

- T<sub>1</sub>—Plate transformer, 600 v. each side c.t. (Thordarson T-6878).
- T<sub>2</sub>—Filament transformer, 5, 2½ and 2½ volts (Thordarson T-5338).
- T<sub>3</sub>—Filament transformer, 12 volts (Delta AD-13).
- T<sub>4</sub>—Filament transformer for 866's (Delta AD-1011).
- T<sub>5</sub>—Plate transformer, 2500 volts each side c.t. (Delta AD-22).
- C<sub>1</sub>—Dual-8 electrolytics in series (Sprague CL-88).
- C<sub>2</sub>—8-μfd. Pyranol.
- C<sub>3</sub>—1-μfd. 1000-volt.
- L<sub>1</sub>, L<sub>2</sub>—30-henry, 110-ma. filter chokes (Stancor C-1001).

- L<sub>3</sub>—Swinging choke (Delta AD-32).
- L<sub>4</sub>—Smoothing choke (Delta AD-42).
- L<sub>5</sub>—Keying choke, 8 henries (Thordarson T-6877).
- R<sub>1</sub>—2000-ohm 10-watt variable resistor.
- R<sub>2</sub>—25,000 ohms, 200-watt (Ohmite).
- R<sub>3</sub>—100,000 ohms, 200-watt (Ohmite).
- R<sub>4</sub>—Bradley Radiostat.
- Ry<sub>1</sub>—D.P.S.T. relay (Dunco RA-1).
- Ry<sub>2</sub>—S.P.S.T. relay (Dunco RA-1).
- Sw<sub>1</sub>—S.P.S.T. toggle switch.
- Sw<sub>2</sub>—S.P.D.T. jack-switch (Yaxley 730).
- Sw<sub>3</sub>—S.P.S.T. jack-switch (Yaxley 720).

tically self-explanatory from the circuit diagram and constants. It is entirely self-contained, with power supply, and is mounted on a standard chassis with a 20 by 10 panel. The tube line-up provides a very substantial amount of spare gain, even from a very low-level crystal microphone. Care should be observed to shield all microphone input leads and grid leads. The input circuit to the 57 is very high impedance and it takes but very little stray r.f. to start an exasperating "sing." A regular National tube shield makes a convenient shield for the microphone terminal strip and grid leak. In operation, the connections from the secondary of the output transformer should be tried first one way and then reversed to determine best operation.

Below the speech-modulator panel is the "miscellaneous" panel, 20 by 11 inches. This is a most useful accessory. It carries the RK28

#### LOW-VOLTAGE SUPPLY

The low-voltage supply for the RK23 is built into a standard chassis with a 20 by 10 panel. At present, half of the chassis (see photograph) supports a pair of 45-volt and one tapped 22½ volt "B" batteries, used for suppressor bias. This space could well be employed for a bias rectifier.

#### HIGH-VOLTAGE SUPPLY

The special chassis for the high-voltage supply has been mentioned previously. It measures 18 by 15 by 4 inches. The 4-inch depth provides space for the 866 filament transformer, filter condensers, two flush-mounted sign receptacles which serve as fuse blocks, and the necessary wiring. The panel associated with this unit is 20 by 17 inches; it carries on its lower right-hand corner the keying relay and key filter, enclosed by the

metal can shown in the photograph. It is a good idea to provide a 4-terminal strip within this can, to which connections can be made to the 2½-volt keying relay source, the filament center tap and negative "B." With these disconnected, the panel can be removed from the rack, giving access to the voltage divider, mounted on stand-off insulators on the front of the power supply chassis.

#### OPERATION

Reference to the coil table and the *Handbook* will give full particulars on tuning and operation of the Tri-tet oscillator. Electron-coupled control can easily be incorporated by the addition of an extra socket adjacent to the oscillator cathode coil. The specified coils will serve in this capacity when properly tapped. The position of the tap is best determined by cut and try methods, using a small capacity (about 100  $\mu\text{fd.}$ ) to replace the crystal.

One trouble that might confront the builder of this rig is self-oscillation in the amplifier as a result of stray coupling between the grid input and plate output circuits. However, if reasonable care is given to wiring and the specified values of r.f. by-pass condensers used, trouble from this source may be eliminated. Care should be exercised to make ground return leads and by-pass condenser leads as short as possible. The usual test for a neutralized amplifier, no movement of the grid current meter when the amplifier tank condenser is rotated through resonance with plate voltage off, will suffice.

For c.w. operation, the suppressor-grid bias is set at 45 volts positive and the amplifier and antenna tuned for maximum output or antenna current as with any triode or the RK20. To change to 'phone, throw the polarity-reversing switch, so that the suppressor grid is made 45 volts negative. Do not change either the antenna or amplifier tuning condensers. It will be noted that the antenna current has taken a decided drop with the application of negative bias. The final adjustment is now made by increasing the negative bias in small steps until the antenna current is exactly halved—that is, half of the maximum c.w. antenna current. The exact amount of bias required is almost impossible to predict because of different degrees of excitation, plate voltage, etc., at different installations. However, it will lie between 45 and 80 volts negative. Small tapped 22½-volt batteries are a big help in obtaining just the right value of suppressor bias voltage. Linear modulation will result when the antenna current is halved as mentioned. Usually it will be noted that a slight decrease in grid excitation will cause the antenna current to rise, possibly by as much as 15 to 20%. *This adjustment is to be avoided.* Let the original amount of c.w. excitation remain. We are not striving to obtain the last possible "tenth" of antenna cur-

rent, but rather an adjustment that will produce good clean modulation and crisp speech. With insufficient suppressor bias, the antenna current will remain higher than its "halved value" and will show little or no increase under modulation. In fact, it will sometimes modulate downward. The plate current will also kick downward. On the other hand, with the suppressor overbiased, or beyond the half-way mark, exactly opposite conditions will prevail. The antenna current will increase tremendously, the plate current will kick upwards no small amount and gross over-modulation with distortion will result. Proper bias will result in the usual 22% increase in antenna current (with tone input) and very slight upward kicks of plate current, with surprisingly good quality modulation. When the proper value of negative bias for 'phone has been established, it is not necessary to lower it for c.w. operation. It

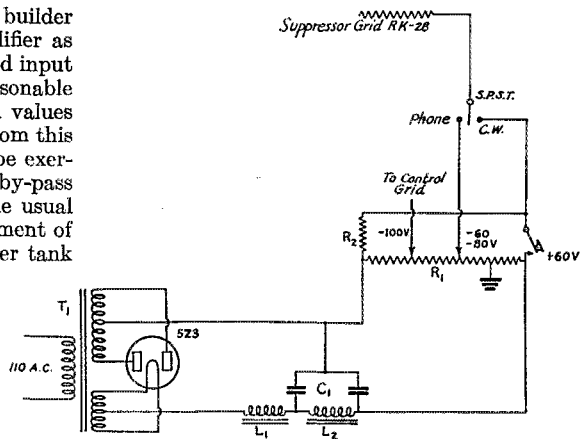

FIG. 4—SUPPRESSOR BIAS SUPPLY

- T<sub>1</sub>—Power transformer, 365-volt d.c. plate winding, 5-volt rectifier winding (Thordarson T-7061).
- L<sub>1</sub>, L<sub>2</sub>—15-henry, 85-ma. chokes (Thordarson R-196).
- C<sub>1</sub>—Double 8- $\mu\text{fd.}$  electrolytic (Sprague).
- R<sub>1</sub>—5000 ohms, 100 watts (Ohmite) semi-variable.
- R<sub>2</sub>—50,000 ohms, 10-watt (Ohmite).

remains only to throw the reversing switch to obtain positive suppressor. Do not forget also to short out the keying filter when on 'phone, otherwise the transmitter will not modulate through the choke in the center tap of the filament return.

Reference to the *Handbook* or back issues of *QST* will furnish information about antennas. A very flexible system is a half-wave 80-meter Zepp with 45-foot feeders. This system will work very nicely on the three major bands: 80, 40 and 20 meters. Employ series tuning for 40 and 20 meters and parallel for 80 meters.

**AUTHOR'S NOTE.**—Since the foregoing article was written, a bias supply for the suppressor and control grid of the RK28 has been installed and the keying system changed to use the blocking

(Continued on page 88)

# An Unconventional Receiver for the Ultra-High Frequencies

Details of a New Development from the National Bureau of Standards

**W**E ARE indebted to Mr. F. W. Dunmore of the National Bureau of Standards for details of a highly ingenious and effective ultra-high-frequency receiver, some aspects of which are right down the ham's alley. The receiver itself includes four r.f. amplifier stages and is designed particularly for operation between 175 and 300 megacycles. In its present form it is, of course, a very special piece of scientific equipment and is hardly the sort of thing most of us would be able to duplicate. Nevertheless, many of the features incorporated in the receiver will surely find their way into the ham game.

The receiver differs from the conventional affair in that it employs quarter-wave concentric transmission lines as coupling impedances between the r.f. amplifier stages. Four of the concentric lines are used and are tuned with ganged plungers which vary the effective line lengths in unison. The use of coupling impedances of this type, together with Type 954 tubes, makes possible an amplification of the order of 2 per stage at 300 mc., 6 per stage at 200 mc. and 9 per stage at 175 mc. The four stages and detector actually show an effective overall amplification of the order of 100,000 at 200 mc.

## THE CIRCUIT ARRANGEMENT

The method of connecting the concentric lines is indicated in Fig. 1. The outer conductor is grounded while the free end of the inner conductor connects directly to the grid of the amplifier tube. Plate voltage is supplied to the preceding tube through a heavily insulated wire running inside the inner conductor of the concentric line assembly. The capacity between the plate feed wire and the inner conductor provides the coupling capacity between the plate of one tube and the grid of the next. The electrical length of each line is varied by means of a metallic plunger *P*, in contact with the inner conductor but capacitatively connected

to the outer conductor in order to avoid noise which would result from variation in a friction contact. In this particular receiver, the plungers for the various stages are all controlled by insulated rods extending through the rear of the concentric lines and suitably ganged. On the line feeding the input to the first tube, a sliding contact *A* is provided on the inner conductor in order to allow the antenna to be "matched in." Con-

ventional cathode resistors and by-pass condensers are used throughout the circuit.

## THE MECHANICAL DETAILS

The receiver illustrated is one designed by Mr. Dunmore for operation on frequencies between 170 and 300 mc. (1.76 to 1 meter). The lower frequency limit is restricted only by the length of the concentric lines used. Obviously, the lower frequency limit could be extended by using longer lines. In the illustration of the receiver completely assembled, the five concentric lines are shown terminating at their lower ends in the circular shield housing containing the separate shielded compartments for each line termination. The input terminals to the receiver are indicated at *A* and *B*. Terminal *Q* is the output from the detector. The central cylinder *D* is merely a shield covering the voltage divider and associated wiring. It could enclose a power pack.

Each line contains a tuning plunger attached to two bakelite rods extending through the upper end of the line (the closed end). These rods are all attached to a common tuning control handle through a disc by means of set screws. By loosening the set screw on a given control rod, that line may be tuned independently when desired. Obviously, the plunger movement could be provided with vernier control if desired. The cap covering the upper end of cylinder *D* contains a terminal block where the B-supply voltage is supplied to the upper end of each transmission line. The

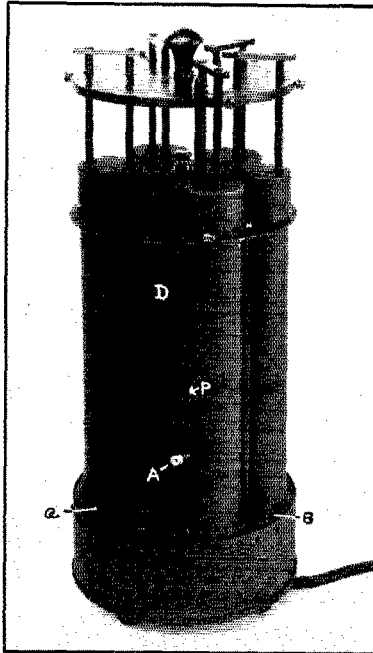

YES, THIS IS A RADIO RECEIVER: A GENERAL VIEW OF MR. DUNMORE'S ULTRA-HIGH-FREQUENCY R.F. AND DETECTOR UNIT.

shielding cover on the top end of each line covers the by-pass condensers  $C_1$ , shown in Fig. 1, and in the case of the last line it contains the r.f. choke  $L_1$  in the detector grid return circuit.

The plate lead is connected to an insulated wire running down through the hole in the inner conductor while the grid lead is connected directly to the inner conductor itself. The tubes themselves are mounted on radial partitions in the lower shield compartment. This ingenious mounting procedure brings the plate of one tube adjacent to the grid of the next.

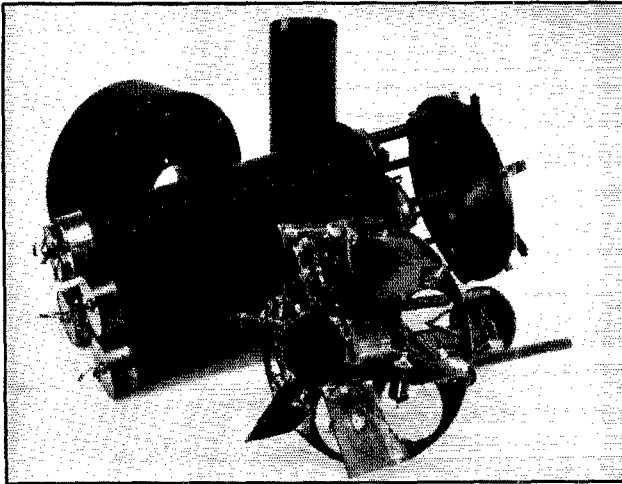

SHOWING THE METHOD OF ASSEMBLY USED IN THE NEW RECEIVER

The type 954 tubes are mounted in radial partitions in the circular shield box, bringing grid and plate leads immediately under the center of each concentric line.

Another illustration shows the receiver in knock-down condition. This photograph shows how, with this type of assembly, the grid and plate leads to the tube may be kept very short.

The third photograph shows the concentric lines used for the input circuit to the receiver and serves to illustrate the construction used. The remaining lines are similar except that they do not have the sliding contact carrying the antenna terminal. This line, however, does not require a plate feed wire through the inner conductor. The pieces of paper held in slits in the tuning plunger insulate it from the outer conductor. They are about 0.008-inch thick. The capacity provided by this plunger is of the order of 156  $\mu\text{fd}$ .

The outer conductor of each line has an inside diameter of 4.6 centimeters and the inner conductor has an outside diameter of 0.49 centimeters. This ratio of 9.2 is the correct one, according to Terman,<sup>1</sup> to give maximum impedance.

<sup>1</sup> "Resonant Lines in Radio Circuits," by F. E. Terman *Electrical Engineering*, July, 1934.

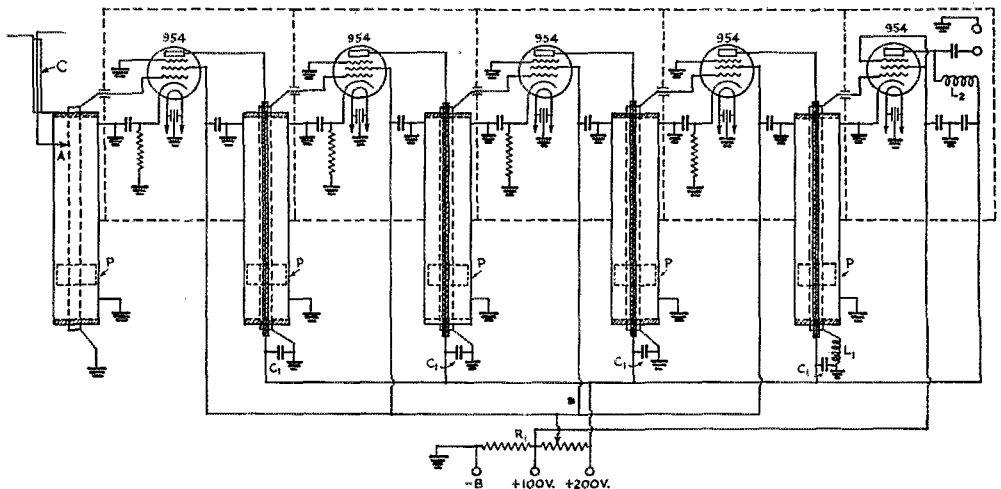

FIG. 1—CIRCUIT ARRANGEMENT OF THE NEW ULTRA-HIGH-FREQUENCY RECEIVER

The values of cathode, filament and plate circuit by-pass condensers and the cathode resistors should follow normal practice. 250  $\mu\text{fd}$ s for the by-pass condensers and 1500 ohms for the cathode resistors would serve as a starting point for experiment. The chokes  $L$  and  $L_1$  are broadcast band r.f. chokes used in the detector circuit to suit it for operation into a broadcast receiver as an i.f. amplifier. The original receiver is used to receive a double-modulated signal—the u.h.f. carrier being modulated by a voice-modulated frequency of about 1000 kc. In this system, the need for a heterodyne oscillator for the first detector is avoided. When operated in a normal superhet the detector would require the usual companion oscillator.



Both inner and outer conductors, and plungers, are made of brass heavily copper plated.

#### LINE LENGTHS

When used as an interstage coupling impedance, the concentric line has shunting it the capacity of the plate of one Type 954 tube and the grid of the following tube with its associated leads. The total capacity due to the tube element is 6  $\mu\text{fd}$ . The leads probably introduce an additional 3  $\mu\text{fd}$ . The line length at resonance is therefore reduced accordingly, the line behaving as an inductance of such value as to form a parallel resonant circuit with the total shunting capacity. It will be seen from the curves in Fig. 2 that the factors just mentioned have a marked effect in reducing the line length from a full quarter wave. This reduction is actually 73 percent at 300 mc. and 50 percent at 171.5 mc.—the percentage becoming progressively less as the frequency is reduced.

#### AMPLIFICATION PER STAGE

The gain per stage as measured at different frequencies has been discussed in the first two paragraphs. Actual measurement of the overall effective amplification of the amplifier and detector described has shown a gain of 125 at 300 mc. and 1,060,000 at 170 mc. Amplification of this order on such frequencies represents, of course, a very substantial accomplishment.

Mr. Dunmore has made measurements on a line with a ratio of inner and outer diameters of 3.6 instead of 9.20. While this ratio should have given more gain due to a greater  $Q$ , the measurements did not show this effect at 300 mc. This, Mr. Dunmore believes, was probably due to the predomi-

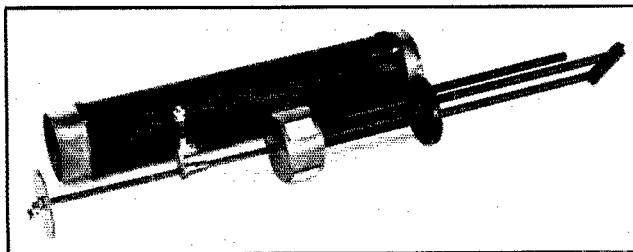

**THE CONCENTRIC LINE FOR THE INPUT TO THE FIRST TUBE**

*A view showing the component parts used in its assembly. All metal parts are of brass, copper plated.*

nance of lead and tube resistance over the concentric line equivalent series resistance.

#### SHARPNESS OF RESONANCE

In this particular receiver, a ratio of diameters corresponding to maximum coupling impedance rather than to maximum selectivity was chosen since extreme selectivity was not desired. Actually, as was afterward found, the selectivity was determined more by other circuit constants than

by the ratio of line diameters. Measurements indicate that the receiver illustrated responds over a band about 4000 kc. wide at the highest frequencies covered.

Mr. Dunmore's development of this unusual

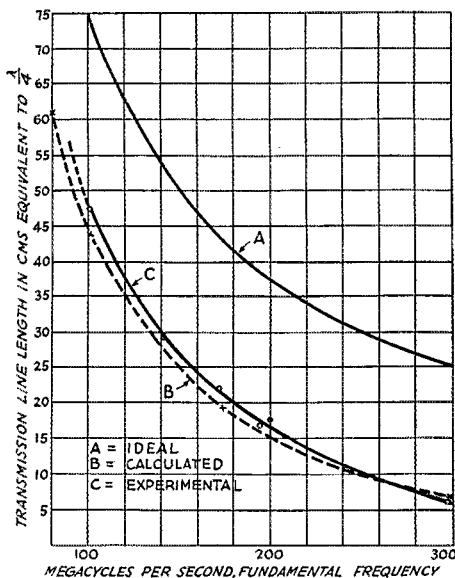

**FIG. 2—LINE LENGTHS WITH AND WITHOUT THE ASSOCIATED TUBE AND LEAD CAPACITY**

receiver is to be the subject of a forthcoming Bureau of Standards' Research paper, No. 856, "A Uni-Control Radio Receiver for Ultra-High Frequencies Using Concentric Lines as Interstage Couplers." Mr. H. Diamond did the theoretical analysis of data obtained during the development of work. The receiver itself was built by Mr. L. L. Hughes.

—R. A. H.



Courses intended for those wishing to become amateur radio operators are being held in the West 135th Street Branch Y.M.C.A. Building, 180 West 135 Street, New York City. The courses cover electrical and radio fundamentals, short-wave receivers, telegraph and telephone transmitters, power supplies, antennas and frequency meters. Classes are held twice daily, 10 to 12 a.m. and 6 to 9 p.m., Monday to Friday. They are held under WPA and are free to those wishing to attend.

# What the League Is Doing

League Activities, Washington Notes, Board Actions—For Your Information

## Election Results

Three new faces appear on the A.R.R.L. Board of Directors as a result of the 1935 elections. In the Midwest Division there is a change; in the Delta Division also, although there the old director was not a candidate; and in the Southwestern a director has been elected for the first time. Two old directors were returned to office by balloting, as well as the three who were declared elected in November as a result of being the only candidates in their divisions.

In December *QST* we reported that the Dakota, Pacific and Southeastern Divisions had returned Mr. Jabs, W9BVH, Mr. Culver, W6AN, and Mr. Adams, W4APU, respectively, and that their respective alternates are Mr. Fred W. Young, W9MZN, Mr. E. L. McCargar, W6EY, and Mr. S. J. Bayne, W4AAQ. Below is the story of the divisions where there was balloting.

### CANADA

Mr. Alex Reid was returned as Canadian General Manager by a thumping majority over three opponents:

Alex Reid, VE2BE.....	285
Samuel B. Trainer, Jr., VE3GT.....	64
Leonard W. Mitchell, VE3AZ.....	42
J. Leonard Walker, VE3JI.....	40

No candidate was named for alternate Canadian General Manager.

### ATLANTIC DIVISION

The race in the Atlantic Division was extremely close, the incumbent, Dr. Woodruff, W8CMP, being returned by a margin of but 22 votes. Mr. Roy C. Corderman, W3ZD, was the victor amongst three candidates for alternate director. The figures:

For Director:	
Eugene C. Woodruff, W8CMP.....	578
Lawrence D. Geno, W8PE.....	556
For Alternate Director:	
Roy C. Corderman, W3ZD.....	491
Walter Bradley Martin, W3QV.....	408
Ward J. Hinkle, W8FEU.....	233

### DELTA DIVISION

The Delta Division chose for its new director Mr. E. Ray Arledge, W5SI, of Pine Bluff, who won handily over Mr. E. H. Treadaway. The former director, Mr. M. M. Hill, was not a candidate. The alternate director for this division was declared elected in November without balloting, being the only candidate: Mr. Fremont F. Purdy, W4AFM. The balloting:

E. Ray Arledge, W5SI.....	112
E. H. Treadaway, W5DKR.....	68

Mr. Arledge, a refrigeration engineer, is a radio amateur of over twenty years' experience. He has a commission in the U.S.N.R. but is also active in A.A.R.S. work, being alternate state net control. He has done some outstanding emergency communication, is an excellent operator, and an A.R.R.L. Route Manager.

### MIDWEST DIVISION

The Midwest Division provided an upset, electing a new director in the person of Mr. Floyd E. Norwine, Jr., W9EFC, of St. Louis, who won over the incumbent, Mr. Kerr, 229 to 192. Mr. O. J. Spetter, W9FLG, of Topeka, is the new alternate. The tally:

For Director:	
Floyd E. Norwine, Jr., W9EFC.....	229
Harry W. Kerr, W9DZW-GP.....	192
Frank J. Sadilek, W9APM.....	73
For Alternate Director:	
O. J. Spetter, W9FLG.....	256
Phil D. Boardman, W9LEZ.....	229

Mr. Norwine, who is in the coffee business, has long been identified with the O.B.P. Amateur Radio Club of St. Louis and has been active in A.A.R.S. work.

### SOUTHWESTERN DIVISION

The new Southwestern Division engaged in spirited balloting in the selection of its first director—elected this year for a term of but one year, so as to stagger its elections with the Pacific Division. The new director, Mr. Charles E. Blalack, W6GG, is in the feed and seed business at Yuma, Arizona, having recently removed from Los Angeles. By a small margin he nosed out Mr. Walter W. Matney, W6EQM, while Mr. Philip S. Snyder, W6UT, enlarged his lead as the new alternate director. Balloting figures:

For Director:	
Charles E. Blalack, W6GG.....	219
Walter W. Matney, W6EQM.....	195
For Alternate Director:	
Philip S. Snyder, W6UT.....	246
William L. Seitz, W6HXU.....	166

It took the Executive Committee and eight clerks an entire afternoon to open and tally the balloting, and had it not been that three of the divisions had had "declared" elections the job would have run far into the night. As the ballots come in to headquarters they are carefully checked against our membership records and arranged by divisions for the committee meeting.

By now the committee has a highly perfected technique for rapidly opening the double envelopes and segregating the director voting from the alternate voting, but the counting is a long and laborious process because it must be completely accurate. All the ballots are counted by every

The list is arranged geographically. In each subdivision, the first office given is that of the district headquarters. This is the office which should be addressed for further information concerning the examinations to be held in the additional cities listed in each district, such as the

**ANALYSIS OF 1935 VOTING**  
**SHOWING ON WHAT FACTOR THE RIGHT TO VOTE WAS BASED**

	<i>Canada</i>	<i>Atlantic</i>	<i>Delta</i>	<i>Midwest</i>	<i>Southwestern</i>	<i>National Average</i>
Licensed Amateur.....	91.9%	89.9%	95.6%	96.6%	91.3%	92.1%
Prior Membership.....	8.1	10.1	4.4	3.4	8.7	7.9

member of the Executive Committee so that each one is personally informed of the accuracy of the count before the winning candidates are declared elected and the certification of election signed.

One of the interesting things about this year's elections was the dwindling number of ballots cast by persons relying upon prior membership in the League, rather than amateur licenses, for their right to vote. The subject was discussed at length in the report of the previous year's elections, on page 27 of our issue for February a year ago. At that time 18.1% of the balloting was by persons who were not licensed amateurs. This year's elections were in different divisions, but the figure might be expected to be similar, whereas it dropped to 7.9%. The working of the system is such that in a brief while this element in the voting will practically disappear altogether. It was noted this year that several dozen members claimed the right to vote by virtue of continuous membership in the League extending from before May 15, 1934, when in fact they were not so entitled. These ballots, of course, were thrown out and not counted. The mere fact that a person was a member some time prior to May, 1934, does not entitle him to vote in A.R.R.L. elections unless his membership has been continuous and without lapse through the intervening period. The possession of either an amateur station or operator license of course entitles the member to vote regardless of how recently he joined the League. Appended is a table showing the distribution of the voting, by divisions, as between licensed amateurs and unlicensed members who relied upon prior membership.

-----  
*QST*, welcoming the new directors into the A.R.R.L. official family, knows that it is reflecting the sentiment of the members in expressing gratitude to the outgoing directors for their long years of labor in the upbuilding of A.R.R.L.

**F. C. C. Examinations**

The Federal Communications Commission announces its 1936 schedule of amateur operator examinations. We list them below for the information of members.

place to report, the exact date where dates are not here stated, etc. It should also be noted that all examinations begin promptly at 9 a.m. local time, except in New Orleans where they begin at 8:30 a.m.; and that no examinations are held on national holidays.

DISTRICT NO. 1

Boston, Customhouse, Seventh Floor, daily except Thursdays.

DISTRICT NO. 2

New York City, 1024 Federal Bldg., 641 Washington St., Tuesdays, Thursdays, Saturdays. Troy, N. Y., some time in March, June, September and December.

DISTRICT NO. 3

Philadelphia, 1200 Customhouse, 2nd and Chestnut Sts., Wednesdays.

DISTRICT NO. 4

Baltimore, Fort McHenry, Wednesdays and Saturdays. Also in Washington, D. C., 5307 New P. O. Bldg., Thursdays.

DISTRICT NO. 5

Norfolk, 402 New P. O. Bldg., Fridays. Winston-Salem, N. C., February 8th, May 9th, August 8th, November 7th.

DISTRICT NO. 6

Atlanta, 411 New P. O. Bldg., Tuesdays and Fridays. Nashville, February 21st, May 15th, August 21st, November 20th.

DISTRICT NO. 7

Miami, 12 New Federal Bldg., by appointment. Jacksonville, Class A only, June 27th, November 21st.

DISTRICT NO. 8

New Orleans, 326 Customhouse, 8:30 a.m., Mondays, also by appointment. Little Rock, Class A only, March 14th, September 12th.

(Continued on page 84)

# A Few Random Remarks

By The Old Man

**QST!!!! Hear ye! Also oyez! T.O.M. is back in QST! Yessir, the same sharp-tongued old cuss who invented the Wouff Hong as a potent remedy for some of our earlier misbehavior. Reporting upon his recent silence, the (fairly) genial old pirate spits on his hands and takes a couple of lusty cracks at what Young Squirts squirt to-day. Heads will be rolling from now on for, T.O.M. has his old-time perception and bite. Let Y.S.'s beware the local custodian of the Buggbilly!—“EDDIE.”**

**S**AY, Son, sprinkle some sawdust on that Young Squirt and sweep him out the back door. Such drool as he bleats in December *QST* ought not be left around. Somebody will slip on it and get hurt.

Gad Zooks! He thinks maybe I dropped in on him! And that hogwash about kicking the top shelf out of his set. Just as though his set had a shelf in it! You can tell by his lingo he has a lot of gear scattered around on a three-legged bedroom wash-stand. I'll bet there's no way to get your legs under it, and in the space intended for the crockery I'll bet he has filament and plate transformers and a thing that he thinks rectifies and filters a.c. Kicking the top shelf out of the set! Dear me, ain't he the cut-up!

The lowest form of animal life in the Navy used to be a midshipman. Well, the lowest form of animal life in amateur radio is one of these Young Squirts. We used to call them Sea Lawyers in the old Navy. The kind that sits around with the new gobs, when they're seasick, damns the officers and tells how the ship ought to be run.

But just leave this young person to me. I have noted him in my little black book along with several of those 45-words-a-minute speed maniacs. On my next regular trip around I will attend to them all. They'll make a couple of sacks of low-grade fertilizer for the A.A.A.

Now about my being a bit quiet of late. Just between us old-timers, I've been busy. I was asked by certain interests to conduct some research work which would lead to the development of a line of devices to be used at the forthcoming Cairo radio conference. This Cairo dog-fight is to be pulled on in a couple of years or so, and they thought maybe I could help out. Having heard of my Wouff Hong, Rettysnitch, Uggerumph and the other tools I got up years ago, when we American amateurs were instilling

a proper respect for law, order and good sportsmanship, they fancied if I could make certain determinations I would be able to devise a few tools, jigs and fixtures for use upon foreign delegates at Cairo. I gave them specifications for some new equipment especially designed to meet these problems. The Flitchgobber is one. It automatically develops supersonics in the intestinal tract the moment the brain starts thinking about objecting to expanding an amateur band, and the party leaves the room immediately for reasons best known to himself. The Oofhogger turns the cortex of the brain to pus when thoughts of general amateur restrictions arise. I also built a neat little Zabsnifer which induces cerebral hemorrhage and consequent general knock-out when objections are raised to our handling third-party message traffic.

This work is now finished and I shall have some time now to devote to Young Squirts, Speed Maniacs, Radio Radicals, and the other rotten things that have crept into American amateur radio. Gawdnose I'm needed, for the listening-in I've been doing lately fills my soul with a thirst for blood. In fact I'm working up a little gadget now to automatically hamstring, tongue-tie and induce writer's cramp in our American Radicals when they start

knocking A.R.R.L. headquarters, and I've got a couple of other little instruments of torture that I propose to use on Young Squirts and Bug-Key Speed Maniacs here in this country. In this fast-and-rotten sending matter, why doesn't some smart aleck start a sending school for Young Squirts? Teach them how to send. They are thick-headed, all right, and they carry what brains they have in the seat of their pants. But if they get a 500-volt poke in the belly every time they get speed-crazy on the key, they would soon learn to send like white men. Why do they send five

(Continued on page 86)



# Audio Output Limiters for Improving the Signal-to-Noise Ratio in Reception

By H. A. Robinson, W3LW\*

**F**AVORED indeed is the radio amateur who enjoys one of those rare but ideal receiving locations far removed from the sources of natural or man-made interference. It is for the greater majority of the members of the amateur fraternity who must, by force of circumstance, receive their desired signals accompanied by more or less frequent bursts of static, ignition interference or disturbances from local electrical devices, that this article is written.

## FACING THE FACTS

From a consideration of the distracting effects of surrounding influences it is generally conceded that head telephones are employed by most amateurs for the reception of those most elusive DX signals or signals that are hard to copy through backgrounds of noise, interference or the like. It is with improvements in the signal-to-noise ratio in headphone reception that this article is concerned. However, the same principles may be applied equally well in the case where a loudspeaker is employed.

In the "good ole days" when the UV-201A tube was the accepted standard of excellence for every tube function in the receiving equipment, and plate supply was limited to 90, or at most 135 volts, depending upon the condition of the amateur's pocketbook, the maximum power output delivered to the headphones was of the order of 10 to 25 milliwatts. Consider now the present trend of amateur receiver design. Here we find the telephone jack connected in the plate circuit of tubes with power output capabilities ranging anywhere from 80 milliwatts to one or two watts!<sup>1</sup>

Now the results of tests conducted on representative operators has substantiated the fact that for the average individual, in surroundings which are fairly free from excessive noise influences, a power output of from 0.2 to 1 milliwatt represents a very comfortable, readable signal in the typical 2000-ohm (20,000-ohm impedance) headset. In surroundings where very high noise levels are present, as in an airplane, a power output of from 1.5 to 10 milliwatts per headset is ample.

\* Silver Lake Farm, Willow Grove, Penna.

<sup>1</sup> "Details of New Receiver Circuits," *QST*, May, 1935.

Can this excess of power output capability have any detrimental influence upon the received signal-to-noise ratio? The answer to this question, when considering the reception of relatively weak signals in the presence of intermittent static bursts and similar electrical interference will be shown in the affirmative by reference to the diagrams of Figs. 1 and 2.

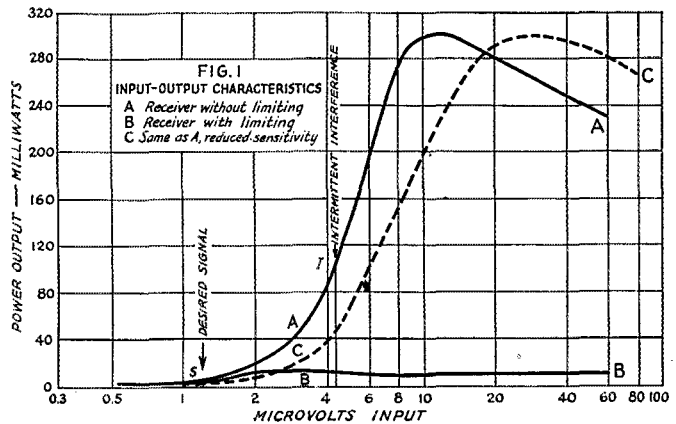

## OUTPUT LIMITING

In the curves of Fig. 1 we have represented the input-output characteristics of two receivers. In these curves, the input signal microvolts, either modulated c.w. or modulated, are plotted logarithmically as the abscissa and the corresponding power output at the telephone jack as the ordinate. Curve A represents a typical receiver in which the headphones connect in the plate circuit of a tube of the 56, 37 or similar type. For receivers in which the headphones are supplied by a power tube of the 41 or 2A5 type, the ordinate scale will be multiplied approximately ten times. Curve B of Fig. 1 represents the input-output characteristic of a receiver of the same type arranged for output limiting.

Considering the reception of the relatively weak desired signal *S*, both receivers have the same sensitivity producing, in this case, 5 milliwatts output. However, the stronger intermittent interference *I* produces peaks of output power of the order of 100 milliwatts with receiver *A*, momentarily paralyzing or dulling the auditory response, while with receiver *B* the interference

peaks are limited to a degree but slightly greater than the desired signal output.

Briefly, the object of the output limiter is to restrict the power output capability of the receiver to a minimum just sufficient to pass the desired signal, thus limiting the disturbing effect

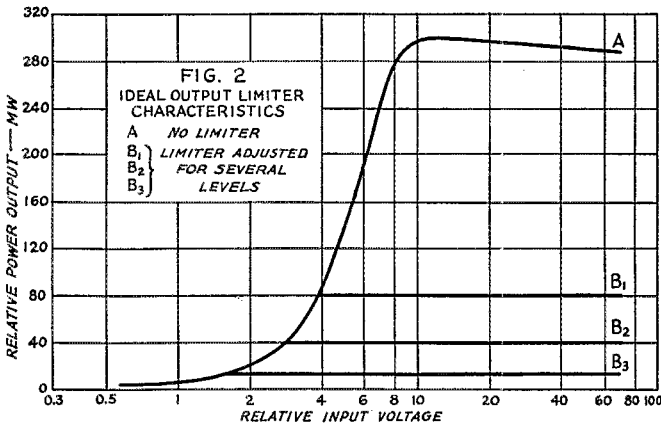

of crashes of static and similar interferences. This output limiting cannot be accomplished by means of the usual volume or sensitivity control since the latter merely changes the overall sensitivity of the receiver as shown by Curve C of Fig. 1, with a negligible change in the signal-to-noise ratio.

The improvement in the signal-to-noise ratio in reception with output limiting depends greatly upon the shape of the input-output characteristics of the receiver and the wave form of the intermittent interference.

In Fig. 2 are set forth the desired features of ideal output limiters. Curve A again shows the receiver input-output characteristic without limiting or with the limiter control at minimum. Curves B<sub>1</sub>, B<sub>2</sub> and B<sub>3</sub> represent ideal limiting levels corresponding to several settings of the limiter control. These ideal curves are relatively flat and deviate but slightly from the unlimited output curve A for input signals lower than the value at which the limiting action begins.

The influence of the wave form of the intermittent interference upon the effectiveness of the output limiter can be understood by reference to the diagrams of Fig. 3A. Bursts of static and the high intensity peaks of electrical and ignition disturbances are effectively ironed out by the limiting action. It can be seen that the output limiter is most effective for intermittent disturbances of high peak amplitude and relatively short duration. In the case of c.w. reception, the output variation of a badly fading signal can be considerably improved by the use of the limiter as shown in Fig. 3B.

The output limiting circuit arrangements usually function in such a manner that an input

signal or interference exceeding the threshold at which limiting becomes effective, is rather severely distorted. This is relatively unimportant in the case of c.w. reception, but for telephone modulated reception the limiter control should be set so that the limiting and distortion begin for input signals just slightly higher than the desired signal level, which will then be undistorted. This makes a convenient way of adjusting the limiter control for any desired signal output level.

#### OUTPUT LIMITER CIRCUITS

Of the numerous circuits arrangements by means of which effective output limiting may be accomplished only a few will be described in the following notes. Each of these limiting circuit arrangements has been employed in actual communication service and has given very satisfactory performance. However, the advantages and dis-

advantages of each arrangement from the amateur viewpoint may prove helpful.

In the output limiter circuit arrangement of Fig. 4A, our old friend the neon tube plays the important role. Connected across the headphone output circuit through the medium of a high step-up ratio audio (interstage) transformer, the neon tube ionizes on interference peaks and transfers an equivalent load back on the headphone circuit, limiting the response. The current limit-

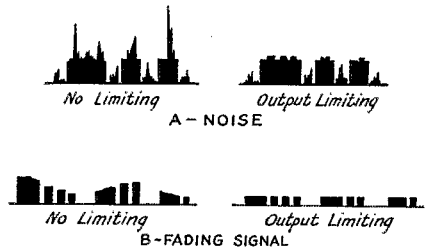

FIG. 3

ing resistor is removed from the base if the usual lamp-type of neon tube is employed. The potentiometer and voltage supply give some degree of control of the threshold level at which limiting takes place. The unavailability of a suitable step-up transformer and the limited degree of level control make this arrangement rather ill suited for the amateur.

The circuit arrangement of Fig. 4B is included here because of its simplicity. The headphones are connected across the level adjusting potentiometer and the inherent output limiting capability of the tube is utilized. To understand the limiting action better, let us consider some spe-

cific values. Assume the output tube normally feeding the headphones would supply 100 milliwatts before inherently limiting. Without limiting action (the potentiometer arm at the plate end) a desired signal input might supply 2 milliwatts to the 'phones for a certain sensitivity setting. Under these conditions interference peaks, if sufficiently strong, could produce headphone outputs up to the limiting output of 100 milliwatts. Using this circuit as a limiter, the receiver sensitivity would be increased until the desired signal produced the maximum output from the output tube while the proportion supplied to the headphones would be adjusted by the potentiometer to a comfortable level near 2 milliwatts as before. Now interference peaks can no longer give additional output since the tube is already working at its maximum output power capability. The great disadvantage of this circuit

a triode tube (Type 56 or 76) supplying the headphones, while circuit D employs a pentode output tube (Type 41, 42 or 2A5) supplying either loud-

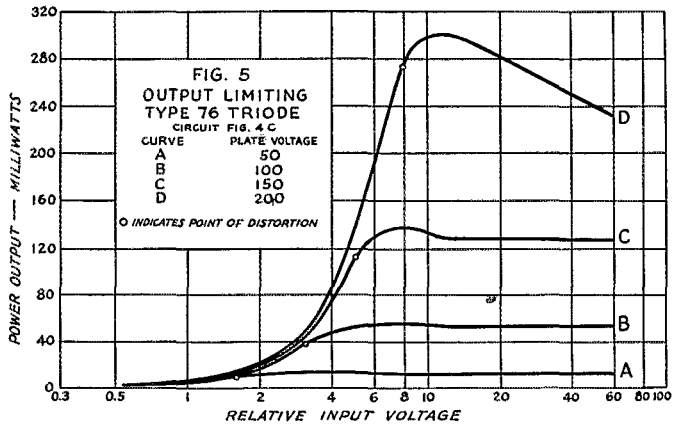

speaker or headphones. The principle of operation of both arrangements is identical. In short, the power output capability of the tube is adjusted by means of the limiter control potentiometer so that it just exceeds the desired signal level, thus limiting all interference responses to the same level. The limiter control varies the plate voltage in the case of the triode and the screen voltage is controlled in the pentode arrangement.

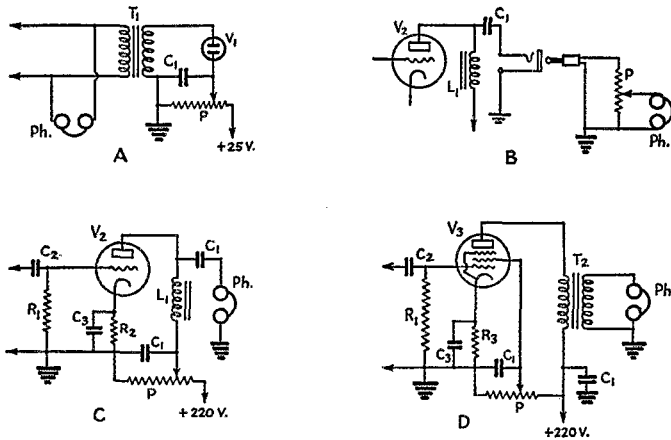

FIG. 4—OUTPUT LIMITING CIRCUITS

$C_1$ —0.25  $\mu$ f.  
 $C_2$ —0.01  $\mu$ f.  
 $P$ —50,000-ohm limiter control (preferably wire wound).  
 $R_1$ —0.5 meg.  
 $R_2$ —2000 ohms.  
 $R_3$ —600 ohms.  
 $V_1$ —1-watt neon tube (see text).

$V_2$ —56 or 76.  
 $T_1$ —Step-up transformer (high ratio interstage).  
 $T_2$ —Output transformer.  
 $L_1$ —15-henry choke.  
 $Ph$ —Telephones (20,000-ohm impedance; 2,000-ohm resistance).

arrangement is the effective decrease in sensitivity as the limiter control is reduced to decrease the level, and the requirement of sufficient reserve receiver sensitivity to swing the output tube to full output on even the weakest signals.

The circuit arrangements of Fig. 4C and D are to be preferred and are recommended for amateur use, both from the standpoint of relative simplicity and operating advantages. Circuit C employs

In Fig. 5 are shown the input-output characteristics for several output level adjustments of the triode circuit of Fig. 4C. A type 76 tube was employed supplying the output power to 2000-ohm head telephones (effective impedance at 1000 cycles approximately 20,000 ohms). The frequency of the audio signal was approximately 1000 cycles and a cathode ray oscilloscope was employed to determine the points at which distortion became apparent for each setting of the limiter control P.

The curves of Fig. 6 show the input-output characteristics of the Type 41 pentode output tube for several settings of the limiter control. The tube was matched for a 10,000-ohm load and the distortion points again noted by means of the cathode ray oscilloscope. It should be noted in both Figs. 5 and 6 that for relatively low signal inputs there is but little deviation of the curves from the unlimited output characteristic, indicating a negligible loss in

sensitivity when operating the output tube at a low power capability.

In conclusion, it is the sincere hope of the writer that this information on output limiters

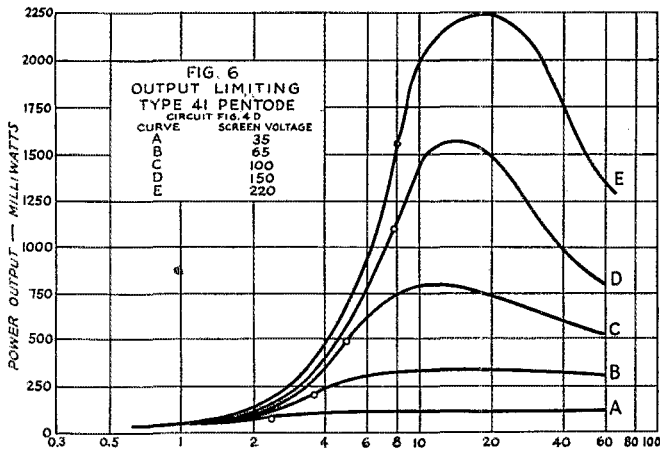

may prove helpful to the amateur fraternity and particularly to those who are hampered in reception by severe intermittent interferences of the nature previously discussed.

## 28 Mc.

AS THIS issue of *QST* goes to press conditions on the 28-mc. band have been showing a considerable improvement over the "depression"—if it could be called that—of mid-December. European DX has been getting more numerous and the signals are louder on the average, while the time during which DX can be heard is lengthening out. Probably the increase in daylight hours is responsible for the latter. From scattered reports we understand that the VK's and ZL's also are putting in better signals on the West Coast now.

Comparatively few reports have been received during the past month—but now the lack of reports is not caused by inactivity, but just the reverse. So much has been going on, so much DX worked, that contacts are almost routine instead of being the sensational accomplishments they were a few months ago. In other words, 10 meters is settling down to being an everyday communication band, at this writing especially good for the sort of intra-continent contacts characteristic of 20 meters. The 20-meter 'phone gang is finding the band ideal for relieving the week-end daytime QRM they've been accustomed to fight, and the problem nowadays is not so much in finding stations to work but in selecting one out of many answers to CQ's!

In connection with 'phone work on 10, we want to repeat the statement of an earlier article—that

10-meter 'phones have to meet every requirement imposed on transmitters and operation for the 160-, 80-, and 20-meter bands. True enough, a Class-A license is not required, but the transmitter itself must be free from frequency modulation and must not be overmodulated. In the past few weeks some "messes" which couldn't have been anything but modulated oscillators have made their appearance; not only are they practically unreadable on a superhet receiver but they swipe around over too much territory and are a direct violation of the regulations. They're distinctly not welcomed by the operators who've taken the trouble to build good transmitters.

Judging by past performances, DX should improve from now on until Spring, when a peak corresponding to that of early Fall should be reached.

If the coming summer duplicates last, the band will be especially good for work within the United States when the warm weather comes. But whatever may be in store for the future, we think all hands who have operated on 28 mc. will agree that the time and effort spent in getting on the band has been worth while. Results have improved in about direct ratio to the number of stations operating, which makes us suspect that for the present period at least, equally as good work can be done on 10 as on 20, although the good operating period is somewhat more restricted.

We should particularly appreciate reports of observations of the ten-meter gang on the anticipated "wipe-out" (see January *QST*, page 8) expected to occur about February 12th. With some exceptions the wipe-out on 28 mc. was practically complete on October 24th; although some signals popped through occasionally on December 18th and 19th, the approximate period of the next wipe-out, both those days were very poor. The period around February 12th will therefore be of especial interest, and the fact that a good many will be on the air on the holiday should facilitate observations.

## WSXAI, 31.6 mc.

The 16-hour broadcasting schedule of WHAM is now being radiated by WSXAI, high-frequency experimental station which operates on a frequency of 31.6 megacycles.

WSXAI is located in the transmitter building of WHAM's 50,000-watt station 15 miles south of the city of Rochester, and is a 75-watt crystal-controlled high-fidelity transmitter with Class B modulation. Starting January 12th, and each

(Continued on page 108)



# Ingang, B.E.R.U., and All That!

By Yardley Beers,\* W3AWH, Ex-WIYU

**I**N AMERICA, so large and remote from most other countries, it is not very often that we meet a foreign amateur in person, and we do not even dream of a ham gathering with attendance of several different nationalities. In Europe, however, such gatherings are not only possible but frequently take place. While spending the summer in England I had the pleasure of attending two such meetings: the tenth annual R.S.G.B. Convention in London, and a hamfest in Belgium, to which I went with a party of English amateurs.

In fact, my hamfesting began before I even left the ship on the voyage over, for one morning a bell boy noticed the call book in my suitcase and immediately introduced himself as W2BND. Later he arranged a meeting with two other passengers, W2BPJ and W2GHA. That evening W2BPJ (a Harvard man) and I spent in good-natured arguments over Harvard vs. Yale, North vs. South, and 'phone vs. c.w.

The past two years a group of the members of the R.S.G.B. has made a visit to one of the nearer Continental countries over August Bank Holiday week-end, the first week-end in August. It was on this year's trip to Belgium that I went. On that Friday evening we assembled at the Liverpool St. Station in London to take the boat train for Harwich. In the party of twenty-two were several well-known G's, including Mr. J. Clarricoats, G6CL, Secretary of the Radio Society of Great Britain. Later, at Harwich, we boarded the channel steamer for Antwerp, where we arrived early the next morning after a calm passage. We were greeted by ON4AA, ON4AC, ON4CC and ON4GW. Shortly we left by train, past the famous battlefield of Waterloo, for Brussels, where we were met by M. Paul de Neck, ON4UU, President of the Reseau Belge, and his wife, who remained with us as guides during the entire remainder of our stay in Belgium. We were then joined by delegations numbering from two to six from Germany, Holland, France, Luxembourg, and Switzerland, and two British YL's, G2IA and G2YL. All of us went by train and then by trolley to Harvengt, near Mons, where Baron de la Roche, ON4HM, kindly entertained us at luncheon at his beautiful home. That day, spent in leisurely strolling about the spacious grounds while we became better acquainted with our new friends or in playing croquet with the YL's and YF's, was a most welcome pleasure after the nearly sleepless

night we had had. Following mid-afternoon refreshments we returned to Brussels where, after we had been installed in our hotel, we spent the evening at the Exposition, which much resembles the late Century of Progress Exposition in Chicago.

After a good night's rest we met at the Television Building at the Fair. This contains the television exhibit and the amateur station, ON4WS. Normally visitors are carried through the building on a motor-driven conveyor, but this was stopped to enable us to examine the station thoroughly and witness a demonstration of the television apparatus while ON4UU made an address of welcome over it. The station, ON4WS, consisting of a high-powered transmitter and a National FBXA receiver with a pre-selector attached, is very neatly arranged behind a large glass window, in front of which the visitors normally pass on a motor-driven conveyor belt. For the remainder of the day we split up into groups, each one guided by an amateur who



A GROUP OF DELEGATES TO THE 1936 R.S.G.B. CONVENTION, SNAPPED AT THE LONDON REGIONAL AND NATIONAL BROADCASTING STATIONS, BROOKMAN'S PARK, HERTS

knew the Fair well, and we toured the Fair and some of the points of general interest in the city.

The next morning we arose very early to catch a train for Ghent. Here we were met by the local amateurs and bought food for a picnic lunch at Ruysselede, where we visited the great Belgium commercial station operating under several calls, ORU being one. An interesting hour or two was spent wandering around the various antennae and the many transmitters, both long-wave and short-wave, 'phone and c.w. Following this we returned to Ghent where we bid good-bye to most of our Continental friends and entrained to Antwerp, where we were met by the local hams and conducted to their club for tea, during which

\* 900 W. State St., Trenton, N. J.

we saw their club station, ON4AA (one of three entirely separate stations using this call). This station was very neatly built and should be an example for many club stations. The club is located in the rooms of an athletic club under a (soccer) football stadium, and after tea we kicked soccer balls around before going on a tour of the city. Among many places of general interest, we went to the top of a twenty-four-story skyscraper,



LEFT, VS7GS; CENTER, G6WY; RIGHT, W3AWH

which had been the scene of some local ultra-high frequency experiments. A twenty-four-story building, although fairly common in the U.S.A., is a great novelty for Europe, and some of my fellow visitors complained of dizziness! We ended the tour at the pier, where we barely caught our boat. As we started, G6CL sent "GB OM's" on the ship's siren, with the kind permission of the captain. Whereas we had taken formal leave of our hosts, there remained still a great thrill to be given us by them, for when we were down the river a few miles, ON4AC and another amateur came out in the former's private airplane and, circling low, waved to us—the perfect good-bye from perfect hosts.

As we steamed down the harbor, our minds were filled with regrets that our pleasant holiday was over. Special thanks for the success of the week-end are due to ON4UU for his indefatigable guidance, ON4HM for his pleasant luncheon, and to G5UK, who conducted the R.S.G.B. group. After another calm passage, we arrived in London at 7:30 a.m., Tuesday, and bid each other good-bye with, "See you at Convention."

The R.S.G.B. Annual Convention is much like an American ham convention except for one thing: the country is small enough geographically to permit amateurs from all over the country to attend. Consequently, together are gathered a large fraction of the active amateurs in the country, which results in a unique spirit. In addition many foreign and colonial amateurs attend, among them this year being representatives of Z1, VK, VS7, SU, ZB1, VE, VP6, ON, PA, D. F. EI, GI, and HB. Other visitors from the U.S.A.

were W5BVF and Paul M. Segal, W3EEA, General Counsel of the A.R.R.L., who was vacationing abroad.

The Convention took place August 22nd to 24th, the end of the National Radio Exhibition at Olympia, the London equivalent of Madison Square Garden. The first event was a visit to the Dollis Hill Research Laboratories of the British Post Office, where many experiments of interest to amateurs were in progress. Following this, the group went to Olympia for supper and an informal get-together at the R.S.G.B.'s stand, where some amateur apparatus was on display. The next morning we departed in a double-decker bus from London for Brookman's Park to the north for a visit to the London Regional and National Broadcasting stations. Especial interest was displayed in the method of frequency control used in one of these transmitters, which is synchronized with two other stations in remote parts of the island. The tone of a vacuum-tube driven audio-frequency tuning fork is conveyed by telephone wires to the other two stations, and at all three it is multiplied until the final r.f. is obtained by means of a series of frequency doublers, the output of which is amplified and modulated by the usual methods.

Following lunch we went on a tour of the New Southgate works of the Standard Telephones and Cables, Ltd., where we saw the manufacture of much apparatus, including two transmitters for the new steamer "Queen Mary." Aside from the great technical interest, this visit gave me the additional interest of comparing factory life in England with that in America. After tea at the factory's restaurant, we departed for the Society's Annual Conversazione at a London restaurant. Around a buffet supper we made new acquaintances with hams who were not able to make the trips. Later moving pictures of the Belgium trip, the National Field Day, and other Society activities within the last year were shown.

The last day of the Convention opened with a business meeting followed by lunch. The afternoon session included the awarding of Society trophies, the taking of a picture of the "gang," and an interesting lecture on cathode-ray tubes by G. Parr, Esq., which was concluded with tea and adjournment until the evening.

As with American conventions the banquet was the climax of this one. However, the method of procedure is very different. After the completion of the meal the President (A. E. Watts, G6UN) arose and proposed toasts to H.M. The King and H.R.H. The Prince of Wales, the latter being patron of the R.S.G.B., and then he said, "Gentlemen, you may smoke." (What a *faux pas* I had nearly committed!) Succeeding these toasts were those to "The Society at Home," "The Society Overseas," and "The Visitors," with the accompanying responses. Between these came some songs by professional entertainers, "The

Swindle" (giving out of the door prizes) conducted by G6CL, and the presentation of the Senior B.E.R.U. Trophy to SU1EC. The affair broke up with a toast to the President and the singing of "Auld Lang Syne" and "God Save the King."

Though the Convention was officially over, it was continued by many ham-fests in local shacks and a number of tea parties in the afternoon. It was my very good fortune to attend the one given by Miss N. Corry, G2YL, at her lovely home in Surrey. I went expecting much because of the local fame of her post-Convention teas, and I was far from disappointed. All of the guests were afforded ample opportunity to see her station which has lately been making 28-mc. news. As might be expected, the station, consisting of a 50-watt c.c. transmitter and an FBXA receiver, displayed feminine tidiness. All too soon the party broke up and we parted to travel our own paths, some of us to the far corners of the globe, but no matter how far we may travel, all of us will carry memories of a most pleasant weekend.

Aside from these meetings, opportunity to visit ham shacks presented itself during my wanderings. For many years I have carried out a frequent correspondence with G5JU and G5WI of Bristol, and it was fitting that my first visit was to them. G5JU, who kindly invited me to spend the night with him, conducted me on a tour of the city ending up at the shacks of G5KT and G6RB, where I had pleasant meetings in person with two old friends over the air. At G5KT's, G5WI took me in charge and took me to his home for the evening. In America we have often heard of the exploits of European low-powered stations with considerable amazement and some doubts, the latter sometimes justifiable. G5WI is one of these "QRP Merchants," using an actual input of nine and one-half watts yet maintaining fairly consistent communication with the U.S.A. on not only 14 mc. but also on 7 mc., sometimes getting R9 reports. In short order we contacted a WI and an excellent QSO followed, one that was certainly an "eyeopener" for one from the land of kilowatt 852's. I wish to tell you, fellows, *it can be done*, and it does not require a phenomenal location but merely a little patience in experimenting on the part of the operator. With all due justice to G5WI, his results have been duplicated by many others, among them being G5JU and G5KT. Whereas

this QSO was a great thrill to me, the biggest thrill of the day was meeting two people I had never seen before, being greeted as an old friend, and finding them as I had always hoped them to be.

The pleasure of Convention weekend was greatly increased for me by my accepting the



**GERALD MARCUSE, G2NM, FAMOUS OLD TIMER AND SHORT-WAVE PIONEER, PAST-PRESIDENT OF THE R.S.G.B., AT THE FOOT OF HIS MAST, SONNING-ON-THAMES, BERKS**

kind invitation of an old friend, "Ham" Whyte, G6WY. This visit enabled me to better my friendship formed by numerous contacts over the air and by a previous visit to his shack three years ago. With his delightful humor, which he tried to teach me, he soon made me feel at home. Also at the Convention he was invaluable in conducting me around and in introducing me. Between events we had a number of callers, among whom were HB9P and VS7GJ, the latter of whom on spying a rain barrel in the "yard" gave a demonstration on how mosquitoes breed. It was an unforgettable delight to sit on the other end of that 250-watt Goyder Lock transmitter and QSO the inaccessible parts of the United States with ease.

It was a stroke of luck that effected my meeting some intimate friends of Mr. Gerald Marcuse, G2NM, and who, though not amateurs themselves, arranged for me to spend a very pleasant day with him. A day with one who as a pioneer DXer and as one of the founders of the I.A.R.U. possesses one of the greatest names in amateur radio is an opportunity not to be turned down. I went hoping to hear him talk of the old days, nor was I disappointed as I heard him tell of going to dinners with Marconi and Sir Oliver Lodge, of the days when the people at Rugby said that all wavelengths below 200 meters were useless for long distance work, and of his trip to America. Furthermore, I was refreshed by his undying enthusiasm, after all these years of experience, though perhaps with a little more calm than the "young squirt" who has just spent a sleepless night over his first VK, as I joined him in successfully keeping schedules with rare DX. Needless to say, as at G6WY's, I had the feeling of being behind a "powerhouse" because of the ease with which we did it. "Powerhouse," incidentally, is a fitting description of the station with separate kilowatt transmitters for 14 mc. and 7 mc., the former only a month old, on one side of the room, and a 100-watt 3.5-mc. transmitter and a FBXA receiver on the other.

Besides these longer visits, telephone calls in Exeter and London brought about pleasant evenings spent with G5QA and G6QB respectively.

Also a chance meeting with ZS2F in London gave me an insight to amateur radio in his country. My trip was saddened by the recent deaths of G2BM, Senior, and G6HP, whose stations I visited three years ago.

From all these contacts I was able to obtain a good picture of amateur radio abroad. First of all, let me attempt to answer the question dearest to the heart of the reader, namely, "What does it sound like?" The best way to answer is to say that when W stations come through, it sounds exactly as it does back in Old W3, except that the near districts predominate and that the average signal strength is perhaps one point on the R scale weaker. 'Phone stations from the U.S.A. roar through on a two-tube receiver with signal strength reports of the order that they give to their correspondents a few hundred miles away, a subject which is a sore one abroad. (C.w. men, you are far from innocent, too.) One remarkable thing I noticed was that the "halo" effect removed all trace of modulation on the signals of W6's, who are so particular to make their signals a bit rough. In fact, one well known W6 who modulates very heavily is said to have the most p.d.c. note of all. During much of the time the 7-mc. band is crowded by "Spitch," 'phone of the worst quality emitting from over-modulated, self-excited transmitters on the Continent, which make the band nearly useless for DX. Contrary to opinion held in the U.S.A., Asiatic signals are rare except for a few times during the year, and I heard only two or three. During the winter American medium-wave b.c. stations come in frequently.

Next it might be pertinent to make a few remarks on the R.S.G.B. The Society in many ways resembles the A.R.R.L., though its backbone is experimental work and not traffic handling, which in general is not permitted over there. One of its most important activities is the Research and Experimental Bureau, the analogue of the A.R.R.L. Communications Department, in which members are divided into groups to work on technical problems. Whereas local clubs are recently becoming popular in England, there is not as great incentive to forming them, for regular monthly local meetings of the R.S.G.B. are held throughout the country under the direction of local officers corresponding to our S.C.M.'s. As headquarters society of the British Empire Radio Union, the R.S.G.B. has done much to make legislation favorable for the amateur throughout the Empire. Also it conducts the annual B.E.R.U. Contest, which is a most popular event for ama-

teurs in the Empire. As the membership is much smaller, about 2000, the headquarters staff consists of only Mr. Clarricoats, G6CL, as secretary and two or three girls; but being very efficient, it has done much to further the interests of the Society. Much of the work, in getting out the

"T & R Bulletin" must be done by volunteers, both in editing and in writing technical articles. Though the standard of the latter is high, it is, as admitted by the G's themselves, inferior to that of *QST*. However, the magazine contains many items of news from all over the Empire and displays a fine spirit which makes it of great interest to American readers. Much of the news and some of the technical articles, even with circuit diagrams included, are transmitted to London from far parts of the Empire through the efficient Empire Link System, composed of outstanding stations, which are directed by my friend G6WY.



LEFT, BARON BONAERT DE LA ROCHE, ON4HM; RIGHT, PAUL DE NECK, ON4UU, PRESIDENT OF THE RESEAU BELGE

However, the most popular feature with American readers is the "Soliloquies From the Shack," in which the anonymous Uncle Tom pokes fun at everybody with a very slight aroma of our T.O.M. and at the same time reflects the spirit of British amateur radio.

I found that American amateurs and the A.R.R.L. are considered in the highest regard, and DX operators enjoy chewing the rag with "Yanks." Nevertheless, they are a bit annoyed at unwanted answers from W stations on directional CQ and Test calls. Furthermore, G amateurs wish me to convey their request not to be placed in embarrassing situations by having illegal traffic offered to them. ZS2F seemed to wonder that we can do anything at all with two-tube receivers in our QRM, when W stations crowd the dial on his. He also said that the ZS amateurs regretted the time of the A.R.R.L. International Contests, as the "wipeout" from March to September, during which most DX on all bands disappears, is just commencing. European amateurs work so many W stations, sometimes 50 a day, that they have a very difficult time remembering individual stations. All envy us for having excellent parts available at low prices. Whereas many American-made superheterodynes are in use abroad, some of the British, being experimenters at heart, look down upon the use of commercially-built receivers and transmitters as a moral suicide.

During the meetings much of the informal conversation centered on the laws in our respective countries. On the Continent most amateurs are permitted the use of up to 50 watts input. In

(Continued on page 88)

# A.R.R.L.'s Eighth International DX Competition

March 14th<sup>1</sup>—22nd

All the World with W/VE—Advance Entry not Required—Swap 6-Figure Groups (RST<sup>2</sup> Report + Self-Assigned Serial Nr.) in DX QSOs—Total Time Limit Retained—New Quota Plan for W-VE's Makes for Reduced QRM and "More Countries" in Each Score—Points from DX Contacts to be Multiplied by number of W-and-VE Districts Represented or Countries (Prefixes) to give Total—Multiplier Also Increased by Working These Districts or Countries on Additional Bands (Replaces Bonus)—Certificates for Winners

By F. E. Handy\*

**A**MATEURS everywhere look forward to A.R.R.L.'s annual DX Contest, open to any ham anywhere regardless of local affiliations, the North American "open season" on DX, with awards to the leader in every country (prefix) as well as in each Section in the League's Field Organization. The rules have been revised in line with the majority expression of desires but where opinions conflicted the injunction of several good amateurs, "This is our biggest event in ham radio; let's not spoil it by radical changes," has been kept in mind. The new way of crediting work on *different bands*, the combining of reports with serial numbers to save time and insure complete reports, and the "quota" idea (for W/VE operators only) are the main features old timers familiar with the DX-swap plan will want to review. The "quota" of 3-stations-per-country for W/VEs is designed to give more time to look for new countries and reduce the QRM level so DX work will be easier when stations are logged. Results will show the general DX capabilities of stations better. Letters express confidence that the quota will also put a jinx on band-edge operation, spread DX contacts to east and west alike and have other advantages. Since U. S. A. stations are in the ratio of 3 or 4 to each foreign station, participants at a distance need have no fears in regard to a scarcity of contacts. Here's DX opportunity . . . *try your luck and report, one and all.*

Don't pass up either the eighty- or ten-meter bands this year! 28 mc., as we write this, is duplicating regularly the characteristics of the 14-mc. band, new WAC's being reported right and left. The 3.5-mc. tests in December were highly successful; fine lists of transocean-stations heard and worked are still coming in. To forget 28-, 3.5- and 1.7-mc. bands will be to give your DX competitor

the edge on building up the all-important multiplier.

Operating points, personal efficiency, and the "man behind the station" (most of all) count! Letters from abroad deplore the "dumbness" of W/VE hams who "CQ DX." Why waste time answering such when one such call from "outside" will bring hundreds of answers from more efficient operators (they reason)! VK3ML says he could have worked twice as many stations in the last DX tests if more of our stations would work BREAK-IN. He and CT2BK urge more speed, the latter urging W/VE's to shoot the number along first before *anything* else. More of his contacts were lost by "Txn FB OM" remarks, he says, than by anything else. U. S. and Canadian amateurs approve continued use of CQ by all stations in *remote* localities but plead that these CQs be made shorter—when a flock of U. S. A.-Canadian stations are so eagerly competing for each one! Everybody agrees that CQ DX is "out" for W/VEs and ought to disqualify 'em. Remotely located participants: Please *sign often* in CQ's or calls. Use QHM, QML, QLM, QMH<sup>3</sup> liberally, or give a listening frequency as a guide of when or how long to call!

#### GENERAL PLAN OF CONTEST

Amateurs with the prefixes W and VE will be taking part in a QSO Party with stations in all parts of the world. When they effect DX QSOs, self-assigned serial numbers (three figure report plus three self-assigned numbers that will be sent all stations) will be exchanged and noted in the contest report. From this record each station will submit its score. From the scores (which the Contest Committee will verify by cross-examination

\* Communications Manager, A.R.R.L.

<sup>1</sup> 6:01 p.m., C.S.T., March 13th, see discussion under "the contest period."

<sup>2</sup> For R-S-T definitions of "readability, strength and tone" in that order: See 1936 A.R.R.L. Handbook, page 323, October 1935 QST page 106, or drop postal for list. Scales correspond to W-R-T of European systems approximately.

<sup>3</sup> QHM—Will start to listen at *high* frequency end of band and tune towards *middle* of band.

QMH—Will start to listen in the *middle* of the band and tune toward the *high* freq. end.

QLM—Will start to listen at the *low* frequency end of band and tune towards *middle* of band.

QML—Will start to listen in the *middle* of the band and tune toward the *low* frequency end.

Time	Starts	Ends
Greenwich	March 14th 0001 (12:01 a.m.)	March 22nd 2359 (11:59 p.m.)
A.S.T.	13th 8:01 p.m.	22nd 7:59 p.m.
E.S.T.	13th 7:01 p.m.	22nd 6:59 p.m.
C.S.T.	13th 6:01 p.m.	22nd 5:59 p.m.
M.S.T.	13th 5:01 p.m.	22nd 4:59 p.m.
P.S.T.	13th 4:01 p.m.	22nd 3:59 p.m.

of logs) the winners will be determined for each locality, and certificates awarded. Three points can result from a full exchange in any band, but no more can be obtained from the same station unless both stations connect in another band for additional exchanges.

Stations outside\* the U. S. and Canada will try to work as many W and VE stations as possible to exchange serial numbers. Stations in all localities need only take part on the dates announced and report results at the end of the tests to receive credit in *QST*, and be eligible for awards.

The main competition each operator must consider comes from operators in his immediate A.R.R.L. Section in the case of W and VE stations,† and in the case of all other amateurs it comes from the individual operators in their country or locality using the same prefix.‡ The W/VE awards are for the operator running up the best record for each Section under the Rules.

#### THE CONTEST PERIOD

To avoid misunderstanding and possible confusion the exact local starting and ending time for our DX competition is given in the above table. These times are based on "Greenwich" and should be computed for any part of the world from the Greenwich meridian. The contest runs from Saturday, March 14th, through Sunday, March 22nd (until Monday, March 23rd, G.T.).

#### SERIAL NUMBERS

The first three digits of the serial number sent shall constitute the Readability—Strength and Tone reports of the station to which the number is sent. Every operator taking part in the contest assigns himself a distinctive three-numeral group, used by him *throughout the contest* as the last part of each number exchanged (sent). All numbers exchanged are SIX figure groups. Try to *send* and *receive* one complete serial number with each DX station.

\* Alaska, Hawaii, Philippine Islands, Cuba, Porto Rico, and Newfoundland, in fact, all localities using PREFIXES other than W or VE will receive *QST* mention and awards based on their work with W/VE stations.

† Page 5 of this *QST* carries a complete list of the Sections of the A.R.R.L. Field Organization.

‡ Consult the list of call-prefixes for different countries of the world as given in the 1936 Edition of *The Radio Amateur's Handbook*, or 1936 Edition of *Operating an Amateur Station* booklet, latter sent on postal card request.

#### TIME LIMIT

Up to and including 90 hours' total contest operation there is no penalty, and nothing to do when computing your score. Should you find that you operated a total of 100 hours (for example), your gross score should be multiplied by the fraction  $\frac{90}{100}$  to give your net or "corrected score."

You can operate 6 hours per day, 12 hours each Saturday, and 16 hours each Sunday, working DX in the contest, and come out about right. This plan permits the average ham to plan for his working day, for meals, for 8 hours' daily sleep, etc. Cross examination of logs makes it possible to check the operating time submitted as may be necessary, of course. The time limit puts contestants on a fair basis whether employed or having full time to apply to the contest.

Operate as much as you want to during the contest period. Keep track of the time you start and stop operating your station. This must be shown in your log report. In counting up your total contest time, please be fair and honest. We know you will. What constitutes "contest operating hours"? Not hours spent keeping local skeds with each other within the U. S. A. and Canada. Not the time spent in local rag chews, swapping DX results, scores, and other dope. If you listen for DX with the ability to call DX stations if, as, and

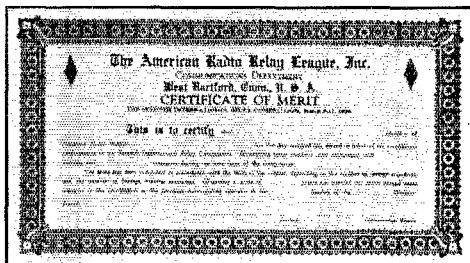

TYPICAL AWARD TO WINNERS

when, you hear them, that time counts, whether you do any calling or working or not. The whole period is to be charged against "contest operating time," and not just the time after you started transmitting.

#### AWARDS

Certificates, handsomely lithographed and imprinted will be awarded: (1) one in each remotely located country or territory—all hams using the same prefix compete for an award, and (2) in each of 64 A.R.R.L. Sections, mainland U. S. A. and Canada (see page 5, *QST*).

All operators using the same prefix † will be in competition with each other—and similarly each A.R.R.L. section-boundary circumscribes a competing group. DX-trans-

† Prefixes are used as the best rule-of-thumb method yet devised to distinguish between countries quickly. See pages 28 and 29 September 1935 *QST* for tabulation of the last DX Contest results showing classifications of prefixes and geographical-political distinctions observed.

mission characteristics being the same for all operators in each award-area, the chances of being a winner depend on operating ability and stations and are equally fair to all.

**AFFILIATED CLUB PARTICIPATION**

To encourage local participation, additional certificate awards (besides the A.R.R.L. Section awards) will be made

through each club where *three or more* individual club members, or new local hams invited by such a club, take part. Reports must be made direct to A.R.R.L., West Hartford, mentioning the name of the club, to be eligible for the affiliated-club-award. Entrants who mention their club will be eligible for both club and Section certificate awards.

**LOG, EIGHTH A.R.R.L. INTERNATIONAL RELAY COMPETITION (Example, W5XYZ, Serial No. 543)**

		Bands:					
		1.7	3.5	7	14	28 mc.	Total
Call Signal.....	Logs from W or VE, show, for each band:						
Name.....							
Address.....	Nr. DX Stations QSOed		3	4	1	1	9
Transmitter Tubes.....	Nr. Countries (prefixes) QSOed		2	3	1	1	7
Plate watts (input last stage).....	Logs from remote points indicate; for each band:						
Nr. Hours Station Operation <sup>1</sup> (14 h. 29 m.)	Nr. W/VE stations QSOed						
A.R.R.L. Section (for W/VE's).....	Nr. U. S. A.—Canada licensing areas worked						

Station Time Record	Operating Time	Date and Time	Station Worked	Country	Worked Record of New Countries <sup>2</sup> for Each. Freq. Band					Serial Nrs.		Points
					1.7	3.5	7	14	28	Sent	Received	
On 7:01 p.m.		Mar. 13th 7:02 p.m. E.S.T. (or 0002 G.T.)	G6RB	G. B.		1				568,543	478,001	3
		Mar. 14th 7:15 p.m. E.S.T.	G2SZ	G. B.		1*					578,988	2
Off 10 p.m.	2 h. 59	9:40 p.m. E.S.T.	ON4AU	Belgium		2				488,543	488,111	3
On 7 p.m.		Mar. 14th 7:38 p.m.	VK3WL	Aust.			1			579,543	579,287	3
		8:50 p.m.	ZL2CI	N. Z.			2			487,543	398,657	3
Off 11:55 p.m.	4 h. 55	11:50 p.m.	J2GX	Japan				1		349,543	588,984	3
On 12:00		Mar. 17th 12:05 a.m. E.S.T.	VK7RC	Aust.			2*			586,543	577,000	3
Off 4:05 a.m.	4 h. 05	3:10 a.m. E.S.T.	VK5PK	Aust.					1	499,543		1
On 1:30 p.m.		2 p.m. E.S.T.	PY2BN	Brazil						487,543	468,852	3
Off 4 p.m.	2 h. 30											

14 h. 29

Multiplier = 2 + 3 + 1 + 1

24 X 7 (countries—prefixes) = 168 Score

"Points" multiplied by the number of

1) Countries or localities (prefixes) for all bands

OR

2) U. S. and Canadian licensing areas for all bands equals the SCORE . . . . . (This is the final score unless the operating time exceeds 90 hours).

I hereby state that in this contest, to the best of my knowledge and belief, I have not operated my transmitter outside any of the frequency bands specified in, or in any manner contrary to, the regulations my country has established for amateur radio stations; also that the scoring points and facts as set forth in the above log and summary of my contest work are correct and true.

Signature of operator(s)

<sup>1</sup> Add second column in log to give total operating time.

<sup>2</sup> "Countries" for W/VE Participants. Change this to read "Districts" or "Licensing Areas" on all reports from other parts of the World.

<sup>3</sup> A progressive record of the number of new countries (or licensing areas) is kept in these columns. A notation is made for each station worked but the figure increases numerically only as additional prefixes (or lic. areas) are added on a certain band. These columns are not added, but the last number notation in each column added to similar numbers in other columns gives the "multiplier." Counting the "number of notations" in each of these columns gives the number of different contacts with "DX stations" or "W/VE stations" on each band, as the case may be, so the information at the beginning of the log-record may be filled in.

## RULES

1. All contest work must take place in the contest period.  
2. Reports must show each time of starting and stopping station operation in the log submitted to A.R.R.L., and if the total time of station operation exceeds 90 hours the proper factor must be applied to the gross score as shown under "time limit."

3. Logs must include date, time of QSO, call of station worked, serial numbers exchanged and other information required tabulated neatly with the claimed score. (See the log examples for required data.)

4. Scoring: Both the W/VE station, and the station in the remote locality receive one point when the W or VE serial number is acknowledged by the station in the remote locality. Each operator, similarly, may add two points further when a six-figure number (to U. S. A./Canada) is acknowledged by a W/VE station.

(a) For W/VE entries. In computing points, each "received" serial number group counts 2. Each serial "sent" and properly QSL-ed counts 1.

(b) For entries from stations using any prefixes other than W or VE. In computing points, each 6-figure number "received" counts 1 point, and each number "sent" (with proper acknowledgment) counts 2 points.

### W/VEs:

5. Quota of three stations per country (prefix) may be worked in each different band and is the limit to count points toward the score, except that if one way exchanges with some of these three have been made, more stations can be worked to give not more than 9 points (basic) per country. This quota shall be permitted in each different band.

6. Multiplier shall consist of the number of countries (prefixes) worked on one band plus those worked on a second band, plus those worked on a third band, etc.

### All Others:

7. No quota limit on stations.

8. Scoring points shall be multiplied (for total) by the number of U. S. A. and Canadian licensing areas contacted (a possible 14). The multiplier is also increased further by working the same areas on additional frequency bands. (Example: All districts are worked on two bands, possible multiplier is 28; 10, 8, 6, and 5 lic. areas are worked on four bands. The sum, 29 licensing areas, is the multiplier to use to get the gross score.)

9. All entrants agree to be bound by the Rules and Contest Announcement. In a contest of this magnitude, no correspondence can be entered into regarding Award Committee Decisions.

10. The highest scoring individual operators score is the official score for all awards. Other operator scores must also be submitted if more than one operator worked a station, and the station score (all points by all countries) stated for purposes of comparison.

11. More than one receiver and receiving operator in use at one time to log available DX is not permissible and shall be grounds for disqualification.

12. The same station can be worked in more than one band, provided the quota of three (per country, per band) is not exceeded.

13. Cross band work does not count in this contest.

14. Reports and logs from participating stations must be received at A.R.R.L. Hdq. from all W/VE stations on or before noon April 23, 1935, to be considered for awards. From all outlying localities, reports must be received on or before May 28, 1935. Play safe . . . mail your report immediately at the end of the contest period to avoid delay and insure that your results are credited in QST. Show your claimed score in full, following a tabulation of points in the log-form indicated with this announcement.

15. The entries received after the competition will be passed upon by an A.R.R.L. Award Committee whose decision will be final in all cases.

## WARNING!

Good notes, not ragged ones are advisable. The F.C.C. monitoring station personnel are well acquainted with the dates of our DX contest, and will be on the job as usual to mail a bunch of those discrepancy reports. You don't want to be a recipient of one of those colored slips for a bum note or a parasitic—better lose out in some operating hours rather than jeopardize your amateur license. Let's make it a contest with *no prehistoric signals*. At any rate, don't let your station come in for F.C.C. trouble!

All competitors are requested to submit their lists, even if they only show a small score. In so doing they are supporting claims made in logs from other stations, and they will receive full credit for their work in QST.

## Noise-Silencing I.F. Circuit

(Continued from page 14)

The amplifier is also disabled correspondingly for the desired signal, of course, but the time is so short that no audible gap is discernible. For instance, with spark pulses occurring 120 times per second and each pulse lasting as long as one-thousandth second, only every 120th cycle is lost at a signal modulation frequency of 1000 cycles per second. This requires a small time constant and freedom from instability in silencing action, demanding not only proper circuit constants but also tubes of suitable characteristics.

### TUBES AND CIRCUIT FEATURES

In earlier experiments with the silencer circuit before the metal type tubes indicated in the diagrams were introduced, various combinations of glass types were used. One combination was a 6B7 pentode-diode in the noise amplifier-rectifier section and a 6A7 pentagrid as the i.f. silencer-amplifier, the rectified noise voltage being applied to the No. 1 grid of the latter. Fair success was obtained with this combination, but not without a tendency to instability and reduced gain in the 6A7 as an intermediate amplifier. Apparently there was considerable internal capacitive coupling between the pentode and diode sections of the 6B7, allowing more fundamental r.f. to reach the diode load circuit than was desirable. As a further complication, considerable i.f. coupling through the 6A7 was evident even when the No. 1 grid was biased sufficiently negative to cut off the plate current. Both of these factors handicapped the silencing action, although the results obtained showed the principle to be sound.

With the newer types made available in the metal tube line, these problems were solved. The 6H6 duo-diode permitted separation of the functions of noise amplifier and rectifier in different envelopes and, more important, the 6L7 was ideally adapted to use as the i.f. silencer-amplifier. With this tube, full normal amplifier gain is obtained, its No. 1 grid's variable- $\mu$  characteristic permits conventional automatic and manual

(Continued on page 90)



# A Ten-Meter Converter

For Band-Switching Superhets Without 28-mc. Coverage

By George Grammer, Asst. Technical Editor

**T**HE rush to ten meters has left behind a good many fellows who want badly enough to be in the swim, but unfortunately are anchored to the lower frequencies because of a band-switching receiver which has no provision for operating above 20 mc. or so. However, there's a way out. It's not so difficult to build a gadget which, used in conjunction with the regular receiver, will bring in ten-meter signals in good shape.

Such a converter unit is pictured herewith. With suitable modification it can be used with practically any type of receiver capable of tuning in the vicinity of 3500 kc., and it is neither difficult nor expensive to build.

The thought of converting 28-mc. signals into a lower frequency to which the regular receiver can be tuned is very attractive, but there are some difficulties which have to be conquered if the thing is to be at all practical. We originally had the notion to revive the old stunt of using a fixed oscillator and a variable i.f., thus making use of the tuning dial and band-spreading properties of the regular receiver. It did not, however, work out in actual practice. For one thing with the receiver covering the range, for instance, between 3500 and 5500 kc. (to give the 2000-kc. spread necessary to cover 28 to 30 mc.) it was almost impossible to keep out signals from stations actually operating in that band of frequencies. Although with reasonable shielding these signals were not loud, their mere presence was enough to cause the idea to be discarded, since it is annoying, to say the least, to find 80-meter and 10-meter signals mixed together. The variable-i.f. arrangement, too, made an untuned output coupling necessary from the converter tube, since with a tuned output tank the signal strength fell

off rapidly when the receiver was tuned a few score kilocycles off the frequency to which the tank was set. In experimenting with the two types of coupling it was also found that the untuned arrangement resulted in an excessive number of "birdies" from harmonics of the oscillator of some receivers, while with the tuned coupling only the normal oscillator harmonics could be heard.

The circuit arrangement finally adopted calls for tuning of the high-frequency oscillator in the converter circuit. To get decent band spread and still have enough tank capacity in the circuit to give good stability, a low-capacity condenser is used for tuning and an air padder for setting the band. A similar air padder is used to tune the converter input circuit. The output circuit of the converter is designed to work on a frequency slightly lower than 3500 kc. This particular frequency was chosen for a number of reasons, among them being the facts that it is usually possible to pick a clear spot in this region; that the gain of most manufactured receivers is quite high around this frequency; that image response will be low, since image signals are 7000 kc. away from the desired 28-mc. signal; and that "birdies" or receiver oscillator harmonics can be spaced so that they do not interfere in the 28-mc. band.

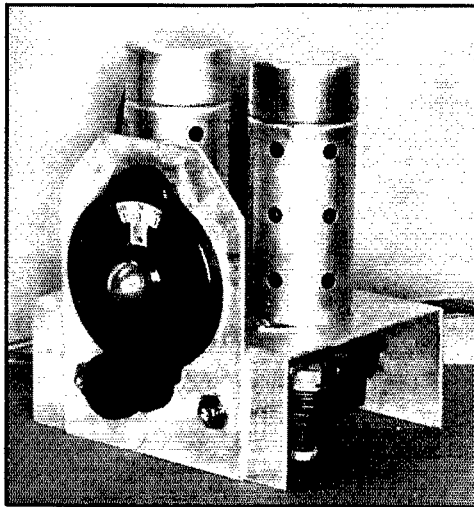

**THIS INEXPENSIVE UNIT WILL CONVERT ANY SUPER TO 28-MC. OPERATION**

*Essentially single control, with non-critical controls screwdriver adjusted. The circuit employs a 56 or 76 oscillator and 2A7 or 6A7 mixer.*

## CIRCUIT AND CONSTRUCTION

The oscillator tube may be either a 56 or 75, depending upon the heater voltage available, and is operated with grounded plate and cathode tap on the tank coil. Its grid is directly coupled to the inner grid of the con-

verter tube, a 2A7 or 6A7. This system gives good sensitivity and avoids the necessity for any special coupling arrangement between oscillator and converter. The circuit, given in Fig. 1, is perfectly straightforward.

The whole unit is mounted on an aluminum chassis measuring 5 inches wide by 4 inches deep by 2 inches high. The oscillator tuning condenser with its dial, a National midget Type BM, is mounted on a small aluminum panel which in turn is fastened to the front of the chassis by the mounting nuts holding the padding condensers,  $C_2$  and  $C_3$ . The tuning condenser,  $C_1$ , is a Card-

from the tuned circuit to the grid of the — A7, causes undue loading of the input circuit  $L_1C_2$ . The dropping resistor,  $R_4$ , in the oscillator plate circuit is not essential to the operation; however, it helps to stabilize the oscillator to some extent.

#### RECEIVER INPUT

The success of the unit will depend largely on the effectiveness of the coupling between the output circuit,  $L_4C_4$ , and the antenna input circuit of the receiver. Before trying to put the converter to work, look up the diagram of the receiver to be used and check the method of coupling to the antenna. Some sets have small antenna coupling coils, some have large; some, in fact, use capacity coupling to the antenna. If inductive coupling is used, the turns on  $L_5$  should be proportioned to those on  $L_4$  in the same ratio that the receiver antenna coil is proportioned to the first tuned circuit inductance. The specifications given in Fig. 1 will be satisfactory for receivers having low-impedance input circuits.

If the receiver is capacity-coupled to the antenna,  $L_5$  should be omitted and the plate of the — A7 coupled to the antenna post on the receiver through a low-capacity variable condenser, indicated by the dotted lines on the diagram. The receiver and converter grounds should be tied together in all cases. After the unit is in operation it may pay to try different sizes of coupling coil to get best signal transfer; with the capacity-coupled system the coupling is readily adjustable through varying  $C_{11}$ . The leads between converter and receiver should be as short

as circumstances will permit.

#### TUNING UP

No doubt the greatest problem in getting the converter into operation is that of finding the 28-mc. band. Since "ten" is not nearly so well populated as the lower-frequency bands, it does not pay to depend wholly on received signals for finding the band except perhaps in the daytime on week-ends. A low-power oscillator on 28 mc. will be invaluable provided its frequency is set accurately enough.

At any rate, the best way to work is from the receiver out to the antenna. With the converter coupled to the antenna input on the receiver and heater and plate voltages applied, set the receiver on some vacant spot outside the low-frequency end of the 3500-kc. band and tune  $C_4$  for maximum noise. There should be a marked increase in background as  $C_4L_4$  comes into resonance with the receiver; if there is not, there is no use trying

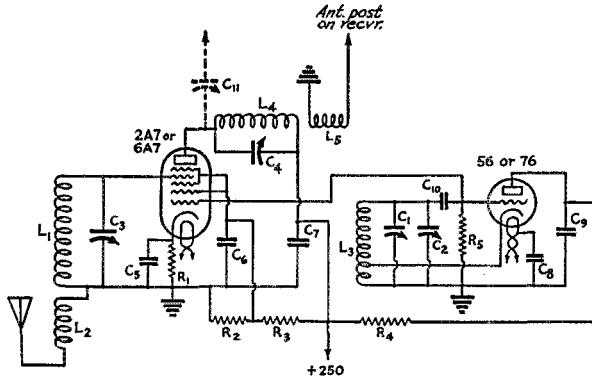

FIG. 1.—CIRCUIT DIAGRAM OF THE TEN-METER CONVERTER

- $C_1$ —Oscillator tuning condenser, 5  $\mu$ fd. (Cardwell ZV-5-TS).
- $C_2$ —Oscillator padding condenser, 15  $\mu$ fd. (Cardwell ZR-15-AS).
- $C_3$ —Detector padding condenser, same as  $C_2$ .
- $C_4$ —Mica padding condenser, 70  $\mu$ fd. (Hammarlund BBT-70).
- $C_5, C_6, C_7$ —0.002  $\mu$ fd.
- $C_8$ —100  $\mu$ fd.
- $C_9$ —0.001  $\mu$ fd.
- $C_{10}$ —100- $\mu$ fd.
- $C_{11}$ —Approx. 50  $\mu$ fd., variable (see text).
- $R_1$ —300 ohms,  $\frac{1}{2}$  watt.
- $R_2, R_3$ —50,000 ohms, 1 watt.
- $R_4$ —10,000-ohms, 2-watt.
- $R_5$ —50,000 ohms,  $\frac{1}{2}$  watt.
- $L_1$ —15 turns No. 18 enamelled wire, close wound on half-inch form.
- $L_2$ —9 turns same as  $L_1$ ,  $\frac{1}{4}$  inch from  $L_1$ .
- $L_3$ —15 turns No. 18 enamelled wire, on half inch form, spaced to occupy length of 1 inch, tapped at 5th turn from ground end.
- $L_4$ —No. 30 enamelled wire, close wound to length of  $\frac{1}{4}$  inch on half-inch form.
- $L_5$ —Same as  $L_4$  but  $\frac{1}{2}$  inch long, spaced  $\frac{1}{2}$  inch from  $L_4$ .

well of the type number specified under the circuit diagram; the solid stator plate furnished is substituted for the split plate with which the condenser comes assembled. Placement of coils, by-pass condensers and resistors should be evident from inspection of the bottom view; leads should be as short as possible in the r.f. sections. The converter plate tuning condenser, a Hammarlund mica padder, is mounted on the chassis with the adjustment screw projecting through the top. The coil assembly  $L_4L_5$  is supported from  $C_4$  by the terminal lugs and coil connections. Condenser  $C_8$ , connected from one side of the heater wiring to ground, should not be omitted; without it the oscillator note is likely to be a.c., in turn causing modulation of all received signals.

Wiring should not present any difficulties, since the circuit is quite simple. We do not recommend using a shielded lead to the grid of the converter tube, because the capacity of shielded wire, even in the 6 inches or so required to reach

to proceed any farther until the coupling between converter and receiver is fixed up. No noise means poor coupling.

With  $C_4L_4$  at resonance, the next step is finding the 28-mc. band. If the input coil,  $L_1$ , has been made to specifications and  $C_3$  has the specified maximum capacity, a first approximation can be made by setting  $C_2$  slightly below half capacity and then adjusting  $C_2$  ( $C_1$  being set at half scale) for maximum background. Unless you have one of those rare locations where there are no automobiles, it will not be difficult to tell when the oscillator and input circuits are "tracking." In daytime, a careful search of this region, plus small adjustments of both  $C_3$  and  $C_2$ , should bring in some signals signing "ten"; once a few such signals are located it's a simple matter to make a final adjustment on  $C_2$  to bring the low-frequency end of the band near maximum capacity on  $C_1$  scale. With  $C_1$  as specified the full condenser scale will cover a little better than half the 28-mc. band; since practically all ten-meter stations are working between 28,000 and 29,000 kc. this entails no sacrifice and makes tuning easier.

If no signals are available, an alternative method may be used to locate the band approximately. Its practicability depends upon the care with which the oscillator tuned circuit is duplicated, although for that matter the same thing is true of the "hunt" method already described. The second method is based on the presence of harmonics from the receiver oscillator; the "birdies" can be made to serve a useful purpose. First find the intermediate frequency used in the receiver (the instruction sheets should give it) then subtract this figure from 4000; for example, an i.f. of 465 kc. subtracted from 4000 kc. gives 3535 kc. Swing the receiver dial to 3535 kc., set  $C_1$  near maximum capacity, and tune  $C_2$  carefully until the "birdie" is heard. It will be quite loud in most cases. Provided the right oscillator harmonic is picked, the converter will be tuned to 28,000 kc. and the only remaining thing to do is to tune  $C_3$  for maximum background and start hunting for signals (the receiver having been reset outside the 3500-kc. band).  $C_2$  should be at about half capacity if the oscillator tuned circuit is carefully duplicated. If one or two more main "birdies" are heard (discard any that do not measure up in strength to the loudest one heard) it will be necessary to apply this method on a Saturday or Sunday afternoon so each spot can be investigated. Of course if a frequency meter is available the band can be located quite readily by using the

two-harmonic method described in the Experimenters' Section in this issue. The same thing can be done with the receiver alone if it covers the frequencies between the amateur bands. Following out the same example, the next receiver harmonic will come at 4666 minus the i.f. (as-

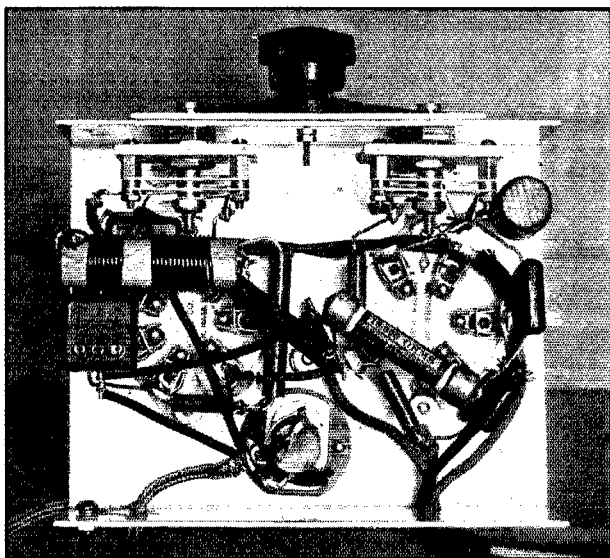

**THIS VIEW SHOWS THE COILS, PADDING CONDENSERS, BY-PASSES AND RESISTORS**

*The three coils should be separated as much as possible. By-pass connections in the r.f. circuits should be short.*

sumed 465 kc.) or 4201 kc. Having located the "birdie" with the receiver set at 3535 kc. it should be possible to swing the receiver to 4201 kc. and bring in another "birdie." If the original point was not 28,000 kc. the second oscillator harmonic will not be heard. Extreme accuracy in setting the receiver is not essential, since the oscillator harmonics in this region are roughly 700 kc. apart and there is little chance of getting the wrong pair.

In using the converter it will be found that the tuning of  $C_3$  is not especially critical and need not be touched when working over the used portion of the band once an "average" setting has been obtained. However, if the need for frequency control is deemed desirable this condenser can be provided with a knob.

Providing care is used in adjusting the coupling between converter and receiver for maximum signal transfer, the gain of the whole rig should be about as good at 28 mc. as that of the receiver itself at 3500 kc. Tuning is not difficult, even with the small dial used on the unit pictured. The receiver tuning dial can be used as a vernier, however, although it should always be kept near one reference setting to avoid changing the calibration of the converter dial.

# How to Read and Use Your QST

## Practical Pointers on Getting the Most From Technical Articles

By Frederic D. Merrill, Jr.\*

*Technical articles are not light fiction, although many of us skip through them as if they were. The following article is based on the writer's experience as an instructor in amateur radio at the Lynn, Mass., Y.M.C.A., where he had a class of adult students. He found that the majority had no conception of how to get the most from technical reading nor did they know how to enjoy amateur radio on a thin pocket book. The old timer can pick up pointers on how to get the most from technical articles, too.—EDITOR.*

IT IS the purpose of this article to give concrete suggestions on how to heed the often repeated advice, "read your QST," since the author believes that very few hams have any idea on how to apply themselves to absorb the excellent material published from time to time. While one's primary interest in amateur radio may rest in relaying of messages or social conversation with unseen friends, there is much basis for saying that a strong technical background in amateur radio is very advantageous. This brings us to the very frank question of how to study the articles in order to learn the most in the shortest time. Since there are very few of us who possess photographic memories capable of retaining in one exposure to the mind the entire contents of new material, a kind of mechanical predigestion for the brain is often very helpful. Most of the suggestions that follow are based on this idea and are well known to psychologists.

First of all, your QST should be regarded as a kind of work book, to be written in. A clean copy in your possession indicates no reaction on your part to the articles you have read. For example, if you read parts you can't understand, label that section in the margin, "too deep." In the developing idea, follow the subject line by line as far as possible and when there is a step you cannot grasp place in the margin a penciled question mark. In a second reading this perplexing point may become clearer so that you can erase the question mark. You may find some statements (such as typographical errors) which are very evidently wrong and which you can label "I doubt it," or pencil some X's in the margin. If the author makes a misstatement, endeavor to write briefly the authority for your opposite point of view, which may be your previous experience, another article, or a fallacy in the author's reasoning.

An additional excellent way to mark your QST is to get out red crayon and underline what you consider are the basic facts which you should retain for future use. These underlined sections do not necessarily constitute the most important parts of the article but rather what strikes you

most forcibly—perhaps the answer to a puzzling problem you have been struggling with for some time in connection with your apparatus, or perhaps a choice section that corrects an erroneous idea you have held. If these underlined sections are read over several times, a week or so apart, you will find this material sticking in your memory surprisingly well. The conclusion from this is to use your magazine as a work book to record tangible evidence of your reactions during the reading.

### WHAT IS IMPORTANT?

The second method for retaining facts that you believe to be of importance is the "question method." Perhaps at this point it would be well to digress a little to consider what might be meant by the term "important." Technical subjects constitute a grand mixture of terms, definitions, laws, assumptions, examples, etc. Amongst all this there is a lot of fill-in; that is, material used to illustrate a point which is being made. The familiar example of the circular ripples caused by a pebble thrown into the still surface of water to illustrate how radio waves spread out is an example of fill-in material inserted to illustrate a principle. Obviously, the important part here would be the statement of the principle and not the example.

When we are learning a new law for the first time, a very minor case which does not follow the general law should at least temporarily be pushed in the background and our attention first concentrated on the law itself. This point is emphasized because the general law applies to innumerable cases while the exception applies to only a few cases, at least in the particular field at the moment. The simple statement of Ohm's law works nicely for direct current circuits but when we get to electric discharges in gases we have to expand the original ideas. Minor details thus rarely constitute the important part of an article. A new term or definition is very important, for we cannot understand the technical language if the words don't make sense.

An assumption is what you accept as being true

\* 30 Marion Ave., Millburn, N. J.

without endeavoring to prove the truthfulness. There is no general rule for knowing when an assumption can or cannot be accepted. Certainly none of us would accept the assumption that because a certain tube oscillates satisfactorily at 500 meters it will do the same at five meters! Experience and study are necessary to know when you can assume things; and, after all is said and done, even the experts make terrific errors, as witnessed by the positive belief that short waves were valueless because, *assuming* the same propagation laws for short waves as for long waves, very great attenuation would be expected.

#### THE QUESTION METHOD

Perhaps we have said enough about what constitutes the important material to allow us to get back again to the second method of studying—the question method. Keeping in mind that the general object is to develop a well rounded-out knowledge of the technical side of amateur radio, we can pick out the important material and then write our pertinent questions on paper to draw out from us the material we expect to assimilate. For this purpose, it is well to have an inexpensive loose-leaf notebook with three rings for taking the 8½-by 11-inch lined paper which is the standard size. We might write only on one side of the paper, saving the reverse side so that the material on several sheets may be taken out and placed side by side in case a comparison is ever necessary. The notebook plus paper can certainly be bought for 30¢, with the advantage that new sheets may be inserted anywhere at will.

At the top of the sheet we can place the title to questions, possibly the magazine name, month, year, volume number, etc., the article being indicated by a page number. Each question is numbered and at the end of the question is placed the page number (and paragraph if desired) where the answer can be found. The page number is very desirable, for it furnishes us with ready means to locate the correct answer to check with what we give. Here is an example of such questions which might easily fit in with the study of radio principles:

What is a kilocycle? Is this the full statement of the term or do we mean kilocycles/second in reality? How do we convert kilocycles to wavelength in meters? What is a Marconi antenna? What is a Hertz antenna?

Of course, after each question the place where the answer can be found should be given. The A.R.R.L. *License Manual* illustrates a catechism for studying by the question and answer method, where the answer is given with the question. One way in which to study the material in this scheme is to consider that five consecutive correct answers on five different days, as shown by lightly penciled numbers 1-2-3-4-5, shows that the material may be left alone for a while. When that whole notebook page has been finished in that manner,

the date the last question was ended may be penciled at the top as, "OK June 30, 1935". That information shows the last time you went over that page, when you are wondering about review—which is a very essential part of the learning process. So much for the question method of studying.

#### METHOD OF BRIEFS

The third suggestion for mental pre-digestion is popularly called "the method of briefs". It consists in paring down a long article into fewer words, and at the same time trying to keep the most important facts. This is very difficult to do; for in the ultimate boiling, when we get down to a few drops, we have had to throw away a lot of lesser important material to keep within the small number of prescribed words we are allowed to use. Suppose that we had to prepare briefs of 500, 200 and 50 words on a one-thousand word article. Each time we cut down on the number of words we must choose what is the lesser important material to be thrown away. If we did our work correctly, then everything found in the fifty-word brief would also appear in the other two briefs. Some statements in the 500-word brief would not be found in the 200-word brief, though. When you can make good briefs quickly it shows your ability to evaluate the importance of the different facts.

#### PARAPHRASING

The fourth study suggestion is aimed at overcoming our personal idiosyncrasy—and not many of us are excluded from this group—to understand statements better when they are expressed in our own words. This is popularly termed "paraphrasing". Often we cannot understand or assimilate the material until we make ourselves the author of it by explaining it in our own way. As a matter of fact, nearly any statement can be expressed in several different ways. By a stretch of the imagination we can say that, " $I$  equals  $E$  over  $R$ ,  $E$  equals  $RI$ , or  $R$  equals  $E$  over  $I$ "—three different ways for expressing the same thing—paraphrases, if you like. We need not necessarily carry out this scheme in writing but only mentally or orally to a fellow student.

#### THE COMPARISON METHOD

Sometimes we find that facts learned at different times are enough alike to be constantly confused when the occasion arises for the use of either one. Two tubes, perhaps, are just alike in all respects except their filament voltage. The only way in which we can remember the distinction (if we consider it desirable) is to place the two facts side by side and constantly review or learn them together. If the two facts are separated very far they are bound to be mixed up. This bringing close together might be called the "comparison

(Continued on page 84)

# A Detector Circuit for Reducing Noise Interference in 'Phone Reception

By Leland E. Thompson\*

**M**AN-MADE" static is probably even more objectionable in 'phone reception than in c.w. telegraph reception. For intelligibility, the noise interference voltage must be lower with respect to the signal than is necessary in c.w. reception. While it is possible to reduce this type of interference by locating the antenna as far as possible from the source of the interference and using a balanced transmission line to feed the receiver, it is often impracticable, if not impossible, to locate the antenna far enough away to be entirely satisfactory.

In a previous article<sup>1</sup> the action of a voltage limiting detector circuit for c.w. reception was described. This circuit, when applied to 'phone reception, was found to work quite well on some types of noise interference. In particular, auto ignition interference on the 14-mc. 'phone band was reduced to the point where it was negligible on any signal above the receiver tube noise. Tube noise, it should be mentioned, is not reduced by this circuit.

Further experiment showed that almost all sources of noise interference found on 14 mc. and at higher frequencies can be reduced considerably. On the one occasion when natural static was found to be strong enough to cause real interference to phone signals on the 14-mc. band, the use of the circuit described here reduced it to the point where it was not in the least objectionable. On the lower-frequency bands the noise interference encountered was not reduced so effectively unless it was so severe as to cover up the signal entirely; and then it was reduced enough to restore the communication value of the signal although it was still objectionable.

Apparently, on the higher frequencies the noise voltage is composed of trains of oscillations of very short duration and very high peak amplitude, while on the lower frequencies the peak amplitude is lower and the duration greater. This is of the greatest importance to the amateur on the 14-mc. 'phone band. Obviously, no improvement is going to be obtained by use of a limiting circuit unless the peak noise voltage is above the signal. Experiments have shown that noise of a peak voltage equal to the signal amplitude does not interfere seriously with reception of a 14-mc. 'phone signal. Therefore, if the noise voltage is strong enough to interfere with the signal, the

peak amplitude of this noise voltage is above the signal amplitude.

The opposite effect from a limiting circuit is obtained in the ordinary "square law" detector. That is, if the noise peak voltage is 5 times that of the signal on the input of the detector, it is 25 times that of the signal in the output of the detector. Perhaps the majority of short-wave receivers in use by the amateur have just this kind of detector. All detectors have approximately a "square law" characteristic with low values of input voltage. The characteristic of a diode detector becomes straight with inputs above approximately 0.1 volt, while that of the biased triode detector requires an input of about 10 times this value (1 volt).

While remarkable results in noise reduction on high frequencies may be obtained by means of a simple limiting circuit, the circuit described here does somewhat more than limit the noise voltage and is practically as simple. The action of the circuit is to balance out voltages beyond a certain amplitude while not disturbing voltages below this amplitude. Of course the signal is balanced

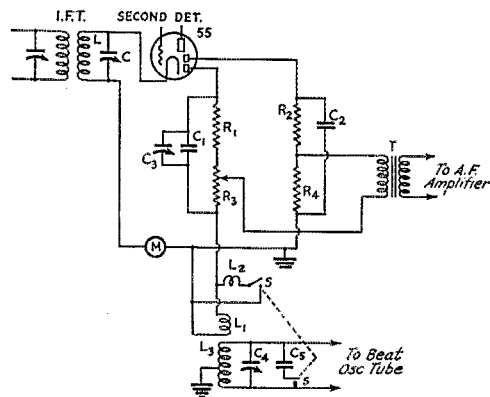

FIG. 1—CIRCUIT OF THE NOISE-REDUCING DETECTOR

- C<sub>1</sub>—150- $\mu$ fd.
- C<sub>2</sub>—200- $\mu$ fd.
- C<sub>3</sub>—70- $\mu$ fd. trimmer.
- R<sub>1</sub>—200,000-ohm.
- R<sub>2</sub>—200,000-ohm.
- R<sub>3</sub>—25,000-ohm potentiometer.
- R<sub>4</sub>—20,000-ohm.
- L<sub>1</sub>—130 turns.
- L<sub>2</sub>—20 turns.
- T—Audio transformer.
- M—Milliammeter (0-1.0 ma.).
- S—C.w. switch.
- L<sub>3</sub>, C<sub>4</sub>, C<sub>5</sub>—Oscillator tuned circuit.
- I.F.T.—I.f. transformer.

\* 740 White Horse Pike, Audubon, N. J.

<sup>1</sup> QST, April 1935, p. 38.

out also during the periods at which the noise voltage rises above this value, but these periods of time are so short on the higher frequencies that the result on the signal itself is negligible.

The circuit used for obtaining this action is shown in Fig. 1. The schematic form of the circuit is exactly the same as the c.w. circuit described in the previous article.<sup>1</sup> The beat oscillator is tuned far enough off the i.f. (20 kc., say) so that no audio beat is heard with the desired 'phone carrier. This voltage, of frequency equal to the difference between the oscillator and the 'phone carrier frequency, is modulated at voice frequencies; but, since it exists only in the output circuit of a "straight line" rectifier, very little rectification takes place and consequently only a comparatively small voltage of audio frequency is present in this diode plate circuit.

The other diode plate circuit functions normally and its rectified voltage is applied to the audio amplifier. If noise interference voltages rise above the oscillator voltage, this oscillator voltage does not change the audio character of the rectified noise voltage. The circuit is "balanced" for these noise voltages and they are not passed on to the audio amplifier. This results from the little recognized phenomenon that in a "straight line" detector on which are applied voltages of various component frequencies and of different amplitudes, the output contains voltages of beat frequencies between each of the smaller amplitude voltages and that of the largest amplitude, and contains little if any voltages of beat frequency between the individual voltages of lower amplitude. Thus, when the noise voltage rises above the oscillator voltage amplitude it acts as this "reference" or "carrier" frequency, and the audio currents in each of the diode plate circuits is exactly the same except for the beat frequency between the noise and the oscillator voltages. The latter is at a super-audible frequency and therefore may be neglected.

#### OPERATION REQUIREMENTS

It is important that the sensitivity of the receiver be adjusted so that the signal carrier amplitude on the detector is below the oscillator amplitude. The ideal condition is obtained when the carrier voltage amplitude is one-half that of the oscillator, so that with 100% modulation of the carrier the peaks do not swing above the oscillator amplitude. Practically, it has been found that signal carrier amplitudes from one-half this value up to 50% greater are permissible. The receiver should have a.v.c. to maintain the signal inside these limits. However, quite satisfactory results were obtained with a manual control using the meter shown in Fig. 1 as an indication of the signal carrier amplitude. Even with a.v.c., the meter is almost a necessity for initially adjusting the circuit.

<sup>1</sup> QST, April 1935, p. 33.

The amplitude of the oscillator voltage should be several volts. This is more than is required for c.w. reception; in fact, this amount could not be used in c.w. reception because the signal tends to "pull in step" the oscillator frequency. The number of turns in the coupling coil shown in Fig. 1 has been found satisfactory for a standard i.f. of 475 kc. The meter shown in Fig. 1 should read at least 0.05 ma. with the oscillator excitation alone. When a signal is being received, the meter should read about twice the "no-signal" value. As shown in Fig. 1, a c.w. switch may be used to connect a capacitor across the oscillator circuit, tuning it near the signal frequency and at the same time connecting in the shorting inductance  $L_2$  which reduces the oscillator amplitude.

Just as required in c.w. reception, the electrical balance of the circuits should be very good. The condenser  $C_3$  and potentiometer  $R_3$  are adjusted for minimum output with the oscillator cut off.  $C_3$  should then require no further attention. When the oscillator is placed in operation, the best adjustment for  $R_3$  will be slightly different from that for c.w. reception. Therefore this adjustment should be accessible.

The use of this circuit should not be attempted on a receiver other than a superheterodyne having comparatively high gain up to the second detector. One high-gain audio stage before the power output stage should be used for loud-speaker operation.

#### RESULTS

It is very difficult to give quantitative data on a circuit of this kind. To say that the circuit reduces noise interference "2 to 1" or "10 to 1" means nothing. In cases where the noise is not severe, little or no improvement may be expected. On the 14-mc. 'phone band, under actual operating conditions where the auto ignition interference was bad, many DX signals have been received without objectionable interference which were unintelligible when using the regular superheterodyne receiver. If the signal is fading badly down to the receiver tube-noise level, all that can be expected is an increase in the percentage of time during which the signal is readable. In general, the receiver sensitivity is limited only by the tube noise.

### Strays

"The Evolution of Tube Testing" is the title of a booklet containing much technical and circuit information in addition to the historical material indicated in the title. It is published by Supreme Instruments Corp., Greenwood, Miss., and can be obtained without charge by servicemen who write on their own letterheads or enclose a business card.

# 1935 Navy Day Competition

SECRETARY SWANSON'S 1935 Navy Day message to radio amateurs, transmitted from NAA and NPG on October 28th, was copied in forty-four states, the District of Columbia, Porto Rico, Jamaica and Hawaii. It was the eleventh year that radio amateurs of the United States participated in the celebration of Navy Day by taking part in a receiving competition held by the A.R.R.L. The competition was in making the best copy of the message from the Secretary of the Navy, C. A. Swanson.

418 operators submitted copies. The table showing "number of participants" and "number of copies" indicates the degree of competition in each Naval District and will prove of interest, especially to Naval Reservists.

The twenty-five letters of commendation offered by the Secretary of the Navy to the operators having the best copies have been distributed throughout the various Naval Districts in approximate proportion to the number of participants in each District. The twenty-five letter-winners appear first on the Honor Roll, which lists all who submitted copies. The winners are listed alphabetically and numerically by calls. All other contestants are listed by Naval Districts in order of their accomplishments as compared to other contestants *in their district only*.

In looking over the twenty-five high, we find several familiar calls. W5BMI has won a letter from the Secretary of the Navy for three consecutive years. W9FQ won a letter in 1930 and 1931 as well as 1935. W7ANU and W8PK were both among the winners in 1933.

The automatic at NAA slipped up in transmitting the word "yourselves" so that "yourfives" was actually sent. This was a real help in grading copies! NPG's transmission was free from errors. Many errors were caused by careless "recopying" of original copies. Notable among the common mistakes was misspelling of the words "possessions," "privilege," "occurred" and "necessitating." Many stumbled over the word "efficiently," coming through with "effectively" in many cases. In past years copies have been received in which the "insular" possessions were interpreted as the "insulated" possessions. A poor guess, at best. This year we were told that the message was addressed to "All amateur radio operators of the *Untied* States"! Hi.

W3QP carefully timed NAA at 17 w.p.m. and NPG at 14.01 w.p.m. . . . Copies were received from every state except Alabama, Mississippi, Nevada and Wyoming. . . . W2BAI made his copy aboard the S.S. *Northern Sword*, KEKC, off the coast of Florida. . . . W6DTY made his aboard the S.S. *Huguenot*, KIVQ, off the coast of

lower California. . . . W9AIR was on the Steamer *Mark Twain*, WIEY, afloat at Fort Madison, Iowa, on the Mississippi River. . . .

—E. L. B.

## 1935 NAVY DAY MESSAGE

Radio Washington Nr 1 CK 137 Twentyeighth 1905  
BT

To All Amateur Radio Operators of the United States and Insular Possessions BT

It is my privilege again this year on Navy Day to extend to our patriotic and loyal American radio operators the best wishes of the Navy Department Period Many of you are members of our Naval Communication Reserve and are now preparing yourselves for future duty in case of local or national emergency Period A serious hurricane emergency occurred in Florida during the month of September necessitating placing in operation the Redcross emergency communication plan which is based upon voluntary service by the Naval Communication Reserve Period I can state with pleasure that this plan functioned efficiently and with credit to the Naval Service and to the Reservists who during the emergency performed many days of voluntary duty  
BT

Claude A Swanson Secretary of the Navy

(This message was transmitted from NPG; NAA's message was a paraphrase of NPG's text. The time on NAA's message was 2100 rather than 1905, and the word "yourselves" was sent as "yourfives" due to slurring of the automatic transmitter. NPG's transmission had no errors.)

## 1935 Navy Day Honor Roll

### *The Twenty-Five High*

W1DUK, P. E. Littlefield, Jr., Rochester, New Hampshire  
W1OG, Carroll F. Pottle, Belfast, Maine  
W2ATM, D. I. Temple, New Rochelle, New York  
W2BZJ, Walter H. Grove, Jr., Manasquan, New Jersey  
W2HHG, Louis R. Clements, Port Jefferson, New York  
W3CBF/1, Richard C. Bechtel, Brunswick, Maine  
W3EEN, J. H. Nicholson, Clarendon, Virginia  
W4—, Julian T. Webber, St. Petersburg, Florida  
W5BMI, E. F. Henning, Little Rock, Arkansas  
W5TR, G. Chiles, Dallas, Texas  
W6EPZ, Horton C. Kessler, San Diego, California  
W6ISR, Donald Pepperell, Oakland, California  
W6LYR/4, H. B. Savage, Jr., Atlanta, Georgia  
W7ALH, D. Harvel Baker, Naches, Washington  
W7ANU, Boyd A. Wolf, Oakridge, Oregon



Naval District	Number of Participants			Number of Copies Received		
	N.C.R. <sup>1</sup>	Non-N.C.R. <sup>1</sup>	Total	Of NAA	Of NPG	Total
First.....	26	33	59	57	17	74
Third.....	40	35	75	73	22	95
Fourth.....	9	11	20	19	7	26
Fifth.....	5	13	18	15	7	22
Sixth.....	5	1	6	6	..	6
Seventh.....	9	4	13	13	9	22
Eighth.....	12	18	30	20	25	45
Ninth.....	53	75	128	93	92	185
Eleventh.....	11	10	21	8	21	29
Twelfth.....	15	7	22	8	20	28
Thirteenth.....	6	19	25	6	24	30
Fourteenth.....	..	1	1	..	1	1
Totals.....	191	227	418	318	245	563

<sup>1</sup> The number of N.C.R. and non-N.C.R. participants was determined as accurately as possible by examination of received copies.

W8ASE, R. Glenn Corbin, Huntingdon, Pennsylvania

W8CHO, Charles Koppe, Galion, Ohio  
W8PK, E. O. Seiler, East Bloomfield, New York  
W8PP, Harold E. Falk, Monroe, Michigan  
W9AHY, Byron A. Carlisle, Kansas City, Missouri

W9BKK, R. F. Schmid, Heron Lake, Minnesota  
W9QF, W. H. Cummings, Valparaiso, Indiana  
W9JAF, J. J. Bovitz, Chisholm, Minnesota  
W9MEV, H. E. Sandstrom, Evanston, Illinois  
W9PKL, R. E. Williams, Kansas City, Missouri

The remaining 393 participants on the Honor Roll follow. They are classified by Naval Districts and are listed under their respective districts in the order of rating. Where calls or names are connected by dashes, it indicates that these participants have equal ratings and are listed in a group, alphabetically:

*First Naval District:* W1ANM-W1BVR W1EAW W1APK-W1CJP-W1KH W1AQW-W1BFT-W1CFG-W1CKI-W1GJB W2FEF/1 W1BKL W3EWP/1 W1FPP W1ABG-W1DCE W1FII W1CBN-W1DMC W1CPH W1BEH-W1DGN-W1HHI-W1IIMD W1CFU W1NA W1DQ-W1IYC W1ATF-W1BZJ-W1EWF-W1EFX-W1EOB-W1EXZ-W1GVH Theodore O. Brigham (WUU) W1FAJ M. W. Eldred W1GXY W1APR-W1BWR-W1EMR W1CAB-W1MT W1AHN-W1GNF W1DWO-W1ZC W1FGW W1HWE W1IUQ W1HIO W1ATK W1EEY W1PQ. *Third Naval District:* W1FNM W2C W1CDZ-W1GWO-W2CCD/KW-W2FRC-W2FWC-L. W. Parish-R. F. Wilson W2BNJ-W8EWP David R. Wingate W2DHI W2FLD W2ALZ-W2BLL W1GKM W2BGO W8DOD-W8JGX W8BEN W1HCM-W8B3J W2CJX-W2HJT-W2HZJ-W2LA-W8DZU-W8GZS W2QL W1AMG W8JQE W8CQW W2FW W2HHH W2FBE-W2F8N-W2GWK W2FRF W3CFB W8DZF W2GES-W2GUA-W2IUO-W8ANQ W2GVZ W2DHS W2CSQ W2CBN-W3SW W2ALL W8ABX W8BDC W8MBI James Freelain W1EBT-W8JRE Cyril Jones W2IWW W2DIJ Miss C. Geneva Lyman W2CJP W. L. Magee W2GGW-L. J. Wolf W8COD W1NP W8N8U W1ES W1IINQ. *Fourth Naval District:* W3QP W3DRD W3ADE W8GN W3DIA-W3DKA W2DDV W3ID-W8IUY W3ANZ W3AR W8KOB W3FFE W3FOS W3BSD W8OFO W3FDE W3AEJ W3DSC. *Fifth Naval District:* W8LSJ W8KKG W4FP W3FGS-W4CQ W3EUB W8HD W3BJX W4DSH-Joseph Pike S. L. Dig-

gle, Jr. W3DVQ W3FSP W3EQP W4DIE W3BKZ W3ESM. *Sixth Naval District:* W4BAY W4AAR-W4AGI W4BDF W4CFD. *Seventh Naval District:* W4AFC K4KD-K4RJ W4DBG-W4HC W4AKV W4AGR W4AHZ W4CBK W5FC W4CCO W2BAI/4. *Eighth Naval District:* W4OI-W5AVZ W4RO W4AFM-W5ESK D. J. Veazey (W4ABY-OI)-W5CEZ-W5DTJ W4DGC W5MN W4CW W5FBQ W5AZB W5NW W5BCW-W5BXA W5BED W5BRQ W5DHU W5BHO W5AUL-W5BNS W5BJG W5DAQ W5DDW W5BAM W5DXQ W5BXY. *Ninth Naval District:* W1CUI-9-W8EGX-W9JDN-W9LJV W9CA W9PB W9VKF-W9LLD W8AXV W8BKM W9PFI W9AQX W8ANJ/SG-W9MGS W8BDG-W9CEX-W9FNQ-W9PIH-W9SQY-W9TJF-Harry A. Beam W9DOE-W9KIT Willis Hudgins (W9BNT)-W9ASV W8HS W9KJY W9GCL W8ATG-W8EJ W8CGP-W9CFN-W9FTJ W8JES-W9CFL-W9RMB-Paul R. Wagner W9EYH-W9GFL W9BXT-W9ENF W9CCE Craig Hare W9FFD W9DGS W9AKT-W9OEO-Robert H. Clarke W8KVX-W9CRY-W9DGR-W9GVM-W9LOL-W9RSO W9DOU-W9KCG W8UW W8PH W8BRN W9DJA W9LGR W8CEU-W8FRY-W9CEE-W9CVL-W9IMV-W. J. McGuffage W9KZL W9CDM-W9HCH-W9NNZ-W9PKV-W9SVY W9OMW W9IWQ W9IAU W8BTT-W9BNI-W9CGS-W9JAR W9DI W9RYZ W9BAZ W9HHW-W9IGW W9CWR-W9SZL-W9VFW-Stephen Gasparovitch W9CUH W9KQA W9CB-W9OGZ W9DYA W9EJU-W9HPQ-W9OUD W9TGN W9BCV-W9DJW W9EGU W9ENH W9CFP W9RVV W9CSJ-W9S0I W9SKF W9CTZ W9KUI W9GLC W8ENP W9PJT W8BXJ W9FYX W8DWT Frank J. Gouednik W9KEI W9AIR W9GEN James R. Walker. *Eleventh Naval District:* W6BMC W5ENI W6ESK W6QA W6CLY W6CVO-W6DTY-W6IAH-W6LFX W6HBD-W6HOS W6ALO W6RB W6BOY R. E. Hall W6BLZ W6KAG W6INH W6FJK W6MHX. *Twelfth Naval District:* W9RTQ W9PVZ-William F. Erdman W6CLV-W6IFP W6AEK W6CIS J. S. Prichard W6DWE-W6IGA-W9FA W6CXM W9NLD W6JNI W4CA/9 W6LXI W9OTR W9KSE W6FPW Jas. C. Hayes W6CWR. *Thirteenth Naval District:* W7CAB W6JVH/7-W7AZY-W7BYE-W7EBQ W7DE W7AVU W7CXK-W7TK W7CHN-W7CZY-W7ECK W7AF W7ATN W7BCV-W7OS W7IG W7ELF W7DTC W7CNC W7LD W7CRK W7NO. *Fourteenth Naval District:* K6CGK.

## Strays

The headquarters staff wishes to express its appreciation to the many members who sent holiday greeting cards. Same to you and many of 'em!

# Using the 6L7 To Improve Superhet Performance

## Adapting Present Receivers to Use the New Metal-Tube Mixer

**A**LTHOUGH most of the new metal tubes are essentially counterparts of well-known glass types, so far as electrical characteristics go, two types are radically different and offer particular operating advantages not attainable with the older glass types. These are the 6L7 superhet mixer tube and the 6H6 duo-diode. Of these, the 6L7 has features making it especially useful as the mixer in amateur superhets, in many of which it can be substituted readily for the present glass-tube first detector. This applies almost universally to superhets using 6-volt tubes and a separate high-frequency oscillator; sets using a pentagrid mixer, in which oscillator and first detector functions are combined, are less adaptable and would have to be modified to incorporate a separate oscillator tube before the 6L7 could be worked in. Receivers having 2.5-volt a.c. filament supply would have to be changed over to use 6-volt tubes, or a separate 6-volt supply provided for the 6L7 heater.

As explained in the new 1936 A.R.R.L. *Handbook* (Chapter Six), the 6L7 has features which correct several deficiencies of other type tubes commonly used as first detectors. The space-charge coupling between detector input and oscillator circuits, which characterizes the -A7 and 6A8 pentagrids, is largely eliminated; while the lowering of plate impedance (and consequently of gain) which is characteristic of suppressor-grid injection in a pentode is absent, since the oscillator grid (No. 3) of the 6L7 is completely screened and is backed up by a separate suppressor grid. Also, a smaller oscillator voltage is required than with suppressor injection (approximately 15 volts r.m.s.), while the power demand on the oscillator is negligible as compared with screen-grid injection. At the same time, the value of oscillator voltage can vary widely, provided it does not fall below a minimum of approximately 15 volts r.m.s. This tolerance is especially helpful in multi-band tuning systems.

### CIRCUIT MODIFICATIONS

In adapting the tube to existing circuit arrangements, any one of several schemes for coupling to the oscillator can be used. The preferred arrangement shown as an example, adapted to the 6-tube regenerative S.S. receiver described in the A.R.R.L. *Handbook*, is given in Fig. 1. While this circuit gives electron coupling between the oscillator and mixer, the oscillator is no

longer of the electron-coupled type. Output is taken from the tuned circuit at the cathode tap, which is above ground for r.f., and both screen and plate are by-passed to ground for r.f. The electron-coupling is all in the mixer tube. In contrast to the usual electron-coupled oscillator, in which output is taken from the plate across a non-selective load impedance in the plate circuit, coupling across the cathode-ground portion of the selective oscillator circuit minimizes harmonics and gives greater fundamental output, even though there is a step-down at the tapping. The full advantage of self-stabilization of frequency which is characteristic of the tetrode oscillator is realized. This oscillator circuit, derived from the grounded-plate Hartley circuits described in April 1933 *QST* ("Stabilizing Superheterodyne Performance"), has been shown previously in *QST* and the A.R.R.L. *Handbook*.<sup>1</sup> It has been adopted by several manufacturers of communication and all-wave broadcast receivers of the present season. Several other coupling schemes, adaptable to different oscillator circuits, are given on page 89 of the 1936 *Handbook*.

In the operation of the present circuit, the oscillator is coupled to the 6L7's No. 3 grid through the condenser  $C_7$ . The resistor  $R_{20}$  provides r.f. impedance between this grid and ground, and the d.c. voltage developed across it by rectification of the applied oscillator voltage in the  $G_3$ -cathode circuit furnishes automatic bias in addition to the cathode-drop bias developed across  $R_2$  and  $R_3$ . Excessive cathode-drop bias on the oscillator grid of the 6L7, which varies with operation of the gain control  $R_3$ , can be eliminated by returning  $R_{20}$  to the junction of  $R_2$  and  $R_3$  or directly to the cathode, instead of to ground. This change may be advantageous in some cases, the choice being determined readily by trial.

There isn't much to the actual process of making the changes. Let's take the popular regenerative type S. S. superhet, the pertinent portion of the circuit being as given in Fig. 1. (For the complete original circuit, refer to May 1934 *QST*, or to recent editions of the A.R.R.L. *Handbook*.) The essential mechanical modifications consist only of substituting an octal (metal-tube) socket for the first detector tube, some rearrangement of the wiring, and substitution of the parts designated as "new" in the specifications of Fig. 1. If the re-

<sup>1</sup> Fig. 525, page 57, 12th edition *Handbook*.

ceiver is already using 6-volt tubes, no other changes will be necessary. If the set has 2.5-volt tubes, the most economical method would be to bring out the 6L7 heater leads separately and use a small 6.3-volt filament transformer on this tube,

input capacitance. In the *QST* regenerative S.S. receiver, this necessitates setting the first detector parallel "tank" condenser at a slightly lower capacitance as compared to the setting for a given band with the glass first-detector tube

which it has replaced. In receivers using complete single control, a slight adjustment of the parallel trimmer condenser to reduce the minimum circuit capacitance would be necessary. Re-alignment of the tuning of the first i.f. transformer primary also might be required, to compensate for a difference in first detector output capacitance. These adjustments should be well within the available ranges in almost any receiver, however.

With all adjustments checked and the circuits in normal operation, several improvements are apparent, especially on the 14- and 28-mc. bands.<sup>2</sup> Interlocking effects between first detector and oscillator are even less than with the original electron-coupled oscillator and control-grid coupling, while oscillator frequency stability is generally bettered. First detector conversion gain, shown by higher over-all receiver gain, is noticeably improved. As a result of the variable mu characteristic of the 6L7's No. 1 grid, gain control is smoother than with a 57 or 6C6 first detector. All-in-all, the 6L7 has enough advantages to warrant its extra cost in comparison with the glass type tubes we have been accustomed to use as first detectors.

—J. J. L. and B. H. G.

<sup>2</sup> For data on 28-mc. coils for the regenerative S. S. receiver, see page 102, Dec. 1935 *QST*.

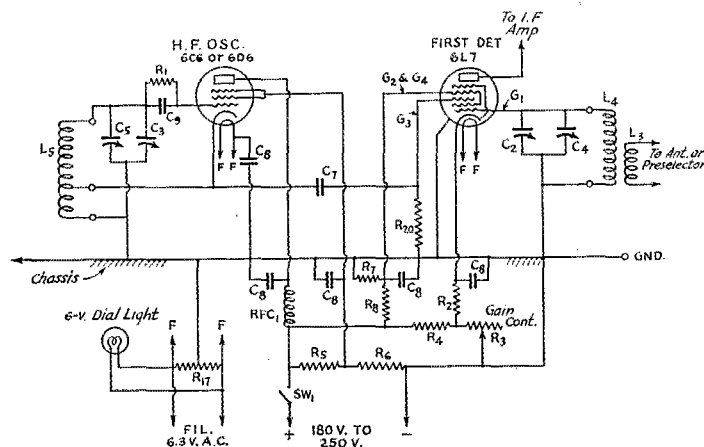

FIG. 1—THE REGENERATIVE S.S. RECEIVER'S CONVERTER CIRCUIT ADAPTED FOR THE 6L7 METAL MIXER See Fig. 723, Chapter Seven, 1934 A.R.R.L. Handbook for the complete receiver circuit.

- L<sub>3</sub>, L<sub>4</sub> and L<sub>5</sub>—Same plug-in coils.
- C<sub>2</sub>, C<sub>3</sub>—Same 25- $\mu$ fd. midjet tuning condensers.
- C<sub>4</sub>, C<sub>5</sub>—Same 100- $\mu$ fd. midjet tank condensers.
- C<sub>7</sub>—New 50- $\mu$ fd. oscillator coupling condenser.
- C<sub>8</sub>—Same 0.01- $\mu$ fd. tubular by-pass condenser.
- C<sub>9</sub>—Same 100- or 250- $\mu$ fd. oscillator grid condenser.
- R<sub>1</sub>—Same 50,000-ohm 1-watt grid leak.
- R<sub>2</sub>—New 500-ohm 1-watt cathode resistor.
- R<sub>3</sub>—Same 12,000 variable resistor.
- R<sub>4</sub>—Same 100,000-ohm 1-watt bleeder resistor.
- R<sub>5</sub>—Same 10,000-ohm 5-watt divider resistor.
- R<sub>6</sub>—New 10,000-ohm 2-watt divider resistor.
- R<sub>7</sub>—New 75,000-ohm 1-watt divider resistor.
- R<sub>8</sub>—New 10,000-ohm 1-watt divider resistor.
- R<sub>17</sub>—New 100-ohm filament center-tap resistor (omit for 6-volt battery operation and connect negative A to negative B).
- R<sub>92</sub>—New 50,000-ohm 1/2- or 1-watt oscillator grid resistor (old R<sub>8</sub> can be used).
- RFC<sub>1</sub>—Same 2 1/2-mh. r.f. choke.

leaving the others connected to the 2.5-volt filament supply. If complete change-over to 6-volt tubes is to be made, the glass types to be substituted are as follows:

- First r.f. stage, 6D6 for 58
- Oscillator, 6C6 or 6D6 for 57 or 58
- I.f. amplifier, 6D6 for 58
- Second detector, 42 for 2A5
- C.w. beat oscillator, 6D6 for 58.

If the desire is to go "all-metal," with octal sockets substituted in every stage, type 6K7's would take their places in r.f., i.f., and both oscillator circuits, while a 6F6 would replace the 2A5. Socket connections for these tubes, and for the 6L7 as well, are given on page 35 of July 1935 *QST* and in Chapter Five of the 1936 A.R.R.L. Handbook.

Tuning adjustment is likely to be slightly different with the metal tubes. In the case of the 6L7, there appears to be a slight increase in minimum capacitance as a result of slightly larger tube



Amateurs with a weakness for both law observance and the use of dimes for the top plates of crystal holders should remember that it is no crime (in the States at least) to file smooth a Canadian dime . . . and that also solves the problem of what to do with them.

—W9EHC

# The Love of Hazel

By Lewis B. Coe,\* W9CNY

**A**FTER eight years of hamming around, ashore and afloat, 1935 finds me nursing a flock of receivers for Zilch Communications at one of their point-to-point stations. Since I've sprayed the ether with everything from a 201-A to a 5-kilowatt spark in the last few years, it now seems odd that I'm on the intake end exclusively, with nothing to worry about but static, fading, QRM and trying to follow a signal when the boys on the other end try to take the transmitter apart. I joined up with Zilch the first of the year and by summer time was pretty well bedded down, feeling strangely contented after quite a few years of doing nothing but ram around.

I'm working an afternoon and evening trick along in June, and in the evening, after I get the

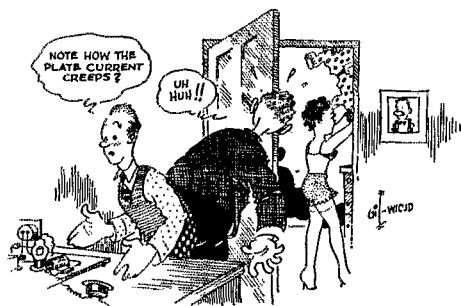

\* THE WAY HER CORNERS WAS ROUNDED THERE WOULD BE NO TROUBLE WITH BRUSH DISCHARGE.\*

receivers safely hogtied, I have a lot of fun taking in the wonders of nature around the field where Zilch has squatted their station. It's surely a restful and pleasant place to pursue the old radio game, what with everything so green and fresh and the songbirds QSOing each other on a million different frequencies around the field.

Well, one evening the later part of June I've strayed 'way out to the far end of our Frisco antenna, which to you is just about a thousand feet from where a good conscientious receiver tuner-inner oughtta be. I'm out there puttering around, shying rocks at a fat old ground-hog, who knows darn well I ain't got no gun and who is doing the badger equivalent of wagging his nose at me.

Being absorbed in this thrilling pastime I kinda forget about the station and the receivers I'm supposed to be watching. So it was that I get kind of a start when I looks up and sees a big cloud of dust coming up the oversize donkey-path that does duty for a road to the station house. I forget about the ground-hog in a hurry, as for all I know this may be one of the big shots on a flying visit

\*213 North East St., Crown Point, Ind.

and it sure won't look well for little Oscar to be 'way out here when I'm supposed to be 'way over there. As I proceeds on a dead run for the station I concocts a tale about having a racket in one of the klunks and going out to see if maybe the Frisco array wasn't flapping against a guy wire somewheres, just in case this gas-buggy coming up the road turns out to be the real McCoy. I puffs up to the shack just about the time one of Henry's last year's jobs slides to a stop and disgorges a young bloke about 17 or 18, who shoves out his duke and says he's Joey Smith, would-be ham and young Edison of the nearby village.

I'm still puffing when he concludes his speech, as I ain't so spry as when I used to run the 600-meter race regular on old W—. Young Joey confesses a great yen to see what makes a real commercial layout tick and I'm so relieved at not being caught by the boss that I whip my ugly map into some semblance of geniality and usher the lad into the presence of our rig. To me, the Zilch receivers are mainly an assorted collection of microphonic tubes, loose connections and floppy dials, slung up in an irregular line on some pieces of old bridge iron, but I can see the kid is impressed and I try to give him the lowdown without bringing in too much of the tart grapes.

We talks of this and that and I relate a few of my thrilling experiences. Finally Joey comes around to what he's putting in his spare time at, namely, getting a rig together so he can do a little ham work, which right now is the acme of his ambition. He says he's having a load of grief with his quartz circuit and wants to know if I'd come around some time and see if the old maestro's touch wouldn't make it perk. Well, I'm not so hot on this until he finally lets it drop that he will have to be going as it is nearly eight o'clock and his sister wants to use the car. At the mention of sister I perks right up and says carelessly that I might be able to drop around some time. I'm having a hard time getting connected up with some steady female company in this town and I figure this might be the break I been looking for.

In due time I shows up at Joey's place and after getting him a needed 5000-ohm resistor it's no trick at all to put his squeak box in good running order. As soon as I get the X-ray eye on this sister, who Joey introduces as Hazel, it don't take me any time at all to see that here was quality with a capital X. She was satin-finished, chrome-plated and custom-built throughout, believe me. The way her corners was rounded there would be no trouble with brush discharge. She slammed my milliammeter right over to the peg and bent it. It

goes without saying that Joey and me became fast friends almost immediately and his transmitter from now on gets more servicing than a 50-kw. broadcast job. However, I didn't rush right in and show my colors, as long experience convinced me that here was a job that needed a delicate approach and careful handling. So I bided my time and contented myself with giving Joey a big shot of my spotless character, knowing that he probably gabs about me to the family all the time.

I get more friendly with the Smith family as time passes by, and now and then after a big session with Joey's transmitter I'm invited to join the family circle for coffee and cakes at late hours. Hazel joins freely in the gab and I'm about convinced that she has a faint suspicion that gold might lie beneath this rough exterior of mine. I figure the build-up is about perfect and, having a few bucks laid aside for some classy clothes, I decide to do something definite about getting a date



with this smooth little oscillator. After making a couple of trips down to the Smith igloo for this purpose and not seeing her around I finally cracks to Joey about it. He looks up from the handbook he's eyeing and yawns, "Aw, her old man's home now so she's gone back to Chicago." "Her old man," I echoes weakly. "Yeah, didn't I tell you she was married? Her old man was away on business, so she come to stay with the folks until he got back."

Getting across the 3500 bus over at K— was a mild experience compared to the jolt I was feeling right now. No kidding, I had a bad case of corrosion in my water jacket and the old breaker nearly tripped with this sudden strain. I force a sickly grin to my features and scrams out to do a little heavy breathing in the July air.

I got a new super with that extra dough. Joey has his ticket and a sweet-sounding rig. All for the love of Hazel!

## Strays

### New Metal Tubes

Four new metal tubes, designated 6Q7, 25A6, 25Z6, and 6X5, have recently been announced. The 6Q7 is a duplex-diode high- $\mu$  triode similar to the 75; the 25A6 a pentode power amplifier similar to the 43; the 25Z6 a high-vacuum rectifier similar to the 25Z5, and the 6X5 a rectifier for automobile use. Tentative data on the tubes is as follows:

#### 6Q7

Heater voltage.....		6.3 volts
Heater current.....		0.3 amp.
Plate voltage.....	100	250 volts
Grid voltage.....	-1.5	-3 volts
Amplification factor.....	70	70
Plate resistance.....	87,500	58,000 ohms
Mutual conductance.....	800	1200 micromhos
Plate current.....	0.35	1.1 ma.

The diode plates are placed around a cathode the sleeve of which is common to the triode unit. The base is the small octal with 7 pins.

#### 25A6

Heater voltage.....		25 volts	
Heater current.....		0.3 amp.	
Plate voltage.....	95	135	180 volts
Screen voltage.....	95	135	135 volts
Grid voltage.....	-15	-20	-20 volts
Plate current.....	20	39	40 ma.
Screen current.....	4	8.5	8 ma.
Plate resistance (app.)..	15,000	42,000	40,000 ohms
Amp. factor (approx.)..	90	100	95
Mutual conductance.....	2000	2350	2400 micromhos
Load resistance.....	4500	4000	5000 ohms
Self-bias resistor.....	625	420	420 ohms

Power output.....	0.9	2	2.75 watts
Total harmonic distortion.....	11	9	10 percent

Small octal base, 7 pins.

#### 25Z6

Heater voltage.....	25 volts
Heater current.....	0.3 amp.

As voltage doubler

A.C. plate voltage per plate (rms).....	125 volts
Peak plate current.....	500 ma.
D.C. output current.....	85 ma.

As half-wave rectifier

A.C. plate voltage per plate (rms).....	125 volts
Peak plate current per plate.....	500 ma.
D.C. output current per plate.....	85 ma.

Small octal base, 7 pins. The two units of the 25Z6 may be used separately or in parallel in half-wave rectifier service.

#### 6X5

Heater voltage.....	6.3 volts
Heater current.....	0.6 amp.
Peak inverse voltage.....	1250 volts
A.C. voltage per plate.....	350 volts
D.C. load current.....	75 ma.
Peak plate current.....	375 ma.

Small octal base, 6 pins. D.C. potential difference between heater and cathode should be limited to 500 volts.

In all ratings given above, figures in right hand column are maximum. Information on the 6X5 is from Raytheon; on the 6Q7 from RCA-Radiotron; on the 25A6 and 25Z6 from both RCA-Radiotron and Raytheon.

# Neon-Bulb Audio Oscillators

## A Simple, Inexpensive Keying Monitor

By F. H. Schnell, W9UZ\*

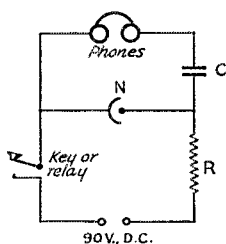

FIG. 1—THE OSCILLATOR USED AT W9UZ  
N—Westinghouse N-1 neon bulb.  
C—0.002  $\mu$ fd.  
R—1.5 megohm.  
Supply, 90 to 110 volts, d.c.

the emitted wave-form, such as it may be. Therefore, it does not replace the regular station monitor. It has to do, solely, with key manipulation. The regular station receiver can be used to monitor the transmitter as often as desirable. The character of the emitted wave-form or note is something that should be known by the operator of the transmitter for which he should not have to depend upon listeners for a report. For that reason, the transmitter should be monitored, and adjustments made in the transmitter at the time, if necessary.

For monitoring keying during transmission the oscillator ought to be connected to the keying system in such a way that it may be used without putting the transmitter on the air. The output of the audio oscillator is supplied directly to the headphones or loud speaker, providing a means of continuously observing the manipulation of the key or bug, or whatever else it is that some amateurs use to splash out what is alleged to be International Morse. Since the oscillator can be keyed without cranking up the transmitter for code practice, by its use idle "air practice" may be reduced considerably.

The note of the neon oscillator affords real relief from the monotonous beat note of the average freqmeter-monitor. The tone obtained is clear, clean and crisp. The frequency of the note can be adjusted or varied from a few cycles per second

\*4915 N. Sawyer Ave., Chicago, Ill.

HERE is a neon bulb audio oscillator for monitoring keying and for code practice which can be assembled for less than \$1.00. But let no mistaken ideas develop as a result of this neon oscillator being called a keying monitor. It does not monitor the transmitted signal. It has nothing to do with the frequency drift or shift or character (if any) of

to several thousands per second. Or, it can be slowed down to one oscillation per second or one oscillation every fifteen seconds, making a nice blinker. It has been observed and known for many years that every radio operator has a preference for some particular listening frequency while operating the transmitter. Some prefer high notes and others prefer low notes. Usually, a frequency range from 150 to 1,500 cycles per second will provide the desired note. Also, it has been observed that some operators can manipulate the key faster as the frequency of the note increases. That may be a function of the ear, but certainly is it reflected in the manipulation of the key.

The frequency of the note of the neon oscillator is constant and the dots of the fast bug are just as crisp as its dashes. In that respect it differs from the buzzer which is seldom free from squeaks and squawks and fluttering frequency.

The keying monitor in use at W9UZ is represented by the circuit shown in Fig. 1. The monitor is keyed with a small relay which is connected in parallel with the regular transmitter relay so that both can be keyed without putting the transmitter on the air. A changeover switch is used to switch the headphones from the receiver to the monitor. Both relays have been adjusted for correct position, as described in *QST*, Feb. 1934. This is important.

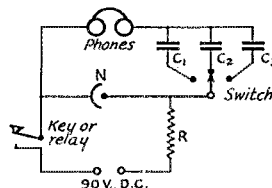

FIG. 2—A THREE-FREQUENCY CIRCUIT

N—Neon bulb.  
C<sub>1</sub>—0.001  $\mu$ fd.  
C<sub>2</sub>—0.002  $\mu$ fd.  
C<sub>3</sub>—0.003  $\mu$ fd.  
R—1.0 megohm.

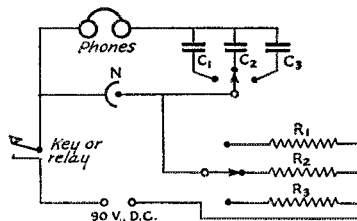

FIG. 3—THIS ONE GIVES A WIDE RANGE OF TONES

N—Neon bulb.  
C<sub>1</sub>—0.001  $\mu$ fd.  
C<sub>2</sub>—0.002  $\mu$ fd.  
C<sub>3</sub>—0.003  $\mu$ fd.  
R<sub>1</sub>—0.5 megohm.  
R<sub>2</sub>—1.0 megohm.  
R<sub>3</sub>—2.0 megohms.  
E—90 to 110 volts, d.c.

The neon bulb is a Westinghouse N-1, although any small neon bulb will oscillate. Several differ-

(Continued on page 74)

# Types of Distortion in 'Phone Transmitters

## Amplitude, Frequency and Phase Varieties and Their Effects

By Durward J. Tucker,\* W5VU

**R**ADIO telephony depends upon the transmission of the signal or "intelligence" by means of a carrier. The signal may be impressed upon the carrier by phase, frequency or amplitude modulation. Since amplitude modulation is the only method in universal use at the present time, it alone will be considered in this article. With amplitude modulation decided upon, the next important step is to insure that the system shall be free from the other types of modulation that would give rise to distortion.

Naturally, if our object is to transmit intelligence, we are concerned that the intelligence be intelligent at the receiving end. At the same time, while we are applying the intelligence to our own carrier, we should see that it does not affect the intelligence of the carriers in the adjoining channels. It is important, not only from the standpoint of our own communication, but also from the standpoint of the fellows on the adjacent channels, that our transmitter be free of distortion.

The places where distortion may occur are many. It can originate in the microphone, in transformers, tubes, volume controls—in fact in almost any piece of apparatus in either the audio stages or radio-frequency stages. In view of the many places where distortion may appear, it might be well first to consider the basic kinds of distortion in order that it may be more easily traced and remedied. The types of distortion in their order of importance are amplitude or harmonic distortion, frequency distortion, and phase distortion.

### AMPLITUDE DISTORTION

As has already been stated, amplitude distortion is the most serious type encountered in 'phone transmitters. One reason is that the distortion products are not always restricted to the frequency channel of our own signal but may severely handicap the signals of fellow amateurs on adjacent channels. Amplitude distortion is caused by the system introducing frequencies into the output which were not present at the input. These new frequencies are usually harmonics of the original signal frequency. The term amplitude distortion is applied to this type because the amplitude of the output is not proportional to the input amplitude; that is, input and output are not linearly related.

\* Experimental Station W5XM, 5712½ Marquita Ave., Dallas, Tex.

Fig. 1 shows how the two side-band frequencies combine with the carrier frequency to give a modulation envelope whose amplitude varies in accordance with some modulating frequency. By inspecting this figure it is seen that the signal frequency (e) introduces two new radio frequencies which are the side-band frequencies. This is not what we mean by amplitude distortion, however, because the two side-band frequencies are proper and necessary in order that the original signal (e) may be present in the modulating envelope (d). The magnitude of each side band should never exceed one-half the amplitude of the carrier as this is the value for 100% modulation.

Fig. 2 shows the results of increasing the amplitude of the side-band frequencies to more than one-half the amplitude of the carrier frequency. It is seen that the modulation envelope is no longer an exact reproduction of the signal. This is amplitude distortion. The distortion is caused by overmodulation. If the side-band power, representing the power introduced by modulation, is increased very much beyond 50 percent of the carrier power, very serious distortion results. This rule holds true only when the carrier is being modulated by one single frequency; that is, by a pure sine-wave signal. If a signal having two or more frequencies is used to modulate the carrier, their respective amplitudes add up to give a wave which may have sharp peaks projecting up from the main

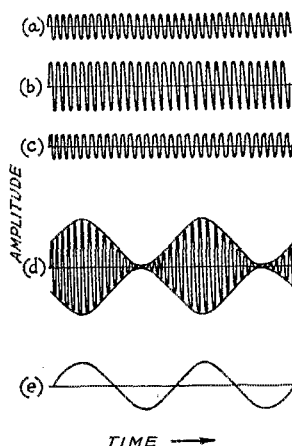

FIG. 1.—PROPER 100% MODULATION

- (a) Upper side-band wave whose frequency is equal to the carrier frequency (b) plus the signal frequency (e).
- (b) Carrier wave.
- (c) Lower side-band wave whose frequency is equal to the carrier frequency minus the signal frequency (e).
- (d) Modulation envelope formed by the combination of the two side-band frequencies (a) and (c) with the carrier frequency (b).
- (e) Signal or modulating frequency.

body of the wave. In some instances it may be necessary to restrict the side-band power to 20 or 30 percent of that of the carrier in order to keep the peaks from overmodulating. In rare cases it is possible, with certain phase relations, to increase the side-band power beyond the 50 percent

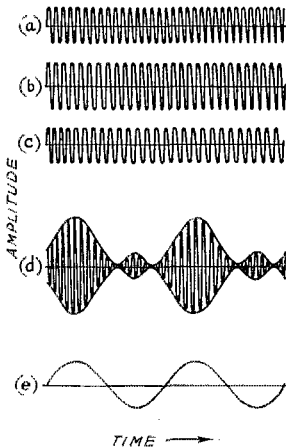

FIG. 2—AMPLITUDE DISTORTION FROM OVERMODULATION

- (a) Upper side-band wave with an amplitude  $\frac{1}{4}$  the carrier amplitude.
- (b) Carrier wave.
- (c) Lower side-band wave with an amplitude  $\frac{1}{4}$  the carrier amplitude.
- (d) Modulation envelope showing distortion introduced by overmodulation.
- (e) Signal.

value and still not overmodulate, as will be shown later in connection with our discussion of phase distortion.

It must be kept in mind that amplitude distortion is not present merely because the observed wave is a complex wave. The point to determine is whether this complex wave is identical in every respect to the impressed wave. In the case examples given in connection with this discussion, the output wave is considered distorted because the phase relations, the component amplitudes, or the frequencies are not the same as in the input wave—but not simply because the output wave happens to be complex. The simplest types of waves are used in order that they may be more readily followed.

Fig. 3 shows the result of amplitude distortion introducing the third harmonic of the signal frequency into the audio system. It will be observed that in addition to the fundamental side bands we have a separate set of side bands for every frequency that appears in our modulating signal. By comparing the modulation envelopes in Figs. 1 and 3 it can be seen that amplitude distortion severely distorts the wave. It should be further noted that should overmodulation also appear on the scene in Fig. 3, then the wave shape would become unintelligible indeed.

will be very complex. At instants when the peaks of several of the frequencies are in phase, there will be a sudden rise in the wave amplitude. The modulating source must be restricted so that these peaks do not overmodulate. These narrow peaks cause 100% modulation even though the main body of the wave falls far short of the 100% value. Hence the average side-band power will be less than 50 percent of the carrier power and the required modulator power will be correspondingly less. For ordinary speech the average audio power required for 100% modulation should not exceed 25 or 30 percent of the carrier power. A modulator with an average audio output of 25 watts is sufficient to modulate a 50-watt carrier (100 watts input with 50% efficiency) provided the modulator is capable of supplying the additional power required on the instantaneous peaks.<sup>1</sup> For 100 percent modulation the average output power (carrier and sidebands) would be  $62\frac{1}{2}$  watts and the instantaneous power at peaks would be 200 watts.

Amplitude distortion is detected by the ear by its disagreeable effect on the quality of music or speech that is being transmitted. It is more noticeable at low audio frequencies because the harmonics then fall within the audible band where the ear is most sensitive. Harmonics resulting from amplitude distortion at high audio frequencies are not as noticeable because they may fall near the upper limit or outside the limit of audibility. On the other hand, the side-bands resulting from harmonics of high audio frequencies may "hash up" the radio fre-

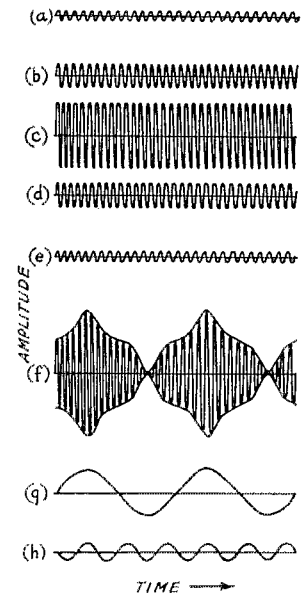

FIG. 3—AMPLITUDE DISTORTION IN MODULATING SIGNAL

- (a) Upper side-band (third harmonic).
- (b) Upper side-band (fundamental).
- (c) Carrier wave.
- (d) Lower side-band (fundamental).
- (e) Lower side-band (third harmonic).
- (f) Modulation envelope.
- (g) Original modulating signal.
- (h) 3rd harmonic of  $\frac{1}{2}$  signal amplitude and in phase with signal peak.

<sup>1</sup> "Greater Economy in Class-B Modulator Design for Speech," *QST*, August, 1935; Chapters Eleven and Twelve, 1936 A.R.R.L. Handbook.



quency band for several kilocycles on either side of the carrier frequency. Radiation of this type is called spurious radiation.

Amplitude distortion may be introduced into a system by passing the signal through any non-linear impedance. This means that the circuit parameters must be a constant; that is, the amplitude of the current must be proportional to the voltage if amplitude distortion is to be avoided. The most common causes of amplitude distortion are overmodulation and overloading the tubes in the audio stages (speech amplifier and modulator). Even under ideal operating conditions a small amount of distortion will be introduced, since the  $E_p - I_p$  characteristic curve of any tube is not a perfectly straight line. Operating on the nearly-straight portion of this curve and working the tube into a high load impedance will minimize the distortion likely to occur in speech amplifiers. Over-biasing or overloading a tube so that the more defined curved portion of the characteristic is utilized increases the amplitude of the harmonics. For a voice frequency of 4000 cycles the third harmonic would be 12,000 cycles and, while of low relative amplitude, this harmonic would cause spurious side bands 12 kc. on either side of the carrier frequency which might cause severe interference to a weak transmission far outside the normal communication band of the defective transmission.

#### FREQUENCY DISTORTION

Another type of distortion is characterized by failure to reproduce all frequencies in the output with the same amplitude relation that existed between the frequencies in the input. This type is called frequency distortion because the system discriminates in amplification of the different frequencies present. Some frequencies might be amplified to a value twice the original amplitude while other frequencies might be amplified to three times the original amplitude. In fact, some frequencies might lose part of their amplitude or even be lost altogether. From the several references to amplitude it might appear that frequency distortion is some form of amplitude modulation. Actually no new frequencies are introduced but the relative amplitudes of the frequencies present are changed; therefore the name frequency dis-

ortion. As has been stated, amplitude distortion is the introduction of frequencies into the output that were not present in the input. With amplitude distortion the amplitudes of the original frequencies would be in the same proportion unless frequency distortion is also present.

Frequency distortion can usually be traced to the audio stages and results from the presence of inductance and capacity in the circuits. The impedance of a condenser or inductance is a function of frequency. Likewise, the current and voltage characteristics of either a condenser or an inductance are a function of the frequency.

Fortunately, frequency distortion does not of itself result in spurious side-band radiation, nor is it so readily detected by the ear. The relative power of any component may be reduced to as low as fifty percent of the other components before serious effects on fidelity are noticed. The typical frequency-response curve of amplifiers is probably well known to most readers. The more nearly this curve becomes a straight line, the less frequency distortion there is present. For amateur work we are interested only in the frequencies covered by speech. It is important that our speech equipment present frequency-response curve be "flat" only within the essential frequency region of speech. If our audio circuits are designed to pass frequencies other than those needed for ordinary speech transmission, we are only inviting trouble. We let in a.c. hum in the lower frequency region (below 200 cycles) and broaden our channel unnecessarily and set the stage for spurious radiations by extending the response at the higher frequency region (above 3000 cycles).

#### PHASE DISTORTION

If the phase relations between the signal frequencies in the output are not the same as in the input, the system is introducing phase distortion. Phase distortion, like frequency distortion, results from the elements of capacity and inductance present in the circuits. The ear is unable to interpret phase shifts so it is only when phase shifts give rise to other effects, such as overmodulation, that it becomes important in amateur telephony.

(Continued on page 98)

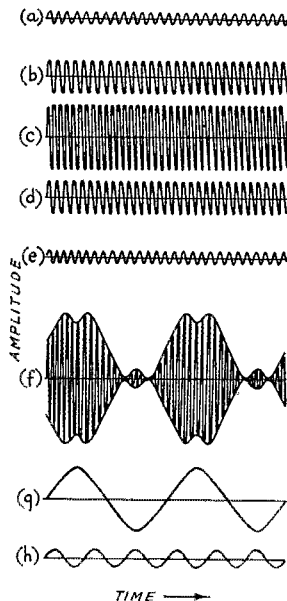

FIG. 4—SPECIAL CASE OF SIDE-BAND POWER GREATER THAN 50% WITHOUT OVER-MODULATION

- (a) Upper side-band (third harmonic).
- (b) Upper side-band (fundamental).
- (c) Carrier.
- (d) Lower side-band (fundamental).
- (e) Lower side-band (third harmonic).
- (f) Modulation envelope.
- (g) Fundamental of modulating signal.
- (h) Third harmonic of modulating signal out of phase with peaks of fundamental (g).



# Amateur Radio STATIONS



## W2BSD, New Rochelle, N. Y.

**A**LTHOUGH W2BSD is licensed under the name of Theo. M. Healy, it was conceived and designed by George C. Cannon, ex-2ZK, who will be remembered as a prominent amateur in the early days of A.R.R.L., and whose work dates back to 1910 when everyone struggled with spark and arc, tuning coils, loose couplers and various methods of detection.

A little later — that is, in the fall of 1916 and the early winter of 1917, 2ZK, through the courtesy of Dr. Lee DeForest, operated the first broadcasting — or “voice transmitter,” as it was then termed — for entertainment purposes in the world. The programs transmitted every evening between nine and ten o’clock were heard by listeners within a radius of 150 miles. This gave 2ZK the distinction of preceding KDKA with scheduled transmissions. Still later, about 1922, 2ZK was the first amateur station to be heard in Europe on voice, from New Rochelle, N. Y., to La Rochelle, France. Today, on 14,170 kilocycles, operating under the call letters W2BSD, a thoroughly modern ‘phone station is again on the air.

The station is complete in almost every detail. It is housed in a separate wooden frame building, with wooden gutters and leaders. On the right in the photograph stands the big Collins 202-A, 1-kw. transmitter, with its Variac control to the left on the floor. To the left and in the background may be seen the modulation monitor. This newly developed instrument by General Radio indicates instantaneously the percentage of amplitude modulation. The monitor is checked from time to time against an oscillograph, using a 400-cycle

audio oscillator of pure waveform. On the far end of the operating table is the speech amplifier, consisting of a two-channel mixer, output monitoring position and remote control switches. In the center of the table may be seen the National HRO receiver.

Although A-cut crystals under temperature control are used in the transmitter, the frequency is constantly checked

by the frequency meter to the left of the operating table.

The stand with its Brush crystal microphone is ready for action, and—the comfortable leather chair makes operating a pleasure. Truly a Ham’s Paradise!

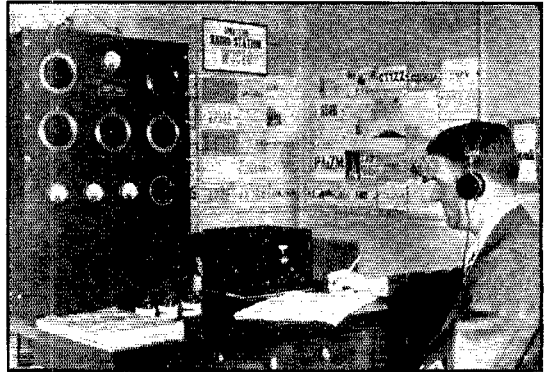

W3CZO

## W3CZO, Carlisle, Pa.

**I**N THE post-war spark period one of the familiar calls in the eastern section of the country was 8VE-8ZD. Fred Westervelt was an active traffic ham in those days, and was one of the original PRR gang. Now a Captain in the Army Medical Corps, stationed at Carlisle, Pa., he’s just as enthusiastic as ever about ham radio, although opportunities for operating are so irregular that most of the work is confined to rag-chewing and DX.

The transmitter at W3CZO is a Collins 30FX,

203A final, running with inputs between 350 and 300 watts in the 7- and 14-mc. bands. It works into a center-fed half-wave antenna with which, despite the fact that it is only 25 feet high, the station has got out well enough so that WAC has been made on 14 mc. and all continents except Asia have been worked on 7 mc. A total of about 50 countries has been contacted, including all the "K" calls—K4, K5, K6, K7 and KA. An SW-3 is used for receiving, although a new super is under construction and should be installed by the time this appears in print.

## N2LA, Larchmont, N. Y.

N2LA is owned by Bob Fischer, of Larchmont, N. Y., who first became interested in the art back in 1920 when vacuum tubes of the Moorehead variety were replacing galena crystal jobs for receiving purposes, and an antenna wasn't an antenna unless it was 600 feet long. Getting his first license in 1923, Bob successfully went through the old Radiotron 202 stages with loop absorption for 'phone in a New York City location. Moving to Larchmont, N. Y., a single 50-watter was installed replacing the older rig, and continually since then various changes were made as the art progressed. One very successful combination used for three years consisted of a dynatron '57 tube, crystal controlled, feeding an 865 intermediate amplifier thence into a 204-A.

The new transmitter shown in the photograph has just been completed, and is operated principally on 3550 kc. in conjunction with Naval Reserve drills, although operation on the 40-meter band is also available quickly and easily. An RK20 crystal oscillator feeds directly into a 204A in the final. The suppressor grid of the 20 is modulated by a 45 tube through a two-stage transformer coupled amplifier.

The receiver used is a Super Skyrider, with crystal filter, which tunes from 13-550 meters.

Fischer is an active member of the U. S. Naval Communication Reserve, holding the rate of Radioman "first," and makes his living as a hardware merchant.

## Strays

W9ORY says that if the signals on your receiver jump about, don't fail to inspect the tube

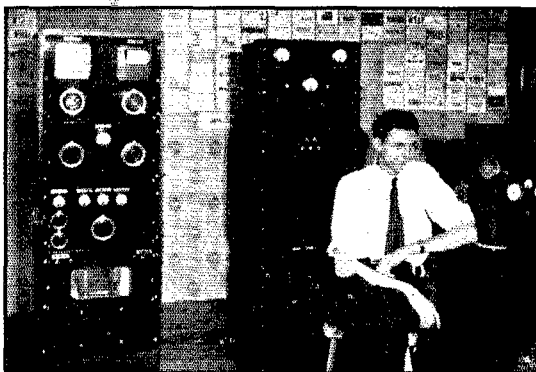

W8KQQ

## W8KQQ, Centre Hall, Pa.

A KING and a pair of queens"—this insignia, quite familiar to 20-meter 'phone operators, means W8KQQ, owned by R. S. Bailey of Centre Hall, Pa., pictured herewith. The station is operated exclusively on 14-mc. 'phone, the frequency being 14243 kc.

The transmitter, built by W8GLY, is in two units, r.f. and speech equipment. The r.f. end has the following tube line-up: RK23 crystal oscillator, Tri-tet connected, doubling to 14 mc. from a 7-mc. crystal, RK20 first buffer, 242A second buffer, and a final stage with a pair of 150T's in push-pull. The final is run with a kilowatt input. Class-B 203A's are used as modulators, the speech amplifiers and drivers being designed to work from an RCA condenser microphone.

An RME-9D with peak pre-selector is used for receiving.

W8KQQ is connected with one of the crystal-grinding laboratories and is unique in owning one of the few 7-mc. A-cut plates—if not the only one—in regular operation.

sockets carefully. He found it necessary to solder the pins or a tube to the socket prongs in one case.

C. W. Sparks sells insurance in N. Y. C.

—W2GHC

In reporting the preliminaries of the 1935 DX contest in *QST* for May we wished for an island where automobiles are not allowed. W8KE says he has found such a location—Mackinac Island, between Lake Michigan and Lake Huron. The same regulation also is in force in Bermuda.



center tap, but are tied to the other side of the key at A and B and to the negative terminal of the oscillator pack. But don't move the grid leaks!

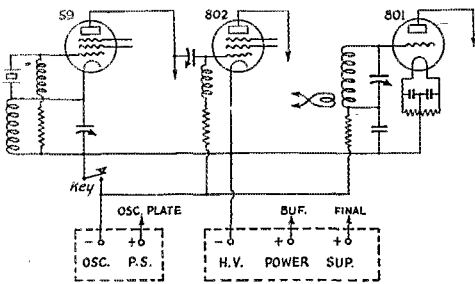

FIG. 2.—THIS CIRCUIT ELIMINATES THE NEED FOR FIXED BIAS ON AMPLIFIER STAGES FOLLOWING A KEYED OSCILLATOR

The blocking bias available is about 200 volts, which will take care of all low- and most medium-power tubes at normal plate voltages.

The system depends on the fact that when the key is open, a considerable voltage appears across it. (With 300 volts on my 59 Tri-tet, there are about 200 volts across the open key.) This voltage is used as negative bias on the amplifier grids to replace the grid-leak bias which exists when the key is closed. Incidentally, the key not only breaks the oscillator cathode current but also the grid current of the amplifier stages. But there seem to be no key clicks, and plate current to the buffer and final cuts off completely when the key is open.

—L. V. Blake, W5FFZ, ex-W1IAT

### Revised Transceiver Circuit

Those who have built the transceiver described in the Experimenters' Section in September, 1935,

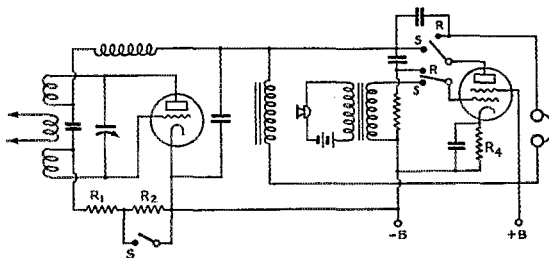

FIG. 3.—REVISED TRANSCIEVER CIRCUIT

The circuit, which requires no special transformer, was originally described in the Experimenters Section in September, 1935, QST. Constants are the same as on page 44 of the September issue except that  $R_1$  is now 5000 ohms;  $R_2$ , 50,000 ohms; and  $R_4$ , 1000 ohms. The audio tube is a power pentode.

QST, will be interested in some modifications which have since been made by its designer, W2DYR, who writes: "The revised circuit is given in Fig. 3. A 2A5 replaces the 27 modulator-amplifier in the 2.5-volt model and a 41 replaces

the 37 for 6-volt operation. The biasing resistor was changed to 1000 ohms for these tubes. The grid leak used for transmitting was dropped from 7000 ohms to 5000 ohms, and for receiving from 100,000 ohms to 50,000 ohms. This made the rig operate with more stability on  $2\frac{1}{2}$  meters."

### Spotting Frequencies

In case some experimenters may be having difficulties in getting "located" in making up tuned circuits for ten and five meters, we print herewith a letter from D. R. Stark, W8DUO, which outlines the "adjacent-harmonic" method of determining the frequency on which the transmitter or receiver may be set. The problem of identifying the order of harmonic picked up from a calibrated frequency meter working on a low-frequency band is considerably simplified by using this method. It has been outlined in QST before, but may have been overlooked or be unfamiliar to some of our newer members. W8DUO writes:

"A calibrated frequency meter is used, in the following manner:

"Set the meter to 1750 kc. and tune for a harmonic in the receiver under test. Then, leaving the receiver set at this point, tune the freqmeter slowly higher in frequency until another signal is heard. Suppose the meter reading is now 1842 kc. Next subtract these figures, (1842-1750) the difference being 92. Divide the larger figure by this difference (1842÷92=20.02+). This result, approximately 20, is the number of the harmonic of the first freqmeter reading;—in other words, the 20th harmonic of 1750 kc., or 35,000 kc.

"Another example: The meter first reads 1750 kc., with the next reading 1823 kc.

"Solving:

$$\begin{aligned} 1823 - 1750 &= 73 \\ 1823 \div 73 &= 25 \text{ (approximately)} \\ 25 \times 1750 &= 43,750. \end{aligned}$$

"Obviously the freqmeter must be read carefully, so that the result of the simple division comes out close to a whole number. If the dial reading were accurate to a few decimal places, the figures would come out in even numbers, but the rough reading will serve our purpose.

"The freqmeter may have coverage on any band, so long as two harmonics can be heard, and they may be any two figures. It is convenient to start with 1750 kc. or 3500 kc., since harmonics will then come at the low-frequency edges of the different bands."

### Combined Plate and Bias Pack

The idea of making one plate transformer supply simultaneously plate and bias voltages through the use of two separate rectifiers, although

described in *QST* many years ago, has had less application than it deserves. Here is some practical dope from M. C. Bartlett, W9JHY, who writes:

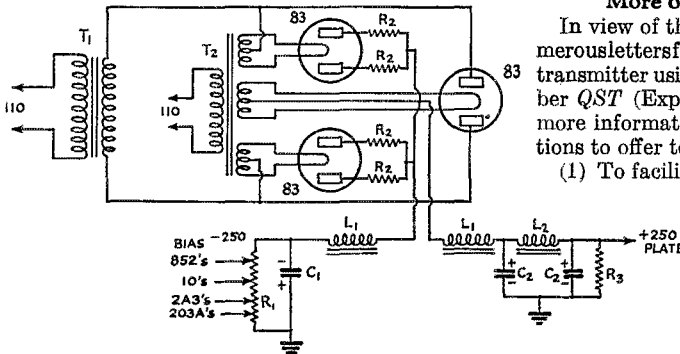

FIG. 4—COMBINED OSCILLATOR PLATE AND AMPLIFIER BIAS POWER PACK

- T<sub>1</sub>—Power transformer, 325 volts each side center tap.
- T<sub>2</sub>—Filament transformer, three 5-volt windings.
- L<sub>1</sub>—5-15-henry swinging choke, 250 ma.
- L<sub>2</sub>—25-henry smoothing choke, 150 ma.
- C<sub>1</sub>—8- $\mu$ fd. electrolytic (can not grounded).
- C<sub>2</sub>—Doubler 4- $\mu$ fd. electrolytic.
- R<sub>1</sub>—1000 ohms, 200 watts.
- R<sub>2</sub>—100 ohms, 10-watt wire-wound.
- R<sub>3</sub>—50,000 ohms, 10 watts.

"I am enclosing a sketch (Fig. 4) of a power supply that solved a problem: That of getting a bias supply cheaply.

"I already had a crystal oscillator power supply and by buying one filament transformer, one choke, one more 83, an electrolytic condenser and a resistor, I had a perfectly good bias supply that avoided the objectionable features of grounding the middle of the bleeder resistor, involving poor regulation, high voltage drop, etc.

"This rig is suitable for use with transmitters having bias requirements up to 250 volts, and is the veritable 'nerfs' for 852 tubes, or others requiring high bias values.

"At W9JHY this rig is used for the oscillator plate, and furnishes bias voltage for the whole transmitter, Class-B modulators and all."

The only point to be watched is to make certain that the high-voltage transformer can supply the additional power to be dissipated in the bias bleeder, which should have low resistance for the sake of good bias-voltage regulation. The total current in W9JHY's arrangement is in the neigh-

borhood of 300 ma., assuming 250 ma. for the bias section and 50 ma. for the oscillator and its bleeder, R<sub>3</sub>.

### More on the 6A7 Transmitter

In view of the fact that I have received numerous letters from amateurs who have tried the transmitter using a 6A7 tube shown in December *QST* (Experimenters' Section) asking for more information, I have the following additions to offer to the circuits as shown.

(1) To facilitate easy oscillation, a coupling condenser of 15-25  $\mu$ fd. should be added between No. 4 grid and plate.

(2) If the output from the secondary of the microphone transformer is less than 10 volts, an additional stage of speech amplification may be

used to give 100% modulation.

Several local amateurs brought their transmitters to me when they failed to make them work properly and in all cases were satisfied with the results obtained after the above changes were made. In one case the tube is used as a driver for a Class-B 59 tube. This seems to be a particularly useful application as a very stable transmitter is obtained with enough output for moderate DX.

—L. Tulauskas, W9LKV

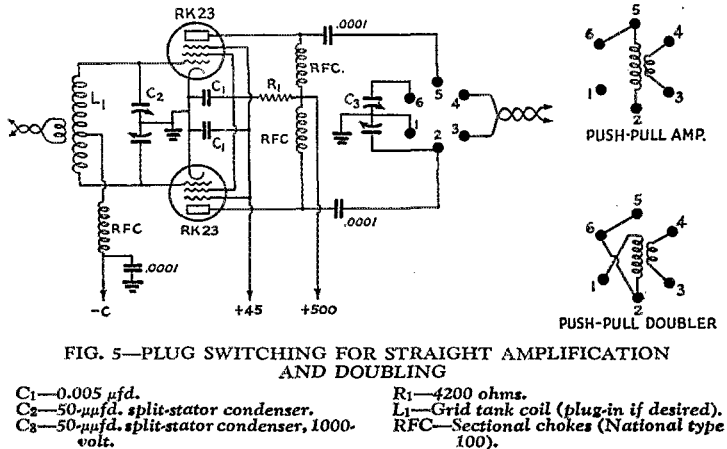

FIG. 5—PLUG SWITCHING FOR STRAIGHT AMPLIFICATION AND DOUBLING

- C<sub>1</sub>—0.005  $\mu$ fd.
- C<sub>2</sub>—50- $\mu$ fd. split-stator condenser.
- C<sub>3</sub>—50- $\mu$ fd. split-stator condenser, 1000-volt.
- R<sub>1</sub>—4200 ohms.
- L<sub>1</sub>—Grid tank coil (plug-in if desired).
- RFC—Sectional chokes (National type 100).

### Quick Shift for Amplification or Doubling

Here's a stunt that worked out a problem for me, and it might be interesting to any of the boys who are using a pair of RK23's or similar screen grid tubes for either a back-to-back doubler or push-pull buffer on a chassis-type rig. What I wanted was a plug-in changeover from doubler to

(Continued on page 74)

---

---

# ● I. A. R. U. NEWS ●

---

---

Devoted to the interests and activities of the

## INTERNATIONAL AMATEUR RADIO UNION

President: H. P. MAXIM

Vice-President: C. H. STEWART

Secretary: K. B. WARNER

Headquarters Society: THE AMERICAN RADIO RELAY LEAGUE, West Hartford, Conn.

### MEMBER SOCIETIES

American Radio Relay League  
Associazione Radiotecnica Italiana  
Canadian Section, A.R.R.L.  
Ceskoslovenski Amatérni Vysilací  
Dienst  
Deutscher Amateur Sende-und-Empfangs  
Dienst  
Experimenterende Danske Radioamatører  
Irish Radio Transmitters Society  
日本アマチュア無線聯盟  
Liga Colombiana de Radio Aficionados

Liga Mexicana de Radio Experimentadores  
Nederlandsche Vereniging voor Internationaal Radioamateurisme  
Nederlandsch-Indische Vereniging Voor  
Internationaal Radioamateurisme  
New Zealand Association of Radio Transmitters  
Norsk Radio Relæ Liga  
Oesterreichischer Versuchssenderverband  
Polski Związek Krotkofalowców

Radio Society of Great Britain  
Rede dos Emissores Portugueses  
Reseau Belge  
Reseau des Emetteurs Français  
South African Radio Relay League  
Suomen Radioamatööriyhdistys r.y.  
Sveriges Sändareamatörer  
Unión de Radioemisores Españoles  
Union Schweiz Kurzwellen Amateure  
Wireless Institute of Australia

Conducted by Clinton B. DeSoto

### Calendar:

As most amateurs know, the business of the I.A.R.U. is transacted by means of semi-annual calendars, in which proposals are formulated, presented, and voted upon, and by special calendars and circular letters. Calendar No. 16, the December Calendar for 1935, has, at the moment of writing, just been completed, preparatory to being sent to the officials of all member-societies. It contains many items of general amateur interest, and we shall therefore review it briefly.

Perhaps the most significant action taken by the Union was the adoption of Proposal No. 18, providing for representation at the forthcoming C.C.I.R. conference to be held at Bucharest in 1937. Under the terms of this proposal the Union accepted the offer of the A.R.R.L. to send its representatives to the Bucharest meeting to act in the name of the I.A.R.U. The A.R.R.L. will underwrite the expense of participation, but the actual cost will be shared by the member-societies upon a pro rata basis, worked out in terms of membership totals.

This was but one of five proposals in the previous calendar, three of which were adopted and two carried over. One of those carried over concerned the policy of the Union with respect to the Cairo conference in 1938; this policy has not yet been defined. The other proposal which was carried over was a constitutional amendment concerning the submission of annual reports by member-societies.

A large and unanimous favorable majority caused the admission into membership in the Union of the *Oesterreichischer Versuchssenderverband* (O.V.S.V.) as member-society from Austria, our twenty-sixth member-society. All members of the Union join in welcoming this new arrival.

The O.V.S.V., although not very old, is already recognized as a strong and flourishing national society with a loyal membership and capable management.

Of most general amateur interest is the adoption of Proposal No. 21, inaugurated at the behest of the A.R.R.L. Board of Directors during their annual meeting last May, which abrogates the membership rule in connection with the issuance of WAC certificates. Under the terms of this new ruling any person can receive a WAC certificate, providing he can satisfactorily demonstrate two-way amateur communication between his amateur station and other amateur stations in each of the six recognized continental areas, regardless of lack of membership in an I.A.R.U. member-society. He is, however, required to pay a fee of 50¢ (U. S. funds) to the A.R.R.L., as the Union headquarters, to cover the expense of preparation and mailing of the certificate. Certificates are issued free of charge as always, to members of Union member-societies.

Certain modifications in the boundaries of the continental areas of the world, as determined by the official I.A.R.U. distribution, have been effected as a result of a suggestion by the R.S.G.B. This has bearing, of course, in connection with the matter of WAC awards. The changes are not great, and involve practically no land areas. For all practical purposes, the map shown on page 41 of the November, 1934, issue of *QST*, can be used until a corrected map is made available. Perhaps the most significant change is the establishment of the African coastline as the boundary between Europe and Africa.

Various societies have commented on the practice, which seems to be achieving a certain international usage, of using the suffix P following

the call to indicate portable operation. This in a sense compares with the United States practice of following the call with a double dash(---) and the district numeral in which operation occurs, except that the oblique sign (-.-.-) is used instead of the break and the letter P is substituted for the numeral. This system is in use

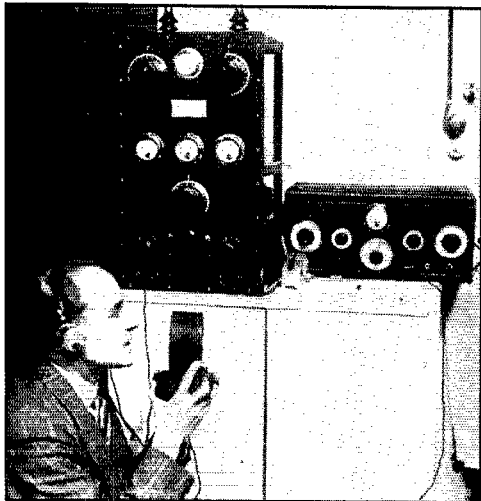

**F3AK, OWNED BY E. KLEIBER, 36 RUE ST. GUIDON, COLMAR, ALSACE, FRANCE, HAS A REMOTE-CONTROLLED 20-WATT INPUT MESNY TRANSMITTER WITH WHICH 23 COUNTRIES IN 6 CONTINENTS HAVE BEEN CONTACTED**

in England, Spain and South Africa; other countries are likely to follow this example shortly.

A variety of new business was brought up in the December Calendar, all of which will be discussed in these columns as soon as definite action has been taken.

## WAC:

The following were issued WAC certificates during 1934: Persons Dozier, Jr., W4ADA; Newton Grieverson, W2DNG; Edward F. Power, W1IAS; Miguel De Luca, PY9AM; Rudolf Lidl, D4BDP; J. M. S. Watson, G6CT; E. W. Taylor, G5VQ; Rene Kerse, ON4GW; J. Grassouw, PAOQL; W. van Heeren, PAOEG; Jack Rademeyer, ZS6AL; Peter Pennell, G2PL; George R. Scrivner, W9GTU; H. H. Kenkel, W9FSO; John N. Montgomery, W8HWU; A. J. Evans, W5EUJ; H. A. Beering, W1GDY; John Lucas, W9ICO; Charles Miller, W3BVE; Wilmer L. Allison, Jr. W5VV; Charles Ken Smith, W5AUC; Ellsworth L. Maxey, W9FUM; Charles J. Dawes, VE2BB; Americo Mantegani, CX2AM; Alexander C. Speyer, Jr., W8DML; W. Johnson, G2LN; P. J. Anderson, VK3PA; Manfred Bayer, D4BBN; K. Siegert, D4BWM; Franciszek Klosko, SP1DN; Józef Zeizer, SP1DT; Andrzej Progulski, SP1FM-SP3FM; Leon Beaurenaud, F8CJ; P. G. Tandy, G2DU; Marcel Meffre, F8PK; B. J. Nijenhuis, ZS6V; C. M. Zoetmulder, PA0ZM; Edward Roberts, W8BFG; William T. Cushing, W1CFU;

Philip C. Girard, W8GRN; Dean C. Swan, Jr., W1BXC; LeRoy W. Hansen, W9NPW; Prof. Louis D. Gadoury, VE2HG; W. G. Southam, VE2AX; W. R. LaVielle, W9ELL; Walter P. Dyke, Jr., W7BPJ; Michael Kotte, W9JDP; George S. Bennett, W6GHD; Beatrice F. Lotz (Miss), W2ML; Willard F. Hunton, W3AG; John H. Smith, W9MIN; A. H. Stovall, Jr., W6FET; Golden W. Fuller, W4BGG; Fred L. Mason, W5CCB (phone); John P. Riley, Jr., W6GPQ; E. W. Helmke, W5QW; Stanton D. Bennett, W7BUB; F. H. Jackson, G2KZ; Otakar Batlička, OK1CB; Karel Mattuš, OK2MS; Gérard de Buren, HB9AW; George A. Spencer, G2KI; W. F. Meyer, ZU6P (phone); G. Brunyee, ZS1AA; E. E. Richardson, ZU5G; J. M. Ross, ZT6A; G. J. Dent, ZS6AM; Division 5 Headquarters Station, S.A.R.R.L., Operator, Oscar Egenes, ZS5L; George Smith, W8CXC; Paul Jäger, D4BHH; Richard Bartholomeu, K4SA (phone); Stan I. Comach, VE2EE; B. M. Scudamore, G6BS; Karl Doppelhofer, OE6DK; Julius Helldoppler, OE7JH; Franz Lehrner, OE3FL; Hernani A. Cesar de Sá, CT1ED; Kurt Hartenstein, D4AAP; Lt. T. H. Beaumont, G6HB; R. H. Jackson, G6ZU; Alf J. Nybro, LA3I; Harris A. Fromhold, W9LLB; Jean W. Seymour, W9JDY; William B. Nulsen, W1AQX; Carl A. Felt, Jr., W3DSY; B. W. Naylor, VE5BI; Ross Bateman, W7AO; D. H. Smith, Jr., W3CHE; Albert Taylor, W5ANU; C. F. Stafford, W8AAU; I. de B. C. Fynn, ZE1JH; S. G. Fisher, VQ4CRP; M. D. Orr, VK3OR; Charles Miller, VK4US; N. M. Templeton, VK3HG; F. J. Stirk, VK2XV; Ron Tandy, VK3KX; Y. A. Li, AC8AL; Antonio Cruz Uribe, X1BT; H. A. Maxwell, W5CYJ; Otto F. Grapp, W3VF; Edward H. Leland, W9MRW; William G. Mathis, W3BES; Robert J. Woolsey, W9RO; Mrs. L. W. Mida, W9LW; Pablo Scremini Algorta, CX1CX; Alex Reid, VE2BE; Perry W. Esten, W8BOX; Roy E. Bardin, W6BSK; F. W. Garnett, G6XL; W. R. Stevens, ZU5N; A. Blanquaert, ON4KD; S. Charlier, ON4NIL-ON4CH; O. A. F. Spindler, VU2FY; J. Scholefield, G2TR; Yasushi Horuchi, J2HC; Werner Reidel, D4BGG; Baron Louis Bonaert de la Roche, ON4HM (phone); Clark C. Rodimon, W1SZ; Franklin H. Huyette, W7ALZ; A. L. Alexander, W1HTP; Guy M. Brown, Jr., W5DXG; Oakes A. Spalding, W1FTR; Vincent J. Haggerty, W6IOX; Louis Hopkins, Jr., W8HHW; Harold J. Pansch, W9BIB; Charles Y. Houck, Jr., W8APD; Joseph W. Donahue, W6HJW; Chester E. Watzel, W2AIF; Willard I. Bohlen, W2CPA; K. T. Harvey, G5KT; R. Barr, Jr., G15UR; Heinrich Schünemann, D4BRF; John S. Theil, W8FTM; Dr. W. H. Riheldderfer, W8KKG; Charles Jeffers, W5EBT; J. C. Patterson, W5EHM; Don Emilio Ortega Obrero, EA7BC; Marcel Mayraert, ON4VC (phone); Nils Tamm, SM5TC; Arne Rydahl, SM5ZL; Erik Olsson, SM7XE; Helmut Kehr, D4BPR; Philipp Grode, D4BBU; Kanichi Ohta, J2CN; Ichiro Terumichi, J2LJK; W. B. Girkin, W5YH; Charles P. Weaver, W9DDQ; E. W. Brambley, XUSCB; Hans Pärjel, ES7C; H. Gordon Wightman, VE5HC; Harold Lotz, W2BST; Dr. Charles A. Rosenbaum, W9GHN; Philip H. Smith, W8HUD; Lester H. Saucke, W9LHQ; Clarence E. Roach, VE1EA; A. M. Crowell, VE1DL; William C. Minor, W8KOL; Frank L. Bernhardt, W7WL; Charles Butt, W3AMP; Jay Buckley, W1ARB; Don H. Mix, W1TS; F. Paul Bour, FB8C; Frans Panniger, D4BJL; Ernest Dell, G2UL; E. B. W. Larsen, OZ8D; Svend Nielsen, OZ9S; W. Self, ZL4CK; N. Walding, ZL1FT; W. G. Turnbull, ZL2CA; W. A. Wilson, ZL2CI; W. Jensen, ZL2CW; W. H. Lister, ZS8AF (phone); B. Coleridge, ZT6M; D. O'Farrell, EI6F; E. J. Lake, VK4EL; F. Hanham, VK3BJ; Roy Stacey, VK2HY; W. E. C. Bischoff, VK6LZ (phone); J. C. Batchelor, VK7JB; H. W. S. Caldecott, VK2DA; F. E. Sechler, W9JGF; Stewart C. Hoepfer, W3CCU; Harold P. Layton, W9LNF; Liscum Diven, W2HHF; John Scarvac, W9GIL; A. W. Hingle, W3CDO; Edmund D. Miller, W8CJJ; Charles L. Crawford, W1FUO; J. L. Foley, W9CVI; Joseph H. Harms, W3COP; Lane Eldred, W9SG; Delmar W. Rowe, W9BPU; Roy W. Weisbach, W9PST; Frank F. Warth, W9LB; Ernest Gill, W3BZB; David H. Evans, W4DHZ; Stewart S. Perry, W1BB; Carl J. Theis, W8BKH; F. A. Alexander, ZU6B; W. S. Pennel, ZS1Z; Juan del Castillo, EA1BD; Fernando Y. Loyola, X1CM; J. de Wilde, ON4SV; C. E. Jefferies,

(Continued on page 78)





# OPERATING NEWS



Conducted by the Communications Department

F. E. Handy, Communications Manager

E. L. Battey, Asst. Communications Manager

OUR remarks this month might well be on the subject of "ham spirit" vs. "selfishness." It is not our purpose to talk at length about the operating policies of amateur radio, but it is high time that the attitude in which a certain group operate stations (which includes oldtimers and newcomers alike) must be condemned by the majority of thinking amateurs. The social status of amateur radio, we are assured, depends on the number of respected contacts we are able to make with the public and other organizations.

Recent letters from Press Wireless, N.B.C. and other organizations show an increasing volume of interference trouble, identified with too prominent harmonics in 3900-4000-kc. 'phone stations and broadcast listener interference. Within our own operating organization ranks complaints pile higher against inconsiderate amateur behavior on the air, not to mention too much indifference toward such important and vital undertakings as the Cairo preparatory survey! 160-meter 'phone harmonics all over the 3500-kc. band; amateurs who refuse to QSP a message; an arrogant attitude of riding rough-shod over the rights of neighboring B.C.L.'s; broad selfish signals (a.c. notes, over-modulation, etc.); failure to cooperate with other amateurs by standing by during important opportunities for emergency work; reluctance to QSL after promising; careless off-frequency operation; failure to check up on harmonic radiation; all these and other things win the censure of every right-thinking amateur. These minority ills based on an improper and selfish individual attitude seem to be widespread, to judge from letters currently received. To quote recent letters, "There was W3BHK calling QRR, and asking for a clear path for his frequency, and I'm telling you it took him over an hour to get it, for I went back from time to time to see how he was making out." "Can it be possible that of thousands and thousands of hams there are only 450 who have the interest of all amateurs and the League at heart (Cairo program) and their own privileges as well?" "Harmonics by the peck; W6 and W3 harmonics louder here than many fundamentals." "Ham spirit? I think not. Something should be said in the mag about the 'priority and common decency business.'" A.R.R.L. organization and tradition is soundly based on constructive policies of station operation and public relations. Without stressing these ills further in detail, this is an appeal to the thoughtful to follow the principles written in The Amateur's Code, and by precept and example, by influencing other amateurs at club meetings and hamfests, to clear up local situations, educate new amateurs where necessary, and report flagrant offenders where necessary to stop operation not in the interest of a respected future for amateur radio. It should be a matter of pride to nip these tendencies in the bud before they blossom into situations that hurt amateur radio. —F. E. H.

## The 1936 1.75-mc. Transatlantic Tests By David S. Mitchell, G2II

FOLLOWING discussions with various 1.75-mc. stations and the circularizing of a letter to all well-known British 1.75-mc. operators, the schedules given herewith have been decided upon.

In view of the remarkable conditions prevailing on the higher frequency bands these tests should prove particularly interesting, and it is hoped that an even greater number of W and VE stations will take part this year.

Up to the time of writing quite a number of G stations have offered to take part, and to assist in identifying weak signals, a list, together with frequencies where known, is given herewith: G6OK 1730 kcs., G2II 1740 kcs., G6FO 1760, G6OO 1766, G5FI 1769.5, G5KT 1775, G6SY 1778, G2XC 1780, G5BI 1786.5, G5MP 1790, G5OD, G2IN, G5KG, G6UJ, G6YQ, G5OP.

The tests are to be held between midnight and 2 a.m. E.S.T. (05.00 to 07.00 G.M.T.) each Saturday and Sunday commencing January 25th, and continuing each week-end until March 15th.

In order to avoid undue QRM, special 15-minute sending and receiving periods have been arranged. *Even when contact has been established* participants are earnestly requested to adhere to the periods, as transmitting in a listening period might ruin the chances of other stations.

W and VE stations are to *transmit* from the hour to the quarter hour, and from the half-hour to the three-quarter hour. These correspond with European *listening* periods.

European stations transmit from the quarter-hour to the half-hour, and from the three-quarter hour to the hour, these periods being W/VE listening periods.

W/VE stations call "CQ G" while G stations will call "TEST USA."

Participants should call TEST or CQ not more than *three* times, and sign their calls *four* times. Last year most stations sent TEST and CQ far too many times without signing.

It is suggested that stations should intersperse their 15 minute calls with short reports of stations heard or remarks on conditions which would be of interest to all.

During the tests G stations will transmit on c.w. only between 1715 and 1800 kcs., but will listen over the whole band (1715 to 2000 kcs.), as last year many of the more powerful American amateur 'phone stations were heard at QSA5 between 1800 and 2000 kcs.

At the time of writing (Dec. 11, 1935) W 'phone stations are already breaking through on the 'phone band, so let's make the 1936 1.75 tests the best yet!!

## Sweepstakes Scores

FOR the information of the waiting multitude we present here the *claimed* scores of some of the highest participants in the 1935 Sweepstakes Contest! Read 'em and weep!!

W8JIN claims a score of approximately 100,000—533 QSO's in 84 sections! It makes a fellow weary to even *think* of the work this represents! Next in line among the high claimants is W1EZ with 504 QSO's in 58 sections—86,690 points! Close in line comes W6HJT with a grand 81,648—457 QSO's, 63 sections—which will undoubtedly clinch western honors. W4AG makes his bid with 79,680—415 contacts in 64 sections. And then we find, in order, the following additional unchecked scores, all over 40,000. The figures indicate (1) total claimed score, (2) approximate number of QSO's, and (3) number of sections worked:

W8BYM 76,725—413—62, W8FIP 75,609—412—62, W3BES 72,215—563—65, W4CA/9 70,492—375—65, VE3QD 68,076—370—61, W9DCB 66,881—358—62, W8NUR (W8GUF opr.) 65,055—397—61, W5ASG 63,612—342—62, W8DOD 61,330—345—59, W8KUN 59,508—349—57, W4PL 58,588—322—64, W5CJZ 58,212—308—63, W1ELR 57,175—408—47, W1DHE 56,916—485—63, W9AUH 56,682—424—67, W3OZ 55,491—350—53, W2HHF 54,312—438—62, W2CWE 53,586—358—62,

W4IB (2 oprs) 53,105-409-65, W4BOU 51,480-286-60, W5WG 51,153-292-59, W1TS 51,124-275-63, W3EOP 50,447-417-61, W9AQD 48,699-405-63, W6LDJ 47,514-269-59, W8BEN 46,942-285-55, W1GME 46,650-311-50, W8CQB 45,705-278-55, W8FDA 45,441-283-54, W2FIS 45,022-337-45, W9RQM 44,958-256-59, W3JTT 44,820-309-52, VE3ACS 43,048-315-50, W8KKG 42,705-330-65, W5LW 42,055-324-65, W1BFT 41,998-275-51, W8AQ 41,536-346-64, W1DDE 40,719-277-49, W9VKF 40,680-225-60, W1BYP 40,470-350-57, W8MAH 40,342-246-55.

The feat of working all League sections during an SS still remains to be accomplished. W9AUH claims 67 sections this time. W4CA/9, W4IB, W5LW and W8KKG each claim 65 sections worked, while the following each list 64: W8JIN, W4AG, W4PL, W8AQ. And those listing 63: W6HJT, W5CJZ, W1DHE, W1TS, W9AQD.

The full report on the 1935 SS will appear in QST just as soon as the final checking is completed. There were hundreds of splendid scores submitted, but we cannot list them all until ready for the final report, which will list the winner in each Section, together with as many details (QSO's, sections, power, etc.) as space permits. Another gala QSO contest has gone down in history!

—E. L. B.

Mr. Hughes' article wins the C.D. article contest prize for this month. Each month we print the most interesting and valuable article submitted in connection with the article-contest. Contributions may be on any phase of amateur operating or communication activity which adds constructively to amateur organization work. Contributions should run between 500 and 750 words. Prize winners may select a 1936 Handbook, six logs, six message files, six pads, blanks, or equivalent credit toward a combination of A. R. E. L. supplies. Let's have your article. Mark it "for the C.D. contest," please.

—F. E. H.

## Fair Play

By Kenneth Hughes, W6CIS\*

THERE is no doubt in any of our minds that our amateur bands are crowded to the limit, and that we should have more territory. Until this additional space is to be had, it appears to me there are many things we could do to improve conditions in the present bands.

Recently I spent two hours on the 7 mc. band during the DX period from 5:30 to 7:30 a.m. During this time I observed several things, that if cleared up, would allow everyone to successfully work more stations. There was W6 --- with his k.w. (?) amplifier apparently not properly neutralized and oscillating, which could be heard for 75 kc. either side of his main wave. The QRM was in the form of a.c. mush which blanketed half the band. Then there was W7 --- with a terrific signal accompanied by equally terrific key clicks, which pretty well took care of the low frequency end of the band. Next was W6 --- with a very poor self-excited sounding signal, r.a.c. in character, with a nice juicy back wave off to one side. Several stations using resonant filters, regardless of the law which stipulates pure d.c.! There were stations working each other across town with their input cranked up to the maximum, to add to the enjoyment.

I am not trying to imply that DX cannot be worked under present conditions, because even with my transmitter running at 300 watts of pure d.c., I am able to work considerable DX. Neither am I advocating a reduction in the power limit on our licenses, but it does seem to me, that one k.w. is enough power for any amateur station.

How a man can get enjoyment from his station, when he uses power way beyond the limitation of his license, and purposely uses a filter to give him a so-called "distinctive" note, is beyond me. He must realize that he is over-riding the smaller stations, who either have no desire, or who cannot afford the more expensive equipment which would put them on an equal footing. The foreign DX man would also

\* Room A, Ferry Building, San Francisco, Calif.

benefit from the cleaning up of our bands. Instead of a few broad "R9-plus" W stations, he would have considerably greater numbers of clean-cut R5/6 stations with which to work.

DX is not the only phase of the game that is hampered by such practices. The traffic man works under overwhelming odds, with conditions as they are in some of the bands. Another thing, the worry and trouble from B.C.L. interference would be greatly reduced, if every station owner would be more careful and play fair with other amateurs and himself.

This game is one of the finest hobbies in the world. However, the fact remains, if each and every operator of an amateur station would watch his input and the quality of the output of his transmitter, everyone would get more pleasure from his time spent on the air. How do you stack up, OM?

## Briefs

Add to stations assisting in Florida QRR work (full report December '35 QST): W4AOK, Bartow, and W4ASE, Orlando. W4AOK was active in all three storms, handling traffic and acting as local emergency station for the National Guard and American Legion; AOK's cooperation also included the dissemination of press and weather reports. W4ASE was on watch for about eight hours.

Rex Ackley, W8IZS, 421 Wayne St., Johnstown, Pa., would like to contact any amateurs interested in cryptography with the view of starting a "cryptography club" among radio amateurs.

W8OYK started something when he told the gang how many calls he has held (page 37, Jan. QST). W1ZJ comes forward to claim the following calls held at one time or another: 1ZJ, 1ECN, 1BYN, 1DE, 3OU, 1DAP, 1IFC, and joint-owner of 1CPN. W3CES has held 1AQE, 1BBD, 1BUS, 1VY, 2HV, 3CES, 3ZZAA; 2HV and 3CES are still active. W8HD claims 8BSU, 8AKZ, 8QY, 8CCX, 8EYE, 8JQG, 8NS, 8HD; also Army assignments of WLH3, WLHB, WLHF—to say nothing of "XZ" before regular calls were assigned. W9VKF puts dates on his: 8AOF 1915-18, 1VC 1920-1, 8BZJ 1921-2, WLAM 1921-2, 8BAB 1925, 8DKE 1925-1935, 8JNI 1932-5, 9VKF 1935.

W2EYG, 60 West 190 St., NYC, feels that he must live in the most "ham-crowded" locality in the world. The following all live within "key click" distance: W2HGL, W2DXT, W2GOH, W2GYA, W2JFS, W2JBO, W2OIL, W2HWF, W2EXM, W2GBM, W2BDE, W2EYG, W2JFS and W2GYA live in the same house.

### 1.75-mc. QRR

At 4:00 a.m., December 28th, W4DSF, Athens, Ga., received a telephone call from the power company, requesting his aid in contacting Atlanta. The company's communication facilities were paralyzed by the worst ice storm in the history of the company, in that section. W4DSF immediately went to work. W4CCP, Gorgas, Ala., called W4DSF, and it was learned that W4CCP had his transmitter in the power company's offices in that city, and that his line to Atlanta was operative. The hook-up was ready to function in twenty-five minutes after the telephone call was received at W4DSF. This was all on 1.75-mc. 'phone.

After reading the excerpt about "splatterbugs" from the "Dixie Squinch Owl" (see page 57, Dec. '35 QST), W8APC suggests that maybe the main trouble is, "They're too much weight on one end, 'n not enuf on 'tother." "Why not 'Blunderbug,'" says he! We recommend that as a fitting label for some of the so-called sending heard now-a-days!

On regular schedule on December 21st, W7DBY, Buxton, Oregon, gave K7LW, Rainy Pass, Alaska, a report of S5. After some delay K7LW came back with the surprise statement that he didn't see how 7DBY heard him at all—because the antenna was off! That's about 2000 miles with no skyhook!

## DX Notes

W3CHG, Kennett Square, Pa., is interested in learning the 3rd district time-record for Working All Continents; he did it in 10 hours, 43 minutes, during December, on Friday the 13th! Stations worked: VU7FY, G5UD, VE2CR, ZT6X, VK2ZH and LU6AX, all on 14 mc. W1DZE has had over 75 foreign QSO's in 20 countries and five continents on 28 m.c.

T'was on a cold and wintry morn,  
That I got up at break of dawn.  
The rig I tuned as best I could,  
Then I sat down, DX was good!  
I heard EA, F8, D4,  
And then VK's, ZL's galore.  
A weak CQ I soon did hear  
And right away I felt some cheer.  
He signed UØ one I knew  
Was rare as even XU2.  
I called him long and signed my call;  
Then he came back? No, not at all.  
I cussed and swore at how hams could  
Have r'ceptors burn, yet rigs so good.  
Though hours and hours I called and called,  
His answer never me enthralled.  
At last I bid myself arise;  
Oh gosh! The sight that met my eyes.  
My knees gave way, my hope was gone;  
I'd failed to hook the sky-wire on.

—W4CQR.

It is helpful to know "where to look for them," and we're grateful to a number of the lads who have sent dope on when and where they are hearing them. These reports are concerned mostly with the month of December. W1TS reports the following heard between 7 and 9 a.m. EST: VU7FY 14,375 kc., VU2CQ 14,260, VS3AE 14,150, VU2LS 14,150, SU1SS 14,300. Also, between 2 and 5 p.m.: CR7GC 14,440, ON4CLS 14,425; between 4 and 9 p.m.: ZD8A 14,300, CP1AC 14,350. W1DZE worked VU7FY on December 3rd and believes it was FY's first W1 QSO. W1DZE, W3AYS, W4CQR, W5EHM, W2GTZ and W8DOD also reports VU2CQ coming through consistently. W3CHG reports VU7FY coming in regularly on about 14,385 between 1200 and 1400 GT. W8BKP worked VU7FY at 8:10 a.m., November 8th. A long list of frequencies comes from W8MAH: CR7AL T9x close to 14,295, between 1900 and 2200 GT. CR7GC T9dc chirp and creep between 14,440 and 14,460, same time. ZT6A 14,010, ZS2A 14,015, ZU6P 14,035, ZS1V 14,027, ZS1D 14,030, ZU1C 14,070, ZS2X 14,050, ZU6M 14,140, ZS1AH 14,270, ZS6AL 14,350, ZT6Y 14,340, ZS6AF 14,370, ZU6B 14,390, ON4CJJ 14,120 & 14,370, ON4CSL 14,440 and variable, VQ4CRO 14,096, VQ4CRH 14,330, MX2B 14,420, UK4LB 14,430, J8CA 14,150, FB8AB 14,320; these VK's have been heard coming through between 2000 and 2300 GT: VK5GW 14,330, VK2HZ 14,375, VK4EI 14,270, VK3RX 14,295, VK3CN 14,330, VK5LJ 14,140, VK3ML 14,060.

W4CQR worked VQ8AF and VQ8AC (old V8AF and V8AC) during the Thanksgiving holidays; frequencies 14,060 and 14,155, respectively; both stations have d.c. notes and are anxious to contact east coast stations. W4CQR reports OA4AA back on the air, crystal-controlled on 14,100 kc.; VO48, the portable-mobile of VP90, has returned to the British Isles and is now operating under GSOT. W4AUU was the first station to work FB8C under his new call, FB8AB. W4AUU WAC'ed in eight hours in November. W8LEC, Detroit, worked ZD8A (old VQ8A, Ascension Isld.) at 2:45 p.m., December 12th; a T9 signal on about 14,300 kc. He also worked FB8AA (old FB8IA) on 7 mc. (near center of band) at 10:15 p.m., December 6th. VE1GE reports NX2Z coming through on 'phone nearly every day on the low-frequency end of the 14-mc. band, also ON4CSL on 14,400 kc. with T9 note almost daily. W4CQG on 14 mc. worked 42 VK's and 6 ZL's from November 28th to December 29th, between 12:15 a.m. and 8:00 a.m.

During late December, South Africans have been worked daily at W6CNX (the combined stations of W6CNX and W6AUX) the long-way around on 14 mc. from 8:00 a.m. to 11:00 a.m., and Africans have been heard the short-path

from noon to 1:30 p.m. They have been able to verify the fact that on the west coast South African signals on 7 mc. come the west-way in the mornings and the east-way in the evenings. Some interesting low-power tests have been held with ZS6AL and ZE1JN on 14 mc. in the mornings over the long-path. ZS6AL succeeded in transmitting copiable signals when using a power input of .12 watts and the same was true of ZE1JN when using .46 watts. The distance to ZS6AL is approximately 14,500 miles, corresponding to 121,000



A MEXICAN HAMFEST

Standing, left to right, X2CB, X2R, X2I, X2CJ, X1GK, X2CV, X2V, X2O, X1G, X2N, X2BQ. Front row, left to right, X2AI, X2BR, X2AX, X2I.

miles per watt. Transmitting and receiving antennas at W6CNX consist of two Rhombic skywires, one for Australia and South Africa, and the other for Europe. It has been found that signals from Australia, arriving in the eastern U. S. around 4 to 5 p.m., are coming the long way around, as on December 21st W6CNX was QSO VK3MR at 1:00 p.m. PST the long way around. At this time the east coast stations were also working VK3MR and other VK's, and at the same time W6CNX was able to hear South Africa the east-way around. VK3MR was absolutely inaudible on the Australian beam, which passes directly over him going the short-way around, while he was perfectly copiable on the European beam, the radiation pattern of which is such that Victoria, Australia, is on the very edge of its pattern.

Some more frequencies: W3CHG reports VQ3MSN, about 14,430, comes through nicely around 1900 GT; ZD8A (ex-VQ8A) has good signal on about 14,320, T9x; VQ2TT, T9x, 14,330, a new one. W8BKP has been hearing VQ2RS, VQ2TT and VQ2XD between 14,275 and 14,325. He worked CR7GC at 4:15 p.m., November 8th, and VK3ES at 3:10 p.m., November 7th, which he says is hard for that neck of the woods (Ohio). Plenty of VK's and ZL's are reported by many on 14 mc.: W3AYS says VK's always good in the morning about 9:00 a.m. EST. W4CQR also reports the VK's rolling in FB in the mornings. W8CYW worked VK2EO at 11:45 a.m. EST on December 8th, the latest he has ever heard VK on 14 mc. W8DOD worked VK5GW at 4 p.m., December 18th. W2GTZ worked VK3MR, December 21st, at 3:30 p.m. EST for an R9 report. VQ2TT is also reported worked by W5DXG on about 14,325 at 2:50 p.m., December 4th, T9x note. W5DXG worked ON4CJJ at 3 p.m., December 9th, T9x.

The first night W9MRH, Saybrook, Ill., was on 3.9-mc. 'phone he was heard in New Zealand by an SWL, it being the SWL's first reception of the U. S. W9MRH has 500 watts to a pair of '03A's and an antenna 214 ft. long, 80 ft. lead-in and 105 ft. counterpoise. Antenna is 125 ft. high at one end, 60 ft. at the other. W2HOU was heard in England on 1.75-mc. 'phone while running only 30 watts input; he was reported S7. D4ARR is looking for a 3.5-mc. contact with South America. Such a contact will make him WAC on four bands—28, 14, 7 and 3.5. Quite a few reports are being made of contact with XOHIT, a Finnish ship. W5AIR sends the following details: "The operator told me that he was Leo Kivi from Helsingfors, Finland—operating aboard the Finnish Training Ship, *Jouten*, outbound from Helsinki, Finland to Venezuela, South America. His QTH when I worked him was 41 degrees West, 16 degrees North. His frequency approximately 7100 kc., a fair d.c. note." Other "odd ones"

## 56 Mc. at Outboard Races

reported, reputed to be ships, are: ZZ2A, worked by W8DOD and heard by W4CQR, approximately 14,350 kc.; B1ST, worked by W5EHM, said to be off coast of China, T9x, about 14,300; XSG2, worked by W5AIR, T7, about 7100 kc., said to be 2500 miles east of Florida coast. W5EHM wants to know, "Who is PF2BD, heard here often, r.a.c., about 14,380?"

W2GTZ suggests the following procedure as a mutual aid move in locating DX stations. He writes, "When we work DX, on our sign-off, why not make the sign-off as follows: Suppose I have just finished with VU7FY whose frequency is 14,385 kc. My sign-off would be VU7FY VU7FY 385 de W2GTZ VA. We all know the band we are working in, so there is no sense in sending the number 14,385. Likewise, if we are working in the 7-mc. band and the DX station is on 7130 kc., the number need only be 130. Thus, if we are hearing a W ham working VU7FY and wait for the sign-off, we immediately know what frequency VU7FY is on and can call him and know where to look for him. Let's hear from the rest of the DX gang as to what they think of the idea."

W5EHM reports Africans coming through on 7 mc. from 10 to 11 p.m., Europeans from midnight to 2 a.m. He recently worked LA1F, and hears G, PAØ, EA, D and F regularly. On 14 mc. he reports Africa rolling in from 1 to about 5 p.m., ZS6AF, 'phone, being heard S7. W8DOD worked ZL2GN on 3.5 mc. at 3:26 a.m., December 16th; the ZL was on 3505 kc. W8LMI on 3.5 mc. has worked six countries on three continents with 40 watts to a type ten; continents are Europe, Africa and North America.

The Central Division Regatta of the American Outboard Association was held September 14th and 15th on Lake Wingra at Madison, Wis. The Four Lakes Radio Amateur Club of Madison provided 56-mc. communication between the judges' barge out in the lake and the shore control position. W9GXN was in charge of the land station, being assisted by W9RZL, W9TDN and W9IYL. These lads were kept exceedingly busy copying and relaying information that came to them from the judges' barge. The barge station was operated by W9HBH and W9RNK. Transceivers were used at both stations. On the first day everything went smoothly and efficiently with the exception of some loss of time in getting information from the shore position to the race pits via land line telephone. This condition was remedied on the second day by the installation of W9IYL's a.c.-operated 56-mc. receiver at the pits; this was operated by W9HBH. By use of this receiver all pertinent information was received simultaneously at the shore control station and the pits. All in all, "the amateurs came through FB" and received the highest praise of the race officials.

September 7th-8th-9th was a gala period for 56-mc. operation at Lake Merritt in Oakland, Calif. These were the dates of the Pacific Coast Annual Outboard Championship races. Two world's records were smashed in the three-day event and several others were equalled. Communication was provided by amateur radio. Five 56-mc. stations were used in all. One at the judges' stands, one at the motor pits and three others operating strictly mobile on the three crash boats. The two shore stations were a.c.-operated with the exception of the storage batteries, while the three crash-boat rigs were battery-operated. Rigs were donated by W6GEA, W6IDB, W6LSJ, W6JBH, W6LTC, W6HLH, W6OT and W6JPR. Operators were W6FKQ, W6IDB, W6MQS, W6LSJ, W6ZCN, W6LDD and W6HH. The two shore stations handled messages between the judges and the pits relative to the program as a whole. The crash boats received orders as to the disposal of overturned speedsters, in aiding the drivers and mechanics who were in the overturned boats, keeping the course open to the racers, and the ferrying of officials from judges' stand to the pits. The judges' float station was used at all times as control station. Speed of message handling was remarkable. One test message was sent by radio to the pits and given at the same time to Naval Reserve semaphore ops. Radio answer was received before the semaphore had finished sending it! Amateur radio was given several fine pats on the back by the officials. It was another job well done!

## BRASS POUNDERS' LEAGUE

(November 16th-December 15th)

Call	Orig.	Del.	Rel.	Total
W1FFL	108	183	1018	1309
W2BCX	32	32	1167	1231
W9HUO	41	12	1148	1201
W1ZQ	34	283	833	1150
W1IP	11	21	998	1030
W1IEG	2	132	810	944
W9JED	251	160	349	760
W9KG	81	109	612	762
K6FKB	250	178	307	735
W6FAM	41	44	650	735
W5MN	42	358	272	652
W2EGF	35	23	548	606
W6CXK	251	320	—	571
W5CEZ	70	59	436	565
W9ESA	28	52	484	564
W9FLG	49	32	482	563
W3EZ	26	102	428	556
W9SCP	69	129	315	544
W2LU	27	32	462	521
W1HWE	214	156	148	518
W9ESA*	22	74	422	518
W8JTT*	38	70	410	518
W1MYY	242	34	226	502

### MORE-THAN-ONE-OPERATOR STATIONS

KA1HR	563	307	922	1792
W9BNT	415	537	754	1706
W3SN-EOU	206	306	663	1265
W1DCW	6	3	988	997
W1OR	75	87	608	770
W4BBV	122	35	518	675
W3CXL	19	28	491	538

These stations "make" the B.P.L. with totals of 500 or over. Many "rate" extra credit for one hundred or more deliveries. The following one-operator stations make the B.P.L. for delivering 100 or more messages; the number of deliveries is as follows: Deliveries count!

W6CDD, 345	W5DZU, 119	W3BWT, 107
W6GHD, 321	W8ATT, 117	More-than-one
W6BMC, 304	W1MK, 114	W1YK, 204
KAILG, 162	W6BPU, 111	W6ZG, 166

### A.A.R.S. STATIONS

Call	Orig.	Del.	Rel.	Total
W1MI (W6GXM)	115	144	788	1047
W1VH (W6MC)	5	19	676	700
W1NF (W2BCX)	22	8	517	547
W1QA (W3OK)	—	—	517	517

### MORE-THAN-ONE-OPERATOR STATIONS

W1M (W3CXL)	232	172	2778	3182
-------------	-----	-----	------	------

A total of 500 or more, or just 100 or more deliveries will put you in line for a place in the B.P.L.  
\* October-November.

## W1MK Schedule

The A.R.R.L. Headquarters station W1MK is on the air from 7:00 p.m. to 1:00 a.m. EST the nights of Sunday, Monday, Tuesday, Thursday and Friday. In addition to maintenance of this regular operating schedule, Chief Operator Hal Bubbs keeps W1MK active on the air during the League's various contests and operating activities. On Monday and Tuesday nights W1MK will be found on 3575 kc. (when operating in the 80-meter band) and on 7150 kc. (when in the 40-meter band). On Sunday, Thursday and Friday W1MK uses 3825 and 7150 kc.

Official and Special Broadcasts are transmitted to A.R.R.L. members from W1MK on the following schedule: Simultaneously on 3825 and 7150 kc.—Sunday, Thursday and Friday 8:30 p.m. EST, Sunday and Thursday Midnight EST, Friday 10:30 p.m. EST. Simultaneously on 3575 and 7150 kc.—Monday and Tuesday 8:30 p.m., Monday 10:30 p.m.

Schedules are kept by W1MK with the following stations: W1CME, W1HJW, W1IP, W9OX, W1F10, W3BJO, W2DXO, W3BWT, W4BBV, W6AM, W8GUF, W9FO, CM5YB, NY1AA. Traffic for headquarters may be routed through any of these stations for speedy delivery. At every opportunity when the station is not busy with schedule work, W1MK is open for general contacts and endeavors to work as many amateurs as possible. QSL cards are sent to all new stations worked.

## W.B.E. Rules

There are some 40 or 50 United States amateurs who hold Radio Society of Great Britain's W.B.E. certificates. In answer to inquiries received from time to time as to the rules governing the W.B.E. award, we print herewith the complete rules as furnished by R.S.G.B. Special attention is called to the fact that R.S.G.B. recommends that all holders of certificates add the letters (C.E.) in brackets after the letters W.B.E. to show they are actually certificate holders. Many claim to be W.B.E. but have no certificate to support it.

1. The W.B.E. certificate shall be awarded by Council to Corporate members of the R.S.G.B. or the B.E.R.U.

2. The W.B.E. Certificate shall be awarded in accordance with Rule 1 to those persons who have effected two-way communications on amateur frequencies, with at least one station in some part of the British Empire located in each of the other four continents. The signal reported shall in no case be less than QSA 3.

3. In forwarding a claim a member shall give a guarantee that his licensed power has not been exceeded in effecting the QSO's upon which the claim is based.

4. All applications shall be made in writing to the Secretary of the R.S.G.B., and shall be accompanied by documentary proof, in the form of letters or postcards, that the claim is justified.

5. For the purpose of differentiating between the five continents, Council shall approve a map of the world showing clearly certain arbitrary datum lines. A copy of this map shall be held at the Headquarters of R.S.G.B. and arrangements made to publish a reproduction in the Society's *Journal*.

6. All claims shall be judged in conjunction with this map.

7. Members to whom the W.B.E. certificate has been issued shall be permitted to use the letters "W.B.E." on personal correspondence during the time they are members of the R.S.G.B. or the B.E.R.U.

8. Communications with ship stations sailing under the British flag and British mobile stations will be considered as Empire contacts.

9. British mandated territory and Protectorates shall be considered as forming part of the British Empire.

The above rules were initially approved in Council January 22, 1930, and amended March 21, 1934.

## O.B.S.

The following is a supplement to the list of A.R.R.L. Official Broadcasting Stations in November *QST* (page 60): W3BIW, W3COT, W4QI, W5DWW, W9HUO, W9TBF.

## Briefs

*In Memoriam:* The Bachelors Club regretfully announces the passing of one of its Charter Members—W8FTW—he was married December 14, 1935! Chalk one up for the YL's.

During November W7ENQ, W7BPM, W7DTK, and an S.W.L. took a portable outfit using one-watt input and drove to W7ENQ's OM's ranch in the Blue Mountains, 25 miles southeast of Walla Walla, Wash. They maintained a daily schedule with W7FCG in Walla Walla, and week-end schedules with W7FIP and W7HR. The second day in the hills a blizzard came up. While the wind blew at a velocity of 40 to 50 m.p.h., and the snow fell at a rate of one foot an hour, the boys began to drive to another cabin two miles away. A mile on they wrecked the car. They hiked back through the snow and cold, getting back just in time to schedule W7FCG whom they asked to advise W7ENQ's dad that they were starting to hike back to town. ENQ's OM advised that he would drive toward them as much as possible and meet them. Two days later ENQ and the S.W.L. returned from Walla Walla with the necessary repair parts, hiking 12 miles back to the wrecked car. ENQ recommends this kind of exercise for that school-girl figure.

Four students at Virginia Tech decided to be partners in electrical engineering lab. Later it was found that all four were hams! They are known in amateur circles as W9GGB, W2DJV, W3BYQ and W3EBD.

Sam Trainer, VE3GT, well-known ardent brass pounder and SCM of the Ontario Section, A.R.R.L., recently embarked on the good ship "Matrimony" with Miss Carroll F. Corley. The best wishes of the gang go to Sam and Tommy, as she is known by their amateur friends!

While conducting a listening test on his new metal-tube super, Jim Lamb (J.J.L.) tuning on 7-mc. logged *W1JL* calling *W1MK1!*

A little brass pounder, an eight-pound boy, arrived at W5NW on October 5th. The West Gulf Division Director has been "running around on all four wheels since that date," and reports the OW and OM doing nicely! FB, "Soupy," and congrats!

The Harlem Radio Club is conducting free classes in radio at the Hunton School of the Y.M.C.A., 180 West 135th Street, N. Y. C. Classes in radio theory, radio servicing and radio operating are being held from 2:00 to 5:00 p.m. and from 8:00 to 9:00 p.m., Monday to Friday, inclusive, and every Saturday from 7:00 to 10:00 p.m., all times E.S.T. Instructors are W2GTU, W2CSQ and W2BCE. Anyone interested is invited to attend these classes.

The notice regarding membership in the newly formed "Bachelor's Club" which appeared in a recent *QST* brought numerous replies and applications. The Chief Bachelor, W9KJY, advises that a few applications were lost. If you did not receive a reply to your request, he would appreciate hearing from you again. Requirements for membership in the Bachelor's Club are that the applicant be a radio amateur, single with a sincere desire to remain that way, over 18 years of age, and must have handled, some time since Jan. 1, 1935, a total of 50 message counts. Address all applications to W9KJY, 327 Brandon Ave., Glen Ellyn, Ill.

VP9O, an officer on the goodwill ship, *H.M.S. Scarborough*, anchored at Portsmouth, N. H., October 6th, was tendered an impromptu reception by the amateurs of Kittery, Maine, Hampton, N. H., and Newburyport, Mass. Soon after arrival at Portsmouth, VP9O got in touch with Kittery hams, who took him to Hampton Beach where W1HSC arranged a series of visits to local shacks. VP9O has a 14-mc. 'phone aboard and is QSO 'most everything when afloat. What a heaven for a 14-mc. job—on a battle wagon! Those participating in the celebration for VP9O were W1HSC, W1CEA, W1GIN, W1GMM, W1EUE, W1AEF and W1QW.

An O.R.S. appointee is a *traffic hound*—not necessarily a *traffic hound*, but an *active*, efficient and reliable operator, keeping skeds as many days per week as possible with other reliable stations, and doing all he can to keep his section on top. His interest is in seeing his section listed among the leaders.

—W9KJY, Illinois R.M.

## VE2HN/W1EBM Aid Auto Crash Victims

Through an emergency call from VE2HN, answered by W1EBM, the life of a man seriously injured in an auto accident was recently saved. The accident, which happened near the home of J. N. Cartier, VE2HN, consisted of an auto skidding, running into a ditch and striking a telephone pole with such impact as to snap the pole. This disrupted telephone communication from VE2HN so he turned to amateur radio to reach the nearest doctor, who lived several miles away. Calling "CQ-QRR" he raised W1EBM, Skowhegan, Maine, who called the doctor by long distance 'phone and brought him to the scene of the accident in time to perform the necessary first aid.

We have previously mentioned several interesting 'phone nets in operation around the country, such as the Knights

of the Kilocycles, The Breakfast Club, The Haywire Net, The Black and Blue Net, etc. A new net, just recently organized, is the "Associated 'Phones," working in the 3.9-mc. band. Among the members of this group we find W9VDQ, KIP, DFI, RG, JI, BBU, AMO, DMG, LZP, RZS, OWW, FAX, BNU, JNI, VZU, DBU, W8IKA, BS, DSE, DFZ, DIA, LXD, IJZ, DJ, PX, HLM, CXM, DX, DJE, DIA, BHD, CCY, KJM, BDD, CYN, LXV, ARW, ICF, MDU, IWL, GGS, LSZ, QA, IKN, DSU, W3AHQ, FVF, BFK, COSYB. The Associated 'Phones meet every Tuesday night at 10:00 p.m. EST.

The results of the Second Polish International Competition (for QSO's between Polish and amateurs of other countries) have been announced as follows: In the outside, Poland group, SUISG won first place with 93 points, U9MI second place with 63 points, and SUIEC third with 57 points. Each of these amateurs received a special diploma and a years subscription to the magazine of the L.K.K. Among the Polish competitors, first place was won by SPIAR with 84,942 points, second place by SPIDN with 33,480, and third by SP1DT with 22,200.

## Did You Know

- that W5BMI and W6BMI both live in Arkansas now, and both rate up in the "heavyweight" division of ham radio?
- that (in 1936) H still has (officially) 4 dots, not 6 or 7?
- that the VE2 QSL Manager, VE2AH, is Oke?
- that according to W5CVO a piece of battery compound melted on the tip of the screwdriver will hold the screw to go in one of those "hard to get at" places?
- that A.R.R.L.'s Emergency Corps has its first chance for tests of portables in the June Field Day?
- that a flashlamp connected in series with the input to the filter condensers will save the rest of the power supply from damage in case of a breakdown and is cheap insurance?
- that short CQs, with call inserted often for identification, always get best results? (that is, next best to *listening* and calling the station you want!)

## ELECTION NOTICES

To all A.R.R.L. Members residing in the Sections listed below: (The list gives the Sections, closing date for receipt of nominating petitions for Section Manager, the name of the present incumbent and the date of expiration of his term of office.) This notice supersedes previous notices.

In cases where no valid nominating petitions have been received from A.R.R.L. members residing in the different Sections in response to our previous notices, the closing dates for receipt of nominating petitions are set ahead to the dates given herewith. In the absence of nominating petitions from Members of a Section, the incumbent continues to hold his official position and carry on the work of the Section subject, of course, to the filing of proper nominating petitions and the holding of an election by ballot or as may be necessary. Petitions must be in Hartford on or before noon of the dates specified.

Due to a resignation in the Washington Section nominating petitions are hereby solicited for the office of Section Communications Manager in this Section, and the closing date for receipt of nominations at A. R. R. L. Headquarters is herewith specified as noon, February 17, 1936.

Section	Closing Date	Present SCM	Present Term of Office Ends
Oklahoma	Feb. 10, 1936	Carter L. Simpson	Feb. 15, 1936
Alberta*	Feb. 10, 1936	J. Smalley, Jr.	Feb. 18, 1936
Montana	Feb. 10, 1936	O. W. Viers	Feb. 18, 1936
Washington	Feb. 17, 1936	Niilo Koski (resigned)	.....
Philippines	Mar. 10, 1936	N. E. Thompson	Mar. 15, 1936
Southern Minnesota	Apr. 10, 1936	Francis C. Kramer	Apr. 16, 1936
Utah- Wyoming	Apr. 10, 1936	Arty W. Clark	Apr. 16, 1936
South Dakota	Apr. 10, 1936	Mike G. Strahon	Apr. 16, 1936
Hawaii	Apr. 15, 1936	Atlas O. Adams	Apr. 23, 1936

\* In Canadian Sections nominating petitions for Section Managers must be addressed to Canadian General Manager Alex Reid, 169 Logan Ave., St. Lambert, Quebec. To be valid such petitions must be filed with him on or before the closing dates named.

1. You are hereby notified that an election for an A.R.R.L. Section Communications Manager for the next two year term of office is about to be held in each of these Sections in accordance with the provisions of By-Laws 5, 6, 7, and 8.

2. The elections will take place in the different Sections immediately after the closing date for receipt of nominating peti-

tions as given opposite the different Sections. The Ballots mailed from Headquarters will list the names of all eligible candidates nominated for the position by A.R.R.L. members residing in the Sections concerned. Ballots will be mailed to members as of the closing dates specified above, for receipt of nominating petitions.

3. Nominating petitions from the Sections named are hereby solicited. Five or more A.R.R.L. members residing in any Section have the privilege of nominating any member of the League as candidate for Section Manager. The following form for nomination is suggested:

(Place and date)

Communications Manager, A.R.R.L.  
38 La Salle Road, West Hartford, Conn.

We, the undersigned members of the A.R.R.L. residing in the ..... Section of the ..... Division hereby nominate ..... as candidate for Section Communications Manager for this Section for the next two-year term of office.

(Five or more signatures of A.R.R.L. members are required.) The candidates and five or more signers must be League members in good standing or the petition will be thrown out as invalid. The complete name, address, and station call of the candidate should be included. All such petitions must be filed at the headquarters office of the League in West Hartford, Conn., by noon of the closing date given for receipt of nominating petitions. There is no limit to the number of petitions that may be filed, but no member shall sign more than one such petition.

4. Members are urged to take initiative immediately, filing petitions for the officials for each Section listed above. This is your opportunity to put the man of your choice in office to carry on the work of the organization in your Section.

—F. E. Handy, Communications Manager

## ELECTION RESULTS

Valid petitions nominating a single candidate as Section Manager were filed in a number of Sections, as provided in our Constitution and By-Laws, electing the following officials, the term of office starting on the date given.

British Columbia	Don R. Vaughan-Smith, VE5EP	Nov. 20, 1935
Connecticut	Frederick Ellis, Jr., W1CTY	Dec. 4, 1935
San Diego	Harry Ambler, W6EOP	Dec. 16, 1935
Northern Minnesota	Leonard Hofstad, W9OWU	Dec. 16, 1935
Southern Texas	Ammon O. Young, W5BDI	Dec. 16, 1935
Saskatchewan	Wilfred Skalte, VE4EL	Dec. 16, 1935

In the Ontario Section of the Ontario Division Mr. John Perdue, VE3QE, Mr. F. H. B. Saxon, VE5SG, and Mr. Arthur Ferguson, VE5HP, were nominated. Mr. Perdue received 48 votes, Mr. Saxon received 43 votes, and Mr. Ferguson received 30 votes. Mr. Perdue's term of office began November 15, 1935.

In the Wisconsin Section of the Central Division Mr. E. A. Cary, W9ATQ, Mr. Karl E. Medrow, W9AKT, and Mr. William G. Cram, W9BVE, were nominated. Mr. Cary received 78 votes, Mr. Medrow received 41 votes, and Mr. Cram received 39 votes. Mr. Cary's term of office began November 15, 1935.

In the Western New York Section of the Atlantic Division Mr. Charles Smith, W8DSS, and Mr. William E. Thompson, W8BDV, were nominated. Mr. Smith received 204 votes and Mr. Thompson received 123 votes. Mr. Smith's term of office began December 8, 1935.

## Station Activities

### CANADA

#### TO ALL CANADIAN MEMBERS:

I wish to express my sincere appreciation for the support accorded me in the recent election. I assure you that I will continue to represent you, as in the past, to the best of my ability. It is not yet too late to extend to all Canadian Amateurs the season's greetings, and my thanks for all the cards and radiograms received.

Fraternally,

ALEX REID,  
C.G.M.

### MARITIME DIVISION

MARITIME—SCM, A. M. Crowell, VE1DQ—Nova Scotia; VE1GL is kept busy lining up T.L. stations and, although QRL in day as Jr. clerk, has the evenings for keeping the Maritime Net in FB shape. ER is still holding several T.L. schedules including VE2DG, HH, outstanding P.E.I. station, schedules GL and EQ daily and GS Sundays for P.E.I. traffic. F'I made over 4000 pts. in the SS Contest. BL is making the '45 do its stuff on 7 and 14 mc. DB is awaiting parts for the new rig. HX is QRL work. BZ has

been quite ill for the past two months. EY is still QRL service work. FW has the new crystal rig on 14 mc. AB is working some DX on 3.5 mc. FG changed his QRA. DM is kept pretty busy making trips to the mainland. BK is a newcomer on the air in Glace Bay. HO will be on 3.5 mc. during the winter months. FV has YL QRM! DL is on 7 mc. again. DR lost his D.B. mike. Ex-DW now sines VA. EC, formerly AC8MN, is going strong on 14 mc. at Dartmouth. ET has the 14-mc. 'phone going now. EV sends in splendid dope on new Moncton Club; officers are: pres., DC; vice-pres., CX; secy-treas., EV. DC is using a pair '46's mod. by '46's Class B with about 40 watts input and is doing some nice work on 28 mc. CX has about the same kind of rig on 14 mc. GI is very busy rebuilding and fixing up rig. IJ has '45 Hartley and t.r.f. d.c. receiver. IK had the misfortune to lose his father. Sorry, OM. EV has '47x and 2A3 rig on 3.5 mc. and Hartley on 7 mc. using '45. He worked G6PF with the '45 for an hour and half. DI had 59 osc. and P.P. '46's on 3.5 mc. GU, North Minto, had fine chat with G2KV on 3.5 mc., getting Q4R4 with only 50-w. input.

Traffic: VE1GL 55 ER 42 HH 8 FT 1.

### ONTARIO DIVISION

#### VE3-3.5-MC. QSO CONTEST

Starts: 6 p.m. E.S.T., Friday, Feb. 7th  
Ends: 12 Midnight, Sunday, Feb. 9th  
3.5/4-mc. band only

Eligible: All VE3 Amateurs.

Scoring: 3 points each QSO; 1 point extra for QSO with R.M. or S.C.M.

For Final Score: Multiply totalled points by the number of counties worked. Multiply this result by 3 if you used a type '45 or single '10 in your final or, by 1, if you used P.P. '45's or upwards in your finalstage.

Example: No. of points by QSO X counties X 3 or 1, according to tube or tubes in final.

Prizes: For highest grand total—Silver Cup!  
Donated by S.C.M. For poorest score at discretion of judges—A Sur-Prize!

Reports of this contest to be in hands of S.C.M. along with your regular report by February 16th, to count in final result.

ONTARIO—SCM, Jon V. Perdue, VE3QK—R.M.'s: 3RK, 3GG, 3DU, 3TM, 3WX, 3QK. Thanks for the grand support in the recent S.C.M. election, Gang! I'll do my darndest to satisfy all of you. JT ups and leaves the traffic gang indefinitely. Scallions to ya, Frank! GT is settled in new diggin's with new wife. Congrats and best wishes, Ban and Tommie! GG, the ole "Footpad," preys on young VE fry with a magical result and keeps T.L. "I" alive in the northland. CG is new traffic man headed for O.R.S. tout suite on a bargain with the S.C.M. ABW tosses his 20 watts around the map like a KW. and will be present at the next O.R.S. Party. FT is opping with the Lincoln Ellsworth Expedition for whom we have grave concern at the moment. AEV is heard on 1.75 mc. daily. KC, TN and PA are DX-bound on 7 mc. BC has QSY'ed to London and schedules our latest thing in benedicts, GT, before the hens arise. DU, besides doing a swell job of R.M.ing, takes time out to claim the first VE/G contact on 28 mc.!! EB, Dave! WD works DX on 3.5-mc. 'phone, HITG being his latest. RO is QRL school and the jitters. WX keeps the Windsor young fry under a downy wing . . . sometimes! ZV is pointing for commercial and O.R.S. tickets. AHE and AHL are newcomers in Windsor on 7 and 3.5 mc. respectively. CP has fist trouble and says that he isn't ole Bill Marks MIM and do we know it!!! ABT can't seem to corral his umpteen harmonics from an ancient '03 that is long overdue for a pension. Walter Kenny, ex-NC3EC, is hard bitten after a QSO with 9AUT from QK's shack, and will be a gain for VE3 when he hits the air. FB, Walt. ACS wants more contests and more XTAL. WK is most reliable O.R.S. in

the Section, and our hats are off to Art, 9AL, and old Whit MB for consistency . . . a lil bird hints that MB and TM are sporting RK-20's with 'phone aspirations! AGM tells us of a 100% A.R.R.L. club in Kirkland. KM runs input up to half kilowatt. NH is turning to 'phone. ADF is building rack and panel. VZ increased power and is trying 'phone. QE is also on 'phone. PO is among Pioneers on 28 mc. HT is thinking of turning his fist to traffic, and we hope Hamilton will at last have a traffic station. TO and VZ have new 830 in final. MX is at grid modulating a 211. AEZ and AFA have new receiver and lots of pep for season. AHG is QRL YL's. YX and AFX represent Caledonia. AEM is all for traffic and will get what he wants. AEL works in with XU, AIB, AEE, MJ, AEF, KJ, on Toronto "Temegang Net." Ianke: . . . we'd like to hear more of that gang. NX, KM, FB, GO and JJ are heard on 'phone and we wonder if they are aware of O.P.S. and P.A.M. appointments and requirements. TH is growing about receiver. WU joins the Oakville gang with 60 cycle to play with. GI is in midst of a.s. receiver: 58-2A7-58-57-2A5-24A . . . how cum the 24A tagging along? AEG will be on by this reading with new receiver. EA had picnic in SS and VE/W shindigs and hooked EA in contest using 59-'46-P.P. '46's for 40 watts . . . he offers FB suggestion that A.R.R.L. sponsor a course in clock reading for the gang who read backwards, such as those who transmit when silence prevails in 3.5-mc. DX tests. WA, MY and OE fiddle around on 28, 14, and 56 mc. respectively. XA, FO, FJ and 9BW threaten to bust forth with 1/2-KW 'phone and s.s.s. receiver. SG is doing FB work with Q.C.A.R.C. traffic comer-upper. The S.C.M. encourages 'phones to avoid 3855 kc. inasmuch as the League has furnished TM and QK with Trunk Line "M" crystals on that frequency and QRM could be mutually avoided with a lil graphite or a 'phone QRX between 7 and 7:30 p.m. I should appreciate a card from any Cairo Survey Volunteers. I think that I may be of assistance. Thanks to "The Gentlemen of the Routes" who so nobly assisted in the founding of the new R.M. network in Ontario on 3765 kcs. C'mon, Gang, and let's swamp Hdqtrs. with a colossal report each month . . . and don't forget the big VE3 QSO Contest on Feb. 7th-9th . . . 73, more anon. . . .

Traffic: VE3QK 91L GG 185 SG 115 TM 93 ABW 84 WK 60 CG 52 DU 43 WX 31 GT-ZV 14 AHL 12 WD 8 ZE 3 TR-JT-CP-BZ 2 WJ-MB 1. VE9AL 20.

### QUEBEC DIVISION

QUEBEC—SCM, Stan Comach, VE3EE—Congratulatory to BE on his re-election as C.G.M., the vote was quite decisive. HM has gone an' done it and sailed for Europe on an extended honeymoon. AX has not been heard since he moved location. CA has installed an HD '03A. BU shows interest in 28 mc., as does IY, but the boys seem to have difficulty in finding the band. HI. LO is a new station with a pair of 803's in the final. LN is keeping regular schedule with Nassau. IJ wants a schedule with La Tuque; the YL lives there. EC has new frequency in the new 'phone band. BA is contemplating Class B. GO is back from Bonnie Scotland. BO and JJ are operating 3.9-mc. 'phone. DM is trying 14-mc. 'phone. LQ puts a nice signal into Montreal. GH and FR are still active on 28 mc. KX listens down there. x3XL is now at Maniwaki under the call 2LX. FG walked away with the SS Contest. EW has hooked that African. Congrats on the W.A.C., Ray. DG was snowed under with Xmas traffic. It is requested that the Trunk Line frequency 3690 kc. be kept clear of; self-excited rigs, please note. Congrats to the M.A.R.C. on the latest "skywire." CO, DR, HO, DG, etc., worked hard to put that over. LJ and KK are building. HG is still after DX. HK is heard occasionally on 14 and 3.5 mc. Did I hear DD calling R.S.G.B.? Hi. CX schedules CU on 3.9-mc. 'phone. BG, BE, HT, AB and CM visited HN. Understand x-AQ and x-DQ are building together; wonder what the calls will be. HS has a nice 'phone on 3.9, 14 and 28 mc. KF is quite a traffic station. EW thinks our traffic lanes are swell, message to Lunenburg and reply in less than two hours. BB schedules JK and AP daily. CO has finished his new rig. DR keeps traffic totals high. DX has station in St. Lambert and one in Toronto; latter call 3AHW. The Cairo Survey needs more observers. Any ham with general coverage receiver can do a great service to

his fellow hams by undertaking this work. Let's hear from you.

Traffic: VE2DG 175 DR 119 BB 119 EC 72 BU 26 CO 25 HT 22 EE 16.

#### VANALTA DIVISION

**ALBERTA**—SCM, J. Smalley, Jr., VE4GD—EO gave LX a run for traffic honors this month with a very nice total. EO expects to be on 'phone soon after the New Year. LX plans a Class B modulator for his '03A rig. NH figures he won the Sweepstakes for Alberta, but some others have the same idea. AX is busy with a 12-tube super and plans to be on 'phone and c.w. shortly. KI and GE are stepping up their power. EQ is giving an 802 the works suppressor grid modulated. IN is dubbed the 100% station after CY visited him with the oscilloscope. We wonder if GX still doubts the modulation capabilities of '10 type tubes. Calgary is minus three more hams. KO has sold his outfit. HV has gone north for Canadian Airways and the old reliable, DX, has been transferred to Vancouver where he will be signing VE5. OF and PB have their rebuilt stations perking FB. DR at Killam, the VE4 QSL Manager, has a flock of cards for stations from Edmonton to Winnipeg. Will stations in Alberta, Saskatchewan and Manitoba please send an envelop so that he can cut down on the stack. It is getting too big to handle. JJ is planning for 7- and 14-mc. operation in a big way. SD is still looking for a crystal-controlled station in Calgary that will join the Legion of Frontiersmen Network. LE reports that if the station is on the air he can hear it with his HRO. LA and LM are spending more time on 1.75-mc. 'phone waiting for spring and DX on the higher frequencies. The Northern Alberta Radio Club is advocating a change in regulations whereby B.C.L. QRM must be made on a modern set before action must be taken. Personally we find more grief with modern all-waves that are out of balance. NC has been wrecked and Jock has gone north with an Airways outfit. HM is talking high power; seeing that the other stations haven't the sense to decrease power he figures he will have to step up or quit. WG is also going up in watts. Gil McLaren, the northern pilot, is now licensed with the call ZE. GM and BW continue their battle of bricks to the amusement of the ham public in general.

Traffic: VE4LX 147 EO 104 GE-QK 9.

**BRITISH COLUMBIA**—SCM, D. R. Vaughan-Smith, VE5EP—Well, gang, here's the last dope of the old year. Glad to report 5GI makes his W.A.C. by working Morocco. Line up boys, let's see who's next! JL, MK and FG all report via schedules. How about a few more by same method? Dawson, Yukon, did very good work handling WX reports for search parties looking for Art Hines and Jack Herman. He is loud in his praises for excellent K7 support. Glad to see AC back in town after couple of months in VE4. KW now holds down three nice schedules with Victoria, Edmonton and Ashcroft. CC reports a swell time in the SS including a QSO with WIMK and Dawson within 15 minutes. Welcome new appointees: FM, Route Manager; AV, O.P.S. and JL, O.R.S. Traffic men, please be advised there are a few vacancies for O.R.S. for active reliable stations. If you are interested, please drop the S.C.M. a card. Same goes for O.P.S. LE and KU (Bill) are now staging a big come-back. Nice going! New calls we've heard: PW, QH and QN. . . . Flash . . . HC worked VK on 28 mc. He is now out for W.A.C. on that band!

Traffic: VE5KW 4 JL 44 FG 20 MK 29 ED-LR 1 EP 54 NF 64 AV 230 CC 5 FM 13 GI 21 EU 7.

#### PRAIRIE DIVISION

**MANITOBA**—SCM, A. J. R. Simpson, VE4BG—Of outstanding importance for this period is the increase in traffic handled. Trunk Line station AG tops the list as usual, but we are glad to note some new stations reporting traffic and hope they will keep it up. Things are moving nicely once again and most stations are to be logged on the 7- and 3.5-mc. bands. TV is working his 3.5-mc. schedules as usual and moving the Rural traffic. MJ of Foxwarren and SV of Little Britain are busy on 3.5 mc. LI reports XT a new op at The Pas who also has a junior op. HI. LO of The Pas gets on occasionally. MW is back on with an RK-20 final after a long layoff and on first QSO handles traffic; he also worked Sweden a couple of times. IP is on regularly

again and his 'phone rig is plenty modulated now. SS is installed at new QRA and claims highest powered VE4 'phone with 300 watts Class B on 1.75 mc. EI is heard on 14 mc. with P.P. '45's. UA is busy rebuilding 'phone rig. VD, ZL and VF are new stations on 1.75-mc. 'phone. EK has pair of RK-20's on the 1.75-mc. 'phone band. ED has 50 watts c.w. on 3.5 mc. RO is working 14 mc. with his 211's only and is contacting Europe regularly. MV and GC are QRL due to work. DU is working all the DX as usual. QY keeps active on 14 mc. KX is active on 14 and 7 mc. and contacts VK on 7 mc. ZK, a new station on 7 mc. with RK-20 final, will soon be heard on 14 mc. also. MY is heard on occasionally. NI's 14-mc. 'phone is still going strong. QF is getting out FB and got quite mad when in a QSO he copied "so lid" and thought the other end was getting sarcastic, but it was "solid." HI. QC has a 211 and has been trying to keep it in one place with a lock exciter system, but has lots of fun doing it. AG finds time from his schedules to use his 3.9-mc. 'phone for rag chews. The Annual Banquet of the M.W.E.A. took place at the St. Regis Hotel, Dec. 12th, and had a large turnout. A good time was had by all, and the local gang demonstrated they could do other things besides pounding brass in the contests lined up. Notable were the balloon blowing and pie eating contests. The four XYL's present didn't have a chance even though this was the first banquet to have any in attendance. The S.C.M. appreciates the numerous reports this month and hopes the gang will keep sending them in.

Traffic: VE4AG 182 IP 28 KX 3 MW 1.

**SASKATCHEWAN**—SCM, Wilfred Skaife, VE4EL—The gang is doing fine. Some have the 1.75-mc. 'phone, others the 3.5-mc. traffic, others the 7- and 14-mc. DX and still others the 28-mc. bug, but more and more seem to be getting the reporting bug, which is all to the good! RB is pounding brass on 3.5 and going to try 7 mc. for a little DX. XB gets his '45's to produce the soup. UH's filter would not stand the strain. YX is now settled in his new QRA and traffic will take a jump. PW got his old crystal back. UC is building up rig to use some of the 211's clattering up his shack. UD thinks he will wipe down his 1.75 slab to 3.5 mc. UG is putting out a nice c.c. sig on 7 mc. RJ is consistent on 1.75-mc. 'phone. TN is also active on 'phone. RI is talking RK-20's for a 'phone rig. QP Senior will be in Saskatoon most of the winter. Stirrings 'round MA's shack indicate another 'phone soon. QS from Lloydminster visited MB. MB is DX bitten, snagging a VK, NY, K6 and looking for more. PQ is going DX with flea power. Good luck, OM. IG is badly bitten by the 28-mc. bug. VQ goes to sleep in the middle of a QSO. PG hears plenty of 7-mc. DX but can't check. SY is trying 59 and e.c. OM is rebuilding. OP is Moose Jaw's night hawk. JV hears FB8AB and XU2U but can't contact. LV got a real kick out of the SS contest. FW is looking for schedules. What say, gang? KS is changing to c.c. KA reports three-feeder antenna very FB. ZB and ZC are new hams. Welcome, fellows. QC with 186 contacts rolls over 29,000 points in contest. FB, Johnny. ES was heard in Honolulu on 14-mc. 'phone. UN is raring to go on 28 mc. UZ has M.O.P.A. on 3.5 mc. EL works Van. on 3.9-mc. 'phone. NE and VU have fine time on 3.9-mc. 'phone. UL, our new O.O., has trouble with his crystal osc. JH has gone to the Pacific Coast. XL plans new transmitter. OR and OE practice code on the mill. KM just about completes final in new rig. ML is building new rig. VR is rebuilding 'phone rig. UQ still keeps 5GI Van. schedule Sundays. UK is active on 1.75-mc. 'phone. EB gets FB results with his 'phone 211 final. YM is building P.P.—Par. rig, with '45's. RM has rig perking fine and is all set for QSO's. HL has Street Car QRM. DB has swell new rig that looks like Comm. job. OH has new 56-mc. rig. DI is heard on 14-mc. 'phone. IY is working on Class B audio rig. XM has new rack rig. 28-mc. sigs. are coming through well. IG works VE2's and 3's and all W's but 7's and 9's. He makes a contact every day 13.00 o 14.00 and wants to hear more locals on this band. Transmitters on 28 mc.: IG, UN, PY and EL; BD coming up. DX heard on 28 mc. by IG: X2C, VP5PZ, K6 and VK.

Traffic: VE4CM 362 FW 22 LV 14 QZ 9 UL 8 BD-EL 4 PG-PQ 2.

(Continued on page 118)





# CORRESPONDENCE

The Publishers of QST assume no responsibility for statements made herein by correspondents

## Voting Age

Corning, Calif.

Editor, QST:

After reading the article in the December issue of QST regarding voting age, I want to disagree with Mr. Ehmsen, W7VS.

As long as the Federal Government grants amateur licenses to anyone who is a citizen of the United States, regardless of age, color, or sex, I think he or she is entitled to vote on matters which concern his or her amateur standing.

Another thing—the majority of amateur radio operators are over twenty-one years old and the number of “kids” voting would not upset matters very much.

As for myself, I am over twenty-one years old, so that I am not arguing as one under voting age.

I also think that most “kids” can think for themselves and lots of them can vote more intelligently than many grown-ups do.

I think Mr. Ehmsen's suggestion lacks true amateur spirit.

—Clyde W. Preble, 2nd Op, W6LYQ

1508 North 27th St., Boise, Idaho

Editor, QST:

I have just finished reading Mr. Temple Ehmsen's letter in the December issue of QST. I am very surprised to see an amateur take such an attitude against the majority of his brotherhood.

I do not believe that our hobby is as corrupt and complicated as our national political situation and cannot see any way the two should be comparable. Any true amateur should know and does know the difference between right and wrong regardless of age, and is able to place his vote intelligently.

If we must stop any one from voting, let us deny the privilege to those members of our League who are non-amateurs and let well enough alone.

—Kenneth S. Stone, W7BMF

2705 S. Avers Ave., Chicago, Ill.

Editor, QST:

We young squirts have just had a chip knocked off our shoulders. W7VS on page 65 of December '35 QST would like to see the power to vote in the A.R.R.L. restricted to members twenty-one

years of age or over. I'm only twenty now, so it's no wonder I contest the proposal.

In the first place, W7VS cites that “we do not qualify ourselves to vote until we have reached the age of twenty-one.” That is certainly right, and it could not be otherwise. Take for example a young man of nineteen, just out of high school. With his education, he will usually in a few years earn enough to acquire maybe a car or home, or maybe even a wife! During the time he is earning the money his average intelligence will not increase very much. He may learn a trade from A to Z, but at the same time he is forgetting much that he once knew as a high school student.

In other words you could ask, “Why can he vote after twenty-one, and why not before twenty-one, if his intelligence is practically the same in both cases?” The whole answer lies in the fact that after twenty-one he has acquired property which he did not have before twenty-one. With his voting power, he will protect his property to the best of his ability. If before he had been twenty-one, he might have used this voting power rashly because having no property of his own, he may have reasoned that nothing minus nothing is still nothing.

The crux of the whole problem therefore lies not in the age of the person, but in what he owns.

As I understand, voting power in the A.R.R.L. is extended only to the licensed members. If that is the case, would there be any justice in limiting the power to vote no matter on what basis? Let age, power, financial position, etc., be what it may, we are all on the same level. The amateur bands are as much the property of the young squirt as they are of the venerable bearded patriarch.

As for intelligence, take any bunch of young squirts and old fogeys, and, dollars to doughnuts, the young squirts will come out in any test of ability.

I maintain that there should be no restrictions of any kind based on age.

—John F. Smith, W9JSL

EDITOR'S NOTE.—Similar sentiments are expressed by J. A. Crutchfield, Jr., W3EVV, ex-K6EEI; Ben Swartout, W2FRU; David Talley, W2PF-WLNA; Dick Martin, W9RXC; Asa W. Adkins, Jr., W9VBO; T. V. Jardine, W2IMI; Jack Dodd, W4CQD; and E. B. Gladding, W1GTW.

With reference to W7BMF's letter, it should be pointed out that, in principle, only licensed

amateurs vote in A.R.R.L. elections. In the current (1935) elections, the non-licensed voting percentage was less than 8 percent, this figure, of course, being made up of long-time members exercising their constitutional rights.

The average age of U. S. amateurs is twenty-six; presumably, the average in A.R.R.L. membership is at least as high if not higher, since approximately 70 percent of those licensed amateurs who are not A.R.R.L. members and buy *QST* from newsstands do so because of financial difficulties; i.e., they are largely the younger element.

1050 N. Platte, Fremont, Neb.

Editor, *QST*:

I have been reading the Correspondence department of the December *QST* and noticed W7VS' letter about voting age. I think he is right about it. He didn't say what age he thought would be right unless he meant twenty-one should be the age, the same as the citizens voting age. I think twenty-one is a little too much. I am seventeen years old and I think I would be able to pick out the right men as well as most twenty-one-year-old men. I think sixteen would be about right as most boys sixteen years old (YL's also) who have taken enough interest in radio and the League to want to vote would be capable of selecting officers for the League.

...

—Garold W. Curl

## Warning

Marshfield, Ore.

Editor, *QST*:

I'm not one to find fault with amateur radio. To me, it's one great hobby, and the genuine friends I have made through the medium of my ham station more than make up for QRM, long CQ's, etc. I only wish I had more time to devote to ham activity.

The object of this letter isn't to deride hams in general or any phase of the amateur game, but to give a word of warning to a few hams, doubtlessly good operators, who don't realize that their rigs are the source of no small amount of QRM far outside any authorized ham band. I am referring to those 75-meter 'phones having strong enough 2nd harmonics to cause serious interference in channels used by several commercial stations for the sending of press to broadcast stations.

It so happens that for the past three weeks the signals we copy at the broadcast station here on the afternoon schedule have been quite weak—not weak enough, however, to prevent perfect copy if it weren't for the interference caused by these harmonics. When it is considered how little power it sometimes takes to put a strong signal into a receiver a considerable distance away, it is evident that a radiated second harmonic representing only a small percentage of the total output may be the cause of considerable QRM.

As an example, last night as I was winding up the early evening schedule, W3—came on with an R8 signal, seriously "messaging up" the last news item on the schedule. After the sked was over, I tuned up to the 75-meter 'phone band, but could find no trace of W3—. Yet back on 7850 he was booming in a good R8.

While W3—was no doubt an exceptional case, it serves to illustrate the point. Since the press station has been weak, due to seasonal changes, the interference from harmonics of 75-meter 'phones (and none of them locals, either) has caused us the loss of as much as 45 minutes copy out of an hour period. This is something to consider, gang. The interests operating these press stations won't stand for interference of this type.

And there's no reason why it should exist. No properly adjusted ham station of any legal power should have a second harmonic strong enough to cause serious interference even a short distance away. And certainly a W3 shouldn't be R8 on 7850 kc. here on the west coast.

What say you 'phone boys be a little more careful in the adjustment of your rigs? If the harmonic still exists, there are a number of simple and inexpensive ways to reduce it to a negligible value—and then it won't do anyone any harm.

—Forest Bartlett, W9FYK/7

## CQ-RC

Marinette, Wis.

Editor, *QST*:

Have just read the article entitled "On Rag Chewing" by W2AKH in the December issue of *QST*, and would like to voice my emphatic approval of his suggestions.

Since it takes two to make a successful rag chew, and since so many of the fellows are unwilling to indulge in it (as I have learned during the past month) it is my suggestion that those of us who still enjoy chewing the old sock should indicate that fact by some appropriate abbreviation. In the absence of any other suggestions why not revive the old CQ-RC?

After some of the utterly meaningless rubber-stamp QSO's inspired by the Sweepstakes Contest of last week I think a few good old-fashioned rag chews are really necessary to maintain a proper balance.

Let's really get to know each other again via the rag chew.

—Harry E. White, W9CNV

## DX Test on 28 Mc.

Forest Grove, Oregon

Editor, *QST*:

Here is another report on "10". Last time I reported four continents in two days and this time I should like to report having contacted four continents (VK, LU1EP, J2HJ, J2LK, and W9) on the 16th of November. I think this should be possible nearly each day, as the band has been in fine shape each week-end, were it not that I am attending college and have to hitch-hike 23 miles to even get on week-ends! J2HJ comes through nearly every day as does T'DC's harmonic at about 27,900 kc., indicating good conditions towards the Orient.

During the latter part of November conditions out this way fell off a bit, but as this is written improved greatly, to-day being exceptionally good. No Europeans or Africans have been logged, due, I am sure to lack of time for operating here. WISZ was logged to-day calling CQ at R7, and numerous W2-W3 QSO's brought R9 reports at each end. Most of the local W7 gang (AMX and AVV, etc.) have worked VP5PZ and VP5AC who come in fine on the high-frequency end. VE1, 2, 3, 4 and 5 have been logged; 1, 3 and 4 being worked at W7BPJ.

I should like to second W8CRA's suggestion of a "10" DX test. That, and that alone, would seem to be the way to "prove 10" to the world. In spite of the greatly added numbers of signals on "10", especially on week-days, commercial harmonics will pound through hours at a time with few amateurs on to take advantage of good conditions.

True, a contest called might be spoiled by bad conditions, but why not take a chance? Or call it for successive week-ends until a good one appears? However, as of the present, "10" shows little sign of falling off—the lack of W1-J contacts might merely be that the shortened winter season brings darkness at one end before the other end "warms up" enough to permit a contact. The same holds for W7-Europe. Why not give a DX test a whirl on "10" in W8CRA's "crazy month." February? New stations, new countries, more WAC's and what's more, really showing some of the doublers that "10" could be used instead of parking on our lower, more crowded frequencies.

I'm all "hepped up" about "10" too. Why not give it a chance?

—Walt Dyke, W7BPJ

## "Can You Explain?"

Corner Brook, Newfoundland

Editor, *QST*:

I have never before written to *QST*, much as I would like sometimes to tell those long-winded CQ'ers what we think of them up here, but the letter of W6JTC in December *QST*

(Continued on page 74)



ELSEWHERE in this issue you will find an announcement of the HRO Junior. In that announcement you will find complete specifications, but you will not find the reasons behind them. We think it would be a good idea to explain what it is all about on this page.

When the standard model HRO was designed, we incorporated every feature that we thought an amateur could reasonably desire. For certain classes of work, many of these refinements are unnecessary and we have lately received a growing number of inquiries from men who did not wish to pay for extra equipment they did not expect to need.

Bowing to this demand, we announce the HRO Junior, which is no more nor less than a standard HRO stripped down to its basic circuit. Since all of its parts are standard, omitted units can be added at any time by returning the receiver to the factory. However, we imagine that most purchasers will find the HRO Junior is more than adequate as it is.

Only three omissions have been made; namely, the crystal filter, the S-meter, and certain coil ranges. Of these, the S-meter requires no explanation. It does not actually aid reception — it is just a gadget that is a lot of fun to play with.

The crystal filter is a different story. Personally, we feel that its value can scarcely be overestimated. However, the fact remains that many amateurs do not use it, simply because the selectivity of the HRO is so high, and its operation so “quiet,” that present conditions do not make a Single Signal filter necessary. But if congestion in the amateur bands becomes worse in the future, you can add the crystal filter at any time.

One set of coils (instead of four) will be supplied with each HRO Junior. Since each set of coils covers two amateur bands (one at 50, one at 450 on the dial) only one additional set need be purchased for coverage of four amateur bands. For the phone man, the choice would probably be for 10, 20, 80 and 160 meters, while for c.w. 10, 20, 40 and 80 would be preferred.

The HRO Junior coils will not have band spread ranges. It has been found by experience that the so-called “continuous band-spread” of the PW tuning unit is adequate for practical purposes. You may recall that the worm-drive condenser has a ratio of 20 to 1, and that the micrometer dial spreads the tuning range over 500 divisions. So effective is this combination that the general coverage ranges of the HRO are actually more open than the band spread ranges of the FB-7. And this is plenty open!

So much for the HRO Junior. You will find more information on the third cover, but we must save the rest of this page for another announcement. Two years ago we started our random discussions here under the heading “Number One of a Series.” It is now twenty-four, and perhaps time for a change. The layout we have used has proved to be pretty formal; sometimes we have had lots of pictures and nothing to say, and sometimes we have had lots to say, and no pictures. We do not know what this page will be like next issue; it may look like anything from a wedding announcement to a comic strip, but it will be here.

JAMES MILLEN



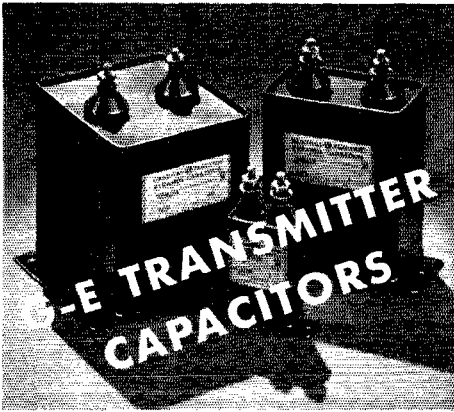

## WHY THEY STAND UP

**1.** They are all treated with Pyranol — a new General Electric synthetic material that assures permanence of their high dielectric strength and operating characteristics.

**2.** Every unit must pass a high-voltage test of double rated voltage + 1000. You can operate them continuously at 10 per cent above rated voltage.

**3.** They are hermetically sealed and leak-tested under vacuum.

G-E transmitter capacitors are very small in size, and fireproof. You can mount them in any position. Get them from your dealer. Bulletin on request. Radio Dept., General Electric, Schenectady, N. Y.



360-104

# GENERAL ELECTRIC

## Correspondence Department

(Continued from page 72)

brings back a flood of memories. As a commercial ship operator in the days of spark, it was not my habit to put on the 'phones having once hung them up on the handle of the magnetic detector for the night. However, in April, 1911, when operator of the old *Lake Erie* (MLE) of the C.P.R., a ship fitted with a 10-inch coil and a tray of Leyden jars (Tune A and B), one night I hung up the 'phones as usual and after going below and scrounging some more supper from the pantry (it was after 8 bells), I got ready for the bunk. All set, I again, for some inexplicable reason, put the 'phones on and found that I had evidently just missed the distress call of the *Titanic* (MGY) two days run ahead of us. I got a curt "stdbi" from the *Caronia* to my queries. Are there any hams to-day who also were on the Western Ocean that night in that vicinity?

Again, can anyone explain what woke me two and a half years later, in February, 1915, off Sable Island, at 6 a.m., to find my "first trick" assistant fast asleep, the magnetic detector run down and a Belgian Relief ship raising *Cain* with a broken tail shaft? And I'm a heavy sleeper!

Some other old timers will have similar experiences to quote, for I feel sure that I was just the average in those days and "turned in" as soon as the watch was over.

—A. R. Stansfield, VO4Y

(Continued on page 76)

## Experimenters' Section

(Continued from page 60)

buffer, with link coupling complicating the situation. The solution was a 6-prong jumbo coil form. In either service, the grids are excited push pull, but the 40-meter (buffer) plate tank is so connected to the base prongs as to provide push-pull plate connection, with the link in the middle at low r.f. potential. The 20-meter plate tank is connected to *parallel* the plates of the tubes, and the two sections of the split-stator condenser. Also, the link is wound on the "ground" end of the coil form.

The diagram of Fig. 5 gives the general idea.

—M. C. Bartlett, W9JHY

## Neon-Bulb Audio Oscillators

(Continued from page 58)

ent types were tried. The applied voltage must be direct current, either from the receiver power supply or from batteries. If batteries are used, they may be the smallest size because the current flow is less than 100 microamperes ( $\frac{1}{10}$ th of a milliampere) and the batteries will last many, many months.

The mounting base is a piece of bakelite,  $\frac{1}{16}$ th of an inch thick,  $2\frac{1}{2}$  inches wide and  $4\frac{1}{2}$  inches long. A grid-leak type of holder supports the resistor and makes possible a quick change when another audio frequency is to be used.

There may be some variation in characteristics of the neon bulbs; therefore, each oscillator should be adjusted to the desired frequency accordingly. Changing bulbs may cause the frequency to shift as much as 200 cycles per second. Varying the voltage by means of a potentiometer, or some other method which will permit small voltage changes, gives corresponding changes in

# RME

**H**ERE is the nearest approach to an ideal medium powered transmitter for the amateur. Rated at 400 watts input, this compact unit gives reliable communication service under trying conditions.

**T**HE RF section consists of a 6A6 crystal oscillator and harmonic generator, 2-42s in push-pull as buffers, 2-801s as intermediate amplifiers, and 2-50Ts in the final class C stage.

**I**N the audio amplifier is found 1-6C6, 2-76s, 2-45s, and 2-50Ts arranged as class B modulators to give full output to the transmitter. The entire power supply to the various stages is conservatively loaded at all times.

**L**ESS than 5% distortion at 100% modulation is obtained. The audio range extends from 100 to 10,000 cycles with less than 5 db deviation.

**M**UCH can be said about the design and appearance of the cabinet into which this transmitter has been built. With double side walls, between which the cable, interconnecting the chassis units, runs, — with front panel doors to keep out dust and protect tuning adjustments, — with meters recessed behind the front panel, — the entire unit presents typically modern construction.

*For complete details our folder T505 is available. Write for your copy.*

**RADIO MFG. ENGINEERS, Inc.**  
306 FIRST AVENUE  
PEORIA, ILLINOIS, U. S. A.

**MODEL**

**5-T-5**

**Now—a high-Powered—**

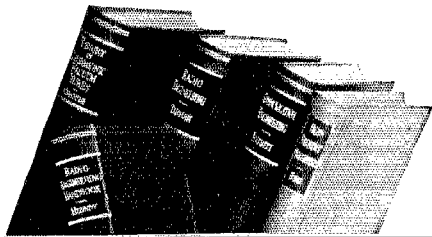

## RADIO ENGINEERING LIBRARY

—especially selected by radio specialists of McGraw-Hill publications

—to give most complete, dependable coverage of facts needed by all whose fields are grounded on radio fundamentals

—available at a special price and terms.

These books cover circuit phenomena, tube theory, networks, measurements, and other subjects—give specialized treatment of all fields of practical design and application. They are books of recognized position in the literature—books you will refer to and be referred to often. If you are a researcher or experimenter—if your interest in radio is deep-set and based on a real desire to go further in this field—you want these books for the help they give in hundreds of problems throughout the whole field of radio engineering.

5 volumes, 2981 pages, 2000 illustrations

1. Everitt's COMMUNICATING ENGINEERING
2. Terman's RADIO ENGINEERING
3. Chaffee's THEORY OF THERMIONIC VACUUM TUBES
4. Hund's HIGH-FREQUENCY MEASUREMENT'S
5. Henney's RADIO ENGINEERING HANDBOOK

### Special Low Price and Easy Terms

Bought singly, the five volumes comprising this library would cost you \$26.00. Under this offer you save \$2.50 and, in addition, have the privilege of paying in easy installments beginning with \$2.50, 10 days after receipt of the books, and \$3.00 monthly thereafter. Already these books are recognized as standard works that you are bound to require sooner or later. Take advantage of these convenient terms to add them to your library now.

#### SEND THIS ON-APPROVAL COUPON

McGraw-Hill Book Co., Inc.  
330 W. 42nd St., New York, N. Y.

Send me Radio Engineering Library, 5 vols., for 10 days' examination on approval. In 10 days I will send \$2.50, plus few cents postage, and \$3.00 monthly till \$23.50 is paid, or return books postpaid. (We pay postage on orders accompanied by remittance of first installment.)

Name.....

Address.....

City and State.....

Position.....

Company..... QST-2-36

(Books sent on approval in U. S. and Canada only.)

the frequency of the note. An increase in voltage will increase the frequency, while reducing the amount of resistance or of capacitance also increases the frequency—and vice-versa. Normally, the neon bulbs break down (that is, they commence to glow) at about 100 to 115 volts. Relatively, this is unimportant because if some particular bulb does require as much as 105 volts, the desired frequency can be obtained by selection of the proper values of the condenser and resistor. Some bulbs will start to oscillate with 75 or 80 volts. It isn't necessary that the orange glow of the bulb be as bright as an airport beacon—the output does not increase materially with increase in brilliance of the glow. The Westinghouse N-1 neon bulb may be identified by the two spiral conductors inside the glass envelope. It fits the standard candelabra socket.

Numerous combinations are possible, giving circuits which are very flexible. The circuit of Fig. 2 provides three frequencies, three condens-

(Continued on page 112)

## Enjoyment Coefficient

Washburn, Wis.

Editor, QST:

A number of very excellent articles on efficient station operation have appeared lately in QST. Will you please QRX a bit longer, while I do the QSOing? Efficiency equals output divided by input. This goes to show that the maximum efficiency anyone can get out of his station is 1, or 100 percent. W3EFL discussed this very nicely in November QST. The technical problem lies in getting as near to the 100 percent as possible.

The same formula may be modified a bit and can be written thus: Pleasure or enjoyment equals output divided by input. If the joy received is the output and the drudgeries (if any) the input, 100 percent can be counted the result of mere satisfaction. Now if your enjoyment coefficient is less than 100 percent, too bad; if greater than 100 percent, OK—and FBI! One can see from this that as the joy increases and the drudgeries (work, to some people) decrease, the percentage or coefficient of enjoyment increases, and the larger this coefficient gets the happier we are. Now I suppose that when the coefficient reaches infinity we will be in Heaven. But if QRM continues and the joy becomes nil and drudgery infinity, the coefficient decreases until it becomes an infinitesimal quantity which I suppose represents Hell (apologies to Carlyle's *Sartar Resortus*). Hi! Let's see what we can do about getting an enjoyment coefficient well above 100 percent. What sa?

Here are my few suggestions (for the sake of justification, even though my coefficient of efficiency is only about 30 percent or 35 percent, my coefficient of enjoyment is far more than 100 percent). May I refer to the 3.5-mc. c.w. band as an example?

1. After CQ (3 x 3) let's start looking for a reply from the end of the band where we are operating. Example: Suppose I call a CQ on 3574 kc. I would start looking for a reply beginning on 3500-kc. end and work toward the 3900-kc. end.

2. In answering a CQ the fellow on 3504-kc. should call my call only 5 or 6 times and sign, saving a lot of QRM and time, knowing my intentions. Now the fellow on 3758-kc. can really stand by for a few seconds and then start calling, knowing what I am doing and at the same time feel assured that he is not busting up all of someone else's QSO with his QRM.

3. As for the fellow on 3700 kc.—well, he is in a tight corner—or center—hi! It's his choice. Let's say I hear a 3700-kc. CQ. I'm on 3574 kc. I'll answer him for 10 or 12 calls or so and sign, with no reply. I conclude that he started at the other end of the band, so, after this short pause, I call him again. By now, if he has not heard another call, I'll be in time for a QSO with little effort and little QRM.

4. If break-in is not used, do not litter the air with QRM

# Newark's

## ★★★ SPECIALS FOR AMATEURS IN THE UNITED STATES

Our new program available to all Amateurs. Deferred payments on receivers. SPECIALS at unheard of prices. NEWARK'S guarantee on all merchandise listed below.

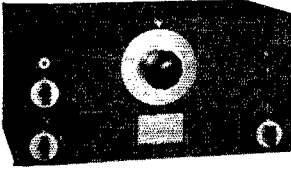

### The HRO, Best receiver ever made had a child: "The HRO JR."

The HRO JR. is the identical chassis and cabinet used in present (Daddy) table model HRO, except that the meter and the crystal filter are completely omitted. The sensitivity of the HRO JR. is so great that crystal filter is not necessary for most uses. The coils differ from the standard in that they do not have the extra or extreme band spread range incorporated in the standard coils. The only receiver at the price with two stages of RF. The amount of band spread afforded with the JR. coils is greater than with the band spread coils for the FB7A. Crystal available at a later date.

**SEND IN YOUR ORDERS AT ONCE! THEY WILL BE FILLED IN ORDER RECEIVED.** Available on NEWARK'S Deferred Payment Plan listed below.

See National Ad for full details — In this issue

	Cash Price	Time Price 6 Months	Time Price 10 Months	Down Payment	6 Months Payments	10 Months Payments
★★★ NATIONAL HRO JR. — with tubes — 1 set of coils, 10 to 20 meters (2 amateur bands)	\$99.00	\$105.84	\$107.70	\$24.00	\$13.64	\$8.37
★★★ NATIONAL HRO JR. — complete with tubes — power supply — 2 pair of coils	\$124.80	\$131.98	\$134.10	\$29.80	\$17.03	\$10.43
★★★ NATIONAL HRO — less power supply and speaker	\$167.70	\$175.34	\$177.90	\$37.70	\$22.94	\$14.02
★★★ NATIONAL HRO — with power supply, less speaker	\$183.60	\$191.44	\$194.30	\$43.60	\$24.64	\$15.07
★★★ NEW SUPER SKYRIDER — less crystal — Model S9	\$79.50	\$86.10	\$87.90	\$19.50	\$11.10	\$6.84
★★★ NEW SUPER SKYRIDER — with crystal — Model SX9	\$89.50	\$96.30	\$98.10	\$19.50	\$12.80	\$7.86
★★★ RCA — ACR — 136	\$69.50	\$75.90	\$77.40	\$19.50	\$9.40	\$5.79
★★★ RME69 — Complete with crystal — tubes — speaker housed in baffle	\$134.90	\$142.16	\$144.50	\$29.90	\$18.71	\$11.46
★★★ HAMMARLUND SUPER PRO — complete with tubes and speaker	\$194.00	\$202.20	\$205.40	\$39.00	\$27.20	\$16.64
★★★ HAMMARLUND SUPER PRO — complete with crystal, tubes and speaker	\$211.68	\$220.36	\$223.88	\$41.68	\$29.78	\$18.22
★★★ PATTERSON PR-16 — complete with crystal, tubes and speaker	\$101.70	\$107.80	\$110.40	\$26.70	\$13.64	\$8.37

Some of the receivers listed here have not as yet been released by the manufacturer. Would advise placing your order now so you can get the first sets released. Full details of any set listed, mailed immediately upon request. Write for our complete catalogue.

**SEND YOUR DOWN PAYMENT WITH YOUR ORDER. SET IS SHIPPED AS SOON AS CREDIT IS OK'D. ENTIRE TRANSACTION APPROXIMATELY ONE WEEK!**

★★★ THORDARSON No. T6878 Plate and Fil. Transformer. 600-0-600 V. at 200 M. A. 2½ V. at 10 amp., 5 V. at 3 amp., 7½ V. at 3 amp. ....	\$2.45
★★★ THORDARSON No. T6877 Heavy Duty choke. 15 henries at 250 M. A. ....	\$1.95
★★★ THORDARSON No. T1998B Choke. 18 henries at 200 M. A. 190 Ohms — 2200 Volt insulation. ....	\$1.25
★★★ NEW LOW PRICES ON RCA TUBES	
852. ....	\$16.40
866. ....	\$2.25
★★★ NEWARK Oil filled — Oil impregnated Filter Condensers	
2 mfd. 2000 V. DC. ....	\$1.50
4 mfd. 2000 V. DC. ....	\$2.25
8 mfd. 2000 V. DC. ....	\$2.75
9 mfd. 3000 V. DC. ....	\$7.25
★★★ NEWARK PAPER FILTER CONDENSERS	
1 mfd. 1000 V. DC. ....	.56c
1 mfd. 1500 V. DC. ....	.66c

SEE OUR AD — PAGE 81 — DECEMBER QST — FOR RESISTOR SPECIALS.

ALL OF THE ABOVE SPECIALS GUARANTEED BY NEWARK. ALL OF THE ABOVE SPECIALS ARE "NEW".

# Newark Electric Company

"FASTER SERVICE—BETTER BARGAINS"

226 W. Madison Street

Dept. Q

Chicago, Illinois

# "PORTABLES" should be PORTABLE!

You'll never get round-shouldered carrying these batteries. Complete equipment: 3 volts "A", 90 volts "B", 7½ volts "C"—weights only 2 lb., 4½ oz.

## EVEREADY



No. X-202  
3 volt "A" battery  
2½" x 2⅞" x 1¼". WT. 7½ oz.  
List price, \$3.35



No. X-203  
45 volt "B" battery  
3¾" x 2⅞" x 1¼". WT. 13 oz.  
List price, \$2.30



No. X-204  
7½ volt "C" battery. Tap at 4½ volts  
1⅝" x 2⅞" x ⅝". WT. 3 oz.  
List price \$6.65

BATTERY HEADQUARTERS

**NATIONAL CARBON COMPANY, INC.**

General offices: New York, N. Y.

Branches: Chicago, San Francisco

Unit of Union Carbide  and Carbon Corporation

by repeating the call of the other fellow for a half hour or so. Simply "W9ONI de W9OTL" is probably sufficient. (If the other fellow's receiver isn't stable enough to hold its frequency for a few minutes, you can suggest purchasing a revised copy of the *Handbook* and building a new one!)

No doubt many of you have had the experience of CQing and, upon hearing a reply, waiting for a "sign"; and after 5 minutes or more of listening wondering what endurance contest is on. Hi! I have used the system suggested above on both ends and the middle of the 80-meter band and find it's a real help. Often in the evening at 6:30 (November 5th for example) I put my 50-watt c.w. rig on 3893 kc. and on hearing an "8" CQ on about 3800 kc. I repeated his call 5 or 6 times and signed twice. An FB QSO resulted. I called a "2" in the same fashion and with the same result, and a "3", and a "7", and a couple of "9's". I signed at 9:30. These QSO's were 100 percent successful, and never a call in vain. My efficiency was 100 percent. Had it not been for a few remarks from the OW and a 300 x 13 CQ, the coefficient of enjoyment would have been infinity. Hi!

I have checked results. I have tabulated and calculated them according to the efficiency formula, and I find that the percentage runs the same using either system and in every case the coefficient of enjoyment has been very much larger.

I am aware of the fact that a similar system already is used by a large number of amateurs and I am sure that it is appreciated by the rest of us. The point is this—let's get the "CQ-ers" and "callers" to cooperate to the extent that none are "QRM-ers". What sa, OM? SK.

—C. R. Wentland, W9OTL

## I.A.R.U. News

(Continued from page 68)

G5JF; Roger Bague, F8XC; W. M. F. J. Otten, PA0HB; J. Shepherd Nicholson, VU2JP; Helge Möller, SM7SQ; J. Bauwens, ON4IJ; S. Cheshire, ZS4E; J. van Ravesteyn, ZUIT; J. Rademeyer, ZS6AL (phone); Emil Zavadil, OK2HX; Karel Koksa, OK2KP; H. F. Rawls, W6DRE; William John Wegge, W2BYK; Kenneth T. Hill, W2AHC; Walfrido Figueira, CX1CG; Robert Hecksher, W4CYU; Charles H. Schrader, W8ADG; Mort R. Miller, W6HEX; T. C. Wood, Jr., W4ET; James Ringland, W8JIN; Julian T. Dixon, W4AJY; Jack M. Story, W6KZH; Paul J. Hitchen, W1CJC; Horace R. Greer, W6TI; Clyde E. Chambers, W8IXS; Lloyd L. Moore, W9FJR; Henry I. Palmer, W9BQM; Raymond M. Stevenson, W6HDV; George C. Goode, VE5EO; Walter S. King, W8KRX; Paul A. St. Vrain, Jr., W9NNZ; Paul L. McGinty, W4SV; C. G. Lane, W7APG; John Hemley, W6BNO; James H. Thomson, W9AQD; Paul W. Hinkle, W9ABB; Adolf Kolar, OK2KO; E. A. Karlsson, SM5WM; M. E. A. Bemelmans, PA0RP; Dr. R. Bevan Dodds, ZL4FK; Frederick H. Black, W1LQ; Sr. Don Enrique Ricart, EA3AN (phone); L. V. Rubeck, ON4ZQ; Ewart S. Wilson, G5CW; L. J. v. d. Toolen, PA0NP; W. Hei, PA0WD; A. T. Martin, G2LB; Leslie G. Call, W9EBE; Dr. Georges Duranceau, CN8MQ; J. G. McIntosh, VU2LJ; Andre Godé, F3AI; B. F. Baptiste, ON4TAF; C. A. Sharp, G6KU; James F. C. Robertson, W7CJV; George Moens, SU1RO; H. Shimomura, J2LU; Andrés Folle Ylla, Jr., CX1BZ; Norman Harrison, W9BTD; Arthur Robin, W6INP; Kunio Nagase, J2LB; Robert C. Maple, W6JRI; Chester B. Frans, W9NFA; Victoriano Fernandez, LU4DC; T. Wakimoto, J3FK; Jess M. Powell, W9DGH; Thomas C. Brandon, W4CEN; R. T. Inman, W9PTC; John Buck Morgan, W3QP; Logan N. Muir, Jr., W9IPP; Ralph G. Kingston, W4DBC; Richard C. Longfellow, W9BVI; Robert W. Godwin, W6FDQ; E. A. Lar Rieu, W6BEM; Albert L. Goepfinger, W6FXL; Bertie Laing, VP5AB; Arthur J. Reynolds, W6HOC; Takashi Morimura, J2KJ; Tadashi Okuyama, J2KN; Charles F. Glass, W8FAD; Aubrey C. Levi, K4ACF; J. B. Hicks, W4UC; George Chato, W2CTX; Gaston Pons, F8JJ; Erich Kohout, HB9AT; Hanns Hess, D4MDN; Otto N. Geyer, W8LEA; William B. Russell, W6PD; Fred Thomas, W9GKZ; Fred Crowder, W6ELC; John H. Bender, W2EVI; James C. Lewis, W9DKU (phone); Jack Quinn, W2DEW; Alfredo Guimaraes Balparda, CX1CC; William S. Graves, W1HUD; Lawrence Trombly, W9DCB; Joseph F. Egan, W2FLG; Robert W. Baunach, W2DEU; Bruno Buyna, D4BAC; Edmond Bonamy, F8RR; M. Tsukada, J2HQ; K. Yamaguchi, J2CB; Ryotaro Hanai, J2CL;



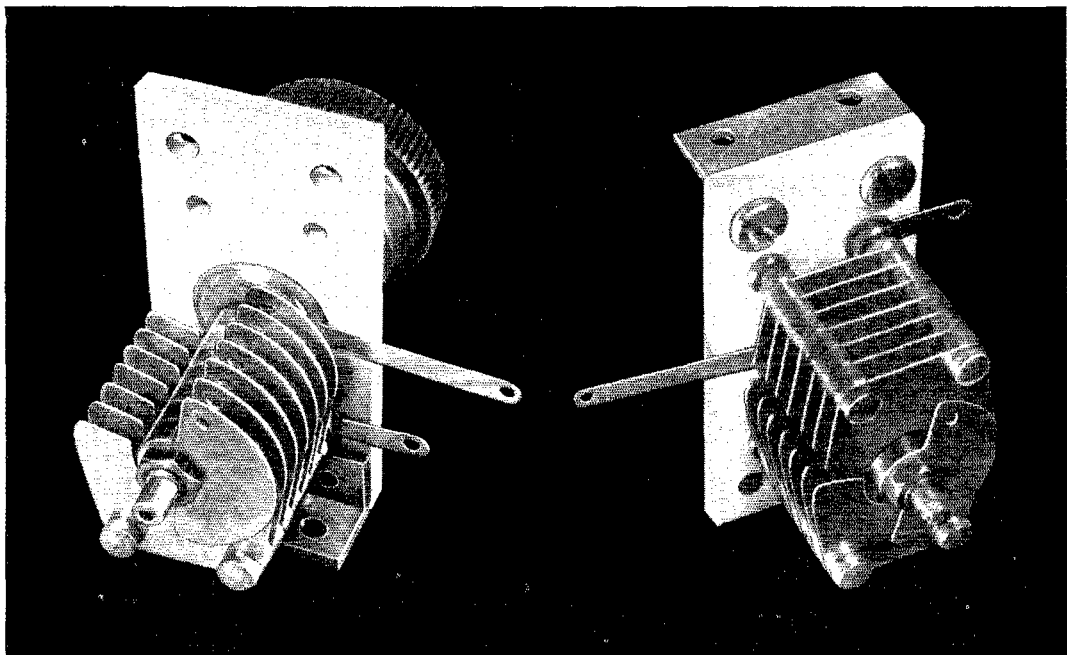

## ULTRA MIDGET CONDENSERS

Ultra High Frequency, Ultra Small Size, Isolantite insulated, these new condensers are ideally suited for use in padding and neutralizing, and for tuning high frequency receivers. They are particularly suitable for Fixed-Tuned exciter stages of band-switching transmitters.

A balanced-stator model is also available, in which two stators act upon a single rotor. Connections are usually made to the two stators only, eliminating the rotor contact, shortening leads, and reducing minimum capacity. For ultra high frequency work these advantages often outweigh the disadvantage of having only ninety degree rotation.

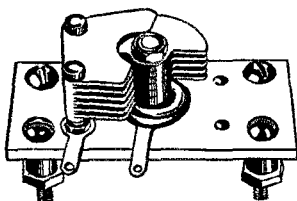
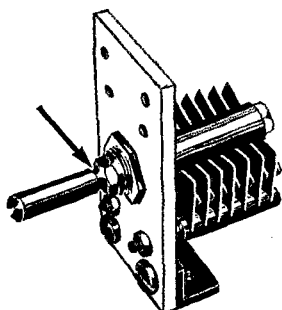

The small size of the new Isolantite Ultra Midget Condensers simplifies efficient layout and effective shielding. They can be mounted inside small coil-shield cans. The shaft extension is long enough for a conventional knob or dial, but may be readily cut off at the groove provided for this purpose. (See arrow at left.) A hexagon head is provided so that adjustments can be made with a socket wrench when the shaft is not used.

The new condensers can be mounted either by the angle foot shown above, or by spacers and bolts direct to the panel, as illustrated below.

Capacity	Symbol	Net Price	Capacity	Symbol	Net Price
Single-Spaced			Double-Spaced		
15	UM-15	\$ .75	25	UMA-25	\$1.11
35	UM-35	.90			
50	UM-50	.96	Balanced Stator, Single-Spaced		
75	UM-75	1.02	25	UMB-25	1.11
100	UM-100	1.14			

NATIONAL CO., INC.  MALDEN, MASS.

Say You Saw It in QST — It Identifies You and Helps QST

# NEW

THE MOST IMPORTANT  
RESISTOR DEVELOPMENT  
IN THE HISTORY OF RADIO



## INSULATED *Metallized* RESISTORS

- The **FIRST** solidly sealed **INSULATED** Resistors — designed for the best in **MODERN** radio performance.
- No danger of shorts. No metal ends or caps. Complete, high voltage insulation molded around **FAMOUS METALLIZED TYPE RESISTANCE ELEMENT** also seals it against moisture.
- Smaller — Quieter — More accurate.
- Opens prevented. Wire leads permanently contacted to resistance element inside molded insulation.
- Rugged — Strong — Vibration-proof — Light in weight.
- Both color coded **AND** imprinted with resistance value.

Never before has a resistance development received the widespread approval accorded IRC Type "B" **INSULATED METALLIZED** Resistors. . . . For here are truly modern units — fully sealed and insulated, compact, quiet and more accurate than ever — designed to meet the most exacting demands of today's sensitive radio equipment — incorporating every famous Metallized advantage plus many new ones besides. Featured by leading jobbers. Two sizes, B- $\frac{1}{2}$  ( $\frac{1}{2}$ -watt) and B-1 (1-watt) meet every need.

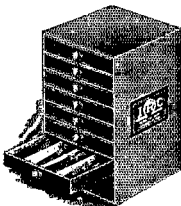

**IRC RESISTOR CHEST**—handiest container for resistors and other parts. Get it free with your order for 56 Insulated Resistors. Ask your jobber.

### INTERNATIONAL RESISTANCE CO.

401 N. Broad St., Philadelphia, Pa.  
In Canada, 187 Duchess St., Toronto

## FREE SAMPLE

We'll gladly send FREE a sample 1/2 watt unit (ask value us 20c) to bona fide servicemen and amateurs. Ask for catalog S-28, and sample resistor.

Yoshio Okamoto, J4EA; Kinichi Ogawa, J2LO; Chaokuang Huang, XU3ST; Minoru Kanagaki, W6KQA; Takeshi Nagano, MX2B; Justo Mahia, CM2JM; Odilon Dias Martins, PY2BM; Erich Lehwald, D4HCF; F. M. Broome, VK2XJ; R. H. Brown, VK2QN; O. E. Alder, VK4JB; F. M. Gray, VK5SU; J. G. Cowan, VK2ZC; W. E. Hagarty, VK4WE; Rex Cawthorne, VK2VG; Herbert Schulz, D4CSA; K. L. Ewald, OZ2M; O. Havn Eriksen, OZ3FL; Christian Nolf, ON4NC (phone); I. Van Hool, ON4FE (phone); Jose de Caluwe, ON4LX; G. J. Dent, ZS8AM (phone); D. Julio Requejo, EA2AD; E. R. Radford, G2IM; James R. Adams, G5KF; S. Roberts, G6QS; Alfred Lotze, D4LWN; E. J. Williams, G2XC; John Butcher, G5XG; Eduard Koranyi, OE1EK; R. Genin, YL2AB; Frederick Ritson, G5RI; Johannes Schröder, D4DIC; W. Gutman, D4BHA; Dr. Tomuschat, D4JVB; Edward Kawczynski, SP1DC; Jan Nowak, SP1OC; Juljus Wierdak, SP1CO; Jesse Smith, XU3GG; William Krause, W8LIJ; George H. Janes 3rd, W1GJQ; Joseph J. Wojcik, W3ANS; William Few, W4TR; Carlton L. Williams, W8JMP; Robert W. Ehrler, W2CTO; N. M. Patterson, W4EG; Dale Schuyler, W6KRI; Louis Wisniewski; W3QM; Jonathan Roehrig, W1ENE; Fred J. Merry, W8DSU; Archie A. Billings, W8CYW; James Krakora, Jr., W9NBM; Arthur E. Lewis, W8CNZ; C. W. Skarstedt, VE2DR; Captain Frederic B. Westervelt, W3CZO; Joseph B. Tomczyk, W9DBC; Stanley I. Comach, VE8EE (phone); George T. Ishida, K6CRU; Roger D. Causse, W3EVV; C. Brewster Lee, W2ADP; E. Crockett, Jr., W9KG; Cammie S. Marie, W3ERJ; R. H. Wickens, W1ZZC; T. Clarke, Jr., W1CCA; Joseph E. Vucko, W8HCL; Hugh Y. Meetze, W3BBB; Carl B. Evans, W1DMD; John M. Thompson, W3HC; Kenneth M. Zinn, W8JRL; Marcel Dupuis, ON4EY; Clarence Vick, W5DUQ; G. W. A. Bäumer, PK1GW; William Coleman, W3EBG; Jean Lips, HB9J (phone); Hugo Fagien, D4SDA; L. Wickliffe Hazle, W9GCH; S. A. C. Howell, G5FN; Alois Kovanda, OK1LM; A. A. T. Cook, ZS6T; A. A. Carneson, ZU5Y; Georges Guidon, F8VT; Joseph B. Losekann, W6JNL; Reginald J. Hunneman, W1WE; I. Fukushima, J2ME; Gilberto Quintanilla, X2C; Leonard Glass, W8DXN; W. E. Nutton, G8NU; Francis C. South, W3AIR; Leon A. Weaver, W8BOF; Albert Francis Nash, W1BQR; Arthur McBride, W6KBH; Horton C. Kessler, W6EPZ; Walter B. Storey, W5DSH; A. de Waal, PA0OK; Sr. Don Alejandro Dumas, EA3CZ; Henri Pottier, F8GV; Werner Mats, D4HYG; Julius Zwerina, OE3JZ; G. W. Slack, G5KG; Jørgen Mortensen, OZ7JM; Carl Martin, OE1CM (phone); Joseph Horvath, W6GPF; Bruce L. Kelley, W8ACY; Bruce L. Kelley, W2ICE; Walter H. Smith, W6JMR; Shuso Teuga, J3DF; E. R. Gabel, W3CHG; Earle D. Byer, W7CFC; John W. Singleton, W1CDX; Archie Davis, AC6AA; Archie Davis, XU4Q; Benjamin Davis, AC6ZZ; William T. Klopp, W8FSK; Andrew C. Perrin, W9RKR; Richard Myers, W2EEA; Arthur N. Fay, W1DYA; Gerald Tipton, W9CFB; George H. Chapman, W5BEE; Roy H. Watterlohn, W9SHE; Robert J. Sinnett, W9JNB; C. L. Arundale, W9GBJ; William Middleton, OM2RX; Leo Yob, W8KY; Robert D. Millholland, W9SPB; H. V. Booth, G2AS; G. Hjalmarsson, SM7YO; J. G. Chaney, W5AEB; Harold H. Smith, W2UL; Peter Jørgensen, OZ5J; D. H. Priest, G2ML; José Rafael de Castro e Freitas, CT1LZ; Rodolfo Maria de Albuquerque Azevedo, CR7AJ; Armando Maria de Albuquerque Azevedo, CR7AI; Dr. W. Lampe, D4ORT; Fr. Struller, D4NXX-D4BKR; Arthur L. De Smet, ON4CC; Paul Antheriens, ON4PA; James Drinnon, W4AUU; C. E. Gresak, W8AZD; Norman F. Smaha, W6CSI; Gaston Pons, F8JJ; M. de Wit, PA0MDW; Stanley D. Fisher, W9DJE; Thompson McNeal, W6LDJ; Ernest C. Wood, W8CYT; H. W. Green, ZT6Y; Shoji Yoshimoto, J2CC; F. E. Pratt, W7DXZ; C. H. Krueger, W4YC; Dr. B. B. Bacheider, W6JPW; Stanley R. Radom, W6KBY; Alain Godefroy, F8KC; E. T. Pethers, G6QC; Rudolf Gruner, D4DHG; G. Hornsby, G6IR; F. C. Clark, ZE1JS; Gordon E. Provance, W7BLT; Antonin Kozel, OK1LN; Vladimír Lausman, OK2DD; Annoët Anscherlik, OK1FZ; Richard J. Cotton, W8LEC.

### Armistice Day Message—1935

(Continued from page 10)

Liaison Officer and First Lieutenant Loren G. Windom, Infantry Reserve as A.A.R.S. Radio

# Expressly Designed for STABILIZED PERFORMANCE

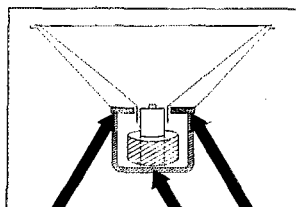

A new G-E process — projection welding — results in a permanent and perfect magnetic path.

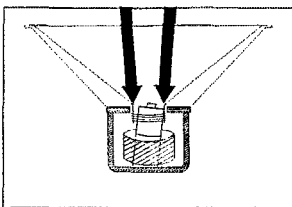

Projection welding also prevents misalignment of center post—a source of many speaker noises.

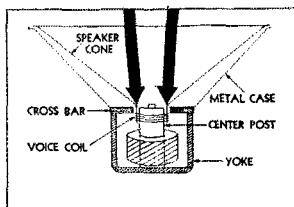

A perfect magnetic path and permanent alignment give crystal-clear tone and stabilized performance.

## MODEL A-82

8 metal tubes, four reception bands  
140-410 k.c. and 540-19,500 k.c.

**\$94.50** (Eastern List Price)

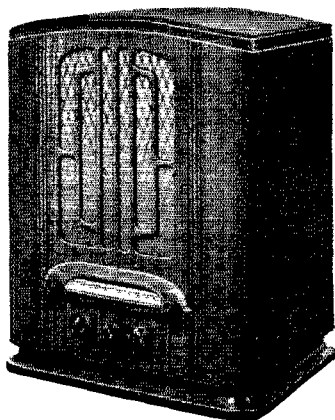

The Stabilized Dynamic Speaker is but one of five major features which contribute to stability in the life and performance of General Electric receivers.

### *Additional features are:*

*Metal Tubes*—strong and clear in signal. Supremely quiet—especially on short-wave broadcasts.

*Sentry Box*—Controls as many as five separate broadcast bands—permitting only one radio wave to pass.

*Permaliners*—Maintain the original factory adjustment of the set. Sealed against moisture and dirt.

*Sliding-rule Tuning Scale*—Shows only one tuning scale at a time. Lists all stations in a straight line. As easy to read as a ruler.

# GENERAL ELECTRIC

## The Original Metal-tube Radio

APPLIANCE AND MERCHANDISE DEPARTMENT, GENERAL ELECTRIC COMPANY, BRIDGEPORT, CONN.



## -it's a Landslide for CENTRALAB

Every serviceman from coast to coast knows Centralab . . . everybody's his friend and the worst thing his enemies can say is that he's a mighty smooth article.

Yes . . . he's smooth all-right . . . and it's that famous non-rubbing contact that makes him "that way."

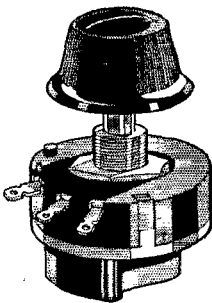

. . . a tip from campaign headquarters: a mere handful will service practically any set ever made . . . "better than ever before."

Every Radio Service Man should be a member of the Institute of Radio Service Men

# Centralab

MILWAUKEE, WISC.

**RADIOHMS SUPPRESSORS  
FIXED RESISTORS**

Aide. Their extremely high percentage of 99% was won by the united efforts of the following Honor Roll Stations:

Ohio: W8ZG (CANC8), W8BBH (CANC 2), W8JC, W8ISK, W8CIO (SNCS), W8CMI, W8UW, W8APC, W8AZY, W8CKU, W8CTP, W8DAT, W8DDM, W8DTW, W8DUP, W8DVL, W8EFW, W8EPP, W8FGX, W8FHV, W8GKG, W8GSO, W8GTU, W8GUL, W8HCS, W8HFE, W8HMH, W8ICC, W8IET, W8INT, W8ITR, W8KHD, W8KIM, W8KJK, W8KKQ, W8KND, W8KUY, W8KYI, W8KZY, W8LCY, W8LJY, W8LJI, W8LVV, W8LWI, W8LZE, W8LZK, W8MAC, W8MEI, W8MQC, W8MQO, W8MUR, W8MVS, W8MWX, W8NAL, W8NKU, W8NLZ, W8NQZ, W8OHP, W8QV, W8RN, W8VP, W8WE, West Va.: W8OK (SNCS), W8HD, W8EIK, W8AFB, W8AKQ, W8ATT, W8BDD, W8CMJ, W8CVX, W8DMF, W8ELJ, W8GOQ, W8HWT, W8JKN, W8KKG, W8LII, W8LJX, W8MCL, W8MCR, W8MEK, W8TI. Kentucky: W9HAX (SNCS), W9BWJ, W9CDA, W9EDQ, W9NKD, W9OMW. Indiana: W9HUO (SNCS), W9LSB, W9ABB, W9CB, W9EGV, W9FQ, W9HPQ, W9HUF, W9MBG, W9ODH, W9SEM, W9SPB, W9TBM, W9TGC, W9UPQ, W9UYF.

The Third Corps Area, which took the honors of having the greatest number of active stations submit copies, includes the states of Maryland, Pennsylvania, Virginia and the District of Columbia. Their Army Amateur Radio System is directed by Colonel Consuelo A. Seoane as Corps Area Signal Officer; Captain H. O. Bixby as A.A.R.S. Liaison Officer and Mr. E. D. Hartman as A.A.R.S. Radio Aide. This corps area's Honor Roll of active stations included the following:

Pennsylvania: W3CB, FC, LC, OK, ADE, AGK, AKU, AKB, ADM, AQN, AZJ, BID, BYS, BZF, BZP, CBK, CIQ, CPJ, CUX, DDM, DJY, DMM, DRJ, DUR, DZS, EAH, EBP, ECA, EDA, EDN, EEM, EFP, EOP, EOY, EPJ, EPS, ETM, EWJ, FFX, W8DMA, JZ, UK, UV, VD, AIT, AMV, API, ASW, AVK, AXD, BEV, BLJ, BRJ, CUG, DIG, DLG, DML, DVA, EBJ, EPA, EJS, EKG, EVX, FCB, FDD, FKO, FLA, GEK, GMZ, GSH, GUB, GUF, HLK, HMU, IWT, KBM, KCW, KLS, KNB, KPU, KRI, KRJ, KTI, KUN, KWA, LAP, LIG, LOQ, LUM, LWK, LWX, LYB, LYH, LYK, LYU, LZS, LZT, MAA, MAB, MFD, MOT, MQH, MRI, MRQ, NAW, NFS, NFV, NUS, OFO, OJK, OJZ. Maryland: W3ER, SN, ABA, BBW, BED, BKY, BWT, CDG, CIC, CIZ, CLH, CMG, CMS, CQS, CYO, DML, DWN, DXJ, ECP, EDS, EIB, EOG, EOU, EPX, ETV, FEK, FIO. Virginia: W3FJ, ALF, ANT, APT, APU, BIW, BJX, BRY, BYA, CFL, CYK, DCU, DQB, ECQ, EGD, EHL, ELA, EPS, EPU, EPW, EPX, EQC, EQU, ESW, EUL, FFO.

The Chief Signal Officer is very gratified that so many Army Amateurs participated in the competition this year. It was a decided increase over last year's contest.

200 Watts C.W., 75 Watts 'Phone

(Continued from page 80)

arrangement described by W6ZH on page 53 of the April, 1935, issue of *QST*. The circuit diagram of the bias supply is given in Fig. 4. It uses a choke-input filter with a fairly heavy bleeder.

The voltage regulation of this pack is such that the removal of any tap does not upset the voltages at the other taps. As shown, one tap is grounded at a point 60 volts from the positive end. The negative suppressor tap is adjusted to cause the antenna current to fall to half its c.w. value. The control-grid tap is set at minus 100 volts.

# Announcing the ALL-STAR BUILD-IT-YOURSELF TRANSMITTER

AT LAST! A transmitter you can build yourself! All you need is the foundation unit consisting of drilled and finished panels and bases and the necessary STANDARD parts. A screw driver, pliers and soldering iron — a few hours' time — and the job's done! With clear instructions as a step-by-step guide, the unit is easy to assemble. When completed, it looks and operates like a professional, ready-built job. Designed for standard rack and panel mounting.

## From 40 to 500 Watts Nothing Discarded

Efficient performance is assured if you use the STANDARD parts recommended by the seven prominent manufacturers listed. These parts have been built into a completed unit that has withstood repeated tests for proved performance. You start with the smallest unit of 40 watts, either C.W. or phone, and expand to a 500-watt C.W. transmitter or a 400-watt plate modulated phone. *No units are discarded in increasing power or going to phone operation.*

## Various Combinations

For C.W. operation, start with a 40-watt unit and low-voltage power supply. The addition of speech amplifier and power supply makes a 40-watt phone station with simultaneous screen and plate modulation, giving a peak power of 160 watts. To increase power, add high-power R.F. amplifier and high-voltage power supply. This gives the 500-watt C.W. transmitter. The same high-powered R.F. amplifier and high-voltage power

supply, with the addition of the 200-watt modulator, gives a 400-watt plate modulated phone, with peak power of 1600 watts.

## 40-Watt Transmitter

Input, 40 watts to final stage. No neutralization required. Operates on 20, 40, 80 and 160-meter bands. Same 40-watt unit also acts as exciter for amplifier having input of 500 watts. Tubes for 40-watt unit — 47 crystal oscillator, 802 buffer-doubler, push-pull 802's in amplifier. Two crystals will give operation on all four bands. Switching arrangement connects meter in plate circuit of any of three stages.

## Seven Leading Manufacturers

**Make Standard Parts for ALL-STAR TRANSMITTERS**  
 THORDARSON ELEC. MFG. CO., 500 W. Huron St., Chicago, Ill.  
 HAMMARLUND MFG. CO., 424 W. 33d St., New York.  
 CORNELL-DUBILIER CORP., 4377 Bronx Blvd., New York.  
 TRIPLETT ELECTRICAL INSTRUMENT CO., Bluffton, Ohio.  
 OHMITE MFG. CO., 636 N. Albany St., Chicago, Ill.  
 E. F. JOHNSON CO., Waseca, Minn.  
 CROWE NAME PLATE MFG. CO., 1749 Grace St., Chicago, Ill.

## See Your Jobber

for STANDARD parts for ALL-STAR Transmitters, or write.

any of the sponsor-manufacturers listed, or write direct to ALL-STAR HEADQUARTERS, 222 W. Adams St., Chicago.

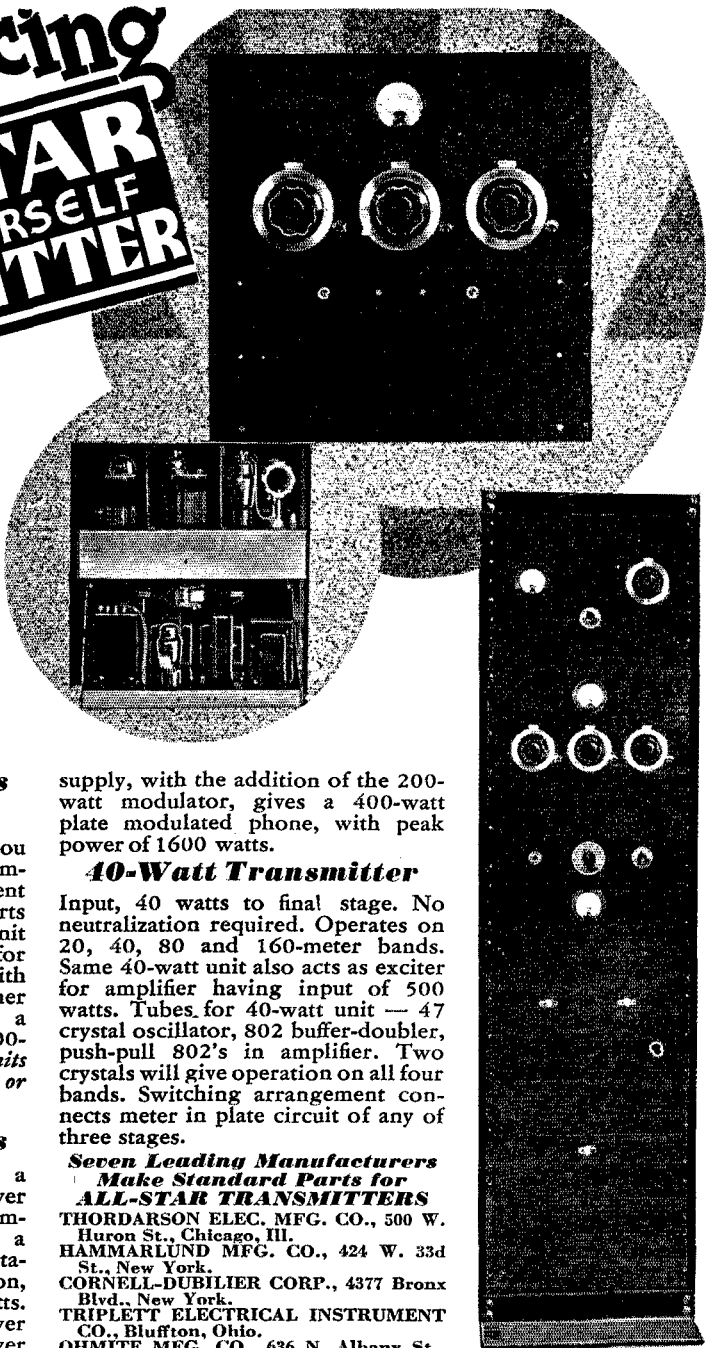

Unit at top and inset, 40-watt All-Star Transmitter. Panel, 400-watt phone transmitter complete.

• • •

★ BUILD YOUR OWN ★  
**ALL-STAR**  
 TRANSMITTER

# New HRO JUNIOR RECEIVER

Two Stages of RF

Multi Revolution  
Dial

Power Pack for  
above No. 5897  
\$15.90 Net

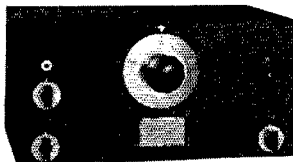

Priced at \$99.00 Net — with tubes and coils covering  
10 to 20 meters.

Additional HRO Jr. coils. Per Range (2 Amateur  
Bands). \$9.90 Net.

The HRO Jr. is the identical chassis and cabinet used in present table Model HRO, except that the meter and crystal filter are completely omitted. The coils differ from the standard in that they do not have the extra or extreme band spread range incorporated in the standard coils. Frequency coverage is the same. All receivers are furnished with the 10 and 20 meter set of coils as standard equipment. This is necessary as factory alignment of these coils to each receiver is essential for best results. Other coils interchangeable and may be added at any time.

*4 hour mail order delivery service.*

## MIDWEST RADIO MART

520 S. State Street

CHICAGO, ILLINOIS

With key down, 60 volts positive is applied to the suppressor grid,  $R_2$  limiting current flow since the bleeder is shorted. With key open, 300 volts negative is applied to the suppressor and the plate current drops to zero. This keying system is preferable to the one first described (Fig. 3) from the standpoint of click elimination.

### What the League Is Doing

*(Continued from page 25)*

#### DISTRICT NO. 9

Galveston, 209 Prudential Bldg., by appointment.

#### DISTRICT NO. 10

Dallas, 464 Federal Bldg., Tuesdays and Fridays.  
Albuquerque, N. M., Class A only, July 18th.  
Oklahoma City, February 15th, May 23rd,  
August 29th, November 28th.  
San Antonio, March 7th, June 6th, September  
5th, December 5th.

#### DISTRICT NO. 11

Los Angeles, 1105 Rives-Strong Bldg., Mondays  
and Saturdays.  
Phoenix, Ariz., Class A only, some time in April  
and October.

#### DISTRICT NO. 12

San Francisco, 328 Customhouse; Class B,  
Mondays; Class A, daily.

#### DISTRICT NO. 13

Portland, Ore., 207 New U. S. Courthouse,  
Fridays.  
Boise, Idaho, Class A only, some time in April  
and October.

#### DISTRICT NO. 14

Seattle, 808 Federal Office Bldg., Fridays.  
Butte, Montana, Class A only, some time in May  
and November.  
Spokane, Washington, Class A only, some time in  
May and November.

#### DISTRICT NO. 15

Denver, 538 Customhouse, first and third  
Saturdays of each month.  
Salt Lake City, Class A only, some time in  
March and September.  
Billings, Mont., Class A only, some time in April  
and October.

#### DISTRICT NO. 16

St. Paul, 927 New Main P. O. Bldg., first Satur-  
day of each month.  
Bismarck, N. D., Class A only, some time in  
February and August.

#### DISTRICT NO. 17

Kansas City, 410 Federal Bldg., first and third  
Saturdays of each month.

# A. C. RELAYS

Made by

## Allen-Bradley

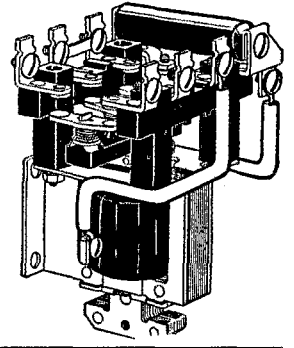
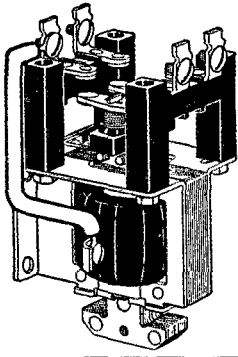

These A. C. solenoid relays are ideal for remote control of transmitters, for control of crystal ovens, and for any general remote control application except for keying. THESE RELAYS WILL NOT OPERATE IN KEYING SERVICE. Silver-to-silver double-break contacts are used throughout.

The maximum contact rating is 10 amp. at 220 v. or 3 amp. at 550 v. The relay coils are wound for 115 volts 60 cycle alternating current. Relays for other voltages can be supplied on special order. Use coupon below.

Type No.	Poles	Nor- mally	Action	Circuit Diagram	Price		Type No.	Poles	Nor- mally	Action	Circuit Diagram	Price	
					Open	In Cab.						Open	In Cab.
A107	1	Open	SP ST		\$3.50	\$4.50	A177	1	Closed	SP ST		\$7.50	\$8.50
A117	1	Closed	SP ST		4.50	5.50	A207	2	Open	DP ST		4.00	5.00
A127	1	Open and Closed	SP DT		5.00	6.00	A217	2	Closed	DP ST		6.00	7.00
A137	1	Open	SP ST		4.00	5.00	A227	2	Open and Closed	DP DT		7.00	8.00
A147	1	Closed	SP ST		5.00	6.00	A237	2	Open	DP ST		4.50	5.50
A157	1	Open and Closed	SP DT		5.50	6.50	A247	2	Closed	DP ST		6.50	7.50
A167	1	Open	SP ST		6.50	7.50	<p><b>Radiostat</b>—A stepless graphite compression rheostat for primary of 550 watt filament or plate supply transformer. Range 4 to 150 ohms. <b>Price \$6.50</b></p>						

### ORDER BLANK—MAIL WITH REMITTANCE TO

Allen-Bradley Co., 108 W. Greenfield Ave., Milwaukee, Wis.

Enclosed find money order for \$..... for which please send me, shipping charges prepaid, the following items:

..... for..... Volts..... Cycles

Name.....

Address.....

# EASY TO DRIVE

## RAYTHEON RK-31

### ZERO BIAS CLASS B MODULATOR

A pair requires but 900 milliwatts grid drive to produce 140 watts of audio power. No bias required. The ideal modulator for all phone transmitters up to 300 watts input.

FILAMENT . . . . . 7.5 V., 3.0 A.

A. F. OUTPUT: 110 Watts per pair at 1,000 V.  
140 Watts per pair at 1250 V.

OVERALL DIMENSIONS . 2 1/16" x 8 1/2"

AMATEUR NET PRICE . . . . . \$10.00

**RK-34 . . . Ultra High Frequency Triode**  
Insulantite Base. Plate leads out top of bulb. Uni-potential cathode system.

HEATER . . . . . 6.3 V., 0.8 A.

R. F. OUTPUT at 300 V. . . . . 14 Watts

AMATEUR NET PRICE . . . . . \$3.50

**RK-23, RK-25...Radio Frequency Pentodes**  
for the Oscillator and amplifier. Lowest losses, lowest internal capacities, highest output in their size classification.

Insulantite Base. Plate mounted on ceramic spacers. Plate connection at top of bulb. RK-23 equipped with 2.5 volt heater. RK-25 has 6.3 volt heater.

R. F. Output at 200 V. Screen, Plus 45 V.

Suppressor and 500 Volts Plate, 24 Watts.

AMATEUR NET PRICE— Either Type, \$4.50.

Ask your dealer or write to the nearest Raytheon Office

**RAYTHEON PRODUCTION CORP.**

30 EAST 42nd STREET, NEW YORK, N. Y.

55 Chapel St.      445 Lake Shore Dr.      855 Howard St.  
Newton, Mass.      Chicago, Ill.      San Francisco, Cal.

# RAYTHEON

TRADE MARK

## AMATEUR RADIO TUBES

Des Moines, January 24th and 25th, April 24th and 25th, July 24th and 25th, October 23rd and 24th.

St. Louis, February 28th and 29th, May 29th and 30th, August 28th and 29th, November 27th and 28th.

DISTRICT NO. 18

Chicago, 2022 Engineering Bldg., Saturdays.

DISTRICT NO. 19

Detroit, 1025 New Federal Bldg., Saturdays.  
Cleveland, some time in April, July and October.  
Cincinnati, some time in February, May, August and November.

Columbus, Ohio, some time in March, June, September and December.

DISTRICT NO. 20

Buffalo, 514 Federal Bldg., last Friday of each month, also by appointment.

Pittsburgh, some time in March, June, September and December.

DISTRICT NO. 21

Honolulu, Aloha Tower, Mondays and Saturdays.

## A Few Random Remarks

*(Continued from page 86)*

dots, I wonder, when they mean H? And why, for Pete's sake, do they think it's "professional" to make I and E sound like S? They think they are aping the commercial ops. They never were more mistaken in all their miserable little lives. Good ops have clean fists. They don't hash everything all up the way these modern Young Squirts do. You can copy their stuff solid at 35, although you'll notice that most of the time they're content with a good steady 22. They don't send a TH so it can't be told from a 6. They don't rip a lot of hash off at 40 and then have to repeat it four times before it becomes evident that the message is "Greetings by radio." Those chaps who *have* to get the stuff the first time send right along, all right, but the letters are spaced, the words are spaced, and there is a steady rhythm to it that makes solid copy flow out on the typewriter like oil.

Bug keys in the hands of Young Squirts! Gorrigh me, but wait till I get at one of them! Extra dots on everything. Letters hatcheted clean in two, F becoming a clean IN, and so on. You simply can't read the stuff. And the babies behind it are so smug and so sure that they're maestros! There's a strong Narcissus element in it; self-hypnotized. It's just plain rotten, and getting worse by the hour. Semi-automatic keys are fine things, and many a punko's bum fist is made readable by ironing out the Lake Erie swing and making dots and dashes out of it. But why must they take off the weights and make the dot speed sound like a mosquito buzz? Don't they know that the manufacturer put the weights there for



***It's a wow!***

EVERYWHERE WE HEAR THE MOST ENTHUSIASTIC PRAISE OF OUR NEW MANUAL OF AMATEUR COMMUNICATION,

# ***The Radio Amateur's Handbook***

In the first month after publication we have sold and shipped over 25 tons of copies, not only in the United States and Canada but in every land where there are amateurs. Why? Because the A.R.R.L.'s Handbook is the standard manual of amateur practice, known for ten years to be written by expert amateurs who know their stuff and can explain it so you may employ their knowledge.

The new 1936 edition is nearly twice as big as its famous predecessors. Written by the amateur technicians who have made *QST* famed and *reliable*: It's an extraordinary piece of work — even if we do say so ourselves. Jim Lamb, George Grammer, Ross Hull, Clint deSoto, and others. Communicating dope by Handy, background stuff by Budlong. C.W. and 'phone. All the way from 160-meters to 1 $\frac{1}{4}$ . Simple and complete. Theory, principles and constructional specifications. Transmitters and receivers, antennas and feeders, power supplies and monitors. Some for every need, every purse. Lavishly illustrated both with photos and diagrams. Dozens of copyrighted original tables of tube dope and charts. Not only technical questions but operating ones, legal ones. And a profusely-illustrated advertising section which is a handy catalog of the best gear in America, right where you want it. The complete answer to the ham's prayer.

480 pages, 6 $\frac{1}{2}$  x 9 $\frac{1}{2}$ , in the familiar *QST* format, heavy dirt-rejecting cover. Unquestionably more words of technical advice, and sounder and more interesting and reliable advice, than has ever been sold before for a measly Bucks 1. Printed in the usual textbook form, this book would be two heavy volumes for about nine good Iron Men plus another for postage. It's the world's best buy in amateur radio literature.

When you buy a Handbook, see that it carries the A.R.R.L. emblem. Only then will you have the reliable and original Handbook created by the Headquarters Staff of the A.R.R.L.



**\$ 1.00** POSTPAID IN  
CONTINENTAL U. S. A.

**\$ 1.15** POSTPAID  
ELSEWHERE

**\$ 2.50** POSTPAID, IN  
BUCKRAM BOARDS

FOR BEST RESULTS IN AMATEUR  
RADIO, ORDER YOURS TO-DAY!

***American Radio Relay League, Inc.***  
***West Hartford, Connecticut***

# THESE SPLENDID BOOKS FREE!



**T**HINK OF IT! 2 books full of invaluable information, to be had for just the mailing costs! One with 20 complete transmitter designs including 12 tested transmitter RF section designs and 8 modulator and speech amplifier designs. Circuits, complete parts specifications, inductances, etc. all included. Outputs ranging from a little fellow all the way up to the big ones comparable to the best broadcasters.

Ten complete designs for public address amplifiers in the other book. It includes one for every purpose, from 3 Watts to 30 Watts output, tried and tested designs that you can build, with complete parts lists for each.

These books should be in every amateur's technical library. Just 22 cents in stamps, to cover postage, brings them both to you, or get them from any Standard Distributor. Send for your copies today.

## STANDARD TRANSFORMER CORPORATION

856 Blackhawk Street, Chicago, Illinois

### MAIL THIS COUPON!

STANDARD TRANSFORMER CORPORATION  
Dept. A, 856 Blackhawk St., Chicago, Ill.

I am enclosing 12c for Transmitter Manual

I am enclosing 10c for Amplifier Manual

Name.....Address.....

City.....State.....

a purpose? Did they never hear that a dot was supposed to be one-third the length of a dash? Do they find nothing incongruous in sending alleged Morse at 30 so far as concerns the dashes, while the dots are at the rate of 65?

Rotten slobber, say I. Rather than removing weights, most of them ought to wrap some additional wire solder around the lever instead. What must people, who know good radio communication, think of us American amateurs when they hear all this will on the air! It's got to stop and I'll be gormed if I don't stop it! I'm going to send one of my new Buggbillies into every A.R.R.L. division and place them in the hands of the most blood-thirsty plug-uglies I can find, and then let nature take its course.

Well, so-long, Eddie. CU agn soon. I'm too daggone mad to send 73. GN.

THE OLD MAN

### Ingang, B.E.R.U., and All That!

(Continued from page 84)

Belgium, however, the R.I. has the habit of being blind and deaf until B.C.L. QRM or other trouble arises, and there are many active high-powered stations. In Holland monitoring stations keep strict watch and make field strength measurements to keep amateurs within their authorized power limit. Also they are prohibited to contact "bootleg" stations in all countries. Switzerland has a law with a rigidity between these two. Because of the high mountains the country contains some very excellent and some very poor radio locations. In Luxembourg all stations are "bootleg." The license examinations are, in general, more difficult than ours, especially in Holland. For example, PAOFY told me he was required to draw the diagram of a S.S. super and to explain the use of a v.t. voltmeter. Most countries have code requirements about the same as ours.

The English radio law is somewhat different from any of these. When one can convince the authorities that he has some experiments of merit in mind he is granted a license for a transmitter operating with a dummy antenna. After a few months, if he can convince the authorities that he has experiments to perform that require a radiating license, he is given a license which permits him to operate on the 1.7-mc., 7-mc., and 14-mc. bands with inputs up to ten watts, and with antennas not exceeding 100 feet in length. For this there is the additional requirement of a code test. If, after the passage of time, he can justify his use of higher powers up to, in rare cases, a kilowatt, or the use of longer antennas, or the use of other bands, he is permitted these additional privileges. Being legally "private experimental stations," British amateurs are required to call "test" instead of "CQ" and are not supposed to QSO except in conducting experiments. In common with the Continental amateurs, the British have to pay a fee for their licenses, which is not surprising, when they have to pay a fee for the license of a B.C.L. receiver. The English law is

**POLICE  
AND AMATEUR  
RADIO CARS  
*need this*  
HEAVY-DUTY GENERATOR**

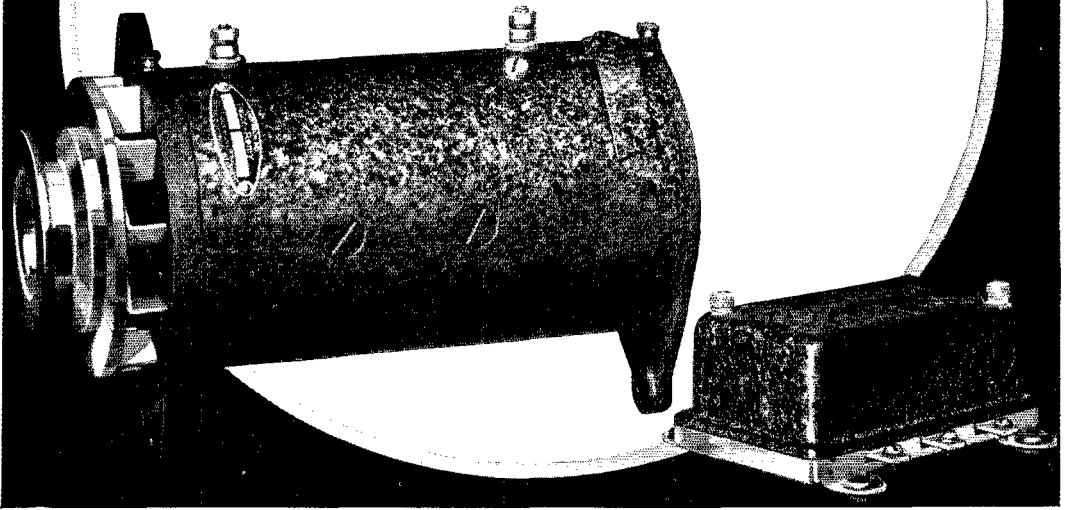

A vital need of a motor car in police or amateur radio service is a generator capable of producing ample current at the speed at which the car is operated.

The Delco-Remy Special Service Generator is the answer to this need. This generator, designed for all types of heavy-duty service, is fan-ventilated and has current and voltage regulation. Types are available for most of the popular makes of cars in either high-

DELCO-REMY CORPORATION . . .

speed or cruising service. The output of the generator is sufficient to supply the equipment load, with ample reserve capacity to keep the battery charged.

To assure peak effectiveness in radio-equipped cars, try one of these new Delco-Remy Special Service Generators. Available now from your car dealer or any Branch or Authorized Electrical Service Station of United Motors Service.

. . . ANDERSON, INDIANA

**Delco-Remy**

Delco-Remy products are sold and serviced in the United States and Canada by United Motors Service

# ... NEVER BEFORE HAS THERE BEEN SUCH A BOOK VALUE!

More than 256,000 words—  
over 500 diagrams, charts and  
photographic illustrations,  
53 basic design formulas,  
42 charts and tables  
in the NEW

## TWICE-AS-BIG

480-PAGE

## 1936 HANDBOOK

It's the equal of a two-  
volume \$7.00 textbook

It's EASY to get one, too—  
use the coupon below

.....  
A.R.R.L.  
West Hartford, Conn., U. S. A.  
Your statistics overwhelm me.  
Here's my dollar—(or \$1.15, I live outside of U. S. A.  
proper).

Please send to:

Name \_\_\_\_\_

Address \_\_\_\_\_

copied in many places in the Empire. In South Africa this is largely true, but everyone is permitted 50 watts, and whereas third-party traffic, when the third party is an amateur, is allowed in England, absolutely none is permitted in South Africa.

As might be expected, amidst the usual exchanging of QSL cards and autographs prevalent at all hamfests, much of the conversation also centered on the apparatus used. I find that the equipment is about the same as in American stations, except in general, the transmitter power is lower according to the law. In England, the home of the Goyder Lock, the driven type of c.c. is fast coming into favor.

In concluding, I wish to mention two things which impressed me deeply. In the first place the complexity of amateur radio in Europe is something which an American cannot hope to fully comprehend except perhaps through a much longer contact than I have had. When I heard the above-mentioned conversations on radio laws, I just began to realize what it means to have a score of countries, each with its own government and official prejudices, within an area comparable to the United States. Furthermore, though many of the Continental amateurs speak excellent English, in Belgium we found ourselves in terrible confusion as we all tried to speak English, French, and German at the same time, and I saw what it is to have a people living a hundred miles or so away speak another language. I can visualize the difficulties in store at Cairo.

The second subject I wish to mention is the excellent amateur spirit I saw displayed and the tremendous hospitality shown to me. I was the recipient of a large number of invitations both during my visit and previous to it, many from amateurs I had never seen in person. I regret that I was able to accept only a few of these, but whenever I accepted, I found hospitality deeply rooted. I could not help considering exhibit of friendliness an enormous tribute to amateur radio, and it makes one wonder if amateur radio is fully aware of its own greatness. Here was a visitor in a strange country, but in short order he found himself among friends, was given a chance to live with them, play with them, and to see how they worked—in short, to share their life. It is not surprising that he came away with a great feeling of friendship and understanding, probably not obtainable in so short a time in any other way—a feeling which will remain with him always.

### Noise-Silencing I.F. Circuit

(Continued from page 38)

gain control, and its No. 3 grid is excellently suited to the noise-silencing action. Its internal shielding is such that there is practically no i.f. output when the No. 3 grid is biased to cut off the plate current and there is no abnormal tendency to instability. While a combination pentode-diode (2B7 or 6P7) might be used for the noise amplifier-rectifier, no other type as suitable as the 6L7 has been found for the i.f. silencer-

# LEEDS LEADS

## GENERAL RADIO

Amateur accessories are always in stock. Here are two handy forms for that multiband xmitter.

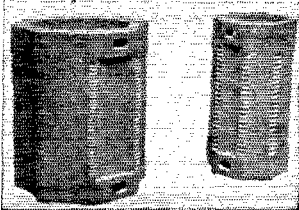

**Type 677-U** — 21 turns, 2 1/2" diameter, resonant on 3.5 mc with 100 mmf. capacity; weight 2 lbs. Price . . . . . 50¢

**Type 677-Y** — 30 turns 4" diameter, resonant 1.7 mc with 100 mmf. capacity. Weight 3 lbs. Price. . . . . 75¢

Also 7-pin base to fit above forms at 70¢ and a matching base with jacks at 65¢.

**Porcelain Stand Off Spacers**  
for pin base. Per pair. . . . . 30¢

## NATIONAL Transmitting Condensers

are outstanding

**Highest efficiency — lowest prices**  
T.M.A. 40 D.C. split stator, 40 mmf. per section, .375 spacing 12000 volt, **\$7.20**

We recommend two in parallel for 75 meters, for 1 KW CW or 500 watt fone transmitter.  
T.M.A. 60 DB. split stator 60 mmf. per section, .250 spacing, 9000 volt, **\$10.20**

T.M.A. 100 D.A. split stator 100 mmf. per section. For 500 watt CW transmitter, .185 spacing 6000 volt, **\$9.60**

**Exceptional values in single section units TOO.**

- 50 mmf. 6000 volt  
T.M.A. 50-A. . . . . **\$3.60**
- 100 mmf. 6000 volt  
T.M.A. 100-A. . . . . **5.40**
- 230 mmf. 6000 volt  
T.M.A. 230-A. . . . . **8.70**
- 50 mmf. 12000 volt  
T.M.A. 50-C. . . . . **4.35**
- 100 mmf. 12000 volt  
T.M.A. 100-C. . . . . **6.60**

## LEEDS OVERSEAS SERVICE

has an established reputation for speed, accuracy, safety and low cost. No matter where you live there is a satisfied Leeds customer nearby.

And now we have the season's outstanding value in **Communications Receivers**

## THE HRO JUNIOR

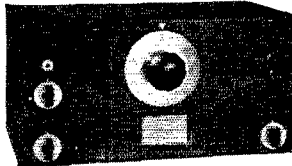

Order yours Today

**RESISTOR SPECIAL**  
IRC one and two watt metalized resistors at 60% off list.

## WESTINGHOUSE AND SANGAMO

Watt Hour Meters

110-120 volt; 60 cycle 2 wire meters. 5, 10, 25 and 50 ampere. The meters are used instruments in perfect condition, tested and reset to zero. A fifteen dollar value, at the extremely **\$3.50** low price of . . . . .

Shipping weight 15 lbs.

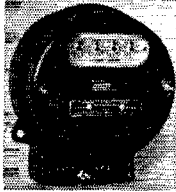

We are pleased to announce our appointment as New York Distributor for Dumont Laboratories. The type 148 Oscillograph, 5 inch tube, 100000 kc linear sweep and two stage amplifier now on demonstration. Price complete with tubes. . . . . **\$106.50**

Descriptive bulletin on request

New Aladdin air tuned iron core 465 kc I. F. transformers now in stock. Price. . . . . **\$3.24**



**LEADS THE FIELD**

World Wide Service to Amateurs

45 Vesey Street

New York City

Tel. COOrdinat 7-2612

Cable Address: "RADLEEDS"

LEEDS offers outstanding values in quality transmitting **TUBES**, backed by our name and guarantee.

*203-A. . . . . \$8.45	†*830-B. . . . . \$7.25
†210-HF. . . . . 1.75	*838. . . . . 11.75
866. . . . . 1.50	†*841. . . . . 2.45
304-A-UHF. . . . . 9.45	*852. . . . . 11.50
†*801. . . . . 2.95	866-A. . . . . 1.95

\*Graphite Anode Tubes  
†Isolantite Base

Tubes Shipped by Express Only

The record is 100% perfect. Thousands of microfarads of Leeds oil filled Condensers are in use without one case of failure.

1 M F 1000 v. . . . .	<b>\$1.10</b>
2 M F 1000 v. . . . .	<b>1.45</b>
1 M F 1500 v. . . . .	<b>1.45</b>
2 M F 1500 v. . . . .	<b>1.95</b>
1 M F 2000 v. . . . .	<b>1.75</b>
2 M F 2000 v. . . . .	<b>2.45</b>

## All COMMUNICATIONS PRODUCTS items in stock.

Vitrolex Band Change Switch, 2 sections, 6 points. . . . . **\$1.95**  
Q Max-3 coil dope; 2 oz. can. . . . . **25¢**

## TRIPLETT METERS

all standard ranges; 0-10 to 0-1000  
MA 3 1/2" bakelite case. . . . . **\$3.75**  
2" bakelite case. . . . . **\$2.94**

**TRIMM** 2,000 ohm phones **\$1.80**  
4,000 ohm. . . . . **\$2.25**

**TRIMM** featherweight **\$5.88**

**FROST** 2,000 ohm. . . . . **\$1.45**

**FROST** 3,000 ohm **\$1.65**. DX

20,000 ohm imp. . . . . **\$2.65**

**WESTERN ELECTRIC** type

P-11. . . . . **\$3.95**

## A THIN DIME

Now that the 1936 bulletins are available, we are renewing our offer of last year. A thin dime brings to you post paid the latest bulletins of 25 manufacturers of short wave equipment, together with our own B-73 bulletin. Far more information on the latest and best short wave equipment is contained in this assortment than can be found in any mail order catalog. Write for yours today.

# 32%

## OF THE APPLICANTS FOR AMATEUR LICENSE PRIVILEGES FAIL THE EXAMINATION

### Why?

Inadequate technical background? Perhaps.

Lack of practical operating experience? Very likely.

Code incompetency? Yes.

Insufficient background of general information? Unquestionably.

A major step toward making certain that you will not fail is thorough study of

## THE RADIO AMATEUR'S LICENSE MANUAL

### Includes:

Corrected text of the amateur regulations up to date.

Corrected answers to typical examination questions relating to regulations, where the same are changed by the amendments to regulations.

Corrections in the text concerning permissible 'phone bands and portable privileges, under new regulations.

Additions to the text about licensing, to incorporate the existing arrangements in Alaska, Puerto Rico and Hawaii, the right to have code tests administered by government radiotelegraph operators; and a similar paragraph extending to cripples the right to have their material dictated or typewritten.

Several notable changes in the way of improved answers to questions in the Class-A 'phone examination, bringing them in line with the modern engineering concept of modulation.

Several other improved answers to questions appearing in the Class-B-C examinations.

UP TO DATE IN EVERY RESPECT. VALUABLE ALIKE TO THE BEGINNER AND THE ALREADY-LICENSED

**25 CENTS POSTPAID . . .** (No stamps, please)

[ No. 9 in the series entitled  
The Radio Amateur's Library ]

## THE AMERICAN RADIO RELAY LEAGUE

WEST HARTFORD, CONNECTICUT

amplifier. It is to be noted also that a sharp cut-off 6J7 is used as the noise amplifier, rather than a variable-mu type tube. The sharp cut-off type has been found considerably more effective in this position, giving more decisive threshold action. In glass types, a 57 or 6C6 would be alternatives to the 6J7.

Apart from the tubes, the circuit of the silencer section is not especially critical. Considerable tolerance is permissible in bias and screen voltage values, and even in the diode load and output filtering network. Variations are also possible in the method used to set the noise threshold bias. Alternative to biasing both the noise amplifier and rectifier by the common cathode resistor  $R_{24}$ , biasing only one or the other has been tried. However, the combination shown has been found to give the most satisfactory threshold setting. Note that a small fixed resistance is used in the cathode of the noise amplifier. This gives the 6J7 a small minimum bias with the threshold adjustment at zero (ground), so that its grid will not be operated at zero bias.

Of a variety of resistance and capacitance combinations tried in the diode load and silencing-grid circuit, those specified with Fig. 1 appear to be as suitable as any. Resistance of between 100,000 and 250,000 ohms for  $R_{29}$  satisfies requirements, with the lower value preferred as giving the smaller time constant. Capacitances  $C_{21}$  and  $C_{23}$  also are fairly tolerant as to value, the largest capacitance permitted by time constant considerations being desirable for best r.f. filtering. Some tolerance in the inductance of  $R.F.C.$ , the silencing circuit filter choke, also is allowable. In no case should this inductance be so large as to affect the time constant appreciably. Resonant combinations were also tried for filtering in this circuit, but were found to cause instability.

Typical voltage values in the circuit, measured to ground with 225-volt B supply and the r.f. gain control set at maximum are as follows: 6L7 screen, 90 volts; 6J7 screen, 90 volts; 6L7 cathode, 3 volts; 6H6 cathode, normal operating setting of  $R_{24}$ , 6 volts; 6L7 silencer grid (No. 3), peak voltage across  $R_{29}$  necessary to block amplifier, approximately 10 volts. It is to be noted that this blocking voltage is aided by the cathode-bias drop across  $R_5$  of the 6L7 and the manual gain control, the diode load resistor being returned to ground. Tests indicate that this connection gives better action in general than return of the diode load resistor directly to the 6L7 cathode.

Although the usual type of i.f. double-tuned input transformer is satisfactory for  $T_2$ , the single-tuned full-wave diode type transformer is essential for  $T_4$ . This transformer should have relatively poor selectivity (low effective Q), the untuned secondary being closely coupled to the primary. The full-wave diode rectifier circuit is an essential feature. It minimizes the fundamental i.f. component in the load circuit and simplifies the problem of keeping this undesirable r.f. voltage from reaching the silencing grid of the 6L7. The full-wave arrangement also insures rectifica-

(Continued on page 108)

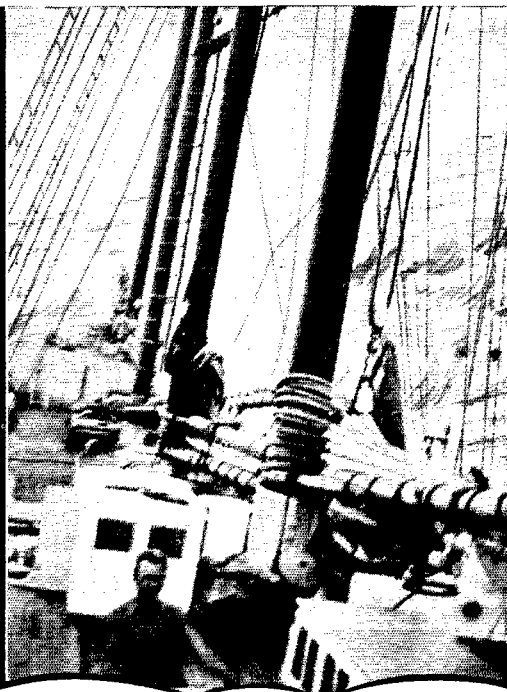

# BURGESS Flashlights

## SAVE A LIFE AT SEA!

*Phillips H. Lord, the Seth Parker of the Radio, and Captain of the Schooner Seth Parker, told us this dramatic story:*

"We had a number of things vital to safety on board the *Seth Parker* when we took her from New York to Portland, Maine. But we had nothing which we appreciated more than our BURGESS Flashlights. In a heavy storm we broke our jib-boom, a fragment ten feet long and a foot and a half in diameter was swinging in an arc of 50 feet. We followed it with our flashlights and lassoed it as it slipped down over the deck and off to the other side. Our BURGESS Flashlights had a great deal to do with saving my life on that trip, and they actually saved the life of one of my sailors."

The dealer who supplies your Radio Batteries will be glad to show you the newest BURGESS Flashlights. Always be sure your Flashlight is powered by dependable BURGESS UNI-CELS. You can identify them by their black and white stripes. You will remember them for their service. BURGESS BATTERY COMPANY, Freeport, Illinois.

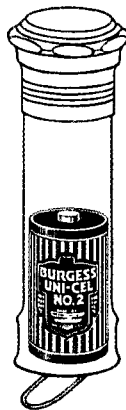
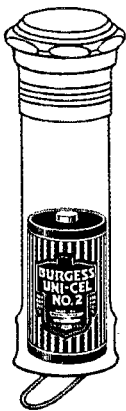

# ≡ BURGESS ≡

Say You Saw It in QST — It Identifies You and Helps QST

AT LAST . . .

"HI-Q" PLUG-IN

# INDUCTORS

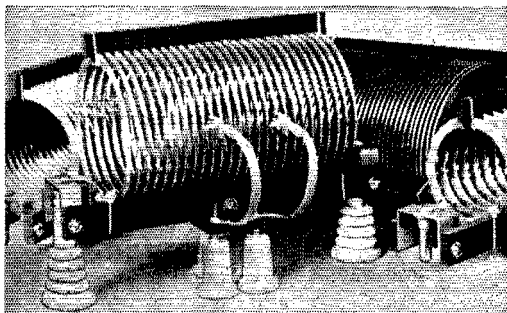

● The dream of nearly every amateur since multi-band operation became possible, is now a reality!

● Think of a series of inductors for the 20, 40, 80, and 160 meter bands, marvelously compact, all interchangeable in seconds. Tuning is accomplished within the range of a single 100  $\mu\text{f}$  condenser (200  $\mu\text{f}$  each section, if a dual-section condenser). Five connections are possible—the two ends, center tap, and two adjustable clips. Perfected JOHNSON plugs and jacks and Thru-panel insulators offer excellent contact, thorough insulation, and firm mounting in any position.

● Ask any JOHNSON jobber for Bulletin 352 containing full information on these inductors, and for our complete catalog No. 960.

HANDBOOK  
PAGES  
447-449  
CATALOG  
SECTION

**E-F-JOHNSON COMPANY**  
Manufacturers of Radio Transmitting Equipment  
WASECA MINNESOTA U.S.A.

## IMMEDIATE DELIVERY FROM AMATEUR HEADQUARTERS

The new HRO Jr. . . . .	\$ 99.00
The new RME-69s . . . . .	118.80
PR-16s (at last) prepaid . . . . .	95.70
National HROs . . . . .	167.70
Breting 12s complete prepaid . . . . .	93.00
Silver 5Ds complete prepaid . . . . .	109.80
Super-Sevens complete prepaid . . . . .	49.50
Super Skyriders complete prepaid . . . . .	79.50
Super Pros complete (when ready) . . . . .	194.04

### RME COLLINS AND RCA TRANSMITTERS

#### Trade in Your Receiver or Transmitter

Consider these reasons why it is genuinely to your benefit to deal with W9ARA. I sell amateur apparatus exclusively and am jobber for every line. Besides guaranteeing to sell to you at lowest wholesale prices and to see that you are entirely satisfied with everything you buy from me, I take in trade your used apparatus and furnish technical help free. I sell on time payments. Write to W9ARA about any apparatus.

**HENRY RADIO SHOP**  
211-215 North Main Street      Butler, Missouri

## How to Read and Use Your QST

(Continued from page 43)

method" for studying, constituting the fifth in our series. The actual comparing can be done in writing, mentally, orally, or in whatever manner benefits you.

### OUTLINES

We now come to the last direct method of studying that has been given the name "outline". Most of us at some time or other in high school have had to do this. We start at the beginning of an article and go through it while making short main phrases characterizing the subject of each paragraph. A line-up might have this general appearance:

Subject: Radio

I. Early History

A. Heinrich Hertz

1. His contributions to radio, etc.

II. Fundamentals

A. Magnets

1. Permanent

a. How made

etc.

This kind of an approach gives a complete picture of the content of an article, the relative importance of the various sections, etc. It may take quite a little time to prepare the outline, although it is one of the best ways to see how all the different parts of an article or book are put together.

### KEEPING RECORDS

There is one sadly neglected part to amateur radio which I never have quite been able to understand—the failure to keep a laboratory notebook telling what the receiver or transmitter set-up was during a certain period; the peculiarities of the apparatus, advantages and disadvantages, why supplanted with different circuits. No commercial laboratory with any pretense at doing organized work can exist without a daily journal of the experiments being performed. Almost anyone who has taken any high school course in physics or chemistry laboratory can remember how he wrote up his work; but it is well to review some of the ways in which data may be kept. The first scheme to be described may be too elaborate for routine work but it at least serves to illustrate what kind of information is desirable. We find the following, tabulated in order:

- Title of experiment
- Purpose of experiment
- Method to be used in experiment
- Apparatus used
- Data: circuit connections
- instrument readings
- observations
- Computations
- Conclusions and remarks

Most of these headings are self-explanatory but it might be well to run through a typical case. Suppose we were experimenting for the first time with a simple detector-oscillator receiving circuit. If this was a general experiment, then the above



# LIGHTNING CALCULATORS

*The Most Useful Gadgets  
You Ever Saw*

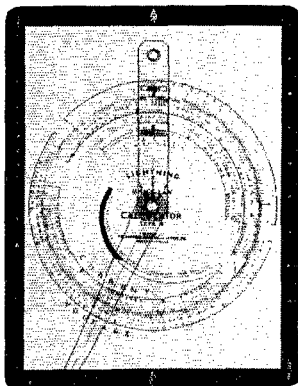

**LIGHTNING CALCULATORS** keep you out of mathematical snarls. They make child's-play of calculations which are usually slow, complicated and confusing. They give you the right answer, right away. They are great time savers for engineers, yet so simple that any dumbbell can use them.

## **L**LIGHTNING RADIO CALCULATOR—Type A

For problems involving frequency, inductance and capacity, in design of radio frequency circuits. Direct reading answers for size of coils and condensers for any range between 400 kc. and 150 mc. Price, \$1, postpaid.

## **L**LIGHTNING OHMS LAW CALCULATOR—Type B

Gives direct reading answers to calculations involving current, resistance, voltage and power with scale for resistance of copper wire and scale for calculating decibel gain or loss. Price, \$1, postpaid.

## **L**LIGHTNING WIRE DATA CALCULATOR—Type C

More information on electrical conductors than you could find in a book full of tables. Price, 50c, postpaid.

## **L**LIGHTNING DECIBEL CALCULATOR—Type D

Gives decibel gain or loss when input and output voltages, currents or power are known. Price, 50c, postpaid.

## **L**LIGHTNING PARALLEL RESISTANCE—SERIES CAPACITY CALCULATOR—Type E

Gives direct reading answers for total resistance of two or more resistors connected in parallel, and total capacity of two or more condensers connected in series. Price, 50c, postpaid.

## **L**LIGHTNING RESISTANCE CALCULATOR—Type F

Permits measurement of any resistor, from 1 ohm to 1 megohm by use of a voltmeter. Makes an ohm-meter of your voltmeter. Price, 50c, postpaid.

AMERICAN RADIO RELAY LEAGUE, INC., WEST HARTFORD, CONN.

## LOW LINE VOLTAGE

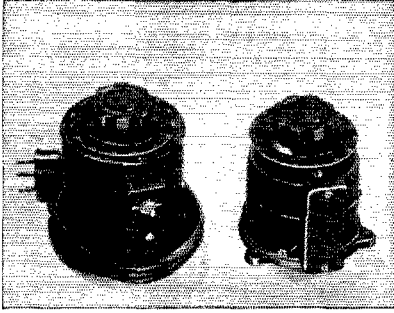

Is your station crippled by this malady?

The General Radio Type 200-C Variac will cure it immediately. The Variac is a continuously adjustable auto transformer supplying output voltages from 0 to 135 volts when used on a 115 volt circuit.

Both models illustrated are rated at 900 watts and are just the thing for correcting low line voltages.

Type 200-CU, behind-the-panel model. . . . . \$14.50

Type 200-CM, table model, with switch, cord, plug and convenience outlet. . . . . \$17.50

Order direct from this advertisement, mention QST, include remittance and we ship prepaid anywhere in U. S. Be sure to mention QST.

**GENERAL RADIO COMPANY**  
Cambridge, Massachusetts

## WRIGHT DECOSTER Port-A-Case



Model 890

This handsome ruggedly constructed carrying case complete with a large Model 790 — 10" D. C. Speaker

**FOR ONLY \$14.40 LIST OR**

Make it an A. C. Speaker by using a Model 470 field supply at the low additional list price of \$4.70.

There is plenty of extra room in the Port-A-Case for the field supply and a small amplifier besides.

Write for catalog giving full description and showing our astonishing prices for the Port-A-Case Complete with the different 12" speakers.

**REMEMBER THE QUALITY always remains the same**

Buy through the Wright-DeCoster distributors. You will find them always anxious to cooperate

**WRIGHT-DECOSTER, INC.**

2259 University Ave.

St. Paul, Minn.

characterization would be sufficient for the title, and the purpose might be stated, "to familiarize the experimenter with the tuning, manipulation and general characteristics of such a circuit." Under the "Method to be used" we can say, "three-element tube, tickler coil feedback"; observations might be by head telephone receivers and check of oscillation by tapping the grid contact of the tube socket. Under "Apparatus used," you should put down specifically all the information which would be necessary to duplicate the same experiment perhaps two years later, when all the details have long been forgotten. Such information would include the radio tube type number, approximate coil data (diameter, number of turns, wire size), condenser capacities, antenna used, ground, etc. Coming to "Data" we would have the entire circuit drawn out, and all the observations we make. Hand capacity effects on beat note (with incoming signal) would be noted, effect of filament voltage, plate voltage, etc. on oscillator frequency, and everything else we recognize to be taking place. In a simple experiment of this kind there would be no "instrument readings," or "computations," but certainly plenty of "Conclusions and remarks." Did the tube go into and out of oscillation smoothly, and if not what, if anything, overcame the difficulty?

If amateurs would be willing to do this kind of serious experimenting instead of aimless, purposeless puttering, there might be fewer empty pocketbooks and less useless gazing at advertisements of expensive apparatus far beyond our means. After one becomes more used to the experimental procedure, less formal recording of the material is necessary. At this point the reader is doubtless asking, "and of what use is all this notebook recording of experiments?" The most direct answer is that this thought-provoking method of using apparatus is one of the very best ways to acquire technical knowledge and skill in radio. Any doubt on this point can be quickly dispelled by glancing at the courses of study in radio or electrical engineering schools and colleges, where laboratory courses and very formal reports on the experiments are required. Moreover, if you should ever discover any valuable patentable things, then the only basis for your claims will rest on your written observations, together with the very important date of writing which should appear on every page of your notebook. To my mind, a bound book for patent purposes is better than a loose-leaf book, but the latter is preferred from the student point of view, since material may be arranged according to subject matter, provided a new page is begun with each new experiment.

Practically every experiment will open up many questions which cannot be answered without a little reference to textbooks or your good old A.R.R.L. Handbook. The references you use in the discussion of results (under "Conclusions") should appear at the end. The same inexpensive three-ring loose-leaf notebook for standard 8½ by 11-inch lined paper may be used.

In this article, I have endeavored to make some



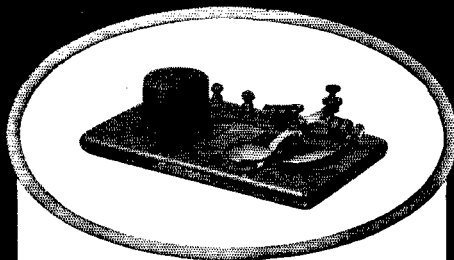

## WIRELESS PRACTICE SETS

### R-68 PRACTICE SET

Designed for those who want a well made instrument to learn the code. Set consists of a key and high frequency buzzer mounted on a mahogany finished wood base equipped with binding posts. The code is printed on a plate and fastened to the base between the key and buzzer. Buzzer is adjustable. List \$3.40

SIGNAL's line of Wireless Keys, Telegraph Instruments and Wireless Practice Sets is complete. Send for our bulletin.

**SIGNAL ELECTRIC MFG. CO.**

Menominee, Michigan, U. S. A.

**SIGNAL**  
MANUFACTURERS OF ELECTRICAL PRODUCTS

concrete suggestions on how to read and study your *QST* more intelligently. I very earnestly recommend that every serious experimenting amateur keep a technical notebook and attach even more importance to it than to the log book. If other amateurs have suggestions on the methods they have found effective along these lines, I suggest they send them in to *QST*.

## Distortion in 'Phone Transmitters

(Continued from page 55)

In Fig. 4 the third harmonic is out of phase with the peak of the fundamental signal, in contrast to the third harmonic relation in Fig. 3. The modulation envelope peaks are reduced and subsequently broadened. This is a special case where the side-band power may exceed 50% of the carrier power without overmodulation.

If the phase relation were shifted by the system so that the third harmonic approached an "in phase" relation with the peaks of the signal frequency, we might have an example of amplitude distortion as a direct result of phase distortion. The carrier envelope peaks would no longer be broad as in Fig. 4, but would be narrow and peaked as in Fig. 3. Since no new frequencies were added and the amplitudes of the separate frequencies (fundamental and third harmonic) were not changed the effect would be unnoticed by the ear unless the amplitude increase of the complex wave resulting from the phase shift, were such as to cause overmodulation.

No definite amount of effective power loss, resulting from a certain percentage of distortion present, can be affixed. It is known, however, that distortion reduces the effective power of a 'phone transmitter very rapidly after a certain minimum value of distortion is reached. Occasionally an amateur 'phone station can be heard, especially in the lower frequency amateur 'phone bands whose "equivalent power" is so reduced, because of distortion, that a transmitter of one-fourth the power and free from distortion could out-distance and out-perform it. Our first aim should be towards maximum transmission of intelligence and power should be of secondary importance. The very definition of radiotelephony is that it is the transmission of intelligence. If we persist in "hashing" up our carrier with something that cannot be understood, then we have something else besides telephony.

Once distortion appears in a system, its removal becomes very complicated in most cases, so far as counteracting cures are concerned. It is usually more advisable to eliminate the cause of distortion rather than to try to compensate for the distortion afterwards.

## The Simple Regenerative Receiver with Separate Beat Oscillator

(Continued from page 15)

its use after a few trials, and the local oscillator for c.w. reception went back into the textbooks

## CONVERTIBLE NON-DIRECTIONAL MICROPHONE

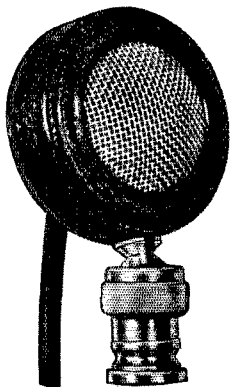

Model 38 for dual mountings as shown with 8' cable List \$22.50

New 1936 literature describes the microphone shown and five other new Turner microphone developments. Ask your jobber or write us immediately.

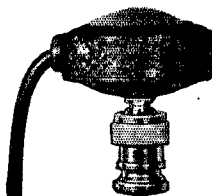

Licensed under patents of the Brush Development Company

**THE TURNER COMPANY**

Cedar Rapids, Iowa, U.S.A.

Now . . .

**Coto**

## MAGICORE I.F. TRANSFORMERS

Meets the demand for greater selectivity on the Amateur Bands. Modernize your present Communication Receiver by installing a set of

**Coto** MAGICORE I.F. TRANSFORMERS. Three stages of these remarkable units will reduce the I.F. Channel Bandwidth from an approximate 20KC. to from 3 to 5KC, with gain equal to that of an air core amplifier. The effect is an apparent widening of the Amateur Bands from two to three times. The Ultra-Selective Characteristic of the **Coto** MAGICORE I.F. TRANSFORMERS is due to the use of a newly developed iron core composed of a magnesium-ferrous alloy resulting in a coil with a Q factor hitherto unattainable. An ingenious method of loosely linking the magnetic fields contributes to the extremely narrow band response.

### **Coto** MAGICORE I.F. TRANSFORMERS (Communication Type—465 KC.)

- CI-50 Interstage (58's or 6D6's)
- CI-51 Crystal Input or Diode Det. Input  
(Secondary Centertapped)
- CI-52 Crystal Output (Step-up to First I.F. Grid)

LIST PRICE  
\$2.00

Other IRON CORE types with high gain-full band response, and standard air core transformers available in all standard frequencies.

Write for Bulletin C-5 describing these and other **Coto** PRODUCTS. Available through your jobber or order direct. Usual Amateur Discount prevails.

**COTO-COIL COMPANY, INC.**  
PROVIDENCE, R. I.

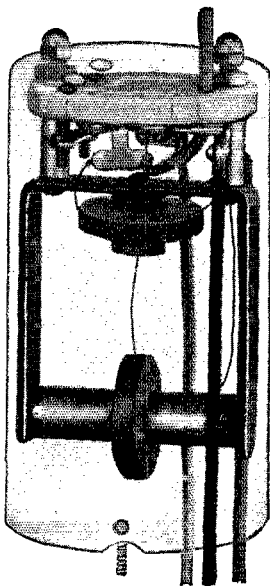

## BIRNBACH Transmitter LEAD-IN INSULATOR



### LIST PRICES

- 10" rod for 4" wall, \$ .90
- 15" rod for 9" wall, \$1.00
- 10" rod and bushings for 4" wall . . . \$1.20
- 15" rod and bushings for 9" wall . . . \$1.50

Porcelain bushings,  
1/2" dia., 1/4", 1/2" or  
1" long . . . 5c each

Write Dept. Q-2  
for Antenna  
Information

**BIRNBACH RADIO CO., Inc.**  
145 HUDSON STREET - NEW YORK CITY

## • DUPLEX TRANSMITTER-RECEIVER

HANDBOOK  
[ Page  
446  
Catalog  
Section.]

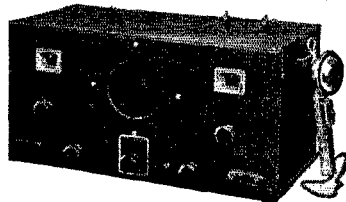

Fixed or  
Mobile

### TYPE TR-6A6—10 WATTS OUTPUT

Employing new 6E6 UNITY COUPLED P.P. oscillator, 6A6 Class B, 6A6 Class A. Phone or I.C.W. without external batteries. Four tube non-radiating receiver. **\$3975**  
7 1/2" x 15" x 8"

**RADIO RECEIVER LABORATORIES**  
8627—115th Street Richmond Hill, N. Y.

Radio Operator's  
Course  
Complete in  
Telegraphy—  
Telephony



Practical  
Experience  
Studio—  
Transmitter—  
Announcing

P. A. C. is an endowed, educational institution — not privately owned, not operated for profit, college rank maintained. Course consists of maximum knowledge necessary to secure Commercial Telegraph Second-class, and Radio-telephone First-class government licenses. Course includes Wireless Code, Radiophone, Announcing, Microphone-Studio Technique, Service, Police, and Aeronautical Radio. We are authorized to teach RCA texts. At the completion of course you receive practical studio technique experience in our commercial broadcast studios located in the administration building, and experience as an operator on K P A C (500-Watt Commercial transmitter located on the campus, owned and operated by the college), and inter-departmental marine communication experience. If interested, write for Bulletin R.

**PORT ARTHUR COLLEGE**

Port Arthur (World-known port) Texas

# Help

## For The AMATEUR

**UNDER-VOLTAGE**  
and over-voltage on  
the filament shorten the life of transmitting  
tubes.

Apply exactly the right values with the aid  
of new-type Electrad Power Rheostats.

Full ranges of resistance values in 25, 50 and  
150-watt ratings. \$4 to \$10 each list.

Write Dept. Q-2 for Complete New  
Catalog of Resistors for All Purposes

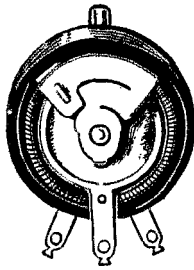

for a while, remembered only as a "good idea if it worked." In a subsequent revival of the experiment it was found that this fault was eliminated by using a weak harmonic of the local oscillator, rather than its fundamental.

The circuit diagram and specifications of the final arrangement are given in Fig. 1. In operation, the detector acts in similar fashion to the first detector of a superhet, the local oscillator signal being simultaneously detected with the incoming signal and the resulting audio beat note amplified by the pentode stage. The amplitude of the local oscillator voltage injected into the suppressor-grid circuit of the detector is controlled by the variable 50,000-ohm potentiometer  $R_2$  which is connected as the r.f. load in the oscillator plate circuit. When the moving contact of this resistor is set at the "ground" position, little or no voltage is applied to the detector, but as the contact is set nearer the "hot" end increasing voltage is supplied. This adjustment is not very critical and once set may be left untouched indefinitely. However, it is necessary to find a preliminary adjustment for optimum oscillator voltage input to the detector for a given set of conditions. It will be found, for instance, that there is one setting which is best for DX reception of weak signals, and another which is better for loud-speaker operation on strong signals. A lower voltage input gives best signal-noise ratio on weak signals, minimizing the noise output resulting from various disturbances beating with the locally-supplied carrier. A general operating or stand-by adjustment would be between the weak-signal and strong-signal settings. Adjustment of this important resistor has no effect on oscillator frequency, since the oscillator uses the electron-coupled circuit with this load circuit practically independent of the frequency-setting tuned circuit.

An important feature of the input circuit is that a separate cathode coil (tickler) is used in preference to tapping the cathode into the tuned circuit-coil in Hartley fashion. By comparison with the arrangement shown, the tapped coil Hartley system noticeably reduces the sensitivity and selectivity. The tickler winding runs somewhat smaller than is usual with plate circuit feedback, one or two turns being sufficient to produce smooth regeneration on the 7-mc. band, for instance. Steatite, isolantite or other really low-loss insulation is recommended for coil forms, condensers, sockets, etc., in this circuit. The improvement in operation resulting from installing such high-grade insulation is decidedly worth the difference.

The resistance-coupling system in the grid circuit of the audio amplifier brings up the lows and is superior to the usual method of connecting a large by-pass conductor (25- $\mu$ f. electrolytic) across the cathode resistor. The filaments of the detector and oscillator tubes are individually by-passed to ground. The cathodes of both these tubes are at r.f. potential above ground and if the heaters were not by-passed r.f. would be fed into the detector circuit through the filament leads



## SHURE "Spheroid" CRYSTAL MICROPHONE

You won't be worried by the artist who "won't stay put" . . . or the chorus that can't be grouped compactly . . . or a hundred-and-one other troublesome pick-up problems . . . if you have a SHURE Model 74B "Spheroid." This "all-around" crystal microphone provides high-quality non-directional wide-range reproduction from every angle . . . and it lists at only \$37.50. Ask your Jobber or write today for Bulletin 134Q!

Licensed under patents of the Brush Development Company.  
Shure patents pending.

**SHURE MICROPHONES**  
SHURE BROTHERS • MICROPHONE HEADQUARTERS  
215 WEST HURON STREET • CHICAGO, U. S. A.

# Now it can be told!

After Bliley LD2 Crystal Units were introduced last May, tests on many production samples indicated that the frequency drift of individual units was considerably lower than the guarantee of 8 cycles per megacycle per degree Centigrade. (The average value was under 2 cycles/MC/°C.)

Performance records of several thousand of these crystal units produced has fully proven that they were under-rated as to freedom from frequency drift.

Effective at once, all Bliley LD2 Crystal Units are guaranteed to have a drift of not more than 4 cycles per megacycle per degree Centigrade. This guarantee also includes LD2 Units either in use or in dealers' stocks.

For accurate frequency control use the Bliley LD2 Crystal Unit. Your Bliley dealer supplies them within 0.1% of your desired frequency or choice from stock for \$4.80.

Bliley Electric Company, Erie, Pa.

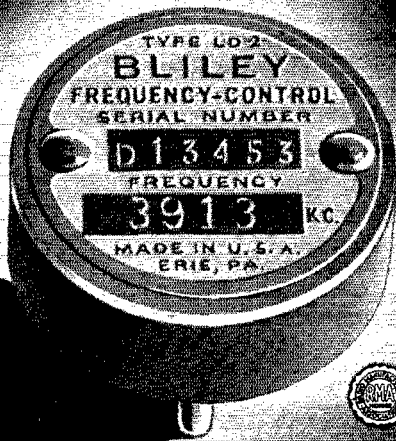

## BLILEY LD-2 CRYSTAL UNIT

### LEARN RADIO

New Classes Now Forming! Send for 40-page catalog, explains

fully, 300 licensed graduates placed in past 4½ years in broadcasting, shipping, police radio, aviation, etc. We teach all branches. Oldest, largest and best equipped school in New England. Equipped with Western Electric sound and broadcasting equipment and RCA marine transmitter. Course prepares for United States Government telegraph or telephone license.

MASS. RADIO SCHOOL, 18 Boylston Street, BOSTON



### UNIVERSAL POWER TRANSFORMER

In Alloy Hum-Proof Casting. 420-350-0-350-420V at 125 M.A. 5V 3A, 6V, 6A, c.t. and El. shield. Code: ALPTA. Net price \$4.50. Chokes in Alloy Hum-Free cases. Each \$1.75. 30-13,000 cycles plus or minus 1 d.b. Multiple coil, Hum-Free, balanced construction, audio transformers in Hum-Proof Cases. Each, net \$3.75. Hum-Proof Alloy Cases No. 1 or 2. Each \$0.75.

AALLOY TRANSFORMER COMPANY, INC. 135-Q Liberty St. New York City

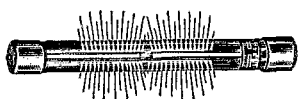

ONLY \$2.00 NET PREPAID

Mounting clips and mirror with motor shaft adapter included.

### NEON Oscilloscope TATTELITE

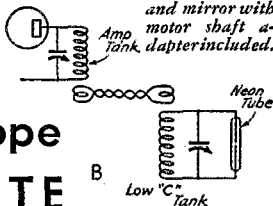

From Oct., 1935, QST

The makers of Tester Tattelites and Neon Potential Fuses can now supply that NEON OSCILLOSCOPE TUBE needed for the inexpensive oscilloscope described in October '35 QST. This new tube is brilliant, highly sensitive and has long life. Being 6" long overall, it has a generous electrode length for scanning. Comes complete with mounting clips and metallic mirror with motor shaft adapter — \$2.00 amateur's net price. Get at your jobber or remit direct. NOTE — This is a special item and continued production is not anticipated. Place your orders now.

SUNDT ENGINEERING CO.

Affiliate of Littelfuse Labs.

4246 Lincoln Avenue

Chicago, Illinois

### NEW! TOBE MICRANOL Transmitting Condensers

PROCESSED IN OIL!

Special Low Prices!



Processed in Micranol — These condensers will withstand peak surges of thousands of volts and will give long faithful service under hard working conditions. Positively sealed against moisture absorption. Housed in round aluminum containers with porcelain insulator supported terminals. Ring clamp for easy mounting.

Even for low power transmitters or PA power supplies these condensers are so low in price it is economy to buy them. Each condenser bears this famous TOBE trade-mark of highest quality technical apparatus. Note the small compact sizes.

WORKING VOLTS 2000 D.C. Tested at 6000 volts D.C.  
 TC-1 1.0 Mfd. Container size 3¼" x 2¼" Diameter. \$1.70  
 Your Cost.....  
 TC-2 2.0 Mfd. Container size 3¼" x 3¼" Diameter. \$2.50  
 Your Cost.....

IN STOCK AT ALL HAM SUPPLY DISTRIBUTORS or order direct. (Include postage.)

TOBE DEUTSCHMANN CORPORATION CANTON, MASS.

# EBY

## Specializes in Quality

**Blinding Posts  
Tip Jacks Male Plugs  
Female Plugs  
Low-Loss Sockets  
A-C Switches  
Tap Switches  
Terminal Strips  
Short Wave Switches  
Moulded Sockets  
Electric Eyes**

Write for Latest Bulletin

**HUGH H. EBY Inc.**  
2066 Hunting Park Ave.  
PHILADELPHIA, PENNA.

## "Why Invite Trouble?"

"I'm through using low wattage resistors! They get noisy, and they're not dependable. I'm using **BROWN DEVILS**. They maintain constant resistance values, and I know that the Ohmite vitreous enamel coating stands up.

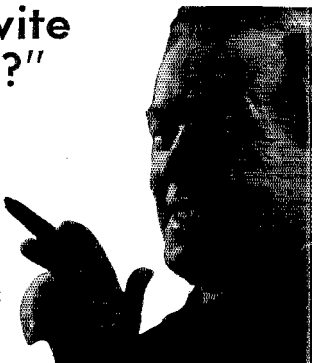

**Easy to Install — Fit all Circuits**

**BROWN DEVIL** Resistors are made with solidly anchored  $1\frac{1}{2}$ " tinned lead wires in 10 and 20 watt sizes and resistance values through 100,000 ohms. Ask your dealer or write for Catalog 14 listing all values.

## OHMITE MFG. CO.

4831 Flournoy Street, Chicago, Illinois



HANDBOOK  
PAGES  
[ 458-459 ]  
CATALOG  
SECTION

from the oscillator. By-passing the filaments right at the tube sockets minimizes this undesirable coupling. The cathode (tickler) coil is also used as the antenna-coupling coil, as per *QST*. Other constructional details are in accordance with standard practice.

### IMPROVEMENT IN PERFORMANCE

Considering the operating advantages over the autodyne, the first comparison is in sensitivity. During the last DX contest, an experimental receiver was just completed. It was immediately tried out on the 40-meter band. Near the low-frequency end, around 7 mc., several weak signals were found using the oscillating detector. However, because of local noise and other disturbances it was almost impossible to copy them. Then the separate beat oscillator was tuned to heterodyne these faint signals and the detector regeneration was backed off until it just stopped oscillating. Immediately the previously unreadable signals came up to a good S5 to 6 and were identified as ZS2A, CT2BK, F8UP, and several others of DX origin—each perfectly readable. The formerly impossible noise level almost disappeared, making the signals seem even stronger than they actually were. That this is not a misleading impression has been confirmed by a number of other hams who have listened to the same receiver. Even the most skeptical ham I know was convinced!

The next consideration is stability. As is well known, the most sensitive point of operation of a regenerative detector is just before it starts to oscillate. But to receive c.w. code signals with an autodyne, the detector has to oscillate. Right here we lose a lot of sensitivity. In attempting to recover some of this lost sensitivity, we back down on the regeneration control until the detector is just barely oscillating; but at this point it is very unstable. For instance, we are listening to a very weak station on 7100 kc., with the detector just barely oscillating, and holding our breath in order to copy the signal. Suddenly another station about a half-mile away opens up with a 40-word per minute CQ on a frequency of 7080 kc., only 20 kc. from our weak DX contact. Every time he closes his key our detector blocks and stops oscillating. The only thing to do is to increase the regeneration in an attempt to keep it going. But by the time the detector is adjusted to a stable oscillating point, the regeneration is so far advanced that the sensitivity is gone—and that's the end of our DX QSO. With the separate beat oscillator, however, this difficulty is overcome. The weak station is tuned in with the detector barely oscillating. Then the separate beat oscillator is brought into tune to give a beat note with the desired signal and the detector regeneration control is backed off to just below oscillation for most sensitive operation. Now, if our high-power local opens up, we have a stable independent oscillator rather than an unstable autodyne detector which goes out of oscillation. The local can't lock our oscillator in with his strong signal. Demonstrating this, West Coast stations have been copied through the local



# YOUR ANSWER TO THE QUESTION — "Do CARDWELLS Cost More?"

Maximum Capacity	Peak Voltage	Plate Edges	CARDWELL'S PRICE	COMPETITOR "A"	COMPETITOR "B"
100 mmf.....	3000	Buffed	\$2.64	\$2.40	\$3.30
150 mmf.....	3000	Buffed	3.30	2.95	3.90
100 mmf.....	6000	Buffed	5.40	5.40	5.70
— DOUBLE — (per sec.)					
50 mmf.....	6000	Buffed	6.00	6.00	7.20
100 mmf.....	3000	Plain	4.80	8.10	6.60
500 mmf.....	1500	Plain	3.60	not in line	5.40
— MIDGET —					
50 mmf.....	.....	Plain	.96	.96	.96
100 mmf.....	.....	Plain	1.05	1.15	1.35

Both the "M" and "T" Series listed in the New Cardwell Catalogue (which will be sent on request) are exclusively CARDWELL! ALL CARDWELL Condensers are manufactured under U. S. Patent No. 1,672,367 and No. 1,626,391, protecting the exclusive CARDWELL Low-loss design.

THE ALLEN D. CARDWELL MFG. CORP., 83 Prospect Street, Brooklyn, N. Y.

## CARDWELL CONDENSERS

SEND US YOUR ORDER NOW—FOR THE NEW  
**NATIONAL HRO JUNIOR**  
IMMEDIATE DELIVERY GUARANTEED  
ONLY \$25.00 DOWN—\$17.00 PER MONTH  
SEE COVER III FOR COMPLETE DETAILS OF THIS SET  
IMMEDIATE DELIVERY ON  
NEW RCA AMATEUR TRANSMITTERS  
NATIONAL HRO — ACR136  
SUPER SKYRIDERS — BRETING 12  
RME 69 — RME3R9 — SILVER 5D  
PATTERSON PR-16 — ETC., ETC.  
SMALL DOWN PAYMENTS—CONVENIENT TERMS  
LIBERAL TRADE-IN ALLOWANCES  
SPECIAL PRICES ON USED EQUIPMENT  
**DELAWARE RADIO SALES CO.**  
405 DELAWARE AVE., WILMINGTON, DELAWARE  
(WILLARD S. WILSON—W3DQ)

### VALPEY PIEZO OSCILLATORS

VALPEY crystals are manufactured from the best grades of material obtainable, machine ground. Calibrated with G.R. equipment. Our type VM2 is especially designed for amateur use, low frequency drift, and high power output, dustproof tube socket mounting. 160-80-40 meter bands within 5 Kc on order or from your dealers stock — net \$3.00. See your dealer or write us for quotations on other amateur and commercial units.

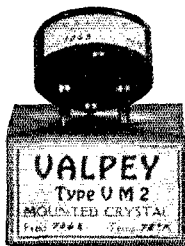

The Valpey Crystals  
377 Summer St., Medway, Mass.

\$3.00

## R A D I O

**ENGINEERING,** broadcasting, aviation and police radio, servicing, marine radio telegraphy and telephony. Morse telegraphy and railway accounting taught thoroughly. Engineering course of nine months' duration equivalent to three years of college radio work. School established 1874. All expenses low. Catalog free.  
DODGE'S INSTITUTE, Day Street, Valparaiso, Indiana

*At Last!* A NEW  
**CODE TEACHER**  
THE NEW MASTER TELEPLEX

for beginners, experienced operators and schoolroom  
No Batteries No Winding

ALL ELECTRIC

JUST PLUG IN AND LET HER GO

The new Easy way to learn code and speed up wpm. This new instrument will record your own sending on double row perforated paper and repeat it back to you at any speed. 10,000 words can be recorded on one tape.

*This New Machine Is Remarkable*

It is the same in principle; and in operation for this purpose is equal to the Wheatstone Transmitter and Perforator, which would cost over \$1000.

BUY IT OR RENT IT

Send for Folder Q, 2, which tells you how to get the use of this instrument without buying it. No obligation. We furnish complete course and personal instruction. Low cost, easy terms. Write today for information.

**TELEPLEX CO.**

72 Cortlandt Street

New York City

THE NEW MASTER TELEPLEX

"The Choice of Those Who Know"

TED McELROY — World's Official Champion Radio Operator — Speed 69 wpm.



HANDBOOK

431  
CATALOG  
SECTION

"IF THERE WERE A BETTER WAY Than the CANDLER SYSTEM of Code Instruction for Developing Speed and Technique, I Would Know It." — McELROY.

### Three Celebrated CANDLER SYSTEM COURSES

SCIENTIFIC CODE COURSE for beginners. Teaches all the necessary code fundamentals scientifically.

HIGH-SPEED TELEGRAPHING for fellows with speeds from 12 to 35 wpm. who want championship speed and technique.

TELEGRAPH TOUCH-TYPEWRITING for those who want to become expert in the use of their "mill" in receiving fast stuff by "touch." Nothing else like it.

FREE — 1936 BOOK OF FACTS For Radio Ops and Beginners. Contains McElroy's own story and valuable information for those wanting to learn code RIGHT or to improve their Skill and Speeds. A card will do.

CANDLER SYSTEM CO.

Dept. Q-2

ASHEVILLE, N. C.

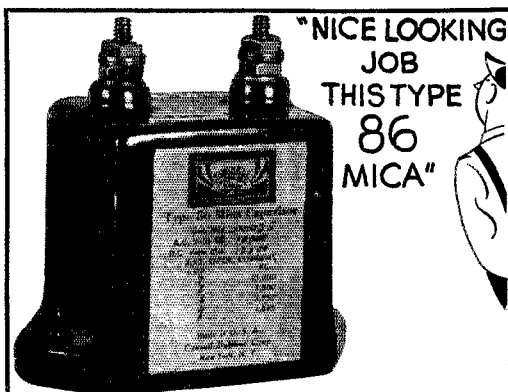

"NICE LOOKING  
JOB  
THIS TYPE  
86  
MICA"

**BUT IT'S MORE THAN  
JUST NICE LOOKING!**

- By the use of mica, instead of the customary glass, as a dielectric, power losses have been reduced by more than 80%.
  - The ceramic casing insulates condenser from interfering ground capacity and prevents field absorption, hence lower R.F. resistance.
  - Available from .00005 mfd. at 12,500 volts to .1 mfd. at 2000 volts.
  - Recommended for amateur plate blocking, grid, and tank condenser applications.
- Let your local C-D distributor demonstrate this unit to you. Amateur Catalog No. 128 available upon request.

**CORNELL-DUBILIER**

CORPORATION

4373 BRONX BOULEVARD  
NEW YORK

QRM of a 1-kw. station about three-quarters of a mile away, with the interfering signal tuned to zero beat on the receiver.

Another aspect of the stability is shown up with badly fading signals. Using the autodyne detector, we tune in an S5 signal and start to copy him. A few seconds later he "fades" up over 9 and our weakly-oscillating detector is pulled into synchronism with his signal so that the beat note disappears. We hurry to turn up the regeneration and retune a bit to get back our favorite beat note. But he immediately fades out again and the beat note consequently changes tone, going so high in pitch as to become inaudible and probably lost in QRM. No matter how we adjust our oscillating detector, this always happens when we try to copy a badly fading signal. But with the separate beat oscillator, the picture is entirely different. The signal we are copying has no way of getting at the heterodyne oscillator and therefore cannot affect it. The beat note remains constant in pitch and there is no blocking. All that is noticed is a change of volume while the signal remains clear because of the stable beat note.

While the selectivity of this type of receiver is not as good as that of the better superhet, it is superior to that of a lot of the cheap ones using a comparable number of tubes. There is an explanation for the increased selectivity, as compared to the autodyne receiver. As has been shown previously in *QST*,<sup>2</sup> with autodyne reception of c.w. signals the detector circuit really isn't tuned exactly to the frequency of the incoming signal but to a point a kilocycle or so away, depending on the beat note we adjust for. The signals actually are tuned in "on the nose" only at zero beat. But under this condition we have no beat note to copy. The loss of signal strength is especially noticeable on weak signals which always become louder as they are tuned nearer to zero beat. In contrast to this, with the separate beat oscillator the detector input circuit actually can be tuned to resonance with the incoming signal while the separate heterodyne oscillator is tuned off this frequency sufficiently to give the desired beat note. Thus full advantage is taken of the selectivity characteristic of the regenerative detector circuit.

In conclusion, there is one possibly contributing factor which might be worth mentioning. In a receiver of this type, we are introducing an a.c. voltage to the suppressor grid which modulates the electron stream between the cathode and plate. At the same time the detector is operating very close to oscillation. When the suppressor is at the peak of the positive half-cycle of this a.c. voltage, the detector should tend to break into oscillation. On the reverse half-cycle this tendency would be lessened. By this action the detector is swung back and forth through a mean point at the local oscillator frequency. This might constitute a species of super-regeneration which would account for the abnormally high sensitivity which has been observed.

<sup>2</sup> Lamb, "What's Wrong With Our C.W. Receivers," *QST*, June, 1932.

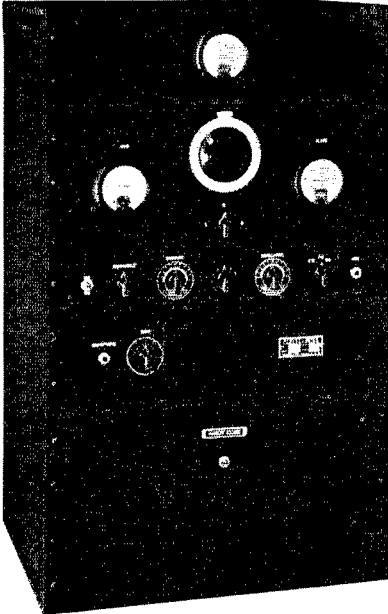

# The HARVEY 200-R

## A Truly Modern Transmitter

**BAND SWITCHING**

**CRYSTAL SELECTION**

**CARRIER CONTROL**

- 5 frequencies in 3 bands as two switches shift coils, crystals and antenna tap.
- 6-60 watts as the phone carrier is completely and efficiently voice controlled.
- 200 watts CW, 60 watts Normal Phone, 6-60 watts Controlled Carrier Phone at will.

*Conditions demand it—You can afford it*

THE 60-T TRANSMITTER in the medium power class employs Band Switching and Crystal Selection, is modern in every detail and reasonably priced. 15 watts Phone, 50 watts CW.

*Write for full details and prices on these two outstanding transmitters*

HAND BOOK  
PAGE  
**422**  
CATALOG  
SECTION

## HARVEY RADIO LABORATORIES

12 BOYLSTON STREET, BROOKLINE, MASSACHUSETTS, U. S. A.  
Export Division, 25 Warren St., New York, N. Y. Cable Address: "Simonrice"



**"HAM" SPECIAL** Standard Teleplex  
A highly efficient code teacher using heavy specially prepared waxed paper tape, having two rows of perforations. Write for Free folder Q.T. DEALERS — Correspondence invited with dealers for protected territories.

We are the originators of this type instrument  
**TELEPLEX CO.**  
72 Cortlandt St., New York City

Instrument with tapes prepared by expert and complete course of lessons; all for \$11.95

## PRECISION CRYSTALS



Crystal Holder

'X' and 'AT' cut crystals one inch square carefully ground for frequency stability and maximum output. Be sure of your transmitter frequency—use PRECISION CRYSTALS. Guaranteed to be the highest quality obtainable.

'X' cut PRECISION Crystals carefully ground for maximum power supplied to your specified frequency accurate to 0.1% and calibrated to within 0.03% are priced as follows: 1750 and 3500 kc. bands — \$3.00 each. 7000 kc. band — \$3.50. Add \$1.00 to above prices if plug-in, dustproof holder is desired. (Holder as illustrated to fit G. R. type jacks or round holder to plug into tube socket can be furnished) G. R. jacks to plug illustrated holder into — \$.15 pair.

The 'AT' cut crystal recently developed has a temperature coefficient of practically zero and will handle more power than ordinary crystals. 'AT' cut crystals ground to your specified frequency accurate to 0.1% and calibrated to within 0.03% are priced as follows: 1750 and 3500 kc. bands — \$6.00 each. Crystal holder — \$1.00. Jacks for holder \$.15 pair.

Crystals and ovens for commercial use quoted on at your request. When ordering our product you are assured of the finest obtainable. Now in our sixth year of business.

**PRECISION PIEZO SERVICE**

427 Asia Street

Baton Rouge, La.

**RAYTHEON VOLTAGE REGULATOR**  
TYPE VR-2 60 WATTS  
\$27.00

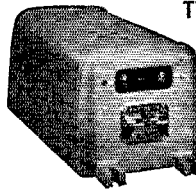

**Stabilizes**  
**A C Voltage to ± 1%**

Input may fluctuate from 95-130 volts AC. Load may fluctuate from 0 to full load. Output will remain 115 volts ± 1%. Time constant is negligible. Automatic — no moving parts or adjustments. Sizes up to 2000 watts.

*Write for Bulletin DL-48-71Q*

**RAYTHEON**  
**VOLTAGE REGULATORS**

Raytheon Manufacturing Company

Electric Equipment Division

190 Willow Street

Waltham, Mass.

ACME-DELTA, RAYTHEON, AND DELTA PRODUCTS

(Continued from page 30)

Sunday thereafter, a special program will be broadcast over W8XAI which will be of exceptional interest to amateurs and short-wave listeners. The broadcast will be on the air from 1:30 to 2:00 p.m., and will deal with 10-meter activities, technical information and interesting data on advancements in the high-frequency field. This broadcast will in no way interfere with the regular schedule of W8XAI. It will continue to operate daily from 7:30 a.m. till 12:08 p.m. EST.

### Noise-Silencing I.F. Circuit

(Continued from page 28)

tion of the maximum half-cycle of i.f. noise, which is likely to be unsymmetrical at the rectifier input.

#### CONSTRUCTION AND OPERATION

No unusual constructional features have been found necessary in the several applications of this silencer system to conventional superhet receivers. A photograph shows the layout of the silencer section and second detector of one receiver in which it is used. (Complete constructional details of this receiver are given in the 1936 A.R.R.L. Handbook, Chapter Seven.) The only extra shielding beneath the base is a baffle separating the noise amplifier-rectifier from the i.f. amplifier-silencer and second detector sockets and wiring. Precautions should be taken, of course, to prevent c.w. beat oscillator r.f. output from getting into the noise silencer circuit. Usual good design will take care of this.

After the circuit connections have been proved by ohmmeter and voltage tests, and with the other receiver circuits in normal alignment, the silencer section is ready for adjustment. The secondary of the input transformer  $T_2$  will be tuned to i.f. resonance using second detector output or tuning meter peak indication. The remaining tuning adjustment is that of the noise rectifier coupling transformer  $T_4$ . Resonance of this transformer will be indicated by peak reading of a d.c. voltmeter connected across the diode load resistor  $R_{23}$  on a test signal tuned in with the noise threshold adjustment ( $R_{24}$ ) set at minimum resistance. Operation of the silencer circuit will then be indicated by complete blocking of the output when a moderate-strength signal is tuned in with  $R_{24}$  at this same setting. Backing off on  $R_{24}$  will allow the signal to come through in normal fashion. The adjustment of  $T_4$  should be made precisely. If no d.c. voltmeter is available, this transformer can be tuned for *minimum* noise output from the receiver, using a buzzer, spark coil or similar noise source.

In operation it will be found that the most effective setting of the threshold adjustment  $R_{24}$  will vary with different settings of the manual r.f. gain control. For c.w. reception (a.v.c. off), it has been found desirable to set  $R_{24}$  for a com-

## 25 TIME-TESTED TRANSMITTING TUBES

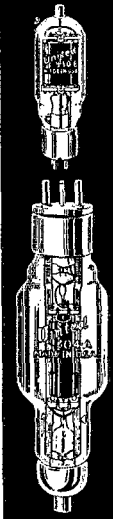

Type		Price
303A.	*130 Watts	\$15.00
304A.	*350 Watts	97.50
310.	* 25 Watts	5.75
311.	*130 Watts	17.50
311C.	*130 Watts	17.50
312D.	*250 Watts	75.00
361A.	*130 Watts	17.50
366A.	*130 Watts	17.50
370.	* 40 Watts	8.75
930B.	* 60 Watts	10.00
938.	*130 Watts	18.00
941.	* 25 Watts	5.75
942.	Audio	5.75
945.	Audio	17.50
949.	*500 Watts	160.00
951.	*1250 Watts	350.00
952.	*165 Watts	16.40
911CH.	*150 Watts	19.50
317C.	Vacuum Rectifier	20.00
966.	Mercury Rectifier	2.25
966A.	Mercury Rectifier	5.00
972.	Mercury Rectifier	15.00
972A.	Mercury Rectifier	16.50
967.	Mercury Rectifier	14.00
973.	Mercury Rectifier	25.00

\* Nominal RF Power Output.

Consult your Dealer or write direct to—

## UNITED ELECTRONICS CO.

42 SPRING ST., NEWARK, N. J.

## GULF RADIO SCHOOL

Radiotelegraphy      Radiotelephony  
Radio Servicing

SECOND PORT } 1007 Carondelet Street  
U. S. A. } NEW ORLEANS, LA.

## Get Your NEW MARTIN VIBROPLEX JUNIOR ONLY \$10 NOW!

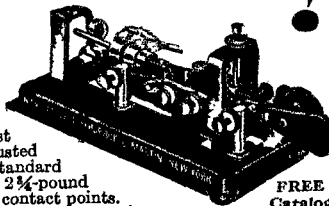

The BUG that satisfies the world's finest operators—can be trusted to satisfy you. All Standard Vibroplex features. 2 3/4-pound japanned base. Heavy contact points. The only difference is in size. Just what you need to develop a good fist. A bargain at this low price.

### OTHER VIBROPLEX MODELS

Famous Improved Vibroplex, Black or Colored, \$17; Nickel-Plated, \$19. Newest Model Vibroplex, No. 6, Black or Colored, \$17; Nickel-Plated, \$19.

Remit by money order or registered mail

THE VIBROPLEX CO., INC.  
852 Broadway      New York, N. Y.

**INTERNATIONAL RELAY RACKS \$13.50**

Another Outstanding Value  
This rack is standard construction, according to W.E. specification. See January QST for details.

**866 TUBES . . . \$1.00**  
H.D. — ISOLANTITE TOPS

RS 203A-Graphite . . . . .	\$9.00
R.S. 800 Graphite . . . . .	5.95
R.S. 801 Graphite . . . . .	2.95
Raytheon RK20 . . . . .	15.00
Raytheon RK23 . . . . .	4.50
Raytheon RK28 . . . . .	38.50
Raytheon RK32 . . . . .	12.50
RCA 210 . . . . .	1.20
RCA 281 . . . . .	1.20
RCA 250 . . . . .	1.50
RCA 800 . . . . .	10.00
RCA 801 . . . . .	3.90

**RCA 866's . . . . . \$2.25**

Eimac 50T-113.50-150T . . . . .	\$24.50
H-K 354 Gammatron . . . . .	24.50

JOHNSON 50W Socket . . . . . \$ 1.05

RK-28 Socket . . . . . \$ 1.20

**The SUPER-SKY-RIDER**

Acclaimed by amateurs as the outstanding set of the year.

Model SX-9 (with xtal) . . . . . **\$89.50**

Less crystal . . . . . **79.50**

Immediate delivery

**THE SUPER-SEVEN \$49.50**  
Seven-tube Super

**THE RADIO SHACK**

**INTERNATIONAL Plate Transformers**

Fully Cased  
Model 2000 — 750-1000  
each side — 300 Mills. . \$5.95  
Model 3000 — 750-1000-1500  
each side — 300 Mills. . \$8.95

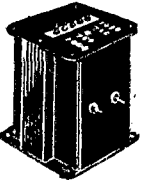

UNEQUALLED FOR VALUE

**INTERNATIONAL CHOKES**

Smoothing — Swinging — Cased  
12H — 200Mill. . . . . \$2.50 5/25H . . . . . \$2.50  
12H — 300Mill. . . . . 3.75 5/25H . . . . . 3.75  
12H — 500Mill. . . . . 6.50 5/25H . . . . . 6.50

10 Volt — 6.5A Fil-Trans. Cased . . . . . \$2.10

Thordarson T6878 Transformer  
600-0-600-2.5V-10A-5V-3A-7.5V-3A  
200Mills . . . . . \$2.75

Valpey Mtd. Crystal. . . . .	40-80 — 160 M. . . \$3.00	Billey BC3 Crystals . . . . . \$3.90
Valpey unmounted. . . . .	80-160M X Cut. . \$1.50	Billey LD. . . . . 4.80
		Billey 20M xtals. . 7.50

BALDWIN TYPE C PHONES . . . . . \$2.50

Readrite Milliam-meters . . . . . \$ .60  
Brush Crystal Phones . . . . . \$5.40

ASTATIC CRYSTAL MIKE . . . . . \$13.50

THE MAC-KEY . . . . . \$7.50  
You can send better with it  
The MAC-KEY, JR. . . . . 4.95

Mail Orders Filled — Send M.O.

**THE RADIO SHACK**

46 BRATTLE STREET, BOSTON, MASS.

**PYRANOL CONDENSERS**

2 Mfd. — 2000 Volts **\$2.90**

In two years we have not been called upon to replace one condenser due to failure in service. This is the best reason why you should decide on the PYRANOL. *Pyranol is your guarantee.*

JOHNSON 5M—O. Ant. \$3.90	2.5V 12A FIL. TRANS. for 866's \$1.25
---------------------------	---------------------------------------

Ohmite Band ch. Switch . . . . . \$1.80

**CARDWELL CONDENSERS**

Full Line — Discount 40%  
Catalog on Request

**COMPLETE STOCK OF TRIPLETT TEST EQUIPMENT**

**TRIPLETT MILLIAM-METERS**  
5 to 1000 mills . . . . . \$3.75

**SUPREME TEST EQUIPMENT**

AMPERITE VELOCITY **MICROPHONE \$18**

PEAK PRE-SELECTOR . . . . . \$19.80

**The TOBE COMMUNICATIONS RECEIVER**

Complete Kit . . . . .	\$41.40
If you want it wired add . . . . .	6.50
Black Crackle Cabinet . . . . .	4.80
Complete Kit RCA Tubes . . . . .	3.32
Wright DeCoata 8" Spk. in Metal Cabinet . . . . .	4.90

**Immediate Delivery**  
on all the new  
**HAM RECEIVERS**  
Hallicrafters New Super Skyrider  
Patterson P R 16  
National H R O  
TOBE Browning  
RCA-ACR 136  
Sargent  
Write for descriptive circular  
**M. & H. RADIO** 512 Market Street  
Philadelphia, Pa.

**HRO-JUNIOR**  
New National  
Superheterodyne

Immediate deliveries on this newest outstanding receiver. All the basic features which have made the HRO so famous are now available in the HRO-Junior at—  
**\$99.00 NET TO AMATEURS**

**CAMERADIO**

601-3 GRANT ST. PITTSBURGH, PA.      30 TWELFTH ST. WHEELING, W.VA.  
Established 1919

**BUILD YOUR TRANSMITTER!**  
Amateurs! Build a real high power transmitter with "PROGRESSIVE" UNITS — step by easy step. Genuine "Push-Pull" Moisture-proofed transformers. ● Send 25c for sensational new "PROGRESSIVE TRANSMITTER GUIDE" — 12 circuit diagrams, 12 illustrations, 28 pages. Shows you clearly how to complete each simple step. ● Or send for Free Bulletin, Form 20, "Progressive Transmitter," listing complete supplies for quality Amateur transmitters.  
GENERAL TRANSFORMER CORP., 518 S. Throop, Chicago

**HIPOWER CRYSTALS**  
THE NEW and IMPROVED  
Completely shielded I. F. Crystal Unit. Designed especially for the S.S. RECEIVER.  
Incorporated in new receivers by leading set manufacturers.  
Supplied in 3 freq. 525 Kc. 500 Kc. and 465 Kc. See it at your dealer's or write for descriptive Literature.  
TYPE IFS. Price \$5.45

**LOW DRIFT TRANSMITTING CRYSTALS**  
Thick cut, low drift "AH" cut crystals are from 2 to 40 times as stable as the X or Y cuts. Supplied within 10 Kc. of specified frequency or choice of dealer's stock.

"AH" 10 . . . . .	1700-3500 Kc. \$2.35	7000-7300 Kc. \$3.90
"AH" 5 . . . . .	3.90	5.90
"AH" 2 . . . . .	8.90	12.90

The number following "AH" is the drift in cycles per °C. per 1000 Kc.

ORDER FROM YOUR DEALER — or direct  
Send for Descriptive Literature  
HIPOWER CRYSTAL CO., 2035 W. Charleston St., Chicago, Ill.

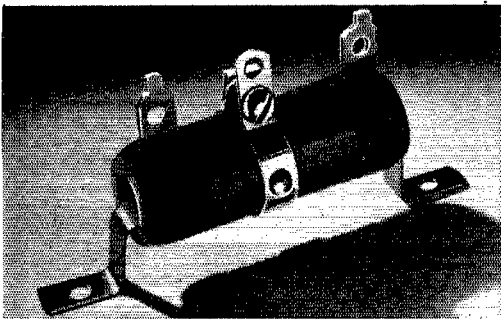

## SLIDE OHMS

... for "X" Resistance



Quality wire on crack-proof refractory tubing.

Vitreous enamel coated. Cleared track for sliding contact band.

In 30, 50, 75, 100 and 200 watt ratings. 1 ohm to 100,000 ohms.

Additional contact bands if desired for voltage divider use.

Exact resistance unknown? That's easy. Install Aerovox Slideohm of sufficient total resistance. Set band for best results. Tighten screw. You now have a positive, permanent, non-fluctuating fixed resistor of exact value required.

● Write for new 1936 catalog on condensers and resistors.



**CORPORATION**  
73 Washington St. Brooklyn, N. Y.

## RADIO COURSES

RADIO OPERATING: Prepare for Gov't License Exam. ●  
RADIO SERVICING: Including Short Wave ● AMATEUR  
CODE ● New Course in ELECTRONICS.  
Day and Evening Classes  
Booklet upon Request

NEW YORK YMCA SCHOOLS 4 West 63rd Street  
New York City

High in Efficiency — Low in Price



## Isotex Sockets

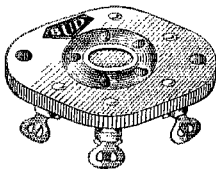

are ideal for your XMITTER and S. W. RECEIVER. Fine for coils, sockets too, and excellent crystal holder mountings. Top and sides glazed to resist moisture. Heavy reinforced springs to last a lifetime.

No. 954 — 4 Prong ..... List \$ .40  
No. 955 — 5 Prong ..... List .40  
No. 956 — 6 Prong ..... List .45  
No. 957 — 7 Prong, Small ..... List .50  
No. 958 — 7 Prong, Large ..... List .50

Ask your Jobber to show you No. 226 BUD SOCKET for 50 watters at only \$1.00 list or No. 227 for those 803's at only \$2.00 list. They are going big!

40% Discount to Amateurs

**BUD RADIO, INC.** 1937 E. 55th St.  
Cleveland, O.

portable no-signal noise level and then to adjust the manual r.f. gain to accommodate the signal, in normal fashion. Extremely strong signals may cause silencing of the receiver, naturally, if the r.f. gain is set too high. A few minutes' experience will suffice to make the operator familiar with

### PERFORMANCE DATA

Weak Signal 'Phone Reception, Spark Interference

Silencer Off		Silencer On	
Output Meter Reading	Oscilloscope Amplitude	Output Meter Reading	Oscilloscope Amplitude
Signal Alone.....	3 v.	1	3 v.
Signal + Noise...	15 v.	3 v.	1
Noise Alone.....	15 v.	0.5 v.	0.6
Noise/Signal.....	5	0.17	0.6

Improvement in signal-noise voltage ratio, 30 times (approximately 30 db)

Medium-Strength 'Phone Signal, Spark Interference

Silencer Off		Silencer On	
Output Meter Reading	Output Meter Reading	Output Meter Reading	Output Meter Reading
Signal Alone.....	5 v.	5 v.	5 v.
Signal + Noise.....	15 v.	5 v.	5 v.
Noise Alone.....	15 v.	0.5 v.	0.5 v.
Noise/Signal.....	3	0.1	0.1

Improvement in signal-noise ratio, approximately 30 db

C.W. Beat-Note Reception, Spark Interference

Silencer Off		Silencer On	
Output Meter Reading	Output Meter Reading	Output Meter Reading	Output Meter Reading
Signal Alone.....	5 v.	5 v.	5 v.
Signal + Noise.....	7 v.	5 v.	5 v.
Noise Alone.....	5 v.	0.5 v.	0.5 v.
Noise/Signal.....	1	0.1	0.1

Improvement in signal-noise ratio, approximately 20 db

the proper combination, however. The settings are not especially critical and the silencer actually operates as an effective signal limiter over a considerable range of amplitude, an incidental feature which is of no little aid in itself. Under extremely bad noise conditions, especially when receiving a weak signal, close adjustment of the threshold control will give the best signal-noise ratio.

In 'phone reception with a.v.c., the manual r.f. gain adjustment may be left at its normal setting and the threshold control set for best signal-noise ratio. A single setting of this control will serve for a wide range of signal strengths, since the noise amplifiers grid is tied into the a.v.c. cir-

# PERFORMANCE *not prophecy*

The performance of an item, not prophecy is what makes it a leader. Tested materials—uniform construction—wide safety tolerances have established the reputation of Premier Crystals over a period of years. Today, "Premier" and "Performance" are synonymous. In 1936, Premier makes this pledge to its loyal following in the amateur and broadcast fields: "Let others prophesy, Premier will give Performance!"

The 180-A isolantite holder is a typical example of Premier perfection. The efficiency of a crystal is dependent upon the contact of the electrodes. To assure maximum contact consistency—electrodes of special nickel silver alloy, heat treated for permanency, are used. Thus, the old evils of loss in output, frequency drift and fractured crystal are eliminated.



## THE CRYSTAL THAT DEFIES THE *Jest of Jime*

Write today for Bulletin 103 describing in complete detail Premier Crystals, Isolantite Holders, etc.



**PREMIER CRYSTAL LABORATORIES, INC.**  
53 PARK ROW · NEW YORK · N. Y.

# ASTATIC

*Crystal Microphones and Pickups*

Guaranteed instruments, known for their quality, dependability and ruggedness. Extensively used in both Professional and Amateur fields. Send for your literature today!

LICENSED UNDER BRUSH DEVELOPMENT COMPANY PATENTS

ASTATIC MICROPHONE LABORATORIES INC. · YOUNGSTOWN, OHIO

## T. R. McELROY

WORLD'S CHAMPION RADIO TELEGRAPHER  
announces

### MAC OSCILLATOR at \$3.95

I am instructing two nights weekly at Massachusetts Institute of Technology and expect soon to start one night weekly at Harvard College. In collaboration with men at these schools and my good friend Kyle Fleming of Trans-Lab, I have developed something which "they" said "couldn't be done." I've got an all-electric a.c. or d.c. oscillator which turns out the most beautiful 1000 cycle note you ever heard. Go to your regular distributor; buy one; open the can; shove in a couple of tubes; plug it into any electrical outlet and zing! Off you go with the finest oscillator that has ever been built for code practice work—so far as I know. For men on ships, it'll use ship juice; for guys in the city it'll use d.c.; for guys in suburbs it'll use a.c. Get a MAC KEY; get a MAC OSCILLATOR and then write to my old pal Candler and if you stick by the three I'll guarantee you'll be as fine an operator as can be developed. MAC KEY at \$7.95. I believe it to be the finest semi-automatic ("bug") key built.

JUNIOR MODEL MAC KEY at \$4.95. I guarantee it to be the finest "bug" built outside of MAC KEY and Vibroplex. MAC AUTO at less than \$100.00. Completely automatic, all electric 5 to 200 wpm. *Literature.*

See my full page in new ARRL Handbook. 73, MAC.  
23 Bayside Street, Uphams Corner P.O., Boston, Mass.

## To match—

- A 599x signal
- A WAC certificate
- An efficient receiver
- An effective transmitter
- A swell layout
- A well-operated station

## you want—

The swanky BUCKRAM-BOUND  
edition of the  
**HANDBOOK**  
See page 87 this issue.

\$2.50 postpaid

**AMERICAN RADIO RELAY LEAGUE**  
WEST HARTFORD, CONN., U. S. A.

# BOUND VOLUME XIX of QST (1935 Series)

**W**E have now a limited number of copies of Bound Volume XIX of QST. Vol. XIX comprises the entire 1935 series of QST. This volume is made up of two books or sections, each containing six issues of QST. This volume is handsomely bound in red cloth and with gold imprint. The complete volume is priced at \$5.00, postpaid.

Better act quickly — only a few copies available.

**QST**

38 LaSalle Road  
West Hartford, Connecticut

cuit so that the threshold point is maintained proper over a considerable range of signal amplitude, even with rapid fading.

## PERFORMANCE CHECKS

Noise interference being what it is, so variable in character and inconsistent, it is difficult to give generally applicable qualitative description or quantitative data on the performance of this silencer system. A great many tests have been made on various kinds of interference with reception of all kinds of signals throughout the frequency range from 30 mc. to the broadcast band. In every case it has been possible to bring the noise amplitude down to or below the maximum signal amplitude at the receiver's output. Most of these tests have been made using a "Model T" spark coil in the same room with the receiver, usually right on the operating table, and typical results obtained with this set-up are summarized in the accompanying table. Without the silencer, the interference from this noise source was so great that all signals were completely unintelligible and the audio circuits of the receiver were overloaded even with the r.f. gain reduced for strong signals and the audio control adjusted for no more than normal loud speaker or headset volume on the signal. With the silencer in operation, it is possible in every case to bring the output noise down to a level which permitted intelligible reception of any signal above the receiver's normal sensitivity level.

A particularly helpful feature aiding 'phone reception is the protection to a.v.c. operation afforded by the silencer. By taking out the noise peaks ahead of the second detector, where a.v.c. rectification normally takes place, the noise pulses are prevented from taking control of the gain by building up high bias voltage in the necessarily slow acting a.v.c. circuit. Provided the noise amplitude is not so great as to overload the grid circuit of the i.f. amplifier and develop a.v.c. bias from rectified grid current through the filtering and diode load resistances, this protection is practically complete.

When the silencing is applied to the final i.f. stage of a single-signal receiver with the crystal filter operating ahead of it, the behavior is considerably different. If the noise interference without the silencer is of sufficient amplitude to cause the crystal to "ping" (with the c.w. beat oscillator on), the silencer will be considerably less effective—less effective with crystal in than with it out of circuit. The explanation for this was given earlier in this article; namely, the low decrement of the crystal circuit increases the duration of the noise wave trains. This is not a fault of the crystal. It results from the very property of the crystal which gives it desirable high selectivity. Nor is it the fault of the silencer circuit. It still tries to perform its function but is handicapped by the increased duration of the noise pulses. The two devices are simply in the wrong relative positions. The silencer should be ahead of the crystal filter, permitting it to give its full benefit and to protect the crystal from shock

Bill sure puts out a sweet note

You bet! His new BC3 does the trick!

**BLILEY BC3**  
**CRYSTAL UNITS**  
**40-80 METER BANDS**

**39¢**  
and up

New  
**MICA CONDENSERS**  
Compact  
ENCASED IN PORCELAIN

"HAMS" A Real Low-Loss . . . Leak Proof . . . Moisture Proof . . . Excellent Power Factor Condenser. Truly a remarkable Engineering achievement accomplished after many expensive and painstaking experiments. Really a precision unit at even a lower price than most ordinary condensers. Available in 2 1/4% capacity tolerance and 5000 Volt construction. Write for catalog sheet and color Chart.

**AMAZING QSL OFFER—SEE HAM-ADS**

See your nearest Jobber or write direct to:  
**FILTERMATIC MANUFACTURING CO.**  
Tacony, Philadelphia, Penna.



## TO ALL AMATEURS WHO ARE MEMBERS OF THE ARRL IN GOOD STANDING:

Do you wear an ARRL pin or button? Do you carry on your correspondence with other amateurs on ARRL member's stationery? You should — we are proud to have you as members and you should be proud to show your allegiance to the organization that has done so much for your amateur radio. These items are exclusively for you, and the pins are available with the different colored backgrounds to distinguish between various Communication's appointments.



Write your radio letters on League stationery. Lithographed on 8½ x 11 heavy bond paper. Postpaid, 100 sheets, 50c; 250 sheets, \$1.00; 500 sheets, \$1.75.

The League Emblem, in heavy rolled gold and black enamel, either pin or button. Special colors available for Communications Department appointees. Red background for the SCM, green background for the RM, blue background for the ORS. Red and green colors available in pin type only, blue available both in pin and button types. Price only 50c postpaid.



## American Radio Relay League

West Hartford, Connecticut

"The Crystal Specialists Since 1925"

### PIEZO-ELECTRIC CRYSTALS

Guaranteed Accurate to BETTER than .01%

### SCIENTIFIC RADIO SERVICE

UNIVERSITY PARK, HYATTSVILLE, MD.

### RADIO ENGINEERING

RCA Institutes offers an intensive course of high standard embracing all phases of Radio. Practical training with modern equipment at New York and Chicago schools. Also specialized courses and Home Study Courses under "No obligation" plan.



Illustrated Catalog on request.

**RCA INSTITUTES, INC.** Dept. ST-36

75 Varick St., New York 1154 Merchandise Mart, Chicago  
Recognized Standard in Radio Instruction Since 1909

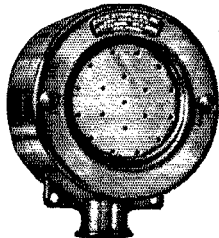

### The Superiority of Our DYNAMIC MICROPHONE

Over Other Types Is Mainly in Its Sensitivity  
No high gain preamplification required. No background noise. No Power Supply. And the price...\$30  
SPECIAL PRICE TO AMATEURS...net \$18

U. S. PATENTS PENDING

Send for Bulletin 3011

**RADIO RECEPTOR CO., INC.**  
110 Seventh Ave., New York City

PROMPT DELIVERY ASSURED

## ★★★ PATTERSON ★★★ ALWAYS RADIO

We ship prepaid except where factory regulations prohibit it.

## PATTERSON

No Down Payment 20 Months to Pay!

Now! All standard receivers and MARINE TRANSMITTERS available on the new MARINE RADIO Budget Plan — Write for full details.

PR-16 complete with 16 matched tubes and 12" heavy duty Patterson speaker..... \$95.70

PR-16C (With Crystal) complete..... \$101.70

RME-69

Receiver only \$118.80. Complete with crystal, set of tubes, and Rola Speaker housed in baffle — nothing else to buy. \$134.90

### SUPER SKYRIDER

Acclaimed as the most popular S.W. receiver of 1935. Your cost..... \$79.50  
With Crystal (Model SX9)..... \$89.50

Also a complete stock of Sargent, McMurdo Silver, and other popular receivers and transmitters. We also build to your specifications.

Literature gladly furnished upon request

## M A R I N E R A D I O C O M P A N Y

General Offices and Plant 124-11 101st Avenue  
Richmond Hill, New York

# EIMAC

## NEW 300T! CHARACTERISTICS

PLATE DISSIPATION.....300 WATTS  
 PLATE CURRENT (MAX.).....300 MA.  
 PLATE VOLTAGE (MAX.).....3500  
 GRID-PLATE CAPACITY.....4 mmfds  
 PLATE-FILAMENT CAPACITY.....6 mmfds  
 AMPLIFICATION FACTOR.....16  
 OVERALL HEIGHT.....12½ INCHES  
 MAX. DIAMETER.....5 INCHES  
 BASE.....STANDARD "50 WATT"

### PERFORMANCE

Class "C" Output 75% Efficiency 800 watts  
 Class "B" Audio (Two Tubes) 1250 watts

PRICE  
**\$60.00**

**EITEL-McCULLOUGH, INC.**  
 SAN BRUNO, CALIFORNIA, U. S. A.  
 CABLE "EIMAC"

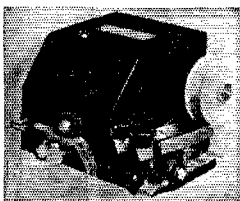

"QLZ - QLZ - QLZ"  
**OPERATORS**  
*Save Your Fists*  
 With the **AUTOMATIC**  
**ROBOT**  
**RADIO KEY**

Repeats calls or messages indefinitely, automatically, by motor-driven endless paper tape, perforated, dot and dash, by attachment on key. Length tape unlimited. Speed adjustable. Induction-type motor. Furnished with two 100-foot rolls of tape. Complete unit. No additional equipment needed. A practical instrument. Answers long-felt want of amateurs or professionals. **GUARANTEED with Full Instructions**

Made by Manufacturer of Electrical Instruments

Price  
**\$10**  
 Postpaid  
 Patent  
 Pending

**Gardiner-Levering Co.** Haddon Heights  
 New Jersey, U. S. A.

## MODERN METERS by HOYT

New square meters with scale 4½ inches long. Made in all popular D.C. ranges as a Milliammeter, Ammeter and Voltmeter. Accuracy is 2% sensitivity; 75 MV in the 1 MA range. Standard case black bakelite, 4¼ inches square; it mounts through a 2¾ inch panel hole. Ask your dealer for these smart new instruments.

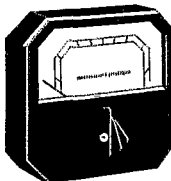

**BURTON-ROGERS**

755 Boylston St., Boston, Mass.  
 Sales Div. Hoyt Elec. Instr. Works

excitation by high-amplitude noise pulses. Since the crystal must work in a low-level stage of the i.f. circuit and since the noise rectifier requires a fairly high level of noise voltage for effective operation, an additional i.f. stage of low gain between the first detector and crystal filter should be used for the i.f. silencer-amplifier; and an additional stage of low selectivity and fairly high gain should be put in ahead of the noise rectifier. This might seem like undue elaboration of the receiver circuits; but if it means the difference between no reception and successful reception, which is an infinite difference, then it is well worth while.

### ADAPTING THE SILENCER CIRCUIT

An adapter unit suitable for superhet receivers using a two-stage i.f. amplifier and having at least one r.f. stage ahead of the first detector is diagrammed in Fig. 2 and illustrated by top and bottom views. It is connected into the i.f. circuit by the tube-base plug which replaces the 58 or 6D6 second i.f. tube, and by the grid-cap lead which connects to the second i.f. transformer grid clip. The shielded grid and plate leads should be as short as permissible. The circuit otherwise is the same as that of Fig. 1, the diode input transformer,  $T_4$ , being tunable to the receiver's intermediate frequency.

With the connections made, the adjustment procedure is identical with that outlined for the other circuit—not overlooking retuning of the second i.f. transformer in the receiver which is necessitated by the increased capacitance of the shielded grid lead and the input of the two noise-unit tubes in parallel.

No trouble with instability or i.f. oscillation should be experienced if the receiver was stable in the first place. If there is such instability, however, good silencing action is unlikely. When receiver and silencer circuit are properly coordinated, silencing performance in accordance with that previously described should result.

### Neon-Bulb Audio Oscillators

(Continued from page 76)

ers of different values being connected together at one terminal while their other terminals are connected to a three-point switch. By switching from one condenser to another, different notes are selected. Another possible combination would be to arrange several condensers which could be connected in parallel by means of a switch. The circuit of Fig. 3 represents a selection of a greater number of frequencies, since each combination of condenser and resistor will generate a different frequency. To this, add a means of voltage variation, and every reasonable audible frequency is at the command of the operator. This is one of the most satisfactory devices for code practice—which, taken occasionally, doesn't do any harm at all.

# THE AMATEUR'S BOOKSHELF

A balanced selection of good technical books, additional to the A.R.R.L. publications, should be on every amateur's bookshelf. We have arranged, for the convenience of our readers, to handle through the A.R.R.L. Book Department those works which we believe to be most useful. Make your selection from the following, add to it from time to time and acquire the habit of study for improvement. *Prices quoted include postage.* Please remit with order.

## RADIO THEORY AND ENGINEERING

**FUNDAMENTALS OF RADIO, Second Edition, by R. R. Ramsey.** A modernized revision of the author's work which has been a favorite with amateurs and experimenters since 1929. 426 pages, 439 illustrations. Price.....\$3.50

**SHORT WAVE WIRELESS COMMUNICATION, by A. W. Ludner and C. R. Stoner.** Not a "how-to-make-it" book, but a text satisfying the needs of practical engineers and advanced amateurs by its thorough treatment of principles and practices in short-wave transmission and reception. The chapters on modulation, aeriads and feeders are especially good. 348 pp., 201 illustrations.....\$3.75

**COMMUNICATION ENGINEERING, by W. L. Everitt.** A general text for both first year and advanced courses. 567 pp., 335 illustrations.....\$5.00

**RADIO ENGINEERING, by F. E. Terman.** A comprehensive treatment covering all phases of radio communication and a comprehensive book for students and engineers. 688 pp., 418 illustrations....\$5.00

**MANUAL OF RADIO TELEGRAPHY AND TELEPHONY, by Commander (now Admiral) S. S. Robinson, U. S. N.** Published by the Naval Institute. Covers both the theoretical and practical fields. 791 pp., 6¼ x 9.....\$4.00

**ELEMENTS OF RADIO COMMUNICATION, by Prof. J. H. Morecroft.** This is the 2nd edition of this book by the author of the "Principles" listed elsewhere. It is about half the size of the larger work, and the subject is treated in more elementary fashion. Simple algebra is sufficient. An excellent book for the "first-year" student. 279 pp., 170 illustrations.....\$3.00

**PRINCIPLES OF RADIO COMMUNICATION, by Prof. J. H. Morecroft.** An elaborate general textbook, and one of the recognized standards on theory for the engineering student. A working knowledge of mathematics is desirable for the reader who expects to get the greatest benefit from this work. 1001 pp., 5¼ x 9.....\$7.50

**PRINCIPLES OF RADIO, by Keith Henney.** This book is chock-full of meat for the experimenter. The subjects treated range from the fundamentals of electricity to the modern concepts of modulation and detection. 471 pp., 306 illustrations.....\$3.50

**THEORY OF THERMIONIC VACUUM TUBES, by E. L. Chaffee.** Based on Dr. Chaffee's research and study at Harvard University, this book offers much new material and many new presentations, especially in connection with regeneration. Recommended particularly for advanced study. 652 pp. 360 illustrations.....\$6.00

## RADIO EXPERIMENTS AND MEASUREMENTS

**MEASUREMENTS IN RADIO ENGINEERING, by F. E. Terman.** A comprehensive engineering discussion of the measurement problems encountered in engineering practice, with emphasis on basic principles rather than on methods in detail. A companion volume to the same author's Radio Engineering. 400 pages, including an appendix of outlines for laboratory experiments and a comprehensive index. 210 illustrations. Price.....\$4.00

**THE CATHODE-RAY TUBE AT WORK, by John F. Rider.** Every owner and user of a cathode-ray oscilloscope should have his copy of this book. The first 109 pages are devoted to cathode-ray tube theory, sweep circuits, a.c. wave patterns and description of commercial oscilloscope units (the author prefers to call them "oscillographs") the next 205 pages are packed with practical information on how to use them, including actual photographs of screen patterns representing just about every condition likely to be encountered in audio- and radio-frequency amplifiers, power supplies, complete receivers and transmitters. 322 pages, 444 illustrations. Price.....\$2.50

**RADIO FREQUENCY ELECTRICAL MEASUREMENTS, by H. A. Brown.** A thoroughly practical book for the experienced

amateur, the experimenter or engineer who has knowledge of the elementary principles of radio communication and of alternating currents.....\$4.00

**HIGH-FREQUENCY MEASUREMENTS, by August Hund.** A thorough, modern book, especially useful in advanced laboratory work. Includes a chapter on piezo-electric determinations. 491 pp., 373 illustrations.....\$5.00

**EXPERIMENTAL RADIO ENGINEERING, by Prof. J. H. Morecroft.** An excellent laboratory text directed specifically to emphasizing the principles involved in the operation of radio apparatus and intended as a companion to the same author's "Principles." Following an introductory chapter on instruments and accessories, 51 choice experiments are outlined. 345 pp., 250 illustrations.....\$3.50

**EXPERIMENTAL RADIO, by Prof. R. R. Ramsey, Revised Edition.** A splendid book for the experimenter. This is a laboratory manual describing 128 excellent experiments designed to bring out the principles of radio theory, instruments and measurements. 150 illustrations, 229 pp., 5¼ x 7.....\$2.75

## COMMERCIAL EQUIPMENT AND OPERATING

**PRACTICAL RADIO COMMUNICATION, by A. R. Nilson and J. L. Hovnung.** A new modern treatment meeting the expanded scope of today's technical requirements in the various commercial fields. The first six chapters are devoted to principles, the remaining nine to latest practice in broadcasting, police systems aviation radio and marine communication. 754 pages, including an appendix of tabulated data and a complete topical index. 434 illustrations. Price \$5.00

**RADIO THEORY AND OPERATING, by Mary Texanna Loomis.** Although giving a moderate amount of theory, it is essentially a practical handbook for commercial and broadcast operators, and as such ranks among the foremost publications of this sort. Used as a textbook by many radio schools. A good book for any amateur. 1000 pp., 800 illustrations.....\$3.00

**THE RADIO MANUAL, by George E. Sterling.** Another excellent practical handbook, especially valuable to the commercial and

broadcast operator, and covering the principles, methods and apparatus of all phases of radio activity. Over 900 pp.....\$6.00

**RADIO TRAFFIC MANUAL AND OPERATING REGULATIONS, by Duncan and Drew.** A book for students, amateurs or radio operators who contemplate entering the commercial field; it will enable you to learn quickly and easily all the government and commercial traffic rules and operating regulations. 181 pp.....\$2.00

**RADIO OPERATING QUESTIONS AND ANSWERS, by Nilson and Hovnung.** A companion volume to "Practical Radio Telegraphy" by the same authors. The latest Revised Edition is very complete, covering Commercial and Broadcast, Amateur, Aeronautical and Police Radio, Beacons, Airways, Meteorology, and Teletype Operating. 389 pp., 5¼ x 8.....\$2.50

## MISCELLANEOUS

**THE RADIO AMATEUR CALL BOOK.** Lists all U. S. and foreign amateur radio stations, s.w. commercials and broadcasters.....\$1.25 (Foreign \$1.35)

**BELOW TEN METERS, by James Millen and R. S. Kruse.** Ultra-high-frequency oscillators, radiating systems, receivers, theories, measurements, television reception, etc. Abundant photographs and diagrams. 64 pp.....\$5.00

**ELECTRICITY, WHAT IT IS AND HOW IT ACTS, by A. W. Kramer.** A modern treatment with the electron as its basis. It deals only with accepted theories, presenting them simply and straightforwardly so that those not mathematically minded can understand them. Two volumes. 592 pp., 242 illustrations.....\$4.00

**RADIO DATA CHARTS, by R. T. Beatty.** A series of graphic charts

for solving, without the use of mathematics, most of the problems involved in receiver design. 82 pp., 8¼ x 11.....\$1.50

**SERVICING RECEIVERS BY MEANS OF RESISTANCE MEASUREMENTS, by J. F. Rider.** 203 pp., 94 illustrations. An excellent book for the service man and amateur constructor....\$1.00

**WHO'S WHO IN AMATEUR RADIO.** Gives photos, personal and station data on over 3000 amateurs. Also includes comprehensive list of radio clubs, s.w. commercials, etc. 172 pp., 140 photos...\$5.50

**RADIO DESIGN PRACTICE, by James Millen and M. B. Sleeper.** A new type of book giving mechanical dimensions and electrical specifications of components and illustrating complete units of 10 manufacturers, with catalog listings appended. Over 150 pages, exclusive of the catalog section. Price.....\$1.00

# Where to buy it

A directory of suppliers who carry in stock the products of these dependable manufacturers.

**ASTATIC**  
*Crystal Microphones and Pickups*  
**ASTATIC MICROPHONE LABORATORY, Inc. YOUNGSTOWN, O.**  
*Pioneer Manufacturers of Quality Crystal Products*

- NEWARK, N. J.** 219 Central Ave.  
 Wholesale Radio Service Co., Inc.
- NEW YORK, N. Y.** 25 Park Place  
 Federated Purchaser, Inc.
- NEW YORK, N. Y.** 100 Sixth Ave.  
 Wholesale Radio Service Co., Inc.
- NEW YORK, N. Y. (BRONX)** 542 East Fordham Rd.  
 Wholesale Radio Service Co., Inc.

**BURGESS BATTERY COMPANY**  
 "Chrome" protected  
**RADIO BATTERIES**  
 Look for the Black and White Stripes  
 FREEPORT, ILLINOIS

- ALBANY, N. Y.** Uncle Dave's Radio Shack 356 Broadway
- BALTIMORE, MD.** 303 W. Baltimore St.  
 Radio Electric Service Co.
- BOSTON, MASS.** Radio Shack 46 Brattle Street
- BOSTON, MASS.** 10 Boylston St.  
 Tremont Electrical Supply Co.
- HARTFORD, CONN.** 210 Chapel Street  
 Stern & Company, Inc.
- MANCHESTER, N. H.** 1008 Elm Street  
 Radio Service Lab. of N. H.
- MONTREAL, CANADA** 285 Craig Street, West  
 Canadian Electrical Supply Co., Ltd.
- NEWARK, N. J.** 219 Central Ave.  
 Wholesale Radio Service Company
- NEW YORK, N. Y. (BRONX)** 542 E. Fordham Rd.  
 Wholesale Radio Service Company
- NEW YORK, N. Y.** 100 Sixth Avenue  
 Wholesale Radio Service Company
- NEW YORK, N. Y.** 142 Liberty Street  
 Harrison Radio Company

- OIL CITY, PENN.** 8 West Front Street  
 Frank Electric Company
- PITTSBURGH, PENN.** 403 Penn Avenue  
 Tri-State Radio Equipment Co.
- READING, PENN.** 404 Walnut Street  
 George D. Barbey Company
- SPRINGFIELD, MASS.** 349 Worthington St.  
 T. F. Cushing
- WILKES-BARRE, PENN.** 50 Hazle Street  
 Radio Service Company

**Super SKYRIDER**  
 the hallicrafters

- ALBANY, N. Y.** Uncle Dave's Radio Shack 356 Broadway
- ARGYLE, N. Y.** Harper K. Richards
- BOSTON, MASS.** 46 Cornhill  
 H. Jappe Company
- BOSTON, MASS.** Radio Shack 46 Brattle Street
- GLOVERSVILLE, N. Y.** 40 Clyde St.  
 Adirondack Radio Service
- HARTFORD, CONN.** 227 Asylum Street  
 Radio Inspection Service Co.
- MANCHESTER, N. H.** 1008 Elm Street  
 Radio Service Lab. of N. H.
- NEWARK, N. J.** 219 Central Ave.  
 Wholesale Radio Service Co., Inc.
- NEW YORK, N. Y.** 51 Vesey St.  
 Gross Radio, Inc.
- NEW YORK, N. Y. (BRONX)** 542 East Fordham Rd.  
 Wholesale Radio Service Co., Inc.
- NEW YORK, N. Y.** 100 Sixth Ave.  
 Wholesale Radio Service Co., Inc.
- PITTSBURGH, PENN.** 403 Penn. Ave.  
 Tri-State Radio Equipment Co.
- PITTSBURGH, PENN.** Tydings Company 620 Grant St.
- RICHMOND HILL, NEW YORK** 124-11 101st Ave.  
 Marine Radio Company
- SPRINGFIELD, MASS.** T. F. Cushing 349 Worthington St.

# Where to buy it

A directory of suppliers who carry in stock the products of these dependable manufacturers.



- MONTREAL, CANADA** 285 Craig Street, West  
Canadian Electrical Supply Co., Ltd.
- NEWARK, N. J.** 219 Central Ave.  
Wholesale Radio Service Company
- NEW YORK, N. Y. (BRONX)** 542 E. Fordham Rd.  
Wholesale Radio Service Company
- NEW YORK, N. Y.** 100 Sixth Avenue  
Wholesale Radio Service Company
- NEW YORK, N. Y.** 142 Liberty Street  
Harrison Radio Company
- PITTSBURGH, PENN.** 603 Grant Street  
Cameradio Company
- PITTSBURGH, PENN.** 403 Penn Avenue  
Tri-State Radio Equipment Co.
- READING, PENN.** 404 Walnut Street  
George D. Barbey Company



- ALBANY, N. Y.** 356 Broadway  
Uncle Dave's Radio Shack
- ALLENTOWN, PENN.** 1024 Hamilton Street  
Radio Electric Service Company
- BALTIMORE, MD.** 303 W. Baltimore St.  
Radio Electric Service Company
- BOSTON, MASS.** 10 Boylston Street  
Tremont Electrical Supply Co.
- BOSTON, MASS.** 46 Cornhill  
H. Jappe Company
- BOSTON, MASS.** 46 Brattle Street  
Radio Shack
- BUFFALO, N. Y.** 216 E. Genesee Street  
Dymac Radio

- HARTFORD, CONN.** Hatry & Young 203 Ann Street
- MONTREAL, CANADA** 211 St. Sacramento St.  
Canadian Marconi Company
- MONTREAL, CANADA** 285 Craig Street, West  
Canadian Electrical Supply Co., Ltd.
- NEWARK, N. J.** 219 Central Avenue  
Wholesale Radio Service Company
- NEW HAVEN, CONN.** Hatry & Young 86 Meadow Street
- NEW YORK, N. Y.** 100 Sixth Avenue  
Wholesale Radio Service Co.
- NEW YORK, N. Y. (BRONX)** 542 E. Fordham Rd.  
Wholesale Radio Service Co.
- NEW YORK, N. Y.** 227 Fulton Street  
Sun Radio Company
- NORFOLK, VIRGINIA** 615 Boush St.  
Newport Radio Service Company
- PARIS, FRANCE** J. C. Balouzet De Tigny, 27 rue de Marignan
- PHILADELPHIA, PENN.** 10 S. 10th Street  
Eugene G. Wile
- PHILADELPHIA, PENN.** N. E. Corner 7th & Arch Sts.  
Radio Electric Service Company
- PHILADELPHIA, PENN.** 512 Market Street  
M & H Sporting Goods Company
- PHILADELPHIA, PENN.** 438 Market Street  
Herbach & Rademan, Inc.
- PITTSBURGH, PENN.** 603 Grant Street  
Cameradio Company
- SPRINGFIELD, MASS.** 349 Worthington Street  
T. F. Cushing
- SPRINGFIELD, MASS.** 397 Dwight Street  
Springfield Radio Company
- WILKES-BARRE, PENN.** 50 Hazle Street  
Radio Service Company



- ALBANY, N. Y.** 31 Hudson Avenue  
Havens Electric Company, Inc.

# Where to buy it

A directory of suppliers who carry in stock the products of these dependable manufacturers.

<b>ALBANY, N. Y.</b>	Uncle Dave's Radio Shack	356 Broadway
<b>BOSTON, MASS.</b>	H. Jappe Company	46 Cornhill
<b>BOSTON, MASS.</b>	Radio Shack	46 Brattle Street
<b>CHARLESTON, W. VA.</b>	Virginian Electric, Inc.	
<b>HARTFORD, CONN.</b>	Hatry & Young	203 Ann Street
<b>NEWARK, N. J.</b>	Wholesale Radio Service Co.	219 Central Avenue
<b>NEW BEDFORD, MASS.</b>	C. E. Beckman Co.	11-35 Commercial St.
<b>NEW HAVEN, CONN.</b>	Hatry & Young	86 Meadow Street
<b>NEW YORK, N. Y.</b>	Bruno-New York, Inc.	460 W. 34th St.
<b>NEW YORK, N. Y.</b>	Federated Purchaser, Inc.	25 Park Place
<b>NEW YORK, N. Y.</b>	Royal-Eastern Electrical Supply Co.	16 West 22nd Street
<b>NEW YORK, N. Y.</b>	Sanford Samuel Corp.	136 Liberty St.
<b>NEW YORK, N. Y. (BRONX)</b>	Wholesale Radio Service Co.	542 E. Fordham Rd.
<b>NEW YORK, N. Y.</b>	Wholesale Radio Service Co.	100 Sixth Avenue
<b>NEW YORK, N. Y.</b>	Harrison Radio Company	142 Liberty Street
<b>PHILADELPHIA, PENN.</b>	Eugene G. Wile	10 S. 10th Street
<b>PHILADELPHIA, PENN.</b>	Raymond Rosen & Company	117 North 7th St.
<b>PITTSBURGH, PENN.</b>	Cameradio Company	603 Grant Street
<b>READING, PENN.</b>	Bright & Company	8th & Elm Streets
<b>SPRINGFIELD, MASS.</b>	T. F. Cushing	349 Worthington Street
<b>WASHINGTON, D. C.</b>	Sun Radio & Service Supply Co.	238 F Street, N. W.
<b>WILKES-BARRE, PENN.</b>	Radio Service Company	50 Hazle Street



**AMATEUR  
RADIO  
EQUIPMENT**

RCA Victor Division of RCA Manufacturing Co., Inc.

<b>ALBANY, N. Y.</b>	Uncle Dave's Radio Shack	356 Broadway
<b>BOSTON, MASS.</b>	H. Jappe Company	46 Cornhill
<b>BOSTON, MASS.</b>	Radio Shack	46 Brattle Street
<b>CAMDEN, N. J.</b>	Radio Electric Service Company	811 Federal Street
<b>ERIE, PENN.</b>	J. V. Duncombe Company	1011 West 8th St.
<b>GREENWICH, CONNECTICUT</b>	Mead Stationery Company	252 Greenwich Ave.
<b>HARTFORD, CONN.</b>	Hatry & Young	203 Ann Street
<b>HARTFORD, CONN.</b>	Radio Inspection Service Co.	227 Asylum Street
<b>MONTREAL, CANADA</b>	Canadian Electrical Supply Co., Ltd.	285 Craig Street, West
<b>NEWARK, N. J.</b>	Wholesale Radio Service Company	219 Central Avenue
<b>NEW HAVEN, CONN.</b>	Hatry & Young	86 Meadow Street
<b>NEW YORK, N. Y.</b>	Bruno-New York, Inc.	460 W. 34th St.
<b>NEW YORK, N. Y.</b>	Sanford Samuel Corporation	136 Liberty Street
<b>NEW YORK, N. Y. (BRONX)</b>	Wholesale Radio Service Co.	542 E. Fordham Rd.
<b>NEW YORK, N. Y.</b>	Wholesale Radio Service Company	100 Sixth Avenue
<b>PHILADELPHIA, PENN.</b>	Radio Electric Service Company	3145 N. Broad Street
<b>PHILADELPHIA, PENN.</b>	Radio Electric Service Company	N. E. Cor. 7th & Arch Streets
<b>PITTSBURGH, PENN.</b>	Cameradio Company	603 Grant Street

# Where to buy it

A directory of suppliers who carry in stock the products of these dependable manufacturers.

**RICHMOND HILL, N. Y.** 124-11 101st Ave.  
Marine Radio Company

**WILKES-BARRE, PENN.** 50 Hazle Street  
Radio Service Company

**BOSTON, MASS.** 46 Brattle Street  
Radio Shack

**BOSTON, MASS.** 28 Brattle St.  
Selden Radio Company

**HARTFORD, CONN.** 203 Ann Street  
Hatry & Young

**MONTREAL, CANADA** 285 Craig Street, West  
Canadian Electrical Supply Co., Ltd.

**NEWARK, N. J.** 219 Central Ave.  
Wholesale Radio Service Company

**NEW HAVEN, CONN.** 86 Meadow Street  
Hatry & Young

**NEW YORK, N. Y.** 542 E. Fordham Rd.  
Wholesale Radio Service Company

**NEW YORK, N. Y.** 100 Sixth Avenue  
Wholesale Radio Service Company

**PITTSBURGH, PENN.** 603 Grant Street  
Cameradio Company

**PITTSBURGH, PENN.** 620 Grant St.  
Tydings Company

**READING, PENN.** 404 Walnut Street  
George D. Barbey Company

**WILKES-BARRE, PENN.** 50 Hazle Street  
Radio Service Company

**ALBANY, N. Y.** 356 Broadway  
Uncle Dave's Radio Shack

**BOSTON, MASS.** 46 Cornhill  
H. Jappe Company

**BUFFALO, N. Y.** 326 Elm St.  
Radio Equipment Corporation

**GLOVERSVILLE, N. Y.** 40 Clyde St.  
Adirondack Radio Service

**NEWARK, N. J.** 219 Central Avenue  
Wholesale Radio Service Company

**NEW YORK, N. Y.** 542 E. Fordham Rd.  
Wholesale Radio Service Company

**NEW YORK, N. Y.** 100 Sixth Avenue  
Wholesale Radio Service Company

**NEW YORK, N. Y.** 227 Fulton Street  
Sun Radio Company

**PITTSBURGH, PENN.** 403 Penn Avenue  
Tri-State Radio Equipment Co.

**PITTSBURGH, PENN.** 620 Grant Street  
Tydings Company

**READING, PENN.** 404 Walnut Street  
George D. Barbey Company

**SPRINGFIELD, MASS.** 349 Worthington Street  
T. F. Cushing

**WILKES-BARRE, PENN.** 50 Hazle Street  
Radio Service Company

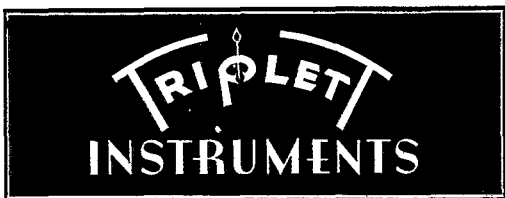

**ALBANY, N. Y.** 356 Broadway  
Uncle Dave's Radio Shack

**RICHMOND HILL, N. Y.** 124-11 101st Ave.  
Marine Radio Company

# STATION ACTIVITIES

(Continued from page 70)

## ATLANTIC DIVISION

**EASTERN PENNSYLVANIA**—SCM, James M. Bruning, W3EZ—R.M.'s: 3AKB, 3AQN, 3EOP, 8ASW. Are you an active amateur or only a B.C.L.? The Section report in Q87 gives the answer. It is the Directory of Stations "on the air." A report to the S.C.M. on the sixteenth of each month puts your call in the preferred list. Brasspounders this month: 3EZ and WLQA (30K). 3ADE asks if you would like an East Penna. QSO contest. If so, please send your comments to S.C.M. 3AQN wants to hear from O.R.S. prospects. 3AYF is back on the air. 3BES made over 72,000 in SS contest. 3BOJ had trouble with 56-mc. antenna. 3BRZ and 3MG report DX good on 14-mc. 'phone. 3BXE has now worked all states except Utah. 3DMQ needs one continent for W.A.C. on both 14 and 7 mc. 3FAO has good luck on 14-mc. C.W. 3EOP is new C.W.-O.B.S. 3EPJ won second place in 3.5-mc. Chess game with 8PPL. 3EUP is new O.R.S. 3EWJ applied for O.R.S. 3EZ handled 4417 messages in 1935. 3FCA is new ham in Tacony. 8ASW and 8EU rebuilt their stations. 8EKG is still working nights. 8NNC burned up a lot of equipment. Frankford Radio Club reorganized and is planning a great winter of activities. New officers are: 3AKB, 3BES, 3BXE, 3COZ, 3KT and 3PB. Amateurs in that vicinity are asked to communicate with one of the officers for details.

Traffic: W3EZ 556 3EOP 417 3ADM 401 3AQN 211 8FLA 207 3BZP 152 3OK 131 (WLQA 517) 3BES 114 3EBP 107 3VR 96 3AKB 70 3DMQ 54 3EUP 53 3ECA-BXE 37 8EKG 28 3EYO 27 8ASW 24 8DMA 20 8NNC 12 8OML 11 3EPJ 8 3ADE 7 3CHI-FKJ 5 3EHZ 1.

**MARYLAND-DELAWARE-DISTRICT OF COLUMBIA**—SCM, Edgar L. Hudson, W3BAK—3CQS, 3CXL, 3EQU, R.M.'s. 3BWT, Chief R.M. DKM works So. America with '10 Hartley. BRS and DOJ are on 1.75-mc. 'phone. EOU is being closed down for short period on account of no opr. for it. EOG has new R.C.A. 136 receiver. CDG has 600 watts on 3.5-mc. C.W. OZ made 55,000 in SS. BKZ worked 59 sections in SS, 35,282 points. BAK is back on c.w., also 'phone. CDQ works lots of DX on 28 mc. FNG did his first operating during the SS; some start!

Traffic: W8SN-EOU 1265 CXL 538 (WLM 3182) BWT 457 ABA 407 CIZ 268 ASO 132 EOG 122 CDG 47 OZ 24 EZN 23 BKZ 17 IL 12 BAK 2 DRE 1 CDQ 2.

**SOUTHERN NEW JERSEY**—SCM, Carroll D. Kentner, W3ZX—The South Jersey Radio Association elected the following new officers for 1936: BGP, pres.; BO, vice-pres.; BEL, rec. sec.; BWR, corres. sec.; John Birch, treas. The new Board of Directors is: BAY, COT, QL, KW, DFK, CES, and ZX. The S.J.R.A. Cup Contest is getting under way again this year, with BEL as the chairman of the Cup Committee. This is the fifth annual competition for the best all-around amateur station in South Jersey, and several other special awards. ENB comes through with the item that his sister and our old fran' UT will soon say "I do." COT reports his transecn. 'phone traffic route is again functioning after a short interruption. FTK finds that several changes in working hours interfere with keeping his schedules. FRM greatly enjoyed his first Sweepstakes. FOS has new QRA: 4124 Terrace Ave., Merchantville. DSC spent his Christmas vacation in Washington, D. C., visiting hams. BIR found that Christmas slowed up his ham radio somewhat. EDP has worked G5BD and ZLZJQ on 3.5 mc. and has QSO'd England on 28, 14, 7 and 3.5 mc. to date. The jinx has hit DNU; he is off the air indefinitely until he can find wherewithal to replace blown apparatus. NF sends regrets about not being able to make Net Sunday mornings, due to late hours Saturday night. BO, AVJ, ZI, EFM, APV and BEI send in constructive comment regarding spot frequency operation of our Net. EFM is sporting the A.A.R.S. call WLNJ, and turns in nice total. EKL and FAF have combined forces, using EKL's transmitter and FAF's shack. APV says if the guy using his call on 14 mc. will call, he can get DX cards, and a black eye! APV also sends in the following dope on the Atlantic City gang: EWK handled quite a bit of traffic but finds the shack a lil' cold this weather. FDO is going strong on 28 mc. EVL is recommended for O.P.S.; he also says 56 mc. is in a slump around A.C. ZX finds 28-mc. 'phone OK (sometimes) and hears Europe, India and Australia on 14 mc. at 8 a.m. E.S.T.

Traffic: W6FTK 70 FBM 69 FOS 10 DSC 155 BIR 5 AEJ 14 EDP 4 DNU 81 COT 5 NF 123 (WLM 210) BO 62 AVJ 12 ZI 162 BEI 48 QL 2 CES 14 APV 203 EKL 87 EFM 161 (WLNJ 157) VE 41 ZX 37.

**WESTERN NEW YORK**—SCM, C. F. Smith, W8DSS—Greetings, Western New York amateurs. I wish to thank you for the splendid support given me during the recent S.C.M. election. I also take this opportunity of congratulating my worthy opponent, Bill Thompson, 8BDV, for the excellent vote he polled. The final figures were: 8DSS, 204; 8BDV 123. Due to various reasons, among which were grave sickness in his family and moving to Tully from Syracuse to enter an entirely new business, our former S.C.M. was unable to fully carry out the duties of office during the last few months of his term. But that is water over the dam now and I am hoping that with renewed cooperation of every O.R.S., O.P.S. and active amateur our Section will soon be at the top of the Atlantic Division where it rightfully belongs. We have the operators, and let me say there are none better in any section, and we have the spirit, courage and what it takes to make a real live section. It is the duty of the S.C.M. to weld these various elements into one co-operative group, and to this end each O.R.S. and O.P.S. will receive a personal letter from me very soon stating my plans and the future program of W.N.Y. Needless to say, any and all suggestions are very welcome, will be studied carefully and put into practice if feasible. Be prompt in sending your news items and traffic reports immediately following the fifteenth of each month. Remember your S.C.M. has to report on the twentieth, so give him a break. OK, gang, let's start this New Year with a firm resolution to put W.N.Y. at the top of the Atlantic Division in the few FB winter operating months we have left. 73.

Traffic: W8JTT 358 KJW 100 BJO 88 JQE 45 GWT 24 DSS 61. (Oct.-Nov. JTT 518 DSS 349.)

**WESTERN PENNSYLVANIA**—SCM, C. H. Grosarth, W8CUG—GUP promises a big total next time, then expects to take a vacation from radio. KWA goes in for 3.5-mc. DX too; he worked PAQASD during the tests. ADY didn't have any luck in Detroit so is back with the gang again. YA says there are no traffic men at State this year! (How about converting some?) CUG had a lot of fun during the SS. KNB visited the S.C.M. and promises better traffic totals. KBM with the help of 3AKB has been organizing a round robin club of hams interested in cryptography. KOB blew up his high voltage power supply during the SS contest. UK says there isn't much new going on. LOQ spent an evening with the S.C.M. and says traffic is going well. LWK, Lanky, promises to report regularly now. OFO does most of his traffic work during A.A.R.S. drills. AXD pounded a lot of brass during the SS. GSH says traffic will be better next time. FIP worked 412 stations and 62 sections in the SS with low power for a score of 75609! (Anybody too that?) DGL likes 7 and 14 mc. CMP is busy finding what Reinartz overlooked in his 802 rig! KQK maintains his 14-mc. frequency to within plus or minus 25 cycles. CQA hasn't much time for radio any more. GLA says someone is bootlegging his call on 1.75-mc. 'phone and asks the O.P.S. gang to help apprehend the culprit. (Give him the works when you find him, boys.) GUY has a new rig from the crystal up. CHT says it's great to get away from the QRm on 3.9-mc. 'phone. IOZ sends his first report; he has been getting out nicely on 1.75-mc. 'phone. Several fellows have asked for a short W. Pa. Section QSO contest during the past few months, and I believe it would be a good idea to have one. However, there is always a certain amount of work to be done such as getting prizes, writing up the rules and giving the thing publicity. The number of logs turned in from contests held in the past would not seem to justify going to the bother. So I am asking that you put a note on your next report card stating whether or not you are in favor of and will take part in a short contest some week-end, possibly in March or April. Your suggestions as to rules and scoring will be appreciated and will help us to give you the kind of a contest you want. Get your card ready now and mail it on the sixteenth of January. The Amateur Transmitters Association of Western Pennsylvania are planning a banquet to be held in Pittsburgh, Pa., February 29, 1936. All amateurs are cordially invited to attend. For details write to R. M. Francis, 8AVY, 3577 Elmhurst St., Pittsburgh, Pa.

Traffic: W8GUF 323 KWA 225 ADY 218 YA 160 (WLMA 573) CUG 102 KNB 86 KBM 79 KOB 45 UK 42 LOQ 56 LWK 26 OFO 23 AXD 19 GSH 14 FIP 11 DGL 9 CMP-KQK 7 CQA 4 FPE 55.



## HUDSON DIVISION

**EASTERN NEW YORK—SCM**, Robert E. Haight, W2LU—EGF was Traffic King of E.N.Y. for 1935. Congrats to Jim. LU enjoys QSO with 2VP. GTW reports Tri-States Radio Club in new club house, Montague, N. J., with FB skywire. FQG's rig went haywire and he tries all circuits in book. FWC enjoyed Holidays at home in N.Y.C. BJA extends Seasons Greetings to the boys, and how! BLL spent Holidays home in N.Y.C. CC's QRA: 59 Carthage Road, Scarsdale. CQA applies for O.R.S. appointment. ATM reports JFA new ham in Mt. Vernon. KW has 04A and 851's for sale or swap. HCM wrote 33 O.R.S., 4 R.M.'s for schedule. Results: 16 replies, only 2 schedules made. HYC is teaching radio to Boy Scouts. HUM is building up RK-20 rig and reports for Kingston boys. HUM reports BDB joins A.A.R.S. DPN has new matched impedance ant. IUR is on 7 mc. with RK-20. GFD is on 14- and 7-mc. c.w. HUB will soon be on 28 mc. IVS is building new rig for 28 mc. HBP is working on new rig and is getting out on O.B.S. CJP, using 350 volts at 50 mc. worked 16 states in 3 weeks; DX: Santa Cruz, Cal. IYH, ex-8EOA, joins E.N.Y. O.R.S. Congrats. FXC is in hospital. LU, S.C.M., extends to E.N.Y. his best wishes for a prosperous and Happy New Year, and may the traffic totals pile high.

Traffic: W2EGF 806 LU 521 GTW 198 FQG 57 FWC 58 BJA 54 BLL 23 CC 18 CQA-ATM 14 KW 11 HCM 10 HYC 7 HUM 3.

**NEW YORK CITY AND LONG ISLAND—SCM**, E. L. Baunach, W2AZV—FF got R9 report on 'phone from 6RH on 28 mc. BGO hears J's and ZL's on 3.5 mc. Europeans can be heard in the early mornings on 3.5 mc. CYX reports FNY worked 6CQE with a '47 oscillator on 3.5 mc. with five watts. AHC continues schedule with HC1FG. HNJ was heard in England on 3.5 mc. with 15 watts input. IAN is on 58- and 1.75-mc. 'phone. IUE has larger rig on 7 mc. HZJ is out to make the B.M.L.—IGP is building new shack. BNJ had new RME-69 receiver. GDF cured B.C.L. trouble by cutting off the antenna and putting up dark colored cord. HBO reports the Tri-Boro Radio Club had its first birthday in Nov.; BMW, pres.; CVO, vice-pres.; HBO, secy-treas. HGO sends in first report. CCD is selling 851's. AYJ has trouble with new receiver. BTF is on the Montreal circuit working for R.C.A. EAF finally got up his 45-foot pole after breaking a few ribs. EYS is QRL Xmas rush in Post Office. DBQ is building 3.5-mc. 'phone rig. DOG finds work too heavy to handle schedules. GZS built new exciter using 53 crystal and doubler. HRT is using a pair of '46's in the final. HMI and HWS had an FB time in the SS. ING is organizing a traffic net with 8JZ. BLK made New Year's resolutions. IOP worked Africa on 7 mc. with 50 watts input. GEI wishes the foreigners would send the QSL's they promise and reports the following: GNO tried to enter SS on 56 mc. IFM layed off DX long enough to enter SS. IFY is keeping his promise with a large traffic total. IIT enjoys long DX rag chews. ATB is in the Watch business. GMI has the rebuilding fever. HXT can't get started at new QRA. HNH finds 7 mc. better than 56 mc. AZV has 50-watt 'phone job. Regular operating frequencies: DXO 3580, 7040, HKO 3580, 7160, KI 3665 kcs. GAC would like to know what became of Clinton High School's old gang: EIO, ERC, ERI, DCF, DCJ and the rest. FZQ is putting new crystal-controlled rig on 3.5, 7 and 14 mc. HVC is moving to a new QRA and putting up new 56-mc. rig. GNL is only ham in 2nd District who is using grid modulation on 56 mc. successfully. GYQ has put in crystal control on 7 mc. FYQ is now on Naval Reserve duty.

Traffic: W2HJZ 208 KI 164 EYS 143 GEI 209 IFM 146 IIT 136 GBO 116 DXO 62 EAF 60 AHC 37 PF 36 CYX 35 HKO 29 GDF 28 AZV 27 OCD 14 HNJ 36 BYL 29 FF 13 HGO 9 AYJ-BMM 7 GZS-BNJ-BKP-FIP 6 FLD 8 ING-HXT 5 HWS-BTF 4 DOG-IOP-ADW 3 HMJ 2 AA 4.

**NORTHERN NEW JERSEY—SCM**, Charles J. Hammersen, W2FOP—BCX says the new N.N.J. net makes deliveries more quickly. GGE doesn't have much time for rag chewing due to his activities in the traffic net and his schedules. HBS was elected secretary of N.N.J. Traffic Club. HNP is new O.P.S. GGW worked several British stations on 3.5 mc. this month. ICM keeps daily schedules with IHKY and ICCH. GVZ handled traffic direct with several ZU and ZS stations. HTX worked Belgian Congo on 14 mc. with 25 watts input. HZY worked GZQZ on 3.5-mc. tests. HBQ is contemplating working on 3.9-mc. 'phone. FOP is now proud possessor of five 3.5-mc. crystals. CIZ is still waiting for his job to turn up. ICJ (Joseph P. Adrosko) answered CQ of ETS (Joseph P. Andrasko) and had an FB

QSO. DPA is using 200-watt 'phone on 14 mc. HZY and HRQ are new O.R.S. GSA is still YL crazy. IYS now belches forth with 500 watts on 3.9 mc. JCT is new ham in Bloomfield. IEK is rebuilding new rack and panel. HTX and HNP are joining N.C.R. HAE is building rig with pair of 103's P.P. final. GKO is waiting for new Skyriker. GHO has 300 watts in pair of 242A's on 3.5 mc. BVA is in hospital for operation. DMN is engineer at WINS. DCP is now working on 56 mc. DLF installed '03A final in 14-mc. 'phone rig. FLP is working BTI from Phillips Exeter Academy, N. H., and wants to work some of the boys on 7 mc. GCC is QRL rifle team and fencing team at Columbia. IEQ has had at least one QSO a day since he got his ticket a year ago. ICL is rebuilding GQX wants O.R.S. and O.B.S. HRN has solid QSO with EA7AO for over half an hour. HAE is on 1.75- and 3.9-mc. 'phone. HFO dropped his only '03A! AIF is building new rig with RK-23 Tri-tet, '03A buffer and 860 final. BTZ is back on the air after two years of rebuilding. BPY, CAY and CQX are having gratifying results on 28 mc. GMN is using a pair of '52's on 3.5 and 7 mc. ABS wants O.R.S. again. IYU got job at Western Electric. ILQ is rebuilding with a W.E. 211D in the final on 1.75-mc. 'phone. IME is getting numerous high voltage shocks daily. Your S.C.M. would appreciate it if you would mail your reports to him so they reach him not later than the 19th of each month, as a summary of the reports must be mailed to Hartford on the 20th of the month. Reports are most welcome from all active hams whether League members or not. If you are active send one along, you don't have to handle traffic to report, send in a line anyway.

Traffic: W3BCX 1231 (WLNPF 647) GGE 407 HBS 210 HNP 150 GGW 249 ICM 111 GVZ 89 HTX 84 HZY 73 HBQ 61 FOP 35 CJX 18 HGX 16 CIZ 15 ICJ 7 BXM-DPA 4.

## NEW ENGLAND DIVISION

**CONNECTICUT—SCM**, Frederick Ellis, Jr., W1CTI—MK B.P.L.'s on deliveries. APZ gets his total with A.A.R.S. traffic and wins C.B.A. traffic banner. FIO is back on the air with regular schedules with MK and 9KG—HYF says no luck in R.S.G.B. tests. GVV is still rebuilding. Amateurs at Wesleyan include 11LF, GYJ/3BYC, 2EWN and GTW. JHK has new Mac-Key. IKE is lined up for O.R.S. appointment. BHM has ordered Harvey 200-R transmitter. EH schedules 9UZ Monday, Wednesday and Friday. The sympathy of the entire Section goes to Gil, ICJD in the loss of his wife, and to IDOW in the death of his mother. DLX says west coast and Europe coming through well lately. JBQ reports receiver trouble. EWD was heard in England on 28 mc. HTS finally set up at new QRA. BFS renewed his A.R.R.L. membership and got the radio bug again. TD is working for D'Elin Elec. Co. IOV plans to increase power. UE worked PAQASD during R.S.G.B. tests. IWT is on the air with pair of '46's and a new antenna. IOS reports a new ham in town, JLE, starting on 14 mc. CJD and IOV won filter condensers awarded as prizes in the low-power contest held for C.B.A. members. EER is active on 56 mc., working stations in New York City. All stations please report no later than the 19th of each month.

Traffic: W1MK 356 APZ 160 DOW 157 CJD 97 FIO 88 AMG 83 HYF 78 UE 58 GVV 49 BDI 48 GTW 32 JHK 31 INP 23 IKE 14 BEM 12 EH 9 DLX 8 JBQ 7 BNB-GKM 4 EWD-CTI 2 HTS-BFS 1.

**MAINE—SCM**, John W. Singleton, W1CDX—OR is the traffic king this month with B.P.L. total. GOJ has been keeping daily emergency schedule with DNA on Half Way Rock lighthouse. INW says plenty of traffic down his way. ALO had hard luck and blew some good apparatus. DHH worked D4CSA on 3.5 mc.—CDX worked G2DQ, G2ZQ, G6PF, PAQASD and HB9AQ on 3.5 mc. during tests. CRP is busy with Trunk Line schedules. HSE is headed for an O.R.S. appointment. DFQ has new O.P.S. appointment. APR is going to Bliss Business College. BHI has new crystal rig. EZR visited the Boston gang. JOA is a new ham in Augusta. HSS is reliable traffic station. There are rumors afloat that a real "honest-to-gosh" hamfest will be put over in Rockland in the spring. If your report does not appear this month, it is because it was received too late at the S.C.M.'s office. Motto: Mail your report on time. The S.C.M. wishes the gang a very happy New Year.

Traffic: W1OR 770 GOJ 138 INW 131 ALO 99 DHH 48 CDX 44 CRP 42 HSE 26 DFQ 6 HSS 108.

**EASTERN MASSACHUSETTS—SCM**, Albert N. Giddis, W1ABG—EVJ worked lots of DX in Transoceanic Tests. FRO reports by radio. ABG visited a few clubs. DDE is new A.A.R.S. Liaison R.M. IGN got a pair of '10's from

QW, BEF has new c.c. 'phone-c.w. rig and HRO. RE is starting to get results on 56-mc. traffic line. KH was WVV's 1st and 10,000th QSO. IWC is well on the way to O.R.S. appointment. QW is new N.C.R. Liaison R.M. HCH is testing out receivers for local hams? LJ says shack is getting cold! HWZ has resumed activities. CIK has largest N.C.R. unit in Section. BR has 1-kw. 'phone-c.w. rig. HRE is in M.N.G. GEX has new speech equipment. BMW worked west coast for first time in SS. BZO has gone to sea. WV was visited by HPIA and worked his 48th state and 74th country. GDY worked VU7FY on Friday 13th for W.B.E.I. IUQ added a pair of '46's to his 59 crystal. BB has new all-band rig and HRO. CRO says reception on 28 mc. better than 14 mc. JCS is new Maynard ham. IZL hopes to be at Harvard next year. BR, GEX and GMD apply for O.P.S. DCW, ZQ and EAQ apply for O.R.S. Well, fellows (and gals!), for once your S.C.M. finds himself without words! In spite of the Sweepstakes, the O.R.S. increased their message-per-station average by twenty-five percent over last month and EIGHTY percent over last year's average! And . . . well, why spoil it? . . . just take a look at the report yourself! Club news: Maynard Radio Club is planning on seeing outfit at Harvard soon. Hams in Amesbury, Hampton, Ipswich and Newburyport are forming new radio club. Good luck, fellows.

Traffic: W1EVJ 244 FRO 204 ABG 183 DDE 149 IGN 79 BEF 73 RE 66 KH 61 IWC 52 QW 49 HCH 46 JL-EAQ 12 HWZ 10 BUU 9 CIK 7 AKE 6 BR-HRE 5 GEX-GGB 3 BMW 1. The following A.A.R.S. reported traffic: W1ZQ 1150 (WLGO 202) DCW 997 (WLGJ 344) HWE 518 DDE 148 HKY 99 PI 1085 FZE 587 CKV 531 IKR 428 AGX 418 GBW 400 IHI 383 AKS 296 AIX 183 JFS 145 AAR 136 IUP 132 TY 128 IWR 106 JHA 103 IPA 65 HNR 60 IPS 49 IAO 44 CCL 43 ECK/IVC 39 AGR 34 AAU 31 JBY 21 HJS 18 ILD 15 EAU/JIT 14 JBT 12.

WESTERN MASSACHUSETTS—SCM, Percy C. Noble, W1BVR—Operators at YK are: 2GNI, chief op., TX, BIE, and OCD. A.A.R.S. traffic is keeping DLH plenty busy. AJD says the electric bill took a wee jump this month. Hi. JJR reports that the Hoosac Valley Radio Club had the local school dept. run a code class as one of their evening educational studies—class had 33 members. IOT is rebuilding for 28 and 14 mc. JAH hooks onto trans-Canada Trunk Line and also Trunk "C." GUO reports his highest monthly score to date. JGY has joined the A.A.R.S. EBH is operating at YD this year. BNL has new 3-tube super. R.M. CCH is now plenty active on West. Mass. O.R.S. channel of 3732.5 kc. BAP is rebuilding home 56-mc. set. The Holyoke Amateur Radio Club, JJO, is now affiliated with the League. New stations in Worcester: JNA, JOP and JMP. And thus endeth the news gleaned from the cards this month. Come on, gang, and give us some dope. No need to be so bashful about what you are doing. By the time this is published, the 3732.5-kc. O.R.S. channel should be in full swing, the schedules starting at 7:00 p.m. every evening.

Traffic: W1YK 409 DLH 364 AJD 287 IJR 277 BVG 238 (WLGE 81) DIE 217 BVR 222 (WLG 346) IOT 123 JAH 105 HNP 79 GUO 65 JGY 51 ASU 42 BKQ 34 DCH 18 DDK 16 APP 15 DUZ 14 APL 9 ICP 8 DIP-IYY 7 ATK 6 COI-JBU 5 ARH 4 BPN-DJQ-ZB 3 BNL-CCH-ISN-JNA 2.

NEW HAMPSHIRE—SCM, Robert V. Byron, W1AVJ —IP and FFL are sure putting the traffic through! Just take a look at their totals. Both made the B.P.L. this month; congratulations to them. CCM is on regularly and has schedule with IMB. CCM is now postmaster at Grafton Center. IDY has new Super Skyriders and a 28-mc. transmitter. BFT is on 28 mc. looking for DX. ANS says it is the same old story. The Great Bay Radio Club at two recent meetings had fine talks by Dr. G. W. Pickard on ultra-high freq. antennas and by BZN of Hygrade Sylvania Tube Co. on tubes. We understand that AEF never misses an ace, and cashes in plenty. AEF has new 1.75-mc. 'phone. HSC gets out very fine with his 1.75-mc. 'phone. Between A.A.R.S. and traffic, when does FFL sleep? HJI worked Europe in 3.5-mc. tests; he will be on 'phone soon. BFT and APK worked Europe in the 3.5-mc. tests. TA has new antenna and more power. GTY is moving to Plaistow. GMM is looking for traffic. EFE sends in first report, and it is a work of art. IJB has pair of 211D's in final now. HTO is busy in A.A.R.S. and now has WLGM call. FFL reports that the 6 p.m. schedule calling CQ NH is proving very successful and more and more hams are making use of it. GHT is busy in A.A.R.S. ADR has Class A license. EAL is on 14 and 3.5 mc. FFZ is busy with A.A.R.S. routine. ELF is going on 14 mc. soon. AVG is rebuilding and will have rig on both 14- and 3.9-mc.

'phone. HOU would welcome ideas on key click filter (at least the local hams would be pleased if he did). HOV plays in an orchestra and does not have time for ham radio.

Traffic: W1FFL 1309 (WLG 188) IP 1030 HTO 393 (WLG 217) IJB 217 GHT 146 BFT 94 EA 68 FFZ 40 EFE 25 GMM 13 GTY 12 AVJ 10 HJI 6.

RHODE ISLAND—SCM, Clayton C. Gordon, W1HRC —IMY has been appointed A.A.R.S. alternate State Control with call WLGR. The Cairo Survey Committee of the P.R.A. wound up its thirteen-week survey on Nov. 26th, and the general comment is that "those buttons were the hardest won emblems they ever got." The A.A.R.S. hereabouts has rolled up a heavy traffic score this month, and much of the traffic was not "rubber-stamp," since we know that GTN invited every member of the First Corps Area to attend the P.R.A. Hamfest in January, by means of A.A.R.S. channels. FAH is the maker of a 5-foot tall wooden axa which was presented to IIP recently. CAB has new Super-Skyrider and reports Europeans coming thru on 3.5 mc. IZO has ¼-kw. input with new 211 rig. IAV says lack of time forced him out of A.A.R.S., but he had a swell time in the SS contest and reports correction that it is 9SCY that is the W9 at school in Newport with him. DDD and HXH started Dec. 19th for 14 days' active duty on S.S. Hamilton (U.S.N. Res.). BLS has an RK-20 on 14 mc. BVI, DIL and DWO are all on 3.5-mc. o.w. in Newport while HPE represents the 7-mc. gang there, having deserted 1.75-mc. 'phone. IRF has trouble with his antenna. JTK has built a new superhet. JNO is the newest ham in Newport. JFF is complaining about getting T6 reports with a self-excited rig—our advice is that if you don't want crystal, get hold of FAH and get bitten by the e.c. bug. ILO is on 14 mc. again. Ole "Doctor Quack" (DQ) reports hearing D4ARR and working G2ZQ for 5 minutes during the Transatlantic tests. ISR reports new QRA is 110 Summer St., Central Falls. BJA says: "With the assistance of HRC, the inspiration of a half pint of 'The Best,' BJA is back on the air again with a '47 crystal and '10 buffer, and the note is 'liquid, like a 'swallow, and if there is a Santa Claus an 830 final will follow." IQP is working plenty of Europeans on 14 mc. JAR is being heard at Empire State Bldg., New York City, on 56 mc. using a pair of 801's. HRC thanks everybody for Christmas Greetings and extends wishes for A Very Happy New Year. Those of you who got your reports in too late to include in this issue are warned that we are taking Headquarters seriously on its "deadline" warning and hope that you take our warning the same way. Our new push-pull 6A6 crystal oscillator is absolutely the best we've tried yet.

Traffic: W1IEG 944 (WLGK 472) IMY 502 CPV 351 GTN 216 CAB 41 IZO 27 IAV 13 HRC 2 DDD 1.

VERMONT—SCM, Forrest D. Drew, W1BJP—The Vermont gang seems to be waking up with a good increase in traffic handling during the past month. BJP had visits from BNS, IT, CBW, BLC, AVP and IQG. BNS is getting schedules lined up. CBW has new crystal rig. EFC is active on c.w. and will be O.R.S. soon, we hope; he sure snagged 'em in the SS Contest. GAE had Christmas schedules on 3540 kc. IQG will be new O.R.S. soon and is doing nice work on 3.5 mc. AVP is still working on the new rig, getting it perfect with the oscilloscope; he heard a couple DXers across the big pond. ATF leads the traffic score this month. Come on, gang, we must try and catch up with him. GNF is busy with Electric Light work, but takes time off to copy the Vermont broadcast from BJP on Wednesday nights. AXN-WLGN is fixing the rig for break-in and has a nice new Mac-Key. Practice up the code, boys, for you'll need it. Carleton Stebbins of Athens, Vt., JOI, will be on the air soon after Xmas for the first time; give him a buzz, gang, when you hear him.

Traffic: W1BJP 34 CBW 3 EFC-GAE 1 IQG 5 ATF 107 AXN 58 (WLG 30).

#### ROANOKE DIVISION

NORTH CAROLINA—SCM, H. S. Carter, W4OG—The S.C.M. hopes that the entire gang had a big Christmas and a Happy New Year, and I wish for you all a New Year filled with much success and good radioing. High Point: I want to thank the High Point gang for the nice way they entertained the Floating Club in December. We all had a good time. DTA is handling quite a few schedules on 7 mc. DVX is a new ham. ADK is handling some traffic and plans to join A.A.R.S. Wilmington: BRK kept you fellows on the map this month by reporting some nice traffic. Warren Plains: BHR is still QRL work, but managed to get on long enough to handle some traffic. Raleigh: DW led the State in traffic this month again. ANU worked YV5AM on 3.9-mc. 'phone for 45 minutes. Maiden: DAM is now work-

ing in Lincolnton with portable 3FUL. DSL is now on the air. Newton: BXE is trying 56 mc. Siler City: QI has been appointed O.B.S. DKN is QRL school work. BYE is now on 3.5-mc. band. DOR will have his rig on shortly. DKF has a new mike. Durham: CUB is handling plenty of traffic on 3.5 mc.; he also has a new 'phone rig. DQM is on 3.5 and 7 mc. with a '10 putting 40 watts into it. Greensboro: ZH reports 6 new countries; his total is now 93; he worked VU7FY 6 times in one week on schedules. Charlotte: BLN is always looking for traffic on 3.5 mc. DCS is in the A.A.R.S. CXK has a nice traffic total this month. Brevard: CUI reports the town has 2300 population and 8 hams. BVU is QRL work. CPF has the RK-25 on 28 mc.; he won it at the Charlotte Convention. CPK is on 14 mc. with a pair of '10's. GUI is on 7 mc. CYF is QRL carrying mail, but is on 56 mc. as often as possible. DGI wants some of ALD's Flit as his rig is full of bugs. CWL is experimenting with television and gets good pictures from 9XG. Albemarle: DPB is on 3.5 mc. with 802 oscillator and gets out FB; he also has a baby girl at his house. Congratulations. Winston-Salem: DWB and DVU are new hams this month. DVU has been a member of the club ever since it was organized. BWC has a nice RK-20 that was left at his house by Santa Claus. CYA is working plenty of DX on 7 mc. CXF was in from college for Christmas and kept 4NC plenty warm. DCQ is rebuilding with a kw. input, 3FIB, of Danville, Va., is working portable here, and reports some traffic. 4AI is pushing 120 watts into his final and gets ½ watt thru QRM. ABT is doing fine with the A.A.R.S., and has a new 802 oscillator going. 4NC worked a few in the 3.5-mc. DX Contest. With the 'Phones: DIS has a new Class-B r.f. amplifier in operation now. DSY is having B.C.L. trouble. DST has about got his 1.75-mc. rig going OK now. ALD is changing over to push-pull final in the hopes of eliminating B.C.L. trouble. BXF was QRL Christmas printing. BMR is getting out FB on 1.75 mc. AEN says DX is good on 14 mc. CTR is on the air when he isn't QRL service work. CEI is on 3.9 mc. CDQ is on 3.5-mc. c.w. but will be back on 'phone soon. BNG has a new ACR-136. CXO works plenty of DX with a pair of '46's on 3.9 mc. WL is building 1-kw. rig for 1.75 mc. CEL is QRL YL's. CLB won the CQ Contest at the High Point meeting; he wants the 3.9-mc. net to start at 8 a.m. so the fellows that wish to can go to church. A very good idea. What does the gang think about it? BV lost his mother. Our sympathy to you, OM. DKI is still burning up 1.75 mc. DTB and DPV are both doing good work with their low-power rigs. BFV is back on the air with a better note than ever after his marriage. (Some of the rest of gang should try that.) BYA has a new rig on the air, and hopes he has a better note now; he is hearing plenty of DX on 28 mc.

Traffic: WADW 63 CXK 58 CUB 44 ABT 32 BRK 22 CZD 21 BLN 20 ANU-ADK 19 BDU 17 NC 12 DTA 11 DCS 7 BHR 3 DWB 2 ZH 1. 3FIB (Portable) 2 3FUL (Portable) 2.

WEST VIRGINIA—SCM, Dr. Wm. H. Rihedaffer, W8KKG—CFB is new W. Va. Net member. HWT has new 150T final. ELO is working W6's on 7 mc. ANU schedules Columbus, O., daily. ATT schedules K5AI weekly and is on 28 mc. four days each week. LSJ worked EA4AV. MCL had swell time in SS. CMJ wants the government to put out new call book. JKN is experimenting with condenser mikes. KBU is doing nice work on W. Va. Net. KKG is listening on 28 mc. (and hearing things). PAJ is new call of MIP's son! BDD won all the prizes at Cambridge, O., Hamfest. JWL is trying a neon tube oscilloscope and a quarter wave vertical radiator for 3.5 mc. MOP has the 28-mc. bug (who hasn't?). QO is back on the air after a long layoff. OXO is new reporting station. NMD operated portable at Boy Scout Merit Badge Show. KSJ has his new power supply going. LSK has new 'phone on 1819 kc. FQB always reports and this time sent two cards. The Bluefield Radio Club had 7 members on for SS contest. CYV was with U.S.N.R. at Norfolk this summer, and won a trip to Halifax on the Oregon. AFX, a real old-timer, got his call back. LCD is back on after six months layoff. ILK is building a new 53-'03A job. AFB, MOL, 9AEN, AHF, BDD and their XYL's attended hamfest at Cambridge. MZD shot 3500 volts on an UNLOADED 50T (oh me). Code classes are being held in two West Virginia cities for XYL's, wives of BOK, MZD, JRL, KKG in Clarksburg, and those of BDD, MZT, AFB, MOL, and EDV in Huntington. These young ladies ALWAYS attend hamfests. LGB makes a heavy mark on paper with a lead pencil, holds it to his tank coil, and Lo! a handy cigarette lighter. (Watch your fingernails.)

Traffic: W8ATT 304 KKG 88 HWT 51 MCR 34 CFB 27

MCL 25 GOQ 13 KBU-LII 11 CMJ-ANU-AKQ 5 CZ-LSJ 4 FLO 3 HD 3 (WLHF 125) TI 2 LXF-MOL 1. W8OK (WLHB 56).

## SOUTHEASTERN DIVISION

ALABAMA—Acting SCM, J. Wesley Davis, W4DS—R.M.'s: 4APU, 4BOU and 4CRF. Let's start the New Year off right, gang. How about a report from every station next month? Thanks. Montgomery: ANT has new QRA now so activity begins. DGY is on 1.75-mc. 'phone. AP is still regular on 3.9- and 14-mc. 'phone. AEZ paid Selma hams a visit; he is on 3.9-mc. 'phone. DPX is new 1.75-mc. 'phone. B'ham: DGS' BCL's cut down his antenna while in operation! He worked SS on 1.75-mc. 'phone and worked 1ACV on 56 mc. as he was passing thru B'ham. AAQ is back again. DGO had good time in SS. Tuscaloosa: CJG, DNH and BOU all had fine time in SS. DQG is fighting bugs in his crystal rig. The U. of Ala. is planning a radio club. Selma: RS is keeping the c.w. and 'phone A.A.R.S. nets in fine shape. VZ is on 1.75 mc. and will have new shack ready soon. DS keeps awful busy these days. Hi. Mobile: DJV wants good traffic schedules and O.R.S. DHG sends code lessons on 1916 kc. COU will be on soon with 1.75- or 3.9-mc. 'phone. CBI is QRL WPWG police station. CIQ, club station, will be on 1.75-mc. 'phone soon. FB has new 1.75-mc. 'phone. CNI is getting out FB on 1.75-mc. 'phone. OA as usual can be heard in the wee hours of the morning on 3.9-mc. 'phone. CPE has a pair of '45's putting out. CRF seems to be the traffic station. Other points: DMZ plans pair of tens on 7, 3.5 and 1.75 mc. RW is active at Maxwell Field. CPN is perking in Ensley. LT is coming back to life on 3.9-mc. 'phone. Our organization is Democratic. Its officers should be elected by the majority of its members. Therefore, don't fail to vote in the S.C.M. election.

Traffic: W4APU 93 DS 47 RS 40 BOU 37 DGS 28 RW 17 BRX 10 DHG 8 CJG 6 DJV 5 DGO 1 DMZ 1.

EASTERN FLORIDA—SCM, Philip A. McMasters, W4BCZ—AGR is handling a lot of traffic on 14-mc. 'phone. DVB, new ham in St. Pete, would like morning schedule; he has 59-'10 transmitter. COB says 28 mc. is FB for DX. BYS leads the gang in traffic and works in a chain store. GQ moved to La Belle and is getting out nicely on 3.9 mc. with grid modulation. DSK at Dunedin is ex-8DGT, the sheik of Dunedin or Ivan the terrible. Hi. BNI can't operate and run the theatre at the same time, as the old Miraco can't do double duty as both an amplifier and a ham receiver. Hi. NN is busy getting the kinks out of his 'phone. FT9 is the call used by the Gen. Hdqs. portable of Air Force of Army to work 3.9-mc. 'phones in this state. DMR is building one of those 1QP special 802 oscillator rigs. The S.C.M. wants to take this opportunity to thank all operators for their service to the amateur fraternity and the state of Florida in our storm work this year. TQ and AOK are two stations who have not previously been given credit for their work. CQZ ordered a 3905-kc. crystal to join the K. of Kes. DUI, new ham in Sarasota, plans to increase power to 150 watts. Notice: The F.C.C. would not grant Tampa as an examining point for Class A due to lack of men and money. We tried, gang, but we couldn't get it.

Traffic: W4AGR 23 BCZ 1 BYS 104 AOK 8 COB 16 AWO 96 CQD 43 DBV 2 GQ 1.

WESTERN FLORIDA—SCM, Edward J. Collins, W4MS—R.M.'s: 4ACB and 4AUW. Newest call in section is DWV in Pensy. Welcome, OM. DVE has a swell looking rig and will be heard on 7 mc. 3FAD/4 has his rig all crackle finished and it looks swell. 3FCD/4 has his new rig about set also. 4DAO has crystal on 7 and 3.5 mc. and is really stepping out. QK hopes to have that '03A final in action after the New Year. VR gets out swell and has an FB harmonic on 28 mc. from his 7-mc. rig! DIC has 300 watts input to his '03A on 1.75-mc. 'phone and it is running cool. ASV promises activity now that he is a telegraph operator. QU is rebuilding N4HQ and has been giving Class "C" exams. DTY is gradually getting things going. COG has just finished a football season and should be on again soon. UW is working on the local police radio station. CMJ has a swell portable rig now. Hear DEZ on 7 mc. with a swell crystal sig. BSJ is till trying to get set at the new QRA. CBD is very active on 4 mc. 'phone and 7-mc. c.w. Ek-4NC is operator at BC station in Tally. ACB has been busy with 4SC, the F.N.G. station. CUR is on 7 mc. in the early A.M.'s. CDE is keeping the foreign QSL Bureaus busy and is thinking about going down to 28 mc. AUW is working to put 1 k.w. into an '04A.

## A.R.R.L. QSL Bureau

FOR the convenience of its members, the League maintains a QSL-card forwarding system which operates through volunteer "District QSL Managers" in each of the nine U. S. and five Canadian districts. In order to secure such foreign cards as may be received for you, send your district manager a standard No. 8 stamped envelope. If you have reason to expect a considerable number of cards, put on an extra stamp so that it has a total of six-cents postage. Your own name and address go in the customary place on the face, and *your station call should be printed prominently in the upper left-hand corner.*

- W1—J. T. Steiger, W1BGY, 35 Call Street, Williamansett, Mass.  
 W2—H. W. Yahnel, W2SN, Lake Ave., Helmetta, N. J.  
 W3—R. E. Macomber, W3CZE, 418 10th St., N. W., Washington, D. C.  
 W4—B. W. Benning, W4CBY, 520 Whiteford Ave., Atlanta, Ga.  
 W5—E. H. Treadaway, W5DKR, 2749 Myrtle St., New Orleans, La.  
 W6—D. Casson Mast, W6KHV, 423 East E Street, Ontario, Calif.  
 W7—L. Q. Kelly, W7BPC, 4919 So. Prospect St., Tacoma, Wash.  
 W8—F. W. Allen, W8GER, 324 Richmond Ave., Dayton, Ohio  
 W9—George Dammann, W9JO, 319 Sherman Ave., Evanston, Ill.  
 VE1—J. E. Roue, VE1FB, 84 Spring Garden Rd., Halifax, N. S.  
 VE2—W. H. Oke, VE2AH, 5184 Mountain Sights Ave., N. D. G., Montreal, P. Q.  
 VE3—Bert Knowles, VE3QB, Lanark, Ont.  
 VE4—Dr. J. J. Dobry, VE4DR, Killam, Alberta.  
 VE5—E. H. Cooper, VE5EC, 2024 Carnarvon St., Victoria, B. C.  
 K4—F. McCown, K4RJ, Family Court 7, San-turce, Puerto Rico.  
 K7—Frank P. Barnes, K7DVF, Box 297, Wrangell, Alaska.



**TRANSFORMERS  
and CHOKES**

Send for complete Reference Guide of Better Transformers and Chokes for all Receiver and Transmitter Purposes.

**UTAH RADIO PRODUCTS CO.**  
Orleans St., Chicago



**CODE TEACHER**

It's easy to learn the code with the Instructograph. Book of Instructions shows you how to study to best advantage. You can rent Instructograph on very attractive terms and rental may be applied on purchase price. A postcard will bring you full details.

**INSTRUCTOGRAPH COMPANY, Dept. Q-2**  
912 Lakeside Place Chicago, Ill.  
Representatives for Canada Toronto  
Radio College of Canada, Ltd., 863 Bay St.

## HOW IS YOUR SUPPLY OF IDEAS?

If they ever run low, make sure that you have a copy of HINTS & KINKS handy. It is chock full of money-saving ideas and stunts of interest to you. There are many times when you will find it invaluable. The price is 50c postpaid.

### AMERICAN RADIO RELAY LEAGUE

West Hartford Connecticut

## Silent Keys

It is with deep regret that we record the passing of these amateurs:

- J. W. F. Gillman, VE1AO, Fredericton, N. B.  
 W. A. Haun, W3AGW, Bluefield, Va.  
 Robert Parker Lewis, K6OA, Honolulu, T. H.  
 Frederick C. Mauch, W2IGC, Newark, N. J.  
 George R. Pattison, W8CLR, McDonnell, Pa.  
 Frank Trower, W6MRS, Oakland, Calif.  
 LeRoy Urry, W6MDC, Salt Lake City, Utah  
 J. H. Yates, W7DOQ, Luther, Mont.

# HAM-ADS

(1) Advertising shall pertain to radio and shall be of nature of interest to radio amateurs or experimenters in their pursuit of the art.

(2) No display of any character will be accepted, nor can any special typographical arrangement, such as all or part capital letters be used which would tend to make one advertisement stand out from the others.

(3) The Ham-Ad rate is 15c per word, except as noted in paragraph (6) below.

(4) Remittance in full must accompany copy. No cash or contract discount or agency commission will be allowed.

(5) Closing date for Ham-Ads is the 25th of the second month preceding publication date.

(6) A special rate of 7c per word will apply to advertising which, in our judgment, is obviously non-commercial in nature and is placed and signed by a member of the American Radio Relay League. Thus, advertising of bona fide surplus equipment owned, used and for sale by an individual or apparatus offered for exchange or advertising inquiring for special equipment, if by a member of the American Radio Relay League takes the 7c rate. An attempt to deal in apparatus in quantity for profit, even if by an individual, is commercial and takes the 15c rate. Provisions of paragraphs (1), (2), (4) and (5) apply to all advertising in this column regardless of which rate may apply.

Having made no investigation of the advertisers in the classified columns, the publishers of *QST* are unable to vouch for their integrity or for the grade or character of the products advertised.

**QUARTZ**—direct importers from Brazil of best quality pure quartz suitable for making piezo-electric crystals. Diamond Drill Carbon Co., 719 World Bldg., New York City.

**RADIO** engineering, broadcasting, aviation and police radio, servicing, marine and Morse telegraphy taught thoroughly. All expenses low. Catalog free. Dodge's Institute, Byrd St., Valparaiso, Ind.

**ENGRAVING** instrument panels exclusively since 1925. A. L. Woody, 189 West Madison St., Chicago, Ill.

**NATIONAL**—Hammarlund, Patterson used sets, 60% off list. W3DQ, 405 Delaware Ave., Wilmington, Del.

**QLS'S**, W2SN, Helmetta, N. J.

1500 volt 300 mill Electric Specialty generator set recently overhauled rheostat 75 dollars 1KW GE transformer \$8. New WE 242A tubes \$12.50 FOB. Write for details. 235 Fourteenth, North Seattle, Wash. Apartment 206.

**QLS's**—two color, with your photograph, 90¢ hundred. Also made to order QSL's. Sample, stamp. W9DGS, Jamestown, N. Dak.

**SELL** W9CPM 500 watt phone transmitter complete with condenser microphone mounted in all steel cabinet; class-B modulation. A real DX phone transmitter.

**QLS's**. Free samples. Printer, Corwith, Iowa.

**CRYSTALS!** Order Biley from W8DED! Bargain (7000kc. band) \$3.95 (holder included!).

**HANDBOOK** (1936) by "Radio," 1000 diagrams, illustrations, \$1. from W8DED.

**QLS's!** "W8DED print" Unbeatable! Samples? (stamp) W8DED, Holland, Mich.

**SELL** Wings' transceiver, \$10. W2BZB.

**HIGHEST bidder**—All-Star, Sr. Complete, A-1. W3BBV, York, Pa.

**BARR** Transceiver, batteries, tubes, hand-set, \$18. FBXA preselector, tubes, power supply, coils 20, 40, 80, \$50. W8IKE.

**CLASS B** transformers—Universal for two or four 46s, 210s, 800s, RK18s, etc., \$7.75 pair postpaid. 70 watts audio from 46s, 100 watts from 10s. Write for details. W8UD, Douglas, Mich.

**RACKS**—38 units GR type, tapped, 100 pounds net, \$12.50 prepaid U. S. A. 3/4" crackle lacquered insulating panels, slotted, extremely rigid, all standard sizes prepaid. 52 1/2 square foot. Stamp for particulars. W1JBR, Storrs & Cooley, 11 Olds Place, Hartford, Conn.

**FOR sale**—Esco alternating current generator, 350 watts, 110 volts, excellent condition. Leon Harris, Olathe, Kansas.

**CRYSTAL** blanks, finest quality AT and V cuts 1/4 in. sq. AT—6 for \$3; V—6 for \$4. G. C. Hunt, Box 164, Carlisle, Pa.

**INTRODUCTORY** offer. One order to an individual. Send \$1 and call letters for 100 two color modern QSL cards (not filled with advertising—send for sample) and six F.M.C. porcelain case mic. low loss transmitting and receiving condensers. Any capacity up to 006 mfd. 6% capacity tolerance 2,000 volt test. Actually a \$7.50 value for \$1! Capacity color chart included. Filtermatic Mfg. Co., Tacony, Phila., Pa.

**CALLBOOKS**—new prefixes, thousands of late W, VE and new DX calls, in the winter 1935 Radio Amateur Call Book. Send postpaid \$1.25, or a whole year (four issues) for \$4. (In foreign countries \$1.35 and \$4.35.) W9FO—610 S. Dearborn, Chicago.

**NEON** oscilloscope tube with complete instructions, \$1.50 postpaid. Your call letters in neon, 3 1/2", high, \$1. each letter. R. F. glow tubes 50¢. Neon R. F. "sticks," \$1. Commercialite Laboratories, Box 47, Omaha, Nebraska.

**SELL** RME9-D complete. Tubes, speaker, A-1 shape. Cost \$132. W9PLW, 3636 Jackson, Gary, Ind.

**RECTIFIERS**: 866—\$1; 866 A—\$1.20; Guaranteed six months. Amateur Service, Fairview, New Jersey.

**QSL** cards, two color, cartoons, message blanks, stationery, snappy service. Write for free samples to-day. W1BEF, 16 Stockbridge Ave., Lowell, Mass.

**TELEPLEXES**, Vibroplexes, Omnigraphs, meters, receivers. Bought, sold, traded, Ryan Radio Co., Hannibal, Mo.

**BREITING** receivers in stock—W8ANT

**SARGENT** receivers—\$59.50—W8ANT

**NEW** Eimac 300T—\$60. W8ANT

**USED** receivers—W8ANT

**W.E. 212D'S**—cheap—W8ANT

**TRANSMITTING** tubes—all types—W8ANT

**AIR-WOUND** coils—W8ANT

**LARGE** stock new and used equipment for sale by southern Ohio's only amateur owned amateur business. Jos. N. Davies, W8ANT, Box 602—R.R. 9, North Bend Rd., Mt. Airy, Cincinnati, Ohio.

**SELL** complete 160 meter phone station having CB-25 and FB7-A. Robert Chaffee, 15 Flint Rd., Watertown, Mass.

**CRYSTALS**; zero out. Guaranteed to compensate at near zero without oven control. Your approximate frequency, 80 or 160 meters \$1.85. Ordinary zero cuts \$1.35 postpaid. Blanks 65¢, plug-in holders 75¢; dozen \$6. Fisher Laboratory, 4522 Norwood Street, San Diego, California.

**MERGED!** "Radio" and "R/9"! The new, merged "Radio" retains entire technical and editorial staffs of both predecessors, including Jones, Hawkins, Kruse, Smith, Gordon, Ferrine. Over 100 pages, enameled paper. Much more practical constructional dope; scopes; enlarged departments; augmented DX section. More than ever "The Worldwide Technical Authority." The deluxe magazine of the field. 30¢ per copy, \$2.50 yearly; two years, \$4.00 in U. S. A., Canada, and American Postal Union. Elsewhere, 75¢ yearly extra. "Radio," 7640 Beverly Boulevard, Los Angeles.

**SPECIAL** offer: "Radio," one year and copy of "The 'Radio' Handbook," \$3.00 in U.S.A.

**CONTEST**: \$50. bonus for best technical constructional article received by March 31st; all articles accepted paid for at regular rates. See pages 70 and 80, January "Radio," 30¢ at most radio parts dealers or from us. "Radio," 7460 Beverly, Los Angeles.

**CRYSTALS**, guaranteed oscillators, 30-160 meter bands, within 5kc. Y cut \$1.; X—\$1.50, 40 meter X within 10 kc. \$2. Postpaid. Herbert Addington, 2252 North LeClaire, Chicago.

**CUSTOM** building and rebuilding of high performance radio equipment. Consult us before starting that new outfit. Write for information on our air wound coils. Barker & Williamson, Ardmore, Pa.

**W9ADN** crystals for individual attention. Temperature coefficient 0.000005—"B" 40-80, \$3.75; 80 "AT"—0.000009, \$2.50; 0.000002, \$4. Holders, 1-1. Lockport, Ill.

**TRANSCEIVER**—five tubes—works duplex self contained power supply. Sell or swap. W2AZI.

**RECEIVERS**—new and used, sold and traded in, Hammarlunds, Nationals, RME69, Sky rider. Schwarz Radio Service, 15 Lawrence Ave., Dumont, N. J.

**QSL's**. Finest cards at lowest price. Samples. Maleco, 1512 Eastern Parkway, Brooklyn, N. Y.

**CRYSTALS**:—New zero coefficient V cuts. 80 or 160 meters your approximate frequency \$1.35—AT \$1.50—X \$1.25. Calibration accuracy .01%. Southwest Piezo Service, Box 792, Abilene, Texas.

**TRADE-INS**: Lafayette PB46A Phone Transmitter-tubes, 80-40-20 coils, 2 Biley crystals, Astatic crystal microphone. \$150 value—only \$95. 1935 Super Sky rider with crystal—\$49. Harvey Radio Laboratories, 12 Boylston St., Brookline, Mass.

**YOUR** call on a beautiful black ring. Send your call, size and \$2.25 to W9TQQ, Delavan, Wisc.

**FB** QSL's at FB prices. Samples. W8NWW Deposit, N. Y.

**VIBROPLEXES** rebuilt \$5 to \$7. Guaranteed. New Bugs \$9. Lydeard, 28 Circuit, Roxbury, Mass.

**SELL**: Kennedy Receiver 145 to 30,000 meter receiver with amplifier. Best offer takes it. W9FRH

**TRANSMITTER** wanted—Collins, Marine or others. 75 or 160 meter phone not less than 100 watts. W9GLR, Mason City, Iowa.

**SELL:**—My 200 watt transmitter, either complete or parts. For full details write, WIBHM.

**I50** 2-color QSL's \$1. W5AIA.

**WANTED**—0-1 d.c. milliameter. W8EBY.

**RAW** quartz, holders 50¢, blanks 50¢ crystals, receivers, free folder. Faberadio, Sandwich, Illinois.

**SELL:** All models National SW3s \$12.50, all coils \$1.75 a pair. National FB7s with tubes \$22. FB7As \$26. W9ARA, Butler, Mo.

**SW3**—a.c.-d.c., 40-80 meter coils, tubes, \$10. W2EXR.

**POWER** supply, metal chassis, Kenyon transformer, 2-section filter, Amerfran chokes, Aerovox condenser block, 400v at 120ma. continuous, \$10. W2EXR.

**PRECISION** Multiple-Meters: 0-1-10-100-1,000 volts, 0-001-.01-1-10 amperes, d.c.; 0-10-100-1,000 volts a.c.; 0-50,000-5,000,000 ohms. Schooley Engineering Company, Terril, Iowa.

**RECEIVERS** (2) 1528 48th, Des Moines, Iowa.

**TRANSMITTERS**—built to order. Save 35%. Write Howard Radio, 154 Pine Ave., Chicago.

**OSLs, SWLs.** Reply getters. Samples. (Stamps) W8ESN, 1828 Cone, Toledo, Ohio.

## NO BALLYHOO!

Thousands of hams who have used Esico electric soldering irons during the last decade will attest to their honest-to-goodness worthiness. For fast—clean and solid solder joints use **ESICO**—the iron that has established its reputation through performance not prophecy.

**ELECTRIC SOLDERING IRON CO., INC.**  
342 West 14th Street, New York, N. Y.

Esico irons are prominently featured on the standard Green Esico display boards at the counters of all Esico distributors.



Mr. E. H. Rietzke, President of CREI and originator of the first thorough course in Practical Radio Engineering.

Don't Wait 'Til You Are

## TOO OLD TO CLIMB

The "Ladder of Success"!

Get off to a flying start! What good is Success when you're too old to enjoy it? Right now is the time to plan your future, and to accomplish your ambitions by preparing yourself with *Technical Training*. Continual new Radio developments create a steady need for technically trained men who can qualify for the big jobs and the big salaries that go with them.

Practical Radio Engineering Is the Short Cut to Success!

The man who **KNOWS** more... is the man who **EARNs** more! Only training and knowledge can place you ahead of the "other fellow." Don't put it off again—write today for full particulars. We can do the same for you that we have done for others.

**WRITE FOR FREE CATALOG**  
Completely illustrated. Gives all details about courses, prices, terms, etc.

**CAPITOL RADIO ENGINEERING INSTITUTE**

14th and Park Road, N. W., Dept. Q-2  
WASHINGTON, D. C.



*How to Become*

## A RADIO AMATEUR

Published by the AMERICAN RADIO RELAY LEAGUE, INC. • West Hartford, Connecticut



Fourth Edition  
Price 25 Cents

“ “ “ “

Price 25¢ postpaid  
(no stamps, please)

**AMERICAN RADIO RELAY LEAGUE**  
WEST HARTFORD, CONNECTICUT

Universally recognized as the standard elementary guide for the prospective amateur

## HOW TO BECOME A RADIO AMATEUR

describes, in clear understandable language, apparatus incorporating features hitherto confined to more advanced stations. Although completely modernized, the station can still be built at a minimum of expense, and the designs have been made flexible so that parts out of the junk box readily can be substituted. While easy to build, the performance of the equipment is such that any amateur can own and operate it with satisfaction and pleasure. Complete operating instructions and references to sources of detailed information on licensing procedure are given, as well as a highly absorbing narrative account of just what amateur radio is and does.

# Your Nearest Dealer Is Your Best Friend

Your nearest dealer is entitled to your patronage. You can trust him. He is equipped with a knowledge and understanding of amateur radio. He is your logical and safe source of advice and counsel on what equipment you should buy. His stock is complete. He can supply your needs without delay. His prices are fair and consistent with the high quality of the goods he carries. He is responsible to you and interested in you.

Patronize the dealer nearest you — You can have confidence in him

## ALLENTOWN, PENNSYLVANIA

Radio Electric Service Co.  
1024 Hamilton Street  
Complete stocks transmitting equipment

## BALTIMORE, MARYLAND

Radio Electric Service Co.  
303 W. Baltimore Street  
Everything for the amateur

## BIRMINGHAM, ENGLAND

Radio Mart  
19 John Bright Street  
Drop in and meet Bill Nightingale—G5NI

## BROCKTON, MASSACHUSETTS

Ware Radio Supply Co.  
913 Centre Street  
Hammarlund, Triplett, Ohmite, Raytheon, Bliley, Skyrider

## BUFFALO, NEW YORK

Dymac Radio  
216 E. Genesee St. — Tel. Cl. 2080  
Complete Stock Amateur Parts — Standard Discounts — W8AWK

## BUFFALO, NEW YORK

Kronson Service Company  
143 East Genesee Street  
Western New York's largest wholesale distributors — W8EHF

## BUFFALO, NEW YORK

Radio Equipment Corp.  
326 Elm Street  
Ham, service and sound equipment

## MANCHESTER, NEW HAMPSHIRE

Radio Service Lab. of N. H.  
1008 Elm Street — Tel. 218-W  
Branches — Portland, Me. and Barre, Vt.

## MONTREAL, CANADA

Canadian Elec. Supply Co., Ltd.  
285 Craig St., W.  
Quality parts and equipment for discriminating buyers

## PHILADELPHIA, PENNSYLVANIA

Consolidated Radio Corp.  
612 Arch Street  
Ham receivers, Transmitting tubes, Collins transmitters, etc.

## PHILADELPHIA, PENNSYLVANIA

Radio Electric Service Co., Inc.  
N. E. Cor. Seventh & Arch Sts.  
All nationally-advertised lines in stock

## PHILADELPHIA, PENNSYLVANIA

Eugene G. Wile  
10 S. Tenth Street  
  
Complete Stock of Quality Merchandise

## PITTSBURGH, PENNSYLVANIA

Cameradio Company  
601-3 Grant Street  
"Ham" Headquarters for Pennsylvania-Ohio-W. Virginia

## PROVIDENCE, RHODE ISLAND

W. H. Edwards Co.  
32 Broadway  
National — Hammarlund — RCA — and other leaders

## PROVIDENCE, RHODE ISLAND

Kraus & Company  
89 Broadway  
Everything for the amateur and serviceman

## ROCHESTER, NEW YORK

Radio Service Shop  
244 Clinton Avenue, North  
Complete stock amateur-BCL parts. Standard discounts. W8NUC

## SYRACUSE, NEW YORK

Roy C. Stage, W8IGF  
Complete stock of standard Ham & BCL parts  
Standard Discounts. Free technical service

## WASHINGTON, D. C.

George's Radio Co.  
816 F Street, N.W.  
Washington's largest distributor of radio parts

## WHEELING, WEST VIRGINIA

Cameradio Company  
30 Twelfth Street  
Complete stock of amateur Equipment at standard discounts

# You Are Protected When You Buy From QST Advertisers

“Advertising for QST is accepted only from firms who, in the publisher’s opinion, are of established integrity and whose products secure the approval of the technical staff of the American Radio Relay League.”

Quoted from QST’s advertising rate card.

Every conceivable need of a radio amateur can be supplied by the advertisers in QST. And you will know the product has the approval of the League’s technical staff.

## For Your Convenience QST’S INDEX TO ADVERTISERS IN THIS ISSUE

Aalloy Transformer Company	101
Aerovox Corporation	108
Allen-Bradley Company	85
All Star Headquarters	83
Astaire Microphone Company	109, 114
A.R.R.L. Bookshelf	113
Bound Handbook	109, 114
Bound Volume	110
Calculators	95
Handbook	87, 90
Hints & Kinks	122
How to Become a Radio Amateur	124
License Manual	92
Supplies	97
Birnback Radio Company, Inc.	99
Bliley Electric Company	101, 110
Bud Radio, Inc.	108
Burgess Battery Company	93
Burton Microphone Company	112
Cameradio Company	107
Candler System Company	104
Capitol Radio Engineering Institute	124
Cardwell Mfg. Corp., Allen D.	103
Central Radio Laboratories	82
Cohen’s Sons, I. S.	109
Collins Radio Company	Cov. 2
Cornell-Dubiler Corp.	104
Coto-Coil Company	99
Delaware Radio Sales Co.	103
Delco-Remy Corp.	89
Deutschmann Corp., Tope.	101
Dodge’s Institute	103
Eby Inc., Hugh H.	102
Eitel-McCullough, Inc.	112
Electrad, Inc.	100
Electric Soldering Iron Company	124
Filtermatic Mfg. Company	110
Gardiner-Levering Company	112
General Electric Company	74, 81
General Motors Company	91
General Radio Company	96
General Transformer Company	107
Gross Radio, Inc.	127
Gulf Radio School	106
Hallicrafters, Inc., The	4, 5
Hammarlund Mfg. Company	6
Harvey Radio Laboratories	94
Henry Radio Shop	92
Hipower Crystal Company	107
Instructograph Company	122
International Resistance Co.	80
Johnson Company, E. F.	94
Leeds	91
M & H Radio	107
Marine Radio Company	2, 111
Massachusetts Radio School	101
McElroy, E. R.	109, 114
McGraw-Hill	76
Mid-West Radio Mart	84
National Carbon Company	78
National Company, Inc.	73, 79, Cov. 3
Newark Electric Company	77
New York Y. M. C. A. Schools	108
Northern Ohio Laboratories	111
Ohmite Mfg. Company	102
Port Arthur College	99
Precision Piezo Service	105
Premier Crystal Laboratories	109
Radio Laboratories	113, 115
Radio Mfg. Engineers	75
Radio Receptor Corp.	111
Radio Shack	107
Radio Specialties, Inc.	109
Radio Supply Company	111
Radio Transceiver Laboratories	111
RCA Institutes, Inc.	99
RCA Manufacturing Company	Cov. 4
Raytheon Manufacturing Corp.	105
Raytheon Production Corp.	86
Scientific Radio Service	111
Shuler Supply Company	109
Shure Brothers Company	100
Signa Electric Mfg. Company	98
Standard Transformer Corp.	88
Sundt Engineering Labs	101
Teleplex Company	103, 105
Triplet Electrical Instrument Corp.	1
Turner Company	98
United Electronics Company	106
United Transformer Company	128
Utah Radio Products	122
Valpey Crystals	103
Vibroplex Company	106
Wright-DeCoster, Inc.	96



DIFFERENT ONLY IN VERSATILITY AND IN PRICE

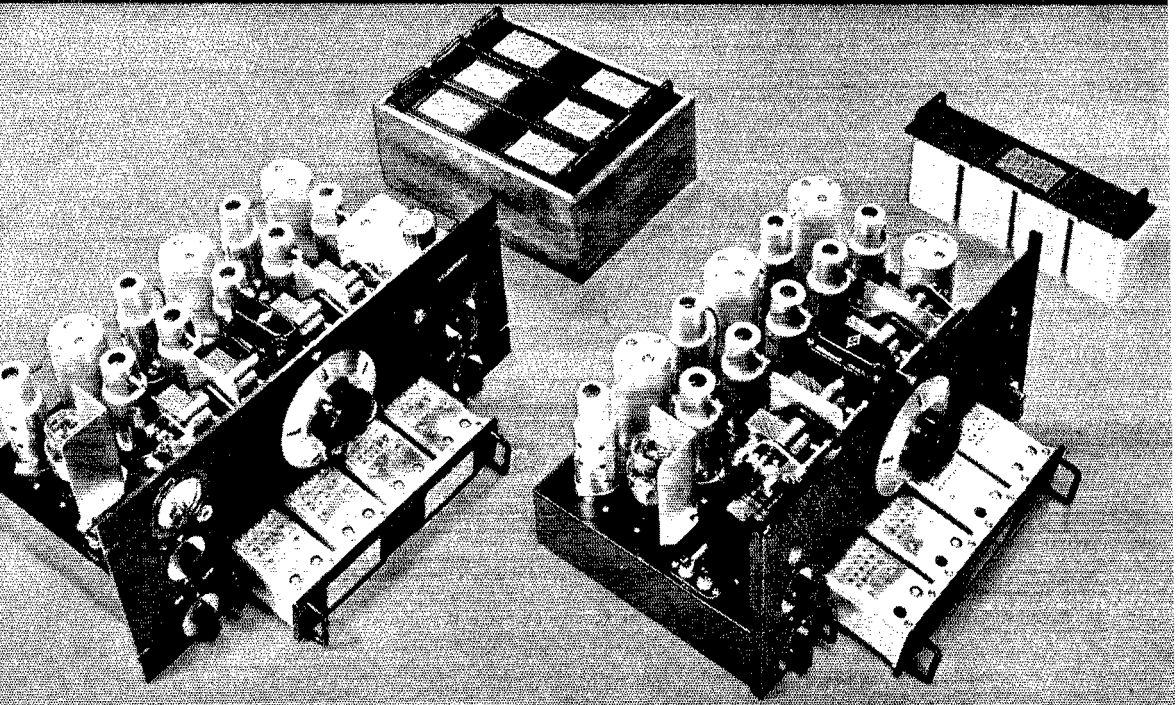

**THE STANDARD HRO :: THE HRO JUNIOR**

**ANNOUNCING THE HRO JUNIOR**

For those who need the high performance of the HRO, but do not require its extreme versatility, a Junior model is offered. The circuit details of both receivers are identical in every respect, but the lower priced model has been greatly simplified by omitting the crystal filter and the S-meter, and by designing coils for "continuous band spread" only.

Although these omissions do not greatly restrict its usefulness, they make it possible to price the Junior HRO at a very attractive figure. A complete description of the HRO Junior and of the Standard HRO will be mailed on request.

HRO Junior	List	Amateur Net
With tubes, one set of coils, 10 to 20 meters (2 amateur bands).....	\$165.00	\$99.00
Additional HRO Jr. coils — per range — (2 amateur bands)	16.50	9.90
5897 AB Power Pack — for above — less tube.....	26.50	15.90

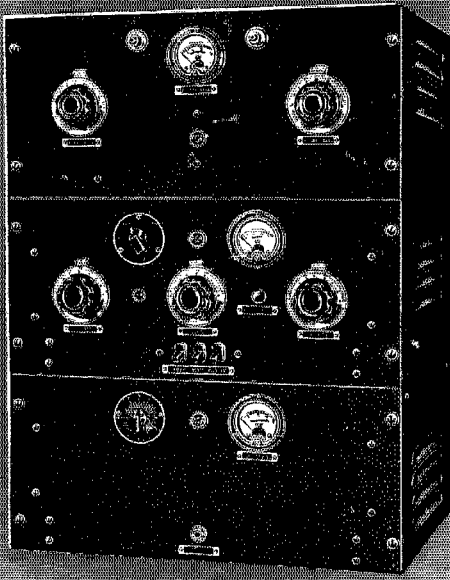

# RCA TRANSMITTERS OFFER MORE WATTS PER DOLLAR

This new RCA 40-watt transmitter is conservatively rated, and has so few losses that it gives you more watts output per dollar and more refinements than other transmitters in its price class. It was designed by RCA transmitter engineers and is built under the supervision of skilled technicians. Each part is tested individually, as well as the completed assembly, to assure reliable as well as efficient operation. The transmitter consists



of four units which can be purchased together, or separately, as your ability to buy permits. This is the RCA unit plan, which also makes it possible for you to increase power at any later time without scrapping the original equipment. ACT-40 is rated at 40 watts output, c-w and phone, and is the outstanding buy in amateur transmitters of this rating. Net price f.o.b. factory, less accessories, \$235.00. Send for complete details.

AMATEUR RADIO SECTION

**RCA MANUFACTURING CO., INC., CAMDEN, N. J.**

A SUBSIDIARY OF THE RADIO CORPORATION OF AMERICA