

QST

november, 1935

25 cents

devoted entirely to

amateur radio

In this Issue—
**A New-Type
Ultra-High
Frequency
Receiver**



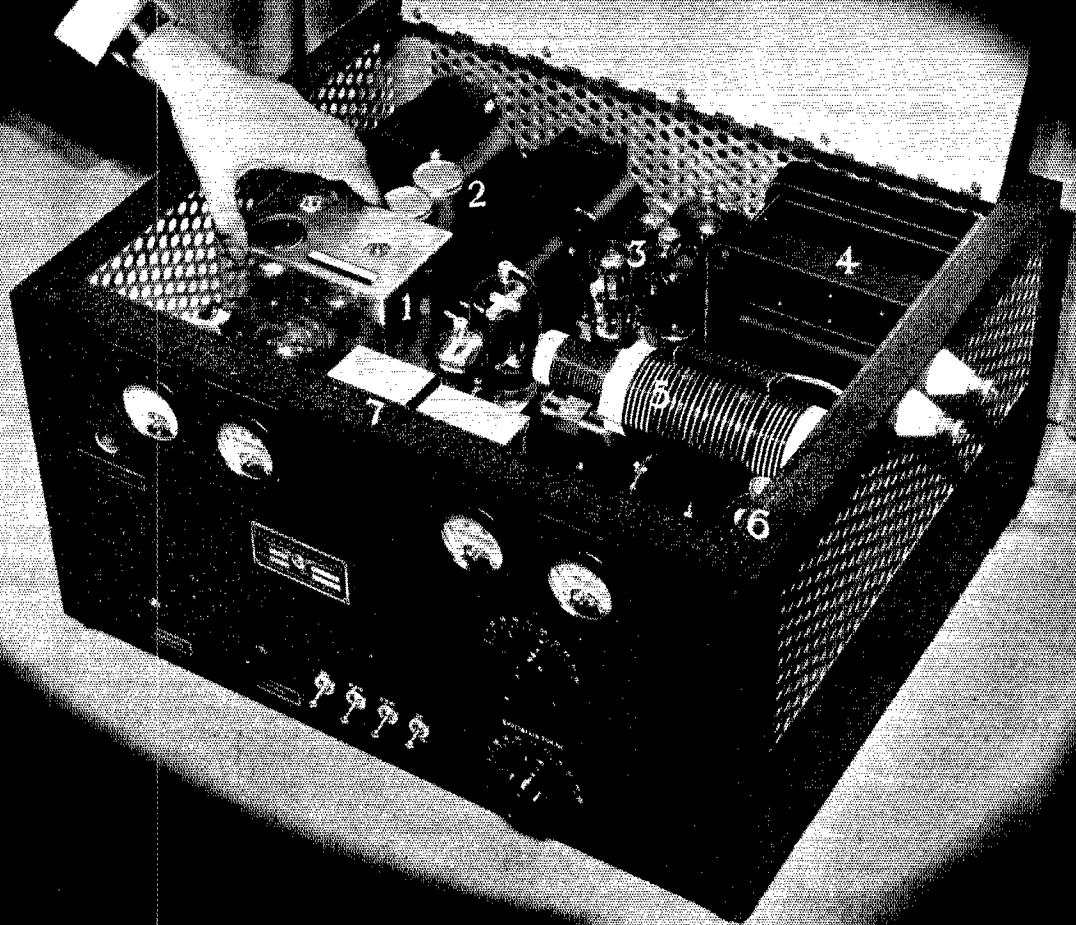

INSIDE THE 45A

"Inside dope" on the 45A is no longer at a premium. The September issue of the **COLLINS SIGNAL** contains the full story. Write at once if you have not received your copy.

Shown above are: (1) Interchangeable frequency shift unit with built-in crystal, (2) low-voltage power supply and its impregnated dielectric filter condensers, (3) rectifier tubes, (4) 400 volt-ampere high voltage transformer, (5) radically new output circuit, (6) plate end of the C-211D output tube, (7) high fidelity speech amplifier.

Not shown are: (a) The neat arrangement of components beneath the chassis, and (b) the times-two factor of safety in every part which makes this transmitter a real high-powered baby.

... still another new model,
a 600 watt set, will be described next month.

Collins Radio Company

CEDAR RAPIDS
New York
11 West 42nd St.



IOWA, U. S. A.
Mexico City
Edificio "La Nacional"

FOR BETTER RADIO

Use

Hammarlund

XP-53 FORMS

- 1 NEW XP-53 DIELECTRIC—
NATURAL COLOR—
LOW LOSS
- 2 GROOVE RIBS—
AIR SPACED WINDINGS—
CORRECT FORM FACTOR
- 3 GREATER SIGNAL
STRENGTH—MORE
SELECTIVITY
- 4 FLANGE GRIPS—METER
INDEXES—EASY DRILLING
- 5 4, 5 AND 6 PRONGS
- 6 *LOW COST!*

WRITE DEPT. Q-11 FOR
GENERAL CATALOG

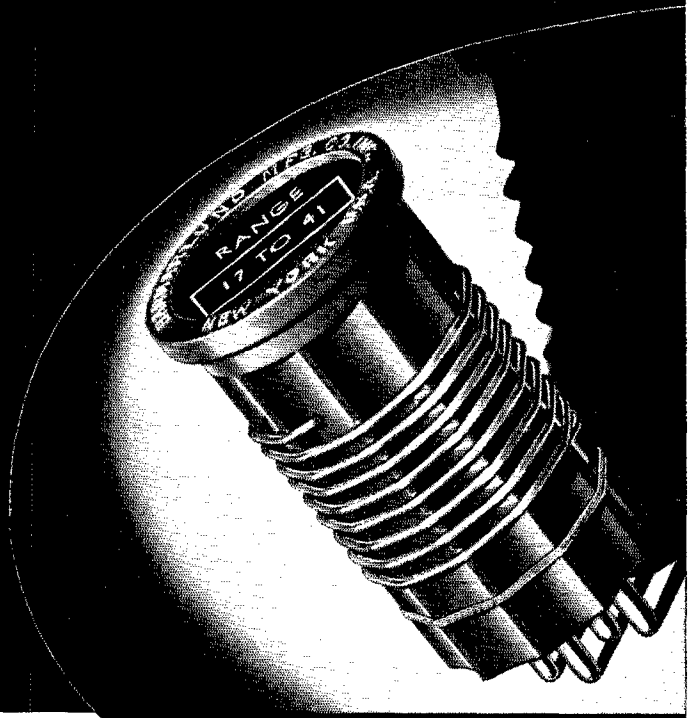

HAMMARLUND MANUFACTURING CO.

424-438 West 33rd Street, New York

CANADIAN OFFICE: 41 WEST AVENUE NORTH, HAMILTON, ONTARIO

Say You Saw It in QST — It Identifies You and Helps QST

THE MARINE 140B



ULTRA MODERN
HIGH FREQUENCY

100-WATT TRANSMITTER

IN EVERY amateur's pipe-dreams there has appeared, at one time or another, the vision of an x-mitter that would possess in its sparkling black cabinet all the most modern gadgets he ever heard of or saw — a rig that he could talk about and continue to talk about, while the ham he is "working" on the "air" has run dry. Now — the dream has come true!

These specifications speak for themselves — let them tell you the story!

- **POWER OUTPUT:** Conservatively rated at 100 watts, CW and phone.
- **FREQUENCY RANGE:** 15,000 to 1,500 K.C.
- **MODULATION CONTROL:** Built in Cathode-ray Oscilloscope allowing for instantaneous visual modulation. Permits maintenance of 100% modulation control.
- **PERMANENT NEUTRALIZATION:** All transmitters are permanently neutralized at the plant before being shipped. Changing bands or using different antennas will have absolutely no effect on the neutralization.
- **HIGH FIDELITY AUDIO CHANNEL:** Speech amplifier has frequency response of 30 to 10,000 cycles, within ± 1.5 db, with a gain of 125 db.
- **AUTO TRANSFORMER:** Tapped in 5 volt steps from 90 to 130 volts to accommodate various line voltages.
- **ANTENNA MATCHING NETWORK:** Capable of efficiently matching any type of antenna in general use.
- **DIMENSIONS:** 60" long x 19½" wide x 15" deep.

MARINE 60G: A moderately priced, high quality, 200 watt CW, 60 watt phone x-mitter, having the same electrical features as the 140B.

MARINE 750B: The most powerful transmitter permitted by the government for amateur use. 1000 watt phone and CW. Built along the Marine quality standards, this rig is the finest of its type available today. All of the latest developments in transmitter design are incorporated in this unit.

Illustrated descriptive catalogs and photographs will gladly be furnished upon request

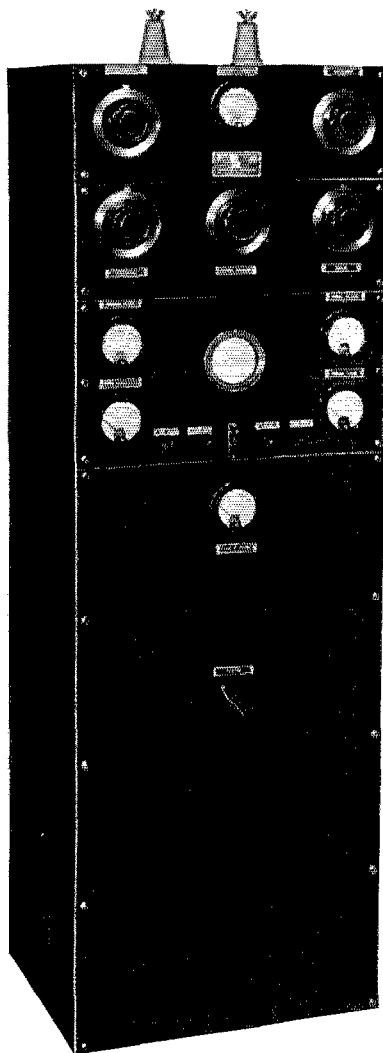

You are assured of complete satisfaction and uninterrupted operation with all Marine Radio apparatus. The Marine Radio iron-clad unconditional guarantee absolutely protects you.

Marine Radio Company manufactures a complete line of transmitters for all purposes.

MARINE

Radio Company

General Offices and Plant:

124-11 101st Avenue
RICHMOND HILL, NEW YORK



QST

Published monthly, as its official organ, by the American Radio Relay League, Inc., at West Hartford, Conn., U. S. A.; Official Organ of the International Amateur Radio Union

devoted entirely to

AMATEUR RADIO

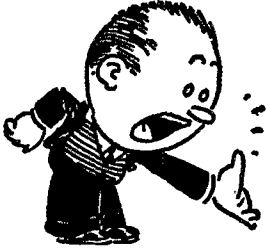

Editorials	9
A New Receiving System for the Ultra-High Frequencies <i>Ross A. Hull</i>	10
A Consistent Antipodal Circuit <i>S. L. Seaton and J. S. Lacey, W3AMS</i>	15
28-Mc. Communication Continues	16
A.R.R.L. QSL Bureau	17
Clair Foster	17
A Quick-Switch 'Phone Transmitter for Two-Band Operation <i>James Millen, W1HRX</i>	18
World Championship Radio Code Speed Tournament. <i>T. R. McElroy</i>	24
What the League Is Doing	25
Rationalizing the Resonant-Line U.H.F. Oscillator <i>A. W. Friend, W8DSJ</i>	26
A Novel Dual-Tuner Superhet <i>Glen H. Browning</i>	29
Yours Very Truly — Goodnight <i>Lawrence E. Hauck, W9CYV</i>	36
Sixth A.R.R.L. Sweepstakes Contest <i>F. E. Handy</i>	38
QRP <i>George Grammer</i>	40
Amateur Contests at Brockton Fair	43
Hamdom	44
With the Affiliated Clubs	45
Amateur Radio Stations <i>W6USA</i>	46
Canada-U.S.A. Contact Contest	48
Experimenters' Section	
CHANGING THE ANTENNA DIRECTIONAL CHARACTERISTICS — CHOKE- COUPLED MODULATION OF R.F. PENTODES — SOLDERING-IRON OUTLET — SOLDERING-IRON HOLDER — VARIABLE COUPLING TO THE ANTENNA COUPLER	49
I.A.R.U. News	51
Operating News	53
Correspondence Department	67
Book Reviews	96
Standard Frequency Transmissions	102
Hamads	107
QST's Index of Advertisers	110

NOVEMBER
1935

VOLUME XIX
NUMBER 11

Kenneth B. Warner (Secretary, A.R.R.L.), *Editor-in-Chief and Business Manager*; **Ross A. Hull**, *Associate Editor*; **James J. Lamb**, *Technical Editor*; **George Grammer**, *Assistant Technical Editor*; **Clark C. Rodimon**, *Managing Editor*; **David H. Houghton**, *Circulation Manager*; **F. Cheyney Beekley**, *Advertising Manager*; **Ursula M. Chamberlain**, *Assistant Advertising Manager*.

Editorial and Advertising Offices
38 La Salle Road, West Hartford, Conn.

Subscription rate in United States and Possessions and Canada, \$2.50 per year, postpaid; all other countries, \$3.00 per year, postpaid. Single copies, 25 cents. Foreign remittances should be by international postal or express money order or bank draft negotiable in the U. S. and for an equivalent amount in U. S. funds.

Entered as second-class matter May 29, 1919, at the post office at Hartford, Connecticut, under the Act of March 3, 1879. Acceptance for mailing at special rate of postage provided for in section 1103, Act of October 3, 1917, authorized September 9, 1922. Additional entry at Concord, N. H., authorized February 21, 1929, under the Act of February 28, 1925.

Additional second-class entries to cover sectional editions authorized March 20, 1935

Copyright 1935 by the American Radio Relay League, Inc.
Title registered at United States Patent Office.

SCION

*of the
distinguished
family*

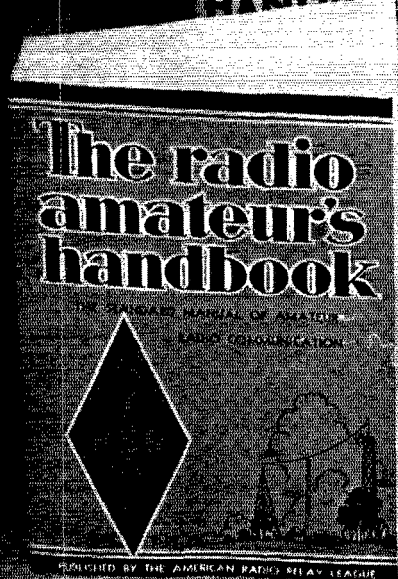

*The
new
twice-as-big*
1936
**RADIO
AMATEUR'S
HANDBOOK**

Say You Saw It in QST — It Identifies You and Helps QST

The 1936 Edition of the

RADIO AMATEUR'S HANDBOOK

Enlarged in Every Respect

THE opening chapters are brought up-to-the-minute, with new illustrations. The electrical and radio fundamentals chapters are completely new treatments serving as the foundation for the thirteen apparatus chapters which follow. They deal exclusively with principles which have practical bearing on actual equipment.

An entirely new 30-page chapter on vacuum tubes contains the most comprehensive tabulated tube data ever published.

The new receiver design chapter treats its subject in an entirely new manner and contains a wealth of circuit features described in concise, practical detail. Receiver construction is given a big chapter of its own. The how-to-make-it of a complete line of successful models, from a simple two-tuber to a Single-Signal model with 12 of the new metal tubes represents the culmination of months of preparatory work.

In the chapter devoted to transmitter design, the theoretical and practical considerations involved in designing and planning transmitters are given comprehensive treatment, while in the chapter on transmitter construction, all of the very latest circuit developments of proven merit are incorporated. There is, in it, dope on all types of transmitters that any amateur could want, including the most modern multi-band transmitters with coil switching.

An enlarged chapter on keying methods is followed by a chapter on the fundamentals of radio telephony

which is a thorough and concise treatment of design — from microphones to controlled carrier systems. The constructional chapter on radio-telephone transmitters gives full details of many successful types.

The ultra-high frequencies are well covered with two big chapters telling how the super-regenerative receivers work, and how to build them; about super-hets and **THE NEW SUPER INFRA-GENERATOR RECEIVER**. Constructional dope for the various types with the acorn, glass and metal tubes is included. The U.H.F. transmitter chapter is a general treatment of the problems of simple circuits, linear oscillators, and oscillator-amplifiers.

The power supply chapter is treated in greater detail than ever, covering receiver-packs, voltage dividers, and supplies for grid bias, as well as all the normal equipment found in modern stations.

Antenna design is covered thoroughly. Numerous charts facilitate the planning of everything from simple single wire antennas to complex directional arrays. Another new chapter is devoted to instruments and measurements, their design and practical use. Included, of course, is the cathode-ray oscilloscope. The chapter on station assembly incorporates new ideas that new equipment has made possible. Communications Department chapters contain the latest dope on good operating practices and the present field organization set-up. In addition, of course, there is the usual — but not so usual — appendix, with its wealth of general information.

\$1 ●
POSTPAID

Buckram Bound
\$2.50 Postpaid

American Radio Relay League, West Hartford, Conn.

MAKE YOUR GOAL

with

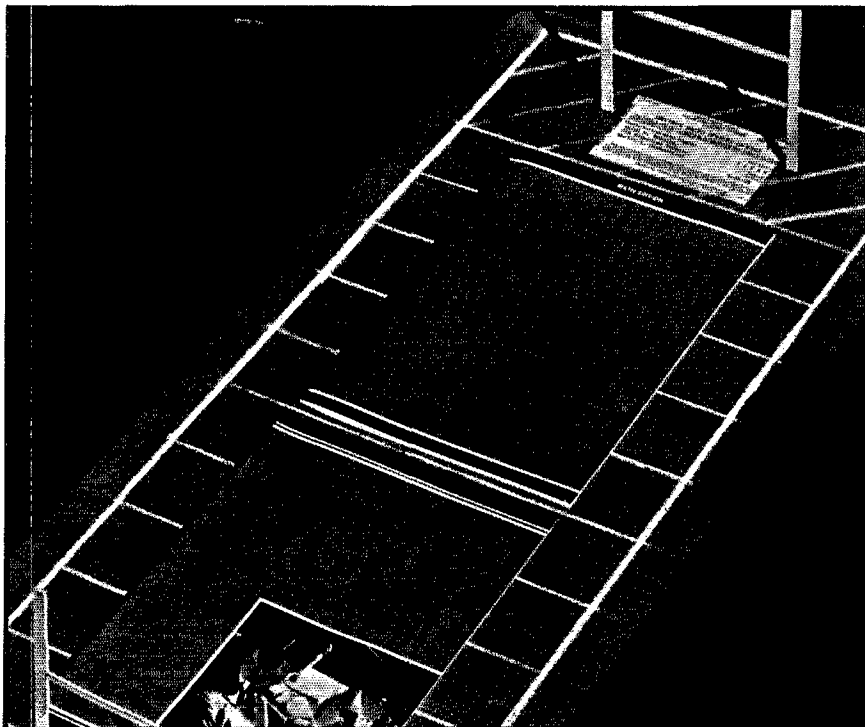

How to Become a RADIO AMATEUR

*Your introduction to
amateur radio*

The standard elementary guide for the prospective amateur, giving, in simple terms, complete constructional information for an inexpensive station with the necessary dope on operating practices.

E A C H

25c

POSTPAID

The Radio Amateur's LICENSE MANUAL

*Gives you the dope
that you need*

Nearly 200 typical license exam questions and answers, where, how and when to apply. In fact, all the dope on amateur licensing procedure as well as the text of the regulations and extracts from the basic radio law.

AMERICAN RADIO RELAY LEAGUE, INC.

WEST HARTFORD, CONNECTICUT

Section Communications Managers of the A.R.R.L. Communications Department

All appointments in the League's field organization are made by the proper S.C.M., elected by members in each Section listed. Mail your S.C.M. (on the 16th of each month) a postal covering your radio activities for the previous 30 days. Tell him your DX, plans for experimenting, results in 'phone and traffic. He is interested, whether you are an A.R.R.L. member or get your QST at the newsstands; he wants a report from every active ham. If interested and qualified for O.R.S., O.P.S. or other appointments he can tell you about them, too.

Eastern Pennsylvania Maryland-Delaware-District of Columbia	W3EZ W3BAK W3ZAX W8DSP W8CUG	ATLANTIC DIVISION James M. Bruning	339 W. Lancaster Ave. 1107 Park Ave. 213 Hickok Ave. 261 N. Balph Ave.	Haverford Laurel, Delaware Collingswood Syracuse Bellevue
Southern New Jersey Western New York Western Pennsylvania		CENTRAL DIVISION Fred J. Hinds Arthur L. Braun G. W. Mossbarger Kenneth P. Conroy Robert P. Irvine E. A. Cary	6618 West 34th St. 5211 Brookville Rd. Box 177 18030 Waltham Ave. 5508 Northcliffe Ave. 3915 No. 19th Pl.	Berwyn Indianapolis Camp Taylor Detroit Cleveland Milwaukee
Illinois Indiana Kentucky Michigan Ohio Wisconsin*	W9WR W97E W9A0H W8DYH W8CIO W9ATO	DAKOTA DIVISION Hartwell B. Burner Mike G. Strahon R. C. Harshberger Francis C. Kramer	601 S. Grange Ave. 1200 Fauquier St. W. Bluff St.	Hope Sioux Falls St. Paul, Minnesota St. Charles
North Dakota South Dakota Northern Minnesota* Southern Minnesota	W9OEL W9PFI W9JIE W9DEI	DELTA DIVISION H. E. Vette W. J. Wilkinson, Jr. J. H. Weems, Jr. Merrill B. Parker, Jr.	2918 West 15th St. 1624 Allen Ave. P. O. Box 244 1912 Oak St.	Little Rock Shreveport State College Chattanooga
Arkansas Louisiana Mississippi Tennessee	W5ABI W5DWW W5CWQ W4BBT	HUDSON DIVISION Robert E. Haight E. L. Baunach Charles J. Hammersen	511 South Holmes St. 7823 10th Ave. 92 Claremont Ave.	Scotia Brooklyn Verona
Eastern New York N. Y. C. & Long Island Northern New Jersey	W2LU W2AZV W2FOP	MIDWEST DIVISION Phil D. Boardman O. J. Spetter J. Dewey Mills Samuel C. Wallace	325 Kirkwood Blvd. 305 Western Ave. Green St.	Davenport Topeka Mount Vernon Clarks Summit
Iowa Kansas Missouri* Nebraska	W9LEZ W9FLG W9CJR W9FAM	NEW ENGLAND DIVISION Frederick Ellis, Jr. John W. Singleton Albert N. Giddis Percy C. Noble Robert Byron Clayton C. Gordon Harry Page	19 Merril Rd. 73 Allen St. 128 Crawford St. 37 Broad St. 12 Humphrey St. 206 California Ave. R. 1	Norwalk Wilton Lowell Westfield Concord Providence Hinesburg
Connecticut Maine Eastern Massachusetts Western Massachusetts New Hampshire Rhode Island Vermont	W1CTI W1CDX W1ABG W1BYE W1AVJ W1HRH W1ATF	NORTHWESTERN DIVISION Richard J. Fox Nelle E. Hart O. W. Viers Frank L. Black Niilo E. Koski	Box 301 Box 6 Box 265 1502 McPherson St. 5822 E. Green Lake Way	Ketchikan Twin Falls Red Lodge North Bend Seattle
Alaska Idaho Montana Oregon Washington	K7PO W7NH W7AAT W7AMF W7LD	PACIFIC DIVISION Atlas O. Adams Edward W. Heim Charles J. Camp Harold J. Burchfield Alan D. Whittaker, Jr. Geo. L. Woodington Newton E. Thompson Vernon C. Edgar	21st Infantry Brigade 716 West Sixth St. 318 Hawthorne Ave. 2940 106th Ave. 79 Elinor Ave. 716 Redwood Ave. P. O. Box 849 732 Blackstone Ave.	Schofield Barracks Reno Palo Alto Oakland Mill Valley North Sacramento Marina, P. I. Fresno
Hawaii Nevada Santa Clara Valley East Bay San Francisco Sacramento Valley Philippines San Joaquin Valley	K6EWQ W6BIC W6BMW W6JTV W6SG W6DVE KA1YA W6CRF	ROANOKE DIVISION H. S. Carter Neil E. Henry Dr. Wm. H. Riheldaffer	115 Crafton St. 1017 Knight St.	Winston-Salem Lynchburg Lost Creek
North Carolina Virginia West Virginia	W4OG W3BRV W8KKG	ROCKY MOUNTAIN DIVISION Glen Glasscock Arty W. Clark	1171 Detroit St. 260 So. 9th West	Denver Salt Lake City, Utah
Colorado Utah-Wyoming	W9FA W6GQC	SOUTHEASTERN DIVISION J. Wesley Davis Phillip A. McMasters Edward J. Collins	405 Union St. 731 Arlington Ave. 1517 East Brainard St.	Selma St. Petersburg Pensacola
Alabama* Eastern Florida Western Florida Georgia-So. Carolina-Cuba- Isle-of-Pines-Porto Rico- Virgin Islands	W4DS W4BCZ W4MS W4CE	Bannie L. Stewart	SC-533, C.C.C. Camp Lawrence	Effingham, S. C.
Los Angeles Arizona San Diego	W6BPU W6LVG W6EVP	SOUTHWESTERN DIVISION Howell C. Brown C. C. Day Harry A. Ambler	120 N. El Molino Ave. "La Posta Quemada" 4101 Hamilton St.	Pasadena Vail San Diego
Northern Texas Oklahoma Southern Texas New Mexico	W5BII W5CEZ W5ADZ W5CGJ	WEST GULF DIVISION Richard M. Cobb Carter L. Simpson Bradfield A. Beard Joseph M. Eldodt	Box 185 2010 So. 4th St. 2030 Quenby Road	Dodd City Ponca City Houston Chamita
Maritime	VE1DQ	MARITIME DIVISION A. M. Crowell	69 Dublin St.	Halifax, N. S.
Ontario	VE3GT	ONTARIO DIVISION S. B. Trainer, Jr.	4 Shorncliffe Ave.	Toronto
Quebec	VE2EE	QUEBEC DIVISION Stan Comach	780 Brault Ave.	Verdun, P. Q.
Alberta British Columbia*	VE4GD VE5EP	VANALTA DIVISION J. Smalley, Jr. D. R. Vaughn-Smith	611 1st Ave., N. W. 1221 Burnaby St.	Calgary Vancouver
Manitoba Saskatchewan	VE4BG VE4EL	PRAIRIE DIVISION A. J. R. Simpson Wilfred Skaife	71 Thelmo Mansions 2040 McTavish St.	Winnipeg Regina

* Officials appointed to act until the membership of the Section choose permanent S.C.M.'s by nomination and election.



The American Radio Relay League

DIRECTORS

President
HIRAM PERCY MAXIM.....W1AW
Box 216, Hartford, Conn.

Vice-President
CHARLES H. STEWART.....W3ZS
St. David's, Pa.

Canadian General Manager
ALEX REID.....VE2BE
169 Logan Ave., St. Lambert, P. Q.

Atlantic Division
EUGENE C. WOODRUFF.....W8CMP
234 W. Fairmount Ave., State College, Pa.

Central Division
EDWARD A. ROBERTS.....W8HC
2699 Endicott Rd., Shaker Heights, Cleveland

Dakota Division
CARL L. JABS.....W9BVH
1822 James St., St. Paul, Minn.

Delta Division
M. M. HILL.....W5EB
P. O. Box 14, Natchitoches, La.

Hudson Division
KENNETH T. HILL.....W2AHC
115 Willow St., Douglaston, L. I., N. Y.

Midwest Division
H. W. KERR.....W9DZW-W9GP
Little Sioux, Iowa

New England Division
G. W. BAILEY.....W1KH
74 Webster Road, Weston, Mass.

Northwestern Division
RALPH J. GIBBONS.....W7KV
3933 N. E. 76th Ave., Portland, Ore.

Pacific Division
S. G. CULVER.....W6AN
2962 Russell St., Berkeley, Calif.

Roanoke Division
H. L. CAVENESS.....W4DW
State College Station, Raleigh, N. C.

Rocky Mountain Division
RUSSELL J. ANDREWS.....W9AAB
1867 So. Latayette St., Denver, Colo.

Southeastern Division
BENNETT R. ADAMS, JR.....W4APU
1512 Grove Place, Homewood, Ala.

West Gulf Division
WAYLAND M. GROVES.....W5NW
c/o Humble Pipe Line Co., Neches, Texas

• **T**HE AMERICAN RADIO RELAY LEAGUE, INC., is a non-commercial association of radio amateurs, bonded for the promotion of interest in amateur radio communication and experimentation, for the relaying of messages by radio, for the advancement of the radio art and of the public welfare, for the representation of the radio amateur in legislative matters, and for the maintenance of fraternalism and a high standard of conduct.

It is an incorporated association without capital stock, chartered under the laws of Connecticut. Its affairs are governed by a Board of Directors, elected every two years by the general membership. The officers are elected or appointed by the Directors. The League is non-commercial and no one commercially engaged in the manufacture, sale or rental of radio apparatus is eligible to membership on its board.

"Of, by and for the amateur," it numbers within its ranks practically every worth-while amateur in the nation and has a history of glorious achievement as the standard-bearer in amateur affairs.

Inquiries regarding membership are solicited. A bona fide interest in amateur radio is the only essential qualification; ownership of a transmitting station and knowledge of the code are not prerequisite. Correspondence should be addressed to the Secretary.

OFFICERS

President.....HIRAM PERCY MAXIM, W1AW
Hartford, Connecticut

Vice-President.....CHARLES H. STEWART, W3ZS
St. David's, Pennsylvania

Secretary.....KENNETH B. WARNER, W1EH
West Hartford, Connecticut

Treasurer.....ARTHUR A. HEBERT, W1ES
West Hartford, Connecticut

Communications Mgr....F. EDWARD HANDY, W1BDI
West Hartford, Connecticut

General Counsel.....PAUL M. SEGAL, W3EEA
1010 Shoreham Building, Washington, D. C.

Address all general correspondence to the executive headquarters at West Hartford, Connecticut

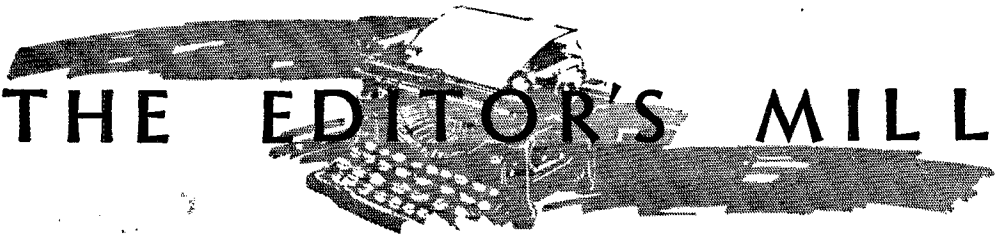

THE EDITOR'S MILL

THE merry month of November will bring ballots to the members of eight divisions of the League for the election of as many directors and alternate directors. Democratic government will be functioning in the control of our society's affairs. A heavy responsibility falls upon the individual member. Popular indifference to the capabilities of candidates for elective office is the outstanding insufficiency of democratic government. Let us endeavor to prove this untrue of amateur radio!

Our A.R.R.L. requires good directors, the best that we can find. We have our league for the protection of our interests as against the outside world and for the promotion of our activities within our own ranks. It is indispensable for our welfare. We cannot all individually participate in the many decisions of policy and practice that our association must make. We lodge this responsibility and this control in a governing body called the Board of Directors, and in each division we select our director by popular vote. What A.R.R.L. is to be in the next five years, what its policies and decisions are to be, depends largely upon the calibre and make-up of the Board. The League is our spokesman, the director of our destiny. It is of the utmost importance that we put the guidance of our course in capable hands.

We pray our members to take this matter with a certain seriousness. We suggest that before voting for a candidate it is desirable to know something of his capabilities and of his stand on amateur radio's current problems. It is not sufficient simply to know that he wants the job, or that he has a swell signal on the air or has a nice microphone voice. Those things do not qualify him to be the custodian of your future rights on the air. The League needs men of good judgment, of sound thinking, of experience in amateur radio and in the affairs of men. Its directors must be neither mentally becalmed nor loose at both ends. Send the Board sound men, capable of constructive thinking and logical planning! Remember that stability isn't nearly so spectacular as instability but is the stuff that counts in shaping your society's future. You are making a choice for two years and must be able to trust your director after you've elected him. Play the American system, whom ever you vote for, hoping he'll win but prepared to accept and cooperate with the candidate selected by the majority, whoever he may be. But let intellect guide your own choices.

The next two years will be a critical period in our League's history. We approach a crisis in our international relations. The social unrest of the times is not leaving our organization unscathed. Never before have we had such need of men with long heads and cool judgment and ripe experience, that amateur radio may be preserved as the glorious institution it is. Let not A.R.R.L. suffer through the unconcernedness of its electorate. Let us demonstrate that the American Radio Relay League is one democracy in which ideals are realized!

On the evening of November first, after nominations have closed, there will be a special broadcast from W1MK at 8:30 and at 10:30 and again at 12:30, E.S.T., simultaneously on both 7150 kc. and 3825 kc., giving the candidates in the various contests and the declared elections where there is but one eligible nominee. Tune in and get the news direct by amateur radio.

K. B. W.

A New Receiving System for the Ultra-High Frequencies

Selectivity of Any Desired Order Combined with Extreme Sensitivity
Wide-Range A.V.C. and Noise Suppression

By Ross A. Hull*

In Two Parts—Part I

At last!—a real advance in ultra-high-frequency receivers! We've long had the super-regen, with its wonderful sensitivity and invaluable ability to discriminate against ignition and similar noise—but it was woefully non-selective. We've also had the superhet, with its selectivity, fair sensitivity but total inability to cope with the noise problem.

Now Ross Hull emerges from the lab, with what we believe to be an absolutely new and original receiving system combining all the good qualities of both previous types. His new receivers are interesting enough just because of their sheer novelty. But the joke is that they perform in a manner that is absolutely stunning! We simply don't believe that any other type of receiver can touch them. They are inherently capable of all the selectivity and sensitivity one could ever use, at the same time retaining the magnificent a.v.c. action and noise discrimination of the super-regen. What more could anyone ask?

Ross Hull has solved the technical problems, but there remains the problem of naming the creation. It is actually a super-heterodyne-infradyne-super-regenerator. Jim Lamb suggests "Super-infragenerator" or "S.I.G." Another suggestion is just "The Super-Super." Who's next?—EDITOR.

IT IS inconceivable that any discussion of ultra-high-frequency receivers could be engaged in without consideration of the principle of super-regeneration. The super-regenerative receiver has been virtually the backbone of ultra-high-frequency working all these years and it has been obvious to many workers that real progress in receiver design has been a probability only if the super-regenerative detector was used as a starting point. The entire history of ultra-high-frequency receivers, other than the super-regenerator, has been a rather sad one; and, even to-day, a simple super-regenerative detector, appropriately adjusted, can "run rings around" other current types of ham receivers with respect to sensitivity, a.v.c. action and general operating practicability. Its only real limitation in practice is its very poor selectivity. Then, it has acquired the undeserved reputation of being "noisy"—a reputation based on wide-

spread misuse and misadjustment of this type of detector.

Much more important than these things, however, is the ability of the super-regenerative

detector to discriminate against ignition noise and other similar man-made interference. This peculiar ability of the super-regen receiver has put it in a class by itself. No other type has the same extraordinary sensitivity combined with a.v.c. action and a striking ability to discriminate against noise.

Summing up the situation, the super-regenerative detector for ultra-high-frequency working has valuable features not available at all in other types of detectors; and it has, within itself, a greater

effective sensitivity than that realized from a whole parade of conventional amplifier tubes strung together. Is it any wonder that the super-regenerative detector is qualified to stand as the starting point for further ultra-high-frequency development?

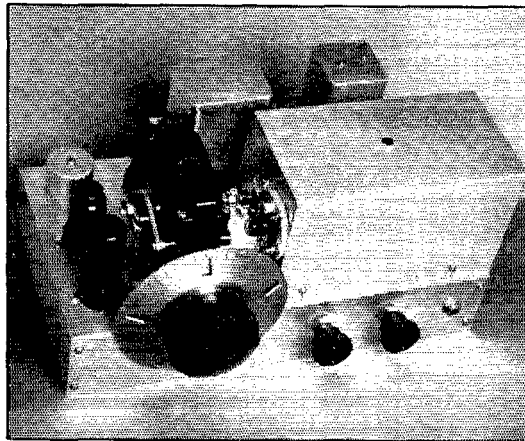

DUBBED "THE SUPER-INFRAGENERATOR" BY THE HEADQUARTERS CREW, THIS NEW TYPE OF RECEIVER HAS ALL THE DESIRABLE CHARACTERISTICS OF A "MUSH-LESS" SUPER-REGENERATOR TOGETHER WITH ADJUSTABLE HIGH SELECTIVITY

* Associate Editor, QST.

EARLY DEVELOPMENTS

Since the earliest days of ultra-high-frequency working, the technical people at Headquarters have maintained a broad view of the ultra-high-frequency receiver problem. Since 1926,

order of selectivity has long been perfectly straightforward and practical. It is merely necessary to follow normal low-frequency practice involving a frequency-converting first detector, two or more intermediate-frequency amplifiers,

and the conventional second detector and audio system. Indeed, the selectivity of such a receiver, when provided with 465-ke. intermediate transformers having a total of, say, six tuned circuits, will be considerably greater than can be handled satisfactorily in practice. Developments in commercial circles have been toward the use of a much higher intermediate frequency. In this way, the selectivity is reduced to a reasonable value and, incidentally, difficulties from image interference are avoided. The outcome of such a plan is a relatively complex receiver having medium selectivity and fair sensitivity. The receiver, however, is in no way equipped to handle the ignition interference and general noise

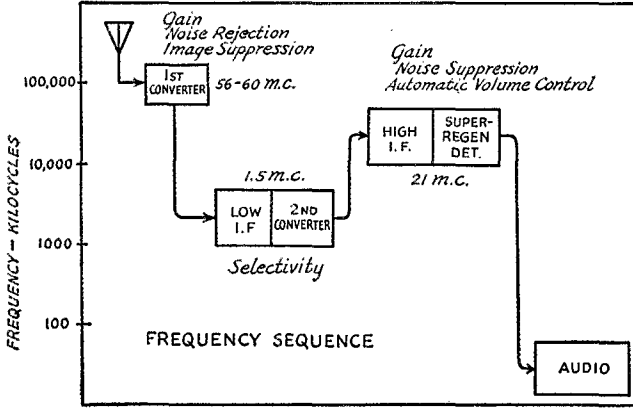

ROUTE TAKEN BY THE SIGNAL IN THE SUPER-SUPER RECEIVER

Three detectors are operated in a row with no amplifiers between them. Two widely different intermediate frequencies are used—one at about 1500 kc. and the other around 22.5 mc.

resistance-coupled autodyne-type superheterodynes and the more adequate conventional superhets have been built and rebuilt. Because these receivers have consistently failed to equal the performance of the simple super-regenerator (except in the matter of selectivity) they have not been exploited to any appreciable extent in *QST*. Our efforts have always been aimed toward the development of a receiver in which adequate selectivity could be obtained without sacrificing the inherent noise discrimination ability, sensitivity and a.v.c. action characteristic of the simple super-regenerator. We present the details of this particular receiver system because we believe we have succeeded in providing one practical solution to the problem.

background characteristic of the ultra-high frequencies (particularly the 56-mc. band). Placed alongside a conventional super-regenerator, the superheterodyne makes an extremely

LIMITATIONS OF THE SUPERHET

The work of setting up an ultra-high-frequency receiver having a high

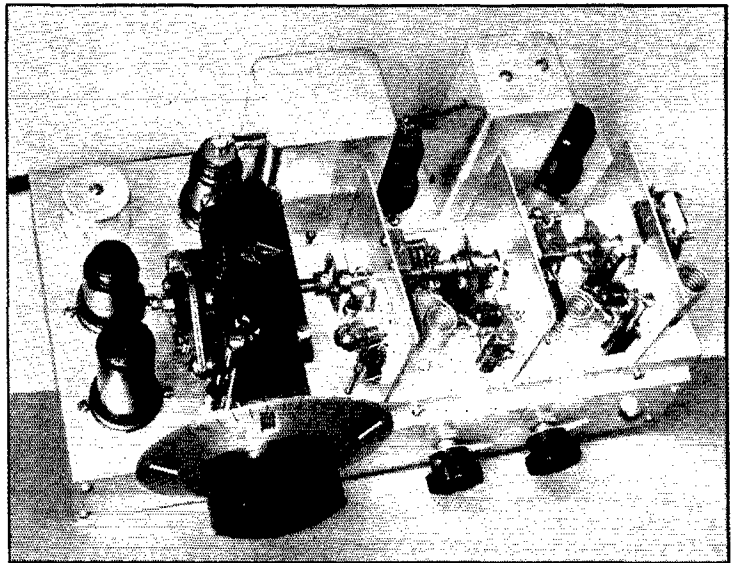

A METAL-TUBE VERSION OF THE NEW RECEIVER WITH THE SHIELD COVER REMOVED

On the partitions, reading left to right, are the first oscillator, first detector and input r.f. stage. Reading from right to left, along the rear of the set, are located the second oscillator; low-i.f. transformer; second converter; super-regen input coil; super-regen detector; quench oscillator coil; quench oscillator and audio amplifier tubes.

poor showing in a normally noisy location. In the sort of location most of us have—on or near busy streets—the conventional superheterodyne, in our experience, is unsatisfactory.

SELECTIVITY PLUS SUPER-REGENERATION

Our enthusiasm over the possibility of building a receiver with the selectivity of the usual superheterodyne but with the noise-discriminating ability of the super-regenerative receiver was boosted greatly after doing some preliminary experimental work along lines suggested to us by engineers of the General Electric Company. This experimental work involved the use of a super-regenerative second detector in a superheterodyne. The early receivers had an intermediate-frequency amplifier operating on about 8 megacycles—a frequency high enough to permit effective super-regenerative action and yet low enough to allow reasonable selectivity and amplification in the i.f. amplifier. Several experimental receivers of this type were constructed and all showed great promise. The chief difficulty rotated around the construction of a stable i.f. amplifier and in the preservation of the noise-discriminating ability of the super-regenerative tube. Further experiment was undertaken with receivers in which the incoming signal frequency was converted to a very much higher frequency (200 megacycles or so). In these layouts, excellent

THE NEW SCHEME OUTLINED

At this stage of the development work, a careful study was made of Armstrong's original paper on super-regeneration published in the *Proceedings of the Institute of Radio Engineers*, August, 1922. Examination of the suggested super-regenerative superheterodyne circuit in this paper, and further study of the basic characteristics of the super-regenerative detectors, led us to hope that we could retain all the desirable qualities of the super-regenerative detector *if only we could avoid having any resonant circuit ahead of the detector tuning to its own frequency*. From the maze of hookups and scrawled diagrams came the concept of a receiver in which the business of obtaining selectivity and that of obtaining super-regenerative action were completely segregated. This concept forms the basis of the receiving system to be discussed.

In the new receiver the incoming ultra-high-frequency signal is converted in the first detector (or mixer) to an appropriate low first-intermediate frequency. This permits the immediate establishment of a desirable order of selectivity. The second detector, instead of converting this low-frequency signal to give an audio-frequency output, converts the i.f. signal to a very much higher frequency suited for thoroughly effective super-regenerative detector action. This high-intermediate frequency is tremendously amplified

and its audio-frequency components made audible by the super-regenerative 3rd detector. It is then amplified with the conventional audio-frequency tube. The receiver, in its present form, therefore consists primarily of three detectors operating on three widely separated frequencies and interconnected with nothing more than appropriate tuned circuits.

The frequency sequence diagram of Fig. 1 will serve to make the arrangement clearer. In this diagram, the first converter unit comprises a pre-selector, an oscillator and a mixer tube. In this unit, the incoming frequency is amplified very considerably by the pre-selector stage, fed to the mixer tube and there converted to the low-intermediate frequency which, in the receiver to be described, is of the order of 1500 kc. (1.5 mc.). The second converter unit consists of the tuned input circuits necessary to provide the desired selectivity, together with a second oscillator and mixer tube. The frequency of the oscillator in this second converter unit is such that the output frequency from the mixer

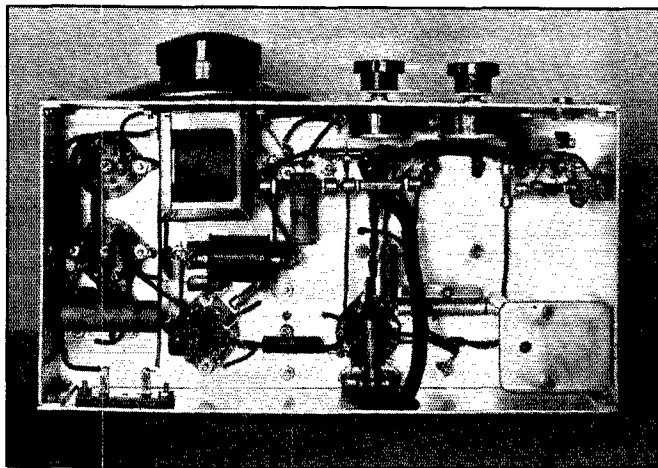

A BOTTOM VIEW OF THE NEW RECEIVER

The wiring of the set is a good deal simpler than the operating principle would lead one to expect. The second oscillator coil and condenser are inclosed in the shield can in the lower right corner. Other units may be identified by referring to the circuits given.

super-regenerative performance was obtained; but the concentric short resonant lines which were to have provided the necessary selectivity, were still inadequate. The outcome was a firm decision that any really "hot-dog" u.h.f. receiver would have to be built around a super-regen final detector.

1500 kc. (1.5 mc.). The second converter unit consists of the tuned input circuits necessary to provide the desired selectivity, together with a second oscillator and mixer tube. The frequency of the oscillator in this second converter unit is such that the output frequency from the mixer

is of the order of 21 to 25 megacycles. (Considerations to be discussed later influenced the choice of some particular frequency in this vicinity.) This second or high-i.f. is fed directly to the super-regenerative third detector. The modulation components then pass to the audio amplifier.

too great for use! This intermediate amplifier is not shown in the receiver illustrated simply because it was found unnecessary. There are instances, however, where such an amplifier might be of benefit. This particular phase of the design will be given treatment later.

Thorough experiment with four models which preceded the metal-tube version illustrated served to convince us that the system is not only sound but permits construction of a receiver of unparalleled performance. In the first two converter stages there is some negative gain. This, however, is more than compensated for by the gain of the first tube of the receiver. The final out-

come is an overall gain greater than that of the super-regenerative detector by itself. This enormous sensitivity, together with the selectivity of the receiver, results in a performance which we have been quite unable to approach with either the conventional superheterodyne or the plain super-regenerator. The receiver is a choice morsel for the advanced and skilled receiver constructor. It is, though, surprisingly straightforward from a constructional angle and no more difficult to line up and adjust than the conventional superheterodyne. With the exception of the pre-selector, no two successive stages

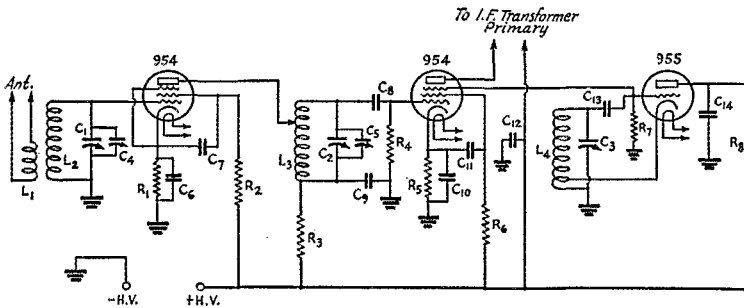

WIRING OF THE THREE-TUBE ACORN INPUT UNIT

This unit is actually a conventional super-heterodyne tuning system with pre-selector, first detector and first oscillator. Suppressor injection is used in the first detector. Constants and adjustment details will be given in Part II of this article.

As is indicated on the diagram, the first converter unit serves to provide appreciable gain, good signal-noise ratio and the suppression of images. The input of the second converter has as its only function the provision of the required selectivity. The super-regenerative third detector is, of course, the heart and lungs of the receiver, providing, as it does, enormous gain, effective suppression of ignition noises and the like, together with a very high order of automatic volume control action.

ABOUT PERFORMANCE

In our early work with this system, we were a little afraid that the receiver would turn out to be a very complicated affair, tricky to tune and so badly handicapped by losses in the first two converter units that high sensitivity would not be realized. The first experimental model was fitted with an amplifier stage offset the losses in the converter that the overall gain of the receiver was actually

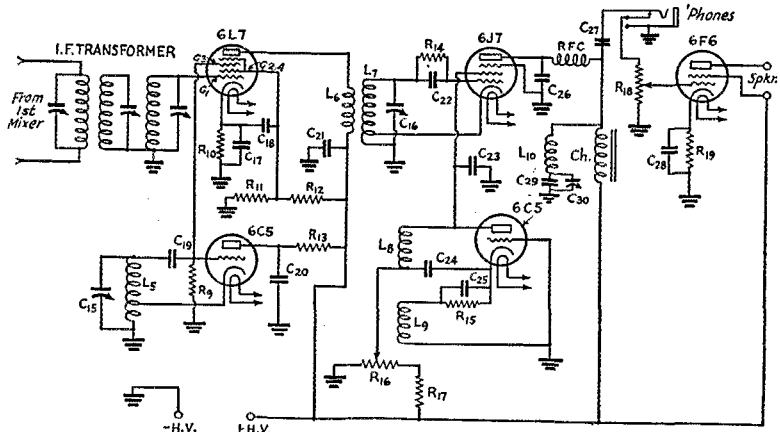

WIRING OF THE TWO INTERMEDIATE FREQUENCY CIRCUITS AND THE OUTPUT SECTION

The tube at the upper left is the mixer, operating in conjunction with the oscillator tube under it to convert the incoming low intermediate frequency to the second or high i.f. The 6L7 mixer feeds through L₁ and L₂ to the super-regenerative third detector, coupled with which is the quench oscillator shown below it. The choke L₁₀ and the condensers associated with it form a filter for the quench frequency. Its action prevents the audio tube from being loaded with unwanted quench voltage.

are operating on the same frequency. This accounts for its unusual inherent tolerance; which, of course, plays a very important part in simplifying the adjustment of the receiver.

VARYING SELECTIVITY

One very desirable feature of the setup just outlined is that the circuits concerned with selectivity are all contained within a single shield can. This immediately permits the provision of variable selectivity over a considerable range of values. For instance, the one low-i.f. transformer may be made plug-in. For reception from transmitters suffering from very severe frequency modulation, this unit could be a single tuned circuit with an appropriate coupling condenser and grid resistor. Alternatively, it could consist of a pair of tuned circuits with mechanical variation of the coupling between them. The metal-tube receiver illustrated is fitted with a three-circuit intermediate-frequency transformer which, as it happens, provides an order of selectivity such that most ordinary modulated-oscillator 56-mc. transmitters are on the verge of being unreadable. Stability permitting, the transformer unit could even be replaced with one containing a crystal filter. In this manner, without disturbing the rest of the receiver, the selectivity may be carried to the very limit.

CHOOSING INTERMEDIATE FREQUENCIES

One important fundamental in the design of the receiver is the choice of appropriate low- and high-intermediate frequencies. The two considerations involved in choosing the low-i.f. are, close-up selectivity and image interference. Practice has shown that two conventional tuned-transformer circuits on 465 kc. give rather more selectivity than can be tolerated at the present stage of general ultra-high-frequency transmitter practice. Further, such an intermediate frequency is not sufficiently high to give a favorable ratio between the incoming signal and its image. The low-i.f. of 1500 kc. used in the metal-tube receiver appears to be a satisfactory figure from both aspects. A triple-tuned transformer at this frequency gives as much selectivity as can be handled conveniently. Then, the frequency is high enough to reduce the image to a very low value. There is, of course, considerable flexibility in the choice of this frequency, and it is altogether possible that the future will reveal the desirability of increasing it further.

The choice of the high-intermediate frequency is not quite so straightforward. The primary requirement is that this frequency should be high enough to allow thoroughly effective super-regenerative action. At the same time, its frequency must be such that none of its important harmonics fall within the tuning range of the receiver. Again, it is very important that the stronger harmonics of the second oscillator are

not so located as to produce beats with strong harmonics of the first oscillator at the frequency on which the third detector is operating. So great is the sensitivity of this third detector that beats between, for instance, the third harmonic of the first oscillator and the seventh harmonic of the second oscillator result in an audible "soft spot" in the tuning range. Fortunately, it is readily possible to obtain a frequency for the high i.f. which will avoid this "birdie" trouble within the limits of the 56-60 megacycle band and harmonically related higher frequencies.

With the second oscillator set on 21 megacycles, for example (the resulting intermediate frequency being 22.5 megacycles), the most serious birdie results from a beat between the fourth harmonic of the first oscillator and the tenth harmonic of the second oscillator. This birdie and the successive ones are, of course, of no consequence in actual practice. In this case also, further study may possibly reveal the desirability of an entirely different order of high-intermediate frequency. Fortunately, changes of frequency in this section of the receiver can be accomplished with the greatest ease.

"HISS" NO PROBLEM

In discussing the performance of the receiver shown on these pages, it would be well first to make a very emphatic statement with respect to the order of super-regenerative "hiss" which must be tolerated. So many ultra-high-frequency workers have been using transceivers, and super-regenerative receivers belonging in the same general group, that a very widespread impression has been created to the effect that a super-regenerative receiver cannot be operated without a continual and immensely aggravating rushing noise. Users of separately quenched super-regenerative receivers, properly adjusted, are well aware that this nuisance is not only unnecessary but that it is a rather definite indication of improper receiver adjustment. When operating correctly, a super-regenerative detector of proper design can be operated in a super-regenerative condition with a hiss level so low as to be substantially inaudible. Nevertheless, in this operating condition the detector is capable of extremely high-signal output. It is found, of course, that the optimum signal-noise ratio with very weak signals is to be had only by a rather precise manipulation of the super-regenerative detector—a setting under which the hiss is clearly audible only in a quiet location. In the average location, however, the sensitivity of the receiver is such that the usual man-made noise is of a higher level than the super-regenerative hiss at the optimum setting of the detector.

As a result, the receiver, in normal operation, sounds almost exactly like any conventional superheterodyne operating on the lower fre-

(Continued on page 100)

A Consistent Antipodal Experimental Circuit

VK6MO and W3AMS Work Daily Half-Way Around the Earth

By S. L. Seaton* and J. S. Lacey,** W3AMS

THE object of this article is to describe what is thought to be the longest, sustained, experimental radio communication circuit in history. Daily communication is maintained between VK6MO and W3AMS over a distance of 11,483 miles. Signals are heard both ways around the earth, although no traffic is handled over the long path because of interference at W3AMS during the early evening hours.

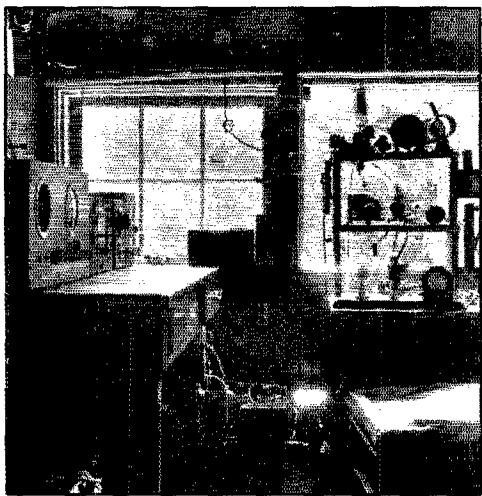

THE STATION EQUIPMENT AT W3AMS, WHICH WORKS THE LONG CIRCUIT TO VK6MO WITH THE 100-WATT TRANSMITTER SHOWN AT THE RIGHT

The circuit was established for the purpose of exchanging scientific information between the home office of the Department of Terrestrial Magnetism, Carnegie Institution of Washington, in Washington, D. C., and its observatory near Watheroo, Western Australia (VK6MO). The results of observations made in studies of the earth's magnetism, electric charge, currents in the earth's crust, measurements of the ionosphere, and other associated observations in related fields, are sent daily over this channel. Since the circuit is half-way around the world it was first thought that communication would be uncertain; but experience has proven that there

* Department of Terrestrial Magnetism, Carnegie Institution of Washington.

** Lacey and Lacey, Patent Attorneys, Barrister Building, Washington, D. C.

are exceptionally few days during which satisfactory contact cannot be had. The average load carried is 1200 words a month of highly technical language and the estimated maximum circuit-capacity is 3000 words a month.

Communication is maintained on the 7-mc. band. Since both power and frequency are limited, there had to be found a time of day such as to use to greatest advantage the available facilities. It has been found that there is, roughly, one and one-half hours during which satisfactory communication may be had each day. The time of the beginning of this period varies with season in such a way that the winter hour is later than

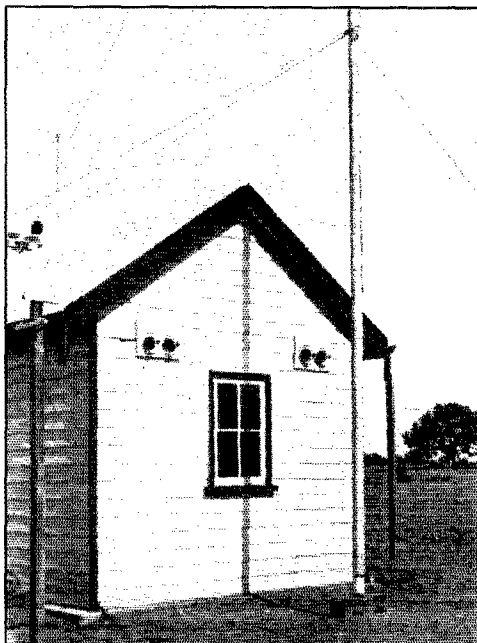

THE ANTENNA LEAD-IN SIDE OF THE "SHACK" AT VK6MO, WATHEROO, WEST AUSTRALIA

The base of the vertical radiating mast is shown in the foreground.

the summer hour (at Washington) for starting operation.

At VK6MO the antenna power is 200 watts and at W3AMS 100 watts. The receiver at Washing-

(Continued on page 74)

28-Mc. Communication Continues

All Continents Actively on the Air—ZSIH and W7AMX Work 5 Continents

THIS summer the 28-mc. band has certainly given the ten-meter gang thrills as well as disappointments. However, activity has been at a high level for the past six months. What with multi-band transmitters and more efficient receivers, it is only a moment's change to go from 14 to 28 mc. if sigs are coming through on 28.

During early summer the ten-meter band opened up and great gobs of real DX contacts at maximum signal strengths were had. New records for this band were hung up and the newcomer was all set for big things during the summer months. However, the old-timers shook their heads and were not surprised when middle summer months were very flat as far as communication over anything but local distances occurred. At the low ebb of communication in August, W4AJY made the prediction that September conditions would match March, and DX would once more come through. Anyone who was active on ten meters during middle September and on up to the present writing knows that AJY's prediction was more than fulfilled.

Africa hasn't been heard from on this band in North America for years, but is now represented by ZSIH who comes through on 28,150 kc. nearly every noon in West Hartford, often at R9 strength. W1DF contacted ZSIH on October 2d for the first W1-ZS contact. W9BVI was the first W-ZS contact in seven years. On October 6th, ZSIH told W1DF that he had worked 5 continents and had called the sixth! LU1EP and X1AY have each worked 4 continents. If conditions don't pick up as far as the W gang is concerned, mighty soon the first ten-meter WAC will be awarded to some foreigner. This honor is about the only DX record in sight for years to come. The cup donated by the Lakewood (Ohio) Radio Club to the first station making WAC on ten meters is still up for competition. The League's medallion awarded the outstanding 28-mc. station-operator during the past year is about to be awarded. There is tremendous interest in both of these projects.

Our files are fairly bulging with reports of 28-mc. DX communication. From this file we are picking the highlights. We cannot predict future conditions or results, the only thing we can do is to record what is being done from time to time and hope that it continues.

W4AJY is the best W contact with South

America. Besides working several LU's, AJY has contacted OA4J. W6VQ works VK's by the dozen. X1AY continues to blast his signal to the four corners of the earth.

X1AY reports 78 contacts the last week in September. When 28-mc. conditions are good he is going to try c.w. telegraph on 56.1 mc. Calls heard at X1AY on 28 mc. from August 16th to September 30th include:

w1akr w1av w1avv w1csr w1dze
w1elr w1eyg w1fgl w1zb
w2bpy w2bqk w2cwe w2dpa w2dza
w2erp w2euz w2ewh w2fdl w2fe
w2gjb w2giz w2gox w2gwe w2rs w2tp
w3adp w3air w3amp w3bph w3bvn
w3ca-5 w3chg w3cgg w3djf w3dlb
w3ejo w3eto w3evt w3frs w3kt w3rt
w4agp w4ajy w4auu w4can w4cen
w4efd w4cjj w4dgm w4hc w4tr
w5afv w5afx w5qf w5ql
w6ahz w6avt w6awt w6azi w6cgg
w6cis w6cnx w6cxw w6dzh w6dio
w6dlm w6eda w6epz w6ewc w6gez
w6grx w6hdy w6idf w6jja w6jju
w6jnr w6jyy w6jzs w6kbb w6kbd
w6kby w6kpr w6kpr w6ldj w6ltr
w6lym w6mjk w6mld w6rhr w6vc
w6vq

w7amx w7avv w7drj
w8apb w8bki w8hof w8cbc w8cra
w8czr w8czu w8dpo w8dvs w8dvx w8dyk
w8elp w8eqq w8gww w8iep w8ipy w8isc w8ita
w8itk w8ixs w8jax w8jdc w8kcz w8ktw w8lhc
w8mod w8mwy w8oe w8uq

w9aew w9aoc w9bqh w9bvi w9dhn w9doe w9drn
w9ege w9evx w9fj w9fm w9fwj w9haq w9iwe
w9jaq w9kpd w9ny w9pya w9rua w9rzb
w9si w9tjf
k5ac k5ag lulep lu2am lu3dd lu3dh lu4da lu6ax
lu7az lu9bv oa4j ti2av ti3wd ve3du vk2lz
vk4bb zslh

W6AVT heard ON4FE on October 3d at 1:20 p.m. PST. W6AVT and W6IDF have been active on 28 mc. for 4½ years and predict that the last three months of this year are going to be the DX months, and they intend to keep up a 24-hour listening watch to bear out their idea. From W8BXC we received the following radiogram from Australia: ON4AU BELGIUM ON 28.2 mc. WAS QSO VK4EI AT 0758 GT OCT. 5 AND AGAIN AT 0952 SAME DATE PROBABLY FIRST OCEANIA EUROPE CONTACT REPORTS BOTH ENDS QSA 5 R6.

W6JJU worked J3FJ on October 1st at 3:30 p.m. PST. W6IDF has contacted F8SQ and a G5. W9NY heard VK2LZ several times

FLASH!!

ZSIH completes WAC by contacting J2HJ October 13th.

Rumored that ON4AU also has WAC.

Who will be the first W?

during the last two weeks in September and worked ZS1H. W9NY will call CQ daily between 1230 and 1235 GT.

ZS1H has worked all but J2IS of the following list: g2hg g5wp on4ac g2yl f8vs j2is f8oz lulep f8ef g5fv on4au d4kpj fa8ih fa8er w9bvi pa0qq lu3dh d4mdn w9ny wldf f8ct f8cnp d4oon g6dh oe7ok vk6sa oklaw wlavv.

LU1EP heard JZIS work VK3BW and VK4BB at 0400 GT on September 29th.

Keep the dope coming through and get the rigs fixed so that valuable time will not be lost in getting on ten meters when conditions are right. So far this has been the greatest year for ten-meter communication. It may continue this way.

A.R.R.L. QSL Bureau

FOR the convenience of its members, the League maintains a QSL-card forwarding system which operates through volunteer "District QSL Managers" in each of the nine U. S. and five Canadian districts. In order to secure such foreign cards as may be received for you, send your district manager a standard No. 8 stamped envelope. If you have reason to expect a considerable number of cards, put on an extra stamp so that it has a total of six-cents postage. Your own name and address go in the customary place on the face, and your station call should be printed prominently in the upper left-hand corner. When you receive cards, you should immediately furnish your QSL manager with another such envelope to replace the used one.

- W1—J. T. Steiger, W1BGY, 35 Call Street, Willimansett, Mass.
W2—H. W. Yahnel, W2SN, Lake Ave., Helmetta, N. J.
W3—R. E. Macomber, W3CZE, 418 10th St., N. W., Washington, D. C.
W4—B. W. Benning, W4CBY, 520 Whiteford Ave., Atlanta, Ga.
W5—E. H. Treadaway, W5DKR, 2749 Myrtle St., New Orleans, La.
W6—C. E. Spitz, W6FZQ, Box 1804, Phoenix, Ariz.
W7—L. Q. Kelly, W7BPC, 4919 So. Prospect St., Tacoma, Wash.
W8—F. W. Allen, W8GER, 324 Richmond Ave., Dayton, Ohio
W9—George Dammann, W9JO, 319 Sherman Ave., Evanston, Ill.
VE1—J. E. Roue, VE1FB, 84 Spring Garden Rd., Halifax, N. S.
VE2—W. H. Oke, VE2AH, 5184 Mountain Sights Ave., N. D. G., Montreal, P. Q.
VE3—Bert Knowles, VE3QB, Lanark, Ont.
VE4—Dr. J. J. Dobry, VE4DR, Killam, Alberta.
VE5—E. H. Cooper, VE5EC, 2024 Carnarvon St., Victoria, B. C.
K4—F. McCown, K4RJ, Family Court 7, San-turce, Puerto Rico.

WE HAVE the unhappy duty of recording the death of Clair Foster, W6HM, one of America's best-known amateurs, in Denver on October 2d, at the age of 67 years. Ill the preceding two months, he was journeying east from his home in California when he was overtaken by more serious illness, stopped at a Denver hospital for treatment, and there passed on after about a week, from a complication of physical troubles.

Mr. Foster entered amateur radio in 1922 and was amongst the early DX-workers. By 1925 he was engaging in a considerable amount of transpacific correspondence and had been the first to work several countries. He was the original proponent of the idea of the Worked-All-Continents Club and in



Clair Foster

1926 received the second W.A.C. certificate ever issued. In later years he became one of the most active and ardent of the A.R.R.L. transpacific traffic handlers. The Pacific Division elected him their director in 1932. He served through one meeting of the Board, resigning in November of that year; he was named by the Board to the A.R.R.L. representation at the Madrid Conference, although he later declined the appointment. He was the author of several QST articles, which we have always considered outstanding pieces of amateur literature because they exemplify so well that vital aspect of amateur radio of which Foster was a master, the thing vaguely called "human interest," the living, human side of the game.

Before the war Mr. Foster was engaged in large-scale construction projects. During the war he served in Washington as a major in the office of the War Industries Board. In 1919 he was commissioned a reserve major in the Quartermaster Corps and was subsequently promoted to lieutenant-colonel in the reserves. Upon reaching retirement age some years ago he transferred to the auxiliary reserve of the Q.M.C.

A writer of considerable gift, Col. Foster in his later years devoted his talents largely to pointed and colorful comment on the course of amateur radio in this country. Although he and we did not see alike on many of these matters, that is now neither here nor there and we know that the real Clair Foster was as fine an amateur as ever lived. For he had this one great gift, and

(Continued on page 96)

A Quick-Switch 'Phone Transmitter for Two-Band Operation

Rack-Mounted Design With Crystal Control, Suppressor-Modulated High-Power Pentodes and Oscilloscope Monitor

By James Millen,* W1HRX

THERE are obvious advantages in having a choice of transmitting frequencies quickly available in each amateur band. Many times one would like to use the transmitter on another band if the labor of band-switching was not too great. Then again, a slight change in frequency during a QSO will often take care of immediate interference difficulties.

Such universal transmitters have been built, of course, but the natural complexity of such gear puts it beyond the facilities of most amateurs. In an attempt to make a successful compromise between convenience and necessity, the transmitter described here was recently built. In actual operation the outfit proved to be so nice to handle that it seemed well worthwhile to pass the dope along.

The most important compromise in simplifying the band switching was to limit operation to two bands. This step was taken with misgivings, but it has not been regretted. Two bands, quickly available, are in practice much more useful than four bands in a transmitter which require laborious handling of plug-in coils and retuning to make frequency changes. For example, a 'phone can do quite nicely with just the 20- and 75-meter bands, which between them will take care of varying conditions of skip, etc. Similarly, c.w. fellows will in most instances want either the 20- and 40-, or the 40- and 80-meter bands.

With this concession made,

* National Company, Malden, Mass.

the transmitter design takes shape rapidly. The system chosen in the present instance was originally introduced by W6ZH, and has since been adopted by a number of amateurs. This system calls for the switching of complete, pre-tuned tank circuits right down the line, from final stage to crystal oscillator. Such a method of band switching minimizes troubles due to variations in contact resistance in the switches, eliminates breaking high r.f. currents, and makes unnecessary any retuning whatsoever when shifting bands. In its original form, such an outfit became rather cumbersome and expensive, due largely to the awkward size and high cost of the transmitting condensers, and to the difficulty in securing constant neutralization with triode circuits when shifting complete tanks. Fortunately, the situation is now largely changed. Compact high-voltage condensers of high quality can be had at quite low prices. And the new medium-power pentodes such as the RK-28 and 803 not only require no neutralization but offer the additional advantages of low excitation and convenient location of grid and plate terminals.

With this ground work disposed of, our pet ideas took shape as follows: The exciter unit has eight separate crystals, four for operation in the 20-meter band, and four for the 75-meter band. A single switch chooses between the two bands, and a pair of four-point switches select the operating frequency in their respective bands. The buffer, employing an RK-23, uses the

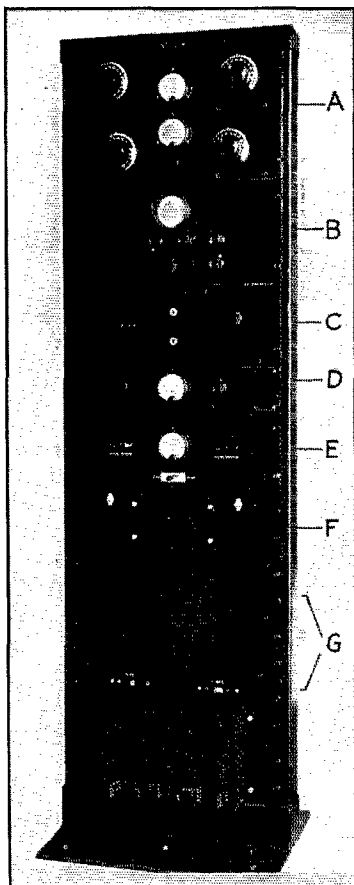

THE COMPLETE TRANSMITTER IS MOUNTED IN ONE RACK WITH INDIVIDUAL PANELS FOR THE COMPONENT UNITS

The letter designations for the panels are identified with the rear view.

W6ZH series tank idea which eliminates switching at this point. The final stage uses a pair of 803's with separate tanks for each band, switched by a single knob. The complete rig, in all its impressiveness, is shown in the illustration.

THE EXCITER

A close-up of the exciter is also shown. It is built up in a modified form of the newer Western Electric practice of vertical chassis arrangement for "dish" relay rack mounting. The variations from standard Western Electric practice that have been made can hardly be called an improvement, but are resorted to solely for the sake of adapting this type of construction to the amateur's workshop. The vertical chassis for the exciter (and buffer) offers worthwhile advantages. Construction and wiring is simplified, tanks and crystals are readily accessible, and an uncrowded compactness is achieved. The rear view of the exciter shows the layout.

At the left are the four 75-meter crystals, along with the shielded tank and the 53 oscillator. At the right are the four crystals for operation at 20 meters. They are ground for 40 meters, a doubler stage being used. The exciter and doubler tanks are mounted beside the crystals with the 53 triode oscillator and doubler between them. The Federal anti-capacity switch used to shift bands shows its butt-end in the foreground. The selector switches are under the chassis. One of these switches is shown in a close-up photo, and more will be said about them later.

The circuit diagram does not require much explanation, as it is quite orthodox. The 53 oscillator-doubler is the well known arrangement introduced by W1CTW,¹ and the pre-tuned tank-switching has been described by W9DRD.²

THE CRYSTAL SELECTOR

The principal novelty of the circuit is in fact mechanical rather than electrical. It will be noted from the diagram that each selector switch has a vernier condenser ganged to it, this condenser being connected in parallel with the

¹ Millen, "A Pentode Output Transmitter With Six-Band Exciter," *QST*, October, 1934.

² Hollister, "A Four-Band Exciter," *QST*, July, 1935.

main tank tuning condenser. The photograph shows a close-up of this arrangement, which consists of a small condenser built up on the frame of the switch. Such a gadget can be built up from odd parts in the junk box without much difficulty. Its purpose is to keep the tank circuit in tune, and hence the excitation constant, as the frequency is changed. Our only excuse for the design is that it works. When one considers that the maximum frequency shift on the 80-meter 'phone band is only 2½ percent (3900 to 4000 kc.), it is obvious that the required effect of the vernier condenser is so small that its adjustment is not at all critical. As a matter of fact, the exciter will operate without it, but its use keeps the excitation more constant, which we think is ample justification for it.

The actual adjustment is extremely simple.

With the crystals plugged in their proper sockets and the switch turned to the highest frequency, the rotor plate should be all the way out. Now tune the tank circuit in the usual way, using the main condenser. Next, turn the switch to the lowest frequency. This puts the lowest-frequency crystal in circuit and turns the rotor all in. Now retune by moving the stator plates of the vernier condenser by means of the nuts on the stator studs. *Do not touch the main tank tuning condensers.* The adjustment is now complete. For the two intermediate frequencies it is unlikely that the tank will be exactly in tune, but it is even more unlikely that they will be more than a fraction of a percent out of tune, which is more than good enough.

THE BUFFER

The exciter just described was originally intended to drive a pair of RK-20's in the final stage. For this purpose its output is entirely adequate. When it was decided to use the larger 803 or RK-28 pentodes, however, it was found that the r.f. output was not sufficient except when running with relatively low plate voltage on the final, and consequently the RK-23 buffer was added. The output of this buffer is more than ample, even when using 803's with

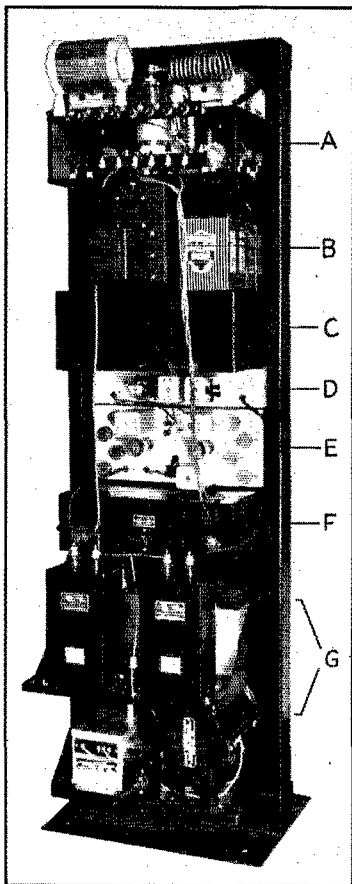

REAR VIEW OF THE TRANSMITTER ASSEMBLY

The panels are identified as follows: A, final power amplifier; B, oscilloscope with p.a. bias batteries; C, speech input and modulator; D, buffer; E, exciter; F, dual low-voltage power supply; and G, high-voltage power supply.

slightly over 3000 volts on the plate, as we have been doing recently in connection with life tests.

The buffer is visible in the rear view, just above the exciter unit. It is built up on the same kind of depressed panel unit that was used for the exciter. The gear on this chassis is quite simple, and the illustration shows the layout of the

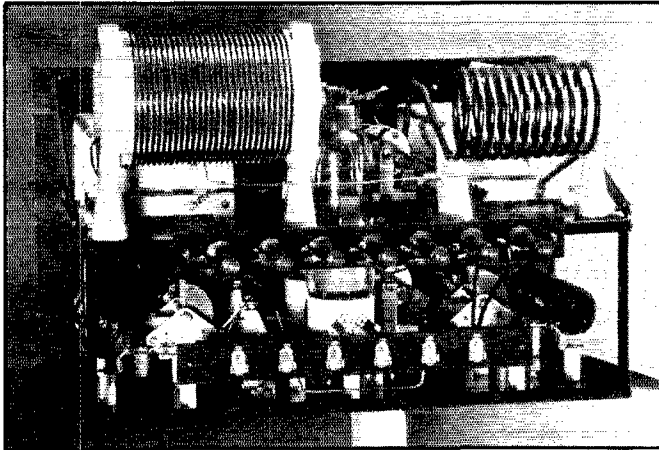

SHOWING THE DETAILS OF THE FINAL POWER-AMPLIFIER UNIT AS VIEWED FROM THE REAR

RK-23, the two tanks, and the plate milliammeter.

The W6ZH plate tank circuit will probably be new to most amateurs. The two tanks for 20 meters and 75 meters are of themselves quite conventional, but it will be noted that they are connected in series and are always in circuit. This is made possible by the fact that the impedance of a parallel-resonant circuit drops rapidly as it is detuned from the driver. Consequently the unused tank causes only a negligible loss by being left in circuit, and virtually the entire output voltage is built up across the used tank. This scheme also eliminates switching in the output circuit of the buffer, and permits the buffer tanks to be permanently coupled to the grid tanks of the final.

There is a further refinement in the buffer circuit which we believe is entirely new. This is the excitation control R_8 , which varies the suppressor voltage from zero to about -90 volts. At zero voltage the RK-23 is doing its best, while at the other extreme the full negative bias is sufficient to cause almost complete cut-off. The control is exceptionally smooth at all positions, and is very satisfactory in every way. The negative voltage is obtained from the voltage drop across the bias resistor R_7 . These resistors are connected in parallel, and could be a single resistor. The reason for the arrangement shown is that it puts the burden of the load on the fixed resistor R_7 , and makes it possible to use a receiver-type potentiometer for the control R_8 .

THE FINAL R.F. STAGE

A double deck type of construction is used in the final stage in order to shield the input and output circuits of the pentodes when mounted vertically as recommended by the tube manufacturers. This shielding also provides a very handy shelf on which to mount the plate tank tuning condensers, coils and band-shifting switch. Similar equipment for the grid circuit is mounted on the lower shelf. The grid coils are standard National R39 receiving coil forms with the pins knocked out of the base and then mounted back to back. The grid and plate switches are ganged together with ordinary link-and-lever construction. These switches may be purchased complete or, as in the case of this transmitter, made from odds and ends to be found in most every amateur work shop. The Steatite discs are from National flexible couplings and the Isolantite strips are from midget receiving condensers. The switch jaws are taken from an old double-pole

double-throw knife switch. The shaft is a piece of $\frac{1}{4}$ -inch rod, and the frame and bearings are bent up from a piece of brass strip.

The circuit in general is exactly that recommended by the tube manufacturers. Care should be used, however, in running the high-voltage plate supply lead to see that it is so placed and bypassed that r.f. is prevented from getting into the power supply. The condenser and r.f. choke shown in the illustration and diagram were found essential for this purpose, even though the circuit is of the push-pull variety. Likewise, an r.f. bypass condenser should be connected across the plate circuit milliammeter. The screen voltage is obtained from the dropping resistors mounted on the back edge of the upper deck. The suppressor-grid and control-grid biasing voltages are obtained from B batteries.

THE SPEECH PANEL

The speech panel is quite conventional and is adapted from the audio chassis of a broadcast receiver. This chassis included a complete power supply, and had excellent tone quality, so that only minor changes were necessary. As completed the input tube is a 56 which swings a pair of 45's, which in turn are transformer-coupled to the suppressor grid circuit of the final amplifier.

Two input jacks are provided. One jack connects directly across the 500-ohm primary of the input transformer, and is for use with a pre-amplifier and high-quality mike. The other jack

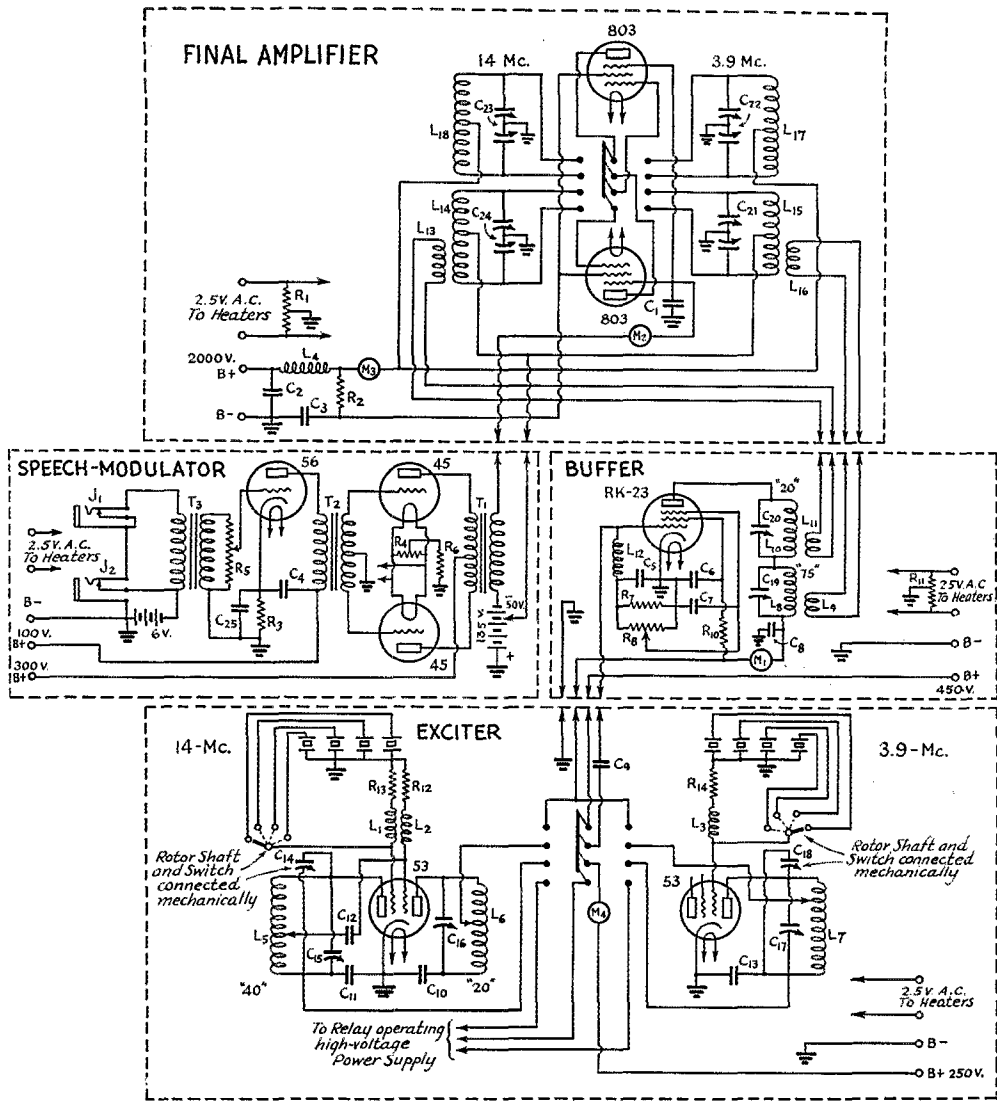
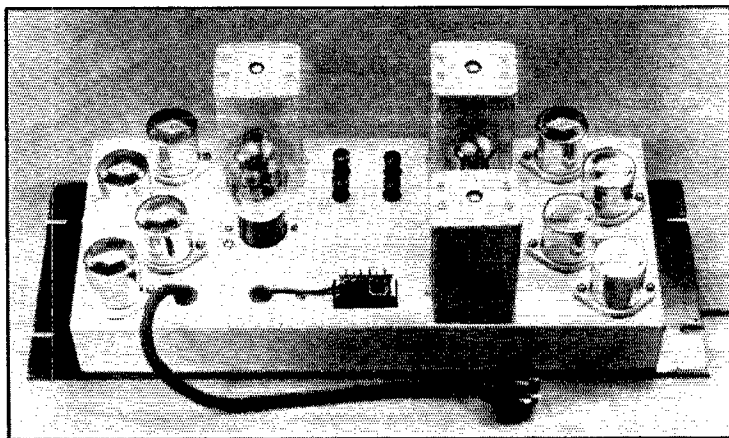

FIG. 1.—CIRCUIT OF THE TWO-BAND TRANSMITTER

- | | | | |
|--|---|---|--|
| <p>L₁, L₂, L₃, L₁₂—2.5-mh. r.f. chokes (National R-100).</p> <p>L₄—4-mh. transmitting r.f. choke (National R-154).</p> <p>L₅—22 turns, center tapped, No. 24 enameled wire on 1" dia.</p> <p>L₆—11 turns, center tapped, No. 24 enameled wire on 1" dia.</p> <p>L₇—40 turns, center tapped, No. 28 enameled wire on 1" dia.</p> <p>L₈—48 turns, No. 28 enameled wire on 1" dia.</p> <p>L₉, L₁₁—3 coupling turns on 1" dia.</p> <p>L₁₀—13 turns No. 24 enameled wire on 1" dia.</p> | <p>L₁₃, L₁₆—3 coupling turns on 1½" dia.</p> <p>L₁₄—16 turns No. 12 wire, 8 turns per inch on 1½" dia. Center tapped.</p> <p>L₁₅—60 turns No. 22 wire, 30 turns per inch on 1½" dia. Center tapped.</p> <p>L₁₇—27 turns No. 10 wire center tapped wound on 4" dia., 6 turns per inch (National XR-12A coil form).</p> <p>L₁₈—10 turns ¼" copper tubing self-supporting on 3" dia., 2 turns per inch.</p> <p>C₁, C₂, C₃—0.001-μfd. fixed.</p> <p>C₄, C₅, C₆, C₇, C₈, C₁₀, C₁₁, C₁₃—0.01-μfd. fixed.</p> <p>C₉, C₁₂—100-μfd. fixed.</p> <p>C₂₅—0.01 μfd. fixed.</p> | <p>C₁₄, C₁₈—Vernier condenser on crystal switch. (See text.)</p> <p>C₁₅, C₁₆, C₁₇, C₁₉, C₂₀—25-μfd. receiving type variable condensers (National UMA-25).</p> <p>C₂₁, C₂₄—Split stator transmitting condenser, 70 μfd. per section, 6000-volt (National TMS-70D).</p> <p>C₂₂, C₂₃—Split stator transmitting condenser, 50 μfd. per section, 6000-volt (National TMA-50DA).</p> <p>R₁—120-ohm fil. c.t.</p> <p>R₂—10,000-ohm 200-watt.</p> <p>R₃—3000-ohm 1-watt.</p> <p>R₄, R₁₁—20-ohm fil. c.t.</p> <p>R₅, R₈—50,000-ohm potentiometer (vol. control type).</p> <p>R₆—750-ohm 1-watt.</p> | <p>R₇, R₉—10,000-ohm 1-watt.</p> <p>R₁₀—12,000-ohm 10-watt.</p> <p>R₁₂—20,000-ohm 1-watt.</p> <p>R₁₅, R₁₇—5000-ohm 1-watt.</p> <p>M₁, M₄—0–50 d.c. milliammeter.</p> <p>M₂—0–30 d.c. milliammeter.</p> <p>M₃—0–300 d.c. milliammeter.</p> <p>T₁—Audio output transformer (National S11).</p> <p>T₂—Audio input transformer (National S51).</p> <p>T₃—Microphone transformer, 200-ohm input.</p> <p>J₁—200-ohm input or microphone current jack. (See text.)</p> <p>J₂—Single button carbon microphone jack. (See text.)</p> |
|--|---|---|--|

has a 6-volt battery in series with it and the primary, and is thus suited for use with a single-button carbon microphone. This battery is made up of four small flashlight cells located on the amplifier chassis. The power pack is the usual

supplies we used a double rack-mounted unit of the type designed for operating a pair of communication receivers. In this particular pack, one side furnishes power for the two 53's in the exciter, while the other side drives the RK-23 buffer. The circuit is wholly conventional.



THE EXCITER UNIT, FACE DOWN, WITH THE 75-METER SECTION AT THE LEFT AND THE 20-METER SECTION AT THE RIGHT

The tank circuits are contained in the shield cans, the tuning condensers being adjusted with a socket wrench.

thing, with an 80 rectifier. Gain is adjusted by a 50,000-ohm potentiometer in the grid circuit of the 56 input tube.

THE OSCILLOSCOPE

In conformance with the new regulations, it seemed desirable to have a built-in modulation indicator. For this purpose a standard table-model cathode-ray oscilloscope using a 906 tube was mounted on a standard rack panel as shown. Incidentally, this panel also supplied a convenient place for mounting the batteries for the control-grid and suppressor-grid bias of the final. Although convenient, this spot is also rather warm (due to the power supply below) and it is a good idea to place a piece of celotex under the batteries.

After having used the transmitter with the oscilloscope built-in, we wonder how we were ever able to operate properly without it. The answer is that probably we didn't.

THE POWER SUPPLIES

It seems hardly worthwhile to describe the power supplies in detail, since most transmitters built these days use power units originally obtained for other gear. This is true in the present case, which is why the high voltage supply is so much oversized. For the final stage any pack will do that can deliver 300 milliamps or more at 2000 volts. If c.w. operation is desired, 450 mils will be required. With suppressor-grid modulation employed, good voltage regulation is not necessary in the high-voltage supply. For the low voltage

ANTENNA COUPLING AND OPERATION

It will be noted that there is a complete lack of antenna or feeder tuning equipment on the main transmitter rack. In our own station, this gear is mounted on a wooden panel suspended from the ceiling directly above the transmitter. The panel contains two separate sets of feeder tuning condensers and r.f. ammeters in order that the 20-meter and 75-meter antennas may be readily and permanently tuned to the transmitter with a mini-

mum of feeder length within the shack. For 20-meter operation, we use a vertical half-wave Duralumin mast³ insulated from the ground. For 75-meter operation, a horizontal 133-foot Zepp running north and south is used.

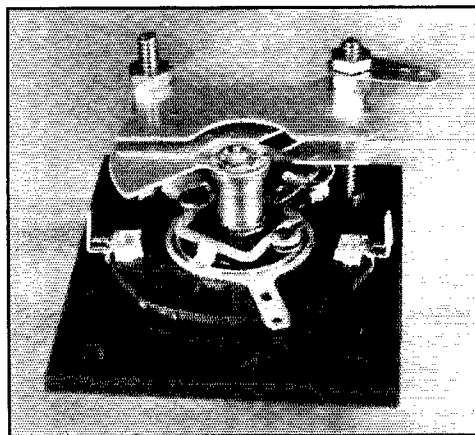

CLOSE-UP OF COMBINED CRYSTAL SELECTOR SWITCH AND OSCILLATOR TANK TRIMMER CONDENSER

The manipulation of the transmitter is very convenient. In switching from 20 to 75, or *vice versa*, the first step is to turn the knob on the final r.f. amplifier panel which controls the two

³ See cover illustration, October QST.—EDITOR.

switches in that circuit. The key switch on the exciter then completes the job when thrown to the corresponding position. There are a sufficient number of contacts on the Federal anti-capacity switch so that in addition to controlling the exciter and buffer, this switch also operates a 6-volt relay that controls plate current to the final stage and the "B" circuit switch in the receiver. Everything is "off" in the mid-position except the receiver.

Incidentally, I have had more fun with this new "sender" than with any transmitter I have ever had before. Apparently the combination of the sender and the mast, plus my misadjustments on the rig, result in a pretty swell signal all through the Middle West.

Strays

Rochester Fall Meeting of I.R.E.

The annual fall meeting of the I.R.E. at Rochester, N. Y., will be held on Nov. 18th, 19th and 20th with the Radio Club of America and the Radio Manufacturers Association holding joint sessions. These annual affairs have established themselves as high spots in the year's technical events, attracting a goodly amateur attendance by their practical, informal nature. This season's program promises to be of even greater interest than usual, with talks by several well-known amateur figures among those to be featured. Door prizes will be awarded at each of the daily luncheons and at the Tuesday evening stag banquet—those having purchased tickets at time of registration being eligible. All sessions will be held at the Sagamore Hotel.

High-Frequency Crystals of New-Type Cut

A new type of crystal cut, considerably thicker than the standard X-cut and having a lower temperature-frequency coefficient, bids fair to make 20-meter—and even higher frequency—crystals as practical as those for the lower frequencies. The new cut has been worked out by engineers of the Bliley Electric Company, and it is expected that production crystals for 14 mc. and higher frequencies will be available in the near future.

Further information on the characteristics of the new crystals and practical dope on circuits is scheduled for an early issue. Sample 14-mc. crystals tested appear to be ready oscillators, and "mike" about the same thickness as a 7-mc. X-cut.

Another example of ham cooperation: Not long ago the last rectifier tubes blew out at KWBG, putting the station off the air. The chief op, W9IXE, rushed to a nearby ham station to find him in the midst of a QSO, but the ham, W9VBK, pulled out his pair of 866's and the b.c. station was back on the air in a few minutes!

—W9FMX



PANEL VIEW OF THE EXCITER UNIT, SHOWING THE TWO CRYSTAL SELECTOR CONTROLS (RIGHT AND LEFT), WITH THE BAND-SWITCH BELOW THE PLATE MILLIAMMETER

A gadget of interest to both hams and service men is a new interference analyzer, a unit which can be connected in series with the 110-volt or 220-volt supply to offending electrical machinery and adjusted for various capacity-filter combinations to find the right values needed

for keeping the noise from getting through the line. Provisions also are made for inserting chokes when necessary. The interference analyzer is made by Sprague Products Company, North Adams, Mass.

From W6HG we learn that W6JAT at Yosemite has quite an antenna—a 265-foot flat-top of No. 9 wire fed by an 800-foot lead!

Believe it or not—W6AM went 14,000 feet in the air on top of Mt. Whitney for his five-meter test, and then had to put up a 20-foot pole to get out!

Harold Mays, W2FDS, of Bayonne, N. J., besides having a fine sending fist has a famous "knockout" fist. W2FDS is a famous boxer and was sparring partner for Primo Carnera.

—W2AFK

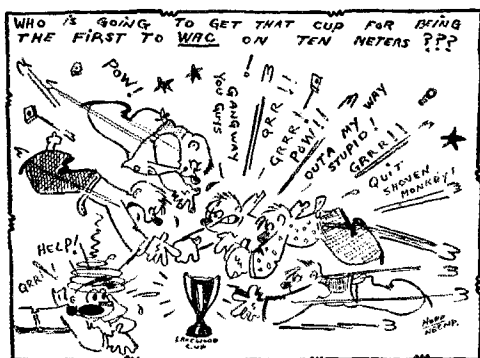

World Championship Radio Code Speed Tournament

By T. R. McElroy*

BOY! Oh boy! What a thrill it will be for me to see once again that official title slapped onto my name, after having lost it two years ago at Chicago. You know when I first won the title back in 1921 or thereabouts at one of the real early tournaments held in Boston, at a speed of 50 or 51 wpm, it didn't mean much. I knew telegraphers and respected their ability. But this radio racket was wholly new to me and I didn't give much thought to radio operating or radio operators. The winning of the title and subsequent tournaments meant only a chance to get a few days off to prepare for the event and a few days afterwards to celebrate. The holding of that title by one of their men didn't mean much to good old Western Union, but I guess the "old man," J. B. Rex, chief operator at Boston, just figured it a chance to give a youngster a few days vacation with pay. Then along came E. R. Shute, Western Union's brilliant and capable, although none-the-less very human, general superintendent of traffic, who along with hundreds of other brilliant radio and telegraph engineers, was a ham. Mr. Shute took a fancy to the tournament idea. Under his guidance I entered quite a few contests. At this point I'd like to make this admission: It is entirely possible there may be dozens or more skilled radio operators throughout the country who would give me serious trouble in a tournament but who have never had the men back of them to push them ahead and prepare the way for their tournament entrance. So much then for a starter, to prepare the way for the story. There was one tournament after another. I was fortunate enough to win, until 1933 when I made an awful flop at Chicago where Joe Chaplin of Press Wireless beat me decisively. There was no question about it, he was far better than I was, then. At Chicago under the rules which allowed

5% errors, Joe won at 57 words per minute with about a dozen errors whereas I flopped with about forty errors. At that time I'd had no practice whatever for several years and I guess I was just swelled headed enough to think that I could win without it. It taught me a lesson.

The first I knew of another big tournament was a notice from Mark MacAdam, W1ZK, who was superintendent of the Radio Exposition of the Brockton Fair. The sheet set forth that a "wide open tournament" for official championship of the world at radiocode reception was to be held at the Brockton Fair, Saturday, September 14th. I received the notice about two weeks prior to that date and immediately got busy with some practice. A friend of mine, Frank Borsody, W2AYN of Brooklyn, N. Y., prepared perforated tape with

which to practice. It was also Borsody who designed the high-speed transmitter used in the tournament and allowed me to use it to practice with. He makes a transmitter very similar to the genuine English Creed which costs about five-hundred dollars. Borsody calls his the "Crude" and the cost is about 10% of the Creed. At the tournament it worked perfectly at 75 words per minute.

The rules called for punctuation consisting of commas and periods to be perforated and put down

by operators. Also proper names and sentence beginnings to be correctly capitalized. When some question arose among contestants in this connection, the judges, Lloyd Greene of the *Boston Globe* and Joe Toye of the *Boston Traveler*, insisted that inasmuch as it was straight English press matter that it should be so transcribed. There was no further question on this and it is significant that at the end of the contest, every operator expressed himself as highly pleased at the efficient manner in which the contest was run. The two newspapermen judges were guided in

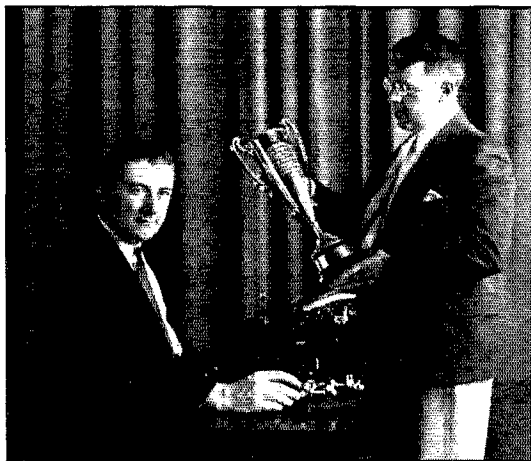

MARK MacADAM, W1ZK, PRESENTING THE TROPHY TO T. R. McELROY

*Code Speed Champion, Dorchester, Mass.

(Continued on page 98)

What the League Is Doing

League Activities, Washington Notes, Board Actions—For Your Information

New Handbook

The headquarters staff has pleasure in announcing the production and present availability of the 1936 edition of *The Radio Amateur's Handbook*. Completely redone from sky-hook to ground connection, it represents half a year's concentrated work by our staff. We are proud of it and hope that it is not only the best edition of the *Handbook* but the most helpful piece of amateur literature that ever has been created.

The new edition is nearly twice the size of previous printings. Of course a major portion of the additional space is given over to the chapters on technical apparatus, all of which have been completely redone in terms of modern knowledge. Many new transmitters and receivers have been built especially for the *Handbook* and are here described for the first time. There are twenty-one chapters and an appendix, to the previous edition's sixteen; meaning, of course, a wealth of new material.

Not the least interesting feature of the book is a quite extensive advertising section in which the manufacturers of the country present their amateur apparatus in catalog form. Dimensions and electrical specifications are important data for the amateur constructor. The availability of this material within the same covers makes of the book more than a manual of amateur practice—it is a true handbook. Plenty of attention is given actual communication practice, as well, with the aim of making the *Handbook* answer every amateur need.

The success of our *Handbook* has been quite inspiring. Over 300,000 copies have been sold and it has gone to every country of the globe. More than 2000 copies, for example, have been sold across the counter of a single store in Shanghai! One group of American stores has sold over 30,000 copies of it. Five-hundred radio stores in this country offer it for sale. Government agencies and libraries purchase many copies of it. Tons of copies have been shipped to scores of foreign ports. It has been adopted as a standard text on radio by many technical schools and classes. In some of the high schools it supplies the basis for a course which yields a credit toward the total required for graduation. But most important of all its uses, it has been a reliable right-hand assistant for the active American amateur. We remember as if it were yesterday the long debate in our office when the first edition went to press many years ago, as to whether we should print 5000 copies or 10,000. We printed 5000, only to have them leave our possession in the first few weeks. Now we print 40,000 or 50,000 at a crack and

think nothing of it, so firmly is the *Handbook* grounded as the standard manual of amateur communication.

We shall all feel happy if the present edition brings as much assistance and inspiration to amateurs as have its predecessors.

Over-modulation

The Federal Communications Commission has sent instructions to all its field monitoring stations to put their new oscilloscopes to work at curbing overmodulation by amateur 'phones. For the present, monitoring stations are not to cite amateurs unless at least two observations show flagrant violation; allowance is to be made for the overmodulation effects that accompany selective fading. That is to say, the effort starts first on the worst signals, as is proper, and will tighten up as the situation itself is gradually cleaned up. Nothing will so improve operation in the 'phone bands as for the Commission to compel the several dozen proprietors of high-power "spray machines" to cease and desist from their endeavor to paint the entire spectrum.

License Notes

The Commission has ruled that when a Class-C amateur appears before an inspector to take the Class-A examination, he is obliged to take the Class-B examination as well, including the code test. Their rules recognize the Class-C license as being somewhat inferior to the Class-B and, as the Class-A is regarded as the highest type, they consider it only proper that the Class-C applicant desiring A privileges be required to take the B part of the examination.

On September 3rd the Commission amended the last sentence of Rule 404 to read as follows:

"Applicants for Class-C privileges must reside more than 125 miles airline from the nearest examining point for Class-B privileges, or in a camp of the Civilian Conservation Corps, or be in the regular military or naval service of the United States at a military post or naval station; or be shown by physician's certificate to be unable to appear for examination due to protracted disability."

Ratifications

Great Britain ratified the Madrid Convention on May 29th. The Union of South Africa ratified the convention and the radio regulations on May 30th, its ratification also applying for the mandated territory of South-West Africa. China, in ratifying

(Continued on page 76)

Rationalizing the Resonant-Line U.H.F. Oscillator

Improved Construction Using Trombone-Tuned Grid and Plate Circuits

By A. W. Friend,* W8DSJ-W8KIU

THE resonant line oscillator circuit is, undoubtedly, the most logical type for use on the ultra-high frequencies. The advantages of this circuit have been set forth previously. They are: first, inherent stability of operation approaching that of the quartz crystal oscillator;

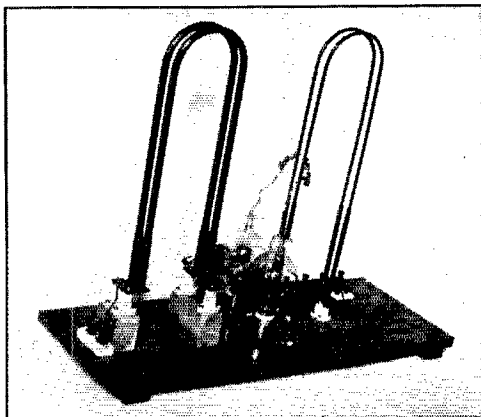

FIG. 1—A HIGH-POWER RESONANT-LINE OSCILLATOR FOR 59-MC. EMPLOYING THE IMPROVED CONSTRUCTION

and second, the greatest of simplicity in circuit design and equipment construction.

There are just two real objections to the resonant line oscillator. The first arises from the fact that for use at any frequency lower than about 200 mc. the lines, as heretofore constructed, require entirely too much of the available space in the operating room. The second objection is that they have not readily lent themselves to any degree of frequency variation.

These difficulties may be banished with the exercise of just a trifle more constructional effort than the mere sawing to length of copper tubing. Fig. 1 shows the general idea of construction.

The quarter-wave grid and plate lines are merely bent into an inverted "U" shape. The two ends of each "U" must be kept sufficiently far apart so as to avoid any degradation of function of the quarter-wave resonant line section. Five to ten times the spacing used between the centers of the line conductors should be amply sufficient

for all practical purposes. This doubling of the lines into the "U" shape eliminates about 60 per cent. of the required maximum dimensions of the oscillator. That feature eliminates the first disadvantage.

The second disadvantage is removed in the process of eliminating the first one. Since the lines are to be bent into a "U" shape, the next logical step is to make provision for the ends of the curved portions to slide in and out of straight ends of the quarter wave lines, in true trombone fashion. Thus, without moving a single connection (except for varying the grid excitation) the frequency may be varied throughout a very wide range with perfect ease.

THE CIRCUIT

To avoid the use of choke coils and blocking condensers, a push-pull circuit is much more desirable than a single tube oscillator. The symmetry of construction is also much superior when the push pull circuit is used.

Fig. 2 shows the circuit diagram of the push-pull oscillator.

The plate line is composed of its external double "U" and the plate leads of the tube. The grid line is composed of only its external double "U."

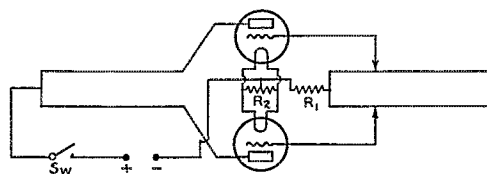

FIG. 2—SCHEMATIC CIRCUIT
Plates across ends—grids tapped on.

The adjustable grid connections to the line are used to vary the excitation applied to the grids of the tubes. R_1 is the grid leak resistor (15,000-ohm 25-watt). R_2 is composed of two 50-ohm 10-watt resistors used to make connection to the filament center tap. All power connections to the resonant lines are made at points of zero r.f. potential; therefore, no r.f. chokes are required.

The antenna may be coupled inductively to the plate line at the region of maximum current, or a feeder may be clipped directly to the plate line at the proper point to match the line impedance. Blocking condensers should be used

* West Virginia University, W8XAW, Morgantown, W. Va.

to keep the high voltage off of the antenna feeder, if it is clipped to the plate line.

CONSTRUCTION

To obtain ease in adjustment and a good permanent type of construction *only hard-drawn copper tubing should be used for constructing the "U" lines.* Soft-drawn copper tubing will not produce permanent solid connections at the sliding contact points of the lines. *Never* use brass tubing for the lines. The high resistance of brass has been found to increase the circuit losses as much as 40 per cent.

The plate line carries a very high current at the shorted end; therefore, for good efficiency it must be constructed in a manner which will present a very large surface for conduction of the ultra-high frequency currents. When using a pair of Type 852 tubes, or a pair of 800's or other tubes of similar power output, $\frac{3}{8}$ -inch copper tubing for construction of the straight "U" ends is excellent. The sliding bent portions of the "U" should then be constructed of $\frac{1}{2}$ -inch hard-drawn copper tubing. This large tubing cannot be bent without flattening at the bends unless proper support for the walls is supplied. The only good method for bending this size which we have tried is to cut the section which is to be bent to the proper length; and then to pour it full of lead. The lead pouring process determines the success of the bend; so it must be done with the greatest of care to assure complete filling of the entire space inside of the tubing.

First, a hole is drilled about an inch into a block of dry wood. The end of the copper tubing should just make a "snug" fit into this hole. Melt a sufficient quantity of lead in a suitable container (iron, for instance) which will allow convenient pouring into the end of the copper tube. When the lead is perfectly molten and free-flowing, skim off all foreign matter from the surface. Keeping the lead molten, quickly heat the tubing to be bent to a temperature only slightly lower than that of the molten lead, insert

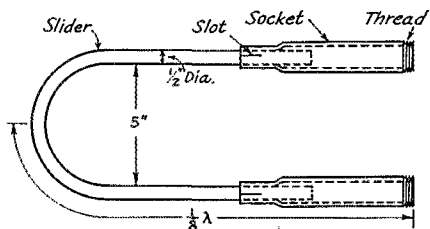

FIG. 3—DETAILS OF THE ADJUSTABLE LINE CONSTRUCTION

the tube into the hole in the wood block and pour in the molten lead until it just fills the tubing.

It is necessary that the copper tubing be preheated, as stated. Otherwise the lead will solidify

upon contact with the cold walls. The solidified metal will clog the tubing so as to produce air pockets which allow flattening of the tube when bending is attempted. If an air pocket is found to exist in the metal, it will be a waste of time to try to remedy the situation without removing *all* of the lead (by heating) and starting over again.

When the tubing is filled with the lead and has become sufficiently cool to handle, a five- or six-inch motor pulley, piece of pipe, or similar cylindrical form, may be clamped in a vise with the points of bend of the tubing between one vise jaw and the cylinder. Pulling evenly upon both ends of the tubing, it is then carefully bent into the "U" shape desired. The two ends must be

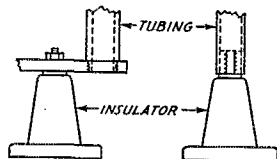

FIG. 4—TWO METHODS OF MOUNTING THE ENDS OF THE RESONANT LINE CIRCUITS

pulled until they are exactly parallel so as to allow freedom of motion in the completed line. When the desired shape has been obtained, the lead must be removed from the tubing. Starting at one end of the tubing, a blow torch or a gas flame is applied to heat the tubing just sufficiently to melt out the lead, without unduly overheating the copper.

The copper should *not* be quenched in water to cool it, because this tends to make it softer. It should be allowed to cool gradually.

Cutting the two ends off even and cleaning the copper with very fine sandpaper completes the construction of the slider portion of the resonant line. Two of these sliders are required for each line.

Fig. 3 shows a drawing of one half of a "U" line. The construction of the slider has already been explained.

The remaining parts are the two straight end sockets into which the bent portion slides for purposes of adjustment.

If the larger tubing for this purpose can be obtained, of such size that it just fits over the smaller tubing of the slider, a considerable amount of work can be saved. All that will be necessary will be to make three three-quarter inch deep hack-saw slots equidistant around the end of the large tubing, and then to carefully work the three segments of copper in so as to give a tight fit around the legs of the slider. The ends of the slider should be smoothed off to allow easy insertion.

In case the larger tubing cannot be obtained to give a snug fit over the smaller tubing of the slider, the same procedure may be followed except that the three segments must be spun in, to fit the smaller tubing, by the use of a lathe or a drill press. Lacking the proper machinery, the segments may be reduced by pushing the end into a

taper reamed hole, using a supporting rod inside of the tubing.

It is evident that hard drawn copper is needed to supply the proper spring action at the contacts between the segments of the large tubing and the slider. The contact area of both pieces should be well polished to provide a smooth sliding, perfect electrical contact. Denting of the tubing is to be carefully guarded against.

The lower ends of the stationary tubes must be mounted by some method. Two suggested types of mounting are shown in Fig. 4. The mounting

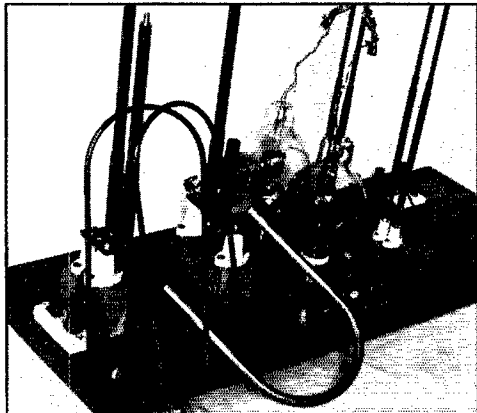

FIG. 5—EXTENSIONS ARE SCREWED IN TO BRING THE FREQUENCY RANGE DOWN TO 50 MC.

must be constructed so as to insulate the two ends which are to be fastened to the plates of the tubes. The other two ends (see Fig. 1) must be fastened together with an especially good contact; for this is the point of maximum current in the resonant line.

The grid line may be constructed of smaller tubing, such as quarter-inch copper, but it is again imperative that *hard-drawn tubing* be used. With the smaller diameter, it is not necessary to fill the tubing before bending, since no trouble will be experienced with flattening at the bend. The other details of construction are essentially the same as for the plate line.

For producing changes of frequency greater than can be obtained by sliding the "U" sections, extensions may be constructed to add to the length of the sliders. We used press-fit threaded brass inserts in the ends of the tubing so that the extensions could be screwed on to the "U" slider sections as shown in Fig. 5. Using the line as shown, without the extensions, the frequency range extended from about 130 mc. to 80 mc. With the extensions in place, the range was changed so as to cover the band from 70 mc. to 50 mc. The grid line, being easy to construct, was not fitted with extensions. Separate sliders were made for each range, as shown in Fig. 5.

TUNING THE TRANSMITTER

When the frequency has been decided upon, the grid line should be adjusted so that the length from one end of the "U" to the other end is equal to $\frac{1}{4}$ -wavelength multiplied by about 0.95. The plate line should be adjusted so that its length plus the length of the lead to the plate of the tube is slightly less than the length of the grid line. The grid leads can be connected first at a point about $\frac{1}{20}$ -wavelength from the shorted end of the $\frac{1}{4}$ -wave line.

Using reduced voltage on the plates, the transmitter will now be ready for operation. If oscillation cannot be detected by placing a neon lamp near the center of the plate line, the power should be turned off and the length of the plate line adjusted until oscillation is obtained with the lowest plate current possible. By moving the grid clips on the line, a point should be found which gives maximum output with good efficiency.

Slight changes in the length of the leads to the grids of the tubes sometimes help to increase the efficiency by shifting the phase of the grid excitation voltage. At a frequency of 100 mc. we

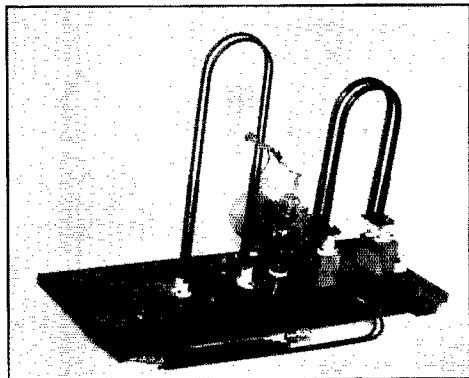

FIG. 6—THE TRANSMITTER WITH LINES ADJUSTED FOR 86-MC. EXPERIMENTAL OPERATION

found it necessary to add about $1\frac{1}{2}$ inches to the length of the normal grid leads on the Type 852 tubes.

When the adjustments have been completed, the full plate voltage may be applied and the antenna adjusted as in the case of lower frequency work.

This transmitter has been found to have excellent stability and efficiency, combined with remarkable ease of adjustment. The only observed case of erratic operation was produced by dirty contacts at the sliding joints of the "U" lines. This trouble was quickly remedied by rubbing with very fine sandpaper and a dry cloth.

Rough field usage over a period of several months has proven the merits of this ultra-high-frequency transmitter.

A Novel Dual-Tuner Superhet

Separate Coil-Switching Units for Ham-Band and All-Wave Coverage

Coverage

By Glen H. Browning*

SOME time ago the writer discussed amateur receivers with J. J. Lamb, particularly on the point that most amateurs are interested in an all-wave receiver which also has exceptionally good band-spread on the amateur ranges. Several methods of accomplishing this were considered, one of which would be to switch in small variable condensers in parallel with the main tank condensers on the amateur bands, while another would be to switch condensers in series with the tank condensers. Either of the above two methods has disadvantages in logging since, in general, it is difficult to reset the main tank condensers accurately enough to duplicate logging on the band-spread ranges. Finally, the proposal was made to "go the whole hog" and use two tuners, one covering only the amateur bands, while the other covers all frequencies from 22.6 mc. to 540 kc. Switching arrangements could then be readily incorporated so that either tuner could be used at will with the same i.f. and audio frequency amplifier.

The resulting set, accordingly, has two separate tuners, one covering the amateur 20-, 40-, 80- and 160-meter bands exclusively, spreading each of these four bands over approximately 120 degrees of arc, while the other, a four-band all-wave tuner, covers all ranges between 540 kc. and 22.6 mc. without skips. Each of these single-control tuners is mounted on the same chassis and a switching arrangement is provided so that either may be used at will. The band ranges for the all-wave tuner are as follows:

- 1st band, 22.6 mc. to 8.8 mc.
- 2nd " 9.2 " to 3.4 "
- 3rd " 3.8 " to 1.4 "
- 4th " 1.5 " to .54 "

The bands covered by the amateur tuner are:

- 1st band, 14.5 mc. to 13.85 mc.
- 2nd " 7.35 " to 6.9 "
- 3rd " 4.05 " to 3.45 "
- 4th " 2.05 " to 1.698 "

The tuning characteristics are described by two terms proposed in May *QST*. The first is

* Tobe Deutschmann Corp., Canton, Mass.

"tuning rate," which is defined as the number of kilocycles covered by one complete revolution of the tuning knob. The fewer kilocycles covered, the better the tuning rate. The second term is "calibration spread," which is defined as the number of kilocycles covered by the smallest division of the tuning scale. This indicates how readily a station may be logged. The following table gives the tuning rate and calibration spread on the amateur bands covered by the amateur tuner:

Band	1.75 mc.	3.5 mc.	7 mc.	14 mc.
Tuning Rate (kc. per knob rotation)	Kc. 26.5	Kc. 20	Kc. 18	Kc. 17
Calibration Spread (kc. per dial div.)	2	3.4	2.0	3.0

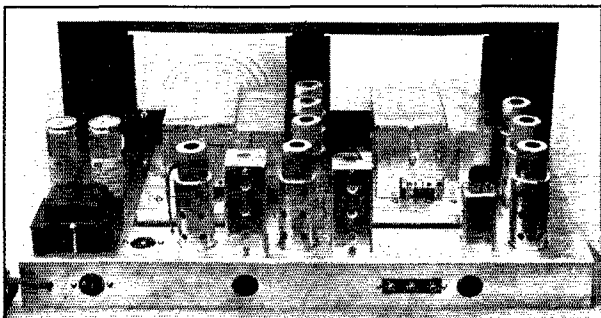

THE OUTPUT OF EITHER TUNER, ALL-WAVE AT RIGHT AND AMATEUR-BAND AT LEFT IN THIS VIEW, IS SWITCHED TO THE COMMON I.F.—AUDIO UNIT

H.v. supply, antenna input and bias circuits of the r.f. and converter tubes are changed in the same operation. Behind the all-wave tuner, at the extreme right, is the beat oscillator unit. To its left are, in order, the i.f. amplifier, second detector and audio amplifier, the tube of the latter being removed from its socket. The power pack is at the extreme left. A separate h.f. oscillator tube for the amateur-band tuner was included at the time this photograph was taken.

As will be noted by the circuit diagram, each of the two tuners has a set of coils for each of the four bands covered, and a switching arrangement incorporated as an integral part of the tuner. The coils are mounted in a catacomb and a shield separates the sets of coils used for the r.f., first detector and h.f. oscillator stages. On top of this tuning catacomb is mounted the three-gang tank tuning condenser. There are only seven connections and a ground which the constructor needs to make to each of the tuners in constructing the complete receiver. Since each tuner is carefully aligned and tracked in production, only slight final adjust-

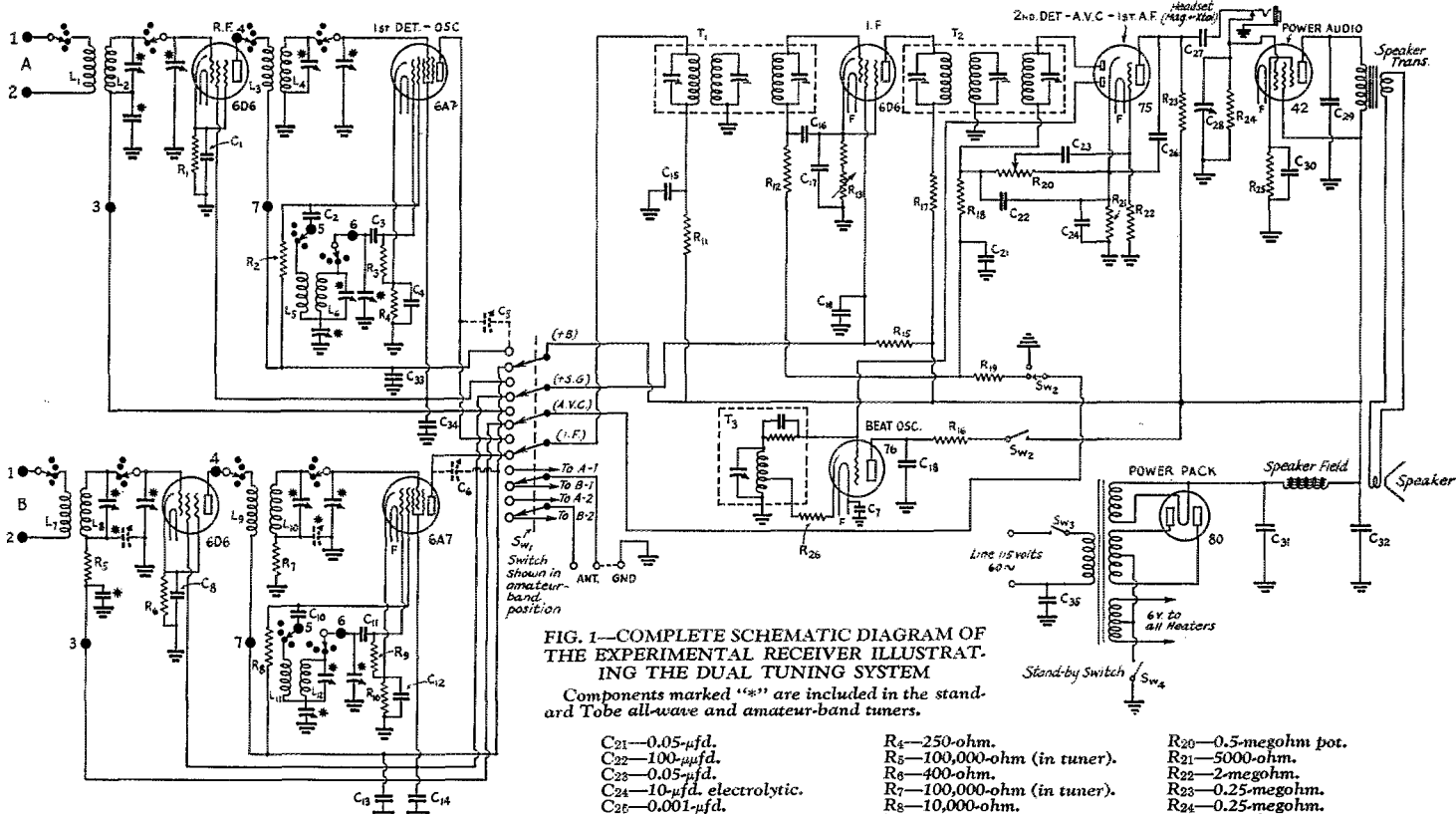

FIG. 1—COMPLETE SCHEMATIC DIAGRAM OF THE EXPERIMENTAL RECEIVER ILLUSTRATING THE DUAL TUNING SYSTEM

Components marked "*" are included in the standard Tobe all-wave and amateur-band tuners.

- C₁—0.1- μ fd.
 C₂—0.002- μ fd.
 C₃—100- μ fd.
 C₄—0.1- μ fd.
 C₅—15- μ fd. trimmer (see text).
 C₆—15- μ fd. trimmer (see text).
 C₇—0.1- μ fd.
 C₈—0.1- μ fd.
 C₉—0.05- μ fd.
 C₁₀—0.002- μ fd.

- C₁₁—100- μ fd.
 C₁₂—0.1- μ fd.
 C₁₃—0.1- μ fd.
 C₁₄—0.1- μ fd.
 C₁₅—0.05- μ fd.
 C₁₆—0.05- μ fd.
 C₁₇—0.1- μ fd.
 C₁₈—0.1- μ fd.
 C₁₉—0.1- μ fd.
 C₂₀—0.05- μ fd.
 C₂₁—0.05- μ fd.
 C₂₂—100- μ fd.
 C₂₃—0.05- μ fd.
 C₂₄—10- μ fd. electrolytic.
 C₂₅—0.001- μ fd.
 C₂₆—0.05- μ fd.
 C₂₇—0.05- μ fd.
 C₂₈—Tone control.
 C₂₉—0.005- μ fd.
 C₃₀—10- μ fd. electrolytic.
 C₃₁—8- μ fd. electrolytic.
 C₃₂—8- μ fd. electrolytic.
 C₃₃—0.1- μ fd.
 C₃₄—0.1- μ fd.
 C₃₅—0.1- μ fd.

- R₄—250-ohm.
 R₅—100,000-ohm (in tuner).
 R₆—400-ohm.
 R₇—100,000-ohm (in tuner).
 R₈—10,000-ohm.
 R₉—50,000-ohm.
 R₁₀—250-ohm.
 R₁₁—1000-ohm.
 R₁₂—1-megohm.
 R₁₃—10,000-ohm potentiometer, 500-ohm min.
 R₁₄—25,000-ohm, 1-watt.
 R₁₆—500,000-ohm.
 R₁₇—1000-ohm.
 R₁₈—1-megohm.
 R₁₉—1-megohm.

- R₂₀—0.5-megohm pot.
 R₂₁—5000-ohm.
 R₂₂—2-megohm.
 R₂₃—0.25-megohm.
 R₂₄—0.25-megohm.
 R₂₅—400-ohm, 1-watt.
 R₂₆—1000-ohm.
 T₁ & T₂—456-kc. triple-tuned i.f. transformer (Tobe FTI).
 T₃—456-kc. beat oscillator unit (Tobe BFO).
 SW₁—6-pole d.t.
 SW₂—D.p.d.t.
 SW₃—S.p.s.t. (on tone control).
 SW₄—S.p.s.t. toggle.

ment of the trimming condensers mounted on each coil need be made in order to have the correct bands covered.

CIRCUIT OUTLINE

As will be noted by the circuit diagram of Fig. 1, a 6D6 is used for each r.f. amplifier, and a 6A7 for each oscillator-first detector. Following the

and a.c. switch are combined in one unit. The audio volume control serves as the load resistor in the diode circuit.

A 6-pole double-throw switch allows the operator to use either tuner at will. To do this it is necessary to switch the doublet-antenna connections, the plus-B connections, the screen connections, the automatic volume control, and the

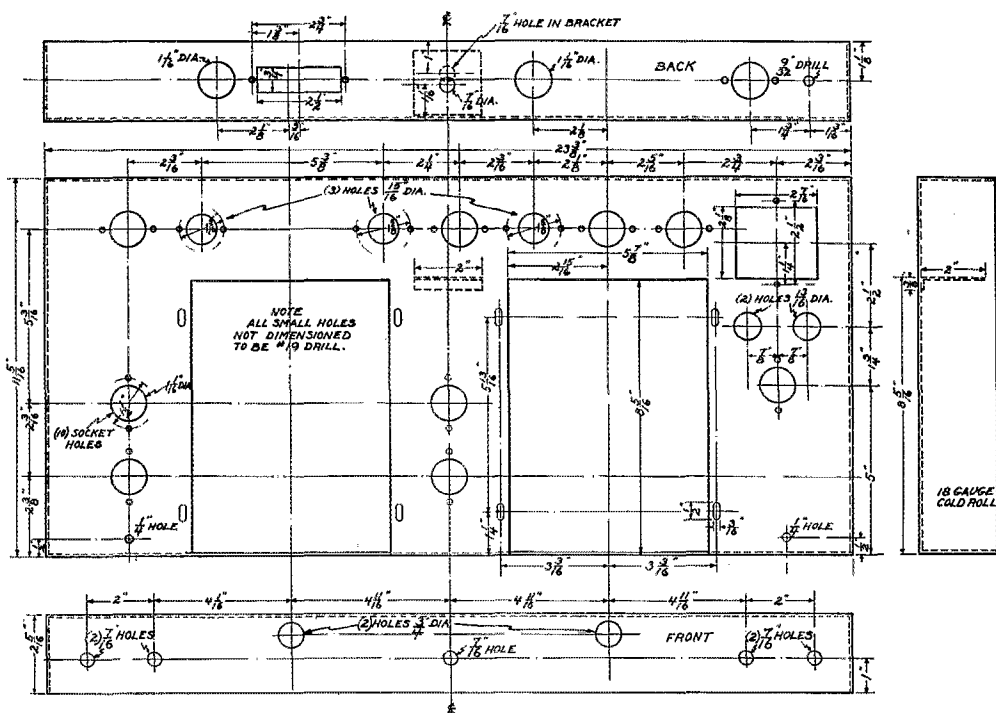

FIG. 2—DETAILS OF THE BASE LAYOUT

tuners, a 6D6 is used for the i.f. amplifier, a 75 for the second detector-audio amplifier and a 42 for the output. The beat-frequency-oscillator is a 56 tube coupled into the second detector through one of the diode plates. The 6A7 pentagrid converter tube is generally satisfactory as a combined oscillator and first detector, provided the proper $L-C$ ratios are adhered to. It has a conversion conductance considerably larger than usually obtained in a first detector operated with a separate oscillator tube, although a circuit of the latter type can be made somewhat more stable in oscillator frequency.

Automatic volume control is obtained in the diode circuit of the second detector. The circuit is so arranged that a switch on the front of the panel throws off the a.v.c. when the beat-frequency oscillator is switched on. Headset connections are provided in the plate circuit of the first audio amplifier, and the stand-by switch cuts off the B-supply to all tubes. The tone control

i.f. amplifier. As the i.f. amplifier has a sharply-tuned plate circuit, it is necessary, for maximum sensitivity, to use a small condenser to balance up the difference in the lead capacitance from the plate of the pentagrid converter tube on both tuners, and as the longest lead to the i.f. amplifier comes from the all-wave tuner, it is usually necessary to use a 15- μ fd. variable compensating condenser connected to the plate of the 6A7 of the amateur tuner. By adjusting the i.f. amplifier when connected to the all-wave tuner and then switching to the amateur tuner and varying this air condenser, perfect i.f. alignment may be obtained for either unit. In fact, the whole receiver is so designed that the amateur may make the final adjustments necessary for maximum performance without the aid of a signal generator.

CONSTRUCTIONAL DETAILS

The construction of the complete receiver is relatively simple after the mechanical assembly

has been done according to the plans and illustrations of the chassis and front panel shown in the accompanying drawings and photographs. All electrical parts used are standard types avail-

ALIGNMENT OF I.F. TRANSFORMERS

Although the triple-tuned i.f. transformers are carefully aligned at the factory for the inter-

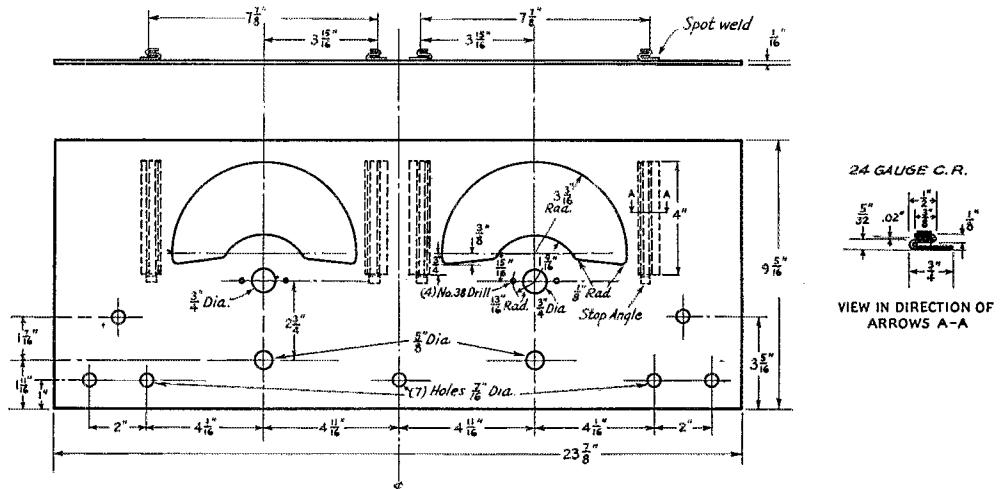

FIG. 3—THE PANEL LAYOUT

able on the open market. The amateur should take particular care in obtaining condensers and resistors which are according to ratings.

Those who desire to obtain regeneration in the i.f. amplifier may do so by allowing some feedback in the i.f. amplifier stage. Under these conditions regeneration may be controlled by the r.f. gain control. This is particularly advantageous in c.w. reception. One method of obtaining regeneration is to cut down partially the shield on the i.f. amplifier tube until the i.f. stage just oscillates when the r.f. gain control is fully advanced. In the model constructed by the writer, the shield was cut down so that only approximately half of it remained. Under these conditions the i.f. amplifier would almost oscillate when the i.f. gain control was fully advanced.

After the mechanical work has been done on the chassis, and the electrical parts mounted and wired, the receiver is ready for trial operation and should bring in some signals without any realignment whatsoever. In case no signals are received, it is advisable to check the wiring and tubes before any adjustments are made on either the i.f. transformers or the trimming or padding condensers in either tuner. Be sure to plug in the loud-speaker before tuning on the set; otherwise an abnormal amount of voltage will be thrown on the filter condensers. The speaker should have an 1800-ohm field and a 7000-ohm input transformer. It is advisable to use an insulated screwdriver for all alignment adjustments. This minimizes the effect of body capacitance.

mediate frequency specified (456 kc.), tube and lead capacitance will slightly change the tuning of all circuits *with the exception of the link circuits*. Hence it will be necessary to make slight adjustments on the circuits which are connected to the plates or grids of the tubes. *The link circuit tuning condensers should not be touched*, since these circuits establish the intermediate frequency without reference to a test oscillator.

For final adjustments the following directions are given to the set-builder who does not have available either an all-wave signal generator or an output meter:

1. Remove antenna lead.
2. Turn on the receiver.
3. Turn both volume controls to the point of maximum response (rotate clockwise as far as possible).
4. Turn tone control as far counter-clockwise (to the left) as possible without turning off the set.
5. Set selector switch on the fourth band of the all-wave tuner (be sure the tuner selector switch is so set that this tuner is connected in the circuit).
6. Turn on automatic volume control; this turns off the beat-frequency-oscillator (rotate a.v.c. switch counter-clockwise).
7. Set tuning condensers so that no signals are being received.

The i.f. transformer, T_2 , which feeds the second detector should be aligned first. It has already been mounted so that the adjustment screws face out from the chassis. Three of these adjustment

screws will be found. *The one to be left alone is the center adjustment screw of the link-tuned circuit.* It is not connected to either the i.f. amplifier tube or to the detector tube, and as a consequence will be correctly tuned to the 456-kilocycle intermediate frequency. Be sure not to change the adjustment of this link circuit, because tube or lead capacitance has no effect on its frequency.

The top and the bottom adjustment screws may be rotated slightly until the maximum hissing sound is heard. A similar procedure should be followed on T_1 , remembering not to change the tuning of the link circuit in this transformer, which also is adjusted by the middle screw. When these transformers are brought into alignment a hiss peak should be heard even with the tube of the first r.f. amplifier removed from its socket. If the wiring has been carefully done, the i.f. will not oscillate during these adjustments even with the 10,000-ohm r.f. gain control fully advanced.

When proper i.f. alignment has been obtained with the all-wave tuner connected in the circuit, switch the tuner-selector switch to the amateur tuner (the amateur band selector switch should be kept on Band 4). The 15- μ fd. i.f. compensating condenser connected to the amateur tuner should then be adjusted for maximum hiss. When this is done the i.f. is in alignment for either of the tuners.

THE ALL-WAVE TUNER

After the i.f. amplifier has been adjusted for maximum sensitivity, the trimming and padding condensers on the individual tuners should have slight adjustments if maximum response is to be obtained. The general procedure on these tuners is similar, but since there are slight differences it is advisable to give the instructions for the tuners separately. With other adjustments as for aligning the i.f., the all-wave tuner procedure is as follows:

1. Set tuning condensers near minimum capacitance. (The dial pointer will be near the high-frequency end.)
2. Set the band-selector switch on the band being adjusted.

As shown by Fig. 4, in the front compartment of the tuner (compartment towards the front panel) are the antenna coils for all four bands. In the center compartment are the r.f. transformers for all four bands, while in the rear compartment are the oscillator coils. The antenna and r.f. coils may be lined up for maximum hiss as follows:

Set the band-selector switch on Band 4 (broadcast band). Looking at the chassis from underneath, the broadcast coils are the ones on the left. The antenna and r.f. trimming condensers

mounted on these coils may then be adjusted for maximum hiss. With the selector switch on No. 3, again adjust the antenna and r.f. trimmers of Band 3 for maximum hiss. Repeat the process with the switch set on No. 2 and adjust the trimmers on the antenna and r.f. coils on Band 2. In

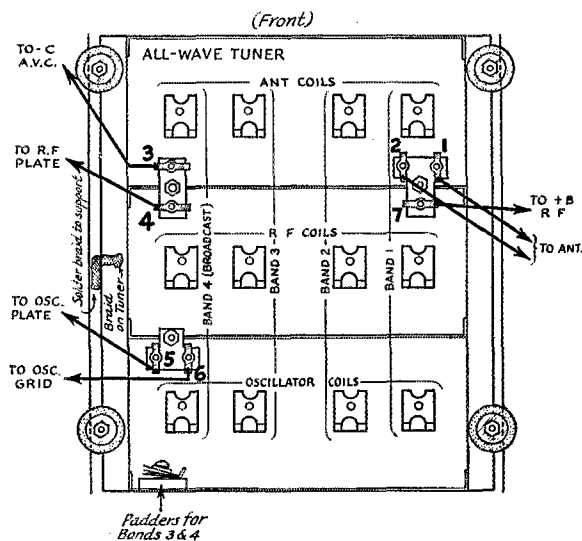

FIG. 4—CONNECTIONS AND CONDENSER ADJUSTMENTS OF THE ALL-WAVE TUNER AS VIEWED FROM THE BOTTOM

adjusting Band 1, the noise level, in most cases, is very materially reduced and consequently it is considerably harder to align this band correctly. A very short antenna may be connected advantageously and the trimming condensers on the antenna and r.f. coils adjusted for maximum hiss. Where a short antenna is being used for these adjustments, the tuning condenser should be set so that no signals are being received.

There is a possibility on both Bands 1 and 2 of adjusting the antenna and r.f. trimmers to the image frequency instead of to the correct frequency. Sometimes it will be found that two points of maximum hiss are obtained, one with the trimmers at the lower capacitance and one with them at a higher capacitance. *The higher capacitance is the correct one*, higher capacitance being with the moving plates closer to the fixed plates.

If any band is lined up on the image frequency the variable tuning condensers will not track correctly throughout the band and, consequently, there will be loss in signal strength. The image frequency is higher than the proper signal frequency by twice the intermediate frequency and, consequently, this means that the trimming condensers would be improperly set at a much lower value of capacitance. On Bands 3 and 4 the trimming condensers will not cover a sufficiently wide

range to change the tuning of the antenna and r.f. circuits by an amount equal to twice the intermediate frequency. Consequently, it would be difficult to align these stages incorrectly.

After the trimming condensers have been adjusted on all bands to set the minimum capaci-

received. The band-selector switch should be set on Band 4. This throws into the circuit the coils marked Band 4 on the picture diagram of the tuner. As will be noted, the locations of the antenna coil, r.f. coils and oscillator coils are marked in Fig. 5.

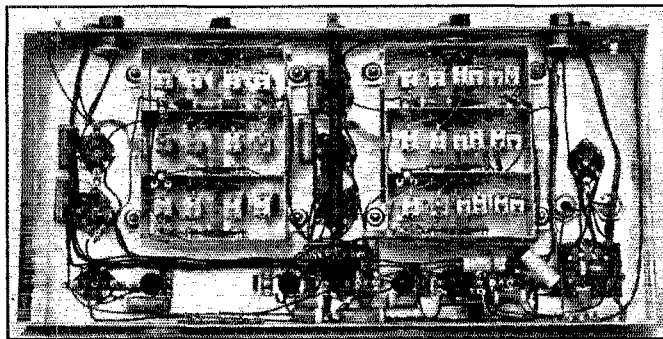

BOTTOM VIEW OF THE EXPERIMENTAL RECEIVER, THE AMATEUR TUNER NOW BEING AT THE RIGHT AND THE ALL-WAVE UNIT AT THE LEFT

The tuner selecting switch is centered, with its extension shaft between the two tuner units.

ties, the series padding or tracking condensers of the oscillator on Bands 3 and 4 are adjusted. These condensers are on the end of the rear compartment of the tuner, the lower one controlling the tracking of the oscillator on Band 4, and the upper one controlling the tracking on Band 3. The screw which adjusts these condensers extends through the rear of the tuner chassis. To adjust the tracking condenser on Band 4, set the selector switch on this band and the tuning condensers near *maximum* capacitance at a point where no signals are heard. (The dial pointer will be near the low-frequency end of the scale.) With the antenna disconnected and the set in operating condition as before, and with the gain and volume controls fully advanced, adjust the *lower* padding condenser for maximum hiss. It will be noted that this adjustment is not nearly as critical as the adjustments of the trimming condensers. Having adjusted Band 4, set the band selector switch on Band 3 and repeat the process, adjusting the *upper* padding condenser for maximum hiss. These adjustments may be conveniently made by means of an insulated screwdriver through the large hole in the rear of the chassis provided for that purpose.

Fixed tracking condensers are used on Bands 1 and 2, since these padders are comparatively large in size and non-critical.

THE AMATEUR-BAND TUNER

With the antenna disconnected, the variable tank condensers should be set near minimum capacitance (high-frequency end). In making all adjustments, set condensers so that no signals are

With the gain and volume controls set at maximum, and the beat oscillator off, the antenna and r.f. coil trimmers are first adjusted for maximum hiss. The oscillator coil trimmer should be left fixed.

Next repeat the process with the selector switch on Band 3, adjusting the antenna and r.f. coils for maximum hiss. Then set the selector switch on Band 2. This band, and Band 1, has series as well as parallel trimmer condensers (Fig. 5). Leave the "S" condensers alone for the present. The antenna and the r.f. trimmers are adjusted for maximum hiss as before, first on Band 2, next on Band 1.

A distinct reduction in noise will be noticed on the last band and it will be necessary to attach a short antenna to make the proper adjustment on this band.

Having thus adjusted the *minimum* capacitance on all bands, the next process is to adjust the padding condensers on Bands 3 and 4 and the series condensers on Bands 1 and 2 to set the maximum capacitance. Set the tuning gang near *maximum* capacitance (low-frequency end). Set the selector switch on Band 4. As in the all-wave tuner, the padding-condenser adjustment for Bands 3 and 4 extends through the rear of the tuner, the Band 4 padder being the lower one. Adjust this padder for maximum hiss, the adjustment being made through the large hole in the rear of the chassis by means of an insulated screwdriver. It will be noted that this adjustment is not nearly as critical as the adjustment of the trimming condensers. Then switch to Band 3 and adjust its padder (the upper one) for maximum hiss.

Adjustment of the series condensers of Bands 1 and 2 follows. With the antenna removed as before, the gang-tuning condenser set near *maximum* capacitance, and the volume controls fully advanced, set the band-selector switch on Band 2. Adjust the series condensers (Fig. 5) on the r.f. and antenna coils for maximum hiss.

Switching to Band 1, a considerable reduction in noise will be noted so that it may be necessary again to connect a short antenna to the receiver. Adjust the series condensers on the r.f. and antenna coils on Band 1 for maximum hiss, or for maximum output meter reading with a test oscillator signal.

CHANGING POSITION OF BANDS

It will be noted that no adjustments have been made on the trimming and series condensers on the oscillator circuits, for these change the frequency to which the receiver is tuned. If it should be necessary to shift the tuning range slightly so that the amateur bands occupy the ranges shown on the calibration card of the tuner, slight adjustments may be made on the oscillator circuit trimming and series condenser. To determine this, connect the regular antenna to the receiver, turn the band-selector switch to position No. 4 and locate a signal which is on the extreme *high-frequency* end of this band. A calibrated test oscillator or heterodyne frequency meter can be used. Then, if the end of this band does not coincide with the marking of the tuner dial, adjustments may be made on the oscillator circuit trimming condensers. Change the oscillator trimmer condenser of this band very slightly by means of the insulated screwdriver, then rotate the tuning knob and again locate the test signal. In this way the high-frequency end of the band may be shifted to the correct position. After shifting the band position by means of the oscillator trimmer, a check of the line-up of the antenna and r.f. stage trimmers should always be made as previously described. To change the position of the high-frequency end of Band 3, repeat the process as above, with the band-selector switch on No. 3.

To change the position of the high-frequency ends of Bands 1 and 2, the same process should be repeated. But in this case it will be noted that above the oscillator coils of Bands 1 and 2 are mounted both the trimming and padding condensers. As in the case of the antenna and r.f. circuits, the *trimming* (parallel) condensers are those having a terminal connected to the switch point. These condensers are the ones to adjust slightly to change the position of the high-frequency ends of Bands 1 and 2. Always be sure to readjust the trimming condensers of the r.f. and antenna coils of each band after making adjustments to the oscillator trimmers.

After these adjustments to make the high-frequency limits of the amateur bands coincide with the tuner calibration, the last step is to bring the low-frequency limits of amateur Bands 1 and 2 in line with the corresponding markings. To do this, it is necessary to make adjustments on the oscillator *series* condensers of Bands 1 and 2. Bands 3 and 4 do not have to be adjusted to bring the lower frequency limits of the amateur bands into line, inasmuch as this was accomplished automatically when adjusting the padders as aforementioned.

The oscillator *series* condensers on Bands 1

and 2 determine to some extent the spread on these bands. The smaller the capacitance of these series condensers, the greater the band-spread; that is, the low-frequency end of the band will be

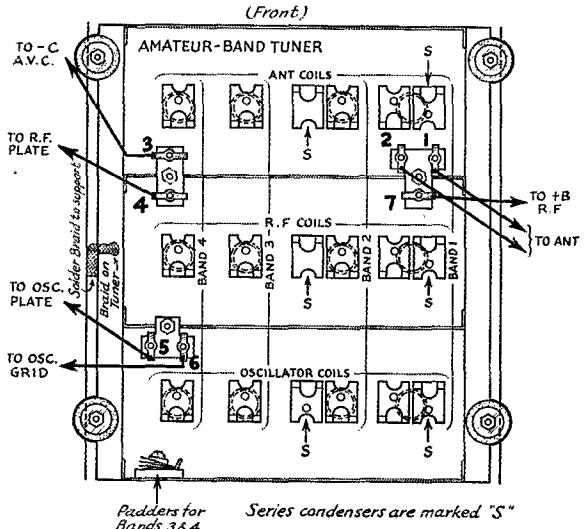

FIG. 5—CONNECTIONS AND CONDENSER ADJUSTMENTS OF THE AMATEUR-BAND TUNER AS VIEWED FROM THE BOTTOM

farther to the right. Consequently, the experienced amateur may spread these bands to suit himself. The process is as follows: Locate a test signal on the *low-frequency* end of the band; change the adjustment of the oscillator series condenser slightly on that band; and again tune in the signal. Only a very slight movement of the adjusting screw should be made at one time. When the pointer's position on the calibration card is at the correct point, leave the series condenser fixed and re-align the antenna and r.f. *series* condensers on that band, as before described, adjusting for maximum hiss with the antenna disconnected. A check should then be made on the antenna and r.f. *trimming* condensers with the tank tuning condensers set near *minimum*, as before described. Changing the oscillator series condensers will change the high-frequency end of the band somewhat, as well as the low-frequency end.

THE BEAT-FREQUENCY OSCILLATOR

A shaft for adjusting the beat-frequency oscillator extends to a knob on the top of the beat-frequency oscillator coil. With the set in operating condition and connected to a short antenna, tune in a carrier exactly and turn on the beat oscillator. If the oscillator is adjusted to the right frequency, a beat-note will be heard. If it is not adjusted to the right frequency, rotate the ad-

(Continued on page 106)

Yours Very Truly—Goodnight

By Lawrence E. Hauck,* W9CYV

YES Sir, CYV, if I could find a young lady up, good looking and intelligent," began the rotten young squirt, "one who's a real honest-to-gosh amateur and can talk my language, I'd settle down and get married!"

I peer dubiously at the young squirt parked in my chair, his feet draped lazily across the table. I weigh the words of this youngster carefully. Truly, here is one of hamdom's unlearned! I resolve therefore to teach him in parables.

"Listen, Seven-and-a-half-watt," I begin, "did I ever tell you the legend of the night ride of Willie Crummit, W9NURTZ?"

"Can't say that I've heard you tell that lie," the young upstart mouths.

"Save your compliments until later," I flash back.

"Several months ago, August 1934, to be exact, I ran into Willie at the Cyclone City convention. Willie comes from a town not far from here and we are fairly well acquainted. The convention festivities are practically over and the gang has enjoyed a big week-end. One YL present has knocked them for a row. She is really an eye-full and brother, not only does she have looks, but also brains. During the convention she wins a half-dozen contests and delivers a technical paper, altho I don't believe the younger element grasps much of the lecture. They are too busy admiring the constructional details, and I don't mean the written ones on the blackboard! This baby can simply be labeled Fig. A-1."

"What's her QRA?" the young squirt breaks in.

"Shut up, Simpleton!" I demand. "Now then, to continue. The fellows have flocked around this cutie for two days and a night, bothering her for schedules, autographs, and what have you? I notice my friend Willie Crummit is in the thick of the voice band. I believe he really thought he was getting over big with this beautiful creature. Presently he breaks away from the admiring group and rushes over to me.

"Listen CYV, will you do me a favor?" he asks breathlessly.

"Sure, Willie. Do you want me to be best man at the wedding?"

"Nope, not that," he blushes. "I want you to drive my car home, after the convention has folded up—Oh, I'm going along too, but I intend to park in the rear seat with—with her!" He points to the girl. "Isn't she a honey? Now you can see why I don't want to be bothered with a steering wheel!"

"Hey, Ixnay," I protest. "I came here on the

*435 East 4th St., Newton, Kansas.

train and I'm going back the same way. Besides I don't want to get mixed up in these roadside necking bees. My wife might object!"

"Aw come on," he urges, "all you have to do is drive the car. She lives out at Clinkerville and we go right through there on the way home."

"No, no, . . ."

"Tell you what—I'll give you that 801 tube I won in the prize drawing if you'll drive the car home for me."

Now every man has his price and considering the fact that I have won nothing but a porcelain insulator in the drawing, I yield to Willie's offer.

"Okay son, for an 801 I would drive June East into my own garage and park!"

Accordingly at 7 p.m. or thereabouts, the gang begins to disperse. Sure enough Willie has persuaded this super-YL to go home in his car.

"Meet my fran Rose—Rosie Plaitte, W9—" he introduces. "This is old man CYV. He wants to ride along with us—maybe do a little driving or sumpin' to earn his fare!"

I color up angrily. "Yeah, I'm going along to take care of Willie's 801 tube!"

She laughs at that, but of course doesn't get the full import. Willie takes it on the chin and comes through like a trouper. He quietly slips the tube in my coat pocket and invites me to drive.

We climb into his hack and I grapple with the controls. Willie suggests to Rose that they ride in the rear seat. Lucky for him the flivver is a coach and the queen doesn't have much choice. We speed out of town just as darkness settles on the surrounding landscape. Rosie is inclined to be talkative. We comment on the convention for ten miles or more. Finally Willie gets down to the text.

"Oh look at the bright moon hangin' up in the east," he romances.

Rosie sighs; "It reminds me of the bright filament in my 203-A. I've a notion to unwind some turns on my filament transformer, tomorrow, or the buffer stage will be minus a tube."

"That's tough," Willie sympathizes, "but it can't possibly burn out as long as you're snuggled here with little me."

"Yes it can!" Rosie protests. She explains that her pappa is physics instructor in the local high school and sometimes plays with the transmitter when she is away.

"Oh hang your pappa!" Willie utters under his breath. "Listen Rosie, aren't you cold? Maybe my arm would help—"

"No, I'm not cold—not a bit. Say, did you ever hear of a storage battery freezing up in cold weather, with the trickle charger running? Ours did last winter!"

"I'm not surprised," Willie mutters. "Why don't you pipe a.c. into the receiver?"

"Oh we did!" she exclaims, "but we get a lot of hum with the new circuit."

"Speaking of hum—" says Willie, "Why shouldn't I hum a little tune to you? 'It isn't the breeze—it's love in bloom!'" he croons.

"No, please don't! I hear enough of that from the broadcasting stations, besides, your exhaling smells strongly of three point two! I don't like boys who drink beer."

"Gee, Rosie, don't cha drink or smoke or neck or chew gum, or sumpin'?"

"Maybe."

"Maybe what?"

"Maybe I could get you and CYV to wire up a modulator for me if I decide to operate in the phone band!"

I duck low and nearly swallow the horn button to keep from laughing.

She continues. "Maybe it would be better if you just sent me the diagram. Pappa and I could wire it, evenings."

"You might let me drive over to your house and get in on the clam-bake," Willie adds. "At least I could stand around and hold soldering irons!"

At the next crossroads, Willie sends me into a store to purchase lime drops. Evidently he figures the convention fire-water is QRming his sex-appeal! During the next mile he munches on half the package and I notice the beer perfume fading away. Instead he now smells like the Amalgamated Fruit Company!

"Now baby," he continues after that intermission, "surely you realize that ham radio isn't everything in life. Think of an evening in June—think of a tropical moon—" he sings softly.

"Think of a schedule at noon—" she interrupts. "Did you ever work W9FMX? He's on every noon."

By this time we are nearing Clinkerville. Willie is desperate. He plays his last card.

"Kiddo, I know you're good. I know you won a lot of prizes at the convention. I know your rig has a mighty sweet note on the air—but I'm askin' you as man to maid—how about just a few 83's for little Willie before we part forever?"

"What're 83's?" she inquires innocently.

I realize she is stalling for time, therefore I interrupt and explain, "Same as 73's only ten degrees hotter!"

"That's it," Willie agrees. "Hurry Angel-Eyes,

we're almost in front of your house!"

The cutie acts completely dumbfounded. Then slowly she begins to register knowledge.

"Oh, I see—I get it now. Sure, I'll be glad to shake hands with you Willie—, with both of you.

I think a lot of you boys, and all the Ninth District fellows for that matter. They've all been so nice to me!"

I stop the car as she warbles good night to both of us. I get in on the handshake too. Willie climbs out of the car after her. He staggers against the fender, too exasperated to go farther. He thinks not at all of escorting her to the house.

It is no offense to Rosie, for she races to the porch and opens the front door. From the threshold she calls back to us, her voice clear and musical on the night breezes—"Come back 'n see me some time!"

Willie stumbles into the car, speechless.

I speak consolation. "I can't do it pal. I haven't the heart to take your 801. Here, Willie, it's yours." I offer remorsefully.

With trembling hands he takes the tube from the carton. He holds it aloft unsteadily for a final glance in the moonlight. Then without a word he hurls it fiercely at Rosie's doorstep.

"That—kiddies and young squirts—ends my story and just goes to show ya that some of the smartest radio gals may prove to be the dumbest!"

I throw my remarks directly at the green and growing thing seated in my guest chair. "Now run along and stop moanin' for baby-doll amateurs. Maybe you can get a date with the little hasher down at the greasy-spoon—she gets off at midnight, doesn't she?"

He stirs out of the chair and brings two awkward feet to the floor with a whack. "Whazat you said? Oh, I musta been sleepin'," he drones. "Yes Sir, CYV, if I could find the young lady op who really knows her radio—I'd up and marry her!"

Without a word I open a window in the shack and push the unfortunate young man through it. I know he will fall exactly sixteen feet to the concrete below. The thought pleases me immensely.

Strays

Speaking of coincidences, when W8NXT hooked up with W8DX not long ago, a check with the call book showed that both had the same names. As NXT says, it's not every day in the week one can QSO with himself!

HOW YOU TELL ONE



Sixth A.R.R.L. Sweepstakes Contest

Nov. 22nd to Dec. 1st—Use 'Phone or C.W. on Any Ham Band

National-All-Section¹ QSO Party

W, VE, K, KA, CM, VO Hams All Invited—New! Separate 'Phone and

C. W. Certificate Awards in Each A.R.R.L. Section,

Club Awards—Modified Power Handicap—New 90-Hour Rule

By F. E. Handy*

THE "SS" this year will be an operating activity for all hams, League members or not, residing in any A.R.R.L. Section,² and it will be run substantially along the lines of the previous Sweepstakes that have won such popular approval. One of the outstanding operating events of the whole year, this time we have consulted a representative cross section of previous participants asking about desirable changes in the "SS" arrangements. A number of suggestions have been received, some with viewpoints widely divergent. We have, however, in all cases followed the will of the majority, since of course it is impossible to exactly comply with every suggestion. This year there will be *two* certificate awards in each Section, one to the leading 'phone operator as well as one to the leading c.w. telegraph man. It will be necessary to report work definitely as all accomplished with a 'phone transmitter, or with a c.w. telegraph transmitter. 'Phone operators will compete with 'phone operators. Telegraphing hams will compete with other telegraphing hams. It is a competition, but not between 'phone and c.w.

62% of the men questioned insisted on a 90-hour-operating-time-total handicap. The rest wanted a full 9-day contest. The new rule will eliminate unfair competition from those with work that may be set aside, or from those who would take a vacation (and a sleepless one at that) to make "a clean sweep of the Sweepstakes." One can work more than 90 hours if he likes, but scoring benefits will be reduced proportionately for such "extra" time. It is required of all contestants that a record of actual station operating time be submitted as part of the log. 60.7% wish to keep the message-exchange-proof-of-QSO rule just as it was last year instead of using numbers. Some want the name of the Section in messages where Sections are larger or smaller than a State. Only 15.4% of those approached wanted a signal report to be part of the

text. The only change in the test message requirement is that the text may be four-or-more words instead of five required, as last year.

The power handicap of last year brought some comments. Quite a number favor having it continued; others wish to abolish it on the grounds that station measuring equipment is often inadequate (in spite of F.C.C. requiring that the power be stated in logs!). To take a step toward the abolition of the handicap we have cut the number of power classifications from three steps to two, and the benefits under the handicap are not as large as instituted last year, but we hope will be as fair as possible to arrange. By analysis of the last "SS" results we have changed the power multiplier to more exactly equalize opportunity, bearing in mind that, as someone has put it, results are due "90% to operating ability, 10% to the station itself." Operating in both low- and high-power classes at different times is still permitted, but scoring rules do not permit Sections worked on high power to be used in the low-power classification. Points of some kind are credited for every QSO where a test message is exchanged, whether the station worked is a leading "SS" man or a ham outside the contest. If one breaks his power class, however, the Total Score is the sum of scores separately computed for each power class and added together.

THE CONTEST PERIOD

Time	Starts	Ends
A.S.T.	Nov. 22nd, 5:00 a.m.	Dec. 1st, 5:00 a.m.
E.S.T.	Nov. 22nd, 4:00 a.m.	Dec. 1st, 4:00 a.m.
C.S.T.	Nov. 22nd, 3:00 a.m.	Dec. 1st, 3:00 a.m.
M.S.T.	Nov. 22nd, 2:00 a.m.	Dec. 1st, 2:00 a.m.
P.S.T.	Nov. 22nd, 1:00 a.m.	Dec. 1st, 1:00 a.m.

The idea of the contest is to see how many stations can be worked! If you have never tried to work "all Sections," this is an opportunity to try it. You will add new Sections, and new stations. Any frequency bands can be used, and either voice or telegraph. Any amateur station in the U.S.A.¹ or Canada can take part. Each station works as many other stations as possible

* Communications Manager, A.R.R.L.

¹ Including Cuba, Porto Rico, Hawaii, Alaska, P. I., etc. Amateurs in Newfoundland are included in the Maritime Section of the A.R.R.L. field organization.

² See the complete list of Sections in the A.R.R.L. organization page 7 of this issue of QST.

working in as many different A.R.R.L. Sections² as possible in the contest period. As necessary proof of "solid" QSO, a short message will be exchanged. Fullest operating enjoyment is assured. W9AUH worked 68 of a possible 69 Sections in the last "SS"! Fun? See page 48 of May QST for full details, or ask any amateur who took part last year!

A fraternal order ours. The "SS" gives opportunity for fraternal contacts. Besides new friend-

A.R.R.L. 'phone and c.w. Section awards) will be made through each club where *three or more* individual club members, or new local hams invited by such a club, take part. Reports must be made direct to A.R.R.L., West Hartford, mentioning the name of the club, to be eligible for the affiliated-club-award. There is nothing more fascinating than to plan local competitions and swap results in a friendly way with the ham-across-town as the operating goes along. Entrants who

PBLE	ADR	Text	SIG	Time, Date, Station
Denver, Colo., W9ZZZ, nr 5, Nov. 24 " " " " 6 " "	W6YZZ W1MK	How score in tests You also heard on 80	W9ZZZ W9ZZZ	

ships the chance is one to test station performance, to work new states and Sections, to improve operating efficiency and ability, all in the true ham spirit.

THE GENERAL CALL

"CQ SS CQ SS CQ SS de W . . . W . . . W . . ." is used by stations looking for contacts in the Sweepstakes. During the most active hours a single snappy CQ SS will bring results!

AFFILIATED CLUB PARTICIPATION

Additional certificate awards (besides the

POWER FACTOR

If the power input to the final stage (plate current times plate voltage— $E \times I$) is:

- (a) Up to and including 100 watts—multiply score by 1.5.
- (b) Over 100 watts—multiply score by 1.

(Continued on page 38)

STATION W/VE . . . SUMMARY OF CONTACTS 6TH ALL SECTION S.S. CONTEST

Date and Time (local)	Operating Time (mins.)	Station Worked	Freq. Band (mc.)	City	A.R.R.L. Section	List Diff. Sections	Points
Nov. 22			On air at 4:05 a.m.				
4:40 a.m.	W6MP	7	San Francisco, Cal.	S.F.	S.F.	2
4:59 a.m.	W6DJI	3.5	San Francisco, Cal.	S.F.	1
	95 mins.		Off at 5:40 a.m.				
2:10 p.m.		On air,				
2:24 p.m.	W9BWF	7	Redfield, Iowa	Iowa	Iowa	2
3:15 p.m.	W8ALC	7	Defiance, Ohio	Ohio	Ohio	2
	70 mins.		Off at 3:20 p.m.				
Nov. 24			On at 11:00 a.m.				
11:14 a.m.	W9KEH	3.5	East St. Louis, Ill.	ILL.	ILL.	2
12:08 p.m.	W9CUH	3.5	Waukegan, Ill.	ILL.	2
12:25 p.m.	W6BIL	14	Tulare, Calif.	S.J.V.	S.J.V.	2
12:48 p.m.	W2ERM	14	Tuckahoe, N. Y.	E.N.Y.	E.N.Y.	2
	175 mins.		Off at 12:55 p.m.				
	340 mins.					6 Sec.	15
	(5 hrs. 40 mins.)		8 diff. stn. QSOs.				

Number and name of operators having a share in above work
 Claimed score: 15 points \times 6 Sections = 90. 90×1.5 (64 watts input) = 135

I hereby state that in this contest I have not operated my transmitter outside any of the frequency bands specified on my station license, and also that the score and points set forth in the above summary are correct and true.

Also please note this score in our affiliated-club S.S. contest as well as in general participation record. Signature Call

Name of Club Secretary's address Address

My Tube Line up: Club Member

Power input: Prospective Club Member

QRP

Practical Methods of Reducing Power for Local Work

By George Grammer*

WHEN a couple of hams get together one sure-fire subject is QRM. Not that the means to avoid it aren't available, because they are—almost any QRM can be conquered by an S.S. Super. But there are still lots of us who haven't the means to get such a receiver, and too many of those that have them don't realize their full capabilities. So it behooves us to look around for methods of reducing QRM at the transmitting end. One scheme that ought to help a bit is that of cutting down power when working nearby stations—an idea about as old as radio itself, since both QRP and QRM have been on the list just as long as there has been a Q code.

One deterrent to reducing power is that it's something that doesn't so ostensibly benefit the fellow who practices it—it mostly helps the other fellow. It took years and years to get across the idea that a d.c. note took up less space than any other kind—apparently it hasn't penetrated into some craniums even now—largely because it meant taking a little more time and trouble in adjustment, and the world at large instead of the individual concerned was the primary beneficiary. Reducing power is in the same category but isn't hard or expensive to do—it actually can save some money on the power bill and prolong the life of equipment. It's not only illogical but wasteful to use 500 watts to do a job that 5 or 50 would do just as well.

We suppose that getting fellows to reduce power for local work is chiefly a matter of making it convenient and painless to do so. There's not much to it, technically. But there are lots of ways to incorporate power-reduction in a transmitter, some of which will appeal to one and some to another. We've collected a few and propose to exhibit them here. Take your choice.

CUTTING DOWN THE OUTPUT

In the final analysis what's wanted is fewer watts in the antenna. For c.w. work it doesn't matter much how the reduction comes about. The most obvious scheme is that of reducing the coupling to the feeders so that less energy gets into the antenna system—where it can be done without making the tank condenser spark over with the load reduced. If you have one of those non-resonant or "matched-impedance" feeders that taps on the final tank coil, just move the taps closer together, keeping them symmetrical

if the tank circuit is a balanced affair. It shouldn't be necessary to retune the tank circuit—if it is, the antenna system should be given a going over because the feeders and antenna aren't matched. For quick change, a double-pole double-throw switch can be rigged up as shown in Fig. 1. With non-symmetrical tank circuits or with single-wire feeders only one tap need be changed and a single-pole double-throw switch will suffice.

The "pi" coupler or matching network ("Col-lins"), properly functioning, also offers a ready means for reducing output. Simply turn the output condenser to make the final draw less plate current, retuning the input condenser if necessary. The range of reduction obtainable with this system probably will depend upon the type of feeder or antenna system used, and it may not be great enough. In that case, a duplicate set of taps on the plate tank, closer together, will do the trick.

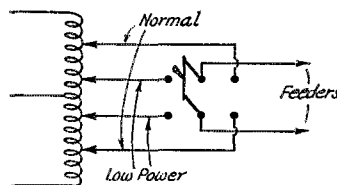

FIG. 1—QRP CAN BE ACCOMPLISHED BY REDUCING ANTENNA COUPLING

The taps also can be switched as in Fig. 1, in which case the points marked "feeders" would connect to the input of the coupler.

We hope it isn't necessary to tell those using inductive coupling how to reduce the power put into the antenna. However, in this case, loosening the coupling probably will require retuning the tank circuit. Detuning the feeder condensers will accomplish the same result without the necessity for changing the physical separation between coils; this method also may require slight retuning of the final tank.

How much can the power be reduced by these methods? It's not hard to check, especially if a current indicator is used in the feeders. Since power varies as the square of the current, other things being equal, a reduction of antenna current to one half its normal value means quartering the power, to one quarter the normal value means cutting the power to one-sixteenth, and so on. Without a current indicator, the input to the final gives a pretty good indication of the reduc-

* Assistant Technical Editor.

tion, since the output is about proportional to plate input in the normal amplifier.

REDUCING INPUT

Maybe it isn't convenient to change antenna coupling, or even impossible where the tank sparks over. In that case the tube output can be held down by various other means, one of the first coming to mind being that of cutting down the plate input. This can be done in several ways, three of them being shown in Fig. 2. If the plate transformer is not one of those combination affairs which also furnishes filament voltage for some of the tubes in the set, a resistor can be connected in series with the primary, shunted by a s.p.s.t. switch to cut it out for full-power operation. The resistance required naturally will depend upon the size of the plate transformer and the extent of power reduction desired. If you don't want to buy a regular resistor, try some 110-volt lamps. A few of different ratings will give quite a range of input control.

The resistor method isn't so good for c.w. work, however. Since the voltage drop depends on the current flowing and the current in turn depends on the power taken from the transformer, it is apparent that under key-up conditions the output voltage is going to be nearly as high with the resistor in as it is with it out. This means that the plate voltage will build up during keying spaces and take a terrific dive when the key is closed. This won't help a bit on key clicks, and each dot and dash will have an initial whack which may travel just as far and cause just as much QRM as though the power hadn't been reduced. Some improvement will result from using a tap on the plate-supply voltage divider, as shown in Fig. 2-B, although this system only partially overcomes the difficulty. A method still better than either is shown at C, where an auxiliary transformer (an old filament transformer or the toy gadget used for Junior's train) is hooked up so the plate transformer is fed either directly from the line or from a low-voltage secondary on the auxiliary transformer. A toy transformer delivering 10 or 15 volts will effect a substantial reduction in power—maybe too much in some cases. An auto-transformer with taps for various voltages will do the same job, although it seems an unnecessary refinement in view of the many other schemes that can be used. Of course the real de luxe method of continuously variable plate voltage control is to feed the plate transformer through one of General Radio's "Variacs." Not only can the input then be set at any value below

normal, but also the primary voltage can be run up to 130 from a 115-volt line. Such "negative" power reduction helps sometimes, too.

While on the subject of reducing plate voltage, W6QF's method, suggested in the "Experimenters' Section" in July, 1935, *QST*, is a good one. His idea is to switch the crystal power supply to the final, which requires no auxiliary apparatus except a switch. A rectifier-changing circuit for

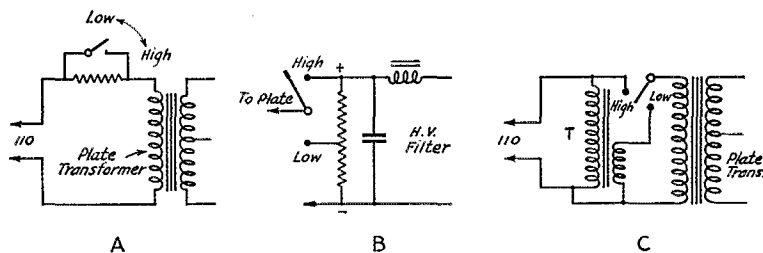

FIG. 2—METHODS OF REDUCING PLATE VOLTAGE

voltage reduction sent in by W4CBV appears in the same issue, while still another scheme used by W8COW is shown in the X Section in May *QST*.

OPERATING ON THE GRID

If tinkering with the plate voltage has no attractions, there are still other ways of making an 852 act like a 46. One scheme is to increase the grid bias so that the tube draws less plate current. Since few people have extra batteries and nobody wants to buy them for the sole purpose of cutting down the output, we'll discard this idea in those cases where battery bias is used. However, a good many amateurs are getting bias from power packs, and others are using blocked-grid keying in one form or another. Increasing the bias under such conditions may not be a financial burden.

Assume for the moment that a bias supply having more output voltage than is necessary for normal operation is being used, the correct bias voltage being obtained from a tap on the bias-supply voltage divider. What could be simpler than to put in a s.p.d.t. switch so that either the regular bias or the full output of the bias supply can be selected? In case a diagram is necessary, Fig. 3-A will be found nearby. Or suppose blocked-grid keying is being used with a separate blocking supply. It's simple enough to select a point on the voltage divider that will cut the plate current to a desirable value, switching back to normal conditions in an instant, as shown in Fig. 3-B. In 3-B it is assumed that the normal bias also comes from the blocking supply, although the amplifier could be grid-leak biased and the "high" switch point be connected to filament center tap. Or make a third assumption that the blocking voltage comes from the plate supply as shown in 3-C. It wouldn't be hard to

find a tap on the lower portion of the voltage divider that would give the reduction in power desired, again using the favorite s.p.s.t. switch for changeover. There are lots of variations on this theme.

Bias also can be controlled to some extent by changing the value of the amplifier grid leak. An auxiliary leak, connected in series with the regular leak and arranged to be shorted out for normal power, often will effect a considerable reduction in power output if its value is high enough. Suggested values are 50,000 to 500,000 ohms, depending upon the type of tube and the excitation. Lower values generally will suffice for high- μ tubes, while a great deal of extra resistance may be required to cut down the output of a medium- or low- μ tube. The power to be dissipated by the extra resistor naturally will depend upon the grid current likely to flow through it. A five- or ten-watt resistor, if in the hundred-thousand ohm class, should be ample for almost any transmitter.

EXCITATION CONTROL

Possibly none of the schemes so far mentioned are simple enough—after all, most of them do require at least a switch, or lacking the switch it may be necessary to lean over to change a tap. In that case, possibly control of excitation would be more satisfactory, because the most elemen-

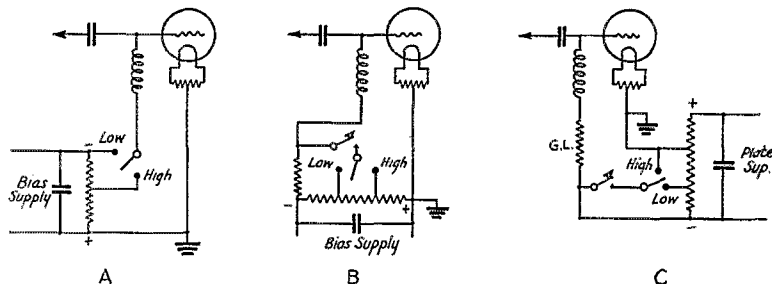

FIG. 3—INCREASING CONTROL-GRID BIAS IS EFFECTIVE

tary form of excitation control requires nothing more than turning a knob through an arc of a few degrees. The knob, of course, is the tuning control of the crystal oscillator. The output of most crystal oscillators can be varied over a considerable range simply by tuning away from resonance. Buffer stages also can be detuned to accomplish the same effect, although it is not advisable to try this on buffers working at high plate voltages—it's too hard on the tube. Tubes of the 2A5-46-59 class operating at 300 or 400 volts will stand it pretty well, however. But the crystal is the safest bet, unless you have one of those rare transmitters with such an excess of excitation that the variation in oscillator output over its working range will have little effect on the final output. In that case the plate voltage on

oscillator or buffers can be reduced by one of the methods already described.

Speaking of excitation, a novel method of reducing power—it also has the merit of simplicity—is used at W1BDI. For local work the plate voltage to the final stage, a neutralized triode, is cut off completely. The final neutralizing condenser is then turned off the correct adjustment, “soup” from the exciter gets through the now-unneutralized amplifier to the antenna and the set is on the air with low power. Returning the neutralizing condenser to the predetermined correct setting and switching on the final plate voltage for high power is the work of but a second. Does it sound difficult?

SCREEN-GRID TUBES

QRP with screen-grid tubes can be effected by almost all the methods previously described, and a few other methods also become possible. If the screen-voltage for a tetrode or pentode is obtained separately from the plate supply, the output can be varied from maximum practically to zero simply by reducing the voltage on the screen. It's not hard to pick a tap on the screen supply which will give sufficient power output for local work while lessening the QRM at a distance. The same s.p.s.t. switch will make the change instantaneous.

With pentode-type tubes the suppressor offers still another power-reducing possibility. Taking the purely hypothetical amplifier of Fig. 4-B, in which one bias supply serves to furnish both negative grid bias and positive suppressor bias, a second tap on the negative side of the divider could be chosen to put negative bias on the suppressor for power reduction. If the bias supply is equipped with one of those sliding-tap resistors, the output can be set at any desired value quite readily. The same switching arrangement is readily adaptable to battery bias, and can even be used when grid-leak bias alone is available, as shown in Fig. 4-C. The grid leak either should be tapped or should consist of two resistors in series. A tap at half resistance should be sufficient to cut the output to about a quarter its normal value with a tube like the RK-20; in some cases a desirable reduction may result when the whole voltage drop in the leak is used to bias the suppressor. A potentiometer-type or multitapped grid leak will give quite smooth control of output—and incidentally offers a possibility for suppressor bias for 'phone.

'Phone requires a little special, although not more difficult, treatment. Taking first the case of plate-modulated amplifiers, probably the best method of reducing power is by reduction of plate voltage, using one of the methods shown in Fig. 2. Since the plate-modulated amplifier has to operate Class-C, the plate current and plate voltage are proportional and the impedance offered to the modulator is therefore constant regardless of plate voltage. It is unnecessary to make any adjustments to the transmitter except to turn down the gain control so the audio output will "fit" the d.c. input to the modulated amplifier. If an oscilloscope or peak-type modulation monitor is used with the set the audio output for full modulation can be determined readily. In the absence of such devices, the old-reliable milliammeter in the modulated-stage plate circuit will have to be depended upon. Don't let it flicker with speech.

The methods which change antenna coupling or change excitation or bias are not so satisfactory for this type of service, because they call for readjustment throughout the set. The complications aren't worth the trouble since a lamp bulb in series with the plate transformer primary will do just as good a job.

GRID-MODULATED AMPLIFIERS

Changing antenna coupling or changing plate voltage are not likely to be very satisfactory with control-grid or suppressor-grid modulated amplifiers, since they also will make complete readjustment necessary if the linearity of modulation is to be maintained. Perhaps the simplest way to reduce power with these systems is to reduce the plate current, and thereby the output, by increasing the negative bias on the control grid or suppressor. A smaller audio swing then will give complete modulation—cut down the gain control until the plate current stands still under modulation. The same end can be accomplished by leaving the bias alone and reducing excitation with control-grid modulation, although it is doubtful if this would be wholly satisfactory with suppressor modulation.

Incidentally, controlled-carrier 'phone is just about the ideal system for power reduction. Any desired level can be attained simply by adjusting the gain control—or by being a bit more gentle with the microphone. Whisper for locals and shout for DX!

How far should one go in reducing power for local work? The answer to that one is the same as to "how far is up?" The safest bet is to follow the rule that's still in the regulations—use the

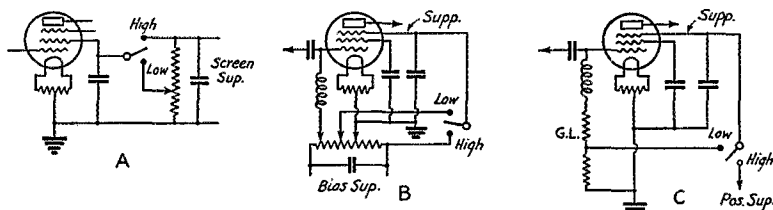

FIG. 4—WITH TETRODES OR PENTODES, CHANGING SCREEN OR SUPPRESSOR VOLTAGE GIVES COMPLETE CONTROL OF POWER OUTPUT FOR EITHER C.W. OR 'PHONE

least amount of power that will cover the distance satisfactorily. Since fading is seldom bothersome locally, it should be possible to find out readily enough how much power is needed for rag-chews with the local radio club members. There are times, though, when a crosstown chat actually requires more power than working the other coast—that happens often enough on the 20-meter band when distant signals override the relatively-weak locals. But that simply proves that the wrong band is being used for nearby contacts. Why not use five or ten for locals and give yourself, as well as everyone else, a break?

Amateur Contests at Brockton Fair

IN addition to the World Championship Code Speed Tournament recounted above, the Brockton Fair Radio Show, September 9th-14th, was the scene of much amateur radio activity, including several contests. A *New England receiving championship* cup was won by Arthur Donovan, W1HM, who copied 38 words per minute, without errors, with a pencil! The cup for the *N. E. straight key sending championship* was won by E. L. Battey, W1UE, at a speed of 27½ words per minute, perfect sending. Minot Simmons, W1HOB, gave him a close race, attaining a speed of 31 words per minute, but made one or two errors. A. H. Macomber, W1DDB, was third in the straight key contest. The *semi-automatic key (bug) sending championship* and cup was won by Bob Ruplenas, W1DDO, at a speed of 25 words per minute. Director Bailey, W1KH, also made a beautiful record at bug sending. These three contests were open to licensed amateurs, who were not also commercial operators. Each contestant's transmission was recorded and later played back for the judges, who were T. R. McElroy, world's receiving champion, Art Donovan, W1HM, N. E. receiving champion, and

(Continued on page 80)

H A M D O M



FOR more than 21 years W. T. Gravely, W3BZ, has been an amateur down in Danville in of Virginny. Bitten by the bug in 1914, he listened for a year without hearing a peep of any kind. It was several years before he even saw a ham station.



The equipment of his station passed through the familiar evolutionary steps—Ford coil, $\frac{1}{4}$ kw. spark and rotary gap followed by a $\frac{1}{2}$ kw. and finally a 1 kw. job as good as they came in those days. Practically everything around the



shack was home-made, tube sockets, variable and fixed condensers, grid leaks, broom-handle insulators, power transformers. W3BZ has been identified with the A.R.R.L. since the very beginning of the League. He has served the organization faithfully and well in many capacities: District Manager, as a League director before the days of divisions, and later as a director of the Roanoke Division for many years. Right now, he says, he's just a ham in the rear ranks, as keenly interested as ever, spending an average of four or five hours out of the 24 in the shack each day.

HAMDOM isn't Who's Who, but why not? Concerning Dr. Lawrence J. Dunn, W2CLA: Entered radio in 1909. Licensed (commercial and ham) in 1913. Deserted radio while at the University of Pennsylvania; graduated with the degree of D.D.S. in 1916. During the war served as First Lieutenant, Dental Corps, U.S.A. Back into amateur radio in 1920, with W2CLA, which call letters have been maintained ever since. First director of Hudson Division, serving two terms, at the end of which period, declined the nomination and turned the position over to Dr. Walsh. Assisted in the formation of the Army-Amateur System, and was appointed Chief Radio Aide to the Chief Signal Officer of the Army by Major General George S. Gibbs. Served in this capacity for five years. Major, Signal Reserve Corps,

Commanding 302nd Signal Battalion. Sometime president of the Radio Club of Brooklyn; president of the Garden City Radio Club. Member of the Institute of Radio Engineers. Transport pilot. As for the rest, ask any W2.

AT THE western end of Trunk Line I there's VE5AC, operated by Reg. K. Town, one of Canada's outstanding traffic men. As a traffic hound, his career dates back to 1929, when he renounced the DX bug. Prior to that time, as both 5FM and 5AC, a variety of ham work had been done at scattered times. The present highly intensive activity commenced in 1932, when he became O.R.S. Elected S.C.M. of British Columbia in 1933, he found his biggest problem to be contact with the stations of his section, so a year later he inaugurated the monthly "Amachewer," high spot in ham sheets. VE5AC believes his most significant performances to have been in QRR work; last October he helped save six people when wires were down, and last January spent 80 hours on the air over a period of 8 days during the big storm. But we point out, in addition, his sked with VE4BZ which has been carried on steadily for five years and his trans-Canada QSO on 80 meters with VE1FL.



B. A. "BUCK" McKINNEY, JR., W5ATF, is perhaps best known in ham circles for the nightly chats with



W6CXW during 1933-34, on which operators all over the world listened in for the tips concerning rare and elusive DX that were banded back and forth. There's not much W5ATF doesn't know about DX; he has worked 109 countries, WAC more than 300 times, winner of the 5th and 6th International Relay Competitions and the 1933 Spanish DX contest. During the last DX test he commuted 125 miles daily for the

(Continued on page 88)

With the Affiliated Clubs

National Capital Hamfest

THE Washington Radio Club, one of the oldest of the A.R.R.L. affiliated clubs, invites all amateurs to come to Washington, D. C., on November 2d, for a "National Capital Radio Hamfest." The Mayflower Hotel will be the seat of the festivities, which will include technical sessions, rag-chewing, speakers, banquet, dancing and prizes. Activities start at 1:00 p.m. and are expected to continue until midnight or later. Principal speakers will be Dr. Irvin Stewart and Lt. E. K. Jett, U.S.N. (retired), respectively Chairman and Chief Engineer, Telegraph Section, F.C.C.; Dr. E. C. Woodruff, W8CMP, Director, Atlantic Division, A.R.R.L.; Paul M. Segal, W3EEA, General Counsel, A.R.R.L., and K. B. Warner, W1EH. It is expected to be Washington's greatest gathering of radio amateurs. Tickets, if obtained before November 2d, are \$2.50 each, or \$3.00 each, if purchased at the hamfest. Reservations are available from the club secretary, Barron P. Freeburger, W3DK, 435 5th Street, N. E., Washington, D. C. It's going to be a big time, gang, so head the gas buggy for the Nation's Capital and *don't miss it!*

W9XAZ Amateur Programs

Each month the Milwaukee Radio Amateurs' Club is broadcasting the entire proceedings of one of its regular meetings over the *Milwaukee Journal's* station W9XAZ. These broadcasts, which will continue through May, take place from 8:00 to 10:00 p.m., C.S.T., the second Thursday of every month, on 31.6 mc. Talks and discussions of general amateur interest are featured. On a frequency near the amateur 28-mc. band, these broadcasts offer opportunity for observations in that territory. Reports of reception of the Milwaukee Radio Amateurs' Club's programs will be appreciated, together with comments and criticisms. Amateurs especially in the Chicago area and along the Indiana and Michigan shores of Lake Michigan are urged to listen for these distinctly amateur programs. Address all communications to W9XAZ, The Milwaukee Journal, Milwaukee, Wis.

The Kilocycle Club of Milwaukee is continuing its regular Saturday evening broadcasts over W9XAZ (31.6 mc.) from 6:00 to 7:30 p.m., C.S.T. With the October 5th program the Kilocycle Club completed a decidedly successful six months on the air at W9XAZ. For the second year this club is supplying the instruction in radio code and theory, which is offered by the Milwau-

kee Public Night Schools and Social Centers. This instruction is supervised by Elmer Ash, W9ESE. So popular were last year's courses that one school building was kept open all summer, and it has been decided to make the Kilocycle Club "license classes" a year-round proposition. As an outgrowth of these classes the Extension Department of the Milwaukee Public Schools has made arrangements with W9XAZ for the origination of a special series of educational programs to be received in every night school and social center in Milwaukee. The Kilocycle Club plans to cooperate in lining up the various receivers necessary to this plan. Reports will be appreciated on the Saturday evening W9XAZ broadcasts.

Pike's Peak A.R.A. Starts Active Season

The Pike's Peak Amateur Radio Association of Colorado Springs started the winter season with a meeting at a local camp; free eats and drinks brought out nearly every ham in the vicinity, and many problems were ironed out for a busy season. The Association is sponsoring a 1.75-mc. 'phone net for low-power local rag-chews and a 56-mc. equipment building contest, with three worthwhile prizes offered. An effort is being made to get the gang on one band, 1.75-mc., for Sunday morning rag-chews. The Pike's Peak A.R.A. is believed to be the only club in Colorado that maintains emergency equipment. Their gear, operating under the club call, W9OKY, includes an 801 Hartley 7-mc. Hi-C transmitter

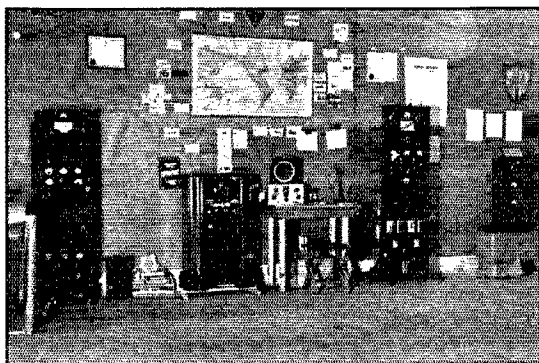

THE WELL PREPARED EXHIBIT OF THE SASKATOON AMATEUR RADIO CLUB AT THE SASKATOON (SASKATCHEWAN) EXHIBITION, JULY 22-27

A 3.5-mc. 'phone-c.w. rig was operated under the call VE4RB. Several other transmitters were also on exhibit.

in the same cabinet as a regenerative detector and two-stage audio receiver using '01A's. Power is

(Continued on page 82)



Amateur Radio STATIONS



W6USA

The California Pacific International Exposition, San Diego, Calif., 1935

By Earl F. Kiernan, W6E00, and Wayne Prather, W6GWY

STATION W6USA at the California Pacific International Exposition, opened May 29, 1935, was built, and is operated, as an example of amateur radio activity. The personnel consists of the following: Wayne Prather, W6GWY, business manager; Earl F. Kiernan, W6E00, designer, builder and licensee; H. K. Breedlove, W6JRM, station manager and Ray Dobler, W6BHF, chief operator.

opportunity to operate the equipment. The operation of the station has been confined to the 75-meter 'phone and c.w. bands on the frequencies of 3910 and 3890 kc., with approximately one kilowatt input.

With the hearty cooperation of the Exposition authorities, a very desirable location was found in the center of the Exposition grounds above the arcade fronting the Hall of Science. A large, airy

room, approximately 16 by 28 feet, with a special 5-kilowatt line fed from our own 5-kilowatt transformer, was set aside for our station by the Exposition officials. This room is reached by an individual entrance by means of a short flight of stairs. Immediately above the room is a 60-foot tower, while 300 feet to the west stands the California Tower, about 210 feet high. The antenna supports were thus ready-made.

After making arrangements to have the call letters "W6USA" assigned to the station for the duration of the

Exposition, actual construction of the equipment was commenced during the latter part of January, 1935. With the cooperation of many of the large manufacturers of radio equipment, materials were obtained for the station. After considerable debate it was decided to build a transmitter with 1000 watts input to the final, capable of operating

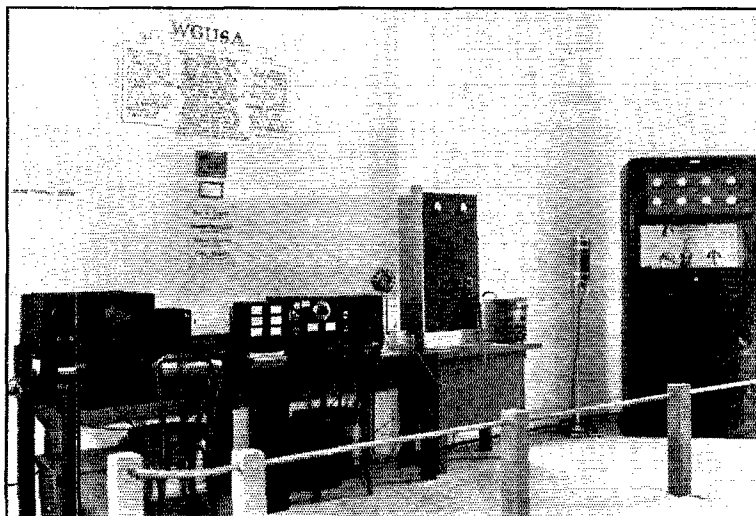

A GENERAL VIEW OF W6USA, AT THE CALIFORNIA PACIFIC INTERNATIONAL EXPOSITION

Operation has been chiefly on 75-meter 'phone and c.w.

The regular operators for W6USA are drawn from the ranks of the various local amateurs through the cooperation of the amateur radio clubs in the San Diego area. No attempt has been made to generate a large volume of third-party messages; however, any amateur bringing his license with him to the station is given an

on the 20- or 75-meter bands, both 'phone and c.w. It was intended to add several additional transmitters as the Exposition progressed, but circumstances have made it necessary to confine our activities to the one transmitter.

The radio frequency unit of the transmitter is housed in a maple frame, 6½ feet high, 3 feet wide and 2 feet deep. This frame is panelled with tempered Masonite suitably molded-in to give a modernistic and pleasing appearance. The two sides are hinged so as to give ready access to the interior. Eight Triplett meters are mounted on a sub-panel behind a glass window at the top portion of the front panel. Immediately below the meter panel is a second window through which may be seen the RCA 851 final amplifier tube with the National tank, neutralizing and coupling condensers. Just below the bakelite name-plate in the center of the front panel is a door opening downward exposing the three tuning controls of the oscillator, doubler and buffer, which are located in a drawer which slides forward and out of the frame. This drawer, constructed of Dural, is divided into three compartments with double partitions between. Each stage utilizes plug-in coils, and all power terminals are brought out to Johnson plugs at the bottom rear edge of the drawer. When the drawer is withdrawn from its normal position all connections are broken as these plugs are withdrawn from a terminal strip. The top of the drawer is hinged to permit access to the various compartments with the drawer in its forward position.

At the bottom of the frame is housed the 3000-volt plate supply for the final amplifier. The second deck holds a 1000-volt plate supply for the doubler and buffer, a 350-volt plate supply for the oscillator, and a 375-volt bias supply for the final and doubler. On the right of this shelf is a vertical panel which has on it the various keying and primary power supply control relays. An overload breaker in the plate lead to the final is mounted just beneath this shelf.

The tube line-up is as follows: 47 oscillator, 801 doubler, 860 buffer, 851 final. The 3000-volt supply utilizes a pair of 872's as rectifiers, feeding a filter system with swinging choke input. This power supply delivers 2850 volts at full load with a regulation of better than 8 percent. The 1000-volt supply uses a pair of 866's, while the oscillator and bias supplies have an 83 and 5Z3 respectively as rectifiers.

The r.f. circuits are strictly conventional throughout, with capacity coupling between stages. The coupling condenser between the buffer and the final is variable to permit adjustment of excitation on the final for grid modulation.

The antenna system consists of a single wire, 380 feet long, 160 feet high at the high end, and 600 feet off the ground at the low end, excited through a coupling condenser at the low end.

The audio amplifier has a four-channel mixer feeding into a 56 first stage, push-pull 56's second stage, and 2A3's push-pull third stage. These stages are all transformer coupled, utilizing high quality T series Inca transformers. The 2A3's

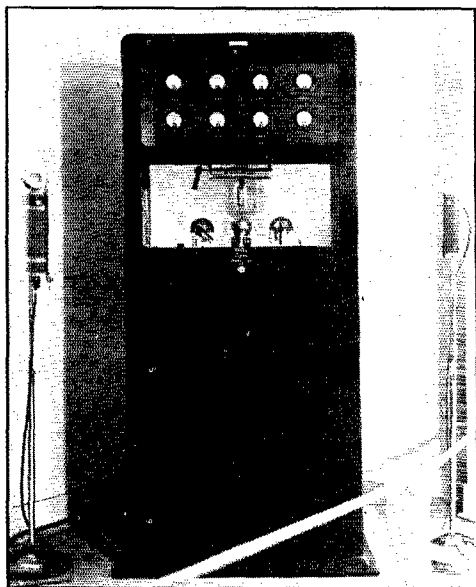

A CLOSE-UP OF THE R.F. SECTION OF THE TRANSMITTER

feed into a 500-ohm line which terminates at the transmitter in a Class-B input transformer feeding the grid of the final amplifier. Although various types and sizes of microphones are available, a close-talking Model A-1 American microphone has been used almost exclusively to eliminate room echo. The speech amplifier and its associated equipment is mounted on steel panels, wrinkle-finish, assembled on a standard 20-inch rack with a Dural dust cover.

Two crystals are housed in a McCorkle crystal oven to the rear of the drawer. Since the c.w. and 'phone frequencies are only 20 kc. apart, changes from one to the other are made quickly by simply throwing a switch controlled by a knob on the top of the oven.

The excitation is adjusted on the final amplifier for proper grid modulation and is left that way for c.w. operation. The input is approximately 1000 watts on c.w. and 850 on 'phone; the efficiency of the final is approximately 40 percent.

All controls are brought from the transmitter to the operating position through shielded cables to a cam switch on the right of the operating table. This switch has off, c.w., and 'phone positions. Immediately upon switching to c.w. or 'phone the receivers are turned off by means of relays in the negative plate leads. On the right

(Continued on page 106)

Canada-U.S.A. Contact Contest

November 8 (6 p.m., Friday) to November 10 (Midnight, Sunday)

ANOTHER W/VE QSO Party! Remember how VE5HQ led the country last year? Canadian amateurs cordially invite hams in every one of the 69 Sections of A.R.R.L.'s Field Organization to take part in three big evenings of operating fun and competition. All W and all VE hams may take part, using any amateur frequency band.

This will give many W's a chance to work all VE districts for the first time. It will be interesting to see what U. S. ham can work most Canadian stations in the period of the tests—and which Canadian station will work most stations and Sections in the U. S. A. likewise. Each contact counts one point, with extra credit for a message exchange¹ in proof of "real solid" contact. This is a splendid opportunity to make new station records and get acquainted with our neighbors at the same time have operating fun.

The Canadian General Manager heartily endorses the enterprise. An A.R.R.L. Certificate of Merit will be awarded the winning station in each Section, this signed for the Award Commit-

tee and by the C.G.M. himself. The Wholesale Radio Company Limited of Toronto is, in addition, presenting a permanent cup and some useful equipment to the leading Canadian station. They are also donating prizes to the runner-up and the station that is third when the results are tabulated. A Committee of Toronto Amateurs again sponsors these 1935 tests. Frank Hartley, VE3JT, Fred Saxon, VE3SG, and Sam Trainer, VE3GT, being the Committee, with VE3GT the chairman. Results should be sent to S. B. Trainer, Jr., Chairman VE/W Contest Committee, 46 Dunvegan Road, Toronto, Ontario, Canada. All logs must be mailed before midnight of November 30, 1935. Here are the simple rules for the W/VE QSO Contest.

DATES: Starts—Friday, November 8th, 6 p.m., local time. Ends—Sunday, November 10th, midnight, local time. Duration—54 hours. Frequencies—Any or all amateur bands may be used.

OBJECT: Each VE will work as many W stations as possible, in as many United States A.R.R.L. Sections (see list p. 5 QST) as possible. Each W will work as many VE stations in as many VE Sections as possible.

Date and Time (Local)	VE or W Station Worked	City or Town	Section	Traffic	Points
Oct. 12 6:02 p.m.	VE3GT	Toronto	Ontario	2 Rel. 1 Del.	3
6:09 p.m.	VE2BE	St. Lambert	Quebec	1
					4
					×2 Sections
					8
					×9
					72 Total Score

FORM FOR REPORTS TO VE3GT ON W/VE CONTEST SHOWING HOW SCORES ARE COMPUTED

tee and by the C.G.M. himself. The Wholesale Radio Company Limited of Toronto is, in addition, presenting a permanent cup and some useful equipment to the leading Canadian station. They

¹ Participants can "make-up" suitable messages if none on the hook. Write them out *before* QSO where practical, make them interesting, avoid "rubber stamp" or stereotyped "standard" texts, etc. Such messages will not, of course, count in regular totals.

² "Handling" a message always includes the transmission and receipt of radio acknowledgment (QSL) of same, and entry of date, time and station call on the traffic, as handled, for purposes of record. All messages should be handled in standard A.R.R.L. form. "Contest traffic" will *not* count in the monthly totals reported to S.C.M.'s, but where regular messages are passed, they will, of course, count for both.

SCORING: Each Canada/USA or USA/Canada QSO counts one point. Handling² of any amateur traffic regardless of number of messages, an additional two points. Maximum points for one QSO³ is three points. VE stations multiply number of points by number of United States A.R.R.L. Sections worked. W stations multiply number of points by number of VE A.R.R.L. Sections worked, and multiply final

(Continued on page 88)

³ Second QSOs with a station that has already been worked do not increase the score in any fashion, unless during such QSO traffic-handling is added, where no traffic was previously handled. In such a case the two points may be added, and special notation entered in the report.

for the EXPERIMENTER



Changing the Antenna Directional Characteristics

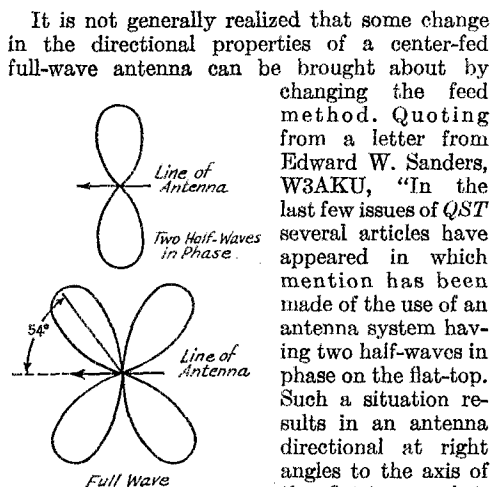

FIG. 1—HORIZONTAL-PLANE DIRECTIONAL CHARACTERISTICS OF TWO-HALF-WAVES IN PHASE (UPPER) AND FULL-WAVE (LOWER) ANTENNAS

It is not generally realized that some change in the directional properties of a center-fed full-wave antenna can be brought about by changing the feed method. Quoting from a letter from Edward W. Sanders, W3AKU, "In the last few issues of *QST* several articles have appeared in which mention has been made of the use of an antenna system having two half-waves in phase on the flat-top. Such a situation results in an antenna directional at right angles to the axis of the flat-top, and is accomplished by the use of a full-wave flat-top with an odd quarter-wave feeder connected in to the center. If we increase the length of the feeder by one-quarter wave by means of loading coils or by switching in the

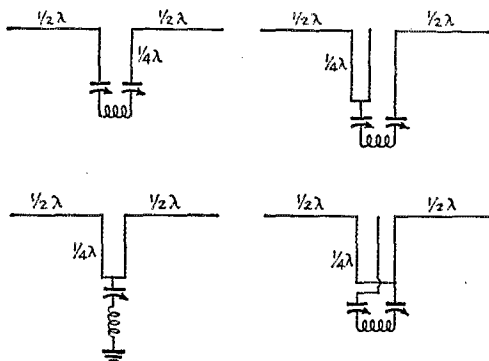

FIG. 2—FEEDER-CHANGING METHODS TO ALTER THE DIRECTIONAL PATTERN TO CORRESPOND TO THE DIAGRAMS OF FIG. 1

The two upper drawings will give a pattern like the upper drawing of Fig. 1. The lower drawings give the lower pattern of Fig. 1.

appropriate length of wire, we will have two half-waves on the flat-top, but they will be out of phase, corresponding to an end-fed full-wave antenna. This system will produce a four-lobed characteristic, as shown in Fig. 1."

The reversal of phase in one half-wave section of the antenna can be brought about in a number of ways. A section of wire measuring a half wave can be inserted in *one* feeder, or a loading coil

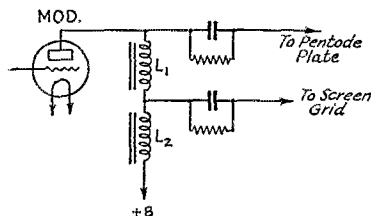

FIG. 3—CLASS-A CHOKE-COUPLED SCREEN AND PLATE MODULATION OF AN R.F. PENTODE

having the same equivalent length can be substituted for the half-wave section. A third method is shown in the lower left drawing of Fig. 2. In this case the two quarter-wave feeders are simply connected together and the whole system worked against ground. A short ground lead is necessary in this case. In all three of these methods the feeders are no longer non-radiating, but become a part of the antenna.

To have the feeders non-radiating with either method of antenna phasing, it is necessary to use a third feeder wire which can be appropriately connected to the other two. The two right-hand drawings in Fig. 2 illustrate the method of connection. The upper drawing corresponds to the usual method, giving the directional characteristic of the upper drawing of Fig. 1. The lower drawing puts the two half-wave sections out of phase, giving the directional characteristic of the lower drawing of Fig. 1. This corresponds to feeding two half-wave antennas from a Zepp feeder. The change can be made quite simply and quickly by installing a switch to shift one of the active feeders from one side of the coupling apparatus to the other.

Choke-Coupled Modulation of R.F. Pentodes

Simultaneous plate and screen modulation of an r.f. pentode, as described in September *QST*, can be applied to Class-A choke-coupled modula-

tion systems by the use of an appropriately-tapped modulation choke or two chokes in series. This method, suggested by A. D. Mayo, Jr., W4CBD, is shown in Fig. 3.

The audio-frequency voltage divides across the two chokes, L_1 and L_2 , in proportion to their inductances. The resistor and condenser in series with the pentode plate are the usual dropping resistor and by-pass to adjust the operating plate voltage in accordance with the modulator requirements, as described in previous *QST*'s and in the *Handbook*. The dropping resistor in series with the screen grid performs a similar function; its resistance should be such that under operating conditions the proper voltage is applied to the screen. The by-pass condenser may be in the neighborhood of 2 μfd .

With most screen-grid pentodes, where the ratio of d.c. plate and screen voltages is approximately four to one, the ratio of choke inductances, L_1 to L_2 , should be the same or higher. That is, if L_1 is 30 henrys, for example, L_2 should be between 5 and 8 henrys.

Soldering-Iron Outlet

A good many of us use the dollar or dollar-fifty variety of soldering iron; most of them

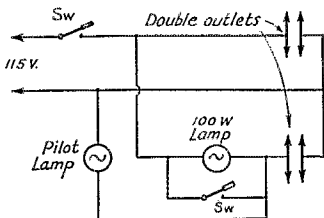

FIG. 4—HANDY OUTLET BOARD CONNECTIONS, WITH PROVISION FOR REDUCED VOLTAGE ON THE SOLDERING IRON

will burn up on ordinary 115-volt house current if left on for any period of time. The diagram of Fig. 4 shows a convenient way to lengthen the life of the iron. A 100-watt lamp, shunted by a s.p.s.t. switch, is connected in series with the socket for the soldering iron plug.

By closing the switch, the iron may be heated quickly to operating temperature. Then by opening the switch the lamp is put in the circuit and the iron is maintained at a temperature which will keep the solder melted but will not tend to burn up the iron. A lamp of different rating may be used if desired; larger lamps will keep the iron hotter and vice versa.

In my case the lamp, switches and two double outlets are mounted on a board as one unit. The upper double socket is connected directly across the line, providing 115 volts, while the lower outlet not only takes care of the iron but also provides another socket for experimental purposes at reduced voltage. When the shunting switch is closed, four 115-volt outlets are available. The

pilot lamp is a precautionary measure against leaving the master switch on unintentionally.

—Bren Quereau, W5BJ

Soldering-Iron Holder

The odd pieces of copper tubing usually found in the shack can be used to make a really fine

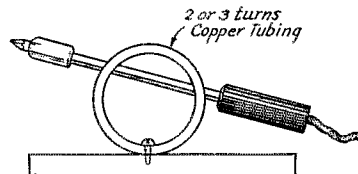

FIG. 5—A SOLDERING-IRON HOLDER MADE FROM SCRAP COPPER TUBING

soldering-iron holder. A typical method of using the tubing is shown in Fig. 5. Two or three turns of tubing are fastened to a board at the ends; the iron is pushed between the turns and is held fast when not in use.

A holder of this type dissipates the heat readily, even when the iron is left on for long periods.

—A. F. Korniejewski, W2AMM

Variable Coupling to the Antenna Filter

In common with W6BOY, whose variation of the Collins antenna filter appeared in the Experimenters' Section in August *QST*, I also have found that the filter will not, under all conditions, perform as it should. Likewise in attempting to overcome the difficulties involved, I have developed a system which I find works efficiently in conjunction with any length of antenna.

With this system an impedance-matching network is coupled to the output plate coil through a low-capacity variable condenser or

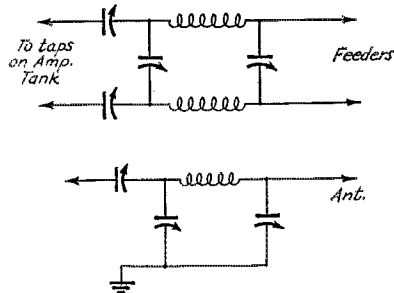

FIG. 6—VARIABLE-CONDENSER INPUT COUPLING TO THE ANTENNA MATCHING FILTER

condensers, as shown in Fig. 6. A capacity of about 30 μfd . should be used for proper loading. At W1ADF a pair of double-spaced 90- μfd . variables are used with the plates one-third interleaved.

To load the amplifier, start with the series condenser at its minimum value and gradually

(Continued on page 88)

• I. A. R. U. NEWS •

Devoted to the interests and activities of the

INTERNATIONAL AMATEUR RADIO UNION

President: H. P. MAXIM

Vice-President: C. H. STEWART

Secretary: K. B. WARNER

Headquarters Society: THE AMERICAN RADIO RELAY LEAGUE, West Hartford, Conn.

MEMBER SOCIETIES

American Radio Relay League
Associazione Radiotelevisi Italiani
Canadian Section, A. R. R. L.
Českoslovenští Amatérí Vysilací
Deutscher Amateur Sende und-Empfangs
Dienst
Experimenterende Danske Radioamatører
Irish Radio Transmitters Society
日本アマチュア無線聯盟
Liga Colombiana de Radio Aficionados

Liga Mexicana de Radio Experimentadores
Nederlandsche Vereeniging voor Internationaal Radioamateurisme
Nederlandsch-Indische Vereeniging voor Internationaal Radioamateurisme
New Zealand Association of Radio Transmitters
Norsk Radio Relé Liga
Polski Związek Krotkofalowcow
Radio Society of Great Britain

Rede dos Emissores Portugueses
Reseau Belge
Reseau des Emetteurs Français
South African Radio Relay League
Suomen Radioamatöörlitto r.y.
Sveriges Sändareamatörer
Unión de Radioemisoras Españoles
Union Schweiz Kurzwellen Amateure
Wireless Institute of Australia

Conducted by Clinton B. DeSoto

Australia:

In an editorial in the July issue of "Amateur Radio," the Wireless Institute of Australia advances its claim to being the oldest national amateur organization in the world. In March, 1910, a small group of wireless enthusiasts formed the nucleus of the organization that has grown into the present Institute. In view of this fact, the W.I.A. is this year celebrating its Silver Jubilee. Coincidental with this celebration, radios E. L. Colyer, VK2EL, via W9GDH, the Amateur Radio Association in New South Wales is changing its name to W.I.A., N.S.W. Division, in conformity with the other divisions. He continues: "The past few years have been possibly the hardest that the Institute has ever passed through, not only due to the lack of the necessary amongst amateurs, but also due to the fact that we have to defend ourselves as being representatives of the experimental side of radio only. This change may not have been too apparent, but it has been a decided underlying factor in our growth. The Institute should now be able to grow unfettered as a representative amateur and experimental body. Personal effort is the watchword of effective growth and we hope it is the aim of every member to carry our banner, display our inducements and reward to members, and to make 1935 for the world's oldest amateur body a year of prosperity. In some states the divisional councils are making special efforts to commemorate the Jubilee, and it is hoped that every state will fall in line and that our Silver Jubilee will be long remembered."

Hearty felicitations and best wishes, W.I.A., upon your many years of effective service on behalf of amateur radio. May you continue to flourish, and to grow in strength and prestige!

General:

A series of trans-oceanic tests on the 3.5-mc. band have been arranged by the R.S.G.B., with the cooperation of the A.R.R.L., for the month of December. All stations on the European and North American continents are invited to take part. Full details will be published in "The T & R Bulletin" and in the Communications Department of the December issue of *QST*.

Mrs. Frank M. Corlett, founder and president of the Wives and Mothers of Radio Amateurs Club of Dallas, Texas, which has become the inspiration and model for similar organizations in other parts of the country, believes that she is soon going to be instrumental in the formation of a new "chapter" of the club in the Netherlands. Noticing a photograph of the officers of the Club in May, 1935, *QST*, J. Roorda, editor of "QSO," published at Hilversum, wrote Mrs. Corlett requesting an article for his ham sheet on the subject, "The lady, whose husband is a Radioamateur." The article was duly supplied. Expect, now, a sudden acceleration of the feminist movement in PA-land!

Although the new Colombian amateur regulations have not yet been announced, a preliminary document disclosing the forthcoming regulations concerning broadcasting in that country has been released. Italo Amore, secretary of the L.C.R.A., tells us that these regulations stipulate that no broadcasting stations will be allowed to operate on bands other than those provided by the telecommunications convention. It seems, therefore, that soon the "amateur" broadcasters of Colombia who at times make our 7- and 14-mc. bands miserable, will soon be ordered to "cease and desist."

QSL:

Cards for Italy can now be sent direct to the following address: Dr. Ing. Roberto Ognibene, 45, Corso Magenta, Milano, Italy. This is the official A.R.I. QSL Bureau. Dr. Ognibene formerly operated under the call I1IP; his transmitter, in common with those of other Italian stations, was confiscated in November, 1934, by government agents.

The current address of the Mexican QSL

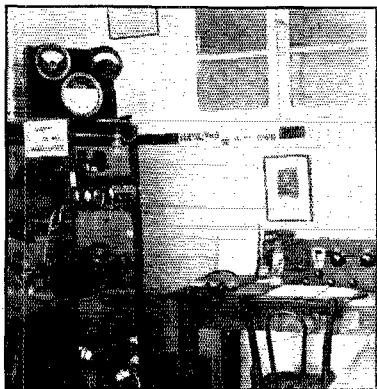

SUIRO, POPULAR EGYPTIAN STATION

Bureau is as follows: L.M.R.E., Apartado Postal 907, Mexico D.F., Mexico.

Writes Barbara Dunn, G6YL, with reference to Iraq: "All YI stations . . . are now closed down. So it would be better to list the R.S.G.B. as the QSL Bureau for Iraq until further notice."

The QSL Bureau for Kenya is now in charge of the Radio Society of East Africa, Box 380, Nairobi.

DX (and stuff):

Records . . . more records . . . most records . . . set 'em up and knock 'em down. The current crop:

Frank Lucas, W8CRA, submits a record four-way QSO: VS1AJ-G5BD-W6GRX-W8CRA worked round-robin for two hours Sunday, August 18th, until W6GRX went to breakfast, W8CRA to lunch, G5BD to dinner, and VS1AJ to bed! As these lines are being written comes word of a four-continent five-way QSO between W6CXW, W6CUH, LU1EP, VK3YP and ON4AU, lasting for more than three hours W. B. Scofield, W2DTB, worked 39 foreign stations on August 13th, 37 of them reporting him QSA5; 20 of them were run off in a row, one-two-three order, without a wasted call—and there were six J's in the lot! The inevitable Ed Stevens, W7BB and K7BC, claims the following records for K7BC, located at Mist Harbor on Nagi Island in the Shumagin group, 1800 miles from Seattle: First K7 to contact

Argentina, India, Palestine, Netherlands, Indies, Afghanistan, Surinam, and first K7 to WAC Shattering W9BTW's 18-hour 9th district record, WAC, his brother, C. F. Norton, W9ELA, pulled the same feat in 12 hours and 45 minutes, working FT4AG, W8CRA, OA4J, U4LD, VK3UJ, and J2HJ The record for the best 'phone performance in Portugal is claimed by Adamastor Graca, CT1AI, who recently worked PY1AY in Rio de Janeiro on 7 mc., receiving an R5 report, with 12 watts power Vernon Dameron, W8HGA, who worked VS1BO recently, wonders whether any other W8 has performed the same feat Flash! ON4AU radios that he and LU1EP achieved TBTOC in 1 hour and 37 minutes, with both R7 on 28 mc., an R7 and an R9 on 14 mc., and R6 and R5 on 7 mc.!

Turning away from "firsts," we chalk up another 'phone WAC, this one going to James C. Lewis, W9DKU; the total is now 21, with three W's and a K4 in the group Some more good 'phone work with moderate power goes to the credit of Cameron Pierce, W6HJT, who has worked G5NI and ON4AC, giving them QSA5 R8 reports G5GQ will be visiting American hams this autumn K6KQM has been closed down; J. K. Kagawa is now attending New York University A few J's still coming through in New England, although the traffic is far lighter than some months back W1ZB and KA1CM contacted three mornings in a row in September In 70 days last summer, K7BC made 769 contacts on 7 and 14 mc., 125 of them with East Coast W's W9KG still likes to recall that day last May when he heard some 50 Europeans on one trip across the dial, all R5 to R8 Among changes wrought by the new German call system: D4BBK is now D4JMK, D4CAF is D4GWF CT1BY regrets that he can no longer QSL reports on his transmissions unless international reply coupons are enclosed; the postage bill has been getting him down Complaining concerning non-QSLing are CT1OI and LU8EN The former sends a list of 52 W stations who haven't acknowledged QSO's; the latter reports that less than 50% of the W's QSL for "they are the more lazy and unprejudiced for sending cards though ours are received OK"; both demand use of the Wouff Hong, or something

Strays

Somehow or other the captions on two of the photographs in "Amateur Radio Stations" in October QST were switched. W9JIR is the station in the upper right corner of page 51, while the smiling face which looks out from the center photo is that of W7BYW. Sorry it happened, fellows.



OPERATING NEWS



Conducted by the Communications Department

F. E. Handy, Communications Manager

E. L. Battey, Asst. Communications Manager

CAIRO survey blanks have been distributed to all who volunteered to help on the commercial occupancy survey. At a number of points, however, we want still more operator-observers who can cover 6-8 mc. and 4-4½ mc. ranges. Drop a card for information if you can receive in either of these ranges, and will assist in the common cause, please.

As we write these lines the fall season is just getting into full swing. No one can deny that we amateurs make intensive use of our frequency bands. Those working in the Cairo Preparatory Survey can tell you how it sounds to run into the ham band, where more use of frequencies is made than in territory where frequencies are assigned individual stations. In some sections of the band the interference level is fairly uniform. There is a slight tendency to crowd at the band edges, especially in the 7-mc. territory, and at the 3500-kc. end of our important domestic band, more crystals being used there to "double down."

The automatic distribution of stations from one end of the band to the other in each licensing area together with the beneficent value of "skip effect" is of course the greatest protection North American amateurs have from mutual QRM becoming unduly heavy in certain parts of the band during the busy operating hours. On 7 and 14 mc. domestic QRM is to a great extent "lifted overhead" during the hours of best DX, when skip is favorable on stations at remote points. In the 3500-4000-kc. range increased skip this fall eliminates or reduces QRM from the many stations 60 to 300 miles away during evening operating hours. Here on the east coast "nines" begin to come through soon after dark on this band, and "sixes" and "sevens" in the late evening. The burden of our story this month is to emphasize those things, in addition to what skip does for us, that we can do for ourselves, to better our operating, reduce mutual QRM further, and approach the ideal uniform distribution of stations throughout the band.

It has been apparent for some time that money invested in equipment is better first invested in selective receiving equipment, than in bigger transmitting tubes, and higher voltage plate supplies. It is probably true that there are still lots of fellows in the game who put the cart before the horse. Super-hot receivers with good "local selectivity" and stability, and the use of crystal filters for single signal reception (the ultimate) constitute the best known and utterly practical methods of handling the QRM situation. While possibly only one out of three hams use supers, and fewer have the advantage of crystal filters, these deficiencies are rapidly becoming remedied now that what real selectivity will accomplish in either 'phone or c.w. reception has been demonstrated. More effective communication by this first method of QRM-reduction is all based on a simple fact—that you have to *hear them before* you can work them!

Crystal control in transmitters has become well nigh universal; at least two out of every three stations; perhaps three out of four are crystal controlled. To an increasing extent, now that crystals are available from many sources at reasonable prices, stations so equipped have more than a single crystal, giving increased flexibility of operation; the ability to work in different parts of each band for greatest effectiveness. A crystal is cheaper "frequency insurance" than a frequency meter; it offers the most inexpensive way to secure a high degree of stability in a transmitter. We doubt if it is necessary to sell any ham on point number two—crystal control in the transmitter, Hi.

We should also observe practical operating points that will better our success in operating, and make life more pleasant due to lessened mutual interference. Making QSOs snappy . . . short calls with frequent intermission for listening for replies . . . these things give us most QSOs for the operating time we put in, and make life easier for other operators. So we'll make snappy procedure or standard procedure, for reporting, calling, or working stations point number three on our list.

In line with practicing what we preach we got ourselves a new receiver this fall, and we've been doing a lot of listening. We observed a heap of things, but first of all, the violation of "the use of local bands for local work" principle, which was suggested to all hams by the Board at its May meeting. Hunting for the reasons for this, we find that in our operating there is seldom any clear line of demarcation between what is DX and what is local. Some of us go in for DX, but most of us take whatever a band affords while we are operating on it. Possibly half the pleasure in operating lies in the unexpectedness of our QSOs, the casual renewals of old ham friendships, the surprise signal that trickles in from near or far, the fraternalism with which we get together to discuss things we have in common with fellow hams. A large percentage of the stations most of us contact are locals or semi-locals. A substantial number of our QSOs are stations within the first several hundred miles of our own location. Even on the 7-mc. band, it is safe to say, there is more rag chewing about DX, than actual DX work itself. Now that band-switching sets for several ham bands are to the fore, and with a good number equipped for u.h.f., the idea of building our stations so we can fully use "local bands for local work," or at least reduce power to the minimum, for local work, should be kept prominently in mind, as we revamp our equipment. Over the next few years progress should be possible in this direction.

Fifth, we suggest that local amateurs in a neighborhood community (or in the club) get together and wherever possible agree to use frequencies just a few kilocycles apart in one sector of the band. If receivers of low selectivity are in use so there is any local "blanketing," this idea will permit all hands to work stations in other parts of the band free from "local" troubles. It would not be so practical to extend this idea to a larger city or bigger area because it would congest certain portions of the dial with all the stations of that area, QRMIing each other, while other band sectors would be blank, due to "skip," so that best use would not be made of the whole band under "minimum QRM" conditions.

On the 'phone bands, round-table QSOs that include all the stations working near a given frequency constitute a mighty nice way of getting together to minimize QRM and get a maximum of enjoyment by making possible 100% QSOs for all concerned. With radio telegraphers just now the organization of Section Nets is very much to the fore. In many cases, the gang interested are joining together and obtaining crystals (all for one frequency) making these one-spot nets. In connection with such planned communication, which makes for communication reliability, we have a sixth thought for QRM reduction. We believe that all such nets should aim at the central portion of our 4- and 7-mc. bands for establishment. Get out of the unnecessary QRM at the band edges, both for individual schedule keeping, and organized net operation, and our "average band density" will be much more uniform . . . and the communication will be more effective. Why not regard our band edge frequencies as

"calling frequencies," whereupon the inside band sectors make ideal spots for consistent communicating work at low interference levels? The upper half of the 3500-4000-kc. band seems a good place to carry on with schedules or nets, in our opinion.

It is suggested that all amateurs interested in participating in a Section Net drop a line to their A.R.R.L. Section Manager (address on page 7, *QST*) giving the time they could work, and frequencies they can work on. In Ohio, the S.C.M. reports a net of "Ohio Regulars" on the job tying all major points in the Section together, using a net frequency of 3710 kcs. The West Virginia net has long operated on 3700 kc. Other Section Managers and Route Managers are likewise ready to go, if you fellows who read these pages and like to operate will give them your full cooperation. A.R.R.L. Headquarters will keep a record of the frequencies reported as chosen by different netters, and make this available to all Section Managers as requested. How about taking part in the Net for *your* Section?

— F. E. H.

Article Contest

We renew our invitation to contribute articles of amateur communication activity. New ideas and viewpoints, criticisms of and remedies for conditions, hints on DX, suggestions concerning radio club organization, information on interference elimination, exceptional two-way communication work covering emergencies, athletic games and trips, timely attention to operating practice, suggestions for better radio-telephony operating, experimenting or development work in present-day amateur radio, data on low-power possibilities, 1750-kc. operation, etc., all are needed. There is plenty of romance and real accomplishment in amateur work. Read the contributions over the last several months. Then give us some real operating stories or the benefit of your views on different subjects.

In addition to publication of the best articles in *QST*, the author whose article appears to have greatest value of those received for consideration has his choice of (1) a copy of *The Radio Amateur's Handbook* bound in leather cloth, (2) six pads of message blanks, or (3) six A.R.R.L. log books, (4) six message files (or equivalent credit toward a combination of the above or other A.R.R.L. supplies). This offer will continue until further notice. The article presented herewith is the prize-winning article for this month. Let's have your article. Please mark it "for the CD contest."

—Communications Manager

Station and Operating Efficiency

Louis W. Moxey, 3rd, W3BFL *

THE efficiency of any apparatus is the ratio of output to input. This may be applied to transmitters, by dividing the output to the antenna by the input to the tubes or transformers. The output of a transmitter, however, cannot be easily measured; moreover, the efficiency measured in this way means very little, since communication is the ultimate object and transmitter efficiency is only a means to this end.

The distance covered per watt input is sometimes used as the measure of a transmitter's efficiency. This takes into consideration not only the transmitter but also the antenna, location and frequency, but unless this method is applied to average distances, freak conditions may make the figures worthless. Even if the average distance per watt is used, the result may be distorted by too many nearby stations being contacted or a freak distant contact being made.

Neither of the above methods take in all the factors which should be considered in over-all station efficiency. A station may make a "miles per watt" record and have a high trans-

mitter efficiency, but resort to an excessive number of calls or CQ's in making its contacts. A record has been kept at W3BFL for several years which shows the number of calls and CQ's which resulted in contacts. These are expressed as a percentage of the total calls made. The average has been around 25% or, in other words, out of every four stations or CQ's called one contact was made. Many factors will affect this percentage. The location in the band, calling procedure, type of signal, judgment in timing the call, and possibly power output all have an effect on the number of contacts made. At W3BFL it has been found that the number of contacts resulting from calling stations who have called CQ is greater than the number of contacts made by calling CQ.

This method of arriving at over-all station efficiency takes into consideration not only the transmitter, but the operator, too, and since the station as a whole reflects the operator's characteristics and ability, station efficiency always should be determined with these things in mind.

If a station has an average of 25%, that would mean that 75% of the calling has been useless. Now if this station could increase its average either by careful transmitter adjustments or better calling procedure (better timing of calls or use of break-in), only 50% or 60% of the calling might be wasted. If one station does less useless calling, another will have a better chance to make a contact and will need to do less calling, and consequently a third station will improve its average. It all lowers the interference level, too.

This is just another way in which everyone may help to improve conditions in the amateur bands. Station efficiency arrived at in this way is a measure of the operator's effort to help. By raising your own average you would help many others to improve theirs, which in turn would benefit you.

DX Notes

SUISS, Cairo, Egypt, is reported by W2HHF as coming through in the afternoon on about 14,360 kc. with a T7 note. W2HHF also reports ZELJS, Bulawayo, Southern Rhodesia, putting in a nice signal on about the same frequency from about 4:00 to 7:00 p.m. with a T9 note, also HABC with a T7 note on about 14,390 kc. SU5NK has also been heard by W2HHF on about 14,260 kc. with a near d.c. note. VK's and ZL's continue to come through daily on 14 mc. in the morning and VK's have been worked as late as 10:30 a.m. by W2HHF. W1CNU worked CPIAC on September 15th and says that he has a rough note on the h.f. edge of the 14-mc. band. W9LBB, Kansas City, Mo., reports an interesting freak that occurred on the 14-mc. band about 2:30 a.m. Central Time, one morning in March: He was QSO ON4AU, who was coming in RS-9, and who reported him R7, but neither could hear another solitary signal on the band!

The following 14-mc. dope is reported by W6GAL: VS2AG is very consistent on the west coast—T9, 14,140 kc.—other VS stations active are VS1AJ, T9, 14,350 kc., and VS3AC, T9, 14,180 kc. W6GAL snagged a rare one when he hooked PZ1AA in Surinam; PZ1AA is r.a.c., 14,375 kc. On August 30th W6GAL had a QSO with UØHR, Siberia, who is on about 14,360 kc., broad r.a.c. W6GAL was his first "W" contact on 14 mc., but he hears many W's, both c.w. and 'phone, and is anxious for QSO's. ZP2AC, another rare one, was worked by W6GAL recently; he was T8, 14,395 kc. His QTH: Felipe Santiviago, Calle Convencion 235, Ascuncion, Paraguay. Using an input of only 85 watts, W6GAL on August 18th worked all continents in one day: FB8C, OH3NP, CX2AK, VS2AG, W8GQB and K6LTZ. An Asiatic country not heard often was QSO'ed by W6GAL on September 4th: J8CA, T8x, 14,170 kc., at Keijo, Korea. K7CGV in New Caledonia is heard occasionally on about 14,340 kc. with a chirpy d.c. note. Best time is 11:00 p.m. to midnight P.S.T.

Ex-CT2BK, well known for his excellent signal during the DX contest, has left for La Paz, Bolivia, 14,000 feet up in the Andes, where he will be in charge of the Bolivian end of the New York-Bolivia-Argentine traffic circuit for Standard Oil. He sailed from the States on September 14th and when established in the new location will be on the air on his old frequencies signing a CP5 call. Watch for that "1 kw. sig. from the CT2BK 20-watt rig"!!

* 525 E. Wadsworth St., Mt. Airy, Philadelphia, Pa.

In a recent QSO, VQ4CRO asked W1ZI to pass the word along that he is now operating a phone transmitter and is anxious to QSO "W" stations. His frequency is 14,096 kc. and he is modulating 42 watts. W2HTH worked F8XH on 14-mc. c.w. using a piece of wire 16 feet long as a radiator. At 7:00 a.m., September 25th, W6SN had a twenty-minute

weeks things are hot. During September I have been using a new V beam on the Europeans; it is 10 waves long (650 feet) on a leg. Another is being put up for trans-Pacific work. These double signal strength on reception."

Chicago 56-mc. Round Table

From 8:00 to 10:30 p.m., September 16th, the following stations participated in a 56-mc. "round table" on the north side of Chicago: W9AI, W9ALE, W9CF, W9DTN, W9EMD, W9GYR, W9IUF, W9KQW, W9LWI, W9LXX, W9NGP, W9NUF, W9PEN, W9PGB, W9POO, W9SPG, W9TRD, W9UJR, W9USR, W9VCB, W9VCX and W9SII—a total of twenty-two stations! In order to handle this get-together with "neatness and dispatch," it was necessary to have a few simple rules, as follows: Each station was allowed to transmit for the duration of one minute only. W9POO acted as master of ceremonies. There were three key stations, W9DTN, W9POO and W9TRD. After these stations finished transmitting, a fifteen-second listening period gave ample opportunity for other stations to join the round table. Any station desiring to leave was requested to announce his intentions of so doing before dropping out. The hams participating in this round table were scattered all over a ten-mile area in automobiles, basements and on top of buildings. It was a grand "shindig," thoroughly enjoyed by all.



A FIELD STRENGTH MEASURING CREW!

Arty Braaten (left), W2BSR, well-known DX man and author of the R-S-T system, and G. S. Wickizer, "Wick" of W2DOG, O.R.S., snapped on a recent stop in West Hartford. Note the hinged 20-foot pole carried horizontally. A second bamboo section may be swung to cross-arm position for measuring horizontally polarized signals.

contact with ZS4E, while the transmitting antenna of W6SN was lying flat on the ground. The antenna is a Hertz; one rope had parted and the other loosened preparatory to fixing the break. ZS4E was called "as a joke," but it turned out to be a surprise QSA5 R5 report instead! On August 5th at 5:50 a.m., on 7 mc., W8MFV, Vandalia, Ohio, worked VS7AI, Colombo, Ceylon. During the DX contest VK3MR clambered up his 100-foot stick in a high wind chasing a broken guy wire; luckily he had to climb only 60 feet! Hi, VK3ML, with his mast broken off short, QSO'ed the W's with his antenna 15 feet above ground. VK7RC and VK3YO were, at one stage of the contest, both on the same frequency in the 7-mc. band; W1SZ called VK7RC. Result—3 points for VK3YO! That shows there is at least one advantage to having another station on your frequency! Here is the kind of report we would all like to receive on our signals: Says W2HBK, "EA4AO comes in so loud that I can't keep the 'phones on and he QRM's my DX on 14 mc."

W5EHM QSO'ed all continents except Asia on 7 mc. in two hours on September 5th. WITS reports DX conditions on 14 mc. (7 to 9 a.m. period) quite poor during September as compared to the last several previous months. J's were heard on the 2nd and 8th only, and have not been heard since up to early October. PK's heard during September included PK3BM, d.c., approximately 14,385 kc., and PK2KO, d.c., approximately 14,125 kc. WITS worked YN1AA, Nicaragua, a rather rare one, on September 8th, 9:00 a.m., frequency 14,300 kc., note T8. KA's came through on the 2nd, 3rd, 4th, 5th, 8th and 15th and started coming through again early in October. VS6AQ and FB8C were heard irregularly during the month. During the last week in September and the first in October, South Africa has started to come through in the morning. Other calls of interest heard at WITS were HJ3AJH, YU7VV and VQ8A. These (as well as YN1AA) are heard best during the 4:00 to 8:00 p.m. period. All stations heard, with the exception of a few VK's, were between 14,250 and 14,400 kc.

W6CUH says, "Conditions seem to point to the biggest winter of DX yet seen or heard. Present conditions match those found in mid-winter last year. F8EX has been R9 on 7 mc. already! G6CJ reports hearing W6 almost every night on 7 mc. By watching very closely the monthly and weekly variations in DX conditions, one can figure in advance when to put on the pressure and lose a lot of sleep with some prospect of return. About one week out of each month things are dead (by that I mean that only a scattering of Europeans and Africans break through), but during the other three

DX TIME TABLE (For Western North America) FALL AND WINTER, 1935-36 By W6CUH

	1 1/4 MC.	1 1/2 MC.	7 MC.
EUROPE:			
EA, CTL, CT3	0000-0200		0200-0500
F, G, ON, PA, OZ, SM, LA, EI, GI, HB, D, TF	1400-1700 & 2000-2200		0300-0700
OK, U, YL, OE, LY, OH, SX	1400-1600		0600-1000
AFRICA:			
ZT, ZS, ZU	1400-1700		0400-0600 & 1430-1700
VQ4, ON4, ZD, ZE	2000-2130		
FMS, FAS, FT4	0100-0200		0400-0600
ZE, CR7, FB8			1430-1600
SOUTH AMERICA:			
All	2300-0100		0200-0900 & 1400-1500
LU, CX, OA, HC	1400-1600 & 2000-2100		
ASIA:			
XU, VU, VSL, VS6, J	1400-1700		1300-1500
VS2, 3, 5, 7			1300-1500
UO, J	0300-0400		1300-1700 & 0700-0900
OCEANIA:			
VK, F7, VR4	1300-1500 & 0300-0500		0500-1500
ZL	0300-0500		0500-1500
PKL, 2, 3, 4, 5, 6, VR2, OM, KA			1100-1600
NORTH AMERICA:			
Central	2000-0300		0200-1500
Caribbean	1600-1800 & 2200-0100		0200-1500
Alaska	0000-0200		0100-1600

The above are best times only. On monthly DX peaks, a considerable extension of the above times can be expected. For example, on 14mc. Europe lasts from 1330 to 0200 GMT without a break during peak conds. 7 mc. is not quite as affected in this way because it is less critical, as is well known.

A.R.R.L. 28-mc. Contest To Be Repeated

Reports and entries on the 1934-1935 Ten-Meter Contest were received up to October 15th, and the date of writing this announcement is too early for us to give the result of the 28-mc. operating and development competition jointly run by A.R.R.L. and R.S.G.B. over the past year. The announcement of which competitor receives the bronze medallion award will be made shortly.

28-mc. interest continues high and new results are being reported right along, as chronicled elsewhere in this QST. It gives us pleasure to announce that the League will sponsor another 28-mc. Contest for the 1936 season, and again, a year hence, make a second 28-MC. ACHIEVEMENT AWARD to the operator or experimenter who has accomplished the most in work in this territory through the intervening months. Here are the rules for the competition for the coming year:

1. The Contest is open to all licensed radio amateurs.
2. The Contest will include work reported as taking place between 0001 GT January 1, 1936, and 2400 GT December 31, 1936.
3. Licensed power must not be exceeded.
4. Contacts may be established at any hour and on any day during the contest period.
5. One point will be scored for each completed 100 miles of contact, with a specific station (e.g. a contact with a station 99 miles away scores no points, contact with a station 658 miles away scores 6 points). All distances will be measured by a Great Circle line between stations.
6. In computing his final score a competitor may claim points for each different station worked once during each calendar week.
7. Proof of contact in writing may be required by the contest committee.
8. An A.R.R.L. Award Committee shall consider the file of reports and data submitted by competitors to the A.R.R.L. Its decision will be based on: (1) The number of weekly reports to A.R.R.L. on 28-mc. work, 25%. (2) Equipment description and development work on same, 25%. (3) Number of points in accordance with Rule 5. 50%. Examination of all reports with ratings weighted on these factors will determine the 28-MC. ACHIEVEMENT AWARD. Entries (from W/VE) must all be received at A.R.R.L. on or before January 15, 1937, to be considered for the A.R.R.L. Award.

A bronze charm will be presented by the A.R.R.L. engraved "FOR 28-MC. ACHIEVEMENT, 1936," and with the call of the winner. One point will be scored for each completed 100 miles of contact. Decision between W/VE competitors will be based on weighted credits. (1) The number of weekly reports to A.R.R.L. on 28-mc. work, 25%. (2) Description of equipment, and development work reported on same, 25%. (3) The number of points scored (monthly contacts with the same stations will be permitted to count), 50%. W/VE entries must be received at A.R.R.L. on or before January 15, 1937. Report your results each week to A.R.R.L., and submit scores and log at the end of the contest if you wish these to count for all awards.

Starting January 1, 1936, this International 28-mc. Contest will be in progress for one year, concluding at midnight December 31, 1936. This is open to all W/VE hams. The A.R.R.L. will award a bronze medallion to the highest scoring United States or Canadian operator-experimenter.

Brief

Due to reconstruction of the Post Office Building, Winston-Salem, N. C., license examinations will be held in that city one day only during November. Exams will be conducted on November 2nd in the City High School Building. Applicants for commercial and more than one class of license must appear at 9:00 a.m.

Hints on Improving Keying

By T. R. McElroy*

GREETINGS, my friends, and I hope you'll all "stay with me." That's an old telegraphers' expression the significance of which I'd like to tell you some time.

As I was saying, I hope you'll bear with me for the next ten or fifteen minutes while I try to tell you in writing what I've told so many hundreds of hams in person during my very informal chats at hamfests throughout the northeast during the past year or so.

Y'know, it's a whole lot easier talking to a gang of guys than it is to write. Talking with hams I find plenty of room for elaboration and clarification in the questions thrown at me. Talking through the medium of the typewriter and printed page, I have to stop and scratch plenty to try and remember to tell you all that I want to and all that I think will help you in improving yourselves as operators.

Anyhow, here goes. Please read it carefully. I'm trying to give you in a few minutes reading the benefit of all that I've learned in over twenty years as a telegrapher and radio operator. It won't do any good to glance through it and figure "pretty good dope, eh, Joe," and then promptly go back to sloppy sending and operating generally.

I tell you that after twenty odd years as an operator I still find more enjoyment in chewing the fat with some other operator, over the air or landline, in code, than in conversing with some beautiful blonde over a few whiskeys. And that's saying something.

To operate correctly is about the greatest thrill there is in the world. And it is so easy to become a really good operator, that it's heart-breaking to find so few of them. Let's get to work on this. All you hams can become as good or better than commercial operators with a little practice. And furthermore it won't take more than a couple of months. No matter how long you've been trying. You follow suggestions and do it right, and you'll be good. I mean good!

Now then, if you have a straight key, take it off the table right now. Put it on a block of lead or iron, or even wood, so that the button is about an inch and three quarters to two inches above the table. *That's where it belongs!* (So you'll have no cramp in your wrist when you send.) And then place it on the table in front of you at about the spot you'd have a letter if you were to sign it. So that key lever runs parallel with your arm, with your elbow just off the table.

Now run off dots. Not jerkily. Just smooth, rhythmically. Do it so that you hit about six or seven dots per second. And then stick a dash in once in a while and the first thing you know you're making beautifully perfect and musical V's. You should all know how perfect V's sound. Heaven knows that's about all you can hear on some of the frequencies that the commercials chisel away from you on the pretext that they've got to have them for commercial expansion, etc., to make V's by the hour!

Now from that point onward there isn't much to say. Simply take a newspaper or a book and sit down and send to yourself for about fifteen minutes each day. And I say emphatically that if you aren't an excellent sender within about two months, I'll donate a Mac-Key as a forfeit to any radio station we have agreed upon.

Now then for the "bugs." No operator anywhere will ever know the real thrill, the real joy in operating until he can sit down and really enjoy listening to himself send on a bug. It gives you all of the joy of telegraphing and removes all of the work from it.

There have been so many improperly designed pieces of junk sold to the hams as "bugs" in the past few years, that "bugs" have suffered in bad repute generally. No operator, no matter how skilled, whether telegraph or radio operator, can possibly send anything correctly on any of these monstrosities. So the first step in attempting to improve bug sending is to get rid of any instrument a ham may have which is improperly designed and which, consequently precludes any possibility of sending correctly.

There are, however, three "bugs" manufactured with

* Holder of world championship code operating records for 11 years, 23 Hayside Street, Uphams Corner P. O., Boston, Mass. See account of regaining the World's Championship on page 24.

which it is possible to become a good bug sender. It would not be politic for me to attempt to mention actual names, but most intelligent hams will know what constitutes a correctly designed bug.

Now then, take your bug and make these changes. Arrange it so that the paddles are about two and one half inches above the table, where they belong, so that your wrist is not cramped when you send. On the adjustment: the dot lever should come to a backstop so that the vibrating rod is just resting against the vibration dampener strongly enough so it does not chatter when you make a dash. The lever should be free to swing easily without binding and yet with no up and down play in it. The dots should be adjusted so that there is about—well, anywhere from eleven to fourteen dots per second. Adjust the dot contact so that after about those eleven dots the contacts stay closed. This makes real heavy dots, the kind you need for radio work.

Then place the bug on the table in the position I described for a hand key, with the lever running parallel with your arm. The bug is directly in front of you, as a sheet of paper you were to sign, your elbow is just off the table, your hand practically vertical, your wrist off the table. Send with a full free arm swing.

To learn to send with a bug, first take your straight key and shove it up on its side. Now send with it. You should make dashes on your bug in *exactly that same manner*. You should be able to slap out dozens of dashes without stumbling once. And it is easy! Honestly! Try it my way and see if it isn't.

That is about enough for one code meal. Let us plan on another soon. But remember! The publishers of *QST* won't know whether you want more on this subject unless you tell them! And I won't know whether it is worth the effort to sit here at this typewriter unless you tell me! So let's know what you want. Also I shall be happy to answer any questions. And now, 73 for another month or so.—*Mac*.

Silent Keys

It is with deep regret that we record the passing of these amateurs:

Charles B. Bradford, W6LFH, San Jose, Calif.

Clair Foster, W6HM, Carmel, Calif.

Robert L. Green, W8GGH, Cleveland Heights, Ohio

Paul E. McGrew, W8IUH, Columbus, Ohio

Isabelle W. Moody, W7DHF, Portland, Ore.

Fred R. Kamp, W9HHK, St. Louis, Mo.

Briefs

When the air-pilot wife of the Governor of Northern Rhodesia crashed in a desolate area ravaged by sleeping sickness, it was a radio amateur who flashed the first word of her safety—ZELJC!

Don't Jump at Conclusions

Who has not, vacationing, felt a pleasurable sense of elation at a glimpse of the droopiest of zepp feeders? Who again does not remember exclaiming, as he viewed even the sorriest of poles bending obediently to a taut nr. 14, "Ah, there's a ham." Of the fruit of such emotions was born an incident in the life of a certain eager, but misguided ham, who we will call W1XXX.

The place was New Hampshire; the scene a very dusty detour around a state highway under construction. Enveloped in a thin cloud of dust a car suddenly thrust itself into

view around a turn. Affixed to its side was a long pole of such plausible dimension and appearance as to preclude any altercation about 56 mc. As the car drew near, W1XXX beamed with the unalloyed interest of a true brother. He leaned out the window of his trusty steed, consumed generous portions of the road, and in raucous tones bellowed, "Dah di dah dit

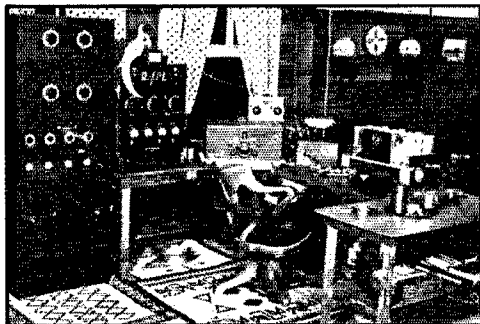

THE NEAT SHACK OF W4PL, O.R.S., SHEPHERD TENN.

dah dah di dah." A look of bewildered surprise, and the car vanished around a bend. On its side in gilt letters were the illuminating and at once embarrassing letters: STATE FISHERIES!—W1CFG, "Speed" Mower.

Miles-Per-Watt Records

W5CPT reports a miles-per-watt record, which may be an all-time high. On April 14th he worked W9GGB, Danville, Ky., about 912.2 miles, reducing power to 4 volts at 2 ma., or .008 watts. This figures about 114,000 miles per watt! W9GGB reported the signals RST 229x, frequency 14 mc. Earlier records made by W5CPT included a 10,365 m/w QSO with W9GGB, a 30,000 m/w contact with W9FAV, both on 14 mc., and an 8000 m/w QSO with W5AMK on 7 mc. This latter is W5CPT's best 7-mc. record.

A low-power test at VK3PG with W6CUH on the receiving end resulted in an 80,000 miles-per-watt record. VK3PG was R7 at 4 watts, R3 at .54 watts, and R1 at .09 watts (45 volts, 2 ma.). This was on 14 mc.

Flash! 28-Mc. Boiling

During the week of October 6th-11th (date of writing) the ten-meter band has gone completely crazy. Europeans are breaking through at 7:30 a.m. and are still in at 1 p.m. W1DF worked 3 Europeans on the morning of the 10th and 5 on the 11th. W3FAR worked 4 Africans on the a.m. of the 11th and only needs Asia for a 'phone WAC! W5AFX reports daily QSO's with many VK's at 6 in the evening as well as LU1EP and ZS1H. The only continent needed at AFX for WAC is Asia. X1AY and ZS1H have heard each other but have not contacted as yet—the moment they do X1AY will have 5 continents. Apparently there are many stations who have worked 5 continents and the 6th has been heard. It's only a matter of hours before someone makes that WAC—and the W stations still have a good chance—contrary to the impression given on page 16. Signals from Europe and Africa often come through at ear-splitting strength—unbelievable signals. Get down there and get your share of the thrills. Those active there these days are making DX history.

On 56 mc.

W3AWU was tuning his 56-mc. super about 11:00 p.m. EDST, July 18th, and heard the harmonic from W3EMJ/3 on 28 mc. W3AWU called W3EMJ/3 and asked him to call CQ 56 mc., stating that he would broadcast him. QSO's were established with W3EET, W3EBA and W3CWR. The last mentioned was portable-mobile with 60 watts input, two receivers plus a 16-watt audio amplifier and a 110 a.c. motor generator. Operators of this set-up were W3CWR

and W3CQL. Much interest was shown by spectators and several of them were permitted to "talk over the radio." All transmissions from W3EMJ/3 were put through the amplifier. There were about 39 tubes in use between the spectators ears and W3EMJ's mike!

The motorcycle hill-climbing contest at South Huntington, L. I., N. Y., June 16th, was timed by the use of 56-mc. transceivers. W2DDU, W2HAV, W2HJM and W2FKB made this possible. At the base of the hill a transceiver was set up as a receiver with four sets of headphones, three for the official judges and one for the operator. A wire was stretched across the starting line, one end being attached to a toggle switch. At the top of the hill another transceiver was used as a transmitter with an audio oscillator in the circuit. A wire was also stretched across the finish line with one end going to a toggle switch. The transmitter put a steady note on the air. The receiver at the starting line was tuned to this note and the wire across the starting line was connected to the toggle switch, which was in the headset circuit. When a machine crossed the starting line it threw the switch, which completed the circuit and the judges upon hearing the signal would start their stop watches. When a machine reached the top of the hill it threw the other switch, which in turn cut the power to the audio oscillator taking the signal off the air, whereupon the judges again took a reading on their watches. The result was extremely accurate timing, and much praise for amateur radio.

On July 14th the Brownsville Radio Club of Brooklyn visited the Northern New Jersey Hamfest at Lake Hopatcong, traveling in two cars. Successful communication was maintained between the cars over the entire distance, both going and returning; 42-42 transceivers were used in both cars, which were at times a mile apart. Four-foot vertical antennas fastened to the rear bumpers were used. Although subjected to terrific bouncing, the equipment worked perfectly at all times.

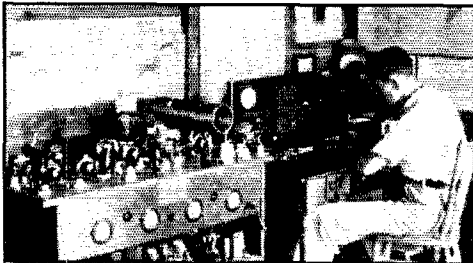

W5DXG, MISSISSIPPI WINNER IN THE 1935 DX CONTEST

The transmitter shown employs a 59 crystal osc., 841 buffer, and P.P. 830's final. A new 100-foot mast will support a 66-foot vertical antenna 33 feet above the ground.

W8IJZ, Mantua, Ohio, should have received credit as King of the April O.P.S. Party—his score was 1350. Due to an inadvertent error W8ICF's worked list had W8CSX in the list twice and duplicated W4BYA in the heard list as well as worked column. Correcting the score to 22 QSO's, W8ICF comes in third, 1320 points, instead of 1390, and still a swell score. Second place goes to W9JZA, Hammond, Ind., with a score of 1344 points, neck-and-neck with W8IJZ.

Armistice Day Message

The seventh Annual Armistice Day message from the Chief Signal Officer of the Army to all members of the Army Amateur Radio System will be transmitted on the night of November 11, 1935, from WLM/W3CXL, Army Net Control Station in Washington, D. C.

W6CUH heard ON4RX, giving W4DEZ some traffic from American Navy men in Belgium to New York City. QSC cut in with still two messages to go, so W6CUH called ON4RX at 5:40 p.m. P.S.T. and after a big struggle got most of the QTC2, which were for Philadelphia and N.Y.C. On signing off with ON4RX, W6CUH was called by W3FNP, who said that he had copied parts of the messages. CUH gave him the balance and he 'phoned the Philadelphia message immediately, taking the one for N.Y.C. for personal delivery next day. Later that night, at 10 p.m. P.S.T. W6CUH confirmed QSP to ON4RX.

W.F.S.R.A.

Amateurs wishing to become members of the World Friendship Society of Radio Amateurs may send their pledges by radio if they so desire. Simply send a message addressed to the secretary, Duane Magill, W9DQD, 730 N. 6th St., Grand Junction, Colo. The text of such message should consist of the membership pledge, as follows:

"I hereby promise that I will, to the best of my ability, make such use of my amateur radio station as will be conducive to international friendships; that I will never voluntarily permit my station to be used as the tool of selfish nationalistic interests; and that I will do what I can, as a radio amateur and as an individual, to promote world peace and understanding." A confirmation copy should be sent by mail, although memberships will be considered equally valid, whether received by radio or mail. The only requirement for membership in the W.F.S.R.A. is adherence to the membership pledge.

Late Contest Reports and Awards

A late 1934 Sweepstakes report—so late, in fact, that it couldn't be considered in the official report—but none-the-less worthy of mention is that from W9GIL, Milwaukee, Wis., who made 42,408 points, 184 stations worked in 57 League sections! Had it been received on time this score would have won the Wisconsin award.

Received too late for mention in the QST report on the 1935 DX contest was the splendid report of X2AI—13,682 points, 354 W/VE QSO's! And from VP3AM, Ocean Island in the Gilbert and Ellice Islands Colony, came a late report of working W6BGW, W7BB and W6CD. Based on evidence recently received three additional club awards have been made for the '35 DX contest: W3HC won the certificate in the Delaware Amateur Radio Club, Wilmington, Del., W5AFV in the Houston (Texas) Amateur Radio Club, and W8ICA in the Dayton (Ohio) Amateur Radio Association.

'Phone Operators, Attention!

Don't miss the "SS" this year. Note that under the new rules it is just as great an opportunity for a "national QSO party" and "operating fun" and new records for 'phone operators as for the c.w. man. The "SS" is not a 'phone-c.w. contest, nor a contest between c.w. and 'phone—but just a good time for 'phone hams in 'phone bands, and telegraphing hams with each other, and a certificate award FOR 'PHONE operating performance separate from the one for TELEGRAPHIC performance, will be awarded by A.R.R.L. in each A.R.R.L. Section.

About the "exchanges" for proof of QSO, a few ruled sheets at the start will enable one to check these off rapidly (like VE9CNE rattled 'em off at the Canadian National Exhibition this year). Friendly greetings, signal reports, station tube line-up, timely humor, etc., constitute texts. See full "SS" announcement, page 38, this issue of QST, mark your calendar, and don't fail to take part.

At the August 1935 National Guard encampment at Pine Camp, New York, one of the radio circuits was manned by three O.R.S.—W1GOG, operating AJ1, Division HQ's; W2EYS, operating LJ1, C.A. HQ's, and Hal Subb, W1MK, operating QR7, 43rd Division, 118th Observation Squadron. These three operators maintained one of the snappiest circuits at the camp.

W6ESC of Hollywood, Calif., and W9IFP of West Fargo, N. Dak., were recently married. W6ESC is Clyde D. Smith, also holder of W9DFP call with which he was outstanding in the Midwest Division as O.R.S., O.B.S., T.L.S., A.A.R.S., U.S.N.R., etc. W9IFP is the former Margaret L. Mannes, North Dakota's first licensed YL operator.

W6KBB had a QSO with VK2OW, following it up with a contact with VK2YL about fifteen minutes later!

W7EFW/K6 spent a month with the Hawaiian Academy of Science Expedition on the Island of Hawaii. It was the first station to operate from the summit of Mauna Kea, 13,860 feet in elevation and the highest peak in the territory. The rig used on the ham bands was a portable and its signals were heard in all parts of the island.

1935 WIMU Hamfest

One hundred twenty persons registered at the Jenny Lake (Wyoming) Hamfest on August 3rd and 4th. The families and friends of seventy-two licensed amateurs from eleven states enjoyed two hilarious days on the shore of beautiful Jenny Lake, nestled at the foot of the stately Grand Teton Mountains. Under the leadership of W6DWH, softball, swimming, horseback riding, movies, campfires and speeches kept everyone busy. Principal speakers were A. D. Hulen, Dept. of Commerce, Airways Division, and Director R. J. Andrews of the Rocky Mountain Division, A.R.R.L. Officers elected for the 1936 WIMU (Wyoming-Idaho-Montana-Utah) Hamfest at Jenny Lake, to be held on the second Saturday, Sunday and Monday of August, were W7BXS, pres.; W7AEC, vice-pres.; and W6GQC, sec'y.

Fort Lincoln, N. Dak., was a regular "ham's paradise" this year, with the following enrolled at the Army Code and Procedure School: W9PGO, W9KZL, W9STT, W9SWC, W9RPD, W9PMN, W9RYZ, W9RZG, W9PML, W9JHK and W9OIS. It was a perpetual "hamfest"!

Navy Day Receiving Competition

The annual Navy Day messages to Radio Amateurs from the Secretary of the Navy will be transmitted, October 28th, on the following schedules:

From NAA, Washington: 9:00 p.m., E.S.T., simultaneously on 4205, 8410 and 12,615 kcs.
From NPG, San Francisco: 7:05 p.m., P.S.T., simultaneously on 4385 and 8770 kcs.

Transmissions will be at approximately 15 words per minute, preceded by a five-minute CQ call. It is expected that 25 letters of appreciation signed by the Secretary of the Navy will be sent to the amateurs submitting the best copies. Also an Honor Roll of participants will appear in *QST*. Forward copies for grading to A.R.R.L. Communications Dept.

A chess game was played by radio via 7 mc. on August 29th between W8MZB, Erie, Pa., and W3EPJ, Easton, Pa. The winner was W3EPJ. The Easton (Pa.) High School Chess Club desires matches with other high school clubs, and W3EPJ would like to play any other ham on 3.5 or 7 mc.

The A.R.R.L. Emergency Corps

The following are the first members of the A.R.R.L. Emergency Corps: W1ANM W1APK W1BDI W1CJD W2AQJ W2DWW W2HWS W3AQN W3BWT W3EFM W3MG W3QV W4AQ W5COK W5DLZ W5DPX W5EDD W5EQO W6AM W6BCF W6CV W6DKZ W6KUS W7BEE W8BSU W8DIG W8HHO W8JWL W8KIM W8KUK W8MYG W8OFO W9ALO W9EFP W9RQX W9TGU W9TXQ W9TZD VE3GG; The Missoula (Mont.) Radio Operators Club; Pike's Peak Amateur Radio Association (W9OKY), Colorado Springs, Colo.; Stanford Radio Club (W6YX), Stanford University, Calif.; Winston-Salem (N. C.) Amateur Radio Club (W4NC). Each of these individuals and organizations have auxiliary transmitting and receiving equipment capable of operation from available emergency power supplies.

The A.R.R.L. Emergency Corps, organized "For Public Service," comprises those amateurs and amateur organizations possessing equipment (transmitter, receiver and auxil-

This Certifies that _____
is a member of the

AMERICAN RADIO RELAY LEAGUE
EMERGENCY CORPS
FOR PUBLIC SERVICE



This operator is prepared to furnish communication to his community in the event of failure of regular communication facilities due to storms, floods and similar disasters.

Comms. Mgr. A.R.R.L.

ary power) suitable for operation in an emergency when regular power and communication facilities are disrupted. All amateurs having such equipment are invited to enlist at once in this "Corps." Simply send a post card to the Communications Department, A.R.R.L., West Hartford, Conn., listing in detail what emergency gear you have, including data on what frequency bands it works on, etc.

Every member of the Emergency Corps must make known his availability for emergency communication to local Red Cross officials, railroads, military units, police departments, representatives of press associations and the like. This is necessary so that they may be called upon to assist when emergency communication is necessary.

The goal of the "A.R.R.L. Emergency Corps" is: AN AMATEUR RADIO EMERGENCY STATION IN EVERY COMMUNITY! Are you doing your part? Send in your application to-day—or if you are not yet qualified, start work on that emergency equipment! Join the A.E.C. as soon as possible.

The "Gatherin'," the 7294-kc. Net organized by W6ZX, now has seventy-three members! Regular "meetings" are held daily at 7:00 p.m. P.S.T. and 9:30 a.m. P.S.T. on Sundays. Even though a regular period may not be in progress, a "CQ 94" usually brings a reply from some member at any time. "7294-kc.," the official net publication, is getting "bigger and better" with each issue, through the efforts of W6ZX, Editor, W6CMQ, Technical Editor, W8GTN, Art Editor, and W6AZ, Publisher. Membership is nearing the "set limit," so anyone desiring to join should work fast!

Those who noticed the box on page 62, October *QST*, relative to land line count of messages probably wondered what happened to the "examples of word count and detailed explanation" stated to be in that issue. It should have referred to the August issue of *QST* (page 40), article on "Ham Message Handling." For complete details on land line count, now the official A.R.R.L. checking practice, see that article. Use land line check!

BRASS POUNDERS' LEAGUE

(August 16th-September 15th)

Call	Orig.	Del.	Rel.	Total
W6HDV	152	188	592	932
W9DMF	194	398	238	830
W2CHK	101	131	590	822
W2BCX	44	117	551	712
OMITB	330	176	136	642
W3NF	5	21	558	584
W5MN	17	193	368	583
W3SN	215	80	252	527
W2EYQ	63	78	382	523
W7NH	2	8	496	506
W8KWA	1	35	468	504
W7BXQ	12	6	484	502
W3OK	22	17	461	500

MORE-THAN-ONE-OPERATOR STATIONS

W9NI	1781	965	—	2746
W9NT**	990	490	—	1480
VE9CNE	1029	9	4	1042
K6EWQ	69	95	594	758
W6ZG	250	328	38	556
W9BNT	125	229	163	517

These stations "make" the B.P.L. with totals of 500 or over. Many "rate" extra credit for one hundred or more deliveries. The following one-operator stations make the B.P.L. for *delivering 100 or more messages*: the number of deliveries is as follows: Deliveries count!

W6CXK, 303	W9FRC** 178	W3BWT, 135
W9RAT, 300	W9RQE** 178	W9FLG, 122
W6GHD, 299	W9PHG, 167	W6HIG, 112
W6KGO, 222	W9GRA** 156	W2GQX, 109
W9NIZ, 192	W9GRA, 138	W4IR, 109
W2GGE, 191	W9BGL, 136	W6MUY** 108
	VE6AV, 136	

A.A.R.S. STATIONS

Call	Orig.	Del.	Rel.	Total
WLMI (W6GXM)	83	173	587	843
WLNF (W2BCX)	41	101	674	816
WMLL (W3NF)	19	15	772	806

MORE-THAN-ONE-OPERATOR STATIONS

WVQB (K6EWQ)	275	136	340	1251
--------------	-----	-----	-----	------

A total of 500 or more, or just 100 or more deliveries will put you in line for a place in the B.P.L.

** July-August.

A.R.R.L. Official Broadcasting Stations

CURRENT information on expeditions, special tests and activities, new F.C.C. regulations concerning amateur operator and station licensing, DX conditions or new records on 23-mc. or u.h. frequencies, etc., is sent regularly (new information each week) in the different amateur frequency bands by the following A.R.R.L. Official Broadcasting Stations. This information is addressed "to all amateurs." The list is revised to include only active appointees. The operators of these stations render amateur radio a distinct service. You will find stations in your own district, and neighboring districts in the list. Make a practice of listening to the "QST" sent from these stations. Report results to these stations when you hear them, so the operators will know their transmissions are successfully received by you and their work appreciated and successful.

W1ABG, W1ACV, W1APK, W1AQL, W1ASI, W1AU, W1BNS, W1BWW, W1BZO, W1CCX, W1DQK, W1DUS, W1EAW, W1EEY, W1FFL, W1FFS, W1GOG, W1GZL, W1KH, W1MK, W1QP, W1SK, W1VF, W1WE, W1ZS/II/BZL.

W2AMB, W2AZV, W2FF, W2FNI, W2FPU, W2HCP, W2SN.

W3AEJ, W3ALE, W3AOJ, W3AVR, W3BIG, W3BIR, W3BWT, W3CDQ, W3DGU, W3DNU, W3EVA, W3UVA, W3ZA.

W4ABS, W4ADN, W4AIS, W4APU, W4ASR, W4AUW, W4BBV, W4BMM, W4CDH, W4CIG, W4CZA, W4DDF, W4MR, W4PW, W4VX, W4ZH.

W5AAX, W5ADZ, W5AOZ, W5AYB, W5BFA, W5DAQ, W5DLG, W5DPX, W5DRR, W5EFV, W5EHM.

W6AM, W6BRI, W6DZQ, W6EXH, W6FBW, W6FYW, W6HEW, W6HHM, W6LLK, W6ITH, W6JTV, W6KMG, W6ZX.

W7AVM, W7BNX, W7BVE, W7CAC, W7CAM, W7COH, W7DP, W7FL.

W8AEQ, W8AQ, W8AXV, W8BQJ, W8CFF, W8CFU, W8CHC, W8CHM, W8CPY, W8CYT, W8DCI, W8DED, W8DLG, W8DME, W8DZO, W8DZY, W8FZE, W8GJM, W8HCS, W8HSX, W8HWT, W8IOH, W8IWT, W8JQE, W8JTI, W8JTW, W8KJW, W8KMT, W8LUT, W8WE.

W9ACU, W9AFN, W9AXH, W9CWC, W9DBO, W9DEI, W9DUD, W9EDW, W9FNK, W9GFA, W9GFS, W9HPQ, W9HQH, W9HUX, W9IQI/TRS, W9JO, W9JZJ, W9KEI/W9KQJ/QR, W9LCX, W9NGZ, W9OEL, W9OLC, W9OOO, W9OXP, W9PDE, W9PSP, W9PWU, W9RH, W9RHM, W9SDQ, W9TE, W9UEU.

CM2WW/WC2WW, CM8YB.
VE1AW, VE1GL, VE1HH, VE2EE, VE2FG, VE3RK, VE4EO.

Code Practice Schedules

W8KXK, Detroit, Mich., is sending code practice on 1802 kc. every Monday, Wednesday and Friday, 7:30 to 8:30 p.m. E.S.T. W9BB at Doane College, Crete, Nebr., will send code lessons on 1942 kc. from 4:30 to 5:00 p.m. C.S.T., Monday, Tuesday, Wednesday, Friday and Saturday. WIHNP, Greenfield, Mass., on 1740 kc. will send practice Wednesday and Sunday evenings from 7:00 to 8:00 p.m. E.S.T. Each Tuesday evening code practice transmissions will be sent by one member of the Cornhusker Amateur Radio Club (Lincoln, Nebr.) on the 1715-kc. band. The transmissions will take place in the early evening, probably around 6:30 to 7:30 p.m. W9FWL and W9RIE are two of the stations cooperating. Anyone hearing these transmissions are invited to write the club as to whether they are interested in having them continued. Address Cliff Ault, 353 S. 26th St., or Ivan S. Storey, 2437 O St., Lincoln, Nebr. Those desiring code practice in the vicinity of Rochester, N. Y., should listen on 1760 kc. every Thursday evening at 9:45 p.m. E.S.T., when lessons are sent by Elmer Grabb, W8—, W5ASF, Ponca City, Okla., transmits code lessons from 6:00 to 6:30 p.m. each Monday, Tuesday, Wednesday and Thursday. A complete list of A.R.R.L. code practice stations, revised for the 1935-1936 active season, will be available when this issue is off the press. Drop a card to A.R.R.L. Communications Dept., West Hartford, Conn., if interested in receiving a copy.

N.V.I.R. DX Contest

1. The contest will be held from November 2nd, 1240 GMT to November 4th, 0040 GMT, and between the same hours on the three following week-ends: Nov. 9th-11th, 16th-18th, and 23rd-25th.

2. Each participant uses several code numbers each of five figures, which he registers with the NVIR Traffic Department seven days before the start of the contest.

3. European contacts do not count in this contest. The Portuguese and Spanish possessions, Azores, Cape Verde Islands, and Canary Islands, since they are at a distance of 3000 km. or more count for points, but the Portuguese Island Madeira does not count.

4. During each contact, one of the code numbers must be given accurately to the DX Station, and its reception confirmed by QSL card.

5. Different contacts with the same DX station during one week-end only count for points if made on different frequency bands. The station may, however, be worked again in a following week-end. A different code number must be given to each station worked.

6. Every contact in which a code number is successfully passed counts for two points if made in the 14-mc. band, three points if in the 7-mc. band, and six if in the 3.5-mc. band. The total number of points is multiplied by the number of countries worked, and also by the number of continents, in order to obtain the final score. For this purpose, North and South America count as one continent, and each district of

the following as one country: U. S. A., Canada, Australia, New Zealand, Dutch East Indies.

7. Scoring is the same for telephony or telegraphy contacts.

8. QSL cards must be received by the NVIR before April 1, 1936.

9. The result of the contest will be published in "CQ NVIR."

10. Judging is to be carried out by the Traffic Department of the NVIR.

Prizes:

For the highest scoring PA station—Special Trophy, together with gilt Silver NVIR medal. Second prize—Silver NVIR medal. Third prize—Bronze NVIR medal.

Special attention is called to the fact that points can be claimed only for contacts confirmed by QSL cards bearing the code number received from the Dutch station, so Dutch participants must rely upon the cooperation of others to ensure credit for their work. All amateurs working PA stations during the contest periods are urged to send QSL card acknowledgments of code numbers received so that proper credit may be allowed.

Hams Afloat

September 1st concluded the 1935 cruises of the Naval Reserve training ship, U.S.S. *Paducah* of Duluth, Minn., Lt.-Comdr. A. O. Rabideau commanding. The *Paducah* carried a radio crew of 32 hams as communication officers, radio officers and radiomen during the cruises. The following amateurs were aboard: Lieutenants—W9DTR, W9DXY, W9HED and W9ZY. Ensigns—W9BRA, W9CJK, W9FNQ and W9KNR. Chief Radioman W9BEZ. Radiomen—W9AKT, W9ART, W9CRY, W9FMJ, W9GRH, W9GVF, W9HDE, W9HFL, W9HJC, W9HNV, W9KTK, W9KZU, W9LGA, W9LJV, W9NGD, W9OAC, W9OZJ, W9PPY, W9PQW, W9SLL, W9SWL, W9UWB, R. W. Ego and R. I. McLean, from the states of Minnesota, Wisconsin, Iowa, Nebraska, Kansas, Kentucky, Illinois and the Dakotas. The ship cruised for a period of two months in company with the Great Lakes fleet, four training cruises of two weeks each with Milwaukee as refueling port. About three hundred messages were handled on each cruise in addition to copying weather reports, press and time-ticks. 56-mc. transceivers were used exclusively by the smaller ships in the fleet for radio communication between ships. These sets proved very effective, especially in Escanaba, Mich., where a YL operator broke in on the 56-mc. boys and nearly disrupted the Naval Communication network! (Thanks to Milt Malloy, radio shipkeeper at NESG, for this account of the cruises of the *Paducah*.)

VE2GK has been operating at sea for eight years on many different ships plying from Canadian ports to all parts of the globe. While home he takes pleasure in working ex-sea-going-ops on the ham bands. He is at present Chief Wireless Officer on the S.S. *New Northland*, VGNC, engaged in Grenfell Mission cruises, Canada to Labrador and has signed the following calls in the past: VGXZ, VGRB, VGDE, VGZR, VGZS, VGTN. VE5HH is Sparks on VGBD, the S.S. *City of Vancouver*, steady running out of Vancouver, B.C., to China and Japan. VE5HP recently acquired VGSQ, the S.S. *Salvage Queen*, normally yanking barges and rafts around the coast and second salvage vessel for the Pacific Salvage Co. VE5LV had a good spell of relieving on the Canadian National coastal passenger ships this summer, running to northern B. C. and Alaska. VE5AG is "it" on the M.S. *Unacana*, GSYX, oil tanker running coast-wise out of Vancouver, B. C. The rig on GSYX is a 500-watt c.w./i.c.w. affair, receiver is detector and two-step, all Marconi equipment. W7OV is pounding the key on KDID, out of Seattle to Alaska. We would like to hear from some of the hams operating on the Tuna fleets, running out of San Pedro and San Diego, also from more of the W7's and W6's "afloat."

W9AUX is operator on the Str. *Consumers Power*, KDUB, a self-unloader carrying coal and stone on the Great Lakes. "Sparks" on the Str. *John P. Reiss*, a bulk freighter also on the Lakes, is W9SBH. At least two ships of the U. S. Navy Destroyer scouting force, second division, carry hams as

radio operators: W3EFE on the U.S.S. *Greer*, and W9MVI on the U.S.S. *Yarnall*, W1DXU is operating on the Trawler *P. J. O'Hara*, WMDX, out of Boston. W2CMY, ex-KUGS, KING, WADQ, KDMD, WKCJ, WPBQ, would like to get in touch with any of the gang formerly operating on the S.S. *Huron*, WADQ, W2CKI is ex-KORQ, KGFJ, WFCE, W2ENZ is second operator, W5ANA third operator, on the S.S. *Gatun*, HRBG, Standard Fruit cruise ship. Chief operator on the S.S. *Granada*, HRBA, is W2DBW, W2BDY is second operator aboard the S.S. *Cefalu*, HRBF. W1CEO hold down WBFY, S.S. *New Bedford*, W1CEL and W1PI are first and second respectively on WODS, the S.S. *Nausahon*. W8BMF has held that amateur call since 1929 and has been a licensed commercial operator since 1931. In 1933 and 1934 he was operator aboard the S.S. *Fontana*, KFTW, and since April '35 has operated KFNS, the S.S. *Presque Isle*. The outfit on KFNS is a 1/2-kw. tube transmitter using two '04A's; the farthest W8BMF has worked with this rig on 700 meters is 390 miles . . . what a different story it would be if those '04A's were on the ham bands!! W1ZCC is Radioman on the Coast Guard Cutter *Sebago*, Norfolk, Va. W3DHS is on the U.S.S. *Electra*, Coast Guard Patrol boat; W3EBB on the C.G. Cutter *Mendota*, and W3BFD on the C.G. Cutter *Perseus*. W1BGN (W1ZCC's brother) is a commercial operator, just off the S.S. *Major Wheeler*, WFIL. W1AOT also pounds commercial brass. W2FWC/W2APO secured his first commercial ticket in 1926, a Radio Operator First Class, and since then has always maintained it in the same rating with similar phone endorsement rating. At present he holds a Radiotelegraph First and a Radiotelephone First, and has had the following berths as Chief Operator: KDDP, KESV, KDAN, HRCA, KOTX, KDVI, WVAU and WZAE. He also put in some time as a junior at WAM/WCC. C'mon, you sea-going-hams, send us some news!

National Highlights

A NEW 56-mc. record was hung up by W6BIP when he had a 100% QSO with W6AM. W6BIP took a rig to the top of Mt. Tamalpais, just north of San Francisco, and stood watch for W6AM on top of Mt. Whitney. This is reported to be the best DX worked from Mt. Whitney by W6AM. The Southern New Jersey A.R.R.L. Section is organizing an R.M.-O.R.S. Net. The purposes are to handle traffic, to receive bulletins from the S.C.M., and to assist the communications organization morale in general by closer contact between the individuals concerned. Wesley Davis, W4DS, is Acting SCM for Alabama following the resignation of W4KP, who is now located in Peoria, Ill. W4BBV, Assistant S.C.M., reports a Georgia Net scheduled to start October 1st. The state is divided into four districts with following O.R.S. in charge of each: W4CM, W4BAG, W4VX and W4DGJ assisted by W4DLW.

The Rocky Ford (Colo.) Amateur Radio Association recently celebrated its third anniversary with a big pow-wow and dinner. W6CRS and W6BAE furnished 56-mc. communication for Malcolm Campbell at his 300 m.p.h. run on the western Utah salt flats. W4CJN is interested in forming a net of school stations; anyone interested should write him at Wake Forest, N. C. The North Carolina 'phone nets are progressing well under the guidance of P.A.M. W4BYA. The West Virginia A.A.R.S. gang were the guests of W8EIK and W8MCL in Bluefield, September 15th. Dinner at the Hotel West Virginian and visits to several Bluefield stations featured the day. The Oakland (Calif.) Radio Club now has a membership of 151, over half of which are A.R.R.L. members. W6IGA maintains nightly schedules with K6MEG. W6BUY keeps nightly 14-mc. 'phone schedules with K6FJF and K6CMC. Ken Hughes, W6CIS, has been appointed Assistant S.C.M. for the San Francisco section. W6KGO handles considerable trans-Pacific traffic on schedule with K6EWQ. Likewise trans-Pacific messages move fast via W6CXK's schedules with KAILG and KA1EE.

K7DEV handled over one thousand words for the Geist Expedition to St. Lawrence Island. Al Giddis, W1ABG, is the new S.C.M. for Eastern Massachusetts. W1BGL, Watson of the Byrd Expedition, is on the air from his home sta-

tion in Dover, N. H., again. The Providence (R. I.) Radio Association has several members signed up for Cairo Preparatory Survey work, 6-8 mcs. W9NI at Kansas National Guard encampment did its usual excellent work this summer, the traffic total being 2746! The following operated W9NI: W9ICV, W9FKD, W9AWP, W9LFB, W9ABG, W9SIL, W9OQC, W9TWI, W9OZN and W9MUY. W1ISZ/W2DQT was radio operator for the Grenfell Mission in Newfoundland and Labrador during the summer. W2AHC and W2DXO are arranging schedules with HC1FG to connect with the Andes-Amazon Expedition of which W2DPQ is operator. The A.R.R.L. operating organization personnel of the Northern New Jersey Section held a meeting, October 4th, and made plans for a lively season.

W5DAQ handled traffic for passengers of the S.S. Dixie while she was stranded off the Florida coast. W4DKW was operated at the Tennessee State Fair at Nashville; considerable traffic was handled for visitors. The Dakota Division will be engaged in a contest from November 8th to 10th. The object is to see which Dakota Division amateur can work the greatest number of other amateurs within that division. Dakota Division S.C.M.'s and R.M.'s will soon operate on a spot frequency with crystals supplied through Director Jabs, W9BVH. The Kentucky Net started its '35-'36 operations on October 1st. The Michigan Net operates on 3656 kc. under the leadership of W8DYH and W8DVC. A traffic net known as the "Ohio Regulars" has been organized by R.M.'s W8MHM and W8IAW. Ohio Official Phone Stations are going strong under the leadership of Chief P.A.M. W8DXB.

W3EOZ took a rush message on 14-mc. 'phone from X1Q addressed to Washington, D. C. Fifteen minutes later he relayed it to W8HV, Washington, via 3.9-mc. 'phone. Sgt. Ed. Day, Chief Operator at WLM/W3CXL, A.A.R.S., was smashed up in a motorcycle accident and is confined to Walter Reid Hospital, Washington. W5EHM handled traffic between VK6MO, Carnegie Institute Magnetic Observatory, Watherou, W. A., and OAAU, Carnegie Observatory, Huancayo, Peru, who are trying to make test QSO. W5AID has averaged 4.25 QSO's per day during 1935, mostly on 'phone. A north-south 56-mc. relay route is planned for the state of Colorado by the gang around Ft. Collins. W8ATT, Nellis, W. V., keeps schedules with ZLIBV.

STATION ACTIVITIES

CENTRAL DIVISION

ILLINOIS—SCM, Fred Hinds, W9WR—R. M.'s: 9AND, ILH, KJY, NXG finds lots of bugs in new 50-watt final. ANQ predicts lots of activity seen in Waukegan. IBC has 1 kw. on 7 and 14 mc. It took KHD three weeks to rebuild. Aussies have no trouble hearing BPU's new 150T final. On Sept. 16th, VCB was one of 21 stations participating in a 56-mc. round-table, POO acting as master of ceremonies. ERU fixed the '04A. That man DOU went and got himself engaged! SKF can't find much DX. KXD and KXE are very QRL. NGG wants O.R.S. renewed. 1.75-mc. 'phone holds charms for CEO. ATS prefers 14 to 3.5 mc. CUH is rebuilding antenna tower. RAQ is working traffic coast-to-coast in 10 hours. HPG is interested in model railroading. TLC is new member of A.A.R.S. DBO reports IEP in Michigan has a new skyrider. 7 mc. is dead at ENQ during summer. NDA is now operating at DJG. GSB acquired an FB7A. STG is back in school. Service work keeps CHM busy. KA is convalescing from a month's illness. SMD is interested in National League pennant race. DX traffic at JO. SSC is trying to work DX on 3.5 mc. TAY hears VK on 3.5 mc. RRX was R9 on 'phone in Spain during recent QSO with EA4AO. NN took a 9000-mile trip through the far west and Mexico. VCF has two new 48-foot masts. YL-it is for SIB. DDO likes his new antenna. VFI is a freshie in high school. PNE is working a mess of DX. PGB worked his first "7" on 3.5 mc. Pair of '46's at INY. COW, off air for four months, now has new 'phone rig for 14 mc. RWS is trying some new schemes. VES works 7 mc. exclusively. HQH

received cards from VK, ZL, G, reporting reception of his 3.5-mc. QST broadcasts! ICN is building ILH a 59-RK20-'52 lineup with panel-switching for band change and crystal selection. Welcome to FFL, newcomer to Illinois from Duluth, Minn. UZG uses a vertical receiving antenna. New frequency meter at WC works nicely. LOL has a versatile station. Poor LXB is a "boiled ham." IWQ and LRX are going on the air with a big bottle. Publishers of "ILLINOISE" request donations of 1½-cent stamps to help cover mailing costs. Report to the S.C.M. each month on the 16th and receive a free copy of our Bulletin.

Traffic: W9CGV 87 DOU 73 (WLT 6) HQH 60 DBO 36 NXG 32 HPG 30 RAQ 26 NGG 20 DJG 19 DOX 18 DDO 11 PGB 11 LIV 10 MRQ 10 ATS 9 VES 8 CUH 7 KJY 6 GSB 4 ERU-WR-KHD 3 BPU-TAY-BRX 2 JO-STG-CEO-VCB 1.

INDIANA—SCM, Arthur I. Braun, W9TE—LSZ rebuilt rig. JST is back from Calif. and is now at Cloverdale. HBK is ready for the old grind. FYB married a little red head. JNX bought a new Ford. MAA is making little ones out of big ones, at a stone quarry. ERP is back at work and carries a radio catalog with him. CFG is armed with Class A ready for 3.5 mc. JJK will study for Class A next time. BMF's new QRA is Bedford. STR likes his 7-mc. rock FB. ULP is new at Bloomington. PIJ is with Crosley at Kokomo. ODH is new A.A.R.S. HUO is now A.A.R.S. Net Control for Ind. DET has new rig ready for the air. VIO is new at Terre Haute. GFS is back at school. TGC is bitten badly by 'phone bug. KRT is president of Calumet Amateur Radio Assn. TEX gets out fine with new rig. JZA says c.w. is FB now that he worked 'phone. QG has new R.C.A. 122B oscillograph. OEC is ready for winter activity. DIJ is ready for heavy traffic. CNY is new at Crown Point. TRN has new 125-ft. vert. antenna for emergency. LTV moved to Indianapolis. HUV hooks a new country now and then. NTP is lining up schedules. PKR has a new RK-20. OVR entered in Rose Poly. RLF is still rebuilding. DFE works plenty of VK's on 7 mc. NBZ will be ready for 3.5- and 1.75-mc. 'phone. LLV is QRL married life. JIW is building c.c. standard frequency meter. HSF is oping as portable from Marion for a couple months. TBM moved to new QRA and joined A.A.R.S. HUF is starting A.A.R.S. schedules. TYF relayed a message for F.D.R. AXH met numerous hams on a trip south. EGQ is still trying for a good DX antenna. SNQ is lining up traffic schedules. OWW and MYP will operate 14-mc. 'phone from Purdue. JHQ is QRL school. VHF is new at Indianapolis. UYP is good at putting up new antennas. NQJ has new rig ready for DX, etc. NNX likes his new rig. Goshen Amateur Radio Club has new officers: OEC, pres.; LLV, vice-pres.; FRY, secy.; SZU, treas. SLJ uses his RK-20 on 1.75-mc. 'phone. SDW is back after a layoff. SRV has left 1.75-mc. 'phone for other hands. PEG and PEF are rebuilding. CB is back on after three years vacationing. UIX uses '47-'46-par. '46's in his rig. TE has new Class B rig ready. SFG has rebuilt rig and added audio to his receiver. OKX is going in for rack and panel job. LCA likes his 1.75-mc. 'phone rig.

Traffic: W9ODH 10 HUO 40 TGC 14 QG 2 DHJ 18 TRN 7 HUV 2 NTP 6 HAF 14 TYF 3 AXH 4 RGQ 1 SNQ 4 JHQ 2.

KENTUCKY—SCM, G. W. Mossbarger, W9AUH—Without the slightest apology, your S.C.N. submits the following disgraceful report for our fair state, famous??? for its O.R.S. competition. For two months no report has graced these here columns and, after scanning the following two months' report, what price censorship? Acknowledgment is hereby faithfully chronicled of the efforts of FEW, EDQ, HBQ, RBV, SDC, and FZV, for traffic reports mailed in. Reports have been received from JL, TKP, SDG, UUR, SDM, UTO, OMW, and SQC. SQC has RK-20 on. OX repairs, IFM and OMW are moving and rebuilding along with CDA. BAZ is still buying receiver. ARU puts in 57th transformer. HAX eagerly awaits Kentucky Net opening. HBQ is down with flu, but keeps schedules. UUR works 56 and 3.5 mc. BWJ tries DX with telescope. SDG handled a message!!! SDC and RBV are off to Purdue. FZV tries to initiate YF. TKP finally W.A.D. JL, through cooperation of KKG and MFT, becomes full-fledged kw. station at U. of K. Kentucky Net officially opened October 1st. HBQ and EDQ with IFM handled net from September 1st on. Let's go, gang. JHY

had to report through Kentucky to give us a report in July. This is your column. Fill it up. "I ain't no mindreader." SEA on 1.75-mc. 'phone wants state traffic. 1XN is better, we are all glad to know.

Traffic: W9AUH 35 ELL 18 IFM 4 HAX 9 SDC 3 FZV 5 RBV-EDQ 12 HBQ 74 TRK 26 JL 41.

MICHIGAN—SCM, Kenneth F. Conroy, W8DYH—This report is being written between moving to new QRA and working on hamfest (it's history now), so pardon the jumble. The gang has started to stir after the summer hibernation and, with 8DVC acting as Chief R.M., it looks like we are going places this season. We'd appreciate a report from every man in the state of Michigan—whether you are just hanging onto a license or what have you—in return you will receive a copy of the D.A.R.A. Bulletin, one for each time you report. 9PDE, Assistant S.C.M. of U.P., has new stock of O.R.S./O.P.S. application blanks—all you Michigan nines write to him for application forms. 8FTW, 8ICM and 8LZV have all got the dates to join the ranks of the "old married men."—There goes our total! The Michigan Net is trying to perk on 3656 kc. and will be going strong very shortly—anyone interested get in touch with 8DYH or 8DVC. 8DPE reports that the Signal Corps has taken over the C.C.C. project and have five stations on 4300 kc. so far. 8GQQ has been pounding brass at 8BKU lately. 9LLD now has another stage on his rig. 8GQB is secretary of the 210 DX Club. Qualifications: (1) WAC; (2) 50 countries or more; () less than 150 watts input; (4) tubes of 210, 801 and 246 type only. 8BNK passes the cigars—new baby boy—FB! 9PCU's renew O.R.S. for another year—about time some of the rest of the gang mail in the old certificates for their yearly endorsements. 9OWG leaves for college—luck! 8ECI says the golf-links pull and the QRN pushes him away from hamming. 9TTY and 9TYS break their daily weather report schedule after all these months—TYS goes to school. 8LTT wants us to see that he gets an O.R.S. soon. 8LSF is lining up his trunk line schedules. 9ADY is out after schedules also. 9OZM is working a butcher—says that 9TQT is still his YL. 8DWB is back in the harness. 8NXT sends his first report. 9RIT worked VK20W on 7 mc. Nice going. 9KDE schedules 9RHM daily. 8GQZ sends nice report for his first one. 8ABH is after schedules. 8IXJ is on for the fall boom with a bang. 9RHM still socks 'em out.

Traffic: W9PCU 40 OWG 21 TTY 16 PDE 5 RIT 4 OZM 1 KDE 12. W8DVE 313 ICM 93 DWB 79 ABH 10 LTT 5 GQB 4 LSF 13 FTW-OEL 2 OXJ 1.

OHIO—SCM, Robert P. Irvine, W8C10—IAW's final stage burned out. ZG is back on the air. MQO is getting more active every day. NAL is running race with MQO for DX honors of Dennison. MXH is new O.R.S. UW is getting all set for fall season. BBH is also getting started again. AQ has new YL Junior op, total now three. NGZ will be O.R.S. soon. DWF wants O.R.S. HMH is working in Trunk Line "B" again this season. JTI is new O.P.S. and O.B.S. KEV wants O.R.S. LCY and LZK report by radio. INT came to life. MZX is QRL college and finds that studies and ham radio don't mix. JFZ is leaving for University of Cincinnati. IET and ITR send good report. BRQ will be out after traffic soon—GSO take notice. FGC had QSO with EA4AV and got R9 report. EFN and CEJ let their station licenses expire. FOO is working at Coast Guard station at Fort Trumbull, New London, Conn. KLN is QRL Ohio State University. DIH is still promising to get back on the air. EMV wants O.P.S. FNX wants O.R.S. and O.P.S. BRB reports Lakewood Radio Club beat Medina County Radio Club at ping-pong. BYF reports W6's coming through on 1.75-mc 'phone. NHO is QRL school. NYP has RK-20 on 7 mc. LBH-7 works 300 miles with one watt input to '30 crystal oscillator on 3.5 mc. MDJ has a new mike. GIL is working on velocity mike. LUT tries 3.9-mc. 'phone and is new O.B.S. LWP builds new receiver. MMN is on 3.5 mc. LBH is QRL C.C.C., Yellowstone Park. KAY's antenna came down. ANU succeeded in blowing up most of his 'phone rig and then went back to college. APC reports via "YE OLD HEN," which has to be seen to be appreciated. MFV is doing good work on 7 mc. using 300 watts input to a pair of 150-T's. FKW is new O.R.S. LAU reports ONX new operator at Salem. ISK is busy with new Ohio Traffic Net. From the promises made by most of the traffic men, we should be going places by this time next month. A traffic net

to be known as the "Ohio Regulars" is being formed and will operate on spot frequency with the cream of the traffic men of Ohio in the ranks. The credit for this net goes to 8JAW and 8HMH. It is hoped that all the fellows who are interested in traffic will get in touch with them. Believe it or not, fellows, 8ZG came to life and reported this month; we hope to hear more from him as time goes on. With this report came the request from several fellows for O.P.S. and O.R.S. and, with several still out and waiting to be heard from, Ohio should be well represented this season. The O.P.S. are going strong under the able leadership of Chief P.A.M. 8DXB, and word comes to us from headquarters that we have the National high scorer in the last O.P.S. contest. Fine work, fellows, keep it up. OPX is new ham in Cleveland, says APC. APC also reports that ODI got "a heck of a cold" at the air races. DVL and APC are changing QRA. Following news sent in by Chief P.A.M. 8DXB: BYF has been appointed Asst. P.A.M. "Doe" is doing fine work on 1.75 mc. JTI is new O.P.S. at Akron, also on c.w. on 7 and 3.5 mc. EDR is active on all bands, even 28 mc. Daily schedules at HFR on 3946 kc. JFC has worked all dist. but W7 on 1.75-mc. 'phone and 28 countries on 14-mc. c.w. LIQ sends fine report; besides O.P.S. he is A.A.R.S. JTW is increasing power. Hi Columbus! KNF and EMV will soon have O.P.S. OKG and ODI are active on 1.75 mc. ICF has real layout, three transmitters. "Doe" uses 'phone and c.w. A few O.P.S. do not report. S'matter?

Members of the Cleveland Heights Amateur Radio Club express their sorrow over the passing of one of the original members of the club, Robert L. Green, W8GGH, on September 19, 1935. Bob was a quiet and reserved chap and well liked by the club members. He fought a losing fight against tuberculosis, and ham radio helped him to live about 2½ years longer than he was given a chance to, three years ago. We will miss him in the ranks.

Traffic: W8IAW 158 ZG 107 MQO 105 NAL 60 MXH 55 UW 35 WE 29 BBH 47 (WLHA 2) AQ 28 NQC 25 C10 19 (WLHC 58) NGZ-DWF 16 HMH 12 JTI 9 KEV 8 KIM 7 LCY-LZK 6 INT 5 MZX 3 JFZ 2 HFR 3 FKW-LAU 1 ISK 31 CMI (WLHI 112) NAF 5.

WISCONSIN—Acting SCM, E. A. Cary, W9ATO—Your new Acting S.C.M. has recently joined the Alimony Club and as a result is rather unsettled. Please send reports to the QRA listed in the directory on page 5. IQW is QRL with YL's and a new job. RQM is putting in a 211D. HSK is busy as Alternate State Net Control for the A.A.R.S. RKP is experimenting. RSR has had receiver trouble. AKT, new R.M. for southeastern Wis., sends in a copy of the *Four Lakes Amateur Radio Club News*. A nice sheet, full of interesting news. He is installing a pair of '03A's and will be on for traffic soon. UJN is c.c. on 3.5 mc. UPM is self-excited on 3.5 mc. IZZ services for Sears. UNY is getting 7-tube 56-mc. set built. UMP, UNY, SYT, ULE, UPM, UVV and IZZ have great time with transceivers at Friess Lake every Sunday. Radio Amateur's League is getting a very good start—meetings held at ULE's house every Thursday where at least one pint of ice cream per head is consumed—every ham invited. UJN has B.C.L. trouble. SYT is trying to find 28-mc. band. IJHG is corresponding with the gang in Milwaukee—they all envy his 56-mc. location. UNY says metal tubes are the bunk. ULE is putting in wire line with friend three doots away. UMP got a new bicycle with balloon tires. SYT made a heroic rescue of two persons at Friess Lake. HRM is again on the road and may drop in on Hqt. soon. DIJ is conducting M.R.A.C. meetings in the absence of HRM. NPS is selling electric fences to keep visitors out of the farmers' apple orchards, etc. GHN has his new '30's going in crystal P.P. rig and is putting out 250 watts on 7 and 14 mc. LJU built new receiver according to latest QST design. GVL is Publications Committee for M.R.A.C. and is doing FB job. RKP would like to know how to make a chirpless M.O.P.A. Hi. BYR is now able to shift his transmitter to five different bands within ten minutes. UIT is pounding out signals on 3.5 mc. and is interested in rag-chewing and traffic. FSV is again getting the bug and hopes to be back on the air in a short time. DII is having crystal trouble. CAS ordered new super. HBP broke his crystal and found it worked OK, but after a few hrs. of CQing on the 1.75-mc. 'phone rig he found crystal was on top of local police station's freq. and was blocking out police

ears in vicinity! ANA is the Technical Committee for the M.R.A.C. and expects to give the boys a lot of talks. CCD is about the only ham in Milw. who is still using '10 transmitter self-excited and an '01A receiver, and says he is having more fun working out than the high-power gang. NY hasn't been on or listened to any other band than 28 mc. for a whole year. ESO says 14-mc. 'phone DX is going dead around 7:30 p.m. lately. RUF says ZL's and other DX are being heard at his shack as early as 10:30 p.m. C.S.T. on 7 mc. at present. DTK will give a brief review of the M.R.A.C. over its first broadcast over W9XAZ—30600 kc. on Oct. 10th. DFJ is the M.R.A.C. Membership Committee and is lining up the local hams to join M.R.A.C. and the League. GSP is using new home-made super. Thanks to ULE and RH for Milwaukee news.

Traffic: W9RKP 8 HSK-RQM-RSR 2.

DAKOTA DIVISION

SECOND ANNUAL DAKOTA DIVISION QSO PARTY

The Second Annual Dakota Division QSO Party will be held from Friday, Nov. 8th, at 6:00 p.m. C.S.T. to Sunday, Nov. 10th, at midnight C.S.T.

All amateur stations within the bounds of the Dakota Division, which includes North Dakota, South Dakota, and Minnesota, are eligible to compete in the party. The object is to work as many Dakota Division stations as possible, using any of the amateur bands, and 'phone or c.w.

The calling procedure will be the same as used last year: CQ DAK CQ DAK CQ DAK DE W9—. The final score is computed as follows: Count five points for each QSO with other Dakota Division stations. The total points made in QSO's is then multiplied by the number of Dakota Division sections worked. There are four sections in the Division, hence a possible multiplier of four.

Prizes are being collected for the winners. There will be a grand prize; a prize for the winners in each section, and many other worthwhile prizes.

At the conclusion of the party tabulate your results, listing stations worked, and mail within ten days to your S.C.M.

Remember: Any frequency may be used. However, most of the activity will take place on the 3.5-mc. band. Here is a chance for the 'phone boys to give the c.w. fellows a run for their money.

—Francis C. Kramer, W3DEI
S.C.M., So. Minn.

NORTH DAKOTA—SCM, Hartwell B. Burner, W9OEL —BTJ has been working 14-mc. 'phone and reports 7 mc. FB for DX. The gang at Ft. Lincoln held miniature hamfest with the following in attendance: JHK, OIS, PMI, PMN, RPD, STT, RYZ, RZG and SWC. KZL reports A.A.R.S. Net working FB with AZV, DHQ, PJT and SAW active. Our good friend Don Holaday reports from Longview, Texas, that he is at KFRO and is awaiting a W5 call. PGO reports a 150-watt 'phone under construction which will be known as "the voice of the basement." TFC of Rolla wants some traffic schedules. SKQ's new QRA is Grand Forks, where he will take electrical engineering course. PHH visited Hope gang and reports QRL Red Owl store. "Doc" (PRU) vacationed in California and is again pounding brass. FKY reports new rig about ready with 830 final. Dakota Division S.C.M.'s and R.M.'s will soon operate on a spot frequency with crystals ground by Director Jabs. The Jamestown gang attended hamfest at Pierre and report an FB time. STT had visit from RYZ. JZJ visited Grand Forks gang.

Traffic: W9HJC 92 KZL 67 OEL 41 PGO 11 PJT 8 PVA-BTJ 5 JZJ 4 DGS 9.

SOUTH DAKOTA—SCM, Mike Strahon, W9PFI—R.M.: 90QV—CRY brought home the grand prize from the

State Convention. Congrats to the Pierre Club for putting on an FB convention. KPQ is on c.w. for the first time since receiving his first ticket. PGV is busy with Army traffic. TY says the DX cards are rolling in these days. SCB is out on the West Coast and KPQ moved to St. Paul. PPE is now located in Sioux Falls. OED reported for the Miller gang and says they would like to have the 1936 Convention. FDD and IQZ are now at Yankton and have the stenos at WNAX going gaga. FOQ got heard card from Russia. TFN and UKL are off to school at S. D. Mines. LBU has new Super-Skyrider. FJR is going on 'phone. PFI is putting 750 watts into a single '52. LDU has a new rig. USH and USI have a new pair of ten's in the final. SXN and FEM are attending State College. UDI and ORY are off the air with transmitter troubles. TJX is moving in with PFI. AZR and OQV are trying to get on trunk lines again this fall. UVG is ex-HSH and is on 3.5 mc. at present.

Traffic: W9SEB-ALO 4 AZR 70.

SOUTHERN MINNESOTA—SCM, Francis C. Kramer, W9DEI—R.M.'s: 9PDL, 9BKK. PDL is rebuilding for fall traffic season. PEV will be on by Oct. 15th with a new rig on 28 and 14 mc. TQG expects to have several good schedules this fall. IDF and SJH are attending Carleton College. LEN resumed his teaching at the local high school. KDI has a new 3.9-mc. 'phone using an 835 final. The Northfield H. S. is organizing a radio club. BN is looking for fall schedules. ATR is anticipating ham operating as soon as shipping season ends. GFA's new rig uses 59 Tri-tet, 841 buffer and '10 final. RKG has his receiver and monitor working swell, and is now on for traffic. BTW, with a total of 67 countries to his credit, still works occasional J's. ELA QSO'ed ZF2AC for 67th country. LKK sends code practice on 3757 kc. at 6:30 p.m. each day except Sat. and Sun. FMA misses those interesting Mpls. Radio Club meetings. DEI is trying to teach a certain PY English via radio. PEV and PDL recently attended a Rochester radio meeting via radio. Be sure to attend the second annual Dakota Division QSO Party to be held Nov. 8—10th. Extra! S.M.R.A. Convention will be held in Mankato, Nov. 3rd. CU at it.

Traffic: W9PDL 65 PEV 43 TQG 18 DEI 7 BN 4 GFA 3.

MIDWEST DIVISION

IOWA—SCM, Phil D. Boardman, W9LEZ/WLUD—R.M.'s—9ABE, CWG, HCH, HMM, LCX. P.A.M.—9AED. This is to inform all hams that the open season on YL's, hamfests, and static is closed. Now is the time to make that application for O.R.S., O.P.S., O.B.S. or O.O., and the 16th of each month is the time for that good old report. Let's have some news, gang. LEZ attended Missouri A.A.R.L. Convention at Joplin. NNM takes LEZ's place on Trunk Line "G." CWG has new rig, which will be on 14 mc. except for A.A.R.S. drill. ACL is working on Airways beam station. NDN is trying to wake up the Dubuque hams. DEA is being chased all over the midwest by his company. PAH is home after summer school at Kansas State. SRK hopes to be eligible for O.R.S. soon. JMX uses '01A's with 750 on the plates! UQD uses only 2 watts!!! IQE and CEN visited new beacon station. RKK has new job. LZI is back at home in the city. AEP has new rig going fine. HAQ is proud owner of new shack and "HRO."

Traffic: W9LEZ 342 (WLUD 157) NNM 159 CWG 42 ACL 21 NDN 5.

KANSAS—SCM, O. J. Spetter, W9FLG—9KG and IOL, R.M.'s. NI takes the front page again this year with a grand total. Following make BFL: NI, DMF, RAT, PHG, NLZ, GRA, FLG and BGL. KG has been DX'ing on 14 and 7 mc. during the summer, but is now ready on 3.5 mc. for the traffic season and A.A.R.S. work. RIZ has 211 final now and is working lots of real DX. PB says new shack is now ready and rig about set up. RAT reports new Jr. op. GDS and UPH are planning activity between school hours this winter. VBK has new HRO receiver. IXEJ has Collins 30XF 'phone on 14 mc. S.A.R.C. is getting set for big winter activities. K.V.R.C. is busy with the biggest convention yet. Everybody and his brother will be there. NI operators: ICV, FKD, AWP, LFB, ABG, SIL, OQC, TWI, OZN, and MUY.

Traffic: W9NI 2746 DMF 880 RAT 456 PHG 239 NLZ 229 GRA 224 FLG 212 BGL 188 YAB 165 GUZ 145 EHA 87

KG 86 RIZ 78 NQE 75 LFN 53 MFH 36 DQJ 20 FMX 16
TKU-DRD-BDX-TPM 3 KCR 1. (July-Aug. W9NI 1480
FRC 363 RQE 226 GRA 211 MUY 180 PB 114 TKU 91
GWN 43 KXB 34 NL 19 DQJ 18 CBT 12 KCR 10 PIW 9
HSN 5 AWP 1.)

MISSOURI—Acting SCM, J. D. Mills, W9CJR.—The Missouri Convention went off with a bang; and WHAT A BANG! Attendance was far above fondest expectations and included many radio notables: DeSoto, Midwest Director Kerr, A.A.R.S. Missouri Net Control Norwine (W9EFC), and many others—even Iowa's S.C.M., Boardman, from far-away Davenport. DIC worked his first VK. EDK is back in Missouri and active. ENF is holding regular A.A.R.S. schedules. SGP reports best DX "One lone K5." FZJ's first DX is VK4-5-6. KEF says he sure enjoyed the convention. KGX reports for first time in four years. Thanks! AJJ is still struggling with "s.s." receiver. KCG says A.A.R.S. will raise his traffic totals. OUD and IGW are rebuilding. TGN is still looking for an Asian to get W.A.C. HUG is running A.A.R.S. schedules. KEI is in the market for traffic schedules—lots of 'em. DHN worked XIAY on 28 mc. PVW is back on 7 mc. AZL is QRM'ed by Jr. operator cutting teeth. LVA is on with new rig. SHV is having crystal trouble. OWQ's antenna was struck by lightning. AWC is in University of Utah. HUN is QRL YL. BTD is looking for a job. NOL reports from Baltimore, Md.! As result of "Stag Party" LBM, RDF and OLC got lost going home. OSL, PRO, KPV and SIS have gone to W6 district. PSM is QRL Court. EFC, "Champion Convention Attender," takes peanuts on every trip. CJR is QRL transmitter troubles and is starting radio shop. The S.C.M. appreciates the many reports now being received.

Traffic: W9DHN 1 KGX-FZJ 2 KEF 5 KCG 6 OUD 7 HUG 9 KEI 23 SGP 32 DIC 8 TGN 49 ENF 55 OLC 68 AIJ 252. (July-Aug. W9DIC 8.)

NEBRASKA—SCM, Samuel C. Wallace, W9FAM—BNT sent a very FB report via radio. FAM is getting lined up for the traffic season. EHW is getting ready for the Army Net with both c.w. and 'phone. IFZ expects to be on the air more this season than in the past. KQX is keeping a fair 3.9-mc. 'phone schedules. RPK of Gering is getting out FB with 1.75-mc. 'phone with a 200-watt rig. TBD is going for traffic in a big way. RUJ rebuilt this summer so he can QSY very quickly. BQR is getting back on the air after the warm weather. INR is getting ready for traffic work. KJP expects to be in the traffic game this season. KVZ is rebuilding for some traffic work. AVX wants to get himself a transmitter built up at Grand Island so he can handle some traffic this season. IGF is busy digging basement under his shack. POB is ready to do his part. DI is moving to St. Louis, Mo., and expects to get DI on the air there.

Traffic: W9BNT 517 (WLU 107) FAM 46 DI 36 EHW 9 IFZ-KQX 6 TBD 1 RUJ 2 BQR 1.

DELTA DIVISION

ARKANSAS—SCM, H. E. Velte, W5ABI—ENL is active in A.A.R.S. work. DRR is opr. at KCMC, Texarkana. DHH moved to Gladewater, Tex. DHG is building new rig. DJQ has 1.75-mc. 'phone. ASD quit C.C.C. for job in K.C. BCI paid visit to ENL. DHU has a job now. DRW is at Hendrix College. BJH is regular in A.A. work. ABL is the beer king in Ark. DYT visited 8CFU and VE3TM. EWW is going back to school. CVO is checking 6000-8000 kc. CPV is back in Camden. EIP is back in school. BTK will be on 1.75-mc. 'phone soon. BNX is working 28 mc. ABI works nights, so nil on radio. IQ has nice total. CGT is active again in A.A.R.S. The hidden transmitter hunt went over big with the gang in Greater Little Rock.

Traffic: W5ENL 224 DRR 94 DHU 218 DRW 42 BJH 22 ABL 13 DYT 7 EWW 6 CVO 2 ABI 20 IQ 180 CGT 21.

LOUISIANA—SCM, W. J. Wilkinson, Jr., W5DWW—DKR has lots of DX QSL's. Send your envelopes today. HR is back on A.A. Net. BPL is keeping schedules. BPN spends all his time on c.w. BDJ completed new transmitter. LA has very fine rig on 14-mc. 'phone. EDY and DZL are on 7 mc. DXK is giving '01A contest for N.O.R.C. EDZ had big time at convention. EVS is planning on 'phone rig. FHH drills holes in needles lengthwise for pastime. EBB is member of N.O.R.C. DWC plans to rebuild rig. JW has

antenna troubles. AOZ and ASH are on 1.75-mc. 'phone. CXQ is getting good results on 14-mc. 'phone. CQF built pre-amplifier for SW3. CWX, CJO and AEH are active in N.O. CFG was visitor in Shreveport. WF moved to Oklahoma City. AGM is active in Shreveport. BYQ and DXW took Radio Telegraph Second exam. QH got DX QSL from Germany. ERV will soon be on 1.75-mc. 'phone. DMF believes in autographs. AKW is still traveling. CEN left for University of Pittsburgh, Pa. ACA is still sailing. DAQ has sailboat on Lake Ponchartrain. ZS is going strong on 'phone. EEZ is still working DX. EMS is back at school. FR is active in Monroe. AO is going strong in Burwood. ASJ is servicing radios. CW is hanging out in New Orleans. CVW is active at Barksdale Field. DXL keeps Monroe on the air. NM is still at sea. Monroe was chosen as next year's Louisiana State Convention site. Everyone is invited to make plans to attend now. Exact dates will be announced at a later date. DAQ handled traffic for passengers of S.S. *Dizie* while it was stranded off Florida Coast.

Traffic: W5DKR 93 HR 17 BPL 2 BPN 10 DAQ 13.

MISSISSIPPI—SCM, J. H. Weems, Jr., W5CWQ—CJB is on 3.9-mc. 'phone. GQ is working in Arkansas. DEJ is operating at CWQ. CWQ is now WLR.L. ELS has new ZEPP. ID is tied up with business. ANI is repairing B.C.L. sets in the Delta. CO is on 3.5-mc. c.w. What happened to the North Miss. bunch? Now that fall is here again, let's see some real activity in all branches of the field.

TENNESSEE—SCM, Merrill B. Parker, Jr., W4BBT—R.M.'s: W4AEP, 44YE, 4CXY, 4RO. CXY is new East Tenn. R.M. AFM has been appointed Ensign C-V(s) U.S.N.R. and will head Unit Four, Section Five, Eighth Naval District. PL did splendid QRR work during recent Florida storm. AEP and ALM attended National Guard camp in S. C. The A.A.R.S. Net has resumed operation with AEP as N.C.S. and BOZ as Alt. N.C.S. DKW was operated during the Tennessee State Fair at Nashville; a considerable amount of traffic was handled for visitors. CW is off the air due to moving, but intends to resume activity on 7 mc. DON worked his first VK. CDC built new rig and is working all kinds of 7-mc. DX. DRE hopes to become O.R.S. AYE's job in a laundry was a washout. BEF and APA journeyed to Atlanta and took exams for commercial tickets. CTM has resumed his pursuit of higher education at Ga. Tech. CBA was called to Nashville by the critical illness of his father. BBT's job is keeping him QRL. The S.C.M. is beginning to suspect that a good percentage of the active hams in this Section are not reporting their traffic or activities. Postal cards may be had at any U. S. Post Office for the nominal price of One Cent, and the S.C.M.'s address may be found on page 5 of any QST. *Make reporting a habit!*

Traffic: W4CXY 141 PL 43 CBA 30 AFM 28 (WLR 143) BBT 20 RO 13 AYE 63.

CANADA

MARITIME DIVISION

MARITIME—SCM, A. M. Crowell, VE1DQ—Nova Scotia: HH has three ops on at times and will handle O.B.C. on 3625 kc., Wed. and Sat., at 6:30 p.m. A.S.T. BZ has new daughter. HX is trying for berth in the R.C.A.F. IA moved to country. EX is W.A.C. now, VK3JA being the lucky man and making 40th country. GL's O.B.C.'s are being copied FB regularly by the P.E.I. gang. EK and he are busy lining up local gang in net for collecting late dope and news of gang. HK is getting out well on 14 mc. with the 211-D final. AA is snagging the Europeans right and left on 14 mc. FB handled some good traffic for "W" visiting hams direct to their home town. EP likes his new '24 Tri-tet and has been contacting lots VK's and PY's. FN was in Toronto on motor trip. ET was home and out again. VO1W sends in fine report for VO gang. II has nice 140-watt 14-mc. 'phone. IH is working with portable. IN and IC are quite active on 14 mc. 4Y puts great 3.9-mc. 'phone signal into the Maritimes. Among recent visitors to Halifax gang were VP9O, W8FRC, FRA, W3CLC, QM, BDF, ESS and W2GYQ. VE1GH installed and operated a ham station at the Tunenburg, N. S., Exhibition.

Traffic: VE1HH 6 EX 5.

ONTARIO DIVISION

ONTARIO—SCM, S. B. Trainer, Jr., VE3GT—SS now has a crystal for 1.75-mc. 'phone. MX reports Ottawa Club has nice new quarters. OD and ADZ of Kapuskasing would like a schedule with Toronto. GG wants to see Trunk Line "I" going again at once. VD is still keeping 7-mc. schedule with England. XU and AEL like 28 mc., and XU is building rack and panel. So is JT, who did a lot of excellent work relaying traffic from 9CNE. The DJ brothers operated 9CNE and did a grand job of it. GI is back at school along with many others. DU has started schedules with WK, who still schedules 2BU in Montreal. 9AL is to be congratulated on the arrival of a new junior "op." QB is on again. SZ says HY croons over CKTB and plays a nice piano. WR is on 3.5 mc. at Camp Borden. It is hoped that every VE3 that can be on the air will participate in this year's VE/W Contest. See rules elsewhere in this issue.

Traffic: VE3SS 8 MX 3 GT 107 GG 73 VD 30 DU 19 QB 11 AU 136 SG 46 WK 167 JT 356. VE9AL 19 CNE 1042.

QUEBEC DIVISION

QUEBEC—SCM, Stan Comach, VE2EE—Our last report commented on the new rig at HK; it sounds swell, but one has to see the rig to appreciate it. FQ is once more back with us after a three months sojourn on Anticosti Island; what with W.A.C., traffic, fishing, flying and forest fires, Syd certainly had a hectic time. We regret that in last month's report we omitted to record FG as a new W.A.C. DR is having trouble with his rig, a refractious '10 is causing Bill lots of sleepless nights. 4UX and 3AD are now with us and both will soon be signing second district calls. Welcome, and may we wish you luck in your new locations. The South Shore gang were the recipients of quite a few visitors this last month. CO6OM from Tuinauc came up with his family. VE4NI and his second op spent a night visiting, and VP9O, who is seeing the world as "GUNS" on one of His Majesty's ships, spent a week visiting and being visited; "GUNS" has obtained permission to operate a ham transmitter from his mobile location and the gang is asked to look for VP9O. EC is still holding down the relay center on the Tri-Colour network, and when the static lifts on the 3.5-mc. band HT, AB and himself will once more be swinging the traffic through. BU kept his traffic totals up even through the summer. HG has been taking a crack at message handling; the Printer's Convention loaded him down until GZ and JK helped him along with some. A relay was handled from England to Vancouver in two hours by DR. HH is still using a clothesline for an antenna, no height, no insulators, but it gets out better than the bedspring at KK. GA is having some trouble with his modulators, and EE is just recovering from an attack of the same trouble. AS is a newcomer on 'phone using grid modulation. IA paid a flying visit to the S.C.M. and gave us the news of the gang in the Eastern Townships. II has torn his rig to pieces and is rebuilding. FE has started business for himself. Best wishes, Greg. EU is building a new receiver. GE has some new ideas on antennae and reflectors. Friends of X2CH will be pleased to hear that he has landed a job and is doing extremely well in his new abode. Judging from the listeners' cards, the transmitter at DC is surely stepping out. DX has erected two new masts and hopes to be on again this fall. AX, GN, EM and FO are still very active on 56 mc., and the 28-mc. bug is beginning to bite in other directions. The M.A.R.C. reopened for its fall and winter activities on the 19th. The officers of the club hope to see all the members at all meetings. HK has received a listeners' card from Bombay, India, reporting his 'phone transmissions R6 on speaker.

Traffic: VE2BU 82 DG 13 KJ 23 BB 10 GO 5 HG 17 EC 13 HH 12 DR 19.

VANALTA DIVISION

ALBERTA—SCM, J. Smalley, Jr., VE4GD—Traffic is picking up with winter drawing on. LX leads for the umpteenth time. SD is now O.R.S. and turned in a nice total for his first report. BZ brought back an Eimac 50T from the Spokane 'fest. LE has the first National HRO. FT and HW have returned to University, and UW and UP are also going this year. QH and QG have joined the Signal Corps and moved to Camp Borden. GE and QK keep very regular schedules and handle lots of traffic. The ham din-

ners are being held again in Calgary at the York Hotel, first Friday of each month, at 6:30 p.m. JP, BA and WG are now on 'phone. GM has procured a '52 for 14 mc. CY, NC, GM, JJ, HM, BW and GD bought breakfast club spot frequency crystals. AX is still YLing. AW is coming out of the north while DA is going in. EO, a Calgary visitor, was taken the rounds. JW and KO have Jones exciters and like them fine. The S.C.M. would appreciate more reports now that the holidays are over. News is scarce. What say, gang??

Traffic: VE4LX 237 GE 186 QK 75 SD 31 EO 6.

BRITISH COLUMBIA—SCM, R. K. Town, VE5AC—With the advent of fall, activities are on the increase. Already we have more stations on than we have had for several months past. We only hope that you fellows will report your activities. This is the last report of yours truly as S.C.M. Don Vaughn-Smith, VE5EP, will be Acting S.C.M., so send your reports to him. JL sent us the Victoria report. V.S.W.C. had a station at the exhibition. EC is having receiver trouble. IM is planning to get going again soon. HP is QRL commercial operating. OO is heard from. Newcomers: OE, OK, OT, YL, B.C.A.R.A. plans big hamfest for November. GF is planning a new heap for the coming season. The emergency committee is discussed at the B.C.A.R.A. What is your opinion, gang? AV is head traffic man and will soon be heard on Trunk Line "I"; he is new O.R.S. DB had a successful time at Y Camp. EZ was V.S.W. club station at the exhibition. CC is becoming active in traffic and applies for O.R.S. JL is building a new t.r.f. receiver. JA managed to spear one message. NG is all settled in her new QRA. OK is newcomer with traffic tendencies. HR handled most of the exhibition traffic. KB comes back after holiday. NI's 3.9-mc. 'phone is very FB. IN's regular reports are appreciated. AC is leaving the Section for parts unknown. Now I must leave you as S.C.M. Thanks for your cooperation during the past two years. Here's hoping to be with you again some time.

Traffic: VE5AV 163 DB 132 MK 26 EZ 316 CC 14 JL 72 JA 1 EP 62 NG 4 EU 30 OK 10 HR 150 KB 4 NI 10 IN 20 AC 31.

PRAIRIE DIVISION

MANITOBA—SCM, A. J. Simpson, VE4BG—Traffic is beginning to pick up after the usual summer layoff. Trunk Line Station AG has a fair total for this period. Most of the gang are still sticking down on 14 mc. and working DX. GC has been busy playing around with 56 mc. AG reports real DX for these parts on 56 mc. when he hooked up with Transcona. RO has been burning up the air with a pair of t250's in the final, but had the bad luck to lose one of his tubes. MY has been changing his power supply around and has been running into tough luck with leakages. Mr. & Mrs. NI visited the Montreal gang and were also down in the U. S. seeing a few of the W's. VE3ADP was a visitor to Winnipeg. MV is QRL with new business. KX is moving to new QRA. DU has a superhet now and the only complaint is that he can't work all the DX he hears. HI. VF is installed in new QRA. KU is heard occasionally. Everything will be in full swing for another winter season, and your S.C.M. wants the gang to get into the habit of reporting the dope.

Traffic: VE4AG 97.

SASKATCHEWAN—SCM, Wilfred Skaife, VE4EL—The summer (dead radio period) is now past, so let's hope that when the flies go in, the (radio) bugs come out for another busy season. RB is getting out nicely on 3.9-mc. 'phone. PE has swell trip visiting hams down East. TN got new superhet. QZ averaged 130 QSO's each month during the summer. UD and UH are joining the "more sock" class. RJ visited hams when at Vancouver. PQ hooks a K6 with 16 watts input. PW is adding his bit to 7-mc. QRM. PG keeps schedule with LU. ES has trouble on his 1.75-mc. 'phone. EL makes nice QSO's on 3.5-mc. 'phone with Brandon, Winnipegosis, Leask etc., and reminds 'phone hams that we have exclusive 50 kcs. at 3.5 end of band. There are experimenters on 23 mc. at Saskatoon, Moose Jaw and Regina. Let's get together; send in your schedules. Manly Haines, Ex-4EU, now 5MQ, is doing well at Kimberley and would like to meet the gang on 3.9-mc. 'phone or c.w.

Traffic: VE4CM 93 QZ 74 EL 13 PG 6.

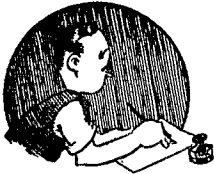

CORRESPONDENCE

The Publishers of *QST* assume no responsibility for statements made herein by correspondents

From Dr. Taylor

Naval Research Laboratory
Anacostia Station
Washington, D. C.

Editor, *QST*:

I was very much interested in the report given in *QST* concerning work in the bands above 20 megacycles, particularly in your [Ross A. Hull's] important work dealing with the effects of the lower atmosphere. Perhaps you will not take it amiss if I venture one or two suggestions concerning reports of work in the high bands.

In the first place, I confess to a certain irritation over the repeated reiteration in *QST* of statements to the effect that those who have been interested in the theoretical side of this work have definitely stated that it was impossible to have sky waves on the upper frequencies. Certainly there is nothing, at least in the early theoretical work of 1925 and 1926, published from this Laboratory which indicated any such thing. The work did indicate that as the frequency becomes higher and higher the chances of getting a lasting contact diminishes steadily. So far, this has been borne out by your own facts. The early work also indicated that with a given physical condition of the upper atmosphere, there would be some limiting frequency above which we might not expect the sky wave to come down again. There is nothing, however, in the earlier publications to exclude the idea that small patches of unusually high ion concentration could not exist so as to temporarily bring back to earth sky waves on relatively very high frequencies.

We have indeed communicated from this Laboratory to one of our battleships off the California Coast on 45 megacycles with moderate power and without the use of directivity at sender or receiver. However, we were only able to do this during two 15-minute intervals in one year, which happened to be about the peak of the sun-spot cycle. At the same time, very large numbers of contacts were made during that year over much longer periods of time and over similar distances on 37 megacycles. It became very evident at that time that the sun-spot cycle and magnetic storms had a lot to do with these interesting but occasional contacts. We have had some evidence, too, which makes it appear clear that the period of best communication on very high frequencies may slightly precede, even by a day or two, a magnetic storm. It may hang over a little after the storm.

My suggestion concerning the *QST* reports is therefore this: Since you undoubtedly receive the daily Ursigrams or can receive them if you wish to, it might be well to publish for the benefit of your people who are working in the 5- and 10-meter fields a summary each month of magnetic conditions day by day of the preceding month. This would permit some attempts to establish the correlation or lack of correlation with magnetic conditions. Also in making reports, it is highly desirable to know the exact day and hour of the contact, particularly the day.

Of the many contacts listed on 5- and 10-meter bands in the August number for instance, there are only a few exact dates given so that we have been unable to show a definite correlation or lack of correlation. We do know, however, that the month of June was, for a considerable period at least, pretty well magnetically disturbed.

I am glad that you are going after more reports and assure you that we shall follow future reports with much interest. . . .

—A. Hoyt Taylor,
Superintendent, Radio Division

Potato-Bug C.W. and the Code Exam.

425 Norton Pky., New Haven, Conn.

Editor, *QST*:

Last night W1HCU, my associate, was literally blasted out of his seat by a CQ emanating from the screen of Poli's Palace Theatre. A potato-bug featured in a cartoon put his antennae into a position resembling a spark gap. R.f. began to flash and there sounded three distinct, well-keyed CQ's. The following c.w. was QRM'd by the laughter of the audience. Evidently he was the only c.w. man in the house as his gentle bellow signified that he was the only patron who recognized the call. The picture was Disney's "Mickey's Garden."

Re the c.w. exam: Having twice journeyed to New York to fail on the code I feel in a position to speak on the subject. My answer to the question is proper instruction. After dropping the code for several months I was induced to go to a few code sessions at the local radio club. In four lessons I could receive the required speed in difficult groups. If I and the other anti-code bellyachers had spent some of the time devoted to said belly-aching in learning the code in the right way we would all be on the air now.

To those who claim to have no source of instruction: Every other issue of *QST* seems to have a list of stations offering code practice in all regions.

—Herbert Gurian

CQ T.O.M.

405 S. 4th St., Yakima, Wash.

Editor, *QST*:

We talk about Cairo, about allocations of new frequencies, bootleg calls, 'phone vs. c.w., and everything else under the sun from technical dope to chain letters and chattering commercial magazines; but we are leaving out of A.R.R.L. and *QST* one of the finest essentials, so carefully handed down through our earlier years, so thoroughly enjoyed, and well thought of—namely, *dope from the old man!*

Around here the gang miss T.O.M. and everyone I've talked to about him has said the same. In the old days when we were blue he pepped us up, and when we were feelin' fine he booted our gluteus maximus and minimus muscles—all the time telling us how rotten we were. Well, maybe we are rotten, but after all he rubbed it in so nicely that I know we hams would like to hear him say it again and in the same old way he used to tell us.

Seriously, though—if there is any way of tipping The Old Man off that a word from him might strengthen our backbones enough to settle down to the problems confronting us at present (we hams as a whole), for goodness sake do so.

If he has really "kicked the bucket," then send me his address, and I'll mail him a lily. If not, then I'll express (post office regulations forbid) him one of our local skunk cabbages to prove to him just how rotten a ham can be at times. Maybe that would pull him out of his lethargy.

Let's have a little cooperation, fellows, and bring out a little of the spirit that is the background of Amateur Radio. Let's demand a little Of-, By-, For-, and From THE OLD MAN. Wat sa? GAI

—Wm. J. (Doc) Dingle, W7DWC

WA(8)C

Wayne, N. J.

Editor, *QST*:

I not only have QSL's confirming "WAC," but have QSL's confirming W8C, viz.: North America, South America, Europe, Asia, Africa, Australia, Arctica (W10XDA, Ellesmere Land) and Antarctica (KFZ at Little America). Maybe I am wrong, but this seems to be some sort of a record, and maybe W2GOQ is the only amateur station in the world that has really worked all (eight) continents. And if no one else has done it, they have a fat chance of doing it for some time to come (.)!

Probably it isn't worth mentioning, but I raised and QSO'd six of the eight on 14-mc. 'phone, and four of the eight on both 14-mc. and 4-mc. 'phone.

—Raymond W. Newby, W2GOQ

More Hams?

Box 872, Artesia, N. M.

Editor, *QST*:

Recently I read of a radio club making very active efforts to interest non-hams in amateur radio, the object being to acquire more disciples to our cause. Without giving the matter a great deal of thought, this would seem to be a gesture very worthy of the ham. He has in amateur radio what is known as a good thing. He appreciates the enjoyment of his fascinating pursuit and he is willing and anxious to share his pleasures with someone else. This is a commendable spirit and well in keeping with the traditions of amateur radio.

Now, to digress a moment, let me mention a man with whom I am acquainted. A number of years ago this man had a small family, made a modest salary, and got along quite well. He paid his debts and managed to live in a small degree of comfort. Let us take this same man a number of years

later—to-day—and see how he has fared. We find that he has been blessed with a very large family. He is deeply in debt and is living in anything but comfort. On investigating the reason for this change of conditions we find that his salary has not increased with his family. He is now trying to take care of an over-large family with the same modest salary. If he continues to be blessed with more children there can be no speculation as to the outcome. He will not be able to take care of them and his family will be disrupted.

With this in mind let us look at the amateur radio situation. Without an additional allotment of frequencies we cannot expect to take care of a larger family. For this reason I maintain that any campaign for additional members to overcrowded ranks shows a lack of common sense. Some may call this a selfish attitude, but I say hams must stick together if they survive. When a ham feels that he is more obligated to a non-ham than he is to a brother amateur, then he has a wrong slant on the situation.

—Haywood Hughes, W5AFQ

DX Test Rules

Neches, Texas

Editor, *QST*:

I believe the DX contests would be more interesting if scoring was accredited only for the number of countries (prefixes) that were worked. To encourage the use of various bands during the contest credit should count double when a country is worked on two bands or three times when that same country is worked on three bands, etc. When there are different districts in a foreign country they could be counted as separate prefixes if desired. For instance, the various districts in Australia would count as separate countries. I doubt if many of the DX contestants are interested in working 25 VK2's just to run up their score when they could be looking for new countries or trying for them on another band. . . . There would not be nearly so much calling were this plan put into practice, therefore the QRM would not be so bad and a fellow would have a much better chance for new DX. I believe this plan would work equally well with the foreign hams as they would have a better chance to work the W-VE districts that are hard for them. When they have succeeded in working all W & VE districts on one band they can turn to another. In noting the results of the last contest in nearly all cases the fellow who had the most countries won the contest in that section, so it is my belief that the above procedure would make a more interesting DX contest. How about it, fellows?

—Wayland M. Groves, W5NW

For Philatelic Hams

92 East Ave., N., Hamilton, Ont., Canada

Editor, *QST*:

It's a flock o' years since I first sent my subscription to *QST* and during the fifteen years (more or less, but not much less) I have never asked a favor. I have just renewed my sub. for the steenth time so I am taking advantage of the opportunity to ask if you would put a small stray in *QST* to the effect that VE3HT is a stamp collector in addition to being a ham and would like to trade Canada Jubilee and pictorials for U. S. or British Colonies with other hams in the world.

This may establish a precedent but I can't see where it will do any harm, as my idea is to build up my collection by mutual exchange with other hams. It is too long a process to get in touch with them over the air, as the average seems to be about one in every hundred. That is, fellows who collect.

I understand K.B.W. is a collector and if this letter reaches him maybe I'll get a break. Hi!

While writing to *QST* may I add that I enjoy my A.R.R.L. membership and *QST* just as much as when I first joined and I find the League bigger and better than ever. Also the QRM. Hi! As for K.B.W., every knock is a boost and I sure would like to see some of the squawkers try and do the job half as well.

Continued success to the A.R.R.L.

—H. Richardson, VE3HT

(Continued on page 70)

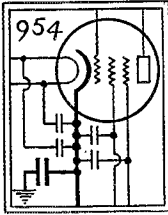

AT WAVELENGTHS of the order of one meter, a socket is not just a place to plug an acorn tube, it is a very important part of the circuit. Consequently, a socket must not only be designed with this in mind, but mounted with equal science. We did not completely realize this ourselves until we started to design our one meter receiver. Before we finished we had developed a new acorn socket, and the reasons for its odd design are worth explaining.

You may have seen the acorn pentode socket. It is built on a flat aluminum plate about 2 inches square, and with each socket you will find a mica sheet of the same size. In most circuits, the cathode should be tied directly to this aluminum plate, which is then insulated from the chassis with the mica sheet. If the socket is flat against the mica and chassis as it should be, it forms a mica by-pass condenser of about 500 mmf. between cathode and ground. Furthermore, since each clip is designed to have a capacity of about 40 mmf. to the aluminum plate, screen grid, suppressor and filament terminals are therefore by-passed to the cathode. The capacities given are just about right to give stable operation in high-gain circuits, provided that the by-passing is done at the tube terminals. At lower frequencies, larger capacities are needed, but at these lower frequencies conventional by-pass condensers can be used.

The socket for acorn triodes uses the same clips, but is built on an Isolantite ring. The solder lugs on these clips are close to the tube terminal, shortening leads by as much as $\frac{1}{4}$ " if other parts are carefully laid out. These clips also provide a straight current path from the solder lug to the tube terminal, and a slight movement of the tube has negligible effect on the length of the path. This is not true of the free clips supplied with the acorn tubes, as these have a reverse curve in the contact which makes the path with the tube all the way in about $\frac{1}{4}$ " less than with the tube *almost* all the way in. Which is not so good for obvious reasons.

As a matter of fact, most of our products are designed to solve some particular problem and like the acorn socket our purpose is sometimes not obvious. The XR-12A transmitting coil form is a case in point. This is designed for high plate voltages and low C. Under these circumstances the No. 10 wire is amply large, because the circulating current is small. The use of a larger conductor would result in losses due to higher distributed capacity. For higher C circuits, copper tubing should be used. However, copper tubing requires no form as it is self-supporting.

JAMES MILLEN





Centralab SAVES THE DAY

Not a rough and tumble player, either . . . but a smooth article, this hero of a million touchdowns.

If it's tough going in the "service game" change to CENTRALAB and watch your score go up.

For CENTRALAB Controls (a mere handful) do the trick with practically every set ever built.

Centralab smoothness results from the patented Centralab non-rubbing contact whereby a strip of polished metal rocks on the resistor so that the only rubbing action is between an oilless wood bearing and the polished metal.

Every Radio Service Man should be a member of the Institute of Radio Service Men

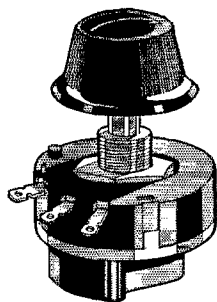

Centralab

MILWAUKEE, WISC.

RADIOHMS FIXED RESISTORS

Correspondence Department

(Continued from page 68)

Hi!

869 Broadway, Paterson, N. J.

Editor, *QST*:

Ever since I became an amateur in 1920, I have been periodically beset by the annoyance of having my subscription to *QST* expire, with the result that I sometimes lose touch with amateur radio for a year or more before I get around to renewing it. To eliminate the difficulty involved in catching up with amateur activities and developments from where I leave them off at these times, I am enclosing a check for fifty dollars (\$50.00) for twenty years' subscription.

This should solve my problem for the time being, at least.

—Gordon Barbour

Sharpshooters' Contest

6077 Allman St., Philadelphia, Pa.

Editor, *QST*:

It has long been debated that the low-power DX man develops a technique that is superior to that of the fortunate fellow who has high power. The contest the writer has in mind should prove whether this opinion is in error.

To be eligible the candidates must have worked over forty countries with an input not exceeding one hundred watts or, having used an input to the final stage exceeding that figure, a total of fifty countries would be necessary. In the contest all final stage inputs must be below one hundred watts at all times. The affair could be held on four week-ends (in the manner of the B.E.R.U. contests and with the same scoring rules applying). Since only a limited number of the gang could qualify for this "sharpshooters' contest," I would suggest that a comic certificate of merit be given to the winner with the names of all competitors on it, attesting to the vast superiority of the winner. Such a certificate would be no small trophy, even in view of its humorous side alone. . . .

—R. E. Hatfield, W3CER/3

EDITOR'S NOTE.—A card from stations that could qualify for such a contest *who would desire to enter* is solicited. If as many as 100 entries could be obtained we would gladly announce such a contest.

Robot QSO's

Le Mars, Iowa

Editor, *QST*:

Recently when I told a non-amateur friend that I had talked to such-a-city the night before, he replied, "Is that so? How interesting. What did he have to say?" Well, there wasn't much I could tell him about the QSO. Of course, he had said the weather was hot, he had certain tubes in his rig, and he sent his best regards. How interesting! Twenty minutes spent talking to someone and I couldn't give an account of it. Nothing about Mussolini, about the hurricane, no jokes, riddles, games. Only a rubber stamp, a robot QSO.

Looking over the last couple dozen QSO's, only two stand out in my memory because of their personality and interest. That's a poor percentage. I'll have to admit I'm not a very active ham, being inclined to tear down my set between each QSO. Although my license is only three years old, I've been a ham at heart since the spark-coil days. But a QSO represents wasted time and I think I'll quit ham radio.

—Theodore Lucke, W9JZN

Add Power Report

413 Monroe St., Passaic, N. J.

Editor, *QST*:

After a year's use of the R-S-T system of reporting signals, it definitely takes care of an outmoded condition that existed from the early days of heyday radio. As an aid to the better understanding of the exchange of reports, I have often wondered if the power input of stations couldn't be used to advantage. Coupled with the R-S-T report, it would give operators an immediate knowledge of the efficiency of each other's station and also indicate general transmitting and receiving conditions using the miles per watt basis.

INSTRUMENTS Modern Style

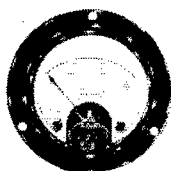

TRIPLETT
A.C. Volt Meter
Model No. 233

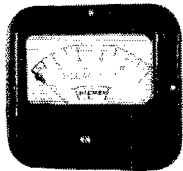

TRIPLETT
D.C. Milliampere Meter
Model No. 1421

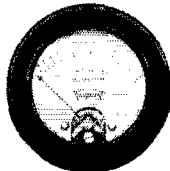

TRIPLETT
Decibel Meter
(Rectifier Type)
Model No. 321

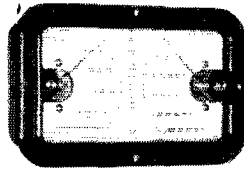

TRIPLETT Twin
(In any combination
of A.C. or D.C.)

PRECISION WITHOUT EXTRAVAGANCE

Gone are the space consuming, difficult to read, cumbersome to handle Electrical Instruments of the past.

Today's choice is TRIPLETT — ELECTRICAL INSTRUMENTS of modern designs that ideally fit present needs.

PRECISION FIRST, but also compactness, lightness, portability, modern attractive cases, more readable scales on metal dials and many other refinements.

OTHER TRIPLETT PRODUCTS

TRIPLETT manufacture a complete line of Electrical Instruments for Radio, Electrical and General Industrial purposes both standard and custom built. If you have an Electrical Instrument problem write to TRIPLETT. See them at your jobbers.

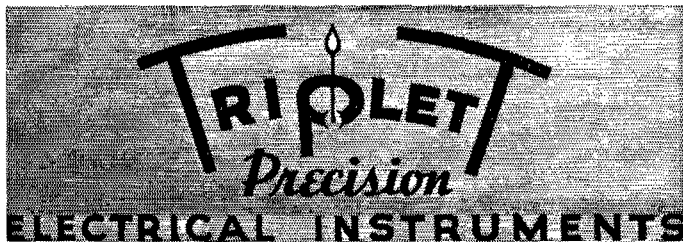

MAIL THIS COUPON TODAY

THE TRIPLETT ELECTRICAL INSTRUMENT CO.,
Bluffton, Ohio, U. S. A.

Please send me 1936 catalog

Name.....

Address.....

City.....State

Lightning Calculators



by
A.R.R.L.

THE various LIGHTNING CALCULATORS are ingenious devices for rapid, certain and simple solution of the various mathematical problems which arise in all kinds of radio and allied work. They make it possible to read direct answers without struggling with formulas and computations. They are tremendous time-savers for engineers, servicemen, amateurs and experimenters. They are highly accurate and computations made by them have greater mathematical accuracy than can be measured by ordinary means. Each CALCULATOR has on its reverse side detailed instructions for its use; the greatest mathematical ability required is that of dividing or multiplying simple numbers. You will find LIGHTNING CALCULATORS the most useful gadgets you ever owned.

LIGHTNING RADIO CALCULATOR—Type A (\$1.00) is for solution of problems involving frequency, inductance and capacity, in design of radio frequency circuits from high-powered transmitters to simple receivers. Gives direct reading answers for size of coils and condensers for any frequency or range between 400 kc. and 150 mc.

LIGHTNING OHMS LAW CALCULATOR—Type B (\$1.00). Gives direct reading answers to calculations involving current, resistance, voltage and power with scale for resistance of copper wire and additional supplemental scale for calculating decibel gain or loss. Answers three separate kinds of problems: Finding value of current, voltage, power or resistance, when any two are known; finding resistance or voltage drop in any wire or circuit or resistor; finding decibel gain or loss in amplifiers or circuits. Answers accurate within commercial tolerances.

LIGHTNING WIRE DATA CALCULATOR—Type C (50c). Puts at your fingertips more information on electrical conductors than you could find in a book full of tables: Such as resistance per foot, per mile, per meter, pounds per foot, per ohm, miles per thousand ohms, current carrying capacity, turns per inch, turns per square inch, diameter in mills for all B. & S. and Stubbs gauges, for all kinds of wire such as copper, aluminum, nichrome, manganin, etc.

LIGHTNING DECIBEL CALCULATOR—Type D (50c). Gives direct reading answers in decibel gain or loss in four kinds of problems: When input and output voltages are known; when input and output currents are known; when input and output power are known; when input voltage to the receiver and assumed output level are known.

LIGHTNING PARALLEL RESISTANCE—SERIES CAPACITY CALCULATOR—Type E (50c). Gives direct reading answers for total resistance of two or more resistors connected in parallel; and gives direct reading answers for total capacity of two or more condensers connected in series.

LIGHTNING RESISTANCE CALCULATOR—Type F (50c). Permits measurement of any resistor, from 1 ohm to 1 megohm by use of any voltmeter and any voltage source. Makes an ohm-meter of your voltmeter.

Postpaid from

**AMERICAN RADIO RELAY LEAGUE
WEST HARTFORD, CONNECTICUT**

This may even lead to a trend of reducing power input rather than one of increasing power. This is a speculation and introduces psychology in that a great number of amateurs like to boast of pushing a signal as far as possible with as little power as possible. Considering the splendid work done by the foreign amateurs with small power, the high power boys might be shaken into realizing that high input and low efficiency isn't anything to brag about. Thus, with the stating of each other's power input in the exchange of reports, the high-power users might be ashamed to state that they are using 400 or 500 watts when the ham at the other end is using only 30 or 40 watts.

I suggest that the report of the station you are working be followed by stating *your* power input to the final stage. A report would read thus: "Ur RST 469X P32," P denoting power, followed by *your* wattage input. The station you are working would in turn state your report, following it with *his* power input. . . .

Let's hear what some of you boys have to say about this idea.

—Saul Kron.

Motivation

Lucerne, Maine

Editor, *QST*:

Maybe someone wiser than I in the ways of the genus "ham" can tell me what purpose motivates the average QSO on any of the bands, 'phone or c.w. I am sure I cannot figure it out.

As far as I can see, one of the following would serve as a legitimate reason for one ham to QSO another.

1. (a) A change has been made in the transmitting equipment and its effects are to be determined.
(b) Ditto for the antenna system.
2. Traffic to be relayed.
3. DX to be worked.
4. A genuine desire to chew the rag with a fellow ham.

As near as I can tell, one or more of the above motivates only about 25% of the QSO's to be heard on any band. The only reason for the other 75% seems to be a desire to fill a log book with as many brief QSO's as possible. This is, in my humble opinion, the reason for the terrific QRM on all our bands. Think it over, fellows.

—Ed Caldicott, W1ICB-W2GV

"Let George Do It"

* 2608 California St., Huntington Park, Calif.

Editor, *QST*:

I have noticed in several issues of *QST*, various suggestions as to ways and means to overcome the crowded conditions of the amateur bands. Some suggest that all don't crowd in one end and others that no additional bands were needed as they had found them to be full of holes.

My understanding as to the load on any band or other article or service, is that the maximum demand or peak load is the one that determines whether or not the service or band is overloaded.

Now if any operator will sit down with any Single-Signal receiver that is working fairly good, he will find out that the 40-meter band is badly crowded and that it is not a case of all hams being bunched up but just the lack of sufficient room to carry the peak load.

So in summing up the above conditions, it is plain to see that we are in need of more space.

In going after more band space or frequencies don't expect them to be handed to you on a silver platter. First, you will have to sell yourself that they can be had. Next, you will have to lay out an intelligent campaign. Then, you will have to work hard to successfully execute this campaign.

I have observed that a large percentage of the hams have the "let George do it" attitude. This attitude, as well as the soap box screaming, is just about as meaningless as anything: I have been able to observe. . . .

—Walter E. Preston, W6IAR:

Bootleg

Hdqtrs. Company 22nd Inf., Fort McClellan, Ala.

Editor, *QST*:

One night as I returned to the key after being away for a



The facts
about the
"MAGIC
EYE"

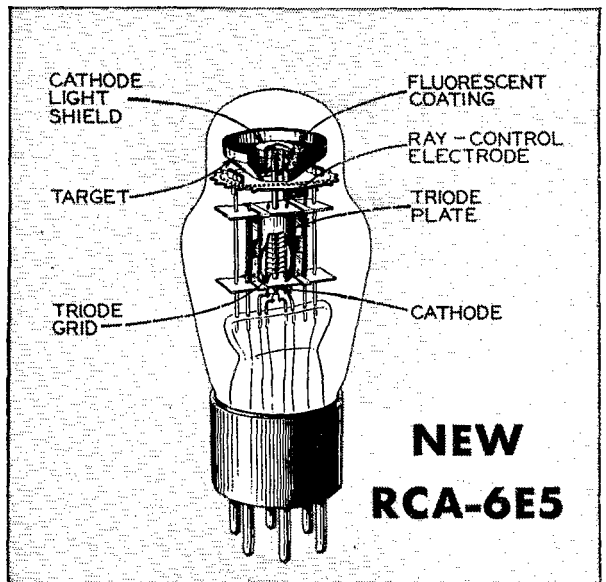

As an amateur, you are sure to be asked, sooner or later, what the "Magic Eye" is, just as many amateurs were asked by the general public about the "Magic Brain" — the r-f amplifying and frequency-converting system that improves the signal-to-noise ratio, amplifies the signal, and eliminates image interference.

The "Magic Eye" is the latest, and we think the best, tuning indicator to be developed. By RCA engineers, of course. It operates on the principle of a simplified cathode-ray tube and is designed so that a ray-control electrode casts a wedge-shaped shadow of variable size on the green fluorescent coating of the viewing target. This new visual indicator, technically described as an Electron-Ray Tube, is designated as the RCA-6E5.

When the 6E5 is used as a tuning indicator (it has other possibilities for amateur use), the grid of its amplifying

triode unit is supplied with controlling voltage from the a.v.c. circuit of the receiver. With no a.v.c. voltage present (condition for no incoming signal), the wedge-shaped shadow on the target is wider; with a.v.c. present (condition encountered with an incoming signal), the shadow narrows. When it is narrowest, the signal is perfectly tuned.

An outstanding feature of the 6E5 is its dead-beat and instantaneous action. Electrons, traveling at speeds of several thousand miles per second, do the trick. With this sensitive visual device, the bcl can tune by eye quickly and accurately. Tuning by eye is far more accurate than tuning by ear, and avoids the probability of shaving the side bands so essential for full, rich, natural reproduction. It's really fb. Drop in at any RCA Victor dealer and try it yourself. Technical data on the RCA-6E5 sent on request.



AMATEUR RADIO SECTION

RCA RADIOTRON DIVISION

RCA MANUFACTURING CO., INC., CAMDEN, N. J.

To OUR READERS who are not A.R.R.L. Members

YOU should become a member of the League! That you are interested in amateur radio is shown by your reading of *QST*. From it you have gained a knowledge of the nature of the League and what it does, and you have read its purposes as set forth on the page opposite the editorial page of this issue. We should like to have you become a full-fledged member and add your strength to ours in the things we are undertaking for Amateur Radio. You will have *QST* delivered at your door each month. A convenient application form is printed below — clip it out and mail it today.

A bona fide interest in amateur radio is the only essential qualification for membership

AMERICAN RADIO RELAY LEAGUE
West Hartford, Conn., U. S. A.

I hereby apply for membership in the American Radio Relay League, and enclose \$2.50 (\$3.00 outside of the United States and its Possessions, and Canada) in payment of one year's dues, \$1.25 of which is for a subscription to *QST* for the same period. Please begin my subscription with the issue. Mail my Certificate of Membership and send *QST* to the following name and address.

.....
.....
.....

Do you know a friend who is also interested in Amateur Radio, whose name you might give us so we may send him a sample copy of *QST*?

.....
Thanks

few minutes I turned on the rig and receiver, hoping to get a nice QSO with someone. As is the custom I listened in first. Ah! Here is a nice CQ and my old friend W4—, I'll bet. Wait a minute. What did he sign? Well, I'll get it next time. Say, can that be? He signed CX8N and on 80 meters! Where can that be? Boy, that must be some DX—I'll give him a nice buzz. Gosh, but it sounded like W4—'s signal, and just like his fist, too. Well, wonder if he can wrk bk in? I'll see. . . . CX8N CX8N CX8N de W4BAQ BK BK. . . . Yep, he sure did sound like W4—. This thing sounds fishy. . . .

I gave him a report and my QRA, etc., and *casually* requested his QRA. Well, he came right back and gave an FB report. But did you ever hear a ham stutter on the air? Say, fellows, he had a heck of a time saying anything, but he started like this: "QRA hr Rio de J dit dah dahhh," then for no reason, apparently, he suddenly changed the subject and asked me about the wx hr. Boy, it must have been a little too hot for him there and the wx was on his mind. Well, the QSO lasted for about an hour, me asking and telling a few little things. He claimed to be a naval reservist and was using a secret call for the purpose of gaining new members. He later said his QRA was in Greenville, Ala. Well, of course, by this time I could not tell what to believe from him.

Near the last he learned that I cared little for working with fellows who used calls which are not assigned to them. And I told him that he was violating a few of the F.C.C. regulations. The QSO terminated rather suddenly. Then I told him that I knew who he was and wanted him to send me some of the information about that call, and I wanted to know more about ——— (the name of the town he was in). Well, do you believe it? He never sent another dot after that.

Fellows, that is not the way to play the amateur game, at least as far as I can see. I don't think that many other fellows will disagree with me. I always enjoy nice QSO's with the friends I have on the air, but what can possibly be gained by such dirty playing around?

—W. E. Meuborn, W4BAQ

A Consistent Antipodal Experimental Circuit (Continued from page 15)

ton is an FB-7 with three stages of preselection, one of which is regenerative, while at Watheroo an FBXA is used. An ACR 136 is also used at W3AMS occasionally. W3AMS uses a three-stage crystal-controlled transmitter working into full-wave horizontal voltage-fed antenna. At VK6MO a half-wave vertical voltage-fed antenna consisting of four-inch tubing is used. It is driven by a four-stage crystal-controlled transmitter. The receiving antenna at Washington is a single wire Hertz while at Watheroo a horizontal rhombic beam is in use. Break-in operation has been found quite satisfactory at both stations and is used continually. It makes for greater accuracy and effectively doubles the maximum circuit capacity. Generally copying is done on loudspeakers. W3AMS is privately owned and operated, and VK6MO is owned and operated by the Department of Terrestrial Magnetism, Carnegie Institution of Washington.

Prior to the establishment of direct communication between the observatory and Washington the scientific results were relayed through VK5HG (Glencol, South Australia) to W3QP (Philadelphia, Pa.) and W2CC (Mount Vernon, N. Y.), the messages being then sent by mail to Washington. Following this W9MKN (Denver, Colo.), W6FFP (Fresno, Calif.) and W6GHD (Walnut Creek, Calif.), assisted by handling traffic from VK6MO to the United States. At present W6GHD is the major stand-by station in case of temporary overload or failure of the main circuit.

Grateful acknowledgment is due to the

They Brag About

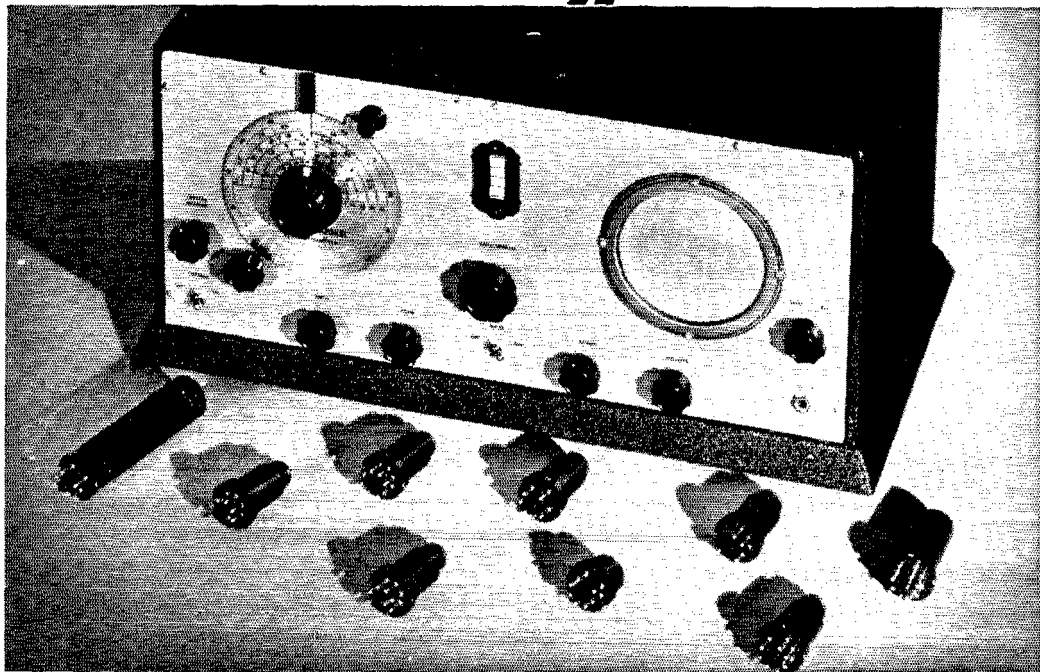

their SUPER SKY RIDERS

NO WONDER. We don't believe you can get a short-wave receiver anywhere that can match the exclusive features and high grade engineering at the low cost of the Hallicrafters' Super Sky Rider. You get complete coverage of the broadcast and short-wave radio spectrum; a flick of the finger and you jump from one band to the next — no plug-in coils or other cumbersome devices; we've eliminated all that. The Sky Rider is compact — speaker, power-pack — everything in one convenient cabinet, no loose units and wiring spread around the table. Look at the list of features you get with the Super Sky Rider — Metal Tubes, Iron Core I. F. Transformers, Electro-Mechanical Band Spread, Beat Oscillators, Controlled Crystal Filter — you can't match these features. Best of all, you don't have to spend a small fortune for this superb receiver. You'll have something left over for the latest development two years from now.

See this Super Sky Rider at your dealer's now. Play with it, examine its exclusive features, its compact precision of operation. You'll understand why men brag about the Super Sky Rider. Write for full information.

- *The signal you want* — clearly and distinctly — that's the Hallicrafters' Super Sky Rider!
- *Compact* — it's all completely enclosed in one convenient and efficient unit, 19¼" x 10" x 10".
- *Complete* — it's all there, speaker, power pack, everything you need in one single cabinet.
- *Convenient* — modern band changing system — any desired bands in the entire spectrum, 7.3 to 560 meters, with the turn of an exact, positive switch — no cumbersome plug-in coils.
- *Controlled Crystal Filter Circuit* gives one signal selectivity.
- *Tone Control* — has many uses from cutting out "hash" to making phone more understandable.
- *9 Metal Tubes* — increase gain and eliminate tube shield noises.
- *No Tuning Charts* — illuminated dial shows you where you are on any band.
- *Beat Oscillator* with continuous range 560 to 7.3.
- *Band Spread* instantly available by turn of switch — no cumbersome adjustment.
- *Assured performance* — each Super Sky Rider logged on at least 3 foreign stations and operated on all bands.

WRITE TODAY FOR DETAILS!

the hallicrafters

3001-Z Southport Avenue, Chicago, Illinois, U.S.A.

Cable Address: "LIKEX NEW YORK"

AMPEREX HF 200

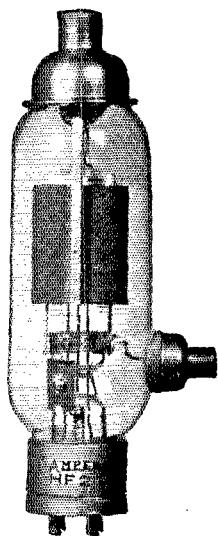

List Price \$24.50

Ultra High
Frequency
Power Tube

RADICAL
in design

STARTLING in
performance

The tube with the highest ratio
of Transconductance to Interelec-
trode Capacitance

A design characteristic which is mainly responsible for the extraordinary performance of these tubes at ultra high frequencies. Plate power outputs as high as 400 watts have been obtained from a single tube at five meters.

There are many other brilliant engineering refinements and radical design developments incorporated in the structure of these tubes as well as the entire line of Amperex Carbon Anode Tubes. They are described in an attractive folder containing tube data and characteristics which will be mailed to you on request.

A partial list of Amperex Tubes suitable for Amateur and Experimental work is listed below:

HF200	400 Watt Plate Power Output..	\$24.50
211-H	175 Watt Plate Power Output..	17.50
203-H	175 Watt Plate Power Output..	17.50
211-C	150 Watt Plate Power Output..	17.50
211-D	150 Watt Plate Power Output..	15.00
830-B	50 Watt Plate Power Output..	10.00
801	25 Watt Plate Power Output..	3.25
872-A	Mercury Rectifier	17.50
866	Mercury Rectifier	4.00

AMPEREX

Electronic Products Inc.

77 Washington St. Brooklyn, N. Y.

Australian Government for permission to use this channel and for their helpful interest in the communication of the scientific data; to Dr. J. A. Fleming, director of the Department of Terrestrial Magnetism, and to Mr. W. C. Parkinson, observer-in-charge of the Watheroo Observatory, for help and encouragement. The authors also wish to acknowledge the many suggestions and helpful contacts had from time to time with other experimenters.

NOTE.—Since the above was written communication has been established over the long route—about 13,390 statute miles—between VK6MO and W3AMS. The first interchange of communication along this route was between 18:30 and 19:00, 75° west meridian time, August 21, 1935.

What the League Is Doing

(Continued from page 25)

on June 5th, served notice that it does not recognize the right of any foreign country or its citizens to operate radio stations in the concessions, establishments, leased territories, or other similar districts. China, in fact, is on the warpath and is attempting to exterminate all amateur radio in that country.

QST Members of the League will be interested to know that the circulation of our magazine continues to increase and is now at the highest figure in its history. The average net paid circulation of *QST* for the six issues dated from January to June, inclusive, of this year was 42,155.

Affiliations The clubs that have been accepted into affiliation with the League by action of the Executive Committee since the last meeting of the Board of Directors are listed below:

Binghamton Amateur Radio Assn., Binghamton, N. Y.; Bridgeport Amateur Radio Assn., Bridgeport, Conn.; The Tri-County Radio Assn., Inc., Rahway, N. J.; The Canadian Radiophone Assn., Toronto, Ontario; Imperial Valley Amateur Radio Club, El Centro, Calif.; Highland Park Amateur Radio Club, Highland Park, Calif.; Northern Wisconsin Wireless Assn., Superior, Wisc.; The Amateur Radio Society of Northern Ohio, Cleveland, Ohio; Westlake Amateur Radio Assn., Rocky River, Ohio; Pierre Amateur Radio Club, Pierre, So. Dak.; Teleoli Radio Club, Brooklyn, N. Y.; Jax Radio Club, Jacksonville, Fla.; Northeast Nebraska Radio Club, Pender, Neb.

Cairo Committee Notes

Scrutiny of the initial agenda of the Bucharest meeting of the C.C.I.R. discloses that none of the items so far presented is of immediate interest to amateurs. However, it seems wise to watch the U. S. A. preparations for



NEW PRODUCTS ADVANCED DESIGNS LOWER PRICES

HERE'S A BRAND NEW LINE to better fit the engineering requirements and pocketbook of amateur radio. Fresh from the ground up — three new basic insulators, Victron G, Vitrolex and Micoroid — vastly better and lower in price. A complete commercial type transmitter frame, you'll accept on sight. Simply turn the bars on the Universal Coil Form and you have a support for 10 to 160 meter coils in a single article. It takes 5800 volts to flash — over "Butt-Ins," a tiny lead-in so inexpensive you can use them everywhere. There's a real band change switch. Ultra-Steatite coaxial transmission line spacers, Q-Max lacquer in small containers and many more items included in this advanced line of equipment described in part below.

SPECIFICATIONS

Universal Coil Form: Diameter 4", length 6 1/4". Grooved for 10, 20 and 33 turns. One bar face for any turn spacing you wish. Price \$1.50 Net. Bars separately — 25c each net.

Transmitter Frame and Panel: Dimensions 36" x 19" x 12" deep with four shelves complete with panel, screws, two beehive Steatite lead-in insulators, terminal studs, etc. Q-Max baking finish. Constructed of heavy gauge steel, sturdy and unsurpassed in appearance. Openings easily made with circle cutter. Shipped knocked down in heavy cardboard container. Price \$8.50 net F.O.B. Jersey City, N. J.

"Butt-In's" (Button Lead-In's) Fit 7/16" hole, pass 6-32 screws, 1/4" high. Long creepage path. Flash-over between screw and panel 5800 volts at 60 cycles. Price 25c per dozen net.

Coaxial Transmission Line Spacers: Made in Ultra-Steatite, a remarkable new dielectric of extremely low

dielectric absorption. Are 1/4" thick, fit standard 5/16" copper tubing and No. 14 wire. Price 15c per dozen net.

Victron Supported Coil Forms: Greatly superior to celluloid supported coils but no higher in price. A complete line in various diameters, and wire size. Send for data sheet and prices.

Vitrolex Fluted Coil Forms: Dimensions — 3" diameter, 5" long, threaded for 30 turns. Vitrolex ceramic ware, unlike porcelain, is non-hygroscopic and low in loss. Price 60c net.

Band Change Switch: Double pole, six point, insulated shaft. Positive contact, high voltage spacing throughout, flexible copper leads from blade to terminal. Vitrolex insulation. May be ganged. Supplied with 1/4" shaft. Price \$1.95 net.

Victron G: A greatly improved product, practically loss free, extremely stable in the presence of water-radio's supreme dielectric.

NET PRICES

	6" x 12"	6" x 6"	1" x 12"
3/16"	\$3.60	\$2.00	\$.75
1/8"	2.50	1.35	.45
1/16"	1.40	.75	.25

Micoroid: A new and superior organic insulator available in sheets. As near an approach to the properties of Victron as it is possible to achieve in an organic insulator. Characteristics, sheet sizes and prices appear in data sheets.

Data sheets on above products are ready. Write for them.

Dealers and mail order distributors everywhere have been invited to stock these items for your convenience. If they are not prepared to serve you, order direct. We will ship postpaid anywhere in U. S. A. on orders of \$2.00 or more, when accompanied by check or money order. Shipment same day.



Ordinary lacquers are harmful in R. F. circuits. Buy Q-Max No. 3 from your dealers — 25c.

COMMUNICATION PRODUCTS, INC.

245 CUSTER AVENUE, JERSEY CITY, N. J.

Producers of Victron—Vitrolex—Micoroid and Q-Max Compositions

Say You Saw It in QST — It Identifies You and Helps QST

"CRANKING DOWN THE WATTS"

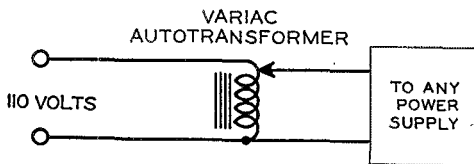

THE CIRCUIT

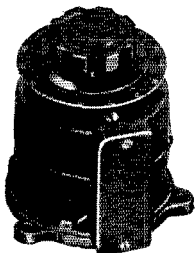

THE CONTROL

The Reason Why

For local communication to avoid interference and to comply with the law. See Warners editorial in September *QST*. And to adjust new set-ups at low voltage to avoid blowing condensers, resistances, meters and tubes.

And How

The General Radio Variac transformer was designed just for this purpose . . . to reduce power. Connected between the line and the input to your rectifier, the Variac supplies output voltages *continuously adjustable* from zero to full line voltage. The Variac is an autotransformer with a sliding contactor. Its output voltage is independent of load.

A number of models are available . . . from 170 to 2,000 watts capacity. The unit illustrated is our Type 200-CU intended for behind the panel mounting. It supplies output voltages from zero to 135 volts from a 115 volt circuit . . . and it's rated at 900 watts. The price? \$14.50 in the U. S. and Canada.

Send your remittance with your order, mention *QST*, and we will ship prepaid anywhere in the U. S. If you have never heard of General Radio (and we did find one ham recently who hadn't) write for further particulars, asking for Bulletin 936.

General Radio Company

30 State Street

Cambridge A, Mass.

the meeting, so that inadvertent embarrassments may not arise. This procedure has been planned chiefly as a matter of routine. Likewise it is necessary for the amateurs to have representation at Bucharest proper, through the I.A.R.U., partly to guard against decisions and wordings that may unintentionally give rise to a multitude of minor annoyances, partly to build up good will, partly to take advantage of everything that may have any bearing whatever on the Cairo situation, but chiefly because amateur radio through the I.A.R.U. has been recognized by the C.C.I.R. with a specific invitation to attend these meetings, and we can't afford to omit anything that may add to our prestige. Hence the activity anent Bucharest and the meetings preparatory thereto. Insofar as these matters fall within the province of the Cairo Committee they are getting their full meed of attention.

Cairo items proper are proceeding normally. The adverse summer conditions no doubt kept many from helping in the occupancy surveys that are under way. Now fall and winter will bring in much better conditions, both for the stations being surveyed and for the listeners. While repeated and prolonged surveys are necessary, yet occasional and limited observations, especially if carried on as part of a group, will also be of great value. The greater the variety in times and places for listening, the better. Please don't let anyone hesitate to join these activities on the plea that their individual service might be especially restricted. We want and need mass action. Tnx vy. 73.

The Cairo Committee

"T.I.S." The A.R.R.L. Technical Information Service is maintained to supply information and guidance to members confronted by technical problems. The rules governing the service are frequently printed in *QST* and are doubtless known to all our members. We are anxious to supply the best possible service. The load is a heavy one because of its terrific volume. One of the things we notice about the letters received is that many of the questions really are "unnecessary," if only the writer would read carefully the *QST* article about which he is inquiring or look up the subject in the Handbook. We willingly spend time, effort and money to answer these questions but our resources are not unlimited and frequently we could answer more important questions in greater detail if the authors of other questions would spend a few minutes in quiet thought or in spotting the answer where it already exists close to hand. Our Technical Information Service answers about 5000 letters, about 20,000 questions, every year. This is at the rate of 70 a day, 400 a week, 1700 or so every month. Of course this represents only a small fraction of the 150,000 or so letters we receive here at the headquarters office annually. But it is probably the hardest lot of all to handle, and it requires much of our time and attention. Your cooperation will enable us to give better service all around.

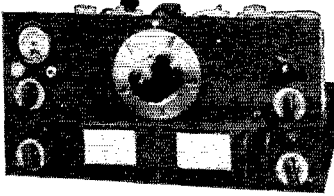

"The Cream of the Crop"

National HRO communication receiver in stock. Table model in cabinet, with tubes and coils covering from 1.7 to 30 mc. **\$167.70**
 HRO Power supply **\$15.90**
 National HRO Speaker in cabinet. . . **\$13.80**
 New JX-100 Steatite 803-RK-23 socket in stock; each **\$1.80**
 We carry a complete stock of all National Products.

RCA receiving tubes in stock. Complete line at 40% and 2% discount from new low list prices.
 Sylvania Metal Tubes in stock, 30% discount.

LEEDS Oil Immersed Filter Condensers. Cased units of unusual quality at prices made possible by quantity buying. 2 mfd. capacity only.
 1000 v. **\$1.45**
 1500 v. **\$2.00**
 2000 v. **\$2.45**

New Brush Crystal Headphones
 In stock — specially priced at. . . **\$5.25**
 Brush Crystal tweeter speaker for hi-fidelity. **\$4.10**

Q-MAX No. 3 coil dope in stock; 2 oz. can. **25c**
 Pint can. **\$1.25**

SPECIAL BARGAINS in used equipment carry **LEEDS** regular guarantee of 100% satisfaction

WESTERN ELECTRIC
 1 mfd 500 v. condensers. **25c**
 2 mfd 500 v. **35c**
 40 Henry 60 ma 850 ohm chokes . . . **49c**
 W. E. Audio Transformers 3:1 ratio. **49c**
 General Radio 310 dials, 2 3/4" **25c**
 General Radio .0005 variable condensers, **75c**

**LEEDS
 50 WATT SOCKET**

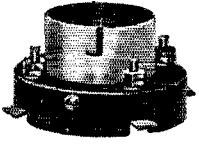

Heavy special porcelain base. Double phosphor bronze springs, high grade construction throughout. Extra special price. **50c**

**OVERSEAS AMATEURS
 ATTENTION**

There is a satisfied LEEDS customer near you, regardless of your GRA. LEEDS export service is being used constantly by amateurs and professionals in 70 countries. One shipment will convince you.

Leeds Type 1-B Freqmonitor

a dual purpose instrument of interest to those desirous monitoring their CW signals and accurately measuring frequency. Fully described in the April 1934 issue of QST. Licensed under Dow patents.

**Price
 complete
 with tubes
 and
 calibration
 \$19.75**

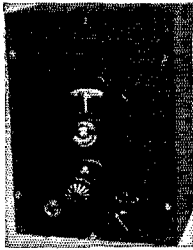

**LEEDS Low Cost
 Power Supply Equipment**

**LEEDS PLATE TRANSFORMERS,
 PRIMARY 115 VOLTS A. C.
 50/60 CYCLES**
 LB-10 900 v. center tapped at 150 MA; 5V-3A; 2 1/2 V-10A; LB mtg. **\$3.25**
 LA-2 1000 v. center tapped at 200 MA; 2 1/2 V.C.T. 14A; 5 V.C.T. 3A, **\$4.00**
 LA-3 1200 v. center tapped at 200 MA; 2 1/2 V-10A; 7 1/2 V-3A; 5V-3A, **\$5.00**
 LA-4 1600 V.C.T. at 150 MA. . . . **\$3.75**
 LA-5 1600 V.C.T. at 250 MA. . . . **\$5.50**

LEEDS SMOOTHING CHOKES
 LB-1 12 H., 200 MA; D.C. res. 140 ohms. LB mtg. **\$2.50**
 LA-30 12 H., 300 MA; D.C. res. 105 ohms. LA mtg. **\$3.75**
 LA-50 12 H., 500 MA; D.C. res. 70 ohms. LA mtg. **\$6.50**

LEEDS INPUT SWINGING CHOKES
 LB-2 5/25 H., 200 MA; D.C. res. 140 ohms, LB mtg. **\$2.50**
 LA-40 5/25 H., 300 MA; D.C. res. 105 ohms, LA mtg. **\$3.75**
 LA-60 5/25 H., 500 MA; D.C. res. 70 ohms, LA mtg. **\$6.50**

**LEEDS FILAMENT TRANSFORMERS,
 PRIMARY 115 VOLTS A. C.
 50/60 CYCLES**
 LA-15 2 1/2 V.C.T. 12A; 5000 V. insulation; 10 V.C.T. 6 1/2 A. LA mtg. **\$4.00**
 LA-16 5 V.C.T. 20A; 7,000 V. insulation; LA mtg. **\$3.75**
 LA-17 5 V.C.T. 20A; 10,000 V. insulation; LA mtg. **\$5.00**
 LB-12 2 1/2 V.C.T. 12A; 7,000 V. insulation; LB mtg. **\$2.25**
 LB 13 7 1/2 V.C.T. 6 1/2 A; 5,000 V. insulation; LB mtg. **\$2.25**
 LB-14 10 V.C.T. 6 1/2 A; 5,000 V. insulation; LB mtg. **\$2.50**
 LB-15 5 V.C.T. 3A; 5 V.C.T. 6A; 5,000 V. insulation LB mtg. **\$2.50**



LEEDS THE FIELD
 World Wide Service to Amateurs
 45 Vesey Street
 New York City
 Cable Address: "RADLEEDS"



LEEDS TYPE 4X EXCITER

247 oscillator 841 buffer doubler. 25 watts output on 1.7; 3.5 and 7.0 mc. 15 watts. 14 mc. coil switching, fixed neutralization, instant QSY, with no back of panel adjustments. An excellent exciter for high power amplifiers and a slick low power transmitter in its own right. Priced at **\$23.50**, less tubes and crystals.

LEEDS Leads as the only distributor in the country, handling **GENERAL RADIO** Amateur accessories and laboratory Apparatus. *Bulletin No. 936 mailed on request.*

GENERAL RADIO coil forms type 677-U price 50c; type 677-Y price 75c. G. R. amateur accessories always in stock. **GENERAL RADIO** dials, with fluted knobs 4" — **\$1.50**; 3 1/2" — **\$1.25**; 2 3/4" — **\$1.00**.

LEEDS type 2 relay; adjusted to operate between 10 and 150 ma. D.C. two contact arms with make or break contacts 350 ohms resistance; price. **\$2.00**

LEEDS Leads the field with transmitting tubes, embodying the latest improvements in design, at lowest prices.

*203-A \$8.45	†#830-B \$7.25
‡10-HF 1.75	*838 11.75
*66 1.50	†#841 2.45
*211 8.45	*845 11.50
†800 7.25	*852 11.50
†*801 2.95	866-A 1.95

*Graphite Anode Tubes
 †Isolatite Base
Tubes Shipped by Express Only

LEEDS Leads with lowest prices on wet processed antenna insulators; glazed porcelain units, one inch diameter:

7" long. **25c**
 12" " **35c**
 20" " **50c**
 Airplane type strain insulators 4c each — 10 for 35c.

Every purchaser of a **LEEDS** Crystal is protected by our guarantee that he must be satisfied with the "plate" in every respect. Our prices speak for themselves. X cut crystals 1.7 mc. **\$2.25**

3.5 mc plus or minus 1 kc. **\$2.25**
 7.0 mc plus or minus 2 kc. **\$3.25**
 Moulded bakelite holder. **\$1.00**
 Hill all brass adjustable holder. . . . **\$1.65**



TOBE KITS IN STOCK

The finest low cost communication receiver on the market. Complete kit. **\$41.40**

Wright DeCoster 8" speaker in metal cabinet. **\$4.90**

Receiver cabinet. **\$4.50**

Complete kit RCA tubes. **\$3.32**

Wiring and testing for lazy hams, including single signal reception with regenerative I.F. **\$6.50**

Announcing the EIMAC

500T

A truly low C High Power Tube

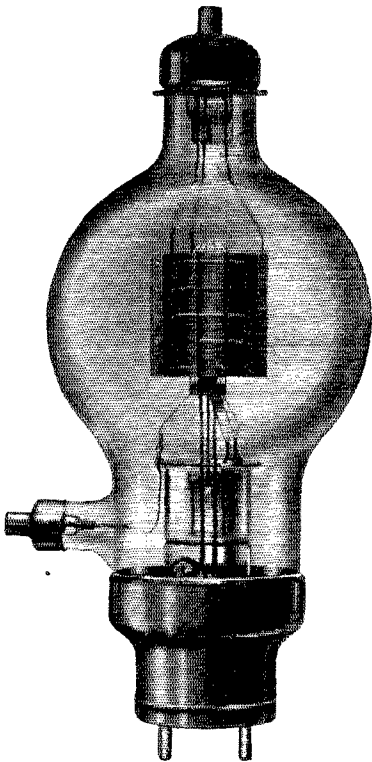

Fil. $7\frac{1}{2}$ V at 20 amps. Plate diss. 500 watts. Max. plate current 450 MA. Max. plate voltage 4000 Volts. Cgp 4.5 μ fds. Cgf 6 μ fds. Cpf .8 μ fds. Overall Height $16\frac{1}{2}$ ". Overall diameter 7".

Nominal class C power output at 72% plate efficiency 1350 watts.

FEATURES

High Transconductance — Low interelectrode capacities — High power gain — Conservative ratings — Longlife — Operates efficiently over a wide range of voltages and frequencies.

Net price—\$175

EITEL-McCULLOUGH, INC.

San Bruno, California

A Novel Dual-Tuner Superhet

(Continued from page 35)

justing screw on the top of T_3 very slowly until the beat note of desired pitch is heard. The beat-frequency-oscillator should then be turned off and another station tuned in. When the beat-frequency-oscillator is again switched on, approximately the same beat-note should be obtained. This adjustment is rechecked because it is possible to adjust the beat-frequency-oscillator so that one of its harmonics beats with the incoming signal in the h.f. circuits. In this case a beat-note will be heard on one particular station and will not be heard on any other.

Amateur Contests at Brockton Fair

(Continued from page 43)

Mark MacAdam, W1ZK, who was in charge of the Fair Radio Show.

An all-around sending contest, open to all, in which material had to be sent in succession with a bug key, cootie key (sideswiper), and straight key, was won by Mark MacAdam, W1ZK, with Allison Macomber, W1DDB, second, and Mort Kahn, W2KR, third. This was an extremely "tricky" contest, it being no cinch to shift quickly from one type key to another. The prize for this event was a deluxe model engraved MacKey, presented by T. R. McElroy.

Among the other amateur events was an interesting two-way plane-to-ground contact via 56 mc. Cliff Ware and Sam Curtis, W1GVF, flew over the fair grounds and talked with the amateur station set up in the hamfest hall. Both sides of the conversation were put on the loud speaker system and were heard distinctly by the many thousand people in the stands and on the grounds. The system used to put this across was as follows: A receiver and mike were installed in front of the grand stand under the control of W1ZK and were wired to the 200-watt P.A. system operated by W1HMM, and from there to the transmitter located in the radio hall operated by W1HUZ and Dinty Moore. W1GVF's agonized groans gave the crowd quite a kick every time the pilot banked the Waco, which was doing about 140 m.p.h.

Ed Myrbeck, W1AKY, and Bud Waite, Byrd Expedition radio operator, ran the contests and events. W1EAU and W1HUZ held down the registration desk. A special contest for 'phone operators was the delight of all who witnessed it—the main requirement being plenty of wind (hot air, W1AKY called it!) to blow up some elephant-sized balloons! A Collins transmitter was won by Wendell Wright of Rockland, Mass., an old-timer from the spark days. All in all, there was always plenty of ham activity at the fair grounds throughout the week, and although we don't know the mystery at this writing, W1ZK says, "If any of the gang want to get a laugh, they should ask George Bailey, W1KH, to describe the sliding contact he saw demonstrated down at the Brockton Fair."



LEFT: Don Wallace W6AM, operating his 5-meter equipment before the Smithsonian Institute Scientific Cabin on top of Mt. Whitney.

RIGHT: W6AM testing his equipment at the Base Camp 8300 feet up the side of the mountain. In both photographs you can see the Ribbon Batteries he is using.



Mt. Whitney Expedition Used **BURGESS RIBBON BATTERIES**

Don C. Wallace, W6AM, Long Beach, California, packed his 5-meter equipment on a mule and climbed 14,502 feet up Mt. Whitney, the highest mountain in the United States. At the summit he set up his aerial, went on the air—and soon hooked up with W6ITH on Mt. Diablo, 214.5 miles away! This distance is a brand new record for 5-meter equipment on the Pacific Coast. And Don Wallace used *Burgess Portable "B's"*, *Burgess Little-Six Batteries* and *Burgess RIBBON BATTERIES* to establish this record way up there on top of Mt. Whitney.

Don Wallace, in a report of the Mt. Whitney expedition, wrote, "Inasmuch as the batteries held up well, W6AM stayed on the top four days and three nights, operating almost all night each night." The batteries "held up well", because they were BURGESS Batteries. It *does* pay to look for the familiar BURGESS *Black and White Stripes* when you buy batteries. BURGESS BATTERY COMPANY, Freeport, Illinois.

BURGESS

Say You Saw It in QST — It Identifies You and Helps QST

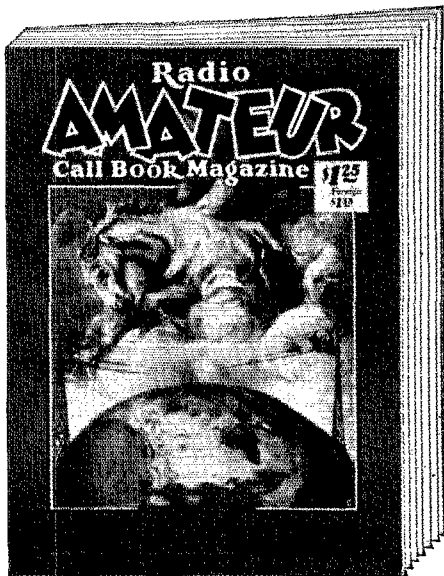

Fall Edition NOW ON SALE

296 pages. Complete. Accurate. Up-to-date. Compiled from official governmental records

On sale at your favorite radio store

The Fall edition of the CALL BOOK contains a list of all U. S. Radio amateurs. Foreign radio amateurs in 124 different countries. High frequency commercial stations. Amateur prefixes. International prefixes. International abbreviations. U. S. radio inspection districts. High frequency press, time and weather schedules. Commercial stations listed by frequencies. U. S. postal rates on cards and letters. "Q, R & T" systems for reporting signals. A map of the U. S. A. showing call and inspection districts.

CHECK YOUR QRA

against a copy of the Fall edition of the CALL BOOK. A double post card is bound into each copy of the CALL BOOK for your convenience in advising us regarding any changes you desire us to make in the listing of your call letters, name or address.

Compiled and Published by Licensed Radio Amateurs for the Benefit of Amateur Radio

Issued Quarterly—March, June, September, December

Annual subscription in U. S. A. and possessions, and countries in the American Postal Union: \$4.00. Single copies \$1.25. Annual subscription in Canada and countries not in the A. P. U.: \$4.35. Single copies \$1.35.

Radio Amateur Call Book

Incorporated

610 So. Dearborn St.

Chicago, Illinois

With the Affiliated Clubs

(Continued from page 46)

obtained from storage batteries and two dynamotors delivering 900 volts at 110 ma. W9OKY was on the job during the Memorial Day flood while city a.c. was off. Pike's Peak is one of the few clubs that have already registered in the A.R.R.L. Emergency Corps. The Missoula (Montana) Radio Operators Club is also a member of the Emergency Corps. It is hoped that many more clubs will provide for emergency equipment in the near future.

A Bowling Challenge

The bowling team of the Northern Nassau Wireless Association, undefeated champions of Long Island, is desirous of obtaining matches with other clubs within a reasonable distance of Long Island, the teams to consist of three or five men. The N.N.W.A., operating W2FJV, is also interested in booking several games to be played by radio.

A New Type Club QSO Contest

The Chester (Pa.) Radio Club has inaugurated something new in the way of club QSO competitions. Details, as explained by the secretary, W3CWQ, are passed along for the information of activities managers of other organizations. Each operator in turn stands a half-hour watch at the club transmitter (W3BKQ) and endeavors to work as many other stations as possible during that time. The number of stations QSO'ed is multiplied by the number of minutes he has actually been QSO to give the score. Each message handled during the party counts as another station for the operator who handles it. The QSO time starts when the other station comes back. If an operator runs over his half hour, he of course gets credit only for that part of the QSO that took place inside the limit. The Chester Radio Club conducts one of these contests every Saturday night, and every operator gets at least two chances to show his stuff. The gang at W3BKQ recommends this activity to other clubs looking for interesting stunts.

Charleston Amateur Radio Club

The first annual hamfest of the Charleston (S. C.) Amateur Radio Club was held September 1st, with many amateurs from all over South Carolina and Georgia in attendance. A harbor sightseeing trip, which included a visit to historic Fort Sumter, proved interesting to all. This was followed by a trip to Fort Moultrie where W4DLE, operator of government station WUD, conducted a tour of points of interest. Among the speakers at the banquet in the evening were Lt. Stevens, U.S.N., Communication Officer, 6th Naval District, Dr. Bass, W4CQG, of the University of Southern Carolina, Prof. Carson, W4MN, also of the university, and Bannie Stewart, W4CE, A.R.R.L. S.C.M. and District Educational Advisor of C.C.C. Camp Lawrence,

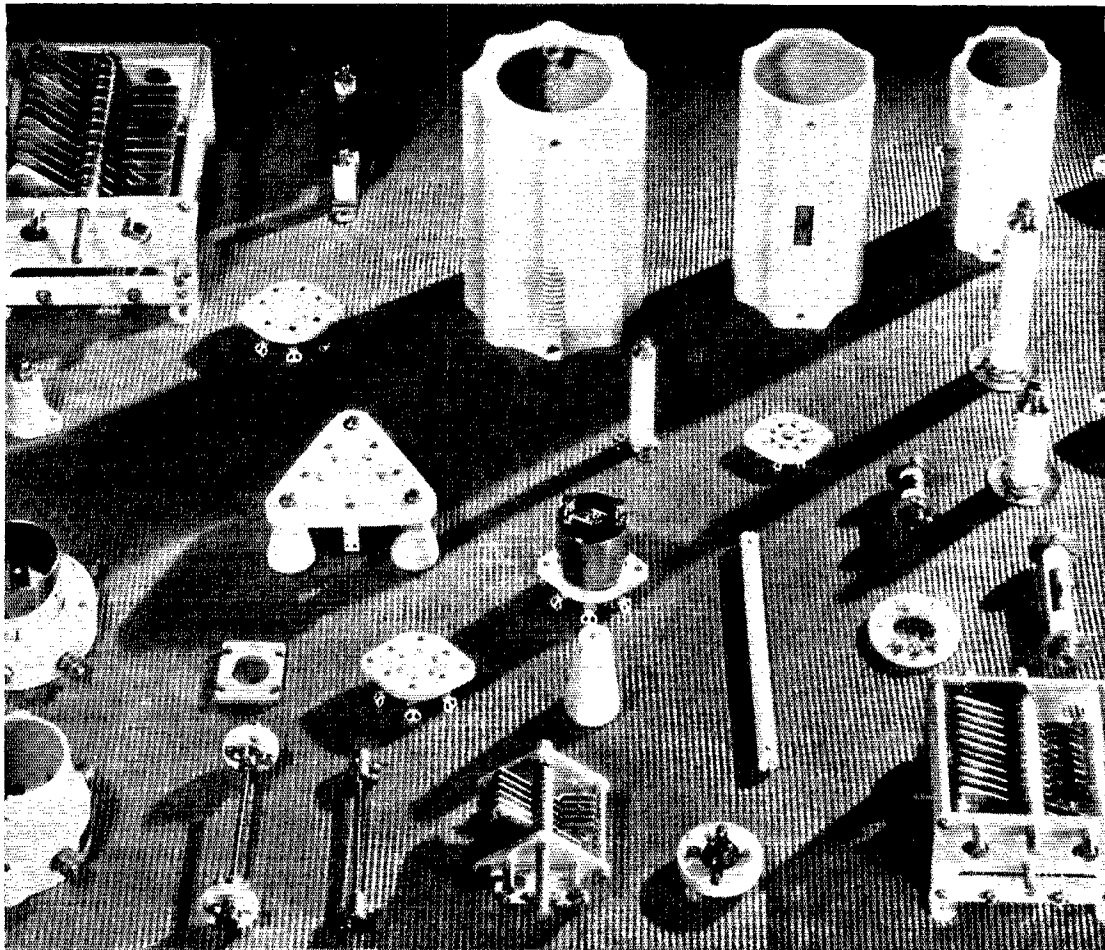

❖ National offers a thoroughly engineered part for nearly every radio purpose. The entire line cannot be compressed into our twenty-page catalogue, much less a single page. But look over the group above. Transmitting condensers from the little 1000 volt TMS in the foreground to the 12,000 volt TMA at the rear. Low loss ceramic coil forms for every amateur band. Low loss sockets for nearly every tube type, from acorns to power pentodes. Flexible couplings from the little TX-12, which will work around a corner, to the big fellows for heavy condensers, high voltages, and low-losses. Strain insulators, spreaders, lead-ins for the antenna; stand-offs, chokes, dials for the rig. National has what it takes.

NATIONAL



COMPANY

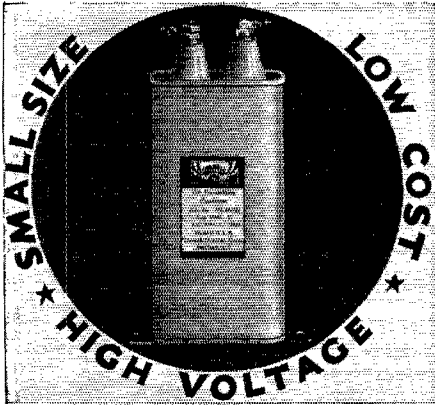

Here's the latest in transmitting and filter condensers

- Non inflammable.
- 50% smaller in cubic volume than comparative condensers of other makes.
- Oil impregnated and filled.
- Hermetically sealed.
- High stand off porcelain insulation.
- Can be operated at voltages 10% above rating without damage.

What more would you expect in an X-mitting condenser?

Write today for information on the new TD Dykanol series!

CORNELL-DUBILIER

CORPORATION

4373 BRONX BOULEVARD
NEW YORK

Effingham, S. C. This affair has started the Charleston club off on an active fall/winter season.

South Hills Brass Pounders and Modulators

The annual hamfest of the South Hills Brass Pounders and Modulators on August 4th was attended by a crowd of four hundred. The program, carefully planned, provided something for everyone. A few good speakers, a game of mushroom ('phone vs. c.w.), a 56-mc. treasure hunt, a tug of war (S.H.B.P. & M. vs. visitors), various novelty races, good eats and a prize drawing made for a full day. The South Hills Club is issuing a club paper, the first copies of which are excellent.

Miscellany

R. F. Tanck is an associate member of the Chicago Suburban Radio Association. . . . The Bloomfield (N. J.) Radio Club plans to run several raffles this winter . . . the club entertained many visitors during the summer. . . . The photo of the exhibit of the Saskatoon Amateur Radio Club at a local exhibition will speak for itself . . . considerable traffic was handled for visitors and amateur radio received much favorable publicity. . . . The Chair Warmers Club is conducting a "G"- "W" QSO contest for its members. . . . New officers, Heart of America Radio Club, Kansas City, Mo.: W9CFL, pres.; W9KNQ, vice-pres.; W9BDX, secy.; W9BUR, treas. . . . The Iron City Amateur Radio Club of Rankin, Pa., plans a 56- and 28-mc. station as one of its 1935 projects. . . . Twelve 56-mc. equipped cars participated in a treasure hunt of the Illinois Ham Club (Chicago) on September 17th. The hidden transmitter was situated on the campus of Northwestern University. W9EMD, accompanied by W9NLK, located the "treasure" in twenty minutes. Second place was taken by W9CF. . . . The Radio Club of Rensselaer Polytechnic Institute, Troy, N. Y., started the season's activities with a social get-together, September 19th. The club operates W2SZ, and has done so for many years, in the Communication Laboratory. Code practice classes are held to aid beginners and to help old-timers increase their speed. . . . The Utica (N. Y.) Amateur Radio Club has twenty-two licensed amateurs on its rolls at present. New officers are W8MLU, pres.; W8MMV, vice-pres.; W8NTX, secy.; W8LVZ, treas.; W8LGR, activities mgr. . . . The Cleveland Heights Amateur Radio Club made a fine showing at the Central Division Convention, members winning many good prizes. The high school members of the club have W8FJE on the air for the fourth consecutive year, and much activity is expected in Cleveland, Ohio, this season. . . .

Visit the Clubs

At A.R.R.L. headquarters there are recorded the addresses of the several hundred amateur radio clubs affiliated with the League, their places and times of meetings. Clubs are splendid

IT PAYS TO BUY THE BEST

Announcing TYPE 60-T A COMPLETE TRANSMITTER

The 60-T is a new, low priced transmitter designed around the CT-60 crystal controlled, oscillator-amplifier employing an RK-20 tube, and designed for telephone and telegraph use in the popular Amateur bands. The compact size of the 60-T makes it ideal for table or semi-portable service.

CHECK THESE FEATURES

Band Switching
Only 2 Tuning Controls
Mounted in Cabinet

Crystal Switching
No Neutralization
50 Watts CW, 15 Watts Phone

And the Net Price \$88.20

Accessories, including all tubes, crystal, crystal microphone and key, ready to plug in and operate, only..... \$41.00

Write for further information

Harvey Radio Laboratories

12 Boylston Street

Brookline, Mass.

A. C. RELAYS

Made by

Allen-Bradley

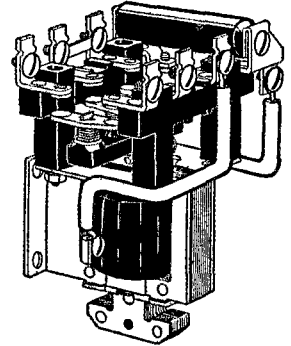
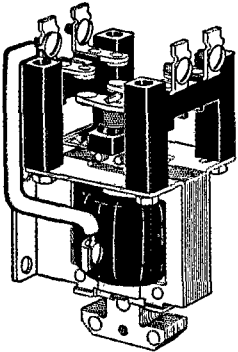

These A. C. solenoid relays are ideal for remote control of transmitters, for control of crystal ovens, and for any general remote control application except for keying. THESE RELAYS WILL NOT OPERATE IN KEYING SERVICE. Silver-to-silver double break contacts are used throughout.

The maximum contact rating is 10 amperes at 220 volts. The relay coils are wound for 115 volts 60 cycle alternating current. Relays for other voltages can be supplied on special order. Use coupon below when ordering.

Type No.	Poles	Nor- mally	Circuit Diagram	Price		Type No.	Poles	Nor- mally	Circuit Diagram	Price	
				Open	In Cab.					Open	In Cab.
A107	1	Open		\$3.50	\$4.50	A177	1	Closed		\$7.50	\$8.50
A117	1	Closed		4.50	5.50	A207	2	Open		4.00	5.00
A127	1	Open and Closed		5.00	6.00	A217	2	Closed		6.00	7.00
A137	1	Open		4.00	5.00	A227	2	Open and Closed		7.00	8.00
A147	1	Closed		5.00	6.00	A237	2	Open		4.50	5.50
A157	1	Open and Closed		5.50	6.50	A247	2	Closed		6.50	7.50
A167	1	Open		6.50	7.50			Radiostat —A stepless graphite compression rheostat for primary of 550 watt filament or plate supply transformer. Range 4 to 150 ohms. Price \$6.50			

ORDER BLANK—MAIL WITH REMITTANCE TO

Allen-Bradley Co., 108 W. Greenfield Ave., Milwaukee, Wis.

Enclosed find money order for \$..... for which please send me, shipping charges prepaid, the following items:

..... for..... Volts..... Cycles

Name.....

Address.....

EBY Announces



TYPE 12-E METAL TUBE SOCKET

A new 8-prong moulded Bakelite Universal Socket for all Octal metal shield tubes. New double action phosphor bronze springs.

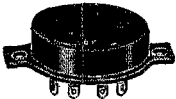

TYPE 8-E SUB-PANEL MOUNTING

Similar to 12-E but designed with laminated Bakelite base for convenient sub-panel mounting.

EBY Quality Radio Products are sold by leading jobbers. Write today for our catalog of service, amateur and experimental parts including:

- BINDING POSTS
- AC SWITCHES
- SHORT WAVE SWITCHES
- TIP JACKS
- TAP SWITCHES
- MALE & FEMALE PLUGS, etc.

HUGH H. EBY Inc.
2066 Hunting Park Ave.
PHILADELPHIA, PENNA.

PEAK X4-56-60MC 10 WATT CLASS B TRANSMITTER

100% MODULATED ULTRA HIGH FREQUENCY PHONE

A high quality ultra-modern transmitter complete, including power supply, and rack. Size 19" x 17 1/2". Your cost—\$59.10 net.

A real professional x-mitter, the type of rig that you would be proud to exhibit to your fellow hams. Specs speak for themselves—check these and let them tell the story.

- Two stage speech amplifier—76 first stage, 6A6 second and driver.
- 6A6 unity coupled with adjustable clips for antenna coupling.
- For use with single or double button microphone.
- Handy "plug-in" arrangement to read oscillator and modulator plate current.
- Panel 8 3/4" x 19" — Cabinet 8 3/4" x 17" x 7" deep.

Your cost X-4 Transmitter Only—\$29.70 net

PEAK X3P Power Supply.
Deliver 300 volts at 200 MA. Swinging choke input with 16 mfd. of filter. Uses 83 mercury vapor full wave rectifier.

19" x 8 3/4".
Your cost — \$23.40 net.

Write for descriptive catalogs to Dept. A

EASTERN RADIO SPECIALTY CO.

Mfrs. of PEAK PRODUCTS

1845 BROADWAY

NEW YORK, N. Y.

places to get acquainted with other amateurs and to participate in interesting discussions on amateur radio. Why not drop in at your local club and "meet the gang"? Address the Communications Manager (enclosing 3¢ stamp, please) for data on affiliated Clubs in your vicinity.

— E. L. B.

Canada-U.S.A. Contact Contest

(Continued from page 48)

score by nine (there being nine times as many U. S. A. Sections).

POWER AND OPERATOR HANDICAP: Every station using less than 50 watts input to the final stage may multiply his score by 1 1/2. If there is more than one operator at a station, the operator having the highest score will be the score for that station.

PRIZES: A.R.R.L. Certificates of Merit will be awarded to the leader in each of the 69 A.R.R.L. Sections in the U. S. A. and Canada. In addition, the W.R.C.L. Cup and apparatus prize will be presented to the leading VE. The VE/W Contest Committee members will not be eligible for prizes, but may aid W stations in obtaining a higher score.

GENERAL CALL: CQ VE/W CQ VE/W CQ VE/W DE W/VE—W/VE—W/VE— (repeated *not more* than 3 x 3) K.

REPORTING FORM: Copies of logs must be received by the Contest Committee not later than midnight November 30, 1935, except in case of K6, K7 and KA.

Take part! Address your log-report to Chairman VE/W Contest Committee (VE3GT), 46 Dunvegan Road, Toronto, Ont.

The form given is suggested for a contest log to be sent to VE3GT at the end of the contest. Six vertical columns are ruled on 8" x 11" paper, as shown.

If you forget to get the name of the Section during a QSO, this can be recorded after the contest by examining the call book, the Operating News in QST, etc. At the end, compute the score. Total the sixth column. Check the number of *different* VE or W Sections worked. Multiply the claimed score by the number of such Sections in the "other" country in which a station was contacted. To get scores on the same basis, U. S. participants will multiply their result by nine (for there are nine times as many U. S. A. Sections to be worked). Multiply *again* by the power handicap (1 1/2), if you used *less* than 50 watts. If your station had more than one operator, submit separate logs.

Reports should be submitted as soon as possible after the contest is over. Messages handled should be kept on file for call if necessary in the case of winners, but it is not necessary to send them in—the simple tabulation or list of QSOs and computation of points claimed is sufficient. Send your report, large or small, to VE3GT.

THE NEW

RME-69

SINGLE SIGNAL SUPER

READY NOVEMBER 1st

SIX-BAND TUNING . . . having a continuous frequency range from 550 KC to 32,000 KC (9 to 550 meters). Calibration held to exceedingly close limits. Amateur bands grouped for a minimum amount of tuning.

SIX-VOLT TUBES THROUGHOUT . . . of known and established characteristics and stable in operation. We do not believe that owners of RME receivers wish to possess experimental equipment. When metal tubes are established through further research RME receivers will have them.

PLANETARY-VERNIER DIAL MECHANISM . . . giving one of the smoothest and easiest tuning devices ever placed on an all-band communication receiver. You will give this feature your unqualified endorsement.

BUILT-IN MONITOR CIRCUIT . . . serving as send-receive switch. Used primarily to monitor phone and CW quality while transmitter is on the air.

CALIBRATED MICROVOLT-R METER TUNING . . . always in the circuit, giving continuous indication of incoming signal strength. Serving also as an output meter in checking I-F frequency alignment.

FULL ELECTRICAL BAND-SPREAD . . . maintaining a separate and distinct band-spread scale. This more expensive method of tuning is adopted because it is far more practical and flexible.

I-F TRANSFORMERS WITH FIXED COUPLING . . . set for optimum coupling value consistent with the desired sensitivity and highest gain. Any lowering in the degree of sensitivity is not in keeping with progress in superheterodyne design, especially in amateur receivers.

QUALITY AND WORKMANSHIP . . . the same rugged construction, with improved design and high quality workmanship is to be found in this new RME-69

CIRCULAR 69 DESCRIBES THIS UP-TO-DATE RECEIVER

RADIO MFG. ENGINEERS, INC. 306 FIRST AVENUE
PEORIA, ILLINOIS

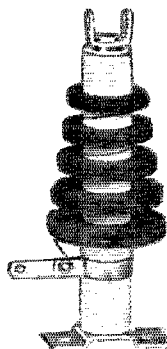

CI-20
.6-8 Amp. . . . List \$1.25

Coto

RADIO FREQUENCY CHOKES

"AN INCOMPARABLE TRIO"

With high R.F. impedance (scientifically tapered pies); universal wound for minimum distributed capacity; Isolantite insulation; conservative current ratings; equally efficient from 20 to 100 ma.; lightweight and compact; and reasonably priced.

For Sale by All Reputable Dealers at Usual Discounts

Write for Copy of Bulletin C-4 Describing Other Products

COTO-COIL COMPANY

Main Office-Factory — 229 Chapman Street, Providence, Rhode Island
West Coast Office — 4214 Country Club Drive, Long Beach, Calif.



CI-11

125 ma. List \$.60

CI-12

250 ma. List \$.75

Remember ESICO — A REAL HE-MAN SOLDERING IRON

ESICO fills a gap which has long existed in soldering irons — the need for a soldering iron that really stays hot and clean during busy moments — an electric iron that allows for hot, speedy, and clean soldering.

A cold solder joint is as good as none at all, says we — therefore ESICO brings you an iron with the following features: —

● Heating element, wound with Nichrome V wire, encased in a cold rolled one piece steel chamber.

● Special drop forged copper tips. These tips stay clean for the full work-

ing day, after tinning.

● A new method of anchoring cord to the iron. Eliminates the irritating fraying and shorting of the electric cord.

A guaranteed quality electric soldering iron well within the reach of your budget. See your local Esico distributor today.

ELECTRIC SOLDERING IRON CO., INC.
342 West 14th St. New York City

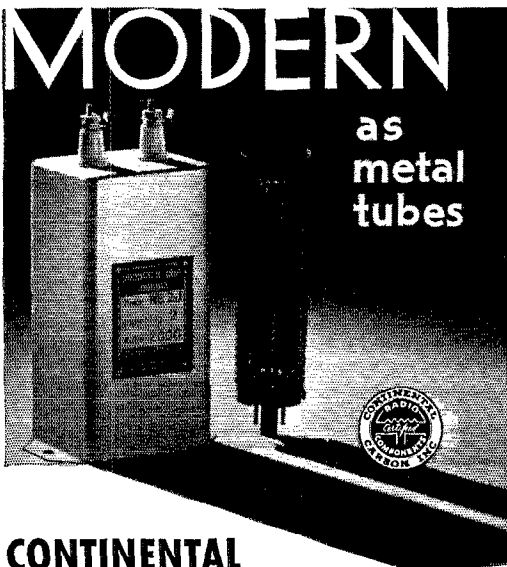

CONTINENTAL
Compact Transmitting Condensers
1000, 1500, and 2000 Volt, 1 to 4 Mfd.
Attractive Prices to Amateurs
Ask Your "Ham" Distributors

CONTINENTAL CARBON Inc.

13924 Lorain Avenue, Cleveland, Ohio
Canadian Plant, Toronto, Ontario

Hamdom

(Continued from page 44)

first five days of the test to get on the air, and so got in less than 40 hours' operating time. The station contains a '47 crystal osc., 261A doubler, 261A buffer, and a 204A final with 900 watts normal input. The operator is a member of the A-1 Operator Club. Some combination! What with radio and the 2-year-old junior op, one suspects Buck has little enough time for his job as Federal Bank Examiner for Texas, New Mexico and Arizona.

Experimenters' Section

(Continued from page 50)

increase the capacity, at the same time keeping the matching network tuned to resonance. This operation will, up to the point of full load, peak the current in the plate circuit of the output tube. The values for the components of the matched impedance network are close enough to those used with the regular coupler so that one should have little difficulty finding their proportions.

—Howard F. Barkley, W1ADF

Sweepstakes Contest Rules

(Continued from page 39)

KEEPING SCORE—TIME FACTOR

As contacts are made keep a list of stations, their A.R.R.L. Section and the number of points for each QSO. List all operators⁵ whose work at your station is responsible for any part of the score.

Scoring system in brief:

All contacts:

One point for each QSO when message exchanged one way.

Two points for each QSO when message exchange is made both ways.

For final score:

Multiply totaled points by the number of A.R.R.L. Sections² worked, that is, the number in which at least one *bona fide* S.S. point or exchange has been made.

Multiply this⁶ by 1.5 if you used 100 watts or less transmitter input.

If over 90 hours' actual operation, the Grand Total is the figure computed as above multiplied by $\frac{90}{x}$, where x is the actual number of hours' operation.

⁵ "Handling" a message always includes the transmission and receipt of radio acknowledgment (QSL) of same, and entry of date, time and station call on the traffic, as handled, for purposes of record.

***** THE RADIO SHACK *****



When You Buy **PYRANOL CONDENSERS**—You Buy the **BEST!**
2 MFD.—2000 VOLTS

- Pyranol permits compact design
- Pyranol raises the factor of safety
- The first choice of commercial stations
- Amateurs report stronger signals after installation
- Guaranteed two years — unconditionally

\$ 2.90

THE PRODUCT MUST BE GOOD TO CARRY SUCH A WARRANTY!

866's H.D. \$1.00 | 2.5V-12A Trans. 60's... \$1.25 | Baldwin Type C Phones \$2.50

HK Gammatron Type 354 \$24.50

Used RCA 860.....\$12 849..... 40 204A..... 30

JOHNSON 5 M.Q. Ant. \$3.90

Birnbach 5M Antenna \$1.50

The Mac-Key \$7.95

International Chokes, fully cased
 12H — 200M. D.C. Resist. 140 ohms \$2.50
 12H — 300M. D.C. Resist. 105 ohms 3.75
 12H — 500M. D.C. Resist. 70 ohms 6.50
Swinging Chokes
 12H — 300M. D.C. Resist. 140 ohms \$2.50
 12H — 300M. D.C. Resist. 105 ohms 3.75
 12H — 500M. D.C. Resist. 70 ohms 6.50

Ohmite Band Change Switch \$1.80
G.R. Coil Forms 677v..... 50¢

Readrite Mill Meters... 59¢
The Super Sky-Rider. S x 9 \$79.50
Astatic Crystal Microphone \$13.50

Cardwell Condensers. 300 in stock to choose from, your discount 40%. Catalogue on Request.
Thordarson Transf. 600-0-600V 5V—3A 7.5V—3A \$2.75 25V—10A 200 MILLS

Dunco Keying Relay AC-DC. \$2.00
 VT203A (Graphite)..... 9.00
 RS800 (Graphite)..... 5.95
 RS801 (Graphite)..... 2.95
 Elnac 50T — \$13.50 — 150T 24.50
 RK20 — \$15.00 RK28..... 38.50
 RCA 800 — \$10, RCA802..... 3.90
 RCA 210—\$1.20, Raytheon 250 .75
 Amperite Velocity Mike..... 18.00
 Biley LD Crystals..... 4.80
 Tobe Communication Receiver 41.40

Harvey C.T. 60 Transmitter \$33.00

Ohmite 200 Watt Resistors 0-10,000 ohm \$1.80 10,000-100,000 ohm..... \$2.10

INTERNATIONAL PLATE TRANSFORMERS

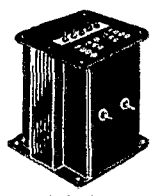

Outstanding for Value. 750 and 1000 volts each side of c.t. at 300 mills. Cased completely in steel. Crackle finish. Model 2000; \$5.95

Model 3000—Same in appearance, 750-1000-1500 each side of c.t., 300 mills..... \$8.95
We know of nothing that equals the value received in these two items

For Construction
CADMIUM PLATES CHASSIS

7 x 12 x 3... \$.84	10 x 12 x 3... \$.90
7 x 17 x 3... .99	10 x 17 x 3... 1.05
7 x 23 x 3... 1.14	10 x 23 x 3... 1.20

THE RADIO SHACK
46 BRATTLE STREET
BOSTON, MASS.

TRIPLET METERS
 0-5 to 500 mills d.c.
 3 3/8" Bakelite Case..... \$3.75
 0-15V-a.c..... 3.75
Complete line of meters and test equipment

IMMEDIATE DELIVERY From Receiver Headquarters

RME9Ds.....	\$112.50
National HRCs.....	167.70
PR-16s complete.....	95.70
Breting 12s complete prepaid.....	93.00
Silver 3Ds complete prepaid.....	109.80
Super-7s complete prepaid.....	49.50
S-9 Super Skyriders complete prepaid.....	79.50
RCA ACR-136s complete.....	69.50
Super Pros complete (when available).....	194.06

TRADE IN YOUR RECEIVER OR TRANSMITTER
 Complete stock of all RCA, Eimac, Taylor, United transmitting tubes and all other amateur apparatus at lowest prices. Your used apparatus taken in trade.
 Every inquiry and order is personally attended to by Robert Henry, W9ARA; an active amateur for eleven years; graduate E.E. from M.I.T.; and owner of Henry Radio Shop selling amateur apparatus for seven years. Your inquiry will prove to you that it is to your advantage to deal with W9ARA. Write for any information.

HENRY RADIO SHOP
 211-215 North Main St. Butler, Missouri

BIRNBACH Superior INSULATORS

HEADQUARTERS for largest and most complete line of Standoff and Feedthru Insulators. 56 numbers, 28 models for every radio purpose. Highest grade white or brown porcelain, nickel-plated brass hardware. Write Dept. Q-11 for Catalog.

BIRNBACH RADIO CO., Inc.
 145 Hudson Street New York City

1 1/4" HIGH
 All other standard models and sizes from 4 1/2" down to 3/8" high.

Radio Engineering Complete in Telegraphy-Telephony

Studio Technique and Transmitter Operating Experience Guaranteed
KPAC
 500-Watt 1260 Kilocycles

IN 3 to 7 months we train you to secure Commercial Telegraph Second-class, and Radiotelephone First-class government licenses. Course consists of Wireless Code, Radiophone, Microphone-Studio Technique, Service, Police, and Aeronautical Radio. We are authorized to teach RCA texts. At completion of course you receive practical studio technique experience in our commercial broadcast studios located in administration building, and experience as an operator on K-P-A-C (500-Watt Commercial transmitter located on the campus and owned and operated by the college), and WPA, 4000-Watt Commercial Wireless Station. If interested, write for Bulletin R.

PORT ARTHUR COLLEGE Port Arthur (world-known port) Texas

"Hi-Q" INDUCTORS

FOR
YOUR
TRANS-
MITTER

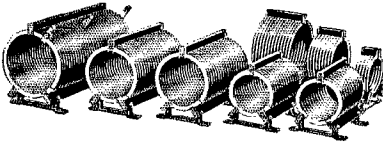

Johnson "Hi-Q" Transmitting Inductors are ideal for modern amateur transmitters. High electrical efficiency is secured by carefully proportioned dimensions, generous conductor size, and excellent insulation properly placed. Nickered edgewise wound copper makes a compact, rigid inductor with ample surface for low resistance clip connections.

Sizes are available for all amateur tank circuits and coupling coils, as well as special "pi-section" impedance matching inductors. Prices are so low, every amateur can own them.

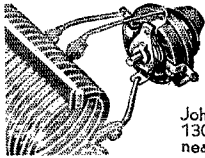

BAND SWITCHING

made easy by the convenience of adjusting clips at ANY POINT and quickly changing them if desired.

Johnson Inductors are described in Bulletins 130 and 350—and are obtainable from nearly all good suppliers, at usual discounts.

Your copy of the complete new Johnson Catalog is waiting for you.

E·F·JOHNSON·COMPANY
MANUFACTURERS OF *Radio Transmitting Equipment*
WASECA MINNESOTA U.S.A.



New, Efficient LINE FILTER

This sensational new Miller Line Filter positively eliminates all line noises. Use it to prevent crackling and sizzling in your radio caused by household appliances and powerline disturbances which "noiseless" antenna systems cannot eliminate. Merely plug it in—no adjustments or attention.

Exclusively combines both inductive and capacitive filtering, with the famous Miller duo-lateral wound choke, and oil impregnated paper dielectrics.

More efficient than any filter on the market. Complete in handsome chromium and black Kem-Art metal case, rubber cord and unbreakable plug. Shipping weight 16 ozs. Beat the demand. Order now from your dealer, or write

No 7818

\$4⁰⁰

J.W. MILLER COMPANY
5917 So. Main Street, LOS ANGELES, CAL.

PROOF OF QSO

At least *one* message must be handled between two stations as "proof of QSO" before points or Sections can be claimed. These exchanges can be simplified to the minimum for "proof of contact." More than one message each way may be handled,³ but add no more to the score. Complete preambles and A.R.R.L. form is required in each test message exchange. Any cases of omission of preamble or use of other form shall be reported by participants, and the information will be used by the judges to modify scores or disqualify contestants, depending on the weight of the evidence to show incomplete changes or "poor" operating in the operating contest, the onus being fixed on the operator responsible, of course. (A.R.R.L. preamble: "*fm Portland Maine W1ZZZ nr . . . Nov. . .*")

A number of *different* short contest messages can be written in advance to use in swapping proof-of-QSOs in proper form. Progress of competitors can be discussed. Humor and imagination inserted in texts add to the interest. Identical-text messages (rubber-stamp type) are ruled out of the count. A different text must be sent each station. All work must fall within the contest period. Failure to provide traffic files if called upon to do so will constitute disqualification. However, participants are requested not to send in message files with their reports, but to hold them for *possible* call.

We suggest (for your own convenience) ruling a letter-size sheet into five vertical columns: (1) preambles on the left, (2) address (call only required), (3) short texts, and (4) call or call and Section for signatures. The 5th column, after a double line, can be used to log "time, date, and station."² A score or more messages can be typed on a sheet in the following convenient form, using ditto marks to save repetition, filling in 2nd and last columns as sent. This is not a requirement, just a time-saving suggestion.

Contest messages do *not* count in A.R.R.L. monthly traffic totals. Since they are short and exchanged as "proof of QSO," they give excellent practice in form and offer a chance to inject some

¹ There is no point in working the same station more than once in the contest period if two points have been earned by exchanging messages. If but one point is made the first time, you can add a point by working this station again and handling a message in the opposite direction.

² The highest individually-attained score of any *one* of the operators of amateur stations having more than one operator is the official score for such a station. The summary of score must show *all* stations worked by *all* operators however, underlining, or circling the entries of stations and/or Sections that cannot count in the official total. Awards will be based on the official total and will be made to the individual operator accredited with this total. To show the possible scores that can be built up by several operators at one station, such scores (all Sections listed by all points listed) may be shown parenthetically after the "official" score that counts toward a possible award.

³ If the power was changed between (a) or (b) during the contest, separate scores must be kept for each power class, and the two added together for the total.

⁴ All hams are requested to submit lists, even if they only show a small score on a postal. By doing this they help support claims made in logs from other stations, and also they receive full credit in QST.

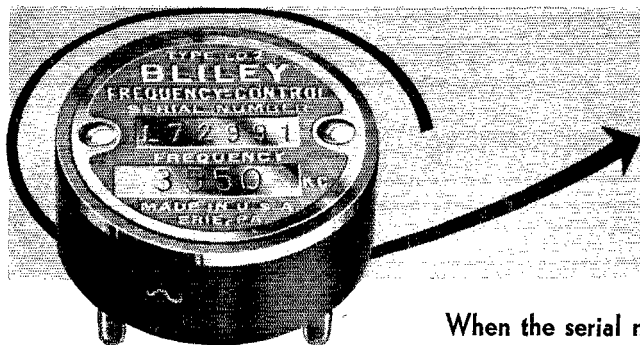

**THIS LABEL
IS YOUR
GUARANTEE**

Watch for Bliley advertisement announcing an entirely new crystal not now available.

For advance information on this product send for our new complete catalogue G-8 about to be released.

When the serial number and frequency are stamped on the stainless steel name plate of the new Bliley LD2 Crystal Unit, it shows that the crystal and holder have passed over 30 inspection tests and have met with rigid qualifications for power output and stability.

This label is a guarantee of dependable, satisfactory performance. Any user will tell you that the new LD2 Unit stands for the utmost in crystal values. See it at your nearest Bliley Dealer. Costs only \$4.80.



BILLEY ELECTRIC CO., ERIE, PA.

RADIO COURSES

RADIO OPERATING; Prepare for Gov't License Exam. ●
RADIO SERVICING; Including Short Wave ● AMATEUR
CODE ● New Course in ELECTRONICS; Day Only. Other
courses, Day and Evening classes.

Resident Courses — Write for Booklet

NEW YORK YMCA SCHOOLS 4 West 63rd Street
New York City

"The Crystal Specialists Since 1925"

PIEZO-ELECTRIC CRYSTALS

Guaranteed Accurate to BETTER than .01%

SCIENTIFIC RADIO SERVICE
UNIVERSITY PARK, HYATTSVILLE, MD.



NAME PLATES

OSCILLATOR 60 different readings
for use on Transmitters,
Receivers, Monitors, P.A. Systems, etc.

\$.10 List — Trade Discount 40%

Write for New 1936 Catalog which fully
describes **BUD NAME PLATES** and
a complete line of essential radio parts.

INSIST on **BUD** products and be
assured of precision built equipment at a right
price.

BUD RADIO INC.
1937 E. 55th ST., CLEVELAND, OHIO

READ SEND **CODE** LIKE AN! EXPERT!

Learn Quickly at Home, Get Real Speed

It's easy, fascinating, to become a good op with the Improved **MASTER TELEPLEX** Code Teacher to help you. Only instrument ever produced which records your sending in visible dots and dashes on copper tapes — then sends back to you at any speed you desire. Also sends practice work, recorded by an expert. That is why so many schools teaching code prefer Master Teleplex. That is why thousands agree this is the surest, quickest way to learn the **FREE** code. We furnish Complete Course, lend you Master Teleplex, give you personal **BOOK** instruction with a **MONEY-BACK** **GUARANTEE**. Low cost. Send to-day for booklet Q. 35; no obligation; post card will do.

TELEPLEX COMPANY

76 Cortlandt Street
NEW YORK, N. Y.

MASTER TELEPLEX — "The Choice of Those Who Know"

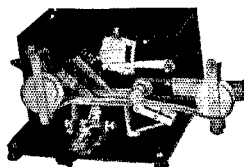

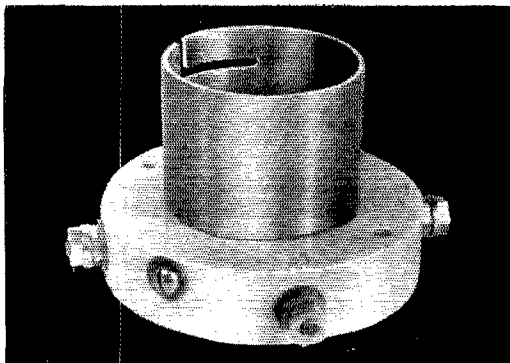

50 WATT SOCKET: Designed for use where voltage is not high enough to justify the all-steatite construction of our standard low-loss socket, the new socket illustrated above uses a metal shell permitting a much lower price. Insulation is high quality glazed ceramic.

Catalog Symbol XM-50 Net Price \$1.20

NATIONAL COMPANY, INC.
MALDEN, MASS.

RADIO FREQUENCY TEST CLIP



No. 45-0S

ENTIRELY NON-FERROUS

Ideal for Use on Transmitters

The Mueller No. 45-0S clip is made of solid copper and is equipped with a phosphor bronze spring and brass screw. It will not heat up when high frequency current is put through it. May be had with red and black rubber insulators to prevent shorts and protect against shocks.

STOCKED BY JOBBERS EVERYWHERE

Write Factory for
Free Samples and Complete Catalog

MUELLER ELECTRIC CO.

1583 E. 31st St.

Cleveland, Ohio

humor into texts. Where regular traffic on the hook is moved, and it always should be, when it can be speedily and properly routed, there is of course no necessity for creating a "contest message" for the purpose. Such regular messages count *both* for the contest and the monthly report.

REPORTING RESULTS

Report ⁷ to A.R.R.L., West Hartford, Conn., giving your list of QSO's, showing Sections, stations, total, time and power, as soon as the contest is over. Hold message files for checking but do not send them unless called for. Use the log form suggested in the example.

All active ham operators are invited to take part and report. You will work a new bunch of stations, make new records for your station, get QSL cards, have a lot of fun, meet new friends, and perhaps rate an A.R.R.L. award at the conclusion. Any new hams will get good operating experience, working with a "swell" bunch of operators and friendly fellow hams. The chances have been made as equal as they can be made for all. Do your best operating and send A.R.R.L. the results for *QST* mention.

ADDITIONAL RULES

1. Where Sections are smaller units than states, the name of the Section complete or in shortened form must be included after the signature on exchanges.

2. A.R.R.L. form is required in test messages; other form, or evidence of omitted preambles or other data constituting incomplete exchanges will be considered as justifying disqualification, depending on the sufficiency of evidence reported.

3. Entries should be (a) in the low-power class, or (b) high-power class, or submitted as the sum of separately computed work at one station falling in each class. Sections worked on high power do not count in the multiplier for low-power-score and vice versa. Logs must show the power used for each QSO or for groups of QSOs.

4. Reports must show operating time for each period spent on the air in the "SS," and the total of such operating time.

5. Logs must be marked for "Phone" or "C.W." entry, grouping all work by either method together as one score.

6. All work must fall within the period of the contest.

7. Decisions of the award committee of C.D. staff members shall be accepted as final.

8. Reports must be received at A.R.R.L. Hdq. from all stations except those in Alaska, Hawaii, and P. I. on or before noon, Dec. 26, 1935, to be considered for certificate awards. From outlying points, reports must similarly be received on or before Jan. 20, 1936.

IN GENERAL

The only competition each operator must consider comes from operators in his immediate Section. Awards are for the operator running up the best communication record for each Section (as indicated by the score). In this manner, operators in each territory are placed on a basis of equality

SPEED UP YOUR CODE

MANY AMATEURS are entering the field of commercial Radio Communications through CANDLER Specialized Training, the acknowledged *short cut* to speed and operating efficiency.

Amateur and Commercial operators, embarrassed by their inability to "hit the ball" with the fast ops., have so increased their code and "mill" speeds with a few weeks' CANDLER training, they not only have won the admiration and respect of those with whom they work, but have been promoted to better jobs where high speed is demanded and paid for.

We train you quickly to successfully meet the new conditions and speed requirements in Commercial Radio. Our instruction is inexpensive and you can take it in the privacy of your own home or while on the job without others knowing it until you surprise them with your increased speed.

McElroy's own story "HOW I LEARNED TO HANDLE CODE" will be sent to you FREE, without obligation. It contains valuable and interesting information.



TED R. MCELROY

New Official Champion Radio Operator of the World. Won title September 14 with a speed of 69 wpm. Ted says:

"In all my code speed contests I have had no other preparation or training than the CANDLE SYSTEM which taught me to read code as easily by sound as I read book print by sight and to put it down on my 'mill' by touch without having to think of how words are spelled. I could not have maintained my record for speed without the aid of this unique, scientific training. Every beginner should learn code RIGHT through this System, and every op. who wants real speed should take it."

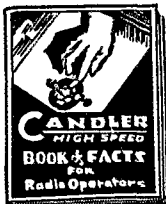

Three Celebrated CANDLER SYSTEM COURSES

SCIENTIFIC CODE COURSE for beginners. Teaches all the necessary code fundamentals scientifically.

HIGH-SPEED TELEGRAPHING for fellows with speeds from 12 to 35 wpm. who want championship speed and technique.

TELEGRAPH TOUCH-TYPEWRITING for those who want to become expert in the use of their "mill" in receiving fast stuff by "touch." Nothing else like it.

FREE!!

Send for It
NO OBLIGATION

CANDLER SYSTEM CO.

Dept. Q-11

ASHEVILLE, NORTH CAROLINA

PANELS — BAKELITE — RUBBER — ALUMINUM
All Sizes Cut to Order **BAKELITE TUBING & RODS**
Drilling, Engraving & Special Work
ALUMINUM CANS — Stock sizes. Special sizes, made to order.
ALUMINUM CHASSIS — Threaded brass studs for 6/32 screws.
Length from 1/2" to 6" — price 5c to 30c.

Insulating bushings
for all size shafts
Bakelite Tubing Threaded to Specifications



Couplings in brass
or Bakelite — 15c



UNITED RADIO MFG. CO.

Transmitting frames and racks
Est. 1923 191 Greenwich St., New York

FOR SALE. Weston Surface mounting bakelite cased Instruments. Type 301. D.C. Milliameters, 0-25; 50, 100, 150, 300 and 500 M.A. each \$3.50. 0-1 M.A. \$5.00. D.C. Voltmeters 0-500 \$7.50, 1000V \$12.50, 1500V \$17.50. Type 476 R.F. Ammeter, 0-2 \$6.00. Thermo Milliammeter, 0-115 mills \$7.50.

WANTED: Distortion analyzing equipment and Single Signal Super.

S. T. Carter, 1525 Thomas Ave., Charlotte, N. Car.

PRECISION CRYSTALS

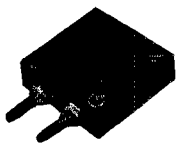

Crystal Holder — \$1.00

NEW low temperature coefficient crystals accurately prepared for maximum power output and frequency stability. These crystals have a frequency drift of only 1/2% or less than that of 'X' cut crystals. Be sure of your transmitter frequency — use **PRECISION CRYSTALS**. These crystals ground to within 0.1% of your specified frequency and calibrated accurately to within 0.03%. are priced as follows: 1750, 3500 and 7000 kc. band — \$3.50 each. Plugin holder — \$1.00. Jacks for holder — \$.15 pair.

The 'AT' cut crystal recently developed has a temperature coefficient of practically zero. 'AT' cut crystals within 0.1% of your specified frequency and calibrated to within 0.03% are priced as follows: 1750 and 3500 kc. bands — \$6.00 each. Holder — \$1.00. Jacks for holder — \$.15 pair.

Crystals and ovens for commercial use quoted on at your request. When ordering our product you are assured of the finest obtainable. Now in our sixth year of business.

PRECISION PIEZO SERVICE

427 Asia Street

Baton Rouge, La.



The first fully sealed and **INSULATED** Resistors — ideal and modern for every purpose. Use them anywhere without fear of shorts or opens. Quiet — vibration-proof — moisture-proof. The outstanding resistance development in years!

INTERNATIONAL RESISTANCE CO.
Toronto, Canada Philadelphia, Pa.

Smaller than a Match

... PYROHM JR. RESISTORS



Available in 5, 10, 15 and 20 watt ratings. Any resistance value.

Crack-proof refractory tubing... adequate heat dissipation.

Quality resistance wire... space wound under tension.

Wire ends brazed to lugs... pistails soldered to terminal bands.

Heavy enamel coating permanently sealed against moisture and mechanical damage.

DATA Send for latest AEROVOX catalog covering complete condenser and resistor line. Also sample copy of Research Worker. Your local supply house carries an AEROVOX stock for your convenience.



CORPORATION

73 Washington Street • • Brooklyn, New York

Married Men appreciate

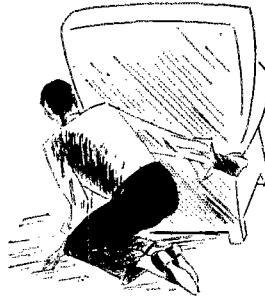

WARD LEONARD MIDGET REMOTE CONTROL RELAYS

You only have in sight the receiving box and sending key. All the unsightly stuff is in the attic or cellar, so women folks won't object. Circular now ready. Send for your **FREE** copy.

WARD LEONARD ELECTRIC CO.
41 South Street, Mount Vernon, N. Y.

Please send me a free copy of your latest bulletin on Midget Remote Control Relays.

Name.....
Street.....
City and State.....
Call Signal.....Q

as to DX conditions and operating opportunity. Those who take part may report improper message sequence or abbreviations in texts (abbreviated words are not ethical in texts).

As a reminder that a station has been worked a mark can be put in the call book. Each time a new Section is worked the list of Sections on page 5 of *QST* can be checked to keep track of the number of Sections contacted.

Most effective use of the available operating hours, intelligent choice of the different amateur bands, and a high degree of operating proficiency will take one a long way toward superlative results in this contest—or in any amateur radio work for that matter. Next to operating ability it is our opinion that a good receiver is most important and essential to success. Single-signal selectivity and high sensitivity will win and bring in the stations at distant points calling you. But the best equipment is only as useful as the man behind the key or mike can make it. Operating proficiency is what counts!

NEW TIME LIMIT

Operate as much as you want to during the contest period, and report all your SS contacts. Keep track of the time you start and stop operating your station. This must be shown in your log report. Up to and including 90 hours' total contest operation there is no penalty, and nothing to be done when computing your score. Should you find that you operated a total of 100 hours (for example), your Grand Total Score should be multiplied by the fraction $\frac{90}{100}$ to give your "corrected score." In counting up your total contest time, please be fair and honest. We know you will.

You can operate 6 hours per day, 12 hours each Saturday, and 16 hours each Sunday, and you will still have put in only 86 hours' total. The 90-hour factor is designed to permit everyone to enjoy DX possibilities to the maximum throughout the whole 9-day period. This plan permits the average ham to plan for his working day, for meals, for 8 hours' daily sleep, etc. Cross examination of logs makes it possible to check the operating time submitted as may be necessary, of course.

Logs will be checked against each other to insure fairness and accuracy in making awards. However, it is not altogether necessary that each station worked be taking part in the contest to make your points count. Any operator who needs information can be referred to this announcement. First of all, ask the operator to come through with a contest message, and take yours.

QUESTIONS ON THE CONTEST

Is a long signature required? It can be shortened to station call, plus Section identification where necessary.

When must Section be identified? When not identical with a state or province. Not in Iowa or Conn., for example, but in Calif., N. Minn., S. Minn., E. N. Y., W. N. Y., N. Y. C., L. I., E. Mass., W. Mass., etc.



We Do Not Sell a Crystal

**IF THE FREQUENCY DRIFT
EXCEEDS 4 cycles/meg./ °C.**

PREMIER AT-CUT CRYSTALS afford Low Frequency Drift that is **REALLY LOW!** Unconditionally guaranteed not to exceed 4 cycles/meg./ °C.!

Do you realize what **Low Temperature Frequency** means to **Frequency Stability**? Just look at the chart below — it assumes a typical condition of 20 meter phone operation with crystal control.

	AT CUT	X CUT
CRYSTAL FREQUENCY.....	4cyc/meg./ °C.	20cyc/meg./ °C.
4th HARMONIC for 20 METER PHONE BAND.....	3550	3550
FREQUENCY CHANGE PER DEGREE C.....	14,200 kc	14,200 kc
ASSUME CHANGE OF 15 °C. IN AMBIENT TEMPERATURE..	56.8 cyc	284. cyc
TOTAL VARIATION IN FREQUENCY	852. cyc*	4260 cyc

* This variation of 852. cycles can be reduced thru the use of our HEATER TYPE HOLDER.

WRITE for Bulletin 103, describing our complete line of crystals and Isolantite Low-Loss Holders



PREMIER CRYSTAL LABORATORIES, Inc.
53 PARK ROW , , , , , NEW YORK CITY

RADIO

ENGINEERING, broadcasting, aviation and radio telegraphy and telephony, police radio, servicing, marine accounting taught thoroughly. Engineering course of nine months duration equivalent to three years of college radio work. School established 1874. All expenses low. Catalog free. **DODGE'S INSTITUTE, Day Street, Valparaiso, Indiana**

ELECTRO-VOICE

★ Proven, dependable Carbon Microphones, priced from \$5.00 to \$25.00, list. A sensational new Velocity series, from \$25.00 to \$75.00, list. Available at your dealer's. Write for Catalogue No. 18.

324 EAST COLFAX AVE. SOUTH BEND, IND.

TRIMM

Featherweight Headsets

give satisfaction

Your headphones will be most sensitive when the impedance matches the output of your radio receiver. Trimm phones are furnished in impedance values from 1 to 100,000 ohms.

For earphone efficiency, rely on Trimm. A phone for every need.

TRIMM

RADIO MFG. CO.
1528 ARMITAGE AVE.
CHICAGO, ILLINOIS

INSTRUCTOGRAPH THE PRACTICAL CODE TEACHER



Thousands of people have tried to learn the code from a Short Wave Receiver and become discouraged. You can learn that way — but it's the hard way.

The easy way, the *practical* way is to have your own Instructograph Code Teacher. It sends perfect code at the speed you want, fast or slow — no waiting for code schedules, no interference.

The better Residence and Extension Schools all use a machine to teach their classes; Government examinations for Amateur and Commercial

tickets are always given by a machine. It's the most practical way — because, if there were a better way, they would have it.

With Instructograph, you study at home, at whatever time suits you best; and with each machine, sold or rented, comes Book of Instructions that explains each step, just as an instructor would do. Terms are very reasonable. Write today for descriptive folder.

INSTRUCTOGRAPH COMPANY—Dept. Q11
912 Lakeside Place Chicago, Illinois

Representatives for Canada
RADIO COLLEGE OF CANADA, LTD., 863 BAY ST., TORONTO

UNIVERSAL Combination Floor Stand

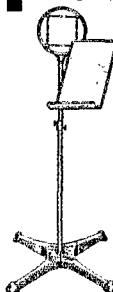

A rugged, three-piece, telescoping, combination banquet and floor stand — Compact — light weight — smooth in operation . . . Finished in fully polished nickle plate . . . Equipped with cadmium plated, adjustable and detachable copy holder, mounted on a flexible steel arm. A clean, workmanlike job, designed and manufactured to Universal standards of quality —

List price, complete with
8 springs, \$10.00

Universal Microphone Co., Ltd.
424 Warren Lane
Inglewood, Calif., U.S.A.

NEW . . .

**THE IMPROVED 5 AND 10 METER
DUPLEX TRANSMITTER-RECEIVER**

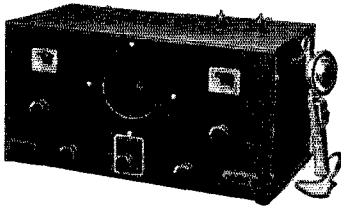

Type
TR-6A6
De-Luxe

TRANSMITTER . . .

- Unity coupled p.p. oscillator using 6A6, 53 or RK-34 twin-triodes, carrier 7-10 watts.
- Class B modulation; 6A6 or 53. U.P.O. 10 watts.
- Class A driver using 6A6 or 53.
- Jacks for microphone and key. (No external batteries or tone needed for phone or i. c. w.)
- Plate voltage panel control switch.

RECEIVER . . .

- Tuned r.f. stage using 78 or 58.
- Super regenerative detector, 76 or 56.
- Audio driver, 76 or 56. Phone jack.
- Panel volume and regeneration controls.
- Pentode output with 42 or 2A5.
- Integral 5 inch dynamic speaker.

Tubes for above \$4.27
Coils for extra band \$2.50; plug-in \$7.50 installed
Universal damped handi-mike \$6.00

POWER SUPPLY . . .

- 110 volt 60 cycle supply—class B swinging and output chokes, 300V at 200 m.a., 6.3V at 3.4 amps. and 2.5 volts at 10.75 amps. Complete with cables, plugs, pilot lamp and 5Z3 rectifier tube \$25.53

Write for Bulletin C

RADIO TRANSEIVER LABORATORIES

8627 - 115th Street Richmond Hill, N. Y.

\$39.75

Complete
TRANSMITTER
RECEIVER

What about the address? Call signal is adequate on originator to addressee messages. Where relayed through even one station, a complete address, with name, street, and number should always be given to facilitate delivery.

Please give me an example of proper A.R.R.L. form for my test message for proof-of-QSO in the SS. Here it is:

*From Houston Texas W5EMX nr 43 Nov 24
W7EPC*

*Glad Hook You On Twenty
W5EMX S TEX*

What can I write texts about? Anything at all. See almanac, magazines, etc. Ask about apparatus, DX, conditions, altitude, 'phone work, frequency bands, new regulations, N.C.R., A.A.R.S., commercial operating, high quality signals, transcons, club membership, the New Deal, favorite sport, occupation, age, temperature, Trunk Lines, ORS/OPS appointment, U.H.F., metal tubes, *QST* articles, etc.

**MAIL YOUR REPORT IMMEDIATELY
AT THE END OF THE CONTEST TO
AVOID DELAY AND INSURE THAT YOUR
RESULTS ARE CREDITED AND KNOWN
THROUGH *QST*.**

Clair Foster

(Continued from page 17)

it is the thing for which he will be remembered: that he built real friendships through the operation of his station, made innumerable friends in all parts of the earth by many hours of conversation over the air. His was, we think, the finest example of the friendship-forming capabilities of amateur radio that we have ever seen. Through that, Clair Foster will live forever in the hearts of his friends.

K. B. W.

Book Reviews

Fundamentals of Radio, Second Edition, by R. R. Ramsey. 426 pages, 439 illustrations. Published by Ramsey Publishing Company, Bloomington, Ind. Price, \$3.50.

A modernized revision of the author's work which has been a favorite with amateurs and experimenters since 1929.

Measurements in Radio Engineering, by F. E. Terman. 400 pages, including an appendix of outlines for laboratory experiments and a comprehensive index. 210 illustrations. Published by McGraw-Hill, New York. Price, \$4.00.

A comprehensive engineering discussion of the measurement problems encountered in engineering practice, with emphasis on basic principles rather than on methods in detail. A companion volume to the same author's *Radio Engineering*.

The Cathode-Ray Tube at Work, by John F. Rider. Published by John F. Rider, New York. 322 pages, 444 illustrations. Price, \$2.50.

(Continued on page 106)

OHMITE "DIVIDOHM"

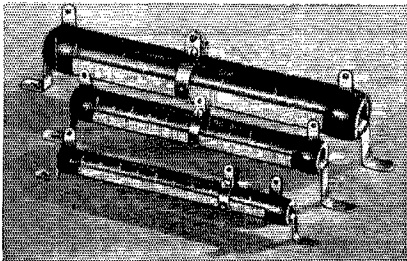

Here's a Useful Unit!

Need a voltage divider? . . . or an odd resistance value? . . . or a tapped resistor? **DIVIDOHM** fills the bill! You'll find dozens of uses for this handy unit.

The famous **OHMITE** vitreous enamel coating is marked with a patented "percentage-of-resistance" scale which helps determine values wanted. Any practical number of adjustable lugs may be used. Made in six sizes, with resistance values through 100,000 ohms. For full information ask your jobber or write for new Catalog No. 14.

OHMITE MFG. CO.

New Enlarged Quarters at

4831 Floumoy Street

Chicago, Illinois

The SHURE

"Spheroid"

- 1. HIGH-OUTPUT
- 2. NON-DIRECTIONAL
- 3. HIGH-FIDELITY

CRYSTAL MICROPHONE

— for the first time in the history of sound reproduction, a crystal microphone with ALL these features!

Through radically new acoustic engineering principles, the "SPHEROID" provides the highest Output Level (minus 55 db) ever attained in combination with true High-Fidelity response (within 5 db from 40 to 10,000 cycles) and Non-Directional (360°) pickup! New "Grafoil" Bimorph Crystal element lowers cable loss.

*For complete technical data, ask your Jobber
— or Write for Bulletin 131Q*

Licensed under patents of the Brush Development Company
Shure patents pending

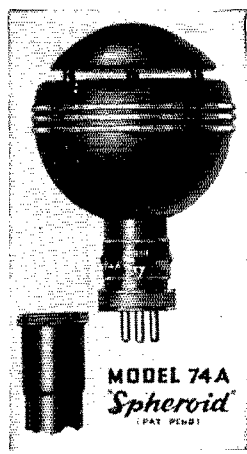

MODEL 74A
Spheroid
(PAT. PEND.)

The superlative performance features, together with the beautiful, distinctive modern appearance and low cost, make the "SPHEROID" the ultimate crystal microphone for high-quality sound reproduction. List price, Model 74A, complete with improved connectors as illustrated, **\$37.50** only.....

SHURE BROTHERS COMPANY

Manufacturers *Microphone Headquarters* Cable Address *SHUREMICRO*
Engineers
215 WEST HURON ST. CHICAGO, U. S. A.

20 TRANSMITTER CIRCUITS

THIS VALUABLE REFERENCE BOOK FREE!

Complete design for 12 tested transmitter R-F section circuits and 8 modulator and speech amplifier circuits.
Outputs ranging from the smallest to a big broadcaster.
Not only the circuit designs, but complete parts specifications. Listing transformers, inductances and all component parts. A complete handbook on transmitter design!

This valuable reference book sent you free. Just tear out this advertisement and send with 12c in stamps to cover mailing expenses in order to get your free copy. There is no further obligation. Hurry! The supply is limited.

STANDARD TRANSFORMER CORP., 856 Blackhawk Street, Chicago, Illinois.

STANDARD TRANSFORMER CORP., 856 Blackhawk Street, Chicago, Illinois

Please send me the Standard Manual of Transmitter Circuits. I am enclosing 12c in stamps.

Name

Address

City.....State.....

Say You Saw It in QST — It Identifies You and Helps QST

HOYT METERS for RADIO AMATEURS

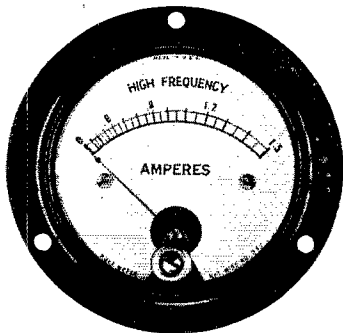

A COMPLETE line of panel mounting William-
meters, Ammeters, Voltmeters — D.C. and A.C.,
High Resistance D.C. Voltmeters, R.F. Antenna
Ammeters (Hot Wire Type), Pocket Battery Testers
in all popular ranges.

The *New Hot Wire Ammeter* for transmitter output is
particularly interesting. It is not affected by frequency
changes, comes in flush mounting bakelite case and is
supplied in the following ranges: 0/1.5; 0/3; 0/5
amps. Ask your Jobber for these instruments. Net
Price to amateurs \$3.58.

BURTON-ROGERS COMPANY

Sales Division of Hoyt Electrical Instrument Works

755 Boylston Street, Boston, Mass.

CRYSTALS for Every Purpose

From 50 to 10,000 Kcs. A Cut X Cut

Reasonably Priced

CRYSTALS FOR 80 OR 160M

A Cut \$3.95 X Cut \$2.95

Request Circular 52 for Complete Data

AMERICAN PIEZO SUPPLY COMPANY

Sunny Slope Sta., P. O. Box 6026

Kansas City, Missouri



RADIO ENGINEERING

RCA Institutes offers an intensive course of high standard
embracing all phases of Radio. Practical training with
modern equipment at New York and Chicago
schools. Also specialized courses and Home Study
Courses under "No obligation" plan.

Illustrated Catalog on request.

RCA INSTITUTES, INC. Dept. ST-35

75 Varick St., New York 1154 Merchandise Mart, Chicago

Recognized Standard in Radio Instruction Since 1909

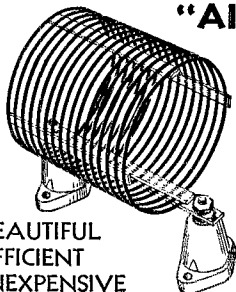

"AIR-WOUND"

TRADE MARK

COILS

NEWEST
NEATEST
FINEST MADE

Most Sizes Less
Than One Dollar

Descriptive Folder
on Request

- BEAUTIFUL
- EFFICIENT
- INEXPENSIVE

WESTERN RADIO PRODUCTS

Box 105, Alhambra, Calif.

World Championship Radio Code Speed Tournament

(Continued from page 24)

large measure by Charles Kolster, radio inspector for the First District. Other officials assisting in running the contest were: R. F. Tropp, code instructor at a Boston radio school; J. F. Rigby, superintendent of RCA, Boston, and Frank Borsody, W2AYN, Brooklyn, N. Y., who handled the actual transmission of the tape. Material for the contest was selected right at the time of the event, out of a heap of old newspapers. Each judge selected several thousands of words, and then handed the selection to Borsody who perforated what was necessary out of the entire lot. This is the first time that test material has been so selected. There could be no chance for any doubt or question. This angle too, met with unanimous approval of all contestants and their backers.

The first run (9 p.m. Saturday evening) was at 54 words per minute at which point all five contestants made perfect or nearly perfect copies. This was the kind of a starter that indicated the type of contestant, all positively the finest operators in the world. The next run was 58 words per minute at which point John Carter of RCA Boston, made several errors and was eliminated, although permitted to continue. This was Carter's first tournament appearance, 58 w.p.m. is extremely fast, and he must have been a bit nervous. Personally, I believe it to have been an excellent showing and believe that Carter will give us some headaches in future tournaments as he grows older and more experienced. The third run was at 61 w.p.m. at which point Chaplin made a large number of errors because of typewriter trouble. Chaplin is probably as fine an operator as ever hit a key, but is handicapped by lack of typing speed. At this speed Vincent Kearney, winner of the office tournament at Mackay Radio New York, was out on errors. Kearney probably would have been with all of us to the limit, excepting for his being handicapped by necessity for capital and small letters on the typewriter. Jack Donnelly, winner of the Hudson Division Convention speed test, also had typewriter trouble. All contestants were allowed to continue, however until final run of 69 words per minute. Up to this point I had made no errors of any kind whatsoever. I guess it was my lucky day.

At 69 words per minute I made what I thought at the time was a perfect copy. Check by the judges indicated that I'd made one error, I'd transcribed the word "inefficient" where it should have been "ineffective." So that the official judges' ruling was that I won with one error. It just goes to show that at that speed it is difficult to know that you've made a perfect copy.

It was a splendidly conducted contest, no friction and no questions. The contestants were friendly and they whole-heartedly congratulated me on winning and moreover I know they all really meant it. Joe Chaplin is such a brilliant operator the judges asked him over and over again if he didn't want another run. Joe asked, "Mac,

A NEW ATLAS TRANSMITTER CABINET

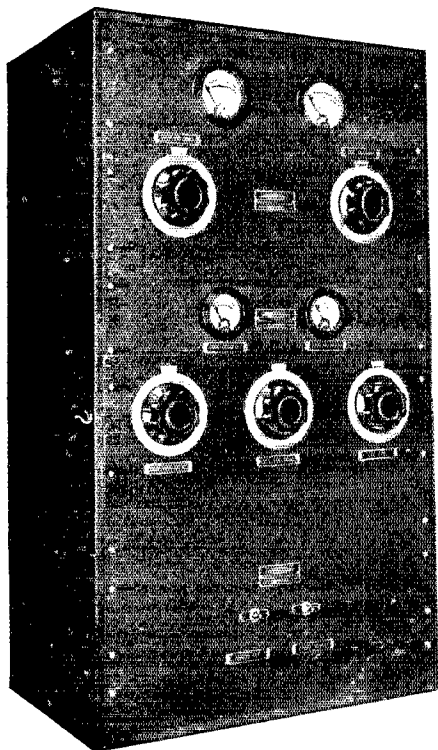

The trend in amateur and commercial transmitters is definitely toward cabinet type construction. Now for the first time you can obtain a commercial transmitter cabinet priced in the spirit of amateur radio. It is strong, beautifully finished inside and out and adds dignity to any station.

BUILT WITH CHARACTERISTIC ATLAS CAREFUL DESIGN

This new cabinet is welded to one piece rigidity. It stands 36 inches high, 20 inches wide and 13 inches deep. Two cabinets can be bolted together, one atop the other, making a six foot floor cabinet. The panel is 14 gauge steel, 35 inches by 19 inches. The face of the rack is drilled in standard relay rack measure and the panels may be cut up in multiples of 1 3/4 inches for individual mounting.

Three chassis pans of new design for supporting heavy parts are furnished, each with angle supports which serve as slides for the chassis. The chassis may be fastened to the sidewalls at any height. The chassis are usually, though not necessarily, bolted to the panel.

TRIPLEX BAKED ENAMEL FINISH

The entire cabinet is of heavy gauge steel with sides reinforced by double channel construction. Exterior finish baked black crackle enamel; interior and chassis finish, aluminum. Shipped complete with panel, three chassis and six chassis slide supports. Shipping weight 90 lbs.

Net price to amateurs.....

\$16.50

GENERAL TRANSFORMERS

MODULATION Class B 800, 830B, RK18, etc., to 5000 or 20,000 ohm load. No. 2340.....	\$4.85
MODULATION Class B 46, or 59 to 5000 or 10,000 ohm load. No. 2344.....	\$2.65
MODULATION Class B 210s to 5000 or 10,000 ohm load. No. 2348.....	\$4.70
INPUT 45s or 2A3s to Class B 830B or RK18. No. 3262.....	\$1.47
INPUT single 46 or 59 to Class B 46 or 59. No. 3272.....	\$1.62
INPUT PP 45s or 2A3s to Class B 210s. No. 3276.....	\$1.62

PATTERSON PR16 available soon. Complete with 16 tubes and speaker \$95.70. With crystal.....\$101.70

LAMTEX PANELS works like wood, looks like steel. Wrinkle enamel finish. 1/8" thick. 7 x 12, 25c. 7 x 18, 40c. 7 x 21, 50c. 12 x 18, 70c. 12 x 21, 80c.

CRYSTAL BLANKS average 1" square. Choice of 160, 80 and 40 meter. Y-cut, 65c. X-cut, 65c. AT-cut, \$1.25.

CRYSTAL GRINDING COMPOUND. Package of three grades.....\$0.20

NEW CATALOG Now Ready

Complete listing of amateur supplies, General transformers, Lamtex panels, Atlas Products. All standard products; National, Hammarlund, Johnson, RCA. 7000 items. Write for it.

NEW MULTI-CRYSTAL HOLDER

A small plug-in mounting that holds SIX SEPARATE CRYSTALS! 1 1/4 inches in diameter by 3 inches high. Plugs into large 7-prong socket. Switch controlled from transmitter panel quickly selects any one of six crystals. Holds large 1 inch square crystals ground for amateur bands. Constructed entirely of polished bakelite. Brass electrode plates and all metal parts nicked. Contact plates are hand lapped and tested. Dustproof. A beautiful job at a price within reach of all amateurs.....



\$3.75

DECALCOMANIAS 2 in. black and gold transfer letters. Station identification for car windows, transmitter fronts, etc. Any letter or number—ea. 5c. 25 for \$1.13. 50 for \$2.00.

QUARTZ CRAFT CRYSTALS strong oscillators, 1 inch square type. Choice of our stock. X-cut, 160, 80 — \$1.50. X-cut, 40 — \$2.90. AT-cut, coefficient 7-0 cycles/Megacycles/c. AT-cut, 160, 80 — \$3.50. AT-cut, 40 — \$3.90.

RCA TMV-135A V-Cut crystal. Temperature coefficient 2 cycles or less per meg. per degree. In improved holder, \$12.00. Holder only, pressure airgap type, \$2.50.

EIMAC TUBES 50T — \$13.50. 150T — \$24.50. Watch for 500T. Available soon!

RADIO LABORATORIES

1515 GRAND AVE. — KANSAS CITY, MO.

Amateur Headquarters in Kansas City

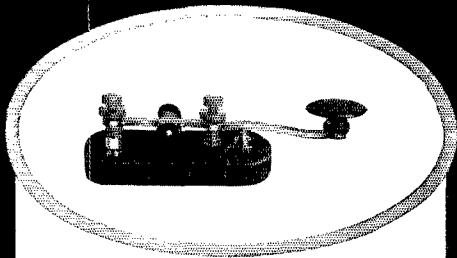

AMATEUR WIRELESS KEY

For amateurs who want an inexpensive, high-grade wireless key, here is the proper instrument. It is equipped with a heavy, cast base, black finish, coin silver contacts, composition knob and nickel parts. The list price is only \$1.50.

The SIGNAL line of telegraph instruments, wireless keys and wireless practice sets is complete. Send for literature.

SIGNAL ELECTRIC MFG. CO.
Menominee, Michigan, U. S. A.

SIGNAL
MANUFACTURERS OF ELECTRICAL PRODUCTS

The Ideal POWER SUPPLY for Your Portable Transceiver

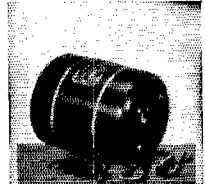

There is wide demand among the 5- and 10-meter crowd for the Pioneer Model "E" Dynamo. Input 6-V or 12; output 50 watts; 500 volts a maximum output. Write the factory for literature.

PIONEER GEN-E-MOTOR CORP.
466 W. Superior Street CHICAGO

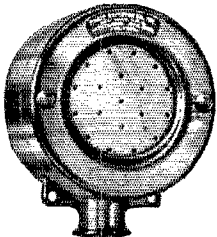

The Superiority of Our DYNAMIC MICROPHONE

Over Other Types Is Mainly in Its Sensitivity
No high gain preamplification required. No background noise. No Power Supply. AND THE PRICE **\$33**

U. S. PATENTS PENDING

Send for Bulletin 3011

RADIO RECEPTOR CO., INC.
110 Seventh Ave., New York City

whaddayuh think?" I said: "Joe, I'm all in, but we'll have it if you want." Joe, like the real guy he is, sez "Aw the —— with it. I'm tired too. Let's get outta here and get a few drinks." So ended the most important radio code tournament I've ever seen conducted.

It is only fair that I give credit to my own typewriter at this tournament. In previous ones I'd used a typewriter such as most telegraphers use. In this one I jumped the speed 12 words per minute largely because of the ease with which I could type. I had a machine with a little gadget on the back of it that you screw in or out to regulate the touch on the keys to get it just right for your own touch. After I'd accustomed myself to it, I found that it speeded me up a very great deal. All in all, my typewriter ran so smoothly that I just forgot all about it and focussed all my attention on reading the signals.

The only bit of advice I want to pass along to youngsters who hope some day to take the title away from me is this: get yourselves a good typewriter and a good short-wave receiver, and *sit down and practice ten or fifteen minutes a day and you'll be surprised at how quickly you'll develop speed.* For high speeds the typewriter is important.

I believe any good short-wave receiver will do the trick and of course I have my own favorite. If any reader of *QST* will address me in care of the magazine I'll be glad to give personal information on any angle of the tournament or any advice on attaining higher speeds. Just drop me a note. 73. Mac.

A New Receiving System for U. H. F.

(Continued from page 14)

quencies. The third detector is not influenced in any way by the tuning of the input of the receiver and the super-regenerative action can be set precisely and left alone. The metal-tube receiver illustrated has been given a very thorough run both on the air and with a General Radio Type 604-B signal generator. The sensitivity of the receiver is far beyond the limits of the signal generator since, at the minimum setting of the attenuator in the signal generator, the receiver is still producing enough clean tone substantially to overload the audio tube. The sensitivity is much better than 5 microvolts. The a.v.c. action is such that the attenuator on the signal generator can be swung across its limits with virtually no audible change in the output of the receiver. The selectivity of the receiver, as measured by varying the frequency of a single signal, indicates that the response is down ten times at 25 kc. off resonance. This figure, it is known, has very little significance from a practical operating standpoint because of the a.v.c. action in the receiver. A "two-signal" method would be necessary for an estimate of the actual operating selectivity, which is unquestionably considerably greater than the above figure.

[A fact not mentioned by Hull but made obvious by his experimental work is that the new

Announcing

A DISTINCTLY NEW CRYSTAL MICROPHONE DEVELOPMENT



The ASTATIC

■ A new principle! A new day for the Amateur! Now, a high quality microphone at a price within range of all! Frequency response is substantially flat to 5,000 cps., with a rising characteristic to 10,000 cps. Output level, approximately -64 db. Central application of power insuring perfect balance of forces transmitted. Beautifully finished in chromium with monel metal grill. Complete with socket and 8 ft. of two wire shielded cable. Hams, equip your transmitter with this remarkable new Astatic crystal microphone and make your station the most modern on the air. List price \$37.50. Usual discount to amateurs. See your jobber today.

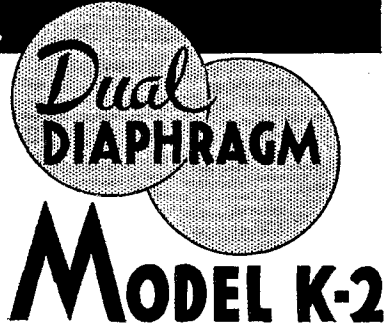

LICENSED UNDER BRUSH DEVELOPMENT COMPANY PATENTS

ASTATIC MICROPHONE LABORATORY, Inc. YOUNGSTOWN, O.
Pioneer Manufacturers of Quality Crystal Products

NORTHERN OHIO LABORATORIES

This Month's SPECIAL

- Sockets 4, 5, 6, prong. Each... \$0.7
- Coil forms 4, 5, 6 prong. Each... .21
- Two button mike. Each... 3.73
- Single button mike. Each... 1.76
- Tubes, types 80, 26. Each... .29
- Tubes 30, 56, 27, 45, 71 A... Each \$3.34
- Tubes 38, 82, 83, 57, 58. Each \$4.48
- Tubes 41, 47, 24A, 5Z3. Each \$4.48
- Tubes 2A5, 46, 77, 78, 19. Each \$5.53

METAL TUBES ALL TYPES IN STOCK

National isolantite sockets. For metal tubes. Each... \$3.36

AARS USNR

Let us supply crystals for your scheduled drills. Write for quotations.

GENERAL TRANSFORMER

High Voltage Plate
3000-4000 V CT. 1000 Watt. Net only... \$18.00

KESTER SOLDER

1 Pound Roll... \$5.55
Small Roll... \$10

Branches in following Ohio cities—
CAMBRIDGE, SHELBY AND SPRINGFIELD

NATIONAL RECEIVERS

— IN STOCK —

FB7A FBXA ACSW3 SRR AGSX
\$37.50 \$51.90 \$19.50 \$19.50 \$123.00

ABOVE ARE NET PRICES LESS COILS AND TUBES

FB-7A FB-XA AMATEUR RECEIVERS

Coils are available in the ranges listed below at list \$10.00 per pair, less 40%.

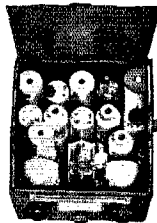

Catalog No.	Range
AB-20	20 meter band spread
AB-40	40 meter band spread
AB-80	80 meter band spread
AB-160	160 meter band spread
FB AA	34000 to 18000 KC
FB A	19500 to 11400 KC
FB B	11700 to 7000 KC
FB C	7300 to 4000 KC
FB D	4200 to 2400 KC
FB E	2500 to 1500 KC
FB F	1500 to 900 KC
AB-10 Coils Net	\$7.20

WRITE FOR NEW NATIONAL CATALOG TODAY
MAIL IMMEDIATE DELIVERY ORDERS

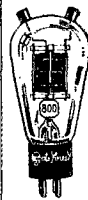

RCA IN STOCK

800	\$10.00
801	4.50
802	3.90
803	38.50
203A	17.50
838	18.00
841	3.25
866A	5.00
852	23.80
860	35.00
865	12.75
906	18.00
954	5.80
955	3.75

WHAT'S A MUGAWUG? New Mac-Key \$7.95 Speed-x bug \$5.70

Heavy Duty 866's. Each... \$1.29
80-160 X Crystals... 1.50
Billey BC2 Holders... 1.00
Isolantite Top 210's... 1.08
Crackle finish black paint, 1/2 pint. \$6.9

CATHODE-RAY OSCILLOGRAPH
RCA Type TMV-122-B. Complete with tube, \$84.50.

SPECIAL WE 211D tubes special... \$3.55

NATIONAL HRO #167.70

NORTHERN OHIO LABORATORIES
2073 WEST 85th STREET, CLEVELAND, OHIO

RCA AC1R-136
NET \$69.50

Say You Saw It in QST — It Identifies You and Helps QST

And the Answer to the demand for a quality Magnetic

is
the
"H
y
f
l
u
x"

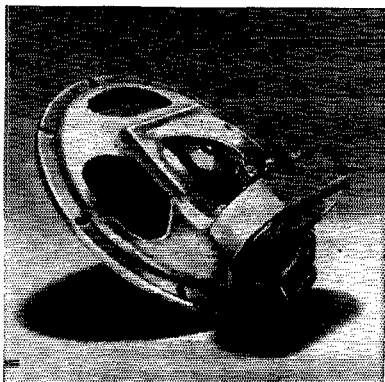

- High Efficiency
- Wide frequency range
- Permanent dust proofing
- Rugged construction

Write for Complete Details, Specifications, Prices

WRIGHT-DECOSTER, Inc.
2259 University Ave. St. Paul, Minn.

LEARN RADIO

New Classes Now
Forming! Send for 40-
page catalog, explains

fully, 190 licensed graduates placed in past 3 years in broad-
casting, shipping, police radio, aviation, etc. We teach all branches.
Oldest, largest and best equipped school in New England. Equipped
with Western Electric sound and broadcasting equipment and RCA
marine transmitter. Course prepares for United States Govern-
ment telegraph or telephone license.

MASS. RADIO SCHOOL, 18 Boylston Street, BOSTON

The **NEW**
TWICE-AS-BIG
HANDBOOK
see pages 6 and 7



TRI-DOT CALL-LETTER ASSEMBLY

Designed for
Any Operating Amateur

For the first time the Amateur may secure his CALL-
LETTERS arranged in a permanent form for mounting on
his transmitter or on the wall of his apparatus room. Tri-Dot
call-letter assembly consists of your CALL-LETTERS
made of 1 3/4" metal letters mounted on a holding bracket
and reinforced with a metal strip at the top. Over-all width
10 1/2". Price complete, prepaid, \$2.25. These are made spe-
cial to order, thus the full amount must accompany each
order. Please specify your call-letters and whether you
desire transmitter or wall-mounting style.

TRI-DOT MANUFACTURING COMPANY
1807 N. California Ave. Chicago, Illinois

system is at least equally valuable for the lower frequencies. In a ham receiver, particularly for 14 mc., the system is "a natural." For aircraft and police receivers, the scheme will doubtless find wide application.

We include the bare circuit of the receiver with this part of the article in order to facilitate an understanding of the system in general. The still more comprehensive Part II will contain these same circuits together with full details of constructional methods, lay-out considerations and the process of lining up the set. A glass-tube model and many circuit and lay-out modifications will also be discussed.—EDITOR.]

Standard Frequency Transmissions

Date	Schedule	Station	Date	Schedule	Station
Nov. 1	BB	W6XX	Nov. 30	BX	W6XX
	A	W9XAN	Dec. 1	C	W6XX
Nov. 2	BX	W6XX	Dec. 6	A	W6XX
Nov. 3	C	W6XX	Dec. 13	B	W9XAN
Nov. 8	A	W6XX		B	W6XX
Nov. 15	B	W9XAN	Dec. 18	C	W9XAN
	B	W6XX	Dec. 20	B	W9XAN
Nov. 20	C	W9XAN		A	W6XX
Nov. 22	B	W9XAN	Dec. 27	BB	W6XX
	A	W6XX		A	W9XAN
Nov. 27	BB	W9XAN	Dec. 28	BX	W6XX
Nov. 29	BB	W6XX	Dec. 29	C	W6XX
	A	W9XAN			

STANDARD FREQUENCY SCHEDULES

Time (p.m.)	Sched. and Freq. (kc.)		Time (p.m.)	Sched. and Freq. (kc.)	
	A	B		BB	C
8:00	3500	7000	4:00	7000	14,000
8:08	3600	7100	4:08	7100	14,100
8:16	3700	7200	4:16	7200	14,200
8:24	3800	7300	4:24	7300	14,300
8:32	3900		4:32		14,400
8:40	4000				

Time (a.m.)	Sched. & Freq. (kc.)	
	BX	
6:00	7000	
6:08	7100	
6:16	7200	
6:24	7300	

The time specified in the schedules is local standard time at the transmitting station. W9XAN uses Central Standard Time, and W6XX Pacific Standard Time.

TRANSMITTING PROCEDURE

The time allotted to each transmission is 8 minutes divided as follows:

2 minutes—QST QST QST de (station call letters).

3 minutes—Characteristic letter of station followed by call letters and statement of frequency. The characteristic letter of W9XAN is "O"; and that of W6XX is "M."

1 minute—Statement of frequency in kilocycles and announcement of next frequency.

2 minutes—Time allowed to change to next frequency.

W9XAN: Elgin Observatory, Elgin National Watch Company, Elgin, Ill., Frank D. Urie in charge

W6XX: Don Lee Broadcasting System, Los Angeles, Calif., Harold Perry in charge.

Schedules for WWV

EACH Tuesday, Wednesday and Friday (except legal holidays), the National Bureau of Standards station WWV will transmit on three frequencies as follows: noon to 1:00 p.m. E.S.T., 15,000 kc.; 1:15 to 2:15 p.m., 10,000 kc.; 2:30 to 3:30 p.m., 5000 kc. On each Tuesday and Friday the emissions are continuous unmodulated waves (c.w.); and on each Wednesday they are modulated by an audio frequency. The audio frequency is in general 1000 cycles per second.

Where to buy it

A directory of suppliers who carry in stock the products of these dependable manufacturers.

ASTATIC
Crystal Microphones and Pickups

ASTATIC MICROPHONE LABORATORY, Inc. YOUNGSTOWN, O.
Pioneer Manufacturers of Quality Crystal Products

CHICAGO, ILL. 833 West Jackson Blvd.
Allied Radio Corporation

CHICAGO, ILL. 601 W. Randolph St.
Pioneer Automotive Supply Co.

CHICAGO, ILL. 901-911 W. Jackson Blvd.
Wholesale Radio Service Company, Inc.

KANSAS CITY, MO. 1012-14 McGee St.
Burstein-Applebee Company

MINNEAPOLIS, MINN. 1124-26 Harmon Place
Lew Bonn Company

Super SKYRIDER
the hallicrafters

BUTLER, MISSOURI 211-215 N. Main Street
Henry Radio Shop

CHICAGO, ILLINOIS 415 S. Dearborn Street
Chicago Radio Apparatus Company

CHICAGO, ILLINOIS 520 S. State Street
Midwest Radio Mart

CHICAGO, ILLINOIS 226 W. Madison Street
Newark Electric Company

CHICAGO, ILL. 901-911 W. Jackson Blvd.
Wholesale Radio Service Company, Inc.

FARGO, N. D. 123 Broadway
Dakota Electric Supply Company

KANSAS CITY, MO. 1012 McGee Street
Burstein-Applebee Company

MINNEAPOLIS, MINN. 1124-26 Harmon Place
Lew Bonn Company

OMAHA, NEBRASKA 2855 Farnam St.
Radio Accessories Company

ST. LOUIS, MO. 927 Pine Street
Gordon Radio Company

E.F. JOHNSON COMPANY
MANUFACTURERS OF
TRANSMITTING RADIO EQUIPMENT
WASECA, MINN.
U.S.A.

CHICAGO, ILLINOIS 226 W. Madison Street
Newark Electric Company

CHICAGO, ILL. Midwest Radio Mart 520 S. State Street

CHICAGO, ILL. 901-911 W. Jackson Blvd.
Wholesale Radio Service Company, Inc.

CLEVELAND, OHIO 2073 West 85 Street
Northern Ohio Laboratories

DETROIT, MICHIGAN 129 Selden Avenue
Radio Distributing Company

FARGO, NORTH DAKOTA 123 Broadway
Dakota Electric Supply Co.

GRAND RAPIDS, MICH. 235 Market Street, S. W.
Radio Distributing Company

LA CROSSE, WIS. 131 South 6th St.
SOS Radio Supply Co.

MOLINE, ILL. 1420 5th Ave.
Bengston's Radio Store

WINNIPEG, CAN. 310 Ross Ave.
Electrical Supplies, Ltd.

NATIONAL
RADIO PRODUCTS
NATIONAL COMPANY, INC., MALDEN, MASS.

BUTLER, MISSOURI 211-215 N. Main Street
Henry Radio Shop

CHICAGO, ILLINOIS 520 S. State Street
Midwest Radio Mart

CHICAGO, ILLINOIS 833 W. Jackson Blvd.
Allied Radio Corporation

CHICAGO, ILLINOIS 415 S. Dearborn Street
Chicago Radio Apparatus Company

CHICAGO, ILLINOIS 226 W. Madison Street
Newark Electric Company

CHICAGO, ILL. 901-911 W. Jackson Blvd.
Wholesale Radio Service Company, Inc.

CINCINNATI, OHIO 633 Walnut Street
Steinberg's, Inc.

CLEVELAND, OHIO 2073 West 85 Street
Northern Ohio Laboratories

DAYTON, OHIO 140 E. 3rd Street
Burns Radio Company

DES MOINES, IOWA 1212 Grand Avenue
Iowa Radio Corporation

DETROIT, MICHIGAN 171 E. Jefferson Ave.
Radio Specialties Company

GRAND RAPIDS, MICH. 235 Market Street, S. W.
Radio Distributing Company

INDIANAPOLIS, IND. 316 N. Illinois Street
State Distributing Company

KANSAS CITY, MO. 1012 McGee Street
Burstein-Applebee Company

KANSAS CITY, MO. 1515 Grand Avenue
Radio Laboratories

Where to buy it

A directory of suppliers who carry in stock the products of these dependable manufacturers.

MILWAUKEE, WIS. Radio Parts Company 332 W. State Street

MINNEAPOLIS, MINN. 1124-26 Harmon Place
Lew Bonn Company

OMAHA, NEB. 2855 Farnham Street
Radio Accessories Company

PARIS, FRANCE
J. C. Balouzet, De Tigny, 6, Avenue Hoche

PEORIA, ILLINOIS 707 Main Street
Klaus Radio & Electric Company

ST. LOUIS, MO. 1100 Pine Street
Walter Ashe Radio Company

WINNIPEG, CAN. 310 Ross Ave.
Electrical Supplies, Ltd.



BUTLER, MO. Henry Radio Shop 211 N. Main St.

CHICAGO, ILL. 226 W. Madison Street
Newark Electric Company

CHICAGO, ILL. 833 W. Jackson Blvd.
Allied Radio Corporation

CHICAGO, ILL. 520 S. State Street
Midwest Radio Mart

CHICAGO, ILL. 901-911 W. Jackson Blvd.
Wholesale Radio Service Company, Inc.

CINCINNATI, OHIO 633 Walnut Street
Steinberg's, Inc.

CLEVELAND, OHIO 2073 West 85 Street
Northern Ohio Laboratories

CLEVELAND, OHIO 1301 Superior Avenue
Cleveland Distributing Co.

DETROIT, MICHIGAN 129 Selden Avenue
Radio Distributing Company

DETROIT, MICH. 171 E. Jefferson Ave.
Radio Specialties Co.

FARGO, NORTH DAKOTA 123 Broadway
Dakota Electric Supply Co.

FLINT, MICH. 203 W. Kearsley St.
Shand Radio Specialties

GRAND RAPIDS, MICH. 235 Market Street, S. W.
Radio Distributing Co.

KANSAS CITY, MO. 1012 McGee St.
Burstein-Applebee Company

LA CROSSE, WIS. 131 South 6th St.
SOS Radio Supply Co.

PEORIA, ILL. 707 Main Street
Klaus Radio & Electric Company



BUTLER, MO. Henry Radio Shop 211 N. Main St.

CHICAGO, ILL. 520 S. State Street
Midwest Radio Mart

CHICAGO, ILL. 226 W. Madison Street
Newark Electric Company

CHICAGO, ILLINOIS 833 W. Jackson Blvd.
Allied Radio Corporation

CHICAGO, ILLINOIS 415 S. Dearborn Street
Chicago Radio Apparatus Company

CHICAGO, ILL. 901-911 W. Jackson Blvd.
Wholesale Radio Service Company, Inc.

CINCINNATI, OHIO 633 Walnut St.
Steinberg's, Inc.

CINCINNATI, OHIO 111 East 5th Street
Krauss Radio Stores, Inc.

CLEVELAND, OHIO 2073 West 85 Street
Northern Ohio Laboratories

CLEVELAND, OHIO 610 Huron Road
Goldhamer, Inc.

COLUMBUS, OHIO 178 N. 3rd Street
Hughes-Peters Electric Corp.

DAYTON, OHIO 140 E. 3rd Street
Burns Radio Company

DES MOINES, IOWA 1212 Grand Avenue
Iowa Radio Corporation

DETROIT, MICHIGAN 1326 E. Congress Street
Aitken Radio Corp.

DETROIT, MICHIGAN 129 Selden Avenue
Radio Distributing Company

DETROIT, MICH. 171 E. Jefferson Ave.
Radio Specialties Co.

FARGO, N. D. 123 Broadway
Dakota Electric Supply Company

Where to buy it

A directory of suppliers who carry in stock the products of these dependable manufacturers.

GRAND RAPIDS, MICH. 235 Market Street, S. W.
Radio Distributing Company

MILWAUKEE, WISC. 720 N. Jackson St.
Taylor Electric Co.

MINNEAPOLIS, MINN. 1124-26 Harmon Place
Lew Bonn Company

PEORIA, ILL. 707 Main Street
Klaus Radio & Electric Company

TOLEDO, OHIO 1014 Madison Avenue
Aitken Radio Corp.

YOUNGSTOWN, OHIO 325 West Federal Street
Ross Radio Company

Microphone Headquarters



SHURE BROTHERS COMPANY
CHICAGO, ILLINOIS

CHICAGO, ILL. 520 S. State Street
Midwest Radio Mart

CHICAGO, ILL. 226 W. Madison Street
Newark Electric Company

CHICAGO, ILL. 833 W. Jackson Blvd.
Allied Radio Corp.

CHICAGO, ILL. 901-911 W. Jackson Blvd.
Wholesale Radio Service Company, Inc.

CLEVELAND, OHIO 610 Huron Road
Goldhamer, Inc.

DES MOINES, IOWA 1212 Grand Ave.
Iowa Radio Corporation

DETROIT, MICH. 5027 Hamilton Ave.
Rissi Bros.

DETROIT, MICH. 171 E. Jefferson Ave.
Radio Specialties Co.

ST. PAUL, MINN. 2168 Ann Arbor St.
R. R. & G. W. Bauman Co.

TOLEDO, OHIO 1014 Madison Ave.
Aitken Radio Corp.



**TRIPLET
INSTRUMENTS**

CHICAGO, ILL. 226 W. Madison Street
Newark Electric Company

CHICAGO, ILL. 520 S. State Street
Midwest Radio Mart

CHICAGO, ILL. 901-911 W. Jackson Blvd.
Wholesale Radio Service Company, Inc.

CINCINNATI, OHIO 633 Walnut Street
Steinberg's, Inc.

CLEVELAND, OHIO 610 Huron Road
Goldhamer, Inc.

DETROIT, MICH. 1326 E. Congress Street
Aitken Radio Corp.

DETROIT, MICH. 5027 Hamilton Ave.
Rissi Bros.

FARGO, N. D. 123 Broadway
Dakota Electric Supply Co.

TOLEDO, OHIO 1014 Madison Ave.
Aitken Radio Corp.



**United
TRANSMITTING TUBES**

CHICAGO, ILL. 226 W. Madison St.
Newark Electric Co.

CHICAGO, ILL. 520 S. State St.
Midwest Radio Mart

CLEVELAND, OHIO 2073 West 85th St.
Northern Ohio Laboratories

DETROIT, MICH. 171 E. Jefferson Ave.
Radio Specialties Co.

FARGO, N. D. 121-123 Broadway
Dakota Electric Supply Co.

FLINT, MICH. 711 W. Dayton St.
Wilke and Sessions

GULF RADIO SCHOOL

Radiotelegraphy

Radiotelephony

Radio Servicing

SECOND PORT } 1007 Carondelet Street
U. S. A. } NEW ORLEANS, LA.

"Quicker than a short circuit!"

LITTELFUSE

INSTRUMENT LITTELFUSES, for meters, 1/200 amp. up. HI-VOLT. LITTELFUSES for transmitters, etc. 1,000, 5,000 and 10,000 volt ranges, 1/16 amp. up. Neon Voltage Fuses and Indicators (Fattellites), 100, 250, 500, 1,000 and 2,000 volt ratings. Fuses for Aircraft, Auto, Radio and Fuse Mountings, etc. You will want to know about all these products — get new free catalog — write

Littelfuse Labs., 4246 Lincoln Ave., Chicago, Ill.



Thick cut, low drift "AH" cut crystals are from 2 to 40 times as stable as X or Y cuts.

"AH" FOR STABILITY, ACTIVITY

ORDER FROM YOUR DEALER — or direct

Crystals supplied within 10 Kc. of specified frequency or choice of dealer's stock.

1700-3500 Kc. 7000-7300 Kc.

"AH" 10	\$2.35	\$3.90
"AH" 5	3.90	5.90
"AH" 2	8.90	12.90

The number following "AH" is the drift in cycles per °C. per 1000 Kc.

WRITE FOR HIPOWER DEFUZZLER SHEET

IT'S FREE

HIPOWER CRYSTAL CO., 2035 W. Charleston St., Chicago, Ill.

Now ...

TURNER

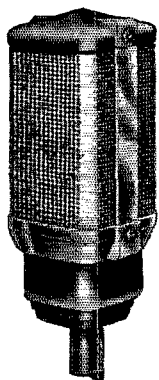

COORDINATED CRYSTAL EQUIPMENT

★ Turner now offers a complete line of amplifier equipment for the Amateur, Broadcast and Public Address operator. Every unit is engineered to realize the maximum possibilities of Turner Crystal microphones. A complete line-up of stands, cable and connectors are also available.

WRITE NOW FOR DESCRIPTIVE LITERATURE

Licensed under Patents of the Brush Development Co.

THE TURNER COMPANY
CEDAR RAPIDS, IOWA, U.S.A.

W6USA

(Continued from page 47)

of the operating position is a large, heavy-duty snap switch which opens the power line into the transmitter in case of emergency.

To the extreme right, next to the speech input panel, is an RCA oscilloscope, used for maintaining correct adjustments and modulation. To the left of the speech panel and at the operating position is the National HRO communication receiver, speaker and coils. To the left is the 5-meter transceiver which is used to work the local amateurs. At the extreme left is the ACR 136 RCA communication receiver. Both of the receivers are connected to a terminal panel at the extreme left of the table, which in turn is connected to an impedance matching transformer which leads out to the 132-foot Lynch Hi-Fi doublet antenna.

The station is normally open from 1 to 10 p.m. (P.S.T.) daily. An attempt is made to work as many amateurs as possible, but, due to a terrifically high noise-level at times, difficulty is had in hearing anything but an extremely strong signal. The best DX to date on 'phone was K7VF at Wrangel, Alaska, but of course the east coast has been worked many times on c.w. The station has had many favorable 'phone reports from eastern cities, but has not been able to contact many amateurs in the eastern part of the United States on account of the before-mentioned noise-level.

Book Reviews

(Continued from page 96)

Every owner and user of a cathode-ray oscilloscope should have his copy of this book. The first 109 pages are devoted to cathode-ray tube theory, sweep circuits, a.c. wave patterns and description of commercial oscilloscope units (the author prefers to call them "oscillographs"); the next 205 pages are packed with practical information on how to use them, including actual photographs of screen patterns representing just about every condition likely to be encountered in audio- and radio-frequency amplifiers, power supplies, complete receivers and transmitters.

Practical Radio Communication, by A. R. Nilson and J. L. Hornung. 754 pages, including an appendix of tabulated data and a complete topical index. 434 illustrations. Published by McGraw-Hill, New York. Price, \$5.00.

A new modern treatment meeting the expanded scope of today's technical requirements in the various commercial fields. The first six chapters are devoted to principles, the remaining nine to latest practice in broadcasting, police systems, aviation radio and marine communication.

Strays

Here's something to relieve the overworked penny of one of its time-honored duties. It's a plug-type fuse in which the low-melting point wire has been replaced by a globule of mercury, which expands in a special chamber and breaks the circuit when an overload occurs. The fuse can be put back in operating condition by "flipping" it much as one would to re-set a clinical thermometer. The fuse is made by the Ever-Nu Fuse Company, 919 N. Larobe Ave., Chicago.

HAM-ADS

(1) Advertising shall pertain to radio and shall be of nature of interest to radio amateurs or experimenters in their pursuit of the art.

(2) No display of any character will be accepted, nor can any special typographical arrangement, such as all or part capital letters be used which would tend to make one advertisement stand out from the others.

(3) The Ham-Ad rate is 15c per word, except as noted in paragraph (6) below.

(4) Remittance in full must accompany copy. No cash or contract discount or agency commission will be allowed.

(5) Closing date for Ham-Ads is the 25th of the second month preceding publication date.

(6) A special rate of 7c per word will apply to advertising which, in our judgment, is obviously non-commercial in nature and is placed and signed by a member of the American Radio Relay League. Thus, advertising of bona fide surplus equipment owned, used and for sale by an individual or apparatus offered for exchange or advertising inquiring for special equipment, if by a member of the American Radio Relay League takes the 7c rate. An attempt to deal in apparatus in quantity for profit, even if by an individual, is commercial and takes the 15c rate. Provisions of paragraphs (1), (2), (4) and (5) apply to all advertising in this column regardless of which rate may apply.

Having made no investigation of the advertisers in the classified columns, the publishers of *QST* are unable to vouch for their integrity or for the grade or character of the products advertised.

QUARTZ—direct importers from Brazil of best quality pure quartz suitable for making piezo-electric crystals. Diamond Drill Carbon Co., 719 World Bldg., New York City.

METER and microphone repairs. Low prices. Estimates free. Quick repair service—broadcasting equipment, all electrical instruments. Sound Engineering Corp., 2200 Kinzie, Chicago.

RADIO engineering, broadcasting, aviation and police radio, servicing, marine and Morse telegraphy taught thoroughly. All expenses low. Catalog free. Dodge's Institute, Byrd St., Valparaiso, Ind.

ENGRAVING instrument panels exclusively since 1925. A. L. Woody, 189 West Madison St., Chicago, Ill.

NATIONAL—Hammarlund, Patterson used sets, 60% off list. W3DQ, 405 Delaware Ave., Wilmington, Del.

QSLs, W2SN, Helmetta, N. J.

QSLs—125 for \$1. W8RW, Bluffton, Ohio.

.00035 variable condensers, 3 for \$1. W8RW, Bluffton, Ohio. 24/1500 dynamotor 350 watt. 750 volt tap, with extension shaft. Run 5 hours. Cost \$43. Sell for \$25. prepaid. M. C. Adams, Sheldon, N. Dak.

150 **QSLs**, two color, one buck. Mitchell, W5AIA, Watonga, Okla.

CLASS B transformers—Universal for two or four 46s, 210s, 800s, RK18s, etc., \$7.75 pair postpaid. 70 watts audio from 46s, 100 watts from 10s. Write for details. W8UD, Douglas, Mich.

QSL cards, two color, cartoons, message blanks, stationery, snappy service. Write for free samples to-day. W1BEF, 16 Stockbridge Ave., Lowell, Mass.

WANT wire instructograph Tapes W4DKM.

FIRST \$22. takes A1-RCA-849. \$35. for All-Star Sr. complete. Cost \$65. Want FBXA, W3BBV, York, Pa.

WANTED receiver. Any condition. 1528 48th. Des Moines, Iowa.

WANTED—good 1500 volt, 200-300 watt d.c. generator. F. Foxall, Raton, New Mexico.

BARGAIN, complete phone station having 400W. 1500V. power supply, eleven meters \$50. W9ROE, 632½ Ingersoll, Beloit, Wis.

QSLs, free samples, Printer, Corwith, Iowa.

TELEPHONE handset \$1.50. Relays 50¢, \$1.00. Want milliammeters. R. White, 11030 Hermosa, Chicago.

FOR sale—200 Watt crystal control phone transmitter and receiver complete \$225. Write for details. W8HBK 2613-109 Street Point Place, Toledo, O.

QSLs two color 90¢. Free samples. W9DGS, Jamestown, N. Dak.

CALLBOOKS—new Fall 1935 Radio Amateur Call Book, thousands of late W and VE calls, many pages of new DX QRA's and important changes in prefixes, is yours for \$1.25, or one year (four issues) for \$4.00. (In foreign countries \$1.35 and \$4.35, postpaid.) W9FO, 610 S. Dearborn, Chicago.

TRANSFORMERS and chokes—new—Hilet low resistance type, unmounted only at large savings. Also meters and miscellaneous material. Send stamp for lists. Leitch Radio, West Orange, N. J.

QSLs! **QSLs!** Unbeatable! Samples? (stamp) W8DED, Holland, Mich.

EIMAC tubes! Order from W8DED.

QST's 1923-24-25-26-27-28-29. What's your bid? Swap?—W8DED.

BLILEY crystals sent c.o.d. no down payment! BC3 \$3.95; LD2 \$4.80. W8DED, Holland, Mich.

FB7A Tubes 40M coils pwr supply \$35. 1413-24 Ave., Meridian, Mississippi.

WANT: FBXA, Band Spread Coils. F. H. Packard, M.S.M.C., Marine Aviation, Coronado, Cal.

WANTED: crystal oscillator-doubler. Also freq-meter monitor. W2EJM, 2013-77 Street, Brooklyn, N. Y.

PHONE transmitter, complete \$50. Will trade for 10 watt 5 meter transmitter and receiver. New Super-Skyrider, \$50. Snyder, 9194 Frankstown Rd., Wilkinsburg, Pa.

WANTED, complete low-power CW xtal transmitter, give description and price. W6MGC, 2901 You Street, Sacramento, California.

INTRODUCTORY offer. One order to an individual. Send \$1. and call letters for 100 two color modern QSL cards and six F.M.C. porcelain case mica low loss transmitting and receiving condensers. Any capacity up to .006 mfd. 5% capacity tolerance 2,000 volt test. Actually a \$7.50 value for \$1. Capacity color chart included. Filtermatic Mfg. Company, Tacony, Philadelphia, Penna.

C MELODY Buascher Saxophone—silver plated, portable mimeograph, both A1 condition, swap for transmitting equipment, W2AN.

NEW Receivers, some used, anything you need in radio. Palmer's Trading Post, Route One, Duluth, Minnesota.

SELL complete Gross Eagle \$8. Abramowitz, 445 E. 5th St., Brooklyn, N. Y.

WANTED—High class DX receiver. Perfect condition. Cash. Aubrey Bates, Brunswick, Ga.

FOR sale: AGSX like new with ABC standard coils 25 meter BS coils. Heinfling, 540 Rosedale Avenue, New York.

SELL—5 tube skyrider—\$27. W2DGF, 1401 Willoughby, Brooklyn, N. Y.

WANTED—used Rider's Manuals. State price. W1ABW, 4 Prospect St., Webster, Mass.

QSL's 300 one color cards, \$1. Samples. 2143 Indiana Avenue, Columbus, Ohio.

COMPLETE kilowatt rig equipment. Very reasonable. W9QS SW3 complete, tubes, power pack, 10-20-40-80-coils \$22.00. Delta class B 800's output transformer. \$7.00. W2LRZ, 1310 Prospect Ave., Bronx, N. Y. Apt. 62.

EXCHANGE Sylvania 865 for bug-key. W2HWO.

SELL—25 watt push-pull xmitter, \$7. Best offer takes 210's class-B modulator with speech amplifier. Want heavy duty xmitting equipment. W8FJU, Utica, Michigan.

ELECTROGRAPH—design, rewind your own power transformers. Direct reading slide rule gives turns, current capacity of wire, etc. Price \$1.00. S. & A. Co., 4715 Eichorn Ave., Cleveland, Ohio.

ALTERNATORS—110v. 60 cycle—500 watt, ball-bearing, compact, portable. Guaranteed \$27.50. W6GSJ.

QSL samples free! Original, colorful. Maleco, 1512 Eastern Parkway, Brooklyn, New York.

NEED cash, sacrifice latest Silver 5C superheterodyne with Bliley crystal, complete, guaranteed. \$55. Cost \$37. W8DVB.

CRYSTALS: unconditionally guaranteed. 160-80 meters within 10 kilocycles Y-cut \$1.00, X-cut \$1.35. within .1% Y-cut \$1.25, X-cut \$1.50. Blanks Y-cut 3—\$1.25, oscillating 60¢ each. I. F. 456 465 etc. \$2. Wright Laboratory, 5859 Glenwood, Chicago, Ill.

CRYSTALS, Y cut, guaranteed oscillators 80-160 meter bands \$1. postpaid. Herbert Addington, 2252 North LeClaire Avenue, Chicago.

AUTOMOBILE call letter plates. License tag type. 85¢ pair. Colors optional. W9AIN, Evansville, Ind.

THOSE "T-9" dependable X cut 40 meter crystals: \$1.50 within ten kilocycles. \$2. exact frequency. Postpaid. Accuracy .05% or better. Guaranteed strong oscillators, and are they good—just ask any user. First six orders received mentioning this offer get additional 40 meter, random frequency crystal free; locals excluded. "Edison's" Temple, Texas.

WANTED—wattmeter, etc. meters, photophone pickup or speaker, Rider's Manuals. W8FSP 2095 W. 15th St. Cleveland, Ohio.

CRYSTALS: Zero cut. Guaranteed to compensate at near zero without oven control. Your approximate frequency, 80 or 160 meters \$1.35. Ordinary zero cuts \$1.35 postpaid. Blanks 65¢, plug-in holders 75¢ dozen \$6. Fisher Laboratory, 4522 Norwood Street, San Diego, California.

SWAP—good 552 for 1000 v. supply W8DX.

SELL for cash, 500 watt phone and other high power parts. Write W8GTY

SELL McMurdo Silver 5C crystal super \$55. Alex Gallinson, 45 Paulison Ave., Passaic, N. J.

NEW! Postselection Filter-Speaker. Selectivity, tone, rivals crystal filter reception. See Sept. QST. EL-ME-AC COMPANY Box 72, Brighton (Boston) Mass.

SELL FBX, powerpack tubes, 7 sets coils, 20, 40, 80, C. D. E. F. excellent condition. \$50. Lieutenant Jordan, 203 Hanover, Annapolis, Md.

WIGY says: Must sell everything. Send for list of complete station, parts, radio magazines, etc. Lee Bates, 274 Main St., Worcester, Mass.

CRYSTALS:—Zero Coefficient "V" cut. Superior to "AT". 1715-4000 within five kilocycles. Ten cycle coefficient, \$2.25. Four cycle coefficient \$3.25. "X" cut, \$1.95. Forty meters, \$2.75. Holders. Request literature. Ham Crystals, 1104 Lincoln Place, Brooklyn, N. Y.

NEW peak preselector bandspread complete. Cost twenty seven dollars, take \$20. Carstarphen, Tarboro, N. C.

SELL—exchange, GE converter 110 d.c./110 a.c. 250 watt—want superhet. Levin 800 E 168 St. NYC.

WANTED: best and most powerful 160 meter phone transmitter and receiver, complete, that \$100. cash will buy. Give all details first letter. Send photo if possible. Herbert Case, Munising, Michigan.

FIRST \$22.50 takes National ACSW-3. Freshman Power Pack and coils 14-550 meters. Also sell Winchester Target Rifle. W9OC, Spencer, Iowa.

RECEIVERS—new and used sold and traded in. Hammarlunds, Nationals, RME9D, Skryder. Schwarz Radio Service, 15 Lawrence Ave., Dumont, N. J.

SELL—gross CB 25. tubes, coils, xtal holder, microphone. Make cash offer. W3FNT, Spring Grove, Penna.

METERS wanted. Buy, sell, exchange, repair. Maccubbin and Stanton, 7317 Richmond, Maplewood, Missouri.

VALPEY crystals! Order from WJEP.

W9ADN crystals. High activity types. Temperature coefficient 0.000002: 40—\$3.75, 80 at—\$4.00. Coefficient 0.00001: 80—\$2.50.

WESTERN Electric rack, 72", \$13. SW3 receiver, AC-DC, with four sets coils. \$21. Frequency meter, monitor and many other excellent items. Write for list—now. W2EQK, 1934 University Avenue, New York City.

SELL AC-SW3, 6 pairs coils, tubes, power supply, speaker, \$30. Melvin Schuler, Delano, Minn.

TRADING. \$500 machinist's, airplane and engine tools. Need transmitter parts and good receiver. F. E. Davidson, 601 West Jackson, Muncie, Indiana.

QSL's—samples—W1AZF, 83 Orange, Roslindale, Mass.

NEW 204A \$50, slightly used 204 \$15, metal plates. Alfred Fritz, 2411 Wells St. Ft. Wayne, Ind.

TRANSFORMERS—mounted. Porcelain stand-off terminals. 1500-1350-850-0-850-1350-1500, 500ma \$11.00; 300ma \$7.50. Trade-ins accepted as 1/4. Spear Manufacturing Company, Waterville, Ohio.

QSLs. The finest obtainable, at the lowest price. Two color, 75¢ per hundred. Free samples. W2FJE, 145 Lafayette Avenue, Brooklyn, N. Y.

SELL trade Midwest Sixteen All-Wave. Three stage two fifty amplifier Periman Oscillator Station-finder, Postel preselector, Electric Hair Clippers, Hand Press. Want Paterson Silver Skryder similar prefer band-spread. Preselector. Glenn Watt, Chanute, Kansas.

FOR sale. Complete amateur station and 10 k.w. mercury arc—bargain. W9MXX.

SELL, FBXA receiver, 80 meter coils, tubes. Perfect condition. Cash \$42. E. E. Huffman, 1 Notasulga Drive, Rome, Ga.

TELEPLEXES, Omnigraphs, Vibroplexes, meters receivers bought, sold, traded. Ryan Radio Co. Hannibal, Mo.

QSL's—your QRA on the map with something really new. Samples.—W8NWW.

SELL regenerative receiver, coils, tubes, speaker, complete \$17. J. Santangelo, 2533 Olivville Ave., Bronx, N. Y.

SELL or trade Triplett 1210 tube checker (new) \$15. Tobe condenser analyzer (new), \$7.50, UV211 tube, \$4.50, Sparton 4 tube converter, \$7, National d.c. 4 tube ham bandsread \$8, nickel jack pot machine, \$20, Webster DE amplifier and 2 button mike, \$15. Blum, 895 Ebner St., Columbus, Ohio.

QSLs, SWLs, modern, neat. Quality stock. Priced right. Samples? Stamps. W8ESN, Toledo, Ohio.

NATIONAL FB7, 4 coils, 5897 supply, tubes, \$37.50. Ryser, 1719 Major St., Salt Lake, Utah.

GUARANTEED crystals, 80-160 meter, X or Y cut. Exact frequency, 1" square, \$2.75. Within eight kilocycles, approximately 1" square, \$1.75. Within 15 kilocycles, less than 1", \$1.35. William Threm, W8FN, 4021 Davis Ave., Cheviot, Ohio.

FREE folder, crystals, blanks 50¢. Holders. Faberadio, Sandwich, Ill.

QSLs on quality stock. Samples. 5-Meter Print, 1112 5th Ave., South, Escanaba, Mich.

SNAPPIEST station in town—relay rack mounted Hi-power variable voltage QST specification transformer equipped. Edison Bs. Rectifier Engineering Service, 4837 Rockwood Rd., Cleveland, Ohio.

SELL, trade: Collins 32A transmitter, Silver 10F transmitter, latest model Comet Pro, WE276As, WE241A 1000 watters. Want Leica or Contax camera and equipment. W9ARA, Butler, Mo.

WANTED—high power telescope and microscope. Must be highest quality. Also telephoto lenses for Contax camera. Trade amateur gear. Give full description and state your needs. Bob Smith (W9LD), 1515 Grand Ave., Kansas City, Mo.

New
MICA CONDENSERS
Compact
ENCASED IN PORCELAIN



"HAMS" A Real Low-Loss . . . Leak Proof . . . Moisture Proof . . . Excellent Power Factor Condenser. Truly a remarkable Engineering achievement accomplished after many expensive and painstaking experiments. Really a precision unit at even a lower price than most ordinary condensers. Available in 2 1/4% capacity tolerance and 5000 Volt construction. Write for catalog sheet and color Chart.

AMAZING QSL OFFER—SEE HAM-ADS

See your nearest Jobber or write direct to:
FILTERMATIC MANUFACTURING CO.
Tacony, Philadelphia, Penna.



Mr. E. H. Kietzke, President of CREI and originator of the first thorough course in Practical Radio Engineering.

A BIG YEAR FOR RADIO ... How Big for YOU?

This is a year when ABILITY is wanted AND PAID FOR. Buying a man, regardless of ability, at the lowest price is a thing of the past. Prepare yourself for big opportunities by applying yourself to CREI Training. It's helped others and can help you.

New 48 Page CATALOG
Just off the Press

Illustrates and fully describes all courses. Write for your free copy.

RADIO ENGINEERING
Three Home study courses . . . Night and Day Residence Schools. Complete details in New Catalog.

Announcing a New Course in SERVICE ENGINEERING
For the exceptionally ambitious service man. A new Course at very low cost. Write for details at once.

**CAPITOL RADIO
ENGINEERING INSTITUTE**
14th and Park Road, N. W. Dept. Q-11
WASHINGTON, D. C.



Your Nearest Dealer Is Your Best Friend

Your nearest dealer is entitled to your patronage. You can trust him. He is equipped with a knowledge and understanding of amateur radio. He is your logical and safe source of advice and counsel on what equipment you should buy. His stock is complete. He can supply your needs without delay. His prices are fair and consistent with the high quality of the goods he carries. He is responsible to you and interested in you.

Patronize the dealer nearest you — You can have confidence in him

CHICAGO, ILLINOIS

Allied Radio Corporation
833 West Jackson Blvd.

Complete standard lines always in stock—W9NRV—W9JBC—W9RZI

KANSAS CITY, MISSOURI

Burstein-Applebee Company
1012-14 McGee Street
"Specialists" in supplies for the Amateur and Serviceman

KANSAS CITY, MISSOURI

Radio Laboratories
1515 Grand Avenue
Amateur Headquarters in Kansas City

CHICAGO, ILLINOIS

Chicago Radio Apparatus Company
415 South Dearborn Street (Est. 1921)

W9RA and W9PST — Amateurs since 1909

LOS ANGELES, CALIFORNIA

Pacific Radio Exchange, Inc.
729-31 South Main Street

Most completely diversified stock of amateur equipment in the West

CHICAGO, ILLINOIS

Mid-West Radio Mart
520 S. State Street
All standard lines carried in stock

MILWAUKEE, WISCONSIN

Radio Parts Company, Inc.
332 West State Street
Complete stock Nationally Known products

DENVER, COLORADO

Inter-State Radio & Supply Co.
1639 Tremont Place
Amateur Radio Headquarters in the Rocky Mountain Region

ST. PAUL, MINNESOTA

Lew Bonn Company
2484 University Avenue
Rex L. Munger, W9LIP, Sales Engineer

Radio Wholesaler

Complete Stock

DETROIT, MICHIGAN

Radio Specialties Company
171 E. Jefferson Avenue
Ham Supplies — National & Hammarlund Sets and Parts

SAN FRANCISCO, CALIFORNIA

Offenbach Electric Company, Ltd.
1452 Market Street

"The House of a Million Radio Parts"

DETROIT, MICHIGAN

Rissi Brothers
5027-31 Hamilton Ave. at Warren
W8KXX Manager Amateur Department

TORONTO, CANADA

A & A Radio Service Supply
101 Queen Street, West
Canada's foremost radio supply house

FRESNO, CALIFORNIA

Ports Mfg. Co.
3265 E. Belmont Ave.
Wholesale: RCA-Thordarson-Bliley. All Standard Lines

You Are Protected When You Buy From QST Advertisers

“Advertising for QST is accepted only from firms who, in the publisher's opinion, are of established integrity and whose products secure the approval of the technical staff of the American Radio Relay League.”

Quoted from QST's advertising rate card.

Every conceivable need of a radio amateur can be supplied by the advertisers in QST. And you will know the product has the approval of the League's technical staff.

For Your Convenience QST'S INDEX TO ADVERTISERS IN THIS ISSUE

Aerovox Corporation	94
Allen-Bradley Company	85
American Piezo Supply Company	98
Amperex Electronics Products, Inc.	76
Astatic Microphone Company	101
A.R.R.L. Application Blank	74
Calculators	72
Handbook	4, 5
License Manual	99
Publications	6
Supplies	99, 103
Birnbach Radio Company, Inc.	89
Biley Electric Company	91
Bud Radio, Inc.	91
Burgess Battery Company	81
Burton-Rogers Company	98
Candler System Company	93
Capitol Radio Engineering Institute	108
Carter, S. T.	93
Central Radio Laboratories	70
Cohen's Sons, I. S.	101
Collins Radio Company	Cov. 2
Communications Products, Inc.	77
Continental Carbon Company	88
Cornell-Dubilier Corporation	84
Coto-Coil Company	87
Delaware Radio Sales Company	101
Dodge's Institute	95
Eastern Radio Specialty Company	86
Eby, Inc., Hugh H.	86
Eitel-McCullough, Inc.	80
Electric Soldering Iron Company	88
Electro-Voice Manufacturing Company	95
Filtermatic Manufacturing Company	108
General Electric Company	111
General Radio Company	78
Gross Radio, Inc.	111
Gulf Radio School	106
Hallcrafters, Inc., The	75
Hammarlund Manufacturing Company	1
Harvey Radio Laboratories	84
Henry Radio Shop	89
Hipower Crystal Company	106
Instructograph Company	95
International Resistance Company	93
Johnson Company, E. F.	90
Leeds	79
Littelfuse Laboratories	106
Marine Radio Company	2
Massachusetts Radio School	102
Miller Company, J. W.	90
Mueller Electric Company	92
National Company, Inc.	69, 83, 92, Cov. 3
New York V. M. C. A.	91
Northern Ohio Laboratories	101
Ohmite Manufacturing Company	96
Pioneer Gen-E-Motor Corporation	100
Port Arthur College	89
Precision Piezo Service	93
Premier Crystal Laboratories	95
Radio Amateur Call Book, Inc.	82
Radio Laboratories	99
Radio Mfg. Engineers	87
Radio Receptor Corporation	100
Radio Shack	89
Radio Supply Company	99
Radio Transceiver Laboratories	96
RCA Institutes, Inc.	98
RCA Manufacturing Company	73, Cov. 4
Scientific Radio Service	91
Shuler Supply Company	101
Shure Brothers Company	97
Signal Electric Manufacturing Company	100
Standard Transformer Company	97
Teleplex Company	91
Tri-Dot Manufacturing Company	102
Trimma Radio Manufacturing Company	95
Triplett Electrical Instrument Corp.	71
Turner Company	106
United Radio Manufacturing Company	93
Universal Microphone Company	95
Ward Leonard Electric Company	94
Western Radio Products Company	98
Wright-DeCoster, Inc.	102

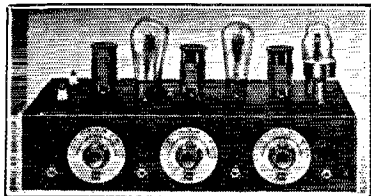

GROSS C C TRANSMITTER—OUTPUT 25-30 WATTS

The "CW-25" transmitter kit due to its low cost makes it possible for anyone to own a modern crystal controlled station. A schematic hook-up and parts layout sheet as well as tuning instructions are furnished, thus enabling the most inexperienced operator to wire and put the set on the air, for real results. The "CW-25" is supplied with a shrivel finished sturdy metal chassis under which all parts are mounted, making the wiring and components dust-proof. A plug-in crystal holder is furnished with the kit. Only one milliammeter is required for tuning the transmitter and each stage is provided with a jack for this purpose. The "CW-25" uses one

'47 as crystal oscillator, one '46 as buffer or doubler and two '46's in the amplifier stage, set of three coils supplied with kit for 20, 40, 80 or 160 band. Additional coils 75c each.

Complete kit, less tubes and crystal..... **\$14.95**

P-25 POWER SUPPLY—for CW-25 transmitter with matching chassis—450 volts at 200 Ma, choke input—complete kit, less tube **\$11.**

KEYING RELAY

will operate on one dry cell. Can be used as Single Pole Single Throw or Single Pole Double Throw. Sturdy construction, has 1/4" diameter Solid Silver Contacts. Compares favorably with expensive types. Special..... **59c**



OUTSTANDING !!

Gross Crystal Holder

WHITE CERAMIC commercial type crystal holder—priced at less than ordinary holders. Adjustable pressure, dust proof, no tools required to open. Takes crystal to 1 1/4" square. Plug standard 1/4" spacing. Most efficient job yet..... **\$1.00**

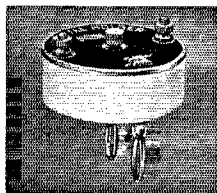

THORDARSON CASED TRANSFORMER

600 volts each side of C.T. 200 MA 2 1/2 V. 10 amps. C.T., 5 V. 3 amps. 7 1/2 V. 3 amps. C.T..... **\$2.45**

THORD. CHOKE 12 H 250 MA..... **\$1.95**

THORD. 15 H 250 MA CHOKES..... **\$2.95**

TAYLOR TRANSMITTING TUBES

825 Carbon Plate 40 Watts 750 V..... **\$ 4.95**
203-A Carbon Plate..... **12.50**
203-B Metal Plate..... **7.50**
HD-203-A Carbon Plate—out of top..... **17.50**

GROSS CASED POWER TRANSFORMERS

650 v. ea. side C.T. 350 ma. fila. 2-7 1/2 v C.T. and 1-5 v will give 500 v with choke input using 83 or 523 tubes. You can run your entire R.F. and class B off this trans..... **\$5.50**

750 v. ea. side C.T. 300 ma. fila. 2-7 1/2 v C.T. and 1-5 v..... **\$5.65**

750-1000 v. ea. side of C.T. 300 watts, **\$6.65**

850-1350-1500 v. ea. side of C.T. 400 watts..... **\$8.75**
(the ideal job to give 750-1000-1250 v D.C. with choke input)

850-1350-1500 v. ea. side of C.T. 550 ma..... **\$12.50**

1500-2000 v. ea. side of C.T. 800 watts, **\$11.70**

MOUNTED CENTER TAPPED FILAMENT TRANSFORMERS

2 1/2 v 8 a — 2 1/2 v 3 a — 5 v 3 a..... **\$1.29**

2 1/2 v 4 a — 7 1/2 v 2 1/2 a — 7 1/2 v 2 1/2 a..... **\$1.29**

2 1/2 v 4 a — 5 v 3 a — 7 1/2 v 2 1/2 a..... **1.29**

5 v 3 a — 7 1/2 v 2 1/2 a — 7 1/2 v 2 1/2 a..... **1.29**

2 1/2 v 6 a — CT (midjet)..... **.74**

5 v 3 a — CT (midjet)..... **.74**

6.3 v 1.5 a — CT (midjet)..... **.69**

7 1/2 v 3 a — CT (midjet)..... **.89**

FILAMENT TRANSFORMERS shielded in metal cases, center tapped secondaries

2.5 Volt 10 amperes for 866's..... **\$2.25**

10 to 12 Volts at 8 amperes..... **2.25**

Special 10-12 Volt 7.5 ampere filament transformer, extra special..... **\$1.10**

NEW!! HOYT BAKELITE CASE HOT WIRE ANTENNA METER

3 3/4" Across Flange, Mounts through 2 3/4" hole. Scale Length 1 1/2". Ranges: 0/1.5; 0/3; 0/5 Amps. **\$3.50**

GROSS CB-25 & CB-100 30 and 100 Watt Phone-CW Transmitters

Very specially priced

Write for data on these and other Gross Transmitters

NEW! HAMMARLUND SUPER PRO

Complete with tubes..... **\$198**
as above, with crystal..... **\$216**
Less 2% for Cash

GUARANTEED TUBES ISOLANTITE TOPS

800 Carbon Plate..... **\$4.90**
866-A 10,000 volts inverse Peak..... **\$1.85**
203-A Carbon Plate..... **\$8.45**

BARR DB3 TRANSCEIVER

less tubes, batteries and accessories. Bulletin on request..... **\$16.20**

EIMAC UNSURPASSED TRANSMITTING TUBES!

Performance—Ruggedness—Power—Price

50-T Output 75 to 250 watts..... **\$13.50**
150-T Output 150 to 450 watts..... **\$24.50**

GENERAL ELECTRIC PYRANOLS

We have been appointed distributors of this famous commercial line of capacitors now for the first time available to the amateur.

	1000 V.	1500 V.	2000 V.
	D.C.	D.C.	D.C.
1 mfd.....	\$1.78	\$2.23	\$3.12
2 mfd.....	2.67	3.71	4.75
4 mfd.....	4.16	5.35	6.53

ALADDIN IRON CORE I.F. TRANSFORMERS

456 KC Mica tuned..... **\$1.76**
456 KC Air tuned..... **3.25**

STEEL AND ALUMINUM RACK PANELS

BLACK CRYSTALLIZED LACQUER FINISH

STANDARD MOUNTING

19" long 1/8" thick

Width	Steel Panels Price	Aluminum Panels Price
1 3/4"	\$.58	\$.75
3 1/2"	.58	1.05
5 1/4"	.68	1.35
7"	.70	1.60
8 3/4"	.95	1.95
10 1/2"	1.15	2.50
12 1/4"	1.35	2.95
14"	1.55
15 3/4"	1.75	3.75
17 1/2"	1.95	3.98
19 1/4"	2.10	4.50
21"	2.40	5.25

RELAY RACKS

Constructed of very heavy gauge steel (about 1/8" thick). Finished thruout in black Shrivel Lacquer — Complete with all panels. Panels 1/8" thick.

Type R4: — with 4 panels 8 3/4" x 19". Overall size 21 1/4" wide, 39" high. Price..... **\$10.45**

20% DEPOSIT WITH ALL C. O. D. ORDERS REMIT BY M. O. INCLUDE POSTAGE Cable Address: GROSSINC

GROSS RADIO, INC., 51 VESEY STREET, NEW YORK CITY

EFFECTIVE SHIELDING

keeps out interference racketeers

You can't keep destructive interference off the air by calling in the G-men, but you can relieve your reception of this enemy to radio enjoyment by calling in the "G-E" men — by listening in on a General Electric Radio.

Here are five General Electric advantages that protect you from interference pumped into the ether: —

1. Sentry Box — Shields and isolates each R.F. circuit.
2. Metal Tubes — A continuous metal envelope eliminates noise and interaction between circuits.
3. Shielded Power Transformer — Eliminates stray hum.
4. Line Condenser — Keeps out interference via the power line.
5. V-Doublet Antenna — Minimizes man made interference on short-waves.

The 1936 General Electric Radio gives you a realism and fidelity of tone unlike anything you have ever heard before.

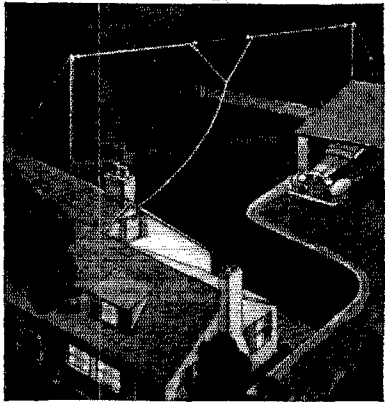
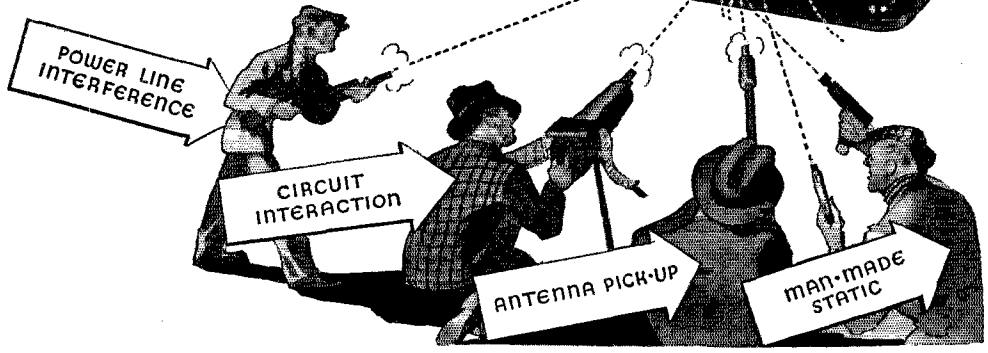
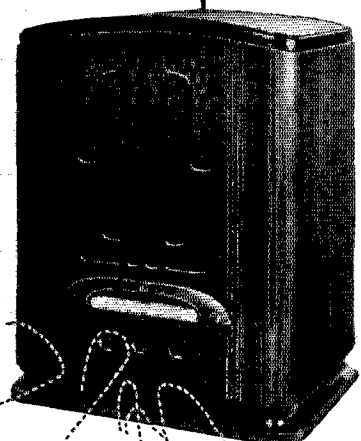

MODEL A-82 — IDEAL FOR DX-ERS

Short-wave listeners and amateur operators will find in Model A-82 many exclusive features that contribute to greatly improved performance — Permaliners • Sentry Box • Sliding-rule Tuning Scale • Stabilized Dynamic Speaker • Noise Control • Automatic Lo-note Compensation • Eight Metal Tubes • Four Bands of reception • CW Oscillator may be added.

\$94.50
(Eastern List Price)

G-E V-DOUBLET ANTENNA SYSTEM

This new antenna system, developed by General Electric, provides uniformly good reception on all short waves and all long waves alike . . . assures maximum receiver efficiency . . . minimum interference. This antenna is a V-Doublet below 55 meters and a conventional T-type broadcast antenna above 55 meters. Change over from one type to another is automatic. | \$5.95

Write for complete details of 1936 General Electric Radio and the V-Doublet Antenna System

GENERAL ELECTRIC

RADIO

MERCHANDISE DEPARTMENT, GENERAL ELECTRIC COMPANY, BRIDGEPORT, CONNECTICUT

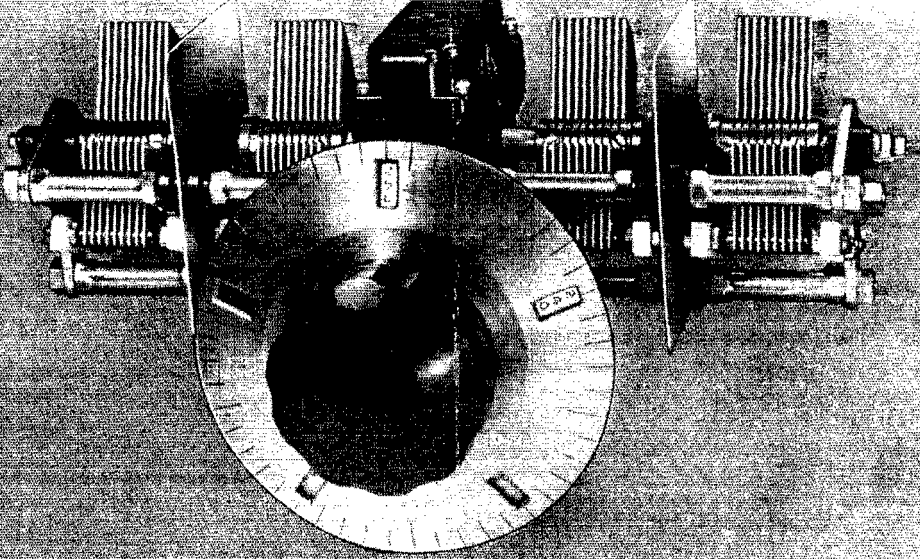

THE MICROMETER DIAL. The dial on the PW Precision Condenser is of an entirely new type, being direct reading to 1 part in 500. It is read exactly like an ordinary dial. Fifty division lines are engraved on the rim of the dial shell, and each tenth division is numbered in the usual way. However, the dial revolves ten times in covering the tuning range. Each revolution the numbers change automatically, giving continuous readings to 500. The numbers turn with the division lines, and change rapidly at the bottom of the dial when they are out of the operator's line of sight.

THE PRECISION CONDENSER. The condenser is of extremely rigid construction, with four bearings on the rotor shaft. The drive is through a preloaded worm gear of great accuracy. Each rotor is individually insulated from the frame by bakelite, each stator is individually insulated by low-loss Isolantite. End bearings are insulated for quietness. The condenser is mounted rigidly to the chassis by bosses on the base of the gear housing. Neither the frame nor the dial touches the chassis or panel at any point, making the assembly immune to bending of the chassis.

RANGES. The PW condensers are available in 1, 2, 3 or 4 sections with 150 or 225 mmf maximum per section. A new single section model now in preparation will provide capacities up to 500 mmf. The plate shape of all ranges is designed to give straight line frequency tuning when the frequency range is exactly 2 to 1.

NATIONAL COMPANY, INC. - **MALDEN, MASS.**

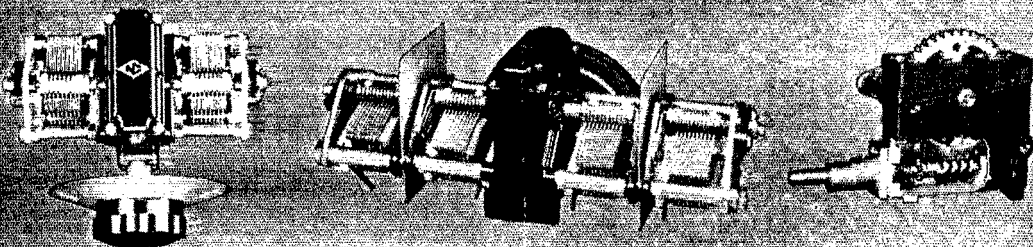

For those whose requirements
are most exacting

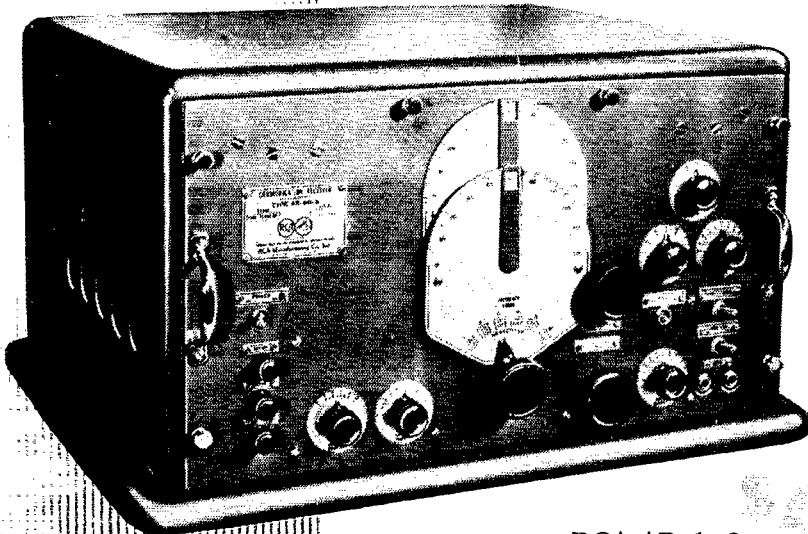

RCA AR-60-S
Rack mounting, \$475; black ripple-
finished case, \$485. Amateur net prices,
f. o. b. factory.

The new RCA AR-60 Receiver is built to meet the rigid requirements of commercial communication companies, and represents the ultimate in a general purpose high-frequency receiver. It is offered to those amateurs who can be satisfied only by the best available equipment. Available through your authorized sales outlet. Descriptive folder sent free on request. Send 25¢ in stamps for Service Notes and Operating Instructions, which give detailed specifications.



AMATEUR RADIO SECTION
RCA MFG. CO., CAMDEN, N. J., A SUBSIDIARY OF THE
RADIO CORPORATION OF AMERICA

Postage
Will be Paid
by
A. R. R. L.

No
Postage Stamp
Necessary
If mailed in
the United
States

BUSINESS REPLY CARD

FIRST CLASS PERMIT NO. 1, SEC. 510 P. L. & R. HARTFORD, CONN.

AMERICAN RADIO RELAY LEAGUE

38 LA SALLE ROAD

WEST HARTFORD, CONN., U.S.A.



MEMBERSHIP—SUBSCRIPTION ORDER CARD

Please enter my A. R. R. L. membership-QST subscription for one year and send me bill for \$2.50.* Begin QST with.....issue.

Name _____

Address _____

*This order card applicable only for United States and Possessions, and Canada.