

QST 

amateur radio

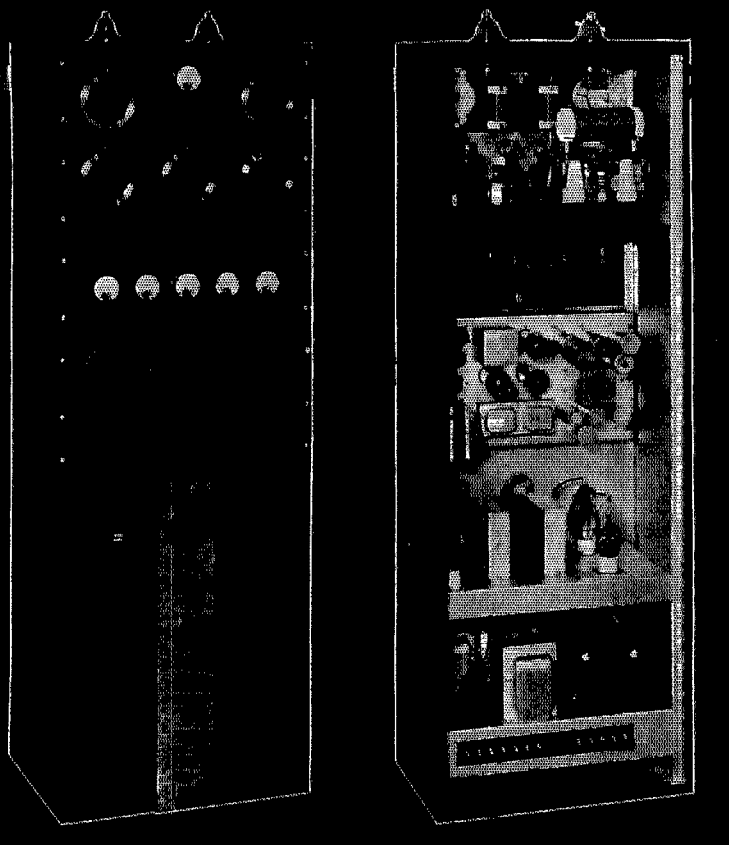



**JOIN THE DISTINGUISHED
GROUP OF STATIONS WHICH
ARE EQUIPPED WITH THE
30 FXB. THEY ARE MAKING
THE OUTSTANDING RECORDS
ON THE AIR**

**THE 30 FXB HAS MANY
VALUABLE FEATURES
WHICH ARE FOUND
ONLY IN COLLINS
TRANSMITTERS**

POWER OUTPUT

100 watts CW and PHONE.

FREQUENCY RANGE

1500-15,000 kc.

FREQUENCY CONTROL

Direct crystal control with provision for use of temperature control.

TUBES

203A in final modulated by 830B's. A flexible arrangement permits similar types to be substituted.

FIXED NEUTRALIZATION

an exclusive *COLLINS* feature. All neutralization adjustments in the 30 FXB Transmitter are fixed at the factory so that the user does not have to do any balancing of the various circuits. Shifting from one band to another is merely a matter of changing the plug-in coils and setting the dials to the calibrated position.

SPEECH EQUIPMENT

The 7C High Fidelity Speech Amplifier is an integral part of the transmitter. Gain: 110 db. Frequency range: 30-12,000 c.p.s. No pre-amplifier is required with low level microphones.

DIMENSIONS

55 inches high, 19 1/4 inches wide, 12 inches deep.

ANTENNA TUNING

The 2C pi Section Antenna Matching Network is furnished as standard equipment. This provision makes it possible to connect the 30 FXB to any available antenna and to accomplish efficient energy transfer with proper attenuation of harmonics.

Write for information on this moderately priced transmitter and regarding a wide range of other transmitting and speech equipment

SYLVANIA GRAPHITE ANODES MAKE GOOD IN ARCTIC!



"S. S. MORRISSEY"
TRANSMITTER
100% SYLVANIA
EQUIPPED



HIRSH PERCY MAXIM, President CHAS. H. STUART, Vice-President		F. B. HANDY Communications Manager		A. A. HERBERT, Treasurer K. B. WARNER, Secretary	
THE AMERICAN RADIO RELAY LEAGUE					
HEADQUARTERS WEST HARTFORD CONN. U. S. A.					
RADIOGRAM					
CITY OF ORIGIN "SS" MORRISSEY	STATION OF ORIGIN W10XA	NUMBER 125	DATE AUG 25	CHECK	
TO SALES MANAGER, HYGRADE SYLVANIA CORP. CLIFTON N. J. <small>(STREET AND NUMBER OR PHONE)</small>		THIS MESSAGE WAS RECEIVED AT AMATEUR RADIO STATION <u>W10XA</u> OWNER <u>R. W. NEWBY</u> STREET ADDRESS _____ PHONE _____ CITY AND STATE <u>RAYNE N. J.</u>			
YOUR TUBES HAVE STOOD THE GAFF IN GREAT SHAPE AND GIVEN US SPLENDID RESULTS. WE ARE A LONG WAY FROM YOU BUT YOUR TUBES PUT IT ACROSS EVERY TIME. SINCERELY (SIG) R. A. BARTLETT. "SS" MORRISSEY					
SEND NO ADDRESS AND PHONE NUMBER FOR RECEIVING.					
Rec'd	FROM STATION W10XA	LOCATED AT ARCTIC OCEAN	DATE AUG 25	TIME 2:15PM EDT	OPERATOR JT-JM
Sent	TO STATION MAILED	ABOVE	AUG 25	4:00PM	RN
PRINTED IN U. S. A. PLEASE READ OTHER SIDE - IMPORTANT					

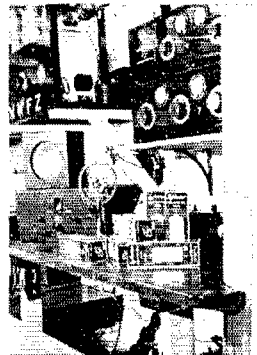
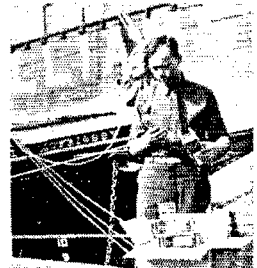

HYGRADE SYLVANIA CORPORATION

ELECTRONICS DEPARTMENT
AMATEUR RADIO DIVISION

CLIFTON NEW JERSEY



Say You Saw It in QST — It Identifies You and Helps QST



BURGESS LEADS AGAIN WITH THE NEW "Little" UNIPLEX (No. 4F4H)

Once more BURGESS Engineers present a new battery development—the BURGESS "Little" UNIPLEX. Like the standard UNIPLEX, it is built in a strong, all metal, wear-resistant waterproof container. Its electrical capacity is fully equivalent to the larger battery, but it is 30% smaller and weighs 40% less! The space and weight saving recommend the "Little" UNIPLEX particularly for portable equipment. These are its characteristics:

Rated voltage	6 volts
Rated capacity	160 watt-hours*
Weight	6.2 pounds
Size	5.75" x 8.50" x 2.88"
Designation	No. 4F4H

*Capacity varies, of course, with the nature of the application. This rating is based on typical usage.)

In the photograph above you see M. J. Dyrud, BURGESS Sales Engineer, comparing the "Little" UNIPLEX with the standard UNIPLEX. If you were to visit our factories in Freeport, Mr. Dyrud would gladly show you how we build the new UNIPLEX, and other recent BURGESS battery developments, from No. 10 (Bureau of Standards Designation F) cells. BURGESS BATTERY COMPANY, Freeport, Illinois.

≡ BURGESS ≡

QST

Published monthly, as its official organ, by the American Radio Relay League, Inc., at West Hartford, Conn., U. S. A.; Official Organ of the International Amateur Radio Union

devoted entirely to

AMATEUR RADIO



Editorials	7
Coming Activities	8
'Phone Transmission With Voice-Controlled Carrier Power <i>G. W. Fyler, W2HLM</i>	9
Modern Design of High-Frequency Stages for Amateur Superhets <i>James Millen, W1HRX and Dana Bacon W1BZR</i>	13
A General Purpose 50-Watt Transmitter <i>George Grammer</i>	16
An Improvement in Twisted Pair Feeders <i>Robert C. Graham, W8LUQ</i>	22
What the League Is Doing	24
Practical Operating Advantages of Low Temperature-Frequency Coefficient Crystals <i>F. C. Baldwin and S. A. Bokovoy</i>	26
Doublet Receiving Antenna and Bucking Circuit for Duplex Opera- tion <i>Stuart W. Seeley, W8ZC</i>	28
More on Gaseous Voltage Regulators for Receiver "B" Supplies <i>H. A. Robinson, W3LW</i>	29
One Ham's Journey	31
Hamdom	32
Shootin' the Works <i>Lawrence E. Hauck, W9CYV</i>	33
Better Crystal Stability Without a Heater Oven <i>Everett L. Dillard, W9BKO</i>	34
Progress on the Ultra-High Frequencies <i>Ross A. Hull</i>	35
Cutting Quartz Crystal Plates <i>Ivan H. Loucks, W9ON</i>	36
Bureau of Standards Extends S. F. Service	39
Canada-U. S. A. Contest Results	40
With the Affiliated Clubs	42
For the Experimenter	
POWER SUPPLY FOR MULTI-STAGE TRANSMITTERS — NOTE ON THE "R" CIRCUIT — FILAMENT VOLTAGE REGULATOR — ELIMINATING HUM MODULATION — REMOTE CONTROL, PUSH- TO-TALK — ELIMINATING THE KEYING RELAY BATTERY — SLIDING BUG WEIGHT — ANTENNA SUPPORTS	43
Amateur Radio Stations <i>W9DUD, W2GIA, W6JYH</i>	46
I. A. R. U. News	48
Strays	49
Operating News	51
Blue Glow in Tubes	66
Silent Keys	66
Correspondence Department	67
Book Review	86
Hamads	106
QST's Index of Advertisers	110

JANUARY 1935

VOLUME XIX
NUMBER 1

Kenneth B. Warner (Secretary, A.R.R.L.), *Editor-in-Chief and Business Manager*; **Ross A. Hull**, *Associate Editor*; **James J. Lamb**, *Technical Editor*; **George Grammer**, *Assistant Technical Editor*; **Clark C. Rodimon**, *Managing Editor*; **David H. Houghton**, *Circulation Manager*; **F. Cheyney Beekley**, *Advertising Manager*; **Ursula M. Chamberlain**, *Assistant Advertising Manager*.

Editorial and Advertising Offices
38 La Salle Road, West Hartford, Conn.

Subscription rate in United States and Possessions and Canada, \$2.50 per year, postpaid; all other countries, \$3.00 per year, postpaid. Single copies, 25 cents. Foreign remittances should be by international postal or express money order or bank draft negotiable in the U. S. and for an equivalent amount in U. S. funds.

Entered as second-class matter May 29, 1919, at the post office at Hartford, Connecticut, under the Act of March 3, 1879. Acceptance for mailing at special rate of postage provided for in section 1103, Act of October 3, 1917, authorized September 9, 1922. Additional entry at Concord, N. H., authorized February 21, 1929, under the Act of February 28, 1925.

Copyright 1934 by the American Radio Relay League, Inc.
Title registered at United States Patent Office.

HAMMARLUND

CHOKES are BETTER

BETTER
in Design,
Mechanical
Construction,
Electrical
Features!

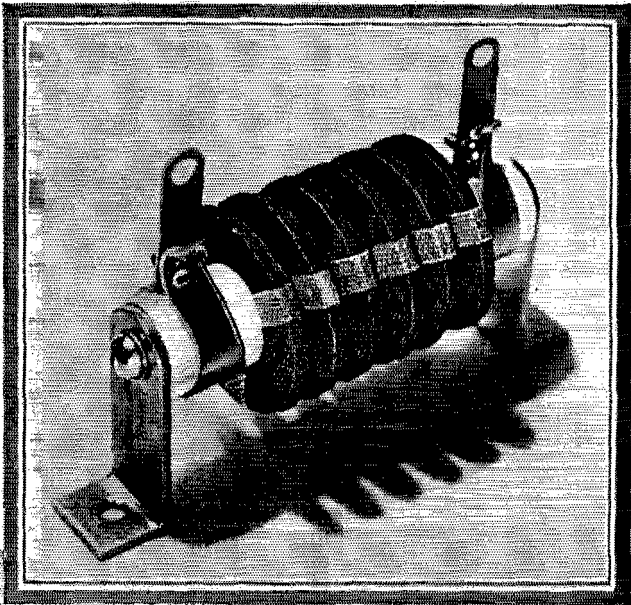

CH-500 TRANSMITTER CHOKE

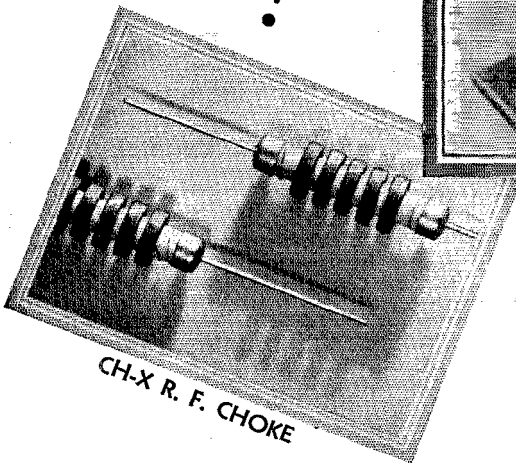

CH-X R. F. CHOKE

The HAMMARLUND CH-X Choke is the smallest and lightest made. Its features are exclusive. Only $\frac{1}{2}$ " x $1\frac{1}{2}$ ", it is small enough for restricted spaces, and so light that the tinned copper leads are ample support. Leads extend straight from the end caps.

This makes for neater wiring. End caps are small, thin and so spaced that distributed capacity to adjacent coils is at a minimum. Inductance 2.1 mh. Isolantite core. Priced so low it can be used generously wherever R.F. filtering is desirable — such as detector plate circuits, all B+ leads, grid leads, etc. Only 75c each, less 40% to experimenters.

The Hammarlund "CH-500" Heavy-Duty Transmitter Choke delivers its highest useful impedance (*more than 500,000 ohms*) precisely where wanted — at the 20, 40, 80 and 160-meter amateur bands. Inductance 2.5 mh. Distributed capacity less than 1.5 mmf. DC resistance 8 ohms. Maximum recommended DC (*continuous*) 500 milliamperes. Isolantite core, with *no metal through center*. Mounts with a single machine screw, with brackets removed. \$1.75, less 40% to experimenters.

Mail Coupon for Details



HAMMARLUND MANUFACTURING CO.
424-438 W. 33rd St., New York

Check here and attach 10c for 16-page Hammarlund 1935 Short-Wave Manual, illustrating and describing most popular S-W circuits of past year, with schematic and picture diagrams and parts lists. Check here for FREE information on Hammarlund Chokes. Check here for FREE new 1935 General Catalog.

Name

Address

.....Q-1



Section Communications Managers of the A.R.R.L. Communications Department

All appointments in the League's field organization are made by the proper S.C.M., elected by members in each Section listed. Mail your S.C.M. (on the 16th of each month) a postal covering your radio activities for the previous 30 days. Tell him your DX, plans for experimenting, results in 'phone and traffic. He is interested, whether you are an A.R.R.L. member or get your QST at the newsstands; he wants a report from every active ham. If interested and qualified for O.R.S., O.P.S. or other appointments he can tell you about them, too.

Eastern Pennsylvania Maryland-Delaware-District of Columbia Southern New Jersey Western New York Western Pennsylvania	W3GS W3BAK W3QL W8DSP W8CUG	ATLANTIC DIVISION Jack Wagenseller Edgar L. Hudson Gedney Rigor Don Farrell C. H. Grossarth	26 Meadowbrook Ave. 412 2nd Ave. 213 Hickock Ave. R. F. D. 3, Eicher Rd.	Llanerch, Upper Llanby Laurel, Delaware Haddon Heights Syracuse Emsworth, Bellevue, Pa.
Illinois Indiana Kentucky Michigan Ohio Wisconsin	W9WR W9TE W9AUH W8DVH W8CJO W9FSS	CENTRAL DIVISION Fred J. Hinds Arthur L. Braun G. W. Mossbarger Kenneth F. Conroy Robert P. Irvine Harold H. Kurth	6618 West 34th St. 911 Reiser St. Box 177 7538 E. Robinwood Ave. 5508 Northcliffe Ave. 9 South Randall Ave.	Berwyn Indianapolis Camp Taylor Detroit Cleveland Madison
North Dakota South Dakota Northern Minnesota Southern Minnesota	W9JVP W9PFI W9JIE W9DEI	DAKOTA DIVISION Fred J. Wells Mike G. Strahan Robert C. Harshberger Francis C. Kramer	1022 11th St., S. 601 S. Grange Ave. 1200 Fauquier St. W. Bluff St.	Fargo Sioux Falls St. Paul St. Charles
Arkansas Louisiana Mississippi Tennessee	W5ABF W5DWVW W5CWO W4BBT	DELTA DIVISION H. E. Velte W. J. Wilkinson, Jr. J. H. Weems, Jr. Merrill B. Parker, Jr.	2918 West 15th St. 1624 Allen Ave. P. O. Box 244 1912 Oak St.	Little Rock Shreveport State College Chattanooga
Eastern New York N. Y. C. & Long Island Northern New Jersey*	W2LU W2AZV W2FOP	HUDSON DIVISION Robert E. Haight E. L. Baunach Charles J. Hammersen	1080 Helderberg Ave. 7823 10th Ave. 92 Claremont Ave.	Schenectady Brooklyn Verona
Iowa Kansas Missouri Nebraska	W9LEZ W9FLG W9EYG-JPT W9FAM	MIDWEST DIVISION Phil D. Boardman O. J. Spetter C. R. Cannady Samuel C. Wallace	325 Kirkwood Blvd. 305 Western Ave. Broadway at Ninth Green St.	Davenport Topeka Monett Clarks
Connecticut Maine Eastern Massachusetts Western Massachusetts New Hampshire Rhode Island Vermont	W1CTI W1CDX W1ASI W1BVR W1APK W1QR W1ATF	NEW ENGLAND DIVISION Frederick Ellis, Jr. John W. Singleton Joseph A. Mullen Percy C. Noble Basil Cutting Albert J. King Harry Page	19 Merrill Rd. 10 High Street 218 Jamaicaaway 37 Broad St. 70 Metropolitan Park Dr. R. 1	Norwalk Wilton Jamaica Plain Westfield Pembroke East Providence Hinesburg
Alaska Idaho* Montana Oregon Washington	K7PO W7NH W7AAT W7AMF W7AYO	NORTHWESTERN DIVISION Richard J. Fox Nellie H. Hart O. W. Viers Frank L. Black Stanley J. Belliveau	Box 301 Box 6 Box 265 1502 McPherson St. Route 7, Box 387	Ketchikan Twin Falls Red Lodge North Bend Yakima
Hawaii Nevada Los Angeles Santa Clara Valley East Bay San Francisco Sacramento Valley Arizona Philippines San Diego San Joaquin Valley	K6EWO W6EAD W6BPU W6BMW W6ZX W6CAL W6DVE W6BIF-W6QC KALXA W6EOP W6FFP	PACIFIC DIVISION Atlas O. Adams Keston L. Ramsay Howell C. Brown Charles J. Camp P. W. Dann Byron Goodman Geo. L. Woodington Ernest Mendoza Newton E. Thompson Harry A. Ambler Clyde C. Anderson	21st Infantry Brigade 1151 Buena Vista Ave. 120 N. El Molino Ave. 318 Hawthorne Ave. 1821 Chestnut St. 141 Alton Ave. 716 Redwood Ave. 1434 East Madison St. P. O. Box 849 4101 Hamilton St. 931 Orange Ave.	Schofield Barracks Reno Pasadena Palo Alto Berkeley San Francisco North Sacramento Phoenix Manila, P. I. San Diego Fresno
North Carolina* Virginia West Virginia	W4EG W3BRV W8HD	ROANOKE DIVISION N. M. Patterson Neil E. Henry C. S. Hoffmann, Jr.	2804 Hillsboro St. 1017 Knight St. 100 20th St.	Raleigh Lynchburg Warwood, Wheeling
Colorado Utah-Wyoming	W9BTO W6QCC-IDM	ROCKY MOUNTAIN DIVISION T. R. Becker Arty W. Clark	1176 Gaylord St. 260 So. 9th West	Denver Salt Lake City, Utah
Alabama Eastern Florida Western Florida Georgia-So. Carolina-Cuba- Ile-of-Pines-Porto Rico- Virgin Islands	W4KP W4BCZ W4MS W4CE	SOUTHEASTERN DIVISION L. D. Elwell Philip A. McMasters Edward F. Collins Bannie L. Stewart	1066 Waverly St. 212 9th St., North 1517 East Brainard St. 310 Orange St.	Tarrant St. Petersburg Pensacola Georgetown, S. C.
Northern Texas Oklahoma Southern Texas New Mexico	W5AIL W3CEZ W5ADZ W5DUI	WEST GULF DIVISION Glen E. Falbutt Carter L. Simpson Bradfield A. Beard Dan W. De Lay	1133 Amarillo St. 3010 So. 4th St. 3030 Quenby Road 407 South Girard St.	Abilene Ponca City Houston Albuquerque
Maritime	VE1DQ	MARITIME DIVISION A. M. Crowell	69 Dublin St.	Halifax, N. S.
Ontario	VE3GT	ONTARIO DIVISION S. B. Trainer, Jr.	4 Shorncliffe Ave.	Toronto
Quebec	VE2GA	QUEBEC DIVISION J. A. Robertson	245 Edson Ave.	St. Lambert, P. Q.
Alberta British Columbia	VE4GD VE5AC	VANALTA DIVISION J. Smalley, Jr. R. K. Town	611 1st Ave., N. W. 1754 Graveley St.	Calgary Vancouver
Manitoba Saskatchewan	VE4GC VE4EL	PRAIRIE DIVISION Reg. Strong Wilfred Skaife	711 Ashburn St. 2040 McTavish St.	Winnipeg Regina

* Officials appointed to act until the membership of the Section choose permanent S.C.M.'s by nomination and election.

The American Radio Relay League



• **T**HE AMERICAN RADIO RELAY LEAGUE, INC., is a non-commercial association of radio amateurs, bonded for the promotion of interest in amateur radio communication and experimentation, for the relaying of messages by radio, for the advancement of the radio art and of the public welfare, for the representation of the radio amateur in legislative matters, and for the maintenance of fraternalism and a high standard of conduct.

It is an incorporated association without capital stock, chartered under the laws of Connecticut. Its affairs are governed by a Board of Directors, elected every two years by the general membership. The officers are elected or appointed by the Directors. The League is non-commercial and no one commercially engaged in the manufacture, sale or rental of radio apparatus is eligible to membership on its board.

"Of, by and for the amateur," it numbers within its ranks practically every worth-while amateur in the world and has a history of glorious achievement as the standard-bearer in amateur affairs.

Inquiries regarding membership are solicited. A bona fide interest in amateur radio is the only essential qualification; ownership of a transmitting station and knowledge of the code are not prerequisite. Correspondence should be addressed to the Secretary.

DIRECTORS

- President*
HIRAM PERCY MAXIMW1AW
Box 216, Hartford, Conn.
- Vice-President*
CHARLES H. STEWARTW3ZS
St. David's, Pa.
- Canadian General Manager*
ALEX REIDVE2BE
169 Logan Ave., St. Lambert, P. Q.
- Atlantic Division*
EUGENE C. WOODRUFFW8CMP
234 W. Fairmount Ave., State College, Pa.
- Central Division*
LOREN G. WINDOMW8GZ-W8ZG
Reynoldsburg, Ohio
- Dakota Division*
CARL L. JABSW9BVH
1822 James St., St. Paul, Minn.
- Delta Division*
M. M. HILLW5EB
P. O. Box 274, Natchitoches, La.
- Hudson Division*
BERNARD J. FULDW2BEG
280 Broadway, New York City
- Midwest Division*
H. W. KERRW9DZW-W9GP
Little Sioux, Iowa
- New England Division*
G. W. BAILEYW1KIH
74 Webster Road, Weston, Mass.
- Northwestern Division*
RALPH J. GIBBONSW7KV-W7B1X
3933 N. E. 76th Ave., Portland, Ore.
- Pacific Division*
S. G. CULVERW6AN
2952 Russell St., Berkeley, Calif.
- Roanoke Division*
H. L. CAVENESSW4DW
State College Station, Raleigh, N. C.
- Rocky Mountain Division*
RUSSELL J. ANDREWSW9AAB
1867 So. Lafayette St., Denver, Colo.
- Southeastern Division*
J. C. HAGLER, JR.W4SS
2424 McDowell St., Augusta, Ga.
- West Gulf Division*
FRANK M. CORLETTW5ZC
2515 Catherine St., Dallas, Tex.

OFFICERS

- President*HIRAM PERCY MAXIM, W1AW
Hartford, Connecticut
- Vice-President*CHARLES H. STEWART, W3ZS
St. David's, Pennsylvania
- Secretary*KENNETH B. WARNER, W1EH
West Hartford, Connecticut
- Treasurer*ARTHUR A. HEBERT, W1ES
West Hartford, Connecticut
- Communications Mgr.* ...F. EDWARD HANDY, W1BDI
West Hartford, Connecticut
- General Counsel*PAUL M. SEGAL, W3EEA
1010 Shoreham Building, Washington, D. C.

Address all general correspondence to the executive headquarters at West Hartford, Connecticut

THE EDITOR'S MILL

THE lone voice which we amateurs of the A.R.R.L. have been raising for a long time on the subject of automobile-ignition interference is at last obtaining an answer. Over a year ago we pointed out on this page that ignition interference was a nuisance of increasing importance and that something would have to be done about it. In the months since then it has been one of our office jobs to bring this situation as forcibly as possible to the attention of those who ought to be concerned about it and who might be able to assist. Now we are to have help, through the formation of the Radio Manufacturers Association's committee on interference reduction, mentioned elsewhere in this issue. Already the talk is echoing up and down the land that motor-car manufacturers must vaccinate their new cars against this disease and that some cure must be found for the existing ones.

This trouble is not confined to ultra-high-frequency reception. Any ham who operates a 14-mc. station near a highway knows exactly what we mean. Nor are we alone in difficulty. It is the nature of the amateur to raise a pioneering voice before the rest of the world is willing to heed; but now the short-wave police people and the manufacturers of all-wave receivers have reason enough to join us, and we hope that in mutual effort some way will be found to abate the nuisance.

SPEAKING of items about which something must be done, we have in our midst a particularly unsavory one: the thievery of amateur apparatus. An unfortunate number of such cases has occurred.

This is an unpleasant topic, far from the spirit of amateur radio. We know that printed appeals to thieves will do no good. We have but one reason for mentioning this topic here:

Some amateurs seem to think that the fellowship of ham radio forbids their "tattling" on a fellow who has purloined gear from another amateur. We even know one victim who was told by other amateurs that they had seen his stolen gear in other hands but that they did not feel it was proper for them to say where. This thought, O.M.'s, is the bunk, and we decry it. We believe that radio amateurs in general are the finest folks in the world, but there will always be some in any walk of life who put themselves beyond the pale.

Thievery is not tolerated in any society. Protecting those who steal is a wrong application of the amateur spirit. In fact it seems to us that this very reluctance to inform on a perpetrator is operating to encourage the swiping of apparatus.

If we break down this human barrier we shall go far to stamp out the evil. In these days it is pretty hard for any ham to operate swiped equipment without the knowledge of others, sooner or later. Most steals are local, and somebody will surely recognize the apparatus. We suggest that those who are robbed should publish a description of the equipment at their local club and pass the information around the old home town. Then we propose that those who recognize it in places where it cannot be accounted for should pass the knowledge on promptly where it will do the most good.

There probably does not live an amateur who isn't willing to lend the equipment he does not need, but there is no place in amateur radio for those who "break and enter." Keep your eyes and ears open for them. Do not shield them. You yourself may be their next victim!

WE do not generally take an editorial position with respect to broadcasting, or for that matter on any radio question that does not concern us. But when it commences to concern us, it is a different story.

The American broadcast set-building industry this winter is largely geared to the idea of all-wave receivers, and great is the propaganda that is issuing about short-wave broadcasting. Much of this stuff has to be taken with large gobs of *NaCl*. We suppose there is a certain fascination in hearing a foreign program, but when it is done by individual short-wave reception it is sheer DX-chasing and it is not often that the result will be of satisfactory "program quality." With the idea of short-wave *relay* broadcasts, to transmit special programs from one continent to another for rebroadcasting to the general population, we have much sympathy. It is an excellent idea, and there are frequency allocations for that purpose. Obviously there are not going to be enough channels for widespread short-wave broadcasting intended to be received directly by the listener, and it seems to us that the industry might well take account of that fact right now.

Internationalism is a swell thing and we're

for it, particularly in the Simon-pure form in which we get it in amateur radio. But let no one believe that world understanding is going to be advanced materially by the direct reception of short-wave foreign broadcasting programs. In most foreign countries radio broadcasting is a highly-appreciated outlet for perfectly-organized nationalistic propaganda to control the public mind. As concerns the ability to receive uncensored foreign news, everyone who knows anything about the European situation is aware that the sweet flower of censorship reaches no more highly developed form than in the control of what is passed out to the people over these stations. It seems to us that it will make for anything but better world understanding.

Nor does it seem to us that the present tendency is in the interests of American broadcasting as we know it. Much of the early development of broadcasting was responsive to sheer hysteria. If the present situation is not controlled, we may

see an increasing number of American advertisers sending their money out of the country to finance foreign short-wave programs to be received in American homes. Let the industry think well of the consequences of this course. It is not progress to resubstitute DX-chasing for program quality. The new hysteria has even reached the point where a spokesman for one prominent manufacturer of all-wave sets is quoted as bemoaning the limited channels available for short-wave broadcasting, pointing at what he terms the excessive allowances given amateurs, and urging a realignment for more broadcasting assignments at the next international conference, presumably at the expense of the amateur. Do we make ourselves quite clear when we say that this gentleman is barking up the wrong tree?

K. B. W.

Season's Greetings to Everybody!

Stray-nge Strays

THE old sayings, "There is nothing new under the sun," and "History repeats itself," are perennially applicable. In the old days, they brought the leads out through the ends of vacuum tubes, now we revert to the practice. . . . A.C. receivers were described in 1921 articles before most people had reached the crystal detector stage. . . . The following year saw write-ups of condenser mikes and single-control tuning. . . . Tone control, lately popular, was included

as a feature of certain battery broadcast receivers in 1926. . . . James K. Clapp, writing in a 1926 issue of *QST*, described the construction and use of a monitor, calling it an "auxiliary receiver."

Misnomers

The word rheostat contradicts itself. *Rheo* is Greek for flow; *stat* for standing still. . . . A soldering iron is really a soldering *copper*. . . . An *amateur spark* (we thought these went by Federal order in 1923) is a ham fireman, according to a *Boston Post* article. . . . A radiophone
(Continued on page 88)

Coming Activities

'Phone-C.W.T. QSO Party

February 9th-10th; February 16th-17th

An unusual opportunity in contest form. New Sections and DX made possible. For 'phone station operators, opportunity to see who can contact the greatest number of c.w. telegraph stations. For c.w. operators, a chance to raise 'phone hams, and determine who can work most of 'em in two week-ends. For both, new variety in QSOs and new friendships. Full details in next *QST*. Set aside these two week-ends!

The Seventh International Relay Competition

March 9th-17th Inclusive

The annual DX contest!! Rules in full will appear in February *QST* to reach all parts of the world before the contest. This year the rules will be similar to those which proved so popular and successful in the past. A "time" factor will be added based on an assumed operating time of 6 hours per day (except Saturday and Sunday) and allowing 12 and 16 hour's operation, each Saturday and Sunday, respectively. Any operation totalling over 90 hours in the contest period will subject those scores to proportionate penalties for "excess time." The idea is to create the usual "open season" for DX, and at the same time plan enough time out to permit the average ham to plan for his working day, and for meals, sleep, etc. Don't miss the DX test. Certificate awards in each A.R.R.L. Section and to the leading ham in each outside locality, awarded by prefixes.

'Phone Transmission With Voice-Controlled Carrier Power

A New Constant-Percentage System Using the Class-B Plate Modulator to Control Carrier Level

By G. W. Fyler, W2HLM*

Numerous schemes have been proposed, and some tried experimentally, for a system of 'phone transmission in which the carrier level is automatically maintained just sufficient to carry the modulation. Of the methods submitted previous to this time, however, none has combined simplicity, positiveness of action and sufficient tolerance to insure against improper modulation to the extent that they are combined in the system described by the author of this article. We have worked W2DC, who uses it, and vouch for its performance. Even this system is not one to be attempted slap-dash in any Class-B modulated 'phone transmitter, however. Close adherence to the design outlined and careful observance of the adjustment procedure specified are prime essentials. And of course no transmitter using the system should be put on the air by any experimenter until it has been thoroughly tested on a non-radiating dummy antenna. Properly used, this system of "squirt" modulation should be beneficial to amateur 'phone. But give it a fair trial.—EDITOR.

A VARIABLE r.f. carrier wave which would rise and fall according to the level of the audio modulation was first tried about five years ago in a 50-kw. broadcast transmitter. The carrier wave in a modulated transmitter usually has a constant average value (Fig. 1A) although it may increase (shift upward) with overmodulation or decrease slightly at high audio levels in a Class-B audio modulation system because of poor regulation of the high voltage plate supply.

Since the intelligibility is transmitted only by the side bands resulting from audio amplitude variations of the carrier wave, it should be possible to reduce the carrier wave to nearly zero when there is no modulation (Fig. 1B), and then let it rise and fall in accordance with the signal amplitude without changing the quantity or quality of the side bands transmitted. The received signal also should be theoretically unchanged with linear detector circuits.

The original circuit for obtaining the voice-controlled carrier was quite complicated in the way it was first applied experimentally to the WGY 50-kw. transmitter. One of the Class-B linear r.f. amplifiers, designated in Fig. 2 as the "Control Amplifier," was biased beyond the cut-off value for the tubes so as to reduce the carrier from the normal 50-kw. value to about 3 kw. for zero audio signal. The bias potential of this amplifier stage was then varied in accordance with the average value of the audio signal. The variable bias potential was obtained from a separate audio amplifier, rectifier and filter connected to the audio system. The rectifier supplied a pulsating voltage

proportional to the audio signal, and the filter cut off all frequencies above 20 cycles, leaving only the syllabic variations of the audio signal—"syllabic variations" meaning the rise and fall of the audio signal at the rate of the occurrence of syllables in speech.

The first system, as described, was fairly successful; but there was question whether the controlled carrier system would introduce objectionable distortion in commercial practice.

THE CLASS-B CIRCUIT

Recently a new circuit has been developed which is much simpler in operation and which has

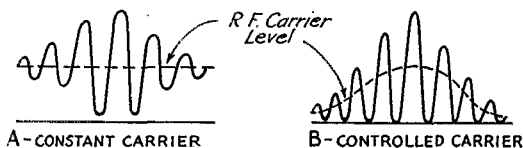

FIG. 1—CONTRASTING MODULATED WAVES OF THE CONSTANT-CARRIER TYPE (A) AND CONTROLLED-CARRIER TYPE (B)

little distortion. This circuit may be applied easily to many modern amateur 'phone transmitters using Class-B audio modulation in arrangements such as that shown in Fig. 3A. It will save one-half of the plate power to the modulator and p.a. and about one-quarter to one-third of the total input power, while reducing the heating in the final r.f. amplifier tubes and circuit and possibly permitting an increase of the output signal. By its use duplex operation should be made possible or at least be aided considerably, and less interference should be caused with other stations.

* Radio Engineering Dept., General Electric Company, Schenectady, N. Y.

The transmitter circuit is shown in Fig. 3B. A Class-B audio modulator and a Class-C modulated amplifier have their plate circuits in series. The d.c. current in both plate circuits must then be the same and the rectifier must supply twice the voltage normally used.

The voltage applied to the p.a. depends upon

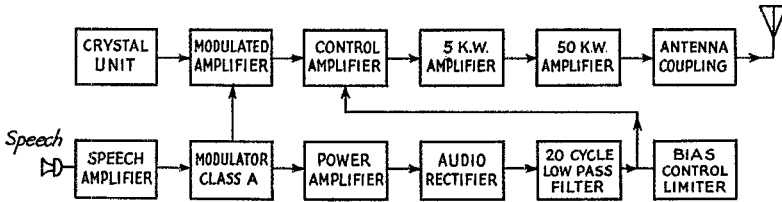

FIG. 2—BLOCK DIAGRAM OF THE EARLY CONTROLLED-CARRIER TRANSMITTER USED IN WGY EXPERIMENTS

Separate stages were used for the voice-operated control circuit.

the plate current drawn by the modulator and this, in turn, depends upon the amplitude of the audio signal. Another way of looking at it is to consider the total rectifier voltage dividing according to the resistance of the two circuits, the modulator and the p.a., with the p.a. plate circuit representing a constant resistance of E_p/I_p , while the modulator plate circuit resistance is high with no signal and decreases when the audio signal increases. Hence, the p.a. plate voltage and the r.f. carrier output are low for no audio signal and both automatically increase with the audio signal. This is an improvement over the original circuit since no separate amplifier and rectifier are required for control.

Several basic requirements must be observed. The rectifier must have reasonably good regulation. High- μ or zero-bias tubes are necessary in the Class-B modulator for a low carrier with no audio signal. The modulator tube peak plate voltage under any degree of modulation will not be higher than in the usual system of modulation, although the d.c. voltage is increased above the normal operating point. A capacitor C_1 of between 4 and 10 μ f., rated for the full rectifier output voltage, is required connected as shown to by-pass the audio currents. This capacitance value may vary somewhat with different transmitters, although 4 μ f. will be generally satisfactory. If it is too small, audio distortion and spurious sidebands will result; and if too large, the rate of rise of the carrier will be limited so that overmodulation takes place before the r.f. carrier voltage becomes adequate.

The rectifier voltage can usually be doubled by changing the usual full-wave to a bridge-type rectifier (if one is not already used) requiring two more rectifier tubes and two additional filament windings;

or the plate transformer can be changed. Two rectifiers of similar current rating might also be connected in series. Since the total d.c. load current to the modulator and p.a. is about half its former value, the filter reactor will be more effective and the filter capacity for the higher voltage need not be so large. It should be noted

that the rectifier tubes have to supply only half the current and, therefore, smaller tubes might be used. However, since the load fluctuations are even greater than with ordinary Class-B modulators, it is essential that a bleeder or other fixed load be

placed on the rectifier to hold down the voltage. It is also essential that choke input be used in the rectifier filter for good regulation.

The separate p.a. filament transformer must be insulated for the full d.c. plate voltage. The modulation transformer secondary is connected in the positive potential lead from the rectifier. Alternatively, this secondary might be connected into the series circuit at the point marked X (in the negative side) to minimize the voltage between windings in the modulation transformer. The results are the same either way as far as modulation is concerned, since the circuit is a series one.

Grid-leak bias is shown for the p.a., and this is a necessity unless battery or some other highly insulated bias voltage supply is available. The whole p.a. circuit is "above ground" for d.c. However, if the excitation should fail, the modulator tubes tend to limit the r.f. amplifier plate current to a safe value with grid-leak bias. The

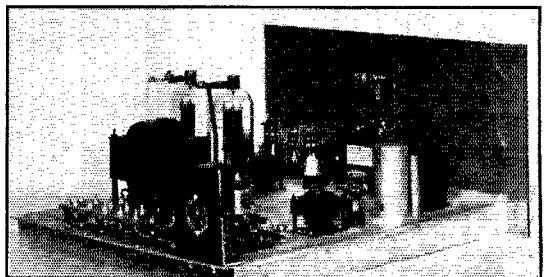

CLASS-B MODULATOR OF THE TYPE USED FOR CONTROLLED-CARRIER 'PHONE OPERATION AT W2DC

Either zero-bias G.E. FP-146's (shown) or 203-A's can be used in the Class-B stage. The speech amplifier (in the foreground) uses a 57 and a 56 resistance-coupled, exciting push-pull 2A3's in the driver stage. The small tube behind the 2A3's is another 56 used as an audio oscillator for test adjustments. The capacitor below the meter is the all-important audio-frequency filter condenser C_1 of Fig. 3B.

grid excitation circuit may be either inductively or capacitively coupled, but sufficient insulation must be provided for bias and plate voltage.

ADJUSTMENT PROCEDURE

In the practical operation of the circuit it is a good plan to start with the normal transmitter (connected as in Fig. 3A) adjusted as follows: The r.f. load coupling should be such that the p.a. plate current approximately equals the modulator plate current under 100% modulation conditions with a common plate power supply. This indicates about 50% overall plate efficiency in the modulator, which is reasonable considering losses in most modulation transformers. When the circuit is changed for controlled carrier operation (Fig. 3B) the normal carrier will then be correct for 100% modulation. For example, if the input to the p.a. is 1000 volts and 300 ma. (300 watts), 150 watts of audio power are required for 100% modulation. If the modulator plate voltage is 1000 volts, the d.c. plate current to the modulator will depend upon the efficiency of the tubes and the modulation transformer. If this efficiency is 50% for 100% modulation, the input power to the modulator will be equal to that of the p.a. and the plate current will be the same.

If the modulator plate current is normally appreciably less than the p.a. plate current for 100% modulation, a resistor R_1 should be added in parallel with the modulator audio filter capacitor C_1 to balance the currents at 100% modulation, so that overmodulation will not result. As a further aid to prevent overmodulation, a resistor R_2 , of some such value as 10,000 ohms, can be connected across the primary of the Class-B output transformer. The residual plate current through the Class-B modulator allows a certain amount of carrier which will prevent overmodulation on the first part of a spoken syllable. Oscillograms taken with ordinary voice and music show that practically no overmodulation will take place if the set is properly adjusted

and that the carrier wave will be fully modulated at all audio signal levels except the very lowest. The circuit as described is particularly adaptable immediately when 46 or similar high-mu modulator tubes are used with 801 r.f. amplifier tubes. In the 50-watt class, the modulators should be 203-A or higher-mu tubes.

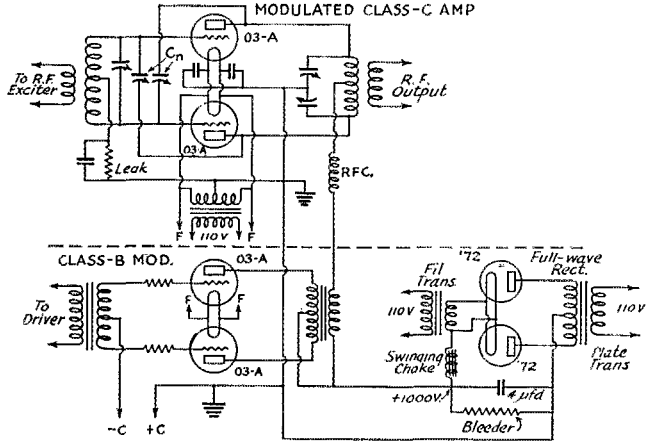

FIG. 3A—CIRCUIT OF THE CLASS-B MODULATION SYSTEM FOR NORMAL CONSTANT-CARRIER TRANSMISSION
Circuit values are usual.

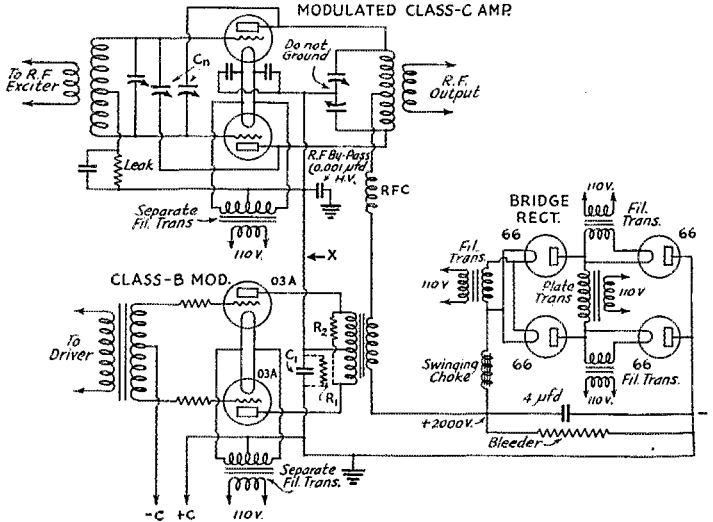

FIG. 3B—THE NORMAL CLASS-B MODULATION CIRCUIT OF FIG. 3A MODIFIED FOR CONTROLLED-CARRIER OPERATION
Details are given in the text.

PRACTICAL AMATEUR 'PHONE TESTS

W2DC, owned by Mr. E. H. Fritschel at Scotia, N. Y., near Schenectady, has been changed over to use this controlled carrier system. Of some twenty stations worked on 20 and 80 meters, only

two questioned why the carrier increased with modulation. Both of these stations apparently had tuning meters in their receivers. All stations worked reported the quality to be excellent. There are two high- μ 50-watt tubes in the modulator and two 211's in the p.a. The rectifier supplies about 1800 volts to the modulator and p.a.

Critical listening tests were also made on W2DC

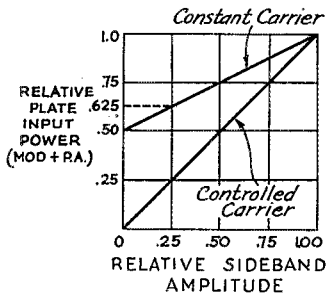

FIG. 4—POWER CONSIDERATIONS COMPARED FOR CONSTANT-CARRIER AND CONTROLLED-CARRIER SYSTEMS

in Schenectady with a GE-K80 all-wave receiver having automatic gain control and with an FBXA receiver with manual volume control. The quality appeared satisfactory on both.

The ratio of maximum to minimum carrier has been made as high as 200/1 at W2DC by adding a small amount of extra negative bias to the modulators to reduce further the plate current and therefore the carrier level. With a 200-watt normal carrier, the carrier was reduced to one watt or less when unmodulated. With this ratio, however, there was some distortion, the modulation sounding slightly accented on the start of a spoken word, particularly with a receiver using automatic gain control. At this low unmodulated carrier level, it was found that a neon lamp could not be lighted on the transmission line, and it was necessary to whistle into the microphone to check the p.a. tuning.

POWER SAVING AND OTHER FEATURES

The voice-controlled carrier with Class-B plate modulation offers many advantages for amateur work. About half of the plate input power to the modulator and modulated amplifier can be saved, as shown by Fig. 4.

It is assumed that the modulator draws as much power as the p.a. under 100% modulation conditions in either system for the same carrier power output. With constant carrier the input power then reduces to about half at zero modulation. With the ultimate case of controlled carrier the input power is zero and the carrier output is zero at zero modulation. The power input then varies nearly linearly with modulation. If we assume an average relative modulation of 25% during the time the power is on, the power used

in the first case is 62.5% of the maximum and in the second case it is 25%. The controlled carrier then saves 60% of the power. Considering the various assumptions made, it seems reasonable to conclude that at least 50% or half of the plate power is saved. It should be noticed that for average modulation of less than 25%, an even greater amount of power is saved.

The system as described will reduce QRM to other stations on nearly the same frequency because the beat note between carriers is greatly reduced in amplitude for a large part of the time. Also, if a nearby station is being worked, the operator has a very convenient means of reducing r.f. output (as required by law) by simply talking farther away from the microphone or by reducing the volume control setting.

The possibilities of duplex operation are good with the voice-controlled carrier circuit. If the excitation stages of the transmitter are well shielded and the power leads are by-passed at the shields, the signal in the receiver from the transmitter can be reduced considerably. This will cause little interference to the receiver if the latter is carefully installed with a remote antenna and transposed or shielded feeders. A wave trap or a highly selective input circuit may be added to the receiver; and if some real experimenting is enjoyed, a neutralizing voltage of the proper phase and amplitude can be applied to the receiver.¹ All of these factors should help in perfecting duplex operation with controlled carrier transmitters on the 160-, 80- and, possibly, the 20-meter 'phone bands.

While the description covers briefly a few of the technical angles of voice-controlled carrier, this does not mean that the circuit requires complicated adjustments for good results. An effort has been made to describe the general features of the circuit so that it may be applied to the most common types of transmitters using Class-B audio modulation.

EDITOR'S NOTE: *Constructional details of the controlled-carrier 'phone system applied to the smaller amateur transmitter will appear in an early issue.*

¹ See W8ZC's article in this issue.—EDITOR.

Strays

Hr news: Irving Vermilya, "Amateur No. 1," VN of 1HAA and 1ZE, has been bitten by that little bug again. Yessir, old 1ZE is coming back. (That is, if he has succeeded in passing his amateur exam!) Hundred watts of push-pull xtal, plus 5-meter gear on a 120-ft. tower. Wrote us the other day wanting to know how long the feeders can be for 56 mc., and lots of easy little questions like that. Welcome back home, VN.

Modern Design of High-Frequency Stages for the Amateur Superhet

Matching, Tracking and Stabilizing Multi-Tuned Circuits

By James Millen, W1HRX;* and Dana Bacon, W1BZR**

Although more than one tuned r.f. stage was deemed practically unfeasible in the simple regenerative receiver of yesterday, two such stages additional to first detector and oscillator are an accomplished fact in several standard amateur-type superhets of to-day—with single-control tuning of all four circuits as a matter of course. Solution of the problems involved in realizing fully the theoretical advantages of such circuits is no little accomplishment. How it has been done in one type of tuning system is described in this article. A different type of tuning system applied to multi-stage input circuits will be described in another article to appear in an early issue.—EDITOR.

THE advantages of a multi-stage r.f. amplifier between the antenna and first detector of a superheterodyne receiver are well known to most amateurs. As repeatedly shown in *QST*, such an amplifier is essential to obtaining high effective sensitivity and a high signal-to-image ratio. Simple regenerative input circuits, while offering some aid, have definite limitations, as well as being difficult to tune and erratic in performance.

Offhand, it might be wondered that receivers employing one or two r.f. stages have not been more generally available to the amateur; but in the construction of such a receiver there have been many difficult design problems to overcome. It is unfortunate that the unquestioned advantages of a multi-stage r.f. amplifier between the antenna and first detector of a superheterodyne receiver cannot be realized in simple fashion.

Amateur-band superhets with pre-amplifiers have become standard, however; and since the receiver is of such primary importance in the amateur station, the design problems of this type of equipment are of no little interest. The principal problems relate to tracking of tuning, uniform gain, h.f. oscillator stability and adequately calibrated band-spreading.

CIRCUIT TRACKING AND UNIFORM GAIN

At the lower frequencies the circuit matching problem is relatively simple and requires only the usual precautions with regard to careful matching of coils and gang condenser sections. Above 10,000 kc., however, ordinary production methods cannot be used. Much greater precision is required. Not only are precisely adjustable trimmer condensers required in all circuits, but also some means must be employed for obtaining inductance trimming. For instance, it was found that the total length of wire in a 28-mc. tuned circuit (including condenser leads, etc.) must be held within one-quarter inch. One satisfactory method

of inductance trimming is illustrated in Fig. 1A. The last half-turn of wire is brought out in a loop, normally at right angles to the rest of the coil. Bending the loop one way or the other gives an inductance variation equivalent to adding or subtracting a half-turn from the coil. The lower

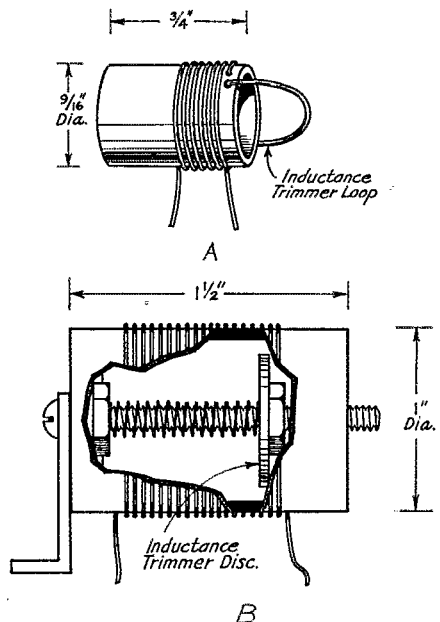

FIG. 1—INDUCTANCE TRIMMING METHODS
A—High-frequency coils.
B—Low-frequency coils.

frequency coils can conveniently employ a different type of inductance trimmer, shown in Fig. 1B. As the disk is moved toward the center of the coil, the inductance is decreased.

Understanding of the electrical matching and tracking will be clarified by an explanation of the

* Middleton, Mass.

** 41 Bellington St., Arlington, Mass.

exact function of each of the somewhat imposing array of condensers associated with each stage in the diagram of Fig. 3. To begin with, the ganged main tuning condensers C_1 (those at the lower right-hand side of each group) have a capacity range determined by the widest frequency span required, namely, 4000 to 1700 kc. All the other variable condensers shown are built into the plug-in coil assemblies and are, therefore, adjusted individually in one range only. The condensers C_3 connected directly across the tuning condensers are the main trimmers, the purpose of which is to bring the minimum capacity of all circuits to the correct value. As far as the general coverage ranges are concerned, these trimmers, together with the oscillator series tracking condenser C_4 (shown just above the stator of the oscillator tuning condenser) and coils of the proper inductance, are all required for exact ganging.

When changing to amateur band-spread, two additional condensers are necessary in each

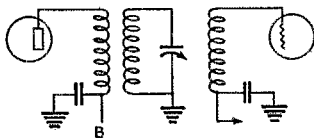

FIG. 2—TUNING ARRANGEMENT USED TO GIVE UNIFORM GAIN IN THE 14- TO 30-MC. RANGE

circuit. The "A" contacts, being open, connect condenser C_5 in series with each tuning condenser, thus lowering the maximum capacity effective and limiting the tuning range so that the desired band is spread over the major portion of the dial. These condensers, now being in series with both the tuning condensers and the main trimmers, also cause the minimum capacity across the coils to be lowered considerably. With the "B" contacts closed, however, another condenser C_2 is connected in parallel with each of the coils, bringing the minimum capacity to the value re-

quired for properly centering the band on the dial.

The problem of obtaining uniform gain over ranges below 14 mc. is comparatively simple since it is only necessary to use high inductance primaries with the correct amount of capacity coupling. To those who are not familiar with this system of coupling, a brief explanation will be of interest. The primary winding has a large number of turns of fine wire, so that it will be broadly resonant just below the low-frequency end of the tuning range. The point of resonance is determined by the circuit and plate capacity of the r.f. tube in parallel with the coil. The signal transfer from the tube to the primary will, therefore, increase as the resonant point is approached; in other words, as the tuning condenser is varied from minimum to

maximum capacity. On the other hand, the impedance of the tuned circuit will decrease as the capacity is increased and at the low-frequency end will, therefore, require the additional signal which the primary is supplying.

It often happens, however, that the effect of the primary is predominant, resulting in higher gain at the low-frequency end. Additional compensation is obtained by a small amount of capacity coupling directly between the plate and the grid of the following tube. This coupling, being small, will have less effect at the low frequencies but will have a large effect at the high-frequency end, since the impedance of the coupling condenser decreases as the frequency is raised. This system of r.f. coupling is entirely satisfactory below 14 megacycles, but between 14 and 30 megacycles it is not effective. In this range the gain falls off rapidly and the resonance of the primary is inadequate in its levelling action.

The system finally devised to overcome this difficulty is illustrated in Fig. 2. The primary plate winding is coupled as closely as possible to the tuned circuit, being interwound with it, and having the same number of turns. The grid winding is also closely coupled to the tuned circuit and consists of a large number of turns of fine wire, the coil itself being resonant just outside the

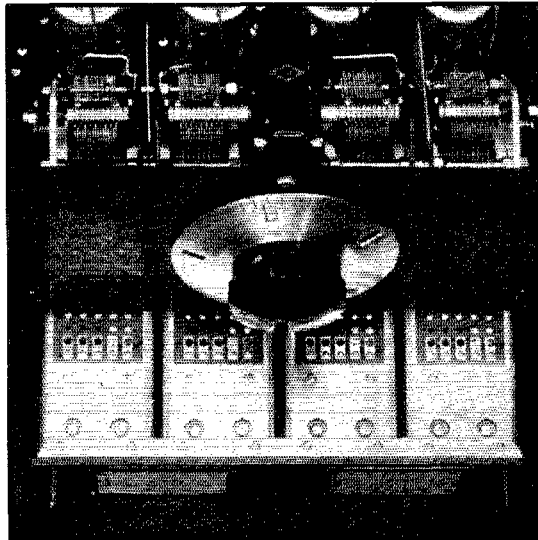

ESSENTIAL ELEMENTS OF THE MULTI-TUNED INPUT CIRCUITS DISCUSSED IN THIS ARTICLE

The shielded coil assembly (shown in front of the panel) plugs in beneath the condenser gang, four such assemblies being used for full frequency coverage.

low frequency end of the range. This grid winding gives considerable voltage step-up and at the same time compensates for the varying impedance of

correct placement of the cathode tap, the oscillator input to the detector may be held constant over the entire range. Incidentally, this coupling

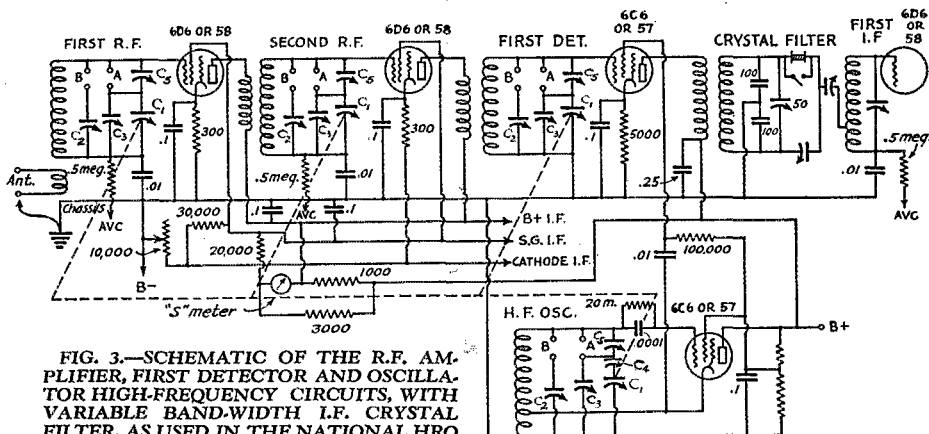

FIG. 3.—SCHEMATIC OF THE R.F. AMPLIFIER, FIRST DETECTOR AND OSCILLATOR HIGH-FREQUENCY CIRCUITS, WITH VARIABLE BAND-WIDTH I.F. CRYSTAL FILTER, AS USED IN THE NATIONAL HRO RECEIVER

The main tuning condensers C_1 are ganged. Other condensers of the high-frequency circuits are identified in the text. Resistance values indicated are ohms, capacitance values $\mu\text{f.}$ (fractions) and $\mu\text{fd.}$

the tuned circuit in such a way that the gain is uniform. It should be pointed out, however, that the grid coil itself is resonant and not the coil plus the circuit and tube capacity.

THE H.F. OSCILLATOR

The third problem encountered in the design of wide range Single-Signal receivers is the high-frequency oscillator. The requisite degree of stability can be obtained through the use of a screen-grid tetrode or pentode in the oscillator. When used in the conventional electron-coupled circuit, however, the tetrode has one particularly objectionable characteristic; namely, it delivers to the first detector not only the desired fundamental frequency but also strong harmonics, the 2nd, 3rd and 4th often being responsible for the reception of phantom signals, whistles, and for the aggravation of general noise. These harmonics are much stronger (as compared to the fundamental) in the non-selective oscillator plate circuit than they are in the tuned grid-cathode circuit. Hence it is more desirable that the first detector should be coupled to some portion of the latter circuit, rather than to the plate circuit. The electron-coupling feature, necessary to isolate the oscillator tuned circuit from the detector tuned circuit, can be obtained in the detector tube.

The circuit diagram of Fig. 3 shows the screen grid of the first detector capacity-coupled to the cathode of the oscillator. Coupling in this manner has the advantages of electron-coupling, inasmuch as the first detector screen is not directly associated with the tuned signal circuits. In addition to eliminating trouble from harmonics, this system has another important advantage; by

condenser serves a double purpose in that it also acts as an i.f. by-pass condenser.

Frequency drift in the oscillator becomes an increasingly difficult problem to solve as the range of the receiver is extended toward 10 meters. While variations in the room temperature are

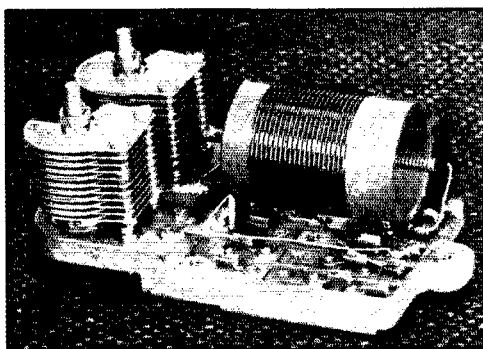

A MEDIUM-FREQUENCY R.F. COIL UNIT REMOVED FROM ITS SHIELD

usually so gradual that drift resulting from this source is not objectionable, it is minimized through the use of padding and tuning condensers which are compensated against temperature change and through the use of material for coils which has a small temperature coefficient.

The cause of the most objectionable frequency drift is the change of inductance of the coils as the interior of the receiver is heated by the tubes and power supply. The chief offender, the power

(Continued on page 100)

A General Purpose 50-Watt Transmitter

Five-Band Operation with Self-Neutralizing Buffer, Full-Wave Doubling,
Permanently-Neutralized Push-Pull Amplifier

By George Grammer*

THE pace of ham radio is so rapid that many really good ideas are passed over and forgotten before they have a chance to be put to work. Combining new with old can be a fascinating pastime, especially if something of present-day practical value results. Indulgence in it, in this instance at least, brought about a transmitter in which modern equipment combines with both modern and not-so-modern circuits to give multi-band operation along lines differing a bit from the usual. It is built on the theory that the transmitter which has the smallest

needed to cover the four most popular bands.

Briefly described, the transmitter is a three-stage affair having a pentode crystal oscillator, a second stage which operates either as a self-neutralized straight amplifier or as a back-to-back doubler, and a permanently-neutralized push-pull final amplifier stage using 801's. A separate antenna-tuning unit, which may be located alongside the transmitter in the cellar or by itself in the attic, also is provided. Although only inexpensive non-screen-grid tubes are used, band-changing requires no retouching of neutralizing adjustments; furthermore, the power output of the final stage is practically the same on all bands with the possible exception of the fifth—28 mc.

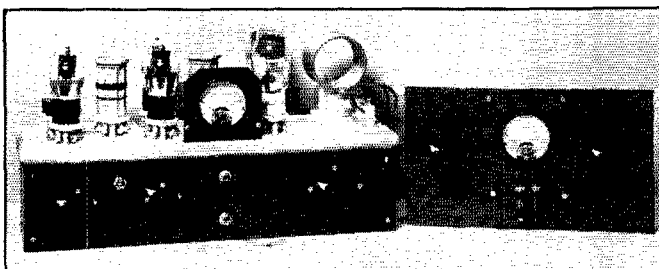

A GENERAL VIEW OF THE 50-WATT TRANSMITTER AND THE ANTENNA TUNING UNIT

This set can be operated in five amateur bands. Features of the circuit used are self-neutralization in the buffer stage, efficient doubling, and permanent neutralization in the push-pull final stage. The antenna tuner is transmission-line fed and may be located in any convenient spot remote from the transmitter.

practicable number of stages, consistent with the output to be expected and the excitation requirements of the final amplifier, will be the one that gives the least trouble and the greatest satisfaction.

Building a set for the lower-frequency amateur bands on this principle always has been easy; it is only when an unwieldy number of doubler and amplifier stages has to be added to reach high frequencies from a low-frequency crystal that the problems mount up. Nowadays, however, there is no reason why transmitter design should be based on the premise that only one low-frequency crystal is going to be used. Reliable crystals for bands up to 7 mc. are generally available, and at least one manufacturer expects soon to market 14-mc. plates. It is cheaper, in fact, to buy an extra crystal or two than parts for a low-power amplifier or doubler stage, everything considered. Hence in this rig the frequency is never doubled more than once; but even so, only two crystals, one on 1.75 mc. and the second on 7 mc., are

stage a pair of 2A5 tubes is arranged with the grids in push-pull and the plates in parallel, a method of connection which gives good output on the second harmonic. For fundamental operation an idea gleaned from an Experimenters' Section note of several years back is put to use. A switch, Sw_1 , is cut in one heater leg of one of the tubes; when it is open the tube does not operate but simply serves as a neutralizing capacity for the other. This is, in fact, quite the simplest way to neutralize the grid-plate capacity of a pentode-type tube, because it is difficult to construct a satisfactory variable condenser having the very small capacity required. In practice the idle tube has proved to be an entirely adequate "neutralizing condenser." For doubling, Sw_1 is closed, whereupon the two tubes work together to produce second-harmonic output. The output circuit is tuned by C_2L_3 , the inductance L_3 being coupled to L_4 , the final amplifier grid coil.

The grid coil of the final stage is, in all cases except one, tuned only by the tube and circuit

CIRCUIT DETAILS

Examination of the circuit diagram, Fig. 1, will disclose the operation of the set. The oscillator circuit is perfectly normal; it is the regular pentode circuit using a Type 2A5 tube as the oscillator. Its plate tuned circuit, L_1C_1 , is coupled inductively to the tuned and balanced grid circuit of the second stage, L_2C_{11} . In this

* Assistant Technical Editor, QST.

capacities and its own distributed capacity. It is therefore much the same as the grid coil of the familiar TNT circuit, and is in fact wound according to the same rules. The single exception is the 1750-kc. coil, where the physical dimensions of such a coil would be so large as to make the untuned coil impracticable with ordinary coil forms. Therefore for this band only an auxiliary condenser, C_{12} , is used to tune the grid circuit.

The plate circuit of the final stage uses a split-stator condenser with grounded rotor. The plate coil is tapped at the center and fed d.c. through an r.f. choke. The amplifier is cross-neutralized, and because of the grounded-condenser plate circuit will be neutralized for all frequencies once the neutralizing adjustments have been correctly made on the first frequency tried. A pair of clips tapping on the amplifier tank coil provide for transferring the r.f. output to the antenna tuner.

Grid-leak bias is used on all three stages. A combination of battery and leak bias might be used on the last stage, the battery being for protective purposes, but since it was intended to key in the center-tap of the last stage it was deemed unnecessary to use it in this case. The 2A5's in the second stage need no protection of this type, since

their plate current drops to a very low value if excitation fails. The 2A5's are not used as pentodes but as Class-B triodes, the control grid and

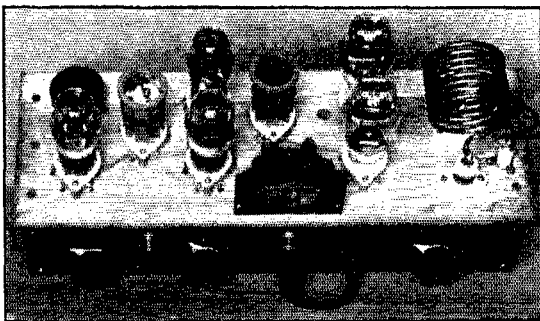

THIS PLAN VIEW OF THE TRANSMITTER SHOWS THE LAYOUT ABOVE THE BASEBOARD

Coils for all stages are plug-in to facilitate frequency changing and the use of crystals ground for different bands. The final stage neutralizing condensers are screwdriver-adjusted, through the holes in the baseboard just to the left of the 801's. The coils shown are for straight-through operation from a 14-mc. crystal.

screen in each tube being tied together.

Plate power for the oscillator is secured from the second-stage supply through a dropping resistor, R_5 . A second dropping resistor, R_4 , reduces the voltage to the right value for the oscillator screen. Jacks are provided in all three circuits for measuring plate currents.

The Type 2A5 tubes are used in the oscillator and buffer-doubler stages because experience has shown them to be relatively free from grid emission troubles as compared with tubes such as the 46, with the result that they operate more stably at fairly high voltages. The reason probably lies in the fact that the control grid in the 2A5 is furnished with a heat radiator which the other tubes do not have. The plate current to these tubes does not climb, even when the tubes are made to operate continuously for long periods.

TRANSMITTER CONSTRUCTION

The type of construction employed is one which, while giving panel controls, offers easy access to the plug-in coils, crystal and tubes. The fixed apparatus on top of the baseboard consists almost exclusively of sockets of various descriptions into which tubes, coils and crystals can be inserted. The exceptions are the plate milliam-

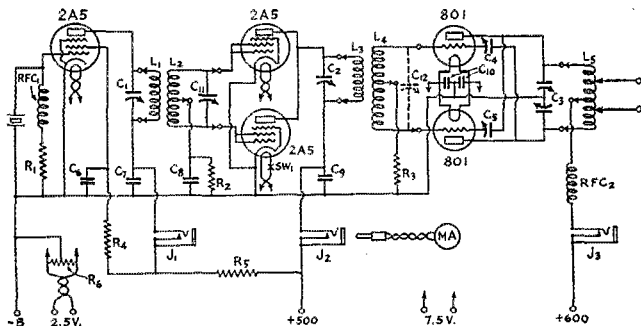

FIG. 1—CIRCUIT DIAGRAM OF THE TRANSMITTER

- C_1 —100- μ fd. variable (Cardwell Type 404-B).
- C_2 —100- μ fd. variable (Cardwell Type 412-B).
- C_3 —100- μ fd. (net) split-stator transmitting condenser (Cardwell Type 157-B).
- C_4, C_5 —25- μ fd. variables, transmitting type (National SEU-25).
- $C_6, C_7, C_8, C_9, C_{10}$ —002- μ fd. paper by-pass condensers, 1500-volt transmitting type (Sprague Type SW-22).
- * C_{11} —Air-padding condensers; for 1.75-mc. coil, 100 μ fd. (Hammarlund APC-100); for 3.5, 7, and 14 mc., 50 μ fd. each (Hammarlund APC-50).
- * C_{12} —100- μ fd. air padding condenser (Hammarlund APC-100), used only on 1.75-mc. coil.
- R_1 —5000 ohms, 2-watt (I.R.C.).
- R_2 —1250 ohms, 5-watt (I.R.C.).
- R_3 —10,000 ohms, 5-watt (Ward-Leonard 507-206).
- R_4 —50,000 ohms, 2-watt (I.R.C.).
- R_5 —5000 ohms, 15-watt (Ward-Leonard 507-341).
- R_6 —20 ohms, center-tapped.
- RFC₁, RFC₂—High-frequency chokes (National Type 100).
- J_1, J_2, J_3 —Single circuit-closing jacks.
- Sw1—S.p.s.t. toggle switch.
- MA—0-300 d.c. milliammeter.

Winding data on coils is given in Table I.

* Mounted in coil forms.

meter, which is mounted on a small bakelite panel, and the output terminal standoffs. The progression is from left to right; the oscillator tube is at the extreme left front, with the crystal socket directly behind it. Next is the plug-in coil for the oscillator plate, then the two tubes in the second stage, followed by the plate coil for that stage, then the amplifier tubes, the standoff-sockets for the amplifier tank coils, and finally the output posts.

The panel controls, from left to right, are the oscillator tuning condenser, on-off switch, Sw_1 (for the double-purpose tube in the second stage), second-stage tuning condenser, plate current jacks, and finally the amplifier tuning condenser.

In the bottom view of the transmitter the order is reversed. The oscillator tuning condenser, C_1 , is at the right, mounted on the panel. Just above it in the photograph are the r.f. choke RFC_1 and the resistor, R_1 , in the oscillator grid circuit. A little to the left of these components are the screen by-pass condenser, C_6 , and dropping resistor, R_4 ; beside them to the left is the oscillator

driver from the top. Since the condensers need be adjusted only once there is no necessity for knobs or panel controls to tempt unauthorized knob-twisters, and this method of mounting gets them out of sight, although not out of reach. The filament by-pass condensers, C_{10} , for the final stage are fastened to the baseboard underneath the neutralizing condensers, as is also the amplifier plate choke, RFC_2 .

The split-stator tuning condenser for the final stage is at the extreme left. While its voltage rating is possibly higher than necessary for c.w. operation at rated tube voltages, the plate spacing is desirable if the transmitter is to be modulated for 'phone—which is intended in this instance, with the modulator unit to be described in an early issue.

All power leads are brought to the terminal strip at the upper right. Bus bar is used for the r.f. wiring, while the filament circuits are wired with heavy flexible rubber-covered wire.

The whole set is quite compact, its overall dimensions (with tubes in place) being $18\frac{1}{2}$ by 11 by 8 inches. The control panel measures 18 by 4 inches and the baseboard $18\frac{1}{2}$ by $6\frac{1}{2}$ inches.

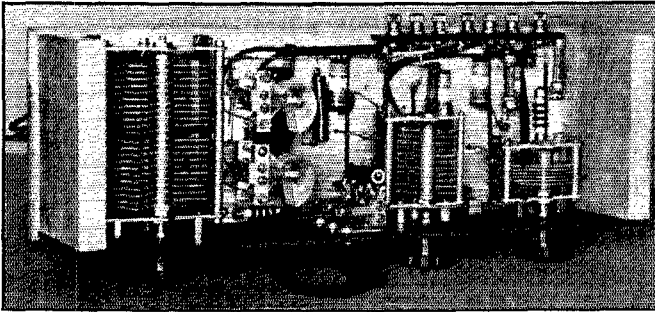

NON-PLUG-IN PARTS ARE LOCATED BELOW THE BASEBOARD AND BEHIND THE CONTROL PANEL

The location of various components is given detailed consideration in the text.

plate by-pass condenser, C_7 . All by-pass condensers in the set are of the tubular paper type made for transmitting use.

The second variable condenser in line is the second-stage tuning condenser, C_2 , also mounted on the panel. Between this and the oscillator condenser is the toggle switch, Sw_1 . The condenser and resistor just above C_2 are the grid resistor R_2 and by-pass condenser C_8 . The filament center-tap resistor, R_6 , is mounted on the baseboard behind C_2 .

The resistor mounted on the two nearer jacks is the oscillator plate dropping resistor, R_5 . Above the jacks on the baseboard are the plate by-pass condenser C_9 and the amplifier grid resistor, R_3 .

The two neutralizing condensers, C_4 and C_5 , are mounted on a 1- by 4-inch bakelite strip elevated about a half-inch from the baseboard. The condenser shafts, which are slotted by a hacksaw, project through half-inch holes in the baseboard so they can be adjusted with a screw-

COIL CONSIDERATIONS AND CONSTRUCTION

The coils for the first two stages are wound on 5-prong Hammarlund XP-53 forms, which have a net winding space of nearly $2\frac{1}{2}$ inches and an inside mounting post for padding condensers. Complete winding data are given in Table I.

The oscillator plate and buffer grid windings, L_1 and L_2 , are on the same form. A buffer grid tuning condenser, C_{11} , is mounted inside each coil form. These condensers vary in capacity with the frequency, and are adjusted by means of a screwdriver when the set is in operation. One setting will suffice for work in any one band. The grid circuit L_2C_{11} is tuned to a frequency considerably higher than that of the crystal; it cannot be tuned to resonance with the circuit L_1C_1 because of the tight coupling between L_1 and L_2 . At first thought it might seem that the energy transfer would be improved if loose coupling were used and both circuits were tuned to resonance, but such tuning would cause the grid circuit to peak rather sharply at one frequency, whereas it is desirable to have a broadly tuned grid circuit so that one setting of C_{11} will hold fairly well for a whole band. This effect can be secured by using tight coupling between L_1 and L_2 and avoiding resonance in the grid circuit.

In the preliminary experiments with the transmitter an untuned (self-resonant) grid

circuit was tried. It was found, however, that while this type of grid circuit worked satisfactorily when the second stage was acting as a straight amplifier, bringing the second tube into action for doubling caused the stage to have a strong tendency toward oscillation around the second-harmonic frequency. This is eliminated by using a grid coil of comparatively few turns and tuning

band so that retuning of the padding condenser is obviated when going from one end of a band to the other.

Enamelled wire is used for all the coils. The turns are first made to stay in place by running on a strip of Duco cement and then are given a coat of dope made by dissolving a little of the same cement in banana oil. In winding the grid

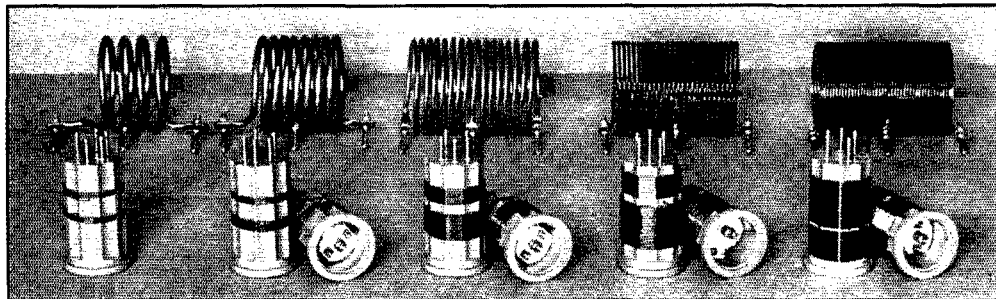

A COMPLETE SET OF COILS FOR OPERATION IN FIVE BANDS WITH CRYSTALS GROUND FOR FOUR BANDS

For working in two bands with a single crystal, only five coils will be needed, one for the oscillator, two for the buffer-doubler and two for the final amplifier. Other combinations readily can be worked out.

The coils are grouped according to frequency. The air padders can be glimpsed in the ends of the oscillator coils, lying on their sides.

it with condenser C_{11} . Although the spacing between the plates of the Hammarlund midgets is small, no trouble with arcing has occurred, partly because the circuit is not tuned to the same frequency as that of the oscillator, and partly because the load of the second stage grids pulls down the r.f. voltage. Mica-dielectric trimmers were tried but found to be completely unsatisfactory. The condensers heated badly and changed capacity so rapidly that it was impossible to keep the circuits tuned.

The buffer plate coils and amplifier grid coils are wound on the same type of form. In this case the grid coils are untuned, being wound to be self resonant, except for the 1.75-mc. coil, as explained previously. This grid coil is tuned by a 100- μ fd. air-dielectric midget. All other coils are wound to be resonant at a frequency slightly below the particular band for which they are designed. In making practical adjustments the grid coils were wound somewhat larger than necessary and then cut down a turn or two at a time while readings of buffer plate current and amplifier grid current were taken. The number of turns which gave the largest amplifier grid current and reasonable buffer plate current was taken as being correct. The 1.75-mc. grid coil was simply wound so that the low-frequency end of the band could be reached with the padding condenser set at half scale.

It will be noted that the grid circuit of the buffer stage is tuned to a *higher* frequency than that of the crystal, while the amplifier grid circuit is tuned *lower* than the output frequency. This tends to level off the excitation over a whole

coils, care should be taken to have the same number of turns each side of the center tap, otherwise the circuits may not neutralize properly.

Specifications for the amplifier plate coils also are given in the table. The coils for the 1.75- and 3.5-mc. bands are wound with enamelled wire by the method described by WIFRQ in December 1934 QST. The ends of the coils are looped around G.R. plugs for the two outer connections. The center tap is made by cutting off most of the threaded shaft of a similar plug and soldering it directly to the center turn. It may be more convenient (and perhaps a better job mechanically) to mount the three plugs on a bakelite strip and clamp the coil to the strip.

The 7-mc. plate coil is made of $\frac{1}{8}$ -inch copper tubing. Lugs made from $\frac{3}{16}$ -inch tubing slip over the ends of the winding and are flattened and drilled so the plugs can be bolted in place. The center plug is fastened to a small strip of copper which is formed around the center turn and soldered in place. These expedients are necessary because the tubing is too thin to permit drilling to pass the plug shanks.

The 14- and 28-mc. coils are wound with $\frac{3}{16}$ -inch tubing with the ends bent and flattened to fit the sockets. The center taps are made simply by drilling through the center turn and bolting the plug in place.

GETTING INTO OPERATION

After a few preliminary adjustments have been made, the everyday operations of band changing and tuning are quite simple; it is necessary only to plug in the proper coils for the crystal and

output frequency to be used, connect the output taps to the final amplifier tank coil, and set the tuning condensers. Before this point is reached, however, it is necessary to find the correct setting for C_{11} on each coil, and also C_{12} if the amplifier is to be used on 1750 kc. To make sure that the transmitter is working properly it is desirable to take readings of grid current during the preliminary work. To do this the lower ends of R_2 and R_3 , Fig. 1, should be disconnected from the common ground and a meter of about 0-50 or 0-100 d.c. range inserted in each lead. The grid current readings are not absolutely necessary, but are quite helpful in checking the performance of each stage.

First give the oscillator a test. With the crystal and an appropriate coil (L_1, L_2) plugged in, but with the other coils out, apply plate and filament voltages and put the milliammeter plug in J_1 . The plate current to the oscillator should be approximately 50 ma. when the tube is not oscillating. Set C_{11} at minimum capacity (preferably with an insulated screwdriver) and turn C_1 slowly until the plate current takes a sudden drop, indicating the beginning of oscillation. With the second-stage tubes out of their sockets the minimum oscillator plate current should be between 10 and 20 milliamperes. With the tubes in and heaters up to temperature, it may be a bit higher. Next, slowly increase the capacity of C_{11} , watching both oscillator plate current and buffer grid current. Both should increase. If, while the capacity of C_{11} is being increased, the oscillator stops working, retune C_1 to bring it into oscillation once more. Eventually a point will be reached where the loading will be so great that the oscillator cannot be made to start, in which case the capacity of C_{11} should be decreased slightly. Under normal conditions, when this point is reached the oscillator plate current will be between 30 and 40 ma. and the buffer grid current between 25 and 35 ma. It is of course desirable to get as much grid current as possible in the buffer stage, but

the loading should not be increased to the point where the oscillator is incapable of starting again, once stopped. The buffer stage grid current will be slightly higher when both tubes are operating than when the "neutralizing" tube has its filament disconnected, but the difference will not be great. There is likewise very little effect on the oscillator plate current.

Neutralizing of the buffer stage can be checked by opening the jack J_2 with a "dummy" plug and inserting the plate coil (L_3, L_4) in its socket. This coil will of course be the one designed for the same frequency as that of the oscillator. Touch a neon bulb to the plate of the buffer and tune C_2 through resonance. The bulb will not glow if the circuit is perfectly neutralized, nor will the grid current change. A slight glow or kick in grid current indicates the presence of r.f. in the plate circuit; it may get there either through lack of balance in the neutralizing circuit or through direct pickup between the two coils. If care is used in keeping the grid circuit symmetrical the neutralizing should give no trouble. On the other hand, it is quite possible that the buffer coil will pick up some energy directly from the oscillator. This can be cured by shielding the

oscillator coil; even a simple baffle shield between the two stages helps considerably. In the transmitter illustrated the buffer stage does pick up some energy from the oscillator, but it is quite small and the stage shows no tendency toward oscillation. Because of this the extra shielding was deemed to be an unnecessary complication. To check for oscillation, stop the crystal from oscillating, put the milliammeter plug in J_2 , and tune C_2 toward

minimum capacity, where it will become resonant with the grid circuit L_2C_{11} . A change in plate current (the plate current should be very small—perhaps 10 ma.—under these conditions) or any grid current at all will indicate oscillation and the circuit should be checked over, with particular attention being given to physical symmetry and the number of turns each side of center tap on L_2 .

TABLE I

Band		1.75 mc.	3.5 mc.	7 mc.	14 mc.	28 mc.
Oscillator L_1	No. of turns....	55	31	18	7	
	Wire size.....	No. 26	No. 18	No. 18	No. 18	
	Length of winding (in.)	0.850	1.300	0.750	0.300	
	Space between L_1-L_2 (in.)...	0.250	0.300	0.300	0.400	
L_2	No. of turns....	40	26	12	6	
	Wire size.....	No. 26	No. 26	No. 26	No. 26	
	Length of winding (in.)	0.600	0.400	0.175	0.100	
Buffer L_3	No. of turns....	50	26	16	6	3
	Wire size.....	No. 26	No. 18	No. 18	No. 18	No. 18
	Length of winding.....	0.850	1.150	0.650	0.250	0.100
	Space between L_3-L_4	0.100	0.200	0.250	0.400	0.500
L_4	No. of turns....	80	60	28	12	6
	Wire size.....	No. 26	No. 30	No. 26	No. 26	No. 26
	Length of winding.....	1.250	0.600	0.425	0.180	0.200
Amplifier L_5	No. of turns....	44	26	16	8	4
	Wire size.....	No. 14	No. 12	1/8" t.	3/16" t.	3/16" t.
	Length of winding.....	3.75	3.5	4.0	2.5	2.5

Oscillator and buffer coils are wound on Hammarlund Type XP-53 coil forms, diameter 1 1/2 inches. Amplifier coils are self-supporting, as described in the text.

With the crystal oscillating and plate voltage applied to the buffer, this stage will tune in the same way as any other neutralized amplifier. Resonance on C_2 will be indicated by a dip in plate current; with the 801 tubes in their sockets and lighted, but with their filament center-tap open so that grid current cannot flow, the minimum plate current to the buffer stage will be in the vicinity of 30 to 40 milliamperes. Closing the center-tap of the final stage should make the buffer plate current rise to something over 50 ma.; it may also make retuning of C_2 necessary. The off-resonance plate current of the buffer stage should be between 80 and 100 ma. at the plate voltage shown. The grid current to the final stage should be between 20 and 30 ma., the plate voltage of course being off this stage and the tubes neutralized.

To use the second stage as a doubler, insert the proper plate coil (L_3, L_4) close Sw_1 and allow the second 2A5 to come up to temperature. The tuning of the stage will be the same as before, except that the minimum plate current under the conditions specified above will be higher—around 50 ma.—and the off-resonance plate current also higher. The stage also should be tested

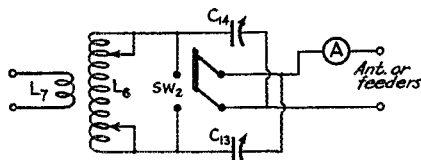
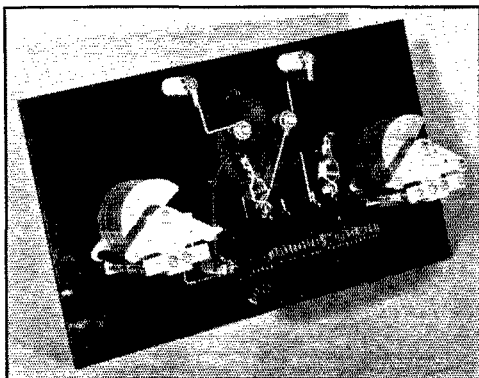

FIG. 2—WIRING OF THE ANTENNA TUNER
 C_{13}, C_{14} —300- μ fd. variables (National Type TMS-300).
 Sw_2 —D.p.s.t. knife switch.
 A —Antenna ammeter, 0–2.5 amp.
 L_6 —24 turns No. 12 enamelled wire, turns spaced to occupy a winding length of 3 1/2 inches, coil diameter 2 inches, tapped as described in text.
 L_7 —2 turns No. 12 enamelled wire, diameter 2 1/2 inches. With Sw_2 open, tuning condensers are in series with L_6 , with Sw_2 closed, in parallel.

for oscillation when operating as a doubler; the same procedure as outlined above is followed. There may be a tendency toward oscillation at the very minimum end of the C_2 scale, but so long as it occurs at a frequency well removed from resonance it will cause no trouble and can be ignored. Keeping down the number of turns on L_2 takes care of this. The grid current to the final stage should be approximately the same when doubling as when amplifying straight through, assuming the same crystal in both cases, since the additional tube increases the output and compensates for the decrease in efficiency to be expected from a doubler as compared with a straight amplifier.

Neutralizing of the final stage is easy, but should be done with care. Start with the neutralizing condensers, C_4 and C_5 , at minimum capacity, plug in the proper coil at L_5 , disconnect the plate

voltage from the final stage, and adjust C_2 to resonance. Touch a neon bulb to one end of L_5 and tune C_3 to resonance, indicated by maximum glow. Increase both C_4 and C_5 together in very



ALL PARTS IN THE ANTENNA-TUNING UNIT ARE MOUNTED ON THE PANEL

A rear view of the antenna tuner. This unit may be mounted on a wall or beside the window through which the feeders enter.

small steps, simultaneously retuning C_2 and C_3 , until the bulb no longer glows at any setting of C_3 . More accurate neutralization can be obtained by watching the flick of grid current as C_3 is tuned through resonance and adjusting the condensers to eliminate it, or by using a thermogalvanometer coupled to L_5 by a loop of wire.

When neutralizing is complete, plate voltage should be applied and C_3 adjusted to resonance, which again will be indicated by minimum plate current. This minimum will be between 10 and 20 milliamperes in most cases. The amplifier may then be loaded until the plate current is normal for the two tubes.

When a stage is working into a load the grid current always drops to some extent from the value it has when plate voltage is not applied. In this case the grid current of the buffer stage drops from an average "no-load" value of 30 ma. to an average of approximately 25 ma. when the buffer is fully loaded. Correspondingly, the grid current to the final stage drops from an average of about 25 ma. to about 20 ma. The exact value depends upon the frequency and the method of operation.

FURTHER OPERATING NOTES

If uniform output over the whole of the two lower-frequency bands is desired, the process of making adjustments as outlined above should be carried out with a crystal cut for the high-frequency end of those bands. The amplifier grid coil, as noted previously, is proportioned so that it tunes to resonance just outside the low-frequency end of the band. If a crystal at the low-frequency end of the band is used and the con-

(Continued on page 96)

An Improvement In Twisted-Pair Feeders

By Robert C. Graham, W8LUQ*

WERE it not for dielectric losses, the twisted pair line would come very close to possessing ideal qualifications for an untuned r.f. transmission line. In twisted-pair construction the wire spacing is reduced to a minimum and the uniform method of transposition greatly reduces electrostatic as well as electromagnetic radiation or pickup. In the past, the physical convenience of the twisted-pair line has justified its existence in spite of its technical shortcomings. It is the intent of this article to explain these shortcomings and how they have been overcome.

For most advantageous use the twisted pair feeder should be strictly an untuned transmission line. That is, the line should be free from standing waves, regardless of the length used. To accomplish this, the line must be connected at a point on the antenna where the characteristic impedance is the same as that of the line. If these impedances are not matched, reflection will occur and the feeders will radiate, thereby causing the original antenna design properties to change as well as decreasing the power input to the antenna proper.

Since the twisted pair is a low impedance line, the logical point to connect it to a half-wave Hertz antenna is at the center, or point of lowest impedance. The characteristic impedance at the center of a half-wave Hertz antenna is approximately 72 ohms, and when a line of the same impedance is connected to the center of such an antenna we have a matched-impedance "doublet" antenna arrangement. On fundamental frequencies and odd harmonics such a system is current-fed.¹ It should be stated here, however, that for maximum performance this type of antenna system should be operated at fundamental frequencies only.

FAULTS TO BE OVERCOME

Three of the more common classes of twisted feeders now in use are ordinary lamp cord, a twisted pair of No. 14 code house wiring material, or a twisted pair of bare rubber insulated wires. The faults common to these types are (1) improper impedance match to the antenna, (2) relatively high dielectric loss in the insulation, (3)

* Electrical Engineer, General Research Lab., General Cable Corp., Rome, New York.

¹ This point is highly important. Since the impedance of the line is fixed, a good impedance match can be obtained only when the line is coupled to the center of a half-wave Hertz antenna. This limits the system to operation in one amateur band only, since the line and antenna are very badly mismatched if an attempt is made to operate the system on an even harmonic of the antenna's fundamental. The line losses will be high in such a case; it may even be impossible to put any power at all into the antenna.—EDITOR.

high r.f. resistance, (4) unsatisfactory moisture absorption properties, (5) poor transmission qualities and (6) inability to withstand the output of high-power transmitters. Lamp cord is probably the most unsatisfactory of the three, with the code wire a close second. The reason for this is that a very low-grade rubber compound is used for the insulation. The dielectric constant of such insulation varies between 4.0 and 6.0, which means a considerable insulation loss; furthermore, the rate of moisture penetration, which is rela-

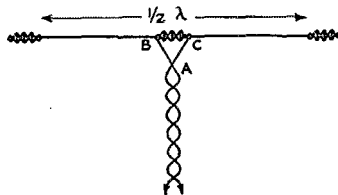

FIG 1—METHOD OF CONNECTING THE TWISTED-PAIR LINE TO THE HALF-WAVE ANTENNA

tively high in this rubber, is further increased by the cotton braid over each conductor. Since the braid is in the strong field and is very susceptible to moisture, considerable surface leakage results in wet weather. This also gives rise to varying geometric dimensions and, consequently, unstable electrical properties. (If there is any doubt about this, count the number of amateurs with twisted feeders who are forced off the air during heavy rain spells.) On the other hand, the amateur without a covering over his insulation finds that in very short order the rubber cracks open (sometimes to the point of complete failure of the insulation) and discolors because of oxidation and sun attack.

During manufacture the copper conductor in nearly all rubber-insulated wires is given a coating of tin to prevent the destructive reaction of the sulphur in the rubber with bare copper, which rapidly leads to corrosion and soft rubber. This is especially true of solid conductors. The presence of the tin coating considerably increases the copper r.f. resistance, a No. 14 tinned copper wire being about equivalent to No. 18 bare copper in effective resistance at radio frequencies.

A NEW DESIGN

Practically all of these foregoing deficiencies are made more noticeable with increases in power and frequency, or both, and show themselves usually in the form of heating and power losses. These losses are not so apparent in low-power

and low-frequency rigs. However, overall efficiency is lacking in any case.

The wires just described were designed to be used for an entirely different purpose than an r.f. transmission line and hence, while perfectly satisfactory for use in house wiring, are quite unsatisfactory for amateur feeder systems. To overcome these difficulties and develop a suitable as well as economical twisted-pair line the first problem, naturally, was to find a method by which the r.f. resistance of the conductor could be kept at a reasonable value. Accordingly No. 12 B. & S. solid bare copper wire was selected as a standard, inasmuch as previous experience had shown this size to be more than adequate for amateur transmitting antennas. Tinning this wire as previously described would increase the r.f. resistance approximately to that of size 16 B. & S. wire, so instead of the layer of tin a thin, tight fabric warp was applied directly over the conductor as a separator between the copper and rubber insulation. This warp has no effect on the r.f. resistance of the No. 12 conductor, but prevents the destructive reaction of bare copper in contact with rubber.

The next problem was the choice of a satisfactory solid insulation that would have low losses, resist moisture, have good aging properties, good transmission characteristics, and be able to give the necessary 72 ohms surge impedance. One rubber compound in particular was found to possess these features; namely, a 60% compound developed especially to meet the stringent specifications of the U. S. Coast Guard for submarine telephone cable. Moreover, being designed for underwater operation, this compound has de-

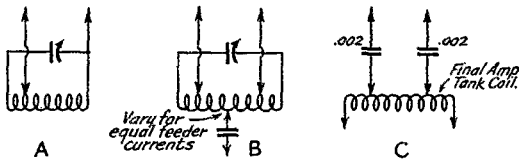

FIG. 2—THE FEED LINE MAY BE COUPLED TO THE TRANSMITTER BY ONE OF SEVERAL METHODS

The tuned circuit at A should be coupled inductively to the final amplifier tank coil. Capacitive coupling is shown at B, using a separate tuned circuit for the feeders, and at C capacitive coupling to the final amplifier tank.

idedly the best resistance to moisture, being four or five times better than the usual code insulation. The dielectric losses are very near the minimum for any solid insulation, the dielectric constant at radio frequencies measuring 2.7. By controlling the wall thickness of the rubber when applied over the conductor and separator, the necessary 72-ohm impedance can be obtained for a twisted pair. This requisite wall thickness was determined mathematically, then checked experimentally and finally measured on the finished cable. Being of suitable thickness and quality, the insulation

will withstand several times the voltage used by high-power amateur transmitters before arcing through. The increased cost of a line caused by the use of this special insulation was felt to be justified by the gain in actual performance and the ability to withstand long-time service.

The question next arose of protecting the rubber from oxidation and weathering. A braid applied over each conductor would readily absorb moisture and, being in the electric field, would change the initial line properties considerably. However, a braid placed over the two twisted conductors would be sufficiently removed from the field to have a negligible effect on operation. Hence, an overall cotton braid was placed about the twisted pair and impregnated to prevent water saturation. The completed cable was then given a finish such as is applied to service entrance cables, enhancing its appearance and permitting the feeder to be clamped to the side of a house without leaving traces of wax. Incidentally, clamping the feeder to a house should in no way impair its operating characteristics inasmuch as the rubber provides satisfactory insulation and the field is nearly all self-contained between wires of the pair. This feature is not so important as the others, but should appeal to amateurs fussy about appearances.

The incorporation of these features in a lowly piece of wire having been accomplished, the following average actual measured test results and allowable tolerances were obtained for this type of construction:

Surge impedance at 3500 kc.—72 ohms (tolerance plus or minus 5%).
Capacity between wires—.0008 μ d. per 100 ft. of line, plus or minus 5%.
Dielectric constant of insulation—2.68, plus or minus 5%.
Dielectric strength (puncture voltage between wires)—Minimum, 25,000 volts.
Moisture absorption of rubber as measured by percent change in capacity after 30 days in water—Less than 5%.
Attenuation—Less than 1.5 db per 1000 feet of line at 3500 kc., 4.0 db at 7 mc., and 5.2 db at 14 mc.

- Surge impedance at 3500 kc.—72 ohms (tolerance plus or minus 5%).
- Capacity between wires—.0008 μ d. per 100 ft. of line, plus or minus 5%.
- Dielectric constant of insulation—2.68, plus or minus 5%.
- Dielectric strength (puncture voltage between wires)—Minimum, 25,000 volts.
- Moisture absorption of rubber as measured by percent change in capacity after 30 days in water—Less than 5%.
- Attenuation—Less than 1.5 db per 1000 feet of line at 3500 kc., 4.0 db at 7 mc., and 5.2 db at 14 mc.

INSTALLATION AND RESULTS

The installation and use of the twisted pair line is simpler and decidedly more convenient than that of open-wire lines. For connection to the antenna (and transmitter end) cut the outer braid back about 8 or 10 inches with a sharp knife or razor blade so that the individual wires may be fanned out to form an equilateral triangle. (See Fig. 1.) Not only does this fanning provide a

(Continued on page 98)

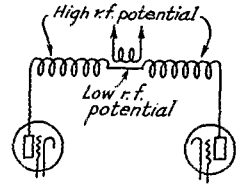

FIG. 3—IF POSSIBLE, THE LINE SHOULD BE COUPLED TO THE TRANSMITTER TANK AT A POINT OF LOW R.F. POTENTIAL

One way of doing this with a push-pull amplifier is shown above.

What the League Is Doing

League Activities, Washington Notes, Board Actions—For Your Information

Chart One of the American radio magazines recently issued, as a supplement, a chart of the radio spectrum as assigned to services in the United States. On this chart there were many blank spaces between 4 mc. and 6 mc. and above 23 mc. which were marked "unassigned." Several amateurs have made inquiry of us about this matter, wondering why the A.R.R.L. does not move to capture some of these channels for amateur radio if there is unassigned territory available.

Included in the F.C.C. regulations is a very long list of frequencies, being the exact center frequency of every channel in the radio spectrum. Opposite each figure appears the name of the type of station to which it is assigned. Without exception the frequencies shown on this chart as "unassigned" are listed by the F.C.C. as available for "general communication service."

In the allocation table of the Madrid treaty every one of these frequency bands is assigned either to fixed stations or mobile stations or to the two jointly. Moreover, the administrations of North and Central America reaffirmed this allocation above 4 mc. even in places where, by mutual consent, they might have made slight modifications in it. The United States is therefore doubly bound to assign these frequencies only to the fixed or the mobile service and may not permit their use by broadcasting stations, amateurs, or other generic types of service.

The F.C.C. does not content itself with making allocations simply to the fixed service or mobile service. They have many subdivisions of these basic types and make their assignments in such terms as point-to-point, agriculture, geophysical, press, emergency, fire, municipal police, harbor, ship telephone, etc. Until the F.C.C. makes up its mind to just which detailed classification it will allocate certain frequencies in the United States, in terms of growing needs, it calls these frequencies available for "general communication service," but they may be used only for the basic type of service designated in the Madrid regulations. It was this term "general communication service" which the magazine in question translated as "unassigned."

We're all interested in more frequencies. A.R.R.L. would be the first to move for these frequencies if it were practicable, but we have been over this ground many times and have investigated every angle of it. That is why we concentrate now on Cairo.

The chart to which we refer also showed sixteen channels within our 3500-4000-kc. band as

available jointly for use by the government, and some members write to ask whether this is a new development which represents the loss of frequencies. The answer is no. This assignment has existed for many years past and is shown in the F.C.C. table of frequencies referred to above as appearing in the complete F.C.C. rules and regulations—which every amateur ought to possess. As we have previously reported in *QST*, sixteen channels in this band are assigned by executive order for the use of naval aircraft. They are used only off-shore, remote from the country. Although the arrangement has been in existence many years, there has never been the slightest QRM; in fact, we have never heard of an amateur who even intercepted any of this correspondence in our band.

Auto QRM

The League continues its drive against automobile ignition interference on the ultra-high frequencies and has been instrumental in stirring up widespread study of the problem. Primarily its solution requires coöperation between many agencies. On November 14th the first national conference on interference elimination was held in Rochester under the auspices of the engineering division of the Radio Manufacturers Association. A committee was formed under the chairmanship of Dr. A. N. Goldsmith to deal with radio interference caused by electrical appliances, power distributing systems, and automobiles. A.R.R.L. is a member. Already there is widespread realization that something must be done about automobile interference. We hope for practical results soon.

Incidentally, at this conference Chief Engineer C. B. Jolliffe of the F.C.C. remarked that interference with broadcast reception almost never comes from amateurs these days and when it does it is almost always attributable to faulty receiver design. Hotcha!

Foreign Traffic

We summarize the progress to date in our quest for authority to handle third-party messages internationally.

Special arrangements have been made with Canada, Chile and Peru whereunder amateurs may exchange, for third parties, messages that would not normally be sent by any existing means of electrical communication, and on which no tolls must be charged. Additional classes of traffic permitted with Canada were recited on page 34 of *QST* for August. The outlook is excellent for the successful conclusion of

special arrangements with Mexico and Cuba, but in each case awaits a pending revision of the local radio law. Argentina, Australia, British India, China, Great Britain, Irish Free State and the Union of South Africa have refused to agree, the argument generally being that local regulations do not permit amateurs to handle any communications whatever for third parties. Word is still awaited from numerous other countries.

We beg to retract as incorrect the statement published in July *QST*, page 19, that the Radio Society of Great Britain, through want of interest in message-handling, had recommended to their government that it reject the proposal of the U. S. The error was caused by misinterpretation of a letter from R.S.G.B.; we're sorry. The R.S.G.B. did not recommend to its government that it decline and is not without interest in the subject, but ascertained that even if the Post Office were willing to permit message-handling by amateurs, the laws of Great Britain forbid it. They point out that conditions are very different in Great Britain; a letter reaches practically any point in the British Isles within 24 hours and most places in 15 hours, so they do not experience our great need for rapid communication over great distances.

District Inspectors

Several changes have occurred recently in the addresses of Radio Inspectors in Charge of districts. Note new addresses as follows: Sixth District, 411 New Post Office Building, Atlanta. Seventh District, P. O. Box 150, Miami. Thirteenth District, 207 New U. S. Court House Building, Portland, Oregon. Sixteenth District, 927 New Post Office Building, St. Paul. Seventeenth District, 410 Federal Building, Kansas City, Mo.

QSL Service

Don't forget that A.R.R.L. supplies a free QSL forwarding service, maintained through the loyal cooperation of some of the fellows. If you have been on the air recently, there are QSL cards awaiting you at the office of your QSL Manager, but it is necessary for you to write for them. A few simple rules must be complied with. See page 30 of *QST* for September for the complete dope. Just this past week we received and transmitted to the QSL Managers over fifty pounds of foreign QSL cards, for distribution to the gang—giving some idea of the splendid service these volunteers are giving all of us. The QSL Managers say that many cards are not sent for. You may have some beauties waiting for you!

'Phone Modulation

The last meeting of the A.R.R.L. Board of Directors instructed that *QST* adopt the editorial policy of urging the use of low-pass filters to limit 'phone modulation frequencies to about 3000 cycles. Subsequent

study having shown that such a policy would be contrary to the best interests of amateur radio, the Board has now rescinded its instructions.

Study has shown that the *normal* speech components of above 3000 cycles make only negligible contribution to interference. The *interfering* side-band components representing audio frequencies above 3000 cycles are mainly the result of overmodulation, originating chiefly in the r.f. section of the transmitter, and would not be removed by a device which limited the upper audio frequencies in the speech amplifier or modulator. It is the belief of our technical staff that the only cure for the extensive broadness of 'phone stations will be a determination upon the part of the individual 'phone operator to avoid overmodulation and kindred maladjustments. This interference caused by overmodulation is generally prevalent and extremely serious, and greatly diminishes the usefulness of the amateur 'phone bands. That is why *QST* so frequently discusses the proper adjustment of 'phone transmitters.

Amending the Act

There is a suggestion going the rounds that the League ought to propose amendments to the Communications Act for the improvement of the amateur position, in connection with the study now being made by the F.C.C. The officials of the League see nothing to be gained by attempting to write some of our present privileges into the law, even if it could successfully be done. It would be sweet, of course, just on general principles, to have our frequencies written into the basic radio law, and we suppose that is the main idea of the proponents. But it would be without value so far as concerns forestalling the effect of a change in international treaty, because a treaty is superior to a statute and the courts have held in such cases that a change in treaty automatically amends the contrary provisions of domestic law. The F.C.C. report will relate primarily to moot points on which no Congressional agreement could be had at the time the act was passed: broadcasting quotas for types of stations, policy on clear channels, competitive wire-radio domestic service, mergers, etc.

Growth Figures

According to the latest F.C.C. report, the total number of licensed amateur stations in the United States on June 30, 1934, was 46,390. The number at the end of the preceding fiscal year was 41,555. The net growth is 4,835. The number of new station licenses issued during the year was 8,790, but there were 3,955 cancellations, largely through surrender of duplicate portable licenses. (There are still some 3,000 to 5,000 extra portable licenses outstanding. They should be surrendered direct to F.C.C. at Wash-

(Continued on page 98)

Practical Operating Advantages of Low Temperature-Frequency Coefficient Crystals

By F. C. Baldwin and S. A. Bokovoy*

PIEZO-ELECTRIC quartz crystals have been widely used for a number of years to control the frequency of all types of radio transmitters wherever it has been necessary that the emitted frequency be held within narrow limits. No simpler, cheaper or more compact form of control seems to have been developed which can equal it in performance and dependability. However, such transmitters, even though crystal-controlled, may be subject to appreciable frequency shift unless certain conditions intimately associated with crystal performance are taken into account. The precautions to be taken, of course, depend on how far the frequency may be safely allowed to deviate from the assigned or desired value. The most exacting case is that of the crystal-controlled primary frequency standard in which it is necessary that the frequency be held continuously within better than one cycle per million. The most exacting commercial case is probably that of the broadcast station whose frequency must at all times be within 50 cycles of the assigned value.

At one time the amateur transmitter was considered well controlled if a good Y-cut crystal was secured and connected between the oscillator grid and cathode, even though it was at the mercy of rapidly changing temperatures and the other ills with which the earlier crystals were beset. This type has been largely succeeded by the X-cut plate, which, if somewhat less active piezo-electrically, is less subject to "parasitics" and other spurious modes of oscillation, and in addition has but one-third the temperature coefficient of the Y-cut.

However, due to the ever increasing congestion of the amateur bands and the contemporary advance in receiver selectivity (as in the Single-Signal superheterodyne for example), even the X-cut crystal without trimmings does not suffice completely and temperature control has been adopted in many cases. A reasonably good heat box and an X-cut crystal will undoubtedly give frequency stability sufficiently good for most work, and a well-designed box will yield a control which is practically perfect. Heat boxes, however, are *non-grata* to the majority of amateurs because of their bulk and the fact that thermometers and

troublesome thermostats and relays must be purchased and incorporated. The work of constructing such a box is appreciable, to say nothing of the cost, and the amount of heating power consumed will be at least 15 watts.

Obviously, the solution for the problem would be a crystal cut so as to have an extremely low temperature-frequency coefficient and, at the same time, to retain all the desirable features of the conventional X and Y cuts. Such a solution, however, at first seemed problematical, since it was generally thought that if a departure were made from either of the conventional cuts the crystal so obtained would oscillate but weakly, if at all. At best, it would probably be temperamen-

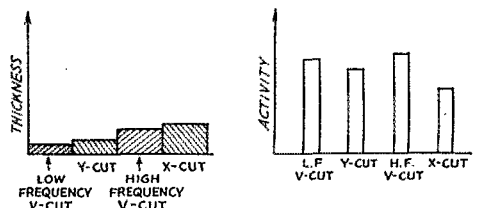

FIG. 1

tal and would respond to a multitude of different frequencies, depending on tuning, loading and temperature. The authors undertook this problem and were finally successful in producing a low temperature-coefficient cut which considerably exceeded expectations. The temperature coefficient was practically zero, the activity was good, and single frequency response was definitely obtained. One characteristic of this cut was that for a given frequency it was only about 85% as thick as a Y-cut and 57% as thick as an X-cut crystal.¹ Such a plate, while highly desirable for low frequencies, would be somewhat fragile in the upper-frequency amateur bands.

Further development was carried on and an optimum cut ultimately discovered which was even more active piezo-electrically than the first, and in addition was found to be practically as thick as an X-cut and about 50% thicker than a Y-cut of the same frequency. This is designated the V-cut. The scale diagram of Fig. 1 shows

* Both of Engineering Dept., RCA Victor Co., Camden, N. J.

¹ The AT-cut crystal described on page 17, October 1934 QST, has the same characteristics.—EDITOR.

graphically the approximate relationship between the various crystal cuts with respect to relative thickness and piezo-electric activity or output, for crystals of the same frequency.

Quantities of these V-cut crystals have now been ground and supplied for exacting use in various services. The temperature coefficient can be held commercially to within 2 cycles per million per degree Centigrade change in temperature between zero degrees and 50 degrees Centigrade. Actually, however, the change with temperature averages less than 1 cycle per million and performance is uniform far below freezing and well above 50 degrees Centigrade. These crystals, in

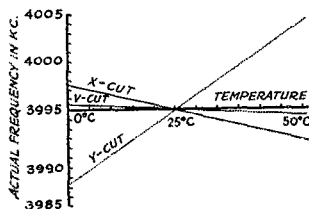

FIG. 2

contrast to many high-frequency plates, are full size—approximately one-inch square—which, together with the increased thickness, definitely places them in the "power crystal" class. They can be ground to cover the amateur bands, give output frequency that is easily doubled and the actual frequency of each can be precisely measured and certified to within .005% as measured at room temperature. Obviously, such a crystal may be used for a precise point-calibration of a frequency meter, since it will hold its original accuracy indefinitely.

The curves of Fig. 2 give a graphical comparison of the frequency shift of average X-, Y- and V-cut crystals ground for a frequency of exactly 3995 kc. at 25 degrees Centigrade. The X-cut has a negative coefficient while that of the Y-cut is positive. The V-cut may be either or both but is shown arbitrarily as negative. The Y-cut curve is shown as linear and continuous; but in some instances, especially if the crystal is improperly ground, this may not be the case and discrete discontinuities may occur. The curves show quite plainly that without temperature control the frequency of an X- or Y-crystal-controlled transmitter can shift enough as the equipment warms up to cause annoyance at the receiving end. If the crystal happens to be operating quite closely to either end of the band the frequency may easily shift outside the limit. When doubling from an 80-meter crystal into the 20-meter 'phone band, the picture is even more startling as shown below for the 4th harmonic of crystals ground to 3561 kc. at 25 degrees Centigrade.

A study of these curves shows clearly that X- or Y-cut crystals not only are unsuitable for operation at the respective extremities of the band

but even may cause trouble unless their frequency is near the center of the band. For example, if the crystal temperature rises 20 degrees Centigrade during the warming-up period, an initial output frequency of 14 megacycles will shift as follows, depending on the cut of the crystal used:

Y-cut	21 kc.
X-cut	7 kc.
V-cut056 kc.

Low coefficient crystals such as the V-cut, hence, may be of a specified frequency but slightly within the band for safe operation. Hence, use of crystals of this type will open up a number of hitherto unusable traffic lanes near the band limits.² The V-cut will definitely hold frequency, even under adverse conditions, with practically undetectable variation and in addition will possess the prime requisites of high activity, freedom from frequency response other than that desired, full size, maximum thickness, accurate calibration and long life.

Even though the nominal frequency of an X- or Y-cut crystal be sufficiently centered in the

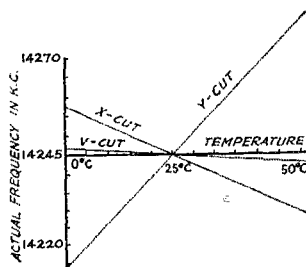

FIG. 3

band to preclude any danger of overstepping, there is still present the equally objectionable condition in which the frequency will gradually drift into a region of interference from other signals. This will occur even though the room in which the transmitter is housed is held at fairly uniform temperature, because an appreciable amount of heat is generated not only by the tubes and associated equipment but also by the oscillating crystal itself. Ordinary crystals even in a practically perfect heat box are not immune to this latter effect unless operated continuously, as the heat generated by the crystal itself will raise the temperature appreciably before the thermostat takes charge and restores equilibrium. The low coefficient of the V-cut, however, is effective whether the temperature rise is produced from outside or inside of the crystal. The receiver

(Continued on page 98)

² Always with due allowance for the sideband width of the transmission, of course. For 'phone transmission the carrier frequency should be at least 3 kilocycles, and preferably 5 kilocycles, inside the band limit. For c.w. telegraph transmission it is advisable to allow at least 500 cycles for side band components resulting from keying.—EDITOR.

Doublet Receiving Antenna and Bucking Circuit for Duplex Operation

By Stuart W. Seeley, W8ZC*

THE purpose of this article is to describe some rather interesting results obtained in duplex operation at W8ZC with a receiving doublet located somewhat more than two full wave lengths away from the 75-meter 'phone transmitting antenna.

The receiving doublet, each half of which is 58 feet long, runs at right angles to the horizontal transmitting doublet in an open field. Connected across its center insulator is one end of the 600-foot transmission line consisting of Lynch "Giant Killer" cable. The constants of this cable were measured and found to be entirely satisfactory for the job. The surge impedance measured 78.4 ohms and the characteristic impedance 71.6 ohms at 4000 kc. The voltage efficiency of the entire 600 feet is approximately 26% at 4000 kc. This means, of course, that the desired signal voltage applied to the receiver is only about one-fourth of what it would be without the cable, but the fact that the local noise voltage is reduced by an average factor of more than four to one improves the signal threshold of the entire system to better than the average value for the old antenna. In other words, the effective sensitivity of the receiver is increased.

No special precautions were used in shielding the superhet receiver, which incidentally is within 3 feet of the transmitter's final tank circuit. However, the input circuit which connects to the transmission line was constructed with considerable care not only to prevent capacity coupling between the pickup coil and the first grid, but also to maintain as near an exact balance of capacities as possible between the wires of the transmission line and ground. The coupling was adjusted until the voltage rise at the first grid equaled the calculated value for the secondary, which has a Q of 212 with a self inductance of 13 microhenries.

This measurement was made using a signal generator, a vacuum tube voltmeter and a non-inductive 70-ohm resistor for the dummy transmission line. The inductive reactance of the primary was insignificant compared to 70 ohms, and therefore it was not necessary to equalize it with series condensers. A self-explanatory sketch of the final unit is shown in Fig. 1.

The antenna was put up and the transmission line strung on a rainy Saturday afternoon. The coupling unit had already been completed and the whole arrangement performed beautifully right from the start. It was found to be possible to copy signals up to within 9 kilocycles of the transmitter carrier of about 400 watts when not modulating, and to work very satisfactory duplex with 20 kilocycles separation.

Right here it might be well to explain that while too much duplex operation in any of the 'phone bands would probably cause an intolerable increase in QRM, because of continuously running carriers, there are other advantages which accrue from the ability to listen on the band when transmitting. When answering a CQ, the call can in most cases be materially shortened if the other station is told to "break in" as soon as you are heard. If he comes back to someone else, you are immediately aware of the fact and can stop calling. When trying to carry on a QSO through heavy QRM, the other 'phone is able to inform you the instant the interference becomes too severe. Then when continuing after the QRM has

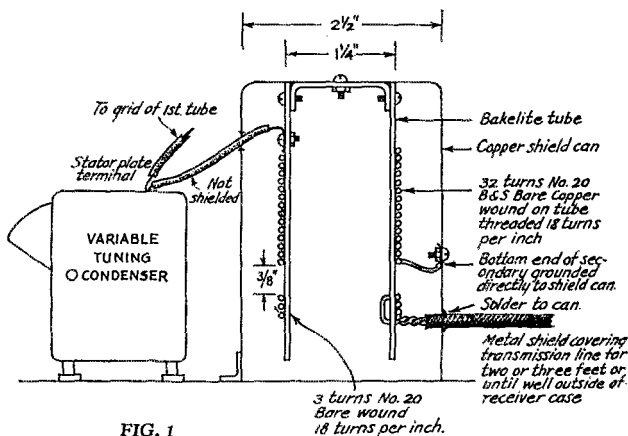

FIG. 1

lifted, you know exactly how much he has received and useless repetition is avoided. As a further example, in cases where the station with which you are working is being QRM'ed, you are able to continue your own transmission until the interference lets up before turning it over to him; or if it is too distracting to listen to the QRM while trying to transmit, your receiver's tuning

(Continued on page 82)

* 774 Audubon Blvd., Jackson, Mich.

More on Gaseous Voltage Regulators for Receiver "B" Supplies

By H. A. Robinson, W3LW*

We forecast that this season will see further concentration on the business of frequency stability in high-frequency receivers, particularly in a.c.-operated superhets of high selectivity. An important phase of this must be in voltage stabilization in receiver "B" supplies. Soaring and diving oscillator plate voltage, resulting from line voltage changes and variation in load current with operation of the r.f. gain control, is an all too common cause of oscillator frequency shift in present designs. Furthering QST's campaign in this direction, this article by W3LW gives quantitative practical data on gaseous-type stabilizers, equally applicable to regenerative and superhet receivers.—EDITOR

IN AMATEUR practice the necessity for a d.c. power supply capable of maintaining a really constant output voltage, unaffected by load variations and voltage fluctuations of the power line, has long been met only by the use of "B" batteries for the plate supply of receivers, frequency meters, monitors and the like. This requirement of constancy of plate voltage supply is one of paramount importance in the case of a high-frequency receiver. In the regenerative type of receiver, still widely employed both in amateur and commercial stations, optimum performance both from the standpoint of sensitivity and selectivity is obtained only with the regenerative detector operating within very close limits of the point of critical regeneration.¹ This is true for reception with the detector in both the oscillating and non-oscillating condition, and to maintain reception at the peak it is necessary that the "B" voltage fluctuation be not more than one or two tenths of a percent for even the most severe line fluctuations.

Although numerous regenerative receivers operating more or less satisfactorily with an unregulated a.c. power supply have been developed and marketed by several radio manufacturing companies within the past few years, their performance could be greatly improved if a power supply of more nearly constant voltage were available.

With the advent of the electron-coupled oscillator, characterized by the compensating effect of the screen and plate voltage variation on the oscillator frequency, the need for a well-regulated power supply for such an oscillator employed in a superhet receiver or in a frequency meter or monitor is less pronounced. However, even with such an oscillator the frequency is affected to some extent, and the amplitude of oscillation changes somewhat with power supply variations. In certain applications, as for example in super-

heterodyne receivers with insufficient oscillator excitation, the amplitude variation alone may prove seriously objectionable.

When an electron-coupled oscillator is em-

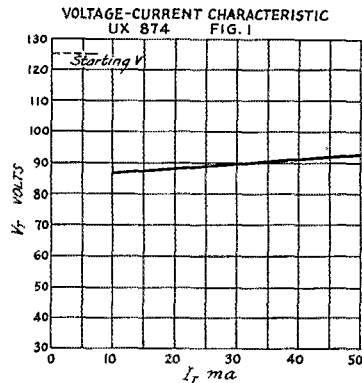

FIGS. 1 AND 3—VOLTAGE-CURRENT CHARACTERISTICS OF GASEOUS REGULATOR TUBES

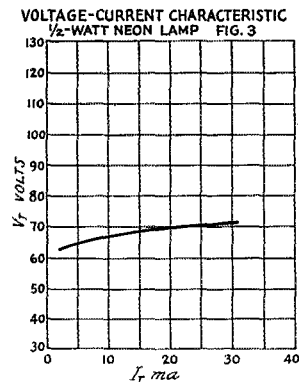

employed as the regenerative detector,² the importance of a well-regulated power supply is not to be

* Silver Lake Farm, Willow Grove, Pa.

¹ Robinson, "Regenerative Detectors," *QST*, February, 1933.

² Grammer, "Rationalizing the Autodyne," *QST*, January, 1933.

overlooked if optimum performance is desired. This follows from the fact that when such an oscillator is employed as the regenerative detector for c.w. reception the tube is oscillating feebly near the point of critical regeneration, and slight fluctuations of the supply voltage will cause the

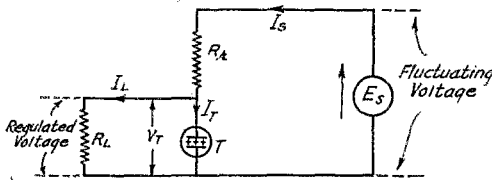

FIG. 2—THE EQUIVALENT CIRCUIT OF THE VOLTAGE REGULATOR

- E_s —Source of fluctuating voltage (output of rectifier-filter).
- V_T —Voltage across regulator tube.
- I_s —Supply current to regulator.
- I_T —Current through regulator tube.
- I_L —Regulator load current.
- R_k —Regulator resistor.
- R_L —Load resistor (or equivalent).
- T —Voltage regulator tube.

receiver to drop in and out of oscillation just the same as with the more usual type of regenerative circuit arrangement.

VOLTAGE REGULATOR TUBES

Now that we have seen the need for a rectified-a.c. power supply which will maintain substantially constant output voltages irrespective of the usual power-line voltage fluctuations, let us consider the ways and means of meeting it.

Limiting our problem to that of regulating the power supply for receiver oscillators or similar circuits requiring less than 30 milliamperes total current drain, we find the gaseous-tube type of regulator by far the most satisfactory at the present state of the art, when considered from the standpoint of reliability, compactness and low cost. The principles upon which such a regulator functions have been clearly explained in a previous article³ and we will but briefly review them here.

When a d.c. voltage is impressed between two electrodes in a glass or other enclosure containing a small quantity of gas at low pressure, no appreciable current passes unless the voltage is greater than the ionization potential for the gas employed. Once ionization takes place, accompanied by a characteristic glow, the voltage across the tube remains practically constant at a value somewhat lower than the starting potential, for a considerable variation in current through the tube. The regulator tube thus functions as a device with a constant back e.m.f. and an ex-

tremely low internal resistance, the resulting current through the tube being determined by the external circuit arrangement.

For a number of years there has been available a tube of this type designated as the 874. The voltage-current characteristic of a typical tube is shown in the curve of Fig. 1. Let us now consider some of the problems in designing the most effective voltage regulator arrangement utilizing this characteristic.

Because of the low internal resistance of the gaseous type of regulator tube, a series resistor (R_k) which we shall call the regulator resistor, should always be employed. The equivalent circuit arrangement shown schematically in Fig. 2 results. From the simple mathematical analysis given in the Appendix, it is apparent that for a given load resistance R_L it is desirable to have the regulator resistance as high as possible, which implies working the regulator tube at as low a value of tube current as will permit its operation for the range of voltage fluctuation desired. This normal operating current can be read from the tube characteristic. Typical examples will be given later. It is important to note that in order to have the voltage regulator tube function at all, the voltage of the source E_s (filter output) must be greater than the starting or ionization voltage for the particular tube employed.

A NEON LAMP VOLTAGE REGULATOR

The versatile little neon lamp can be readily modified to function as a voltage regulator. The modification consists merely of removing the limiting resistor found inside the base. Slightly heating the base over a low gas flame and twisting it with pliers will loosen the cement. After the

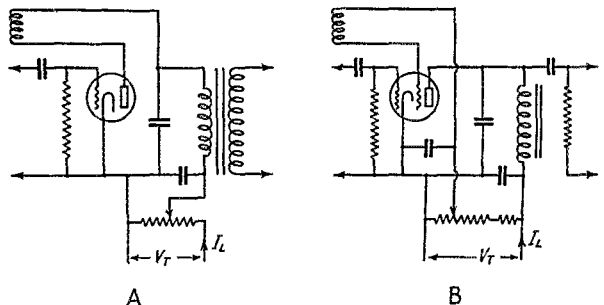

FIG. 4—APPLICATION OF THE VOLTAGE REGULATOR TO REGENERATIVE DETECTORS, A BEING A TRIODE CIRCUIT AND B FOR A SCREEN-GRID TUBE

V_T is the voltage across the regulator tube and I_L the regulated load current, as also shown in Fig. 2.

resistor has been removed the lamp may be mounted by cementing it on a tube base or other holder, taking care to mark the leads connecting to the internal elements. The characteristic curve of Fig. 3 was obtained with a G.E. $\frac{1}{2}$ -watt type

(Continued on page 84)

³ Dekker and Keeman, "Stabilized 'B' Supply for A.C. Receivers," *QST*, October, 1932.

One Ham's Journey . . .

TAKE a look at the station in the photograph below. No, this isn't a station description, but—take a look, anyway.

Very neat, isn't it? That massive S.S. receiver reposing so competently on the operating table, not to mention the monitor beside it—the transmitter, all enclosed and workmanlike, on the cabinet at the right—the complete portable station in natural wood near the center—don't you envy the craftsmanship they represent?

That picture, a few facts, and we're ready for the story. Here are the facts: The complete station, from start to finish, both transmitters and receivers—winding coils, winding transformers, altering variable condensers, down to the last detail—was built by its owner and operator, Thomas A. Benham, W3DD, of Ardmore, Pennsylvania. And—Tom Benham has been totally blind for the past eighteen years!

Here is the story:

Thomas A. Benham was born at Hartford, Conn., on December 30, 1914. At two years of age he contracted whooping cough, which, together with a tonsil complication, left an arthritic condition eventually resulting in loss of sight.

He attended the Western Pennsylvania Institution for the Blind at Pittsburgh until 1926, at which time his family moved to Philadelphia and he transferred to the Blind Institution at Overbrook. In 1933 he entered the Lower Merion High School at Ardmore, Pa., and this fall he was admitted to Haverford College.

His first contact with radio as a hobby came about five years ago during a long convalescence from an attack of grippe, and progressed through the usual evolution from a one-tube affair to the present outfit.

The transmitter at W3DD consists of a crystal oscillator stage using a type 47 tube, a buffer with an 865, and an amplifier stage employing a 203-A with 1000 volts on the plate. It operates on 3.5, 7 and 14 mc., and has been heard in all continents on 7 mc. and in Europe on 3.5 mc. The operating desk carries a monitor, receiver, and loud speaker. The receiver is a Single Signal superheterodyne, incorporating a 58 r.f. stage, 2A7

W3DD

From left to right, monitor, receiver, loudspeaker, portable rig, and transmitter



THOMAS A. BENHAM,
W3DD

combination mixer and oscillator, followed by the conventional i.f., second detector and c.w. oscillator circuits, with a 2A5 audio and 80 rectifier.

The entire station is operated from a row of toggle switches, inset into the desk top. The portable outfit contains a complete station, including power supply and loudspeaker. The transmitter consists of a 47 crystal oscillator and '10 amplifier; the receiver is a tuned r.f. set using two 58's, a 56, and a 2A5.

In the face of that performance, what ham can protest that his obstacles are too great to overcome? In W3DD's own words, "All the work of construction . . . was done as a matter of education as well as of expediency, for only in this way could practical knowledge of principles and construction be obtained."

Perhaps this evidence of the possibility of overcoming handicaps not common to the average amateur may encourage some other fellow when the disappointments get piled too high on the ol' hook. We hope so.

—C. B. D.

Strays

W9ALO has been getting excellent results with the spark-coil plate supply described by W9FJV in June, 1932, *QST*, using a BH type rectifier instead of the 01-A's. The BH tubes must be "broken in," however, by operating at low voltage at first, otherwise they're likely to give trouble. W9ALO starts out with only four to six volts on the coils and loosens the vibrator tension. The output will be low at first but after a few hours' operation the full 12 volts may be used.

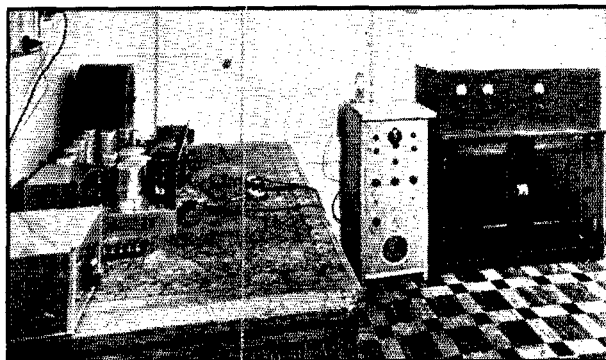

H A M D O M



MANY a man has gone from hamdom to the Navy. Lt.-Comdr. Wm. Justice Lee, however, served in the Naval Reserve Flying Corps during the war, and entered hamdom in 1920 with 4IU on 200 meters. In 1922, famed 4XE was built and installed at Jacksonville, Fla., in cooperation with Lieut. John C. Cooper. From it, the first north-south communication on 20 meters was established with John Reinartz, W1QP. Later, from Winter Park, 'phone



work was done with Australia and New Zealand in 1924. In 1926, Lt.-Comdr. Lee organized Florida's NCR unit, establishing the first Naval Reserve control station, NRRG, now NDJ. In 1929 he was ordered to Washington to organize and train the NCR on a national basis. Since that time, this organization has developed into a large and efficient group of more than 5000 officers and men, owning and operating 2000 licensed amateur stations and 32 N. R. Control Stations—a splendid organization toward which the eyes of many nations of the world are turned in envy and emulation.

WHEN a harassed schoolmarm grasped Walt Colpus firmly by the collar and the seat of father's built-over trousers and summarily graduated him in the middle of a semester, he set out to do his own educating. The process was complicated in 1923 when he became ill with an obscure disease which confined him to a wheel chair until three years ago. Fortunately, the ham virus had inoculated him long before the other, and in the intervening years W8BRS has grown to an enviable status in the amateur world. Secretary and co-founder of the Chair Warmer's Club, that enthusiastic band of shut-in hams, some time O.R.S., A.A.R.S., and O.O. (until he made the sad mistake of "calling" a highly vindictive and sarcastic YL), Walt now spends most of his time rag-chewing and playing with the new gear that



decorates *QST*'s pages each month. It all goes to show what a swell guy can do with such a swell mode of "vocational therapy"—as the pill-rollers have it.

M. L. "PAT" PATTERSON, W4WS, was a Michigan lad who went to Cuba in 1904 as irrigation engineer. After remaining there for eight years, he went to Burma, British India, as field engineer for the Burma Oil Co. In 1914 he was sent to lower Burma by the British government to mine tungsten. Then he was made manager of the Thabaleik tin mines, near the frontier of Siam, remaining there until 1923 when he returned to the U. S. A. because of poor health. The radio bug bit in 1926, but it was not until 1929 that the well-known 3500-kc. 'phone rig went on the air. For the past four years W4WS has been the Master Oscillator (president) of the Florida 'phone gang, organized as the "Knights of the Kilocycles," having charge of the

meetings held each Sunday at 8 a.m. over the air. Pat is also alternate net control for the Florida Army 'phone net, as well as O.P.S., O.B.S., and R.M. His business, as well as his hobby, is radio. Just to guarantee his amateur status, he likes to do a bit of fishing on the side—and his CQ's sure bring 'em in!



THIS man Molinari, in common with so many of the California lads, has been a high-power man almost from the beginning. He opened up 6AWT in 1921, after five years of procrastination, with four VT2's in a 'phone-c.w. set. The list then reads 202, 203, 204, a pair of them, a lone 204A, and then a homemade water-cooled tube. It was this rig that won him the Hoover Cup in 1924. After that honor, interest dropped off somewhat until 1931, when a pair of 212D's were impressed into service in a new location. It was with this rig, and later with a pair of 204A's, that the current fame of W6AWT was earned. That fame is now world-wide.



Shootin' the Works

I Learn About Hits And Klinks

By Lawrence E. Hauck, W9CYV*

I TURNED to the "Stray" on page 76, December *QST*. "Whazis? Whazis?" I ask myself.

Some sordid soul has suggested a new way to drill window glass to pass feeder wires through. Sort of a Dillinger scheme; plug the pane with a .22 slug or use lil' brother's BB gun! It is claimed the shot will plunk a smooth quarter-inch hole just made to order for Zepp feeders.

"Zounds!" I exclaim, "this is the process just made for a lazy ham like I am!" I have heard the ancient legend how the Ozark hill-billies plant their cornfields on the mountainside, with a ten-gauge shotgun loaded with kernels. The planting act being done from the front doorstep! Now here is the same thing, only different—this shootin' act beats the old drill and turpentine formula by a mile. Look out, you window glass! I decide henceforth to run my feeders through the pane instead of through the hand-carved window sill.

Accordingly I take down the old bolt-action .22 and load up. Now make no mistake, I'm no Tom Mix, but I am considered a fairly handy fellow with shootin' irons. Therefore I grab a cake of that pink body-odor soap and mark a pair of crosses about eight inches apart—the marks, as you have guessed, to be the spots where the feeders enter. So far, so good. Now comes the shot that is heard around the block. Klank! I cut loose from across the shack and let her have it.

Do I get the quarter-inch hole neatly drilled out for said feeder? Brother hams I cannot deceive ye—I do not! I get instead a handsome brocaded cupid's bow—something like those lips of Betty Boop, just before breaking into osculation. Small pieces of glass tinkle to the floor. Well, that operation was no success! Therefore I take up the kid's BB shooter, thinking perhaps a .22 has too much output. I bear down on the other cross-mark and let the BB gun burp forth. Plink! This time I get something in the window that resembles an angry boil; or is it an indignant carbuncle? I decide to press the muzzle closer and ream out the perforation to take No. 12 wire.

Crack! And now a five-pointed star in the window pane and a hole big enough to run through a plate lead for WLW's biggest bottle!

"Aw nertz!" I growl in disgust, "since the old pane is ruined I may as well practice on it."

I fire a volley from the air rifle and cut designs and didos in that pane. Then I pick up the .22

and cut my initials in glass. But nowhere do I get the quarter-inch hole to take the Zepp feeder. Instead, the pane now looks like a jig-saw puzzle that some drunk has pieced! I determine to finish it outright and grab up my faithful twelve-gauge shot gun. Just as I'm in the act of calling CQ on the trigger, the wife grabs me by the back of the neck. In the excitement I lose my aim and shoot too high. Blooie! I hit just above the top of the window and take out a brand-new porthole, six inches across, making the lath and plaster fly in all directions.

"Say, you lunatic, you inebriate—just what in the blankity blank do you think you're doing?" she hollers at me through the smoke and flame.

"Why now, sweetheart, I'm cutting a hole in the window for my antenna—it's in *QST*, honest it is—"

"Yeah, and just look what's in this—" she comes back at me as the smoke clears. I look at what she is holding up for me to gaze upon. It is, or rather it was, a pair of those pink silken things they call—oh well, you know!

"Can't a lady hang up her lingerie on the clothesline without some lame-brained radio nut shooting holes in them?"

I gasp in dismay and right well may I gasp—for the posterior of those dainty things looks like a ten-dollar punch board. Daylight is gleaming through them where once was woven silk. I fall back and stifle a cry of utter chagrin and despair. I realize the garment has hung in a direct line of fire from my shack. I also realize my bullets have cut many a perforation in those lovely articles of feminine wearing apparel!

Then I remember the final instructions in *QST*. Something in the procedure I had failed to heed—. It cautioned, "Be sure to have a good back-stop!"

Knowing that to argue with a woman like my wife, whose temper can at times reach 350 mils, would be folly, I sadly and reluctantly dig down into my jeans and bring forth the price of new "whatchamaycallits"! I then solemnly resolve to bring my feeder wires down the chimney!

Strays

"High Power Cement" makes a swell stickum for repairing ceramic standoffs cracked by putting on too much elbow grease when tightening the screws.

—W3AAJ

* 435 East 4th Street, Newton, Kansas.

Better Crystal Stability Without a Heater Oven

More Accurate Control of Frequency Easily Obtainable

By Everett L. Dillard, W9BKO*

IN THIS day of Single-Signal receivers and crystal-controlled transmitters it is important that both the receiver and transmitter be as constant in frequency as possible. The amateur is not assigned a definite operating frequency, as is the commercial radio station, but is permitted to choose any frequency desired so long as he stays within amateur-band frequency limits. Hence he is not confined to maintaining his transmitter to within a very narrow tolerance limit of a predetermined frequency, but is concerned primarily with maintaining any chosen frequency as constant as possible over short periods of time.

We now can have good frequency stability in our receivers due to the adoption of electron-coupled oscillators in our "supers" and their use has practically eliminated the necessity of frequently retuning the receiver itself even in our 7- and 14-megacycle bands. This is especially true if the receiver is allowed to warm up over a few minutes time before using and where the receiver is operated in a room not subject to too-sudden or violent fluctuations in room temperature.

Now, with crystal-controlled transmitters it would seem, even on our higher frequency amateur bands, that a pre-adjusted setting of the receiver should be sufficient to warrant good reception over a considerable period of time without the necessity of retuning the receiver due to frequency drift of either the receiver or the transmitter. But, if we will tune our receiver to different stations—especially in the 14-mc. band—we will find that some signals will stay tuned in over long periods of time with the same audio-frequency heterodyne note and yet others will "creep" so far in frequency within the first few minutes of transmission that if the receiver adjustment is left untouched the beat note will climb past audibility.

Certainly, then, there is something radically wrong with some of the crystal-controlled transmitters. What is the cause of the trouble and what is the remedy for it? Will operation of the crystal in a constant temperature oven invariably solve the problem? The answer is, "No." The actual truth of the matter is that rarely, if ever, will a heater oven improve the frequency stability of a transmitter when the basic trouble lies in the all too common fault of overloading the crystal.

Excessive plate voltage on the crystal oscillator

* 433 East Gregory Blvd., Kansas City, Mo.

tube and working the crystal at its hardest by tuning the tank circuit of the oscillator to the point of maximum excitation (lowest plate milliammeter dip) results in the crystal itself generating heat, which heat, because of the temperature coefficient of the quartz, causes the operating frequency to drift either lower or higher than the initial frequency—the direction of frequency shift depending upon whether the crystal is an X- or Y-cut. Where the crystal is worked excessively it is not unusual to have this temperature

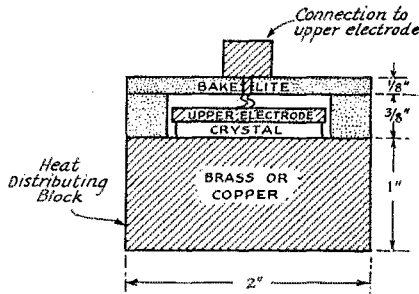

FIG. 1—CONSTRUCTION OF THE CRYSTAL MOUNTING, WHICH MAY BE ROUND OR SQUARE

It is important that the electrode surfaces contacting the crystal be perfectly flat.

change amount to several degrees Centigrade above that of the normal operating room temperature. This change of operating temperature of the crystal is always most noticeable during the first few minutes of transmission, as it will later stabilize itself if the oscillator circuit is kept in continuous operation.

Thus, it can be seen that even to place our crystal in an excellent constant temperature oven and yet to continue to overload or improperly adjust our tuning only results in a repetition of the results we had before; the heat generated in the crystal itself will cause the crystal temperature to rise above that of the oven and a change of frequency is inevitable.

Ordinary room temperatures remain fairly constant over considerable periods of time, and even though there is a wide change in temperature over a twenty-four-hour period such changes in temperature generally take place slowly. Room temperature is sufficiently stable (unless the

(Continued on page 74)

Progress on the Ultra-High Frequencies

The New York-Boston Path Conquered; 75 Miles Spanned on 224 Mc.: Further Notes on DX Working

By Ross A. Hull*

THE unexpected continues to happen on 56 mc. and above. With interest and activity running high in many parts of the country, links are being established over distances which would have been considered outlandish a few months ago. Back in August we were quite prepared to be obliged to admit that 100-mile backyard to backyard working on 56 mc. with directive antennas was a mere freak; something that would be possible only once in a blue moon. At this stage, with almost four months of unbroken nightly observation behind us, much strength has been added to our conviction that the ultra-high-frequency directive antenna is here to stay; that with its aid long indirect-path working will become the general thing.

W2CUZ AND W2JN HIT BOSTON

But before we go too far off the deep end, let's pop the month's highlight. On November 21st and 22d, W2JN, Montclair, N. J., and W2CUZ, Yonkers, N. Y., did the impossible. Using directive antennas and normal medium-powered 56-mc. transmitters they poked their signals into Boston and beyond without calling for the help of airplanes or mountain tops at either end. Harold Turner, Reading, Mass.; W1GCU, Waltham and W1BZQ, Arlington were among those reporting the second district signals. It is already obvious that this sort of thing is now only possible under excellent atmospheric conditions but it is work having the greatest significance. Surely it is only a matter of a week or two before two-way contact is had over this 190-mile path.

THE NEW YORK-HARTFORD LINK

Contact between Hartford and the New York area has proved rather disappointingly unreliable in comparison with the Boston-Hartford path. During the month, only four really good nights have been had. On these occasions, with signals banging up to R8, a very fine time was had by all. Strangely, the only signals so far heard at W1AL (the three of them contacted) are W2AG, W2CUZ and W2JN. The most thorough possible search has failed to reveal any other second district signals, even under the best conditions. One possible explanation of the relatively poor work on this circuit is that AL's location is a very unsatisfactory one for transmission to the south

west. Another is that AL's fixed-angle directive antenna, while directive towards Boston, has its other face pointed considerably north of the populous New York and New Jersey areas. A new antenna at AL and the establishment of many new directive rigs in the New York area will soon give us new thoughts on the subject.

UP BOSTON WAY

Communication between Boston and Hartford on 56 mc. has continued well into its fourth month without any very marked change in character. Good periods still follow the bad ones at intervals of a few days and just as we decide that things are flattening out for the winter, along come a couple of "whiz" nights with transmission attenuation so close to zero that almost the whole Boston ham population is dumped in our lap. The operators at W1AL continue to take "tricks" every morning and night and the enormous wad of data is being given continuous study in the effort to discover the actual atmospheric conditions required for good transmission and the exact manner in which the waves are bent. Since this work is to be continued throughout the winter, AL has been thoroughly revamped and refitted. The "long lines" controlled 224-mc. ($1\frac{1}{4}$ -meter) transmitter (fitted with a pair of W.E. 304-A tubes) now has a companion transmitter on 112 mc. ($2\frac{1}{2}$ meters). The new one has a pair of 800's with a quarter-wave resonant-line grid circuit. The original 56-mc. transmitter has also had its share of treatment. A pair of $2\frac{1}{2}$ -inch diameter tubes arranged as a resonant line now constitute its frequency control element. It is hoped that space considerations will allow a description of these three transmitters in an early QST.

224-MC. WORKING

The one 224-mc. ($1\frac{1}{4}$ -meter) highlight that we know anything about is a duplex contact between W1AL and W9BOE, portable, on Mt. Wachusetts, Mass., the distance being approximately 75 miles. Transmission at AL was on 224 mc. while W9BOE talked on 56 mc. W9BOE, by the way, is the station of H. Selvidge who is doing the work at W1FQV (illustrated last month). Selvidge braved thick soupy fog and rain to make the trip to Wachusetts with his 224-mc. receiver and directive antenna and the

(Continued on page 80)

* Associate Editor, QST.

Cutting Quartz Crystal Plates

The Practical Method and Equipment for X and Y Cuts

By Ivan H. Loucks, W9ON*

QUARTZ crystals which are suitable for the manufacture of piezo-oscillators for radio use are obtained from Brazil, Madagascar, Japan, and some parts of the United States, Brazil being the principal source of supply of large crystals. These crystals are hexagonal in shape, and when in their true form have an apex at each end. The methods of mining and also the process of growing are such, however, that the crystals when received in this country are rarely of ideal form but usually have only one apex, and even that apex and the sides are very irregular.

The usual crystal which we may hope to cut into blanks may be shown in its ideal form by Fig. 1a. In this crystal the optical axis is parallel to an imaginary line ZZ which is drawn between the two apexes of the crystal and parallel to the true sides. This optical axis is called the Z axis and will be referred to as such whenever later mentioned in this article.

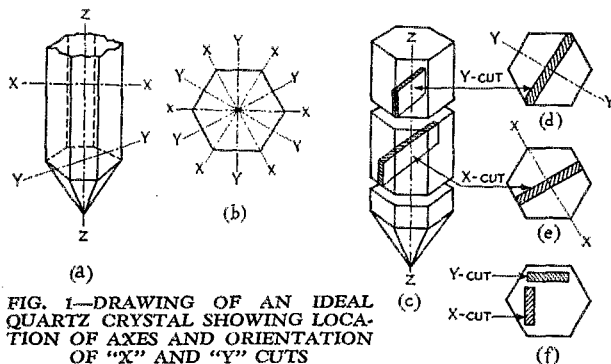

FIG. 1—DRAWING OF AN IDEAL QUARTZ CRYSTAL SHOWING LOCATION OF AXES AND ORIENTATION OF "X" AND "Y" CUTS

Two types of so-called electrical and mechanical axes of the crystal are of importance when considering its use for radio purposes. These axes, which are called the X and Y axes, are all in planes perpendicular to the Z axis and at multiples of 30 degrees to each other, as shown in Fig. 1b. The Y axes are always perpendicular to two faces of the crystal and 60 degrees from each other, while the X axes are always at 30 or 90 degrees with a Y axis and are parallel to a face of the crystal. In an ideal crystal the X axes would be parallel to the diagonals of the crystal as well.

* U. S. Radio Inspector, 222 West Ninth St., Grand Island, Neb.

CUTTING THE CRYSTAL

The process of cutting X- and Y-cut blanks or plates from the raw crystal consists primarily of two steps. The crystal is first cut into sections of the proper thickness, the cuts being made directly across (perpendicular to) the Z axis as shown in Fig. 1c, and then the blanks are cut from these sections, at the proper angles with the axes, as shown in the top views of Fig. 1d and 1e. The portion of the crystal from which the blanks are cut is unimportant provided that the cuts are made at the proper angle with the axes. This is demonstrated in Fig. 1f, the only requirement of the cuts being that the faces of an X-cut plate must be perpendicular to an X axis and parallel to a Y axis and also the Z axis. Similarly, a Y-cut plate must have its faces perpendicular to a Y axis and parallel to an X axis and the Z axis.

The problem of cutting the crystal directly across the Z axis to secure the proper section of Fig. 1c often is somewhat complicated by the fact that the crystal is far from ideal in shape, more often being shaped as shown in Fig. 2. If the crystal has enough regular sides it may, of course, be cut squarely across these sides and therefore squarely across the Z axis; but if it is irregular, use must be made of the "growth lines" or "steps" in the faces to determine the cut. One of the peculiarities of the crystalline structure is that these steps always are squarely across the line of the true faces, so it is only necessary to make the cuts parallel to these "steps" to have them perpendicular to the Z axis. A section of the crystal of Fig. 2 thus secured will be similar in appearance to Fig. 3, and the X-cut and Y-cut plates can be taken from it as shown.

THE MUCK SAW

The equipment set-up and method of making these cuts through the quartz is shown in Fig. 4. This cutting rig was constructed by W9IGF and the author nearly two years ago for cutting IGF's quartz, and has proved to be very satisfactory. The cutting saw is a disc of hard-drawn copper running in a tank of water and carborundum. The crystal is mounted so that it rides on

the top of the disc and feeds down by its own weight as it is cut. This is accomplished by clamping the crystal to a hinged board which is carefully mounted so that its swing is exactly in line with the disc.

The process of lining-up the crystal and the disc so that the cut will be made exactly as desired calls for extreme accuracy and care in adjustment of the cutting rig. The first requirement is that the disc run true, without any "wobble or bumpiness." It is then necessary to line up the hinge of the rig to be exactly parallel to the shaft of the disc, so that the "bed" will swing exactly in line with the disc and not at an angle to it. The hinge also must be tightly fitted to prevent "wobble" of the "bed," and the "bed" itself must be a perfectly straight piece and square with the disc when touching it. It may be necessary to ream the hinge and use an oversize pin to secure the necessary rigidity.

SETTING UP THE CRYSTAL FOR CUTTING

When the rig is completely lined up and ready for use, the next step is to mount the crystal for the cut. The point on the bed at which the disc touches when in the extreme position is marked so that the point at which the cut will come will be known. The bed is then removed from the rig and the crystal clamped to it in such position that the cut will come at the desired point and

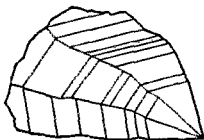

FIG. 2.—CRYSTALS IN THE ROUGH USUALLY DEPART CONSIDERABLY FROM THE IDEAL HEXAGONAL FORM

This drawing illustrates the growth lines of "steps" characteristic of raw crystals.

will go through the crystal at the correct angle. The cuts which are made to secure the sections similar to the one of Fig. 3 are the hardest to set up, since it is necessary to set the crystal at an angle with the "bed" rather than flat on it, except in the case of crystals having one or more perfect sides. To do this, it is necessary to block up the crystal until the "steps" are all in planes which are perpendicular to the "bed," and then to turn it to the point at which the cut across it will be parallel to the same steps. It is also advisable to set the crystal up on spacers slightly away from the "bed," regardless of other conditions, so that the disc can cut clear through without cutting into the "bed."

After the crystal is properly set in position and solidly clamped, it should be completely imbedded in plaster-of-Paris as a further aid to holding it properly and to prevent chipping of

the edges by the disc. This plaster-of-Paris should also be fastened to the "bed" so that the part of the crystal which is cut off will not fall. The plaster-of-Paris can be made to harden

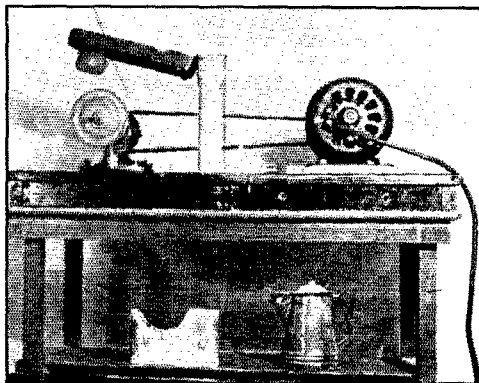

CRYSTAL CUTTING RIG BUILT BY THE AUTHOR AND WSIGF

The working drawing of Fig. 4 shows the constructional details.

almost immediately by the addition of a slight amount of common table salt just before mixing. As soon as it is hard, the "bed" can be replaced in the rig with the crystal in position, riding on the top of the disc ready for the cut.

MAKING THE CUT

The cutting compound for filling the tank into which the disc dips should now be mixed up. This compound is a mixture of carborundum and water of the consistency of thick mud, and will need careful watching during the cutting operation to prevent its hardening. The grade of carborundum best suited to this purpose is about No. 160 Aloxite, but nearly any grade between No. 100 and No. 600 may be used. The coarser grades have a greater tendency to chip the crystal and to wear away more material, but they also break down or wear out sooner, while the finer grades, which last longer, do not cut as rapidly. However, nearly any of them can be used.

The disc should not turn faster than about 500 r.p.m., since greater speeds tend to throw off too much of the cutting compound. The disc should turn as rapidly as is feasible, however, for the sake of speeding the cut. For this purpose it is advisable to use stepped pulleys on the drive shaft, so that the best speed under the individual conditions may be chosen. The disc should rotate away from the hinge, both to prevent—or at least reduce—chatter and to confine the splashed material to the inside of the rig. It is advisable to provide splash guards on both sides of the disc and on both edges in line with the disc, and also to set the tank in a larger pan to catch the splashed mixture. It is also advisable to provide splash guards between the disc and the bearings

of the shaft carrying the disc, since it is very important that no carborundum get into the bearings.

The thickness of the crystal sections is of course dependent upon the size of the desired finished plates. A recommended minimum size for amateur use is $\frac{1}{2}$ by $\frac{3}{4}$ inches. A width of $\frac{3}{4}$ inches is recommended unless crystals for direct operation on forty meters are desired, in

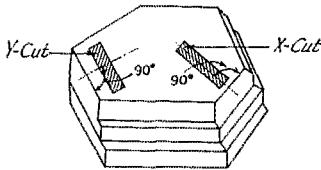

FIG. 3—A SECTION OF CRYSTAL CUT FROM A PIECE OF RAW QUARTZ SIMILAR TO THAT OF FIG. 2

This drawing also shows the way in which the blanks are cut from a crystal section.

which case the width of the cut should be somewhat greater (1 inch). The amount by which the crystal must be set along on the bed each time to secure sections of this width is slightly more, of course. The allowance for wear and for the thickness of the cutting disc will be about $\frac{3}{32}$ -inch if No. 16 copper is used for the disc. This thickness of copper is recommended for making the larger cuts, being a practical compromise between having material heavy enough for the purpose and not having it so heavy as to waste too much quartz.

THE "BLANK" PLATES

In slicing the plates from sections such as indicated in Fig. 3, a somewhat thinner disc may be used; it is possible to use No. 20 hard-drawn copper to advantage. The process of cutting these plates is very similar to that of cutting the

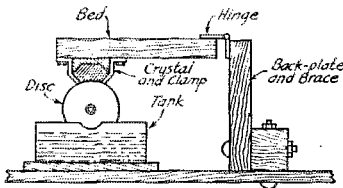

FIG. 4—THE CRYSTAL-CUTTING RIG OR "MUCK SAW"

The "muck-saw," a rotating disc of copper, dips into a tank holding the abrasive mixture which does the actual cutting. The weight of the crystal and hinged "bed" supplies all the pressure needed.

larger sections. If the sections were cut accurately across the Z axis, it is only necessary to line up the section so as to cut across the desired X or Y axis and to mount the section flat with the "bed." The cut automatically will be along the Z axis if this is done. Once a section is set up properly on the bed, several slices may be made from it with-

out moving it, by the expedient of moving the shaft of the disc along through its bearings. The amount of this set-over is the same as the amount by which the crystal should be moved if the disc were left alone, and is equal to the desired thickness of the plates plus the proper allowance for the thickness of the cut.

In cutting plates or blanks for amateur use, a thickness of a little more than one-eighth inch is convenient. This can be varied with the acquisition of cutting experience and with a definite determination of the desired finished thickness of the plate. The allowance for the thickness of the cut, when using No. 20 hard-drawn copper for the disc, should be slightly over $\frac{1}{16}$ inch. The total set-over each time, therefore, will be about $\frac{1}{32}$ inches.

The slices obtained by this operation will be similar to the one sketched in Fig. 5a, and will still require trimming to the final size. If cut from a $\frac{3}{4}$ -inch thick section, and if blanks $\frac{1}{2}$ -by $\frac{3}{4}$ -inch are desired, the plates may be cut

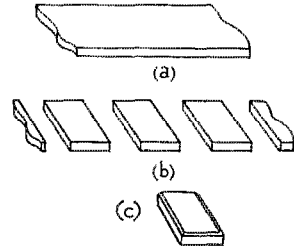

FIG. 5—EVOLUTION OF THE ROUGH BLANK FROM A SLICE CUT FROM THE CRYSTAL SECTION OF FIG. 3

crosswise into piece $\frac{1}{2}$ -inch long by clamping them to the "bed" of the cutting rig again and cutting with the disc. This is an easy operation and requires very little time, although the slices are now very thin and must be handled with care. The ends of the slices will also need squaring in some cases to eliminate irregularities on the outside of the crystal. The blanks made from the slice of Fig. 5a are shown in 5b, while one of these blanks is shown in 5c ready to be ground to the desired frequency. The edges of this blank have been beveled and the corners have been slightly rounded to eliminate any trace of chipping which may have occurred. This beveling and rounding of the corners is done by holding the blank in the fingers against the side of the cutting disc while it is running, and allowing the compound to wear away the edges and corners as desired. Steady nerves and fingers are required for this job, or the fingers will be ground away as well.

EDITOR'S NOTE: The process of grinding the blanks into finished oscillating crystals of the frequency desired will be described by the author in another article to appear in an early issue.

Bureau of Standards Extends Standard Frequency Service

WWV to Transmit Twice Weekly on 5, 10 and 15 Mc.,
Commencing February 1st

THE National Bureau of Standards announces changes in its schedule of standard frequency emissions from its station WWV, Beltsville, Md., near Washington, D. C. The changes will substantially increase the service available to transmitting stations for adjusting their transmitters to exact frequency, and to the public for calibrating frequency standards and transmitting and receiving apparatus.

The emissions will be on two days a week instead of one day as formerly, and will be on the three frequencies: 5000, 10,000, 15,000 kilocycles per second, instead of the single frequency of 5000 kc. The changes are the result of experimental emissions made by the Bureau on 10,000 and 15,000 kc., with the aid of a large number of organizations and persons who observed the received signals at various places. These tests showed that service could be rendered at all distances in the daytime by the use of the three frequencies. With the use of 5000 kc. alone it was necessary to have emissions at night in order to give service at distances greater than a few hundred miles from Washington. With the use of the three frequencies no night emissions will be necessary.

Of the emissions now scheduled, those on 5000 kc. are particularly useful at distances within a few hundred miles from Washington, those on 10,000 kc. are useful for the rest of the United States, and those on 15,000 kc. are useful in the United States and other parts of the world as well.

THE NEW SCHEDULES

Beginning February 1, 1935, and continuing each Tuesday and Friday thereafter (except legal holidays) until further notice, three frequencies will be transmitted as follows: noon to 1:00 p.m., Eastern Standard Time, 15,000 kc.; 1:15 to 2:15 p.m., 10,000 kc.; 2:30 to 3:30 p.m., 5000 kc.

The emissions consist mainly of continuous, unkeyed carrier frequency, giving a continuous tone in the 'phones when received with an oscillating receiving set. For the first five minutes the general call (CQ de WWV) and the announcement of the frequency are transmitted. The frequency and the call letters of the station (WWV) are given every ten minutes thereafter.

The accuracy of the frequencies transmitted is

at all times better than a part in five million. From any of them, using the method of harmonics, any frequency may be checked. Information on how to receive and utilize the signals is given in a pamphlet obtainable on request addressed to National Bureau of Standards, Washington, D. C.¹

The Bureau desires to receive reports on reception of these emissions, especially because radio transmission phenomena change with the season of the year. The data desired are approximate

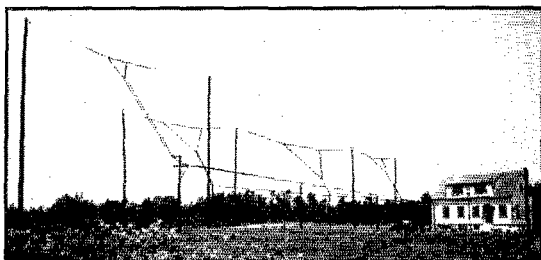

ANTENNAS AND TRANSMITTER HOUSE AT WWV

field intensity, fading characteristics, which of the three frequencies is received best, and the suitability of the signals for frequency measurements. It is suggested that in reporting on intensities, the following designations be used where field intensity measurement apparatus is not used: (1) hardly perceptible, unreadable; (2) weak, readable now and then; (3) fairly good, readable with difficulty; (4) good, readable; (5) very good, perfectly readable. Statements are desired as to intensity of atmospherics and as to whether fading is present or not, and if so, its characteristics, such as time between peaks of signal intensity. Correspondence should be addressed, National Bureau of Standards, Washington, D. C.

¹ These transmissions are readily useful for calibrating amateur-band frequency meters by harmonics from an auxiliary 100-kc. oscillator, as described in previous *QST* articles. See, "Electron-Coupled 100-kc. Oscillator" (Experimenters Section), June, 1933; "Temperature Compensation for the Frequency Meter," by G. F. Lampkin, Oct., 1933; and, "The Bandsetter," by G. F. Lampkin, Feb., 1934.—EDITOR.



Correction—Switched Cuts in December Issue

The cuts of Figs. 1 and 2, pages 37 and 38, in the article on quartz crystals, should be interchanged.

Canada-U. S. A. Contest Results¹

THE second A.R.R.L. Canada-U. S. A. Contact Contest, held from October 12th (6 p.m.) to October 14th (midnight, Sunday) was thoroughly enjoyed by all. In the contest, each W/VE contact had the basic count of one point, with the special power and operator handicaps outlined with the rules in October 1934 QST. Congratulations are particularly due to those making the highest ten scores for their achievement. Certificates have been presented to the winners in each A.R.R.L. Section, signed in full by the Contest Committee. We are pleased to present the highlights of the competition herewith.

193 VE's were worked by the W's during the contest, a 10% increase over the "worked and heard" of the last VE/W contest. 17 W's scored more points than the leading W in last VE/W contest. 6 VE's scored more points than the leading VE in the last VE/W contest.

Great credit is due the leading W's for their fine work in QSOing so many VE's, for in comparison to W's on the air over that week-end there were very few. W9GBJ worked 50 VE's. W2GWE worked 43 and W8AQ 40. Eleven others worked more than 30 VE's. VE5HQ worked the most U. S. Sections, 45. VE2FG worked the most W stations, 169. VE3JT worked 151 W's and VE2DR worked 146.

W2GKR and W2DJM operated continuously at W2GKR which was the only two-operator station. They noted, "VE stations were far more numerous than ever before; most VE's used the new RST system; it took patience to raise the two missing VE Sections." W8AQ, W9GGB, W9GBJ, W8DQZ and W9ABB worked all seven Canadian Sections. No one did this feat in the last VE/W contest! W3BET, W8DKE, W9DQH, W8UV, W8FIP, W4AJY, W6KU, W5ASG and W6BHV worked six Canadian Sections. W3DMQ, W2ABS, W8DED, W2GWE, W2GKR, W8LRI, W9EMY, W4BRG and W6HEX worked five Canadian Sections.

Most common quotation, "I wish to thank the contest committee for a very enjoyable week-end." The small scorers' alibi, "Sorry my time was limited." Oft-heard cry following a fast QSO, "You're my first VE, please QSL." A number of VE's worked their first W6 and W7 stations and many W's worked their first VE5, and VO8.

W8AQ, who just moved back to the U. S. after residing four years in Canada, almost proved he knew how to work the most VE's. W5CPT used

140 Volts B Batteries on pair of '31's in P.P. W8DED presented W9GBJ with 100 QSL cards for winning in U. S. A. Several contestants used "160 'phone" and reported many VE's there. VE5HQ threatened to beat VE3GT, so VE3GT went "on the committee." Unanimous opinion of all entrants was that this contest should be an annual affair.

3.5, 7 and 14 mc. were, of course, the most popular bands. However, the majority of VE's appeared to be on 7 and 14 mc. The usual amount of grief in blown-down antennas and blown-up equipment was reported, but even unfortunates reported it was worth while to see the chokes go "poppin'." W9GBJ thought he had an 8th VE Section when he worked VE5LM in the Northwest Territories of Canada (included with A.R.R.L. B. C. Section). W8UV and W9ABB were the only two stations to win for their Sections in both VE/W contests.

W2FLT said, "Long live the friendship between VE/W, and certainly hope to meet some more of you next year." Several stations that were on for the last contest equalled or bettered their previous records inasmuch as 20 hours less operating, which speaks for efficiency in operating as well as general knowledge among all VE and W's as to the idea of the contest. The contest committee wishes to thank all who so carefully prepared their scores, and for the fine coöperation shown by many who did not "actively participate."

THE TEN HIGHEST

CANADA

VE5HQ.....	22,410	VE2DR.....	12,586
VE3GT.....	20,680	VE2DG.....	9,702
VE3JT.....	16,419	VE3EM.....	7,699
VE2FG.....	15,542	VE3TF.....	7,350
VE3DJ.....	12,798	VE3RK.....	6,725

UNITED STATES

W9GBJ.....	7,938	W8UV.....	5,238
W8AQ.....	7,182	W1DMD.....	5,040
W4BRG.....	6,345	W9ABB.....	5,040
W2GWE.....	5,715	W3EYH.....	4,860
W3BET.....	5,616	W9GGB.....	4,788

CANADA—U. S. A. CONTEST SCORES

Station	Score	Station	Score
MARITIME			
VO8Y.....	2511	VE1EP.....	1392
VE1FT.....	2480	VE1FB.....	666
VE1EX.....	2223	VO8W.....	42
VE1BB.....	1785		
ONTARIO			
VE3GT.....	20680*	VE3TF.....	7350
VE3JT.....	16419	VE3RK.....	6725
VE3DJ.....	12798	VE3DU.....	5934
VE3EM.....	7899	VE3ER.....	5778

* Committee member, not eligible for award.

¹ This report was prepared by the VE/W Contest Committee: Chairman L. W. Mitchell, VE3AZ, Room 704, Northern Ontario Building, Toronto, Ont.; S.C.M. S. B. Trainer, Jr., VE3GT, 4 Shorncliffe Ave., Toronto, Ont., and A. G. Palmer, VE3WK, 85 Patricia Road, Toronto, Ont.

Station	Score	Station	Score	Station	Score	Station	Score
VE3AAG	5550	VE3SA	682	SOUTH DAKOTA			
VE3NO	5504	VE3SG	462	W9FOQ	3321	W9CFU	14
VE3TT	3150	VE3BZ	312	SOUTHERN MINNESOTA			
VE3NS	2267	VE3UP	240	W9ZT	135	W9RIA	54
VE3MI	1980	VE3VZ	126	ARKANSAS			
VE3SZ	1239	VE3OT	114	W5ASG	1782		
VE3MX	928			LOUISIANA			
QUEBEC				W5DAW	459		
VE2FG	15542	VE2HF	1368	EASTERN NEW YORK			
VE2DR	12586	VE2EC	720	W2AQN	1080		
VE2DG	9702	VE2CZ	435	NEW YORK CITY-LONG ISLAND			
VE2CO	5513	VE2BU	126	W2GWE	5715	W2ETT	486
VE2AA	3036	VE2IJ	54	W2GKR	4635	W2FNI	324
VE2IG	2025			W2DHI	1512	W2BGO	324
ALBERTA				W2EYS	1377	W2BYW	324
VE4EO	480	VE4PH	310	W2FXE	1377	W2GZU	270
BRITISH COLUMBIA				W2CUQ	891	W2HBO	81
VE5HQ	22410	VE5EU	1008	NORTHERN NEW JERSEY			
VE5FG	3465	VE5JL	722	W2ABS	2700	W2GGE	459
VE5AM	1725	VE5MR	54	W2FLT	2565	W2GVZ	162
VE5JC	1326	VE5JP	30	W2CLM	2430	W2CFJ	27
VE5HR	1218			W2EKM	810	W2GTA	14
MANITOBA				W2GHO	638		
VE4KX	1007	VE4IU	147	IOWA			
SASKATCHEWAN				W9NWX	770	W9RCR	135
VE4IG	2100	VE4QS	528	W9HCH	432		
VE4CV	1152			MISSOURI			
U. S. SCORES—CANADA-U. S. A. CONTEST							
Station	Score	Station	Score	Station	Score	Station	Score
EASTERN PENNSYLVANIA							
W3BET	5616	W3BXE	648	W9GBJ	7938	W9BWX	90
W3DMQ	4680	W3CZO	567	W9KEL	1026	W9FFR	27
W3ABE	2052	W3BGD	243	CONNECTICUT			
W3CHH	1980	W3BUH	54	W1GME	2700	W1GKM	189
W3ADE	729	W3EUP	27	W1MK	1215		
W3CYN	702			EASTERN MASSACHUSETTS			
MARYLAND-DELAWARE-DISTRICT OF COLUMBIA							
W3CWE	216			W1ESI	2160	W1GCJ	324
SOUTHERN NEW JERSEY				W1ABG	850	W1WV	180
W3EYH	4860	W3CBR	1593	W1BZO	810	W1BSX	162
WESTERN NEW YORK				W1RY	351	W1HKY	90
W8JTT	3456	W8JQE	540	W1IDU	324		
W8AQE	1242	W8CDK	324	WESTERN MASSACHUSETTS			
W8IIZ	1161	W8GWY	81	W1COL	3834	W1HRV	27
W8EMW	1053			W1DCH	54		
WESTERN PENNSYLVANIA							
W8UV	5238	W8BWL	2106	NEW HAMPSHIRE			
W8LRI	4455	W8JZZ	1355	W1DMD	5040		
W8FIP	3888	W8KNB	1177	VERMONT			
W8APQ	3240			W1ELR	2227		
ILLINOIS							
W9DQH	4131	W9CUH	324	MONTANA			
W9PNE	1215	W9ASZ	216	W7CMB	1215	W7CRH	324
W9IYA	450	W9FXW	189	W7ERP	567		
W9CEO	450	W9MZZ	54	WASHINGTON			
W9AGM	396	W9PGB	14	W7ECK	567	W7CZY	41
INDIANA							
W9ABB	5040	W9LKI	527	NEVADA			
KENTUCKY				W6BPO	4158		
W9GGB	4788	W9PLM	1296	LOS ANGELES			
MICHIGAN				W6HEX	2835	W6FVD	72
W8DED	3375	W8LSF	82	EAST BAY			
W8HUD	1094	W8GSP	41	W6HRN	36		
OHIO							
W8AQ	7182	W8CTP	527	SAN FRANCISCO			
W8DZQ	3024	W8BYM	405	W6ENM	972	W6HRY	216
W8EFW	2633	W8ITR	203	SACRAMENTO VALLEY			
W8DKE	2484			W6GZY	27		
WISCONSIN				SAN DIEGO			
W9BQM	324	W9EFX	41	W6BHV	2538	W6KBD	576
NORTH DAKOTA				SAN JOAQUIN VALLEY			
W9EMY	1845	W9LBI	1152	W6KU	2700	W6AGV	364
				W6CLP	684		
				NORTH CAROLINA			
				W4MR	1062	W4DW	756

(Continued on page 78)

With the Affiliated Clubs

A successful 1935 to all amateur radio clubs! Through coöperation in organization great things can be accomplished. May the new year see an even closer relationship between the A.R.R.L.-affiliated clubs for the advancement of amateur radio. Perhaps a network on the air composed of club stations would help to bring this about. Would there be any interest in such a project? Let us hear from you.

Federation of Long Island Radio Clubs

On October 31, 1934, the "Federation of Long Island Radio Clubs" elected officers as follows: W2HN, president; W2AIQ, vice-president; W2EVA, secretary; W2VL, treasurer. The charter member clubs of this federation are the Astoria Radio Club, Northern Nassau Wireless Association, Nassau Radio Club and Sunrise Radio Club, all A.R.R.L.-affiliated and active in Hudson Division matters.

Victoria Short Wave Club

The club station of the Victoria Short Wave Club is in active operation under the call VE5EZ. The transmitter uses a pair of tens in the final stage with 250 watts input. The annual meeting of the club was held November 10th. Officers elected for the coming year: VE5EC, president; VE5IE, vice-president; VE5DY, secretary-treasurer; VE5HP and VE5JA, executives.

Detroit Amateur Radio Association

A good stunt is reported for the December meeting of the Detroit Amateur Radio Association: a rig to be installed at the club rooms and all crystals brought in by the gang to be checked; checking to be done at the shack of W8IFE about ten miles away. Future programs at D.A.R.A. meetings will be more of a "show" than anything else; less technical material is planned, the belief being that the gang doesn't care too much for deep technical discourses. The club still issues a monthly bulletin and recently put out its third anniversary number.

Metropolitan A.R.A. Hamfest

The Metropolitan Amateur Radio Association of Melrose, Mass., celebrated its first anniversary on October 20, 1934, with a hamfest. What a birthday party it was! Upwards of 500 hams turned out for the "doings"! Speakers included W1FSK, president of the M.A.R.A.; W1KH, director, A.R.R.L., New England Division; W1ASI, A.R.R.L. S.C.M.; James Millen, National Co., and Richard Purinton, Rathen Co. Ross Hull's talk on "beam transmission on 56

mc." was enjoyed by all. The club has its own quarters where a crystal-controlled transmitter using a type ten in the final stage is used on 3.5 mc. and a 56-mc. rig is operated for local work. Ex-K6CLJ, now W1CLJ, is an honorary member.

Heart of America Radio Club

Much enthusiasm is being shown in the Heart of America Radio Club, Kansas City, Mo., over the project of a club transmitter. Steps are being taken to secure a meeting place where the transmitter can be installed. Through the efforts of one of the club members, who is also an employee of the telephone company, ham calls are now listed in the 'phone book in Kansas City. A QRM Committee continues its good work; members of this committee have agreed to each spend a half hour a week listening to the various amateur bands. A Naval and Military Affairs Committee has been chosen composed of W9CFL (U.S.N.R.), W9FHV (A.A.R.S.) and W9BKO (civilian member). Officers for the year ending November 1935: W9JEH, president; W9CXE, vice-president; W9KEF, secretary; W9BMA, treasurer.

Station Activities

Section Communications Managers of the A.R.R.L. are interested in the activities of all amateur stations. One club publicity officer inquires as to what type of material is wanted for the "Station Activities" columns of *QST*. Any and all "dope" on accomplishments of active stations is desired. DX records, outstanding 'phone work, unusual stunts, traffic totals, all kinds of operating news will find a place in "Station Activities." In many clubs the activities manager, secretary or publicity officer collects the news of each active operator each month and forwards it "in a bunch" to the S.C.M. in the A.R.R.L. Section in which the club is located. This assures mention in *QST* of the activities of all club operators. The S.C.M. is also interested in the general activities of the club itself.

Visit the Clubs

Clubs are splendid places to get acquainted with other amateurs and to participate in interesting discussions on amateur radio. Do you want to be put in touch with a club in your vicinity? Would you like to attend a club meeting in another city you are visiting? The addresses of the several hundred amateur radio clubs affiliated with A.R.R.L., their places and times of meeting, are recorded at headquarters. Address the Communications Manager (enclosing 3¢ stamp,

(Continued on page 90)

for the EXPERIMENTER



Power Supply for Multi-Stage Transmitters

The question of economy in power supplies for multi-stage transmitters has always been quite a problem, since the differences in voltages required by succeeding stages usually make more than one power supply necessary. Voltage dividers may be used to obtain lower voltages, within certain limits, but where the voltages differ by any great

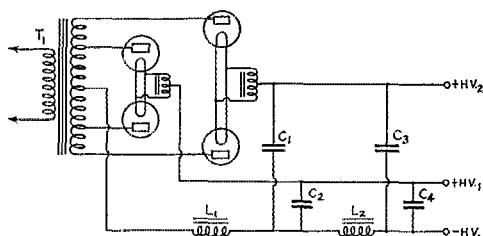

FIG. 1—A POWER SUPPLY CIRCUIT IN WHICH A SINGLE TRANSFORMER AND SET OF FILTER CHOKES IS MADE TO SERVE FOR DIFFERENT VOLTAGES

Each voltage has its own rectifier and filter condensers. Although only two voltages are indicated, others may be obtained provided the transformer has the necessary taps.

amount a voltage divider consumes considerable power, besides having poor voltage regulation.

The circuit shown in Fig. 1 was designed for use with multi-stage transmitters where the successive stages require much greater voltages in comparison to the voltages of the preceding stages. The cost of the equipment is considerably less since but one transformer and filter is required to produce several different voltages. Compactness is another advantageous feature of the circuit.

The transformer is center-tapped at the various voltages required. These voltages are rectified independently of each other and then filtered through a common filter whose chokes are in series with the center-tap or negative lead from the transformer. Transformers having taps at all the voltages likely to be required may be hard to obtain commercially, especially if more than two voltages are needed. One can be made especially for the job, however, or an old one can be rewound.

The rectifier performance will be improved if the input choke, L_1 , is of the swinging variety instead of the ordinary type. Filter constants are not given since they will depend upon the vol-

tages and currents to be handled. Design data can be found in the *Handbook*. The chokes must of course be built to handle the total direct current to be taken from all taps on the power supply.

The wave form was not studied by means of an oscillograph; however, two oscillators of different powers were rigged using the rectifier for power source. Either oscillator could be keyed without noticeable change in filtering. As true of any circuit the parts must be of the proper ratings with a suitable safety factor.

The circuit has been used at W7CNS and K7CKK for over two years with proved success. Several modifications were also tried out, but the circuit of Fig. 1 seemed to be most satisfactory.

This power supply will furnish voltages for any number of stages, from oscillator to final amplifier, although for a modulated transmitter it is suggested that two supplies be used, especially when dealing with large power.

—E. E. Comstock, *Ensign*, U.S.S. Coast Guard

Note on the "R" Circuit

The following comments on the excellent article in November *QST* by Don Edmondo Ruspoli, on high-power crystal oscillators, may be of interest:

The author recommends weakening the excitation from L_1 (Fig. 2) and introducing crystal action. This weakening of excitation, when using plate potentials of the order of 1000 volts or more, necessitates the use of a low-resistance grid leak for reasonable output, resulting in low grid bias, hence low efficiency.

Instead of dividing the excitation, allow L_1 to supply all of it. Adjust L_1 so that (with crystal cut out) when tuning C_2 from maximum capac-

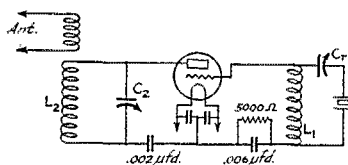

FIG. 2—THE "R" CIRCUIT

Constants not shown will depend upon the frequency. Further information on the circuit is given in November, 1934, *QST*.

ity down, the tube will commence oscillating and the plate current begins to drop until a minimum

is reached, then commences to rise. This rise should occur at the frequency of the crystal. Couple the antenna and tune to maximum output (this keeps r.f. grid current low) and then cut in the crystal with minimum R capacity. Vary C_2 while listening in the monitor at the crystal frequency, and when the tuning approaches the crystal frequency the oscillator will lock in. The monitor will make this tuning point evident immediately. Then increase condenser R until the crystal current rises to normal. If a thermomilliammeter is lacking the crystal current can be judged by holding the base of a neon bulb to the "hot" electrode of the crystal, increasing R until the bulb barely glows. It is best when using high inputs to have a load on the plate tank continually, since this keeps the crystal current low. A high $L-C$ ratio is permissible and preferable.

I have been using a 203-A in this circuit with 210 watts input at 1400 volts on 3850 kc. The output is more than 100 watts, while the crystal current is less than with a Tri-tet. Either filament center-tap or primary keying can be used, and there is no frequency creep, chirp or thump.

—Nick C. Stavron, W3DFN, W3AWB

Filament Voltage Regulator

Many amateurs are troubled with poor line voltage regulation; also, when the key is pressed, the filament voltage drops, which is hard on the filaments.

To overcome these troubles the writer devised a system whereby the filament voltage could be regulated when the line voltage changed, and also be kept constant while keying. This system will

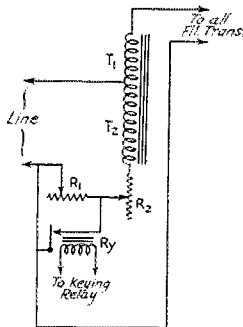

FIG. 3—SYSTEM FOR COMPENSATING FOR FILAMENT-VOLTAGE DROP WHEN KEYING

Provision also is made for adjustment of the filament voltage to take care of line voltage variations.

compensate for changes of 18 volts each way from 110 volts, as well as changes in filament voltages of 10% caused by keying.

As shown in Fig. 3, the equipment needed includes an auto-transformer, T_1-T_2 , a pair of variable resistors, R_1 and R_2 , and a relay, Ry , which is connected in parallel with the keying relay. The auto-transformer is homemade, wound on a

core measuring $1\frac{1}{2}$ by $1\frac{1}{2}$ by $5\frac{1}{2}$ inches. The 110-volt winding consists of 510 turns of No. 20 s.c.e. wire, while the step-up winding, T_1 , has 107 turns of No. 12 d.c.c. R_1 is a small 75-ohm wire-wound variable resistor; the voltage drop across it is low so its power rating need not be very large. For R_2 the writer uses a 500-ohm 250-watt Super-Power Clarostat. The relay is simply an automobile generator cut-out.

To put the system into operation, turn R_1 so that all its resistance is cut out and adjust R_2 to give the proper filament voltage. This should be done with the plate power off. Then apply plate voltage, close the key, and note the drop in filament voltage. Remove the plate power and re-

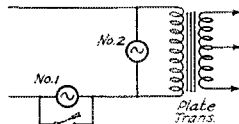

FIG. 4

adjust R_2 until the filament voltage is as much above normal as it was below when plate power was applied, then adjust R_1 to give normal voltage once more. The filament voltage will then stay constant with keying. Line voltage variations can be compensated for by varying R_2 ; R_1 probably will not need to be touched again so long as the line voltage changes are not excessive.

—Victor Emmert, W6DVV

Eliminating Hum Modulation

Many hams who change from battery to resistor bias find that with only the transmitter filaments on an a.c. hum is imposed on signals tuned in on the receiver. The popular "10's in push-pull" do this plenty. In one instance, a high resistance voltmeter across the plate supply read 600 volts positive when "on" and 20 volts negative when "off" the air. Being cut-and-try here, we looked for the cure first, and found that a $7\frac{1}{2}$ -watt lamp in series with the plate transformer primary balanced out the hum. A small "C" battery in series with the grid resistor sometimes works, too.

Going a bit farther, the diagram of Fig. 4 shows a simple "on-off" signal device. Lamp No. 1, in series with the primary of the plate-supply transformer, shows white when the set is off the air. Lamp No. 2 comes on red with the transmitter and No. 1 goes out. Both lamps are $7\frac{1}{2}$ watt. The lamps help smooth things for primary c.w. keying also.

—Harry Hurley, W6QF

Remote Control, Push-to-Talk

A remote-control system which offers the feature of protection for the final stage in case of excitation failure, and in addition provides a

push-to-talk arrangement in which the receiver is automatically cut off during transmitting periods, is shown in Fig. 5. It is used by W. O. Conrad, W9WC, who writes, "This system . . . does everything except throw out the cat and shut off the alarm. The filaments of the transmitter tubes are thrown on when the receiver power supply is turned on by means of the relay Ry_4 , which is an

comes on when getting excitation because of the operation of this relay.

"The 'stop' button shoots the voltage supply to the relays, thus opening them, cutting the transmitter and closing the 'B' minus to the receiver.

"The switch Sw is in the locking circuit of the relays, and if left open the circuit may be used for 'push-to-talk,' since the relays will not hold themselves closed. When the start button is held down it puts on the transmitter and cuts out the receiver. When the button is let up the reverse takes place. This is similar to the airways system."

The excitation-failure protection can be made even more accident-proof if the relay Ry_2 is made to operate from the final amplifier grid current. This would take care of accidental detuning of the buffer plate circuit, which might cause the tube to draw plate current without delivering excitation power to the final stage.

Eliminating the Keying Relay Battery

In casting about for some cheap means of eliminating the one remaining battery in the shack—i.e., the 6-volt hot-shot to deliver 40 mils or so to the 150-ohm keying relay—the writer hit upon the simple but effective stunt shown in Fig. 6. The idea is to make the bleeder current (in this case that of the power pack supplying a 47 crystal oscillator and 46 buffer) do something more toward the general cause besides generating BTU's in the resistor. With the key up, the bleeder resistance is 13,000 ohms, drawing 23 ma. With the key down, the resistance is 12,130 ohms, and, contrary to expectations, the current is within $\frac{1}{4}$ mil of 23 ma., since, although the resistance is lowered, the keyed load goes on the pack and pulls the voltage down to around 275 v.

The relation between R_2 and the resistance of the relay coil of course determines the amount of current flowing in the latter, and with the values shown this current is ample to actuate the relay (an ordinary telegraph relay is used here) at high "bug" speeds. The generally accepted current value for a 150-ohm instrument of this type is 40 mils, but the writer finds that this can be reduced to 20 mils and still give enough "range" for an application of this sort. The value of R_2 is not at all critical within a few hundred ohms. As low as 300 ohms will

(Continued on page 78)

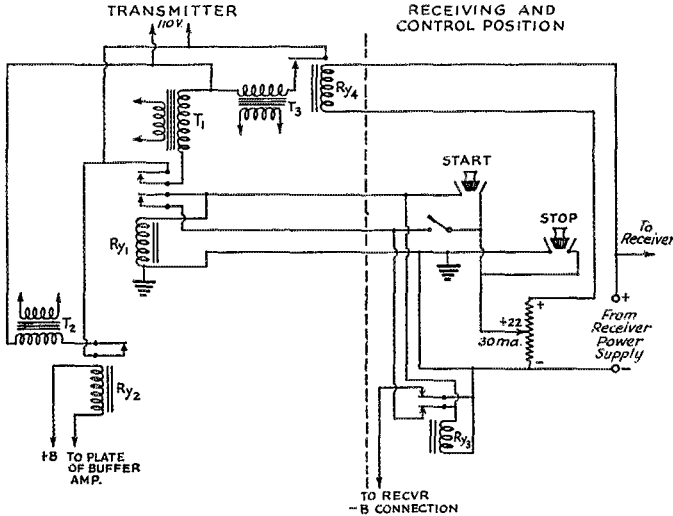

FIG. 5—REMOTE-CONTROL SYSTEM INCORPORATING "PUSH-TO-TALK" WITH AUTOMATIC RECEIVER CUT-OUT AND EXCITATION-FAILURE PROTECTION

automobile generator cutout rewound to operate on about 10 ma. Thus the current drawn by the receiver power-pack bleeder is enough to operate this relay, which closes the primary of the filament transformer, T_3 .

"Under ordinary circumstances the control system uses two push-buttons, one to start and one to stop. Under these conditions the switch, Sw , remains closed. Current to operate the relays is taken from the receiver power supply, the relays being wound to operate on 22 volts at about 10 ma. The system operates as follows: When the 'start' button is closed the relays Ry_1 and Ry_3 are energized. Ry_3 has two sets of contacts, one a make and the other a break set. The break set cuts the negative 'B' lead to the receiver, and the make set locks the relay in the closed position. Relay Ry_1 has two sets of contacts that make when closed; one set is used to lock the relay and the other set to close the primary of the plate-supply transformer for the oscillator doubler and buffer. As the plate current comes up to normal in the buffer stage it closes relay Ry_2 , which is wound to operate in series with the buffer supply, and which in turn closes the primary circuit of the transformer which supplies plate voltage to the final amplifier and modulator. The final only



Amateur Radio STATIONS



W9DUD, St. Louis, Mo.

THOSE of us who have to fit our apparatus into a corner of a room dedicated to some entirely different purpose than radio can well be pardoned a twinge of envy on glimpsing a photo of a station like W9DUD, shown herewith. Plenty of space, sunshine pouring through the windows—everything to put a fellow into the



W9DUD

right frame of mind for one of those "very pleasant QSO's." And the equipment lives up to its surroundings—neat and businesslike, with no haywire.

Wells Chapin, who owns W9DUD, has been a ham for thirteen years, holding the call for the last nine of them. The station has been on the air continuously for the whole period, with various kinds of transmitters and receivers. The outfit shown is capable of operation on both c.w. and 'phone on all bands from 3.5 to 28 megacycles; its r.f. end has five stages, beginning with a 47 crystal oscillator and ending with an 852. In between are amplifier-doubler stages, the first and second using 10's, and the third using an 852 to drive the same type of tube in the last stage at high inputs. An output of 600 watts can be obtained from the last stage when the 852 really settles down to work. Each of the five r.f. stages has its own separate power supply.

For 75- and 20-meter 'phone a pair of 212-D's is used as push-pull Class-AB (or A') modulators. These are driven by a pair of 45's in push-pull. Ahead of the 45's is a two-stage speech amplifier using 27's. A double-button carbon and a home-made condenser mike handle the voice pickup.

The receiver at W9DUD is a home-built S.S. job of the regenerative type. It has a stage of pre-selection using a 57, a 57 first detector, 58 high-frequency oscillator, 58 regenerative i.f. stage, a non-regenerative i.f. stage also using a 58, a 2A5 detector, and two audio stages, the first having a 56 and the second 45's. A frequency meter-monitor of careful construction, encased in a sturdy box of quarter-inch aluminum, also is a useful piece of station equipment.

W9DUD's signals have been heard in 29 countries, many of which have been worked. All continents have been worked, as well as all Australian and New Zealand districts. Appointments as Official Observer, ORS, and Official Broadcasting Station are held. W9DUD is something of a family station, "DUD'S" father and brother, both of whom hold ham tickets, often taking a hand in the operating.

W2GIA, Jamaica, N. Y.

SPEAKING of stations that have to be located in an odd corner, here's a view of one that appears to be about the ultra of deluxe compactness. W2GIA is the call, and this tailor-made rig belongs to Dave Mako, of Jamaica, L. I. Fellows who have little space but aren't afraid to try their hands at cabinetwork will find many points of interest in its construction.

Mako is a real old-timer, having gotten into the game in 1912, the heyday of the E. I. Company, the Bulldog spark coil and the galena detector. Dropping out along about the time broadcasting got into full swing, a long vacation from ham radio ended in August, 1933, when W2GIA was put on the air. The transmitter is a low-power outfit, using a 47 crystal oscillator, 46 doubler and a pair of 46's in the amplifier. The r.f. part of the transmitter is on a separate chassis which slides into the cubicle at the top of the desk (the term "desk" hardly seems adequate) from the rear. A light-colored moulding serves both as a stop and frame for the transmitter panel. The two large cubicles on either side of the transmitter are reserved for QST's. Directly below the transmitter is a hooded light with drawers on either side for holding spare crystals, receiver coils, neon bulbs, etc., the coil

handles serving as handles for the drawers. Four extra cubicles are available for holding head-phones, extra tubes and spare parts.

The receiver is a National FBX, to the left of which is a built-in loud-speaker. An electron-coupled frequency meter is at the right of the receiver. Spaces are provided above the speaker

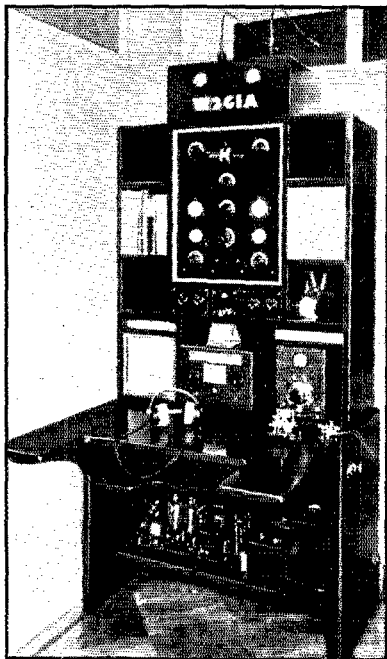

W2GIA

and monitor for log sheets, call book and stationery. The operating desk is shaped to give operating ease and comfort; when the station is not in operation the desk folds down, covering the "junk" shelf directly beneath. Power supplies for the transmitter, receiver and frequency meter are accommodated on the lowest shelf.

The back of the cabinet is covered with removable Presdwood panels set in flush. Back of the transmitter is a hinged removable door which permits easy access to the transmitter area. The whole cabinet is sprayed with black lacquer, the call letters at the top in chromium making a nice contrast. The "penthouse" at the very top houses a d.p.d.t. switch for grounding the feeders when off the air.

Most of the work at W2GIA is being carried on in the 7-mc. band. Some changes are being contemplated (naturally enough) and a new transmitter using 59's and RK-20's is under way. A preselector is also to be added to the receiver in the near future.

W6JYH, Los Angeles, Calif.

DURING the summer of 1934 (May to September) W6JYH hung up a record of DX worked on 160-meter 'phone which any 200-meter c.w. specialist of some ten years ago would have been proud to make, even under winter conditions. Every U. S. call area was contacted, stations in thirty-six states and two Canadian provinces being worked. It was done, furthermore, with only an average amount of power, the input to the modulated stage running between 75 and 100 watts.

W6JYH is registered under the name of Malcolm P. Mobley, Sr., who also belongs to the pre-war generation of hams, having had a spark set going in 1910. When Malcolm, Jr., became interested in ham radio in 1933, the OM's interest also revived. Both took their exams at the same time, the call W6JYG being issued to Junior.

The transmitter at W6JYH has three r.f. stages: 47 oscillator, 10 buffer, and a pair of 10's



W6JYH

in push-pull in the final. The speech amplifier has three resistance-coupled stages using 56's and a 45. A double-button microphone is used. The receiver is a Patterson PR-10.

Under the call W6JYG work is also carried on with c.w. on twenty and forty meters.

Strays

The winter edition of the Radio Amateur Callbook has just come off the presses. Bulkier than ever before and the amateur calls taking several more pages the callbook has been brought up to date with calls of all amateur stations of the world as well as a short-wave station and frequency section. New price, \$1.25.

● I. A. R. U. NEWS ●

Devoted to the interests and activities of the

INTERNATIONAL AMATEUR RADIO UNION

President: H. P. MAXIM

Vice-President: C. H. STEWART

Secretary: K. B. WARNER

Headquarters Society: THE AMERICAN RADIO RELAY LEAGUE, West Hartford, Conn.

MEMBER SOCIETIES

American Radio Relay League
Associazione Radiotecnica Italiana
Canadian Section, A.R.R.L.
Ceskoslovenski Amatérský Vysílač
Deutscher Amateur Sende-und-Empfangs
Dienst
Experimenterende Danske Radioamatører
Irish Radio Transmitters Society
Liga Mexicana de Radio Experimentadores

Nederlandsche Vereeniging voor Interna-
tionaal Radioamateurisme
Nederlandsch-Indische Vereeniging Voor
International Radioamateurisme
New Zealand Association of Radio Trans-
mitters
Norsk Radio Relæ Liga
Polski Związek Krotkofalowcow
Radio Society of Great Britain

Rede dos Emissores Portugueses
Reseau Belge
Reseau des Emetteurs Français
South African Radio Relay League
Suomen Radioamatööriilitto r.y.
Sveriges Sandareamatörer
Unión de Radioemisores Españoles
Union Schweiz Kurzwellen Amateur
Wireless Institute of Australia

Conducted by Clinton B. DeSoto

News:

The Fourth Annual Convention of the *Liga Mexicana de Radio Experimentadores* will be held in Mexico City on January 6, 1935. Expansive plans are being laid for an exhibition and general good time for that date and the week preceding. F. Castro Herrera, secretary of the L.M.R.E., writing on behalf of the convention committee, states that they hope to have the pleasure of welcoming visiting amateurs from the United States and other countries of the world.

The first Danish International Competition has been concluded, and the winners are as follows: 1st, OZ7KG; 2d, OZ3FL; 3d, OZ7Z; 4th, OZ7ON; and 5th, OZ1I. The foreign winners, according to Paul Heinemann, OZ4H, president of the E.D.R., are: CT1ZZ, CT2AN, D4BFH, EA2AD, ESX5C, F8TQ, FM4AA, G2QX (and G2YL), HAF3D, HB9AU, I1IW, LA3X, LY1J, LU6DJK, OE3WB, OH1NT, OK1LM, ON4BLA, PA0AT, PY1AW, SP1DU, SU1SJ, U2KDJ, VE3GH, VQ4CRL, VU2JH, W1DHE, YL2BQ, YM4ZO, YU7AU, ZL1HY and EI6M. All these amateurs will get special certificates for their excellent work in connection with this first test between foreign and Danish amateurs.

Since October 1st the new president of the D.A.S.D., replacing Prof. Dr. G. Leithauer, has been Dr. phil. h.c. Otto Groos. Dr. Groos is a retired vice-admiral of the German Navy, and his occupancy of the presidential chair brings added lustre to the D.A.S.D.

At a general assembly held in Gand on September 30th the *Reseau Belge* transferred control power from the A.S.B.L. to the executive committee, composed of Paul de Neck, ON4UU, Rene Kersse, ON4GW, and Max Cosyns, B9, in addition to six district representatives. Prof. Turlot,

ON4EL, will edit "QSO"; Jacques Mahieu, ON-4AU, has been placed in charge of I.A.R.U. affairs.

Sweden:

From Gunnar Jansson, SM6VX, comes the following discussion of present-day amateur radio in Sweden:

"The Swedish government permits all the treaty bands, and our country has 100 licensed transmitters; the most of them are active. Most of the one hundred are members of the S.S.A., which has 57 listening and 7 corresponding members, as well. The hams may use any power they want, but high power seldom is used. We have many boys who use only 5 watts, with good results. The custom is 20 to 100 watts. Telephony is permitted on all bands. The station license costs 40 kr. or about \$10, and is good forever. But the amateur is obliged every year to buy the common h.c. receiving license.

"Amateur radio in Sweden is still growing. Most stations are now crystal-controlled. Regular tests are held, 1.75 and 3.5 mc. being the bands most used; 75% of the members participate in these tests.

"This year we have lost two members. One was our president, Dr. Bruno Rolf, and the other the editor of our periodical, *QTC*, Folke Berg, SM5UR. The new president is well known throughout the world—John F. Karlson, SM6UA, of Gothenburg. Mr. Karlson's age is 69, but he is certainly one of the best and most active amateurs in Sweden. Of course, he has WAC, WBE, and RCC certificates. His station is the best we have. In his hands, S.S.A. will be under capable guidance, and our relations with the postal authorities good.

"Finally, I will give a list of English speaking amateurs of the S.S.A. in Gothenburg, the seaport of Sweden. Overseas visitors will be welcomed by any of us, and we will be delighted to show you our town.

"SM6UA, John Fr. Karlson, Redbergsplatsen; SM6UB, Captain Berbil Karlson, Redbergsplatsen; SM6XC, Ing. Nils Sjoberg, Torpet, Berga; SM6ZH, Alf Bredberg, Haga Kyrkogata 22; SM6VX, Policeman Wennshom, Klaraborgsgatan 38; SM6WR, Fred Hedstrom, Mariag. 21.

"Come on, OM's. You are welcome!"

General:

More WAC-on-'phone certificate holders: Guy Janssen, ON4BZ, issued May 15, 1934; A. C. Embrechts, ON4ACE, issued July 2d; and George Brown, G5BJ, issued November 10th Add to international ham invitations: All foreign amateurs in London are cordially invited to visit

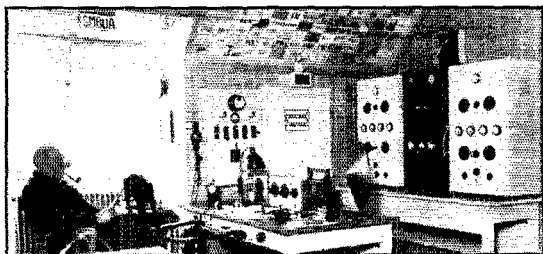

SM6UA, JOHN F. KARLSON, PRESIDENT OF THE S.S.A.

G5YH, Harold Chorley, 78, Nightingale Lane, S. W. 12, telephone (before 9 a.m. or after 7 p.m.) BAttersea 4235 J2GX is being heard in New England between 2200 and 2240 G. T. on 14.4 mc. at the time of writing, says W1CNU W1LZ reports that 1230 G. T. seems to be the best time for VK QSO's on 14 mc. all year 'round; when spring comes again, 1245, 2400 and 0730 are expected to look good Eric W. Trebilcock, long known as the "overtone king" of Moonta, South Australia, logged 100 countries in ten months CE1AI and W2BSR recently completed their 150th QSO; while this record does not compare with some VK-W contacts, it is remarkably good in view of the difficulty of contact over that route With the growing use of 'phone, increasing numbers of QSL cards are found by the various bureaux to be incorrectly addressed This is due to misinterpretation of call signals heard internationally, often over long routes and under poor conditions Listeners and amateurs should make every effort to hear calls correctly, and should not send cards unless they are reasonably sure of their accuracy; transmitting amateurs, especially on the DX bands, should take pains to enunciate clearly and

give identifying words to clarify the call sign

"Out of the metal a framework,
Out of the wood heart a box, and the mighty gates of distance
A touch of my hand unlocks.
Out of the emptiness atoms,
Out of electrons their charge, and the motion of the spaces
My casual wish enlarge.
Born of the nothing a rhythm,
Melody I can prolong, comes from the stillness voices
Out of the silence a song."
— William H. Howard, in "DX"

Special:

We have examined with considerable care each of the 44 numbers of the *J.A.R.L. News* that has been thus far published. We have read the article headings, looked at the pictures, and endeavored to figure out what it was all about—the headings, being in English, the pictures a universal language but the text being in Japanese characters. We have determined that the average issue contains eight 9" x 12" pages, in which several dozen topics of distinctly amateur interest and flavor are treated, apparently at some length if English wordage were the yardstick. Our conclusion is that anyone capable of reading the Japanese language would find the *J.A.R.L. News* interesting and valuable reading, and would be well advised to send \$1.00 U. S. (the annual dues for foreign associate membership in the society) to the J.A.R.L., P.O. Box No. 377, Tokyo, Japan, in order to get the magazine. And if you read anything in it in which you think we'd be especially interested, we'd appreciate being informed.

Strays

Troubled with arcing between the leads below the press in small rectifier tubes such as the 83 and 81, VE3QH cured several of them by removing the base, cleaning the wires and then pouring in about an eighth inch of rubber cement. After the cement dried the rest of the glass stem was filled up with plaster of paris and the base replaced. To remove the base, first unsolder the lead wires in the pins and then immerse the base in warm water, which will soften the cement which holds it to the glass.

Speaking of fast QSL's, about five minutes after W6GXL signed off with a ham recently the postman arrived with a card from that same station. Service plus!



STRAYS



In connection with the "Stray" in a recent *QST* recommending a celluloid cover for the postcard licenses, W1IKC suggests using cellophane for the same purpose. Since nearly everything comes wrapped in it nowadays, it's probably easier to secure than sheet celluloid and costs nothing. Simply cut a piece to double the size of the license, fold and bind on three sides with narrow binding tape. What with this type of license becoming more prevalent every day this idea should prove popular.

When working local an output of a few watts is just as useful as several hundred—and there's no point to paying for power that's not needed. W9BMN keeps a 100-watt lamp in series with the primary of the plate transformer for his 203-A for local ragchews, and finds that with the lamp in he has better local contacts because the low power doesn't block the other fellows' receivers. A switch across the lamp shorts it out for DX work. The lamp also is handy during tuning because the plate current doesn't go to dangerous values when the tank gets off resonance.

If your rig is remotely located in the dog-house, garage or attic where there's no heat in the winter and you have trouble getting those 866-A's to pass the voltage applied to them, dig out the old 79-cent parabolic electric heater and beam it on them. They'll put out!

If no heater is available a 75- or 100-watt lamp close to the tubes will bring them to life quickly.

—W5MN

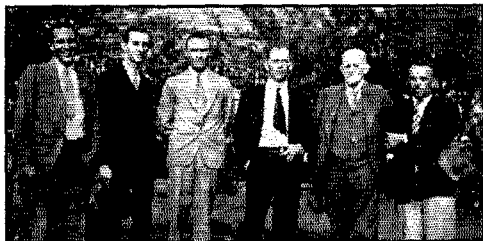

A GROUP OF WELL KNOWN 14-MC. PHONE OPERATORS

Left to right: H. L. Brown, W5AOT; Karl O. Wylar, K7SM; W. L. Kline, W5DE; H. L. Geomets, W5AEC; Dr. J. M. B. Hard, X1G; W. H. M. Watson, W5BCO (ex-5NT). This photo was taken following a banquet in honor of Dr. Hard and his wife at El Paso, Texas.

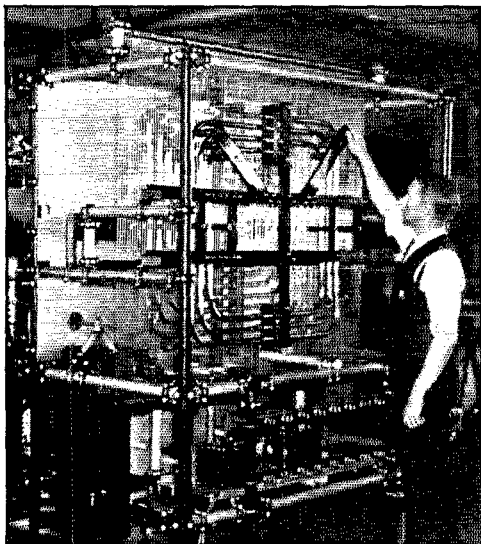

TRY THIS GADGET IF YOU HAVE HARMONIC TROUBLES

KYW's new transmitter in Philadelphia has this over-size Faraday shield between tank and antenna-coupling coils, to eliminate electrostatic coupling and thereby reduce harmonic radiation.

In the course of trying various methods of key-thump elimination, W2CTR hit upon a scheme which is not only ultra-simple but also wiped out completely a click which persisted despite efforts along the usual lines. A turn of wire was wrapped around the tank coil of the crystal oscillator and connected in series with the key; then, with the key closed, the oscillator and following stages were adjusted for maximum output. On opening the key the crystal circuit was detuned sufficiently to make it stop oscillating. Result—no sparks, no sudden application of plate voltage, no clicks. Sounds worth trying.

In a pinch an old ammeter or voltmeter (range unimportant) can be pressed into service as a milliammeter simply by placing it near a filter choke in the power supply. The magnetic field around the choke does the trick.

—W6DVI

Celluloid from an old tooth-brush handle can be dissolved in banana oil to make a quick-drying coil dope. Thickness depends on the amount of celluloid added. The banana oil can be obtained cheaply from nearly every hardware dealer.

—W3ELY



OPERATING NEWS



Conducted by the Communications Department

F. E. Handy, Communications Manager

E. L. Battey, Asst. Communications Manager

Operating News

NO ONE who was on the air during the recent Sweepstakes Contest can doubt the great success and popularity of that activity in which any amateur can take part . . . and most amateurs did! An individual had but to adopt the password of the brotherhood (CQ SS) to add to acquaintances and DX, and roll up a score in a twinkling, if so inclined. Contestants were strong in their praise of R-S-T, pointing out they enjoyed unusually complete reports and found it a great time-saver as well. Likewise there was more praise than otherwise for the new "power multiplier."

With the New Year, thoughts will be focussed on the DX tests (March) and a 'phone contest (February). Advance announcement of these appear elsewhere in this issue. We have already received a considerable number of letters about the DX competition, which is the only activity which parallels the "SS" for sheer breadth of ham interest. Increasingly fine DX conditions are noted on the low-frequency amateur bands this season. "Skip" comes on early and stays late. Once again coast to coast work on 3500 kc. is no great accomplishment. In the coming tests we should like to see interest revived in 1750 kc. and 3500 kc. DX, as well as to record results on 28, or perhaps even 56 mcs. after the tests are over. VS6AIH has suggested a score multiplier by the number of frequency bands on which at least one completed contact was made. We lean toward accomplishing the same thing, by introducing a fixed credit, to be added to scores (after multiplier), this 500 point credit to be doubled, each time DX contacts on an additional band are completed. Thus we would all add 500, 1000, 2000, 4000, or 8000 points to our scores for successful number exchanges on one, two, three, four, or five different amateur bands. It will be appreciated if you will let us know whether or not you like this idea—and if a majority do, it will be incorporated in the rules.

— F. E. H.

With the O.R.S.

Eighty active stations have qualified for Official Relay Station appointment in the last two months. Interest continues high in this appointment and in the activities for which it stands.

Opportunity for testing station performance, similar to that offered in the annual Sweepstakes, is furnished O.R.S. and O.P.S. appointees quarterly. The O.R.S. certainly took advantage of the opportunity on October 20th and 21st with the result that a most enjoyable get-together took place on those dates. No O.R.S. need be reminded of the pleasure derived from O.R.S. Parties!

As reported last month, W9KJY, Glen Ellyn, Ill., was the first to win the W9AUH-O.R.S. Cup Trophy. This cup will be the temporary trophy of each winner of the quarterly O.R.S. activities until another winner comes along. It will be awarded permanently to the O.R.S. winning it three different times, whether consecutive or not. With an incentive such as this trophy, O.R.S. get-togethers will be even more interesting than in the past!

The fourteen highest scores of operators in the October O.R.S. Party follow:

	QSOs	Sec.	Hrd.	Input Watts
W9KJY, 19,277	111	37	65	50
W4NC, 18,870*	114	34	81	200
W9BMM, 16,992	105	36	40	55
W8JRK, 16,467	99	32	88	85
W8EUY, 16,170	110	33	40	475-550
W2AYJ, 15,968	104	32	72	225
W1DMD, 15,198	85	34	92	200
W3EOU, 13,440	95	32	60	250
W9IYA, 12,865	92	31	37	150
W3KD, 12,731	97	29	41	50
W9LEZ, 12,705	88	33	23	80
W8AQ, 12,150	87	30	45	150
W3CUH, 12,145	72	35	49	
W9EMN, 11,872	82	32	33	100

* W4RA, Opr.
Although not eligible for the cup award, the performance of W9AUH and W1MK in the October Party will be of interest; W9AUH scored 24,108 (128 QSOs, 41 sec., 69 hrd.), W1MK (opr Hal) made 21,142 points (136 QSOs, 35 sec., 50 hrd.). Two operators at W1CJD (GIL and W1UE) ran up 19,675 points for the station (122 QSOs, 35 sec., 65 hrd.). Individual scores at W1CJD were: Gil 9592, W1UE 9594.

Newly appointed "reliables" now included in the roster of O.R.S. are as follows:

W1AWW	W3BFW	W5BPN	W7KJL	W9IU
W1BNC	W3DNU	W5CHJ	W8EOA	W9KJP
W1CEL	W3EBD	W5DTI	W8FGA	W9KPA
W1CTK	W3EDG	W5VW	W8GBB	W9KZL
W1ERB	W3EJP	W6AXN	W8GUL	W9NUF
W1EZR	W3MG	W6CU	W8HUD	W9RIZ
W1FNG	W4AEP	W6FYR	W8ITR	W9RKG
W1FQU	W4AFQ	W6HIR	W8JM	VE2HF
W1JLB	W4ANK	W6HRY	W8JQE	VE3BZ
W1LNE	W4ABR	W6LIE	W8KBS	VE3GG
W1TS	W4BIT	W7AEA	W8LCY	VE4CM
W2DCP	W4BRX	W7ALH	W9ASZ	VE4FW
W2EAR	W4CQD	W7DIE	W9AWP	VE4QG
W2ESO	W4CRH	W7DJJ	W9CDM	VE5FM
W2HKO	W4CXY	W7DTG	W9DVB	K6FAB
W3ABA	W5BEF	W7DUE	W9IEL	K6KTF

Briefs

Bowlers, Attention!

W8GUL suggests the organization of a bowling league among radio amateurs. Teams could be chosen by cities, states, districts, clubs, or by any other distinction. Those hams interested in bowling should drop a line to W8GUL, Frank P. Fix, 7910 Detroit Avenue, Cleveland, Ohio, stating their suggestions and probable average. Teams and matches will be arranged if sufficient interest is shown.

DX Briefs

QSOs between Japan and the state of Maine were quite common-place on 14 mc. from October 27 to November 17, 1934. W1BPX reports the following records over that period: W1DHD—four "J" QSOs (two each with J2HG and J2GX); W1DHE—two QSOs with J2HG; W1IGK—two QSOs with J2HG; W1BPX—ten QSOs with J2HG and one with J2GX. All contacts took place between 5:00 and 6:00 p.m. E.S.T.

More and more contacts are being reported with the new Belgian Congo amateur station, FC4CJJ. W3AIU and W1BPX advise that FC4CJJ is located at Leopoldville; he is working in the 14-mc. band. QSLs may be sent via Reseau Belge.

The October O.P.S. Party

The biggest success yet! Official 'Phone Station operators were out in full force to roll up new operating records during the October 20th/21st activities. Good operating conditions and more O.P.S. active at one time on the air than ever before resulted in many stations bettering their previous high records for *communication results*. Virginia, ably represented by W3BIG and W3CNY, was, notwithstanding, forced to bow to Michigan, whence hails the new "O.P.S. Party QSO King," W8IKZ. W8IKZ's score and W3BIG's, as well, topped 1000 points! Dozens of scores were sent in by successful participants. Those winning honors by placing in the "high ten" are as follows:

W8IKZ (Mich.) 1160 (16 QSOs in 10 Sec., 18 h)	W1BR (E. Mass.) 440 (9, 8, 5)
W3BIG (Va.) 1050 (14, 10, 10)	W8AHF (W. Va.) 305 (5, 5, 18)
W1GZL (W. Mass.) 686 (10, 7, 24)	W3CNY (Va.) 294 (14, 6, 0)
W9ACU (Ill.) 624 (12, 8, 9)	W9WC (Ill.) 290 (6, 5, 14)
W9LLV (Ind.) 462 (12, 7, 3)	W1DY (N. H.) 285 (7, 5, 11)

A.R.R.L. 'PHONE ORGANIZATION NOTES

Since the last additions to the O.P.S. roster appeared in *QST*, the following 48 O.P.S.'s have received appointment: W1ARV, W1BIC, W1GZL, W1WIV, W2HQB, W3CMO, W4BNI, W4CWR, W5DRR, W5DYB, W5HR, W5KZ, W6DDO, W6DZQ, W7ABZ, W7ARK, W7AW, W7CAM, W7DAA, W7WK, W8CSX, W8CVF, W8DXB, W8EKT, W8FEE, W8QFV, W8LAI, W8ICF, W8JSM, W8JTW, W8KMT, W8KVD, W9ARK, W9BRX, W9FKE, W9IGF, W9IGX, W9ITA, W9LLV, W9NKP, W9PWU, W9RE, VE3FP, VE3II, VE3JI, VE3NX, VE4HQ, VE4JK.

If you have a good 'phone, why not drop a line to your SCM (address on page 5) for application blanks for O.P.S. appointment? A.A.R.L. Headquarters will also be glad to send information regarding O.P.S. work to any amateur who inquires, including sample copies of bulletin material as long as extra copies last. Appointments are not made by Hdq., however, but handled direct with your duly elected administrative Section official, who has full authority in such matters.

ANNOUNCEMENT TO O.R.S. AND O.P.S.

January 19th and 20th again brings opportunity for testing station performance, making new friendships and QSOs, for two-way radio work (general operation) between key stations and real operators. Mark those dates, and look for full details in the O.R.S. and O.P.S. bulletins to be mailed you from A.R.R.L. Headquarters well in advance. All newly appointed stations will also receive full details by mail. Be on hand for some real operating. Watch the scores mount above previous records. Don't miss this fun.

Special ORS awards: January 19-20 operations will decide 2nd call to be engraved on the *ORS Trophy Cup* (see page 55, December *QST* for photo of this beautiful award by W9AUH). Also the ORS with highest official score is offered choice of any standard scale, wide flange, d.c. or a.c. Triplet millimeter redonated by W9AUH.

Virginia ORS Attention: Bob Eubank, W3AAJ, will denote to the winner a Triplet Model 321 3/4" d.c. ma., any scale, specified by the winner. All these prizes are "of, by and for" ORS.

INVITATION

Non-O.R.S. who have active stations and handle messages accurately, and move them speedily and reliably are cordially invited to apply to the proper S.C.M. for appointment. Non-O.P.S. working voice stations, avoiding over-modulation, and living up to the Amateur's Code

of fraternalism and cooperation are similarly invited to inquire regarding the 'phone appointment. Traffic interest is *not* required of O.P.S. Activity reports are *welcomed* from all. The proper Section Manager who has full authority in making these field organization appointments (see address, page 5 this *QST*) will be glad to see that application forms are sent you, and arrangements with Route Managers or Phone Activities Managers made to get proper endorsement-recommendation on each application.

S.C.M.'s solicit activity reports from *all* amateurs, whether holding special appointments or not. But if you have a really good station, why not qualify for O.R.S. or O.P.S. appointment. These stations are widely known for their excellence. You will enjoy QSO's with skilled operators.

A.R.R.L. organization has two basic appointments. The Official Relay Station appointment for the telegraphing amateur interested in handling traffic and in maintaining a high degree of operating proficiency and activity. . . The Official Phone Station appointment especially for voice operated stations, for every ham who normally uses his mike more than his key, who takes pride in maintaining a superior type 'phone station, with the highest standards of apparatus adjustment, with a really good signal, and high operating ideals.

Sweepstakes Scores

Over 600 logs have already been received for the 1934 Sweepstakes Contest as this issue goes to press—and they're still coming! Any operator who had the slightest part whatsoever in SS activities is interested in the "results." Rather than keep you waiting until the final checking has been done, we are listing here the *claimed scores* of some of the highest scoring participants; the calls will be familiar to the "SS gang":

Running neck-and-neck in claimed scores for "national high" place are W9HKC and W4BRG, W9HKC with 113,679 points!! and W4BRG with 113,360!!! W4BRG used 45 watts input on 3.5, 7 and 14 mc. W9HKC used 17 watts on 7 mc. and 21 watts on 3.5 mc. Not far behind these two QSO-hounds we find W5ASG with 92,628 points. . . W6ENM with 89,334. . . W8HUU with 84,294. . . W9TJ 82,167. . . W9AUN something over 82,000. . . W8FIP 81,600. . . W9IFE 80,640. . . W8EUY 79,663. . . W8FDA 76,284!!! Some of the other highest scores claimed in each district follow; number of sections worked follow the scores:

In the First District: W1MK (Hal) 51093-63, W1ASY 42896-56, W1GME 32984-38, W1CPS 2912-44, W1DMJ 32704-56, W1RY 8240-52, W1AIV 28408-55, W1AVJ 28202-59, W1BEP 25674-33, W1DEB 23036-52. Second District: W2BGO 55573-44, W2DPB 55125-63, W2DQH 50736-42, W2BLV 49060-55, W2DMY 47136-48, W2DJK 47734-58, W2FGG 41904-36, W2ABS 41004-51, W2DBE 37012-38, W2CLM 35088-51, W2GFV 31500-45, Third District: W3BES 55188-33, W3CPV 41922-57, W3DPU 35908-48, W3EOP 26007-49, W3CWE 26400-44, W3ECI 25938-33, W3EXB 24618-33. Fourth District: W4AG 71890-65, W4APU 68262-62, W4PL 54120-60, W4BOU 47908-58, W4MS 32160-48, W4BSJ 31252-52, W4GX 30322-39, W4AGS 28992-48, W4BGG 29600-50, W4COV 28116-33. Fifth District: W5BZL 57644-82, W5BSC 51840-64, W5KCK 44712-54, W5CUX 39050-55, W5AQE 38772-54, W5CPT 36000-50, W5CPE 35100-45. Sixth District: W6HET 55832-58, W6HEX 48678-61, W6BPO 41071-67, W6WJV 35190-51, W6DQR 34048-58, W6CGP 28248-58, W6AZC 25620-40, W6FRN 24660-45, W6TQY 20068-58. Seventh District: W7CY 34898-57, W7BSU 32940-60, W7CONM 20368-47, W7EET 14678-41, W7ARS 10240-40. Eighth District: W8JIT 70556-64, W8HGG 69264-48, W8ETH 65888-68, W8KWX 61876-62, W8GQB 58116-58, W8EET 55800-62, W8KWA 55488-48, W8ANQ 46528-64, W8AQE 43040-40, W8KNB 40392-44, W8KRG 37988-63, W8AQ 37698-61, W8KZO 35510-58, W8KXG (6 Ops.) 53142-51. Ninth District: W9RBE 74990-55, W9GBJ 71492-61, W9FIM 71340-58, W9DEN 69426-63, W9AQD 68178-66, W9IFD 68137-61, W9DRN 59970-63, W9KEH 57310-55, W9OIC 56880-60, W9QG 55176-57, W9DCB 53880-60, W9DMA 60020-61, W9DMY 47444-58, W9EMN 41866-48, W9GGB 41106-58. Canada: VE3HQ 52620-60, VE2DR 46930-41, VE3KF 41838-57, VE3GT 37808-54, VE4KA 33920-53, VE8DU 25929-43, VE5U 17316-39, VE1EX 16302-33.

So far it appears that no operator worked all 69 sections. W9AUH came mighty near, however, making successful contacts in 63 of them, all but the Philippines! W6BPO, W8DED and W8EUY each worked stations in 67 sections. . . W9AQD made contacts in 66. . . W4AG and

W4BRG 65. . . W5BSG, W8ANQ and W8JTT 64.

It must be remembered that the scores and work reported above do not constitute by any means a complete report on the Sweepstakes. All scores are as claimed by the participants and have had absolutely no checking as yet. It will take some time to whip the "final" report into shape so . . . keep your fingers crossed, gang, until all logs are in and checked. It was a grand QSO party/con-test!!

—E. L. B.

The following contribution by Messrs E. Aymar, W9HVA and E. M. Davis, W9ACL, wins C.D. article contest prize for this month. Your articles on any phase of amateur communication activity are likewise solicited and may win you a bound Handbook, six logs, or equivalent credit applied toward other A.R.R.L. supplies. Let us have your article, and mark it "for the C.D. Contest," please.

—F. E. H.

Break-In

By E. Aymar, W9HVA and
E. M. Davis, W9ACL*

WHILE break-in operation for c.w. and phone is mentioned in both *QST* and the *Handbook*, it appears to some of us who use the system that many operators do not understand the term or its use.

A station working break-in has a transmitter which is ready to work whenever the key is pressed, and a receiver which is working whenever the key is open. In such a station, of course, there can be no send-receive switch. But let's take up the technical details later. First we shall give some examples to show how it works out.

You send a CQ and the first thing you hear is a strength-5 signal on your end of the band answering you. The call lasts for what seems like ages. Your whiskers grow a quarter of an inch waiting for some of these long-winded guys to sign. How do you feel? Well, if you're used to break-in operation you'd better watch your blood pressure. But suppose this station works break-in. You just say BK, sign, and contact is established and a message is off the hook or a good rag-chew under way.

Suppose you are sending a long message, punching each letter slowly and carefully because conditions are bad. You reach the end and expect an OK. What you get is, "Sri OM, QRM just started up and smeared you," and so on with all the details while you sit back powerless to stop him. Finally he says, "Pse fill text & sig." Now wouldn't it have been much better if, when QRM blotted your signals, he had said, "BK BK AS AS" till the QRM left off, and then started you on the first word of the text? (Or whatever conversation was missed.) There's the real beauty of break-in operation—you know that what you have sent so far has been received as long as the other fellow doesn't BK. No need for cluttering up the air with superfluous call letters and such trash as "OK on first part, OM," or "OK OK OM solid."

Some will argue bk-in would be good stuff but, since so few use it, there's not much gained by the station using it. But it isn't necessary for both stations to work break-in to get at least half the benefit of two-way break-in operation. Suppose you are fixed for break-in operation, and answer a CQ from W9— who does not work break-in. Your call goes like this: "W9— W9— W9— BK W9— W9— W9— BK" and so on. If he starts calling somebody else, you QRT at once and waste no more time on him. If he hears you, and if he is a bright lad, he will throw his send-receive switch, swap his 'phone plug from his receiver to his monitor and go through the various other contortions necessary in the average station to shift from receiving to sending, and say "BK BK." You then sign a couple times and your QSO is under way.

* 136 Rountree Ave., Plattville, Wis. and 1228 Mississippi Ave., Davenport, Iowa.

† A good holder and a good crystal are the two most important factors for success. See the article on Break-in, page 18, September 1934 *QST*.

The trouble is that many of these lads are not so bright. He may let you call till you're tired and disgusted and sign your own call before giving up (to cover F.C.C. regulations), whereupon he will come back at you with "OK OM sri no bk-in here." It was a couple instances such as this that prompted this article. Now for the dope on how it's done.

With a self-excited rig break-in is no problem. Such things as receiver blocking, etc., are remedied by experimenting with grid leaks and juggling plate and screen voltages. With crystal control the problem seems more difficult. Why should it? Too many otherwise good stations say, "Sri using xtal & can't BK" (because the oscillator kills the receiver on frequencies close by).

The answer to the whole problem is simple: *Key the oscillator*. Why not? The crystals at W9ACL and W9HVA and many other stations have been keyed for several months. Contrary to popular opinion, the crystals don't object in the least to being started and stopped suddenly¹ and often. The keying is steady and clean, and there is no back wave to confuse the man at the other end. All filaments are heated all the time, and plate voltages on the buffer and amplifiers, though biased to cut-off, are there ready to work as soon as you start keying in the oscillator plate circuit and thus supply excitation to the following stages. There is your break-in, not a theory, but a fact. It works for us and it will work for you and give you far more efficient and enjoyable operation.

The "Before Breakfast" Club

The "Breakfast Club" originated back in 1929 by W6EFD of El Centro, Calif. About that time QRM was getting bad on the "80-meter 'phone band." Trying to figure some way out to have a 100% QSO, he hit upon the idea of early morning contacts. He talked to another ham about it and they arranged a schedule for the following day. The contact was made and the lack of QRM and QRN pleased them greatly. Word was spread around, and gradually more stations came on in the early hours. Finally the number got so great that QRM again became a problem. It then occurred to W6EFD to make a "round table" affair of it. With only one station on at a time, it worked out fine. The club has continued ever since; the old-time members and mainstays are: W6EFD, W6UT, W6FDM, W6QF (ex-CKS), W6KT, W6DJZ, W6GG, W6FP, W6ABF, W6AQD, W6DA, W6EAN, W6ESX, W6BGL, W6BOS, W6FFN, W6EQJ, W6AEK.

Bol-Inca Expedition — CP1GB

Operator Barbour of CP1GB, the Bol-Inca Expedition in Bolivia, sends some data on the expedition. In addition to radio operator, Barbour is labor director, geologist and acting manager of the Bol-Inca Mining Corporation mine. Time for radio work is, therefore, limited. CP1GB is located in the jungle, seemingly on the edge of one of the biggest static factories in the world. It is hoped that CP1GB will be on the air regularly each Monday, Wednesday and Friday between 6:00 and 8:00 p.m. E.S.T. on the high-frequency end of the 14-mc. band. Amateurs wishing to QSL direct to CP1GB should address G. Barbour, Bol-Inca Mining Corp., Siapiapo Placer, Bolivia, S. A., using plain envelopes and *not mentioning* station call letters.

W8CYW, Grand Rapids, Mich., worked CP1GB at 6:00 p.m. E.S.T., November 13, 1934.

Emergency Work in the Northwest

A violent storm struck the Oregon and Washington coasts early on the morning of October 21, 1934, attaining maximum force off the mouth of the Columbia River, where a wind velocity of 109 miles was reported. Tillamook Rock Light Station, Oregon, situated 20 miles south of Cape Disappointment, at the entrance to the Columbia River, and over a mile from shore off Tillamook Head, sustained the full force of the storm. The focal plane of its light is 133 feet above normal high water. Repeatedly the entire station was completely submerged in the

tremendous seas!! A section of the rock itself was torn away, great fragments of it being thrown over the station, many of them through the plate glass of the first order lantern, 16 panels of which were shattered, rock fragments 60 pounds in weight falling inside. Unbroken seas flooded the lantern, filling the watchroom, where the keepers struggled to erect storm shutters in the shattered lantern panels, submerged at times to their necks before the rush of water could escape through the door into the tower and quarters below. This was the situation at Tillamook Rock. Telephone cable equipment was put out of commission. So—amateur radio again came through. . . .

Henry Jenkins, W7DIZ, assistant keeper at the light, rigged up a 3.5-mc. transmitter out of a broadcast receiver. W7WR and W7CXX, at Portland and Seaside, Oregon, respectively, were working a regular schedule. W7DIZ broke in. W7WR heard the very faint signal calling W7CXX, passed the dope along to CXX and communication was established. A message to the Light-house Service at Portland was handled giving details of the damage and advising that the light was out. A broadcast was sent to all ships giving the information. Regular schedules were maintained for many days facilitating preparations for permanent repairs to the light station.

Other amateur emergency work during the storm of October 21st included the establishing of communication between Seaside, Astoria, Tillamook and Portland (all in Oregon), when all lines between these points were broken. W7ALM and W7COU at Astoria, W7CXX at Seaside and W7BOG at Tillamook established connections with Portland through W7WR and W7AXJ. Several hundred words of press were handled as well as traffic for the Pacific Telephone & Telegraph Company and several individuals. W6ZG, San Francisco, assisted when skip prevented some of these stations from hearing each other.

Vancouver, B. C., amateurs also had an opportunity to show the "Ham's" value in the pinches during this same October gale. Six watchmen were stranded when work-houses collapsed at the Boundary Bay fish traps. Aid was requested from the U. S. Coast Guard, but all communication lines were down to Bellingham, Wash. VE5JE, who lives near commercial station VAI, was apprised of the situation. He called "QRR Bellingham" on 3.5 mc. He was answered by VE5AC, who joined in the effort to raise Bellingham. VE5AC heard VE5BJ working W7CMJ, Bellingham, on 3.5-mc. 'phone. VE5BJ received an urgent telephone call from 5AC, who handed him the message from VE5JE. VE5BJ gave the message to VE5EF, who had more power, and who got it through O.K. to W7CMJ. The Coast Guard received the message and found the six men nearly exhausted when they reached them. But they are alive, thanks to amateur radio.

3500-ke. DX has been coming up of late. HB9Y, Berne, Switzerland, comes through around midnight E.S.T. and has been worked by W2EZJ, W3DUK and W1ABN (all on the night of November 28th-29th). On September 10th W2EZJ worked K6LHK, Honolulu. About 2:00 a.m. E.S.T. on December 2nd, PAØASD was worked by W1CJD and W1IJB. During the month of December, 1934, W1DIJ, Portland, Maine, worked D4BMJ, PAØDC and PAØLE on the 3.5-mc. band. He keeps a schedule each Sunday at 1:30 a.m. E.S.T. with D4BMJ, and at 2:00 a.m. E.S.T. with PAØDC.

W3AIU reports VKs coming through on 14 mc. at about 10:00 a.m. E.S.T. He was QSO VK3MR on December 4th at about that time. VK3CP was heard.

Q R M

(With apologies to W9IYA, p. 39, July QST)

Plague take the ham
Whether old or new
Who insists on sending
A long CQ!

—VESRD

W1HUG, Newton Highlands, Mass., worked ZS2A at 1:00 p.m., November 3rd, on 14 mc. It was daylight all the way.

K6JPT and LU5CZ were QSO November 12th. LU5CZ, using 'phone, played a record for K6JPT, who is an Army operator. Not knowing this, LU5CZ selected "Stars and Stripes Forever" for JPT's amusement!

WCFQ

W4AXJ (ex-1AXE) and his YF, ex-W4AXK, are heading for New Zealand in the sloop *Igrasil*, a 37-foot, 13-ton craft, built, owned and sailed by them. Starting from Jacksonville last June, they have traveled to the Canal Zone, stopping at Jamaica, where the VP5 gang entertained them. The radio gear aboard the *Igrasil* consists of a '47 crystal oscillator, '46 doubler and two '46s in the output, operating under the call WCFQ on 4150, 8300 and 12,450 kes. All other ship high-frequency channels are assigned to WCFQ and will be used as needed. Stations worked must expect considerable delays in replies since it is necessary to hand-start a 10 h.p. engine each time. Present plans indicate that W4AXJ and his YF will be dropping in on some ZL amateurs about October, 1935.

W4AXK, the station of Mrs. W4AXJ, was, during its period of operation, a unique amateur station. Operated on daily schedules for some ten months, it handled many thousands of words with W4AXJ, but was never QSO any other station!

W8AMP, a mailman himself, suggests that each local postal inquiry section be supplied with the most recent used call book that has been replaced for use in determining the addresses of hams. It is also a good policy to keep your post office advised of your call letters and address at all times.

One of the latest uses for 56 mc. has come to light at Rutgers University, New Brunswick, N. J. A 56-mc. transmitter has been used during Rutgers football games to facilitate the operation of the score board. The yards gained, downs and minutes to play, as well as other pertinent information, are relayed direct to the score board where an assistant puts it on the board for the spectators to see. A child's wagon is used to "haul" the equipment around the field. A set-up is usually also installed at the score board to speed up the correction of mistakes, etc. The call of the station used on the field is W1BVU (portable). The work is carried out in conjunction with the Rutgers Radio Amateur Club.

All-Canadian QSO Contest

The Canadian Tire Corporation, Ltd., announces a contest open to all Canadian amateurs to commence at 12:01 a.m. E.S.T., February 9th, and to finish at 11:59 p.m. E.S.T., February 19th. QSOs in the same district but outside the city or town in which contestant resides will count 5 points. QSOs in the adjoining district will count 10 points. QSOs two districts away, 20 points. QSOs three districts away, 40 points. QSOs four districts away, 80 points. There will be a power handicap. Two groups of prizes will be donated, one to the C.W. stations, one for the 'phone group. Complete details will appear in February QST.

John Dortch, W4DDF, 1206 Stratford Ave., Nashville, Tenn., will send a neat printed card with the R-S-T system to any amateur requesting same on a QSL card.

At 10:30 a.m. on December 4th, W9ROM received a telegram which had been three hours in transit from Bethesda, Md. At 10:50 a.m. he raised W3ASO, Washington, D. C., and sent a reply. In eleven minutes W3ASO had delivered the message and returned a verifying message to W9ROM. This contact was with 10 watts input to a single 59 at W9ROM.

W3ZX and W3COT have moved their 56-mc. remote control link down to "2½ meters"—with excellent results. They are able to modulate the 14-mc. transmitter with better signal-to-noise ratio than when using 56-mc. remote control link. Transmitter at W3COT is an 800 with 25 watts input. The signal from this rig is picked up at W3ZX and retransmitted on 14 mc. W3ZX says that the signal on "2½" pushes the super noise completely out. The distance between COT and ZX is about three miles.

Using a crystal receiving set, Paul Dayen, Wilksburg, Pa., on November 25th, about 5:05 p.m., picked up W8DK, Mt. Clemens, Mich., on 3.9-mc. 'phone!

W1MK received a rush message for France Field, Canal Zone, from W3BWT. A directional CQ raised K5AA, Fort Amador, but he didn't get the message complete. A later CQ brought a call from K5AJ right at France Field, who had received the message while it was being sent to K5AA and had an answer ready for W1MK.

W2BC, Rye, N. Y., leaves about the first of January for a ten-month cruise as radio operator on the Yacht Atlantic, WQBG.

28 Mc.

From 11:50 a.m. until shortly after 2:00 p.m., November 25, 1934, distant signals broke through on the 28-mc. band. Alphy Blais, VE2AC, Theford Mines, P. Q., heard harmonics from W6BXL, W4OI, N4JF, W9NUG, W9DHH, W6BBL, W9NDF, W9FCN, W4CPS, W9ARW . . . many of these signals R-S-T 559. On December 2nd, VE2AC logged W9HFO, who was QSO W9END. During the latter part of November and early December W9GBJ, Springfield, Mo., logged the following stations on 28 mc.: W1HRI, W1HTZ, W1IBL, W6ANQ, W8BVI, W6WQ, W1FUD, W1GF, W1SI, W6BXL, W6CXW, W6FKD, W7ASB and W7BPJ.

Word is received from G2HG via W9GBJ as follows: "I run a schedule on 28 mc. during the winter on Saturdays from 1430 GMT and on Sundays from 1000 GMT to 1800 GMT. I call 'Test ten' at the hour and half-past the hour during this period. These times will be extended to 2200 British Summer Time (that is 2100 GMT) during the summer months." G2HG uses a locked T.P.T.G. with input of 30 to 50 watts.

W6AM transmits a broadcast dispatch each Monday evening at 7:45 p.m. P.S.T. on 28 mc. using a "Q" antenna 171 feet high on his new tower.

28-mc. signals breaking through at W9GFZ include W6CAL, W9RHK, W9JJ, W9TBX and W9XF. W9GFZ has new vertical antenna for 28-mc. work.

Word is just received from W6CAL that on Thanksgiving Day he was QSO W8DJV and W9NY on 28 mc. That band is coming to life for fair.

The new headquarters transmitter mentioned last month has received its license—W1INF. Operation at present is on a frequency of 14,204 kcs. Plans have been made to extend operation to other bands in the near future.

W8EU is one ham who can't get enough radio. Here's how his day goes: In morning turns on BC set and listens to programs while eating breakfast; enroute to shop listens to the auto-radio; arriving at the shop repairs BC sets all day until 9 p.m.; enroute home auto-radio again; after 9 p.m. listens until 10 p.m.; then to the shack, turns on another BC set until 10:30; 10:30 fires up the ole bottle, gets the receiver perking, dates a page in the log, and gets on the air; pounds brass until the wee sma' hours; and another day has started!

C. J. Franks, W3CYF, Danville, N. J., announces that he will put a signal on the 28-mc. band with mechanical keying, to be in operation as many hours as possible each day (possibly the whole twenty-four). The call will be W3CYF, the frequency 28,300 kcs. 28 mc. experimenters are asked to watch for W3CYF and report reception.

BRASS POUNDERS' LEAGUE

(Oct. 16th-Nov. 15th)

Call	Orig.	Del.	Rel.	Total
W6JXX	46	52	1528	1626
W6ETI	188	204	1019	1404
W6KJY	102	222	955	1279
W9RYD	171	92	1014	1277
W6BMC	15	20	1209	1244
W1ILH	24	80	1010	1094
W9BSA	59	180	812	1031
W9FQI	575	189	214	978
W6CBZ	117	151	680	948
W8GUF	32	56	849	937
W9FWW	40	43	748	831
W3DOU	47	193	590	830
W9FLG	125	138	546	809
W9KG	34	207	484	725
W9DOL	68	116	472	754
W2BCX	39	29	662	730
W8FTW	50	81	565	696
W6QQC	31	43	586	660
OMITB	215	84	347	646
W5MN	35	99	508	642
W2CHK	133	192	404	629
W9DI	30	54	522	606
W6EK	51	73	476	600
W1CJD	41	54	494	589
W3BYG	101	125	322	548
W1AMG	120	139	282	541
W3JTT	50	50	440	540
W6CUU	101	413	16	530
W3ANT	96	241	180	517
W1MK	106	140	265	511
W3BWT	73	81	351	510
K6JFT	385	57	66	508

MORE-THAN-ONE-OPERATOR STATIONS

W6ZG	588	936	344	1868
K6EWQ	343	210	1208	1761
W9BNT	360	674	476	1510
K4IHR	300	359	766	1425
W3CXL	232	43	500	750
W5OW	81	428	261	770

These stations "make" the B.P.L. with totals of 500 or over. Many "rate" extra credit for one hundred or more deliveries. The following one-operator stations make the B.P.L. for delivering 100 or more messages; the number of deliveries is as follows: Deliveries counted

W1FIO, 289	W3CWL, 152	W9GNK, 105
W6CVF, 198	W3CIO, 150	W3EZ, 104
W2BLK, 199	K4ILG, 122	W2EYQ, 103
W9BMA, 181	W9IEL, 118	W6FLG*, 122
W6HZT, 173		

A.A.R.S. STATIONS

Call	Orig.	Del.	Rel.	Total
WLQC (W3BND)	106	629	108	843
WLMF (W9RYD)	286	62	266	614

MORE-THAN-ONE-OPERATOR STATIONS

WLM (W3CXL)	527	330	2169	3026
WLJ (W5OW)	143	85	387	615

A total of 500 or more, or just 100 or more deliveries will put you in line for a place in the B.P.L.
* Sept.—Oct.

VK2NR advises that a Guinea Movie Expedition from Sydney, Australia, is located at Papur, and is operating in the 7 mc. band with a 50 watt c.c. rig, under call letters VLI.

An amusing example of what sometimes happens to the texts of amateur messages: A message was delivered which concerned the arrival of a junior operator and read, in part: "Take the weed draperies out to the cupboard." The addressee explained that no Scotchman would do that, and sent back the correct version of the message: "Take the wee drappie out o the cupboard!"

Regarding the return of 1¢ postals to the sender, W6QX points out that the domestic postal regulations do provide for return but only when return name and address appear in the upper left, accompanied by the words *return postage guaranteed*. The practice of many amateurs in addressing cards to merely call and city is extremely wasteful and 90% of such cards are promptly junked, as they cannot be delivered. Uncle Sam's mail carriers are not mind readers. A full and complete address is also just as much an absolute requirement in mailings as on all messages.

What I've Learned

By George L. Burk, W6FIV

I still can recall that supreme day of all,
And the thrill when I knew I had passed
The dreadful exam that would make me a ham,
And boy, I was now one at last!

I could then almost shout, and my chest just
swelled out,
And my soul was enraptured with song;
And it made me so proud, I then and there
vowed,
I'd never do anything wrong.

I'd stay in the band, and 'I'd always demand
A crystal or p.d.c. sig,
And you could always trust me on a long QSP,
And I'd not be a frequency pig.

I'd be always polite, and I'd do all things right;
Each guy I would sure QSL;
But I'm sorry to say as I sit here today
That I've broken nigh every blame rule.

But to be really fair, I will have to declare,
'These years of hard work deserve thanks;
For I've learned what to send from beginning to
end,
Till now I just fill in the blanks.

For I say to each fan: "All ok old man,
Es tnx fer the rpt (or call);
Yer *blankety* sigs QSA *blank R blank*
Hr in *blank*; wx: *blank*;" and that's all

O.B.S.

The following is a supplement to the list of A.R.R.L. Official Broadcasting Stations in October *QST* (page 49): W1EEY, W2DCP, W3EZJ, W4ADN, W4BAT, W8GJM.

Canal Zone: K5AF/WZAL reports a message total of 247 for the October-November month.

Lack of space prevents publication of complete details on the A.R.R.L. Trunk Line System in this issue. An early number of *QST* will contain full details on each line and an outline map of the entire system.

STATION ACTIVITIES

ATLANTIC DIVISION

EASTERN PENNSYLVANIA—SCM. Jack Wagenseller, W3GS—R.M.'s 3ALX, 3EZ. MC is oping at sea. EZ has been appointed R.M. EWJ worked 7 U. S. districts with 7 watts input. AKB is rebuilding. ABZ is building separate rig for naval drills. ADE reports 56-mc. activity around Harrisburg. O.O. 8DIG reports lot of 1.75-mc. 'phone harmonics around 3800 kc. AQN schedules ten stations. EWR operates portable at Girard College. 8IWT's transmitting tubes are on last legs. SASW is building "All Star" receiver. ADM is going strong in A.A.R.S. 8BFF is again active. CJI's B.C.L. trouble is all fixed; he moved. CPV needs Asia for W.A.C. SCVS has new rig. Skip breaks up ECD's schedules. EDA has new 250-watt rig. QM using 30 watts was heard in Japan. MG is mostly on 56- and 3.8-mc. 'phone.

YL QRM is bad at 8LRI. DYX bought a motorcycle, took a spill and now doesn't have a motorcycle. DVC put new pole on roof. EPJ, ECD and EOP have been appointed O.R.S. GS has been QRL building seven transmitters. The affiliated clubs of Philadelphia and vicinity met at club rooms of Frankford Club, December 11th. Over 50 club executives attended. Don't forget your suggestions for a Section contest, party, or what have you! BYS and EZ B.P.L. A Merry Christmas and Happy New Year to All.

Traffic: W3ADM (WLQH 11) 176 EWR 12 AQN 197 ADE 5 ABZ 3 AKB 400 EWJ 272 CPV 23 BYS 548 MC 1 CJI 27 CL 17 EZ 402 EDA 35 ECD 100 GS 32 EOP 109 EPJ 12. W8BFF 18 ASW 5 IWT 35 DIG 41 FLA 121 LRI 4.

MARYLAND-DELAWARE-DISTRICT OF COLUMBIA—SCM, Edgar L. Hudson, W3BAK—3CXL, 3CQS, R.M.'s. 3BWT, Chief R.M. CXL uses remote receiving equipment of WAR 9 miles from Washington. BND now uses 200 watts. BWT's 3.5-mc. signals were heard in Germany. ABA is new O.R.S. BAK is experimenting with 1.75-mc. 'phone. EKJ worked three Australian Dist. in one morning. BHE can QSO in bed—remote control—hi. EDS has Class "A" ticket—wants O.P.S. DML got in O.R.S. contest. Ex-3CAC is now 9SXR in Chicago. CMG is putting up 90-ft. mast for 7-mc. vertical ant. EYX was 2CYA. CDG took part in SS contest. ECP is undergoing treatment at Walter Reed Hospital, Washn.

Traffic: W3CXL 775 (WLM 3026) BND 41 (WLQC 843) EOU 830 BWT 510 (WLMB 2) CIZ 96 ASO 88 DUK 65 ABA 45 BAK 35 EKJ 21 ATQ 13 EIL 12 BHE 7 EDS 5 CDG 4 DML 3 DRE 2.

SOUTHERN NEW JERSEY—SCM, Gedney M. Rigor, W3QL—DNU and AEJ work on 56 mc. CWL is terminus of Trunk Line "M." O.P.S. AYZ is starting to handle traffic on 'phone. AZX is recommended for O.R.S. BEI changed QRA. Report from DQO in Millville, first one from there in years. ZI is pounding lots of schedules with his own station. VE keeps 28 weekly schedules. APV is now terminus of Trunk Line "B." BIR reports much activity in radio club in Trenton. QL took another trick on a tanker, "KUZO." ATJ has new rack and panel job. BYR rebuilt completely. UT, old R.M., is now on 56 mc. NF plugged away at Sweepstakes again.

Traffic: W3QL 5 APV 169 VE 38 BI 68 (WLNE 34) DQO 39 AYZ 1 AEJ 3 CWL 209 DNU-ATJ 4 BYR 6 AVJ 14 ZX 5 NF 22.

WESTERN NEW YORK—SCM, Don Farrell, W8DSP—The Fort Stanwix Radio Club is going F.B. DRM and GWP are on 14-mc. 'phone. EWZ is grinding crystals. DT is building 250-watt 'phone. LUQ is perfecting a new feeder system. EXT is on vacation shooting bears. HNV is winding transformers for Rome gang. IFF talks with his parents from VE3II. KJW and LIW are working together on traffic. BQJ got a nice buck on hunting trip. MLM has new d.b. mike. BLP and KGM want O.R.S. LGY reports a bunch of M.V.A.R.C. working on 56 mc. EOA added an '03A amp. KBS is working on new rig. LUJ is doing plenty rag chewing. FOY has the S.C.M.'s new rig nearly finished. EZ is on with low power rig. GWY installed break-in. LIJ got on 14 mc. FMX has been inactive on account of sickness and a death in his family. AQE is carrying several schedules. JQE enjoyed his first O.R.S. party. JTT is turning in some fine totals. FTB copied the Armistice message correctly on A.A.R.S. schedules. LDA operates on 7 mc. daily. AOW and family have left to spend winter in Florida. AED has two new 56-mc. rigs. LGR has Collins 10-B. DHU is in Chester, N. J. GPS, BDC, LTN, HTT, GJI joined N.C.R. DES is winding 3000-volt transformer for his 851. CDK is handling traffic at C.C.C. camp at Quaker Bridge. KMC is drilling with A.A.R.S. and U.S.N.R. AYD worked a bunch of DX. HWR has taken up flying. HB is grinding crystals. DEJ is coming on with new rig. DSA installed Class "B" mod. ELU and GPX are doing lot of deer hunting. LKL is building Tri-tet. MAH has several fine schedules. The Buffalo gang reports that FTF is woman

hater. BHW, old-timer, is on 1.75-mc. 'phone and starts reporting again. DSS visited CP. AGS is back on 1.75-mc. 'phone. FYF enjoyed SS contest. EUY worked J2HG.

Traffic: W8GWY 50 LIJ 2 FMI 10 AQE 43 JQE 24 JTT 540 FTB-LUJ 5 KBS 4 EWP 5 EOA 2 LGY 7 BLP-MLM 9 BQJ 24 AYD 7 KMC 3 CDK 74 GPS 8 DSA 3 ELU 1 MAH 82 BWY 18 BHW 5 DSS 209 GZM 44 FYF 7 EUY 39.

WESTERN PENNSYLVANIA—SCM, C. H. Grosarth, W8CUG—GUF has schedules running nicely. KWA schedules 3BND and 8HCS on Trunk Line "M." CUG has 56-mc. directive array working. YA is QRL A.A.R.S. LOQ wants a bug. CMP has been running around to hamfests, etc. KSG is putting pair of '03A's in final. JZR reported by IOH. IOH says IU is back on. GJM reports the Hal-low-een party given by S.H.B.P. & M. was attended by 94 hams, YLs, OWs, etc. PX and CKO went rabbit hunting. ZAB can be heard on 1.75-mc. 'phone. AYA has a nice rig. HBG hears lots of DX. KQQ uses new "AT" cut crystal. KYW is building new power supply. MUE is new Mt. Lebanon ham. MTD sends first report. How many O.R.S. are in favor of organizing an O.R.S. Net to help move traffic along which is to be delivered in the Section? Do you think a net would help? Let's have your comments, gang. 3GER, F. W. Allen, 324 Richmond Ave., Dayton, Ohio, the 8th District QSL Manager, has over 5000 foreign QSLs for 1200 different 8th District amateurs that are un-called for. Why not send him a stamped, self-addressed envelope and get yours! CFV is active as O.P.S.

Traffic: W8GUF 937 KWA 459 CUG 186 YA 64 (WLMA 370) LOQ 52 CMP 33 KSG 30 JZZ 20 AXD 16 JZR 11 IOH 5 GSH 8 FKU-GJM-AYA-HBG-KQQ 2 KYW 1 GBC 1 IUY 76 CFV 4.

CENTRAL DIVISION

ILLINOIS—SCM, F. J. Hinds, W9APY-W9WR—R.M.'s: KJY, ILH and ERU. CBJ is doing 56-mc. work. SRC worked a VE5 with a '45. OXA worked KJY on OXA's QSO No. 1007, representing one year's radio hamming on the air. OVS is thinking in terms of c.c. COW is experimenting with indoor antennas. PNE works his usual DX. Believe it or not—HQH is O.P.S., O.R.S., A.A.R.S., L.N.C.S., Alt D.N.C.S. LBL has new M.O.P.A. OLA is thinking of trying May QST 1.75-mc. rig. LLX uses 500 watts on 1.75 mc. OLW has new 'phone with 211's Class "B." KJY won the O.R.S. cup. DRN is out for O.R.S. NUF is one of newest O.R.S. PNV says C.S.R.A. is coming along fine DBO won first prize (a pair of '66s) in 6th Corps Area A.A.R.S. recruiting contest. HWN uses a pair of '45s. SG had a fine three-way QSO with 5BMI and 4AFI. CKC is on A.R.R.L. trunk "A"—giving service from New York to Milwaukee in 45 minutes. AFN averaged 100 points an hour in Australian Centennial DX tests. Activity at IVF is entirely A.A.R.S. ANQ and CUH have new Ffanstiehl s.s. supers. New rig of '10 final—at STG. RMN uses T.P.T.G. with 40 watts input. SKF has 132-ft. Zepp. ERU has new super. Power supply at DDO burned up. The Corn Husking Contest at Earlville used the call IEP. ASZ uses one of those hard coal plate '10's with a crockery base—so he says. DOU is breaking into 56 mc. IYA is doing "Stuffed Owl" operating. KXD says A.A.R.S. 'phone net coming along fine. MCC rebuilt. BYZ is on the air after five months' rest. MLH is pounding brass from Univ. of Ill. WC had good time in O.P.S. contest. HPG is all set for Illinois QSO party. CEO is sliding down into the 7-mc. band for a change. BNA is on 3.5 mc. Rebuilding: PFJ. PIO has new "homegrown" 58-56 receiver. EZV has a new 825.

Traffic: W9KJY 1279 ILH 1094 DOU 424 (WLT 247) HUM 411 CKC 186 HQH 176 RMN 135 MLH 123 HPG 122 OXA 101 SG 85 DBO 52 IYA 46 FO 40 SQY 38 KEH 37 AND 35 KXD 31 ASZ 24 IVF 23 (WLTD 5) BNA 20 NXG-PNV 15 CUH 14 IEP 11 MRQ 10 EMN 9 CEO 7 LIV 5 ANQ-ICN-LNI 4 COW-STG 3 WC-NUF-MCC 2 SKF-RDU-SRC 1.

Central Division Get-Together Parties

The first of a series of Get-Together QSO Parties for Central Division amateurs is announced by W9AND for the week-end January 11th-13th. The fun will start at 5:00 p.m. C.S.T., January 11th, and will continue until Midnight, January 13th.

Each O.R.S. worked—4 points.

Each Director, R.M., S.C.M., P.A.M.—10 points.

Each station other than above—2 points.

Only QSOs with Central Division stations count. Contest is for Central Division stations only.

Grand Prize: Cup to be donated by W9AND. Any station winning three times gets the cup permanently.

These QSO Parties/Contests will be held every three months on the second week-end, hours as stated for the January Party. Who will be the Central Division QSO Party Champ?!

INDIANA—SCM, Arthur L. Braun, W9TE—9FQ Chief R.M. JRK was out to win SS. HPG is rebuilding. HUO is building 14- and 3.9-mc. 'phone. HUV is DXing on 7 mc. AEA has new crystal mike and pickup. QG is putting speech inverter on rig. FQ says traffic picking up. SUT is new at Valparaiso. DET is ready for traffic schedules. MQV has new amp. tube. LSZ wants O.R.S. HUF gets out fine on 3.5 mc. GFS and HBK are QRL school. OXG likes R.S.T. system. MPR has 75-ft. ant. pole. SFG has new rack and panel. LLY is getting to like 3.9-mc. 'phone. CKB, CLF, ETH, JOQ, KPD, PWZ are experimenting on 56 mc. JOQ is lining up A.A.R.S. schedules. FSG has new receiver. IU is new O.R.S. TE has ant. trouble. KJF is in radio business for himself. IKX is attending school at 5YH. FUT came to life for SS contest. PZP is commercial op on a ship. Indiana phones interested in O.P.S. get in touch with 9TE or 9AXH.

Traffic: W9JRK 155 (WLHM 45) HPG 11 HUO 25 HUV 8 AEA-QG 2 FQ 9 HBK 4 DET 6 MQV 3 LSZ 7 HUF 29 JOQ 6 TE 7.

KENTUCKY—SCM, G. W. Mossbarger, W9AUH—The S.C.M. says "Sweepstakes" is the Kentucky report this month.

MICHIGAN—SCM, Kenneth F. Conroy, W8DYH—Wishing the gang a happy, prosperous and ACTIVE 1935. MICHIGAN NINES: R.M. PDE is trying to blast the QRM with low power. R.M. ADY has arranged to handle PCU reports during the winter—no mail to Isle Royale for rest of season! RHM has new rig and high-speed bug. OZM's latest romance is with RIT's sister. Understand that CEX and EQV are confirmed bachelors! CEX says Dollar Bay leads U.P. in activity. CB returned from the hunt. CWR is QRL. HSQ hit SS hard. Marquette County R.C. hums with activity. CSI plans a 200-watt modulator. BX is ex9KS of Minneapolis attending Houghton School of Mines. HKK is piling them up. BWU did FB job for campaign mgr. in recent election. P.A.M., CWD invites more U.P. hams to become O.P.S. EGF is still putting out that FB "U.P. Bulletin." MICHIGAN EIGHTS: J.A.R.A. threw nifty party for Ann Arbor hams, says EKT. EGI found rat's nest in his power supply! IIA reports ICM's YL(?) running around with VE2HK in Montreal. Leading man is FTW—read write-up on the gentleman in D.A.R.A. Bulletin—copies free to all reporting stations. By way, D.A.R.A. now owns FB new mimeograph machine; meets 2nd Thurs. month. ARR reports IDB working at gas station. COW has 2 pc. filament in 250-watt s.g. tube and happier neighbors! GBB has to observe "s-h-sh" hours. ABH is after O.R.S. MQU is new in Lawton. LZV is after traffic. KNT reports LTG station at NW High School, Detroit. SH reports new oprs. in M.S.C.R.C.—LQB, DTN and LWC. CSX reports all well at Lakeland R.C. IKZ, P.A.M., finally got his O.P.S. gang going at 10 a.m. every Sunday. IFQ is QRL with L.R.C. station, HXT. AYO would like few more A.A.R.S. in Flint, Lansing, Bay City and Saginaw. Code practise from DYH, 3838 kc., Tues. and Fridays, 5 p.m.; Sunday at noon, 6 to 10 w.p.m. QSL. FPK wants Detroit men for radio ops in N.G. CAT got tired of SS contest—loaned his bug to GQB and straight key too much work! Hi. AEQ still piles 'em up. Brothers

at CW back again. DVC has his Trunk Line schedules complete. KYS reports QT QSY'd from piano player to bar-maiden. FAV has new car. CFZ reports DSD back after two-year absence. LTS (ex-5AUW S.C.M. New Mexico) is becoming more active at new QRA in Benton Harbor. GRB reports an '01A taking 10 v. on filament and 1000 Ep.—blew power transformer! CUX complains of voice QRM in c.w. portion of 14-mc. band. CJK is coming back. JIU reports D.A.R.A. Bulletin getting better and better. Ole man Cupid got IXI an '83" schedule with Elmira (NY). EGX reports DUA as cop in Kazoo. ECI is still after Asians on 7 mc. LYS is out for O.R.S. Sorry to hear of death of S.C.M. W2EKM of N.N.J. Section. KNP is fast becoming Pontiac's leading traffic man. JCS's "push 'em up" went blewie! MAY is working on new sleeping-potion for B.C.L.'s! CPY is going after Tri-tet and new antenna. CEU/W9SOS is going to Northern State Teachers College. DED was in SS contest hot and heavy. Report activities to S.C.M. 16th month.

Traffic: W8FTW 696 DVC 450 QT 320 AEQ 284 HUD 156 CPY 146 DWB 128 JCS 82 GRB 69 EGI 68 IOR 62 LSF 57 CAT-IIA 56 GBF 53 DYH 49 ABE-GRN 39 FX 38 DED 35 COW 33 IBB 27 BGY 26 ARR 25 NR 24 EGX-ICM-LYS 22 AYO-KYS 20 EKT 19 CFZ 16 MPT 13 IWM-IXI 12 LZV 11 GQS-IFD 10 LTT 9 CW-HBZ 8 KLR 6 KNT-KCX 4 KWX 3 FPK-IKZ-JIU-SH 2 GSP 1 LFA-LSU-LTS 1 MAY 6 KNP 25. W9ADY 161 HK 158 RHM 55 PCU 50 PDE 48 OZM 33 HSQ 19 CE 10 CEK 7 BX 4.

OHIO—SCM, Robert P. Irvine, W8CIO—IET gets a big kick out of traffic work. RN wants information on how to eliminate parasites. HCS, ATN and EPP report by radio. GSO says trunk line "B" is going fine. DVL works mostly A.A.R.S. schedules. BBH is Alternate Net control A.A.R.S. LUS is new Akron reporter. BDY says GSO likes garlic and vin rouge. HMH says MQC pounds a key on Buckeye pipe line. New hams in Lakewood: MOK, MOH, MMO and 6HBQ from Arizona. LZK wants dope on O.R.S. UW is assistant Net control A.A.R.S. HGE and GUL are trying 56 mc. LEM will be O.R.S. soon. ESN handled all traffic on 'phone. ITR is new O.R.S. WE says Inter-City Radio Club is putting on a campaign to get 60% membership for affiliation. EJ has a pair of '04A's. KWJ wants O.R.S. and O.B.S. HSX has new steel mast. LJJ and MQC are new reporters. BKM handles U.S.N.R. schedules. JIN is looking for Asia for W.A.C. MAE uses '01A T.N.T. with 4 watts input. FGA is new O.R.S. LAU says BPU is in U.S. Navy. BKE worked his first VK. The goblins got BAC's new 50-ft. mast and he had to put it up again! BRB works 100% 'phone. AMF is just getting out of hospital. KLP is rebuilding to c.c. JOU is new reporter. FGC is busy at college. GET is home again. DND has plenty QRM from power lines. BMK has new mast and transmitter. DIH says N.A.R.A. is coming back again. BRQ is working as guide at WLW. AAJ sends first report for 10 years. PV works on 3501 and 14,004 kcs. Report from Chief P.A.M. GDC says: ESN forwarded 74 messages to members of the Deauville Hunt & Fish Club while they were camping in the wilds of Canada. It was one way traffic, being picked up on a combination BC and SW receiver, but all messages were received solid. O.P.S. reporting are KVD, ESN, KIP. GDC was visited by X1G of Mexico City. Lakewood Radio Club is putting on a ham-fest in February.

Traffic: W8IET 287 RN 280 CIO 236 (WLHC 89) HCS 159 GSO 147 DVL 137 BBH 124 (WLHA 177) LUS 117 LCY 116 ATN 80 BDY 66 PV 65 HME 62 BON 59 LZK 53 UW 47 (WLHI 308) HGE 46 LEM 24 ESN 28 ITR-EPP 20 WE-EJ-KWJ 16 HSX 13 LJJ-MQC-BKM 14 JIN 10 PO 9 GUL 8 MAE-FGA 7 EEZ-LAU 6 BKE 5 ISK 4 BAC-BRB-AMF 3 KLP 2.

WISCONSIN—SCM, Harold H. Kurth, W9FSS—ATO is new R.M. for Milwaukee Co. OXP is on Trunk Line "A." LFK was in SS contest. IQW is new R.M. of N.E. district of Wisc. HDP requests O.R.S. SHN plans a vacuum-tube bug. DNU is operating under call TAR during school year. RQM is good snappy opr. NSM worked a VK. JDP made W.A.C. RFJ hooked his first YL opr. GWK is

again operating from Univ. of Wisc. dormitories. OTL is also a school teacher. ETM has new 8-tube super. OUF has job in Mpls. AKT, IHB, IYL, and LAS are on 56 mc. EEQ claims he has some bugs to take out of rig. HBB was elected president of renovated Four Lakes Radio Amateur Club. RZL, B.M.O.C. (big man on the campus), has been on only twice since Univ. started. Lightning struck the aerial of KBT and wrecked two receivers. JSN and STP are new hams. HNX is a papa now. KLL is still operating on S.S. Charles West. IDG completed a 1.75-mc. 'phone. BTA and HSU are also on 1.75-mc. 'phone. CDC works DX 'phone with an '04A. ACK uses a '49 with 500 watts input on C.W. AGX visited CPC, HSU, ACK, and SCR. HTZ, publisher of "QRZ," asks that all subscriptions be sent direct to him at R.F.D. No. 5, Burlington, Wisc.

Traffic: W9ATO 228 HSK 165 SDK 113 OXP 111 PGU 38 LFK 34 HDP-SHN 22 IQW 30 NZY 12 FCS-DNU 10 RQM 9 NSM-RFJ 4 OTU-GWK 1.

DAKOTA DIVISION

NORTH DAKOTA—SCM, Fred J. Wells, W9JVP—BTJ put up new Zepp. EIG uses c.c. RPD wants schedules with Candler students. JZJ has new 14-mc. 'phone. KZL is C.C.C. opr. at WUCR. DGS has Trunk Line "A" working FB. OEL has new power generator. PGO is QRL WUCR. PAI is QRL KFYY. Grand Forks gang put on very nice smoker. DIW has new FBXA. KBE's antenna went down. S.C.M. visited 27 hams on his vacation.

Traffic: W9DGS 127 OEL 86 HJC 72 (WLUI 108) KZL 3 FVV 7 PHH-JVP 10 PRU 20 LBI 49.

SOUTH DAKOTA—SCM, Mike Strahon, W9PFI—PFI is on Trunk Line "H." ALO is making changes. DNS says RK20 working good. CFU has '10 final. DGR is building new c.c. rig. Your S.C.M. wants more reports from the gang.

Traffic: W9PFI 48 ALO 23 FQO 11 DNS 1 BLZ 2.

NORTHERN MINNESOTA—SCM, Robert C. Harshberger, W9JIE—OPA and RJF are on 1.75 mc. LAY is experimenting on osc. for 2-volt tubes. BRA is back on in traffic game. RAG uses suppressor grid mod. IGZ is on 14 mc. with four watts. OOO is on 14-mc. 'phone. Your S.C.M. is resigning after Jan. 1st, or until new man is elected. BX-KS is now instructor of Radio and Communication Engineering at Michigan College of Mining and Technology.

Traffic: W9SMG 5 OPA 1 RJF 24 BRA 13 HDN 38 OOO 13 OMI 7. (Sept.-Oct. W9OMI 11 RAG 4 RJF 50 IGZ 44 FTJ 6 SMG 13 OOO-HDN 43).

SOUTHERN MINNESOTA—SCM, Francis C. Kramer, W9DEI—BN has five schedules. DH has new '03A on the air. FNK is after DX. BTW-ELA worked all continents four times in two months. RKG is trying to get on 7 mc. RAB has new SW5. RBW's RK20's get out better now. HCC likes his new 7-mc. vertical antenna. GFA kept OAB in touch with his wife while the latter was in the Clinic. MOW has '03A modulated by '10's Class B. MOV is on 3.9-mc. 'phone. PAS has new 1.75-mc. 'phone. RET would like five point schedules on 3.5 mc. BKK operates remote control. SKW has two 30-ft. masts. ANU is now in Mpls. DGE will soon be back from the river. KVI was heard in England. Lightning hit FMA's antenna, taking the life of his '10. PVE tried to sell a gas mask, printing press, and old pipe organ to PJA, GTE, and FMA! PJA's antenna persists in coming down. CRW is on with new Collins rig. LS erected vertical antenna. STK, STL are new Mpls. hams. SJX has his 1.75-mc. 'phone worries. PBH works 1.75-mc. 'phone. SNW punches thru with a Tri-tet on 7 mc. DEI is rebuilding, this time for 'phone. DGH, BIS are printing QSL cards advertising the coming "Mid American" Convention. Talk this coming convention up over the air—let's make it the greatest of conventions. Let's have the following as a slogan: SEE YOU AT THE "MID AMERICAN." BNN reports news scarce. DVH says there are prospects for a radio club in Owatonna. 107 attended S.M.R.A. Convention in Mankato. Following officers were elected: MZN, Pres.; JDO, Vice-Pres.; HQG, Secy.-Treas.; BTZ and BKK were two new directors elected.

Traffic: W9BN 148 DEI 131 BKK 36 DH 35 RHT 34 MOW 9 ZT 5 GFA 3 HCC-RAB 2 RKG 1 DVI-BNN 3.

DELTA DIVISION

ARKANSAS—SCM, H. E. Velte, W5ABI—BMI has new bottle. BED is on Trunk Line "H." ABI is handling Trunk Line "D." DRR has been appointed O.P.S. DJQ has new 8-tube super. DYT wants O.R.S. DSW has new DB mike. DVR is experimenting with low power on 14 mc. DFZ took Class A exams. FB schedules AQD. AQD suggests a State Hamfest. What say? BDB has 400 watts in final. MU has gone c.c. CZG worked EA8, LU2, and HI8. CPV has new rack and panel. DZE is on 7 mc. mostly. EIP is going on 1.75-mc. 'phone. CVO built new power supply. ENH uses 26's P.P. with 12 watts input. ANZ moved to Texas. DUS has new FB7A. DRZ has new Federal receiver. DZK has 500-watt rig. EKT is in Texas looking for a job.

Traffic: W5BBI 253 (WLUA 60) BED 122 ABI 117 DRR 57 DJQ 39 DYT 36 DSW 34 DVR 17 DFZ 16 FB 14 DHG-AQD 12 BDB-MU 11 DHU 9 CZG 8 CPV 6 DZE 4 EIP 3.

LOUISIANA—SCM, W. J. Wilkinson, Jr., W5DWW—BYQ and DZL handled State Fair traffic. DXW will have 'phone soon. DKR, R.M., is working hard for this Section. DYR wants O.R.S. CWX schedules HR. AOZ is building 1.75-mc. 'phone. BPL is new P.A.M. HR is new O.P.S. BZR gets lots of C.C.C. traffic. KC has new Jr. op. Congrats. VT operated at State Fair. EAI had emergency transmitter going for Fair. JW likes to sling sideswiper. DIQ has new c.c. rig. CXQ got some DX cards. DES operates 56- and 14-mc. 'phone. AVO and OZ are still at sea. ST is Activities Mgr. for N.O.R.C. AEH has swell-looking rig. BFN is new O.R.S. CYC is located in Shreveport. QH is again Pres. of S.A.R.C. AGM is active in club work. AKW is active at KTBS. AYA is Secy.-Treas. of S.A.R.C. CEK is on 3.9-mc. 'phone. The New Orleans gang had a local QSO party. The Shreveport A.R.C. installed a c.w. and 'phone transmitter at the Louisiana State Fair. The S.A.R.C. is trying to get the building which has been housing the Airways Station KOAK for a club house and station location. BUK is in N.C.R. CNG is in A.A.R.S.

Traffic: W5EGV 3 BYQ 43 AYZ 3 BID 15 DXW 140 DWC 6 DKR 71 DYR 16 CWX 15 AOZ 47 BPL 11 HR 18 BZR 101 BYY 24 KC 6 EDZ 16 VT 243 EAI 18 DZL 28. AXU 5.

MISSISSIPPI—SCM, J. H. Weems, Jr., W5CWQ—DEJ has new Zepp. VJ, BJO, and DNV are on 3.9-mc. 'phone. DVE visited 9USA. CUU has '03A final. EPO and EBF are new hams. The Jackson Radio Club has been organized with VJ, Pres. and CQJ, Secy.-Treas. DYJ, DUA and EKA are on 1.75-mc. 'phone. ECV sold out to EDP. EKV is looking for DX. CJB is building Tri-tet. EFX traded '45 for a '10. CLK is building 1.75-mc. 'phone. EGE uses P.P. '45's. CLD is active in A.A.R.S. The S.C.M. will be glad to have reports from all.

Traffic: W5DEJ 164 CWQ 67 EKV 2.

TENNESSEE—SCM, Merrill B. Parker, Jr., W4BBT—AFM tops the Section's list. AM has regular schedules with ON4CSL. CW is on the air again. ACU and CDC have new supers. ALM is on 3.9-mc. 'phone. AEP is heckled by BCL's. BMH put his "flea power" rig on 3.5 mc. LN wants traffic schedules. CYR is building c.c. rig. AYV was busy with SS. CFA is on 7 mc. FR and BEK are QRL at WDOD. DDZ moved to Louisville. AYE demonstrated short-wave transmission and reception at East Nashville High School. RO is N.C.S. of a swell A.A.R.S. Net. CDC worked J4TK. RP hopes to become O.R.S. at early date. The Nashville Amateur Radio Club now publishes a monthly paper. DDF is editor. CXY is applying for O.R.S. PL is erecting two 85-ft. masts.

Traffic: W4PL 414 AYV 35 RO 32 (WLRJ 15) ACU 27 BBT 11 CYP 3 AEP 36 ALM 22 ABY 25 CU 16 BQK 3 LU 7 AFM 117 (WLRH 422).

HUDSON DIVISION

EASTERN NEW YORK—SCM, Robert E. Haight, W2LU—E. N.Y. mourns the passing of "Buddy," W2EKM, S.C.M. N. N.J., and extends its deepest sympathy to his family. New appointments: P.A.M. 2DC, R.M. 2UL, O.R.S. 2ESO. R.M. EGF is rebuilding at new QRA.

W2BZZ is on special freq. handling A.A.R.S. traffic with WLMG. LU enjoys UL visit. FQG schedules VE3DJ. BJX reports activities of M.H.A.R.C. with nice report. GZP is on 3.5 mc. GWY has his troubles. DOS' new QRA: Freedom Plains. COY is active in N.C.R. DWO is announcer at WMCA. 56-mc. bug bites CGT, CSM, QY, BRS, CVT, AEQ, HKY. GPB reports HTH new ham. ATM was active in SS contest. FKL worked Dutch ship, PGGP. HCM is unable to get out after dark. CC schedules UL, BPH, DTB, CVJ, ZS5U. DTB has 600 watts to new final. ESO with new SW3 and Go-Devil bug is all set for O.R.S. party. EVJ is on 3.9-mc. 'phone. FFX has 825 final. GMM is DXing. HMM does FB work on 1.75-mc. 'phone. CLL is 100% C.W. CJS got Tri-tet perking. SZ reports making QSL rack. G2KB of Rugby, Eng., now in Schenectady enjoys contact with home thru DC's 'phone rig. BJA is having trouble getting new rig perking. DC attended 9PZ hamfest, and was visited by X1G and YF. HHO is building 1.75-mc. 'phone. GTC is rebuilding for 14, 7, 3.5 mc. DSH uses 47osc. '10 doubler and '03A final. HJN handles traffic via 'phone. ACY totals 52 countries with one DX QSO a day. GFD reports for Colonial City Radio Club. New hams: HUB, HUK, HUM, HUI. DPN completed new rig. CPW's YF is in hospital. HUI is starting on 3.5 mc. HUB has a Gross transmitter. HUM's Hartley won't oscillate. HUK is still in a daze over getting his ticket. DQP, after 10 years, reports. The S.C.M. extends his best wishes for a Merry Christmas and a Happy New Year.

Traffic: W2EGF 247 BZZ 179 LU 142 FQG 122 BJX 42 GPB 20 DOS 18 ATM 12 FKL 11 HCM 7 CC-UL 6 ESO 4 CLL-ACY 2 HJN 1.

NEW YORK CITY AND LONG ISLAND—SCM, Ed. L. Baunach, W2AZV—HFM is out for O.R.S. 9SER is now located in Locust Valley. CHK and BRB are on 3/4 meter. FDQ christened his police pup "QRM." CEH will soon have 2nd op. EYQ worked his first foreigner, a "VK." BEF uses pair of 800's on 14 mc. GSF uses single '71A on 7 mc. HJQ will have two '10's in final. HGM uses e.c. 59osc. and 10, final. DOG and BFB are touring the country from Maine south in a new survey truck, and have a portable using a '03A in final. GDF finds conditions FB on 3.5 mc.; he reports two new locals: GBH, HPN. HUH is new N.Y.C. station. BTF built an automatic sender. FF is going in for high-power 'phone. PF operates SC every Monday night. HMD uses only pair 46's final but works DX. HLD is on with new rig. EVA reports officers of Federation of Radio Clubs of Long Island: HN, Pres.; AIQ, Vice-Pres.; EVA, Secy.; VL, Treas. During past month ESK worked 11 countries in three days. HJK had '96 QSO's in 14 days. BGO works west coast regularly on 3.5 mc. CP blew filter and '81's. DBQ is QRL publishing "The Washline" for A.A.R.S. ELK is also lending a helping hand. BEG and BNY are battling out on 3.9-mc. 'phone. GJW works locals by keying the antenna. The 56-mc. bug bit FS. GEI is on 1.75-mc. 'phone. GNO gets FB reports from his 'phone on BC band! ATB has '10 in final modulated stage on 1.75 mc. GMI took Class "A" exam. DXO spent 23 hours in O.R.S. party. HBO worked his first "9." FIP has been rebuilding. EYS worked his first "7" on 3.5 mc. HSV is new station. DUP spotted a car with 73 on the spare tire; driver turned out to be a commercial op. DJP worked his first TI2 in Central America. AZV is on both C.W. and 'phone. The N.C.R. hams in Nassau County have been conducting some very FB meetings. Any of the gang interested should get in touch with either ADW or AZV.

Traffic: W2CHK 639 EYQ 308 ELK 303 BGO 137 FDQ 98 ESK 92 (WLNJ 60) DBQ 93 (WLNB 35) EYS 35 CYX 37 PF-GDF 31 AZV 23 KI 20 DOG-CP 14 DXO-ADW-BYL 12 BPJ-WK-ALZ-CIT-AA 11 BKP 10 FIP 6 FF 5 BTF-CCD-ATU-BVT-ASG-BIK 4 AOV-GSF-GEI-HGE-GZ-ENS 3 DUP-AGC-LO 2 FLD-BNJ 3 FKO-CEH-FS-BNY-BFA 1 QS-GJI 2.

NORTHERN NEW JERSEY—Acting SCM, Charles J. Hammersen, W2FOP—BCX handles Army traffic thru WLNK. GGW is on 3.5 mc. with pair '45's. FOP handled traffic at Catholic Bazaar in Verona. DCP is new O.R.S. BXM is rebuilding. GNV reports DX accomplishments.

3EFX is looking for DX on 7 mc. 2DLF built new Tri-tet. DVZ is experimenting with 224 mc. FZB is back on 1.75-mc. 'phone. HRN, Kearny, who 801 T.N.T. on 7 mc.; his first QSO was with 8KPV, who started him off right with courtesy and patience. GKE will appreciate heard cards and will QSL. ECO is on at new location. HSC reports for first time from No. Plainfield. Two newcomers on 56 mc. in Newark: EKU and GBY. Intercity Radio Club visited XEM, Newark Municipal Police 28-mc. station. The untimely passing of W2EKM, our S.C.M., is a great loss to our fraternity. The gang will miss him. FOP is acting as S.C.M. and is ready to give all the service required. Drop him a card.

Traffic: W2BCX 730 GGW 112 FOP 111 LK 80 CGG 34 DCP 31 CJX 26 ECO-HRN 2.

MIDWEST DIVISION

IOWA—SCM, Phil D. Boardman, W9LEZ—9ABE, Chief R.M., 9CWG, 9HCH, 9HMM, 9LXC, R.M.'s. Greetings to new R.M. for central Iowa; 9LXC, 1138 Seneca, Des Moines. Have your club secretary shoot in the dope on your club on the 16th. Everybody in the club can report for three cents. LCX and DHN report Trunk Line "H" going fine. LEZ was appointed S.N.C.S.-A.A.R.S. HCH wants to hear from gang in western Iowa. ACL has new Tri-tet. FLK schedules 7DUE. IO has nine operators. DEA wants Midwest O.R.S. party. CWG was visited by 9AIR. FZO had fun in SS. NNM and FTG received Class "A" licenses. RCR and CEN joined A.A.R.S. NDN reports club quarters renovated. GWT likes link coupling. FYC increased power. YA was appointed O.B.S. DMX is on 3.5 and 1.75 mc. RQR works all bands. HMQ uses 6 watts on 7 mc. CYL is on 'phone and C.W. DNU/TAR is a "he" school marm. PHR uses twisted pair antenna feeders. JMX says, "Cum up an' see me on 160." AWH schedules 1EBU daily. STN is on 1.75-mc. 'phone. BUZ is building portable. AED applies for O.P.S. CGY moves again. INM has 100-ft. high antenna. LZJ is building new rig. ADD moved to Tulsa, Okla. HJA worked W4 on 1.75-mc. 'phone at 5:30 p.m. ABE made W.A.C.

Traffic: W9LXC 363 LEZ 200 HCH 82 ACL 72 FLK 36 IO 34 DEA 31 CWG 26 FZO 25 NNM 19 RCR 16 NDN 15 GWT 14 FYC 8 YA 6 DMX 5 PAH 4 RQR 3 HMQ-OZW 2. ABE 8.

KANSAS—SCM, O. J. Spetter, W9FLG—9KG and 9IOL, R.M.'s. 9ESL, P.A.M. KG let his operator's license lapse! EFE ditto. RIZ was appointed Chief O.R.S. GXV is rebuilding to 'phone. KUP has new c.c. rig. RQE is a prof. LJO is coming back with 56- and 1.75-mc. 'phones. IFF will be on with 100-watt 'phone. LVS returns from Port Arthur Radio School with Class "A" and Radiophone First-Class licenses. RAT reports working with "2½ meters." IEL worked a VK. MFH is on with P.P. '45's. FMX reports for Hutchinson. GDS is building Tri-tet. IXE and GXD toured with South and East. IXE has new PR10. AWB is QRL orchestra. Sunflower Club held election: LRR, Pres.; CNW, Vice-Pres.; FMX, Secy. Hiawatha Radio Club was renamed Hiawatha Radio Operators Association: PB, Pres.; Charles Weltmer, Vice-Pres.; Carson Hargis, Treas.; IQI, Activity Manager.

Traffic: W9FQI 978 KG 785 IOL 754 FLG 809 IEL 408 AWP 150 OZN 76 EYY 74 RIZ 59 NI 49 OAQ 47 KFQ 44 FRC 34 HSN 32 CMV 31 EFE 18 NJS 17 SNX-SJV-CNW-CDM 10 LYN 5 RAT 3 FEL 1.

MISSOURI—SCM, C. R. Cannady, W9EYG-JPT—DEN was on full force in S.S. SNR is on 7 mc. with pair of ten's. DOE sends nice report. BMA is QRL business. SOO handled his first traffic. RDF worked first ZL for Jeff. City gang. MZF is on 7 mc. with P.P. 211's final. RJP sends first report for Carthage gang. DIC reports for Moberly gang. IXX is on 'phone. IXH got Class "A" for 3.9-mc. 'phone. X9CBV plans to return with 400-watt 'phone. RYD gets O.R.S. and is on a Trunk Line. NNZ gets in FB dope on State Net. KEI worked first "EA." HEL came back to St. Louis from Hazel Park, Mich. BGE is on 3904-kc. 'phone as P.A.M. NQH at Kemper

blew '61A. State Net is progressing rapidly and will soon be rounded into shape.

Traffic: W9DEN 303 SNR 9 BMA 391 SOO 1 HUG 16 MZF 1 RJP 5 DIC 9 RYD 1277 (WLMF 554) CRM-KEI 22 ECE 28 MLR 11 AIJ 171 EFC 4.

NEBRASKA—SCM, S. C. Wallace, W9FAM—BNT is going strong on both c.w. and 'phone. DI keeps a bunch of schedules. KPA and FAM are working Trunk Line "L." RUJ has new c.w. and 'phone rig. DMY is in SS contest. EHW says new transmitter is F.B. KVZ blew a fifty. KJP revamped receiver. DGL is trying to land CT1AA. FWW is trying to beat IFE's traffic record of last season! IFE had some hard luck; ground his crystal too much. IGF, P.A.M. for West Nebraska, is busy rebuilding big transmitter and new frequency meter.

Traffic: W9BNT 1510 (WLU 259) DI 606 KPA 374 FAM 364 RUJ 165 DMY 88 EHW 56 KVZ 18 KJP 4 FWW 831 IFE 264 FZX 312.

NEW ENGLAND DIVISION

CONNECTICUT—SCM, Fred A. Ellis, Jr., W1CTI—CJD, AMG, MK and FIO B.P.L. AMG bought a farm. Due to illness in the family, FIO has had to QRT awhile. Sorry, Cliff. GME gets the banner back! BDI handled important Rochester traffic in real quick time. CVL-WLGI loses banner to GME, but says, "Watch me get it back again!" CTI battles with skip. DBU says QRM from QV. HYF is now O.R.S. TS is working on output amplifier. APW is on 14,200 kc. HSX says new hams are IQT and ILG. QV handled part of his traffic on 'phone. NE has separate transmitters on 3.5 and 7 mc. GKM rebuilt rig in new rack. ACV reports for IIS. HXZ enlisted in U.S.N.R. DLX visited 2EFI and the gang in N.Y.C. BEI reports CLH, ACV, BEI, DHS, and DOV active in Bridgeport. ETE applies for O.R.S. UE moved to Newington. ARB entertained members of C.B.A. at his station, Nov. 1st. The club drove to Ansonia with four of the cars equipped with 56-mc. 'phone. Needless to say, plenty of rag chwing between cars was effected. BTU and DNN's sister were married Oct. 27th; DNN was best man.

Traffic: W1CJL 589 AMG 541 MK 511 FIO 412 GME 231 BDI 181 CVL 148 (WLGI 35) UE 115 CTI 93 DBU 62 DOW 52 HYF 41 GXZ-TS 34 APW 29 HSX 23 QV 12 NE-GKM 10 BNB-ACV 9 IIS 1 HXZ 8 FXQ-FMY 4 TD-DLX-CEJ 2 EAO 1 ETE 19.

MAINE—SCM, John W. Singleton, W1CDX—CRP is holding down his end on Trunk Line "C." EBM has R.M. appointment. BTG is QRL A.A.R.S. GOJ pushes plenty of traffic. OR says some nice ops at Bowdoin this year. IJX is new Auburn ham. EZR puts out nice signal. DHH gives 14 mc. a whirl. FQU is converting to c.c. GBM says DX is F.B. IIE is building new rig. EFA is putting in 212D. IBM is busy entertaining YL. EEY is rebuilding c.c. rig. FNG and ERB are new O.R.S. FXA is rebuilding. HUX has e.c. rig. IDN has high power on 56 mc. Jack Pierce of ARV fame has new position at Harvard in Research Dept.

Traffic: W1CRP 183 EBM 118 CDX 66 BTG 63 GOJ-GLR 55 OR 32 EZR 30 DHH 29 FQU 26 GBM 24 IIE 21 BNC 18 AQW 17 EFA 14 IBM 9 EEY-HUX-IDN-IFT 2.

EASTERN MASSACHUSETTS—SCM, Joseph A. Mullen, W1ASI—ASI is experimenting with beams and 955's. ABG topped E. Mass. list in O.R.S. party. KH reports FB results with acorn tube. WV received W.A.C. and W.B.E. certificates. VS is climbing back into place. BZO is visiting lots of stations. FRO is Boston station on Trunk Line "C." GCL wants a Section O.R.S. party. CRA is QRL traveling. FPO is renovating the shack. CEL is working 56-mc. rig in Boston. SW has '45 going on 56 mc. CRO finds 56 mc. FB for traffic. BZQ is piling up traffic on 56 mc. BR is putting in G.E. transmitting ant. GDY worked J29X for W.A.C. on 11/17/34. FCB is making world tour—has FB7 along. HKY is running 59-46-pair '10's on 14 mc. EXT is dusting off transmitter. DFE has new transmitter under way. CL is on *Pres. Hoover* in Orient. BPE reports formation of Brattle Radio Club. DRO finished FB new receiver and Tri-tet. CKD was "up in the air" this summer running air taxi. HFJ has '10 Hartley on 3.5 mc. DJ is busy with "land line" work. CWZ is com'l op'r Eastern S.S.

lines. HQW has new ant. and c.c. 150-watt rig. HUU, ex-7AUO, is at West Point. DSE, ex-8BAV, was laid up with sprained ankle. GGP moved to Winthrop from Quincy. HQM had sinkle operation. DJI is building M.O.P.A. BTM has new SW3. BJM has married the YL. CCG is playing with 56 mc. HZA plans a 3.5-mc. job. HZH worked Providence and Fall River on 56 mc. BB is on 7 mc. with FB DX reports.

Traffic: W1ASI 25 ABG-KH 48 WV 19 EVJ 37 BMW 1 RE 3 VS 77 BZO 11 FRO 50 GCL 35 FPO 6 CEL 19 SW 4 CRO 34 BZQ 26 BR 9.

WESTERN MASSACHUSETTS—SCM, Percy C. Noble, WLG/W1BVR—Chief R.M. DVV is getting schedules running again. GHU resigns as R.M. and O.R.S. COI reports that GXX on 1.75-mc. 'phone with 18 watts input to a '46 was heard in England. DUS has new antenna strung between two pine trees and says it oscillates without excitation from transmitter (the wind alone is aplenty). DIE sends following about Worcester Radio Ass'n: "BNL, Pres.; IDG, Sec.; CWG, Treas." BWY is increasing power of 1.75-mc. 'phone. APL is back on 3.5 mc. using a '52 with 250 watts. HJR has new 5-tube receiver. The Conn. Valley Radio Club now has following officers: EOB, V.-Pres.; Thomas Barrett, Treas.; IJT, Corr. Sec.; FOF, R. Sec.; JQ, Trustee. West. Mass. O.R.S. party of October 28th sounded fairly good, but very few reports on same.

Traffic: W1BVR 207 (WLG 204) DVW 60 COI 25 DUS 20 AWW 19 CTK 17 DCH 16 DIE-DUZ 14 GUO 12 IJT 9 BSJ 7 BWY 6 ARH 4 APL-AJ 2 ASY-BNL-GXL 1.

NEW HAMPSHIRE—SCM, Basil Cutting, WIAPK—IP renewed his O.R.S. HQE has code practise now. AGO is back on 56 mc. HTO has a job. AGO, HQE, GHT held four-way 56 mc. QSO with mobile TA. IMB is new station at Glendiff Sanatorium. IJB, "No. 13," is a fast-rising young ham. HOU is experimenting. AUY says, "Things slow at lake front." SK has fine list of schedules. ILN is new Keene ham. HFO is very fine op. HJI had lots of fun in SS. ILH is going full blast. BPI is experimenting with 100 mc. FMG is new opr. at Mt. Washington Observatory. ANS works duplex on 56 and 1.75 mc. IDY expects to put in more power. AVJ's new RK-20 works FB. DMD worked all 48 states in the SS. HYO has good 'phone on 1.75 mc.

Traffic: W1ERQ 350 GHT 23 HJI 9 SK 47 AUY 2 HOU 3 IJB 34 CCM 10 APT 11.

RHODE ISLAND—SCM, Albert J. King, W1QR—HEH and ARK work DX on 1.75 mc. FUB and AFO are building 56-mc. rigs. BIT uses 6BJM's break-in system. BES swapped motor generator for 16-mfd condenser. FAH uses e.c. IEX and DBF are on 3.5 mc. with fifties. GOG reports 3.5-mc. DX FB. HRC resigned from A.A.R.S. HVK blew '03A. GTN is busy with P.R.A.

Traffic: W1GOG 105 HRC 26 (WLGK 24) QR 21 GTN 10.

VERMONT—SCM, Harry Page, W1ATF—EFC (now has Class "A" ticket) can "sling hash" in N.H. and pound brass for Vt. Section and stands in line for P.A.M. BD and AXN squirt traffic reports via A.A.R.S. GNF reports new ham, ILP at C.C.C. Camp, Windsor. GAE is building 59 Tri-tet. CUN spent a week with BJP. DQK has come to life with a bang! N.B.! O.R.S., have your certificates endorsed at once.

Traffic: W1AXN 54 DQK 48 BJP 26 BD 14 (WLGA 28) ATF 30 GNF 10 GAE 6 EFC 2.

NORTHWESTERN DIVISION

IDAHO—SCM, Don D. Oberbillig, W7AVP—ERD is new Caldwell ham. DJW is on 3.9-mc. 'phone. DMT and DZO are to rebuild. KV laid over in Boise on account of bad flying WX. KJ visits in Boise. New Boise hams: ESM, ESO, ETM, ETB, ETS. Idaho loses loyal amateur in the moving to California of 7GL, Jerome, GL was pioneer radio amateur and S.N.C.S. of A.A.R.S. for many years. BAA is new S.N.C.S. ABK has new rig. BKX has new 211. EFL is fishing for DX. CFX, BYW: QRL service work. AVZ: QRL theater. CHN is back in Buhl. AAJ is assisting in moving KSEI. Boise Junior College has station under call of BRU. DAW bought GU's receiver. AXY reads all radio magazines.

CSP has FB new ham shack. CZO has new car. EMT is building S.S. super. BMF is acting alternate S.N.C.S. for A.A.R.S. CUG has nice sounding rig. Fellows, due to the fact that AVP is taking over trunk line and also wishes to conduct 56- and 28-mc. experiments, we are resigning and 7NH is acting as S.C.M. 7NH is located at Box 6, Twin Falls, Idaho. Please send your reports to her. I want to thank all you fellows for your loyal assistance and cooperation. Let's all pull together and make Idaho the liveliest section in the U.S. 7CSW handles QRR traffic from Olympia and is building 5-meter beam antenna.

Traffic: W7AVP 77 BRU 4 DBP 17 NH 60 ASA 16 CSW 1 BAA 33.

OREGON—SCM, F. L. Black, W7AMF—UJ heads traffic list. KL is ALT. for UJ on Trunk "F." Valley Radio Club visited Oregon State College Physics Laboratory as guests of Corvallis Communications Club. Salem has new club: Salem Radio Society; ELO, Pres.; ECH, Secy.; and DIW, Activities, Mgr. Pendleton new officers: KR, Pres.; Bee, Secy.-Treas.; MQ, Vice-Pres. and DP O.O. EX moved to Pendleton airport job from Pasco. BVH and CWV are located at Bonnerville Dam. AYW is chief OP at C.C.C. station WUBG. Rebuilding: CIK, HD, DAA. DIK just got married. EKD joined C.C.C. CIK is D.N.C.S., third Oregon. DHZ and DYK got Class "A" tickets. CVR reads press to boys isolated on Tillamook Rock lighthouse over 3.9-mc. 'phone. DIZ on Tillamook Rock did notable work in building ham transmitter out of B.C.L. set and handling emergency traffic during heavy storm. Official broadcast from DP, 6:30 p.m., Wednesday, 7 p.m. Friday. Reports are wanted by DP on these broadcasts. A lot of Portland boys heard talk by Fred Schnell, 9UZ, at Multnomah Hotel, and felt well paid for coming out. Portland Sevens meet every Friday night at their club house. Visitors always welcome. DUE is on Trunk "G." BOG handled some emergency traffic during storm.

Traffic: W7UJ 248 CXX 163 BWD 83 MF 76 WR 72 KL 40 CTL 40 DUE 37 SY 23 CIK 16 DP 15 AMF 11 DAA 9 SY 8 DNP 6 AWB (WLVO 14) WL 4 CEB 4 DZH 3 DYK 3 ABZ 3 ECQ 3 AHZ 2 CRK 2 BUB 1 DTG 53 AYW 44 BOG 3 W8SB-BT7 10 W9OPC 7.

WASHINGTON—SCM, Stanley J. Belliveau, W7AYO—BBY del. message from Norway 24 hours after origination. Reports received from: W7CWN, CPK, BG, DDO, ANI, BCV, EAW, BHH, ABU7, AUP, BUX, BAK, EMA, DWE. W7DDO says it pays to deliver traffic . . . he was invited to a party by a YL as the result of a del. Advance dope on the convention: Spokane Club promises a 1 convention. Don't forget the Rothrock Memorial bug and the code speed contest. They also promise a substantial prize to the person contacting the most Spokane stations. . . . Scoring will be based upon the number of "Convention QSL's" shown. So when working one of the Spokane gang, please request the special "convention QSL's." For all the latest dope write W. L. Miller 7AAN, Convention Chairman, 604 E. 18th Ave., Spokane, Wash. Spokane Radio Club is going to give a cup to the 7th dist. Ham handling the most traffic. The cup will be presented at the coming convention. More dope on this in the Brasspounder. Merry Christmas and a Happy New Year from "Stan," your SCM.

Traffic: W7WY 318 CQI 268 CZY 157 LD 83 APS 62 DGY 56 QI 37 ALH 22 IG 21 DLN 21 BRT 20 AYO 15 AQ 11 AHQ 10 AW 9 RL 9 EPT 8 UE 8 APR 7 DZX 7 AVM 6 AEA 6 BAZ 5 ECX 4 AG 4 DJJ 4 RT 4 BCS 3 ELN 3 DRK 3 DRY 2 CQJ 2 BOF 1 BBY 1 EKA 1 (LD 10, Sept.-Oct.).

PACIFIC DIVISION

HAWAII—SCM, A. O. Adams, K6EWQ—The O.A.R.C. has lots of fun with 56-mc. 'phone. JPT is new R.M. FAB is trying to consolidate his many notes on 7 mc. LBB has 11 operators. EDH is trying to make receiver work. IBW schedules JPT. GZI works coast with '30. COG awaits transformer. JRN is rebuilding. Reports received from CIB, EDH, FJF, YAL.

Traffic: K6EWQ 1761 (WVQB 344) JPT 508 KTF 152

LBB 105 FAB 47 IBW 46 GZI 27. (Sept.-Oct. K6EWQ 1748 (WVQB 507) JPT 570 DV 282 LBB 149 CGK 66 RFF 21 GZI 13).

NEVADA—SCM, Keston L. Ramsey, W6EAD—GYX is on Trunk Line "B." AJP holds N.C.R. meetings and drills Tuesday nights. GGO has new 60-ft. lattice mast. BIC demonstrated duplex 'phone operation with Univ. of Nev. on Home-Coming Day with YAR. BYR is on 14-mc. 'phone. KWO is new ham with 47 crystal and '10 output. JVH and BPO were rivals in Sweepstakes. GFT uses monitor for receiver. AAX sent his first QSL card in over three years of operation. Nevada Amateur Radio Assn. had a demonstration of an oscillograph, showing pictures of BIC's wave form.

Traffic: W6GYX 249 AJP 33 GGO 24 UO-BIC 16 YAR 8.

LOS ANGELES—SCM, Howell C. Brown, W6BPU—6GNM. C.R.M. Five make B.P.L.: ETL, EK, CUU, CVF and HZT. DOK hears VQ5AF, R8, 12:05 a.m. AIF is getting better. FB. JYH works all districts and VE3, 4, 5, on 1.75-mc. 'phone with 20 watts. HDV reports Russians coming in strong on 7 mc. 5-7:30 a.m. ALR is new R.M. for Redlands, Riverside and San Bernardino. Report but no traffic: BXV, WO, EXQ, JYH, DZI, ALR, CV, MA, COF, CII, CU, DCJ, BKY, GEX, FXL, DYQ. BKY is new R.M. for Whittier and vicinity. GVT asks for O.R.S. DBF puts 1400 volts on '10! FWN and DRL now have 1 KW. GMA, CDK and GLZ are now ops with C.C.C. HHG helps out by reporting for Ventura; hams there are having DX contest on 3.5 mc. for rigs under 100 w. LDM, LDX, LDU and LHI are new hams. EK leaves for vacation. CVF has trouble with key clicks. IOX applies for O.R.S. IKK is now station on Trunk "D." AM has new 173-ft. wood tower. GXM has new YL op. Congrats. UP in one month has QSOs on all bands. DEP has rigs on 3.5, 14 and 56 mc.

Traffic: W6ETL 1404 (WLVS 156) EK 600 CUU 530 EDW 293 GNM 379 CVF 335 HZT 173 JJI 103 IOX-AKW 102 IIK 68 EQW-JQS 54 BPU 41 DJC 37 DBF 36 DNA 35 DWP 31 AM 35 FYW 27 KBY-IFW 24 RZ 23 JWY 22 GXM 49 JAG 19 FGT 15 UP-HEM 14 HWM-HEW 13 DEP 12 ZBJ 11 AUB-KRI 10 GLZ-AGF 9 CDK-HAH 8 CVV 7 BVZ-LXH-ANN-GMA-LEL-IVU-DVV-IRD-IRA 6 JUL-CZT-KNP-ADP-DRL 5 GIG-AAE-JSK-JTA 4 JDB-KEI-BGF-AIF-DSP-BPM 3 CAH 4 HHG-ETI-IOJ-EUV-ERT-VO-DOK-DUX-HOG-GG-YBB-JGA-KJE 2 GWO-FVD-HDV-GKZ-INC-HZM-ELZ-KUK-FT-LGP-FWN-KBB 1.

SANTA CLARA VALLEY—SCM, Chas. J. Camp, W6BMW—BSO reports for first time. LFG sends long list of schedules. YX, Stanford Univ., has three transmitters under construction. BCF has been working on 56 mc. FBW handles usual amount of traffic. QR uses RK20. YG, Santa Cruz High School, has class of 23 in radio including 7 YL's. CUZ increased power to 150 watts. New Santa Cruz station: LJE, AOF has 56-mc. transmitter in car and worked Florida on 1.75-mc. 'phone. JDV is still on 56 mc. CEO is anxious to get going. BMW gets a little time to operate. AMM sends a fine letter.

Traffic: W6BSO 2 YG 138 CUZ 17 LFG 124 FBW 84 AOF 11 BMW 14 (Sept.-Oct. W6LFG 352 YG 130).

EAST BAY—SCM, P. W. Dann, W6ZZX—I am glad to report rapid improvement of CIZ and YF. 6BLP from Phoenix visited the S.C.M. and other East Bayites. RJ reports following visitors: "CW" of ZG, EK and DPJ and APM from Utah. EJA is winner of the HAMMOND MEMORIAL BUG for this quarter. Congrats, Chas. HRG works plenty of 14-mc. DX. IEW sends a fine report of doings in Oakland Tech High Radio Club. ICW is going on 56 mc. IJV worked a K7 on 3.5 mc. KQ is building 56-mc. rig for Oakland Radio Club. YJ was on the air on Tech's open-house night. FS is busy printing A.A.R.S. "BULL." The good old NAPA bunch have come to life. Thanks for the report, AUT. II spends most of his time on Army Net. CZN plans changes in receiver and transmitter for operation on 7 mc. APB moved to new QRA. BYS has trouble shooting the bugs in new 59 Tri-tet. GYA is 1.75-mc. 'phone enthusiast. JNX had misfortune to break his arm.

HKA of Sonoma paid Napa gang a visit. ITH has 'phone operating on 1951.5 kc. CI has packed his old kit bag and hid himself to San Diego to assist our old friend ZQ in some Naval rebuilding. The S.C.M. wishes all a very Merry Xmas and Happy New Year.

Traffic: W6WJ 264 EJA 129 HJS 128 YM 94 HRN 45 FS 7 HH 5.

SAN FRANCISCO—SCM, Byron Goodman, W6CAL— with R.M. work. LIE uses remote control. HRY is busy ZG leads all. JXK got his with K6 schedules. RH is busy on Trunk Line "F." JNI is U.S.N.R. control at Petaluma. HSA is new A.A.R.S. KNQ has new P.P. '10s c.c. rig. HJP is interested in O.R.S. JAL is resuming schedules. JDG reports LJO new at Fort Bragg. JQV works DX with new rig. KJQ is building QRO 1.75-mc. 'phone. JVU used 8 watts in SS contest. CAL is finishing s.s. super. IPH worked first J and VK. LBK worked all districts. AZK is QRL university. JQJ has Patterson PR-10. CWR joined U.S.N.R. CIS rebuilt for winter. DZQ is busy publishing *Hamflashes*, which is sent free to reporters each month.

Traffic: W6WZ 1868 JXK 1626 RH 346 (WLV 310) LIE 188 HRY 135 JNI 73 HSA 44 KNQ 26 HJP 16 JPA 14 JAL-JDG 13 JQV 7 KJQ-JVU-CAL 6 IPH 5 LBK-AZK 4 JQJ 1.

SACRAMENTO VALLEY—SCM, Geo. L. Woodington, W6DVE—Convention and SS contest held the stage this month. Seen at convention: AHN, AK, CKH, CFP, CGJ, ESZ, FW, GDJ, IQH, INT, UM, GZY, HEP, BDX and EUH.

Traffic: W6CGJ 23 FRP 6 GZY-DVE 4 DVD 61.

ARIZONA—SCM, Ernest Mendoza, W6BJF-QC— BFA is building separate 7- and 3.5-mc. rigs. IIG now uses M.O.P.A. on three bands. KKEE has son, DPS, for second operator. FZQ gets half a kilowatt from a 61 c.c. oscillator! FIP plays the bass drum in Yuma band! IQY put up new antenna. KTR moved from Bisbee to Phoenix. KOK using c.c. on 7 mc. LDC joined headquarters company, 158th inf., Ariz. N.G. HJX moved from Phoenix to Superior. JND is now on 3.9-mc. 'phone. AND makes W.A.C. on 14 mc. HUZ and GJC try for Class "A" ticket. JYQ has '52 in final, with 3000 volts. DSA is mining at Vicksburg. HEU is on way back from Lima, Ohio, by motorcar. BYD coaches a friend for Class-C exam. KIM works near Boulder Dam. EKU moved to Sacramento, Calif. DSQ contemplates trip to Mexico on business. IUY finds herself QRL with three school children. GDD, IIG, BLP made auto trip to Pacific Convention. FXK finds that new partner gives new life to radio service shop. SKNY and 8KDJ of Middlefield, Ohio, are now at Phoenix. EGI helps DUQ as instructor of radio at Tempe Teachers College. HBR is splurging more on QSL card printing equipment. IDR handles a machine gun in National Guard. GGW is at Phoenix, attending Junior College. KGL is working at Ajo Hotel. KGQ moved to better QRA for 1 KW DX rig. New calls: Phoenix: LET, ELM, EJQ, JUC, GFL. Tucson: LAB, JJO. Tempe: KSE, Globe: LCI. Prescott: LFJ. Glendale: CJM. We extend our deepest sympathy to HKX, in the recent loss of his mother. S.C.M. returns home after conclusion of Parker "war," Nov. 15th (8 mo.). Phoenix army (ALU) handled official traffic to and from Parker N.G. troops. Mr. Budlong, from headquarters, stopped over for one day on his way from Pacific Convention, and several Phoenix hams had the pleasure of meeting him in person.

Traffic: W6BFA 63 IIG 40 KKE 17 FZQ 12 KOL 5 FIP 2. GW4 (W6QC) 115 GN4 (W6ALU) 36.

PHILIPPINES—SCM, N. E. Thompson, KAIXA— This report received by radio at W6CVF, mailed to HQs. We had two bad typhoons during month, but all KA stations back on the air again.

Traffic: KALHR 1425 LG 452 RC 237 SX 230 CS 113 CO 66 FS 52 XA 41. KA9WX 46. OM1TB 646. OM2RX 406.

SAN DIEGO—SCM, Harry A. Ambler, W6EOP—BMC makes the B.P.L. EFK says Trunk Line "F" is in full swing. Any one wanting schedules get in touch with the R.M., FQU. BEV has schedules north, Hawaii and east. AXN was appointed R.M. for Imperial Valley. All 'phone

men wanting schedules get in touch with P.A.M., IBK. ACJ reports Helix Radio Club going strong. BAM says DX is beginning to come in. BLZ is building new c.c. rig. GNT has new c.c. rig on 14 mc. LD is on with new 'phone rig with crystal mike.

Traffic: W6BMC 1244 (WLVH 8) EFK 256 FQU 164 BHV 109 AXN 38 IBK 13 ACJ-BAM 11 BLZ 7 EOP 6 GNT 3 LD 2.

SAN JOAQUIN VALLEY—SCM, Clyde C. Anderson, W6FFP—The Turlock gang all reported in fine shape. KGO leads the Section in traffic with AGV next. EXH fell down slightly due to QSO contest QRM which takes rigs away from the OW GQZ. FYM is hot about 56 mc. DZN found some time to get on the air. GXL is bit by 56-mc. bug. HIP reported by contact. The Fresno gang has gone 56 mc. also. AJJ is a proud papa. HYG won big receiver at convention. DJQ proudly exhibited new N.C.R. transmitter he is building. FPW and YF GDX are trying to find time to sleep after convention activities. To has new 'phone rig. KB broke away from KMJ for few mins. to sock chew some OT's. QK was 56-mc. champion. DQR won sending contest. CXM attended his first convention banquet. The Tulare gang was present in full force with ASV the only W.A.C.er among 'em. DWE handled all the money and then slept with the convention transmitter, with GMW snoring CQs in same room. FYN served on every committee between drinks. The Modesto Wouffhong gang were down in full force. ILH and IPN were only Stockton representatives. IAD and EUF represented Clovis. AOA was busy hopping bells, but EJU and BRO were up from Bakersfield. WA dropped in for second via plane on Navy Day. Armistice Day was celebrated with Modesto N.C.R. gang being color guard with Fresno Unit doing right shoulder arms with the cannons in parade. GCS and YF GEV with AXE from Visalia liked the convention.

Traffic: W6KGO 147 AGV 78 EXH 57 DZN 17 FYM 2 HIP 1 FFP 14.

ROANOKE DIVISION

NORTH CAROLINA—Acting SCM, N. M. Patterson, W4EG—4AVT has resigned as S.C.M. and 4EG, 2804 Hillsboro St., Raleigh, N. C., has been appointed to fill his unexpired term. AVT made a fine S.C.M. and every amateur in N. C. regrets that press of other duties forced him to resign. ADW has been re-elected Director and 3ZA Alternate Director, both without opposition. Charlotte has a fine club, shack and grounds; call is CZV, 3571 kc. BXF is again handling traffic. CLB and BX are on 1.75-mc. 'phone. FFB is on 3.9-mc. 'phone. CXC is now A.A.R.S. Durham: CUB and AW are operators at WDNC. RV made good score in O.P.S. contest. TR is on 14- and 28-mc. c.w. CVQ, Ft. Bragg, will be host of next Central Carolina Club meeting. The Graham Club Station call is GYE, 3780 kc. CJP will take Bar examination in Jan. Greensboro: ZH is planning beam antenna. MR piled up fine SS score. ACY is active on 3.9-mc. 'phone. PW, Guilford College, is putting more power in his 'phone. Raleigh: BTC and BRT keep several schedules. DW keeps two daily schedules on Trunk "C." JB helped install new 5KW rig at WPTF. CGL is buying parts for RK20 portable 'phone. QI is active at Siler City. Warrenton: TP is on 7 mc. BVD is reliable on schedules. CJM is QRL drug store. BHR, Warren Plains, wants new sky hook. Wilmington: BKS is active in traffic. CSA, a new ham, is old telegraph op. CUA, the club station, is going fine. FT worked 5 continents with 18 watts input on 7 mc. BQZ has trouble with '03As in 1.75-mc. 'phone. BRK has 50-watter on 7 and 14 mc. BPL left WDNC. Winston-Salem: BOH is going to work in Virginia. OG is new club pres. CAY moved to Charlotte. BYA enjoys fine 1.75-mc. 'phone work. IY has receiver trouble. RA is DXing. AHF moved. NC is busy with traffic and contests. CFR and PA are new club vice-pres. ABT keeps schedules at NC. AI is ready to go with fine rig. CJU is trying to work all states. COK is working on high-power rig. IF, BPU, CJA, DCQ: QRL school. CJK is club secy. CYA, CXP, DCQ: new hams. Tarboro: ALT is back from C.C.C. camp. CCH is trying to get on 14 mc.

Traffic: W4BTC 490 DW 159 NC 152 OG 25 BRK 24

CVQ 21 ZH 20 EG 17 BEH 10 CSA-CYA 4 BKS-MR-CJM 3 QI-ACY 2 BXF-PW-AHF 1.

VIRGINIA—Retiring SCM, R. N. Fubank, W3AAJ—BJX schedules BWT, AZU, APU, CHE, ENJ. Congrats to BRY on S.C.M. election. BEB is on 1.75-mc. 'phone. 4DBU operates port. in 3rd dist. EUL schedules BRY, BYA, FJ. CWJ has 955 for 224-mc. band. AUG has 56-mc. directive ant. to Washn. APU schedules BJX, FJ, EUL. BAD is on 3788 kc. EGD has new c.c. rig. EEN schedules INR, GOJ, 3CHE. ALF schedules BRY, CSI. EHL schedules APU, BRY, FJ. CFV is in A.A.R.S. DCU is rebuilding. EBD applied for O.R.S. AAJ added matched imp. unit. EQQ worked ZL, K6's. CA is building 56-mc. transceiver. EDG is now O.R.S. DQD schedules 4MO. CYM is taking Class "A." DWE is on 3605 kc. BIW has P.P. RK20's final. EPH is EJK at Rose Hill, Va. AMB sends lots of dope. DBI, Petersburg Club Station, is on 3806 kc. ECQ is on 3790 kc. UVA schedules VU2FY. AOT is busy A.A.R.S. BZE has worked 43 states. DZW added '03A final. ELJ has Collins rig. GE experiments on 56 mc. BAN's QRA is Rudwall Apts. CQW schedules CWJ. EPK blew power pack. DVO made over 10,000 points in last O.R.S. party. CPN is on 7 mc. WM is on 7250 kc. AAF is in Club Net. BYA is Va. trunk station. CFL has new 40-ft. mast. FJ attended A.A.R.S. Conference. Reports should go to 3BRY in future. AUG and FJ have 56-mc. beam antennas pointing to Washington. 3AAJ is giving a meter to highest scoring station in January O.R.S. party. Old Dominion Radio Net, composed of colored operators in Virginia, operates Sundays, 12 to 1:30 p.m.; stations are 3CSY, APT, BDQ, ALF, BRE. International Negro Net operates Tuesdays, 9 to 11 p.m., with 2ESK as control. AAF informs us of 1.75-mc. club station 'phone net operating Mondays, 7:30 p.m.; Thurs., 7:30 p.m.; Sundays, 2 p.m. AIJ is on 1.75-mc. 'phone. ASK ordered PR12. BUR has FBXA. BGS is building new receiver. BLE is on 14 mc. BFW worked EA5. BAG is exper. on 56 mc. with FJ. BFQ is rebuilding whole station. BRA wants receiver. BTR has Tri-tet now. CVU has new shack, 18 ft. by 9 ft. DEH was in SS. DGT's new rig: 47-46-10-10s180 W. DRK is operating CAH's new rig, 300 watts. ELC was just married. Congrats. EOX has new c.c. rig. EOO is J. B. Fuqua, near Prospect. Mr. 3EMX has Class "A" ticket. MQ is QRL trip. CNY wants '52. ECR has '10s in c.c. T.N.T. EZL is Carter, ex-3AGT. EZJ is Ben Wanniner, ex-5AXO. AVR is on 3.5-mc. c.w. and 'phone. ENO is building c.c. job. ELA had big time in SS. CHE has new YL opr. Congrats. EAP is building 224-mc. rig per Hull. ELB is on 3840 kcs. BIG, 3.9-mc. Chief 'Phone Activities Manager, plans some great things for Virginia 'Phone Net. Mr. Foley advises that new Radio Inspector's address is Room 402, NEW P. O. Building, Norfolk. ANT schedules K6KTF, K5AA, W6LBE, K5AG and 3CHE. 3AAJ broadcast message re death of W2EKM. Wish to take this means of thanking you fellows for kind words and fine help while I was S.C.M. Regret that I had to give up due to business. Your new S.C.M. is a good one who will break my records, if you boys will report to him. Thanks, and keep Virginia at the top.

Traffic: W3ANT 517 BJX 158 (WLQF 14) ENJ 57 BRY 38 BEB 30 EUL-CWJ 23 AUG 22 APU-BAD 21 EGD 17 EEN 16 ALF-EHL 15 CFV 14 DCU-EBD 12 AAJ-EQQ 8 CA-EDG 7 DQD 6 CYM-DWE 5 BIW-EPH 4 AMB-DBI-ECQ 3 AOT-BZE-DZW-ELJ-GE 2 BAN-CQW-EPK 1 DVO 16 CPN 5 WM 4 AAF 2 BYA 281 (WLQJ 6) CFL 20 APT 10 EPM 1 FJ 109 (WLQD 21) BXP 3 CYK 3 ELA 21 CHE 144 EVN 2 EAP 1. W4DBU 28.

WEST VIRGINIA—SCM, C. S. Hoffmann, Jr., W8HD—ADI announces equipment from Navy Dept. arrived in Wheeling for "NDE," U.S.N.R. station. CXR has Junior opr. HCL moved to Ohio. FVU joined A.A.R.S. HD/WLHF schedules WLHI daily on Army Corps Area Net. CSF is back on air. CDV and ELO are rebuilding. KSJ is on 3.9-mc. 'phone. Stroebel, old 8ZW, visited Radio Communications Assn. meeting in Wheeling. DPO is trying for "W.A.C." on new B.C.L. receiver. HI! ANU is building station at Bethany College, Wheeling. BKG is

experimenting with 56-mc. 'phone. CIJ is with U.S. Forest Service in Texas, where he got married recently. JFP and EYX work with 56-mc. transceivers. IKN returned from U.S.N.R. duty on U.S.S. *Babbitt*, "NEPX." IKN uses Army call XY-4 on 4080 kcs. to contact WVZ daily. AKZ, CAY, IKN were issued N prefixes. CMJ, KKG, LBE, FQB attended Clarksburg hamfest. JWL is building s.s. receiver. KKG schedules K5AF, 8KWA, DSS, AKQ, 3BYS and ASO. First directive antenna installations comes from Charleston, where it is understood BKI is constructing them for both 28 and 56 mc. MUX is new Wheeling station. EZR joined U.S.N.R. BDD uses suppressor grid-modulated 'phone. MQF is new Huntington station. Two code classes are held at Y.M.C.A., Huntington, the youngest pupil being in his 'teens, the oldest 89! Skip has MOL; Hi! EGA is again active. EWM reports Bluefield Radio Club active. 13 stations make up a 1.75-mc. 'phone net in Bluefield. MCL uses '59 Tri-tet-'45 Buffer-'211 P.A. LTD worked his first "W6," using single '46.

Traffic: W8HD 57 (WLHF 53) DPO 8 HWT 10 BKG 7 KKG 161 EZR 8 EWM 10 MCL 4 LTD 2 DFC 6 OK 52 (WLHB 26).

ROCKY MOUNTAIN DIVISION

COLORADO—SCM, T. R. Becker, W9BTO—CDE has regular schedules. EHC is teaching "Radio Operating" at Federal Transient camps. FXQ is going to install RK20. PWU is dreaming about 400 watts on 1.75 mc. P5A and GBQ were having experimenting with 56 mc. PVZ is on Trunk Line "L." HIR has new transmitter. KJL is on 3.9-mc. 'phone. PGS got R9 from K6. SWY is new ham. OFJ visited PGS. GLI is now RMc 1st in N.C.R. MLU is rebuilding to c.e. NPP rebuilt to c.e. SBB has new c.e. rig. NUP hooked up with N.C.R. CWX is awaiting PR12. DDF likes 1.75-mc. 'phone. CBU is on 14, 7 and 3.5 mc. RNF is on 1.75-mc. 'phone. FA keeps the Navy from sinking. BYK has a good speech amplifier. FYY still works "J's" and Aussies. CJJ has new Carbon plate 50-watter. BYY got his 50-watter going. IPH has an FB 14-mc. 'phone. OUI says it's easier to understand 'phone than c.w. HI. FYG is on with low power. LWF is on Trunk Line "B."

Traffic: W9CDE-EHC 25 FXQ 2 PWU 15 ESA 1031 RTQ 200 GNK 219 PVZ 227 PGS 27 GLI 32.

UTAH-WYOMING—SCM, Arty W. Clark, W6GQC—Utah: Congratulations to W9AAB as Director and W6BTX as alternate Director. New stations: LMR, S.L.C., LKJ Hennifer, KZW Riverdale. 9CSK has call 6LOX. ZZBI changed to LNK. Ex-6EEM is now 5DVH, Kirtland, N. Mex. DTB is "Just Married." Congrats. Utah Amateur Radio Club was entertained by Ogden hams, visiting some very fine transmitters and partaking of splendid cake and ice cream. LLH fights QRM and power leaks. W6KGM built May QST portable revr. LCM schedules 7BZZ. DGR is doing fine work on Trunk "B." EVF, AWV, IOF, and LOX received Class "A." AFN helped JVA move sticks to new QRA. Wyoming—Assistant SCM, T. J. Rigby, W7COH—ARK is rebuilding some fine towers. DLC has completed his sky line with new towers. GVD is on 7 mc. mostly. CSE is active in A.A.R.S. CRF has '03A going. CCC has new Silver transmitter. AMU has new sky hooks. NY and ADF are building supers. CVD from Glenrock visited Casper Radio Club. CHR is combining radio and woodworking. EDC is going to get up a piece of wire and get on the air. DIE had radio display in "Hobby" exhibit at church. CLG is putting on code practice on 1.75 mc. COH is building c.e. rig for T.L. work. Skip gets Wyo. A.A.R.S., but the old gang is still active 100%. HX is the real old-timer, for he started in 1896 in Omaha and can prove it! AXG is busy engineering for Bighorn County. AEC is mixing pills in Pinedale. DIE is on A.R.R.L. Trunk Line "E," COH is on line "G."

Traffic: W6GQC 660 DGR 122 KDI 118 FYR 72 LCM 22 GPJ 11 AFN 7 EVF 2 ILH-KGM 1. W7AMU 26 COH 219 DIE 23.

SOUTHEASTERN DIVISION

ALABAMA—SCM, L. D. Etwell, W4KP—4DS, Chief R.M., is Alt. N.C.S. A.A.R.S. AJY put up new antenna. RS reports plenty of traffic. BRX and BIT are out for O.R.S. AAQ has his rig in B'ham Club room under call CUE. DAT reports new ham, DFK. APU, candidate for Southeastern Director reports B'ham Club going FB. BMM, P.A.M., keeps schedules on 3.9 mc. CYW promises to give the old heads a run for traffic. ATD, exPAI, reports again. CIU handled a message for Jack Dempsey. ARF has gone in for traffic. CVS reports on the fellows from his locality: ALV is active again; DCI moved to Florence, Ala.; DDN and CRC are new hams. AUP, BZG, BCU, ZS, BMM, BDE, AP, PFR, RS and KP are active on A.A.R.S. 'Phone Net. BGO reports from Mississippi. CRG is new ham on 7 mc. BHV is having a new rig to go with Comet-Pro. GN built an FB ten tube Super.

Traffic: W4RS 220 DS 53 BJA 49 APU 33 CYW 24 BMM 12 BRX 9 DAT-CIU 7 ARF 5 DFK-CVS 4 AJY-ATD 2 BIT 1 KP 7.

EASTERN FLORIDA—SCM, Phil McMasters, W4BCZ—CQD applied for O.R.S. CQZ organized ham club in Lake City. COV had visit from Clearwater hams. BBX moved to Brunswick, Ga. CJR worked VP4JR without antenna. BCZ had caller, 5 CUU. Congratulations, M.A.R.C., on getting Division Convention for next year. CXB edits paper for 1.75-mc. 'phone every week in Miami; title, "Harmonics." BUI moved to Miami. GWR is building new receiver. CFC has Class "A." St. Pete. Club moved from BCZ's store to new quarters in Y.M.C.A. Bldg. ACZ and BNI are starting club in Lake Placid. AIV is building new 1-KW 3.9-mc. 'phone. AQ is on 1.75-mc. 'phone. AVQ is handling traffic on 'phone. CBP visited BNI on way to Legion Convention at Miami. KM, CFC, AGY, LS and ACZ attended Mobile Convention. Hams at U. of Fla. this year are BIN, HC, GWV, BPI, ZU, ZV, BJS, ACO, CPW. CZI has been on the air since July, '34.

Traffic: W4BCZ 16 CQZ 11 COV 3 BNI 4 CJR 41 DBA 7 AVQ 5 CTS 2 ASR 141 CQD 15.

WESTERN FLORIDA—SCM, Eddie Collins, W4MS—R.M.'s, 4ACB and 4AUW. CDE added pre-selector to super. CTZ has new 801. QR is back from trip to Md. BSJ got out FB in SS. AUA has new QRA. ABJ was home for visit. BCB is on 7 mc. KB is heard regularly. AFT is back after two-year layoff. BOW uses a Tri-tet. CRU rebuilt. AQY has new super. AXP is QRL selling BCL sets. CQF confines his activities to 3.5 mc. BGA and MS and their YF's received some FB calf-skin bedroom slippers from VK2AP. CMJ is getting two RK20's from RS. BMJ wants new power supply. ACB has Tri-tet. BKQ is returning to air with M.O.P.A. DBL gets out nicely. DAO is getting an FB7A. BFD has antenna back up. VR plans new equipment for his station. QK is going to build Tri-tet. QU and ASV are QRL NDD. HQ is progressing under guiding hand of BGA. COG does his brass pounding at MS. CSR is getting an SW3. CTA is leaving Pensacola for West Coast. BSJ is getting 56-mc. outfit ready. MS is working on 56-mc. outfit for West Fla. 56-mc. net. Any other stations interested in 56-mc. net, please write BSJ, ACB or MS.

Traffic: W4AXP 1 BSJ 20 ACB 6 AUW 4 CTZ 3 VR 3 DAO 3 COG 5 MS 18 CTA 10.

GEORGIA-SOUTH CAROLINA-CUBA-ISLE OF PINES-PORTO RICO-VIRGIN ISLANDS—Acting SCM, Bannie L. Stewart, W4CE—CRH applied for O.R.S. DDO gets out well on new 1.75-mc. 'phone. DX is installed in new radio shop. BZX studies hard at Univ. of S. C. CQG is new president of Palmetto A.R.C. W2HBQ is at C.C.C. Camp, Awendaw, S. C. BAT wants O.B.S. CSP is new in Charleston, S. C. VX handles lots of traffic in Columbus, Ga. ANK is eastern terminal Trunk Line "D." AFQ wants S.C. schedules. DAA is new in Savannah. BW is active in A.A.R.S. CM2AN is building new layout with 800's in final. CM6XS uses "Bruce" diamond antenna. CMR works good DX with '45's. WA, old-timer, is on 1.75-mc. 'phone. DAM visited Ashville,

N. C., hams. CZA has new rig on 7 mc. ADN uses c.w. and 'phone. DAR, BUF, and CQQ are QRL Ga. Tech. ATO is building 3.9-mc. 'phone. BUW uses '10's on 7 mc. HU is at B.C. station in Albany, Ga. CIR uses "B" batteries for power. CPY moved to Augusta, Ga. CFD has 59 Tri-tet. ZL has new crystal. AAR has FB 56-mc. rig. BDT applies for O.R.S. IR heads "Jones Army" in 4th Corps Area! CWY uses Zepp antenna with 98-ft. feeders. CE has F.B. N.C.R. station in Georgetown. CYG wants more power. The Southside Amateur Association of Atlanta put on a hidden transmitter hunt at recent meeting. The Charleston A.R.C. plans to affiliate with A.R.R.L. In recent election the Palmetto A.R.C. in Columbia, S. C., elected CQG, Pres.; CRV, Vice-Pres.; and GB as Secy.-Treas.

Traffic: W4CRH 12 BZX 3 VX 175 AFQ 73 ADN 20 CFD 4 BDT 67 IR 156 CWY 1 CE 4.

WEST GULF DIVISION

NORTHERN TEXAS—SCM, Glen E. Talbutt, W5AUL—BII is on Trunk Line "D." DXA says CIN is still "Grandpa," 'phone man. AZB finally got bit by traffic bug. ZD connects Dallas to trunk lines via BII. ARS promises not to bite S.C.M.!! CPB has new rig. CHJ is now O.R.S. CPT was in the SS. DJE is building 1.75-mc. 'phone. AVF will soon be on at Vicksburg, Miss. ANU is getting back on. BZT is working DX. AJ is making a ham out of the "YF." CDC, ABW, COK and AHM from Palestine "made" the Convention. DUR is a fire preventionist. IT is secy.-treas. of the Phoney Phone Phields, or s'umpin. DLP had 92 QSO's last month. EPR is new Commerce ham. IA is back with us. DX at Dallas wants to contact other 56-mc. fellows. DAA reports for Terrell gang. CAE, CYJ, CEL: active. CZZ gives code practice each night on 1810 kc. PO reported. CAK at Pecos is on 14 mc. and has PR-10. EBW is new Ft. Worth ham. EEW is candidate for O.R.S. AUJ has new "W.A.C." SP wants applications from prospective O.P.S. QA is still grinding coffee. BXY is trying to get married. AUL is on 7276 kc. regularly, and has new QSLs; want one? The Abilene Club is working with 56 mc.

Traffic: W5BII 234 CCD 86 DXA 83 AZB 67 ZD 65 ARS 52 CPB 39 AW 37 BKH 32 CHJ 28 ARV 14 CPT 13 BXA 11.

N. T. QSO CONTEST

ATENTION: A Northern Texas QSO contest will be held beginning at 12:01 a.m., Feb. 9th, ending Midnight, Feb. 16th. One year's membership in A.R.R.L. will be donated to winner by S.C.M. Any other prizes will be accepted for the winners. The rules are simple: use same log form as the Sweepstakes (Nov. 1934 QST); contact as many other stations in this Section as possible; count 1 point for contact, 1 point for message received and 1 point for message sent, making 3 points maximum for each QSO; multiply your total score by the number of counties worked. Messages exchanged should state what county you are in. The general call will be "CQ NT." There is no power handicap. Add 3 points for each Phone/CW contact. All logs must be mailed before midnight Feb. 25th.

OKLAHOMA—SCM, Carter L. Simpson, W5CEZ—CEZ installed WE242A in final. ASF did more pinch-hitting for CEZ when rig broke down. AMT is getting AVR in shape for relief station in the pinches. BQZ's A.A.R.S. Dist. made a perfect score on Armistice Day message. BJJ is putting in good licks for A.A.R.S. The wind blew down BKK's antenna. BAR has FB list of schedules. BDX was in SS contest. BWN is getting practice as alt. D.N.C.S. for 1st District. DTC wishes skip would lay off during weather reporting schedules. BLJ visited in Edmond. DZU worked WX schedules while BKK was down. CVA has rig on 3.5 mc. ASQ has new rig perking FB. EFK blew power transformer. DZZ uses four '45s P.P. Par. KZ, new O.P.S., is trying to get 'phone boys organized to form a 3.9-mc. traffic net which will operate during early morning hours. BMU applies for O.P.S. The Section suffered a great loss by the death of

Kenneth Turner, W5CRS O.R.S.-O.B.S., of Shawnee, and extends sympathy to his family. ATB gets fine results with a Johnson Q antenna. AIR is building temperature-controlled freq. meter.

Traffic: W5CEZ 948 ASF 275 AMT 268 BQZ 241 BJJ 159 BKK 123 BAR 102 BDX 70 BWN 61 DDW-DTC 48 BLJ 32 DZU 20 CVA 17 ASQ 12 EFK 11 DZZ 2.

SOUTHERN TEXAS—SCM, Bradfield A. Beard, W5ADZ—OW is consistent with large traffic reports. MN is live-wire Army man. BFA carries Army schedules. BEF is new O.R.S. DWN has 225 watts input on crystal oscillator transmitter. AJY has new 830. CLZ has 56-mc. rig. BDI kept DPA going during South Texas Exposition. ADZ had nice visit with 4AII. EKN worked all districts with his '45's. DYB is new O.P.S. DPX is new O.B.S. CLP is on 56-mc. 'phone. WE is operating a portable rig from his hospital bed. AXO is now 3EZJ in Lynchburg, Va. Active: DZI, EBU, QW. CUJ worked LYJ and G5YH in 30 mins. on 14 mc. He is now W.A.C. EPS is new Fort Sam ham. QW is now W.A.C. BEQ is Alternate Director for West Gulf Div. AVF is building rig for N.C.R. Thanks to San Antonio gang for fine convention they put over. 5DKR, 5th Dist. QSL Manager, has many fine DX cards for Texas hams. Please send him your stamped envelope whether you expect DX cards or not. Do it now! CCU and CTC are doing advanced 56-mc. work at Houston Vocational School. Transmitter of moderate power with modulated note runs continuously from 8 a.m. to 12 a.m. each week day. Please report any unidentified signals you may hear to S.C.M. CCU and CTC are using beam antennas.

Traffic: W5OW 770 (WLJ 615) MN 643 BFA 164 BEF 77 DWN 62 BJ 54 CVQ 31 AJY 26 CLZ 17 DPA 14 ADZ 7 DTJ 8.

NEW MEXICO—SCM, Dan W. De Lay, W5DUI—ZM takes traffic honors, followed by DLG and CGJ. ELL, ZU, and CVB went strong in SS contest. ZM ordered new PR12. CGJ has PR10. How about getting acquainted with the S.C.M.? Send a report on the 16th.

Traffic: W5ZM 132 DLG 125 CGJ 80 (WLJE 29) CJP 23 EAO 21 DUI 26 ENI 2 CVB 12 AAX 11.

CANADA

MARITIME DIVISION

MARITIME—SCM, A. M. Crowell, VE1DQ—Nova Scotia: AP is now W.A.C. HG works big DX on 14' mc. GH has three separate rigs in steel rack. GL is on 3730 kc. GN is on 1.75-mc. 'phone. GM uses pair '45's T.N.T. FT schedules WIBML daily. BZ and EY are now O.M.M., having annexed YF's. FH is doing fine duplex work on 3.9-mc. 'phone. EF applied for O.B.S. GE is going to rebuild to c.c. DQ has again hit the air on 7 mc. GR is adding a 211 to his 1.75-mc. 'phone. Newfoundland: VO8W uses e.c. osc. with 3 watts input.

Traffic: VE1GL 11 FT 9 HH 8 GE 6 AP 2. VO8W 1.

ONTARIO DIVISION

ONTARIO—SCM, S. B. Trainer, Jr., VE3GT—ABW reports for first time. JI and FP are new O.P.S.; NX has applied. BZ is new O.R.S. JT is on the "Trans-Canada Route." SE visited SZ and W8MMP, 3LB, 3MX called on MB, WJ, OM, WU are rebuilding for 1.75 mc. MB, GP, GR, and SZ are also rebuilding. The Queen City Club had successful first annual hamfest. New officers of Ottawa Club: 2GP, 3RK, and 3WR. RO and JW are erecting masts. QB is editor of a fine ham sheet for Ottawa Valley amateurs. Give him your support. ACC and AAZ continue to report. LI, XL, RK and QK remember the YLs. PL is back from dinosaur hunt in the west, KR is back from the north. 2BU visited WK. SG is QRL R.C.C.S. EM and SR are going e.c. CE broke his. BC has plenty troubles. ABD is on 1.75 mc. ER, VD, UU, GT, and DJ called many CQ SS's. Five hundred VE3s missed a good time in VE/W contest. HA is at Sioux Lookout with O.F.B. The S.C.M. would like more reports from Ontario stations on 16th of each month.

Traffic: VE3JT 177 RK 166 WX 156 WK 87 GT 67

ABN 51 MB 48 DU 43 DJ 39 NO 34 BZ 26 SG 15 ABW-
VD 8 JI 6 ER 5 UF 1. VE9AL 35.

QUEBEC DIVISION

QUEBEC—SCM, J. A. Robertson, VE2GA—HF qual-
ifies for O.R.S. IE is recommended for O.R.S. IN
puts out nice signal. BU visited 3WK. CG has YLitis.
AA is considering 'phone. DR wants more traffic. HG says
new FBXA the business. HH is building new rig. GA
hopes to have 'phone soon. HK, our R.M. and O.B.S.,
has nice 'phone. CQ is active again. HE visited S.C.M.
AX has 10-watt 'phone. BT collects cards. DG resumed
schedule with HQ. ER is experimenting with 56 mc. CA
considers rig for each band. Welcome to newcomer JW.
GO enjoys traffic handling. EE makes excellent QSL man-
ager. Sorry, gang, that I find it necessary to resign from
my appointment as your S.C.M. To those of you who
have been such staunch supporters I offer my sincere
thanks. Your new S.C.M. will need your help—give it to
him whole-heartedly. Traffic: VE2BB 7 GO 12 HH 4
HG 3 HK 151 CG 29 BU 46 DR 80 AA 48.

VANALTA DIVISION

ALBERTA—SCM, J. Smalley, Jr., VE4GD—LX leads
traffic men. QK does his share of Calgary traffic
work. PH uses '71A's in final. JK is heard consistently on
3.9 mc. KG has an antenna big enough for KDKA. GD,
OG and DX have new rigs. Alberta has good "Be-
fore Breakfast Club" on 3.9 mc. Miss Mark Oakes is new
YL operator in Calgary. AW finds his YL slows up re-
construction program. HQ wrecked his Class B output
transformer. BW, EA and HM add their two cents worth
to 'phone QRM. Traffic: VE4LX 38 QK 25 PH 15 OG 10
JK 4 KG 1 SD 2.

BRITISH COLUMBIA—SCM, R. K. Town, VE5AC—
AL gave FB crystal demonstration at B.C.A.R.A. HC is
experimenting. FM becomes O.R.S. and handles T.L.
"F." DZ schedules KG in Vernon. KY has 90 watts on
1.75-mc. 'phone. KN reports from Okanagan. MR is ex-
VESIR and schedules JJB. DF is going on 1.75-mc.
'phone. EC is pres. of V.S.W.C. JC worked G6WY on 7
mc.; claims first VE5/G contact on 7 mc. BL keeps
schedule with BY for emergencies. BR blew eight tubes
in one night. HP uses locked oscillator transmitter with
211, 300 watts input. GT walks a mile to schedule AC
at 6:45 a.m. VE9AJ is station of B.C.A.R.A. IM is re-
building. HN has nice quality on 1.75 mc. AM is trying
3.5-mc. c.w. QRR messages were handled by JE, BJ,
EF and AC. LJ is first YL station in this Section. The
"Amachewer" makes its first appearance. This is your
Section paper. R.M. EP's YL passed exam. V.S.W.C.
held elections; E. Cooper is president. The Island net
on 1.75 mc. wants Vancouver hook-up. C U in the
"Amachewer."

Traffic: VE5AL 24 HC 16 EP 6 FM 91 DZ 6 KY 33
KN 5 MR 1 EF 2 DF 7 JA 14 EC 12 JC 55 JL 13 BL 3
BR 5 HP 47 GT 17 AC 34 AM 12 JE 1. VE9AJ 2.

PRAIRIE DIVISION

MANITOBA—SCM, Reg. Strong, VE4GC—DU has
worked 21 countries. KX is active with 200 watts
e.c. KU's rig works FB. AE has "heard" card from
Czechoslovakia. MV has new modulator and mike. NI
has pair of RK20's. MW is going on 56 mc. CP is on
3.5-mc. 'phone. RO had good score in VK contest. BG has
swell 1kw rig. AG is T.L. station. DJ worked an LU.
MY is modulated on 14 mc. IT has super under control.
GQ worked 'phone duplex. GL in on 14-mc. 'phone. LH
is rebuilding. SS is on 56 mc. The M.W.E.A. held its
general meeting; officers elected: AG, Hon. Pres.; DU,
Pres.; GC, Vice-Pres.; MW, Secy.-Treas.; CD, Ass't
Secy. Traffic: VE4GC 15 KX 12 MV 3.

SASKATCHEWAN—SCM, Wilfred Skaife, VE4EL—
RE changed from par. to series feed. BF gets nice re-
sults on 14-mc. 'phone. JV hooks a VQ for W.A.C. EU
is now in B.C. and signs 5MQ. CM and BF are coming
on new trunk line. DI is building new rig using supp.
grid mod. JH is in hospital for serious operation. FW is

on again. Your S.C.M. gets wedding cake from BB. OE
is up at Ladder Lake Air Base. CM and EL are going in
for new receivers. MH got new rig going. BN has nice
note. Sorry to report the death of wife of LW. GR has
been on sick list. Traffic: VE4CM 123 PM 54 MH 38 GA
25 EL 8 RE 5 ND 2.

Blue Glow in Tubes

CONTRARY to a somewhat general belief, re-
vealed by inquiries to the Technical Informa-
tion Service, blue glow in certain types of tubes
does not mean, necessarily, that they are gassy and
therefore defective. It all depends on what kind
of glow and where it occurs within the tube.
Mercury-vapor rectifier types glow properly, of
course, as a consequence of the ionization neces-
sary for their rectifying action. Other types, par-
ticularly audio-frequency power tubes such as
46's and 59's, also may show the blue without
damage—provided it occurs as a sort of haze out
near the glass envelope and not within the ele-
ment structure. As explained by Roger Wise, of
Hygrade Sylvania, in a recent statement, the
fluorescent glow is usually violet color and is
noticeable around the inside surface of the glass
bulb. This glow is a phenomenon caused by
electronic bombardment taking place within the
tube, and changes in intensity with signal
strength. It may at times be quite brilliant.
Fluorescent glow has absolutely no effect on the
operation of the receiver.

Silent Keys

It is with deep regret that we record the
passing of these amateurs:

A. W. Cox, W8DKI, Akron, Ohio
Harold P. Creek, W6HGX, Reno, Nevada
J. Holland Douglas, W9AJW, Joplin, Mo.
Louis A. Era, ON4BC, Antwerp, Belgium
John H. Fuhman, W8JJH, Cincinnati,
Ohio
Roswell D. Hunter, W2UI, Hollis, L. I.
Addison S. MacKenzie, San Francisco,
Calif.
N. W. McKenzie, W1FEM, Danvers,
Mass.
Guy Paquay, ON4GP, Brussels, Belgium
John B. Rideg, Jr., W2EKM, Cedar
Grove, N. J.
Harvey L. Robinson, VE3AE, Clinton,
Ont.
Floyd K. Sanborn, W9IAA, Paynesville,
Minn.
Bailey Shaw, W6KBX, Buena Park, Calif.
Kenneth Turner, W5CRS, Shawnee, Okla.
Victor Wasielewski, W1AJM, Chelsea,
Mass.



CORRESPONDENCE

The Publishers of *QST* assume no responsibility for statements made herein by correspondents

No 7-Mc. Restriction

University Farm, Davis, Calif.

Editor, *QST*:

In answer to Mr. Caywood's communication in the November issue of *QST*, I would like to take the negative side of this "restricted 7-mc." idea. In the first place, were this band to be restricted to 20-word-per-minute code speed and special examinations, many of the 7-mc. operators would flock to the 14- or 3.5-mc. bands, unduly crowding both. Many of these fellows are working men and can only enjoy the air during their few restricted hours. If they were made to take a special examination, they would surely either leave the air entirely or move to another band, this latter being both inconvenient and expensive.

As to his statement to "let the lids" use 3.5 or 1.7 mc., I wonder how many of these so-called "lids" are just beginners? . . .

Just because part of the hams in Missouri happen to think it a good idea to restrict the 7-mc. band is no sign that the rest of our "brotherhood" is in favor. How about it?

—Louis K. Bean, W6FQK

Social Distinctions

Enid, Oklahoma

Editor, *QST*:

I am heartily in agreement with W9KGX on restricting the 7-mc. band. Only let's restrict it to DX hounds, report gatherers and punks in general.

As for myself I will stay down on 3.5 mc. with the lids where a QSO is really a QSO and the hams are gentlemen.

—A. J. Burton, W5BDX

Harm

Coast Artillery Armory,

Water and O Sts., S.W., Washington, D. C.

Editor, *QST*:

. . . After reading the November issue of *QST* I find that several of the fellows are acting a bit selfish. They want the 7-mc. band to themselves. They forget that they too were once "lids," and if someone else had not helped them as they did me they wouldn't be on the air to-day.

I cannot feature a bunch of sports (as an ama-

teur is assumed to be) squawking because some one else cannot do 20 w.p.m. The way I see it, there are too many restricted bands now, and if I were one of the fellows with such wishes I would be ashamed of it.

Coöperation is essential in an organization such as ours, and restricting some of the undesirables would in no way appease them. So I beg of you, if you cannot do good to your fellow amateur for goodness sake don't do him harm.

—Wm. W. Brantley, W3EZN

Happier Without Restriction

315 East 18th St., New York, N. Y.

Editor, *QST*:

. . . I must say that there is absolutely no end to the desires of the 'phone men in general. After all, the 'phone men compose but a small minority of the forty-odd thousand amateurs in the air. They have already been given 100% increase in the formerly allotted frequency band with privileged restrictions. I think that they should be content with this and do the best they can. I am certain that the improved receiver construction will eliminate much of their trouble.

. . . That the 7-mc. band be restricted to so-called experts in the field is certainly a very selfish request. I have been working this band for quite a while and found no serious handicap. . . .

. . . The less restriction, the happier the crowd.

—Lewis J. Friedman, W2IO

"Discontent"

53 East 7th St., Holland, Mich.

Editor, *QST*:

Editorials, essays and letters have done wonders many times in the history of the United States. They have often brought unknown, unfair conditions to light. Every amateur in United States knows we need more frequency. Why not write articles in all the radio magazines showing discontent with the present conditions in amateur radio and perhaps something can be done. Complete silence on this condition, which means much to the amateur, might mean still more loss in frequency and enjoyment. Let's start a "more frequency campaign" and use our magazines to show our feelings. Here is my plea:

The amateur in the United States is being unjustly treated by the government because we are given the same laws and frequencies that are given the foreign countries. Does not the United States government know that we have four times as many amateurs with licenses, as all the rest of the world put together? Look in your call book and you will find 200 pages of licenses in United States to less than 50 for all the foreign countries put together. Then, in all fairness and justice, how can we, the American amateur expect to be given justice from nations whom we outnumber more than four to one? The only possible outcome would be injustice to the American amateur which at present he is getting.

Every amateur in the United States knows the present conditions make it almost unbearable and far less interesting to him under 1934 laws. We are actually having to use less frequency now than in 1924 when we had only about one-fifth the number of amateurs in the United States as now. New modern receivers cannot be purchased by the average amateur and they will not clear up interference when five or more stations use the same frequency.

The American amateur does not have to pay a tax for operating his station like many foreign countries do. However, the American amateur would gladly pay a small fee were he given just treatment! Each and every amateur band could be *doubled* and we would not have enough frequency yet. However, we would be temporarily satisfied with that increase. Besides countries outside of North America should *not* be allowed in the North American frequencies. They should have their own separate frequencies which would greatly increase the enjoyment in contacting them. To-day one has to work through the terrific interference of the North American amateur to work other countries; an unjust treatment to the American amateur.

The present unlimited 'phone law is not efficient. Merely passing a Class "A" license does not mean the person passing will put an efficient 'phone station on the air. Any person can memorize those questions and pass the examination if he is intelligent enough. After passing the examination his knowledge leaves him quickly, as a rule. A new law doing away with the Class "A" license, which is also a great expense to the government, should be passed. A law that requires the proposed 'phone man to give his complete diagram, with all parts shown and type and make given besides a few questions which cannot be found in books. "Common sense" questions that cannot be memorized. Then he should show his 'phone transmitter to a government inspector OR a person given the government approval to check this new 'phone station's equipment, etc. To-day we are getting far too many poor stations on the air merely because the fellow memorizes the questions and cares little about his over-modulation and quality.

'Phone men should have a separate band for their use. Now we have a terrible condition in the present 14-mc. band. Allowing 'phone transmission in the middle of that band (14,150-14,250) has cut up the band in two parts for the c.w. man. He must work either bottom or top of the band and these two halves are far too small to satisfy even fair communication. Why should the c.w. man have his band cut to pieces by a few 'phone men when he needs every available kilocycle for himself!

The present 3.9- to 4-mc. and 14,150 to 14,250-kc. 'phone bands are far too small for the 'phone men. They work under worse conditions than the c.w. man does. Surely both c.w. and 'phone men deserve a better break. Each day brings new and more interference to both the c.w. and 'phone band.

What the United States government must do is to give us a law of our own. Give the amateurs back what was taken away from them in 1927. Give the American citizen and the American amateur enjoyment to the best of their ability so this great country of ours may be composed of happy citizens justly treated!

The government owes much to the amateur of to-day. The United States has by far the greatest number of excellent radio operators in the amateur ranks which are a great help to the government in peace time disasters and a still greater help to United States in war times! Give us justice!

—Russell Sakkers, W8DED

"Commercials"

Dear Eddie:

Did you fellows see what Walter Holland, chief engineer of Philco, said the other day in a speech before some convention, about short-wave broadcasting needing some of the amateur frequency bands? That makes me mad. We amateurs show them how to use the short waves and then they want to steal them away from us. Maybe other manufacturers don't feel that way. Maybe Philco's point of view is cock-eyed like their famous loudspeaker panels. But they need to be told that there wouldn't have been any of their lousy short-wave broadcasting if it hadn't been for amateurs, and I, for one, am sorry it ever started.

—Ralph J. Woodfield

EDITOR'S NOTE.—Yes, we saw it and told him about it. See also this month's editorials.

Stork, Then Thrill

Jonesboro, Tenn.

Editor, QST:

Just read in November QST of the thrill W8CDT got when I answered his CQ and he had a message for me.

I have had plenty of thrills since I got on the air, until I am almost hardened to them, but here is another one I had just the morning before the incident mentioned by W8CDT.

The stork visited our home early one morning and after things had quieted down a bit I sent a message announcing the fact to my aunt in D. C. through W3ASO. I then went to breakfast. That was at 7:30. Well, at 8:21 and before I left the house to go to work, I received "congratulations" from Washington via Western Union delivered by messenger boy. Boy, was that a thrill!

— P. T. Metzger, W4BQK

Unamateur

Lancaster, N. H.

Editor, QST:

Periodically there appear in these pages letters from individuals, and sometimes groups, who are not satisfied with the present federal restrictions on amateur activities, and they are trying to burden us with more laws, regulations, examinations and what not.

Probably the most consistent cries from the soap-box orators have to do with restrictions on the beginner, restrictions on operating in certain bands, restrictions on power, and a plea for more frequencies.

... The examination, Class B or C, is now stiff enough so that the beginner must actually know his theory or he just can't pass. Nothing is cut and dried about it. As to the code, I believe there most certainly should be an exam in it for *any* band, but any speed more than ten w.p.m. would not be fair or reasonable, except for a radio school graduate. To you who would restrict a beginner to the 160-meter band for one year, how would you like to try it, with DX as good as it is?

... I am using 120 watts to a pair of tens on 3535 kc. and I don't have any trouble with the high-powered boys. Is it the station or the operator? I have heard 245's that gave me a bigger headache than any 204-A could.

And now we come to frequencies. I would be very pleased if Uncle Sam would say, "Help yourselves, boys," but it is now out of U. S. hands. It is international. You will find by band-spreading your receivers, and moving to the higher frequencies of each band, that there is still plenty of room left for us. Contrary to the evidently popular belief, not every one tunes across the band from the low frequency side to the high frequency side.

If these questions ever come to a vote I sincerely hope there will be enough unbiased and broad-minded amateurs to stop this unamateur business of forever trying to curtail the other fellow for your own benefit.

—Dr. John Alden Stewart, W1SK

(Continued on page 70)

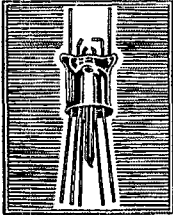

WE ONCE REMARKED on this page that the price of an insulator was an approximate indication of its quality. There is one important exception to this rule, for the best dielectric we know — air — costs nothing at all. Unhappily, we cannot very well sell air for insulating purposes, but we can and do recommend its more general use.

Some months ago we were working on a high performance 56 mc. superheterodyne for a commercial client and made the discovery that the use of spaghetti on the oscillator leads introduced enough loss to stall the oscillator completely. Usually the use of low-frequency insulation

does not have such spectacular results, and its losses pass unnoticed. But we wonder how many watts of precious output are wasted in the wire coverings of enamel, cotton, rubber and even friction tape that we have seen in high-frequency circuits. Use *bare wire!*

The great difficulty with air is that it is not a structural material, and some solid dielectric must be used for mechanical reasons. As no solid dielectric has negligible losses at high frequencies, the trick is to use solid materials in such a way that the losses will be at a minimum. They should be located outside of concentrated fields. For example, good transmitting condensers have their insulators located outside the end plates, where they are more or less shielded, and inductance forms are ribbed to air-space the windings. It is also good practice to make insulators long and slender — long to make the potential gradient low, and slender to keep the volume of insulation small. (Losses are per pound of insulation, of course, other things being equal.) This last principle cannot be applied to coil forms, since their shape is determined by the coil design. However, they can be made thin. For instance, our new Steatite transmitting coil forms are cast centrifugally, which gives a thin, uniform section; so thin that they are translucent.

Slender, or thin, sections have the additional advantage of making the insulators run cooler in operation. Though perhaps not generally realized, most insulators have an enormous negative temperature coefficient, not only as regards power factor, but even as regards D.C. Resistance. To give a specific example, we made a test on the insulation of a 227 tube with the base, bulb, and elements removed, leaving only the leads and glass stem as in the picture above. Measured cold, the plate-grid resistance was very large, over 100 megohms. We then heated the glass. The resistance dropped to a megohm even at comparatively low temperatures. The resistance was 10,000 ohms before red-heat, and less than 750 ohms at red-heat. These measurements were made on direct current.

We mentioned above that coil forms should be ribbed for low losses, which is not done in our receiving type plug-in coils. The reason for this is a practical one. The plug-in coils in receivers are wound with fine wire and are subjected to rough handling. Consequently, to maintain accurate calibration, we have supported the wire completely by using round threaded forms. This has required the use of an extremely low-loss material, and it was for this purpose that R-39 was developed. R-39, as many know, is composed of a special grade of powdered mica, molded with a special bakelite binder, and seasoned in the mold. Its exceptional properties are an old story now.

Recently, materials having the characteristic yellow color of R-39 have been placed on the market, and some of them have been given names similar to R-39. This is none of our business, except that we don't want amateurs who use them and are disappointed, to feel that it is R-39 that has gone back on them.

JAMES MILLEN



Compare
Them with
RACKS
Selling at
Any Price

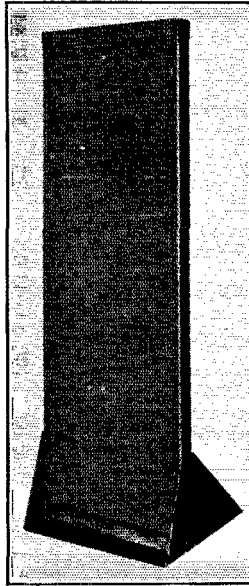

Constructed of very heavy gauge steel (about $\frac{3}{8}$ " thick). Finished thruout in black Shrivel Lacquer — Complete with all panels. Made in two sizes.

Type R7: — with 7 panels $8\frac{1}{2}$ " x 19". Overall size $21\frac{1}{2}$ " wide 66" high.
Price..... **\$16.95**

Type R4: — with 4 panels $8\frac{1}{2}$ " x 19". Overall size $21\frac{1}{2}$ " wide 39" high.
Price..... **\$11.45**

DUE TO EXTREME LOW SELLING PRICE, PLEASE IN-
CLUDE 75 CENTS FOR PACKING CHARGE

866 TUBES 99c

Insulantite tops — Heavy duty rectifiers.

A SPECIAL buy makes it possible for us to give you at this price, the same tube we previously sold for \$2.15. These also carry our full guarantee.

THORDARSON CASED TRANSFORMER
600 volts each side of C.T. 200 MA $2\frac{1}{2}$ V. 10
amps. C.T., 5 V. 3 amps., $7\frac{1}{2}$ V. 3 amps.
C.T. **\$2.79**

THORD. CHOKE 12 H 250 MA. \$1.99

NATIGO TR-1 BATTERY MODEL TRANSCEIVER
(See Sept. QST, p. 66)..... **\$9.70**

Announcing the CB-70

A new 70-watt Radiophone and CW transmitter — Value that will astonish you—available in kit form. *Descriptive Literature on Request.*

OIL FILLED CASED CONDENSERS
2mfd 2000 V. Working.... **\$3.95** 2mfd 1000 V..... **\$2.10**

HOYT ANTENNA METER
Hot wire antenna meters. $2\frac{1}{4}$ " mounting hole, flange 3" diameter, supplied in $1\frac{1}{2}$, 3 and 5 ampere ranges. Why work without antenna meters when you can buy them at this special price? **\$2.75**

OUTSTANDING!!
Gross Crystal Holder

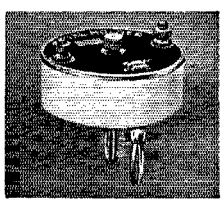

WHITE CERAMIC commercial type crystal holder — priced at less than ordinary holders. Adjustable pressure, dust proof, no tools required to open. Takes crystal to $1\frac{1}{4}$ " square. Plug standard $\frac{1}{4}$ " spacing. **\$1.00**
Most efficient job yet.

GROSS RADIO, INC., 51 VESEY ST., N. Y. CITY

Correspondence Department

(Continued from page 68)

It's a Ham World

331 Melwood St., Pittsburgh, Penna.

Editor, QST:

I thought I'd drop you a line to tell you some of the things that have been happening to me, as a ham, down here at the University of Pittsburgh. About the first thing I noticed was a placard on the eighth floor of the 42-story Cathedral of Learning. The placard said, "W8IAT Pse QSL!" So I added my call and QRA. On going back to see the sign a few days later, I noticed that it had picked up the calls of W8MGB, W8MCW, W9SAJ, W8IZW and some others that I didn't know. We're going to get together.

The next thing that I remember was getting stuck on a diagram I was drawing in Math class. Just to be funny, I asked the fellow sitting next to me for some help and showed him the diagram. Well, you could have knocked me down with a brick when he took the thing and finished it! It was W8IZW I had picked!

Another time, I walked into the men's lounge in one of the buildings. A bunch of guys were sitting around smoking and talking. I sat down and started to consume the sandwiches I had by way of lunch. I had thrown open my coat and the bird across the table noticed the A.R.R.L. pin which I always wear on my vest. He yelps, "You, too?" It was another ham. I forget his call now, but we had quite a QSO before class.

And just yesterday, I was over at the Sigma Alpha Epsilon house and a few fellows, a visitor and a YL were all chewing the rag when the YL asked me what the old familiar diamond was for. I told her the American Radio Relay League. The visitor took his feet off the kitchen table and hit the floor and sings out, "Are you a ham?" all at the same time. It seems that he was old ex-SGG of the spark-'n'-arc days. We had quite a long talk before he had to leave. He is an aviator, now, but I think he's going to come back.

My roommate down here at the University saw how much of a kick I was getting out of this, so he asked me to teach him to be a ham. He'll be ready soon.

And now here's one that took the fur-lined 210! I told my YL that she either takes the plunge or it's SK. So now, SHE'S going to be a ham!

And all because of a diamond only half an inch long!
—Charles C. Miller, W8JSU

DX "CQ"

27 Maple St., Ramsey, N. J.

Editor, QST:

Have you ever listened in on the 20-meter band, or 40 too for that matter, when the DX is coming through? What happens? Unless you happen to be a CQ artist you listen feverishly for those foreign signals. You listen to every CQ you hear for the sign (and believe you me some of them are plenty long) and then find nine times out of ten it is a W. That is, unless you happen to run into a station calling test. Then you can park right there and be assured it is an English station. . . .

Some one once said never to criticize anything unless one could suggest something better. So here it is. Instead of using the conventional CQ why not use the prefix of the nation followed by Q? It would work something like this: The United States call would be WQ—Irish call would be EIQ—German call would be DQ—etc. A W calling CQ would call in the conventional manner except for this change: WQ WQ WQ de W2ETJ W2ETJ WQ WQ WQ de W2ETJ, etc. Simple enough, yet what a difference it would make on the DX bands. Instead of spending 90 percent of your time hunting for a foreign station via the CQ and sign method, you could hop through the band and pick them right out! And can you imagine the help it would be in a DX contest? Especially in filling in those countries you hadn't QSOed as yet. Too, this system would work equally as well with the DX friends of any other country as with we W's.

Let's take a tip from the English and their test system. What say?

—Harry D. Rohman, W2BLV

We Are Pleased to Present These Outstanding New Developments

GENERAL ELECTRIC

Pyranol condensers — we have been appointed distributors of this famous commercial line of capacitors now for the first time available to the amateur. Complete line ranging from .5 mfd. to 10 mfd., 600 to 5,000 volts ratings.

Bulletin and discounts on request

R C A ACR-136

Communications Receiver is a seven-tube superheterodyne receiver covering from 540 to 18,000 kilocycles. Pre-selection, A.V.C. front-panel band switching, and a mechanical band spread system with calibrated dial and vernier pointer which permits positive logging of any station, are some of the outstanding features of this new amateur receiver.

Price complete with self contained power supply, tubes and speaker **\$69.50**
(Immediate delivery)

EIMAC TUBES

Performance — Ruggedness
— Power — Price

50-T output 75 to 250 watts.....**\$12.00**
150-T output 150 to 450 watts.....**\$24.50**
(Immediate delivery)

The "EAGLE" Three-Tube Short-Wave Receiver

"Band Spread" over any portion of the tuning range — only finest material used thruout. Employs one '32 R.F., one '32 detector and one '33 Pentode Audio — 15 to 200 meters — four coils, supplied. The "EAGLE" is economical — two dry cells will operate the filaments. See March or April 1933 *QST* for full description of this most excellent value in short-wave receivers.

"Eagle" completely wired and tested.. **\$11.95** Three tubes tested in your receiver.. **\$3.00**

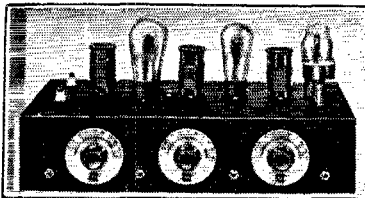
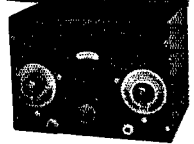

GROSS C C TRANSMITTER—OUTPUT 25-30 WATTS

The "CW-25" transmitter kit due to its low cost makes it possible for anyone to own a modern crystal controlled station. A schematic hook-up and parts layout sheet as well as tuning instructions are furnished, thus enabling the most inexperienced operator to wire and put the set on the air, for real results. The "CW-25" is supplied with a shrivel finished sturdy metal chassis under which all parts are mounted, making the wiring and components dust-proof. A plug-in crystal holder is furnished with the kit. Only one milliammeter is required for tuning the transmitter and each stage is provided with a jack for this purpose. The "CW-25" uses one '47 as crystal oscillator, one '46 as buffer or doubler and two '46's in the amplifier stage, set of three coils supplied

\$13.95

Complete kit, less tubes and crystal.....

NEW!!! BEEDE BAKELITE
Cased, 3½ Meters. 0-5 to 0-1000 MA.
In all standard ranges..... **\$3.35**

NEW!! RAYTHEON RK-23
The new small edition of the RK-20 (in stock)..... **\$5.95**

RAYTHEON RK-20
The New RF Pentode Power Amplifier
Tube in stock..... **\$15.00**
(see page 14 June *QST*)

SPECIAL TUBES!!
CARBON PLATE 203-A..... **\$8.75**
CARBON PLATE 800..... **4.90**

510-A Tube Thoriated Tungsten Filament Graphite Plate — Isolantite Base..... \$2.45
210 Tube — Thoriated Tungsten Filament Special..... \$1.15
½ and 1 watt Neon Bulbs..... **\$2.29**

the MAC-KEY
The perfect semi-Automatic and Straight Key..... **\$10.50**
(circular on request)

Filament Transformers shielded in metal cases, center tapped secondaries
2.5 Volt 10 amperes for 866's..... **\$2.25**
10 to 12 Volts at 8 amperes..... **2.25**

Cased Combination Filament Transformer
2 ¼ V. C.T. 10 amps for 866's.
10 V. C.T. 7 amps for '50's or '52's.
10,000 Volt Insulation..... **\$3.24**

Hoyt Milliammeters and Voltmeters
Perfectly damped meters at a price. These are not to be confused with the usual inexpensive meters. 2" mounting hole, flange 2¾" diameter, supplied in the following sizes: 10 ma, 25 ma, 50 ma, 100 ma, 150 ma, 250 ma, 300 ma, 4 V. AC, 10 V. AC, 15 V. AC, 10 V. DC. Price each **\$1.30**, 3 for..... **\$3.60**

EXTRA SPECIAL!!!
GROSS CASSED 20 H. 350 MA CHOKE
Limited quantity, special price..... **\$3.95**

Thord. Choke 15 H 250 MA..... **\$2.95**
Gross Cased Choke 30 H 125 MA..... **\$3.95**
Gross Cased Choke 30 H 200 MA..... **\$1.94**

FILAMENT TRANSFORMER FOR BRIDGE RECTIFIERS
Using 83 tubes 5 v-5 v-5 at 3 amps C.T. — 3000 v insulation..... **\$2.25**
For 866 tubes 2 ½ V.-2 ½ V.-2 ½ V. C.T. 10,000 volt insulation..... **\$4.50**

GROSS CASSED POWER TRANSFORMERS

650 v ea. side C.T. 350 ma fila. 2-7 ½ v C.T. and 1-5 v will give 500 v with choke input using 83 or 523 tubes. You can run your entire R.F. and class B off this trans..... **\$5.50**
750 v ea. side C.T. 300 ma fila. 2-7 ½ v C.T. and 1-5 v..... **\$5.75**
750-1000 v ea. side of C.T. 300 watts..... **\$6.65**
850-1350-1500 v ea. side of C.T. 400 watts..... **\$8.70**
(the ideal job to give 750-1000-1250 v D.C. with choke input)
850-1350-1500 v ea. side of C.T. 550 ma..... **\$12.50**
1500-2000 v ea. side of C.T. 800 watts..... **\$11.70**

EXTRA SPECIAL MOUNTED, UNCASSED TRANSFORMERS

500-750-1000 volt each side of C.T. 300 watts..... **\$5.50**
400-800 volts each side of C.T. 160 ma..... **\$3.40**

MOUNTED CENTER TAPPED FILAMENT TRANSFORMERS

2 ½ v 8 a — 2 ½ v 3 a — 5 v 3 a..... **\$1.29**
2 ½ v 4 a — 7 ½ v 2 ½ a — 7 ½ v 2 ½ a..... **\$1.29**

FILAMENT TRANSFORMERS FOR EIMAC TUBES

Cased 5 volts CT 12 Amps..... **\$2.95**
Cased 5 volts CT 20 Amps..... **5.95**

UNIVERSAL ANTENNA COUPLING SYSTEM INDUCTANCES

Wound on threaded double X natural bakelite tubing, can easily be tapped, with clip supplied, ea..... **\$1.50**
(Use one coil for single-wire feed and two coils for two-wire systems)

Low C 40-80-160 Meter Amplifier Coils
(See transmitter by GRAMMER page 46 May *QST*) Plug-in, wound on threaded natural bakelite tubing, will tune with 50 or 60 mmf. condenser, any size, each..... **\$1.50**

BLANK CHASSIS

Ideal for mounting power supplies, RF units, etc. 18-gauge metal — welded corners — black telephone finish inside and out. Complete with bottom dust covers.
8" x 3" x 8 ½"..... **\$1.65**
10" x 3" x 8 ½"..... **.75**
17" x 3" x 4"..... **.85**
17" x 3" x 8"..... **1.15**
17" x 3" x 10"..... **1.30**

200 WATT VITREOUS RESISTORS With Variable Sliders

1000 ohms..... **\$1.99**
2500 ohms..... **1.05**
5000 ohms..... **1.05**
10000 ohms..... **1.11**
15000 ohms..... **1.20**
25000 ohms..... **1.29**
35000 ohms..... **1.35**
50000 ohms..... **1.44**
60000 ohms..... **1.49**
80000 ohms..... **1.59**
100000 ohms..... **1.65**

20% DEPOSIT WITH ALL C. O. D. ORDERS. REMIT BY M. O. INCLUDE POSTAGE

Cable Address: GROSS INC.

GROSS RADIO, INC., 51 VESEY STREET, NEW YORK CITY

RAYTHEON

TRADE-MARK

TRANSMITTING R.F. PENTODES

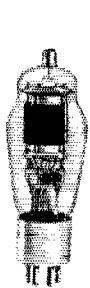

RK-23



RK-20



RK-25

HAPPY NEW YEAR

That Transmitter will be new and modern too if you use Raytheon RK Pentodes because they require:

- No neutralization
- Low excitation for full rated output
- Low audio power for suppressor grid modulation

An ideal tube lineup:

- Crystal oscillator and buffer
RK-23 or RK-25, ten-wattors
- Final amplifier
RK-20, fifty-wattor

Use them at rated conditions to obtain the greatest uninterrupted service

Refer to May, June, August, October, and December issues of *QST* for circuit details and applications or write

RAYTHEON PRODUCTION CORPORATION

30 East 42nd Street
New York, N. Y.

Chicago, Ill. San Francisco, Calif. Newton, Mass.

Canada-U.S.A. Contest Results

(Continued from page 40)

Station	Score	Station	Score
VIRGINIA			
W3AZU.....	180	W3ELJ.....	162
COLORADO			
W9PGS.....	1188		
ALABAMA			
W4BOU.....	1188	W4AG.....	972
W4AJY.....	1188		
EASTERN FLORIDA			
W4COV.....	1539		
GEORGIA			
W4BRG.....	6345		
NORTHERN TEXAS			
W5CPT.....	770		
SOUTHERN TEXAS			
W5BDI.....	216		

Experimenters' Section

(Continued from page 46)

still allow enough current to flow through the relay to energize the windings, but the operation becomes feeble and the dots "light." The maximum power to be handled by R_2 (1,000

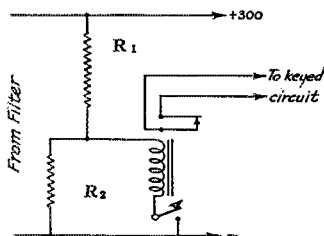

FIG. 6—POWER SUPPLY FOR THE KEYING RELAY FROM THE LOW-VOLTAGE POWER PACK

R_1 is the regular bleeder resistor, 12,000 to 15,000 ohms. R_2 is 1000 ohms, 1-watt size. The keying relay is a 150-ohm telegraph relay. Any relay capable of working on 15 to 20 ma. d. c. can be used successfully.

ohms) is 0.5 watt with key up—with key down it is negligible—and a 1-watt resistor is ample.

—Arnold W. Lewis, VE4YI

Sliding Bug Weight

It sometimes becomes necessary to change the speed adjustment of a bug during a QSO. Usually the set-screw on the weight is tight, and above all the operator gets a shock trying to change the dot

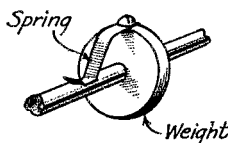

FIG. 7—A SPRING CLIP ON THE BUG WEIGHT MAKES RAPID ADJUSTMENT EASY

adjustment. All this takes considerable time. Here's my way of solving the problem, and it may be helpful to others.

Scooped!

.... by 9 months

Nine months ago, the hallicrafters introduced the SKYRIDER—now the SUPER-SKYRIDER offers these advanced features . . .

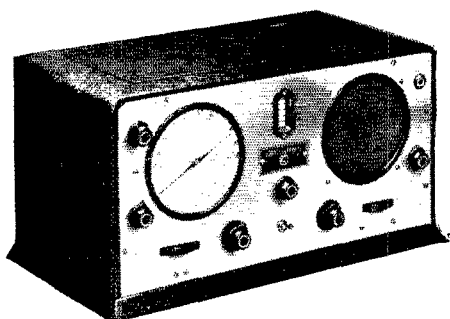

CHECK THESE IMPORTANT FEATURES!

BUILT-IN POWER PACK AND SPEAKER—An important feature of hallicrafters to short-wave set construction.

FOUR SHORT-WAVE BANDS—instead of two or three — Fifth band — 10 meter or broadcast band — optional.

FULL SEVEN INCHES OF BAND SPREAD ON 40 METER BAND — Greater spread on all bands.

PRE-SELECTION — Built into the Super SKYRIDER — subdues noise, makes signal reading easy.

FIVE BAND SELECTOR SWITCH — No plug-in coils.

TWO STAGE DUAL AIR TUNED INTERMEDIATES — Designed for best ratio for both gain and selectivity.

CRYSTAL FILTER — Flexibility designed to give single signal reception without reduction of sensitivity.

ACCURATELY CALIBRATED DIAL SCALE — for all ranges. Easy to locate any desired frequency.

LESS THAN 3 MICROVOLTS SENSITIVITY, At 50 mil-watt output. Hear CW signals at a fraction of a microvolt.

POWER OUTPUT OF 3 WATTS MAXIMUM IN SPEAKER.

TRANSMIT-RECEIVE SWITCH — with special control to compensate for power delivered by the transmitter. Eliminates blocking in the receiver.

WHEN the hallicrafters' SKYRIDER was announced nine months ago, it heralded a new advance in regenerative short-wave receiver design, offering truly professional standards at a reasonable price.

Examine the features that contribute to the new SUPER-SKYRIDER'S performance. Note, for example, that by using four short-wave bands, each with separate coil, the LC ratio is increased 33% — affording a tremendous improvement in the signal to noise ratio. Note, too, that the I.F. circuits operate at only 50 microvolts input — an indication of the high gain in the R.F. stage.

Compare the SUPER-SKYRIDER, feature for feature, with any set offered today. Convince yourself of its sensitivity — of its vibrant power. For real dollar for dollar value — the SUPER-SKYRIDER offers you more for your money.

Write today for complete descriptive literature

W. J. Halligan, Pres.

the hallicrafters, inc.
3001 Southport Avenue Chicago, Illinois

the hallicrafters, inc.

BACK COPIES of QST

WITH INDEXES

102 ISSUES — \$15 — See Below

↙ HERE THEY ARE ↘

1923 — May only.....	\$.25
1924 — November only.....	\$.25
1925 copies (except January, March, May and July).....	\$2.00
1926 copies — complete.....	\$2.50
1927 copies (except January and July).....	\$2.50
1928 copies (except January, Febru- ary, March, and August)....	\$2.25
1929 copies (except February, March, April and May).....	\$2.00
1930 copies (except January, Febru- ary and July).....	\$2.25
1931 copies — complete.....	\$2.50
1932 copies (except August, Septem- ber and October).....	\$2.50
1933 copies — complete.....	\$2.50
1934 copies — complete.....	\$2.50
1935 copies — as issued, each....	\$.25

**Complete Set of Copies (except 1935 series)
as Listed \$15.00**

(Outside U. S. and Possessions, and Canada,
add \$3.00 for postage)

**Single Copies 25c Each, and Yearly Sets at
Prices Indicated**

ALL PRICES INCLUDE POSTAGE

See Page 97 this issue QST
for Binders to hold these copies

AMERICAN RADIO RELAY LEAGUE

WEST HARTFORD ■ CONNECTICUT

A piece of spring brass with a hole in one end, such as a contact spring from the old type UX tube socket, is fastened to the weight with a short screw and the spring bent so as to place tension against the armature of the bug, as shown in Fig. 7.

The rest is simple. Whenever adjustment is desired it takes only one finger to reach over and slide the weight to any speed desired. If the spring tension is correct the weight will stay in any position indefinitely.

—D. B. Lane, W9BMA

Antenna Supports

The winter season often sees many an antenna lying on the ground because the wire contracted and snapped, or because it was forced down by heavy snow or a strong wind.

I have saved myself a lot of annoyance and trouble by stringing up my antenna as shown in Fig. 8. Of course, weights on pulleys or other superior ways of holding up an antenna are to be preferred, but most of us depend on fixed supports to hold up our antennas, and in such cases this idea may help.

We must have our antennas tight enough so as not to sway too much, and as a result it doesn't take much to snap the supporting wires. If another supporting wire (as shown) is provided to hold the antenna temporarily in place, the an-

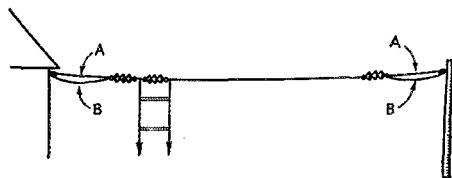

**FIG. 8—COLD-WEATHER PROTECTION FOR THE
ANTENNA**

The regular supporting wires are of lighter gauge than the antenna wire to ensure their breaking before the antenna itself in case of unusual strain. The extra loops will hold up the antenna until the broken wires can be replaced and normal tension restored.

tenna is still operative, and when a warm day comes the broken wire can be replaced.

—Antonio Gelineau, W1BHR

Better Crystal Stability

(Continued from page 34)

crystal is near a source of heat or cold, such as a stove or draft of air) to permit very stable operation of crystal transmitters—even approaching the stability of oven operation—over periods of thirty minutes or longer. This is more than enough time required for the average good QSO.

Here are a few hints for eliminating frequency "creep" due to generation of heat by the crystal itself:

With the tuned-plate type oscillators, work with as low a plate voltage as practical on the oscillator tube. Triodes preferably should not have more than 150 volts on the plate, pentodes

A value that cannot be matched

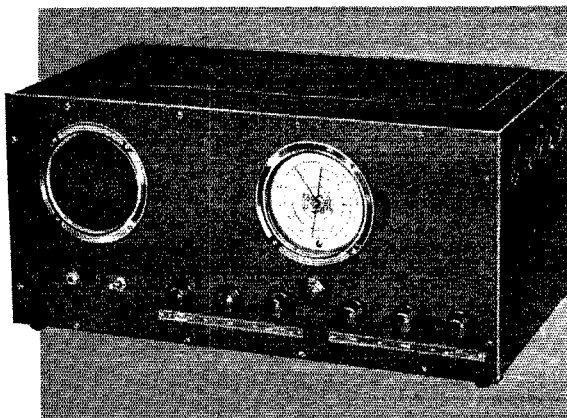

IN the one short month since it was introduced, the ACR-136 has won for itself an enviable position in the amateur receiver field.

It has done so, not on the basis of the ultimate in amateur performance, but because as an exceptionally adequate and workmanlike piece of apparatus, the ACR-136 offers the amateur substantially greater value, dollar for dollar.

The ACR-136 sells complete, including coils, tubes, power supply and speaker, for only \$69.50 F. O. B. factory. There is nothing else to buy. Connect the antenna, plug in the power and your phones, and you are ready to operate a receiver of superior sensitivity, selectivity and operating characteristics, which has, in addition, many refinements to warm the veteran operator's heart.

If you can match this combination of features at anywhere near the price, our recommendation is to buy it. But in order to compare, first visit our authorized sales outlet in your vicinity, to see and operate the ACR-136.

A descriptive folder is available free on request. Or, you may prefer a more complete Instruction Book, including circuit diagrams, etc., for which a charge of 10c is made, to cover postage and handling. For either, write to



Amateur Radio Section
RCA VICTOR COMPANY, INC.
Camden New Jersey

E

FOR

EVEREADY

also for the

EXCELLENCE

ECONOMY

ENDURANCE

ENERGY

EFFICIENCY

EXPERIENCE

which is the Essence of

EVEREADY

BATTERIES

expertly packaged

ELECTRICITY

HEADQUARTERS FOR BATTERY INFORMATION

NATIONAL CARBON CO., INC.

GENERAL OFFICES: NEW YORK, N. Y.

BRANCHES: CHICAGO, SAN FRANCISCO

Unit of Union Carbide  and Carbon Corporation

not over 250 volts. These plate voltages should be sufficient to excite any of the ordinary tubes used as buffers or doublers, such as the Types 10, 65, 47 and 46. If more output is required add another r.f. amplifier and let it take the load; not the crystal. Under any conditions never work the

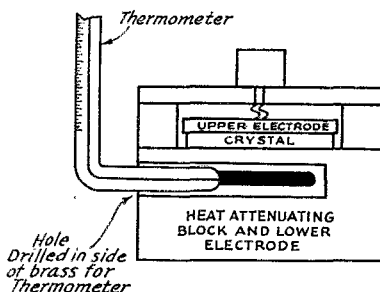

FIG. 2—THE ADDITION OF THE THERMOMETER FOR TEMPERATURE CHECKING

tube to the point where the crystal gives off a corona discharge or the electrodes "burn."

Do not tune the tank circuit for maximum output—work it considerably off-tune of the crystal frequency, on the high frequency side, of course.

With the Tri-tet type circuit the important adjustment to minimize creeping is in the tuned cathode circuit. As this circuit is tuned to lower its resonant frequency (tuning capacity increased) the excitation increases. With the circuit tuned near resonance creeping is likely to be bad, as the result of excessive r.f. excitation and heating of the crystal, and the output is likely to be less than that obtainable with the capacity considerably reduced. Therefore this circuit should be resonant to a frequency considerably higher than the crystal frequency, as has been pointed out in recent *QST* articles. With the Tri-tet the screen (or screen and suppressor) voltage should be adjusted for stability, about 100 volts being best with Type 59 tubes. Plate voltages considerably higher than recommended for tuned-plate type oscillators may be used—400 to 500 volts on the 59 oscillator, for instance—and even higher voltages on screen-grid tubes having really small grid-plate capacity.

Use an X-cut crystal in preference to a Y-cut crystal because of its lower temperature coefficient. When it is mentioned that at some frequencies in the amateur bands the Y-cut crystal has a frequency change exceeding three times that of the X-cut crystal for a given change in temperature, the advantage of using X-cuts is easily seen.

Use a crystal holder properly designed for good heat transfer and distribution. This can be done best by employing a mounting having a large mass of copper or brass for the bottom plate of the holder. The action is briefly this: Heat generated by the oscillation of the crystal is dissipated rapidly by the metal bottom plate of the holder due to the high thermo-conductivity of the metal used and the fact that the quartz rests directly on

Right on the Nose

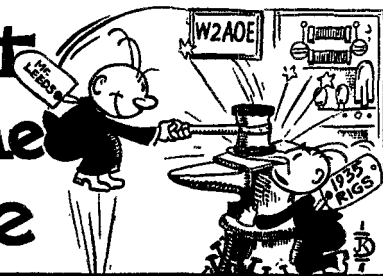

THERE is more to good rack and panel construction than bent iron and black paint. LEEDS RACKS, PANELS and BASES are designed to work in partnership as described by W2BLL in November 1934 QST. They afford maximum flexibility of construction at lowest prices. No extra charge for packing.

RELAY RACKS

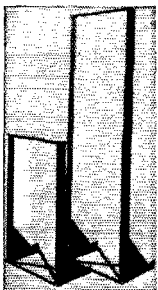

Type RAU Rack, fitted with cross bases, top and bottom spacing bars 1 3/4" angle 3/4" thick, 35" high, 20 1/2" wide to take standard panels 19" wide, **\$5.45.** Type RAD

Rack, same size as above with a complete set of drilled and tapped panel mounting holes to take any combination of standard panels, **\$8.95.** Shipping weight of either 30 lbs. Type RBU as illustrated, 5' 8" high, 20 1/2" wide, without panel mounting holes, **\$11.35.** Type RBD same size as RBU with a complete set of drilled and tapped mounting holes, **\$16.75.** Shipping weight of RBU or RBD 50 lbs.

The New RCA ACR-136

In stock. A real ham superhet receiver, plus broadcast reception. A descriptive bulletin is yours for the asking on this remarkable receiver. Price, **\$69.50**
Nothing else to buy

New Junior VIBROPLEX in stock; this new bug key must be seen to be appreciated. Price, **\$10.00**

No fancy trimmings outside, but plenty of service built inside. LEEDS 866's were worth \$1.50 six months ago, they certainly are worth \$1.50 today.

Junior Pentodes Raytheon RK-23, RK-24 in stock, priced at, **\$5.95**

Triplet Meters No. 321 all sizes from 5 mil. to 500 mil. **\$3.75**
No. 331 A C bakelite case, 5-10-15 volts, any size, **\$3.75**
Complete line of new Triplet Analyzers and Testers in stock.

NATIONAL COIL FORMS

XR-10A Steatite; 2 1/2" x 5"; 26 turns **\$1.50**
List. Special, **\$.90**
XR-12A Steatite; 4" x 6 1/2"; 28 turns **\$2.25**
List. Special, **\$1.35**

The NATIONAL SW-3

is still the pacemaker after 3 years in the T R F receiver field. 2 1/2 volt AC. 6 volt AC-DC and 2 volt models in stock at, **\$19.50**
Band spread and general coverage short wave coils, per range, **\$3.00**
All National products as advertised in October QST always on hand for immediate shipment.

RACK PANELS

LEEDS standard 19" panels 3/8" thick, black shrivel finish with mounting slots for regular rack mounting, are available in aluminum and steel as listed below.

Aluminum			
No.	Width	Weight	Price
PA1	1 3/4"	2 lbs.	\$1.65
PA2	3 1/4"	3 "	1.85
PA3	5 1/4"	3 "	2.15
PA4	7"	4 "	2.35
PA5	8 3/4"	5 "	2.45
PA6	10 1/4"	6 "	2.55
PA7	12 1/4"	7 "	3.00

Steel			
No.	Width	Weight	Price
PS1	1 3/4"	2 lbs.	\$1.20
PS2	3 1/4"	4 "	1.30
PS3	5 1/4"	4 "	1.35
PS4	7"	7 "	1.45
PS5	8 3/4"	8 "	1.55
PS6	10 1/4"	10 "	1.70
PS7	12 1/4"	11 "	1.70

LEEDS

Type 1-B Freqmonitor

is now in use in hundreds of amateur stations. A complete description of this two purpose instrument may be found in the April 1934 issue of QST. "Ask the man who owns one." Complete with tubes and calibration chart. **\$19.75**



Our type 1-E Power Supply is ideal for use with the 1-B priced at, **\$6.50**

For new low prices on **Precision CRYSTALS**, see our Dec. adv. Your complete satisfaction is part of the sale. "Ask the man who owns one."

NATIONAL Steatite type 4- 5- 6- or 7-prong sockets, **36c**



LEADS THE FIELD

World Wide Service to Amateurs

45 Vesey Street
New York City

Cable Address, "RADLEEDS"

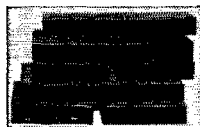

BASES and Demi-Bases

by LEEDS can be used in a variety of ways aside from their use with standard panels. Each unit is made of 20 gauge steel fitted with a bottom cover plate so that any apparatus under the chassis may be kept free from dust and at the same time electrostatically and magnetically shielded. Two demi-bases can be bolted together to make a full size base if desired. 17" bases may be bolted together to give chassis depths of 12"-16" and 18" in addition to the single 4'-8" and 10" depths.

Demi-Base Units	Weight	Price
8 x 8 3/4 x 2	4 lbs.	\$5.55
10 x 8 3/4 x 2	5 lbs.	.65
Full Bases	Weight	Price
4 x 17 x 2	5 lbs.	\$7.75
8 x 17 x 2	7 lbs.	1.00
10 x 17 x 2	7 lbs.	1.20

Cornell-Dubilier CONDENSERS

Working voltage 1000 V. D.C.
750 V. R.M.S. Rect. A.C.

TD-10010. 1-Mfd. **\$1.50**
TD-10020. 2-Mfd. **2.70**
TD-10040. 4 Mfd. **4.20**

Working voltage 1500 V. D.C.
1000 V. R.M.S. Rect. A.C.

TD-15010. 1 Mfd. **\$2.25**
TD-15020. 2 Mfd. **3.75**
TD-15040. 4 Mfd. **5.40**

We carry the complete line

New BURTON-WEBBER all-wave No 10 direct reading test oscillator complete less batteries, **\$29.50**

RCA all-wave oscillator, **\$29.50**

Type 1 Midget Relay, described in our Bulletin No. 73 Special, **29c**

General Radio forms; No. 677-U **50c**
No. 677-Y **75c**

General Radio split stator cond. **\$1.25**
Described fully in December issue

PHONES

Trim 2000 ohm. All bakelite case. List **\$3.00**, Special, **\$1.75**
Trim 4000 ohm. List **\$3.75**, Special, **\$2.25**
Trim featherweight, high impedance, Special, **\$5.88**
Western Electric, P-11, Special, **\$3.95**
Baldwin type C mica diaphragm, **\$3.75**

PAWOOD circle cutters are ideal for making large holes in metal panels.

JUNIOR — cuts 1" to 4" dia. hole, **\$1.25**

JUMBO — cuts 1" to 5" dia. hole, **1.95**
Extra blades, **.25**



"Since using your control I feel like a new radio." . . . "never performed better in my life," writes another.

and so it goes . . . thousands of old, worn out, tired radios are being rejuvenated by alert servicemen with CENTRALAB replacement units.

And remember you can do a better job with a smaller stock of controls if you stick to CENTRALABS.



The new patented RADIOHM



The sturdy fixed RESISTOR



The efficient motor Radio SUPPRESSOR

Every Radio Service Man should be a member of the Institute of Radio Service Men

Centralab

RADIOHMS — RESISTORS
MOTOR RADIO SUPPRESSORS

Division of Globe Union Mfg. Co., Milwaukee

the metal with its greatest surface area contacting it. Therefore, the bottom plate resists any sudden change in temperature of the crystal; and the quartz, because it does contact the metal, will tend to remain at the same temperature as the metal. Because of its mass of metal, the lower plate temperature will tend to be the same as the average room temperature. The temperature of the metal may actually be more constant than the room temperature.

A comparatively large upper plate made of brass may also be used to good advantage, provided that the weight of this upper electrode is not so great as to materially dampen the oscillation of the crystal. High-frequency crystals, however, are as a general rule quite vigorous oscillators and they will stand considerable pressure from the electrodes before their oscillations are seriously dampened.

With the type of crystal holder shown in Fig. 1 the writer has eliminated any noticeable frequency shift in the carrier of W9BKO on the 14-mc. band, even after several hours of intermittent transmitter operation, provided that the room temperature stays constant within two or three degrees Fahrenheit—which it does most of the time.

Where an amateur must park on the very edge of the band (why is it that some fellows are serious in their belief, and will argue for hours, that they do not get out half as well on 7020 as on 7000.5 kc.?) it is suggested that in addition to the holder precautions given above, the scheme shown in Fig. 2 be followed. This shows a hole drilled in the side of the bottom plate of the holder just large enough to insert the thermometer immediately under that portion of the plate upon which the crystal rests. The thermometer now gives us a good comparative check on the temperature of the crystal from one operating period to the next. Then, if the temperature reading is considerably different from that previously determined by test to give operation sufficiently within the band for safety's sake, the operator will have a satisfactory visual warning to *stay off the air* until the temperature reading returns to that value where he can start up without worrying about whether or not he is in the band. Either straight or right-angle thermometers can be used, and it makes no difference whether the thermometer is calibrated in Centigrade or Fahrenheit—all we are interested in is a comparison of readings.

It is evident that, whether the crystal is to be used in an oven or without one, the use of a large quantity of brass or copper in its holder construction will be found extremely beneficial in stabilizing its temperature.

Good frequency stability is entirely possible and practical in crystal-controlled amateur transmitters without the use of expensive accessory apparatus, provided that the transmitter is in a room subject only to normal room temperature variations, that the circuit is properly adjusted and the crystal oscillator run at low excitation, and that the holder in which the crystal is mounted is designed for good heat conductivity

... THEN HE INSTALLED *Crystal* CONTROL

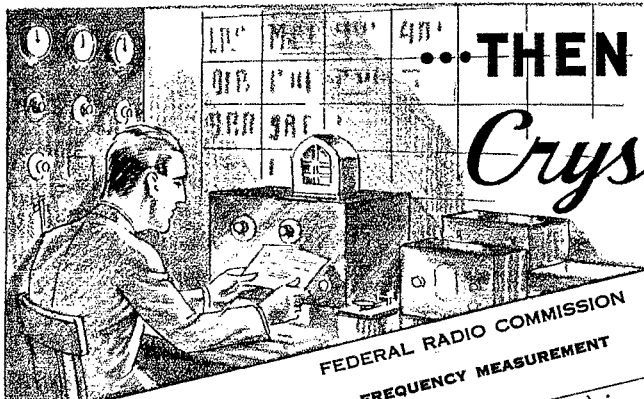

FORM FCC 782

DETROIT, MICH.
Monitoring Station

FEDERAL RADIO COMMISSION
FREQUENCY MEASUREMENT

Station Call *W9AKC*
Date *DEC. 20, 1934*

Time (E.S.T.)	Assigned	Frequency (kc) Measured	Deviation (cycles) :		Remarks
			High	Low	
<i>11:00 P.M.</i>	<i>Amateur Bands</i>	<i>3499.0</i>	<i>1000</i>		<i>Outside 3500-4000 KC Amateur Band</i>

To: *MR. JOHN DOE
GREENWOOD, IOWA*

Sir: Inasmuch as the above deviation is in excess of the licensed tolerance of this station, you are directed to comply with Rule 24 of the Rules and Regulations of the Federal Radio Commission by submitting in triplicate a reply to this notice direct to the Federal Radio Commission. Rule 24 has now been modified so as to require licensees to submit direct to the Commission instead of to Supervisors of Radio.

Very truly,
BBS
Operator making measurement.

OUT-OF-BAND operation may be easily caused in a number of ways — vibration, accidentally brushing against the dials or periods of inoperation. Unless it is checked daily and before every transmission, the frequency of your transmitter is likely to be most anywhere. **UNLESS . . .** crystals are used . . . but, they must be good reliable crystals, accurately ground and properly mounted. Poor crystals are weak in power, drift at a high rate and jump from one frequency to another.

Crystal control is the best insurance against receiving Federal "Pink Tickets" for out-of-band operation. For best positive results, use Bliley Crystals. They are guaranteed to give satisfactory operation. Amateurs the world over have learned that Blileys are less expensive in the long run.

Bliley Crystals are used on police, aircraft and government services where reliable communication is essential for the safeguarding of life and property.

BLILEY ELECTRIC COMPANY



UNION STATION BLDG.

ERIE, PA.



THORDARSON presents

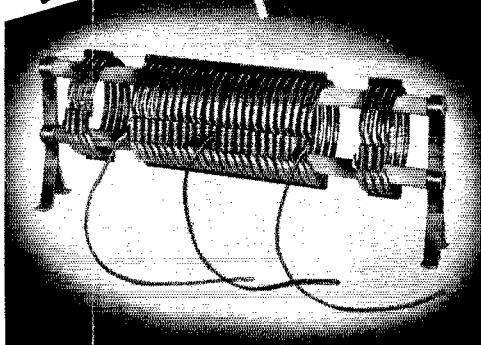

a UNIVERSAL TRANSMITTING INDUCTANCE

● 80 TO 20 METERS IN ONE UNIT . . .

No longer are separate coils necessary for each band. Instead this exclusive THORDARSON development covers from 80 to 20 meters with a single unit.

● MAKES BAND CHANGING EASY . . .

Band changing is quickly accomplished by the removal of convenient clips. Coil changing is eliminated.

● CAN BE USED ON ALL TRANS-

MITTERS . . . The unit may be adjusted for High-C or Low-C circuits, either single-ended or push-pull.

● LOW IN COST . . .

The complete cost—including mounting, leads, and all clips—is less than the cost of copper tubing alone to make coils for equivalent band coverage.

NEW THORDARSON TECHNICAL MANUALS

The NEW THORDARSON Amateur Transmitting Guide, containing 32 pages of new and improved transmitting circuits for the new tubes, is now ready. Also NEW 32-page Sound Amplifier Manual. Mail the coupon to your jobber, enclosing 15 cents for each book desired. If your jobber cannot supply you, write directly to us.

THORDARSON ELECTRICAL MFG. COMPANY 500 W. Huron St. Dept. B Chicago, Illinois

Please send the following NEW THORDARSON Literature:

- Universal Transmitting Inductance Bulletin No. SD 203 (FREE)
- Amateur Transmitting Guide No. 344-A (15c enclosed)
- Sound Amplifier Manual No. 346-A (15c enclosed)
- Both above books, bound in heavy Transformer Manual loose-leaf binder (40c enclosed)

Name.....
Address.....

and attenuation. Frequency stability exceeding that required for amateur work is possible under these conditions.

Progress on the U. H. F.

(Continued from page 35)

contact was run off with heavy rain over most of the route. The 224-mc. signals were R8, while those from W9BOE varied between R2 and R4—the wide difference between the two bands doubtless being explained by the difference in power used. The test, however, was extremely encouraging. We'll have Boston-Hartford direct contact on 224 mc. soon or bust.

The chief problem on this band is now seen to be that of obtaining suitable transmitting tubes. The W.E. 304-A's are proving highly satisfactory at W1AL, but they are available only with great difficulty. The 800 is, as far as we know, the only other bet in the way of a fairly high-powered bottle. Unfortunately, not all 800's appear to be satisfactory. The recent tubes of this type, according to reports, will not perform properly at 224 mc.—even though they exhibit their usual excellent characteristics on the lower frequencies. The acorn or even the 37 are quite satisfactory for very low-power work, but at this stage of the game we are inclined to think that plenty of "steam" is essential for breaking DX records.

WE TAKE IT BACK

Speaking of records, we must admit being rather careless in saying last month that W2CUZ has the credit of breaking down the barriers between the first and second districts. Messrs. C. H. Crawford and W. C. Snyder of Schenectady point out that back in September W2CVZ-1 operating on Mt. Greylock (3,505 feet) in the northwest corner of Massachusetts contacted W2DVC and W2ACB-8, thus linking the first, second and eighth districts. The barriers are doubtless being broken down between the first and second districts nightly along the border line.

AN EXTRAORDINARY PERIOD

The nights of November 21st and 22d were probably the best we have had since early August. On that occasion, a somewhat unusual meteorological condition provided us with an extensive upper layer of warm air wedged in place over New England. DX signals were all of extraordinary strength and a typical report of characteristic reception is that of W1BBM at North Harwich, Mass. (Cape Cod), who bagged twenty stations, at an average distance of 100 miles, in one evening—and that from a low-lying home location.

DX IN THE WEST

Out in San Diego, W6XAP and W6EWU have spent a couple of Sunday afternoons on an 800-foot hill near the city. In a total listening time of two hours and a half, they logged fifteen Los Angeles area stations. W6KLO, HXX, KOK, JSB, ACJ, JCK, GG, CLH, IBU and CLY were on the transmitting end.

A. C. RELAYS

Made by

Allen-Bradley

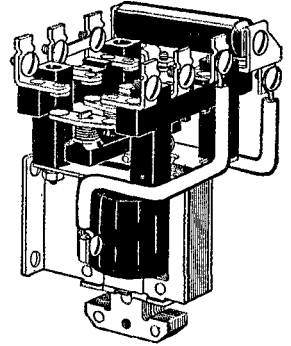
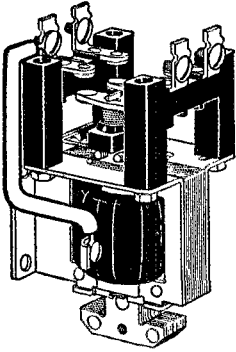

These A. C. solenoid relays are ideal for remote control of transmitters, for control of crystal ovens, and for any general remote control application except for keying. **THESE RELAYS WILL NOT OPERATE IN KEYING SERVICE.** Silver-to-silver double break contacts are used throughout.

The maximum contact rating is 10 amperes at 220 volts. The relay coils are wound for 115 volts 60 cycle alternating current. Relays for other voltages can be supplied on special order. Use coupon below when ordering.

Type No.	Poles	Normally	Circuit Diagram	Price		Type No.	Poles	Normally	Circuit Diagram	Price	
				Open	In Cab.					Open	In Cab.
A107	1	Open		\$3.50	\$4.50	A177	1	Closed		\$7.50	\$8.50
A117	1	Closed		4.50	5.50	A207	2	Open		4.00	5.00
A127	1	Open and Closed		5.00	6.00	A217	2	Closed		6.00	7.00
A137	1	Open		4.00	5.00	A227	2	Open and Closed		7.00	8.00
A147	1	Closed		5.00	6.00	A237	2	Open		4.50	5.50
A157	1	Open and Closed		5.50	6.50	A247	2	Closed		6.50	7.50
A167	1	Open		6.50	7.50	<p>Radiostat—A stepless graphite compression rheostat for primary of 550 watt filament or plate supply transformer. Range 4 to 150 ohms. Price \$6.50</p>					

ORDER BLANK—MAIL WITH REMITTANCE TO

Allen-Bradley Co., 108 W. Greenfield Ave., Milwaukee, Wis.

Enclosed find money order for \$..... for which please send me, shipping charges prepaid, the following items:

..... for..... Volts..... Cycles

Name.....

Address.....

In Stock — Immediate Delivery

The New PR-12

PATTERSON

All-Wave Radio

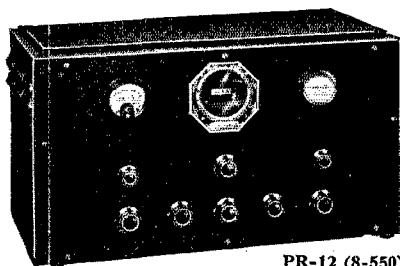

PR-12 (8-550)

56 FEATURES — AMONG THEM ARE:

- Higher sensitivity; greater selectivity.
- Uniform gain over entire range.
- Full range, 8 to 550 meters.
- Shielded 100 per cent.
- Patterson Selector-Band Dial; airplane type; shows only band in use; microthermic 2 speed tuning; 10 to 1 and 50 to 1 reduction; anti-backlash rubber drive.
- New 6 section tuning gang condenser gives an exceptionally low G tuned circuit, resulting in extremely high gain (approximately twice) on the short-wave bands, equaling or surpassing plug-in coils.
- Newly designed coils, with new type of switch, lowering the amount of dielectric loss and skin effect in tuned circuit.
- Pre-selection ahead of first detector results in higher signal to noise ratio, decreasing amount of image response to a minimum; increasing sensitivity, overall gain and selectivity.
- Modulation and R meter.
- Crystal filter, which can be cut in as a series or parallel filter; affords two degrees of selectivity, further raising signal to noise ratio and increasing selectivity.
- Monitor switch, for use in checking quality of your own transmission percentage of modulation indicated visually and orally.

NOTE: ■ indicates NEW; ■■■ indicates NEW and EXCLUSIVE!

NET DELIVERED PRICES COMPLETE

(absolutely nothing else to Buy)

PR-12 Crackle cabinet without crystal	\$83.70	PR-12 Crackle cabinet with crystal...	\$89.70
PR-12 Console without crystal	101.70	PR-12 Console with crystal...	107.70

Chassis also available

SARGENT

8-34 — 15 to 560 meters, 8 tube super-het complete with tubes, speaker, etc.....	\$ 49.50
"Marine" model — same as 8-34 except for tuning range — 15 to 1500 meters, complete.....	57.50

Watch for our new phone c.w. transmitter

SHIPPED PREPAID — if full purchase price accompanies your order. Send for our bulletin "Amateur Transmitter" which lists and describes

"Everything for the Ham"

L. I. MARINE & ELECTRIC CO.

W2GOT — W2GRQ

163-18 JAMAICA AVENUE

JAMAICA, N. Y.

It strikes us that so many things are happening so fast on the ultra-high frequencies that it will soon be necessary for a halt to be called to permit a check-up! We had hoped to get up some sort of a list of DX records and their owners but that is now obviously impractical. What say, fellows, to the idea of sending us the full dope on DX work on any of the ultra-high frequency bands?

Doublet Receiving Antenna and Bucking Circuit for Duplex Operation

(Continued from page 28)

meter can be made to tell the story the minute the channel is clear.

BUCKING OUT THE LOCAL SIGNAL

The question came up as to whether it would be possible to pick up energy directly from the transmitter tank and, with proper attenuation and phase shifting devices, apply it to the transmission line at the receiver to buck out the local signal picked up by the receiving antenna. This was tried using the tuning meter of the receiver to indicate the intensity of the signal on the first grid. Tests showed that a small variable condenser set at approximately 11 μmf . and connected from one side of the transmission line to ground caused over a five to one decrease in transmitter signal on the first grid. It was at first assumed that this was the magnitude of the capacity unbalance between the two sides of the transmission line and ground, but this was soon found not to be the case. It happened that there were 15 or 20 feet of slack in the transmission line between the point where it entered the room and the receiver, and as this was moved about in the room with the 11 μmf . condenser connected, the received carrier could be increased or decreased.

This indicated that the two wires of the transmission line were acting in parallel as a receiving antenna for the local signal, and that by causing some of this current to flow through the pickup coil, by virtue the unbalance in the capacities of the two sides to ground, actual bucking of 80% of the received signal could be accomplished. This was an excellent first step, and indicated that more could be accomplished if the phase of the bucking voltage could be shifted. This was finally obtained by grounding the opposite side of the line through a series circuit consisting of a low-capacity coil of about 250 microhenries and a carbon resistor of somewhat over 1000 ohms. (The latter was filed to the correct resistance.) Exact values are unimportant, for individual cases would require widely different treatment. As new values were tried, the transmission line was moved about to produce a new minimum. It is interesting that without the unbalancing network, the position of the cable in the room had no effect, even when brought to within a foot or so of the transmitter tank.

As the balance became more exact, some rather weird results were produced. Signals less than one kilocycle from the transmitter frequency not only

THE NEW TWIN INSTRUMENT

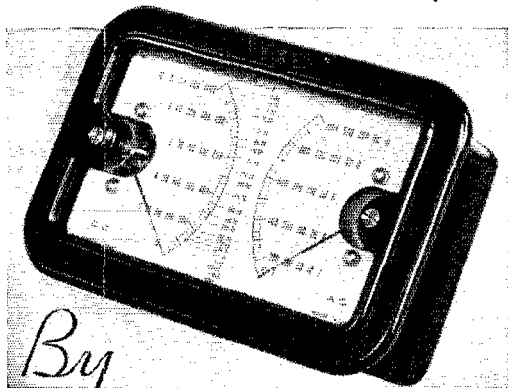

By

TRIPL

THIS unit is appropriately named the "NEW TWIN" because it is made up of a combination of two DC or AC instruments. Both are housed in a bakelite case that takes up a minimum of space. This unit has many outstanding advantages: To take simultaneous readings of both instruments when connected in the same circuit, such as ammeters and voltmeters; to balance loads in three-wire circuits; to observe line fluctuations when load readings are taken; to measure antenna and modulation current; to determine filament and plate voltages. It has a multitude of other applications where quick, accurate, double readings are essential.

The scales of each instrument are arranged side by side. The pointers are always directed in the line of vision. No longer is it necessary to look from one meter to another. The "New Twin" enables you to observe two readings at a glance. The instrument accuracy itself may be lost several times its rated value if readings are not correctly made.

The combinations in the New Twin Triplet are made up of scales corresponding to the 3" individual instruments in single, double and triple ranges — AC-DC, Thermo-Couple and Copper-Oxide for panel mounting.

YOUR JOBBER CAN SUPPLY YOU

Triplet Electrical Instrument Company
110 Main Street, Bluffton, Ohio

MAIL TODAY FOR DETAILS!

Triplet Electrical Instrument Company
110 Main Street, Bluffton, Ohio

Gentlemen:

Please send your latest literature on the "New Twin" Instrument.

Name

Address

City.....State.....

became audible, but 100% readable. A W8 in Pennsylvania was copied for several minutes while producing less than a hundred-cycle beat. But the strange part was the action of the residual signal from the transmitter. It was noticed that a balance could not be maintained at absolute minimum for any period of time (incidentally this was still with a fairly good R8 signal), but rather the meter would fluctuate, returning every so often to the minimum point, sometimes even going below what was first thought to be the minimum, then moving up scale again. The first guess that this was caused either by the transmitting antenna or the receiving antenna, or both, swinging slightly in the wind and thus changing their relative positions, was unfounded; for there was no wind blowing and the action showed no definite periodicity. Hence the result could be explained only by assuming that fading phenomena were producing a change either in the amount or phase of the signal picked up by the receiving antenna. While this might be a change of only one part in one thousand, still the balance obtainable was exact enough so that the magnitude of this variable portion became large when compared to the unbalanced residual.

More on Gaseous Voltage Regulators

(Continued from page 30)

neon lamp modified as described and having the spiral element as the cathode (negative terminal).⁴ The tube will function with the spiral element as the anode (positive) but does not give quite as flat a characteristic. The starting voltage is of the order of 90 volts for this connection. With normal current not exceeding 17 ma. the tube is working at or below its normal rating and should

TABLE I

Voltage Regulator Tube	UX874	½ Watt Neon
E_s	250	250
V_T	88.5	68.2
I_L	3	2
I_T	20	15
I_s	23	17
R_s	7020*	10,640*
Change in E_s	±3%**	±3%**
Corresponding change in V_T	±0.12%	±0.15%
Improvement in regulation	25:1	20:1

* In practice use nearest standard value.

For $E_s = 200$ v; $R_s = 4900$ and 7800 ohms respectively.

** Typical line fluctuation at short intervals.

have an indefinitely long life. The voltage across the tube for this current is slightly over 68 volts for this particular lamp. The larger neon lamps will carry more current and have slightly different, but similar, characteristics.

OPERATING AND DESIGN DATA

As a typical example, let us consider the application of the voltage regulator tube to a regenerative receiver. Only the regenerative detector will

⁴ Newer type tubes have semi-cylindrical elements — either element can be anode.

1935 + TWELFTH EDITION OF THE RADIO AMATEUR'S HANDBOOK

SWEEPING changes in short-wave radio technique have been made since publication of the last edition. These changes have called for a drastic revision of the book. The chapters devoted to apparatus design and construction have been rewritten all through, with new illustrations and new circuit diagrams. Needless to say, the new methods and technique which have so recently almost revolutionized ultra-high frequency working have been treated in full detail.

The twelfth edition is more than half as large again as the first edition. The chapter on receivers, for instance, has been enlarged and rewritten to cover all the recent developments; while the chapter on transmitters has been expanded to permit discussion of all the new methods devised during the last year. New circuits and layouts are given and a special attempt made to treat all possible problems which could be faced in designing or adjusting transmitting equipment. Drastic changes in circuit arrangements for the ultra-high

frequencies have meant a complete rewriting of the chapter devoted to that subject. New transmitters and receivers employing new circuits are described for all three of the ultra-high frequency bands. Full details are also given of directive antenna systems for these bands. All of the chapters have had their share of attention to bring the book up to the minute. The chapters on antennas, keying, power supplies, have all been revamped so that all equipment and circuits can truly be said to represent the best in current practice.

In other words, our policy of leaving nothing in the book that does not represent the very latest practice has been maintained to the letter.

268 PAGES—237 ILLUSTRATIONS **\$1**

AT ANY PRICE, AN AMATEUR COULD
ILL AFFORD TO BE WITHOUT IT • **Postpaid**

(BUCKRAM BOUND, \$2.00)

THE AMERICAN RADIO RELAY LEAGUE, INC.
WEST HARTFORD, CONNECTICUT

THE IMPROVED CATHODE-RAY OSCILLOSCOPE

Linear sweep model for broadcast stations
and advanced amateurs, physics labs., etc.

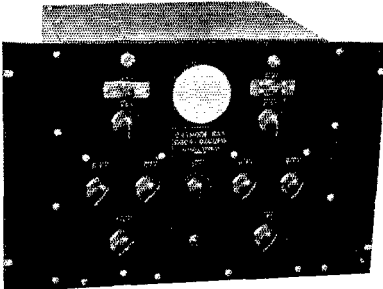

★ Controlled linear sweep. ★ Controlled external sweep.
★ Freq. locking device for sweep frequency. ★ Picture
centering adjustments. ★ Wide range focus adjustments.
★ Complete component shielding. ★ Unit is self contained
and includes batteries and 110V-60 cycle power supply.
★ Tubes RCA 906-885-234-281-280. ★ This instrument
embodies all features ordinarily contained in only the
highest priced Cathode Ray equipment.

Completely Equipped Ready to Use
F.O.B. Newark — \$97.50
Literature now available

★ R.F. Reactors ★

Specially designed for the Amateur bands. These units present a far higher impedance to R.F. than the R.F. Chokes you are now using. This is a brand new idea that you will hear more about soon. Meanwhile you might send us a 3¢ stamp for some red hot dope on R.F. Reactors.

TUBES
210
15W
Large
Plate
\$1.15

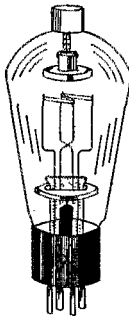

866
1000 hr.
Guarantee
New
Construction
\$1.35

**DUPLEX POWER
SUPPLY**

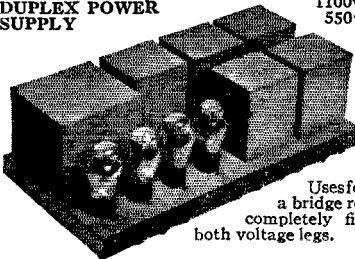

1100v. 250ma.
550v. 250ma.

Uses four 83's in
a bridge rectifier—
completely filtered in
both voltage legs.

\$35.00

These units can be had on special
order in any size, mounting, or form.

We are specializing in transmitter construction to customers' orders and specifications. Write for quotation on your favorite transmitter.

Special code classes for beginners. No charge. Telephone for appointment.

KALTMAN & ROMANDER
62 Court St. Newark, N. J.

need to have its voltage supply regulated. In the case of triode detectors, transformer coupled, the circuit arrangement will be similar to that of Fig. 4A. With a screen-grid detector, either electron coupled or of the standard form, it will be necessary to feed the plate through a choke or audio coupler because of the low plate voltage available. A typical arrangement employing screen-grid feedback is shown in Fig. 4B.

Because of the various tube combinations and operating points, for purposes of illustration we will consider the total current drain (I_L) for both types of detectors as 3 ma. at 88 volts (V_T) and 2 ma. at 68 volts. Referring to Fig. 2, taking ES , the output voltage at the filter bleeder, as 250 volts and employing the relations deduced in the Appendix, the typical performance data given in the table are obtained. The very considerable improvement in voltage regulation is self evident and is typical of that obtained under actual operating conditions.

Appendix

CIRCUIT RELATIONS OF A VOLTAGE REGULATOR
TUBE

Referring to Fig. 2 and applying Kirchoff's Laws:

$$V_T = R_{LL} I_L \quad (1)$$

$$ES = V_T + R_r I_S = R_{LL} I_L + R_r I_S \quad (2)$$

$$I_S = I_L + I_T \quad (3)$$

$$ES = R_{LL} I_L + R_r I_L + R_r I_T \quad (4)$$

$$ES = \left(\frac{R_L + R_r}{R_L} \right) V_T + R_r I_T \quad \text{substituting (1) in (4)} \quad (5)$$

$$ES = \left(1 + \frac{R_r}{R_L} \right) V_T + R_r I_T \quad (6)$$

Designating the changes in voltages and currents resulting from line voltage fluctuations by ΔES , ΔV_T and ΔI_T respectively:

$$ES + \Delta ES = \left(1 + \frac{R_r}{R_L} \right) (V_T + \Delta V_T) + R_r (I_T + \Delta I_T) \quad (7)$$

$$ES + \Delta ES = \left(1 + \frac{R_r}{R_L} \right) V_T + \left(1 + \frac{R_r}{R_L} \right) \Delta V_T + R_r I_T + R_r \Delta I_T \quad (8)$$

subtracting (6) from (8)

$$\Delta ES = \left(1 + \frac{R_r}{R_L} \right) \Delta V_T + R_r \Delta I_T$$

For a given fluctuation in the voltage of the source ΔES , resulting from the supply line fluctuation (since our purpose in employing the voltage regulator tube is to minimize the variation of the regulated voltage ΔV_T) it is desirable to have the coefficient of the term in ΔV_T , and also the second term on the right-hand side as large as possible. Both of these conditions require the regulator resistor R_r to be as large as possible.

Book Review

Signals and Speech in Electrical Communication, by John Mills. Published by Harcourt, Brace and Co., New York. 281 pages.

"Tell them what they need to know and no more." Taking it as his position that every member of the lay public should be possessed of a minimum knowledge of the art of electrical

Hair-Splitting PRECISION AND UNPARALLELED EFFICIENCY

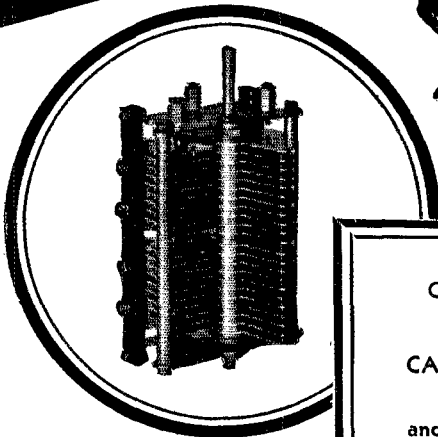

THE HAIR Splitting Precision that goes into the making of every Cardwell Condenser is something more than an advertising catchword. Each assembly is thoroughly tested and checked. Every bit of material that goes into a Cardwell Condenser is the finest that money can buy. Cardwells have never been the lowest priced condenser because Cardwell consistently refuses to compromise the dependability, accuracy and unparalleled efficiency of a product that, for years, has been "The Standard of Comparison". There's a Cardwell for every Tube and Purpose. Write for Literature.

CARDWELL "TRIM-AIR" MIDGET
CONDENSERS

CARDWELL "STANDARD" MODELS
FOR RECEIVERS
and MEDIUM POWER TRANSMITTERS

CARDWELL MIDWAY
"FEATHERWEIGHT" CONDENSERS,
RECEIVING and TRANSMITTING

CARDWELL 16-B TRANSMITTING
CONDENSERS FOR LARGER
TRANSMITTERS

CARDWELL HIGH VOLTAGE
CONDENSERS FOR COMMERCIAL
RADIO-TELEGRAPH and
BROADCASTING STATIONS

CARDWELL S-2244 OIL DIELECTRIC
FIXED CONDENSERS FOR HIGH
FREQUENCY FURNACES and TUBE
BOMBARDERS



THE ALLEN D. CARDWELL MFG. CORP'N.
83 PROSPECT STREET, BROOKLYN, N. Y.

"THE STANDARD of COMPARISON"

THE RME-9D SINGLE SIGNAL SUPER

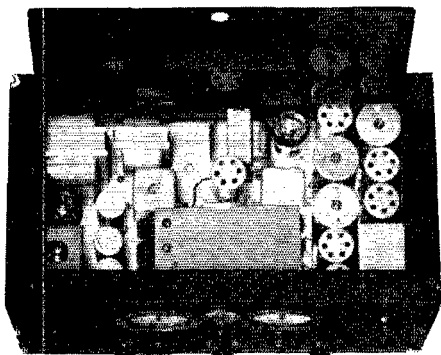

with a built-in, high gain rf circuit, rigid coil mountings with change-over switch for band selection, built-in crystal filter with a multiplicity of functions for phone and CW reception.

PIONEERED

- 1 The built-in MONITOR circuit for checking carrier modulation;
- 2 The built-in BRIDGE-CIRCUIT METER to indicate carrier strength of incoming signal, calibrated in R values and microvolts;
- 3 The built-in RESONATOR to assure peak performance at all times anywhere in the frequency range of the receiver;
- 4 The SIX-SECTION variable condenser for high rf gain at all frequencies;
- 5 The synchronized band-spread of all frequencies, utilizing three section variable capacitor tuning;
- 6 A completely calibrated receiver in megacycles;
- 7 The centralization of ALL controls on the front of the panel;
- 8 Solid, heavy duty, CAST aluminum chassis frame.

A Complete Descriptive Folder Sent
upon Receipt of 10 Cents

RADIO MFG. ENGINEERS
313 Bradley Avenue Peoria, Illinois

BIRNBACH Superior INSULATORS

BIRNBACH'S line of radio insulators and complete antenna equipment is the largest available. "Navy-Type" Insulators with center hole for anchoring transmission line, and the "Wing-Nut" Standoffs are popular new numbers. Strong, highly-glazed ceramic. Well-rounded corners and edges. Nickel-plated brass hardware. Write Dept. Q-1 for Data.



BIRNBACH RADIO CO., Inc.
145 HUDSON STREET NEW YORK CITY

STANDOFF

communication, the author proceeds to supply that minimum. The position of the reviewer is that if every member of the lay public knew as much, in the way of common workaday knowledge, of electrical communication as this book presents, the general level of world intelligence would be considerably raised. Which may be construed as another way of saying that every ordinary radio amateur can read this book with pleasure and profit, and learn many things thereby. Terms and terminology — ohms, amperes, attenuation — more often than not given without definition or explanation, and therefore assumedly complex and mysterious to the average reader, fall familiarly on the ears of the radio amateur and convey him to the point of view of examining his native element. But what of the book itself? It is a good book, giving the official engineering point of view of the telephone, telegraph, and radio industries in such fashion that they can be understood and appreciated by the individual; and at the same time the functioning of the major mechanisms of these industries is described enjoyably, tolerantly, readably — and withal with a cultured, sympathetic aplomb. In more exact adjectives: not a textbook, but a popular treatise on technical subjects, successfully performed.

— C. B. D.

Stray-nge Strays

(Continued from page 8)

is an apparatus for producing sound by the action of heat or light rays. . . . A tester is a coin which once was worth thirty-six cents.

Mirabile Dictu

Insects had antennae long before man dreamed of radio. . . . The spark gap, remembered only by Old Timers of the rock-crusher is the world's oldest electrical device—it was vented by Nature in the lightning flash. . . . W4CS weighs 275 pounds and is named *Stout*. . . . W3BWP's last name is Money. . . . W9LZM's is Ledin. . . . Shades of The Old Man, the eminent English yachtsman Sopwith's initials are T. O. M. . . . Some hams have streets named for them; others the whole town. Walter Janvrin, W1BQ, lives on Janvrin Avenue; Phil Gildersleeve, *QST* cartoonist (Gil), lives in Gildersleeve, Conn. Jimmie Mohn, W3CKD lives in Mohn-ton, Pa.

W1AGK lives on *Spring St.* in *Watertown*. . . . W1EC on *Love Lane*. . . . And W1CPD pounds brass in *Hamden Cirele*. . . . There are no Egyptians in the Egyptian Radio Club (a League affiliate). . . . Aluminum, popular stuff for radio shields and kitchen pots, is extracted from clay. In 1856 it cost ninety dollars a pound. . . . When in Washington, be sure to see W3DLC's shack—it is built of lumber from the Roosevelt inaugural stands. Only one chip is allowed to each souvenir-gathering ham. Hi. . . . Prof. G. C. Williams, former President of Ithaca College, has made an extensive study of laughter, and he says that *hi* is an expression used by folks who dislike laughter and try to avoid it! . . . The old FRC received as many as a thousand amateur applications in a single week. . . . But in 1922 a radio big-shot predicted that Amateur Radio would kill itself by overgrowth. . . . *Zenith*, name of a popular BCL receiver, grew out of the ham call, 9ZN—

THE NEW PR-12

PATTERSON

All-Wave Radio



PROMPT
DELIVERIES
ARE NOW
BEING MADE

LARGE ILLUSTRATED FOLDER AVAILABLE ON REQUEST

F.O.B. WILMINGTON, DEL.
OR LOS ANGELES, CALIF.

PRICES COMPLETE
ABSOLUTELY NOTHING ELSE TO BUY

NO TIME PAYMENTS
OUTSIDE U.S.A.

	List	Net Cash	Time	Down P'mt	Monthly 5 P'mts
Chassis, Tubes and Speaker without Crystal....	\$129.50	\$77.70	\$84.18	\$34.18	\$10.00
Chassis, Tubes and Speaker with Crystal.....	139.50	83.70	90.75	35.75	11.00
Metal Case, Complete, without Crystal.....	139.50	83.70	90.75	35.75	11.00
Metal Case, Complete, with Crystal.....	149.50	89.70	97.25	37.25	12.00
Console, Complete, without Crystal.....	169.50	101.70	110.20	45.20	13.00
Console, Complete, with Crystal.....	179.50	107.70	116.70	46.70	14.00

DELAWARE RADIO SALES CO.

EASTERN DISTRIBUTORS

405 DELAWARE AVENUE

Cable Address: DELRAD

WILMINGTON, DELAWARE

ESTABLISHED 1920

(Prices and Terms Subject to Change Without Notice)

ATTENTION W3DQ

NEW YORK BRANCH:

136 LIBERTY ST., N. Y. C. — W2KR

CANADIAN REPRESENTATIVE:

J. L. WALKER — VE3JI — ROCKCLIFFE, ONT.

RADIOGRAM

The radiogram blank has been revamped to allow for that much needed room for the body of the message and to facilitate copying of messages. 7½ x 8½ sheet padded 100 sheets to the pad.

35c each 3 for \$1.00

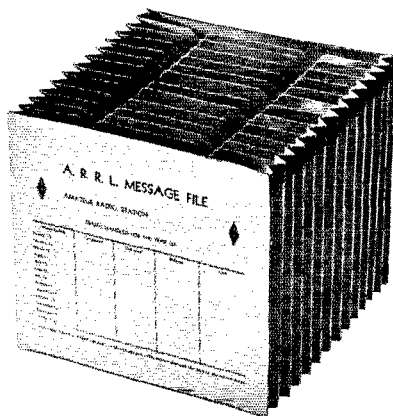

MESSAGE FILE

The F. C. C. requires amateurs to keep messages handled for a period of one year. The message file has been designed to facilitate compliance with that regulation. An expanding file of thirteen compartments (one for each month and one for extra papers), it provides for more messages per month than the average station will handle. On the face of the FILE, space is provided for a complete and accurate record of traffic handled. It will accommodate a year's traffic. For a practical and convenient solution of the regulation, you can't beat it.

40c each 3 for \$1.00

AMERICAN RADIO RELAY LEAGUE, WEST HARTFORD, CONNECTICUT



A.R.R.L. EMBLEM

— *insignia of the radio amateur*

IN the January, 1920, issue of *QST* there appeared an editorial requesting suggestions for the design of an A.R.R.L. emblem — a device whereby every amateur could know his brother amateur when they met, an insignia he could wear proudly wherever he went. There was need for such a device. The post-war boom of amateur radio brought thousands of new amateurs on the air, many of whom were neighbors but did not know each other. In the July, 1920, issue the design was announced — the familiar diamond that greets you at the top of this page — adopted by the Board of Directors at its annual meeting. It met with universal acceptance and use. For fourteen years it has been the unchallenged emblem of amateur radio, found wherever amateurs gathered, a symbol of the traditional greatness of that thing which we call Amateur Spirit — treasured, revered, idealized.

Do You Wear the A.R.R.L. EMBLEM?

The League Emblem, in heavy rolled gold and black enamel, is available in either pin or button type

There are three special colors for Communications Department appointees. . . .

- ▶ Red background for the SCM
- ▶ Blue background for the ORS
- ▶ Green background for the RM

Red and green available in pin type only, blue may be had in either pin or button style. All Emblems priced the same

\$1.00 POSTPAID

**American Radio Relay League
West Hartford, Connecticut**

in the beginning, the set was called *ZN-iih*. . . . The annual Wouff-Hong trophy, awarded by the Modesto (Calif.) Radio Club, is moulded from the elements of tubes from five hundred record-breaking transmitters. . . . Just a pleasant thought for slow-moving folks—the r.f. currents in a 1-meter oscillating circuit completely turn around in their tracks three-hundred million times each second!

(And do you know that Rufus P. Turner, W1AY, who contributed these facts, is willing to prove any of the statements on receipt of a stamped envelope?—EDITOR.)

With the Affiliated Clubs

(Continued from page 42)

please) for data on Affiliated Clubs in your vicinity.

Miscellany

The Providence (R. I.) Radio Association, Inc., invites all amateurs to attend its annual hamfest on Saturday, January 19th. Reservations may be made and further details received by writing the association at 3 Valley Street, Providence, R. I. . . . Officers elected by the Manitoba Wireless Experimenters' Association for the 1934-35 season: VE4AG, honorary president; VE4DU, president; VE4GC, vice-president; VE4MW, secretary-treasurer; VE4CD, assistant secretary-treasurer. . . . Visitors are always welcome at the meetings of the Coos Bay Amateur Radio Club, North Bend, Oregon, every second and fourth Thursday; ask W7WL in the North Bend post office as to whereabouts of meeting. . . . The Bloomfield (N. J.) Radio Club recently celebrated its 20th anniversary. . . . Thirty amateur radio operators participated in the 56-mc. hidden transmitter hunt of the Lancaster (Ohio) Amateur Radio Association on November 5th. The three-hour search resulted in W8DOC taking first honors. The headquarters of the hunt were at W8GGG's cottage at Fairfield Beach, Buckeye Lake. The committee in charge was W8GGG, W8FEQ, and W8HDF. . . .

The Starved Rock Radio Club, Spring Valley, Ill., set up a station at the Illinois State Corn Husking Contest. Results of the contest were sent "blind" on 3594 kcs. by W9ABZ to an operator at the studio of BC station WLS. Communication from the station to a truck out in the field was maintained by the use of two 56-mc. transceivers. The S.R.R.C. issues a well-prepared paper to its members entitled "Static." . . . The Williamsburg Radio Club of Brooklyn, N. Y., contemplates a series of lectures on fundamental and advanced radio theory. A new club transmitter is under construction. . . . The Goshen (Ind.) Amateur Radio Club elected the following officers: W9OEC, president; W9LLV, vice-president; W9SZU, treasurer; W9FRY

AT-CUT CRYSTALS BY PREMIER!

IN A NEW LINE OF ISOLANTITE HOLDERS

- ★ MORE POWER
- ★ BETTER STABILITY
- ★ NO FREQUENCY DRIFT
- ★ NO PINK TICKETS

Every PREMIER crystal is mounted in a sealed isolantite holder and guaranteed for frequency calibration and power output.

Sixteen new types of isolantite holders are now available for specific commercial and amateur requirements. Send for Bulletin No. 103.

Do not overlook the possibility of increasing the power output from your present equipment. A prominent ham, using a PREMIER AT-cut crystal mounted in a Type 182 holder, reports an increase of 77% in power output as against his old crystal in a bakelite holder. Write for full particulars of this test.

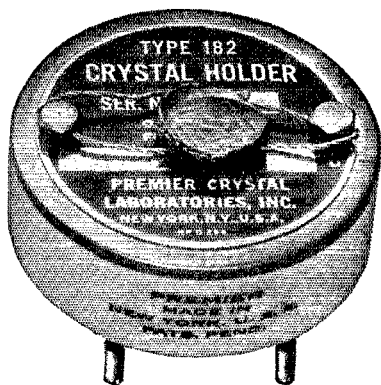

PREMIER CRYSTAL LABORATORIES, INC.

53 PARK ROW, NEW YORK, N. Y.

"Quicker than a Short circuit"

LITTELFUSES

- INSTRUMENT LITTELFUSES, for meters, 1/400 amp. up.
- HI-VOLT. LITTELFUSES for transmitters, etc., 1,000, 5,000 & 10,000 volt ranges, 1/4 amp. up.
- NEON VOLTAGE FUSES & Indicators (TATTELITES), 100, 250, 500, 1,000 & 2,000 volt ratings.
- AIRCRAFT FUSES, AUTO FUSES, FUSE MOUNTINGS, etc. Get new Cat. No. 6.

Littelfuse Labs., 4509 Ravenswood Ave., Chicago, Ill.

New QUIET VOLUME CONTROLS and RESISTORS for Every Amateur Purpose

Write Dept. Q for Catalog.

175 Varick St. New York, N.Y.
ELECTRAD

Radio Engineering
Complete in
Telegraphy-
Telephony

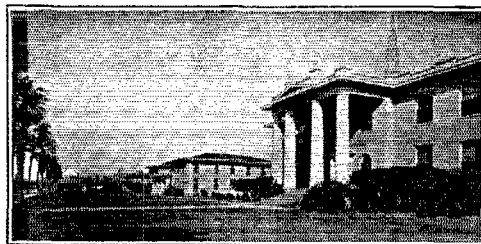

Studio Technique
and Transmitter
Operating Expe-
rience Guaranteed

K P A C

500-Watt 1260 Kilocycles

In 3 to 7 months we train you to secure Commercial Telegraph Second-class, and Radiotelephone First-class government licenses. Course consists of Wireless Code, Radiophone, Microphone-Studio Technique, Service, Police, and Aeronautical Radio. We are authorized to teach RCA texts. At completion of course you receive practical studio technique experience in our commercial broadcast studios located in administration building, and experience as an operator on K-P-A-C (500-Watt Commercial transmitter located on the campus and owned and operated by the college), and WPA, 4000-Watt Commercial Wireless Station. Return coupon for details.

PORT ARTHUR COLLEGE

Port Arthur (world-known port) Texas

Name.....
Street or Box.....
City and State

ACME-DELTA

COMPLETE POWER SUPPLIES REALLY HANDLE CLASS B!

(As used by James Millen. See Oct. '34 QST)

AD-60

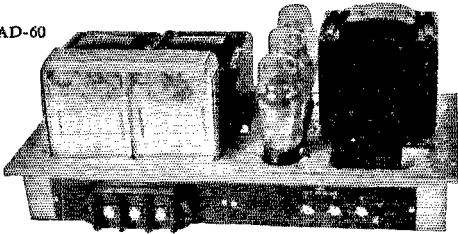

Standard Input 115 V., 60 Cycle, A.C.

Cat. No.	D.C.		Rect.	Ripple %	Reg. %	List Price
	Volts	Amps.				
AD60	1000 & 500*	.250 total	3-83	0.20	11	\$100
AD63	1250 & 1000	.400	2-66A	0.15	10	\$160

*Note: No filter included for 500 Volt tap. Auxiliary filter required — two AD44 Chokes and one 2 x 8 mfd. Electrolytic Condenser. List prices are less tubes and subject to change without notice. Authorized distributors extend 40% discount to amateurs and experimenters. We also sell components. Send for Bulletin DL-48-13. Also DL-48-34 on Class B Amplifiers.

DELTA MANUFACTURING COMPANY

190 Willow Street, Waltham, Mass.

F. S. Dellenbaugh, Jr.
Pres. & Ch. Engr.



G. E. M. Bertram
Treas. & Gen. Mgr.

UNIT OF RAYTHEON MANUFACTURING COMPANY

IN THE WEST

The AMATEUR'S Headquarters
are at the

RADIO SUPPLY CO.

912 So. Broadway, Los Angeles, Calif.

All the latest Nationally Advertised
Parts and Kits in stock at all times

9 Licensed Amateurs on our staff at your service

Be a Good Radio Operator

Learn at Home in Half Usual Time with

Instructograph



Code Teacher

Beginners, Amateurs and Experienced Operators everywhere say there's no better way to get the code practice necessary to become a good operator than by practice with Instructograph. . . . Sends real code just as an expert would. . . . No experience necessary. . . . Book of Instruction shows how to practice to advantage. . . . Simple as A B C. . . . Prepares you for any code exam. . . . Machines, Tapes and Book of Instruction for sale or rent. . . . Terms

as low as \$2 per month. . . . Rental may be applied on purchase price if desired. . . . Rent for a month. . . . If you do not agree that Instructograph is the best way to learn the code and become a good radio operator — return it. . . . Send postcard for full particulars. . . . No obligation.

INSTRUCTOGRAPH CO., Dept. O-13
912 Lakeside Place Chicago, Illinois

secretary. . . . The Houston (Texas) Amateur Radio Club became affiliated with A.R.R.L. in 1919. . . . The Delaware Amateur Radio Club of Wilmington is planning a hamfest for some time in February. . . .

—E. L. B.

Low-Temperature Coefficient Crystals

(Continued from page 27)

set to receive signals so controlled should require no retuning even during the time the cold transmitter is warming up or at any time thereafter.

Crystals of the low-coefficient type will probably replace all other cuts and in so doing should, in time, eliminate the issuance of off-frequency notification by the Federal Communications Commission to the unfortunate amateur whose heat-box thermostat has stuck or whose previously well-behaved X- or Y-cut crystal, not having a constant temperature home in which to live, has become somewhat feverish and decided to jump over the frequency fence into the next pasture.

What the League Is Doing

(Continued from page 25)

ington for cancellation.) The continued great growth in amateur license figures is largely attributable to the fact that there have been no expirations of station licenses since the adoption of the three-year licensing plan. It will be early 1935 before the first of these licenses expire. Thus it will be middle 1936 before we have a report for a fiscal year which actually shows our net growth. For example, we know that we showed a net increase last year of 4,835 after deleting cancelled portables but we have no idea how many of the fellows who were issued licenses back in 1932, and who are still carried on the books, abandoned the game.

By the way, if you have an old-fashioned large-size station license, better take a look at the expiration date. It has been so long since a station license expired that we're out of the habit of looking at their dates. But all of them issued in early 1932 for one year and extended for two additional years by proclamation will expire in early 1935. Renewal applications must be filed at least 60 days in advance of expiration and be accompanied by both station and operator licenses. The renewed license will be in the form of the combination card. See the *License Manual* for particulars.

An Improvement In Twisted-Pair Feeders

(Continued from page 23)

better impedance match but it also decreases "end" leakage effects which are common to all solid insulations, especially at high frequencies. The edge of the braid at point A, Fig. 1, should be well taped to prevent fraying and to keep water from creeping under the braid at this point. Do not cut into the rubber wall while preparing these connections.



Amateur Stations Are Going —

PYRANOL TRANSMITTING CONDENSERS

2MFD
2000 VOLTS

These filter condensers impregnated and filled with Pyranol have been designed to meet the needs where used in high voltage filter circuits. — They have a safety factor heretofore unknown in filter condensers. While we rate these at 2000 volts working we know of cases where they are in use at a 50-75% overload. Made by one of the world's largest manufacturers of electrical apparatus. Guaranteed to be satisfactory or your money back.

\$2.50

**IMMEDIATE DELIVERY
ON ALL ORDERS**

866 Tubes Heavy Duty.....\$1.69
V.T. 203A Graphite An..... 9.00

Triad 210.....\$1.25
Triad 250..... 1.25

Raytheon R.K. 20.....\$15.00
Raytheon R.K. 18..... 10.95

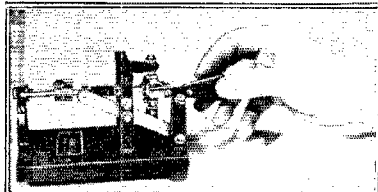

THE NEW MAC-KEY \$10.50

Try your fist and see what a difference this key will make. See page 81 December Issue, QST.

Baldwin Phones.....\$2.50
2 1/4 Volt 12 Amp Fil for 866 tubes..... 1.25

100 Ft. No. 14 En. wire.....\$.49
100 Ft. No. 12 En. wire......69
Deforest 281 Tubes......99
Triad 83 tubes......55
G.R. Coil Forms 677 U......50
50 watt socket.....1.20
Sylvania Tubes in stock.

Guardian Keying Relay 5-15 Volts AC-DC.....\$3.30
Billey Crystal Holders for 40-80M..... 1.00

USED TUBES

RCA 211.....\$9.00 RCA 204A.....\$30.00
RCA 860.....12.00 RCA 204.....18.00
RCA 852.....14.00 WE 276A.....10.00
RCA 849.....49.00 WE 212D.....15.00
ALL GUARANTEED

Haigis 5M Transceiver.....\$19.20
RCA Hand Mike..... 1.50
Mike & Audio Trans..... 1.20
Output to match......90

Triad 841..... \$2.50
Sickles 5 Meter Kit..... 1.20
K.K. 3" Vernier Dial......49
National Pickard Ant..... 2.25

Complete stock of parts for the amateur — all standard lines — your discount 40%. Drop in and be numbered among the 10,000 amateurs that we have served in the last year. Start the New Year right. Mail orders filled. Please send check or M.O., include postage.

Triplett 3 1/4" Bakelite Case
D.C. Mill Meters.....\$3.75
Complete line in stock

THE RADIO SHACK ■ 46 BRATTLE STREET ■ BOSTON, MASS.

**A REAL NEW DEAL FOR
ALL U.S.A. HAMS!**

\$7.50 TO \$10.00 DOWN
PUTS THESE SETS
IN YOUR STATIONS
10 MONTHS TO PAY BALANCE

**MCMURDO SILVER 5C
PATTERSON PR12
PFANSTIEHL S.S.**

WRITE—WIRE—CALL—PHONE
for technical bulletins on these sets and
dope on our "painless" payment plan

All amateur parts in stock

WILCOX RADIO SALES
(W9DDE—W9CRT—W9APY—W9WR)

506 S. Wabash Avenue Chicago

WEBster 4101

for the SUDDEN LOAD

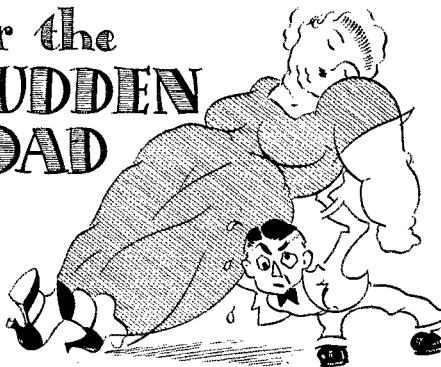

Ward Leonard Midget Overload Relays provide protection to the tubes while tuning or through loss of excitation. The Underload Relays protect class "B" tubes and transformers. Send for Free bulletin 507B. Learn about Ward Leonard Protective Relays and how to use them.

WARD LEONARD PROTECTIVE MAGNETIC RELAYS

WARD LEONARD ELECTRIC COMPANY

41 South St., Mount Vernon, N. Y.
Please send FREE Bulletin 507B.

Name.....
Street.....
City and State.....
Call Signal.....



"E. H. Rietzke SPEAKING!"



Mr. E. H. Rietzke, President of CREI, and originator of the first thorough course in Practical Radio Engineering.

Are You Making a Living . . . or MAKING HEADWAY?

There's quite a difference between "just getting along" and really working with a future. Radio offers every man the opportunity to forge ahead, if he has the necessary technical training to grasp and understand problems as they arise.

We're not interested in "Beginners"

CREI courses are planned only for ambitious, experienced radiomen, who recognize that specialized training is necessary in so technical a field as Radio. CREI courses in Practical Radio Engineering are the most thorough available.

Write now for complete details and easy terms

● 44-Page Booklet Sent on Request ●

CAPITOL
ENGINEERING



RADIO
INSTITUTE

14th and Park Road, N. W.
Dept. Q-1

Washington, D. C.

Dependability



Assured with Aerovox components for your transmitter, such as—

Oil-filled transmitting condensers . . . quality inside and out . . . latest engineering . . . remarkable performance . . . long life . . . and irresistible prices (for example: 1/2 mfd. 2000 v. \$6.50 list).

Transmitting grid leak resistors . . . also for voltage dividers . . . adjustable contact slider . . . wire-wound, vitreous-enamelled . . . heaviest-duty work.

Precision mica condensers . . . bakelite molded . . . lowest dielectric losses . . . small in size and price—big in usefulness.

New Catalog . . . 1935 Edition just off the press describes complete Aerovox line. Also free copy of our monthly Research Worker.



CORPORATION

73 Washington St.

Brooklyn, N. Y.

The bare rubber ends AB and AC should be dipped in paraffin or given a coat of rubber paint, such as that used for auto top dressing, before the conductor is soldered to the flat-top section. This will insure against leakage and will overcome sun checking of the bare rubber.

Whenever possible it is advisable to have the feeders leave the antenna at right angles. Since the line is untuned, the feeders may be of any length whatsoever and can be given a gradual bend wherever necessary without affecting the operation. As explained previously, it is even possible to clamp the feeder to a house or pole with ordinary porcelain cleat insulators. Do not attempt, however, to join the feeder to another twisted pair of different dimensions and properties, because resulting mismatch of impedances undoubtedly will result in losses and, perhaps, standing waves.

Any of the methods outlined in the *Handbook* for coupling a doublet line to the transmitter are satisfactory. A, B and C, Fig. 2, are three typical methods of coupling. Since the system is of low impedance, the coupling should preferably be at the low potential point of the tank coil. (Fig. 3 shows a representative method.) Tuning is carried out in the same way as with any doublet arrangement. A good antenna proper (half-wave Hertz for this system) is essential for maximum performance of any transmitter, regardless of the feeder efficiency. The *Handbook* should also be consulted for correct tuning and antenna procedure.

Twisted pair line of the type described may be used in lengths up to 1000 feet before transmission losses become noticeable.

The improvement gained in operating properties now places the twisted pair line on a level with good open spaced lines with a decided advantage in ease of installation and elimination of the probable errors in the construction of an open-wire type line. The efficiency is sufficient for operation on frequencies as high as 28 megacycles and for power inputs up to 1 kw. The twisted-pair doublet transmitting antenna also is ideal for short-wave reception purposes.

This type of line has been successfully used by W8LUQ and W8AAC for several months on the 20-, 40- and 80-meter bands and performance in every case, regardless of length and other conditions, has been found to be equal to or better than that of a corresponding matched impedance system using a 600-ohm open-wire feeder line. A fundamental frequency half-wave Hertz antenna is used for each band.

Transposition accomplished by twisting the insulated wires in a pair provides uniform separation of the feeder wires at every point in the line. This uniform spacing is essential to maintain constant inductance and capacity for any unit of length. That is, any line that does not possess uniform spacing (such as one using frequent transposition blocks) does not have continuous and uniform impedance over the feeder length. Such systems should preferably be used as tuned lines; that is, as Zepp feeders.

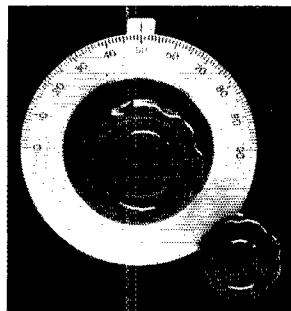

Types 705-A and 705-F

A NEW GENERAL RADIO DIAL

A companion to our popular 2 $\frac{3}{4}$ - and 4-inch dials is now available in a 3-inch diameter dial, both with and without friction slow-motion drive. Beautifully finished, accurately etched and easily mounted, this new dial adds to the appearance of any radio equipment. Its large fluted knob is designed for easy handling.

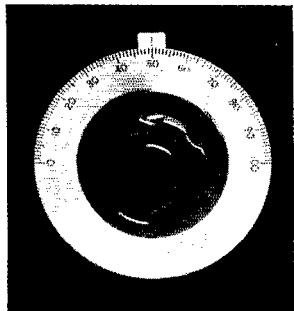

Types 712-A and 712-F

SPECIFICATIONS

Dial — 3 $\frac{3}{4}$ inches in diameter — nickel-silver finish — insulated from shaft.
 Graduations — 180 degrees — 100 divisions — photo-etched.
 Knob — polished bakelite — fluted with rounded edges — 2 $\frac{3}{4}$ inches in diameter.
 Indicator — single hole mounted — rides on edge of dial eliminating parallax.
 Shaft diameters — For both $\frac{1}{4}$ and $\frac{3}{8}$ inch shaft.
 Friction drive — single hole mounting — adjustable tension.
 Supplied complete with indicator and drilling template.

Type 712-A Direct drive for $\frac{1}{4}$ inch shaft \$1.25
Type 712-F Direct drive for $\frac{3}{8}$ inch shaft \$1.25
Type 705-A Friction drive for $\frac{1}{4}$ inch shaft \$1.75
Type 705-F Friction drive for $\frac{3}{8}$ inch shaft \$1.75

Order direct from this advertisement and we will ship prepaid anywhere in U. S. and Canada if cash accompanies order.

Other General Radio dials, knobs and experimental and amateur accessories described in *Bulletin Q-1*.

GENERAL RADIO COMPANY
 30 State Street Cambridge A, Massachusetts

BOUND VOLUME XVIII of QST

(1934 Series)

WE have now a limited number of copies of Bound Volume XVIII of QST. Vol. XVIII comprises the entire 1934 series of QST. This volume is made up of two books or sections, each containing six issues of QST. This volume is handsomely bound in red cloth and with gold imprint. The complete volume is priced at \$5.00, postpaid.

Better act quickly — only a few copies available.

QST

38 LaSalle Road
 West Hartford, Connecticut

MIDWEST
 stocks ALL
 these
 worthwhile
 lines:

- ▼
- NATIONAL
- JOHNSON
- SYLVANIA
- RAYTHEON
- RCA-
- DEFORST
- THORDARSON
- HAMMARLUND
- WESTON
- TRIMM
- BLILEY
- OHMITE
- SIGNAL
- AEROVOX
- CARDWELL
- ELECTRAD
- LYNCH

... and every
 other recog-
 nized line.



Midwest
 . . . offers complete
 stocks . . . fast service
 . . . practical advice
 on amateur problems.

Midwest offers the amateur the most complete and reliable service obtainable anywhere.

Complete stocks of every worth while line are always on hand—ready for instant shipment to any part of the world.

Members of Midwest's staff operate Station W9RTV to analyze amateur transmitting needs. Their advice on all amateur problems is yours for the asking.

Midwest's famous 4 hour service applies to EVERY order. Within 4 hours of the time your order is received, your shipment is on its way.

Send for This Big Winter Catalog!

Send for your FREE copy of the world's largest catalog of shortwave transmitting and receiving equipment. Mail the coupon today!

Midwest Radio Mart
 520 S. State, Chicago, Ill.

Please send me your big
 Winter Catalog.

Name _____

Address _____

EIMAC

TRANSMITTING TUBES ARE HUSKY AND EFFICIENT

Less excitation is required for maximum power output and efficiency. Tantalum grid and plate prevent damage or impairment of high vacuum during momentary overloads.

UNSURPASSED IN RUGGEDNESS AND PERFORMANCE

Characteristics	Eimac-50T	Eimac-150T
Filament volts	5 V	5 V
Filament current	6 A	10 A
Filament watts	30 W	50 W
Amplification factor	13	13
Normal maximum plate dissipation	50 W	150 W
Normal maximum plate current	100 MA	200 MA
Normal power output class C (75% eff.)		
plate voltage 1000	75 W	150 W
plate voltage 2000	150 W	300 W
plate voltage 3000	250 W*	450 W
	*(at 83% eff.)	
Price (Net)	\$12.00	\$24.50

SOLD ONLY THROUGH DEALERS

"COMPARE AND REFLECT"

EITEL-McCULLOUGH, INC.

SAN BRUNO, CALIFORNIA, U.S.A.

A 50-Watt Transmitter

(Continued from page 21)

denser C_{11} adjusted for maximum buffer grid current, a crystal at the high-frequency end of the band will be loaded so greatly, with the same setting of C_{11} , that it will not start oscillating. Hence the adjustment should be made with a crystal at the high-frequency end if the transmitter is to be used at both ends without readjustment of C_{11} . On the other hand, if operation at only the low-frequency region is contemplated, C_{11} might as well be set for peak operation at the start. This will result in somewhat increased excitation to the final stage. Conversely, if the transmitter is to be used exclusively for 75-meter 'phone, the amplifier grid coil, L_4 , can be wound to give peak operation at that end of the band. This means reducing the total number of turns on L_4 from 60 to 50. On the 160-meter 'phone band it simply means adjusting the padding condenser, C_{12} , for maximum amplifier grid current.

With normal input to the 801's the power output of the last stage is 50 watts or better on all but the 28-mc. band. The efficiency of the doubler when going from 14 to 28 mc. shows a marked decrease, however, with the result that the excitation on 28 mc. is reduced—grid current in the vicinity of 10 ma.—and the output drops to 25 or 30 watts. The doubler is driven quite as well by the 14-mc. crystal as by the others from all indications, since its grid current is the same as with 7- and 3.5-mc. crystals. In fact, experimental 14-mc. plates furnished by the Bliley Electric Company perform as readily and reliably as the lower-frequency crystals.

The output of the amplifier can be increased considerably by raising the plate voltage beyond the manufacturer's ratings, and the 801 appears to be a tube that can take fairly high voltages without danger. The plate current should be kept in the neighborhood of 70 ma. per tube, however, if the voltage is raised above normal.

Considerable experimenting was done with grid-leak values for both doubler and amplifier stages. The value of 1250 ohms for the second stage represents a practical optimum, giving maximum output with no tendency toward tube instability. Lower values increase the grid dissipation to an undesirable value and do not increase the output. The 10,000-ohm leak recommended for the amplifier stage was found to give more linear plate modulation than lower values, although for c.w. work a 5000-ohm resistor will give slightly increased output.

ANTENNA TUNING

The antenna tuning arrangement is one suggested in a note from W6AJP published in the Experimenters' Section in June, 1934, *QST*. It is built into the unit shown in the photographs, and can be coupled to the transmitter through a transmission line of any reasonable length. The line may be of ordinary twisted pair or can be made by spacing a pair of No. 14 wires an inch or so apart. The latter type possibly would have lower losses if the line is to be of considerable length.

DESIGNED for BETTER "HAM-BAND" RECEPTION

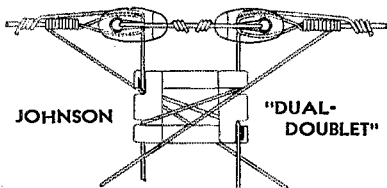

JOHNSON

"DUAL-
DOUBLET"

The NEW "JOHNSON" "DUAL-DOUBLET"

Ideal general-purpose amateur receiving antenna—specially designed to provide remarkably efficient and uniform reception over a wide range of frequencies. Maximum signal pickup with minimum noise. Lead-in losses practically zero in the ceramic-insulated transposed line which may have any desired length.

No. 320A Johnson "Dual-Doublet" Antenna Kit. Contains all essential material and complete instructions. List Price. . . . \$4.75

This and other JOHNSON products are available from your regular Distributor

E. F. JOHNSON COMPANY

Manufacturers of Radio Transmitting Equipment

WASECA, MINNESOTA, U. S. A.

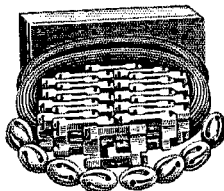

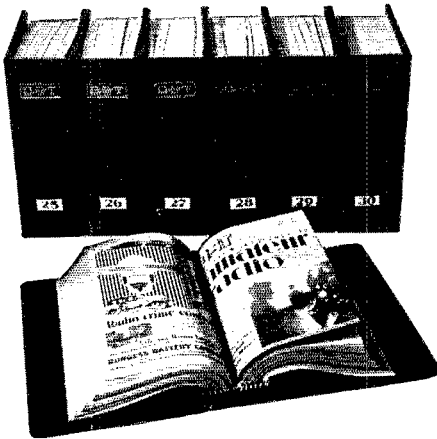

TO

- ▶ enhance the appearance of your station
- ▶ facilitate your reference work
- ▶ preserve the records of the advancement of the radio art

YOU NEED

QST Binders

One for this year's issues and one for each of the accumulated year's issues that you have. It will accommodate twelve issues of *QST* and a yearly index. The *QST* Binder is covered in deep maroon cloth. It is cleverly designed to take each issue as received and hold it firmly without mutilation. It permits the removal of any desired issue without disturbing the rest of the file.

A GOOD INVESTMENT AT

\$1.50 POSTPAID

• **NOTE** •

The illustration shows each binder with a yearly mark. This marking is not stamped on the binder. Simply cut the year label from a calendar, or paste on a piece of paper, marking it in your own handwriting.

AMERICAN RADIO RELAY LEAGUE, WEST HARTFORD, CONN.

GULF RADIO SCHOOL

Radiotelegraphy Radiotelephony
Radio Servicing

SECOND FLOOR } 1007 Carondelet Street
U. S. A. } NEW ORLEANS, LA.

PEAK REGENERATIVE Pre-selector—Pre-amplifier

Is winning new friends. Many amateurs who have hesitated to spend a large amount of money on new equipment have welcomed the introduction of the PEAK. The PEAK, when used in conjunction with your present receiver, will *modernize and predate it* — and will bring weak phone, CW and foreign broadcast signals which are now unreadable up to R9. This is what PEAK gives to your receiver:

1. Tremendous increase in Signal Strength
2. Consequent increase in Sensitivity
3. Rejection of Image
4. Considerable increase in Selectivity
5. Reduction of Noise to Signal Ratio

BUILT IN COILS covering 14-200 M. in 3 steps, 2 Hi-gain stages type 58 tubes, smooth electron-coupled regeneration, self contained filament supply, heavy gauge black crystal finish chassis and cabinet.

Results guaranteed as described above by your dealer and by us! LIST \$33.00 — 40% discount to Hams; Your cost, less tubes: \$19.80 at all Radio Supply Houses.

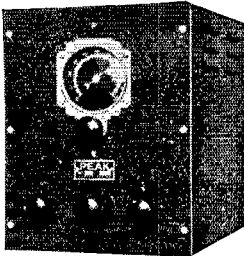

Write for literature and name of nearest Dealer

EASTERN RADIO SPECIALTY CO.

Mfrs. of PEAK PRODUCTS

1845 Broadway Dept. Q15 New York, N. Y.

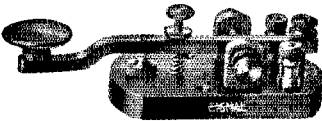

WIRELESS KEYS

Signal Wireless Keys are known the world over for their dependability, quality and moderate price. You can buy them with assurance you are getting the best. Available with 3/16", 1/8" or 1/4" coin silver contacts. Write for a circular on complete line.

SIGNAL ELECTRIC MFG. CO.
Menominee, Michigan

OFFICES IN PRINCIPAL CITIES

SIGNAL

MANUFACTURERS OF ELECTRICAL PRODUCTS

ARMY AND NAVY

SURPLUS RADIO AND ELECTRICAL EQUIPMENT

Receivers	Generators
Transmitters	Dynamotors
Meters	Keys
Switches	Condensers
Transformers	Microphones
Motors	Insulators

→ Send 5¢ in stamps for large illustrated list ←

MANHATTAN ELECTRICAL BARGAIN HOUSE

105 FULTON STREET, NEW YORK

RADIO

ENGINEERING, broadcasting, aviation and police radio, servicing, marine radio telegraphy and telephony, Morse telegraphy and railway accounting taught thoroughly. Engineering course of nine months duration equivalent to three years of college radio work. School established 1874. All expenses low. Catalog free. DODGE'S INSTITUTE, Day Street, Valparaiso, Indiana

FROM 1715KC. TO ABOVE 110MC.

HAMS EVERYWHERE

ARE GETTING BETTER RESULTS
ON ALL BANDS
using the new



ANTENNA SYSTEMS

A Bulletin Containing
All the Dope
Is Waiting for Your Request

ARTHUR H. LYNCH, INC.

227 Fulton Street New York, N. Y.

Pioneer of Noise-Reducing Aerials

The antenna tuner is mounted on a 7 by 12 bakelite panel. The two tuning condensers, C_{13} and C_{14} , are at opposite ends of the panel with the tuning coil, L_6 , mounted between them on National Type WGS-1 insulators. A pair of similar insulators at the lower edge of the panel serve as input terminals and as supports for the coupling coil, L_7 , which is concentric with L_6 . A small piece of insulating material between the two coils, cemented to both of them, makes the assembly quite rigid and keeps the spacing constant. The method of construction of L_6 is identical with that of the 3.5-mc. amplifier tank coil. Taps are made by soldering wire "ears" to the turns. There are four taps, the first pair being four turns in from the ends of the coil, and the second pair four turns in from the first. The output terminals to the feeders or antenna system are at the top of panel. A double-pole single-throw switch for changing the tuning condensers from series to parallel is mounted on the front panel just below the r.f. ammeter.

Small copper spring-clips are used to make connections to the taps on the coil L_6 and also to the amplifier tank coil, L_5 . These clips are a new product of the Mueller Electric Company and are especially suited to r.f. circuits. The difference between these and the older steel clips of the same design is quite noticeable. The copper clips stay cool — certain evidence that the losses are low.

The method of adjusting the antenna tuner will depend upon the antenna system in use. Enough inductance is provided in the coil to make parallel tuning possible at the lowest amateur frequency. The *Handbook* contains suggestions for tuning various types of feeder systems and should be consulted if there is any doubt about the right scheme to use. When the system is decided upon the clips may be placed on the taps that appear to be about right — low inductance for series tuning, high inductance for parallel tuning — and the condensers C_{13} and C_{14} left at some random setting. The clips on L_5 should then be attached a turn each side of the center, the plate power applied to the amplifier and C_3 adjusted to resonance. C_{13} and C_{14} then should be adjusted to make the amplifier draw normal plate current, after which C_3 should again be set to resonance. If the plate current drops when this is done, the same process should be gone through again. When the tuning is correctly done, the plate tank and antenna circuits will both be tuned to exact resonance; it should not be necessary to detune either C_{13} or C_{14} to keep the plate current down to normal. If this should be found to be necessary the coupling should be decreased by moving the clips on L_5 closer together. The right position for the clips will be the one which results in normal plate current — about 140 ma. — when all circuits are correctly tuned. Temporary taps on the 1.75- and 3.5-mc. enamelled-wire amplifier tank coils may be made by scraping the insulation off a few turns about the center for the first trials. When the right positions are found, wire ears should be soldered in place as permanent taps.

THE HARVEY TRITET

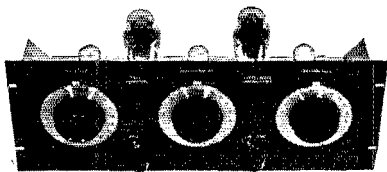

A distinctive and efficient exciter unit, offering commercial type construction and performance at a new low Amateur price. Employs two low-cost type 59 tubes and delivers 2-8 watts of excitation on five bands with an 80-meter crystal. Fully wired and tested with one set of coils, less tubes and crystal. **\$42.50**

TYPE HF-3 — A non-radiating super-regenerative receiver for 5-10 meter operation. Ideal for use with a beam antenna. Price with one set of coils, less tubes. **\$23.50**

TYPE MO-45 — An ultra-high frequency transmitter with 10 watts output. Especially suitable for two-way communication between central station and moving automobile. Further details on request. Price fully wired and tested, complete with tubes. **\$29.50**

TRANSCEIVERS 2-volt, \$18.75. 6-volt, \$17.95

ANNOUNCEMENT

We have under construction a new medium power radio-telephone transmitter featuring quality construction at low cost. It will pay you to wait for the appearance of this new unit in the near future.

Bulletin on Request

HARVEY RADIO LABORATORIES

12 Boylston Street, Brookline, Mass.

ORDER NOW

PATTERSON PR-12 complete shipped prepaid \$83.70.
RME9D shipped prepaid \$112.50.
SILVER 50 complete shipped prepaid \$74.70.
SUPER-PRO complete shipped prepaid \$164.64.
NATIONAL HRO \$139.80 not shipped prepaid.
ALL COLLINS transmitters at lowest prices.

Trade in Your Receiver or Transmitter

Absolutely all other amateur apparatus at the lowest prices quoted by anyone. Your used apparatus accepted in trade on any apparatus you want, too, and a large stock of used apparatus for sale at low prices.

Every inquiry and order is personally attended to by Robert Henry, W9ARA; an active amateur for ten years; graduate E.E. from M.I.T.; and owner of Henry Radio Shop selling amateur apparatus for six years. Your orders are valued and appreciated. Write for any information and bulletins. Orders gladly shipped C.O.D. if 10% deposit sent with order.

HENRY RADIO SHOP

211-215 North Main St.

Butler, Missouri

NEW-HRO NATIONAL SUPERHETERODYNE

NOW IN STOCK FOR
IMMEDIATE SHIPMENT

DISCOUNT 40%

Write for our new 1935 catalog

CAMERADIO

603 GRANT ST.
PITTSBURGH ~ PA.

HAVE YOU ENTERED SYLVANIA QSL CONTEST?

Enter now! See your nearest Sylvania specializing distributor or December issues R/9, QST or Radio for further details. Begins December 4 — ends February 4.

Hygrade Sylvania Corp.

ELECTRONICS DEPARTMENT

AMATEUR RADIO DIVISION

CLIFTON • • • NEW JERSEY

PANELS — BAKELITE — RUBBER — ALUMINUM

All Sizes Cut to Order **BAKELITE TUBING & RODS**
Drilling, Engraving & Special Work
ALUMINUM CANS—Stock sizes. Special sizes, made to order.
ALUMINUM CHASSIS—Threaded brass studs for 6/32 screws.
 Length from 1/4" to 6"—price 5c to 30c.

Insulating bushings for all size shafts or Bakelite—15c
 Bakelite Tubing Threaded to Specifications.

UNITED RADIO MFG. CO. Est. 1923 191 Greenwich St., New York

PRECISION CRYSTALS



Crystal Holder—\$1.00

'X' and 'AT' cut crystals one inch square carefully ground for frequency stability and maximum output. Be sure of your transmitter frequency — use **PRECISION CRYSTALS**. Guaranteed to be the highest quality obtainable.

'X' cut **PRECISION** Crystals carefully ground for maximum power supplied to your specified frequency accurate to 0.1% and calibrated to within 0.03% are priced as follows: 1750 and 3500 kc. bands—\$3.00 each. 7000 kc. band—\$3.50. Add \$1.00 to above prices if plugin, dustproof holder is desired. Jacks to plug holder into — \$1.5 pair.

The 'AT' cut crystal recently developed has a temperature coefficient of practically zero and will handle more power than ordinary crystals. 'AT' cut crystals ground to your specified frequency accurate to 0.1% and calibrated to within 0.03% are priced as follows: 1750 and 3500 kc. bands — \$6.00 each. 7000 kc. band — \$9.00. Crystal holder — \$1.00. Jacks for holder \$1.5 pair.

Crystals and ovens for commercial use quoted on at your request. When ordering our product you are assured of the finest obtainable. Now in our sixth year of business.

PRECISION PIEZO SERVICE

427 Asia Street

Baton Rouge, La.

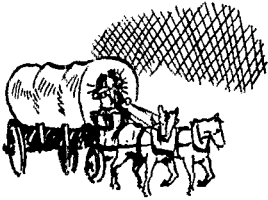

.....Pioneers

Scientific Radio Service was one of the "First" to introduce "Piezo Electric Crystals" for commercial use . . . that was back in 1925 . . . and today we still pride ourselves with the fact that our aim is toward "QUALITY" Crystals rather than Quantity.

AMATEURS

Crystals are supplied to within 5 KC of your specified frequency in either 80 or 160 meter band, \$15.00 each unmounted. Calibration supplied accurate to *Better* than .03%.

"THE CRYSTAL SPECIALISTS"

Send for Booklet and Price List

Scientific
RADIO SERVICE
124 Jackson Avenue, University Park
Hyattsville, Maryland, Q-1-35

RADIO ENGINEERING



RCA Institutes offers an intensive course of high standard embracing all phases of Radio. Practical training with modern equipment at New York and Chicago schools. Also specialized courses and Home Study Courses under "No obligation" plan.

Illustrated Catalog on request.

RCA INSTITUTES, INC. Dept. ST-35

75 Varick St., New York 1154 Merchandise Mart, Chicago
Recognized Standard in Radio Instruction Since 1909

CRYSTAL MICROPHONES

**in a Series of New
Advanced Models**

now available at

"Microphone Headquarters"

Built to the same high standards as our well-known Carbon and Condenser types . . . Advanced engineering features, with a background of years of microphone development experience.

(Licensed Under Brush Development Co. Patents)

See your Jobber for complete details, or write to us.

SHURE BROTHERS COMPANY

Microphone Headquarters

215 WEST HURON ST. CHICAGO, ILLINOIS



Although "flexibility" is an overworked word in connection with amateur apparatus, this transmitter has about as good a claim as any to the title. It may be built for one band or five, and building it for one does not preclude the possibility that some day a few more coils can be added for work in some or all of the other four. There is also some flexibility with regard to tubes, which are just as much plug-in as the coils. Type 41 or 42 tubes can be substituted for the 2A5's, and in the final stage 10's or even 830's can be used in place of the 801's. The 830's can be driven nicely for c.w. work at their rated voltages. Time has not permitted investigation of the possibility of modulating them fully, however.

Modern Design of High-Frequency Stages for the Amateur Superhet

(Continued from page 15)

supply, fortunately can be a separate unit; but the tubes must remain in the receiver. To minimize heating the coils are placed at the very bottom of the receiver, underneath the chassis, in a separate shielded compartment. The heat from the tubes will, of course, rise toward the top of the receiver and the coils will remain nearly at room temperature. The coil shielding must be complete, of course, to prevent convection air currents from coming in contact with the coils, as well as for good magnetic and electro-static shielding.

The oscillator must be of the Hartley type if the full advantages of the tetrode type of oscillator are to be utilized.¹ The system described fulfills this requirement, in that all the tuning devices are connected across the whole coil. This is important. If, for instance, the tuning condenser is connected across only a portion of the coil, the circuit tends to become unstable and the frequency will change with variations in the line voltage. In receivers employing separate coil units for the general coverage and band-spread ranges, however, it is permissible to use extremely high "C" circuits to obtain stability.

Probably as the result of broadcast receiver practice, many short-wave receivers have been designed with the idea of covering the greatest possible range with the fewest coils, with the individual coil ranges determined entirely by the size of the tuning condenser. This is hardly satisfactory for amateur work since unfavorable L/C ratios and non-uniform band spread result, and the operator must refer to calibration charts in order to locate, even approximately, any amateur band. In the tuning system under consideration, the coil ranges are chosen so that each just covers two amateur bands, one at either extremity of the range. For instance, the highest frequency range starts just above 30 megacycles and extends to just below 14 megacycles; the next range starts just above 14 megacycles and extends to just below 7 megacycles; and so on. For general coverage it is thus possible to tune through any two adjacent bands without change of coils.

¹ This circuit is derived from the Hartley arrangement described by J. J. Lamb in the article, "Stabilizing Superheterodyne Performance," *QST*, April, 1932.

The TURNER (Type G) Crystal Mike

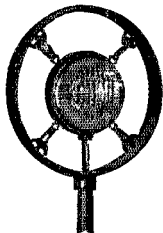

The Turner Type G is arranged for either spring or base mounting. Prices on either type mounting quoted on request.

A FLOOD of inquiries from coast to coast indicates that the better amateur operators are greatly interested in crystal microphones. The wider frequency response without background noise or hiss, together with the fact that no energizing current is necessary, is making the Turner Type G the preferred mike with amateur stations. Finest precision construction. Fully guaranteed to give complete satisfaction. The Turner Type G Crystal Microphone (Brush Patents) lists at \$20.00, with a 40% discount to amateurs. Write today for free descriptive circular and circuit diagram.

THE TURNER COMPANY
CEDAR RAPIDS, IOWA

Have you changed your QST address? Please notify us at once to insure prompt delivery of your next copy.

READ CODE LIKE AN EXPERT!
SEND CODE



Learn Quickly at Home; Get Real Speed

It's easy, fascinating, to become a good op with the New MASTER TELEPLEX Code Teacher to help you. Only instrument ever produced which records your sending in visible dots and dashes — then sends back to you. Also sends practice work, recorded by an expert, at any speed you want. Thousands agree this method is surest, quickest. Used by U.S. Army, Navy, A. T. & T., R. C. A., and others. We furnish Complete Course, lend you Master Teleplex, give you personal instruction with a MONEY-BACK GUARANTEE. Low cost. Send today for booklet Q. 25; no obligation; post card will do.

TELEPLEX COMPANY

76 Cortlandt Street
NEW YORK, N. Y.

FREE BOOK

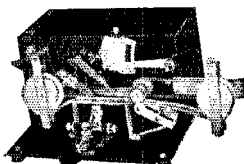

Say You Saw It in QST — It Identifies You and Helps QST

HAVE YOU ENTERED SYLVANIA QSL CONTEST?

Enter now! See your nearest Sylvania specializing distributor or December issues R/9, QST or Radio for further details. Begins December 4 — ends February 4.

Hygrade Sylvania Corp.

ELECTRONICS DEPARTMENT
AMATEUR RADIO DIVISION
CLIFTON • • • NEW JERSEY

LOOK at your modulation
with a **CLOUGH-BREngle**
Cathode Ray Oscilloscope

Write Today Get the most from your xmitter. Check modulation, filters, etc., with this low cost, easy-to-use equipment. Write for full particulars.

The **CLOUGH-BREngle Co.**
1130-J W. Austin Ave., Chicago, U.S.A.

Antenna Dope ... Valuable Map

FREE



The most comprehensive and helpful treatise on antenna since Auntie came back into prominence! Map o'creation, with all the foreign and American short-waves charted ... call letters and kilocycles, too! Complete diagrams and illustrations of latest CORWICO Antenna jobs and how to install 'em. Really, this is one of the outstanding bits of technical literature for 1934-5. Be sure to write for your copy ... QUICK.

CORNISH WIRE CO.

30 Church Street

New York City

**THE FASTEST SELLING PLATE
BLOCKING CONDENSER IN THE WORLD**

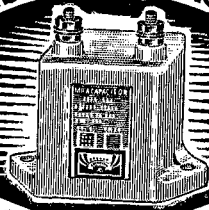

A M A T E U R S: Here's a buy you can't afford to miss

- Type 86 mica capacitor with ceramic casing. Our 25 years of experience and service back every Cornell-Dubilier condenser you buy.

No. 22A-86 .002 Mfd. 12500 v. Working Potential

List Price, \$6.50. Your Cost **\$3.90**

MICA • OIL • PAPER • ELECTROLYTIC

•Send for your copy of Catalog No. 126.•

CORNELL-DUBILIER
CORPORATION

4373 BRONX BOULEVARD
NEW YORK

New!

LOG Book page 83

Here It Is! MARTIN JUNIOR

For Limited Time
ONLY \$10

Think of it!
A Genuine
MARTIN
Vibroplex
for only \$10

All standard features. Heavy contact points. 2 3/4 pound black japanned base. The only difference is in size. Ideal for radio. Easy to use. A bargain at this low price. Don't wait—order **YOURS NOW!** Remit by money order or registered mail.

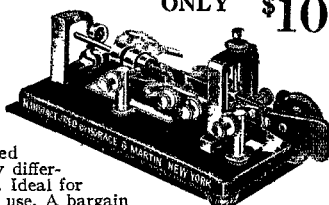

BUY NOW!

OTHER VIBROPLEX MODELS

Famous Improved Vibroplex, Black or Colored, \$17; Nickel-Plated, \$19. Easy-Working Vibroplex No. 6, Black or Colored, \$17; Nickel-Plated, \$19. Write for catalog.

THE VIBROPLEX CO., INC.
825 Broadway New York, N. Y.

Furthermore, any coil unit may be used alternatively for either general coverage or calibrated amateur band spread. As indicated in the circuit diagram of Fig. 3, there are two pairs of contacts in each tuning circuit. When the "A" contacts are connected, the general coverage ranges will be as described above. When the "A" contacts are open and the "B" contacts closed, two circuit changes are made: A small condenser is connected in series with the main tuning condenser thus reducing its capacitance range; and an additional trimmer condenser is connected across the coil, thus increasing the minimum circuit capacitance. These condensers are of such size that, when in use, full band spread will be obtained on any amateur band. For instance, changing the contacts from "A" to "B" on the 30- to 14-megacycle coils will give full band spread on the 30- to 28-mc. amateur band. The 14-mc. band can still be received without change of connections by using the next lower frequency set of coils.

There are several advantages to this system, the first and most obvious being a positive, unchanging and uniform calibration for each of the band-spread ranges. The condensers are, of course, adjusted so that each band has the same spread on the dials. There is still another advantage which is not readily apparent from an inspection of the diagram; namely, that it is possible to obtain straight-frequency-line tuning on both band-spread and general coverage ranges. It will be noted that one trimmer condenser is connected directly across the tuning condenser while the other is connected across the coil terminals with the "B" contacts in series. With the "A" contacts connected ("B" open) the first mentioned trimmer is directly across the coil and serves as a conventional padding condenser. The plates of the main tuning condenser are shaped so as to give straight-frequency-line tuning on the full coverage ranges. With the "A" contacts open and "B" closed, this trimmer is effective only in increasing the minimum capacity of the tuning condenser and by so doing gives practically straight-frequency-line tuning on the band-spread ranges also.

MECHANICAL CONSIDERATIONS

So far we have discussed principally the electrical considerations involved. The mechanics of the tuning arrangement, together with the condenser and coil construction, are fully as important.

A good tuning system should be convenient to operate and this requirement necessitates the use of a positive vernier drive in order that band-spread tuning may be obtained at any point in the frequency range. A little thought will show that band-spread tuning is always obtained through a combination of mechanical and electrical devices. While continuous band spread might seem possible mechanically with a condenser drive having a sufficiently large reduction, in practice a very large reduction is not easy to obtain without introducing backlash, or without sacrificing accuracy of calibration.

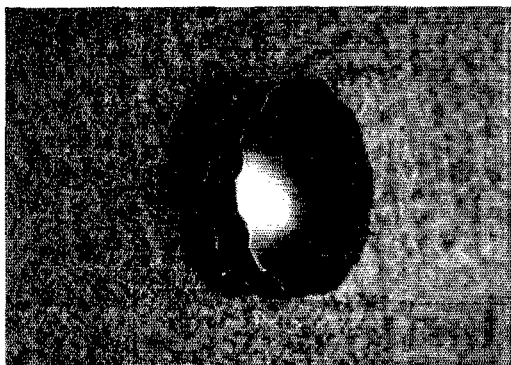

OVERSIZE KNOB: This large knob, $2\frac{3}{8}$ inches in diameter, facilitates critical tuning when used to replace standard knobs on FB-7 or other receivers, and it has a comfortable grip which is not tiring in use. Standard equipment on the HRO. Catalog Symbol HRK.

List Price \$.85

Usual Discounts apply

NATIONAL COMPANY, INC.
MALDEN, MASS.

A.C. Electric Generating Plants

ONAN ALTERNATING CURRENT ELECTRIC PLANTS furnish the same current as city service — 110 volt, 60 cycle, A.C. Operate Radios, Water Systems, Refrigerators, all household appliances.

Size 300 to 50,000 Watts

Operate on Gasoline, Gas or Distillate. No battery used except to start engine. Ideal for places remote from electric service. For Public Address, Sound Amplification, Portable Lighting and Standby Equipment.



\$99.00

Also a complete line of D. C. Models

Some Dealer's Territory Available

D. W. ONAN & SONS

457 Royalston Ave., Minneapolis, Minn.

HAVE YOU ENTERED SYLVANIA QSL CONTEST?

Enter now! See your nearest Sylvania specializing distributor or December issues R/9, QST or Radio for further details. Begins December 4—ends February 4.

Hygrade Sylvania Corp.

ELECTRONICS DEPARTMENT

AMATEUR RADIO DIVISION

CLIFTON ■ ■ ■ NEW JERSEY

RADIO COURSES

Radio Operating

Prepare for Gov't license exam.

Radio Amateur Code

Radio Servicing

Including short wave receivers.



Resident Courses

Write for Booklet

NEW YORK YMCA SCHOOLS

4 West 63rd Street, New York City

IMMEDIATE DELIVERY ON THIS NEW EQUIPMENT

DEL-RAD TIME PAYMENTS WILL FIT YOUR POCKETBOOK

	Net Cash	Time	Down P'tmt	Balance	Monthly 5 P'mts.
RCA Victor Model ACR-136 Complete.....	\$ 69.50	\$ 76.50	\$26.50	\$ 50.00	\$10.00
National HRO with Coils.....	139.80	151.45	41.45	110.00	22.00
RME 9D Complete.....	125.00	135.00	45.00	90.00	18.00

We Are Also Authorized Distributors for

Collins Transmitters — RCA De Forest — Sylvania — Taylor Tubes
Hammarlund — Thordarson — Carter Utah — Delta — Weston — Triplett
Patterson — Cardwell — Cornell Dubilier — Astatic — Burgess — Raytheon, etc.

DELAWARE RADIO SALES COMPANY

405 DELAWARE AVE.

CABLE ADDRESS
DELRAD

WILMINGTON, DELAWARE

EST. 1920

(PRICES AND TERMS SUBJECT TO CHANGE WITHOUT NOTICE)

ATTN W3DQ

To
OUR READERS
who are not
A.R.R.L. Members

YOU should become a member of the League! That you are interested in amateur radio is shown by your reading of *QST*. From it you have gained a knowledge of the nature of the League and what it does, and you have read its purposes as set forth on the page opposite the editorial page of this issue. We should like to have you become a full-fledged member and add your strength to ours in the things we are undertaking for Amateur Radio. You will have *QST* delivered at your door each month. A convenient application form is printed below — clip it out and mail it today.

A bona fide interest in amateur radio is the only essential qualification for membership

AMERICAN RADIO RELAY LEAGUE
 West Hartford, Conn., U. S. A.

I hereby apply for membership in the American Radio Relay League, and enclose \$2.50 (\$3.00 outside of the United States and its Possessions, and Canada) in payment of one year's dues, \$1.25 of which is for a subscription to *QST* for the same period. Please begin my subscription with the.....issue. Mail my Certificate of Membership and send *QST* to the following name and address.

.....

Do you know a friend who is also interested in Amateur Radio, whose name you might give us so we may send him a sample copy of *QST*?

.....

Thanks

In the mechanical section of the tuning system under consideration² the tuning condensers are driven through a worm gearing, spring-loaded to take up backlash and wear. The main dial is mounted directly on the worm shaft and is rotated ten times for 180° rotation of the condensers. The auxiliary dial numbers appear through windows in the main dial shell and are changed automatically every revolution of the dial by means of an epicyclic gearing so that the calibration is numbered consecutively from 0 to 500. Through this mechanism, it is thus possible to obtain a continuous dial reading of from 0 to 500, the actual useful length of the equivalent scale being twelve feet. The result is that signals are well spread out on the scale, even on the general coverage ranges, making tuning and logging both convenient and precise. With the coil connections shifted to give full spread on any amateur band the character of the system is especially striking. The 14-mc. band, for instance, is given 400 dial divisions, which, since the band is 400 kc. wide, means that the tuning rate is 1000 cycles per dial division. This feature will be especially appreciated by anyone who is accustomed to tuning the Single-Signal type receiver with the crystal filter circuit adjusted for maximum selectivity.

GAIN CONTROL AND STRENGTH METER

We come now to the matter of r.f. gain control. While no unusual difficulties are presented, the multi-stage r.f. amplifier offers the designer an opportunity to overcome problems which are bothersome in simpler receivers. In order to obtain the best signal-to-noise ratio the first tube should be operated at maximum gain. This is especially important for weak signal reception. When two tubes precede the first detector, the manual r.f. gain control may be connected only to the second r.f. tube (and to the i.f. tubes) with a decided gain in weak-signal performance. The a.g.c. circuits are, however, connected to both r.f. stages, so that strong signals will be held more closely to the same output level.

Such a combination of a.g.c. and manual control makes possible accurate "S-meter" measurement of the carrier strength of any received signal. Fig. 3 shows the "S-meter" network connected in the B-supply circuit to the r.f. and i.f. stages. Actually the meter is the indicator of a bridge circuit, three legs of which are fixed resistors, and the fourth (variable) leg the plate circuits of the a.g.c. controlled tubes. The bridge is balanced by means of the manual r.f. gain control, which, through its action of indirectly changing the plate resistance of the tubes, automatically adjusts the r.f. and i.f. gain to a predetermined level at the same time that the meter is brought to zero. The strength of the incoming signal is, therefore, accurately indicated by the action of the a.v.c. circuits in controlling high frequency gain.

² Credit for the novel mechanical design belongs to W. Graydon Smith, who tackled the job after a conference during a visit of W6ZH some months ago when he outlined to us his general views on the importance of improving the mechanical design features of high-frequency receiver tuning mechanisms.

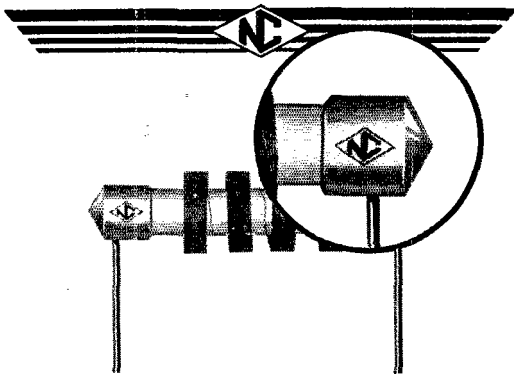

Appearance is much easier
to imitate than performance

PATENTED

NATIONAL COMPANY, INC.
MALDEN, MASS.



NEW!

LOG Book

See page 83

LEARN RADIO

70% Placement Last Three Years

At the oldest, largest and best equipped privately owned radio operating school in the East. Western Electric and RCA tube transmitters; 180 licensed graduates placed in past three years in broadcasting, shipping, police radio, aviation, service work, etc. Course prepares for all U. S. Government Telegraph and Telephone licenses. Send for 40-page catalog. Investigate. New classes every six weeks from Sept. 10th. Open all year around.

MASS. RADIO SCHOOL, 18 Boylston St., BOSTON
R. F. TROP, Treas. — EST. 1899 — G. R. ENTWISTLE, Pres.

ONE OF AMERICA'S LEADING RADIO SCHOOLS

HAVE YOU ENTERED SYLVANIA QSL CONTEST?

Enter now! See your nearest
*Sylvania specializing distribu-
tor or December issues R/9,
QST or Radio for further de-
tails. Begins December 4 —
ends February 4.

Hygrade Sylvania Corp.

ELECTRONICS DEPARTMENT

AMATEUR RADIO DIVISION

CLIFTON ■ ■ ■ NEW JERSEY

28 and 56 M.C.
TWIN-TRIODE
● TRANSCEIVERS
● DUPLEX UNIT
TRANSMITTER-
RECEIVERS

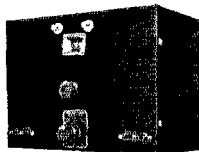

TRANSCEIVERS, each employing push-pull oscillator,
Class B modulator. 19, 53 or 6A6 tubes, 10" x 7" x 5".
\$22.50 and \$26.50

COMBINATION-TRANSMITTER-RECEIVER
UNITS, each with push-pull oscillator, Class B modu-
lator transmitter and separate receiver employing r.f.
stage. Built-in dynamic speaker. 10" x 14" x 5". 19, 53 or
6A6 tubes. \$36.75 and \$39.75

Bulletins on Request

RADIO TRANSCIEVER LABORATORIES
8427 105th Street Richmond Hill, N. Y.



SANGAMO
ACCURATE
CONDENSERS

A quality product for the amateur who
wants the best results. Available in
1000, 2500, and 5000 volt construction

Write for catalog sheet

SANGAMO ELECTRIC CO.
SPRINGFIELD, ILLINOIS

HAM-ADS

(1) Advertising shall pertain to radio and shall be of nature of interest to radio amateurs or experimenters in their pursuit of the art.

(2) No display of any character will be accepted, nor can any special typographical arrangement, such as all or part capital letters be used which would tend to make one advertisement stand out from the others.

(3) The Ham-Ad rate is 15¢ per word, except as noted in paragraph (6) below.

(4) Remittance in full must accompany copy. No cash or contract discount or agency commission will be allowed.

(5) Closing date for Ham-Ads is the 25th of the second month preceding publication date.

(6) A special rate of 7¢ per word will apply to advertising which, in our judgment, is obviously non-commercial in nature and is placed and signed by a member of the American Radio Relay League. Thus, advertising of bona fide surplus equipment owned, used and for sale by an individual or apparatus offered for exchange or advertising inquiring for special equipment, if by a member of the American Radio Relay League takes the 7¢ rate. An attempt to deal in apparatus in quantity for profit, even if by an individual, is commercial and takes the 15¢ rate. Provisions of paragraphs (1), (2), (4) and (5) apply to all advertising in this column regardless of which rate may apply.

Having made no investigation of the advertisers in the classified columns, the publishers of QST are unable to vouch for their integrity or for the grade or character of the products advertised.

QUARTZ—Direct importers from Brazil of best quality pure quartz suitable for making piezo-electric crystals. Diamond Drill Carbon Co., 719 World Bldg., New York.

RADIO engineering, broadcasting, aviation and police radio, servicing, marine and Morse telegraphy taught thoroughly. All expenses low. Catalog free. Dodge's Institute, Byrd St., Valparaiso, Ind.

1000W transformers (GE) 1100-2200-4400 volts each side centertap. Same as hundreds sold A.R.R.L. members. Dawson, 5740 Woodrow, Detroit, Mich. \$13.50.

QSLs, W8AXD, Smethport, Pa.

WANTED: QST's December 1915; all 1916 except August, December; September, October, November, December, 1917; all 1919; January, June, October, 1920. Must have covers in fair shape. Sumner B. Young, 705 1st National-Soo Line Bldg., Minneapolis, Minn.

QSLs, Free samples, Printer, Corwith, Iowa.

NEW RCA—Victor amateur receiver; National parts, receivers; Hammarlund, Cardwell, Electrad, Aerovox, Yaxley, RCA-DeForest "Acorns," 800, 801 in stock; RK-20, RK-19; Thor, Kenyon, Sprague, Bliley; Aerial wire, insulators, etc. Hatry & Young, Hartford.

SALE radio transmitting parts, tubes, condensers, etc. To close estate. Write for prices and list. M. McClintock, Elm Ave., Rahway, N. J.

SELLING out. Write for list. W2EYE.

WILL buy all used National, Hammarlund, etc. Cash paid. Schwarz's Radio Service, 15 Lawrence Ave., Dumont, N. J.

QSL cards, two color, cartoons, message blanks, stationery, snappy service. Write for free samples to-day. WIBEF, 16 Stockbridge Ave., Lowell, Mass.

SELL: All issues of QST from 1922. \$1 for each year. W9CDE.

SELL—brand new National AGSX complete. Power supply, tubes, dynamic speaker, 20-40-80-160 and set of B band coils. \$150. W9TJD.

CALLBOOKS—new WINTER 1934 Radio Amateur Call Book, many new pages of late W and VE calls, hundreds of new DX hams, is yours for \$1.25, or four issues (one year) for \$4.00 (in foreign countries \$1.35 and \$4.35, postpaid). W9FO-610 S. Dearborn, Chicago.

QSLs! SWLs! "W8DED prints the finest cards I've ever seen!" writes W8GIL. Stamp for samples. W8DED, Holland, Mich.

TRANSFORMERS—1200 watt 1200-2200-3200 each side \$21.50. 225 watt 600-800 each side, \$6.75. Frank Greben, W9CSE, 2012 S. Peoria St., Chicago, Ill.

SALE—used RCA 849 tube and sockets. Chromium plated bug. Write W9ACK.

TRADE—unused 1934 GREI course for d.c. sw receiver and cash, or what? Elmer, Cahokia, Eureka, Calif.

QSLs, samples, 2143 Indiana Ave., Columbus, Ohio.

CLASS B transformers—Universal for two or four 46's, 210's, 800's, RK18's, etc., \$7.75 pair postpaid anywhere in United States. 70 watts of audio from 46's. Write for details. W8UD, Douglas, Michigan.

FBXA tubes, four sets band spread coils, National power pack, RCA speaker, \$55. W2HAL, 35 East 9th St., New York. Stuyvesant 9-1925.

QSLs by Maleco. Finest in country. Free samples. Maleco, 1512 Eastern Parkway, Brooklyn, N. Y.

SELLING out—superhet receiver 3-stage 511 final xtal rig with power supplies; also Class B 203A modulator. Write for list. W2AGD.

AMATEUR equipment manufactured to order. Holmes C. Miller, Box 105, Palo Alto, Calif.

PATTERSON PR-12 \$89.70; standard lines of amateur and short wave parts, Cardwell, Ward Leonard, Speed-X, Signal, Raytheon, others; All-star receiver kits; xtals; used apparatus. Vinson Radio Co., W5VK, 2123 Broadway, Little Rock, Arkansas.

QSLs, SWLs, 200 \$1. Service 24 hours. W8ESN, 1827 Cone, Toledo, Ohio.

FOR sale—1934 National SW3 a.c. complete. \$25. Elmer Gruchow, Waterloo, Wis.

TELEPLEXES, Omnigraphs, receivers, meters, Vibroplexes, crystals. Bought, sold, traded. Ryan Radio Co., Hannibal, Mo.

SELLING out! Factory RK20 xmttr complete with tubes, similar rig page 27 August 1934 QST. Also FB7 receiver complete and high power merchandise. W9CIY, Jr., Hibbing, Minnesota.

CRYSTALS, guaranteed excellent oscillators, 80-160 meters, your approximate frequency, \$1. postpaid. W9FHS, 4433 N. Kilbourn, Chicago.

BLACK crackle enamel for transmitters—receivers. Half pint 75¢. Primer for porous surfaces, 65¢. Radio Specialty Labs., 340 Monroe, Brooklyn, N. Y.

WANTED—bug—used super, W8HVX.

BELL-Howell Filmo 35mm motion camera, tripod and head, complete for amateur or making marketable news shorts for income. Holmes Protector 110 v. a.c.-d.c. 1000 w. Suitable lodge, church, club or other income work. Want 1 kw xtal, cw-phone xmttr. W3AOL, Box 117, Bernardsville, N. J.

TRADE—quality sheet aluminum any gauge cut to your specifications. Want s.s. receiver hi-power cw, fone equipment. W8BKH.

PEERLESS a.c. frequency meter, \$12.50. 4 mfd. 1500 v \$2.50. Three tube d.c. receiver \$4.50. F. S. Smitz, 429 N. Central Ave., Chicago.

D.C. SW3, 2 sets coils, \$13. Steven L. Gabil, Box 333, Pinconning, Mich.

HAMMARLUND Comet Pro, perfect, complete, tubes, speaker, all coils. Make cash offer. W2GJH, 184-32 Edgewood Ave., Springfield, L. I.

CRYSTALS: Guaranteed excellent oscillators, 160 or 80 meters, your approximate frequency \$1.35 postpaid. Crystal Maker's blanks 1"-65¢, dozen \$6.00. Irregular shapes 25¢. Improved dust-proof Bakelite holders, non-exposed 1½" silvered electrodes, plugs into G.R. or tube socket mountings, any position, 75¢. Fisher Laboratory, 4522 Norwood, San Diego, California. "Pioneers of low priced crystals."

CRYSTALS: guaranteed 160-80 meter oscillators. Within five kilocycles, \$1.75. W8DDY, Sycamore, Ohio.

CRYSTALS—160-80 meters, within three kc., \$1.50. Guaranteed strong oscillators. Vollmer Radio Lab., 5126-35th St., San Diego, Calif.

QSLs, 75¢ a 100, two colors. Order from this ad or send for samples. W9DGH, 1816 5th Ave., N., Minneapolis, Minn.

TWO unused RCA 852s. One used 560. Want modulation equipment or receiver. W1BW.

SELL surplus National SW3, National HFC, dyn. frequency meter, 1000 v condensers, Weston meters, honeycomb coils, GR wavemeters, back numbers QST, Bliley xtals, Bargains. Cash only. Write for prices and list. W1WV, Chestnut Hill, Mass.

PREPAID—PATTERSON PR-12 Crackle cabinet complete \$82.00; With crystal \$37.90—Console \$99.65; With crystal \$105.55. Sargent 3-34 Complete \$49.50; Marine model (15 to 1500 meters) \$57.50. Patterson Pre-Selector \$17.84; Peak \$19.80. All shipped prepaid. Send for new issue "Amateur Transmitter" listing "Everything for the Ham." See our display ads this issue. L. I. MARINE & ELECTRIC CO. W2GOT-W2GRQ 163-18 Jamaica Avenue, Jamaica, N. Y.

GENERAL Electric 24/750 volt, 150 watt dynamotors, \$25. 12 volt input delivers 375. 500 cycle 500 watt 110-220 volts \$7.50. 6-15 volt d.c. 500 watts, \$10. Henry Kienzle, 501 E. 84th St., New York.

NEW and used Weston, Jewell meters at bargain prices. All types. Perfect condition. Individually checked. Free bulletin. W2EDW, Far Rockaway, N. Y.

QUARTZ—for piezo electric crystals. Direct import from Brazil. F. Baumgardt, 198 Broadway, New York City.

NEED cash sacrifice 150 watt xtal xmitter, 3 power supplies; 4 stages. Details, \$75. W9HSG.

WIRE—small sizes magnet wire at amateur prices. Also 110v a.c. Alternator for car 60 cycle 125 watt. Need auditorium dynamics. Seikel Labs, Dover, Ohio.

CRYSTALS—Eighty meters. 1" "X", within three kilocycles, \$1.95. Unconditionally guaranteed. Bakelite Holders, \$7.75. "Ham Crystals", 1104 Lincoln Place, Brooklyn, N. Y. QSTs, vols. X, XIII, bound. Make offer. Howard Schreiber, WABC, New York.

WANTED: IP500 or 5B type receiver, loading coils and amplifier tuning 175 to 25,000 meters or Kennedy Universal receiver type 110 tuning 175 to 28,000 meters, with type 525 amplifier. Sumner B. Young, 705 First National-Soo Line Bldg., Minneapolis, Minn.

SELL—transmitter, 212Ds, transmitting condensers, miscellaneous parts. Write for list. W9CFU.

FOR sale or trade, slightly used 849, 211s, National SW3 and coils, Philco SH converter, xtal Class B 75 m phone and c.w. rack-panel wired and tested. Need FB7X or Comet Pro. W4BPF, Albany, Ga.

CRYSTALS: 160 and 80 meters, \$1.25, 40 meters, \$3. Approximate frequency. Guaranteed. W9KPV, Joplin, Mo.

SELL—swap nearly new RCA880, \$12.50. W8JWC.

CASH for your late PR-10 or Comet Pro. W8FUJ, Utica, Mich.

SELL—Patterson PR-10. Henry Luhrman, CMA, Culver, Ind. 866's, heavy duty, 1000 hour guarantee, \$1.85 postpaid. Eimac and Taylor tubes. Panels; chassis; custom-built transmitters. Howard Radio, 5648 Race Ave., Chicago. Phone Austin 0177.

CRYSTALS, receiving and power. Low quantity prices. Star Crystal Co., 1935 Hazelwood Ave., Detroit, Mich.

CASH prizes—equipment for QSL designs. Send 4¢ stamps for details. Capital Advertising Service, Harrisburg, Pa.

CRYSTALS: inch square power ground, unconditionally guaranteed. X-cut 80-160 meters within 5 kc. \$2; exact frequency kcs. \$2.50, 40 meters 25 kcs. \$3; 5 kcs. \$3.75. Blanks 65¢, \$6.00 dozen. Gentry Labs., 803 W. Maple, Independence, Mo.

SELL used broadcast and short wave equipment. Write for list. White Radio Lab., Sandpoint, Idaho.

STAMP size pictures for QSLs, 25 for 25¢. Rolls developed for amateurs, 8 prints 25¢. Other photo needs priced accordingly. Dixie Photo Service, Box 230, Port Orange, Fla. W4BRV.

50 Watters, \$7.50; 203As and 854s, new. Amateur Service, Fairview, N. J.

CRYSTALS, guaranteed. 160-80 meter, less than 1", X or Y, plus or minus ten kilocycles, \$1.35. Plus or minus two kilocycles, 1", \$2.25. Blanks, 60¢. Odds and ends five for \$1; oscillating 85¢. Grinding instructions 25¢. Holder, \$1. Speedy service. Wm. Threm, W8FN, 4021 Davis Ave., Cheviot, Ohio.

CRYSTALS: 160-80 meter: trade for tubes, meters, transformers. Wm. Threm, W8FN, 4021 Davis Ave., Cheviot, Ohio.

MORE output—less outlay, 50 to 100% more capacity than competing lines. Power, Class B equipment. Edison battery headquarters. Relay racks. Add that finishing touch (Page 27 November QST). See October Hamad. Rectifier Engineering Service.

HAM equipment bought, sold or traded. Distributors of all nationally known Ham apparatus. Write for catalog. Walter Ashe Radio Co., St. Louis, Mo.

TRADE Seth-Thomas Ship-Strike Clock for ham junk or wot hv u? Good time keeper; fb for fone station; answer all letters. W6LM.

WANTED: For Ham Antique Collection—Radiola 2—portable. DeForest Audion Panel, bulb. Any other early radio equipment. Answer all letters. W6LM.

QSLs! Bigger and Better! W6FZQ, Box 1804, Phoenix, Arizona.

TRADE—Gibson mandolin in perfect condition. Cost \$125. Want 1000-1250 volt transformer and meters. Don Farrell, SCM-WNY, 213 Hickok Ave., Syracuse, N. Y.

REPAIRS: Microphones, meters, broadcasting equipment, electronic devices, instruments. Prompt repair service. Low prices. Estimates on request. Sound Engineering Corp., 2300 Kinzie, Chicago.

A-C-CURRENT-ANYWHERE!

WITH KATO LIGHT PLANTS

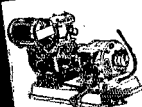

A little gas and a kato AC plant enables you to operate AC radios, amplifiers, transmitters and other standard household appliances. Sizes 300 watts and up. Write for interesting descriptive literature on AC and DC models. Prices \$99.00 and up.

KATO ENGINEERING CO. Mankato, Minn., U. S. A.
 AC Generators, \$16.00 and up. Converters for operating AC radios from 6, 12, 32 and 110 volts DC \$18.00 and up.

NEWARK

offers Immediate
Shipment of the

RCA ACR-136 RECEIVER—

7-Tube Superheterodyne, 460 K.C.

Intermediate Frequency. Frequency range 540 to 18,000 K.C., continuous in 3 bands. Dial is calibrated in K.C. and megacycles. Vernier pointer makes 9 revolutions while main pointer covers one band. Power supply and 5" full electrodynamic speaker built in. Complete with coils and tubes — ready to operate. Send for complete descriptive circular.

Amateur's
Net
Price

\$69⁵⁰

NEWARK Transmitting Condensers

All enclosed in black crackle finish metal case. Angle mountings. Paper condensers. Porcelain insulated leads. A real value.

- 1 mfd — 1000 working volts, D.C. Size 3" x 1 3/4" x 4", Wt. 1 1/2 lbs. **\$.95**
- 1 mfd — 1500 working volts, D.C. Size 3" x 2 3/4" x 4", Wt. 2 lbs. **1.29**
- 2 mfd — 1500 working volts, D.C. Size 3 3/4" x 4" x 5", Wt. 4 lbs. **2.19**

NEWARK ELECTRIC COMPANY

226 W. Madison St., Dept. Q, Chicago

Send for FREE CATALOG

The Radio Amateur's LICENSE MANUAL

(No. 9 in the series entitled
The Radio Amateur's Library)

A NECESSITY for the beginner — equally indispensable for the already licensed amateur. Going after your first ham "ticket"? You need the manual for its instructions on where to apply, how to go about it in the right way — and, most important of all, for the nearly 200 typical license exam. questions and answers. Already got a license? The manual is still necessary — for its dope on renewal and modification procedure, the Class A exam. (with questions and answers), portable procedure, etc.

All the dope on every phase of amateur licensing procedure, and, of course, the complete text of the new regulations and pertinent extracts from the basic radio law.

ORDER YOUR COPY TODAY

25c postpaid (no stamps, please)

AMERICAN RADIO RELAY LEAGUE
West Hartford, Conn.

Your Nearest Dealer

Your nearest dealer is entitled to your patronage. You can trust him. He is equipped with a knowledge and understanding of amateur radio. He is your logical and safe source of advice and counsel on what equipment

Patronize the dealer nearest you—

<p>ALLENTOWN, PENNSYLVANIA Radio Electric Service Co. 1024 Hamilton Street Complete stocks transmitting equipment</p>	<p>CHICAGO, ILLINOIS Mid-West Radio Mart 520 S. State Street All standard lines carried in stock</p>
<p>BALTIMORE, MARYLAND Radio Electric Service Co. 303 W. Baltimore Street Everything for the amateur</p>	<p>CLEVELAND, OHIO Northern Ohio Laboratories 2073 West 85 Street Wholesale Distr. for National, Hammarlund, Thorderson, Cardwell</p>
<p>BOSTON, MASSACHUSETTS Nutter & Cross, Inc. 99A Milk Street All OMs, OWs, and YLs welcome — W1HRF</p>	<p>DENVER, COLORADO Inter-State Radio & Supply Co. 1639 Tremont Place Amateur Radio Headquarters in the Rocky Mountain Region</p>
<p>BROCKTON, MASSACHUSETTS Ware Radio Supply Company 913 Centre Street Hammarlund, Sylvania, Ohmite, Raytheon, Triplett Meters</p>	<p>DETROIT, MICHIGAN Radio Equipment Sales Co. 14036 Woodward Avenue, Highland Park A complete stock of amateur, shortwave and service parts</p>
<p>BUFFALO, NEW YORK Dymac Radio 216 E. Genesee St. — Tel. Cl. 2080 Complete Stock Amateur Parts — Standard Discounts — W8AWK</p>	<p>DETROIT, MICHIGAN Radio Specialties Company 171 E. Jefferson Avenue Ham Supplies — National & Hammarlund Sets and Parts</p>
<p>BUFFALO, NEW YORK Kronson Service Company 143 East Genesee Street Western New York's largest wholesale distributors — W8EHF</p>	<p>DETROIT, MICHIGAN Serlin 1419 Broadway Detroit's Pioneer Radio Merchants</p>
<p>CHICAGO, ILLINOIS Allied Radio Corporation 833 West Jackson Blvd. Complete standard lines always in stock — W9NRV — W9RZ1</p>	<p>ERIE, PENNSYLVANIA Jordan Radio Laboratory 2512 Peach Street Amateur, service parts, including Bliley, National, Raytheon, W8CXG</p>
<p>CHICAGO, ILLINOIS Chicago Radio Apparatus Company 415 South Dearborn Street (Est. 1921) W9RA and W9PST — Amateurs since 1909</p>	<p>HARTFORD, CONNECTICUT Radio Inspection Service Company 227 Asylum Street What do you need? We have it</p>
<p>CHICAGO, ILLINOIS Newark Electric Company 226 W. Madison Street Chicago's oldest radio parts store — established 1921 John T. Wallace, Technical Adviser</p>	<p>HOUSTON, TEXAS Straus-Frank Company Distributors for nationally advertised amateur products RCA-DeForest transmitting tubes</p>
	<p>JACKSONVILLE, FLORIDA Glover Weiss Co. Radio Headquarters for Southeast Distributors: RCA, Victor, Stromberg-Carlson, Standard Ham Lines</p>
	<p>KANSAS CITY, MISSOURI Burstein-Applebee Company 1012-14 McGee Street "Specialists" in supplies for the Amateur and Serviceman</p>
	<p>KANSAS CITY, MISSOURI Radio Laboratories 1515 Grand Avenue Amateur Headquarters — Complete Stock — Quality Parts</p>

This advertisement is paid for by the firms listed above. Qualified dealers

Is Your Best Friend

you should buy. His stock is complete. He can supply your needs without delay. His prices are fair and consistent with the high quality of the goods he carries. He is responsible to you and interested in you.

You can have confidence in him

LOS ANGELES, CALIFORNIA Pacific Radio Exchange, Inc. 729-31 South Main Street <i>Most completely diversified stock of amateur equipment in the West</i>	ST. PAUL, MINNESOTA Lew Bonn Company 2484 University Avenue Rex L. Munger, W9LIP, Sales Engineer Radio Wholesaler Complete Stock
MANCHESTER, NEW HAMPSHIRE Radio Service Lab. of N. H. 1008 Elm Street — Tel. 218-W Branches — Portland, Me. and Barre, Vt.	SAN ANTONIO, TEXAS Straus-Frank Company Distributors for nationally advertised amateur products RCA-DeForest transmitting tubes
MILWAUKEE, WISCONSIN Radio Parts Company, Inc. 332 West State Street Complete stock Nationally Known products	SAN FRANCISCO, CALIFORNIA Offenbach Electric Company, Ltd. 1452 Market Street "The House of a Million Radio Parts"
NEWARK, NEW JERSEY Kaltman & Romander 62 Court Street Drop in for an over-counter QSO	SIoux CITY, IOWA Warren Electric Co. Standard Lines and Discounts T. J. Morris, W9SSN, Mgr. Parts Dept.
PEORIA, ILLINOIS Klaus Radio & Electric Co. 707 Main Street Amateur Radio Department	SPRINGFIELD, MASSACHUSETTS T. F. Cushing 349 Worthington Street An amateur, endeavoring to sell good parts
PHILADELPHIA, PENNSYLVANIA Consolidated Radio Corp. 612 Arch Street Ham receivers, Transmitting tubes, Collins Transmitters, etc.	SYRACUSE, NEW YORK Roy C. Stage, W8IGF Complete stock of standard Ham & BCL parts Standard Discounts. Free technical service
PHILADELPHIA, PENNSYLVANIA Freeland Radio Supply Co. 5 N. 7th Street "If it's radio we have it"	TORONTO, CANADA A & A Radio Service Supply 101 Queen Street, West Canada's foremost radio supply house
PHILADELPHIA, PENNSYLVANIA Radio Electric Service Co., Inc. N. E. Cor. Seventh & Arch Sts. All nationally advertised lines in stock	TORONTO, CANADA Wholesale Radio Company, Limited 1133-39 Bay Street Canada's Largest Amateur Supply House
PHILADELPHIA, PENNSYLVANIA Eugene G. Wile 10 S. Tenth Street Complete Stock of Quality Merchandise	TRENTON, NEW JERSEY American Radio Co. 5 N. Broad Street Central Jersey's leading radio parts store
PROVIDENCE, RHODE ISLAND W. H. Edwards & Company 32 Broadway, Room 23 Amateur Equipment — National, Hammarlund, RCA Tubes	WASHINGTON, D. C. George's Radio Co. 816 F Street, N.W. Washington's largest distributor of radio parts

are invited to apply for rates, etc., to Advertising Department, QST

Say You Saw It in QST — It Identifies You and Helps QST

You Are Protected When You Buy From QST Advertisers

“Advertising for QST is accepted only from firms who, in the publisher’s opinion, are of established integrity and whose products secure the approval of the technical staff of the American Radio Relay League.”

Quoted from QST’s advertising rate card.

Every conceivable need of a radio amateur can be supplied by the advertisers in QST. And you will know the product has the approval of the League’s technical staff.

For Your Convenience

QST’S INDEX TO ADVERTISERS IN THIS ISSUE

Aerovox Corporation	94
Allen Bradley Company	81
A.R.R.L. Application Blank	104
Back Copies	74
Binder	97
Bound Volume	95
Emblem	90
Handbook	85
License Manual	107
Log Book	83
Message File	89
Birnback Radio Company	88
Bliley Electric Company	79
Burgess Battery Company	2
Cameradio Company	99
Capitol Radio Engineering Institute	94
Cardwell Mfg. Corp., Allen D.	87
Central Radio Labs	78
Clough-Brengle Co.	101
Collins Radio Company	Cov. 2
Cornell Dubilier Corp.	102
Cornish Wire Company	101
Delaware Radio Sales Co.	89, 103
Delta Mfg. Company	92
Dodge’s Institute	98
Eastern Radio Specialty Co.	97
Eitel-McCullough, Ltd.	96
Electrad, Inc.	91
General Electric Company	112
General Radio Company	95
Gross Radio, Inc.	70, 71
Gulf Radio School	97
Hallcrafters	73
Hammarlund Mfg. Company	4
Harvey Radio Labs	99
Henry Radio Shop	99
Hygrade Sylvania Corp.	1, 99, 101, 103, 105
Instructograph Company	92
Johnson Company, E. F.	96
Kaltman & Romander	86
Kato Engineering Labs.	107
Leeds	77
L. I. Marine & Electric Co.	82
Litelfuse Labs	91
Lynch, Inc., Arthur H.	98
Manhattan Electric Bargain House	98
Massachusetts Radio School	105
Midwest Radio Mart	95
National Carbon Company	76
National Company	69, 103, 105, Cov. 3
Newark Electric Company	107
New York YMCA Schools	103
Onan & Sons, D. W.	103
Port Arthur College	91
Precision Piezo Service	99
Premier Crystal Lab.	91
RCA Institutes, Inc.	100
RCA Radiotron Company, Inc.	Cov. 4
RCA Victor Company, Inc.	83
Radio Mfg. Engineers	88
Radio Shack	93
Radio Supply Company	92
Radio Transceiver Labs	105
Raytheon Production Corp.	72
Sargamo Electric Company	105
Scientific Radio Service	109
Shure Brothers Company	100
Signal Electric Mfg. Company	97
Teleplex Company	101
Thordarson Electric Mfg. Co.	80
Triplet Electrical Instrument Co.	84
Turner Company	101
United Radio Mfg. Co.	99
Vibroplex Company	102
Ward Leonard Electric Company	93
Wilcox Radio Sales	93
Yaxley Mfg. Company	111

READ WHAT THEY SAY

about this amazingly complete
and authoritative Service Manual

VANCOUVER, B. C. "The new line of Yaxley Controls is the greatest improvement ever. The Manual is perfect."

BOSTON, MASS. "Any service man without the new Yaxley Replacement Volume Control Manual has no business servicing radio sets. He can't be up-to-date in any other way. The controls are swell."

SAN JOSE, CAL. "I have used your volume controls for some time in my servicing and congratulate you on an even finer product."

SAN FRANCISCO, CAL. "We have never stocked your controls before, but from now on we are 100% Yaxley."

DALLAS, TEXAS. "I have been waiting for this for years, wondering why someone didn't do it. The controls are beautiful, simple to install and work better than anything I have ever used."

FINDLAY, O. "The work in compiling this information must have taken months. It is splendid."

PONTIAC, MICH. "Your volume control catalog is the finest I have seen."

LANCASTER, O. "Just what the service man needs."

NEW YORK CITY, N.Y. "Complete isn't the word. The manual is perfect."

PASADENA, CAL. "Thanks, the manual is perfect."

NORFOLK, VA. "Congratulations on your progressive move. The Manual is certainly complete and the merchandise better than we believed it could be possible to make. We wish you the best of success."

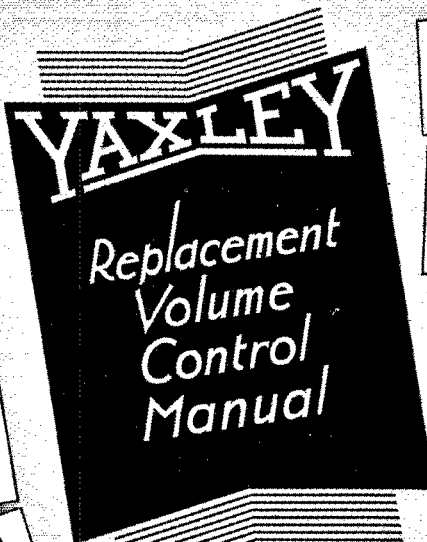

Mail this Coupon Now

The comments above are just a few picked at random from a tremendous number of enthusiastic letters received from service men the country over. Send the coupon now for this free illustrated book of more than 100 pages that contains invaluable

information and lists the 30 new Yaxley Replacement Volume Controls that will service 98% of the 3200 set models now in existence. Get the full facts about the greatest volume control advance ever made — the biggest boon to service men ever developed.

YAXLEY MANUFACTURING CO., INCORPORATED
Division of P. R. Mallory & Company, Incorporated
Indianapolis, Indiana

Cable Address: Pelmallo

YAXLEY MANUFACTURING CO., INC.
Division of P. R. Mallory & Co., Inc.
Indianapolis, Indiana



Gentlemen:

Please send me — absolutely free — a copy of the complete Yaxley Volume Control Manual.

Name

Address

My Jobber's name is

Less noise and more signal...
MORE USEFUL SENSITIVITY

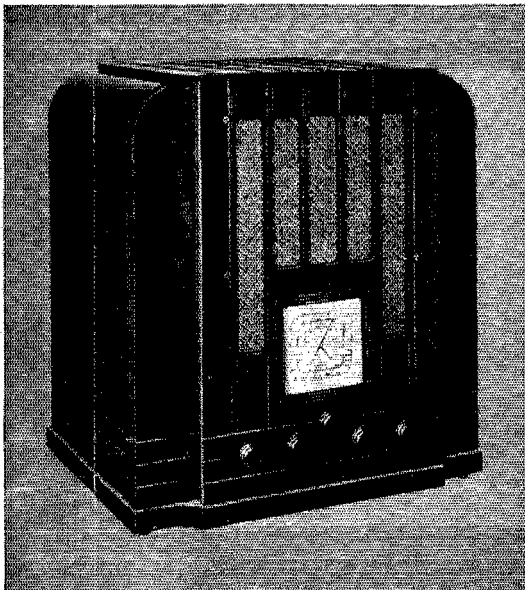

**G-E Model M-81
 All-Wave \$9750**

Other models from \$44.95 to \$375.00
 (Prices slightly higher West, Midwest and South)
 Subject to change without notice.

In standard broadcast reception, the useful sensitivity of a radio receiver is ordinarily limited only by extraneous noise or interference picked up by the antenna. In short-wave reception, however, especially below 40 meters, set noise or "tube hiss" becomes the factor which limits the ability of a receiver to give good reception on weak signals.

General Electric All-wave Receivers, because they are designed and constructed with that condition in mind, have extraordinary ability to perform well on weak short-wave signals. An extremely low level of set noise is obtained by the careful apportioning of amplification to radio, intermediate, and audio frequency stages of the instrument.

Don't attempt to judge the ability of a receiver when the bands are "hot." Then almost any radio will perform well. Listen to a G-E All-wave Receiver on one of those "dead" bands. You will get the surprise of your life!

C.W., TOO!

If you are interested, this receiver can be adapted for C.W. reception. Mail the coupon for full information.

GENERAL ELECTRIC COMPANY
 Radio Sales Section, R-151, Bridgeport, Conn.
 Please send me full information on adapting M-81 G-E Radio for C.W.

Name.....
 Street Address.....
 City.....State.....

GENERAL  ELECTRIC

ALL-WAVE RADIO

MERCHANDISE DEPARTMENT, GENERAL ELECTRIC COMPANY, BRIDGEPORT, CONNECTICUT

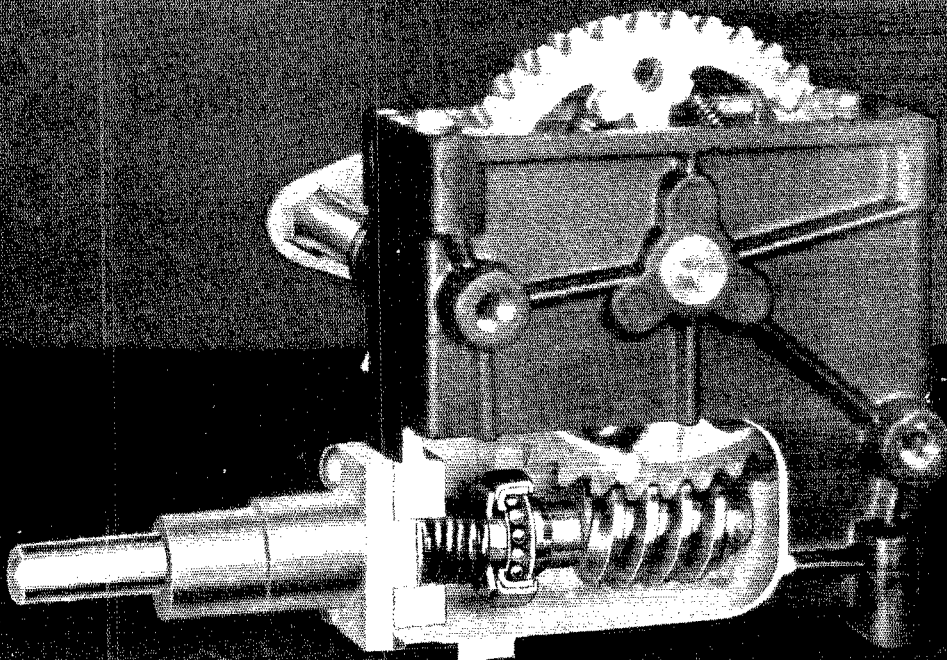

Regarding a product such as the new PW Condenser, no better advertisement can be written than a plain description of its design features. The drive is smooth and positive, through a steel worm and accurately hobbled worm gear, preloaded with springs to eliminate backlash and wear. The worm bearing is conical with a ball-bearing thrust, spring-loaded to take up wear. The entire drive is enclosed, the ratio being 20 to 1. The rotor shaft is $\frac{3}{8}$ " in diameter, grounded in the center, and rotating in insulated bronze bearings at the ends. There are four radial bearings, and two ball thrust bearings. Each rotor is individually insulated, contact being made through a four-leaved brush. Plate shape is straight-line frequency, and Stator insulation is Steatite. It is made with one, two, three or four sections. The dial is of a new micrometer type having an effective scale length of twelve feet, and reading to one part in five hundred. As the dial and condenser sections are floating, the condenser is immune to distortion from warping of the panel or chassis.

Equally suitable for laboratory instruments, or for the finest High Frequency Receivers, we feel that the use of the PW Condenser is indicated wherever high precision in calibration is desired.

NATIONAL COMPANY, INC., MALDEN, MASS.

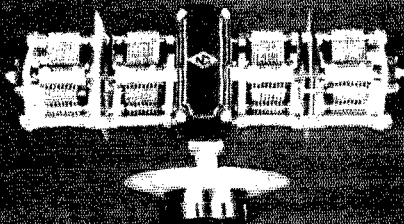
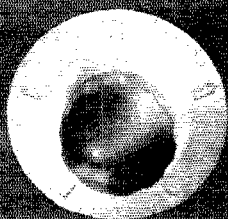
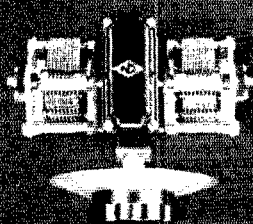

Time Out for a New Year's Greeting



We have so much of a serious nature to tell you that in the normal course of events the use of the whole back cover of QST just to say "Happy New Year" would seem like gross extravagance. As a matter of fact, this space was originally reserved for an important announcement on a tube every amateur should have. Then, at probably the very last moment it was possible to make a change (QST was entirely in type, actually going on the press), we found that we simply had to postpone that announcement until next month. Ordinarily this would be cause for disappointment and chagrin, but to be entirely truthful, Jack Warner, John Reinartz, Ed Spitzer, Bob Burnap, Ed Hughes and the rest of the Radiotron group to whom amateur activities come especially close to home, are secretly pleased that fate has made imperative what their conscience wouldn't let them do—use valuable advertising space for a simple New Year's greeting. We are in a reckless mood. Instead of writing the QST staff a thank-you letter, we are going to use a part of this space (this part) to say we think it was darn swell of them to make this last-minute substitution. Happy New Year! P.S. You'll hear about that important announcement next month.

RCA deForest Amateur Radio Division
RCA RADIOTRON CO., INC., CAMDEN, N. J.