

GERALD L. WEIDT

NOV 1954
\$0.50

QST

developed especially for amateur radio

Each issue
5-Meter DX
with
Effective
Antennas



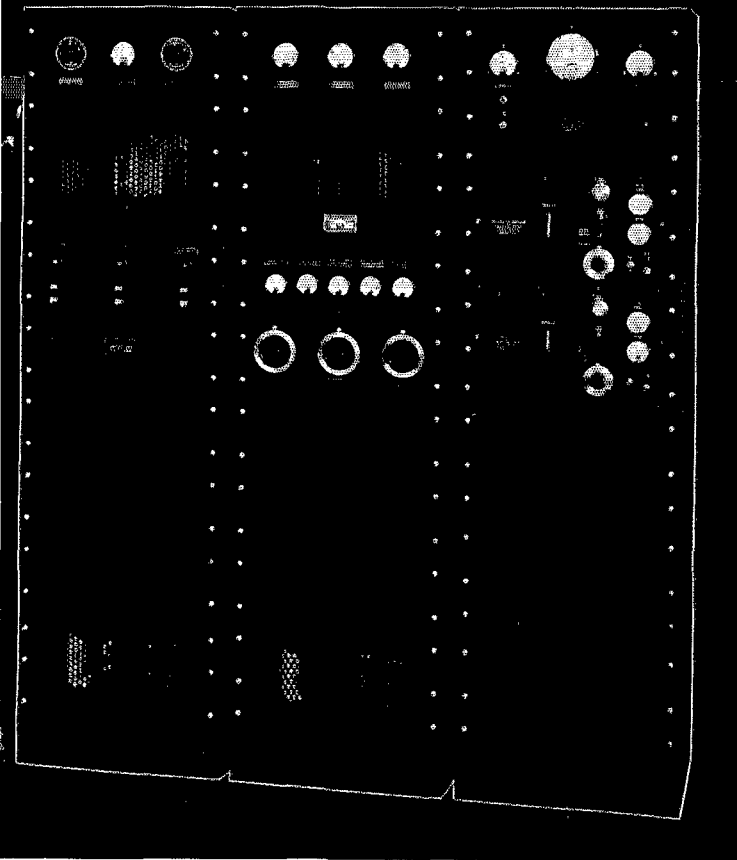

**COLLINS OFFERS A 250-
WATT RADIOPHONE
INSTALLATION WHICH
IS FAR IN ADVANCE OF
THE GENERAL TREND
OF STATION DESIGN**

COLLINS 300B RADIOPHONE TRANSMITTER

EXCELLENT MECHANICAL DESIGN

Complete Protection Against Adverse Weather Conditions with Corrosion-proof Metals and Alloys, Vacuum Impregnated Transformers, Oil Filled Filter Condensers, Isolantite, Pyrex and Micalex Insulation.

EFFICIENT — ECONOMICAL

High Level Class "B" Modulation, Low Operating Cost, Low Installation Cost, Moderately Priced Speech Equipment (COLLINS 12B).

HIGH FIDELITY

Uniform Frequency Response (30-10,000 CPS), Minimum Audio Harmonic Content at 100% Modulation.

SIMPLE OPERATION

No Generators or Batteries, Entirely Self-Contained and AC Operated, Complete Metering, Automatic Starting, Fixed Neutralization, Minimum Tuning Operations, Installation Usually Completed in a Few Hours.

PRECISION FREQUENCY CONTROL

Precision Temperature Controlled Oscillator and Frequency Monitor Optional.

MODERN APPEARANCE

Rack Cabinets Finished in Lustrous Black Crinkle with Aluminum on Interior, Aluminum Front Panels, Aluminum Radio Frequency Chassis, Small Metal Parts Nickel Plated.

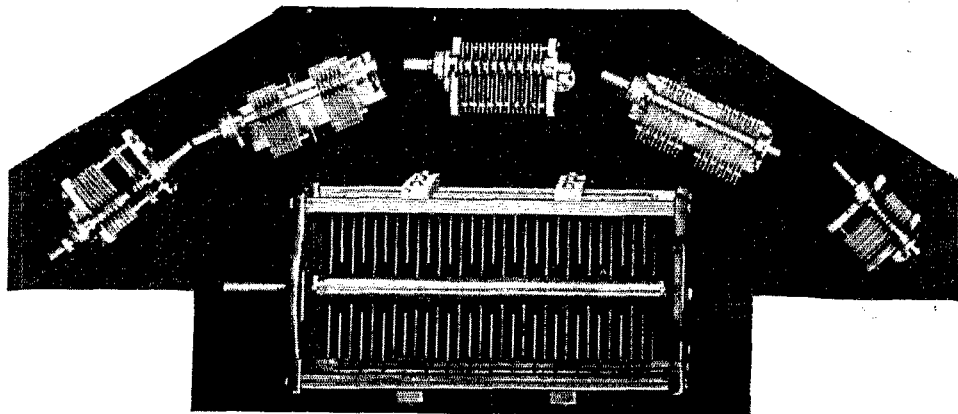

HAMMARLUND for HAMS

THE HAMmarlund catalog bristles with devices every HAM needs—devices proved by 33 years of engineering experience and time-tried tests by radio leaders throughout the world.

Condensers, Chokes, I.F. Transformers, Coils, Coil Forms, Shields, Sockets for all receiving and transmitting requirements.

And not forgetting the superior COMET "PRO" 8-to-550-meter Professional Superheterodyne, which every amateur respects even if he doesn't own one.

Mail the coupon for your free copy of the Hammarlund Catalog.

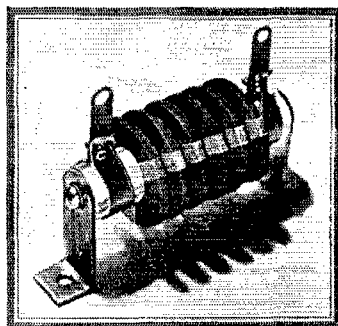

HEAVY-DUTY TRANSMITTER CHOKE

New "XP-53" LOW-LOSS COIL FORMS and COILS

REMARKABLY efficient due to the new "XP-53" low-loss dielectric. Rugged, durable, good looking, *low-priced*. No artificial coloring. Ribbed for air-spacing. Easy grips with "Meter-Index." 4, 5, or 6-prong forms, 35c each list. Set of four 4-prong coils (15-220 meters), \$3 list. Set of four 6-prong coils (15-220 meters), \$3.75 list. Other coils for lower or higher ranges. Silver-plated secondaries on the higher-frequency (10 to 75 meters) coils.

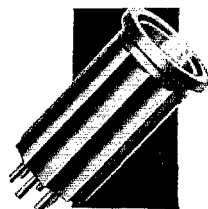

HAMMARLUND MANUFACTURING CO.
424-438 W. 33rd St., New York

- Check here and attach 10c for 16-page Hammarlund 1935 Short-Wave Manual, illustrating and describing most popular S-W circuits of past year, with schematic and picture diagrams and parts lists.
- Check here for FREE information on XP-53 Forms and Coils.
- Check here for FREE General Catalog.

Name.....
Address.....
.....Q-10

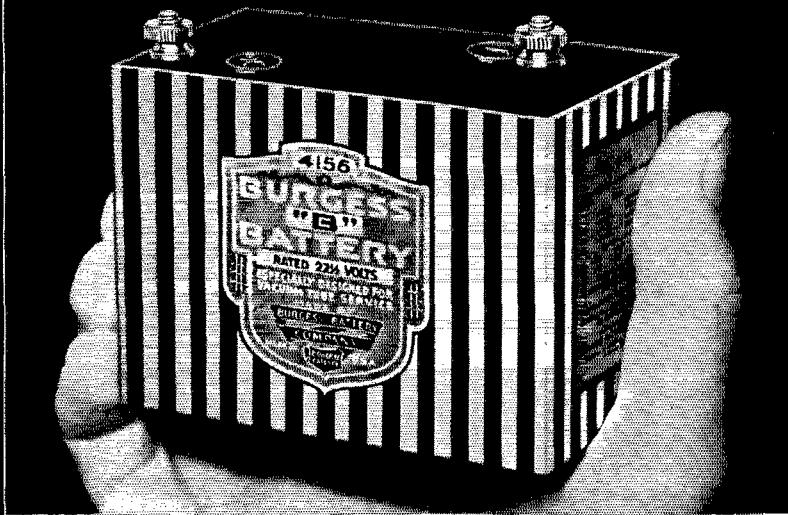

IT TOOK A WAR TO DEVELOP THIS BATTERY

THE 4-15-6 "B" BATTERY

America had plunged into the World War. American military needs demanded a new "B" battery of almost impossible specifications. The War Department set up these requirements: "Must deliver $22\frac{1}{2}$ volts, must be no larger than $3\frac{3}{8}'' \times 2'' \times 2\frac{1}{2}''$ ", weigh no more than one pound, must have storage life of 100 days." ● Burgess answered the challenge with the remarkable "4-15-6", shown above. Notable developments during the past 17 years of continuous production have increased shelf life to one year, improved portability, perfected seamless zinc cans. Its general appearance, however, remains the same: 15 tiny No. 4 cells connected in series, delivering $22\frac{1}{2}$ volts. ● Our Specialty Division has answered many a special dry battery requirement. A recent development is a flexible $22\frac{1}{2}$ volt battery which weighs only $5\frac{1}{2}$ ounces. If you have a new or special battery need, write us.

Burgess Battery Company, Freeport, Illinois, U. S. A.

≡ BURGESS ≡

QST

Published monthly, as its official organ, by the American Radio Relay League, Inc., at West Hartford, Conn., U. S. A.; Official Organ of the International Amateur Radio Union

devoted entirely to

AMATEUR RADIO

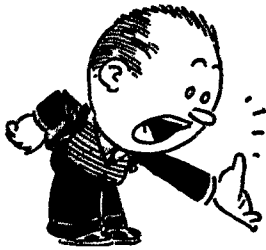

Editorials	9
Extending the Range of Ultra-High Frequency Amateur Stations <i>Ross A. Hull</i>	10
Tailoring Tuned R.F. Transformers for Short-Wave Receivers <i>L. W. Hatry</i>	14
Third Corps Area Asks Amateur Help. <i>H. O. Bixby</i>	16
Technical Topics	17
A New Standard System of Reporting Signals <i>Arthur M. Braaten, W2BSR</i>	18
What the League Is Doing	20
Amateur Radio in the Soviet Union <i>John D. Kraus, W8JK</i>	22
With the Affiliated Clubs	23
A Pentode Output Transmitter With Six-Band Exciter <i>James Millen, W1HRX</i>	24
Coming Conventions	28
Applying the Tri-Tet Principle to Frequency Multipliers <i>Frank M. Davis, W9FVM-W5CR</i>	29
The Melbourne Centenary International DX Contest <i>R. H. Cunningham, VK3ML</i>	33
For the Experimenter	
SINGLE-TUBE HEAD AMPLIFIER FOR CONDENSER MICROPHONE-LINK-COUPLED TNT AMPLIFIERS—5-METER ANTENNA FOR THE CAR—KEY-THUMP KINKS—BOOSTING THE PLATE VOLTAGE—BATTERY GRID BIAS—EASILY MADE HIGH-VOLTAGE SWITCH—PARTIAL APPLICATION OF CRYSTAL-LOCK SYSTEM—GOVERNING THE WIND GENERATOR—NOTES ON 14-MC. C.C. TRANSMITTERS—METERING INDIVIDUAL TUBES IN PUSH-PULL CIRCUITS	35
Spreading Out the Calibration Curve	39
Canada-U. S. A. Contact Contest	40
Amateur Radio Stations <i>W6RJ-WLVB, W8GQ, W2BJ</i>	41
Amateurs Undertake Ocean Flight	42
I. A. R. U. News	43
Operating Notes	45
Correspondence Department	59
N. E. Div. Conv.	86
Standard Frequency Transmissions	101
Silent Keys	104
Hamads	110
QST's Index of Advertisers	114

OCTOBER
1934

VOLUME XVIII
NUMBER 10

Kenneth B. Warner (Secretary, A.R.R.L.), Editor-in-Chief and Business Manager; Ross A. Hull, Associate Editor; James J. Lamb, Technical Editor; George Grammer, Assistant Technical Editor; Clark C. Rodimon, Managing Editor; David H. Houghton, Circulation Manager; F. Cheyney Beckley, Advertising Manager; Ursula M. Chamberlain, Assistant Advertising Manager.

Editorial and Advertising Offices
38 La Salle Road, West Hartford, Conn.

Subscription rate in United States and Possessions and Canada, \$2.50 per year, postpaid; all other countries, \$3.00 per year, postpaid. Single copies, 25 cents. Foreign remittances should be by international postal or express money order or bank draft negotiable in the U. S. and for an equivalent amount in U. S. funds.

Entered as second-class matter May 29, 1919, at the post office at Hartford, Connecticut, under the Act of March 3, 1879. Acceptance for mailing at special rate of postage provided for in section 1103, Act of October 3, 1917, authorized September 9, 1922. Additional entry at Concord, N. H., authorized February 21, 1929, under the Act of February 28, 1925.

Copyright 1934 by the American Radio Relay League, Inc.
Title registered at United States Patent Office.

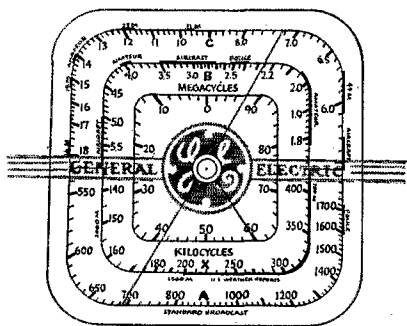

AT LAST!

BAND-SPREAD AND ACCURATE LOGGING FOR SHORT-WAVE RECEPTION

GENERAL ELECTRIC BAND-SPREAD DIAL
General Electric's new Band-spread Dial—by means of a separate scale and needle geared to the main tuning needle—makes possible the accurate recording of dial settings for many short-wave stations, the logging of which otherwise would be practically impossible.

GENERAL ELECTRIC RADIO—Model M-81 has many other distinctive features:

Fine tuning anywhere from 540 to 18,000 kilocycles. Dual tuning ratio of 50 to 1 and 10 to 1, either ratio being instantly obtained.

This receiver is quickly and easily adapted for C. W. without chassis changes. See the coupon below if you want complete details.

Outside noise may be minimized through the use of a double-doublet receiving antenna, for easy attachment of which provision is made in the receiver.

High-gain 6-watt audio system, feeding a large, built-in, dynamic speaker.

Four frequency bands: 140-410 kilocycles, 540-1720 kilocycles, 1720-5400 and 5400-18000 kilocycles. The band indicator identifies at a glance the frequency range in use.

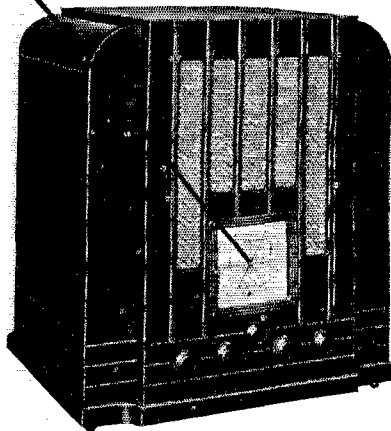

General Electric All-wave receiver—Model M-81. Priced at \$97.50 complete—nothing else to buy. (Prices slightly higher in West, Mid-West and South, subject to change without notice).



GENERAL ELECTRIC COMPANY
 Radio Sales Section, R-6710, Bridgeport, Conn.

Please send me, without charge or obligation, full technical details of the M-81 receiver. My special interests are checked below.

Name.....

Street.....

City..... State.....

New receiving antenna data Using the M-81 for C. W. I do radio service work

Section Communications Managers of the A.R.R.L. Communications Department

All appointments in the League's field organization are made by the proper S.C.M., elected by members in each Section listed. Mail your S.C.M. (on the 16th of each month) a postal covering your radio activities for the previous 30 days. Tell him your DX, plans for experimenting, results in 'phone and traffic. He is interested, whether you are an A.R.R.L. member or get your *OST* at the newsstands; he wants a report from every active ham. If interested and qualified for O.R.S., O.P.S. or other appointments he can tell you about them, too.

Eastern Pennsylvania	W3GS	ATLANTIC DIVISION Jack Wagenseller	26 Meadowbrook Ave.	Llanerch
Maryland-Delaware-District of Columbia	W3BAK W3OL W8DSP W8CUG	Edgar L. Hudson Gedney Rigor Don Farrell C. H. Grossarth	412 2nd Ave. 213 Hickock Ave. R. F. D. 3, Eicher Rd.	Laurel, Delaware Haddon Heights Syracuse Elmworth, Bellevue Pa.
Southern New Jersey		CENTRAL DIVISION Fred J. Hinds	6618 West 34th St.	Berwyn
Western New York	W9WR W9TE	Arthur L. Braun	911 Reisner St.	Indianapolis
Western Pennsylvania	W9ADH W8DVFH W8CIG W9LFFK	G. W. Mossbarger Kenneth F. Conroy Robert P. Irvine Carl F. Thoms	Box 177 7533 E. Robinwood Ave. 3308 Northcliffe Ave. 3802 W. Villard Ave.	Camp Taylor Detroit. Crawford Milwaukee
Illinois		DAKOTA DIVISION Fred J. Wells	1022 11th St., S.	Fargo
Indiana	W9JVP	Mike G. Strahan	601 S. Grange Ave.	Stoupe Falls
Kentucky	W9PF1	Robert C. Harshberger	1200 Frazier St.	St. Paul
Michigan	W9TIE	Francis C. Kramer	W. Bluff St.	St. Charles
Ohio	W9DE1			
Wisconsin*		DELTA DIVISION H. E. Velte	2918 West 15th St.	Little Rock
North Dakota	W5ABI	W. J. Wilkinson, Jr.	1624 Allen Ave.	Shreveport
South Dakota	W5DWW	J. H. Weems, Jr.	2919 Seventh St.	Meridian
Northern Minnesota	W5CWO	F. E. Purdy	P. O. Box 173	Kingsport
Southern Minnesota	W4AFM			
Arkansas		HUDSON DIVISION Robert E. Haight	1080 Helderberg Ave.	Schenectady
Louisiana	W2LU	B. Baunach	3823 10th Ave.	Brooklyn
Mississippi	W2AZV	John Ridez, Jr.	20 Buena Vista Rd.	Cedar Grove
Tennessee	W2EKM			
Eastern New York		MIDWEST DIVISION E. M. Davis	1228 Mississippi Ave.	Davenport
N. Y. C. & Long Island	W9ACL	O. J. Spetter	305 Western Ave.	Topeka
Northern New Jersey	W9PLG	C. R. Cannady	Broadway at Ninth	Monett
	W9EYCG-JPT	Samuel C. Wallace	Green St.	Clarks
	W9FAM			
Iowa*		NEW ENGLAND DIVISION Frederick Ellis, Jr.	19 Merrill Rd.	Norwalk
Kansas	W1CTI	John W. Singleton	10 High Street	Wilton
Missouri	W1CLX	Joseph A. Mallen	16 Mercier Ave.	Ashmont
Nebraska	W1ASJ	Percy C. Noble	37 Broad St.	Westfield
	W1BVR	Basil Cutting	66 Lisbon St.	Pembroke
	W1APK	Albert J. King	R. 1	Providence
	W1QR	Harry Page		Hinesburg
	W1ATF			
Connecticut		NORTHWESTERN DIVISION Richard J. Fox	Box 301	Ketchikan
Maine		Don D. Oberbillig	P. O. Box 1271	Boise
Eastern Massachusetts		O. W. Viers	211 Stevens St.	Missoula
Western Massachusetts		Frank L. Black	1502 McPherson St.	North Bend
New Hampshire		Stanley J. Belliveau	Route 7, Box 387	Yakima
Rhode Island				
Vermont				
Alaska	K7PO			
Idaho	W7AVP			
Montana	W7AAT			
Oregon	W7AMF			
Washington	W7AYO			
Hawaii	K6EQW	PACIFIC DIVISION Atlas O. Adams	21st Infantry Brigade	Schofield Barracks
Nevada	W6EAD	Keston L. Ramsay	1151 Buena Vista Ave.	Reno
Los Angeles	W6BPU	Howell C. Brown	120 N. El Molino Ave.	Pasadena
Santa Clara Valley	W6BMW	Charles J. Camp	318 Hawthorne Ave.	Palo Alto
East Bay	W6ZC	P. W. Dann	1821 Chestnut St.	Berkeley
San Francisco	W6CAL	Byron Goodman	141 Alton Ave.	San Francisco
Sacramento Valley	W6DVE	Geo. L. Woodington	716 Redwood Ave.	North Sacramento
Arizona	W6BJF-W6QC	Ernest Mendoza	1434 East Madison St.	Phoenix
Philippines	KAIXA	Newton E. Thompson	Boulevard Apartments	Manila, P. I.
San Diego	W6EOP	Harry A. Ambler	+101 Hamilton St.	San Diego
San Joaquin Valley	W6DZN	G. H. Lavender	Route 6, Box 425	Stockton
North Carolina	W4AVT	ROANOKE DIVISION G. H. Wright, Jr.	2817 Montrose Ave.	Wendell
Virginia	W3AAJ	R. N. Eubank	100 20th St.	Richmond
West Virginia	W8HD	C. S. Hoffmann, Jr.		Warwood, Wheeling
Colorado	W9BTO	ROCKY MOUNTAIN DIVISION T. R. Becker	1176 Gaylord St.	Denver
Utah-Wyoming	W6GQC-IDM	Arty W. Clark	260 So. 9th West	Salt Lake City, Utah
Alabama	W4KP	SOUTHEASTERN DIVISION L. D. Elwell	1066 Waverly St.	Tarrant
Eastern Florida	W4BCZ	Philip A. McMasters	212 9th St., North	St. Petersburg
Western Florida	W4MS	Edward J. Collins	1517 East Brainard St.	Pensacola
Georgia-So. Carolina-Cuba-Isle-of-Pines-Porto Rico-Virgin Islands	W4UT	George A. Love	50 Muscogee Ave.	Atlanta
Northern Texas	W5AUL	WEST GULF DIVISION Glen E. Falbutt	1133 Amarillo St.	Abilene
Oklahoma	W5CIZ	Carter L. Simpson	2010 So. 4th St.	Ponca City
Southern Texas	W5ADZ	Bradheld A. Beard	2030 Quenby Road	Houston
New Mexico	W5DU1	Dan W. De Lay	407 South Girard St.	Albuquerque
Maritime	VE1DQ	MARITIME DIVISION A. M. Crowell	69 Dublin St.	Halifax, N. S.
Ontario	VE3GT	ONTARIO DIVISION S. B. Trainer, Jr.	4 Shorcliffe Ave.	Toronto
Quebec	VE2GA	QUEBEC DIVISION J. A. Robertson	245 Edision Ave.	St. Lambert, P. Q.
Alberta	VE4GD	VANALTA DIVISION J. Smalley, Jr.	611 1st Ave., N. W.	Calgary
British Columbia	VE5AC	R. K. Town	1754 Graveley St.	Vancouver
Manitoba	VE4GC	PRAIRIE DIVISION Reg. Strong	711 Ashburn St.	Winnipeg
Saskatchewan	VE4EL	Wilfred Skaife	2040 McTavish St.	Regina

* Officials appointed to act until the membership of the Section choose permanent S.C.M.'s by nomination and election.

Better and Still More Inexpensive

GROSS CB-25

Radiophone and C.W. Transmitter

Quantity production has made it possible for us to sell this laboratory constructed and wired transmitter at the new extraordinarily low price.

Built to the Highest Standards of Quality and Performance

By fortunate combination of ingenious design and skillful construction, Gross transmitters offer a degree of perfection which we believe is unexcelled. Enthusiastic users in this and foreign countries testify to their high order of satisfactory performance. Literature descriptive of this outstanding transmitter will be sent upon request.

Output 25 to 28 watts — 100% Class B modulation — operates on all amateur frequencies — uses two 46's in Class C Stage and two 46's in Class B — entirely self contained from microphone jack to antenna coupling coil.

PRICE, LESS TUBES, \$90

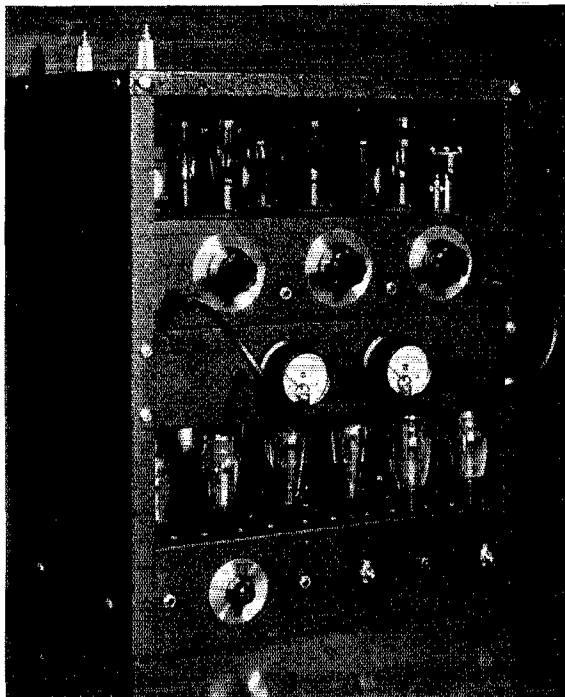

REALLY PORTABLE TRANSCIEVERS

with battery space in same case

This feature will be appreciated by anyone doing serious 5 meter work in the field. Sold at Prices you would like to pay But NOT built down to those Prices.

NATICO transceivers can be supplied in three models, all of which have the same outward appearance.

Type TR-1: Battery Model \$10.95 (less tubes and batteries)

This NATICO 5 meter transceiver is strictly portable, allowing two way communication even when being carried. This is accomplished by the fact that the two dry cells and 90 to 135 volt B battery are self contained in the one case.

TUBES REQUIRED: One 30 and One 33.

Type TR-2: Mobile Model \$11.95 (less tubes, battery or eliminator)

Specially designed for automobile use or wherever a 6 volt battery is available. The case has sufficient space to hold the 135 to 180 volts of B battery or a 6 volt B Eliminator which eliminates the necessity of all B batteries.

TUBES REQUIRED: One 76 and One 41.

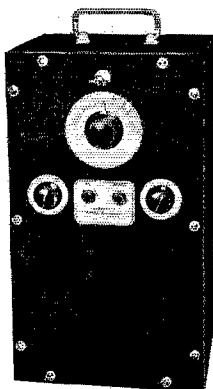

Type TR-3: A. C. Model \$16.95 (including power supply, less tubes)

Here you have a portable A.C. transceiver which includes power supply in the same case (size only 6 1/2" x 7 3/4" x 12 3/8"). It can be operated anywhere that 110 volt A.C. is available.

TUBES REQUIRED: One 76, One 41 and One 80.

Accessories

Matched Kits of National Union Tubes for —

TR-1	\$ 1.95
TR-2	1.75
TR-3	2.15
6 VOLT B Eliminator for TR-2	11.50
Hygrade very high gain hand mike with battery switch, special	5.50

GROSS RADIO, INC., 51 VESEY STREET, NEW YORK CITY

EXTRA SPECIAL

210 tube — Thoriated Tungsten Filament
\$1.15

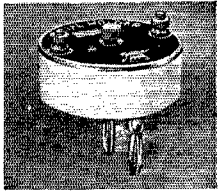

GROSS Crystal Holder

WHITE CERAMIC commercial type crystal holder — priced at less than ordinary holders. Adjust a die pressure, dust proof, no tools required to open. Takes crystal to 1 1/4" square. Plugs standard 1/4" spacing. Most efficient job yet. \$1.00

required to open. Takes crystal to 1 1/4" square. Plugs standard 1/4" spacing. Most efficient job yet. \$1.00

Cased Combination Filament Transformer
2 1/2 V.C.T. 10 amps for 866's
10 V.C.T. 7 amps for '50's or '52's
10000 volts insulation. \$3.24

FILAMENT TRANSFORMER FOR BRIDGE RECTIFIER
using 83 tubes 5 v-5 v-5 at 3 amps
C.T. — 3000 v insulation. \$2.25

GROSS CASED POWER TRANSFORMERS

650 v ea. side C.T. 350 ma fila. 2-7 1/2 v C.T. and 1-5 v will give 500 v with choke input using 83 or 5Z3 tubes. You can run your entire R.F. and class B off this trans. \$5.50

750 v ea. side C.T. 300 ma fila. 2-7 1/2 v. C.T. and 1-5 v. \$5.75

750-1000 v ea. side of C.T. 300 watts, \$6.65

850-1350-1500 v ea. side of C.T. 400 watts \$8.70

(the ideal job to give 750-1000-1250 v D.C. with choke input)

850-1350-1500 v ea. side of C.T. 550 ma. \$12.50

1500-2000 v ea. side of C.T. 800 watts \$11.70

Mounted Center Tapped Filament Transformers

2 1/2 v 8 a — 2 1/2 v 3 a — 5 v 3 a . . . \$1.29

2 1/2 v 4 a — 7 1/2 v 2 1/2 a — 7 1/2 v 2 1/2 a, \$1.29

2 1/2 v 4 a — 5 v 3 a — 7 1/2 v 2 1/2 a. . . 1.29

5 v 3 a — 7 1/2 v 2 1/2 a — 7 1/2 v 2 1/2 a. . . 1.29

2 1/2 v 6 a — CT (midget).74

5 v 3 a — CT (midget).74

6.3 v 1.5 a — CT (midget).69

7 1/2 v 3 a — CT (midget).89

EXTRA SPECIAL

510-A tube Thoriated Tungsten Filament
Graphite Plate — Isolantite Base. . \$2.45

REMARKABLE TUBE VALUES— Carrying Our Full Guarantee— Ask the Man Who Has Used Them

865 Graphite Plate \$ 7.75
203-A Graphite Plate. 8.75
852 Graphite Plate. 16.95
204-A Graphite Plate. 67.50
888 or 871 tube Isolantite top.95
81 tube.80
1/4, 1/2, and 1 watt Neon Bulbs35

Universal Antenna Coupling System Inductances

Wound on threaded double X natural bakelite tubing, can easily be tapped, with clip supplied, ea. \$1.75
(Use one coil for single-wire feed and two coils for two-wire systems)

Low C 40-80-160 Meter Amplifier Coils
(See transmitter by GRAMMER page 46 May QST) Plug-in, wound on threaded natural bakelite tubing, will tune with .50 or 60 mmf. condenser any size, each. \$2.00

THORD. 15 H 250 MA choke. \$2.95
GROSS 30 H 200 MA cased choke. 1.94
Cased 30 H 125 MA choke.95
Cased 20 H 350 MA choke. 4.95

GROSS CASED CLASS "B" TRANSFORMERS

Heavy Duty — for use with 10's, '46's or 4-46's in push-pull par. per pr. . . \$7.50
For 2-46's only, per pr. 4.65
GROSS uncased Class B transformers for '46's or '53's special per pair. . . \$3.85

Filament Transformers shielded in metal cases, center tapped secondaries
2.5 Volt 10 amperes for 866's. \$2.25
10 to 12 Volts at 8 amperes. 2.25
Special 10-12 Volt 7.5 ampere filament transformer, extra special. \$1.10

GROSS SPECIAL TRANSFORMER
600 volts each side of C.T. 200 MA
2 1/2 V. 10 amps., 5 V. 3 amps.,
7 1/2 V. 3 amps. \$3.39

CONTINENTAL MIKE — Stretched diaphragm — 24 K. gold spot Double Button. Spec. \$3.95

GROSS C C TRANSMITTER — OUTPUT 25-30 WATTS

The "CW-25" transmitter kit due to its low cost makes it possible for anyone to own a modern crystal controlled station. A schematic hook-up and parts layout sheet as well as tuning instructions are furnished, thus enabling the most inexperienced operator to wire and put the set on the air, for real results. The "CW-25" is supplied with a shrivel finished sturdy metal chassis under which all parts are mounted, making the wiring and components dustproof. A plug-in crystal holder is furnished with the kit. Only one milliammeter is required for tuning the transmitter and each stage is provided with a jack for this purpose. The "CW-25" uses one '47 as crystal oscillator, one '46 as buffer or doubler and two '46's in the amplifier stage, set of three coils supplied with kit for 20, 40, 80 or 160 band. **\$13.95**
Additional coils 75c each. Complete kit, less tubes and crystal.

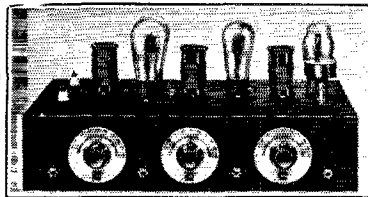

and two '46's in the amplifier stage, set of three coils supplied with kit for 20, 40, 80 or 160 band. **\$13.95**
Additional coils 75c each. Complete kit, less tubes and crystal.

The "EAGLE" Three-Tube Short Wave Receiver

"Band Spread" over any portion of the tuning range — only finest material used thruout. Employs one '32 R.F., one '32 detector and one '33 Pentode Audio — 15 to 200 meters — four coils, supplied. The "EAGLE" is economical — two dry cells will operate the filaments. See March or April 1933 QST for full description of this most excellent value in short wave receivers.

"Eagle" completely wired and tested. . . \$11.95 Three tubes tested in your receiver. . . \$3.00

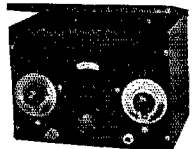

20% deposit with all C.O.D. orders. Remit by M.O. Include postage

GROSS RADIO, INC., 51 VESEY STREET, NEW YORK CITY

The American Radio Relay League



• **T**HE AMERICAN RADIO RELAY LEAGUE, INC., is a non-commercial association of radio amateurs, bonded for the promotion of interest in amateur radio communication and experimentation, for the relaying of messages by radio, for the advancement of the radio art and of the public welfare, for the representation of the radio amateur in legislative matters, and for the maintenance of fraternalism and a high standard of conduct.

It is an incorporated association without capital stock, chartered under the laws of Connecticut. Its affairs are governed by a Board of Directors, elected every two years by the general membership. The officers are elected or appointed by the Directors. The League is non-commercial and no one commercially engaged in the manufacture, sale or rental of radio apparatus is eligible to membership on its board.

"Of, by and for the amateur," it numbers within its ranks practically every worth-while amateur in the world and has a history of glorious achievement as the standard-bearer in amateur affairs.

Inquiries regarding membership are solicited. A bona fide interest in amateur radio is the only essential qualification; ownership of a transmitting station and knowledge of the code are not prerequisite. Correspondence should be addressed to the Secretary.

DIRECTORS

- President* HIRAM PERCY MAXIM W1AW
Box 216, Hartford, Conn.
- Vice-President* CHARLES H. STEWART W3ZS
St. David's, Pa.
- Canadian General Manager*
ALEX REID VE2RE
169 Logan Ave., St. Lambert, P. Q.
- Atlantic Division*
EUGENE C. WOODRUFF W8CMP
234 W. Fairmount Ave., State College, Pa.
- Central Division*
LOREN G. WINDOM W8GZ-W8ZG
Reynoldsburg, Ohio
- Dakota Division*
CARL L. JABS W9BVH
1822 James St., St. Paul, Minn.
- Delta Division*
M. M. HILL W5EB
P. O. Box 274, Natchitoches, La.
- Hudson Division*
BERNARD J. FULD W2BEG
280 Broadway, New York City
- Midwest Division*
H. W. KERR W9DZW-W9GP
Little Sioux, Iowa
- New England Division*
G. W. BAILEY W1KH
74 Webster Road, Weston, Mass.
- Northwestern Division*
RALPH J. GIBBONS W7KV-W7B1X
3134 N. E. 25th Ave., Portland, Ore.
- Pacific Division*
S. G. CULVER W6AN
2962 Russell St., Berkeley, Calif.
- Roanoke Division*
H. L. CAVENESS W4DW
State College Station, Raleigh, N. C.
- Rocky Mountain Division*
RUSSELL J. ANDREWS W9AAB
1867 So. Lafayette St., Denver, Colo.
- Southeastern Division*
J. C. HAGLER, JR. W4SS
2424 McDowell St., Augusta, Ga.
- West Gulf Division*
FRANK M. CORLETT W5ZC
2515 Catherine St., Dallas, Tex.

OFFICERS

- President* HIRAM PERCY MAXIM, W1AW
Hartford, Connecticut
- Vice-President* CHARLES H. STEWART, W3ZS
St. David's, Pennsylvania
- Secretary* KENNETH B. WARNER, W1EH
West Hartford, Connecticut
- Treasurer* ARTHUR A. HEBERT, W1ES
West Hartford, Connecticut
- Communications Mgr.* ... F. EDWARD HANDY, W1BDI
West Hartford, Connecticut
- General Counsel* PAUL M. SEGAL, W3EEA
1010 Shoreham Building, Washington, D. C.

Address all general correspondence to the executive headquarters at West Hartford, Connecticut



THE EDITOR'S MILL

THE last half of August has seen 5-meter interest in New England whipped to fever heat. It all started when Ross Hull, of the *QST* staff, built a reflector antenna system at WIAL and aimed it at Boston. In the Boston area is a considerable number of 5-meter stations, most of whom know each other well and who have been in peaceful communication with each other over modest distances of ten to twenty miles. Into this tranquil local communication there suddenly projected itself, one night in middle August, a large and juicy R8 signal which claimed to originate in West Hartford, Connecticut. At first nobody would believe it; everybody thought it was a portable-mobile station — more particularly as they could work this station, and West Hartford was a hundred miles away! When finally the gang was convinced of the genuineness of the signal the wildest excitement broke out. And we'll say right now that the excitement on the West Hartford end of the circuit was just as wild as anybody's. The only fitting comparison we can make is to the period when hams first worked across the Atlantic. It was the only subject of conversation, everybody wanted to work the distant station, and the question on everybody's mind was "How do you do it?"

In the two weeks which have preceded this writing, WIAL has been in two-way communication every night and almost every day with some dozens of amateur stations spread over an arc from Fall River to the New Hampshire border at an average distance of a hundred miles. The fellows on the other end use their normal rigs, generally a pair of 245's on a doublet, and the signals at WIAL average R6 and 7.

To those of us who have worked with and boosted the ultra-highs through the jeers and sneers of the low-frequency brethren and the faint cheers of the growing u.h.f. gang, it has been tremendously encouraging and inspiring. There is of course nothing new whatever in the idea of using a beam antenna. But it would seem that in not long ago applying the idea to our ham 5-meter stations we overlooked a mighty valuable aid. From one way of looking at it, there is nothing amazing about the result. If a beam antenna gives a power gain of 20 and one has an input of 100 watts, the transmission has the strength of 2 kilowatts in a doublet, and a 2-kw. signal might very conceivably cover the distance. The really sweet thing about it is that reception similarly improves and that that same effective power gain is applied to the other fellow's signals.

At this writing no station in the Boston region has come on the air with a similar beam. We're not going to claim a single thing as to the adaptability of this system to general amateur work — not until we've had more experience. There may be something freaky in the location of WIAL, on a modest hill commanding the Connecticut Valley. Perhaps the weather has been freaky and is never to be duplicated. There may be a 5-meter "groove" between Boston and West Hartford. It may never happen at any other location or for any other amateur. Of course we don't actually believe it is that way but we'll do no general shouting until a few more beam stations get on the air and demonstrate the general usefulness of the reflectors. What we do know is that reflector systems hold out the most fascinating promise to the earnest workers in that most fascinating field, the ultra-high frequencies. *QST* this month presents some further comments on the subject, and we very much want to hear about the results of other hams. We amateurs are going to lick these ultra-highs before we are through with them, old sons!

K. B. W.

Extending the Range of Ultra-High-Frequency Amateur Stations

The Story of Some Extraordinary Results Obtained with Directive Antennas

By Ross A. Hull*

When Ross Hull walked into the office one morning recently and said he'd had four hours of solid QSO with 100-mile-distant Boston stations the night before on 5 meters, we said, "Oh yeah!" and turned to our morning mail; such ultra-high-freak DX, except with airplane altitudes for the apparatus, was simply one of those things we all dream about, but which every one knows is impossible. Impossible, eh? Not on your directive antenna, it isn't! As we write this, three weeks of almost unbroken day and night QSO has been going on between West Hartford and the Boston area, ground stations at each end, and with signal strengths that make even strong men (on 80 meters) weep for sheer jealousy. Boyoboyoboy!—consistent 100-mile work on "five" from backyard to backyard! And the nice thing about this directive antenna is not only that it dumps RS sigs into ordinary receivers at Boston, but that it enables swell reception here of ordinary non-directive-antenna transmissions from Boston!

Enough of this; read the article which follows, learn how to do it yourselves—and then do it!—EDITOR

ANTENNAS having well-defined directivity have been widely used for radio transmission and reception ever since Hertz revealed their effectiveness in his work prior to 1888. In the commercial world, directive antennas of all shapes and sizes have become almost universal, for the very good reason that they provide an inexpensive means of obtaining enormous increases of effective power in some one or more particular directions. On the lower amateur frequencies it has not been possible to exploit such antennas very fully because the necessary extensive space in which to erect them has rarely been available. It is fortunate that, on the ultra-high amateur frequencies, directive antennas can be installed in almost any location. The rather surprising observations to be related in this article make it clear that such systems will receive much more attention in the future than they have in the past.

Of course, directive antennas, even on the amateur ultra-high frequencies, have been used for a great many years. Many experimental investigations of their radiation have been made and they have been the subject of a great deal of

discussion. Examples of prolonged amateur communication on the ultra-high frequencies with directive antenna systems are quite rare, though, and in all these years the surface of the whole subject has hardly been scratched.

IT WORKED AT FIRST CLICK

Our latent interest in directive arrays was tripped off during a recent visit to Provincetown,

where we had an opportunity to marvel at the effectiveness of the directive arrays used by the New England Telephone Company on their ultra-high frequency circuit across Cape Cod Bay to Brant Rock. Immediately upon our return from the trip we gathered together some wire, insulators and rope and strung up a simple directive system across the veranda roof of a house, on the outskirts of West Hartford. From this particular location,

with normal antennas, the greatest 56-mc. DX during the past three years has been communication with a mountain-top station thirty-five miles distant. We were justified, therefore, in obtaining a terrific thrill upon discovering that the use of the new directive array for transmission and reception immediately permitted two-way contact

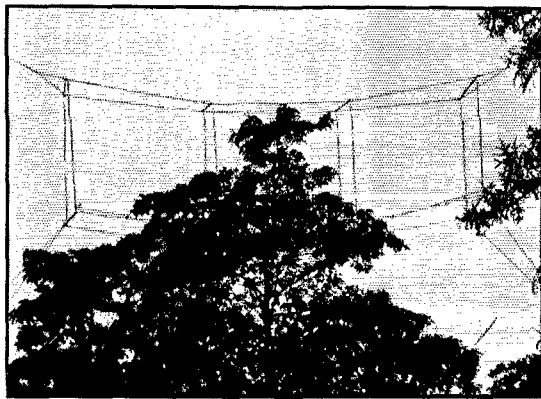

THE DIRECTIVE ARRAY AT WIAL

Strung between a 40-foot pole and a tree of similar height, this antenna supplanted the earlier and lower one. Capable of a power gain of at least ten times, this conglomeration of wire and rope is the approximate equivalent of a normal antenna at least 400 feet higher! WIAL is located 320 feet above sea level.

* Associate Editor, QST.

with many stations in the Boston area, 100-odd miles away. During the first few hours of operation (W1ANA doing the work) nine Boston-area amateurs were contacted, R8 to R9 reports being received. Even more surprising was the fact that a 45-degree lobe from the antenna permitted us to make entirely satisfactory contact with stations in Fall River.

The first night of operation over the one-hundred-mile path proved not to be completely typical of the performance to be expected, but in 24 days of operation since that time (with operators of the Headquarters staff taking "tricks" in charge) satisfactory two-way contact has been established on all except four days. Signals have been received from the Boston area without any break whatever.

AN ARRAY AT BOTH ENDS

All of this communication was made possible by the use of a directive array at one end of the path. Early in the proceedings we became mightily eager to go the whole hog—to investigate the possible performance of two such antenna systems, one at each end of the link. Negotiations were immediately opened with some of the Boston amateurs with this in view, and it is somewhat unfortunate to have to relate that, though several of them erected directive antennas, they did not immediately obtain a successful performance.

During the second and third weeks of these tests, W1HRX, located at Middleton, Mass., conducted prolonged experiments with his receiver. At his location it was impossible for him to hear our signals with a normal vertical antenna. Upon the installation of a temporary directive antenna he began to turn in reports of R8 and R9 signals. Three days ago he completed and successfully tuned a permanent directive array which was immediately effective—boosting his signals from zero to a value which reaches R9 on many occasions. Unbroken contact with this station has been maintained, day and night for the last three days.

The one other confirmation of the striking effectiveness of directive antennas in

this work comes from W1ANA, located about 60 feet above sea level in the Connecticut River valley at Wethersfield. A simple four-wire array installed in his attic has permitted him to receive good signals from a group of Boston stations—signals entirely inaudible on a normal single antenna.

RELIABLE CONTACT VS. FREAKS

The sole aim in concentrating our attention on these contacts at distances of 100 miles and more has been to establish quite definitely that a good directive antenna can result in an almost unbelievable increase in range and that the increase is by no means a will-o'-the-wisp. Ultra-high frequency signals have been heard over great ranges from time to time without the benefit of directive antennas. These examples of reception, however, represent abnormal and extremely rare conditions. The long-distance contacts under discussion belong in an entirely different category being, as they are, at least as reliable (if not more so) than contacts established over the same route on the lower frequencies. Indeed, we have had evenings of continuous contact with Boston (with R8 to R9 signals at both ends) on occasions when the Hartford 50-kw. broadcast station WTIC on 1040 kc. was fading below the limit of audibility in the northern city. As a final mention of the communication maintained, the log shows that during 25 days of operation, a total of 172 two-way contacts have been established with stations at distances of the order of 100 miles or greater. Experiments from time to time established that none of the signals from those stations was audible with a normal antenna in place of the directive systems—even when conditions were at their very best.

It is now high time that we quit talking of performance and turned our attention to the directive antenna itself.

A directive antenna does not give one something for nothing. However, it does concentrate the radiation from the transmitter in one or more directions and hence provides a great increase in effective power in those directions. For reception,

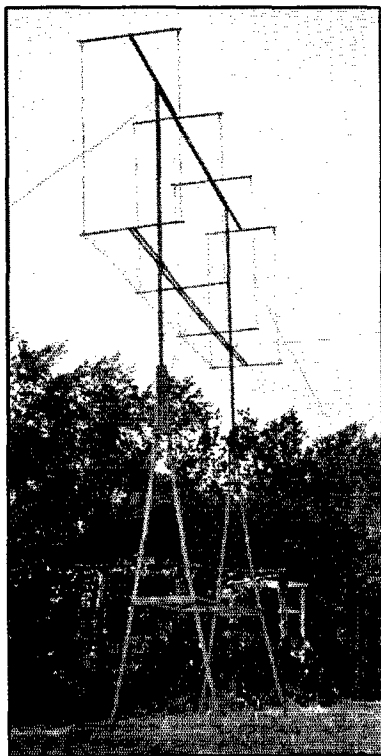

THE RIGID DIRECTIVE SYSTEM AT W1HRX

Mounted on a substantial wooden framework, the antennas and reflectors of this assembly are held in good alignment at all times. The electrical design of this array is exactly similar to that shown in Fig. 1.

the effect is the reverse and one has, then, somewhat the equivalent of a very large and very effective hearing trumpet. It would be futile to attempt to outline the various practical types of directive antennas chiefly because the subject is such an extensive one and also because many very comprehensive treatments of the subject are available.¹ We must be content, at this juncture,

erected for this program of experimental work. As will be seen, it consists of a box-like assembly of spreaders, reflectors, antennas and feeders, approximately 25 by 8 by 4 feet, suspended on two main ropes which, in turn, are strung to two appropriate supports. In its first location, our antenna was supported between the branches of two trees, the antenna itself hanging about three feet above the metal roof of the veranda and approximately thirteen feet above ground. The first week of communication was run off with this antenna and with a transmitter having two Type 45 tubes feeding it. Since that time the antenna has been re-strung higher above ground in a spot clear of the trees and the transmitter power has been increased to 200 watts input. These changes have resulted in a perceptible though not very great increase in performance.

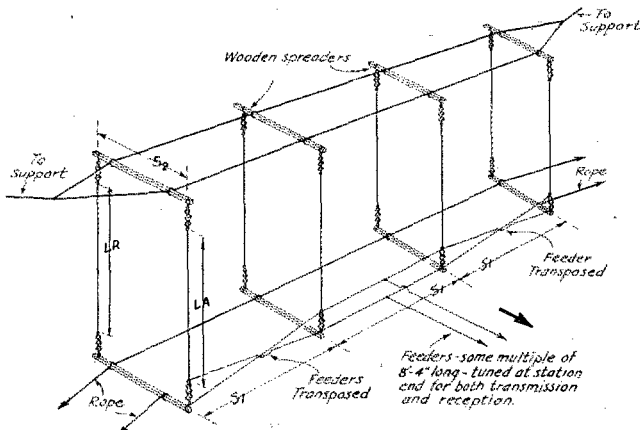

FIG. 1—ILLUSTRATING THE TYPE OF CONSTRUCTION USED FOR WIAL'S DIRECTIVE ANTENNA

The four front vertical wires, fed from their lower ends, are the radiators. Behind them are the four reflectors. Both antennas and reflectors are suspended from light wooden spreaders, suspended in turn by two main ropes. The assembly should be made as light as possible in order to reduce the sag to a minimum. The direction of transmission is indicated by the heavy arrow. Feeder spacing is unimportant; 2 inches is a suitable value.

The dimensions of the various elements of the array follow:

Frequency Mc.	Wavelength Meters	Ant. Length LA	Ref. Length LR	Ant. Spacing S ₁	Ant. to Ref. S ₂
56	5.357	8' 4"	8' 7"	8' 9"	4' 4 1/2"
57	5.263	8' 2 3/8"	8' 5 1/4"	8' 7 1/2"	4' 3 3/4"
58	5.172	8' 0 1/2"	8' 3 3/4"	8' 5 3/4"	4' 2 3/4"
59	5.085	7' 10 3/4"	8' 2"	8' 4"	4' 2"
60	5.0	7' 9"	8' 0 1/2"	8' 2 1/2"	4' 1 1/4"

to describe the particular antenna with which we have had so much success, together with some minor variations of it. This system is of a perfectly conventional type and, though proportionately smaller, is exactly similar to the arrays used very widely in commercial work. We chose it from the many types possible because of its simplicity and because of the possibility it afforded for straightforward adjustment.

BUILDING THE ARRAY

Fig. 1 is intended to illustrate the first antenna

¹ Two papers appearing in the Proceedings of the Institute of Radio Engineers are worthy of close study: "Certain Factors Affecting the Gain of Directive Antennas" by G. C. Southworth, September, 1930; and "Development of Directive Transmitting Antennas by R.C.A. Communications, Inc." by P. S. Carter, C. W. Hansell and N. E. Lindenblad, October, 1931.

The ideal structure for the support of an antenna of this type is a rigid framework such as that used by W1HRX. In this way the relative positions of the antenna and reflectors are maintained accurately and no trouble is experienced from the antenna tossing around in the breezes. The simple scheme shown, however, proves to be thoroughly effective, provided the whole structure is made as light as possible. The spreaders in our own antenna are of 5/8-inch square section pine with the exception of the outer members, which are one-inch square cross section. The wire used is No. 16 or 17 and the insulators are small and as light as possible. Too much emphasis can hardly be placed on the absolute necessity of adhering strictly to all dimensions, and of the extreme desirability of stretching all wire before cutting it to the desired length. When used for transmission, such an antenna must be operated in the immediate vicinity of the frequency for which it was designed. The failure of several individuals to obtain satisfaction from their directive arrays leads us to suspect that the adjustment of the system is considerably more critical than one might at first think.

TUNING THE SYSTEM

Providing the various reflector and antenna wires have been cut correctly and that their spacing is accurate, the next most important item is to make quite certain that the feeder is capable of being tuned. The length between the points at

which the main feeder joins the array and the antenna coil of the transmitter itself must be approximately some multiple of a half-wave long. A slight increase in this length will make it necessary to use series condensers for tuning the feeders, while a slightly shorter length will call for a parallel tuning condenser. Provision must be made for either parallel or series tuning and, hence, the exact length of the feeder might well be determined by cut-and-try method. The usual thermo-couple ammeter may be used to indicate maximum feeder current, although in low-powered installations this may become a little difficult since the feeder current of an array will be considerably less than the value obtained when feeding a simple antenna. In such cases, the usual rise of tube plate current may serve the purpose.

PROVISION FOR RECEPTION

Since the antenna is to be used both for transmission and reception, a double-pole-double-throw switch should be provided to change the feeder from transmitter to receiver. Then, since the feeder is to be tuned for reception also, either a series or a parallel tuning condenser should be provided at the receiving position. In our own installation the tuning condenser is connected across a single-turn coil which is inductively coupled to the grid coil of the receiver. Should the receiver be equipped with the conventional small series antenna coupling condenser, it is a good plan to provide a simple tuned circuit at the receiving end of the feeder, using bare wire for the coil of the tuned circuit. The antenna post of the receiver is then connected by means of a clip to some point on the coil. Experimental determination of the most desirable point is, of course, necessary.

In some locations it may be impossible to erect the array shown in Fig. 1. In this case the simple system shown in Fig. 2 could be used. Examination of the diagram will reveal that this system is merely the middle bay of the larger antenna—the outer reflectors and antennas having been removed. The effectiveness of the system is, of course, considerably reduced but it should nevertheless be well worth while.

ARRAYS FOR TWO DIRECTIONS

Both the systems described are capable of transmitting effectively in only one direction. Should transmission at high effectiveness be desired in a variety of directions, the only real solution would be to mount the array on some structure capable of rotation.² It would seem, though, that in most instances there will be some one or two directions in which most DX activity is confined.

A very desirable type of bi-directional antenna which we intend to install at W1AL is that shown

² There are some hot ideas in John P. Shanklin's article, "A 14-Mc. Rotary Beam Antenna for Transmitting and Receiving," in July, 1934, *QST*.

in Fig. 3. It consists of two groups of half-wave antennas, one above the other, and fed in exactly the same fashion as the array of Fig. 1. No reflectors are provided and the transmission effectiveness both fore and aft is probably equivalent

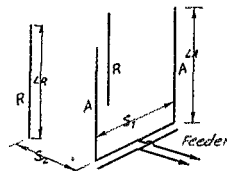

FIG. 2—A DIRECTIVE SYSTEM FOR RESTRICTED SPACE

Using only four elements and occupying a space approximately 8 by 8 by 4 feet, this array should be capable of very definite gain in both transmission and reception. The dimensions of the antennas, reflectors and feeders will be in accordance with the table under Fig. 1.

lent to that of the uni-directional transmission of the present system.

As we have already mentioned, countless other types of directional antennas are available for this type of work. We restrict our description to one general type simply because it has shown itself to be so effective in this instance. We can foresee the probability that, in the early future, ultra-high frequency amateurs will be adorning the landscape with many weird and wonderful structures in designs not yet even visualized.

During the course of the activities undertaken at W1AL a great many interesting observations on transmission and reception phenomena were made—phenomena concerning which we can find no mention in the ultra-high frequency literature. An outline of these new-found transmission and reception phenomena is entirely beyond the scope of this article, but it is our hope to work up some of our observations for an early issue. In the meantime, we wish to express our gratitude to the following amateurs who showed splendid cooperation during contacts and tests with W1AL: W1DBE, Lowell; GDJ, Fall River; VW, Fall River; GJZ, Weston; HRX, Middleton; DEK, North Waltham; BHJ, Nashua, N. H.; XW, Blue Hills; IHY, Chelsea; AFF, Lynn;

(Continued on page 106)

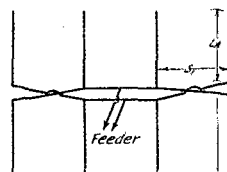

FIG. 3—AN ARRAY WHICH TRANSMITS EQUALLY WELL IN TWO DIRECTIONS

Consisting of two rows of half-wave antennas, one above the other, this system should be capable of a somewhat similar order of gain to that obtained with the array of Fig. 1 but with the added advantage of transmission in the two directions at right angles to the plane of the array. Antenna and feeder dimensions from the table of Fig. 1 should be followed.

Tailoring Tuned R.F. Transformers for Short-Wave Receivers

A Design Method for Peak Performance

By L. W. Hatry*

TUNED r.f. transformers passing energy from a tube to a tube, or for that matter from an antenna to a tube, are always a problem for the amateur. He would like to obtain the practical optimum of amplification from the tube preceding the transformer, or the same effectiveness in feeding from antenna to tube. This practical optimum can be realized only when the primary has sufficient turns; that is, when the primary has better than the commonly accepted "somewhat fewer turns" than the secondary.

The words "practical optimum" mean nothing unless defined. So let us set down just what they mean. Considering the case of the regenerative detector following a tuned r.f. amplifier, optimum

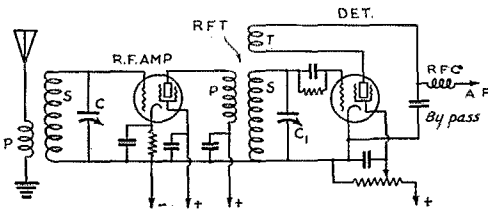

FIG. 1

performance would mean the following things: Greatest selectivity against strong signals consistent with highest *practical* amplification, and smooth regeneration control with smallest tickler. Since, in general, *highest* amplification comes at an appreciable sacrifice of selectivity, this way of stating the first requisite is understandable. And since the price of oversize ticklers is squealing and regeneration-control detuning of signal, the smallest tickler is desirable.

All of which may give the impression that you will be told exactly the correct number of primary turns to wind for a 24 tube, a 58 tube, etc., and be handed an all-inclusive table of coil data. On the contrary, this is written with the intention of making that unnecessary—particularly since the practical optimum for one receiver may be an atrociously useless design for another. Physical layout and circuit details have a direct bearing on the design; and you can easily discover for your own receiver the proper number of primary turns.

The essential circuit to which this information

applies is shown in Fig. 1. *R.F.T.* is the transformer whose primary winding we are concerned with. We shall presume that the primary turns lie between the secondary turns, which is probably the most satisfactory and practical design for the homemade coil since d.c.c. wire on both windings gives effectively high conductor spacing and collodion or a similar "celluloid" binder will effectively moisture-proof what finally will be a quite good coil. If the primary and secondary are wound at the same time and of the same number of turns, removal of part of the primary will leave the surplus secondary space-wound.

Notice Fig. 2. Here the plate-cathode capacity of the r.f. tube is indicated in the way that it affects the coil. This capacity can resonate the primary winding. If the primary winding is large enough this resonance frequency will be within the range of the secondary's tuning as determined by condenser C_1 . Now if the primary is actually resonant within the tuning range of C_1 , the detector tube either will not oscillate with any size of tickler or else will only oscillate above or below, or above and below, the primary's resonant frequency. When the primary is so tuned it acts as an "absorption" circuit, wavemeter-wise. This absorption effect serves as a simple and effective guide to the "practical optimum" primary turns.

SECONDARY AND TICKLER PROCEDURE

Since *QST*, the *Handbook* and other sources contain ample coil data of a general nature, it can be assumed that you know the approximate size

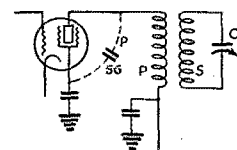

FIG. 2

of the secondary or grid coil. If you are using three-winding transformer data, negligible secondary change will be necessary. If you are using antenna-to-detector coil data the secondaries will be too

large; but turns are easy to remove—so what of that? First, get the tickler sizes correct. As long as your coils are not intended individually to cover more than a 2-to-1 frequency or wavelength range (such as 10 to 20 meters, 3 to 6 kc., etc.), the following general instructions will be satisfactory. A range greater than 2-to-1 is hard to tune, will

* Hatry & Young, 203 Ann St., Hartford, Conn.

not give as smooth oscillation control and otherwise is somewhat unsatisfactory. But a smaller range per coil, such as for band-spread purposes, will make the instructions even more satisfactory.

The tickler can be adjusted with the r.f. tube out of its socket. The tickler should be just large enough to give strong oscillation when the secondary tuning condenser is at full capacity. If you seem to have just enough tickler to get oscillation, add about 25 percent more tickler. In a typical instance, with a 58, a 7-mc. coil took a tickler of $2\frac{1}{2}$ turns on a $1\frac{1}{2}$ -inch form for what might be termed an efficient setup: I mention this because the $\frac{1}{2}$ turn in the example is the extra 25 percent. For detector tubes like the 24, whose screen-voltage adjustments are critical for best performance, the first desirable fact to learn is, what setting of the regeneration control is correct for this "just large enough" tickler? If a steady local signal such as a broadcast harmonic can be heard with the tube not oscillating, disconnect the tickler and connect the plate direct to the audio coupling as shown in Fig. 3. Then find the regeneration control setting that gives maximum volume. This found, wind the tickler just large enough to give oscillation at that setting of the regeneration control when the secondary tuning condenser is at full capacity.

It is not unlikely that the sole reason for the general acceptance of the variable- μ 35, 58, 51 or 6D6-78, as grid-leak regenerative detectors superior to the 24-77-57-6C6 type of tube has resulted because

the effort was not made with the latter types to find and use the critical screen voltage required for greatest wallop. I believe that the straight screen-grid or non-variable- μ tubes are actually more sensitive for c.w. and appreciably more sensitive on "loudspeaker" signals—when the screen voltage is right.

Remember that the tickler should be slightly larger than necessary. Once so set up you will probably find that with the secondary tuning condenser at minimum (if the tuning range is 1.5:1 or 2:1 or more) the regeneration control can be turned up high enough to produce a squeal, an effect that should be impossible the other end of the tuning range. And now to adjust the primary.

THE PRIMARY TURNS

If you wound the primary as suggested, with as many turns as the secondary, connecting it to the r.f. tube and putting that tube into operation may prevent oscillation anywhere within the tuning range. However, even though you do get a little

oscillation, the primary is too large; so remove 10 percent of its turns, from the "top" end. If anything, you should now get oscillation with the secondary tuning condenser set to maximum, or you should get it further down on the dial than was possible before. The game is to remove

primary turns until the regeneration control setting and action is about the same at C_1 's minimum as at its maximum, and oscillation is uniformly smooth, without squeal, irrespective of control setting. This primary will then give as much amplification from the preceding tube as is satisfactorily practical; and it likewise will be doing least to spoil selectivity.

Having found, for any given frequency range, a satisfactory number of primary turns, the rest of the coils for this socket in this set will in general have the same ratio of primary to secondary turns. That is, if this coil has 10 primary and 15 secondary turns for one band, others may have 4 and 6, 20 and 30, etc., a continuous 2:3 or 1:1.5 ratio. However, if speed is not necessary and you have the patience for further adjustments, better have a few more turns than necessary in the primary of each transformer to start with and then tear down turns to get the thing just right.

The design of tuned transformers for a multi-stage tuned r.f. amplifier can be determined in exactly the same manner as above. The tickler used in developing the pattern coil can be omitted from others. Where maximum selectivity is of prime importance, the primary should be reduced until its effect upon regeneration (with the secondary tuning condenser at minimum) is small or nil. Note that "maximum selectivity" should be distinguished from the "optimum" described earlier in the article.

Coils so designed give what can be regarded as practical optimum all-around performance in shortwave receivers of the general type of Fig. 1. However, coils so made must give maximum r.f. amplification at the highest frequency to which they are tuned if they are reasonably good at that frequency. When the coils are made for a multi-stage amplifier this means that the amplifier will tend to have sensitivity that rises as the frequency increases. This also means that if the primary should be wound larger than the secondary and adjusted to affect oscillation at maximum tuning capacity, the sensitivity increase will be at the low end of the frequency range. If using this method of adjustment suggests design of coils with more uniform sensitivity throughout their tuning ranges, hop to it.

THE ANTENNA COIL

Since the antenna coils are also primaries, they can be designed in the same manner—the experi-

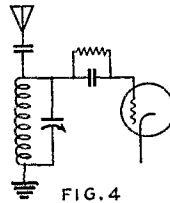

FIG. 4

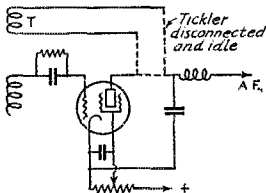

FIG. 3

mental tickler being torn off afterward or not used, unless regeneration is to be a feature of the r.f. stage.¹ They should be adjusted for a given antenna or feeder system. The primaries of the antenna transformers may be deliberately wound over-size so that they affect oscillation with the secondary tuning capacity at maximum. Thus in a receiver of the type of Fig. 1, the sensitivity will be higher at the input stage for the low-frequency end of a given tuning range and higher at the detector for the high-frequency end of the range. The final overall result will tend toward a more even general sensitivity for a given pair of coils.

The chap who runs his antenna direct to the detector r.f.t. (one-, two- and three-tube receivers) cannot easily surpass feeding the antenna through a small series condenser direct to the grid side of the tuned coil (Fig. 4). However, if he does this he obtains good results with small antennas and deliberately loses the benefits of large antennas. By designing coils on the general plan suggested

¹ See, "Regeneration in the Tuned R.F. Stage," Sullivan and Kienle, *QST*, May, 1934.

and carefully adjusting the primaries to a given antenna he can, on the contrary, expect generally superior results in benefiting from a long antenna. When the antenna feeds the detector, the primary should be adjusted (with the antenna connected) to affect oscillation with the tuning condenser set to minimum for the same general reasons that that procedure was suggested for tube-to-tube r.f. transformers; to wit, smooth oscillation control plus good overall sensitivity with reliability of logging and ease of operation.

Or, if the antenna used and liked is a short one and primaries are adjusted for it, longer antennas will work quite well if brought down to about the same general electrical characteristic by means of a series antenna condenser of around 100 μfd . Remember in this connection that the antenna may have an electrical length producing vagaries not completely compensated by the series condenser. Such a length is most easily and practically recognized without carrying a set of data in the pocket or the mind. If the series condenser has to be adjusted to quarter capacity or less, lop off or add on wire.

Third Corps Area Asks Amateur Help

Heavy Traffic Coming from C.C.C. Camps

By H. O. Bixby*

THE Third Corps Area Signal Officer has given the Army Amateurs of that corps area the job of keeping the men in the C.C.C. camps in touch with their homes by radio. The Third Corps Area consists of the states of Pennsylvania, Maryland and Virginia and the District of Columbia. All of the C.C.C. radio stations of those states, which normally operate on special army frequencies between 4300 kc. and 4650 kc. in the daytime, are being licensed as amateur stations for evening operation and will accept messages from the men in the camps at any time. This means that there will be 35 stations all originating traffic from upwards of 30,000 men. In addition to this it is planned to try to enlist the help of amateurs who live within reach of other C.C.C. camps not equipped with radio. In this way it is expected that there will be a large volume of worthwhile traffic originated during the next A.A.R.S. season which begins September 3d.

With these facts in mind, three transmitters are now in process of being installed at Third Corps Area Headquarters in Baltimore, to be used by the corps area net control station. One of them is a built-up job of 200 watts input

* 1st Lieut., Signal Corps, U. S. Army; assistant to Signal Officer, Third Corps Area, Baltimore.

which will operate on the special Army-Amateur frequency of 3497.5 kc. under the call WLQ. The other two are both Collins jobs, one of about 200 watts input and the other of about 400 watts. These transmitters are being installed in the Baltimore customs house and remotely controlled from Third Corps Area Headquarters in the post office building. They will operate in the 80-meter band using W3EQU and probably W3SN. A regular army operator will be assigned to operate seven nights a week and it is planned to invite members of the Mike & Key Club of Baltimore to help out with the operation.

The next big problem is to get enough A.A.R.S. members, so located as to be able to clear the traffic properly into every fair-sized town and city in the corps area daily. The objective at present is from 300 to 350 members. To accomplish this every amateur in the corps area will receive a circular letter explaining the situation and inviting him to join the A.A.R.S. In addition to this, all amateurs known to be active traffic men will receive a special invitation to help out, thus making available a group of experienced traffic operators in addition to the present list of experienced Army Amateurs. Amateurs who apply for membership will be accepted entirely

(Continued on page 98)

A-Cut Crystals

No. 1 development of the day to come out from behind the cloud of rumor is Bell Laboratories' new-cut quartz crystal having characteristics that give it a temperature-frequency coefficient of practically zero and, simultaneously, a greater power-handling capability. Although we had the essential dope some months ago, via those grapevine channels that reach A.R.R.L. Headquarters from almost every place, we couldn't talk about it. But now the lid is off, with the whole story in July *Bell System Technical Journal's* article, "Some Improvements in Quartz Crystal Circuit Elements," by F. R. Lack, G. W. Willard and I. E. Fair.

Briefly, starting from the Y cut, it is shown that with orientation of the cut about the X axis, plates are obtained at certain angles that have a simplified frequency spectrum (that is, practically single-frequency response); while at certain other angles the temperature-frequency coefficient becomes zero (that is, there is no change in frequency with temperature over a considerable range). With the angle of rotation about the X axis measured with reference to the Z axis, the single-response cuts come at plus 31 degrees and minus 60 degrees; while the zero-temperature coefficient cuts come at plus 35 degrees and minus 49 degrees. The plus 31-degree cut which gives the simplified frequency response is designated the "AC cut"; and the plus 35-degree (zero-temperature coefficient) cut is designated the "AT" cut.

Although the "plus" and "minus" sense of rotation is not explained in this paper, it is presumably the same as given in another interesting paper on crystal filters in the same issue of the *Journal*; namely, "A positive angle is a clockwise rotation of the principal axis for a right-handed crystal, when the electrically positive face (determined by squeeze) is up. For a left-handed crystal a positive angle is in a counter-clockwise direction."

The notable combination is the AT cut, since it has the zero temperature-frequency coefficient qualification and, at the same time, is very close to the ideal 31-degree value that gives the simplified frequency response. Hence it is this AT cut that has us all keyed up. While it still remains for crystal specialists to take care of the little matter of getting such crystals into the hands of amateurs (the cuts are obviously critical and require special equipment and skill), it is not difficult to foresee the potential benefits that will accrue to us

with their availability. The zero temperature business means that we can have well-nigh perfectly fixed frequency, without the complexity of temperature-control gadgets; and the elimination of other modes of vibration, giving the crystal greater power-handling ability, means that crystals can be used to control larger oscillators without getting into trouble. The Bell Labs people casually mention running the power of experimental circuits up to 200 watts "without fracturing the crystal," and state that 50-watt oscillators "would appear to be practical" at 2000 kc.—which is right at the high end of the 160-meter band.

The AT cut is somewhat thinner than the usual Y cut from which it is derived, incidentally; 85 percent as thick, judged by data given for 1000-ke. AT and Y cuts. But, while fully as "active" as the Y cut, the AT cut is practically free of the coupled vibrations that not only give the Y cut its notorious double humps but also make it liable to fracture in operation. Crystals don't break up just because they are thin. They do so more because they try to go too many ways at once. And the new cut promises to whip this weakness.

New Receivers

No. 2 development coming over the horizon is new receivers. Manufacturers are ready to introduce new models especially designed for amateur duty. Superhets predominate, of course, with circuit and mechanical improvements their distinguishing characteristics. More input selectivity (two pre-selector stages in at least two jobs), improved tuning mechanisms and dials, slick plug-in and switching systems that give new operating convenience and adaptability, better i.f. circuits including crystal filters, automatic gain control particularly adapted for 'phone reception and new ideas in tone modulation for c.w. Not to be overlooked is some real progress in getting results with superhets at ultra-high frequencies—sets that aren't just arm-chair diagrams but are working realities which give the super-regens a run for their money in sensitivity, without hissing like the snake pen at the zoo. An amateur development in this line is the one Ross Hull has in the works. He isn't quite satisfied with it yet, but we have played with it in action, have listened to 56-mc. Boston ham sigs here in West Hartford, and are convinced it is the business. *QST* will have it soon.

—J. J. L.

A New Standard System of Reporting Signals

Use the R-S-T System!

By Arthur M. Braaten, W2BSR*

Most amateurs will agree fully with the author, after examining the reporting practices that have grown upon amateur radio, that it is high time for an improvement. In August QST KAINA emphasized the need for change in our signal-report practice. We think W2BSR's R-S-T system answers a very definite need. In it we find no such glaring inconsistencies as in existing usages.

How about adopting the R-S-T system as A.R.R.L. standard practice? Put it into use in your station operation at once, just as explained herein. Talk up the new R-S-T reporting practice over the air. You and all amateurs will benefit. Logical and brief, you will find R-S-T increasingly satisfying as you keep using it. WIMK will use the R-S-T form effective September 27th.

—COMMUNICATIONS MANAGER

Q SA3 R7 T5".

The above report translated literally is, "The strength of your signals is fairly good, readable, but with difficulty; good strong signals, copiable through QRM and QRN; nearly d.c. tone, good filter, but has key thumps, or back wave, etc." Very concise and definite, isn't it?

It is obvious that the method now used by amateurs for reporting or describing signals is little better than worthless. It is a makeshift arrangement, handed on unchanged from year to year, and the only possible reason for its continued use is that no one has taken the trouble to work out a better one. I should like to point out the inconsistencies and the limitations of the present method, which I feel should be abandoned immediately. In its stead I propose a new system which, in addition to being simple, will furnish the sender with a report on his signals which will have some meaning.

A glance at the so-called systems of audibility and readability will show how inconsistent they are. Each one contains both audibility and readability qualifications. If both codes are used there must necessarily be conflicts between them. How can any signal possibly be QSA3 and R7 at the same time? The one contradicts the other. Yet such reports are very commonly heard on the air.

The "QSA" code is being used to indicate readability. Now the exact meaning of QSA is, "The strength of your signals is . . ." Obviously there is something wrong here, twisting a code which is meant to indicate signal strength around to mean readability. There is no doubt that very little judgment was used in drawing up the "QSA" code when readability was injected into it.

The "R" code of audibility was introduced in QST, in 1925. It is supposed to be concerned only with the strength of the signal. However, it will be noticed that it is hopelessly tied up with

readability also. Before the advent of the "QSA" code it was fairly satisfactory, but when the latter was introduced the trouble began. The "QSA" code was supposed to take the place of the older "R" code. However, someone conceived the bright idea of using both, forgetting of course to revise them, and we have been struggling along with them ever since. One of the main objections to the "R" code is that it really indicates audibility and not received signal strength. The sender is not concerned with how much amplification you are using to receive him. He wants to know how his signals are coming in, not how loud they are after coming out of your particular receiver. He should expect to receive the same report from a listener using a one-tube set as from one using a powerful superheterodyne. This is obviously impossible under the present definitions of the code. With sufficient amplification almost any signal that can be detected can be brought up to at least R8 (heard several feet from phones). To make the "R" code mean anything all mention of absolute audibility must be eliminated and the definitions made to apply only to received signal strength.

The so-called "T" system for tone is particularly obnoxious. There is actually no system to it. Many U. S. amateurs refrain from using it at all, although foreign amateurs use it a great deal. No time need be wasted in trying to point out its faults. One thing to bear in mind, however, is that a tone code should concern itself with tone, and tone only. No mention should be made of key clicks, back wave, etc. Also, no definite figures for frequency of modulation should be given, since amateurs have greatly different opinions on what the frequency of any given tone is.

About eight years ago the R.C.A. originated a system known as the "Traffic Frame Code." This code is now the standard for fixed, point to point, commercial stations and is used in practically all countries of the world. The reports are always sent in a given order, which is deter-

* Box 979, Riverhead, L. I., N. Y.

mined by the letters of the word "FRAME." These letters stand for the following:

F—Frequency, R—Relative strength, A—Amplitude variation, M—Musicality of note, E—Estimated readability. Each of these characteristics is divided into a scale increasing from 1 (poorest) to 9 (best). The definitions, while satisfactory for commercial work, are not at all suited to amateur practice. The system is of interest to us in that it shows the desirability of following a definite scheme in reporting signals. After several months of study of all available methods and codes a new system has been evolved especially for universal amateur use.

In amateur work the main characteristic of a signal in which we are interested is *Readability*. Next, in order, come *signal strength* and *tone*. Frequency and amplitude variation (fading) are not so important. By far the greater majority of stations on the air have stable signals, and we may expect further improvement as time goes on. There is no need for a code for frequency. The reporting procedure should be as simple as possible consistent with accuracy. It is much easier to tell five senders that their frequency is bad than to tell ninety-five others that theirs is good. Also, since there are so many ways in which a frequency might vary, it is simpler and more accurate to say what the trouble actually is than to make up a code that adequately covers all possible types. Simply say, "swinging," "chirps," "idle radiation" (back wave), "clicks," etc. Fading is something over which the sender has no control. It is generally of minor importance and can be taken care of in the readability part of the report, if necessary to do so.

In the new system codes are proposed for readability, signal strength, and tone. This is exactly what we have been accustomed to report. However, the new codes are thoroughly revised ones, for greater accuracy. First we shall start with readability. What we have been using for this characteristic appears fairly satisfactory. We shall not call it "QSA," however. Such things as QRM, QRN, fading, etc., are taken care of in the readability part of the report.

Readability

1. Unreadable.
2. Barely readable—occasional words distinguishable.
3. Readable with considerable difficulty.
4. Readable with practically no difficulty.
5. Perfectly readable.

Next we take up signal strength. This takes the place of what we now call audibility. Care has been taken to avoid any mention of absolute audibility in this code, such as, "heard several feet from phones." This is to make the report independent of the kind of receiver used. Since the method of estimating is aural, it is neither necessary nor advisable to have more than five

classifications. Any more would make for confusion. A listener can soon determine how the strongest signals sound in his particular receiver. This will fix the top level of his scale. Signal strengths below this best value are then easily estimated by him. By this arrangement a sender is more likely to receive identical reports on his strength at a given place, regardless of the type of receiver used by the reporter.

Signal Strength

1. Faint—signals barely perceptible.
2. Weak signals.
3. Fairly good signals.
4. Good signals.
5. Very strong signals.

A perfect tone code is almost impossible to devise; there are so many widely different types of notes to be heard. Most of them, however, can be satisfactorily grouped into one of the nine classes. To be of any value the tone code must concern itself with tone only. No absolute values of frequency of modulation are given, because it is rare that several observers agree on the frequency of a given tone. It is believed that the following code will satisfactorily meet most amateur requirements. It is the corresponding part of the "Traffic Frame Code" revised for amateur practice.

Tone

1. Extremely rough, hissing note.
2. Very rough a.c. note—no trace of musicality.
3. Rough, low-pitched a.c. note—slightly musical.
4. Rather rough a.c. note—moderately musical.
5. Musically modulated note.
6. Modulated note—slight trace of whistle.
7. Near d.c. note—smooth ripple.
8. Good d.c. note—just trace of ripple.
9. Purest d.c. note.

If the note appears to be crystal controlled simply add an X after the appropriate number.

The method of using the "RST" system is simplicity itself. The letters R-S-T determine the order of sending the report. In order that the system may become standard this sequence should never be deviated from. When desiring a report the sender should say, "QRK?", or "RST?". The answer may be somewhat like this. "Ur RST 347X QRM." This means, "You're readable with difficulty; signal strength good; crystal controlled, near d.c. note—smooth ripple; interference." Now look back at the report at the beginning of this paper. Which gives the better description? Another example might be, "RST 251 QRN." This shows that although the signals are very strong, they are barely readable, because the extremely rough, hissing note is hard

(Continued on page 106)

What the League Is Doing

League Activities, Washington Notes, Board Actions—For Your Information

Election Notice To all A.R.R.L. Members residing in the Central, Hudson, New England, Northwestern, Roanoke, Rocky Mountain and West Gulf divisions of A.R.R.L.:

You are hereby notified that, in accordance with the constitution, an election is about to be held in each of the above-mentioned divisions to elect, for the 1935-1936 term, both an A.R.R.L. director and an alternate director. Your attention is invited to Sec. 1 of Article IV of the Constitution, providing for the government of A.R.R.L. by a Board of Directors; Sec. 2 of Article IV, defining their eligibility; By-laws 10 to 20, providing for their nomination and election; and By-law 11, providing for the simultaneous election of an alternate director. Copy of the constitution and by-laws will be mailed any member upon request.

Voting will take place between November 1 and December 20, 1934, on ballots which will be mailed from the headquarters office in the first week of November. The ballots for each division will list, in one column, the names of all eligible candidates nominated for the office of director by A.R.R.L. members residing in that division; and, in another column, all those similarly named for the office of alternate director. Each member will indicate his choice for each office.

Nomination is by petition. Nominating petitions are hereby solicited. Ten or more A.R.R.L. members residing in any one division have the right to nominate any member of the League residing in that division as a candidate for director therefrom, or as a candidate for alternate director therefrom. No person may simultaneously be a candidate for the office of both director and alternate director. A separate petition must be filed for the nomination of each candidate, whether for director or for alternate director. The following form for nomination is suggested:

(Place and date)

Executive Committee
American Radio Relay League
West Hartford, Conn.

Gentlemen:

We, the undersigned members of the A.R.R.L. residing in the Division, hereby nominate, of, as a candidate for director [or for alternate director, as the case may be] from this division for the 1935-1936 term.

(Signatures and addresses)

The signers must be League members in good standing. The nominee must be a League member in good standing and must be without commercial radio connections: he may not be commercially engaged in the manufacture, selling or renting of radio apparatus or literature. His complete name and address should be given. All such petitions must be filed at the headquarters office of the League in West Hartford, Conn., by noon of the first day of November, 1934. There is no limit to the number of petitions that may be filed, but no member shall append his signature to more than one petition for the office of director and one petition for the office of alternate director.

Present directors from these divisions are as follows: *Central*, Mr. Loren G. Windom, W8GZ-W8ZC, Columbus, Ohio; *Hudson*, Mr. Bernard J. Fuld, W2BEG, New York City; *New England*, Mr. G. W. Bailey, W1KH, Weston, Mass.; *Northwestern*, Mr. Ralph J. Gibbons, W7KY-W7BIX, Portland, Oregon; *Roanoke*, Professor H. L. Caveness, W4DW, Raleigh, N. C.; *Rocky Mountain*, Mr. Russell J. Andrews, W9AAB, Denver, Colorado; *West Gulf*, Mr. Frank M. Corlett, W5ZC, Dallas, Texas.

These elections constitute an important part of the machinery of self-government in A.R.R.L. They provide the constitutional opportunity for members to put the direction of their association in the hands of representatives of their own choice. Members are urged to take the initiative and file nominating petitions immediately.

For the Board of Directors:

K. B. WARNER,
Secretary

August 1, 1934

Longhand Our Rule 415 requires amateur applicants to execute examination papers in longhand, and a similar rule makes the same requirement of applicants for commercial licenses. Both the League and other groups have had occasion to make representations to the Commission on behalf of applicants who, because of blindness or other physical disability, are unable to execute the examination in longhand. The Commission has now ruled that in justifiable cases involving blind or physically disabled applicants, examining officers shall permit the copying of the code test and the answering of examination questions to be done on a typewriter or to be dictated. In such cases a certification must be made by a witness or by the examining officer that the contents

represent solely the applicant's efforts or dictation, without outside assistance.

Financial Statement

Because the League operates on a narrow margin of gain for the whole operating year, the summer quarters almost always show a loss. A small loss was recorded for the second quarter of this year, which also included the unusually expensive anniversary issue of *QST*. By instructions of the Board, the operating statement is here published for your information:

STATEMENT OF REVENUE AND EXPENSES FOR THE THREE MONTHS ENDED JUNE 30, 1934

REVENUES			
Advertising sales, <i>QST</i>	\$13,933.96		
Advertising sales, Handbook.....	612.00		
Newdealer sales, <i>QST</i>	9,742.64		
Handbook sales.....	6,695.24		
Booklet sales.....	2,318.18		
Membership dues.....	8,973.41		
Membership supplies sales.....	1,996.37		
Interest earned.....	267.52		
Bad debts recovered.....	40.00		
Cash discounts earned.....	226.85	\$44,806.17	
<i>Deduct:</i>			
Returns and allowances.....	\$2,803.07		
Exchange and collection charges..	18.99		
Cash discounts on sales.....	294.50		
Increase of provision for newsstand returns of <i>QST</i>	27.30	3,143.86	
Net Revenues.....		\$41,662.31	
EXPENSES			
Publication expenses, <i>QST</i>	\$14,679.19		
Publication expenses, Handbook..	2,288.98		
Publication expenses, Booklets...	614.00		
Membership supplies expenses....	707.22		
Salaries.....	17,309.32		
<i>QST</i> forwarding expenses.....	816.30		
Telephone and telegraph.....	608.66		
Postage.....	1,574.49		
Office supplies and general expenses.....	1,887.76		
Rent, light and heat.....	817.53		
Traveling expenses.....	1,539.05		
Depreciation of fixed assets.....	232.01		
Communications Dept. field expenses.....	126.36		
Headquarters station expenses....	103.77		
Federal tax on checks drawn.....	7.18		
Total Expenses.....		43,311.82	
Net Loss from Operations.....		\$ 1,649.51	

Ordinances

We have previously mentioned editorially that the so-called automobile receiver ordinance now being enacted by a number of cities and some states represents a possible obstacle to amateur mobile operation on the high frequencies. The intent of such measures is to prohibit short-wave receiver installations in automobiles unless a permit has been secured. From the amateur standpoint the difficulty is that in some cases, while the permit language is included in the measure, the permits are not being issued. Because the requirement of permits for such installations is,

in itself, probably legal, it seems more profitable for us to seek a clear recognition of the obligation of city or state officials to issue permits to licensed amateurs, upon presentation of evidence of good character and the possession of an amateur license; the League, therefore, is concentrating its study on this feature. If necessary, a test suit may result and to this end an intensive study is being made of two state measures, in particular. In the meantime, amateurs will do much to help themselves if they will immediately report to Headquarters whenever pending measures of this kind are spotted, since it is often possible to modify these acts considerably during their period of formation, if prompt action is taken.

Ultra-High Frequencies

The frequencies above 110 mc., recently opened to amateur and experimental use through the efforts of the League, may be used for any type of emission — c.w. telegraphy (A-1), i.c.w. telegraphy (A-2), telephony (A-3), television and picture transmission (A-4).

New Penalties

Violations of the Radio Act of 1927 were punishable by fines up to \$5000 or imprisonment up to five years, or both; violations of the regulations were punishable by a fine up to \$500. Under the new Communications Act the penalty for violation of the provisions thereof may be a fine up to \$10,000 and imprisonment up to two years, or both; and violations of F.C.C. regulations may be punished by a fine of up to \$500 for every day of such offense. Careful note of these changes should be made by applicants going up for an amateur ticket. The rest of us might just as well be fined \$10,000 as \$5000 MIM.

About this new law: It won't hurt to have a copy around; you may be interested in reading it some time when the power is off. Address the Superintendent of Documents, Government Printing Office, Washington, D. C., sending 5¢ and asking for a copy of the Communications Act of 1934. He'll accept a nickel but no stamps.

Telegraph Division

When the Federal Communications Commission, with its seven members, got down to the job of organizing itself, it split into three divisions, one each in charge of broadcasting, telegraph and telephone. Each division is in effect a miniature commission largely self-sufficient. Frequency allocations to *services* will be made only by the full Commission but otherwise the decisions of the divisions on their own matters will be final, subject only to appeal to the federal courts unless the full Commission first agrees to review a particular case. We are most interested

(Continued on page 108)

Amateur Radio in the Soviet Union

By John D. Kraus, W8JK*

Hams are hams the world over. The author of this article, a recent visitor to the U.S.S.R., describes his experiences visiting Russian members of the fraternity, tells of familiar ham spirit under conditions unfamiliar to the rest of us. Recently increasing contacts with U stations make the story of timely interest in this part of the world.—EDITOR

AT THE present time there are about 500 amateurs in the entire Union licensed to use transmitters and, in addition, about 2000 registered short-wave receiving stations. The Soviet Union occupies more than one seventh of the land area of the earth and many of the amateurs are widely separated from each other, but one finds also that much activity is centered around such cities as Moscow and Leningrad.

The amateurs are a self-governing group; the "Central Bureau of the Short-Wave Section" (abbreviated C.B.S.K.W.) is at the head of their affairs and has its headquarters in Moscow. One finds in nearly every city or district of any size a

Qualification." Among its duties are the working out of regulations and standards for the amateurs, the classifications of the amateurs into groups depending on their qualifications, the giving of license examinations, and the solution of technical discussions and questions arising between individual short-wave sections. Many of the regional districts also have such committees based on this model.

To secure a transmitting permit, one first obtains from the local Short-Wave Section (S.K.W.) of the Society of Friends of Radio (O.D.R.) a petition, which is then submitted to the regional organization of the S.K.W. After the amateur has been given a written examination and a code test by these regional organizations, they may issue a recommendation for a license. The recommendation is forwarded to the People's Commissariat of Communication, which then issues the license. For 5- and 10-meter transmission the recommendations may be given out directly by the local organizations. Only amateurs who have reached the age of 18 years and are actively engaged in the S.K.W. are qualified to receive licenses. By special permission of the C.B.S.K.W., however, persons under 18 may be recommended.

The Soviet amateurs are licensed in three groups or categories. The amateurs in the third or beginning category must have a code speed of 10 words per minute (5 characters to the word), a knowledge of radio abbreviations and procedure, and a general practical understanding of radio technique. For workers in productive industry and members of the Communist party, the code speed requirement is reduced to 6 words per minute. Privileges include 20 watts in the antenna and operation on 5, 10, 40, and 80 meters. On 40 meters the time of operation is limited to between midnight and 8 a.m. Moscow time with a tone not less than 4. The other wavelengths have no such limitations. Only 6 percent of the amateurs are classified in this category.

The second or middle category amateur is required to show in the examination a more thorough understanding of radio technique and a knowledge of the fundamental units used in elec-

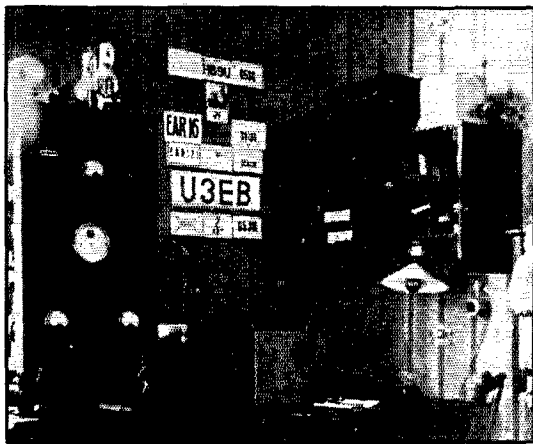

THE STATION OF ALEXANDER KAMALAGIN IN LENINGRAD, WHICH WAS VISITED BY THE AUTHOR

The call was U3EB before June 1st and is now U1AP. The transmitter is a 4-stage c.c. rig with 40 watts input to the final amplifier. Operation is on 40 and 20 meters.

"Society of the Friends of Radio" (abbreviated O.D.R.). The members include broadcast listeners and experimenters, but the societies have in most cases also a "Short-Wave Section" (S.K.W.), and it is in this section that the transmitting amateurs are active. Directly subordinated to the C.B.S.K.W. is a board made up of five amateurs which is known as the "Committee on

* Arlington Blvd., Ann Arbor, Mich.

(Continued on page 98)

With the Affiliated Clubs

AUTUMN! The magic word that brings amateur radio out of its summer doldrums. "Are you going to the club meeting?" again becomes a common question among the fraternity as the active season for things radio makes its appearance. Meetings are being resumed and clubs are getting up more steam each day. May the affiliated bodies lead the way through a glorious fall-winter season.

Modesto Wouff-Hong Trophy

The Modesto (Calif.) Amateur Radio Club will once again award the Wouff-Hong Trophy to the best station in the Sixth District. This yearly award was originated several years ago by the old Modesto Radio Club, since reorganized under the new name. Work between October 1, 1933 and October 1, 1934 will be considered in the contest. The following points will be used in picking the "best station": (1) DX miles per watt, max.—35%; (2) Traffic handled, total number of messages—25%; (3) Operating ability—20%; (4) Percentage of homemade apparatus—20%. Operators wishing to enter their stations should mail entries to C. E. Marsh, W6FFU, 127 Santa Rita Ave., Modesto, Calif., including description of station (photo, if one available), log covering station activities, Oct. 1, '33 to Oct. 1, '34, and QSL card covering DX claim. All entries must be received at W6FFU before November 1, 1934.

Annual Banquets Scheduled

The fifth annual hamfest-banquet of the Schenectady Amateur Radio Association to be held Saturday, October 6th, at the Masonic Temple, Scotia, N. Y., promises to be the biggest event ever held by that organization. Hamfest starts at 1:00 p.m. to continue all afternoon. Banquet at 6:30 p.m. Many valuable prizes will be available. The fee, including banquet, is \$1.25 for advance registration, or \$1.75 at the door. Reservations may be made through N. K. Eaton, W2DHS, 536 Thompson St., Schenectady, N. Y.

The Southern Tier Transmitting Amateurs (Pen Yan, N. Y.) will hold their annual banquet-hamfest, October 20th, at the Wagner Hotel. Good program and prizes offered. All hams invited. Registration opens at 6:30 p.m. Price \$1.50 at door, \$1.25 in advance. Address all communications to Francis Orcutt, W8GWT, Secretary, S.T.T.A., 127 South Ave., Penn Yan, N. Y.

56 mc. in Pennsylvania

The Shamokin (Pa.) Radio Club is doing considerable work on 56 mc., utilizing the advantages offered by the state forest fire towers. The club is contemplating a 56-mc. relay across the state of Pennsylvania and would appreciate a word from clubs and individual amateurs interested in such an undertaking. Address communications to the Shamokin Radio Club, care of the secretary, Louis Graw, Shamokin, Pa.

28-mc. Test Results

The Metropolitan Amateur Radio Association,

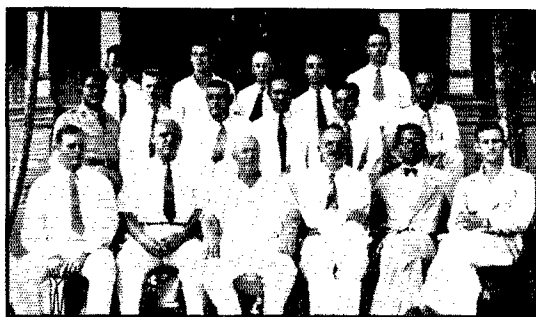

MEMBERS PHILIPPINE AMATEUR RADIO ASSOCIATION, JUNE 24, 1934, MEETING AT KAIJR

Back row, left to right: Lt. R. G. Meyer—KAIHR, KAIAN, KAIIRC, KAI DL, KAI CS. Center row, left to right: Sgt. Mimin-guez—KAIHR, J. H. McDonald, KA4GR, KAIOR, KAI EL, KAI GZ. Front row, left to right: KAI NA, KAI XA, KAI JR, KAI LG, KAI TS, KAI OP.

Melrose, Mass., reports results of its 28-mc. tests held on the last two Sundays in July and the first Sunday in August. The first Sunday was very active, but poor conditions slowed down results on the last two. W2TP, Leonia, N. J., was by far the highest scorer: 256 points! W9FM, Wheaton, Ill., rolled up 190 points for second high. Certificates go to each of the following, highest scorers in their respective districts: W1AV 27, W2TP 256, W4MR 24, W8FDA 12, W9FM 190, VE4IG 1. Others submitting scores: W1CTW 53 (not eligible for award, chairman of Contest Committee), W1FBV 9, W1BZC 2, W9GBJ 52, W9DRN 36, W9LWD 21. Much credit is due the M.A.R.A. for initiative in these 28-mc. tests.

Clubs on Job in Emergency

Members of the Houston (Texas) Amateur Radio Club and the Corpus Christi (Texas) Radio Club demonstrated during July the value of organized amateur radio.

(Continued on page 94)

A Pentode Output Transmitter With Six-Band Exciter

140-Watt C.W.—30-Watt Suppressor-Modulated 'Phone—Dual
53 Universal Excitation—Demountable Rack Construction

By James Millen, W1HRX*

THE new medium power r.f. pentodes such as the RK-20,¹ recently developed in accordance with suggestions of the technical staff of *QST*, make possible a very effective semi-portable, all-band crystal-controlled 'phone and c.w. transmitter. By utilization of relay rack construction, not only are attractive appearance, efficient lay-out, and compactness secured, but also there results semi-portability in that it

becomes possible readily to disassemble the complete transmitter on short notice for transportation in several relatively small and lightweight units. In this manner, the transmitter illustrated herewith was taken on an extensive trip to the West Coast during the past summer, and in addition to being set up at several hamfests *en route*, was operated for nearly a month from the shack of W6GWX at South Pasadena, California.

As will be seen from the accompanying diagrams, the circuit culminates in a pair of RK-20

* 84 Autumn St., Malden, Mass.

¹ J. J. Lamb, *QST*, May, 1934.

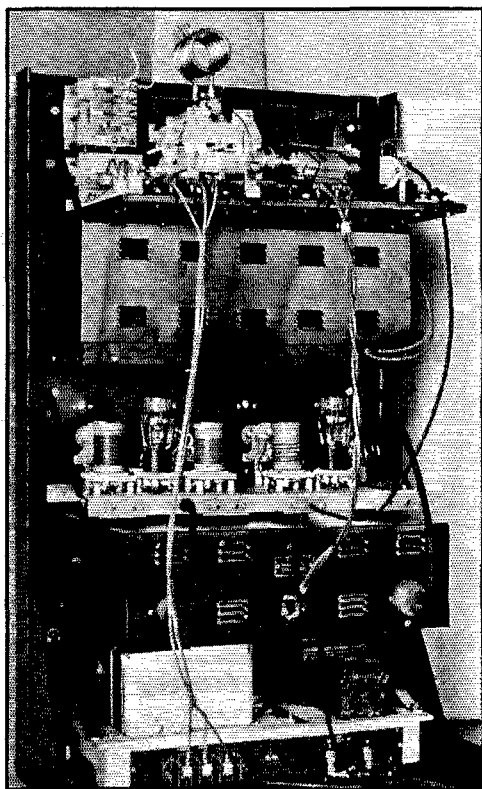
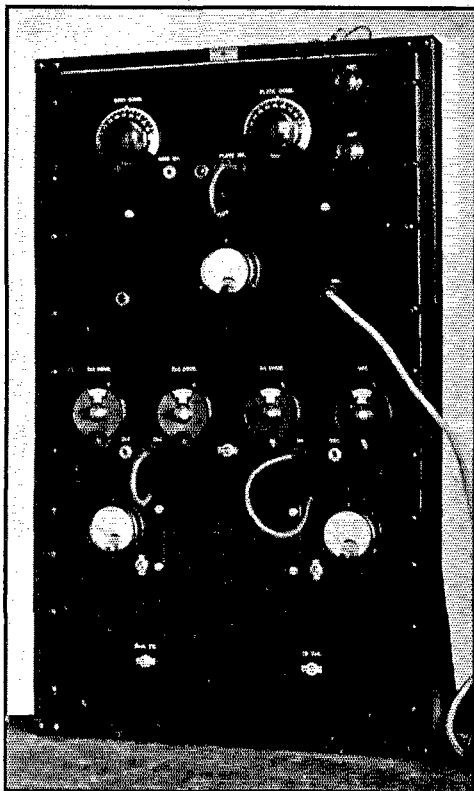

FRONT AND REAR VIEWS OF THE COMPLETE TRANSMITTER IN ITS RACK MOUNTING

From top to bottom the panel units are: final pentode amplifier and antenna coupling filter, speech amplifier and modulator, crystal-controlled exciter, modulator and exciter power supply, and 1000-volt power supply for the final stage. Note the individual jack strips (rear) for each stage of the exciter from which r.f. output of the desired frequency is tapped by the plug-and-cord link to the final stage.

r.f. pentodes with suppressor-grid modulation. The transmitter is built up as five separate units, which, from top to bottom, are: First, the final output stage containing also a "pi" type output-filter;² second, the modulator comprising the 56 speech stage, the 45 push-pull audio power stage, and the small 45-volt suppressor grid biasing battery. This battery is used to bias the suppressors at minus 45 volts for 'phone operation and is reversed to provide a positive bias of 45 volts for c.w. operation. Two small flashlight cells are also mounted on this modulator panel to take care of the single-button microphone of the Western Electric handset. The mike is plugged into the jack shown on the front of the panel.

Third, and directly beneath the modulator unit, is located the all-band exciter. This unit was built from the design developed a year or so ago by W1CTW and described by him at the different club meetings in and around Boston. Incidentally, a great many of these ex-

² A. A. Collins, QST, Feb., 1934.

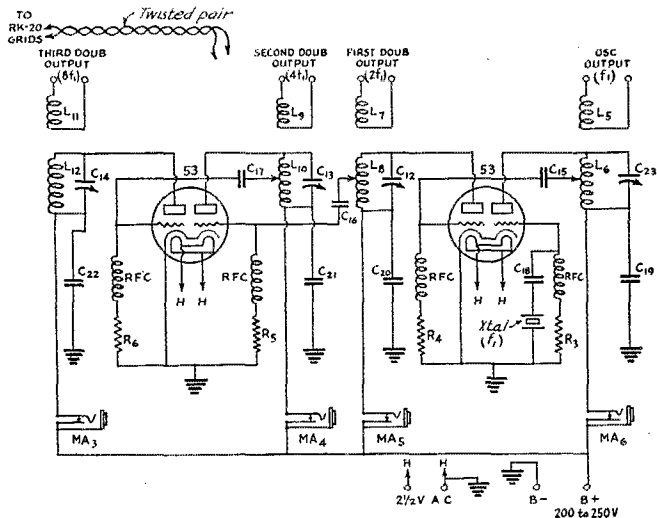

FIG. 2—CIRCUIT OF THE EXCITER UNIT

- L5, L6—Plate inductances and link coupling coil for crystal oscillator. See table.
 L7, L8—Plate inductance and link coupling coil for 1st doubler. See table.
 L9, L10—Plate and link coils for 2nd doubler. See table.
 L11, L12—Plate and link coils for 3rd doubler. See table.
 C12, C13, C14—20- μ fd. midget variable condensers (National Type SEU-20 or equivalent).
 C15, C16, C17, C18—0.001- μ fd. mica coupling condensers.
 C19, C20, C21, C22—0.01- μ fd. mica bypass condensers.
 C23—100- μ fd. midget variable condenser (National Type SE-100 or equivalent).
 R3—5,000-ohm 2-watt metalized grid leak.
 R4—20,000-ohm 2-watt metalized grid leak.
 R5—10,000-ohm 2-watt metalized grid leak.
 R6—10,000-ohm 2-watt metalized grid leak.
 RFC—R.f. choke (National Type 100 or equivalent).
 MA3, MA4, MA5, MA6—Single-circuit closing jacks for 0-50 millimeters. The key is plugged into the oscillator or 1st doubler plate jack for c.w.

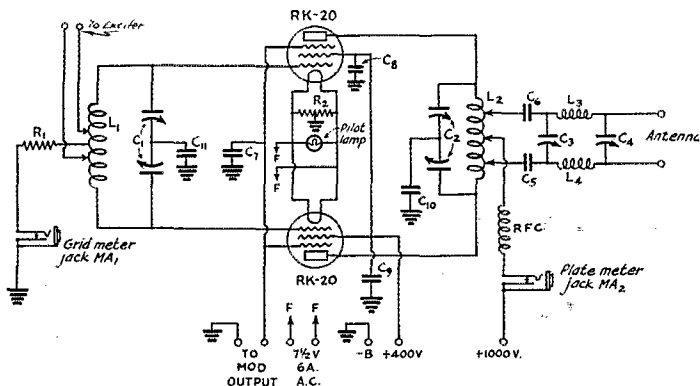

FIG. 1—THE RK-20 FINAL AMPLIFIER CIRCUIT

- L1 and L2—Grid and plate coils. See coil table.
 L3 and L4—Antenna coupler coils. See coil table.
 C1—Split-stator midget variable, 50- μ fd. per section (National Type STD 50 or equivalent).
 C2—Split-stator transmitting condenser 100- μ fd. per section, 3000-volt (National TMP-100 or equivalent).
 C3 and C4—Receiving type variable condenser, 150- μ fd. (National EMA-150 or equivalent).
 C5, C6 and C7—0.001- μ fd. mica bypass condensers.
 C8, C9, C10 and C11—0.01- μ fd. mica bypass condensers.
 R1—12,000-ohm 25-watt grid leak.
 R2—50-ohm filament center-tap resistor.
 RFC—Receiver-type r.f. choke (National Type 100 or equivalent).
 MA1, MA2—Single-circuit closing jacks for 0-200 millimeters.

citers are in use in this part of the country and have proven to be extremely practical. Two 53 tubes are used as the equivalent of four separate triodes. The 53's are used instead of single triodes not only to save space, but also because no single type triodes available have the desirable characteristics of the 53's for use either as crystal oscillators or doublers. The 53 has considerable power output, high mu, and very satisfactory cathodes. For use on 160-, 75-, 80-, and 40-meter bands, with an appropriate crystal, one section of the first 53 is used as a triode oscillator with its tuned plate circuit link-coupled directly to the RK-20 grid circuit without any intermediate buffer

stage. For operation on 20 meters with a 40-meter crystal, the other section of the first 53 used as a triode doubler, the output of which is then link-

ably more simplified arrangement, such as using the 53 push-pull unit as the output stage, is therefore preferable. Consequently, the transmitter is intended for full-output operation on the 10-, 20-, 40-, 80- and 160-meter bands.

The remaining two units, the fourth and fifth, are the power supplies. Three in all are used. The transmitter, made up on rather short notice, was assembled from standard equipment wherever possible. The 1000-volt supply for the final stage, for instance, is one of the standard Acme-Delta AD-60 units, which has been remounted on a relay rack panel along with the two a.c. switches (rectifier filament transformer and high-voltage transformer). The other power supply unit is a special National double AGS receiver pack which consists of two separate 200-volt supplies with individual type 80 rectifiers. One side takes care of the exciter, while the other takes care of the modulator, 2½-volt filament supplies being included. In order to conserve

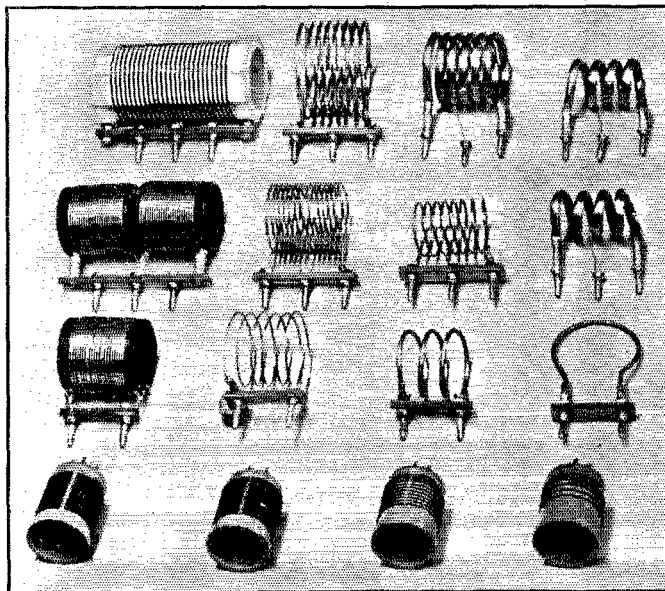

ILLUSTRATING THE FIVE TYPES OF COIL CONSTRUCTION USED
Winding data are given in the tables.

coupled to the grid circuit of the final stage. Similarly for 10 meters, a second doubling is resorted to in the first section of the second 53. It was originally planned to take the doubled output from the remaining side of the second 53 for 5-meter operation, with a 40-meter crystal, but on trial it was found that the excitation secured on 56 mc. was insufficient to drive the final stage. Consequently a buffer stage was built employing a single 53 as a neutralized push-pull 56-mc. buffer. While several local stations were worked with this arrangement, the output was still small in comparison with that obtained on all lower frequencies. For present day 56-megacycle operation a consider-

EXCITER COIL DATA

Main coils L_6 , L_8 , L_{10} and L_{12} are wound on 1½-inch diameter standard plug-in coil forms (5-pin) except L_{12} for 56 mc., which is a self-supporting winding of No. 10 wire, 1¼" in diameter. Link windings L_5 , L_7 , L_9 and L_{11} are each 2 turns of same wire as main winding, wound between ground-end turns of latter. Pin and socket connections are the same for each coil and stage so that coils are interchangeable to give proper combinations with different crystals. Specifications for the main windings are as follows:

Frequency	1.75 mc.	3.5 mc.	7 mc.	14 mc.	28 mc.	56 mc.
Total Turns	60	35	20	10	4	3
Tap Turns*	20	12	6	3	1½	—
Length**	1½"	1½"	1½"	1¼"	¾"	1"
Wire Size	No. 28	No. 22	No. 16	No. 16	No. 14	No. 10

* Excitation tap turns are counted from ground end of coil.

** The turns are spaced to occupy the winding length given.

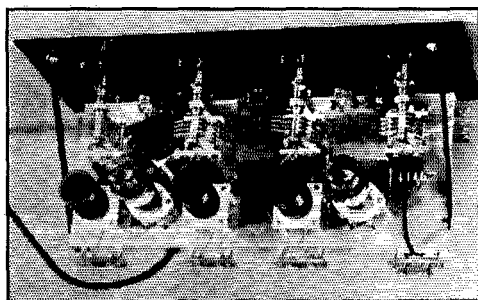

PLAN VIEW OF THE EXCITER UNIT SHOWING IN DETAIL THE ARRANGEMENT OF THE COMPONENTS

Two 53 tubes do the work of four triodes in the crystal oscillator (left) and three doubler stages. The coils in place are for 56-mc. output from a 7-mc. crystal.

rack space, the two millimeters for the exciter unit, instead of being mounted on a separate meter panel, are mounted as shown on this power pack panel.

A photo shows the group of coils as used for the 5-, 10-, 20- and 75-meter bands, the table giving the necessary specifications. The antenna filter coils shown were found to be just about right for use with either a Zepp or doublet antenna. All of these coils have GR plugs, the jacks being mounted on strips of Victron. Similar strips with

G.R. plugs and jacks are also used for the link coupling terminals.

In operating the transmitter on the lower frequency bands, it is necessary either to remove the unused exciter doubler coils or to detune the unused circuits. The amount of excitation is controlled by varying the coupling between the link and the grid coil of the RK-20's.

Even though full data already have been given in *QST* on the use of the RK-20,³ with the necessary cautions regarding overloading, it may be well to repeat again that for 'phone operation with the suppressors biased at 45 volts negative, the combined plate current of the two tubes under load should not exceed 110 ma. The carrier output for 100% modulated 'phone operation is then 30 to 40 watts. For c.w. operation with the suppressor grids biased at 45 volts positive, the combined plate current should not be over 200 ma., with carrier output approximately 140 watts.

The transmitter was only completed last June a few hours before leaving on a trip to the West Coast, but nevertheless was "test operated" on

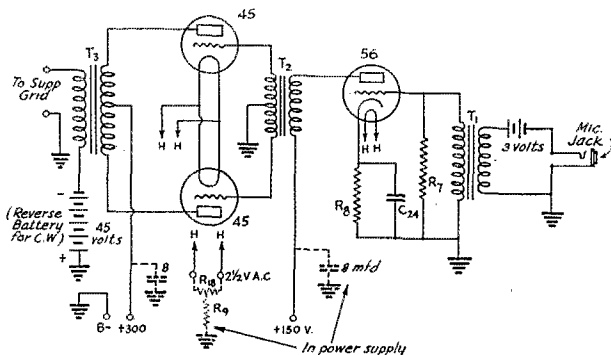

FIG. 3—THE SINGLE-STAGE SPEECH AMPLIFIER AND MODULATOR CIRCUIT

- T₁—Microphone transformer for single button mike (National Type T-1 or equivalent).
 - T₂—Push-pull input transformer (National Type S-51 or equivalent).
 - T₃—Push-pull output transformer (National Type S-11 or equivalent).
 - R₇—1/4-megohm metalized grid leak.
 - R₈—2000-ohm 5-watt biasing resistor.
 - R₉—750-ohm 10-watt biasing resistor.
 - R₁₀—Filament center-tap resistor.
- Note: Both R₈ and R₁₀ are mounted inside power unit.
C₂₄—0.5-μfd. low-voltage paper bypass condenser.

POWER AMPLIFIER COIL DATA

Frequency Mc.	L ₁ (Grid)	L ₂ (Plate)	L ₃ and L ₄ (Ant.)
1.75 (160-meter band)	81 T. 3" D. 5" L. No. 18	51 T. 4" D. 6" L. No. 14	34 T. 3 1/2" D. 1 1/2" L. No. 16
3.5 (80-meter band)	54 T. 2" D. 3 3/4" L. No. 16	34 T. 3" D. 4 1/2" L. No. 14	34 T. 1 3/4" D. 1 1/2" L. No. 16
7.0 (40-meter band)	28 T. 2" D. 1 3/4" L. No. 16	22 T. 2 1/4" D. 3" L. No. 14	12 T. 2" D. 1 1/2" L. No. 16
14.0 (20-meter band)	14 T. 2" D. 2 1/2" L. No. 14	8 T. 3" D. 2 1/4" L. No. 10	6 T. 2" D. 1 1/2" L. No. 14
28.0 (10-meter band)	8 T. 1 1/2" D. 2" L. No. 14	6 T. 2" D. 2" L. 1/4" tub.	3 T. 1 3/4" D. 1 1/2" L. No. 10
56 (5-meter band)	4 T. 1 3/16" D. 2" L. 1/4" tub.	4 T. 1 3/16" D. 2 1/2" L. 1/4" tub.	1 T. 2 1/4" D. No. 10

T. = No. of turns. D. = diameter of coil. L. = Length of coil. No. = Wire gage (B & S). Tub. = Copper tubing of specified diameter. Total turns are given for push-pull plate and grid coils; put tap at center.

Plate coils for 1.75, 3.5 and 7 mc. are wound on standard National Steatite transmitting coil forms. Plate coils for 14, 28 and 56 mc. are self-supporting. (See coil photo.)

all of the bands. During the few minutes we were on 10-meter 'phone, W4KR heard us and sent back a QSA 5 R8 report on 20 meters via

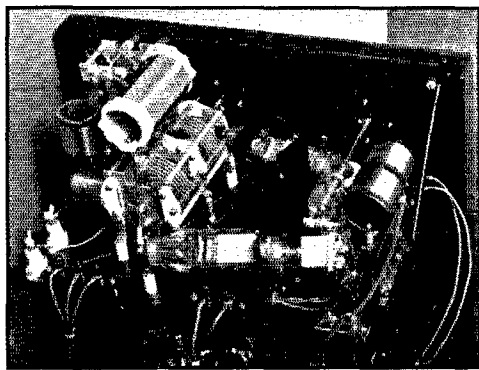

LOOKING DOWN ON THE PUSH-PULL FINAL STAGE

Link-coupled grid input circuit at the right, plate tank and antenna coupler at the left.

W3CPC-W1SZ. At this same time a cathode-ray oscilloscope check was made on percent modulation and the fixed resistor (R₇) placed permanently across the mike transformer to hold the gain down to a level that would prevent over-modulation.

While in California, we were visited by a great many amateurs who, having learned of the RK-20 through *QST*, were most anxious to see the

(Continued on page 108)

³ J. J. Lamb, p. 14, *QST*, June, 1934.

Coming Conventions

Delta Division Convention

October 13th and 14th—Memphis, Tenn.

THE two colonels may continue unabated their argument concerning the respective merits of crushed and uncrushed mint in the concoction of seasonably superb mint juleps; the ol' Mississipp', lazy after a long, dry summer, may forget its greedy arrogance and keep away from yo' door; the yella gals and the black boys may pursue their love making uninterrupted under the harvest moon . . . but all these things will fade into misty insignificance down in Memphis, near the Old South, when the Delta Division of the A.R.R.L. holds its 1934 annual convention at the Hotel Gayoso—a name rich in significance by itself alone. If you want a taste of the true Southern hospitality, if you want to attend a convention of real hams, send your \$2.00 for advance registration at once to J. C. Flippin, W4VT, Convention Manager, 3222 Choctaw Ave., Memphis, Tenn. It will cost you \$2.50 if you wait until the convention, and \$1.50 for the ladies—but whatever you pay, it will be a small detail in contrast to the wonderful time you're going to have.

Kansas State Convention

(Midwest Division)

October 13th and 14th—Topeka, Kansas

AT: The Hotel Jayhawk.
By: The Kaw Valley Radio Club.
Out of: The Sunflower State.
Booked by: John H. Amis, W9CET, 915 Lincoln, Topeka.
Track fast, weather clear . . . and a rousing good time for all. Be there!

West Gulf Division Convention

October 26th and 27th—San Antonio, Texas

IF Saint Anthony of Padua, patron saint of those things which are lost, is prone to watch more carefully over regions settled in his name than over others, his particular attention should be called to the Hotel St. Anthony in historic San Antonio during the last week end of October—for there's no telling what may or may not happen when a couple of hundred or more enthusiastic amateurs congregate there for the annual West Gulf Division convention. And they are going to congregate. The spectacular program which is being arranged, as well as the sterling good time which is being guaranteed, have already

attracted promises of attendance from nines, sixes, and even eights—and of course the entire fifth district. If you plan to attend—and, by all means, you should—send in your reservation with the \$3.50 convention fee, now, to H. W. Wallace, Secretary, San Antonio Radio Club, 1415 W. Rosewood Ave., San Antonio, Texas. Even if you don't get to anything else, you can't afford to miss that Boiled Owl party (for hams only) on Friday night!

Pacific Division Convention, 1934

November 10th and 11th—Fresno, Calif.

NEAR Fresno, Calif., is located the world's largest winery, we are told. We hope it's also one of the most substantially built, for this November it is going to have to survive a visit from what gives every indication of being the Pacific Division's most successful convention; a trip to it is to be one of the features of the program which the San Joaquin gang has generated for the hundreds of hams who will congregate at the Hotel Fresno. Among them will be such well known amateurs as Frank C. Jones, Jim Warner, Ralph Heintz, Charles Perrine, Don Wallace, Norris Hawkins, A. L. Budlong from A.R.R.L. Hq., Pacific Division Director S. G. Culver—and hundreds and hundreds of West Coast amateurs. If you intend to be one of them (and, incidentally, make yourself eligible for a special "reservation" prize) you'd better send in your reservation and the \$3.00 convention fee now to C. L. Kirkpatrick, W6DWE, P. O. Box 739, Fresno, Calif. You can't afford to miss the stellar program of technical features and general good time that has been arranged. From the opening address Friday morning by Mayor Leymel to the awarding of the Modesto Wouff Hong trophy at the banquet Saturday night, you're assured of a bang-up good time—a real Pacific Division convention!

Southeastern Division Convention

Battle House, Mobile, Alabama
October 19th-20th

THOSE at the Birmingham convention last year saw the determined effort made by the Mobile delegation for the 1934 convention. They meant business. Publicity now being released promises well for the convention at Mobile. Make proper note of the dates above and accept this announcement as a cordial invitation to be at the convention. Watch the publicity to be mailed

(Continued on page 32)

Applying the Tri-Tet Principle to Frequency Multipliers

A 14-mc. Transmitter With a Single Stage "Double-Doubler"

By Frank M. Davis, W9FVM-W5CR*

QUITE frequently a circuit which we call new really is only a modification of some older basic circuit resulting from an attempt to improve its performance or characteristics. The circuit described in this article is just such a development.

The output of the Tri-tet oscillator is rich in harmonics. We know that a tube can give more output when used as an amplifier than when used as an oscillator, assuming the same input in each case. In view of these two facts, why not separately excite the Tri-tet oscillator? It ought to make a swell doubler, and perhaps it would even quadruple with good efficiency!

We sketched the circuit (Fig. 1) in order to examine it critically. Remembering that the Tri-tet circuit operates much as a triode oscillator and a tetrode amplifier,¹ it was considered possible to quadruple with the circuit by doubling in the triode part, then doubling again in the tetrode part. Thus we have not a quadrupler, but a "double-doubler" circuit, or, speaking the alphabetical language of the New Deal, a "T.T.-D.D." amplifier circuit. Such we have dubbed it.

We set up the circuit in experimental form and played with it for a while. After the circuit constants were determined and we became familiar with its operation, it was found to answer in an unexpected but very satisfactory manner the problem of getting enough excitation from two stages for a medium-power Class-C amplifier on 14 mc. The crystal oscillator on 3.5 mc. can be of the pentode type, well known for its kindness to crystals even when used with fairly high plate voltages.

THE "DOUBLE-DOUBLER"

The circuit is similar to that of a Tri-tet with separate excitation substituted for the crystal,

* 1826 Third Avenue, S. E., Cedar Rapids, Iowa.

¹ For a description of this equivalence, see "A More Stable Crystal Oscillator of High Harmonic Output," June, 1933, *QST*.—EDITOR.

except that in the Tri-tet oscillator the cathode tank circuit is tuned to a considerably higher frequency than that of the crystal and acts as an excitation control for the oscillator portion of the circuit.

The operation of the double-doubler might be explained by considering that the cathode, control grid and screen grid of a tetrode tube act as a conventional triode doubler, and these three elements, together with the plate of the tube, then act as a tetrode doubler. The triode anode (the screen grid) is grounded with respect to radio frequency, so that electron coupling prevails between the triode and tetrode parts.

The tubes used are 59's. One tube alone is satisfactory, but two tubes in parallel divide the load and increase the output slightly over that obtainable with one tube. The tubes are used as tetrodes, with the Nos. 2 and 3 grids tied together. No work has been done with other types of tubes, although any tetrode, preferably of the heater type, should work satisfactorily.

The voltage on the screen grids is much lower than might be expected. For maximum output this voltage is between 40 and 50 volts. If it is obtained by means of a series resistance, the plate current will rise to dangerous values when either tank circuit is tuned off resonance. This gives a nice resonance dip, but the voltage divider method of obtaining the voltage is much more desirable from the standpoint of tube life. With the resistances shown at R_4 and R_5 in the complete exciter circuit, Fig. 2, the plate current of the tubes is limited to a safe value. The grid leak for this stage gives a negative grid bias of between 150 and 200 volts, which seems to be about right for maximum output. It varies with excitation, of course.

The plate voltage to be used depends on the excitation demanded by the following stage. With 300 volts on the oscillator and d.d. stages there is ample excitation for a pair of 10's. This excitation can be almost doubled by raising the

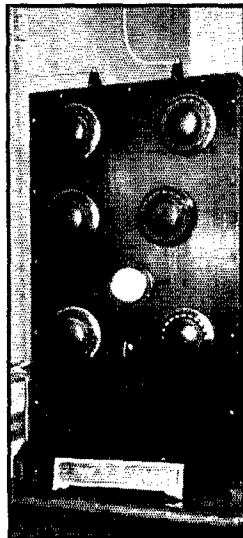

W9FVM'S TRANSMITTER

Oscillator and doubler tuning dials are in the lower row, with the tuning knob for the doubler cathode circuit between. Grid and plate tuning condensers for the push-pull final amplifier are just above the plate milliammeter. Antenna coupler dials are at the top.

plate voltage to 400 volts. The d.d. plate current is not high, being only 60 to 70 milliamperes for the two tubes in parallel, so that voltages as high as 500 or 550 might be safe, with a corresponding

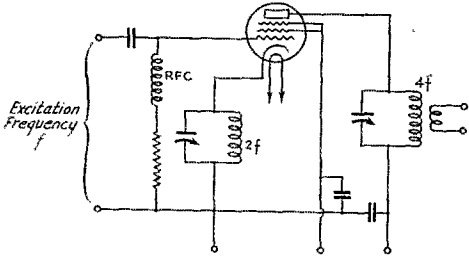

FIG. 1—THE FUNDAMENTAL CIRCUIT OF THE "DOUBLE-DOUBLER"

The cathode tank is tuned to the second harmonic and the plate tank to the fourth harmonic of the excitation frequency.

increase in output. The higher plate voltage has not been tried, but judging from the operation at 300 and at 400 volts, the output on 14 mc. with 500 to 550 volts on the plate possibly would be sufficient to excite a 203-A.

The excitation lead to the d.d. grids should be taken directly from the plate of the oscillator tube. If it is tapped down on the coil, self-oscillation is almost certain to occur with the tapped portion of the oscillator plate coil furnishing the resonant grid circuit. The d.d. stage then oscillates on 14 mc. in a manner similar to the TNT circuit. A careful choice of coupling condenser capacity must be made to get sufficient output without overloading the oscillator. Probably inductive or link coupling would be desirable, but capacitive coupling is satisfactory if the above precautions are observed.

The tuning of cathode tank circuit, L_3C_2 , is not critical. In fact, it need scarcely be touched for QSV anywhere in the 14-mc. band, so that it need not be controlled from the panel at all. However, a shorting switch across L_2 is necessary for 7-mc. operation, and in this transmitter C_2 is mounted on the panel and used as a shorting switch by means of a bent corner on one of the rotor plates. Also, we know that regardless of the location of the controls we'll be turning them, so we might as well put them all on the front panel where they will be convenient.

One point which seems very important is that the filaments of the 59's must be tied solidly to ground through large by-pass condensers. Without this by-passing operation is erratic and the output much reduced.

A COMPLETE TRANSMITTER

After the experimental work was finished, a complete transmitter, to be used chiefly for 14-mc. 'phone and c.w., was built up around the double-doubler. Thanks to the new circuit, the number of stages could be reduced to three with a certainty of plenty of excitation. This provided a welcome change from the unwieldy oscillator-doubler-doubler-buffer-final amplifier outfit previously used.

The transmitter uses a 59 pentode oscillator on 3.5 mc., a pair of 59's in parallel in the d.d. stage, and a pair of 10's in push-pull in the final amplifier. The oscillator tube might as well be a 47 or 2A5, since either is practically equivalent to a 59 pentode-connected. It is probably needless to mention that to use the 59 as a pentode oscillator the No. 3 grid must be connected to the cathode. A mounting for two crystals is used, with a s.p.d.t. switch to change from one to the other.

There is nothing unconventional about the push-pull final amplifier. Split-stator condensers are used in both plate and grid tank circuits.

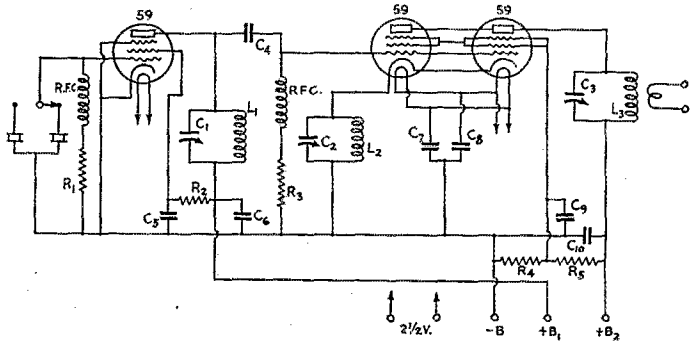

FIG. 2—AN EXCITER UNIT FOR 7- AND 14-MC. WORK USING A 3.5-MC. CRYSTAL

- C_1 —50 μ fd.
- C_2 —75 μ fd.
- C_3 —300 μ fd. (see text).
- C_4 —100 μ fd.
- C_5, C_7, C_8, C_9 —0.002 μ fd.
- C_6, C_{10} —0.01 μ fd.
- R_1 —40,000 ohms, 2 watt.
- R_2 —12,500 ohms, 2 watt.
- R_3 —10,000 ohms, 10 watt.
- R_4 —30,000 ohms, 2 watt.
- R_5 —50,000 ohms, 2 watt.
- RFC—National No. 100 or similar.
- L_1 —25 turns No. 16 d.c.c., coil diameter $1\frac{3}{4}$ inches.
- L_2 —13 turns No. 16 d.c.c., coil diameter $1\frac{3}{4}$ inches.
- L_3 —5 turns No. 16 d.c.c., coil diameter $1\frac{3}{4}$ inches, for 14 and 7 mc.; for 3.5 mc., 20 turns same with neutralizing winding of 10 turns No. 22 d.c.c. inside the coil.

Although the amplifier is series fed, r.f. chokes are used both in the high-voltage lead and in the bias lead to avoid grounding the taps on the coils, which might upset the circuit balance. In fact, if

the chokes are known to be good, parallel feed may be used with the bias fed through the choke to the grid of one tube, and the high voltage through another choke to the plate of one tube, thus avoiding any taps on the coils. No noticeable unbalance will be caused if chokes of low distributed capacity are used. Again, it should be pointed out that identical chokes in the plate and grid circuits of a stage may cause low-frequency self-oscillation.² Normal input to this stage is about 150 watts.

Link coupling is used and recommended between the d.d. stage and the final amplifier, with two turns in each coupling coil. Coupling to the d.d. tank is variable, with the coupling coil mounted on a slotted bakelite strip which in turn is mounted on a stand-off insulator. The grid tank of the final amplifier, L_1 in Fig. 3, is wound in two identical sections spaced about $\frac{3}{8}$ -inch apart on a $1\frac{1}{2}$ -inch diameter 5-prong tube base type coil form. The two-turn link coupling coil is wound between halves of the grid coil. This split coil construction was used solely for reasons of symmetry, since the split-stator condensers take care of the circuit balance.

With one exception, all the tuning condensers are made as small as possible to cover the required frequency range. This is done for the same reason that band-spread condensers are used in receivers—to spread the band and to give non-critical tuning. The one exception to the rule is the d.d. output tank condenser, C_2 . It was desired to cover two bands with the same coil and condenser, so this condenser tunes to 14 mc. at about 15 and to 7 mc. at about 95 on a 100-division dial. Plates were removed from the condenser, originally 500 $\mu\mu\text{fd.}$, until the desired spread was obtained.

The coils in the oscillator and d.d. stages are of the popular self-supporting type, doped and stuck to bakelite strips carrying G.R.-type plugs. They plug into jacks mounted in stand-off insulators.

The transmitter is keyed in the positive lead to the d.d. stage, making it necessary to use fixed bias on the final stage. This method of keying is used to prevent emission of a backwave. With the key up only the oscillator tube operates, and since the oscillator is on 3.5 mc., break-in operation is possible within a few kilocycles of the operating frequency on 14 mc. A switch is provided to open the primary circuits of the plate transform-

ers when it is desired to cut the oscillator also.

For 7-mc. operation the cathode tank is shorted out by means of the shorting condenser, C_3 , and the circuit functions as a straight doubler.

It is necessary to use a few tricks to get 3.5-mc. operation. With the parallel 59's operating as straight amplifiers quite a bit of r.f. excitation feeds through the grid-plate capacitance, so that the tubes must be neutralized. A simple method of neutralization is to wind a few turns inside the 3.5-mc. coil at L_3 , and connect it through a small neutralizing condenser to the grids of the tubes. This neutralizing condenser is permanently mounted with one terminal connected to the grids. The other terminal is left unused unless operating on 3.5 mc., in which case it is connected to a flexible lead from the neutralizing winding on the coil. The cathode tank circuit is shorted, of course.

The power source for the transmitter is located in the bottom section of the rack. Two separate power supplies are provided, giving 300 to 400 volts for the exciter stages and 600 to 750 volts for the final stage. Variation in voltage is by means of taps on the transformer primaries. Since

the usual power supply circuits are used, no diagram of this part of the transmitter is given.

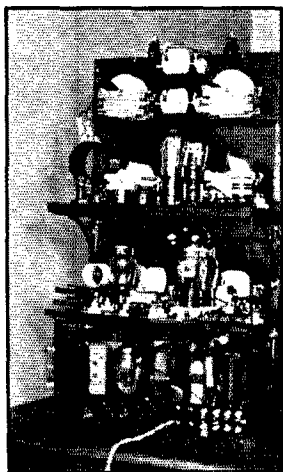

EXCITER AND AMPLIFIER UNITS OCCUPY THE TWO CENTER DECKS IN THIS REAR VIEW OF THE TRANSMITTER

The two power supplies are at the bottom of the rack. Provision has been made in the power equipment for using 830's in the final stage, since the output of the exciter is sufficient to handle them.

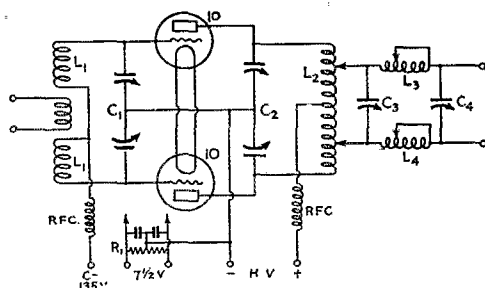

FIG. 3—THE PUSH-PULL FINAL AMPLIFIER

- C_1 —Split-stator condenser, 50- $\mu\mu\text{fd.}$ effective capacity.
 C_2 —Split-stator condenser, 35- $\mu\mu\text{fd.}$ effective capacity (Cardwell 413-B).
 R_1 —75-ohm center-tapped resistor.
 L_1 —14 mc.: each section 5 turns No. 22 d.c.c.; 7 mc.: each section 12 turns No. 22 d.c.c.; 3 mc.: each section 23 turns No. 22 d.c.c. Space between sections is $\frac{3}{8}$ inch. The two-turn coupling coil is wound between sections.
 L_2 —14 mc.: 6 turns No. 14 enam., space wound, 3-inch diameter; 7 mc.: 12 turns No. 14 enam., space wound, 3-inch diameter; 3.5 mc.: 26 turns No. 14 enam., space wound, 3-inch diameter.
 C_3, C_4, L_3, L_4 —Usual constants for antenna coupler. (See February, 1934, QST, page 16, and April, 1934, QST, page 24.) Filament by-pass condensers are each .002 $\mu\text{fd.}$

² The Radio Amateur's Handbook, Eleventh Edition, page 110.—EDDOR.

ASSEMBLY DETAILS

The transmitter is rack and panel mounted, with uprights of $\frac{3}{4}$ -by- $1\frac{3}{4}$ -inch stock. The overall height is 27 inches, the width 15 inches and the depth 9 inches. The baseboards, which are of $\frac{1}{2}$ -inch soft pine, are carried on ordinary 5-by-7-inch shelf brackets mounted on the uprights. The front corners of the baseboards are sawed out to fit around the uprights so that the baseboard can fit up against the panel. The frame is assembled with long wood screws in drilled holes, and the entire assembly is strong and rigid. All the tuning condensers are mounted on the baseboards, and nothing is mounted on the panel except the meter.

The two tuning condensers for the antenna matching network are carried on a dummy panel mounted on the back of the uprights at the top. Extension shafts are used to extend through to the dials on the front panel. The coils in this tuning unit are of the same type as used in the exciter stages. The antenna connections are made to stand-off insulators mounted on the top crosspiece of the frame.

There should be no question about the operation of any part of the transmitter except the double-doubler itself. Each of the two tank circuits in this stage will cause a pronounced dip in plate current when tuned through resonance, so that the stage may be tuned by plate milliammeter in the usual fashion.

Perhaps the old warning about hitting the wrong harmonic should be sounded again. Be very sure that the cathode tank is actually on 7 mc. and the plate tank is on 14 mc. The third harmonic is very easy to hit by mistake, and the output is about the same. Incidentally, there is absolutely no 7-mc. output from the stage if both the plate tank and the cathode tank are tuned to that frequency. For 7-mc. operation it is necessary to short the cathode tank as described above, or at least to detune it considerably. The best policy is to short it completely.

The Tri-tet double-doubler principle can be used in many different applications besides the one illustrated in this article. For example, a 3.5-mc. oscillator followed by two d.d. stages might provide 56-mc. excitation for a transmitter on that band. A Tri-tet doubling in its plate circuit followed by a d.d. should make a nice exciter for a 28-mc. transmitter. Time has not permitted experimenting with these applications, but the indications are that they would be practicable—and useful.

* * * *

EDITOR'S NOTE.—A similar circuit has been suggested by R. M. Winch, VK2OA, in a letter received at about the same time as W9FVM's article. Mr. Winch's circuit is shown in Fig. 4. The chief points of difference lie in the method of coupling the amplifier to the preceding exciter—the input terminals replace the crystal between grid and cathode in the original Tri-tet circuit, instead of being con-

nected between grid and ground as in W9FVM's circuit—and in VK2OA's proposal to operate the triode part of the tube as a neutralized amplifier on the same frequency as the driving stage. The tank circuit L_1C_1 is, therefore, tuned to the driving frequency and neutralized as though it were an ordinary amplifier; the plate circuit L_2C_2 is tuned to the second or a higher harmonic. Although circumstances made it impossible for VK2OA to give the circuit a trial, it might offer some possibility of increasing the output of a frequency-multiplying stage. It should be mentioned that W9FVM

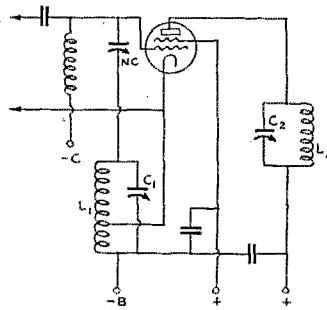

FIG. 4

tried neutralizing the triode portion of the tube in an endeavor to increase the output (doubling in the triode portion) but could discover no benefit as a result.

Southeastern Division Convention

(Continued from page 28)

to all licensed amateurs in the division for details of the program. It will be worthwhile. A.R.R.L. headquarters will have a representative and it is hoped that Lieut. John L. Reinartz, W1QP, the well known amateur and consulting engineer, will be present with some interesting demonstrations. We are glad to announce an initiation in the Royal Order of the Wouff Hong. Just write M. J. McDermott, Sec'y Mobile Amateur Radio Club, 54 S. Franklin St., Mobile, Ala.

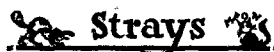

Foreigners still address cards to "SWL, United States"! These cards should be sent directly to the individual listeners, for our QSL Bureau cannot handle these.

Are foreign calls self-assigned with a knowledge of the English language and a bit of humor? To wit: ON4MAD, ON4ACE, F8PUP, F8FIZ, F8PEP, etc.

More DX Scores

Missing from the scores in the DX Contest report in Sept. *QST* were the following:

Austria—OE	Denmark (OZ)	Sweden (SM)
OE1JZ (2) ... 12	OZ7Z (2) ... 36	SM5UR (2) ... 36
OE3WB (1) ... 4		
NORTH AMERICA		
Canada—NY/K5	Mexico—(X)	
NY1AB (14) ... 25648	X1AA (14) ... 22722	
K5AF (12) ... 42124	X1AM (13) ... 11349	

The Melbourne Centenary International DX Contest

Four Week-Ends October 1934—Contact VK's on All Bands

By R. H. Cunningham, VK3ML*

THE Victorian (VK3) Division of the Wireless Institute of Australia is staging a world-wide DX contest. Every VK station will be on the air and will be there to provide another "kick" to ham radio—to provide something different. On this special occasion the W.I.A. feels that it would like to contribute to the world's major DX contests as an endeavour to return to those who have sponsored for many years thrills and fun for its own members.

The idea of this contest is simple. During the four week-ends in October, 1934, all hams are invited to contact as many VK stations as possible on all bands. What a chance for those hams who have not contacted VK to date! This is where we hope to return some hospitality that we have been sitting back and enjoying. The B.E.R.U. and A.R.R.L. Tests have helped many a low-powered VK ham and made his first foreign contact. Australia ranks about third in the world order of the number of active stations, and can therefore provide your QRP stations with DX.

The scoring will be one point for every 1000 miles of QSO. The grand total is to be multiplied by the number of VK Districts worked. An exchange of serial numbers and signal strength reports must be made between participating stations before points can be claimed.

The familiar A.R.R.L. system of making up and handling serial numbers will be used. Each participating station allots himself three figures, anything between 111 and 999. These figures form half the six-figure serial number that he hands over to the station he contacts. The other half, at the first QSO, consists of three noughts, 000. For example, 453,000 may be a station's number that he passes on to his first contact. In exchange he will receive a similar number, say, 687,989, which shows that that station has worked another station before, because the three 0's have been replaced by 989. The second half of the six-figure serial number is taken from the *first* three figures of the number received at the previous QSO, and is added on to a station's own three figures. Then this combination is given to the next contact, and so on throughout the test. Always retaining the first three figures, adding the second and transmitting them in that order. For example, VK4AB assigns himself 674 and has received from his foreign contact 234,678. VK4AB

then gives to his next QSO 674,234. If he in turn receives, say, 976,532, his next number to be sent would be 674,976 and so on. U. S., Canadian, and other stations do exactly the same as VK4AB has done, and both participants enter the received and sent serial numbers in their logs.

Naturally the distant stations will be most sought after because of the points per 1000 miles basis. This puts the W1's and 2's on a similar footing as W6, etc., in fact, it makes the contest fair to stations in all parts of the world.

Priceless Centenary Certificates are waiting to be awarded. They only appear once in a hundred years! Each country participating will be awarded a certificate to its winner, and special awards will be made to the winner in each licensing area of U.S.A. and Canada, as well as to each of the British Isles.

In our moments of enthusiasm and dreams we have not forgotten the countless number of S.W.L.'s in the world, and have therefore opened up a separate contest for their benefit. The awards, scores and rules that follow hold good for both receiving and transmitting contests.

Contest Rules and Conditions

1. There shall be two contests:
 - (a) Transmitting.
 - (b) Receiving.
2. The Wireless Institute of Australia Centenary Contest Committee's ruling will be binding in case of any dispute.
3. The nature of the contest requires the world to work Australia.
4. The contest is to be held from 0001 GT Saturday, October 6th, till Sunday, October 7th, 1934, at 2359 GT, and will be continued over the four week-ends in October at the times stated above on each occasion. The dates of the other week-ends are October 13-14, October 20-21, and October 27-28, 1934.
5. The contest is open to all licensed transmitting amateurs and receiving stations in any part of the world. Unlicensed ship and expedition stations are not permitted to enter the contest. Financial members of the W.I.A. and its affiliated societies only will be eligible for an award in VK.
6. Only one licensed operator is permitted to operate any one station under the owner's call sign. Should two or more operators operate any particular station, each will be considered a competitor, and must enter under his own call sign and submit, in his log, the contacts established by him. This debar persons from entering who have not a ham license.
7. Each entry must be signed by each competitor as a declaration of the above statement.
8. Each participant will assign himself a serial number of three figures as detailed in the contest description. When two or more operators work the one station each of them will allow himself a separate number.
9. All amateur frequency bands may be used.

* Manager Centenary Contest Committee.



Single-Tube Head Amplifier for Condenser Microphone

The single-tube condenser-microphone head amplifier shown in Fig. 1 has been used with success by R. G. Seeli of Hartford. The gain is at least equivalent to that obtainable from the usual cascaded resistance-coupled 30's, a large voltage step-up being secured through the use of a 32 screen-grid tube. A novel feature of the circuit is the output coupling device, which is simply a single-button microphone transformer reversed so that the secondary is connected in the plate

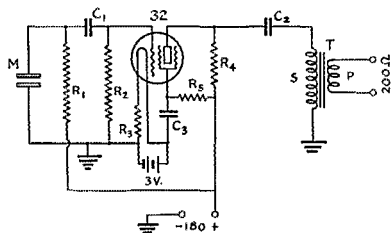

FIG. 1 — SINGLE-TUBE HEAD AMPLIFIER FOR CONDENSER MICROPHONE

- C₁ — 0.01 μ fd.
- C₂ — 0.1 μ fd.
- C₃ — 0.25 μ fd.
- R₁, R₂ — 5 megohms.
- R₃ — 16 ohms.
- R₄ — 250,000 ohms.
- R₅ — 75,000 ohms.
- T — Single-button microphone transformer.
- M — Condenser microphone head.

circuit and the primary used as an output winding to work into a low-impedance line. To avoid having the plate current flow through the secondary, with a consequent reduction in inductance, the plate voltage is fed to the tube through a 250,000-ohm resistor, the transformer being coupled to the plate through a 0.1- μ fd. condenser. The 1-volt drop across a 16-ohm resistor in series with the filament of the tube is utilized as grid bias.

An amplifier of this type offers savings in both space and cost.

Link-Coupled TNT Amplifiers

Nearly everyone who has tried link-coupling between stages, and between the transmitter output and the antenna tuning unit, is aware of its advantages over other methods of coupling.

The only real disadvantage, as I see it, is the

necessity for added tuning controls and the expense for extra variable condensers. Why not a TNT amplifier instead of t.p.t.g.? The TNT oscillators seemed to work as well as t.p.t.g. rigs so why wouldn't the same reasoning apply to a neutralized amplifier? If it worked the only disadvantage to link-coupling would be overcome. I tried it on my rig and it sure did "perk." I got every bit as much excitation, the note seemed to improve and neutralization was more complete. What's more, there is no more apparatus used than with capacity coupling.

The TNT grid coil from an old self-controlled job was connected in place of the tuned condenser-coil combination and while it is doubtful if the coil was the proper size for the tube used, the rig performed perfectly. I have not as yet had time to experiment with different coil sizes but what little I have done has assured me that my new rig will be link-coupled throughout with TNT amplifiers in every stage.

—Tom J. Boland W6AJP

5-Meter Antenna for the Car

Needing a method of supporting a 56-mc. vertical antenna on a car so that the antenna would be

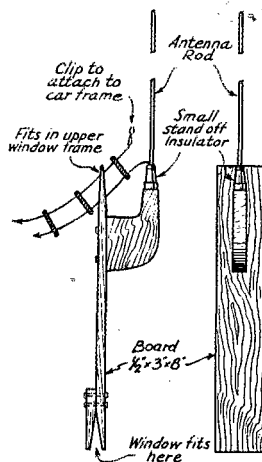

FIG. 2 — DEMOUNTABLE FIVE-METER ANTENNA FOR THE CAR

readily demountable and not mar the car in any way, I devised the scheme diagrammed in Fig. 2. It worked very successfully, so I am passing it on

to any of the five-meter gang who may be in the same predicament. The car window is cranked all the way down, the upper (sharpened) end of the flat wood piece is fitted in the groove where the glass usually goes, and the window is then cranked up into the groove in the lower end of the wood piece. For the antenna itself, a lath or bamboo flower stake supporting a wire would work just as well as the rod and stand-off combination, which is not very strong in a wind. I use a 46-inch rod with six-foot feeders spaced two inches, a combination which works out well for mobile operation where trees are low over the streets. A small battery clip grounds the odd feeder to the metal rain gutter around the roof of the car.

—Edgar V. Seeler, Jr., W3BBZ, W1BDF

Key-Thump Kinks

The diagram of Fig. 3, showing the arrangement used to eliminate key clicks and thumps at W1AUN, is submitted in the hope that it may be of help to other amateurs who are bothered by the same trouble. It has taken a long period of experimenting here with all sorts of arrangements to find that the trouble was being caused by the

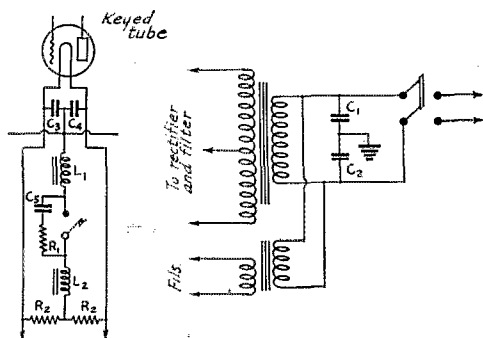

FIG. 3 — KEY-CLICK ELIMINATOR

- C₁, C₂ — Filter condensers from "B" eliminator (0.5 μfd. or more each should be sufficient).
- C₃, C₄ — Oscillator filament by-pass condensers (.002 or larger).
- C₅ — 1 μfd.
- R₁ — 10,000 ohms.
- R₂ — Center-tap resistor.
- L₁, L₂ — Chokes from "B" eliminator.

high-frequency surges getting into the 110-volt supply line, and being wired to most of the neighboring BCL sets, causing anything from an ordinary click to complete blocking of the receivers.

In common with the average operator, I was very much against any arrangement which would decrease the power of my transmitter, but the circuit shown in Fig. 3 had not the slightest noticeable effect on the efficiency.

The parts were obtained from an old "B" eliminator, except for the condenser and resistance across the key. C₁ and C₂ are simply the

condenser block from the eliminator, and L₁ and L₂ are the chokes. The 110-volt line to the power transformers should be run in BX cable with the metal covering grounded.

One thing seems to be very important in regard to the key connections. The wires from the key to L₁ and L₂ must be as short as possible. Wires only a foot long will radiate enough energy to be heard in a neighboring BCL set. Shielded cable with the shield grounded may be of help although I have not tried it. However, by locating the chokes directly at the key, and with the parts arranged as in the diagram, no interference, except for slight harmonics,¹ is caused in a nine-tube superheterodyne located in the same house and having its aerial connected to the same pole as my transmitting antenna.

—Gordon Wiley, W1AUN

Boosting the Plate Voltage

Many power transformers, particularly those used with low-power transmitters, have unused filament windings. By connecting such a filament winding in series with the primary winding so that the voltage drop across the filament winding bucks that of the primary winding, the turns ratio is increased and a higher output voltage results.

To determine the proper connections, place an a.c. voltmeter across the secondary high-voltage winding and note voltage, then place one of the filament windings in series with the primary winding and note the change in voltage. If it increases the connection is correct, if not reverse the filament connections.² More than one may be connected in series and then placed in series with the primary. If excessive heating is noted, it is advisable to cut out one or more bucking windings to prevent damage to the transformer.

I have used this kink for some time. The transformer in question normally supplied 1300 volts a.c. at 200 ma., and since placing one 2½ and one 7½-volt winding in series with the primary, the voltage increased to 1500 volts with the same load current without heating.

—Dean C. Logan, W2GKZ

Battery Grid Bias

There are certain grid bias requirements, such as in Class-B audio and Class-B linear amplifiers, demanding a constant voltage which can be most satisfactorily and easily met by the use of battery bias. Batteries are also much used for biasing Class-A and Class-C amplifiers.

One difficulty often experienced with the use of

¹ Undoubtedly the fault of the receiver, not the transmitter. — Ed.

² If a high-range a.c. voltmeter is not available the high-voltage winding of the transformer may be connected to the 110-volt line and the voltage across what is normally the primary measured by a filament voltmeter. — Ed.

bias batteries is the effect of the grid current. This current, flowing through the battery in a reverse direction, has a charging action which often results in very erratic battery voltage and short battery life. The circuit shown in Fig. 4 will

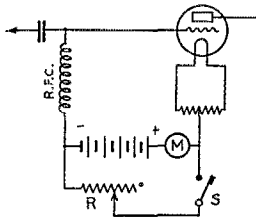

FIG. 4—BY CHOICE OF SUITABLE RESISTANCE VALUE AT R, THIS CIRCUIT WILL ELIMINATE BIAS FLUCTUATIONS AND PREVENT DAMAGE TO BIAS BATTERIES CAUSED BY GRID-CURRENT FLOW

correct this condition. The resistor in shunt with the bias battery eliminates the charging component by compensation. In operation, all tuning and neutralizing adjustments are made with the switch *S* open. Then, after closing the switch, the resistor *R* is adjusted so that the milliammeter reads zero.

Under these conditions the grid bias is definitely fixed at the open-circuit voltage of the bias battery and is not subject to fluctuations because of charging. Since no current is drawn from the battery its voltage will remain constant except for the slow decline due to aging. Of course, the switch should only be closed during periods of operation.

To determine the value of resistance needed, divide the battery voltage by grid current (in amperes) and for the wattage multiply the same two factors.

— L. S. Fox, W2AHB

Easily Made High-Voltage Switch

In the construction of many amateur transmitters there is a need for a high voltage switch that costs little yet will not have high distributed capacity or a tendency to break down at crucial moments.

The switch illustrated (Fig. 5) was made for use in a 50-watt transmitter as a wave changer. It seems to have all these desirable qualities and no faults. It is made of bakelite discs held to a shaft with collars salvaged from a defunct radio receiver. The frame is made of bakelite and the side contacts are jack springs. The end contacts in the base of the frame are spring buttons made to hold doors shut. The contact elements are brass strips that cover one half the periphery of the bakelite discs. These are annealed, bent, and bolted on. This type of switch is not only simple in construction, but can be made to handle any number of

circuits within reason at any ordinary current. The switch illustrated handles 10 amps. on one of the discs without heating.

—Ronald L. Ives, 32 Laurel Pl.,
Upper Montclair, N. J.

Partial Application of Crystal-Lock System

Since the publication of my article on "Low Cost Crystal Control for High Power" in June 1934 *QST*, I have received numerous letters

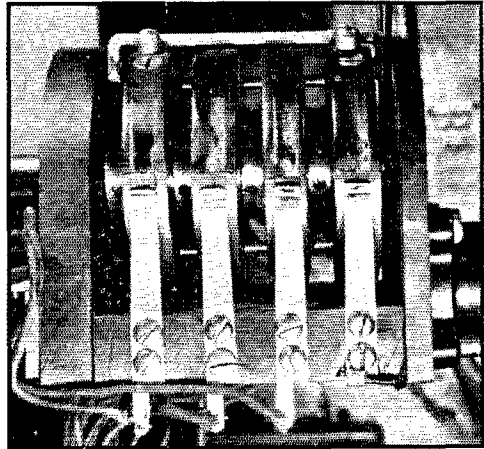

FIG. 5—HOME-MADE HIGH-VOLTAGE SWITCH

indicating an extensive interest in this type of crystal control. Since link coupling is fast becoming universal in its application another phase of the crystal-lock system is worthy of consideration.

In the present-day link coupling system, in which the grid circuit is tuned, it is seen that the final amplifier can readily be converted to a self-excited t.p.t.g. unit by de-neutralizing the amplifier merely by rotating the neutralizing condenser. If the final amplifier is of husky proportions and the doubler or pre-amplifier stage is of modest output power, a distressing condition may exist. This distressing condition is none other than insufficient excitation to the final amplifier. The transmitter can be converted to a partial lock-crystal system without any change at all except changes in adjustment. By partially de-neutralizing the final stage feeble regeneration will set up, which may not be enough to let the unit oscillate by its own excitation, but will be enough to furnish the added excitation required for increased output power. The coupling from the previous doubler or amplifier stage and stages farther back, including the crystal stage, can all be decreased, as little power is required of these units in crystal lock stages. Two 212-D's are used in push-pull at W5VU at present instead of the single 212-D that was in use when the article was

sent to *QST* and the same 112 crystal oscillator and 46 doubler unit shown in *QST* is in use.

It will probably be found that the whole transmitter will function better as the tubes in the preliminary stages will have a chance to "cool off" and operate somewhere near their intended operating conditions. Incidentally, this should cut down the number of trips to the tube store.

—Durward J. Tucker, W5VU

Governing the Wind Generator

In connection with wind-driven battery chargers such as were described in *QST* for March 1934, John Scott, VE4EN, offers a suggestion for making the mill automatically turn itself out of the wind when the charging rate becomes too high. The essentials of his arrangement are shown in Fig. 6. In brief, the hub of the impeller is offset from the line of the tailpiece and pivoting point—the amount of offset is actually 8 inches, as shown—and the tail is provided with a separate pivot.

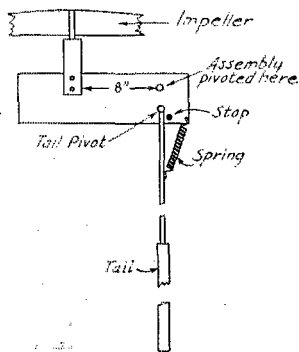

FIG. 6—RIG FOR AUTOMATICALLY TURNING THE IMPELLER OF A WIND-DRIVEN BATTERY CHARGER OUT OF A HIGH WIND

Under normal conditions the line of the tailpiece is at right angles to that of the impeller, being held that way by the tension of the spring pulling the assembly back so that the tailpiece rests against the stop. If the wind becomes too high, however, the impeller tends to turn itself out of the wind, pulling against the spring as it does so. By adjusting the tension of the spring the maximum charging rate can be regulated. VE4EN's rig starts to kick out at about an 8-amp. rate, never going above 12 or 14 amps. even with high winds. The tail should be of fairly good size—VE4EN's is 14 by 20 inches and is set on an arm 3 feet long.

Notes on 14-mc. C.C. Transmitters

From QSO's on the 3.9-mc. 'phone band I find that many hams are having trouble in making crystal controlled rigs work on 14 mc. This was the case at W8HCR, and about three months

were wasted in trying to obtain sufficient excitation to a pair of 10's in push-pull on 14 mc. The following points seem to cover the main sources of trouble.

1. In using Type 46 or 47 tubes as doublers, high plate voltage seems to be necessary and desirable. The 47 is used the same as a 46, with the two grids tied together. A plate voltage of 500 to 600 volts is desirable and is safe if the grid bias is kept high on these tubes.

2. Do not use automatic grid bias of the grid leak type on these tubes at plate voltages above 400 volts. If a fixed grid bias of between 50 and 150 volts is used, depending on the plate voltage and the output needed, there is no danger of the grids going positive under any normal load. This fixed bias may be obtained from batteries or from a "C" bias eliminator with a low resistance voltage divider (not over 20,000 ohms for a 250-volt supply).

3. Neutralizing seems to make no appreciable difference in the operation of the frequency doublers.³ When using the 46's neutralizing is easy and the tubes may then be run as straight buffers at any time. However, 47's are difficult to neutralize and are usually run as doublers only.

4. Capacity coupling between stages is used, the condenser being connected directly to the plate end of the preceding tank coil. Capacity values can be from 40 μ fd. to 100 μ fd. for coupling between the oscillator and the doubler stages. The capacity for coupling from the second doubler to the 210's in the Class-C amplifier may range from 100 μ fd. to 500 μ fd.

5. No series radio frequency chokes were found necessary in the plate supply leads. These leads were each by-passed to the filament center-tap with a 0.002- μ fd. condenser.

6. Shielding between stages was found to be absolutely necessary and was the point that had been causing practically all the trouble. Without shielding, the tuning of the second doubler and final amplifier was extremely critical, and regeneration was being set up in such a way as to counteract a large part of the excitation voltage which was being impressed on the Class-C stage. As a consequence the final amplifier would not load up and the doublers ran extremely hot. The shielding as used consisted of galvanized sheet iron baffles between stages with a height great enough to extend above all apparatus in each stage. Also, a galvanized iron sheet was placed on the sub-base and all parts mounted on top of this. No shielding was needed in front or back of the stages and none on top. The shielding was insu-

³ Neutralizing accomplished by feeding r.f. voltage from the plate circuit back to the grid often increases the efficiency of a doubler stage by introducing some beneficial regeneration, although there is no tendency toward oscillation. This effect seems to be more pronounced with low- or medium- μ tubes, however, than with high- μ tubes which inherently are good doublers.—Ed.

lated from all equipment and connected at one spot to the negative "B" lead. This cleared up all the trouble and each stage tuned up as easily on 14 mc. as on 3.9 mc., and sufficient excitation was obtained to drive the final 210's in the modulated stage.

In conclusion I wish to state that the information on shielding and plate voltages was given me

by W8DLD and came at a time when it had seemed to be impossible to make the transmitter work properly. I am passing this information along to the rest of the hams in hopes that it may help someone else who has been having the same troubles.

—Weldon B. Sanger, W8HCR
(Continued on page 88)

Spreading Out the Calibration Curve

A Handy Kink for Increasing the Readability of Graphs

AS WE have pointed out before in *QST*, the accuracy with which frequency measurements are made depends to a large extent upon such purely mechanical things as precise reading of dials and calibration charts, as well as upon the goodness of the frequency meter itself. The use of a large sheet of cross-section paper and a large curve to make precise reading possible has therefore been recommended. But it is some-

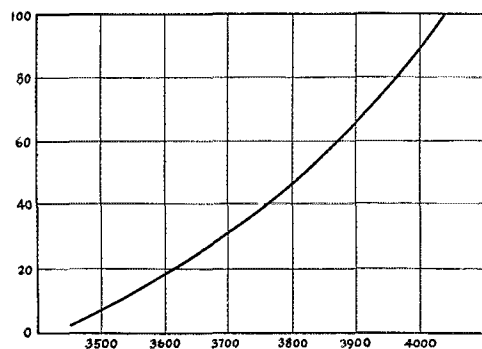

FIG. 1

times inconvenient to have to unfold a large curve sheet every time one wishes to take a reading, besides the difficulty of following accurately the lines from the margins to the curve without resorting to the use of a rule.

A scheme called to our attention recently by one of our readers overcomes both of these objections nicely and makes it possible to fit a large curve into a small space as well as increase the ease of reading. It is best explained by reference to Figs. 1 and 2. In Fig. 1 we have a sample calibration curve occupying a 5 by 7 inch space on a sheet of ordinary cross-section paper, which has 20 lines to the inch. To avoid confusion only the lines spaced an inch apart are shown in the drawing. The calibration is assumed to cover the 3500-kc. band. This size of curve is easy to handle, but is difficult to read precisely because each dial division occupies only one-twentieth of an inch on the chart, and the nearest one can read is

about a half division. The same is true of the frequency readings — the limit of precise reading is only about five kilocycles.

In Fig. 2 the curve has been split into several sections, and the spacing has been doubled for both the dial and frequency readings, *without increasing the size of the sheet*. Each dial division now occupies a tenth of an inch, and the frequency can be read to $2\frac{1}{2}$ kilocycles as easily as to five in Fig. 1. Besides this the chart is more easily followed because the values of ordinates and abscissas are plotted right on the curve.

The idea can of course be applied to any size of curve, and the sections may be chosen for the greatest convenience in use. For instance, the first section might include the phone band only, or might be drawn so that all of the 7- or 14-mc. harmonics would be on a single section.

In connection with plotting curves, it is a good idea to use a needle and make a small prick in the paper at the plotted points rather than to plot

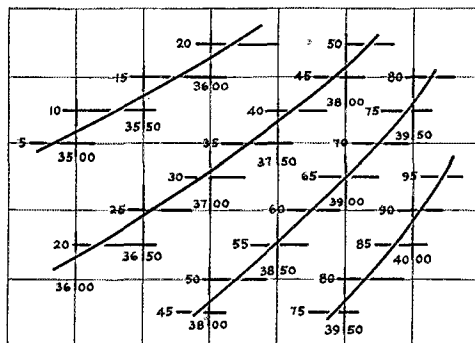

FIG. 2

with a pencil. The advantages are obvious. The needle may be mounted in a wooden handle if many curves are to be drawn. Needless to say, the curve itself should be drawn with a hard pencil sharpened to a fine point or with a fine-pointed ruling pen, since a thick line is hard to read.

— G. G.

Canada—U.S.A. Contact Contest

October 12th (6 p.m., Friday) to October 14th (Midnight, Sunday)

FOR several months plans have been discussed for holding another W/VE QSO Party. Canadian amateurs now propose to make this an annual activity, and cordially invite hams in every one of the 69 Sections of A.R.R.L.'s Field Organization to take part in three big evenings of operating fun and competition. All W and all VE hams may take part, using any amateur frequency band.

This will give many W's a chance to work all VE districts for the first time. It will be interesting to see what U. S. ham can work most Canadian stations in the period of the tests—and which Canadian station will work most stations and Sections in the U.S.A. likewise. Each contact counts one point, with extra credit for a message exchange¹ in proof of "real solid" contact. This is a splendid opportunity to make new station records and get acquainted with our neighbors at the same time we have operating fun.

A Committee of Canadian amateurs acts as sponsor of these 1934 tests. The Canadian General Manager heartily endorses the enterprise. An A.R.R.L. Certificate of Merit, like that represented herewith, will be awarded the winning station in each Section, this signed for the Award Committee and by the C.G.M. himself. The Utah-Carter Radio Corporation of Toronto is, in addition, presenting a cup to the leading Canadian station. Here are the simple rules for the W/VE QSO Contest.

DATES: Starts—Friday, October 12th, 6 p.m. local time.

Ends—Sunday, October 14th, midnight, local time.

Duration—54 hours. Frequencies—Any or all amateur bands may be used.

OBJECT: Each VE will work as many W stations as possible, in as many United States A.R.R.L. Sections (see list p. 5 QST) as possible.

Each W will work as many VE stations in as many VE Sections as possible.

¹ Participants can "make-up" suitable messages if none on the hook. Write them out before QSO where practical, make them interesting, avoid "rubberstamp" or stereotyped "standard" texts, etc. Such messages will then add to regular totals reported for the period Sept. 16th—Oct. 15th.

SCORING: Each Canada/USA or USA/Canada QSO counts one point.

Handling² of any amateur traffic regardless of number of messages, an additional two points.

Maximum points for one QSO³ is three points.

VE stations multiply number of points by number of United States A.R.R.L. Sections worked.

W stations multiply number of points by number of VE A.R.R.L. Sections worked, and multiply final score by nine (there being nine times as many U.S.A. Sections).

POWER AND OPERATOR HANDICAP: Every station using less than 50 watts input to the final stage may multiply his score by 1½. If there is more than one operator at a station, the



Date and Time (local)	VE or W Station Worked	City or Town	Section	Traffic	Points
Oct. 12 6:02 p.m.	VE3SGT	Toronto	Ontario	2 Rel. 1 Del.	3
6:09 p.m.	VE2BE	St. Lambert	Quebec	1
					4
					x2 Sections
					8
					x9
					72 Total Score

FORM FOR REPORTS TO VE3AZ ON W/VE CONTEST SHOWING HOW SCORES ARE COMPUTED

operator having the highest score will be the score for that station.

(Continued on page 98,

² "Handling" a message always includes the transmission and receipt of radio acknowledgment (QSL) of same, and entry of date, time and station call on the traffic, as handled, for purposes of record. All messages should be handled in standard A.R.R.L. form.

³ Second QSOs with a station that has already been worked do not increase the score in any fashion, unless during such QSO traffic-handling is added, where no traffic was previously handled. In such a case the two points may be added, and special notation entered in the report.



Amateur Radio STATIONS



W6RJ-WLVB, Oakland, Calif.

W6RJ's history dates back to 1925, when J. H. MacLafferty, Jr., opened up with a 5-watter in the Armstrong circuit, fed from a chem rectifier and hitched to an inverted "L" antenna made of four strands of twisted copper ribbon. International DX was coming into its own around that time, and "Mac" was the first Sixth District ham to hear G2SZ, one of the famous calls of those days. Branching out a bit

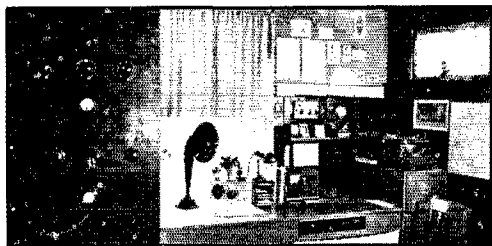

W6RJ-WLVB

on his own, the following year 6RJ put in a 50-watter with a plate supply which unquestionably was d.c.—it consisted of a 1200-volt bank of wet "B" batteries! With this rig plenty of DX was worked, and its signals were reported from England and Italy, among other countries more commonly reached by California stations.

Although the intervening years have seen a good many changes, the transmitter still uses a "50-watter," now a VT4B (UV-211). The 1934 rig, which is concealed behind the panel at the left in the photograph, is a four-stage crystal affair having a 47 oscillator, 46 doubler, 10 buffer, and of course the VT4B. Link coupling is used between the last two stages, with the final running at an input of 250 watts. Separate power supplies are used for each stage. A low-power emergency set, using a 46 in the high-C Hartley circuit, battery operated, is kept underneath the operating table ready to go should the regular power mains fail. An SW-3 takes care of reception. The gadget in the aluminum case in front of the window is a frequency-meter-monitor.

"Mac" is one of those fellows who gets his chief kick out of ham radio by taking an active part in organized activities; W6RJ signs WLVB on 3497.5 and 6990 kc. as Alternate Corps Area

Net Control Station, Ninth Corps Area, A.A.R.S., and is Radio Aide for that Corps Area, which means a lot of bulletin writing and correspondence handling in addition to activity on the air. He is also Route Manager for the A.R.R.L. East Bay Section. W6RJ was a participant in the radio work with the Dole and Southern Cross Pacific flights, and during the Long Beach earthquake not long ago organized an emergency set-up among the Army-Amateur stations in his Corps Area, a job which won him a letter of commendation from the Chief Signal Officer.

W8GQ, Utica, N. Y.

HARRY H. LOTT, former W2ARX and now owner of W8GQ, is another of the gang whose first acquaintance with radio was made in the days during and just after the War. Running from spark through c.w. (the first c.w. transmitter used an Audiotron, no less!) more and more power was used until finally a high-power holiday was declared and the transmitter shown in the station photograph was built. This is an all-210 outfit, using one tube as a crystal oscil-



W8GQ

lator, a second as buffer or doubler, a third as an additional buffer, and two in the final push-pull stage. The last two are given plenty of work to do, however, being operated at 750 volts and 200 ma., an input of 150 watts. The oscillator is

operated at low voltage and the crystal is temperature-controlled, both factors contributing to the stability of the transmitter.

The rack on which the transmitter and power supplies are mounted is built from steel channel to standard relay-rack measurements. The panels are $\frac{1}{8}$ -inch steel sheet, with 18-gauge steel sub-panels. Aluminum paint on the rack accounts for the light color. Power supplies, of which there are two, one of 350 volts for the first two stages and the other delivering 750 volts for the last two, are mounted behind the bottom panel. The panel above it is a spare on which it is intended to build a modulator. The thermometer for the crystal oven can be seen on the lowermost of the r.f. panels.

Receiving equipment includes a home-made detector and two-step short-wave receiver using Western Electric 264-A tubes, a Kennedy long-wave receiver with audio amplifier, and a frequency meter.

WSGQ will be glad to arrange daytime skeds with other traffic handlers.

W2BJ, Brooklyn, N. Y.

ALTHOUGH W2BJ is less than three years old, its owner, Ray Farwell, of 1269 E. 94th St., Brooklyn, dates his ham experience back to the early post-war spark era. With the lifting of the ban on radio operation first a spark coil and then a $\frac{1}{2}$ -kw. spark were in operation under the call 2BDJ. Ham work had to be abandoned soon after because of extensive travelling and it was not until November, 1931, that the urge to come back became so irresistible that a 10-Hartley transmitter and an SW-3 receiver were put on the air. The station has been enlarged since, until now the transmitter is a crystal outfit using a 47 oscillator, a pair of 10's as a power doubler, and a 511 final



W2BJ

stage. The r.f. part of the transmitter is built into a cabinet of $\frac{1}{4}$ -inch aluminum; the power supplies are on a separate rack. There are three of these, a 350-volt supply for the oscillator, 800-volt supply for the doubler, and a 1500-volt supply for the

amplifier. Inputs up to 650 watts have been used on the amplifier. Practically all work is done on 7000 kc. except during July and August, when a portable 14-mc. transmitter is used at Rockaway Point, L. I. A Hammarlund Crystal Pro is used for receiving.

W2BJ likes his DX, although rag-chewing and traffic handling are indulged in frequently. Up to the early part of this year some 55 countries and five continents had been worked; we imagine quite a few more must have been added to the list since.

Amateurs Undertake Ocean Flight

FOR years we have been looking forward to the time when amateurs would have a chance to show the feasibility of contacts via amateur

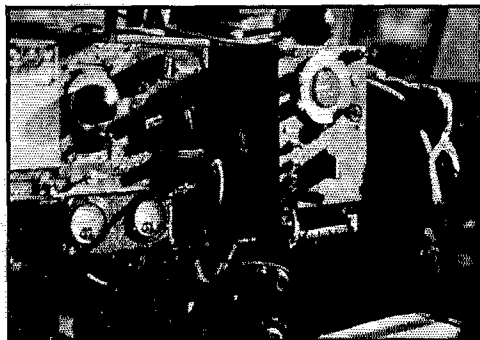

RADIO EQUIPMENT ON KHMZA

Transmitter is at the left and receiver at the right, directly in back of pilot's seat. Trailing antenna reel may be seen at front center. Operator's position is across aisle from the equipment.

radio with an airplane on a long flight. As we go to press just such a project is under way.

KHMZA is owned and piloted by Dr. Richard Light, a prominent New Haven surgeon. Radio operation and navigation is at the hands of Robert F. Wilson, recently graduated from Yale University. The plane is a Wasp-powered Bellanca equipped with pontoons.

Leaving New Haven, Conn., on August 20th, KHMZA docked at Nova Scotia for the first leg of a flight which will be made in easy stages over Labrador, Greenland, Iceland and Europe, lasting through October.

The radio equipment includes a 60-watt c.w. and modulated-c.w. Westinghouse transmitter which will tune to the assigned frequencies of 3120, 5515, 8340 and 12,480 kc. The receiver is an all-band Lear superheterodyne. Complete shielding and bonding allows excellent reception on all frequencies. Either trailing or fixed

(Continued on page 90)

● I. A. R. U. NEWS ●

Devoted to the interests and activities of the

INTERNATIONAL AMATEUR RADIO UNION

President: H. P. MAXIM

Vice-President: C. H. STEWART

Secretary: K. B. WARNER

Headquarters Society: THE AMERICAN RADIO RELAY LEAGUE, West Hartford, Conn.

MEMBER SOCIETIES

American Radio Relay League
Associazione Radiotelegrafica Italiana
Canadian Section, A.R.R.L.
Ceskoslovenski Amatérni Vysilaci
Deutscher Amateur Sende-und-Empfangs
Dienst
Experimenterende Danske Radioamatører
Irish Radio Transmitters Society
Liga Columbiana de Radio Aficionados

Liga Mexicana de Radio Experimentadores
Nederlandsche Vereniging voor Internationaal Radioamateurisme
Nederlandsch-Indische Vereniging Voor Internationaal Radioamateurisme
New Zealand Association of Radio Transmitters
Norsk Radio Relæ Liga
Polski Związek Krotkofalowców
Radio Society of Great Britain

Rede dos Emissores Portugueses
Réseau Belge
Réseau des Emetteurs Français
South African Radio Relay League
Suomen Radioamatööriyhdistys r.y.
Sveriges Sandareamatörer
Unión de Radioemisores Españoles
Union Schweiz Kurzwellen Amateur
Wireless Institute of Australia

Conducted by Clinton B. DeSoto

General:

The world will be looking toward VK3 during October, engaging in the Melbourne Centenary International DX Contest, not to mention the widely publicized "Centenary Air Races" from England to Melbourne One hundred years ago this month the city of Melbourne, now capital of Victoria and second city in Australia in age and size, was founded Full details of the Centenary DX Contest elsewhere in this issue of *QST* Jacques Mahieu, ON4AU, claims the first 'phone contact between Europe and Hawaii, having worked K6COG with an R7 report The U.R.E.'s new official organ, which they are publishing independently, is prospering; write Apartado 262, Madrid, for details Henry Sasaki, W6CXW, reports European DX to be coming through fairly consistently on the European West Coast for the first time in several years In about four months he had 180 QSO's with about 90 stations in 17 different countries, on both 7 and 14 mc. Federal QSL Bureau of the W.I.A. is Geo. W. Luxon, VK5RX, 8 Brook Street, Mitcham, S. Australia The new address for Hungary is the National Union of Hungarian Short-Wave Amateurs, VIII, Mátyás-tér 6, Budapest, Hungary The official bureau for all Roumania remains in the hands of Lieut. ing. F. Dinescu, Ecole Polytechnique, Bucarest, Roumania The British Empire has finally declared the change of prefix for the Fiji Islands from VP1 to VP2 to be official F. Fleming, of Suva, reports that all Fiji stations will now use VP2 ONK-4, a special license Belgian station, was recently QSO the United States on 3.5 mc. with but 4 watts input to a crystal oscillator The

S.A.R.R.L. recently elected Major K. B. Warner, Secretary of the I.A.R.U., an honorary life member Last July 11th VK5HG reached his 10,000th QSO It was with W2CC, with whom he has had more than 800 contacts on a four-days-a-week sked VK5HG works 9 or 10 W stations daily on 14 mc. just before sunset in Australia Add H. Tscherning Petersen, OZ7Z, to the list of English-speaking and hospitable Danish hams Add Frank Gow, W1AF, to the growing list of TBTOC qualificants (Three-Band Transoceanic Club) His first work was with that ubiquitous TBTOC'er, PA0DC, although he has since repeated the performance with HB9Y Next month this department will present the official I.A.R.U. WAC map of the world, dividing all the world into continental areas and showing just where each spot you work is located in the continental distribution

Amateur Radio in Switzerland

By Rudolph Stuber, HB9T, Traffic Manager
USKA

Before the war, only a very small number of experimenters, chiefly watchmakers, were owners of receiving licenses, working with entirely home-made sets. Mr. Ess (now HB9AE) of Basle belongs to those pre-war hams who know the spark-coil.

All licenses were cancelled and the wireless apparatus confiscated in 1914. There was not the slightest sign of activity until 1920, when a few amateurs began to try the first commercial French vacuum tubes. Mr. Roesgen (now HB9AN) belongs to the pioneers participating in the transatlantic tests of 1923, picking up a cou-

ple of U. S. stations. Transmission was still strictly forbidden in Switzerland. Nevertheless, a few amateurs began to work secretly.

In 1925 the Post & Telegraph Department of our government issued the first regulations governing amateur and experimental transmission. But the regulations were so severe and the fees so high that no amateurs applied for licenses that year. The result was the confiscation of several amateur stations by the authorities; it was also the end of the first Swiss Amateur Transmitter's Society, of which Dr. Merz was president.



R. STUBER, HB9T

The first licensed amateur in Switzerland was Mr. Degler of Zürich (HB9A), who, in 1926, began to work with the calls EH9XA and EH9XD, and who established the first two-way contacts with 23 countries. Then followed Mr. Wüst (HB9C) and Mr. Schneeberger (HB9G), both in Lausanne. In 1929 Mr. Degler and Mr. Schneeberger founded the U.S.K.A., and Mr. Degler was elected first president of this organization.

Thanks to the U.S.K.A. ham radio made rapid progress. The Union has now about 200 members, of which 50 are transmitters, the rest being registered receiving amateurs or experimenters. We are glad to note that actually all Swiss transmitting amateurs are members of the U.S.K.A.

We are now on very good terms with the postal authorities, cooperating with them as much as possible. Every serious amateur can now get a license in Switzerland. The applicants are required to pass an examination on theoretical subjects and knowledge of the regulations, and be able to copy and send code at 10 w.p.m. The license fee is fixed at francs 40.- per annum, or about \$13.- The highest input to be used is fixed at 50 watts. Swiss amateurs are allowed to use all the Madrid bands except 1.75 mc., for which a special license is required. Only communications relating to tests are authorized.

The Board of the U.S.K.A. is elected for one year by the Amateur Convention held every year in the spring. The officers may be reflected. The Board consists of President (actually, Mr. Anderegg, HB9S), Vice President, Secretary, Treasurer, Traffic Manager, QSL Manager, and Editor. In places where the number of members is sufficient, sections were formed under the leadership of a section manager, recognized by the Board. Sections at present exist in Basle, Berne, Bienne, Geneva, Lausanne, St. Gall and Zürich.

Our official organ is a mimeographed bulletin entitled "Old Man," which appears every month

and contains useful information and traffic news. Besides, in the two leading Wireless Papers of Switzerland (one French and one German), a special page is placed at our disposal for a popular review of amateur work and news of general interest.

We should like to point out that the U.S.K.A. refuses absolutely to support unlicensed Swiss stations and to forward cards for them, etc. Cooperating with the government, we have been successful in stopping several unlicensed transmissions, several amateurs having been condemned, and this policy will be continued. The official list of calls is published in each issue of the "Call Book."

Swiss amateurs have been making efforts to improve their apparatus. Most stations are crystal controlled. A great and fine task for our amateurs is the study of the propagation of wireless transmissions in our mountainous country. Regular traffic and relay tests are held, chiefly on the 3.5-mc. band and not seldom 50% of all transmitting stations are participating. Our DX stars (HB9J, HB9Q and HB9Y) are chiefly working on the 14-mc. band. The following hams are members of the WAC Club: HB9G, HB9J, HB9S, HB9U, HB9X and HB9AK.

In conclusion, may we add that we are always very pleased to meet and entertain hams from abroad. Those who intend visiting our country should not forget to drop us a line, in order that we may arrange a "Swiss Hamfest."

Strays

Jess Cordova of world-famed EA4AO has recently married, which may account for the fact that EA4AO has really not fired up in old-time form.

Believe it or rip, Notley, we've just filled an order for log-books from an SWL in England named Mr. X. Y. Zzygy, a name that comes about as far down the alphabet as any we ever heard!

Why is it that Spanish amateurs have the highest percentage of futuristic QSL cards as well as the most elaborate designs?

Special Notice!

When sending remittance to us, please send personal check, money order, bank draft or registered letter. We cannot assume responsibility for currency which has been sent in ordinary mail and lost in transit. You alone take the risk when sending cash through the mails. This matter is of sufficient importance to call to your attention, and your strict adherence to this request will always be to your advantage. Resolve to do it at all times.



OPERATING NEWS



Conducted by the Communications Department

F. E. Handy, Communications Manager

E. L. Battey, Asst. Communications Manager

THE R-S-T system represents, to our mind, the newest advance in amateur radio operating. After careful examination we have no hesitancy in recommending that you try the R-S-T system. If you approve it, and use it, it will be accepted as A.R.R.L. standard practice.

The letters R-S-T themselves determine the order of sending the report. The system is an amateur method of indicating Readability, Signal Strength, and Tone in the most abbreviated manner. To the three figures which may be requested by sending RST? (or simply QRK?) may be added an X to indicate that the steadiness or other characteristics of the signal seem to indicate it is crystal-controlled. Fully explained elsewhere in this issue, we commend the new standard system of giving amateur signal reports to your attention. By using the letters R-S-T with the reports you give, there can be no confusion with reports given in terms of QSA- and R-definitions. Logical and brief, you will find R-S-T increasingly satisfying as you keep using it. Use the new system. Yours for RST559!

Mt. Crillon Expedition

The expedition to Mt. Crillon, Alaska, returned to the states in mid-August after a most successful summer. The mountain was climbed twice and several aerial photographic flights were run off without difficulty. The scientific study of the geology of the region and of the movements of glaciers was also satisfactorily accomplished. The radio equipment worked under the portable call W1CVF BT K7, with David Putnam, W1CVF, as operator. Some two hundred messages were handled during the six weeks the base camp was occupied. All outside communication was on 3538 kcs. Schedules were maintained with K7PQ and VE5GT. A fine route via VE5GT, W7BXO and W2GOX got messages east in short order. K7VH and K7EBR also assisted in moving traffic. 56 mc. was used to maintain communication between the base camp and the high camp during the period of preparation for the climb. A transceiver was used at the high camp and two other transceivers at various locations near the base camp. Three schedules per day were kept for ten days, greatly aiding the preliminary work.

W1OXDA

Operator Bob Moe, Schooner *Morrissey*, W1OXDA, continues to work and be heard by many amateurs. Among those to contact W1OXDA during the past month: W1SZ, W2GOQ, W3QV, W9CSI, W9DXJ and W9USA. W6CXW, W8JTT, G5JD and several British receiving stations report logging W1OXDA. W2GOQ (with W2GOQ, W3CQN, W3CDO, W2AJF, W3EFU and W2GOC as operators) is handling most of the traffic from the *Morrissey*. Keeping a daily schedule since July 19th, W2GOQ on August 25th had missed only three days. About 100 or more messages have been handled, all delivered. W9CSI also reports a nightly schedule with W1OXDA.

Word from folks receiving expedition traffic to A.R.R.L. indicates that W9EIB has been giving the expedition most splendid cooperation. Also, radiogram number 174 from the operator of W1OXDA reaches us September 7. This reads as follows: "Having good trip and wonderful success with 'phone transmitter. Will give you all the news when we return. W2GOQ handles all our traffic and is doing a great job of it. 73.—Bob Moe."

W1BLI, Orono, Maine, worked CP1GB, the Bol-Inca Expedition, on August 13th, 5:45 p.m. EST. A message was handled for New York City. W6CXW, Long Beach, Calif., reports CP1GB's signals consistent during June and July, and has had a couple of QSO's with the expedition.

WANTED—STATIONS TO SEND CODE PRACTICE

The A.R.R.L.'s program of code practice on the 1715-ke. band is at this season being revised for the coming active radio season. Stations that engaged in the work last season are being requested to furnish a new schedule for publication in *QST*. There are great possibilities to this 1715-ke. code practice work, and it is one of the most worthwhile of amateur endeavors. Any amateur working in this band wishing to volunteer regular schedules of code practice is invited to get in touch with A.R.R.L. Headquarters, so that his schedule may appear in *QST* and also be distributed by mail to those interested. Helpful hints relative to the sending of code lessons are furnished all volunteers by A.R.R.L.

56-14-mc. Relay

A novel two-band relay took place on August 4th when W3COT operating from a plane in New Jersey worked two-way with W9USA, World's Fair. W3COT using a 56-mc. transceiver in the plane was picked up at W3ZX and relayed to W9USA on 14 mc. W9USA's signals were similarly relayed through W3ZX to W3COT via the same route. After signing with W9USA, CM2RA was raised and, with W3ZX again doing the relaying, an excellent QSO ensued between W3COT in the plane and CM2RA in Cuba.

56-mc. Possibilities

"In a bit of spare time I have picked out some possible long DX shots for 56 mc. I believe that from Mt. Rogers, Va., el. 5717 ft., one could shoot to Short Mt. in Cannon County, Tennessee—a distance of about 270 miles with practically unobstructed view. Another good shot would be from Lookout Mt., Chattanooga, Tenn., to Clinch Mt. at Burkes Garden, Va., about the same distance. We are in heaven here in Greeneville, Tenn., for 56 mc. work; the Smoky Mt. Park with 6600 foot peaks rising out of the valley has good trails and roads. Many high peaks are accessible by motor: White Top, 5520 ft., just south of Rogers in Virginia; Roan Mt., 8313 ft., on North Carolina line; Mitchell, 6684 ft., highest in East; Pisgah, 5749 ft.; and Cumberland Gap Pinnacle, which has a great, sweeping view from only 3000 ft. Only

12 miles east we have Cold Spring Mt., 4889 ft., having an excellent outlook. The Coast & Geodetic Survey maps showing its triangulation stations are a great thing for 56-mc. men. Any two stations shown joined by a line on these maps are visible to each other. Many are good distances apart, 50 and even 70 miles, which is something in this locality of hills and mountains. The Survey will furnish information as to the location of triangulation stations. I hope to work out more possible DX locations. If I am successful in interesting some fellows who will cooperate, I feel we can go a long way in delving into the mysteries of our 56-mc. band."

—Herrick Brown, W4ZZ-ABR

The following contributions by Mr. R. H. Votaw, W7WY, and Mr. Donald P. Love, W2BJX, via G.D. article contest prizes for this month. Your articles on any phase of amateur communication activity are likewise solicited and may win you a bound Handbook, six logs, or equivalent credit applied toward other A.R.R.L. supplies. Let us have your article, and mark it "for the G.D. Contest," please. —F. E. H.

Station Appearance

R. H. Votaw, W7WY*

ALTHOUGH at first glance station appearance and "communicating efficiency" may not appear to be very closely related, a little thought on the matter will prove the contrary. The old adage which states that "beauty is only skin deep" cannot well be applied to the modern amateur station. A glance into any station will usually reveal instantly the merits of the operator. Efficient communications work necessitates a neat, well-kept station.

Plenty of operating room is highly desirable, with space for a station log, call book, traffic file, QSLs, etc. A station bulkhead furnishes an excellent means of providing ample operating space. A large sheet of veneer tacked to the side of the table, directly in front of the operator, serves this purpose admirably. It is an ideal place to post station certificates, and in conjunction with a few shelf brackets can be constructed so as to furnish a place for many of the station necessities that would otherwise occupy the table.

It is an impossibility to conduct an experimental laboratory and an efficient operative station on the same table. Too often the operator glances at the clock to find it is time for a schedule, but the key is buried under several feet of miscellaneous apparatus, or part of his power supply is connected to the experimental rig. If a traffic handler is interested in the experimental field, he should arrange to carry on his experimenting in such a manner that it is not necessary to molest his regular outfit.

Station appearance also has a great deal to do with the opinion the visiting amateurs form of the operator of the station. Many operators of low-power stations which are kept in good order are more highly esteemed by their fellow-amateurs than the high-power lads who reply to your summons on the door by telling you that you'll have to climb the fire escape and enter through the window, since it is impossible to get the door open because of apparatus on the floor.

I vividly recall a visit paid to a certain station en route to a convention several years ago. The operator of the station was not at home, and we were greeted at the door by his father—a jolly old Irishman who evidently imbibed quite freely of the flowing bowl. He informed us that his son was not at home, but we could look at his outfit, and remarked, "Shure, an' I'll sell ye the whole outfit for the price of a gallon of moonshine!" After leaving the station, we decided that the old fellow

* Route 1, Box 398, Vancouver, Wash.

would have to stay thirsty for some time to come if the sale of the station was the only means of purchasing his moonshine! The operating table was buried under scraps of wire, year-old newspapers and letters, and various other sundry articles. The station was evidently primarily designed for a rack-and-panel job, but the panel was missing. The tank coil and tube were harnessed together, but were not self-supporting—they supported one another. They occupied the highest portion of the "rack"—a shelf several feet from the floor. A mess of wires (largely assorted as to size, color, and absence of insulation) leaped out on all sides of the shelf and cascaded downward in a manner that threatened electrocution of the operator, should he make a pass at the key. A rheostat was suspended approximately mid-way between the shelf and the floor. Several fixed resistors jutted out at crazy angles from the maze of wire. The batteries resided on the floor—the final shelf of the rack. Needless to say, the members of our party did not hold a very high opinion of the operator of such a station.

Surely such an important thing as station appearance is deserving of more time and consideration than many of the amateurs give it.

Accuracy

By Donald P. Love, W2BJX *

THE handling of free message traffic for the public via amateur radio stations is an extremely important public service, and a service that could be and should be appreciated and used much more than it is now. And, through club news in local newspapers, radio broadcast programs featuring amateur radio, and by word of mouth, this particular phase of amateur radio is being brought to the attention of the public more and more.

But, if we hams would have our message handling looked upon as being a really valuable public service, performed by conscientious amateurs who really take this activity seriously, we must pay more attention to accuracy in relaying such traffic.

Volumes could be and probably have been written on this subject; nevertheless it is of such paramount importance that it can well bear repeating. In any line of skilled endeavor, be it typewriting or operating a machine in a factory or writing shorthand or sending code—or handling messages—speed is important, but accuracy is far more important. 25 wpm sending is FB—if the receiving operator can copy 25 solid, but if he can't copy that speed solid, then it's his duty to request QRS, rather than do as so many do—come back with "R OK FB SOLID," and then guess at the words missed. It is very possible for the "guessing" operator to totally misinterpret such parts as he has been able to copy, and consequently "fill in" words that will give the message an entirely different meaning from that intended by the sender. For example, such words as "form," "address," "clear," "route," "relay," "check," "state," and innumerable others, have several meanings—they can be either nouns or verbs—and can carry totally incorrect meanings and make a message misleading or completely unintelligible if wrongly interpreted through guesswork on the part of the receiving operator.

Everyone admires the really good fast operator—the fellow who can send evenly spaced, easily copiable material at 30 per, and who can also copy solid at the same speed. But the pseudo "speed artist" who tries to "make an impression" on his fellow hams by always coming back with an "R," whether he actually copied solid, or merely got half of it and guessed at the rest—he's the fellow who gives amateur traffic work a black eye, and he's the reason why so many people consider it "kid stuff" and refuse to take it seriously.

I know one ham that I used to clear traffic through frequently—until one day, after I had given him several messages ("QSG all" by his request), I happened to listen to him later, while he was giving some of this same traffic

* O.R.S., 129 Winlake Avenue, Foughkeepsie, N.Y.

to one of his skeds. I was absolutely amazed and disgusted at the errors he had made in copying the traffic I had given him—errors in numbers, dates, addresses, texts! Here was bitter disillusionment for me. I always considered him one of the best and most dependable operators on the air, but never again will I have confidence in his "R OK" to a string of messages.

Such carelessness is inexcusable. We who are O.R.S., or R.M. are seriously engaged in rendering a valuable service to the public through free traffic relaying, and we naturally expect people to take our endeavors seriously. But—how can we expect to command the public's respect if, in relaying those messages which they entrust to us, we twist and garble them so they are unrecognizable and unintelligible to the recipient?

What impression of amateur radio relay work do you suppose the addressee who gets a badly garbled message receives when it is delivered? Do you wonder why I say accuracy—ACCURACY—A C C U R A C Y—first, last, and all the time?

A Boat Trip and 56 mc.

THIS is an account of a boat trip taken in early July by a group of 56-mc. hounds. The gang: Chief, Al Sise, WIASF, Brookline; Skipper, Chas. Welch, Amesbury; Chas. Best, WIDYC, Amesbury; Wes Wheeler, W1QW, Newburyport, all in Massachusetts. The outfit: Double-button mike, pre-amplifier with 135 volts, 37, 41 into pair of 2A3's modulating P.P. T.P.T.G. '45's with pair of 300-volt motors turning up the B.M.F. The boat: Revamped Coast Guard double-ender, 24 feet long with small cabin forward in which the outfit was stored, powered by Chevvie motor.

We got under way about 9:00 a.m. on the fourth and headed down river from Amesbury, Mass. W1QW with his duffle was picked up at Newburyport. During the first portion of the voyage up the coast after passing Newburyport, we worked Prof. Pickard, W1FUR, Seabrook Beach, N. H. WIASF went ashore with our rig at Seabrook and he and W1FUR made minor alterations on it.

About noon of the next day we pulled anchor again and headed for Cape Porpoise, Maine. All afternoon and evening we took measurements of W1XAV, W1FUR and W1XW. About sundown we picked up Cape Porpoise Light and came into as neat a little harbor as you'd ever wish to see. We tanked up both ourselves and the boat with the best the port had to offer and hit the hay. We arrived at Portland the following afternoon after an early morning start. We anchored out at Cushings Island for the night.

Coming down the coast July 8th we heard and worked the following: Worked—W1APQ and W1EMR (portable at Cape Porpoise). Heard—WIDBE, 5 miles north of Isle of Shoals; W1HPM, at Shoals; W1HRP, at Cape Porpoise; W1HOY, at Boon Island Light; W1KB, couple miles south of Shoals; W1BVL and W1APK also heard.

—Wes Wheeler, W1QW

A Golf-Hamfest

HAM radio and golf may seem an odd combination, but W3BFB and W2BZR found an interesting and enjoyable way to mix the two. The writer, W2BZR, and "Doc" Terry, W3BFB, have long tried to have a game of golf together. This summer we decided definitely to play on August 25th at Braidburn Country Club, Madison, N. J. "Doc" suggested we get some other 75-meter 'phone band "golf-talk addicts" together at the same time. We did, with the assistance of considerable "air publicity" from W3CKD of Mohnton, Pa.

W2BZR (who is with Hygrade Sylvania Corporation) decided that tubes would make very acceptable prizes. Two '03A's and two '10's were the goal that inspired

BRASS POUNDERS' LEAGUE

(July 15th-Aug. 16th)

Call	Orig.	Del.	Rel.	Total
W2EKM	70	90	2228	2388
W2ELB	24	72	1406	1502
W3KGC	92	187	1062	1341
W6BTL	219	418	326	963
VE5DB	663	235	4	902
W6AZU	131	365	362	858
W9PB	276	484	—	760
W9JWI	58	27	652	737
W9GJQ	30	20	680	730
K6JPT	538	67	78	683
W2AYJ	39	84	516	639
W8DSS	51	52	498	601
KA1NA	136	36	392	564
W3BND	138	141	266	545
W5KMC	78	82	378	538
W3BWT	72	110	352	514
W6RJ	11	175	324	510
W8JTP	300	100	110	510
W9TRC	260	244	—	504

MORE-THAN-ONE-OPERATOR STATIONS

W9NT	2042	1252	—	3294
K6EWQ	447	334	2324	3105
W6ZG	756	161	988	1905
KA1HR	519	283	818	1620
W3FOU	93	114	686	893
W5OW	116	81	514	711
W8CVS	229	406	8	643
W1MK	51	123	331	505

These stations "make" the B.P.L. with totals of 500 or over. Many "rate" extra credit for one hundred or more deliveries. The following one-operator stations make the B.P.L. for delivering 100 or more messages; the number of deliveries is as follows: Deliveries count

VE5EU, 237	W3ANT, 135	OM2AA, 105
W9ACL, 201	W2EYQ, 133	KALIG, 105
W9APF, 196	VE5HR, 125	VE5GT, 104
W1RWN, 182	W6JZT, 113	W6CJD, 102
W1DZL, 174	W8SDK, 114	More-than-one-opr.
W9FLG, 171	W6DQN, 113	W6AEK-K1J, 177
W9HPG, 146	W2ELK, 111	
W3CL, 145	W9AWB, 111	

A.A.R.S. STATIONS

Call	Orig.	Del.	Rel.	Total
WLNF	9	37	705	751

A total of 500 or more, or just 100 or more deliveries will put you in line for a place in the B.P.L.

some real "hot" golf. The two '03A's were to go to the player getting the lowest gross score, the two '10's to the one having lowest net score. W2CIF, Henry Abreau of Newburgh, N. Y., won both prizes. His score over the grueling eighteen-hole par 73 Braidburn course was 84. A twelve-stroke handicap gave him a low net of 72. W3AXR of North Hills, Pa., obtained an 89 and, with his fourteen handicap, netted a 75. W3CC of Abington, Pa., had an even 90 with a net of 76. W2BZR scored 86 with a thirteen handicap netting a 73. One of the remarkable shots of the day was a drive made by W2AIH. "Toots" birdied the 14th hole. His ball hit a bird in flight. What a golfer! The only disappointment in the whole affair was the fact that "Doc" Terry was held in Reading, Pa., at the last minute by the world-famous bird called the "stork"!

Those who did attend were: Mr. and Mrs. W3CC, Mr. and Mrs. W2LV, James C. Mohn W3CKD, "Johnny," the second op at W3CKD, W8CHU, W3AXR, W2AIH, W2CIF, and W2BZR.

Luncheon and dinner were two miniature hamfest banquets with some golf talk thrown in. Jimmy Mohn, W3CKD, acted as Master of Ceremonies at dinner and made a fine speech. W2CIF presented Jimmy with the two '10's, knowing that he would have some real use for them at W3CKD, which operates daily on 75-meter 'phone, spreading sunshine and cheer. Jimmy Mohn has friends far and wide who listen to his voice—many of these friends are without the sight of their eyes—Jimmy helps to make life happier for them.

The party broke up about nine o'clock. A very fine time was had by all—and next year we hope to have a bigger golf-hamfest.

—Doug. A. Smith, W2BZR

Invitation, and Announcement of A.R.R.L. ORS/OPS October Activities

Basically A.R.R.L. organization has two types of appointments. The Official Relay Station appointment for the telegraphing amateur interested in handling traffic and in maintaining a high degree of operating proficiency and activity . . . the Official Phone Station appointment especially for voice operated stations, for every ham who normally uses his mike more than his key, who takes pride in maintaining a superior type 'phone station, with the highest standards of apparatus adjustment, with a really good signal, and high operating ideals.

Non-O.R.S. who have active stations and handle messages accurately, and move them speedily and reliably are cordially invited to apply to the proper S.C.M. for appointment. Non-O.P.S. working voice stations, avoiding over-modulation, and living up to the Amateur's Code of fraternalism and cooperation are similarly invited to inquire regarding the 'phone appointment. Traffic interest is not required of O.P.S. Activity reports are welcomed from all. The proper Section Manager who has full authority in making these field organization appointments (see address, page 5 this QST) will be glad to see that application forms are sent you, and arrangements with Route Managers or Phone Activities Managers made to get proper endorsement-recommendation on each application.

S.C.M.'s solicit activity reports from all amateurs, whether holding special appointments or not. But if you have a really good station, why not qualify for O.R.S. or O.P.S. appointment. These stations are widely known for their excellence. You will enjoy QSO's with skilled operators.

Announcement to O.R.S. and O.P.S.: October 20th and 21st again brings opportunity for testing station performance, making new friendships and QSOs, for two-way radio work (general operation) between key stations and real operators. Mark those dates, and look for full details in the O.R.S. and O.P.S. bulletins to be mailed you from A.R.R.L. Headquarters in October. All newly appointed stations will also receive full details by mail. Be on hand for some real operating. Watch the scores mount above previous records. Don't miss this fun. Typical comments from July logs: "Sure had an enjoyable time. Was surprised to hear the DX coming thru in spite of conditions.—W3." "Had a fine chat with my buddy W4BJA. Got a message he had collected in the party for me. QSO my very good friend W4PL 30 minutes. We are better organized than ever. Enjoyed the party.—W4." "Seemed good to renew contacts.—W6." "A grand party and I enjoyed it, except I couldn't be on all I wanted to.—W2." "A suggestion to lift the crown from the QSO King, allow a point each time his signal is heard!—W8." "Heat, and neighbors with antique electric fans (!), and we fell asleep at the switches, too, but sure enjoyed ourselves and had a great time.—W8." "These parties sure are a great thing. Keep up the good work.—VE3." "Sure liked it fine, will be in all future activities.—W5."

A.R.R.L. Phone Organization Notes

National 'phone organization is gaining momentum with the appointment of A.R.R.L. Phone Activities Managers in each Section. At this writing new certificates are being printed for all P.A.M.s. The new 'Phone Managers will recommend qualified voice stations for Official Phone Station appointment, make tests and station inspections in their territory, etc. If you have a good 'phone, drop a line to your S.C.M. or to A.R.R.L. for application blanks for O.P.S. appointment, and ask to be put in touch with the P.A.M. in your territory.

Since the last roster appeared in QST, 22 O.P.S.s have been newly appointed. They are: W1BR, W1ANS, W1IDY, W1DFE, W1FPS, W2EMN, W3AYZ, W3AQC, W5EBU, W6CV, K6FJF, W7BJS, W8CFU, W9KYV, W9JHY, W9MOW, W8FKE, W9WC, W9YA, W9IGY, VE5AM VE4KX, W4BV, W4BYA.

All new O.P.S. appointees will soon receive the October 'phone bulletin issued by A.R.R.L. Headquarters. The next period of O.P.S. activities is scheduled for October 20th/21st. Every station holding Official Phone Station appointment on that date is invited to take part . . . enjoyable operating assured.

JULY O.P.S. PARTY SCORES

Summer 'phone parties were handicapped by temperatures running above 100° F. in many cases, so that participation for the first time dropped, and July scores were decimated (compared to April operations). W3CIJ retained for the Virginia Section the honors of highest scoring. The "high ten" scores were as follows:

W3CIJ (Va.) 66 (5 QSOs in 3 Sec., 4 hr.)	W7DNP 15 (Ore.) (3 QSOs, 1 Sec.)
W3BIG (Va.) 63 (3, 3 Sec., 3 hr.)	W8IKZ 14 (Mich.) (2 QSOs, 3 hr.)
W4RV (N. C.) 62 (5, 2 Sec., 3 h.)	W9EQX 9 (Ill.) (1, 1, 2)
W6QR (S. C. V.) 45 (3 in 3 Sec.)	W9BRX 5 (Ill.) (1, 1)
W7AHZ (Ore.) 22 (4, 1, 1)	W9DLC 5 (Mo.) (1, 1)

Official Relay Station Progress

Eighty-nine active stations have qualified for Official Relay Station appointment in the last three months, a gain of interest sure to be reflected in the October 20th/21st activities. In spite of hot weather during the July Party, the scores and participation suffered very little.

W8EUY of the Western New York Section won the crystal prize offered by W9AUH. W8EUY's score of 10,560 was made from 76 QSO's with O.R.S. in 32 Sections, and 16 additional O.R.S. were heard by him in the July O.R.S. Party.

Newly appointed "reliables" now included in the roster of O.R.S. are as follows:

W1CRA	W3BAI	W6HEW	W9FRC	W9RIF
W1FXA	W3DUK	W6AFN	W9OKS	W9ACL
W1FPO	W3EOU	W7BRU	W9DDO	W9MZE
W1HVK	W3BYS	W7ASA	W9HCH	W9PHH
W1CVL	W4CTU	W7DGY	W9ANQ	W9LBT
W1GNF	W4BRT	W7AMF	W9CHA	W9PQW
W2FQG	W4BV	W7AXJ	W9JQC	W9B7J
W2DJP	W4BRA	W8HWT	W9BTO	W9RMT
W2GDF	W5EIP	W8EGX	W9EHC	W9DJG
W2BTF	W5CRS	W8KYS	W9KVV	VE3MB
W2GFW	W5DRR	W8JTF	W9OXL	VE3HP
W2ABS	W5ASF	W8KPN	W9MCG	VE3AU
W2K1	W6ETJ	W8DPE	W9DGR	VE2BU
W2DXO	W6ON	W8ANZ	W9HAT	VE4ND
W2ECO	W6KNO	W8GSH	W9FDD	K6LBB
W2EGE	W6HHM	W8IOH	W9ALO	
W2COG	W6IDZ	W8CIZ	W9CIZ	
W3DML	W6EZK	W9DBO	W9NKG	

As usual, there were hundreds of O.R.S. in on the July Party. Conditions were none too good. Many shacks were uncomfortably hot, and QRN was bothersome in some sections. But the usual enthusiasm prevailed, as attested by scores of fine letters with the reports, which are more numerous than we can give in full. The 12 highest scorers follow:

W9AUH 14,076	91 QSOs.	34 Sec.	910 Input watts
W8EUY 10,560	76	32	375
W2EKM 10,501	74	34	85
W9JRK 10,290	68	30	85
W4NC 10,144	62	32	180
W8GUF 9,331	65	31	85
W9DEI 9,077	37	29	300
W2AYJ 8,932	71	28	400
W8AQ 8,410	66	29	150
W8EBR 6,509	37	23	30
VE8GT 6,480	33	24	34
W3ADE 6,400	54	25	...

Dakota Hamfest—October 13th—14th

The radio clubs of Miller and Pierre, South Dakota, announce a two-day hamfest for the hams of South Dakota and neighboring states to be held in Pierre, Saturday and Sunday, October 13th and 14th. Well known speakers will be featured, including the state governor. A novelty of the hamfest will be a Buffalo Hunt. It is planned to divide the gang into groups in trucks to hunt the buffalo, reporting the find to the base station on "snake buttes." 56-mc. rigs will be used throughout. A banquet and presentation of prizes will close the hamfest Sunday night. All amateurs are invited to attend. Hamfest headquarters will be the Senate Chamber, State Capitol, Pierre, So. Dak.

A.R.R.L. Official Broadcasting Stations

Current information on expeditions, special tests and activities, new F.C.C. regulations concerning amateur operator and station licensing, DX conditions or new records on 28-mc. or u.h. frequencies, etc., is sent regularly (new information each week) in the different amateur frequency bands by the following A.R.R.L. Official Broadcasting Stations. This information is addressed "to all amateurs." The list is revised to include only active appointees. The operators of these stations render amateur radio a distinct service. You will find stations in your own district, and neighboring districts in the list. Make a practice of listening to the "QST" sent from these stations. Report results to these stations when you hear them, so the operators will know their transmissions are successfully received by you and their work appreciated and successful.

W1ABG/BYK, W1APE, W1AQL, W1ASI, W1ASY, W1AUD, W1BKY, W1BZO, W1CBB, W1CCX, W1CDX, W1DQK, W1EAW, W1EBM, W1FPS, W1GOG/ZS, W1MK, W1SG, W1SK, W1VF, W1WR, W1ZS/GOG, W1DUS, W1EOB, W1GZL.

W2AZV, W2BLU, W2BZZ, W2CHK, W2DTT, W2FF, W2SN, W2UL.

W3AEJ, W3ALE, W3AOJ, W3APV, W3AQL, W3BIG, W3BIR, W3BND, W3BWT, W3CDQ, W3CNY, W3CWL, W3DCU, W3DLF, W3DUV, W3ZA, W3ZX, W3AEI.

W4AAD, W4AIS, W4APU, W4AUW, W4BGA, W4BIP, W4BMM, W4BPC, W4BSJ, W4CDH, W4CE, W4CIQ, W4CUE, W4DS, W4EG, W4MR, W4NN, W4PM, W4PW, W4WS, W4ZH.

W5ADZ, W5AOZ, W5ATB, W5AVB, W5BFA, W5BZT, W5CRS, W5DLG, W5DRR, W5MS, W5NT.

W6AMM, W6ATT, W6AZK, W6BRI, W6CBF, W6CIX, W6CIZ, W6CVV, W6DVE, W6DYQ, W6DZQ, W6EDW, W6EXH, W6FBW, W6FPH/GUF, W6FRP, W6FYW, W6HRN, W6IKK, W6ITE, W6KBY, W6NF/CFN, W6ON/BLS.

W7AFC, W7AGQ, W7AVM, W7AVP, W7BVE, W7CAM, W7COH, W7EL, W7LD, W7BLN, W7DP, W8AEQ, W8AFM, W8AWX, W8AXC, W8AXV, W8BON, W8BQJ, W8CFF, W8CHM, W8CXY, W8CVF, W8DED, W8DGL, W8DME, W8DZY, W8FZE, W8HCS, W8HLD, W8IGA, W8KJW, W8KMT, W8SS, W8UX, W8WE, W8WF, W8CHC, W8IWT.

W9ACU, W9AFN, W9AUH, W9CHA, W9CWG, W9DBO, W9DEI, W9DET, W9DJU, W9DUD, W9EDW, W9EQX, W9ESL, W9FFF, W9FKE, W9FNE, W9GFA, W9GQH, W9HMM, W9HPQ, W9HUX, W9IK, W9IPN, W9JO, W9KQJ, W9LEZ, W9NRV, W9OEL, W9PSP, W9RH, W9TE, W9ZT.

CM2WW, CM5YB.
VE2HK, VE3AU, VE3GT, VE4EO, VE4MW, VE5AC.

Trunk Lines

Reorganization of the A.R.R.L. Traffic Trunk Lines for the '34-'35 season is at this time under way. New plans for the system this season promise to better the service offered. Vacancies in the trunk line set-up occur from time to time and must be filled promptly by other reliable traffic men. Any O.R.S. appointee interested in getting in on the T.L.'s when the opportunity affords is invited to place his name on file with the Communications Department.

J. V. Perdue, VE3QK, R. M., Windsor, Ontario, is establishing a trunk line from the Ontario border cities (East Windsor, Walkerville, Windsor, Sandwich) to Toronto, via London, Ontario. It is desired to connect the already operative Maritime-Toronto line with southwestern Ontario. Any interested amateur in the cities mentioned, especially in London, Ont., should get in touch with R.M. VE3QK.

W3AKT heard G6VP calling "test" on 14-mc. c.w. W3AKT on 1.75-mc. 'phone called W3LD and asked him to

call G6VP on 14 mc. G6VP heard W3LD's call OK. W3AKT copied G6VP and sent the dope to W3LD via 1.75-mc. 'phone along with dope on G6VP's QRK; W3LD sent QRK to G6VP. In other words, W3LD worked G6VP 3000 miles distant and didn't hear him.

Conditions for 1.75-mc. 'phone work have been improving of late. On August 27th between 1:30 and 5:30 a.m. E.S.T. W3EOZ, Bryn Mawr, Pa., and W3EFS, Philadelphia, each worked all U. S. districts.

WIMK

Addressed transmissions to amateurs are sent simultaneously on two frequencies, by automatic, from the Headquarters station, WIMK, on the following schedule:

Days	Times E.S.T.	Speeds (w.p.m.)	Frequencies
Sunday	8:30 p.m.	13	3825-7150 kcs.
Sunday	Midnight	22	3825-7150 kcs.
Monday	8:30 p.m.	22	3575-7150 kcs.
Monday	10:30 p.m.	13	3575-7150 kcs.
Tuesday	8:30 p.m.	13	3575-7150 kcs.
Thursday	8:30 p.m.	13	3825-7150 kcs.
Thursday	Midnight	22	3825-7150 kcs.
Friday	8:30 p.m.	22	3575-7150 kcs.
Friday	10:30 p.m.	13	3575-7150 kcs.

Immediately following the 8:30 p.m. transmission on Thursdays and Fridays, a special message is sent to all amateurs interested in 28-mc. work; this message contains a summary of 28-mc. reports received during the preceding week.

Schedules at present are with W1DOW, W1ERQ, W1GOG, W2BZZ, W2ELK, W3BWT, W6AM, W9AUH, W9FO, NY1AA. The additional time is divided between 7 and 3.5-mc. bands for "general" contact with any ham who may call. Operators try to "chew the rag" with just as many hams as time permits, as well as QSP whenever possible. QRG service is also available.

Headquarters operators and their personal "sines": Harold A. Bubb, "HAL," Chief Operator WIMK; F. E. Handy, "FH," W1BDI; E. L. Battley, "EV," W1UE; A. A. Hebert, "AH," W1ES; C. C. Rodimon, "ROD," W1SZ; F. C. Beekey, "BEEK," W1GS; C. B. DeSoto, "DC," W1CBD; K. B. Warner, "KEN," W1EH; George Grammer, "HG," W1DF; Don Mix, "DON," W1TS; Jim Lamb and Ross Hull W1AL.

Briefs

W6BLZ recently made a trip to the Orient on the S.S. *President Lincoln*. At Hong Kong he met Clyde DeVinna, W6OJ, well-known movie photographer, who was on his way to Indo China where he will operate on 7 mc. with P. P. '01As. W6BLZ also met VS6AG, K6BAZ, K6CRU and K6DVQ.

PORT INDIAN RIVER CARNIVAL

The Port Indian River Carnival is a yearly event staged by Sea Scouts at Port Indian, Pa., on the Schuylkill River. The program consists mainly of swimming and boat races. Communication between the judges' stand, turning buoy, and starting and finishing points is necessary to speed up the activities. For the last two years the Norristown Radio Club has supplied this communication à la 56 mc. At this year's carnival, on July 28th, a new stunt was introduced.

A diving helmet was provided by one of the Sea Scouts. A microphone was installed in the helmet, it being found necessary to line it with felt before understandable speech could be transmitted. The diver descended from the boat *Miriam* in the middle of the river and his voice was relayed via the 56-mc. installation on the *Miriam* to the land station at the judges' stand, from where the voice from the river bottom was presented to the interested public through a P. A. system.

W3EGT was operator on the boat, with Russel Raker as

assistant. W3ECD was operator at the judges' stand, Norris Rigg assisting. A portable outfit was used on a float in the middle of the river and was operated by W3ERN, assisted by Hideo Takeuchi. At the turning buoy one quarter mile up the river, another outfit was operated by W3BPJ with the assistance of Louis Dewees.

Edgar Klingeman, W3ECD, was in charge of all radio communication at the carnival, as well as being operator of the control station at the judges' stand, W3BFR. The control station operated on 59.5 mc. and all others used 56.5 mc. Thus duplex operation with any of the other stations was possible. No station was on unless called by the control station. None of the other stations communicated with each other (to cause unnecessary QRM), and the whole communication enterprise went over without a hitch. The public was greatly impressed by this demonstration of amateur radio.

On January 26, '34, the following stations were in a six-way QSO on 3.5-mc. c.w.: W9DFY, W9MDL, W4BBT, W9EUI, W5AWX, W5BDX; also, on January 31st: W9DFY, W7CCR, W3AIL, W5BDX had a four-way; and on February 3rd: W9DFY, W7CCR, W4BJA, W9EEW, W3UT, W5BDX, a six-way.

The new official Department of Commerce list of World Short-Wave Radiophone Stations is now available from the Bureau of Foreign and Domestic Commerce, Washington, D. C., or at any district office of the Bureau. Price is 25¢ per copy. The list contains information on approximately 2400 stations, arranged by frequencies. Distances from the United States to foreign stations may be readily ascertained by means of a novel chart and tables. Special identification used by some of the better-known stations is also provided. The list contains 112 pages, including two maps, and is believed to be one of the most complete logs of short-wave stations ever published.

M. L. Peterson, W8FMX, spent, during August, two weeks at Boy Scout Camp Russell, White Lake, in the Adirondacks, where he set up W8FMX and maintained daily schedules with W8JSD, Richfield Springs, N. Y. A total of 74 messages originated at W8FMX, all but one of these going to W8JSD. The other was a message for Amsterdam, N. Y., which was moved directly to W8ISX, Amsterdam, after a plain CQ (not directional) from W8FMX!

W4AYV, Johnson City, Tenn., read in his local newspaper that an uncle of his had fallen out of a hotel window in Baltimore, Md. To relieve the worries of an anxious family, he turned to amateur radio. With the assistance of W3BYA, he raised W3EOU in Baltimore and told the operator there, R. N. Fox, what he had read. Fox called the newspaper there, secured the necessary details, and then called the hotel, where he learned that the injuries were not serious. This information was transmitted back to W4AYV, the whole incident taking only forty-five minutes.

A good time was had by Southern California hams at their annual camp and picnic during July at Oceanside. Many portable sets were present. The rigs were set up on the beach, tents furnishing the housing facilities. Portable W6AM was one of the rigs in operation. The following were among those who operated that station: W6AKY, W6HQM, W6GTM, W6BPP, W6GTE, W6DTF, W6FBM, W6HJW, W6AM, K3AAA, W6UT, W6CJW, W6FHI, W6FHN, W6KRI and W6XAP. In all about 300 hams visited the "doings." Many stayed the full four days. C.W. men beat the 'phones at ball, 7-6.

"KA" of W8BFF-W8GQM did some great glider-meet traffic work, distributing a bunch of messages via 3.5- and 1.7-mc. band skeds. The Elmira Radio Amateur Ass'n gang also handled all the local meet-communications efficiently on 56-mc. duplex 'phone. Results were 100%. In spite of the fact that the meet (July 11th-24th) split the message-

month, new records for making the B.P.L. *entirely* on 'phone, and also on 56 mc. were established by all three portable stations — W8AUJ, 1165; W8FZX, 459; and W8GQM, 570!

"AUTOMATIC" MESSAGE CHECKING

In connection with the matter of "checking" traffic in message relaying, some one may point out that this takes time and trouble. When receiving on a "mill" one can make a practice of copying *ten words to the line*, or if copying with pencil, *five words* to the line, double spacing alternate lines so the number of groups of ten words each can be counted. This greatly simplifies the verification of the check, and saves much time.

Another idea on the value of QSL cards, by W9IH: "QSLs are useful to refer to as a verification of results with various hookups of equipment at different times. They are not 'just wall paper.'"

"Was QSO W8 — last week and enjoying the conversation, when W1 —, with the rawest kind of an r.a.c. sig, began CQing. QRX'ed ten minutes... finally had to quit! After three nights of copying calls of these fellows who should be on Mars, I counted them. On two bands there were forty-six r.a.c. notes. Every time I hear one of these birds I wish for a 'disintegrator.' Can't someone fix these sigs, or do we have to declare a boycott on *all rotten notes*? Why not refuse to answer anyone with an r.a.c. note — maybe that would cure 'em — how?" — WIDFT-FXD

WAC AT LAST

At last, RCA Communications has WAC!! If you don't believe it, listen for station WAC (New Brunswick, N. J.) on 13,900 kc., or see page 223 of the Spring call book. HI.

D4ADI, working on 7060 and 14,120 kc. with only 8 watts input, requests reports on reception of his signals — especially from North America. Address QSLs to Kurzwelengruppe, Berlin-Schoneberg, Ebersstr. 92.

Harry Wells (ex-PMZ), operator at OA4U, Carnegie Institute Magnetic Observatory, Huancayo, Peru, advises that his Washington office is preparing a special plate for OA4U QSL cards; all QSOs will be acknowledged when these cards are received at Huancayo.

W5BDX, Enid, Okla., claims 2368 QSOs in a period of one year, March 10, 1932 to March 10, 1933. W1YU, Yale University, has made 4019 QSOs in 19 months of operation. Who can better these records?

Stations in the Gulf Coast Radio Storm Net held a 7-mc. QSO Party Sunday, April 23rd, from 8:00 a.m. until noon C.S.T. This party demonstrated the success with which daylight 7-mc. schedules may be maintained. It is expected that these QSO Parties will be held every Sunday. Galveston members of the Storm Net are on watch for other netters daily at 12:30 p.m. C.S.T. on 7 mc. The G.C.R.S.N. was organized to handle emergency communication, the following stations being in the line-up: W4OA, ASV, MS, BPI, AFV, ANI, AVO, W5CGO, MS, JB, BKV, AHK, BD, ABH, AUX, BEH, BTK, CPA, CPM, CVV, BUZ, AMZ, AVO, BI, DAQ.

A 48-hour watch was held at W2BXJ recently from 9 p.m. Friday to 9 p.m. Sunday. Three operators (W2BXJ, W2DUE and W2AQQ) worked in "shifts" and report the following results: All U.S. districts worked twice within the 48-hour period, no QSOs being duplicated; all districts contacted once within the first 11 hours; 22 states and 7 countries QSOed; a total of 100 stations worked; the greatest DX worked made a 40 "miles per watt" average, and an average of .025 "watts per mile"; the maximum cost (not including deterioration of parts) for the 48-hours of operating was figured at \$1.50 — and the operators say it was worth many times that in enjoyment.

W4AXO on 7050 kcs. and NY1AB on 14 mc. wanted to QSO. NY1AB couldn't hear W4AXO on 7 mc., so copied his 28200-kc. harmonic! W4AXO copied NY1AB on 14 mc. There's an inter-band QSO!

Dakota Division QSO Party

The First Annual QSO Party for Dakota Division amateurs will be held from Friday, Sept. 28th at 6:00 p.m. C.S.T. until Sunday, Sept. 30th at Midnight, C.S.T.

Qualifications: Only stations in the Dakota Division who send in their final scores will be eligible for prizes.

Object: To work as many stations as possible in the division.

Scoring: Five points may be counted for each QSO with other Dakota Division stations. Each additional Dakota station heard and not worked may be counted one point. Total points may be multiplied by the number of Dakota Sections worked.

Calling procedure: CQ DAK CQ DAK CQ DAK DE W9 ---

Frequency: Any frequency may be used although 3.5 mc. should prove most satisfactory. Either phone or c.w. may be used.

Prizes: Grand prize is an R.F. Ammeter. Winner in each Section receives an A.R.R.L. Handbook.

Turn in Score: At conclusion of the party tabulate results, listing stations worked and heard, and mail to your S.C.M.

—Francis C. Kramer, W9DEI,
S.C.M. So. Minn.

ELECTION NOTICES

To all A.R.R.L. Members residing in the Sections listed below: (The list gives the Sections, closing date for receipt of nominating petitions for Section Manager, the name of the present incumbent and the date of expiration of his term of office.) This notice supersedes previous notices.

In cases where no valid nominating petitions have been received from A.R.R.L. members residing in the different Sections in response to our previous notices, the closing dates for receipt of nominating petitions are set ahead to the dates given here-with. In the absence of nominating petitions from Members of a Section, the incumbent continues to hold his official position and carry on the work of the Section subject, of course, to the filing of proper nominating petitions and the holding of an election by ballot or as may be necessary. Petitions must be in Hartford on or before noon of the dates specified.

Section	Closing Date	Present SCM	Present Term of Office Ends
Virginia	Oct. 15, 1934	R. N. Pubank	Dec. 15, 1933
Kansas	Oct. 15, 1934	O. J. Spetter	July 29, 1934
Nevada	Oct. 15, 1934	K. L. Ramsey	Aug. 15, 1934
Saskatchewan*	Oct. 15, 1934	Wilfred Skafle	June 15, 1934
Alaska	Oct. 15, 1934	Richard J. Fox	Feb. 16, 1934
San Joaquin	Nov. 1, 1934	G. H. Lavender	Nov. 14, 1934
Valley	Nov. 15, 1934	T. R. Becker	Nov. 30, 1934
Colorado	Dec. 5, 1934	Henry E. Velte	Dec. 15, 1934
Arkansas	Dec. 5, 1934	W. J. Wilkinson, Jr.	Dec. 15, 1934
Louisiana	Dec. 5, 1934	W. J. Wilkinson, Jr.	Dec. 15, 1934
San Francisco	Jan. 15, 1935	Pyron Goodman	Jan. 18, 1935
Maritime*	Jan. 15, 1935	A. M. Crowell	Jan. 18, 1935
Michigan	Feb. 1, 1935	Kenneth F. Conroy	Feb. 9, 1935
Manitoba*	Feb. 1, 1935	Reg Strong	Feb. 15, 1935
Sacramento	Feb. 1, 1935	George L. Woodington	Feb. 15, 1935
Valley		Woodington	

* In Canadian Sections nominating petitions for Section Managers must be addressed to Canadian General Manager, Alex Reid, 169 Logan Ave., St. Lambert, Quebec. To be valid such petitions must be filed with him on or before the closing dates named.

1. You are hereby notified that an election for an A.R.R.L. Section Communications Manager for the next two-year term of office is about to be held in each of these Sections in accordance with the provisions of By-Laws 5, 6, 7, and 8.

2. The elections will take place in the different Sections immediately after the closing date for receipt of nominating petitions as given opposite the different Sections. The Ballots mailed from Headquarters will list the names of all eligible candidates nominated for the position by A.R.R.L. members residing in the Sections concerned. Ballots will be mailed to members as of the closing dates specified above, for receipt of nominating petitions.

3. Nominating petitions from the Sections named are hereby solicited. Five or more A.R.R.L. members residing in any Section have the privilege of nominating any member of the League as candidate for Section Manager. The following form for nomination is suggested:

Communications Manager, A.R.R.L. (Place and date)
38 La Salle Road, West Hartford, Conn.

We, the undersigned members of the A.R.R.L. residing in the Section of the Division hereby nominate as candidate for

Section Communications Manager for this Section for the next two-year term of office.

(Five or more signatures of A.R.R.L. members are required.) The candidates and five or more signers must be League members in good standing or the petition will be thrown out as invalid. The complete name, address, and station call of the candidate should be included. All such petitions must be filed at the headquarters office of the League in West Hartford, Conn., by noon of the closing date given for receipt of nominating petitions. There is no limit to the number of petitions that may be filed, but no member shall sign more than one such petition.

4. Members are urged to take initiative immediately, filing petitions for the officials for each Section listed above. This is your opportunity to put the man of your choice in office to carry on the work of the organization in your Section.

—F. E. Handy, Communications Manager

ELECTION RESULTS

Valid petitions nominating a single candidate as Section Manager were filed in a number of Sections, as provided in our Constitution and By-laws, electing the following officials, the term of office starting on the date given.

Frank L. Black, W7AMF Aug. 15, 1934
Santa Clara Valley Charles J. Camp, W6BIMW Aug. 15, 1934
Eastern Florida Phillip A. McMasters, W4BCZ Aug. 15, 1934
Kentucky G. W. Mossbarger, W9AUH Sept. 8, 1934

In the Missouri Section of the Midwest Division, Mr. C. R. Cannady, W9EYG, and Mr. Robert A. Hathaway, W9GTFK, were nominated. Mr. Cannady received 95 votes and Mr. Hathaway received 82 votes. Mr. Cannady's term of office began July 27, 1934.

In the Ohio Section of the Central Division, Mr. Robert P. Irvine, W8CFO, and Mr. Harry A. Tummonds, W8HAI, were nominated. Mr. Irvine received 285 votes and Mr. Tummonds 203 votes. Mr. Irvine's term of office began August 8, 1934.

In the Southern Texas Section of the West Gulf Division, Mr. Bradford A. Beard, W5ADZ, and Mr. Frank S. Libbe, W5BBR, were nominated. Mr. Beard received 85 votes and Mr. Libbe received 56 votes. Mr. Beard's term of office began August 8, 1934.

In the Mississippi Section of the Delta Division, Mr. J. H. Weems, Jr., W6CWQ and Mr. L. A. Wolfe, W5AQW, were nominated. Mr. Weems received 20 votes and Mr. Wolfe received 12 votes. Mr. Weems' term of office began September 6, 1934.

STATION ACTIVITIES

ATLANTIC DIVISION

EASTERN PENNSYLVANIA—SCM, Jack Wagenseller, W3GS—3CL and 8CVS B.P.L. 3BYS joined O.R.S. ranks. AQN and 81WT are renewing schedules. 3CHH worked 33 countries in four months. EPJ broke four neon bulbs, two '10's, one 59 and one resistor! COZ's roof spilled a ton of water on the works. 8DPY is portable at C.C.C. camp in Reading. 3EOP sent local news to NF who was on vacation. EII handled lot of N.G. traffic. AQW is away on a ship. DPU handled lot of 103rd Cavalry Camp traffic. ECM is conducting code practice. DYX drove 3000 miles on trip to 9USA. ADE is rebuilding. ALX and EEY visited 1MK and 9USA. Why do they call AHR "Steamboat Bill"? AZT had BMS up in a plane testing a transceiver, and on a vertical bank BMS lost the transceiver. Your S.C.M. is on 56, 14 and 3.5 mc. from new QRA.

Traffic: W8BYS 272 AQN 33 CHH 7 ABZ 8 EPJ 2 COZ 4 CL 407 EZ 205 EOP 14 EII 37 AQW 2 DPU 74 ECM5. W81WT 16 CVS 643 DPY 42 ASW 9.

MARYLAND-DELAWARE-DISTRICT OF COLUMBIA—SCM, E. L. Hudson, W3BAK—W3CQS, R.M.; W3BWT, Chief R.M. EOU works remote control; changes freq. by remote control. BWT made trip to eastern shore. DUK is new O.R.S. DML is joining A.A.R.S. BGI is building power supply for FB7A. DTO is rebuilding receiver. CDG is rebuilding rig. CDQ is doing some 56-mc. work. BAI is touring Alaska as radio opr. in airplane. CXL (Ed) has been vacationing on motorcycle. CQS made trip with his wife to N.Y.C. ASO has been touring around on eastern shore with his family. CRB blew three filter condensers in one week. CIZ gets out fine with Tri-tet. EKJ is building 1 KW 'phone and c.w. rig. CWE has been visiting hams in New England. BRS popped his '03A. EUK, new ham, is joining A.R.R.L.

Traffic: W8EQU 893 BND 545 BWT 514 DUK 66 DML 53 BAK 27 BGI 31 EOG 6 DTO 4 CDG 2 EHW/OZ 10 CRB 2 CIZ 73 DRE 1 EKJ 36.

SOUTHERN NEW JERSEY—SCM, Gedney M. Rigor, W3QL—The Southern N.J.R.A. and Greater Camden Ass'n held annual field day. ZX with COT worked 9USA; one station was in airplane flying around Camden, the other was operated via 56-mc. remote, using 14 mc. through ZX to

Chi. S.J.R.A. held 56-mc. hunt; won by ZX/COT, second by AQC and V.X, third by 2DMU and Fred Green. BIR is new sec'y of D.V.R.A. CWL handled this end of watch for encampment of N.J.N.G. in Pine Camp with 3ZI at the camp end. VE in Pine Camp for two weeks handled key at SGHY.

Traffic: W2BIR 2 AYZ 5 VE 23 APV 98 EDP 4 ZI 43 CWL 116 AEJ-DST 3 ZX 11 ATJ 4.

WESTERN NEW YORK—SCM, Don Farrell, W8DSP—DSS, R.M., made B.P.L., and painted house in spare time. Hi. KMC visited DSP, DSS and FWY. JTP is bidding for traffic honors. JTT, R.M., was at Camp Dix for 18 days. JQE has nice bunch of schedules. DUB at Speculator Y.M.C.A. camp kept gang in touch with home. FWY carried DSS' schedules for week while DSS was off air due to death of his father. FTB is busy with Boy Scout work. CPJ does some fine traffic work on 'phone. EUY had 10 visitors during month. LUJ is keeping 2FOP (who is summering in Glens Falls) in touch with home. GPS is known as "Chippy the Cop." GWT is renewing schedules. VJ is experimenting with portable rigs. EBR was visited by IHSX and 2GOB. FYF graduated from flea power to fly power! BQJ, KBS, AYD, ERU, JJJ, IDJ, IMR, LGR, HQE, GPT, AFM, FYC, KXA, AAR are all active. GWY was on cruise with U.S.N.R. CJJ blew '52. DHU took unto himself a wife! Best of success and happiness, OM and YF. LDA reports traffic for first time. The Rome Club erected two new transmitting towers. LUQ worked Belgium on 'phone, R-8. EXT is on 28-mc. 'phone. LUZ is leaving for Univ. of Mich. and IFF for Univ. of Toronto. JLG advises that Tri-County Radio Club has FB orchestra. BGO is well satisfied with his Collins 30FX. DSP sold his new transmitter to EOA and is building an RK-20 Tri-tet. Someone is using ERU's call on 3880 kc.; this same pirate also uses ZL3CX at times; let's try to nab him!

Traffic: W8DSS 601 KMC 538 JTP 510 JTT 357 JQE 259 DUB 204 FWY 206 AEK 160 FTB 157 CPJ 69 EUY 59 LUJ 41 GPS 30 EWP 29 GWT 27 VJ 24 BQJ 22 KBS 21 EBR 20 AYD 10 ERU-JJG 16 FYF 15 IDJ 11 IMR 5 LGR 1 LDA 8 JLG 1 BGO 22.

WESTERN PENNSYLVANIA—SCM, C. H. Grossarth, W8CUG—KWA is experimenting with RK 20. HXY handled KWA's schedules while he was on vacation. KYW reports for first time. CRA scheduled the Bartlett Expedition in Greenland. DVZ is Chief Op of Penna. C.C.C. Net at WVH, Wildwood, Pa. Phone R.M. ABS is hopeful winter will produce a bunch of new O.P.S. CMP is still using '46 as crystal oscillator and says it's best tube for the purpose. KQJ got a new '04A. IUY wants O.R.S. KD has been handling traffic with KB's. FZG is operating C.C.C. station at Asaph, Pa. GJM says JOP and DJE are back on 1.75-mc. 'phone. OW has a fine oscilloscope. KSG says 1.75-mc. 'phone is going great. AVY got an SW3. CFR is getting the itch to work some more PY's! IOH and GSH apply for O.R.S. CFU applies for O.P.S. CUG has the rig on 3.5 mc. again.

Traffic: W8KWA 109 CRA 58 GUF 55 KYW 39 CQA 45 ABS-GBC-CUG 10 CMP 9 JZZ-KQJ-IUY 7 KD-FZG 6 AYA 4 AXD 3 GJM 2.

CENTRAL DIVISION

ILLINOIS—SCM, F. J. Hinds, W9APY-WR—R.M.'s: 9AND, 9ERU, 9KJY. OZJ is building s.s. super. OXA puts 175 watts into pair of '10s. HB is now A.A.R.S. HZA has Tri-tet with pair of '46s final. BTf married. KJY has been appointed R.M., N. E. Ill. DDO worked first XL. SCH uses '10 with dandy sky hook on 7 mc. COW, using 12 watts on 'phone, worked K4SA in getting R-7. DOU spent time at Ft. Sheridan. CKC operated portable at Camp Grant. HUM and GAW are 56-mc. boys in Champaign. AFN worked Argentina as his 70th country. IZP is rebuilding. EMN went on N.C.R. cruise. KDU says "CQ Tfc" if you want it. KEH worked his 20th country. WC has his initials as his call. ACU has nice Deleo light plant. FTX has c.c. Tri-tet. ERU is on 7 mc. New Tri-tet at EQX. FO sometimes uses N prefix. New rig at ANQ. Power leaks at HUX. BRX visited 9USA and 8UD. LHH is now a W6. GSB is right across

the street from OBS. HSG is out for traffic honors. DXers: PNE, IKQ, OVS, DLO.

Traffic: W9HPG 298 DOU 197 (WLT 37) CKC 159 CGV 104 DBO 87 HUM 77 LW 69 IEP 39 KEH 36 CUH 34 OXA 27 EMN 25 AFN 22 HZA 12 BDO 13 CEO 10 DSS 9 GKX-IZP 8 FTX-HQH 7 ERU 5 NDO-WC 3 ACU 2 FO 3 IKQ-NDB-WR 2 PNE 1.

INDIANA—SCM, Arthur L. Braun, W9TE—HML learned a lot on N.R. cruise. MQV has new transmitter. EGQ has low-power 1.7-mc. 'phone. HPQ is organizing local club. AXH is new 'Phone Activities Mgr. DET plans e.c. rig. HUU is getting ready for A.A.R.S. net schedules. GFS is rebuilding. PEG has new receiver. PEF is experimenting on 56 mc. HUV is giving 28 mc. a try. FQ uses N prefix in N.R. work. PQL worked hams while at 9USA. CHA is reinstated O.R.S., O.B.S., R.M. RE has new oscilloscope. OXM moved to Indianapolis. CVQ likes Tri-tet. AUT has '52. FOS has '46 c.c. rig. BHC runs 500 watts into an '03A. LMD is proud of new YL jr. op. MDU has parasites in new rig. FVI gets out FB on 28 mc. CXQ has c.c. at last. JRK is rebuilding.

Traffic: W9HML 23 MQV 13 EGQ 10 MQQ 14 HPQ 8 AXH 6 DET 10 JOQ 1 PEG 2 PEF 6 PQL 1 CHA 3 JRK 2 (WLFHM 5). TE 10.

KENTUCKY—SCM, Carl L. Pfumm, W9OX—KKG leads pack during August heat. EDQ is looking for two bucks! HBQ is keeping gang supplied with PANIC QST's. HAX is afraid he will have to leave Ky. ALD is now in Owensboro. NEP returned to air from school. BWJ reports Keurad fellows to erect 1 KW Club station in Owensboro. CDA's A.A. Net call is WLKH. ECO had visits from 8INY and 4CQQ. BGA returned to air on 7 and 14 mc. The U. of Ky. will have amateur radio station exhibit at Ky. State Fair. This is your S.C.M.'s final report, and I wish to thank each and every one of you for the fine cooperation afforded me. Let's do the same for the new S.C.M.

Traffic: W9KKG 64 EDQ 32 HBQ 22 HAX 13 ALD-IXN 12 EDV 10 BAN 9 PXX 3 BWJ-CDA 2 FGK 1.

MICHIGAN—SCM, K. F. Conroy, W8DYH—M. Zunich, W8FTW, Acting SCM.—Mr. and Mrs. 8DYH have gone for a well-deserved vacation. Michigan Nines: R.M. PDE is back on from Munising. ADY leads U.P. PCU has nice list of schedules. CE heard entire story from Stratosphere Balloon. RHM will soon be O.R.S. OXL is new O.R.S. GQF got a job. CWR says traffic should be starting up anytime now. Michigan Eights: DVC left for vacation. GUC is doing FB with A.A.R.S. JZD would like more traffic. Quote LFA: "Jackson is teething its new hams on crystals." MBM has been on two months. CVF is experimenting for Conservation Dept. HFB reports via radio from Camp. QT is rebuilding. JO is going North. ARR is doing some stepping on 56 mc. KOX was sick. DED works some more DX. AYO is QRL distilling Peppermint. CSL got hitched. BUH and CUX have 14-mc. DX contest with CUX in lead. DPE is building new receiver. DZ is building bug. EHD will be on regularly. GHP and LSU are looking for O.R.S. IFD is back from Camp. IWM completed low power c.c. job. GQS doesn't like approx. seven fellows on his freq. KNT is vacationing in Ontario. IFQ made changes in transmitter. AEQ pounds brass for P.T. all day. HFU is troubled by more QRM—new Jr. opr. LZV is looking for DX and traffic. FX spends most of his time on 'phone. NQ is trying new antennas. KLR got back from Camp. IZV inquires about O.P.S. EGX yells for Bull. CPY reports via radio. IOR is member Mich. A.A.R.S. Net. AIJ hopes to be honored by visit from Mr. and Mrs. DYH. IFE has access to a plane for radio tests. CPH reports from Chi. ETP has new "Sky Wire." C'mon, Michigan, let's put Michigan on TOP. Report to W8DYH as usual. Each station that reports gets a BULL. More O.R.S. and O.P.S. needed.

Traffic: W8DVC 213 GUC 159 (WLTG 140) FTW 153 HFB 133 MV 124 AEQ 71 QT 63 EGX 54 JO 26 CPY 25 IOR 23 ARR-DYH 22 KOX 18 IFQ 15 DED 14 QQS-IKZ-KNT 10 IPX 9 DWB-IWM 8 FX-HNB-ICM 6 JIU-LZV 5 HFU-JZD-LFA-MBM 4 CFZ-HCC-EGI-IFE 3 AIJ-CPH-CVF-ETP-GDR-IZV-LSU 2 DSQ-KLR-NQ 1. W9ADY 74 PCU 58 CE-RHM 31 OXL 7.

OHIO—SCM, Robert P. Irvine, W8CIO—LCY leads state with BON a close second. The Lakewood Radio Club is sponsoring activities at National Air Races this year; three stations will keep the judges informed as the planes pass the Pylons. Dist. No. 1: DVL got married July 28th. FGC is hot after W.A.C. KZJ is going to junk his old '01A receiver. RN is still pounding brass on Str. Michigan, KFLN. BAH went on N.C.R. cruise. Dist. No. 2: EEZ returned from cruise on U.S.S. *Wilmington*. Dist. No. 3: APC has plenty of schedules. Dist. No. 5: BMK had to get on 14 mc. to get his only message from a "G." DXB broke his "Driver" (Golf) and is turning to amateur radio now. 8CJG had visit from 4BUX. KLP wants to know if anyone can tell him how to keep a sky wire up longer than five days. Dist. No. 6: GDC had 18-minute QSO with G5BJ on 14-mc. 'phone. JTW is rebuilding. LJK will soon be on 3.5 mc. for traffic. Dist. No. 8: BKE has new set. JIN handled some important traffic due to auto accident. Dist. No. 9: ANW is going to Bethany College, Bethany, W. Va. Welcome HXR, Ex9KRI. AQ enjoyed visit to HQs. GDC reports following on 56-mc. 'phone: JJV, EQV, EDW, CBF, GDC, OV, CFT; on 14-mc. 'phone: GDC; on 1-7-mc. 'phone: JAL. CFT crashed while testing 56 mc. from plane; not seriously hurt.

Traffic: W8BON 60 EQC 18 KZJ 7 APC 30 LCY 61 WE 15 BMK 1 DGC 4 BKE 10 JIN 7 GSO 1 CIO 25 (WLEHC 18) GUL 8 AQ 44.

WISCONSIN—Acting SCM, Carl F. Thoms, W9LFK —LFK is at lake. This report prepared by ATO. SDK visited 9USA. OKS has new AGSX. RKP works D4BGT on 14 mc. IQW has 1500 volt pack. OXP has c.c. rig. KJR has W.A.C. PQU has new '03A. NSM reports JDP relayed message from Costa Rica to N.Y.C. in ½ hour. BIB is in Calif. on visit. SKX is new Eau Claire ham. DNU, JNU and KJR have Class-A tickets. RKP, NHM and RSA have new antennas. NMK had trouble with F.C.C. on bad note. EYX is operating portable at lake. OTL is building a baby portable.

Traffic: W9ATO 164 SDK 144 OKS 62 RKP 43 IQW 31 OXP 19 KJR 10 DNU 8 PQU-NSM 6 JDP-ETM 4 OTL 14.

DAKOTA DIVISION

NORTH DAKOTA—SCM, Fred J. Wells, W9JVP—New O.R.S.: LBI, BTJ, MZE, PHH, PQW, JVP. HJC and PQW were on Navy cruise. RWJ visited S.C.M. PDC is leaving state. KBE has new FB7. PQW is putting in '52. OAX is putting P.P. '52s on 3.5 mc. Minn.-Dak. Radio Club meets in Lidgerwood next meeting. EOZ joined C.C.C. SEI is new Fargo call. Will see you all in Division QSO Party.

Traffic: W9OEL 76 KBE 74 PDC 46 PRU 23 SAW 21 BTJ 9 PHH 8 MZE 2 FEF 3 EFN 2 JVP 91 PQW 6 LHS 9 KZL-PJT 4 HJC 2 KVA 8 PAI 4.

SOUTH DAKOTA—SCM, Mike G. Strahan, W9PFI —RLM is trying 1.7-mc. 'phone. PFI installed Bk-in. CFU's new QRA: 231 Iowa St., ES., Huron. IQD visited A.R.R.L. Hq. SCB is Mrs. TY. CYQ is building new receiver. DES is experimenting with ribbon mikes. CRY is organizing N.R. unit. OED is building 1.7-mc. 'phone. ALO works all bands. Five of Sioux Falls gang got 56-mc. bug.

Traffic: W9RLM 10 TY 9 PFI 3.

NORTHERN MINNESOTA—SCM, Robert C. Harshberger, W9JIE—FTJ has '03A. BVI worked 10 ZL-VK's one a.m. RJF is going to 9USA. RAG is QRL Scout Camp. OOU is at VCC Fort Snelling. OMI is getting set for Army Net. PIE is 1.7-mc. 'phone. PUB's power is 50 watts. SJY is new in Buffalo. SJZ is new in Howard Lake. AEL-4CND is back in Brainerd. LFO has 400 watts on 1.7 mc. JIE uses 800's P.P. on 7 mc.; '03A on 3.5 mc. DJW is 3.9-mc. 'phone. RJF is new O.R.S.

W9ISA is turning tricks at KGDE, Fergus Falls.

Traffic: W9FTJ 18 BVI 4 RJF 9 RAG 6 OOU 8 JIE 64 IPN 24.

SOUTHERN MINNESOTA—SCM, Francis C. Kramer, W9DEI—DEI was heard in Russia. GUX schedules

St. Paul N.G. RAU played tennis in Wis. tournament. BN is putting up new antennas. PDL operated USA while at fair. RKG has new receiver. DH visited some VEs. FCS built portable for school. BNN makes his 48th consecutive report! RHT will soon have c.c. rig going. BTZ has '04A on 7 mc. RAB plans on attending U. of Kans. EGG visited hams on way home for vacation. RBW, ADQ and RAB have been using field-strength meter with view of increasing efficiency. FMA works 56 mc. IOG is at Fort Snelling. PJA is new Mpls. ham. DRO moved to Hokah from LaCrosse. OAK and AIR had FB time at St. Cloud meeting. HCC is having AGSX overhauled. ZT attended U. of M. summer school. ELA was QSO FM8BG. ANU is now in New Ulm. LEN is on after summer at the lake. IDF works at Carleton. KDI and FCS will attend U. of Wis. extension. SJH is new Northfield ham. Send 50¢ for years subscription to QRZ, new ham sheet. Don't forget the Dakota Div. QSO party, Sept. 28th, 29th and 30th.

Traffic: W9DEI 82 GUX 32 RAU 18 BN-PDL 14 RKG 6 DH 4 FCS 3 BNN 1.

DELTA DIVISION

ARKANSAS—SCM, H. E. Velte, W5ABI—DTI applied for new license. ECM has Class-A license. CPV has 66-foot zepp in 30-foot space. CGT is on 3570 kc. DYG moved from Paris to Russellville. BMI has new panel job. DRY is on 3780 kc. CVO rebuilt into 100-watt job. DRW has home grown receiver. DYF is awaiting new tube for final. DHU reported by radio. DLN is located at Wynne. EIP got R8 from VK5. VZ is lining up traffic net for C.C.C. CFD operates at VZ. DVR is lining up fall schedules. CZG/DVI received SWL cards from OE. BED is on with type '10. CVZ is on 3748 kc. ABL took in convention in K. C. DRR has 400-watt 'phone. DSU uses Class-B modulation. DFZ is on 'phone most of time. DJQ has double button mike. DEG has 59 suppressor grid-modulated rig. ABI is c.c. with pair of '46s.

Traffic: W5DTH 17 CGT 25 BMI 38 (WLUA 218) DRY 7 CVO 3 DRW 41 EIP 5 VZ 17 DVR 39 CZG/DVI 15 BED 28 DRR 15 DSU-DJQ 3 ABI 21 EAR 1.

LOUISIANA—SCM, W. J. Wilkinson, Jr., W5DWW —Several O.R.S. are due for cancellation should they fail to report first month after this appears. AXU gets lots of DX reports on his 'phone. AOZ is a N. O. cop. DKR wants you to send envelopes for your DX QSL cards to 2749 Myrtle Street, New Orleans. AQC, BBW, CMQ attended convention. BPL, HR, OSD are A.A.R.S. 'phone net members. CTR has 3.9-mc. 'phone. AEH is QRL police radio. BPN reports. ST, CJO and EDY will soon be A.R.R.L. members. BSK visited in N. O. CWX is 100% for C.W. CXQ got some DX cards. DES and LA are working 56 mc. KC is doing some DX work. DLD will always QSP to N. O. AYA was busy with convention work. AGM's YF helps him operate. BID, BZR, AFW, ZK will all take your traffic. BMM makes plenty "whoopie" on 14-mc. 'phone. ZS is going strong. ML, AKI are heard from via radio.

Traffic: W5BZR 76 DKR 41 AOZ 16 AXU 11 DLD 10 KC 9 BPL 2.

MISSISSIPPI—Acting SCM, W. P. Allen, W5VJ—(W5CWQ sends most of the news this month). New Brookhaven station: EFX, EKV, EGE. BXZ is back on air. DXN is N.C.R. Section Control station. CWQ spent several days visiting 4PL, Shepherd, Tenn.

Traffic: W5DEJ 22 CWQ 20 DXN 18 EKV 5 EFX-BXZ 1.

HUDSON DIVISION

EASTERN NEW YORK—SCM, Robert E. Haight, W2LU—BLU is ready for fall activities. EGF is building couple bug keys. LU was visited by IVB and family. FQG is on 7 mc. BJX is on 3519 kes. EGE is c.c. on 3585 kes. GTC visits hams of Mid-Hudson Radio Club. UL installed new receiver rack. DTB totals 650 foreign QSO's. KW reports plenty woodchucks at Radio Hill. FKL is building rack-panel job. FXCC was awarded scholarship to State Teachers College. CC was visited by

Z85U. CDM has '03 final. GNI uses 830 amp. GGQ reports FHZ vacationing at Ft. Worth, Ind. ACY enjoys radio birthday (licensed since Aug. 1926). CJS visited 1MK. CBN visited Brooklyn hams. DC reports Mrs. 5IT QSO with 5IT at home. HJN is experimenting with 56 mc. GPB uses portable at Alton Bay, N. H. BLL sports Navy N call. GMM welcomes HMM on air. EUB has new 40-ft. mast. GFD reports for new Radio Club of Kingston. BJA, Chief R.M., is enjoying vacation. ENC visited S.C.M.

Traffic: W2BZZ 422 BLU 380 EGF 452 LU-FQG 351 BIX 234 EGE 141 GTC 86 UL 24 DTB 18 KW 16 FKL 15 FXC 13 CC 12 QY 11 CDM 10 GNI 1 GGQ 2.

NEW YORK CITY AND LONG ISLAND—SCM, E. L. Baumach, W2AZV—HBK reports from Parshall, Col. GDF will visit 9USA. HDF reports from the Catskills. BLH is using Tri-tet. HHD is on 7 mc. HLO is on the air. FNI is new O.B.S. in Brooklyn. HBO gets T9 reports. DUP schedules ICVL in Morse. DWV is rebuilding GEI's rig. ATB has the bug again. DOG reports BSR writing articles for ST. US continues to work on RK20. AIQ roams around in Chevy with 56-mc. portable aboard; has FB results working duplex going at 40 per. AZV, KR and PF will put exhibition station on at Electrical Show in Madison Square Garden. AYJ, ELB, ELK and EYQ make B.P.L. Northern Nassau Wireless Assn. installed 56-mc. rig at American Legion Convention. BRB's garden and crop has been very successful. BTF and FRZ are rebuilding. EVA reports EXI built a one-mast sailboat with his brother. CXI is looking around for swaps to build a new rig. ETT is in hospital with acute appendicitis. CRK was on 14 mc. for summer. CSO is heard in Europe often on 7 mc. BGO is back from vacation. GQC sends following: GOO has case of YLitis. EOL is on 1.7-mc. 'phone. EON uses '71s on 1.7-mc. 'phone. Plenty of luck to FAX in new a.c. apartment. BIP works plenty of DX. Best wishes for speedy recovery to AGI after recent operation. EYS is heading for a vacation. FIP changed rig to '47 crystal, '46's doubler and pair tens. Vacations lightened GLJ's traffic. BAS is 56-mc. convert. DJP is ready for coming season. CEH is on looking for rag-chewers. AXN is repairing a certain YL's receiver every night. HI. FDQ is going after W.A.C. EYQ has ham visitors galore. EQA is working with O.M. ELB cured BCL key click QRM by using primary keying in final.

Traffic: W2ELB 1502 AYJ 639 EYQ 483 ELK 404 KI 194 DJP 107 DUP 84 GLJ 70 CYX 61 EYS 56 BGO 45 FDQ 42 AZV 30 PF 22 GDE 19 FIP 18 CSO 15 DRE 12 LB 15 DOG 5 DBQ 10 HBO 5 CHK 4 BTF 3 EVA 2 DXO 1 AGC 3 BVT-ETG 2 BKY-AXN 1 CEH 2.

NORTHERN NEW JERSEY—SCM, John Rideg, Jr., W2EKM—EKM was installed at Towu's Fair Aug. 19th; hundreds of visitors were amazed at this amateur exhibition. ABS, after being active at Camp Miller, is now operating under call 8KUV. CGG spent vacation touring and visiting New York State hams. CJX continues fine traffic work. GGW, ABS and ECO received O.R.S. appointments. GAS ups aboard commercial vessel. FLT keeps four daily schedules. DPB, CTT, BXM, HFK and the members of the West Essex Radio Club are active on 56 mc. CIZ received new license. GGE, 14-year-old ham of So. Orange, reports for first time. BPY spends his time cruising around bay with 56-mc. portable. DLF and DCP are rebuilding for fall. JC, the Bloomfield Radio Club, is active on 3.5 mc. HBQ reports GSA, DZH, CTI, GAR, GPI active at Point Pleasant. FOP has been assistant scout director in New York State. FQW enlists with A.A.R.S. Those interested in A.A.R.S. please get in touch with your S.C.M., who is N.C.S. of N.N.J. DEN is active in A.A.R.S. DPA is rebuilding for 500-watt input final.

Traffic: W2EKM 2388 LK 479 (WLNF 751) BSC 298 CGG 75 CJX 54 GGW 41 GAS 27 ECO 25 ABS 22 FLT 21 DPB 11 CTT 8 CIZ 5 GGE 9 RPY 2 BXM-CLM 1 DLF 4 DCP 2 JC 6 HBQ 20 DEN 14 DPA 32 FRC 100.

MIDWEST DIVISION

IOWA—SCM, Phil Boardman, W9LEZ—9ABE, Chief R.M. 9CWG, 9ECH, 9HMM, 9HPA, R.M.'s. Mr. A. A. Hebert honored Tri-city Amateur Radio Club by being their guest on Sept. 4th. 9ACL will act as S.C.M. during LEZ's absence from Iowa; he has been transferred to Nashville, Tenn., for few months. ACL is reinstated O.R.S. CWG increased power. HMM is forming traffic net. ABE says Aussies easy to QSO. IEZ was visited by 3DZF. NTW is building super. DRW attended hamfest in Wyoming. HPA has new rack. FYC is active in A.A.R.S. OXO is commercial operator. HMQ has new rig. GSY is touring east coast. IZD moved to Illinois. RVR and JXO scheduled Boy Scout camp. JEB says, "Wanna buy a transformer?" LYA is on 1.7-mc. 'phone. PBF and OZW are new Dubuque hams. KMJ is rebuilding. LCE is on 3.9-mc. 'phone. MXC operates portable. SBQ wishes schedules.

Traffic: W9ACL 395 CWG 25 HMM 24 ABE 22 GWT 16 LEZ 14 NTW 13 RDK 10 NDN 9.

KANSAS—SCM, O. J. Spetter, W9FLG—9KG, C.W. R.M. 9 ESL, Phone Activities Mgr. IOL has moved to Tulsa, Okla. RIZ has rack and panel. NI (CX7) is setting the pace in traffic handling at Fort Riley. ISJ is new at Hiawatha from Broken Bow, Nebr. K.V.R.C. State A.A.R.L. Convention Hotel Kansan, Oct. 13th and 14th. Depression Fee \$1.98!

Traffic: W9NI 3294 KG 1341 PB 760 FRC 504 APF 269 AWB 288 DZI 248 FLG 232 GWN 216 OKA 193 EYI 130 KXB 112 PKD 54 KFQ 41 DQJ 38 IQJ 32 IOL 29 RIZ 22 IGQ 6.

MISSOURI—SCM, C. R. Cannady, W9EYG—JWI was with N.G. two weeks. CJR is busy with campaign. AIJ continues Army schedules. AAN is trying 3.9-mc. 'phone. GBJ is trying 28 mc. DEN is interested in net for North Central Missouri. JAP is rebuilding with '03A final. EYG built new receiver. LCG took Class A exam. IAC is getting pair of 851's. NIS wound a 1/2-kw transformer. JXG is active on 1.75-mc. 'phone. RTK and RSO are new Webb City hams. KEF attended Hannibal hamfest. ARH got new rig on in time for one QSO. Whitnah of 2DIU fame at Fort Monmouth, N. J., comes to Missouri—St. Louis—to increase traffic totals under call 9RYD. Missouri Convention held at Kansas City kept K.C. gang busy. Thanks to all Missouri hams for my reelection as SCM for Missouri for next two years! Make your suggestions on how this office should be handled and we will try to please!

Traffic: W9JWI 737 MZD 401 CRM 140 NNZ 52 CJR 44 AIJ 41 AAN 25 BUL 9 GBJ 4 DHN 2 MLR 1 HUG-JAP 9 EYG 6.

NEBRASKA—SCM, S. C. Wallace, W9FAM—FWW and EWO returned from U.S.N.R. Cruise on Great Lakes. KVZ is new O.R.S. DI is ready for traffic season. BEW is now Grandpa! DHO and OPP took radiotelephone exam. RUJ has new low power 1.7-mc. 'phone.

Traffic: W9FWW 43 KVZ 8 DI 1 RUJ 87.

NEW ENGLAND DIVISION

CONNECTICUT—SCM, Fred A. Ells, Jr., W1CTI—CVL wins C.B.A. traffic banner, which has been held by DOW since its inception. CTC handled lot of traffic at New Haven Scout Camp at Winsted. DOW reports Bristol Radio Club had joint outing with Waterbury Radio Club at Northfield, Aug. 5th. GKAM can handle Canadian and Mass. traffic. HPI is up to his eyebrows in work at WTIC. BQS says a radio club is forming in New Britain. IBT visited Radio Bugs Club (HTH) in Devon. EJP testing a portable with .01 watts input worked W1 and W2. IED is new Danielson ham. GC, FPL and DLY are on 56 mc. 57 hams attended C.B.A. Annual Banquet, Aug. 16th. E. L. Bletney spoke on work of Communications Dept. FIO explained about A.A.R.S. and AMG put in good word for Navy. Among real old-timers present were exIBM and IFW, who gave the meeting some inspiring talks on amateur radio. Several lucky amateurs carried home prizes. IDJ is call of Bulkeley Radio Club, Hartford. Hal of MK was at N.G. camp for two weeks. W1GUC was at N.G. camp. AVT is radio operator on the Yacht *Onwego*, KMGC.

Traffic: W1MK 505 CVL 335 (W1GI 52) AMG

230 CTC 176 DOW 175 UE 63 GKM 57 GME-BDI 41 BHM 24 GC 22 GGX-HPI 19 CTI 11 RQS 6 AGT 7 HSU 6 HLE 5 IBT 3 CJD 2 BHI 3. GUC 31.

MAINE—SCM, John W. Singleton, WICDX—EZR enjoys A.A.R.S. GOJ is going to try 56 mc. GKC has Colpitts transmitter. AQW says things are perking up a bit in Lewiston. BLI handles traffic with CPLGB. IBM has new c.c. rig, FJP is installing '03A. JHH lost some tubes. EBY took GXB of Hartford for buggy ride. ERO is giving 28 mc. a whirl. AGL has a YL who is a ham, HWY. FXA has new receiver. CDX added 56-mc. rig. ALO and HXO are known as "5-meter twins of Franklin County." IDN is building 1.7-mc. 'phone. ARV is installing high-power 'phone at North New Portland. Get set for Fourth Annual Maine Section Traffic Contest to start in October. EF resigns as R.M. because of lack of time. If you want dope on 56 mc., get in touch with FA at South Portland.

Traffic: WICDX 36 EZR 27 GOJ 16 GKC 15 AQW-BLI 11 IBM 7 DHH 4 FJP-EEY-AGL 2 ERO 1.

EASTERN MASSACHUSETTS—SCM, Joseph A. Mullen, WIASI—ANI has call at new QRA: IHU. WV and CGM went to 9USA. RE is on 1.7 mc. BZO is building rack job. FRO leads Section. CRA is on vacation. FPO is on 7 mc. MD is coming up with pair '10s. HBR heard 4HYA on 10 July 15th. FCK is looking for schedules. CRL works 56-mc. schedules with mainland. ZK is working to make Army Net 100% O.P.S. AKN is summering at Wareham with transceiver. UG is getting haired up on 56 mc. DOF installed new M.G. IAV is summering on Nantucket, working port.

Traffic: WIABG 82 AGA 1 EVJ 38 BMW 1 DFS 16 RE 28 BZO 13 FRO 147 FPO 9 ECK 30 CEL 76 ZK 16 IAV 39.

WESTERN MASSACHUSETTS—SCM, Percy C. Noble, WIBVR—DVV is now chief R.M. FOB worked ship, GMTB, who was on 3485 kc. BVR has Comet Pro. EFM enters Andover Academy this fall. GZL visited several VE2's. DDK was reported QSA5 R8 in Scotland on 3.5 mc. BVP is back from New Haven. FQA is active on 56 mc. GXL sends first report. HJR operated portable in Madison, Maine. ZB worked Europe with portable at camp. New officers of Western Mass. Amateur Radio Ass'n: pres., DJB; vice-pres., Clyde Hill, Jr.; secy., FSD; treas., BGY; activities mgr., APL; member-at-large, EVZ.

Traffic: W1EOB 168 BVR 79 (WLGB 220) GUO 60 EFM 35 GZL 16 AJD 15 DUS 9 DUZ 8 DDK 6 ARH-COT 5 BNL 4 BSJ 9 BWY 5 DVV 36 DIE 12.

NEW HAMPSHIRE—SCM, Basil Cutting, WIAPK—FFL/WLGB does very good job delivering messages. CCM installed 845 modulator. UN is most consistent traffic man in this state. AUY has 1.7-mc. rig. FFP has receiver trouble. ANS has caught about all the trout in the state. IDY has fine rig perking in Pelham. IGI is new Nashua ham. HQE had 56-mc. rig at N.G. camp at Rye. AGO has Pickard receiver. HTO has new 3.5-mc. rig. GHT sends fine report. HJI visited World's Fair. CJT will be on 1.7-mc. 'phone in Peterboro. ERQ is back with high total. DUB is pushing traffic through ERQ. GEY expects to join the Benedicts. FGC broke his arm on 56-mc. expedition. DMD is DXing on 14 mc. HOV and HOU have been rebuilding. AVJ has new 56-mc. rig. AVG is busy in his garage. FAW works for Hoods, ice cream business. The SCM is visiting as many hams as he can.

Traffic: W1ERQ 371 (WLGB 108) FFL 133 UN 76 GHT 40 CCM-FCI 2 HJI 10 GEY-APK 4 IDY 1.

RHODE ISLAND—SCM, Albert J. King, WIQR—BKU is new ham from Orono, Me. ASZ is recovering from accident. AKK moved to Newport. HVK is new O.R.S. GTN is experimenting with c.c. IEG is giving his OML, GTN, a hard battle for traffic honors. HRC has c.c. frequency meter.

Traffic: WIASZ 16 HRC 11 QR 10 GTN 8.

VERMONT—SCM, Harry Page, WIATF—Vt. R.M., BJP, visited DQK, EBF and TJ. GAE broke his '10, but is on with '46's. GNF pushes traffic on 3847 kc. GXP

visited St. Maurice gang. Ex-SCM BD attended Governor's Day celebration at V.N.G. Camp Wilson. BJP, TJ, and ATF spent a pleasant morning at GGT's FB shack. In the afternoon we all joined the V.N.G. Field expedition, where we found BAS assisted by ERJ in charge of field radio equipment. The boys successfully demonstrated communication with the army portable rigs. The power supplies for the transmitters are hand-driven dynamos. FSW, GYG, and HZZ—all guardsmen—were there ready to keep the ether stirred up.

Traffic: W1GAE 39 GNF 6 ATF 4 BJP 23.

NORTHWESTERN DIVISION

IDAHO—SCM, Don Oberbillig, W7AVP—BRU has Class B outfit. BMF is grinding crystals. CHT worked 13 VK's. EPU is new Wendell ham. New A.A.R.S.: DEB, DOH, W7ASA working on new station. CFX is on 14 mc. DAW has new transmitter. AIS, ALY, ATN spent day in Boise visiting hams. DQC is leaving for eastern school. CSP attended N.W. Division Convention. BNJ, DZO took vacation in Wyo. and Mont. DSL is working on new rig. CKY moved to Butte, Mont. GL is preparing for busy winter of A.A.R.S. activity. EMN is going after O.R.S. GU has 150 watts input. Idaho hams attending Jenny Lake hamfest: BRU, BMF, AVP, ACP, BZJ, GL, DAW, BLL, BAA, DMT, KI, AAJ, ACD, BNJ, DZO, EHP, BME, EEK, CHV, BAU, ENO, DEB, BBE, BKF, AAJ is leaving for visit in Calif. BZJ handles state A.A.R.S. Net while GL is out of town. EFR is putting in c.c.

Traffic: W7AVP 19 BRU 5 NH 4 ASA 11 CHT 6 GL 42 BAA 20 BMF 12.

OREGON—SCM, F. L. Black, W7AMF—AXJ heads traffic list. DTG, DP, and AXJ hold first place in number of schedules kept. WL, IF and MJ get package of QSL cards thru QSL bureau from Europe. Eugene Club held annual picnic on Oct. 12th. The Coos Bay Radio Club held annual picnic at Broadbent on Aug. 12th with DIW of Salem and DEH of Bandon as guests. AZJ, WL and AMF have new antenna system. AMF claims highest antenna, 150 feet. AHZ, P.R.M., reports all O.P.S. keeping schedules 100 percent F.B. BUF is rebuilding. BLN and DP are new O.B.S.

Traffic: W7AXJ 241 DTG 72 WR 23 BLN 29 DP 12 AMF 15 WL 4.

WASHINGTON—SCM, Stanley J. Bellevue, W7AYO—Hope by this time you all have seen a copy of the Section bulletin, *The Washington Brasspounder*, edited by W7WY and sent to all hams reporting traffic to the S.C.M. From now on all but the important news will appear in the Section bull. If you want to keep posted and up to date on activities of this Section, send in a traffic report and be sure of getting a copy of a really fine Section paper—*The Washington Brasspounder*. For more information write either W7LD, W7WY, or the S.C.M. CQI has been handling traffic from Mt. Crill on Expedition, W1CVF/k7. New O.R.S.: DGY of Port Angeles. CGO is located at Grand Coulee Dam. AHQ has FB route for K7 traffic. AW has been clearing bugs out of his 'phone with aid of an oscilloscope. EPS is new Ritsville ham. EQG is new Yakima addition. EKA clicked HB9AD with 255 watts. DRK worked J2GX with 20 watts. ECX, ANI, BBS, CWN, and EPT report.

Traffic: W7CQI 263 CZY 208 DGY 177 QI 81 WY 79 AYO 60 LD 48 BHH 46 APS 44 DRY 37 CGO 34 AEA/730 AHQ 26 RL 23 ALH 20 DJJ 19 AW 13 BUU-BBK 12 CAM-AQB 10 CCT-EKA 9 AUP 5 EIW-IG-UE 4 APR-AZI 3 ECM-CQJ-DRK-AVM 2 (May 16th-June 15th W7ECA 77 AHG 10).

PACIFIC DIVISION

HAWAII—SCM, A. O. Adams, K6EWQ—CRW and IDK spent vacation in HU. ABP and JNN were visitors at EWQ. JNS moved to HU. W4EI is awaiting new receiver. LBB is on three months' vacation. DHW and GBY are returning to mainland. EGGE expects to leave soon. KKA is rebuilding. KKC, KPJ, KPV, and KRY are on 14 mc. OW has weekly chat with her husband, AJA, who is working on the coast. JPT received delinquent report from F.C.C. Glover of W4EI, one of the first c.c. stations in the south, will soon be signing K6.

Traffic: K6EWQ 3105 JPT 683 FAB 367 LBB 290 GQF 157 GZI 63 CRU 45 JRN 39 CGK 13 FJF 12 EDH 10 CIB 9.

LOS ANGELES—SCM, Howell C. Brown, W6BPU—This report prepared by Edward P. Stropole, W6AUB. AZU's is all trans-pacific traffic. HZT reports on vacation near Vancouver, B. C. IIK reports LED new ham at San Pedro. ERT has mobile 56-mc. set in car. FLC is traffic chairman F.V.R.C. KBF blew 50-watter. IUL joined C.C.C. KBY is working lots of DX. EK is looking for transportation to Santa Barbara; has rock on C.A. Net now. GEX has new Collins antenna system. HDV finds DX FB. DBF has new rig with Collins. HDC uses 2A5 crystal tube. TH is at Camp Mill Creek. EUV has new rock. BGF has new rig. ANN is on 28 and 56 mc. BVZ has transmitter trouble. HEW is on 56 mc. CJI is rebuilding receiver. FJK does lots of fishing. Let's all get our reports in next month. Remember the deadline is the 16th. 56-mc. work seems to be picking up. Try it. It's a lot of fun. JFS, DZI, HCN report.

Traffic: W6ETL 963 AZU 858 HZT 388 IIK 371 BMC 318 (WLVB 21) ETJ 270 (WLVK 240) BPU 253 ERT 229 GNM 187 FLC 175 KBF-KNP 85 IUL 53 KBY 52 IOX 50 EK 45 FYW 40 GEX 38 HDV 37 CGE 35 CQM 34 JSK 32 JTA-DUX 30 DBF 29 KRI-DNA 28 AKW 24 (WLVG 9) HFG 24 HDC 23 KAE 15 FJT 16 TH-FGT 14 UP 13 GTE 12 EGJ 11 INH 10 VJ-DWP 9 EUV 8 LXH-CV 6 CVV-BGF 5 ANN-KFK-CPM 4 HIT-DSG 3 GVI-IXS-GSL-BVZ-VO-KPU-JRX-HEW-CJI 2 AGF-HZM-FJK-KBB-DYQ 1.

SANTA CLARA VALLEY—Acting SCM, Barton A. Wood, W6DBB—DBB finished rack and panel 100-watt portable. JBI is active ham at Hollister. BMW is looking for let-up in forestry work. HJF has new rack and panel job with '03A final. HZW and DBB are fixing up radio-equipped shack for week-ends. FYD has new c.c. rig. GBI sports new 55-foot poles. JYW is on 1.7-mc. 'phone. JUQ got his doubler working. JTE has Collins rig on 7 mc. FF sold his equipment to HJF. FQY/KG have new Collins equipment. Active on 56 mc.: JDV, AGJ, JCW, KC, KG, KQK, FQY, HBB, IUZ, NX, HB.

Traffic: W6DBB 53 JBI 10 BMW 7.

EAST BAY—SCM, P. W. Dann, W6ZX—RJ is still high traffic man! JTH handled all his on 56 mc.! GHD resumed P. I. and Orient schedules, Sept. 10th. EJA has quite a DX record. HZK has new Gamatron on 7 mc. ZX was heard in Moscow, Russia, with a single '10. FS finished his third panel transmitter. CIZ got EE going on 56 mc. 9LFI of Chicago was recent visitor at CIZ's. HRN received Expedition Certificate; is also new O.B.S. BMS, EDR, EDT and CZQ, all old-timers, are getting ready for the active season. KWK is constructing a 'phone rig with Class "B" modulation. CI, a real old-timer, is building a very FB transmitter.

Traffic: W6RJ 510 (WLVB 26) ITH 197 GHD 102 AKB/ALH 71 EJA 49 ZX 40 FS 39 CIZ 36 CGU 22 HRN 11 HH 6 KNO 2 KWK 1.

SAN FRANCISCO—SCM, Byron Goodman, W6CAL—Acting SCM, Art Holmes, W6JAL—RH is going on 1.7-mc. 'phone. JDG received R9 from K6 with '46 final. JPA has new QRA. CIS keeps one schedule. EKQ is changing rig. BIP is QRL servicing work. JAL is QRL A.R.A. sec'y work. KBM has trouble with rig. KNQ is working on boat. DZQ is celebrating a raise. IPH has filter trouble. We ask the help of every local ham in building up our Section; report on Oct. 16th and receive a copy of our 7-page news bulletin—*Hamflashes*.

Traffic: W6ZG 1905 DDO 62 RH 27 JDG 33 JPA 30 CIS 26 EKQ 24 BIP 21 DZZ 1 FVJ 19 HSA-JAL 14 KBM 10 KNQ 8 DZQ-IPH 1.

SACRAMENTO VALLEY—SCM, George L. Woodington, W6DVE—W6AHN reports George Woodington, W6DVE, S.C.M., was burned in gas explosion, but coming along O.K. Expects to be back on the job soon. W6GAC is busy with new grocery store.

Traffic: W6CGJ 11 GZY 10 W6GAC 17.

ARIZONA—SCM, Ernest Mendoza, W6BJF-QC—AEK/KIJ had schedules with transient camp, N.G. camp, Boy Scout camp, and Camp Moeur. QC completes fifth

month on N.G. patrol duty. KOL changed antenna to single-wire hertz. FIP returned from Ocean Beach. IQY is pres. of Flagstaff Radio Club. GFK is Standard Oil Co. engineer for southern Arizona. CDU used portable of ALU at Flagstaff N. G. encampment. IZU bought receiver from IQY. LET is new Phoenix ham. LAB is at Broom Creek, near Prescott. IIG left for month's vacation at Long Beach. HXK moved from transient camp radio to N.G. camp radio. JYQ is rebuilding to '52 c.c. rig. HUZ, JZQ, KGQ, GDF, IDR, PRX, are at N.G. encampment at Flagstaff. KKE keeps daily schedules with his son, DPS, in L.A. Radio School. EFC received heard card from England on 14-mc. 'phone. AND makes WAC contacts on 14-mc. 'phone. BPV is heard every morning on 3.9-mc. 'phone "Breakfast Club." KGL has '46 final on 14-mc. 'phone. FZQ increases power with P.P. '60s in final! BFA keeps daily schedule with N.G. detail at Parker. GBN has lots of QSO's interrupted by choo-choo coming by his telegraph station-wire tower! Clubs are going strong in Phoenix, Flagstaff and Cottonwood. Tucson will soon organize another.

Traffic: W6ABK/KIJ 274 EL 107 QC 49 KOL 15 FIP 5 IQY 3 GFK 1.

PHILIPPINES—SCM, Newton E. Thompson, KA1XA—Next meeting P.A.R.S. at ISX, Clarkfield, 65 miles from Manila. INA is not leaving until September. ICO will be back on air August 24th.

Traffic: KA1HR 1620 NA 564 LG 249 CM 197 CS 166 FS 145 SX 162 RC-EE 133 AN 120 XA 47 TS 25 SP 19. KA4GR 26. KA9W 57. OM2AA 430.

SAN DIEGO—SCM, Harry Ambler, W6EOP—DQN leads Section. BHF schedules Alaska. EFK has three schedules. FQU uses Collins antenna for receiving. AXN is on three bands. CNK has new Silver Super. BAM worked "OE," and "HAF." BLZ is back from trip to Orient. BHV visited 2DBQ and 3NT while on east coast with fleet. FKT is building new frequency meter. BOW schedules Hawaii. BMC is away on vacation. GOG and APC are building all-d.c. portables. DNS and LD have new 'phones. HY is building new 'phone. QY is on 14-mc. C.W. DNW is back from vacation. LAZ, LAG, LAF, GCY are new 'phones. CYI has new crystal mike. FIP is on 1.7-mc. 'phone.

Traffic: W6DQN 170 BHF 137 EFK 96 FQU 94 AXN 14 BOW 13 EOP-CNK 12 BAM 3 BLZ 1.

SAN JOAQUIN VALLEY—SCM, G. H. Lavender, W6DZN—HYG reports Fresno Convention is going to be best ever held in the Division. Don't forget the dates: November 10th and 11th at Fresno. FYM handled traffic for Mt. Crillon Expedition in Alaska. EXH has new Tri-tet. KGO is chief traffic man for third district A.A.R.S.

Traffic: W6DZN 55 FYM 45 EXH 39 KGO 41 HYG 23.

ROANOKE DIVISION

NORTH CAROLINA—SCM, G. H. Wright, Jr., W4AVT—The S.C.M. wants the gang to know that AVT is back on 3830 kc., and welcomes a call from any ham; a 1.7-mc. 'phone is under construction and the S.C.M. hopes to get in on some 'phone net activity. CGH has new receiver. ALK visited the World's Fair. New calls: CYY, CXD, CXQ and DCL, who returned from Port Arthur Radio School. CXO gets out FB with pair of '45s. Lightning hit AGE's rig. DQ burned out filament supply. CJP and AEH are doing excellent work with Boy Scout Amateur Radio work. SBAL, of Syracuse, N. Y., is temporarily located in Troy, N. C., with U. S. Forest Service; he is using "8" call as portable. ZH is QRL baseball. TJ worked HB9AQ. BHR, BH8, CXL, CTR, BV, BX, CLB, AVT, BYA, are interested in 1.7-mc. 'phone. BPL is with B.C. station, WDNC. BKS wants O.R.S. OG is putting 2500 volts on single '52. CCF is rebuilding.

Traffic: W4CJP 63 AEH 62 BWE 11 BRK 15 BRT 11 NC 10 BOH 8 ALK-BV 7 DW-OG-BYA 4 CYA 3 BVD-MR-BFB-CXC-CXF 1.

VIRGINIA—SCM, R. N. Eubank, W3AAJ—BFW has May QST 'phone. ENO has new SW3. EHL has '47-'46-'s par. ALF operated at EKL. BRY says club starts Sept. DZW has new s.s. receiver. RL has '24A Tri-tet '46 Amp. BZE delivered message to Governor. ELJ is build-

ing new ant. DBI is Petersburg Club station, Buchanan operator. BIG is in all O.P.S. parties. UVA worked "GFMX." EVN uses '45s TNT. EOQ (our R.I.) and Mrs. were at Norfolk fest. EBD has new receiver. DWE is at Augusta Mil. Academy. AGW has been in hospital four months. DNR is op at C.C.C. Co. 1363, Spotsylvania, WVGF. BGE is operator at WVGP, Clinchport. 56-mc. men: BZA, BEK, DRR and MQ. ELA wants 1600-V. transformer. BXN has new opr., 7 days old. Congrats. COO says Patterson PR-10 berries. CA is Roanoke Convention Chairman. BTR shot power transformer. BAD is D.N.C., A.A.R.S. 5th dist. ASK has '47, RK20, '52s line-up. EAP keys crystal stage. EQQ is operator at WHVB. CIE has new c.c. 50-watt rig. BSW has new rig on 3650 kc. EFY and EOO send first reports. 2GRZ is operator at EPH. BEB is on 1.7 mc. FJ gave 56-mc. demonstration at camp. CNY is going to Central Div. Convention. CPN says WM has c.c. '10 rig. Staunton Club and nearby hams cooperating with Glider meet at Great Meadows, Va., in Sept. "Bob," Virginia Section Comm. Mgr., forced to resign at end of present term of office due to pressure of business. Major Hawthorne, ex3EFT, is back at Washn. Capt. "BN," CXM, is in P. I. Murr, BAL, took flight to Alaska with Army planes. See you at Roanoke Div. Convention, Roanoke, Oct. 5th-6th. BNH, BSM and Allen are three hams at WPHE.

Traffic: W3BFW 2 AAJ 1 EHL 24 ALF-ECQ 9 BRY 4 DZW 2 RL 1 ANT 174 BZE 17 CYM 15 ELJ 6 DBI 5 WM 4 BIG 3 EGD-UVA 1 DNR 70 AHQ 19 BGE 14 MQ 4 BAN 3 ELA 3 BXN-COO 1 BYA 279 CFV 7 EAP-EQQ 3 CIE 1 EPH 50 BEB 27 CYK 17 FJ 16 EPX 97 DCU 55 EPW-CSI 22 BIW 8 EOX 2 ELB 1 APF 29.

WEST VIRGINIA—SCM, C. S. Hoffmann, Jr., W8HD—Ed. day of WLM spent his vacation at EIK, and several days with KKG. OK and LJX operated N.G. field set station, call GK8, on 4080 kcs. GBF, with 750 watts input, schedules KKG. JRL is completing new 1-KW rig. MIP is new Clarksburg ham. HCL is rebuilding. EWM schedules 4AAY daily. DNX and YF visited HD. FQB schedules GBF daily. HWT built new '52 c.c. set. HGA is testing for Asia stations Dec. 3rd to 7th inclusive, listening for replies 7:30 to 8 a.m. and 1 to 1:30 p.m. (EST). KLO is home on vacation. CDE expects to move out of W. Va. LSJ and LSK joined Baptist choir. KWL visited 3AAF and 8CDE. LIN moved to New Martinsville. JWL reports several followers of his code practice lessons taking "B" exams. 6FEW visited BOW, BTV, KSJ. New U.S.N.R. applicants requested; get in touch with ADL For A.A.R.S. applicants get in touch with OK. MIP and MBB are new Clarksburg stations. Junior operator at BOK. AWT will attend school in Richmond, Va. CVX has new '59, RK20 rig, 'phone and C.W. JRL and KSJ visited 9USA. EZR visited Fairmont. 3EUG visited JM, KWV. DSO is moving to Erie, Pa.

Traffic: W8KKG 129 OK 66 (WLHB 3) HCL 2 EWM 3 FQB 18 HWT 12 LSJ 1 KWL 3.

ROCKY MOUNTAIN DIVISION

UTAH-WYOMING—SCM, Arty W. Clark, W6GQC—Utah: 6HVU visited CNX. FRN rebuilt to 59 tri-tet. JYD had to go back to '45s P.P. BTX finished season at Yellowstone Park. GQM is on with 250W. KDI is building c.c. DTB erected 3.5 mc. antenna 86 ft. high. LCB is new reporter. GQC got his first KA1. KOZ is looking for 50 watter. AFN is assistant ed. on WIMU MONITOR. KMA is working on frequency calibration from 100 kc. osc. EWW visited 9USA. Wyoming: 7EKR is on 7 mc. CRP is working on 1.75 mc. 'phone. CSE had grand time at W1MU. ARK and COV find 14 mc. 'phone DX good. AMU lost out in primaries. CHR displayed splendid portable at W1MU. CVD worked P.I. CPB moved to Billings, Mont. Sheridan Amateur Radio League is now affiliated with A.R.R.L. Splendid time at W1MU Hamfest with 74 licensed calls registered; 10 from Utah, 21 from Wyoming. 6DWH was elected pres., 7DXQ vice-pres., and 7GL, secy.

Traffic: W6GQC 127 KDI 102 FRN 51 BTX/7 37 KKG 16 AFN-GPJ-JYD 8 KOZ 3 DTB 2 LCB 1. W7AMU 26 CSE 24 COH 18 COV 10 AEC 6.

COLORADO—SCM, T. R. Becker, W9BTO—W9GJQ

730 GNK 42 CDE 4 PWU 3 JCQ 2 PGS 2.

SOUTHEASTERN DIVISION

ALABAMA—SCM, L. D. Elwell, W4KP—APU leads state in traffic; he gathered a lot from BRX at N.G. camp. DS delivered message to So. America. CIU, new O.R.S., reports antenna blown away. BOU spent two weeks with N.G. encampment. BJA is keeping schedules. BGO returns to air with 3.9-mc. 'phone. BIW has FB time on 14 mc. GN is after commercial tickets. GL, R.M. for southern part, reports two stations on regularly. BZG has forsaken 'phone for 7-mc. C.W. AUP has a new neighbor, CYV on 1.7-mc. 'phone. AXU paid the SCM a call. COA is getting back on in B'ham. Get your registration fee in to the Mobile gang before Oct. 1st in order to have a chance on a special prize. Dates of Convention: Oct. 19th-20th at the Battle House.

Traffic: W4APU 70 DS 49 BJA 23 BOU 19 BIW 13 KP 7 CIU 4.

EASTERN FLORIDA—SCM, Ray Atkinson, W4NN—Shake hands with the new S.C.M., fellows, Phillip A. McMasters, W4BCZ, 212 9th St., North, St. Petersburg. Make your future reports to him. BRA is our newest O.R.S. ASR is going to World's Fair. AZB has new RK20 rig. ALJ says, "Hello, gang," from the fair. FM is on 7 mc. DU and YF along with NN and AGB made a pleasant fishing trip to the home of BYY. UX was tied up in Seafle by West Coast strike. CWV is building new receiver. Well, fellows, I sure enjoyed being S.C.M. for the last two years. Drop us a line once in a while.

Traffic: W4NN 226 AGB 44 ASR 26 AZB 18.

WESTERN FLORIDA—SCM, Edward J. Collins, W4MS—R.M.: 4AUW, 4ACB. AGS has receiver fixed. Our newest ham is DAO. CSR has transmitter trouble. BGA is moving NDD. BFD installed "Collins Antenna" timing system. CQF has swell 3.5-mc. rig. AUW says 14-mc. DX nice. AUV has new job. CRU blew power supply. RS and ACB were visitors to Pensacola. BSJ is looking for African QSL for W.A.C. CDE has everything in relay rack. BPI and CTZ put out FB crystal notes. AXP does FB U.S.N.R. work. BCB is on every p.m.

Traffic: W4CTA 2 VR 14 COG 3 ACB 7 AGS 62 AXP 37 CDE 10 MS 14.

SOUTH CAROLINA—Assistant SCM, Bannie L. Stewart, W4CE—CQQ and BZX passed "Radiotelephone first" exam. BDT joined N.C.R. ARH is building new 'phone. GH plans 250-watt phone. ACI moved from Hendersonville to Spartanburg, S. C. PFN moved to Greenville, S. C., from Hendersonville, N. C. CPB is new in Greenville. CZA has FB signal on 3.5 mc. ADE runs radio repair shop. CEF is Mrs. ADE. AIF is with Coast and Geodetic Survey. ANK is in an orchestra on a Ga. beach. AZT is on 3.9-mc. 'phone. BCY works DX with 3 watts. BXS operates at WCSC, Charleston. CUS puts a cus-sing good signal on air. CE visited hams in Columbia, Gaffney, and Spartanburg. BQM schedules S. C. stations. CVD is coming on from Sumter, S. C. CQJ is rebuilding whole station. BEN, DX and CIR took part in tactical operations in N.G. camp. BCN is on 3.5-mc. C.W. CYG needs filter condensers. OW is working on new 'phone.

NY1AA, Balboa, C. Z., reports 122 messages handled July-Aug. month; schedule still kept with W1MK. K5AF upholds the A.A.R.S. in C. Z.; traffic 431.

WEST GULF DIVISION

NORTHERN TEXAS—SCM, Glen E. Talbutt, W5AUL—W5BII, Chief R.M.; W5SP, P.A.M. CPB is high traffic man. ARS goes on Navy cruise. BII had big time at Guard camp. CMS is putting in '52. BXY is going to Texas Tech. CHJ keeps ZD's schedules. AW and AUJ were commended for radio work at T.N.G. camp. EEW spent vacation in Amarillo. DXA is A.A.R.S. CXS is going on 14-mc. 'phone. DUR likes new PR-10. DM likes fast ops. AJ and "YF" visited S.C.M. AXK is going to A. & M. BKH now has "N" call. ARV has that African card for W.A.C. IA visited Chicago Fair. EJJ is new Mesquite ham. DAF and EES want O.R.S. CYU has new "YF." DYU is trying to get more power.

Traffic: W5GPB 84 ARS 74 BII 66 EES 53 CMS 33 BXY 28 CHJ 24 AW 18 NW 8 EEW 7 DXA 6 CPT 5

CXS 24.

OKLAHOMA—SCM, Carter L. Simpson, W5CEZ—CEZ spent most of month in bed with mumps. ASF is our newest O.R.S. BQZ is getting his A.A.R.S. district in shape. DTC is helping out with weather reports for 8th Corps Area. BAR is going to make a relief operator out of his younger brother. AVR has new transmitter. BKK is looking for A.A.R.S. recruits. AKX is installing rig at new QRA. AA applies for O.P.S. AIR checks frequencies for neighboring hams. DDW has been off due to illness. CGH runs 400 watts input on 3.9-mc. 'phone. EHL has '45 P.P. job. RU, DQB and AJF go to N.G. camp. BLJ and EHP apply for A.A.R.S. ARK has been seriously ill with appendicitis, but is on way to recovery. Oklahoma welcomes 9IOL of Winfield, Kansas, who is moving to Tulsa.

Traffic: W5CEZ 203 ASF 101 BQZ 80 AMT 52 DTC 20 EHP 17 BAR 9 AVR 2.

SOUTHERN TEXAS—SCM, Bradfield A. Beard, W5ADZ—MIN keeps FB A.A.R.S. schedules. BFA is building new portable. BDH, BYV, BDT work 56 mc. BYF is new County Attorney. EBU was appointed O.P.S. DPX, 'Phone Activities Mgr., had emergency transmitter on during storm. EJV is on 3.5 mc. with 45's P.P. AXO reports for Ft. Clark gang. AMJ is at new QRA. Portable 9IGX was appointed O.P.S. BHO requests O.P.S. DPA, Houston Club, has 300-watt 7-mc. rig, and has under construction a suppressor grid modulated 1.7-mc. 'phone. Don't forget A.R.R.L. West Gulf Division Convention at San Antonio, Oct. 26th and 27th. I wish to thank the Section membership for electing me S.C.M. Please send all reports, etc., to 5ADZ, 2030 Queeny Road, Houston.

Traffic: W5OW 711 MN 150 BFA 45 DWN 39 BEF 16 ADZ 13 BHO 3 AXO-FRU 2.

NEW MEXICO—SCM, Dan W. De Lay, W5DUI—DLG is new O.B.S. DZY has new crystal. DVH is preparing for winter. DUI is looking for 1 K.W. pot for plate transformer. AQ took commercial exam.

Traffic: W5DLG 32 DZY 1.

CANADA

MARITIME DIVISION

MARITIME—SCM, A. M. Crowell, VE1DQ—Nova Scotia: The Halifax Amateur Radio Club is arranging for complete amateur booth at Nova Scotia Provincial Exhibition. EP QSO'd his 40th country. HG, brother stationer to EP, has contacted 20 countries. GH says visitors are hard on equipment. GC is proud father of YL op. EG uses 112A and 135 V. GH needs only Asia for W.A.C. BY (the R.L. to you) visited Lunenburg gang. GL installed c.c. DQ is held up for parts. FT has been working G's on 7 mc. HH is c.c. on 7 mc. HH, BZ and FT are experimenting with 56 mc. Newfoundland: From July 23rd to July 29th VOSW was operating at Trail's End, One Island Pond, Tor Bay; schedule was held with VOSHK. VOSH operated portable from Brigus on holidays, also scheduling VOSHK.

Traffic: VE1GL 8 FT 3 VOSW 11.

ONTARIO DIVISION

ONTARIO—SCM, S. B. Trainer, Jr., VE3GT—New R.M., QK, again leads in traffic with NO a close second. MB was visited by XS and 2DU. DU and MB enjoyed first O.R.S. party. SG worked hard to move Toronto's Centennial traffic. JT, Toronto R.M., will arrange schedules for you. Write him! Loneliness has hit SM. IZ reports for first time. AU made CQ machine. ABD starts out with c.c. AAN and AAO are newcomers in London. Welcome to new O.R.S.. R.O. VF is working nights. UU, EA, are rebuilt. The Brantford A.R.C. held meeting at Paris. SL, ZM, HX, PS, OY, LU, YQ, YY, UP, EE, and TV being present. Reports have it that DU is getting married. IJ is back; ZL, VW plan to be. MX is on 14 mc.; GH is getting ready for it. JV gets too many QSL cards. EM has a '45 that can take it. ER reports much DX. IQ is in on Weston. PN has his troubles. RK visited Toronto. RM and QN find 3.5 mc. FB. C.C. at SZ. Ontario Sunday morning QSO parties start Sunday

Sept. 30th on 3.5 mc., 9 a.m. to 1 p.m. and continue last Sunday of each month. Don't forget the Ontario Convention and VE/W Contest!

Traffic: VE3QK 364 NO 334 SG 167 JT 156 GT 94 DU 8 WK 13 SM 6 MB-IZ 4 GH 3 AU-WU 1.

QUEBEC DIVISION

QUEBEC—SCM, J. A. Robertson, VE2GA—HK is new O.B.S. CH now has W.A.C. certificate! BU is new O.R.S. BT hooks VK. GO applies for O.R.S. EE has already netted four continents on 'phone. Junior operators at DR and DJ. Congrats, OMs. BX visits CG. CO is on 56 mc. AP is QRL fishing. DG works VK's and ZL's with pair of tens. Welcome to JJ. IE has new high-power rig. AC handles important traffic from W1OXDA. HG works 35th country. EC has new schedule with WIGXP. BE, BG, BT, CA visit S.C.M.

Traffic: VE2BB 8 DG 9 CO 1 DR 111 CG-BG 12 GA 7 EC 10 BT 16 EE 10 BU 27.

VANALTA DIVISION

ALBERTA—SCM, J. Smalley, Jr., VE4GD—VE3PL is operating portable under call 4TA. LG is at Gull Lake and QX at Sylvan for summer. HM QSO'd W1OXDA in Jones Sound on 14-mc. 'phone. EA prefers 14-mc. 'phone. PH is leaving for Naval Reserve training. GY is visiting in England. EY is contemplating a license to make a YL into a YF. 14-mc. 'phones, FI, HW, HQ and JK are getting DX QSO's. JK applies for O.P.S. LX goes in for DX schedules. AF, OF, OI and AA are trying 1.7-mc. 'phone. EO gets a new Patterson. KG has eyes on FB7. Mr. Hebert's visit in Calgary was appreciated and enjoyed by the 34 hams who heard him. DR at Killam has many QSL's awaiting Manitoba and Saskatchewan stations. OA is now c.c.

Traffic: VE4BZ 35 LX 25 AF 21 EO-QX 8 KG 11 GD 2 LG 6 OA 9.

BRITISH COLUMBIA—SCM, R. K. Town, VE5AC—56-mc. enthusiasts are out in force; AL, DD, BC, GF, are getting best results. Y.M.C.A. camps under DB, HC, IC, HR, EU do excellent work. B.C.A.R.A. held hamfest in honor of Mr. Hebert's visit here. 3.5-mc. 'phone has new enthusiasts in BJ and HI, while ER, BK, BY continue good work. IE reports junior op. Congrats, daddy. CK and AG take fatal step. Best wishes to both. Among the rebuilders: HU, JK, DC, KY. Newcomers: LY, 1.7-mc. 'phone; JC, 3.5-mc. C.W.; KA, C.W. DXers: GS, HQ. Visitors on vacation: KT, FL, KN. Important! All traffic men report your schedules to the S.C.M. HP uses 211Ds. AC is putting in 1.7-mc. 'phone. DB reports highest traffic total ever handled in here! EU won a mike at hamfest. HR conquers the Tri-tet. IC operated the Y camp station at Sooke. JE contacts Y camp. KB took his heap to church camp. EZ is Victoria Club station. DF reports via LV. JU is newcomer. KN is going to North-western Convention. AS has his heap at church camp. GT plans visit to Vancouver.

Traffic: VE5HP 146 JA 42 EC 4 DO 6 AL 17 EP 25 AC 50 DB 902 EU 360 GI 184 HR 195 IC 247 JE 62 KB 56 EZ 4 HQ 12 DF 61 CV 133 JU 4 KN 8 HC 51 JK 59 AS 55 GT 101.

PRAIRIE DIVISION

MANITOBA—SCM, Reg Strong, WE4GC—The Section was glad to welcome Mr. Hebert during his recent visit. The M.W.E.A. held a picnic and hamfest at Portage La Prairie. Those present, from Brandon: AC, IF, PR, LN, NR, AK, LM and RK; from Winnipeg: AG, FT, RO, DZ, KU, LH, MV, TV, TJ, NT, IC, BQ, IT, PC, GC, QA, IA, OB, AQ and many others. DQ and W90PA were recent visitors to the club. SV is active at Little Britain.

Traffic: VE4AG 9 GC 7 PC-NW 6 MV 5 RO 3.

SASKATCHEWAN—SCM, Wilfred Skafie, VE4EL—EH is working 3504-ke. 'phone. CM is on 3524-ke. crystal 'phone. CM tops the list for traffic. Regina was fortunate to be visited by A.R.R.L. official Mr. Hebert, the treasurer.

Traffic: VE4CM 70 GR 50 QR 21 RE 8.



CORRESPONDENCE

The Publishers of *QST* assume no responsibility for statements made herein by correspondents

One Kilowatt—More . . .

47 W. Fairview Ave., Dover, N. J.

Editor, *QST*:

QST has been here a week now, and it seems that every time I open it Mr. Csak's letter on power reduction stares me in the face. The idea itself is nothing new. Throughout all history, ham and otherwise, the lowly have been seeking to bring the powerful down to their own level. Hence to-day we have Communism, Socialism, and Mr. Csak's letter.

From his letter one might imagine a real problem existed. On 3.5 and 7 mc. evenings I will admit that QRM is pretty bad, but stations are still working other stations. I maintain that if all stations above one hundred watts were brought down to that level the reduction in QRM would not be worth noticing. This is because the number of stations using high power is not too great, and the QRM producing capabilities of a one-kilowatt transmitter are not as great as one might be lead to believe. A one-kilowatt transmitter in our bands having a clean signal and no key impacts is most decidedly not the nuisance the S.I.A.R.A. seems to consider it.

. . . It seems that low-power transmitters and simple receivers are still serving. Folk still write to *QST* about the emptiness of the high-frequency end of forty. Ten-meter 'phone is still free from QRM, 1.7-mc. c.w. is rare, and I have found it as dependable as 80, using a 7-mc. Zepp on both bands. During the early morning hours, 2-mc. 'phone and all c.w. bands are decently clear and don't clog up too much during the day. Simple T.R.F. receivers are still serving to put stations up toward the top of the B.P.L. If these things are true, then where is the need for power reduction?

We can still work low-power stations during the evening with the worst kind of receivers. Surely a ham who can afford a kilowatt can afford an S.S. receiver, whose sensitivity, being accompanied by decent selectivity, may well be used to drag in those weak, flea-powered signals. On my receiver 3.5-mc. 'phone seems one unholy mess evenings, but I realize there are other times of the day when I could work there, and also that a good super or S.S. set would probably make the band workable. . . .

Rather than ask for reduction to 100 watts I would suggest that you ask for an increase to ten thousand watts for all non-modulated amateur

signals. From this one might gather that my power is 999.99 watts. I have never used over a hundred watts, but I recognize that the greatest traffic work, the most consistent DX, and the finest operating are usually the spawn of high power.

—L. Lyon Cook, W3BDH

220 Tennyson Ave., Highland Park, Mich.

Editor, *QST*:

. . . Am I regusted? Why a bunch of supposedly intelligent amateurs, pulling for ham radio, should propose more restrictions on the ham is a mystery. A hundred watts! It's mutiny; that's what it is. Did you guys ever stop to think how much apparatus such a regulation as that would junk? How much it would curtail the manufacture of parts?

. . . The first thing you know we'll be using our monitors for QSO. . . .

—C. R. Funk, W8GWA

St. Louis, Mo.

Editor, *QST*:

. . . The only way to work if high power gets the best of you is to move to the center of the band, for there is plenty of room for all in our bands. If you doubt this statement, read W6BXR's letter in *QST* for July, and if still in doubt tune over the bands and find out for yourself. Why not let the high-powered stations fight it out on the edges and let the low-powered stations QSY, if they so desire, until they can compete with the others?

Let's cut out the crying about more frequencies and less power and go to work and enjoy what we have. . . .

—E. A. Whitnah, W9RYD

77 Washington Ave., West Hazleton, Penna.

Editor, *QST*:

Anyone proposing or "fostering" or fathering any further amateur regs should be shot at sunrise, if not the day before. All this country needs is rigid and straightforward enforcement of *existing* regs!! Why can't these doggoned "Associations" attend to their own biz and dues collecting?

And if you have time, please tell Lieut. Redgrave (page 55, same issue) for me his "SCRAM" system would be just so much more QRM from the States for the KA's. Anyway, there ain't any more "musical" sigs since I kissed my ole rotary

sad farewell! There are just eleven xtal P.D.C. sigs (counting both my odd an' even harmonics) on the air, to date, and the rest are just one sickening racket that everyone over here calls "FB T9"—whatever that means!

—Herb Wallace, W8BQ

112 W. Webb St., Calumet City, Ill.

Editor, *QST*:

That bunch out on Long Island kinda griped me about limiting things to 100 watts. . . . At N.B.C., Chicago, where I work, there are 60 or more of us, and very few who are not hams, and I haven't run into one yet that sympathizes with their proposal. . . .

—J. R. Miller, W9CP

Neches, Texas

Editor, *QST*:

Since the letter from the Staten Island Amateur Radio Association was published in the August, 1934, issue of *QST*, some serious and considerate thinking has been done by the several amateurs here in the oil company camp. There are four of us here, all owning and operating 40-meter rigs ranging from 150 watts to 1 kw., and we thoroughly sympathize with the amateurs of congested areas where there must be many powerful transmitters operating almost continuously.

. . . . For the sake of the thousands of amateurs who have healthy sums of money invested in ham rigs and other expensive equipment, please know that the sentiment of the scattered hams in the southwest would be against such a move to reduce power. There's no sanity in giving up a good thing simply because some club of hams suddenly gets sore at the 1-kw. rigs in their neighborhood; they could invest a bit and buy some good receivers—that solved the problem on this hill-top.

—J. Pronto Poston, W6AJ

. . . Or Less

Montclair, N. J.

Editor, *QST*:

I am writing concerning this low-power question. I am in hearty agreement with Mr. Csak's letter in August *QST*. I have been thinking for some time that the amateur power limit should be 100 watts instead of the present 1 kw. If others can get out successfully with limitations, why can't we? By looking through the amateur regulations of the world as shown in the I.A.R.U. section of August *QST*, it is evident that many foreign countries are limited to 50 watts input and quite a few are allowed but 10 watts.

I do not think it would be much of a handicap to the American ham if he were limited to 100 watts input. For quite some time I have been running my crystal transmitter at inputs less than 100 watts and have attained quite a respectable DX record, and so far I have no desire to increase my power. I think if some of these fellows would invest their jack in a hundred-foot pole instead of high-power equipment, they would get out just as well and with less local QRM. A good deal of the interference caused by high power is local. If the antenna were attended to with a field-strength meter and then boosted up in the air, the local signal would be at a minimum and the range of the transmitter as good if not better than a lot of these inefficiently run high-powered jobs. Taking the cost of high-power equipment and upkeep into consideration, in some cases it probably would be much cheaper in the long run to erect one of these rotary-directional antennas as shown in a recent *QST*.

I don't think that anyone will say that the Portuguese come through any more consistently than the Spaniards, although their allowed power is six times greater than the latter's. That is just an example. What are we going to do when all U. S. hams are using a kilowatt? Certainly the government isn't going to allow us any more power, so why not do something about it now before it gets too late? I'd just as soon copy an R6 sig through an R7 one as an R8 through an R9.

—David Scott, W2DLM

213 S. Bellinger St., Herkimer, N. Y.

Editor, *QST*:

. . . . Amateurs have always played an important rôle in advancing short-wave communication, but having the good fortune to be able to invest large sums in big rigs is no particular contribution to the advancement of the art. Much can be done with low power rigs and good receivers. . . .

—L. J. Schell, W8KJO

Hellam, Penna.

Editor, *QST*:

I have read with interest the article on limitation of amateur input power to 100 watts, which appeared in August *QST*.

This idea, to my way of thinking, is the best as yet proposed to relieve the congested conditions of the bands.

I certainly want to go on record as being entirely in favor of it. . . .

I respectfully suggest that your fine magazine give this idea plenty of publicity.

—R. S. Krebs, W3ESY

Perhaps You're Right, OM

Kennedy, Ala.

Editor, *QST*:

Please, please don't let it start again. We had it a few years ago and we are right where we were before it started. I guess some want it, and some don't want it, and some are indifferent—personally, I don't believe I can wade through the pro's and con's that we will have to listen to all over again.

It must be the heat—that is the only thing I can think of—that would cause a revival of the high-power holiday. Yep, that's what I mean, the revival of the Schnell high-power holiday. You know—it broke out in the August issue of *QST*. Yes, I know, it came from a different section of the country, and had its face lifted; but no sir, you can't fool me—it's the same old holiday, in the same "Correspondence" section.

Again, maybe it's the heat (heat seeming to be the main factor back of it all) that makes me think I can't stand it again. So please, Mr. Editor, regarding the power question, let's don't discuss it. Thanks.

—M. H. Gravlee, W4AG

Restricting Beginners

Brownsburg, Ind.

Editor, *QST*:

In regard to your editorial in the July issue of *QST* on the subject of restricting beginners to a certain portion of the amateur spectrum, I would like to comment:

Having received my license two days ago, I can certainly class myself as a beginner in ham radio, although I have followed it from the receiving end for several years. I am ready and willing to be restricted as to frequency for a period of a year, as I believe it would be an advantage to me right now as well as later after the year was up. Most of the "old-timers" would get out of the "tenderfoot" band to avoid QRM, and so we raw hams would know where to find each other on the air. As most of us start with low power, we would not be drowned out so often by 0.99-kw. sigs at about 35 w.p.m. The band would be a meeting place for us to work out our problems and prepare to join the "great fraternity" on the other bands at the end of our probation. However, I hope I would not be restricted to the 160-meter band, as I have never been able to hear much c.w. activity on it out here.

Perhaps six months would be long enough, but a year would be all right if the restrictions were not too severe and the band too narrow.

Wonder what some of the other neophytes think of the idea?

—L. E. Foltz, W9SFG

(Continued on page 62)

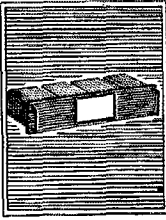

It is fortunate for the science of H.F. communication that amateurs are experimenters. Many important improvements are due to their investigations, and they have won the thorough respect of the commercial organizations. Realizing their value, we endeavor to try out every new scheme as it is presented, and we have a well-equipped laboratory for that purpose. Unfortunately, the last two or three published schemes we have seen have been unsound and poorly engineered. This would be none of our business except that they were plans for "improving" FB-7 receivers, and rather than have some receivers spoiled, we are using this space to tell the amateur to steer clear of them. We promise to let you know if we run across any good suggestions.

We are going to explain our views on two controversial subjects while we are about it: — external power packs and plug-in coils. The reason why we use them is because they are better. Most amateurs have found this out, but for those who haven't, we will give reasons: —

As we see it, there are four points in favor of external packs, and one against them. To begin with, the noise and hum level is always lower. If you are using a short wave receiver with a built-in power supply, try disconnecting it and using an external supply. The hum level and noise level will be reduced very materially. (Note: Wire pack back again afterwards. See first paragraph above.) We have tried this on a number of commercial sets, as well as trying internal supplies on our own receivers, and the hum and noise level is always higher with built-in pack.

Furthermore, we claim greater flexibility. In many National sets, it is possible to convert to battery operation for portable use by simply changing tubes and leaving the pack at home. Similarly, one power supply will suffice for more than one receiver. And finally, an external pack saves space on the operating table. The only disadvantage is that the receiver is not wholly self-contained. What of it?

Our views on the question of plug-in coils versus coil switching are also based on experience with both types, our first coil-switch receiver having been built three years ago. We have found that image frequencies, noise and selectivity are greatly affected by the size of the coil shields as well as the type and size of coil, and further that it is very difficult to obtain optimum proportions in a coil-switch layout. The new HRO receiver has seven sets of plug-in coils, with four coils in each set. If these same twenty-eight coils were all built into the receiver, it would require a prohibitive amount of space and very long leads. The usual solution is to sacrifice the ideal proportions of the plug-in coil when designing for switching, with a corresponding degradation of performance.

There are other difficulties, of course, such as absorption losses due to idle coils. We have found a solution to this problem, however, as well as other details, and our coil switch equipment has given very creditable performance. But at the present state of the art, we definitely consider such sets as primarily short-wave broadcast receivers, and sell them as such.

And top-notch High Frequency Amateur equipment should use plug-in coils and external packs.

JAMES MILLEN



VARYING LINE VOLTAGE

+ + + + +

THE VARIAC

AN adjustable transformer by means of which the supply voltage can be varied continuously from zero—better than a rheostat or potentiometer—high efficiency—no heating—output voltage independent of load—compensates for varying supply voltages.



TYPE 200-B

Particularly useful for controlling filament and plate-supply voltages—direct, simple and effective method for continuously reducing plate power—dial calibrated in output voltage—maximum current, one ampere—either breadboard or panel mounted—**Price \$8.50**

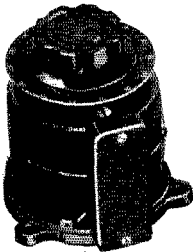

TYPE 200-C

A larger unit rated at 5 amperes—on 115-volt circuit gives output voltages from zero to 130 volts—for high power plate-supply control—filament supply—compensates for low line voltage—dial calibrated—**Type 200-CM** with mounting case, cord, plug and outlet **\$16.50**—**Type 200-CU** (illustrated), without case, for panel or baseboard mounting **\$14.00**.

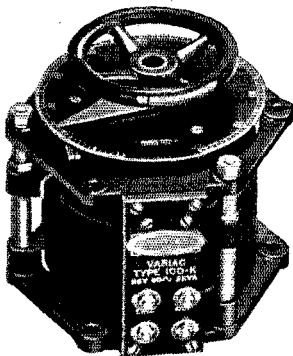

TYPE 100

A still larger model furnishing output voltages from zero to line—rated at 2 kva at line voltage—**Type 100-K** (for 115 volt line) **\$40.00**.

Order direct—sent prepaid anywhere in U. S. and Canada if cash accompanies order

GENERAL RADIO COMPANY

Cambridge A 30 State Street Massachusetts

(Continued from page 60)

2304 Chamberlain Ave., Chattanooga, Tenn.

Editor, *QST*:

Your editorial . . . meets with my approval.

I am not yet an "op," and for that reason may present a different viewpoint from many other members, but I am learning, and hope to have a "sheepskin" and permission to sign a portion of the alphabet instead of my legal name in the near future.

The majority of licenses are granted to those who can barely pass requirements (and I am going to be in that class), and what they need is practice, without interfering with others who may have important things to handle. It would seem that they would get this best by working with others in similar circumstances. If they were all in the same portions of bands—say near the low frequency end of such bands—they would naturally find each other easier and faster operators would naturally keep above them. I would suggest part of the 160-meter band and part of the 5-meter band would be sufficient and logical; the former for obtaining knowledge of actual traffic-handling conditions and the latter for practising without causing interference beyond local limits. As to how long a beginner should stay on these special bands, I would say until he can pass higher speed requirements by actually working with some designated person, perhaps an O.R.S. or S.C.M. who could recommend his promotion. . . .

—W. H. Lord

On the Other Hand

The Glades, Minot, Mass.

Editor, *QST*:

If beginners in amateur radio were segregated in certain portions of the bands, the beneficial influences of communication with seasoned amateurs would be denied them. Through numerous contacts with skilled, courteous operators, the beginner rapidly picks up the operating technique and the "sense of cooperation and amateur ethics" that distinguish his older brother.

Why not start us off on the right foot?

—Clifford Nelson, W1DA

R. F. D. No. 2, Anacortes, Wash.

Editor, *QST*:

Since when have we, as an amateur organization, become so greedy of our hobby that we cannot give the aspiring newcomer a chance? Let him enjoy himself even as we do. Having operated in the U. S. Navy for five years before entering amateur radio, I may not have been exactly inexperienced, but I was far from an old-timer, and even now my ticket is only one year old, but I can understand how I would have felt had I been restricted to one of the lower frequency bands for even a short period of time. Why not give the beginner a chance because who, if not they, will be called the old-timers of to-morrow?

True, other nations limit their beginners to restricted operation, but which nation is foremost in its knowledge and development of amateur radio? We must have knowledge to be proficient, but without experience, how can we hope to obtain this knowledge? Why not think of the present beginner as you would have been thought of when you were struggling with your first blooper, trying to figure out why the darned thing wouldn't perk? Great names and accomplishments are coming from those "lids," whose weak and wobbly signals may blanket our pet DX QSO. But there is DX enough for everyone, so why not try a little patience and understanding?

There is a thrill in DX, even for the old-timer. You had your thrills when you started, so why not give the fellows, who look to you as a model, a chance to enjoy it also? Inconvenient, perhaps, but try a little patience and understanding. It helps you as much as the other fellow.

—Monte L. Porter, W7DZX

U. S. Naval Air Station, Pensacola, Fla.

Editor, *QST*:

. . . Regarding the proposal to put on probation beginners "without previous experience," it would seem that

(Continued on page 86)

You Can't Do Without It . . .

And It's

FREE!

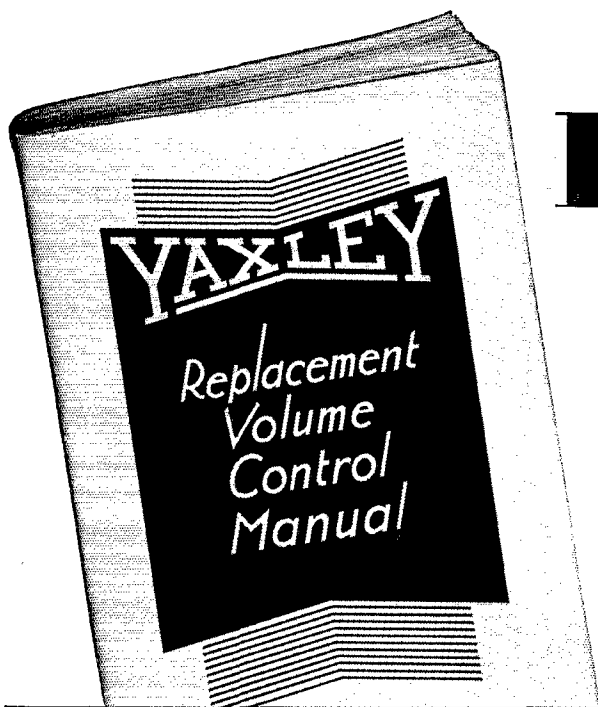

The most complete Manual for Service Men ever published . . . the first that is authoritatively accurate. There's nothing like it. You need it to simplify your work. You need it to make your work more profitable . . . and it's FREE! All you need do is send in this coupon.

The publication of a complete manual of controls has been attempted often but never before accomplished. Now Yaxley meets the need with an illustrated book of more than 100 pages that is both complete and more definitely helpful than any authority. Along with other invaluable information it

lists the 30 new Yaxley Replacement Volume Controls that will service 98% of the 3200 set models now in existence. It shows, for example, how 4 Yaxley controls will cover 1398 models—how a single control will service 618 different models. Mail the coupon now for this indispensable book.

YAXLEY MANUFACTURING CO., Incorporated

Division of P. R. Mallory & Company, Incorporated

INDIANAPOLIS · INDIANA

Cable Address: Pelmallo

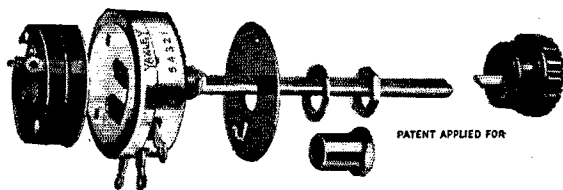

You want to know about this new Yaxley Replacement Volume Control. It's the greatest advance ever made . . . the biggest boon to service men ever developed.

Detailed information is included in the complete Yaxley Replacement Volume Control Manual.

YAXLEY MANUFACTURING CO., INCORPORATED
Division of P. R. Mallory & Co., Incorporated
Indianapolis, Indiana

Gentlemen: Please send me—absolutely free—a copy of the complete Yaxley Volume Control Manual.

Name _____

Address _____

My Jobber's name is _____



NATIONAL RADIO PRODUCTS

are marketed through the following distributors who carry a large and complete stock of all the items listed in our No. 240 catalog, presented herewith.

These concerns extend to the amateur and experimenter

a discount of **40%** from the list prices

By dealing directly with the distributor in your territory you will not only be assured of prompt and dependable service but will also be certain of receiving the latest type products in factory sealed cartons.

Prices quoted in No. 240 Catalog become effective Sept. 15, 1934. Subject to change without notice

CALIFORNIA

Radio Supply Co., 912 S. Broadway, Los Angeles
Pacific Radio Exchange, 729-31 S. Main St.,
Los Angeles
Ports Mfg. Co., Fresno
B. J. DeJarnatt, 2501 Tulare St., Fresno
Electric Supply Co., 12th & Fallon Sts., Oakland
I. S. Cohen's Sons, 1025 Market St., San Francisco
Offenbach Electric Co., 1452 Market St., San
Francisco
Coast Electric Co., 744 "G" St., San Diego
*Radio Television Sup. Co., 1701 S. Grand Ave.,
Los Angeles
(*Does not sell direct to amateur. Sells only
to Movie Studios, Colleges, Schools, etc.)

CANADA

Canadian Marconi Co., 211 St. Sacramento St.,
Montreal and branches. Exclusive Canadian
distributor for Receivers and Power Units.

COLORADO

Inter-State Radio & Supply Co., 1639 Tremont
St., Denver

CONNECTICUT

Hatry & Young, Inc., 203 Ann St., Hartford

DELAWARE

Delaware Radio Sales Co., 405 Delaware St.,
Wilmington

ILLINOIS

Chicago Radio App. Co., 415 S. Dearborn St.,
Chicago
Mid-West Radio Mart, 520 S. State St., Chicago
Allied Radio Corp., 833 West Jackson Blvd.,
Chicago
Klaus Radio Electric Co., 707 Main St., Peoria

IOWA

Iowa Radio Corp., 1212 Grand Ave., Des Moines

MARYLAND

Radio Electric Service Co., 303 W. Baltimore
St., Baltimore

MASSACHUSETTS

H. Jappe Co., 46 Cornhill, Boston
T. F. Cushing, 349 Worthington St., Springfield
Springfield Radio Co., 397-99 Dwight St.,
Springfield

MISSOURI

Walter Ashe Radio Co., 1100 Pine St., St. Louis
Burstein-Applebee Co., 1012 McGee St., Kansas
City
Radio Laboratories, 1515 Grand Ave., Kansas
City

MINNESOTA

The Lew Bonn Co., 2484 University Ave., St. Paul

MICHIGAN

Radio Specialties Co., 171 E. Jefferson Ave.,
Detroit

NEW YORK

Wholesale Radio Service Co., 100 Sixth Ave.,
New York City
Leads Radio Co., 45 Vesey Street, New York City
Sun Radio Co., 227 Fulton St., New York City
Dymac Radio Corp., 359 Capen Blvd., Buffalo
Maurice Schwartz & Son, 710-712 Broadway,
Schenectady
Roy C. Stage, 265 Erie Blvd. West, Syracuse

OHIO

Northern Ohio Laboratories, 2073 West 85th St.,
Cleveland
Burns Radio Co., 140 East Third St., Dayton
Hughes-Peters Electric Co., 178 North Third
St., Columbus

OKLAHOMA

Southern Sales Co., 130 West Third St., Okla-
homa City

OREGON

Wedel Co. Inc., 1207 S. W. Washington St.,
Portland

KENTUCKY

P. I. Burks & Co., 911 W. Broadway, Louisville

PENNSYLVANIA

M & H Sporting Goods Co., 512 Market St.,
Philadelphia
Eugene G. Wile, 10 South 10th St., Philadelphia
Radio Electric Service Co., N. E. Cor. 7th &
Arch Sts., Philadelphia
Radio Electric Service Co., 1024 Hamilton St.,
Allentown
Cameradio Co., 603 Grant St., Pittsburgh

RHODE ISLAND

W. H. Edwards & Co., 32 Broadway, Providence

TEXAS

Straus-Frank Co., Travis at Calhoun, Houston
Straus-Frank Co., 301-307 S. Flores St., San
Antonio
Amateur Supply Co., 1808 St. Louis Ave., Fort
Worth
Western Battery & Magneto Co., 618 Montana
St., El Paso

VIRGINIA

Hudson Radio Supply Co., 27th & Marshall Sts.,
Richmond
Newport Radio Service Co., Newport and 35th,
Norfolk

WASHINGTON

Wedel Co. Inc., 520 Second Ave., Seattle
Spokane Radio Co., 611 First Ave., Spokane

WISCONSIN

Radio Parts Co., 332 W. State St., Milwaukee

DISTRICT OF COLUMBIA

National Electrical Supply Co., 1328 New York
Ave., N. W., Washington

It is obviously impractical to list in a general catalog all of the radio products of our manu-
facture. Should you not find listed such apparatus as will fully meet your particular requirements,
we invite you to write direct to our Engineering Department.



NATIONAL COMPANY, INC. • ENGINEERS AND MANUFACTURERS

61 SHERMAN STREET • MALDEN, MASSACHUSETTS

NATIONAL RADIO PRODUCTS

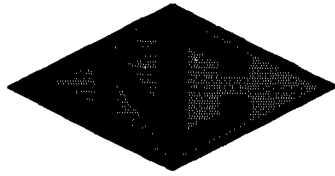

FOLLOWING the precedent established last year, we are again presenting our new catalog in the pages of *QST*. We have found that practically all members of the A.R.R.L. desire copies, and to save inconvenience and delay, we are describing our 1934-1935 products in this direct manner. Additional copies of the catalog may be had for the asking at any time.

JAMES MILLEN



NATIONAL *Ganged* CONDENSER

PRECISION CONDENSER MICROMETER DIAL

The New National Ganged Condenser is designed to overcome the defects which are so evident when ordinary ganged condensers are used in High Frequency Receivers. For such work, extremely low loss electrical design must be obtained, plus a mechanical rigidity and accuracy of control that is not approached in Broadcast Receiver construction.

To meet these requirements, an entirely new design has been evolved. The drive, at the midpoint of the rotor, is of the worm-gear type with a ratio of 20-1. Heavy springs are used to preload the drive and the worm bearings, insuring permanent freedom from backlash. The condenser sections, of unusually rigid construction, are mounted directly on the gear housing and do not touch the receiver chassis at any point. By this means, distortion of the chassis cannot affect the condenser adjustment and calibration.

The rotor shaft of $\frac{3}{8}$ " diameter steel rod, is supported in four bearings. Two bearings are in the center for rigid gear support. Additional bronze bearings at each end provide radial support as well as taking end thrust, and are insulated from the frame to eliminate electrical noise.

The rotor plates are of the 180 Degree straight-frequency-line type, and each rotor section is individually insulated, connection being made through a multi-fingered brush. The stators have four-point support. Insulation is Isolantite.

The Micrometer Dial mounts directly on a support

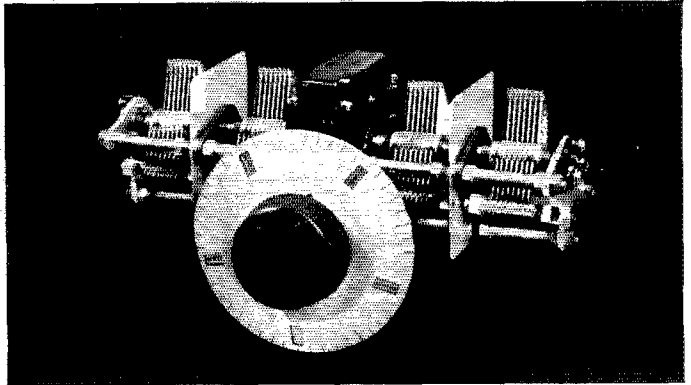

projecting from the gear housing, and does not touch the panel at any point. The condenser is thus protected from misalignment and warping of the panel. The dial has fifty divisions, and makes ten revolutions in covering the tuning range. Consequently the condenser setting may be read directly to one part in 500. The dial is numbered every ten divisions. The numbers rotate with the divisions in the conventional manner, but are automatically changed every revolution by a mechanism within the dial.

The materials and workmanship are first class in every respect. The worm-gears and steel worm are hobbled and accurately fitted. All working parts are accurately machined, and the assembly is carefully aligned. In every detail the unit has been designed with quality, rather than price, as the first consideration.

The type PW Condenser is listed below with either 1, 2, 3 or 4 sections. Though primarily a multi-gang design, the single section unit is offered as being particularly suited to precision frequency-meters and laboratory equipment.

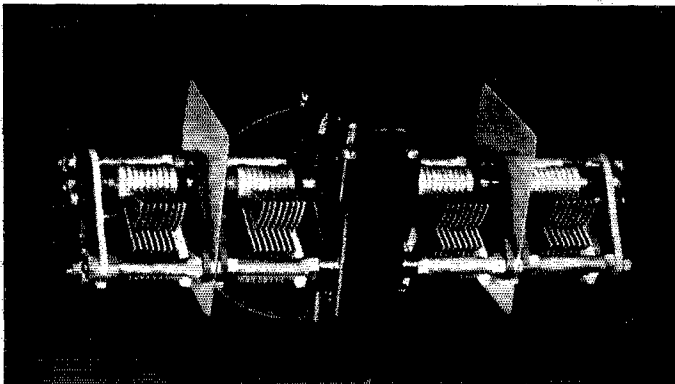

PW-1, Single section—
List price \$13.50

PW-2, Two section—
List price \$17.00

PW-3, Three section—
List price \$20.50

PW-4, Four section—
List price \$24.00

Above prices include dial, which is not sold separately.

NATIONAL COMPANY, INC., MALDEN, MASS.

NATIONAL DIALS

"VK" DIAL

FIG. 1

Full Vision Dial, Type VK, has become well known through its use on SW-58 and FB-7 Receivers. The long seven-inch scale permits accurate logging, and the travelling pointer remains vertical at all times. Ratio is 10 to 1. It is available with either 2, 3 or 4 scale. **List Price, each \$4.50**

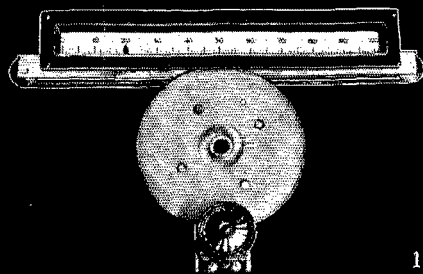

"N" & "NW" DIALS

FIGS. 2 & 3

Precision Dials, Type N, have engine divided scales and verniers of solid German Silver. The Verniers are flush, eliminating errors from parallax.

The four-inch Type N dial (Fig. 3) employs a smooth and powerful planetary mechanism with a 5 to 1 ratio. It is available with either 2, 3, 4 or 5 scale. **List Price, each \$6.75**

The six-inch Type NW dial (Fig. 2) has a variable ratio drive that is unusually powerful at all settings. It is recommended for use on large transmitters and precision instruments. Available with either 2, 3, 4 or 5 scale. **List Price, each \$15.00**

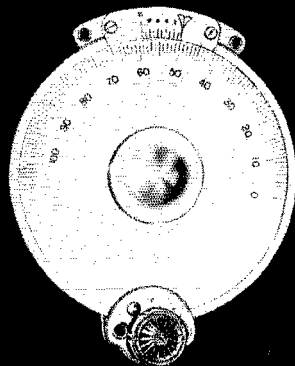

"A" DIAL

FIG. 4

The original "Velvet Vernier" Dial, Type A, is still an unchallenged favorite for general purpose use. It is exceptionally smooth and entirely free from backlash. The mechanism is contained within the bakelite knob and shell. Ratio 5 to 1. Available with either 2, 4 or 5 scale in 4" diameter. Available with 2 scale in 3 3/8" diameter. **List Price, each \$3.00**

"B", "BM", & "BX" DIALS

FIGS. 5, 6, 7

"Velvet Vernier" Dial, Type B (Fig. 7) provides a compact variable-ratio drive that is smooth and trouble free. The mechanism is inclosed in a black bakelite case, the dial being read through a window. Available with 1 or 5 scales. **List Price, each \$2.75**

The Type BX Dial (Fig. 6) is mechanically identical to the Type B Dial, but is equipped with an etched dial scale and vernier reading to 1/10 division. Available with 5 scale only. **List Price, each \$3.50**

The Type BM Dial (Fig. 5) is a smaller version of the Type B Dial for use where space is limited. It is similar to the Type B Dial in appearance and mechanism, but does not have the variable-ratio device. Available with 1 or 5 scales. **List Price, each \$2.50**

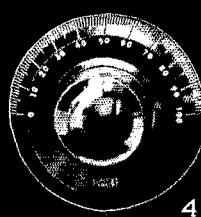
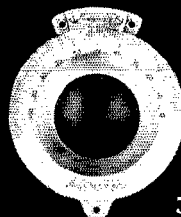

"H" DIAL

FIG. 8

Projection Drum Dial, Type H, employs the proved and popular non-conducting cord drive with spring take-up. The dial scale is optically projected on a ground-glass screen, considerably enlarged. Parallax is entirely absent. Condenser shaft must be parallel to panel. Available with either 2, 3 or 4 scale. **List Price, each \$5.50**

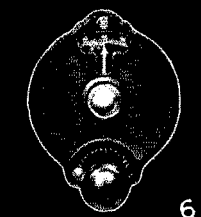
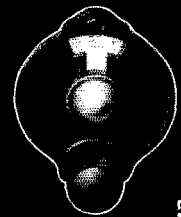

DIAL SCALES

The above dials are available with one or more of the following scales.

Scale Type	Divisions	Degrees Rotation	Direction of condenser rot. for cap. increase
1	0-100-0	180°	Either
2	0-100	180°	Counter Clockwise
3	100-0	180°	Clockwise
4	150-0	270°	Counter Clockwise
5	200-0	360°	Counter Clockwise

National Dials are licensed under Federal Telegraph and RCA patents, and are protected by National Patents.

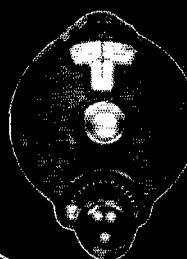

NATIONAL COMPANY, INC.

NATIONAL *Transmitting* CONDENSERS

TMS {*Low Power, Compact, Inexpensive*}

Type TMS is a new condenser designed for transmitter use in low power stages. It is compact, rigid, and dependable. Provision has been made for mounting either on the panel, on the chassis, or on two stand-off insulators.

Front bearing is conical, rear bearing radial with single-ball thrust. Insulation is Steatite-Isolantite. Voltage ratings listed are conservative.

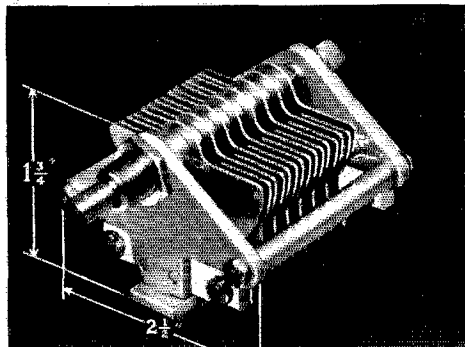

Capacity	Peak V	Length	Plates	Cat. Symbol	List Price
FOR OSCILLATORS, BUFFERS, DOUBLERS, ETC.					
100 Mmf	1000 v	2 3/4"	10	TMS-100	\$2.25
150 Mmf	1000 v	2 3/4"	14	TMS-150	2.50
250 Mmf	1000 v	2 3/4"	23	TMS-250	2.75
50-50	1000 v	2 3/4"	5-5	TMS-50D	3.50
100-100	1000 v	2 3/4"	9-9	TMS-100D	4.25
FOR LOW C, TYPE 210 AMPLIFIERS					
35 Mmf	2000 v	2 3/4"	8	TMSA-35	2.75
50 Mmf	2000 v	2 3/4"	11	TMSA-50	3.00

TMC {*Moderate Power, Compact*}

Also of new design, the TMC is designed for use in the power stages of transmitters, where peak voltages do not exceed 3000. The frame is extremely rigid and arranged for mounting on panel, chassis or stand-off insulators. The plates are aluminum, with buffed edges. The front bearing is conical, rear bearing radial with single-ball thrust. Insulation is Steatite-Isolantite, located outside of the concentrated electrostatic field. The stator in the split stator model is supported at both ends.

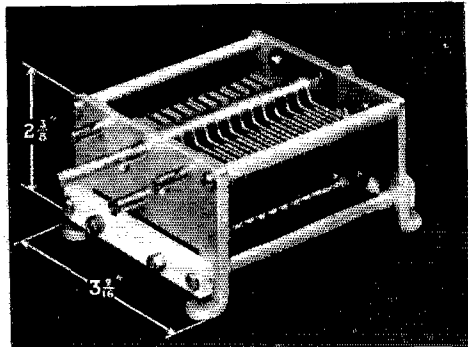

Capacity	Peak V	Length	Plates	Cat. Symbol	List Price
FOR RK-18, RK-20, RCA-800, 830, 203A, 210, ETC.					
50 Mmf	3000 v	3"	7	TMC-50	\$4.00
100 Mmf	3000 v	3 1/2"	13	TMC-100	4.25
150 Mmf	3000 v	4 5/8"	21	TMC-150	4.75
100-100 Mmf	3000 v	6 3/4"	13-13	TMC-100D	7.50
Air Gap = .077"					

NATIONAL COMPANY, INC., MALDEN, MASS.

NATIONAL *Transmitting* CONDENSERS

TM *(Standard, General Purpose)*

Type TM is widely used by leading commercial communication companies and government departments for moderate power transmitters. The rotor and stator plates have rounded edges (milled and polished). Insulation is Isolantite. Front bearing is conical, rear bearing radial with single-ball thrust.

The front plate is drilled and tapped for mounting a standard "A" dial, as illustrated. The dial is not regularly furnished, but will be supplied at an additional List Price of \$3.00.

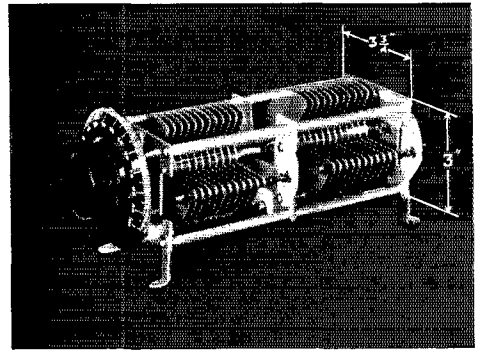

Capacity	Peak V	Length	Plates	Cat. Symbol	List Price
100	3000 v	3 1/4"	11	TM 100	\$4.50
150	3000 v	4 9/16"	17	TM 150	5.00
230	3000 v	4 9/16"	23	TM 230	9.00
50	6000 v	4 9/16"	12	TM 50A	6.00
100	6000 v	6 7/8"	23	TM 100A	10.00
150	6000 v	9 5/16"	35	TM 150A	14.00
100-100	6000 v	12 9/16"	46	TMP 100A	16.00

TMU *(Heavy Duty)*

Type TMU is designed for higher powers than the standard TM Condenser. Rotor and Stator plates are of thick aluminum plate, with milled and polished edges. Insulation is Micalax. The rotor contact is through a heavy laminated brush having a contact area 1/8" x 1/2". The frame is particularly rigid, being composed of sand-cast aluminum end plates and heavy tie-bars.

Front bearing conical, rear bearing radial, with single-ball thrust.

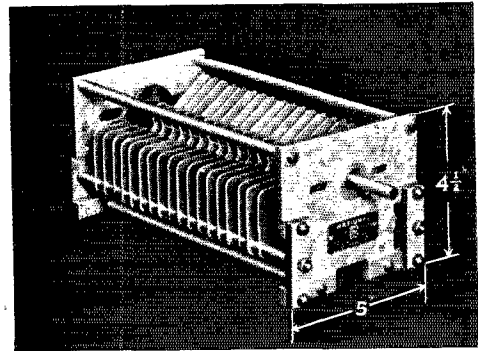

Capacity	Peak V	Length	Plates	Cat. Symbol	List Price
For 849, 860, 852, 861, 204A, etc.					
50	7500 v	6 5/8"	8	TMU 50A	\$29.50
150	7500 v	11"	23	TMU 150A	31.50
250	7500 v	14 7/8"	37	TMU 250A	33.50
Special Sizes, and Higher Voltage Ratings, can be supplied on special order. Correspondence necessary.					

NATIONAL COMPANY, INC., MALDEN, MASS.

NATIONAL *Receiving* CONDENSERS

SE 270° Straight-Line-Frequency

The well known Type SE Midget Condenser has 270° Straight-Line-Frequency Plates. The plates and frame are of aluminum. Insulation is Steatite. The rotor has two bearings in all models, the front bearing being insulated to prevent noise from ground currents in the frame. The rotor contact is through a quiet constant impedance pigtail.

The SEU-15, SEU-20 and SEU-25 condensers have thick plates with rounded and polished edges, and are suitable for high voltages. The SEU-25 is illustrated below. The other SE models do not have polished edges on the plates.

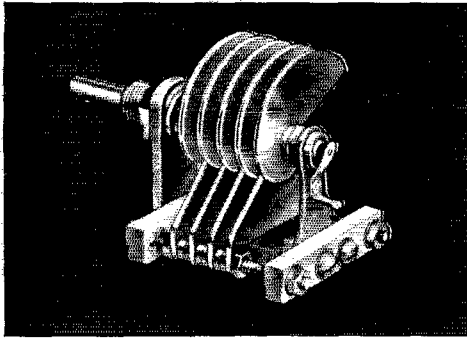

Cap	Air Gap	No. Plates	Length	Cat. No.	List Price
15	.055"	6	2¼"	SEU 15	\$2.50
20	.055"	8	2¼"	SEU 20	2.75
25	.055"	9	2¼"	SEU 25	2.75
50	.026"	11	2¼"	SE 50	3.00
75	.026"	15	2¼"	SE 75	3.25
100	.026"	20	2¼"	SE 100	3.50
150	.026"	29	2¾"	SE 150	3.75
200	.018"	27	2¼"	SEH 200	3.75
250	.018"	32	2¾"	SEH 250	4.00
300	.018"	39	2¾"	SEH 300	4.00
335	.018"	43	2¾"	SEH 335	4.25

ST 180° Straight-Line-Wavelength

The ST Condenser is very similar to the SE Condensers described above, but has 180° Straight-Line-Wavelength plates. Also, the use of 180° plates permits a more compact frame with less overall height. In all other details, the two condensers are identical.

A single bearing model is also available in the smaller sizes, in which overall length is reduced to a minimum. The split-stator model is illustrated; the single stator models have a frame similar to the SE condenser illustrated above.

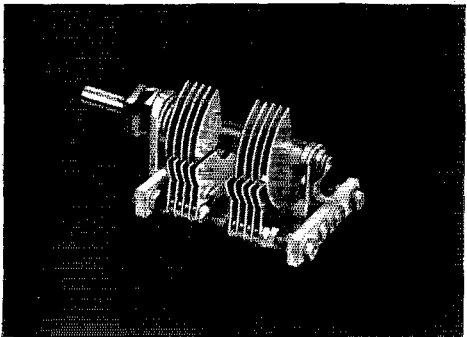

Cap	Air Gap	No. Plates	Length	Cat. No.	List Price
Single Bearing Models					
15	.018"	3	1¾"	STHS 15	\$1.40
25	.018"	4	1¾"	STHS 25	1.50
50	.018"	7	1¾"	STHS 50	1.60
Double Bearing Models					
35	.026"	9	2¼"	ST 35	1.50
50	.026"	11	2¼"	ST 50	1.80
75	.026"	15	2¼"	ST 75	2.00
100	.026"	20	2¼"	ST 100	2.25
140	.026"	28	2¾"	ST 140	2.50
150	.026"	29	2¾"	ST 150	2.50
200	.018"	27	2¼"	STH 200	2.75
250	.018"	32	2¾"	STH 250	3.00
300	.018"	39	2¾"	STH 300	3.25
335	.018"	43	2¾"	STH 335	3.50
Split-Stator Double Bearing Models					
50-50	.026"	11-11	2¾"	STD 50	3.50
100-100	.018"	14-14	2¾"	STHD 100	4.50

NATIONAL COMPANY, INC., MALDEN, MASS.

NATIONAL *Special Purpose* CONDENSERS

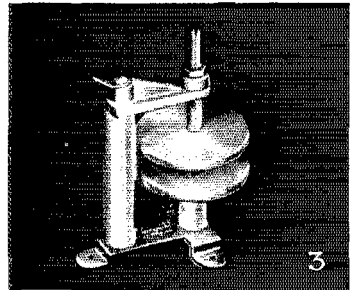
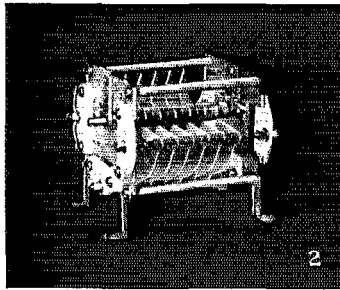
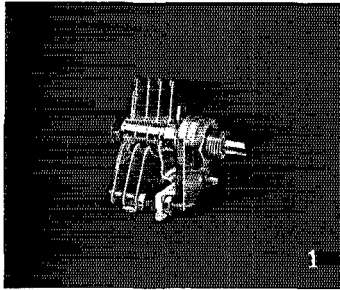

NEUTRALIZING CONDENSERS

STN (Fig. 1) A compact, rigid, and efficient condenser particularly suitable for neutralizing 245, 247, 210 and similar tubes in amplifier, buffer or doubler stages. Very low minimum capacity. Isolantite insulation. Maximum capacity 18 mmf. Peak voltage breakdown — 3000v. **List Price, \$2.00**

TMN (Fig. 2) A heavy duty neutralizing condenser having a peak voltage rating of 6000 volts. Suitable for use with 203A, 852, 204A and similar tubes. Maximum capacity 50 mmf. **List Price, \$6.00**

NC 800 (Fig. 3) A high voltage neutralizing condenser. Particularly suitable for use with the RCA-800. Both plates are insulated from ground on Isolantite pillars. **List Price, \$3.00**

PADDING CONDENSERS

National Air-Dielectric Padding Condensers (Fig. 4) are extremely compact, and have very low temperature coefficient. The aluminum shield is 1/4" dia. by 1/4"-1 1/8" high.

A very small mica Padding Condenser (Fig. 7) is also available, mounted on Steatite and designed to be supported by circuit wiring. Maximum Capacity is 30 mmf., and overall dimensions are 13/16" long x 9/16" wide, x 1/2" high.

W75 (75 Mmf. Air)
W100 (100 Mmf. Air)
M30 (30 Mmf. Mica)

List Price \$2.25
List Price 2.50
List Price .35



GENERAL PURPOSE

EM (Fig. 5.) National EM Condensers have high electrical efficiency, and calibrations may be relied on. Insulation is Isolantite, and Peak Voltage Rating is 1000 volts. Plate Shape is SLW.

Capacity	No. of Plates	Cat. Symbol	List Price
150	9	EM 150	\$3.00
250	14	EM 250	3.50
350	18	EM 350	3.75
500	26	EM 500	4.00
1000	46	EM 1000	5.50

Split-Stator Models

350-350	18-18	EMP-350	5.00
---------	-------	---------	-------------

FREQUENCY METER CONDENSER

A special purpose condenser designed for amateur frequency meters and monitors. On the 80 or 160 meter bands the special rotor provides a spread of 80 divisions (on a 100 division dial). Minimum Capacity is 40 mmf., Maximum 75 mmf. Not illustrated, but same frame as EM.

Type 40-75

List Price \$5.50

I.F. TRANSFORMERS

In the better H.F. Receivers, it has become standard practice to tune I.F. Transformers with air condensers. National units (Fig. 6) employ Steatite Insulation, Aluminum Plates, and Litz-wound Coils. Adjustments are on top of shield, knob tuning on Oscillators. Two models, 450-550 K.C. or 175 K.C.

List Price, Transformers or Oscillators, \$5.00

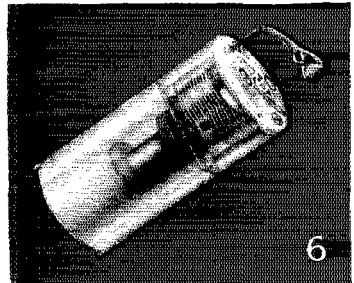
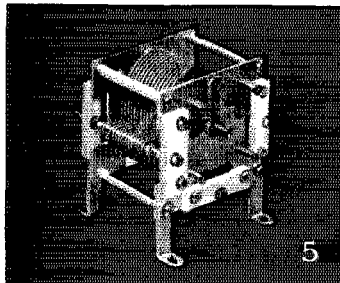
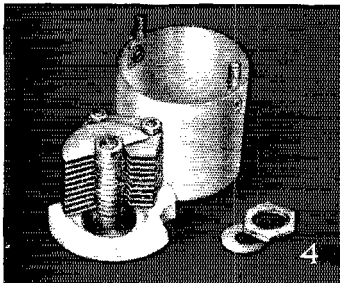

NATIONAL COMPANY, INC., MALDEN, MASS.

NATIONAL *High Frequency* RECEIVERS



TYPE HRO AMATEUR RECEIVER

In designing this new receiver National has attempted to meet every requirement of the most advanced amateur. It embodies every feature which we have found to be desirable in such a receiver.

Its circuit is notable in the use of two preselector stages, giving remarkable image-frequency suppression, and weak signal response. The first R.F. stage has been designed to provide maximum gain to minimize effects of Thermal Agitation, and provide highest Signal-to-Noise Ratio. The two high-gain I.F. stages employ Litz-wound coils and are tuned with air condensers. As would be expected, the usable sensitivity and selectivity are remarkable.

As a further aid when operating under adverse conditions, a Lamb-Single-Signal crystal filter precedes the I.F. amplifier. All controls are brought out to the front panel.

Other circuit details include automatic or manual volume control (with panel switch), and a vacuum tube voltmeter indicating carrier intensities directly in R. Units. A neon lamp is wired across the input circuit, automatically shunting the terminals whenever excessive voltages are picked up by the antenna, such as may occur during transmission, heavy static, etc. In addition to protecting the receiver, this device eliminates blocking and permits quick come-back when operating on the break-in system. A phone jack is, of course, provided on the front panel, as well as a Send-Receive switch for cutting B Voltages during transmission.

Most notable among the mechanical details is the use of a new precision four-gang condenser with worm drive tuning, providing a ratio of 20-1. Due to preloading of the gears, backlash is entirely absent. The micrometer dial has fifty divisions and revolves ten times in covering the tuning range, thus reading direct to 1 part in 500. Quarter divisions may be easily estimated. Every tenth division is numbered, the figures being changed automatically as the dial is rotated. The condenser and dial are described more fully on Page Two of this catalog.

The HRO Receivers employ plug-in coils rather than coil switching. This is because we have found that, other things being equal, much better performance is obtained with plug-in coils. The principal reason for this is the necessity for crowding coils into a small space, without well-proportioned individual shielding, when the switch is

employed. This increases image frequencies and signal-to-noise ratio, and tends to introduce dead spots. These difficulties are not insuperable of course, and we have designed a new coil switch, as well as a new receiver employing it, which we believe represents the highest development in this type of equipment. This receiver though in many other respects similar to the HRO, is not listed in this catalog, as we consider it a Short Wave Broadcast Set, rather than preferred equipment for amateur use. Our choice of plug-in coils for the HRO Amateur Receivers is based on definite engineering experience with both types of receiver, as well as on the expressed preference of a number of amateurs. A description of the ganged plug-in coils used in the HRO will be found on the opposite page.

The HRO has been designed to employ an external power supply, as many amateurs already possess suitable power supplies. However, an HRO Receiver with built-in power supply is also available and listed below, for those who prefer to sacrifice performance to convenience.

Tubes required for 2 volt HRO: Four 58, Three 57, One 2B7, One 2A5. Power Supply requires 1 Type 280.

Tubes required for 6 volt HRO: Four 6D6, Three 6C6, One 6B7, One 42. Power Supply (for AC operation) requires 1 Type 280.

HRO Receiver, 2 volt or 6 volt A.C. model, complete with coils, as described above, but without tubes, speaker or power supply.

List Price, \$233.00

HRO-S Receiver (2 volt), with built-in power supply, 115v. 60 cycle, complete with coils, as described above, but without tubes, or speaker.

List Price, \$257.50

HRO-P Panel for Relay Rack Mounting, leatherette finish, engraved and machined to fit over the regular front panel of the HRO.

List Price, \$20.00

NATIONAL COMPANY, INC., MALDEN, MASS.

NATIONAL *High Frequency* RECEIVERS

OUTSTANDING FEATURES:

- Nine Tubes, not including rectifier.
- Two Preselector Stages.
- Single Signal (Crystal Filter) standard equipment.
- Ganged Plug-in Coils, with each coil individually shielded.
- Strictly single-control Tuning.
- Calibration for each range mounted on coil.
- Four gang Precision Condenser, with preloaded worm-drive tuning, 20-1 ratio.
- Micrometer Dial, spreading tuning over 500 divisions, numbered every 10 divisions, direct reading.
- Automatic or Manual Volume Control.
- Vacuum Tube Voltmeter with Instrument calibrated in R scale of carrier intensity.
- Electron Coupled, air padded oscillators.
- Two I.F. stages with Litz-wound coils, air condenser tuned.
- Beat Frequency Oscillator for "Offset" C.W. Tuning.
- Phone Jack on Panel.
- 2½ Volt AC and 6 Volt AC or Battery models.
- Relay Rack Mounting available.
- Built-in Power Supply available.

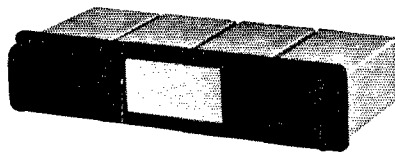

GANGED PLUG-IN COILS

Each of four coil units in the HRO ganged plug-in assembly has an individual aluminum shield, and is mounted on an aluminum panel, on which is framed the calibration curve for the range covered. The assembly is illustrated above.

Due to special features in the design of both the tuning condenser and the coils, it has been found possible to combine Calibrated full band-spreading on the 20, 40, 80 and 160 meter amateur bands with continuous coverage of all frequencies from 1.7 M.C. to 30 M.C. Special band-spread coils are not required.

A complete set of coils for the range from 1.7 M.C. to 30 M.C. is supplied as standard equipment with each receiver.

Two additional sets of coils covering the broadcast band (550-900 K.C. and 900-1700 K.C., respectively) are available at extra cost. **List Price, each \$20.00**

POWER SUPPLY

The 2 volt HRO Receiver is designed to operate from the FB-7 power supply, Type 5897. Similarly, the 6 volt HRO operates from the AGS Power Supply, or from the Type 5886 (SRR Power unit). Amateurs already owning any of these power supplies may employ them without alteration. Types 5887 and 5880 may also be used if available, but are not recommended. For general description of National Power supplies, see Page 14.

Power Supply Unit, Type 5897, for 2½ Volt HRO Receiver, 115v, 60 cycle, less tubes, **List price, \$26.50**

Power Supply Unit, Type 5886, for 6 Volt HRO Receiver, 115v, 60 cycle, less tubes, **List price, \$34.50**

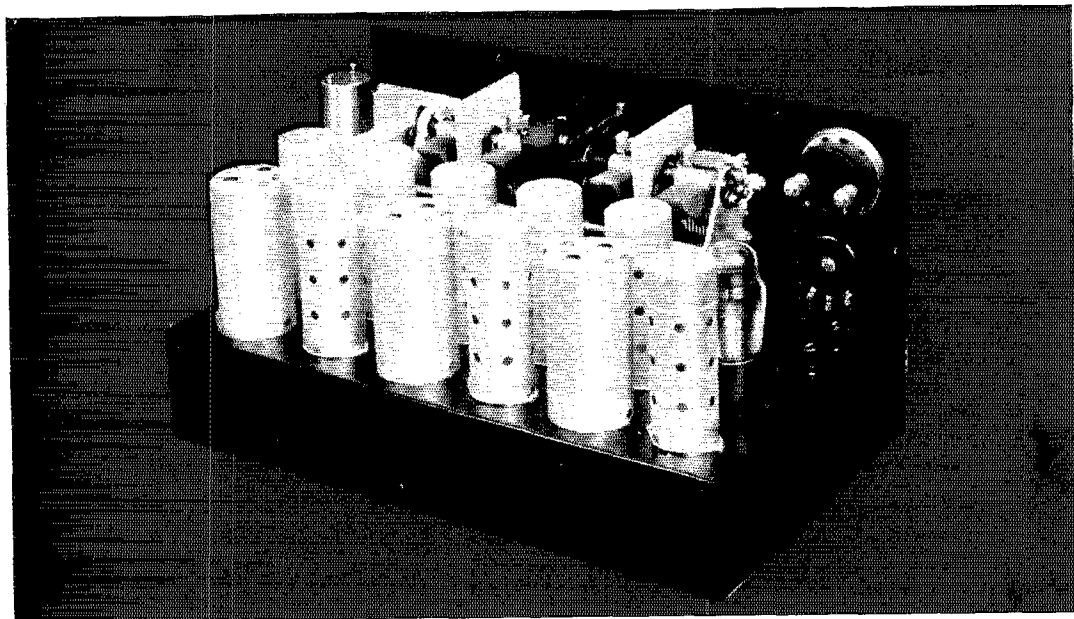

NATIONAL COMPANY, INC., MALDEN, MASS.

NATIONAL *High Frequency* RECEIVERS

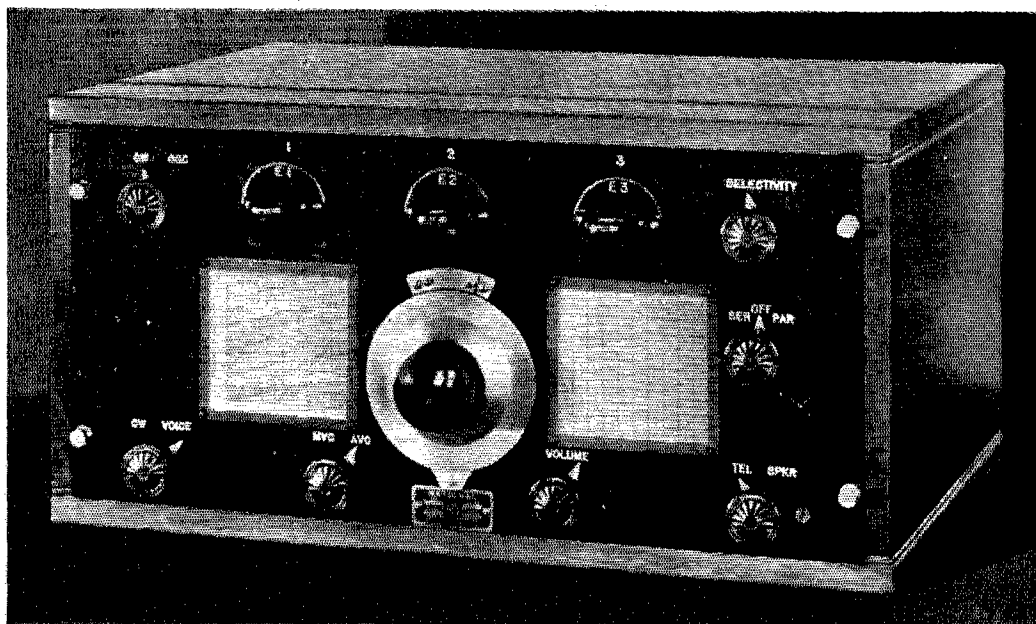

"AGS" and "AGSX" Communication Type RECEIVERS

A professional receiver in which considerations of price are entirely subordinate to those of performance and reliability, the AGS has been designed in cooperation with the Airways Division of the U. S. Department of Commerce, to provide high usable sensitivity and selectivity, easy operation, and permanent frequency calibration.

Particularly important is its unusual preselector circuit, which is largely responsible for its exceptionally high signal-to-noise ratio and almost complete image suppression.

Both AGS and AGSX employ nine tubes in a superheterodyne circuit, comprising a preselector stage of tuned R.F. amplification; a first detector; a high frequency oscillator; two stages of high-gain I.F. amplification; I.F. power detector; and Pentode output with provision for either phones or loudspeaker. Details typical of its electrical refinements are the use of electron-coupled air-padded oscillators, air-dielectric tuning condensers in I.F. amplifier, single dial tuning, automatic or manual volume control,

C.W. beat-frequency oscillator and calibrated band-spreading.

The AGSX illustrated above offers a still further refinement in the use of a Single Signal Crystal Filter circuit with front-of-panel controls. With this device, selectivity is measured in cycles rather than kilocycles, almost completely eliminating interference from unwanted signals, and greatly reducing static.

The mechanical construction of the AGS receivers is particularly rugged, heavy aluminum plate being used throughout. All parts are designed for continuous duty under commercial operating conditions, and are easily accessible for inspection. The standard models are designed for Relay Rack mounting and have a heavy aluminum dust cover and shield. (Not illustrated). A shielded walnut cabinet for table use will be supplied on special order at a slightly higher price.

A booklet describing this receiver in detail will be mailed on request.

Tubes required: Three 236, One 237, One 89, One 77, Three 78. Power Supply requires One 280.

AGS Receiver for relay rack mounting, complete with coils (1500-20,000 k.c.), but without tubes, speaker, or power supply. **List Price, \$265.00**

AGSX Receiver, as above, but with Single Signal Filter built in. **List Price, \$295.00**

GRSPU-6 Power Supply, relay rack mounting, for one AGS or AGSX receiver. **List Price, \$49.50**

GRDPU-6 Power Supply, relay rack mounting, for two AGS or AGSX receivers. **List Price, \$79.50**

Speakers, Relay Racks, Power Supplies, etc., are described on Page 14, in detail.

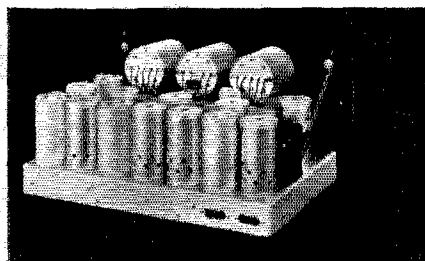

NATIONAL COMPANY, INC., MALDEN, MASS.

NATIONAL *High Frequency* RECEIVERS



FB-7 AMATEUR RECEIVER

The FB-7, designed primarily for the experienced amateur operator, is a seven tube receiver having exceptional sensitivity, selectivity, stability and other characteristics essential in order to contend with the crowded conditions of the amateur C.W. and phone bands. Ample sensitivity and selectivity are assured through the use of a circuit employing two stages of high-gain air-tuned I.F. amplification (six tuned circuits). Individual filtering of all circuits, including the electron-coupled oscillators, together with thorough shielding, results in unusual stability. There is no pulling-in or blocking by strong local signals, and frequency drift in both high frequency and beat oscillators has been eliminated. Variation of the volume control has no appreciable effect on the pitch of C.W. signals, even at 14 mc.

A Single-Signal (crystal filter) unit is available, and may be added to the receiver at any time. With this device, selectivity is measured in cycles rather than kilocycles, almost completely eliminating interference from unwanted signals and greatly reducing static.

Every effort has been made to promote ease of operation. Tuning is strictly single-control, and calibration is permanent. The coils plug-in from the front of the panel without disturbing shielding. Tuning curves are mounted on the front panel. Switches for the C.W. oscillator, and for cutting B voltages during transmission are conveniently located. A phone jack is located in the second detector output circuit.

PLUG-IN COILS

The coils employed in the FB-7 receiver plug in through the front panel. The windings are on accurately threaded R-39 forms, and are protected from damage by an outside sleeve of special bakelite. The grounded metal handle is designed to complete the shielding when the coil is plugged in.

Coils are available in the ranges listed below at a list price of \$10.00 per pair. Unwound coil forms (Symbol XR-39) are listed on page 16.

Catalog No.	Range
AB-20.....(air padded osc.)	20 meter band spread
AB-40.....(air padded osc.)	40 meter band spread
AB-80.....(air padded osc.)	80 meter band spread
AB-160.....(air padded osc.)	160 meter band spread
FB A.....	34000 to 18000 KC
FB A.....(air padded osc.)	19500 to 11400 KC
FB B.....(air padded osc.)	11700 to 7000 KC
FB C.....(air padded osc.)	7300 to 4000 KC
FB D.....(air padded osc.)	4900 to 2400 KC
FB E.....(air padded osc.)	2500 to 1500 KC
FB F.....(air padded osc.)	1500 to 900 KC

Tubes required. 2-volt type: one 56, one 57, two 58's, one 59, two 24's. 6-volt type: one 37, one 77, two 78's, one 89, two 36's. Power supply requires one type 80 rectifier.

FB7-A, with air tuned I.F. transformers, without coils, speaker or power supply. **List Price, \$62.50**

FBX-A, as above, but with single-signal (crystal filter) unit, without coils, speaker or power supply. **List Price, \$86.50**

5887 AB Power Supply for 2-volt FB receivers, 115-volt 60 cycles, less tube. **List Price, \$24.50**

5897 AB Power Supply for 2-volt FB receivers, high voltage for maximum audio power, 115-volt, 60 cycles, less tube. **List Price, \$26.50**

TYPE 5880 Power Supply may also be used if available.

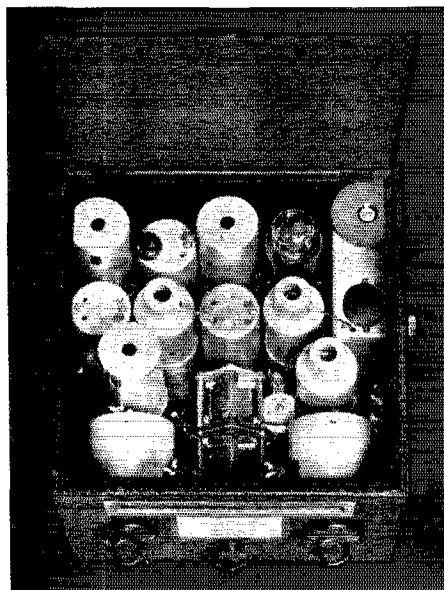

NATIONAL COMPANY, INC., MALDEN, MASS.

NATIONAL *Five Meter* RECEIVERS

SRR 56 MC Super-Regenerator RECEIVER

Type SRR is a compact and efficient three-tube receiver designed primarily for use on 56 MC, though the use of plug-in coils enables it to be used on the 10, 20, 40, 80, and 160 meter bands as a conventional "detector and one stage."

Exceptionally high sensitivity is obtained through the use of a special electron-coupled detector. The 56 MC band is spread over 50 dial divisions, and regeneration is constant over the entire scale. The interruption frequency oscillator is coupled to the screen grid of the detector, effectively isolating it from the audio circuits, and giving the optimum super-regenerative action. A phone jack is connected to the detector output by means of an impedance matching transformer. The 89 pentode provides ample power for loud-speaker operation.

The receiver requires a 6-volt (D.C. or A.C.) filament supply, and a 135 volt B supply, which may be obtained from B batteries or from the power supply listed below. Tubes required: one 36, one 37, and one 89.

Type SRR receiver, with 56-60 M.C. coil, but without tubes, speaker, or power supply. **List Price, \$32.50**

Type 5886 Power Supply, 115 volt, 60 cycle, for operating SRR receiver, less tube. 10, 20 or 40 meter coils. **List Price, each \$1.25**

80 or 160 meter coils. **List Price, each \$1.75**

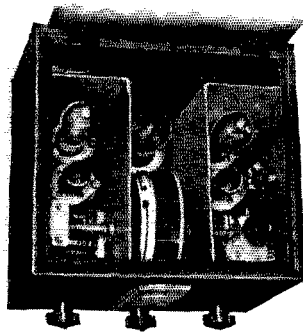
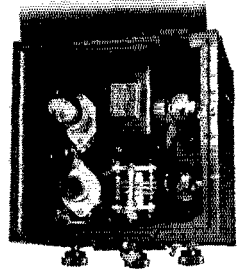

HFC 56 MC CONVERTER

Type HFC Converter is designed for use on the 28 and 56 MC bands, which are spread over 90 dial divisions. A regenerative detector results in high gain and high conversion efficiency. This, and other features, result in exceptional weak signal response, greatly improve signal-to-noise ratio, and definitely eliminate image frequencies. Isolantite insulation is used throughout the HF circuits except the coil forms, which are moulded R-39.

The output of the first detector is coupled through a high gain I.F. Transformer to a low impedance output coupling tube which insures efficient signal transfer to the antenna circuit of the B.C. Receiver, which should be of the TRF Type. Tubes required: two 24's, one 27 or two 36, one 37.

135 Volts B supply is required, which may be obtained from B batteries or from any of the National Power Units. A filament supply of either 2 1/2 Volts (AC) or 6 Volts (AC or DC) depending on tubes used, is also required. Type HFC Converter, with both 28 and 56 MC Coils, but without tubes or power supply. **List Price, \$39.50**

TR 56 MC TRANSCEIVER

The National Transceiver, as the name implies, is a combination receiver and transmitter designed primarily for portable use on the 56 mc. band. Two tubes are employed, a Type 30 and a Type 33. When used as a receiver, the Type 30 functions as a self-blocking superregenerative detector, transformer coupled to the 33 used as an audio amplifier. When used as a transmitter, the Type 30 tube functions as an oscillator and the Type 33 as a modulator.

The Transceiver is made in two models, the Type TRW, illustrated, self-contained in a wooden carrying case with compartments for the various batteries, hand-set, etc., and a compact model, Type TRM consisting of the Transceiver unit proper mounted in a metal case with a three foot cable for connection to external batteries.

Provision is made for using either a single wire antenna, or any of the various doublet or Zepp types. The recommended system is the Pickard Antenna, which however requires a coupling transformer between feeders and antenna, such as the TRP listed below.

A booklet describing the Transceiver will be sent upon request.

Type TRW, in quartered oak case, as illustrated, but without tubes, batteries or hand-set. **List Price, \$67.50**

Type TRM Transceiver in compact metal box without tubes, batteries or hand-set. **List Price, \$45.00**

Type TRP Coupling Unit for Pickard Antenna. **List Price, \$ 3.75**

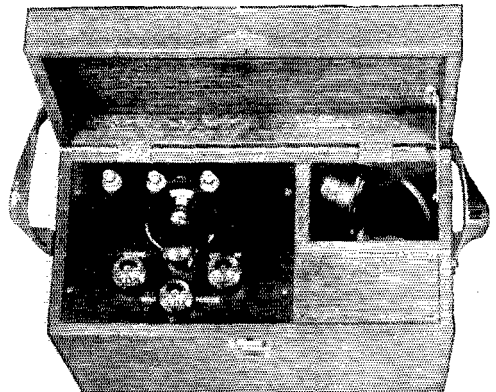

NATIONAL COMPANY, INC., MALDEN, MASS.

NATIONAL High Frequency RECEIVERS

SW-3 High Frequency RECEIVER

The SW-3 Receivers employ a circuit consisting of one R.F. stage transformer coupled to a regenerative detector and one stage of impedance coupled audio. This circuit, as incorporated in the SW-3, with thorough shielding, grooved R-39 coil forms, Isolantite insulated condensers and tube sockets, etc., provides maximum sensitivity and flexibility with the smallest number of tubes and the least auxiliary equipment. The single tuning dial operates a precisely adjusted two gang condenser; the regeneration control is smooth and noiseless, with no backlash or fringe howl; the volume control is calibrated from one to nine in steps corresponding to the R scale, and is connected in the antenna input circuit; — the features all contribute to the efficiency and ease of operation so essential to equipment of this type.

The receiver especially suitable for installations where space is limited as in semi-portable or mobile stations, on yachts, etc.

Tubes required — 2 Volt AC Model, two 58, one 27 — 6 Volt DC Model, two 36, one 37 — 2 Volt DC; two 32, one 30.

Available in three models — ACSW-3 for AC operation — 6DCSW3 for 6 volt DC operation — 2DCSW2 for 2 volt DC operation. AC Models use "60" Series Coils. DC Models use "10" Series Coils.

SW-3, any model, without coils, speaker or power supply.

List Price, \$32.50

5880-AB Power Supply, 115 V, 60 cycle, without 80 Rectifier.

List Price, \$26.50

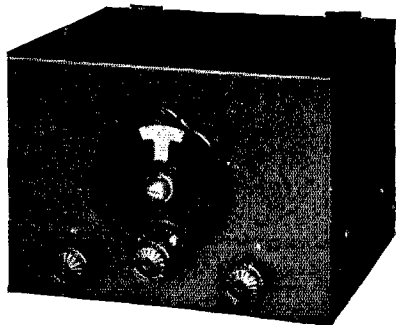

General Coverage Coils

Catalog Number	Range	List Price Per Pair
10 or 60	9 to 15 meters	5.00
11 or 61	13.5 to 25 meters	5.00
12 or 62	23 to 41 meters	5.00
13 or 63	40 to 70 meters	5.00
14 or 64	65 to 115 meters	5.00
15 or 65	115 to 200 meters	5.00
16 or 66	200 to 360 meters	5.50
17 or 67	350 to 550 meters	5.50

Five additional sets of coils are available to cover up to 3000 meters

Band Spread Coils

10A or 60A	— 10 meter band	5.00
11A or 61A	— 20 meter band	5.00
13A or 63A	— 40 meter band	5.00
14A or 64A	— 80 meter band	5.00
15A or 65A	— 160 meter band	5.00

PRESELECTOR

The National Preselector has thoroughly demonstrated its utility for use with either superheterodyne or TRF Receivers. Although originally designed for use with the FB-7, it is equally effective with the SW-3 or receivers of other makes. It is not recommended for use with the AGS or HRO, as these receivers have very efficient preselectors built in.

The use of the preselector provides additional selectivity as well as additional gain and weak signal response. In Superheterodynes, there is a corresponding reduction in image-frequencies.

The power supply requirements are not particularly critical and may be in general obtained from the receiver with which the preselector is used. The tube may be either a 58 or 78 depending on whether a 2½ or 6 Volt filament is more convenient. Plug-in coils are available in the same ranges as listed for the FB-7.

Type PSK Preselector, without coils or tube,

List Price, \$19.00

Coils for preselector, same ranges as FB-7 coils,

List Price, each \$6.00

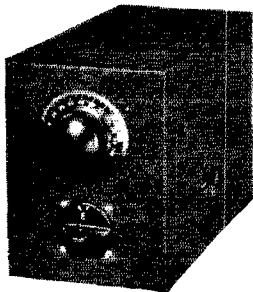

CATHODE RAY OSCILLOSCOPE

Providing an instantaneous graphic picture of the actual operating conditions in transmitter circuits, the Cathode Ray Oscilloscope gives important information not readily obtainable by other means. Percentage Modulation, Signal Distortion and Peak Voltages, for instance, are indicated directly, and results are easily interpreted.

The Cathode Ray Tube is the 3-inch diameter RCA-906. No linear sweep device is provided, as it has been found more desirable to use an audio signal from the transmitter for this purpose. The resulting "trapezoid pattern" may be interpreted more readily, and percentage modulation more easily circulated, than with a linear sweep. However, the linear sweep may be added at any time if it is found necessary for special work.

The unit is entirely self-contained, the power supply and control devices being built-in.

Tubes required: One RCA-906 and one 80.

A booklet describing the Cathode Ray Oscilloscope will be mailed on request.

Type CRO Cathode Ray Oscilloscope, without tubes, **List Price, \$29.50**

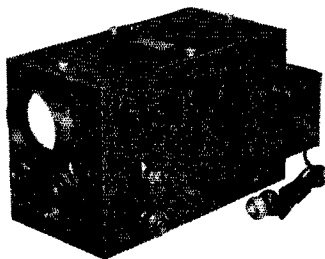

NATIONAL COMPANY, INC., MALDEN, MASS.

NATIONAL RELAY RACK & POWER UNITS

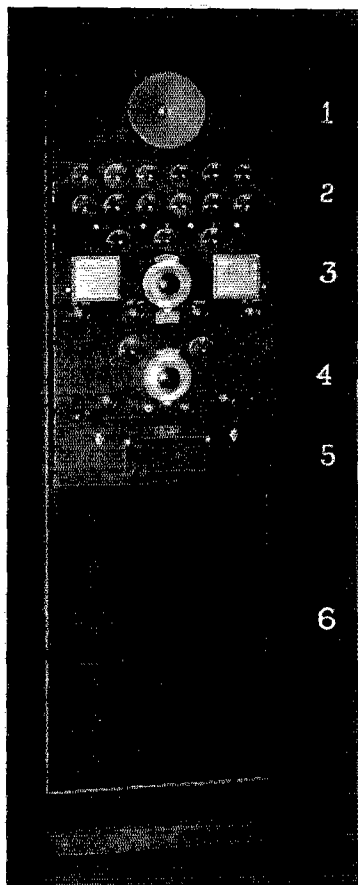

RELAY RACK UNITS

Rack-Panel Units permit the assembly of complete equipment to suit individual requirements. In the illustration at the left, a set-up is shown which is frequently used in Airport Installations. Unit 3 is the Type AGS Receiver described on page 10. A brief description of the other units follows.

1. This Monitor Speaker Panel employs a dynamic speaker of the permanent magnet type, requiring no power supply. The speaker is mounted on a standard panel (8 $\frac{3}{4}$ " x 19") and is provided with an impedance matching transformer and connecting cord.
Monitor Speaker Panel, Type RFS.

List Price, \$30.00

2. This small panel (5 $\frac{1}{4}$ " x 19") carries receptacles for the twelve idle coils of the set of fifteen required for the National AGS Receiver.
Coil Rack, Type CRP.

List Price, \$15.00

4. This Type 58C Receiver is the well-known National SW58 arranged for rack-panel mounting, with front of panel coil changing. Circuit details are essentially the same as for the Standard SW58, described in special catalog. Briefly, the receiver has two tuned circuits, using type 58 tubes as R.F. and Detector, a 227 as first audio, and a pair of 245's as final audio stage. Because of the definitely superior signal-to-noise ratio, many hundred receivers of this type are in use by the principal American Continent Air Lines.

Type 58C Receiver, with four sets of coils (13 $\frac{1}{2}$ to 115 Meters).

List Price, \$120.00

Additional coils available to 2000 Meters

5. Rack mounted packs either single or double and for either 2 $\frac{1}{2}$ volt or 6 volt tubes.

Type GRSPL. Single.

List Price, \$49.50

Type GRDPL. Double.

List Price, \$79.50

6. This rack, built to Government Specifications and drilled and tapped to receive standard panels of all sizes, is of steel, finished in black gloss Duco.

Relay Rack, Type RR.

List Price, \$65.00

LIGHT WEIGHT RACK

A knockdown, lightweight rack, designed especially for amateur station use is now available. This rack can be "cut down" for bench mounting if desired. Not illustrated.

Type LRR.

List Price, \$22.50

POWER UNITS

National Power Units have exceedingly low inherent hum, employing a double section filter using good quality chokes and ample condenser capacity. The power transformer has an electrostatic shield between the primary and other windings in order to isolate line disturbances. A special R.F. filter is a feature of all National Power Packs designed for short wave use, and is one of several factors contributing to the complete elimination of so-called "tunable hums" frequently encountered in short wave reception.

Power units for National Receivers are equipped with a receptacle for plugging in the power cable from the set (Fig. 5 and Fig. 8) and have filament windings specially wound to compensate for voltage drop in the power cable. Proper filament voltage is extremely important, and unless the above power supplies are used, filament voltage should be carefully checked at the socket terminals. For convenience these power supplies are listed with the receivers they are designed for. National also supplies a general purpose power unit (Fig. 7). This unit provides four B voltages, the three intermediate taps being adjustable. Voltages are as follows: 22-45V for detector, 45-90V for R.F., 90-135V for A.F., and 180 Volts (35 M.A.) for power tube.
Type 3580, without 80 rectifier tube.

List Price, \$16.50

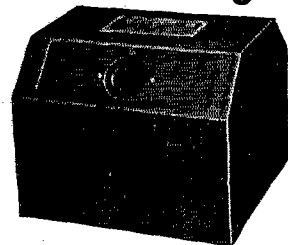
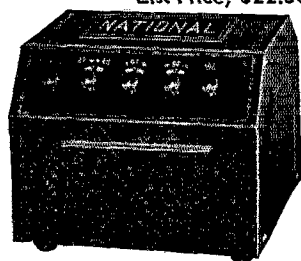

NATIONAL COMPANY, INC., MALDEN, MASS.

TRANSFORMERS & R. F. CHOKES

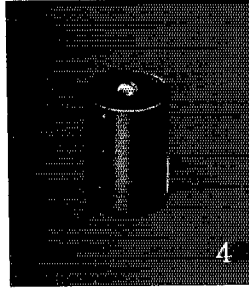
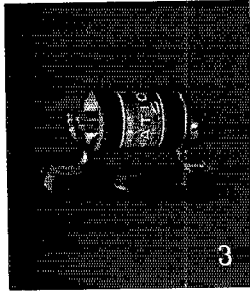
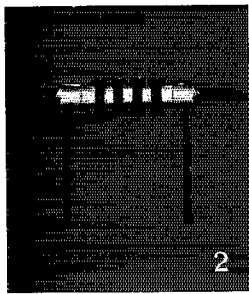
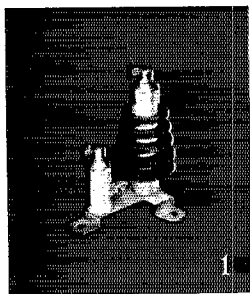

R. F. CHOKES

R-152 and R-154 (Fig. 1). These two universal transmitter chokes have windings of the honeycomb type, divided in five sections, and are rated to carry 0.6 amperes continuously. Inductance 4 m.h., D.C. resistance 10 ohms. The R-152 is designed to give maximum impedance in the 160 meter band, and the R-154 in the 40 meter band. R-152 or R-154, **List Price, \$2.25**

R-100 (Fig. 2). Isolantite mounting, continuous universal winding in four sections. For pigtail connections or standard resistor mountings. Inductance $2\frac{1}{2}$ m.h.; distributed capacity, 1 mmf.; D.C. resistance 50 ohms; Current rating, 125 M.A. For low powered transmitters and high frequency receivers. **List Price, \$.75**

R-90 (Fig. 3). Has proper value for all by-passing work on screen-grid or plate circuits of screen-grid tubes and between detector and first audio, in accordance with best practice. Multisection winding adapts this choke for short-wave as well as broadcast work. D.C. resistance, 350 ohms. Inductance, 90 millihenries. Fits standard grid-leak mount. **List price, without mounting, \$1.25**

R-201 (Fig. 4). A two-section honeycomb-wound choke in R-39 case, suitable for output circuit of second detector in H.F. receivers (475 KC Intermediate Frequency). Inductance, approximately 12 m.h., D.C. resistance approximately 120 ohms. **List Price, \$1.25**

TRANSFORMERS

CLASS B INPUT TRANSFORMER (Fig. 5). Designed for coupling two 45's in push-pull to a pair of 210's or 46's working Class B. The transformer has excellent frequency characteristics. Primary Inductance, 20 henries. Primary Resistance (total), 150 ohms. Secondary Resistance (total), 200 ohms. Type Bl. **List Price, \$6.50**

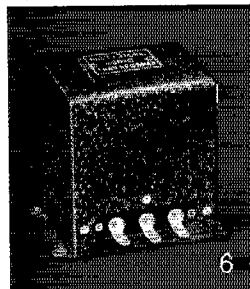
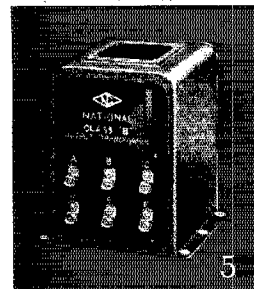

CLASS B OUTPUT TRANSFORMER (Fig. 5). Designed for coupling a Class B amplifier employing 210's or 46's to various load impedances. The secondary is not designed to carry R.F. amplifier plate current. Insulated for 5000 volts. Primary Inductance, 20 henries. Primary Resistance (total), 115 ohms. Type BO. **List Price, \$8.50**

AUDIO TRANSFORMERS (Fig. 6). Type P-50 is a high quality input or interstage audio transformer. It employs a nickel-steel alloy core and special windings, giving unusually fine frequency characteristics. The secondary is center-tapped. Turns ratio is 4 to 1. Type P-50. **List Price, \$9.50**

Output Transformer, Type P-10, is for coupling push-pull output tubes to speaker. Turns ratio is 5 to 3. Type P-10. **List Price, \$5.50**

SCREEN GRID DETECTOR COUPLING UNIT (Fig. 6). This impedance coupling unit, when employed to couple the output of a screen grid detector to an audio amplifier tube, will give from two to three times as much amplification as resistance coupling. Plate choke, 700 henries. Coupling condenser, .01 mfd. Grid leak, 250,000 ohms. Type S-101. **List Price, \$5.50**

FILAMENT TRANSFORMER (Fig. 7). A compact filament transformer having excellent regulation with a single secondary winding, $2\frac{1}{2}$ volts at 10 amperes. Type CFL. **List Price, \$3.00**

POWER TRANSFORMER (Fig. 8). A general purpose transformer conservatively rated at 100 watts. Center-tapped High Voltage Secondary, 400 volts per side, 125 M.A. Center-tapped Heater Voltage Secondary, $2\frac{1}{2}$ volts at 10 amps. Center-tapped 245 or 247 Secondary, $2\frac{1}{2}$ volts at 3 amps. Rectifier Filament Secondary, 5 volts at 2 amps. Type VSA. **List Price, \$10.00**

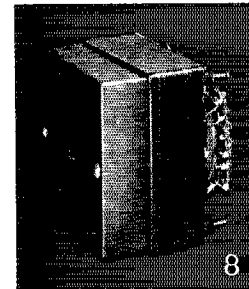
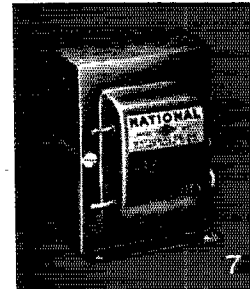

NATIONAL COMPANY, INC., MALDEN, MASS.

PARTS

LOW-LOSS SOCKETS

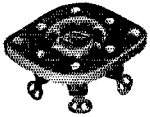

RECEIVING SOCKETS. National Receiving Sockets are available in either Isolantite or Steatite, to fit all standard receiving tubes. The special coil sockets for National 6-pin coils are square with four mounting holes. Tube sockets are as illustrated.

Tube Sockets, all models.
Square Coil Sockets.

List Price, \$.60
List Price, \$.75



50 WATT SOCKET. An unusual socket — it cannot break down by arcing from contacts to metal shell, for there is no shell, nor will it arc downward from tube prongs to chassis, for the socket has a solid base. One piece,

all Steatite, with positive electrical contacts.

Type XC-50.

List Price, \$3.50

GRID GRIPS. This convenient little Grid-Grip is the most simple method of attaching a wire to the metal top-cap terminal of multi-element tubes. Easy to operate, never works loose, makes continuous electrical contact. Eliminates possibility of loosening cap on tube when removing lead. Made in two sizes.



Type 24 — to fit broadcast set tubes. **List Price, \$.05**
Type 12 — to fit large type tubes, such as 872.

List Price, \$.10

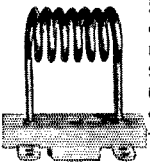

5 METER COIL. Consisting of a heavy copper air-spaced winding and mounted on a Steatite base, this coil is specifically designed for 5-meter transmitters, receivers or transceivers. They are usually used in pairs.

Type XR-9, complete, per coil.

List Price, \$.45

LOW FREQUENCY OSCILLATOR COIL. Two separate inductances, closely coupled, in an aluminum shield. It is used in the SRP and other super-regenerative receivers for the interruption-frequency oscillator.

Type OSR.

List Price, \$1.50



MIDGET COIL FORM. Made of low-loss R-39, these small coil forms are designed with excellent form factor, contributing to high efficiency in H. F. circuits. Diameter, 1"; Length, 1 1/2"; Wall thickness, 1/16". They are available with 4 prongs, or plain.

Type XR-1, four prongs.

Type XR-2, without prongs.

List Price, \$.50

List Price, \$.35



LOW-LOSS COIL FORMS



TRANSMITTER COIL FORMS.

In addition to the three low-loss Steatite coil forms listed below, National offers two low-price forms for use where high efficiency is not essential. Though not comparable to Steatite, these less

expensive forms are not to be confused with ordinary porcelain forms.

XR-10, Steatite, 20 or 40 meter. **List Price, \$3.75**

XR-11, Steatite, 80 meter. **List Price, \$6.50**

XR-12, Steatite, 160 meter. **List Price, \$8.00**

XR-11A, Low-Loss Ceramic, same dimensions as XR-11. **List Price, \$1.50**

XR-12A, Low-Loss Ceramic, same dimensions as XR-12. **List Price, \$2.25**

RECEIVER COIL FORM. These well-known R-39 forms are machinable, permitting the experimenter to groove and drill them to suit individual requirements. They are available in 4-, 5- and 6-prong types, and plug into the sockets shown on this page. Length, 2 1/4". Dia. 1 1/2".

XR-4, XR-5, or XR-6.

List Price, \$.75

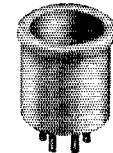
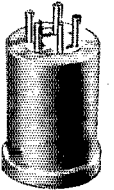

RECEIVER COIL FORM. Smaller in size than the R-39 forms listed above and made of Steatite, these forms are drilled for leads and left unglazed to provide a tooth for coil dope. They have 4, 5 or 6 prongs.

Type XR-20.

List Price, \$.35

PLUG-IN COIL FORMS. These R-39 coil forms, originally used in the FB-7, are designed for plugging-in through the front panel of a receiver, monitor, etc. A padding condenser mounts inside the coil, and a special bakelite sleeve protects the

winding. The coil shield listed is bolted to the back of the panel, and supports the Isolantite socket.

XR-39A Coil Form, Air Tuned.

List Price, \$4.75

XR-39M Coil Form, Mica Tuned.

List Price, \$3.65

XCS Coil Shield and Socket.

List Price, \$1.75

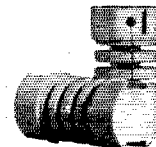

COIL FORM. This Steatite Choke Coil Form is ideally suited for small choke coils and precision resistors. The winding is divided in four sections by partitions. A slot is provided for leading the wire from section, and to the terminals.

Type XT-8.

List Price, \$.50

NATIONAL COMPANY, INC., MALDEN, MASS.

SHAFT COUPLINGS



The small coupling illustrated at the left has Steatite insulation, providing high electrical efficiency when used to isolate circuits.
Type TX-9. **List Price, \$1.00**

The small coupling illustrated at the right is well known and liked for its small size and freedom from backlash. Insulation is canvas bakelite.
Type TX-10. **List Price, \$.55**



NATIONAL COIL DOPE

National Coil Dope is a special R.F. lacquer, specially prepared to give low power factor. It may be used as a cement for holding windings in position without spoiling the low-loss features of the coil support. It provides a tough, protective film, seals surface pores, and gives a moisture-repellent surface. The Coil Dope is applied with a brush, and dries in air without baking. Per can. **List Price, \$1.50**

CODE PRACTICE OSCILLATOR

This small audio oscillator is suitable for either code practice, or as an audio signal source for ICW on the Ultra High Frequency Bands. Being a real oscillator, the tone is excellent, and is much more satisfactory than "squealers."

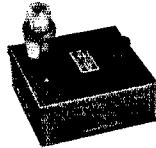

A type 30 tube is used, and four flashlight cells in the case provide the necessary filament and plate current.
Type CPO, without battery or tubes. **List Price, \$6.00**

TUBE AND COIL SHIELDS

Aluminum shields for experimental and custom set work.

Catalog Symbol	List Price
J30 Coil Shield, 2 1/2" dia., 3 3/4" high — square flange at bottom 2 3/4".....	\$.35
B30 Coil Shield, 3" dia., 3 3/4" high.....	.35
B30 Coil Shield, as above with mounting base..	.50
TS Tube Shield with Top Cap and Bottom Mounting Plate.....	.40
T58 Tube Shield with Top Cap and Bottom Mounting Plate (For dome-top tubes such as the 57, 58, 77, 78, etc.).....	.40

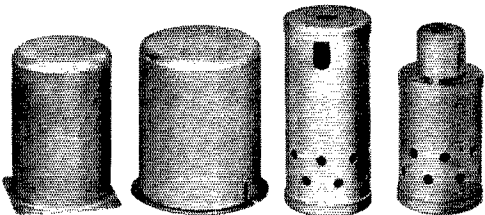

VICTRON

A synthetic material, possesses almost incredible electrical properties. Its Loss Factor (0.2) is one-eighth that of "Low Loss" Hard Rubber, and one-ninetieth that of the usual R.F. Insulators. Its Power Factor is .06%-.08%, compared to .09%-.20% for Steatite. In color it is a transparent amber. It may be readily drilled or sawed. Being non-hydroscopic, it is suitable for outdoor use. Its Tensile Strength is about 6,500 lbs. per sq. in.

The ease with which Victron sheet can be machined makes it an ideal material for the experimenter. Standard sheets are 6" x 12".

Victron, 3/16" thick, per sheet,
Victron, 1/8" thick, per sheet,

List Price, \$6.00
List Price, \$5.00

CRYSTAL HOLDER

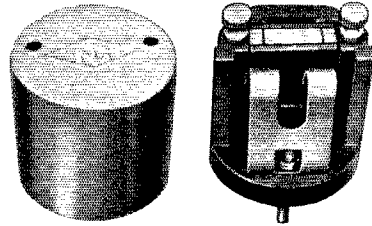

The new National Crystal Holder possesses a number of desirable features. The crystal is held in a vertical position, which permits it to vibrate more freely. Crystals may be changed very readily, making it feasible to use the holder with different crystals as required. The cover is of metal and is used for protection and shielding only. It is not used for clamping the crystal or plates. The body of the holder is molded R-39, and has two prongs on the base for connections. When ordering specify whether for transmitting or resonator (single-signal) crystals.

Type CH, without crystal

List Price, \$2.50

STANDARD CABINETS

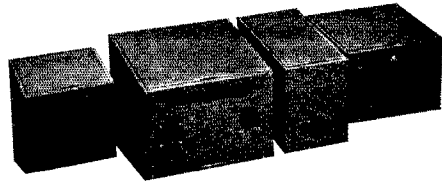

National Receiver cabinets for use in constructing special equipment are illustrated above. Left to right, are the cabinets regularly used for the SRR and FB-7 receivers, the PSK Preselector, and the SW-3 receiver. Available plain or with panels and sub-bases punched for standard assemblies. List prices include sub-base and bottom cover:

Type C-SRR **\$3.50**
Type C-FB7 **\$7.00**

Type C-PSK **\$6.00**
Type C-SW3 **\$5.50**

NATIONAL COMPANY, INC., MALDEN, MASS.



H. F. DIELECTRICS

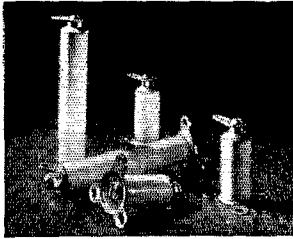

STAND-OFF INSULATOR. This well-known little insulator is now offered in two lengths. Long and slender, the larger model is shaped for extreme electrical efficiency. It is an excellent core for H.F. solenoid chokes. (Isolantite)

Type GS-1 (L = 1 $\frac{3}{8}$ ") . . . List Price, \$.25
 Type GS-2 (L = 2 $\frac{7}{8}$ ") . . . List Price, \$.35

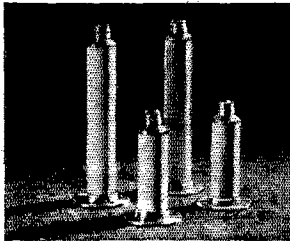
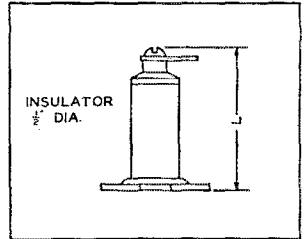

STAND-OFF INSULATOR. Metal mounted like the smaller units, these heavy Isolantite stand-offs combine electrical efficiency with strength and convenience. The insulator is $\frac{3}{4}$ " diameter and is available in two lengths.

Type GS-3 (L = 2 $\frac{7}{8}$ ") . . . List Price, \$.80
 Type GS-4 (L = 4 $\frac{7}{8}$ ") . . . List Price, \$ 1.00

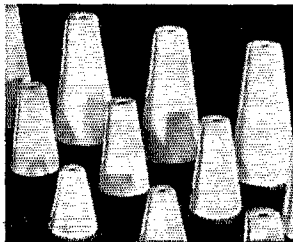
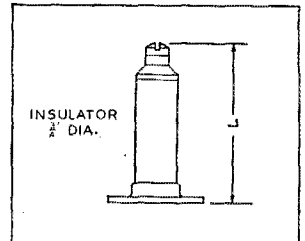

STAND-OFF INSULATOR. This popular style of insulator is offered in three sizes, all of low-loss Steatite. The smallest model is tapped 8-32 each end, the larger 10-24.

Type GS-5 (A = 1 $\frac{1}{2}$ " , B = 1 $\frac{1}{4}$ " , C = 1") . . . List Price, \$.25
 Type GS-6 (A = 5 $\frac{1}{8}$ " , B = 2" , C = 1 $\frac{1}{8}$ ") . . . List Price, \$.35
 Type GS-7 (A = 3 $\frac{1}{4}$ " , B = 3" , C = 1 $\frac{1}{2}$ ") . . . List Price, \$.65

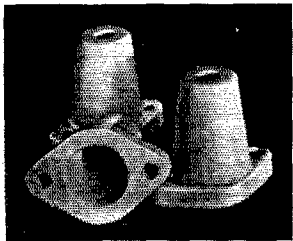
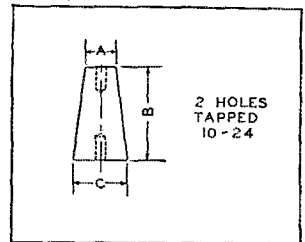

STAND-OFF INSULATOR. Another small insulator suitable for a variety of applications. Being made of Steatite, it is eminently suited for Low Loss H.F. circuits. It is available in a special model with a jack for mounting plug-in inductances.

GS-8 List Price, \$.25
 GS-9 (with jack) List Price, \$.35

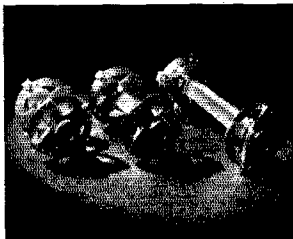
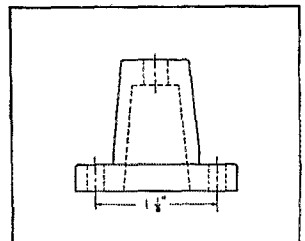

HIGH VOLTAGE SHAFT COUPLING. Isolantite insulated, rugged, and free from backlash, this coupling is made in three lengths, bored for $\frac{3}{8}$ " or $\frac{1}{2}$ " shafts. Leakage path is $2\frac{3}{4}$ " less than over-all length.

Type TX-3 (L = 3 $\frac{5}{8}$ ") . . . List Price, \$ 7.00
 Type TX-5 (L = 5") List Price, \$ 7.75
 Type TX-7 (L = 7 $\frac{1}{2}$ ") . . . List Price, \$ 8.50

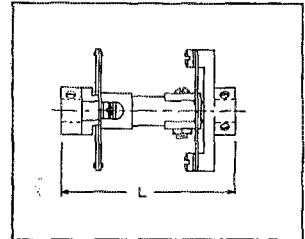

NATIONAL COMPANY, INC., MALDEN, MASS.

H. F. DIELECTRICS

INSULATOR $\frac{1}{4}$ " DIA.

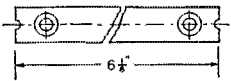

SPREADER. Conventional in design, unusual in efficiency, these Steatite spreaders will more than justify their slight extra cost. They are at present available only in the six inch length.

Type AA-3.....List Price, \$.30

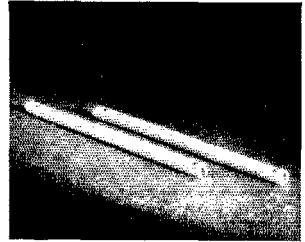

INSULATOR $\frac{1}{2}$ " DIA.



STRAIN INSULATOR. This aircraft-type insulator, in spite of its short leakage path, has a variety of uses in small portable, mobile and police installations. Being loaded in compression, the insulator provides great mechanical strength.

Type AA-5.....List Price, \$.20

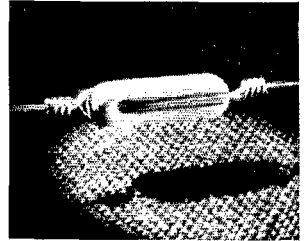

INSULATOR $\frac{1}{4}$ " DIA.

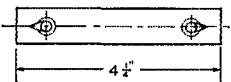

ANTENNA INSULATOR. This insulator is particularly suited for general use by the amateur. Its length provides ample leakage path, while its cross-section provides ample strength for all but the heaviest loads. The use of Steatite assures excellent electrical performance.

Type AA-6.....List Price, \$.25

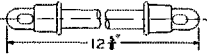
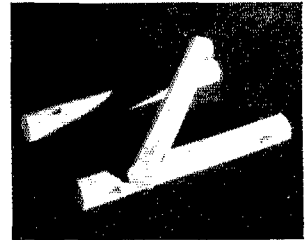

INSULATOR DIA. = $\frac{3}{4}$ "

ANTENNA INSULATOR. Designed for sustaining heavy loads, this insulator combines great strength with low losses. The Steatite bar is $\frac{3}{4}$ " diameter and has a leakage path of $8\frac{1}{4}$ ". The fittings are of bronze. The weight of the complete insulator is approximately one pound.

Type AA-7.....List Price, \$5.00

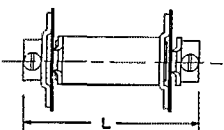
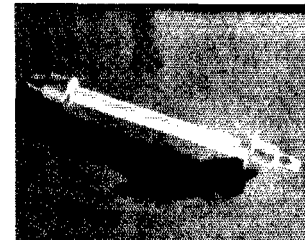

HIGH VOLTAGE SHAFT COUPLING. Also Isolantite insulated, but smaller than the models described opposite this coupling possesses their excellent design features. For $\frac{1}{4}$ " shafts only. Leakage path $\frac{3}{4}$ " less than over-all length.

Type TX-1 (L = $1\frac{3}{4}$ ").... List Price, \$1.00

Type TX-2 (L = $3\frac{1}{4}$ ").... List Price, \$1.10

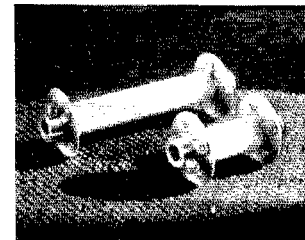

NATIONAL COMPANY, INC., MALDEN, MASS.

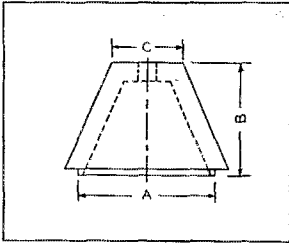

H.F. BUSHING. This small Steatite bushing has a variety of uses in transmitter construction, not only as a neat and efficient means of bringing H.F. leads through partitions, but as a support for coils, etc. Each pair of cones includes suitable metal fittings.

- Type XS-1 (A=1", B=1 1/16")
per pair..... **List Price, \$.60**
- Type XS-2 (A=1 1/2", B=1 3/16")
per pair..... **List Price, \$.80**

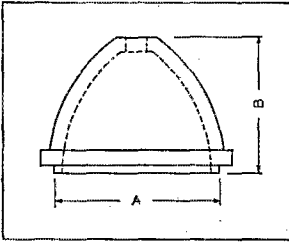
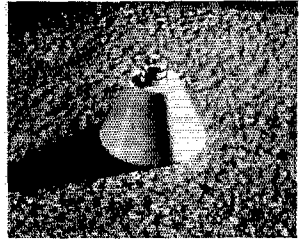

H.F. BUSHING. Larger in size than the bushings described above, and shaped to conform to the lines of electrical stress, these Steatite insulators are suitable for higher H.F. voltages. Prices are per pair, with metal fittings.

- Type XS-3 (A=2 3/4", B=2 5/16")
List Price, \$ 3.30
- Type XS-4 (A=3 3/4", B=2 25/32")
List Price, \$ 6.00

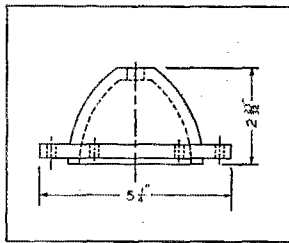
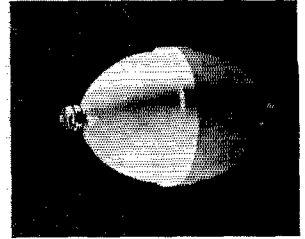

H.F. BUSHING. A heavy bowl-type lead-in, suitable for large transmitters, this Steatite insulator provides a weatherproof joint for antenna lead-in purposes. Leakage Path 3 1/4".

- Type XS-5 each..... **List Price, \$ 7.50**
- Type XS-5, with fittings, per pair
List Price, \$15.50

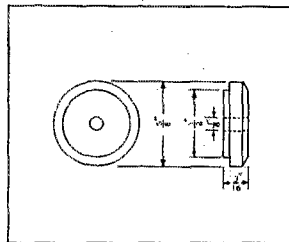
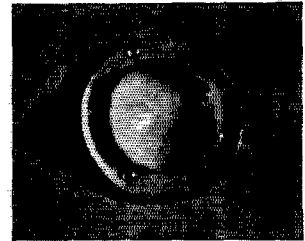

H.F. BUSHING. A small, inexpensive Steatite bushing that has a variety of uses in H.F. Transmitters. Convenient as well as efficient, they give a professional appearance to amateur equipment.

- Type XS-6..... **List Price, each, \$.10**

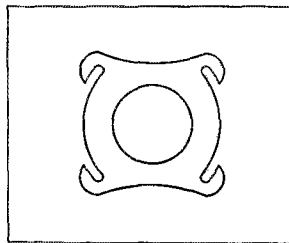
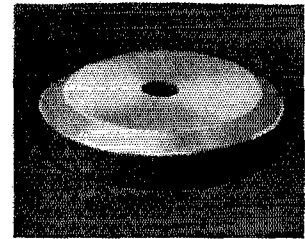

TRANSPOSITION BLOCK. In addition to the popular AA-1 Victron Block, National now offers a smaller Steatite Block. Both are light in weight, both are highly efficient. The Victron Block AA-1 separates feeders 1 1/2", the Steatite Block, AA-2, provides 1" separation.

- Type AA-1..... **List Price, \$.35**
- Type AA-2..... **List Price, \$.20**

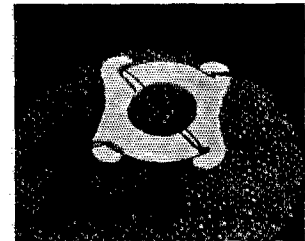

NATIONAL
61 SHERMAN STREET



COMPANY
MALDEN, MASS.

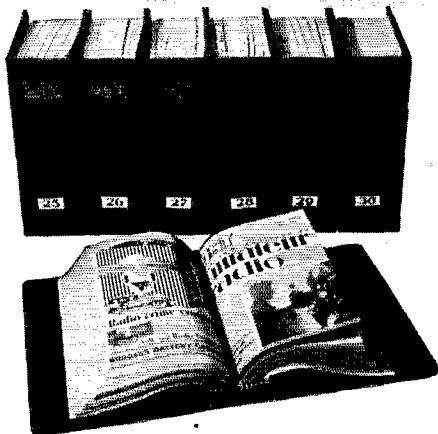

QST Binders

TO ENHANCE the appearance of your station, to facilitate your reference work, and to preserve the records of the advancement of the radio art, you need a BINDER. You need one for this year's issues and one for each of the accumulated year's issues that you have. It will accommodate twelve issues of *QST* and a yearly index. The *QST* Binder is covered in deep maroon cloth. It is cleverly designed to take each issue as received and hold it firmly without mutilation. It permits the removal of any desired issue without disturbing the rest of the file.

• NOTE •

The illustration shows each binder with a yearly mark. This marking is not stamped on the binder. Simply cut the year label from a calendar, or paste on a piece of paper, marking it in your own handwriting.

A GOOD INVESTMENT AT
\$1.50 POSTPAID

AMERICAN RADIO RELAY LEAGUE
West Hartford, Connecticut

(Continued from page 82)

this would be just another piece of legislation that could be more properly taken care of by education. An "inexperienced beginner" would be difficult to define. It is assumed that such a person would be one without previous experience in construction, adjustment and operation of transmitting apparatus. But to be absolutely fair, personalities must be considered. For instance, what about the amateur who, we will say, is an electrician of sorts, meticulous as to his construction work, careful in knowing the "how and why" of adjusting his transmitter before "blasting the ether" and, above all, blessed with a mature gift of consideration for other people? Compare him with another new amateur, maybe a very young fellow carried away, as most of us have been at one time or another, by the thrill of "getting on" in one fashion or another. Both are without previous experience as far as radio is actually concerned. It is evident that the proposed legislation, though intended for the latter, would also include the former amateur and most certainly work an injustice on him and dampen the enthusiasm of a promising good "ham." . . .

Lieut. J. P. Mullen, Jr., W4CMJ

The New England Division Convention

LIKE CREASER said that this year's convention was to be a WOW,—and it was. May 4th and 5th, 1934, will go down in the annals of New England Division conventions. From early Friday morning till the wee small hours of Sunday there were no idle moments. With a cordial welcome by Percy C. Noble, W1BVR, who introduced Mayor Martens of the city of Springfield, and a response by OM Hebert, A.R.R.L. fieldman, the program was well launched.

The Communications Department was well represented by F. E. Handy and its field force, reports of section activities being made by "Hewie" Hewinson, W1ASY, Western Massachusetts; Joe Mullins, W1ASI, Eastern Massachusetts; J. H. Izart, W1AUU, acting for New Hampshire; and A. Izzo, W1EMQ, acting for Vermont. A guest who came a long way was Bob Eubank, W3AAJ, SCM, for Virginia, who gave a good talk.

The 'phone group under the direction of Col. Boyden, W1SL, had two meetings during the convention and organized the New England Division Radiophone Association. The Navy was well represented by Ensign Green, U.S.N.R., W1ASU; and the Army had that good friend of the Army-Amateur Net, Major Platt of the 1st Corps Area.

Nothing was left desired in the technical program with such well-known names as Lieut. John Reinartz, W1QP, whose talk on cathode ray tubes kept the delegates at attention for over an hour. "Five-Meter Problems" was well covered by W. C. Ellsworth, W1BZC, of the Westinghouse Co. Mr. H. N. Harmon, from the same company, spoke on "Antennas." Filter Condenser Network was well covered by William Allsion, W1FFK, of the Sprague Products Co. Bob Chapman, W1QV, understands "Interference Elimination," and his lecture must have been of assistance to those who have such trouble.

One of the unusual features of the convention was a sea food dinner on Friday night which kept the delegates together and enabled everyone to enjoy the evening's entertainment, consisting of a skit by the New London Radio Club; Liars'

Ten Years Ago . . .

passing the government amateur operator license examination was little more than a formality. Ten rather simple stock questions were asked, and the questions were always the same. You passed your code test — or, more often, swore that you could if called on to prove it — and that was that.

To-day . . .

things are mighty different. When you step up for that examination (and you *have* to step up; there's no getting out of it, unless you're in the remote wide stretches and even then the exam is just as hard) you may be asked any ten of a group of hundreds of questions — all different, and all difficult. You have to know your stuff to get an amateur license these days. Requirements have been stiffened; the art has broadened, branched out, increased in complexity. Amateur radio of today is a far more complicated and involved affair than it was ten years ago; you have to be able to keep up, if you expect to join the race.

Now . . .

There's only one sure way to guarantee yourself that 1934 speed. There's only one sure way to insure yourself the knowledge, the ability, the technique required to pass that stringent present-day license examination. That sure way is to use the A.R.R.L.'s complete Course of Study for the Would-Be-Amateur:

HOW TO BECOME A RADIO AMATEUR

(No. 8 in the series entitled The Radio Amateur's Library)

A necessity for the fellow who wishes to get started right.

25c postpaid

THE RADIO AMATEUR'S LICENSE MANUAL

(No. 9 in the series entitled The Radio Amateur's Library)

Complete dope on license procedure, with questions and answers.

25c postpaid

(No stamps, please)

THE AMERICAN RADIO RELAY LEAGUE
WEST HARTFORD CONNECTICUT

THE IMPROVED CATHODE-RAY OSCILLOSCOPE

Linear sweep model for broadcast stations and advanced amateurs, physics labs., etc.

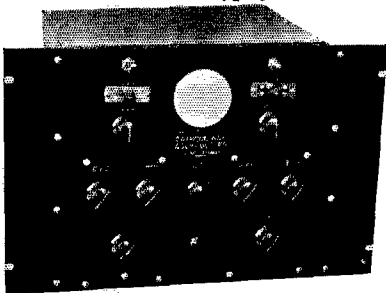

- Controlled linear sweep 0-150,000 C.P.S.
- Controlled external sweep.
- Freq. locking device for sweep frequency.
- Picture centering adjustments.
- Wide range focus adjustments.
- Complete component shielding.
- Unit is self contained and includes batteries and 110V-60 cycle power supply.
- Tubes RCA 906-385-234-281-280.
- This instrument embodies all features ordinarily contained in only the highest priced Cathode Ray equipment.

COMPLETELY EQUIPPED READY TO USE
F.O.B. Newark — \$97.50
Literature now available

Bliley Crystals — New Reduced Prices

BC-3 mounted crystal in holder, 80- and 40-meter band. **\$3.95**

RK-20's in stock. **\$15.00**

SPECIAL THORDARSON \$2.75
Filter Choke
250 MA- 12H. 110 ohms.

TUBES

to fit the depression pocketbook of the amateur fraternity. These tubes are first class products and carry our absolute guarantee for 90 days.

281	\$1.00	866 HD	\$1.35
281 Mercury	1.00	203A & 211	
210 — 15W	1.15	Graphite Anode	8.75

PLATE TRANSFORMER — two 7½ and two 2½ volt fil. windings — 750-750-160 mils. **\$3.50**

DUPLEX POWER SUPPLY

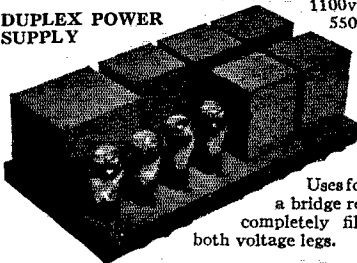

1100v. 250 ma.
550v. 250ma.

Uses four 83's in a bridge rectifier — completely filtered in both voltage legs.

\$35.00

These units can be had on special order in any size mounting or form

We are specializing in transmitter construction to customers' orders and specification. Write for quotation on your favorite transmitter.

Special code classes for beginners. No charge. Telephone for appointment.

KALTMAN & ROMANDER
62 Court St. Newark, N. J.

Contest, won by W1BDW and W1ACV, and the initiation in the R.O.W.H. under the very efficient master of ceremonies, C. R. Reid, and his degree team, W1EVZ, W1BGB, W1GBZ, W1EBH and Jesse Richardson. The YL's and XYL's were well looked after by Mrs. Ellsworth with shopping tours and theatre parties.

Several manufacturers had very fine displays. The five-meter set kept perfect contact with the station on top of Wilbraham Mountain. Every state in New England was well represented, with Massachusetts and Connecticut having the largest delegations. New York, Pennsylvania, Virginia, and Canada also had a number of delegates. The "ham" coming the greatest distance was ZL1FQ, who enjoyed himself hugely.

At the banquet, Director Bailey, in his capacity of toastmaster, was in his glory in introducing the guests of honor, consisting of Hon. Mayor Martens, President Maxim, Sec'y Warner, the latter two receiving quite an ovation; Major Platt, Lieut. Reinartz; Ensign Green and Director Fuld from the Hudson Division. There is no doubt that the large attendance was due to the fine advance publicity work of Walter Deane, W1SB, who made use of the Yankee Net Work and many newspapers.

But we must not forget the two clubs, which sponsored this convention—The Springfield Radio Association and The Western Massachusetts Amateur Radio Association, and the convention committee: W1BVP, W1APL, W1DJB, W1CCH, W1BVR, W1ASY and the chairman, W1BSJ, to whom a big vote of thanks goes. On to Worcester in 1935!

—A. A. H.

Experimenters' Section

(Continued from page 39)

Metering Individual Tubes in Push-Pull Circuits

Most users of push-pull radio-frequency amplifiers, while knowing that to obtain maximum efficiency their circuits should be symmetrical, cannot tell whether or not the circuits actually

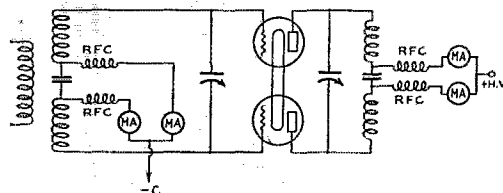

FIG. 7 — CIRCUIT FOR MEASURING PLATE AND GRID CURRENTS OF INDIVIDUAL TUBES IN A PUSH-PULL AMPLIFIER

are balanced because the conventional push-pull circuit does not permit measuring the plate and grid currents of the individual tubes.

The circuit of Fig. 7, in use at my station for some time past, provides a quite satisfactory method for determining whether or not balance



FRED H. SCHNELL

Former Traffic Manager, A. R. R. L., owner of W9UZ, and famous radio pioneer, says

"This GRUNOW Licks 'Em All for World Reception

"It gets foreign stations other sets miss — makes world reception easier than ever before. It's a real professional's set.

I'VE spent my life in radio development. I know what every well-known radio can do. And this Grunow licks them all. Designed and engineered correctly, it's in a class by itself — at the top."

You're right, Mr. Schnell! Leading radio engineers and amateurs are buying this amazing new Grunow for their own use — because it has the real professional features that experts know you have to have for real results.

The Signal Beacon (beat oscillator station finder) — the sensitive tuned r.f. pre-amplifier operating on *all four* wave bands — the two-speed split-hair tuning control — the built-in double-doublet antenna circuit with automatic antenna selector — these are just a few of the professional features that make this Grunow the choice of men who really know radio.

Hear and tune the Grunow yourself. You'll get a real kick out of its performance, and you'll be delighted at its price. Do it today.

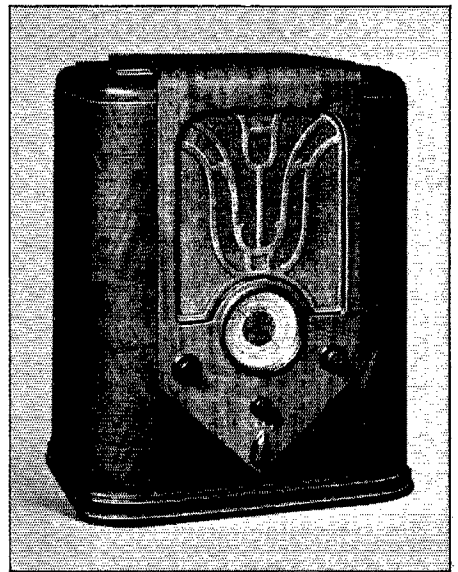

Grunow All-Wave Model 750. *A real go-getter with complete coverage from 550 to 21,700 kc. Has Signal Beacon beat oscillator, tuned r.f. pre-amplifier on all wave-bands, and all other Grunow advancements. One of 16 wonderful new Grunow models.*

Grunow
ALL-WAVE RADIO
PRODUCT OF GENERAL HOUSEHOLD UTILITIES CO.

2650 N. Crawford Ave., Chicago

Say You Saw It in *QST* — It Identifies You and Helps *QST*

LIGHT

in that dark corner of your receiver or transmitter—to find that lost part under the operating table or work-bench—keep an—

EVEREADY FLASHLIGHT



handy—hanging up by its convenient ring hanger.

Keep your flashlight loaded and ready for action with—

EVEREADY UNIT CELLS METAL SEALED→

Power cannot leak out. Moisture cannot creep in. You know they're fresh because they're DATED

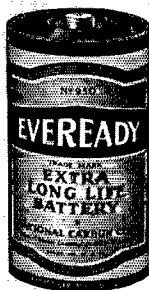

EVEREADY FLASHLIGHTS & BATTERIES

NATIONAL CARBON COMPANY, INC.

GENERAL OFFICES: New York, N. Y.

Branches: Chicago · San Francisco

Unit of Union Carbide  and Carbon Corporation

is being obtained, as well as indicating the operation of both tubes. It is necessary that both grid and plate coils be split, which offers no particular constructional difficulties. In capacity-coupled circuits individual grid-current measurements are quite simple, since the ordinary arrangement calls for separate grid chokes. A single meter can be used for all measurements if an appropriate plug-and-jack system is installed.

— F. J. Homsher, W3AXR

EDITOR'S NOTE. — Despite the fact that series feed is used in both plate and grid circuits, the r.f. chokes shown in the d.c. leads in W3AXR's diagram should not be omitted. The full tank current flows through the mica condensers inserted at the centers of the coils, and the chokes are needed to prevent power-supply or other connected apparatus from trying to act as part of the r.f. tank. This was discussed by Charles S. Linell in the Experimenters' Section in October, 1932, QST.

Amateurs Undertake Ocean Flight

(Continued from page 48)

antennas may be used for transmission. Signals of maximum strength have been heard from KHMZA on 5515 kc. well up to 1000 miles. As contact with U.S.A. will be hoped for at all times, look for KHMZA on the higher assigned frequencies or close to the 14-mc. band. An Omnigraph with disc sending, "VVVVV DE KHMZA KHMZA KHMZA" will be used while in flight so amateurs can follow the plane at all times. This will be interrupted for the first 15 minutes of every hour when contacts with amateurs will be made. From time to time Wilson will send back word of those amateur stations with the best and most consistent signals. Direct schedules will be kept with these stations if possible.

Dr. Light, U. S. Army-trained pilot, expresses great hope for amateur contact as a method of communication. In every sense this flight is strictly amateur, with no commercial affiliations of any nature. Bob Wilson will be remembered by many who have contacted W1YU in the past four years. An excellent operator on land; the conditions should not be altered, as Wilson has his "bug" fashioned to the ship in a mighty comfortable position.

As this is written KHMZA is at London, England. Schedules are being arranged with G2BM and G2ZQ among others so that word of their progress will come back to the States via ham channels. The 8340-kc. frequency has proved most effective to date.

As the flight progresses Official Broadcasts will carry the latest news as well as calls of stations putting the best signals out to KHMZA. Send all reports to A.R.R.L.

—C. C. R.

~~Strays~~

Frank M. Ham, W1FW, is not a ham in name only. Been in the game for years and has a complete file of every issue of QST from the start, bound in leather.

PROPHECY NUMBER ONE—CLANG!!

We certainly "rang the bell" when we predicted the 1935 season would be rack and panel. The immediate widespread acceptance of our new line of modern constructional accessories certainly proves that amateur gear will be "dressed up" as never before. All the dope is in our B-73 bulletin.

PROPHECY NUMBER TWO?

The transmitter of tomorrow will be screen grid throughout

WHAT PRICE MODULATION

Grid? Plate? Screen? Suppressor?

Class B Heising modulation is the most economical for any given power output. Both the initial cost and operating cost are lower than with any other system. That's why we designed our DBS speech amplifier (\$12.25) to drive our DB 46M (25 watts at \$10.25) our DB 210M (50 watts at \$12.25) and our FB 800M (100 watts with 800's — 190 watts with 830B's at \$22.50).



FB 800M Modulator

There is a LEEDS Modulator to fit every amateur's power and pocketbook. B-73 tells all.

All modulators transformed by Thor-darson. Output transformers carry R.F. plate current.

Remember MYCALEX is the low loss insulation that can be sawed, drilled or tapped to fit your requirements. See our advertisement in August QST for complete description and prices.

Add 10% to price of SHEET Mycalex for cutting charge.

GENERAL RADIO

We carry a complete stock of General Radio amateur accessories. General Radio low loss porcelain coil forms, for 20-40-80 meters, type 677U 50c For 160 meters, type 677Y 75c SPECIAL — General Radio straight line frequency split stator condensers; single spaced; 175 mmf per section; 85 mmf effective capacity. Shipping weight 3 lbs. Special \$1.25

FLECHTHEIM

The complete line of high and low voltage condensers at a special discount of 50% off list.

PRICE REDUCTION ON OUR

Type 1-E Power Supply for SW-3's, freqmeters, etc. \$6.50 Now only..

LEEDS BASES AND DEMI-BASES

can be readily bolted together to form a wide combination of chassis sizes. The cost is surprisingly low. 8" x 8 1/2" x 2" 55c 10" x 8 1/2" x 2" 65c Full size bases 4" x 17" x 2" 75c 8" x 17" x 2" \$1.00 10" x 17" x 2" \$1.20

EVERYBODY'S TALKING ABOUT

our new 5-A Super Regenerative receiver, described in June QST. \$13.75 brings you one of the most sensitive super regenerators on the market — Raring to go! \$9.75 brings you the complete kit, including drilled cabinet and sub chassis.

SYLVANIA GRAPHITE ANODE TUBES IN STOCK

AMERICAN TYPE E.L.

Double button carbon micro- \$4.95 phone; List \$10. Special

TRIPLETT METERS AND SERVICE EQUIPMENT

We carry the complete line of this high grade, low cost precision apparatus.

Lowest prices of course

MAGNET WIRE

All even sizes from No. 14 to No. 38 in enamel, double cotton, or double silk on 25c spools. Prices on larger quantities are yours for the asking.

WE CAN'T IMPROVE OUR SERVICE SO WE ARE INCREASING ITS SCOPE

Those "thin dimes" are rolling in, in increasing numbers, and of course they are rolling right out again as postage on twenty-five bulletins from the country's foremost manufacturers, together with our own B-73 folders and discount sheet. If you want information on the specialized equipment you need for that new rig, this encyclopedia of parts contains the most complete, accurate, detailed information on short wave equipment obtainable anywhere.

AUTOMATIC TRANSMISSION

Three years ago we started the development of 56 mc gear. D. A. Griffin's July article and our August advertisement describe an amazingly interesting new application of 56 mc equipment for "remote control." The heart of the system is embodied in our MP-1 and KP-1 units.



LEEDS MP-1 three rack mounting position mixer. A quality unit that makes possible the simultaneous retransmission of two incoming phone signals and the operators voice at any desired level. \$15



LEEDS KP-1 rack mounting combination tone generator for MCW and vacuum tube operated relay circuit for automatic retransmission of CW telegraph signals. \$15

ACME DELTA

We are New York distributors. A complete stock of their line constantly on our shelves at 40% and 2% from list price.

CORNELL-DUBILIER AEROVOX CARDWELL HAMMARLUND

A complete line of these well known manufacturers products always on hand at LEEDS low net prices.

HARD DRAWN ANTENNA WIRE

#12 tinned copper wire, 100 ft. 55c #10 tinned copper wire, 100 ft. 85c #12 phosphor bronze wire, 100 ft. 75c #10 phosphor bronze wire, 100 ft. . . . \$1.25 Other lengths in proportion



45 Vesey Street, New York City

New York Headquarters for Transmitting Apparatus and Short Wave Equipment

Perhaps it's "fun to be fooled," but "it's more fun to know," particularly when you are buying something. All prices quoted by us are strictly net for cash. The country's largest laboratories, broadcast networks and amateurs throughout the world get the same low prices at LEEDS. Perhaps some individuals may measure value by the size of a "discount" from a "list price" no one ever pays. We could easily multiply our low net prices by two and then give everybody a 50% discount. Perhaps it's fun, but who is fooled?

LEADS
the procession.
World-wide service to amateurs



The boys on the service benches all over the land are "eatin' 'em up." No wonder . . . for CENTRALAB Replacement Controls are doing a keen job . . . and (ahem) in many cases making the original old fashioned control look like six cents in comparison. For these replacement units represent the last word in Volume Control efficiency.



The CENTRALAB patented non-rubbing contact eliminates wear and insures both mechanical and electrical smoothness of operation.

Every Radio Service Man
should be a member of the
Institute of Radio Service Men

Centralab

RADIOHM

Central Radio Laboratories
MILWAUKEE

Canada—U. S. A. Contact Contest

(Continued from page 40)

PRIZES: A.R.R.L. Certificates of Merit will be awarded to the leader in each of the 69 A.R.R.L. Sections in the U.S.A. and Canada. In addition, the Utah-Carter Cup will be presented to the leading VE. The VE/W Contest Committee members will not be eligible for prizes, but may aid W stations in obtaining a higher score.

GENERAL CALL: CQ VE/W CQ VE/W CQ VE/W DE W/VE ---- W/VE ---- W/VE ---- (repeated *not more than* 3 × 3) K.

REPORTING FORM: Copies of logs must be received by the Contest Committee not later than midnight October 31, 1934, except in case of K6, K7 and KA.

Take part! Address your log-report to: L. W. Mitchell, VE3AZ, Chairman VE/W Contest Committee, Room 704, Northern Ontario Building, Toronto, Ont.

The form given is suggested for a contest log to be sent to VE3AZ at the end of the contest. Six vertical columns are ruled on 8" × 11" paper, as shown.

If you forget to get the name of the Section during a QSO, this can be recorded after the contest by examining the call book, the operating news in *QST*, etc. At the end, compute the score. Total the sixth column. Check the number of *different* VE or W Sections worked. Multiply the claimed score by the number of such Sections in the "other" country in which a station was contacted. To get scores on the same basis, U.S. participants will multiply their result by nine (for there are nine times as many U.S.A. Sections to be worked). Multiply *again* by the power handicap ($1\frac{1}{2}$), if you used *less than* 50 watts. If your station had more than one operator, submit separate logs.

Reports should be submitted as soon as possible after the contest is over. Messages handled should be kept on file for call if necessary in the case of winners, but it is not necessary to send them in—the simple tabulation or list of QSOs and computation of points claimed is sufficient. Send your report, large or small to VE3AZ.

Third C. A. Asks Amateur Help

(Continued from page 16)

upon their merits as shown by their application blanks, those who appear to be the best qualified for the job being chosen first. Fast operating although desirable is not essential. Reliability is the thing that will count the most.

Mr. E. D. Hartman, W3OK, of Bethlehem, Pa., has been appointed civilian radio aide of the corps area and has been engaged for the summer to organize the nets and have everything ready for a big start at the beginning of the season.

Any amateur in the corps area who is interested

FOR *Accurate* MEASUREMENT OF FILAMENT VOLTAGE

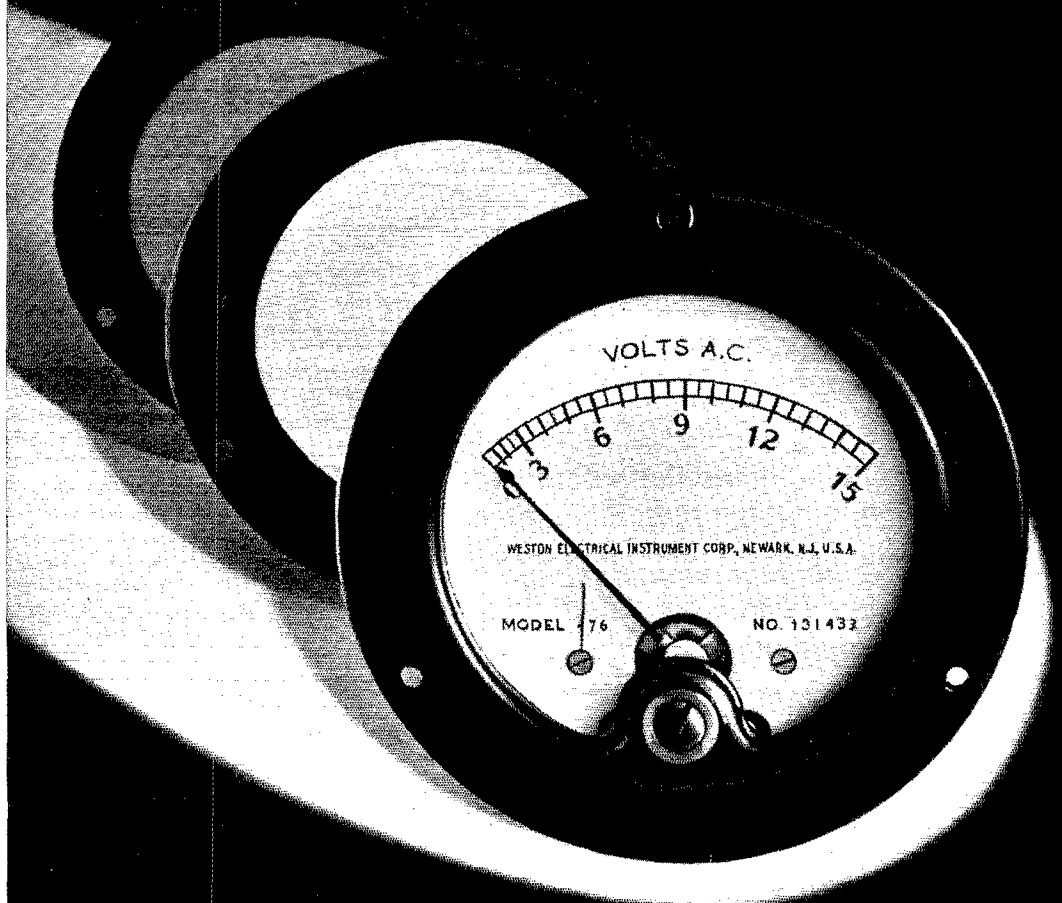

Filament voltage must be maintained accurately if you are to get long, efficient service from transmitting tubes. Your best safeguard is to use only a voltmeter of known dependability . . . and thus remove all uncertainty over voltage measurements. Here a Weston Voltmeter should be used . . . just as Westons should be used for all transmission needs. It is risking too much to use instruments below the proved Weston standard . . . Weston Electrical Instrument Corporation, 602 Frelinghuysen Avenue, Newark, New Jersey.

WESTON
Radio Instruments



TODAY'S Most Modern Precision Measuring Instruments

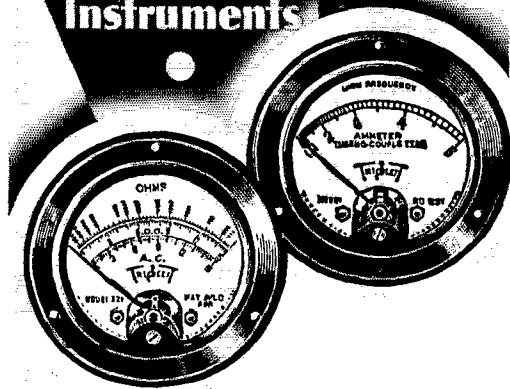

THERE is a Triplett Precision Measuring instrument for every radio purpose. Their advanced design, precision construction and many exclusive features represent the master achievement of some of today's most prominent instrument engineers. Prove their greater worth by a competitive test . . . learn why, more and more, they are being regarded as the yardstick of fine instrument performance . . . as today's modern precision measuring instruments.

Triplett makes a Precision Measuring Instrument for every radio purpose, including Thermo-Couple Ammeters (High Frequency), Universal A.C.-D.C. Meters (Copper Oxide), Portable Instruments, A.C. and D.C. Panel Instruments. These instruments are made in several sizes: 2", 3 1/2", 5 1/8". They are obtainable in these types of cases: Wide flange, projection, portable—metal and Bakelite.

The metal dials of these meters are enameled permanently white with black figures. The contrast makes for easiest-reading scales. The finest sapphire jewel bearings are used. The aluminum needle and other parts are ribbed and made unusually strong throughout. The moving coil is light in weight. The scales are extra long, uniform and easy to read. All have zero adjustments.

**THE TRIPLETT
ELECTRICAL INSTRUMENT COMPANY**
90 Main Street, Bluffton, Ohio

Mail Today For Details!

Triplett Electrical Instrument Co.
90 Main St., Bluffton, Ohio

Gentlemen: Please send me information about Triplett meters. Also catalog on servicing instruments.

Name

Street Address

City State

in helping out on this worthwhile project is invited to write to Mr. Hartman at Room 333, Post Office Building, Baltimore, Maryland. Here, amateurs, is a chance to help out with President Roosevelt's recovery program in a unique way and at the same time to do amateur radio a real service. The U. S. Army has gone to bat for the amateur at many radio conferences. Here is a chance for the amateur to go to bat for the Army.

With the Affiliated Clubs

(Continued from page 28)

The storm and hurricane season usually opens up on the Texas Gulf Coast about June and lasts through September. In preparation for this, the Houston Amateur Radio Club built and installed a complete station in their club quarters with the call W5DPA. The station was in operation just two days before the first serious storm, which broke down the coast near Corpus Christi in the early morning hours of July 25th, bringing down telephonic lines and nearly all power lines in that section. The club secretary was roused from his slumbers by a local newspaper requesting information from the outside. W5DPA staff operators, W5ADZ and W5EI, promptly fired up the rig and succeeded in raising W5MS in Corpus Christi, right in the center of the storm area. W5ABA, Kingsville, was also hooked and gave the dope from that point. All communications was on 7 mc. over about 300 miles. A reporter from each of the local newspapers was assigned to the club, and several extra editions were published, the bulk of news being furnished by W5DPA. As well as press and storm reports, many personal messages were handled. Others cooperating in the operation of W5DPA were W5BHO, W5BKW, Jim Jeffries and Bob Salter. Following the closing of W5DPA about 5:00 p.m., W5BHO went on the air at his home station and worked portable W8GDF, who was marooned at Refugio with water three feet deep in the main street and no power to go on. W8GDF, with typical ham initiative, had "borrowed" fifty storage batteries from stalled cars, thus getting on the air! Contact between W5BHO and W8GDF was maintained until midnight, many important messages being handled.

At Corpus Christi, members of the club there maintained constant communication with many gulf coast and inland towns in addition to work with Houston. Among those on the job were W5AQK, W5BXX, W5MS, W5EEY and W5DVK (at Portland). These stations were kept on the air in spite of the fact that all antennas were swept away by the high winds.

Miscellany

In thinking of club doings getting under way again, we recall that some organizations carried out a summer program of outdoor activities, thus keeping the boys pepped up and club-conscious.

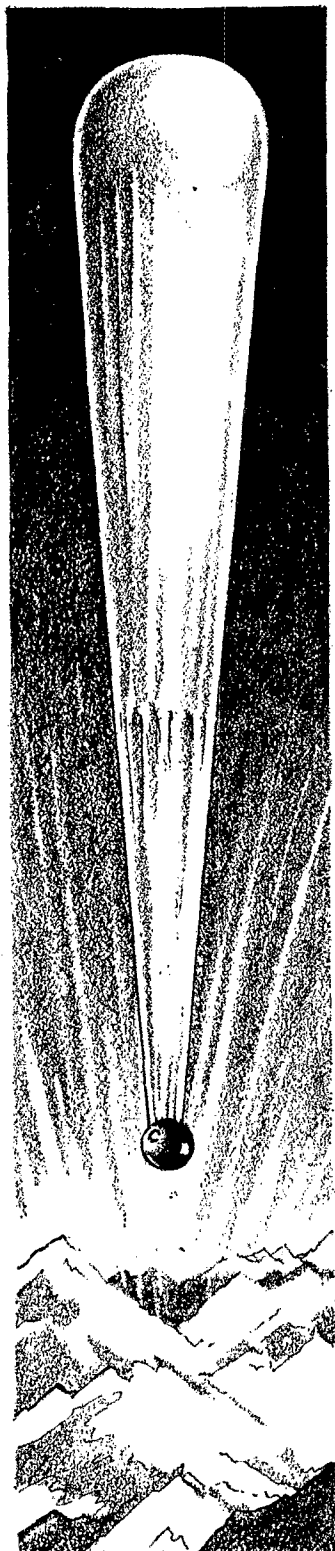

Reaching **NEW HEIGHTS** in **DEPENDABLE PERFORMANCE**

HAZARDOUS flights into the Stratosphere are necessary to establish accuracy or fallacy of certain long debated theories or to discover, if possible, the existence of hitherto unsuspected phenomena.

One needs but to look about him and inquire into past performances, however, to discover a reason for the popularity enjoyed by Cardwell condensers.

Month by month and year after year as the radio art progresses, the good Cardwell finds added recognition for its efficiency and dependability. Stick to the time-proven Cardwell!

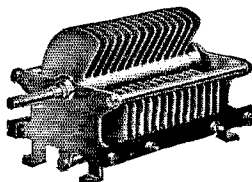

CARDWELL "STANDARD" MODELS FOR RECEIVERS
and MEDIUM POWER TRANSMITTERS

CARDWELL MIDWAY "FEATHERWEIGHT" CONDENSERS,
RECEIVING, and TRANSMITTING

CARDWELL 16-B TRANSMITTING CONDENSERS FOR LARGER TRANSMITTERS

CARDWELL HIGH VOLTAGE CONDENSERS
FOR COMMERCIAL RADIO-TELEGRAPH and BROADCASTING STATIONS

CARDWELL S-2944 OIL DIELECTRIC FIXED CONDENSERS
FOR HIGH FREQUENCY FURNACES and TUBE BOMBARDERS

Send for literature

★ ★ **NOTICE:** Increased manufacturing and material costs have made unavoidable increases in the list prices of MIDWAY and TRIM-AIR condensers. Therefore, effective Oct. 1, 1934, the list prices of MIDWAY and TRIM-AIR condensers will be advanced 10% over present list prices. This is the first increase in list prices ever made by Cardwell — reductions have been the rule — and other models remain, at sacrifice to us, at the reduced list prices of two years or more ago. ★ ★



THE ALLEN D. CARDWELL M'F'G. CORP.
83 Prospect Street, Brooklyn, N. Y.

"THE STANDARD of COMPARISON"



TUBES for the NEW TRANSMITTER

RK-20 RF POWER PENTODE

Suppressor grid or plate modulation.
No neutralization required.
Requires only one watt R.F. or 0.2 watt audio input.

R.F. Output — 50 Watts.

AMATEUR NET PRICE — \$15.00

RK-18 HIGH MU, HIGH MUTUAL TRIODE

R.F. oscillator or amplifier or Class B modulator.
Low capacities.

R.F. Output — 40 Watts.

Class B Audio Output — 100 Watts (2 tubes)

AMATEUR NET PRICE — \$10.95

RK-19 FULL WAVE HIGH VACUUM RECTIFIER

For the 1000 volt D.C. power supply.
Low voltage drop.
Free from R.F. noise.

AMATEUR NET PRICE — \$7.50

RK-24 NEW 2 VOLT-0.12 AMPERE TRIODE

For the portable 5-meter transmitter or transceiver. High output with low filament drain.

AMATEUR NET PRICE — \$2.25

Also Raytheon Types RK-15, RK-16, RK-17 and R-866A

Ask your dealer or write for characteristic data

RAYTHEON PRODUCTION CORPORATION

30 East 42nd Street, New York, N. Y.
San Francisco — Chicago — Newton, Mass.

... Field days were most popular. ... The Lakewood (Ohio) Radio Club held a successful one, the week-end July 21st-22nd ... eighteen hams and a proportionate amount of fun ... a 1.75-mc. 'phone and 7-mc. c.w. outfit were used between sporting events. ... The annual meeting and hamfest of Philippine Amateur Radio Association was held at KA1JR, June 24th ... see photo ... there were also many YLs and YFs present. ... A passing thought: Why not 56-mc. 'phone for club QSO parties? ... Or 160-meters? ... QSO parties between meeting dates preserve the fraternal touch ... and they're ultra-enjoyable when the contacts are your club brothers ... common aims and common interests. ... Money ... there's a common interest. ... Dues ... there's a common aim ... we aim to pay them, and the club treasurer aims that we will. ... Speaking of money, raffles are good money-makers ... and we recently heard of cake and candy sales ... dances, parties, well-managed hamfests, all bring silver to the club treasury ... sometimes. ...

The Cleveland Heights Amateur Radio Club is pushing 56-mc. experimentation. ... W8IJP, parked in front of a cemetery, worked two-way with W8DKK ... many dead spots were reported ... we bet there were! ... This Cleveland Club is interested in exchanging notes with other clubs on experimentation along any lines ... good dope ... clubs should keep better contact between each other ... what one doesn't think of another will. ... We have long harbored a big question ... how many clubs have their own club houses? ... their own stations? ... please give us the answers for these columns. ... South Jersey Radio Association held another 56-mc. station hunt mid-August ... two hidden stations to locate, then an outing and 'fest at the shore ... it was great sport. ... Mr. P. H. Herndon, Jr., from F.C.C. office, Sixth Licensing District, visited Nashville Amateur Radio Club, gave talk and answered questions. ... R. I.'s are always interesting club speakers ... but busy men. ... A drive for more licensed amateur members has been started by Bluffton (Ohio) Amateur Short Wave Radio Club ... they spend half hour each meeting teaching code ... several prospects are already making progress. ...

The second annual Inland Empire Hamfest held June 9th-10th by the Radio Operators' Club, Spokane, Wash., was very successful with registration of 182. ... The Connecticut Brass-pounders Association annual banquet fulfilled the expectations of all for a "very FB" affair. ... We understand the clubs of the San Francisco area are considering a Federation ... much like the successful Southern California group. ... The Tri-City Amateur Radio Club (Davenport, Iowa) helped a sizeable bunch of their members join A.R.R.L. by advancing money on deferred payment plan ... the money was proceeds of a hamfest. ... The Wichita (Kansas) Amateur Radio Club is fast heading for the 100% mark in members who are also A.R.R.L. members. ... Clubs can do much for amateurs locally by

The Radio Amateur's **HANDBOOK**

IS THE STANDARD GUIDE TO AMATEUR RADIO

Chapter I outlines the story of Amateur Radio — its start, its difficulties, its accomplishments; of the formation of the League to protect and preserve the rights of amateurs. Chapter II explains in detail how to get started in this finest of hobbies. Chapters III & IV, in simple language, explain electrical and radio fundamentals. Chapter V is devoted entirely to receivers. It contains circuits with complete constructional details and makes comparisons of the various circuits. It is full of constructional tips. Chapter VI recognizes monitors and frequency meters as essential parts of the equipment and tells how to make various types; how to calibrate them, and how to use them properly. Chapter VII covers transmitters, the most important part of a station. Self-excited and crystal-controlled; what ones to build, how to build them, how to tune them, and countless other helpful things, are all here. Chapter VIII, headed "Radiotelephony," covers the particular problems of 'phone transmitters and their operation, thoroughly and completely. Different types of modulators and amplifiers are shown and attention called to their various advantages. Chapter IX, written by pioneers in the Ultra-high Frequency field, points out the unusual circumstances to be found and gives the necessary information to build complete transmitters and receivers for use on frequencies of 30 megacycles and up. Chapter X treats of the vital subject

HERE IS WHAT IT CONTAINS

of power supplies. Largely upon your power supply depends the quality of your note. Here you will find power supplies designed especially to meet your particular needs. Chapter XI tells you how to prevent and cure various types of interference. It considers broadcast reception interference, and suggests the best keying methods. Chapter XII, on antennas, is packed with useful suggestions of how to best meet this frequently bothersome problem. The best of transmitters cannot make up for a poor antenna. The solution to your antenna difficulties will be found in these pages. Chapter XIII suggests various station arrangements both for the fellow who has plenty of room and the fellow whose space is limited. Chapter XIV explains the workings of the League's Communications Department. It tells of its aims and purposes; of its extensive field organization and how you may take part in all its activities. Chapter XV gives full instructions on the best operating procedure. From the calling of a station to the keeping of a log, it is all covered. Chapter XVI tells how messages should be handled, the correct form, and the restrictions governing message handling. In addition to these chapters there is an appendix full of useful data such as international prefixes, list of "Q" signals, commonly used abbreviations, and many useful charts and tables. In wealth of information (260 pages) and its 224 illustrations, the HANDBOOK is a big book.

**AT ANY PRICE, AN AMATEUR COULD
ILL AFFORD TO BE WITHOUT IT**

\$1.00 Postpaid — Buckram Bound \$2.00

THE AMERICAN RADIO RELAY LEAGUE
WEST HARTFORD, CONNECTICUT

HARVEY OFFERS FOR YOUR APPROVAL

Type HF-3 Receiver

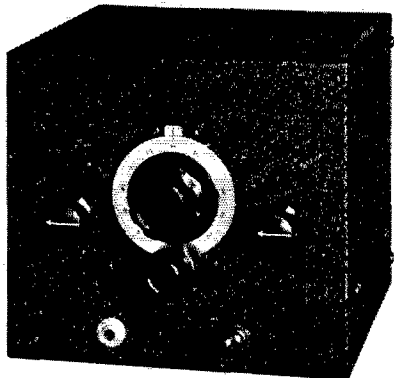

A three tube non-radiating unit employing the latest tubes in an efficient circuit. Additional plug-in coils permit full coverage from 5 to 10 meters. Filament requirements — 6.3 volts AC or DC.

5-10 Meter Transmitters



Type MO-71 with 2-3 watts output and Type MO-45 with 8-10 watts output. Both types are class B modulated and extremely stable in operation. Either unit wired and tested for 56 MC. complete with tubes, \$29.50
RK-20 Power Amplifier as described in QST for August, complete with two tested tubes and coils for one band, \$69.50
Transceivers for 56 MC. work 2-volt, \$18.75. 6-volt, \$17.95

Write for our latest Bulletin describing the above equipment

HARVEY RADIO LABORATORIES
12 Boylston St. Brookline, Mass.

issuing a ham news sheet. . . . We are interested in compiling a list of club bulletins. . . . Does your club have one? . . . Activities Managers: Why not line up your clubs for intra-club competition in national contests this season? . . . It adds interest. . . . Secretaries: Let us hear from you . . . soon . . . with some good dope on your clubs. . . .

Visit the Clubs

One good feature of the majority of ham clubs is that they don't require a visiting ham to produce a long list of credentials before entering the club portals. By and large, any ham is welcome at any ham club, so don't be bashful about dropping around to your local society. Clubs are splendid places to get acquainted with other amateurs and to participate in interesting discussions on amateur radio. At headquarters we have recorded the addresses of the several hundred amateur radio clubs affiliated with A.R.R.L., their places and times of meeting. Do you want to be put in touch with a club in your vicinity? Would you like to attend a club meeting in another city you are visiting? Address the Communications Manager (enclosing 3¢ stamp, please) for data on Affiliated Clubs in your vicinity.

—E. L. B.

Amateur Radio in the U. S. S. R.

(Continued from page 28)

trical work. Code speed must be 16 words per minute, but this is reduced to 10 in the case of workers in productive industry and party members. Operation may be on 5, 10, 40, 80, and 160 meters with 40 watts in the antenna. By special permission of the C.B.S.K.W., 20 meters may also be used. There are no time or power supply limitations. This category contains about four fifths of the amateurs of the Soviet Union.

The examination for the first or highest category requires, in addition to the material demanded for the second category, a more fundamental knowledge of tube operation, tube characteristics and parameters, and the use and operation of quartz crystals. Included are also questions on electric motors, dynamo machinery, and even on the internal combustion engine. An amateur applying for a telephone license has additional questions on modulation and microphones. A note in the examination program requests that the examiners refrain from giving catch questions—not a bad idea on any exam. The first category, which takes in about 14 percent of the amateurs, carries privileges of operation on 5, 10, 20, 40, 80, and 160 meters and the use of up to 100 watts in the antenna. Time of work is unlimited. Further, these amateurs acquire the right to take part in polar and other scientific expeditions of All-Union importance and the right of teaching in all courses organized by the Society of Friends of Radio. These societies hold regular meetings during the winter

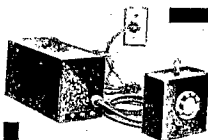

UNIVERSAL MODEL "G"

A completely assembled, ready-to-use condenser microphone unit
— All A.C. operated — Nothing to add — No batteries or battery expense, yet guaranteed as silent as batteries. Just plug into 110 v. A.C. 50-60 cycle socket and be assured of trouble-free, full-satisfaction performance — 2 stage amplifier with No. 230 tubes — barometric adjustment — temperature compensator — shielded diaphragm — Frequency response 70 to 7,000 cycles — Engineered by Universal to guarantee maximum results at the lowest price consistent with Universal standards.

Dealers Net Cash \$49.39

UNIVERSAL MICROPHONE CO., LTD.
424 Warren Lane Inglewood, Calif., U.S.A.

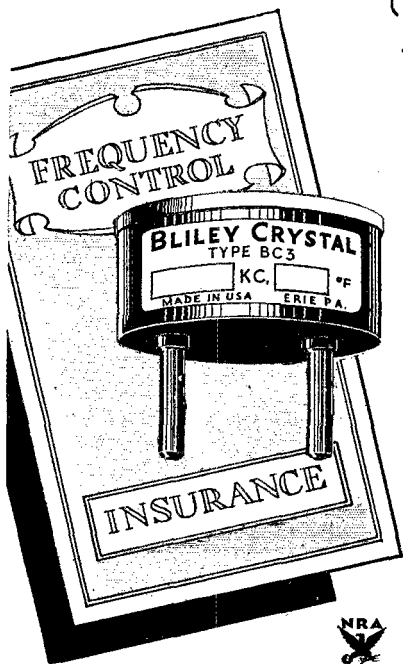

Frequency Stability is INSURED with BLILEY CRYSTALS

Starting with raw Brazilian quartz of the highest quality obtainable, Bliley's modern manufacturing methods produce the finest crystals possible. Over 20 separate inspection tests insure perfect operation of every crystal that leaves the Bliley plant.

That's the reason why Bliley crystals are backed with a guarantee of satisfaction. That's the reason, too, why thousands of amateurs all over the world depend on Bliley Crystals for frequency stability and high power output.

Type BC3 mounted crystals in the 3.5 and 7.0 Mc bands having a precision of .03% supplied within 10 Kcs or any frequency from distributor's stock, **\$3.95**—to exact specified Kc at slight additional cost. Bliley Crystals are sold by all progressive distributors of amateur equipment. If our distributor doesn't have your choice in stock, he can get it for you quickly, order from him. Bliley Electric Company, 208 Union Station Building, Erie, Pa.

Bliley Standard Quality Crystals Used by Byrd Antarctic Expedition

"Quicker than a Short circuit" **LITTELFUSES**

- INSTRUMENT LITTELFUSES, for meters, $\frac{1}{200}$ amp. up.
- HI-VOLT. LITTELFUSES for transmitters, etc., 1,000, 5,000 & 10,000 volt ranges, $\frac{1}{16}$ amp. up.
- NEON VOLTAGE FUSES & Indicators (TATTELITES), 100, 250, 500, 1,000 & 2,000 volt ratings.
- AIRCRAFT FUSES, AUTO FUSES, FUSE MOUNTINGS, etc. Get new Cat. No. 6.

Littelfuse Labs., 4509 Ravenswood Ave., Chicago, Ill.

GULFRADIO SCHOOL

Radiotelegraphy Radiotelephony
Radio Servicing

SECOND PORT } 1007 Carondelet Street
U. S. A. } NEW ORLEANS, LA.

QST! QST! QST!

Schwartz offers new equipment at the right prices

- Thordarson output, coupling 46 or 59 plates to 5M (100 M.A.) or 10M (50 M.A.) ohm loads.....**\$3.82**
- Thordarson input, coupling 46 or 59 to P.P. 46 or 59 grids.....**\$2.35**
- Thordarson input to couple a 30 in class A to class B 19 grids-shielded.....**\$1.62**
- Thordarson output to couple a 19 in class B to 2700 ohm load-shielded.....**\$1.76**
- Bliley BC3 mounted Xtal 7.0, 3.5 MC band.....**\$3.95**
- Hammarlund Midget Condensers; 50 mmf. 94c; 100 mmf. **\$1.32**; 140 mmf.....**\$1.47**
- National Midget Condensers — 40% off list.
- National R. F. Chokes, type 100, $2\frac{1}{2}$ M.H. — 125 M.A.....**\$.45**
- Transceivers stocked — Harvey, Haigis, Jacobs.

20% deposit with order, balance C.O.D. Only M.O. accepted.

Write for prices on parts interested

M. Schwartz & Son

710-12 Broadway

Schenectady, N. Y.

I AM A MURDERER . . .

of NOISE. I can't stand disturbing clicks, buzzes and crashes. I kill noise before it enters the radio set I protect. I do, however, allow the full signal strength of all radio stations to enter. I am the new, patented and guaranteed

**LYNCH
"HI-FI" SIMPLEX ANTENNA
SYSTEM**

(where you have all the room you want) and the

**"HI-FI" DUPLEX ANTENNA
COUPLING SYSTEM**
(for limited space)

Both systems have noise-reducing properties on wave lengths from 5 to 600 meters impossible of attainment by other systems. No tricky spreading, cumbersome metal tubing or masts. Installation is simplicity itself. One system is a complete kit—the other can be used with any existing aerial. **INVESTIGATE**

At Leading Radio and Dept. Stores,
or Write Us for Full Details

ARTHUR H. LYNCH, INC.
227 Fulton St., New York, N. Y.

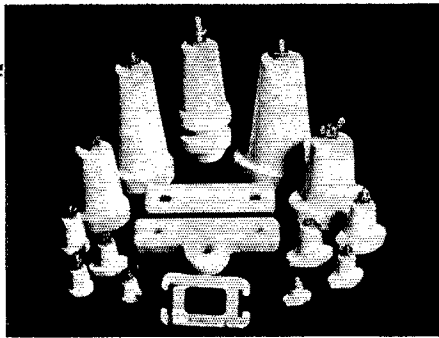

New BIRNBACH

MOST COMPLETE LINE **Standoffs**

BIRNBACH announces the most complete line of white and brown, highly-glazed porcelain Standoff Insulators available. 30 different types (including 56 new numbers) from 5/8" to 4 1/2" high.

Standard and "Feed-Thru" models, wingnut, plain or jack. Nickel-plated brass hardware. Cork mounting washers. Compact—Rugged—Safe! Also new high-resistance Doublet Antenna Insulators and Transposition Blocks, with exclusive features.

Write Dept. Q-10 for Complete Data Sheets
BIRNBACH RADIO CO., INC.
 145 Hudson Street New York City

Are You "Stuck"? LEARN CODE QUICKLY AND EASILY AT HOME

*Become a Skilled Amateur
 or Com'l Radio Operator.*

Watson, WIBGL, op Bear of Oakland, Byrd Expedition, says: "Candler training helped me to pass rigid competitive tests for this position."

Many Instructors and ops in U. S. Army, Navy and Aviation were Candler trained.

The FASTEST and most SKILLED Amateurs and Commercial ops during the past 23 years were Candler trained. 9 year old Jean Hudson won championship in Class "E" 2 months after beginning our Code Course for Beginners. McElroy was Class "A" Champion for 13 years.

If you're wise you'll get your SPEED where the champions got theirs and prepare for that Amateur or Commercial Ticket the CANDLER SCIENTIFIC WAY. It's EASY and INTERESTING.

CANDLER STUDENTS NEVER FLUNK. Tell us what ticket you're preparing for and we'll show you how easy it is to obtain.

SEND FOR BOOK OF FACTS for Radio Ops, Amateurs and Beginners. Your questions answered promptly. No obligation.

CANDLER SYSTEM CO.
 Dept. Q-10 6343 S. Kedzie Avenue, Chicago

Candler System Code Guild

An organization of CANDLER trained ops sending practice programs daily from their stations all over the U. S.

Bec o m e a C S C G M e m b e r. We furnish Schedules listing all C S C G stations, time on the air, speed 8 to 45 wpm.

You can bring in C S C G Practice Programs with your S.W. Receiver. This is REAL practice that costs you nothing. There is no substitute for it. CANDLER trained ops will help you develop your code technique.



months and, although technical discussions are the rule, courses of instruction are given if there is sufficient demand.

Many short-wave sections publish "ham sheets" with reports of tests and activities. The one which I saw from the Leningrad district was a mimeographed publication of about two dozen pages and done in approved ham fashion. Q signals and familiar amateur abbreviations appeared often along with the Russian. The most popular radio journal is "Radiofront," and enjoys a very large circulation. It is issued twice a month and a portion of each copy is devoted to a section called "Short Waves," which carries material of particular interest to the amateur. Technical articles, amateur news, and station write-ups are included.

Collective or club stations in which the apparatus is pooled by the members are quite popular. Equipment cost is not so high, however, but that a person of moderate means can afford his own station. The Soviet workers are paid in the so-called "paper rubles" which through governmental control have no foreign exchange value. One is accordingly forced to buy only domestically available equipment which is all of Soviet manufacture. Parts, especially indicating meters, are apt to be quite liberally proportioned. As is always true among hams, a good portion of the gear is home-made. There are many radio shops where complete broadcast receivers, individual parts, and accessories can be purchased. Some equipment is very modern; some quite old—much reminding one of 1925 radio in America. As is generally true in Europe, broadcast receivers with regenerative detector are common. A loud-speaker jutting out from a store-front or second-story window is a fairly frequent sight, but the reproduction is usually not so "hot." Public address systems are numerous, especially in the larger railroad stations. In radio shops—as in every shop or store—there is an abacus, a calculating device usually about a foot square having a set of parallel wires on which to shove wooden beads back and forth. Judging from their frequent use, it would seem that a Russian store-keeper without his abacus is almost as bad off as an American engineer without a slide-rule.

Station layouts vary considerably, but the QSL card acts in its capacity of wallpaper almost everywhere. Receivers are of rather simple design using 2 or 3 tubes. A detector and audio is common with two tubes; but a third tube as tuned r.f. makes a popular arrangement. Although the simpler types of transmitter are still common many hams have crystal-controlled or CO-FD-PA rigs. The rack and panel arrangement is much used. Transmitting tubes rated at from 20 to 150 watts are available. The single wire-fed antenna is known as the "American type" and enjoys much popularity. On June 1st the Soviet amateur districts were renumbered and the amateur call letters reassigned.

For the operation of an amateur station a small fee is charged. This includes the privilege of a broadcast receiver which ordinarily requires a fee of its own. The handling of messages is prohibited

RME-9D SINGLE SIGNAL SUPER

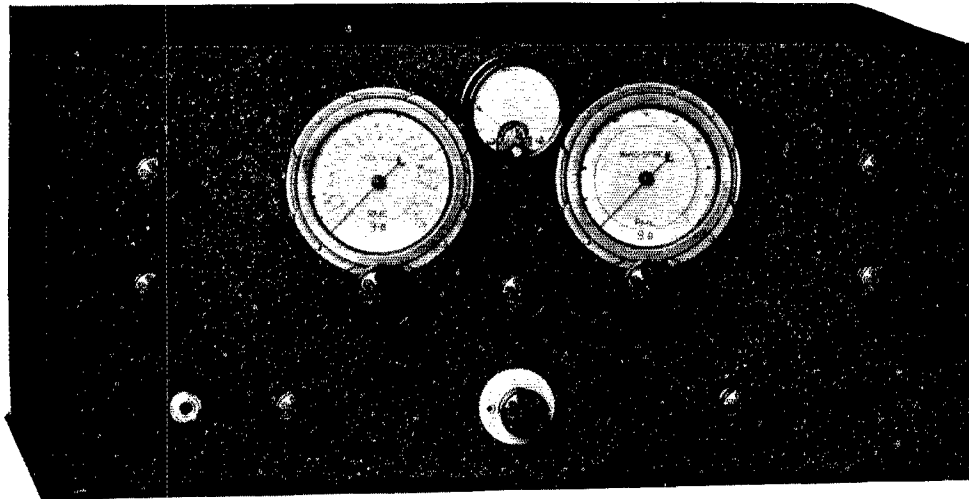

Incorporates a highly selective tuned rf stage, series-parallel quartz crystal filter, tone control, phone monitor, audio-beat oscillator, carrier current indicator or R-meter, automatic and manual volume control, continuous band-spread from 13 to 550 meters, built-in coil switching arrangement and power supply, all in one cabinet. Send 10c for folder 10A fully describing this outstanding receiver. Absolutely guaranteed in every respect.

RADIO MFG. ENGINEERS

313-315 BRADLEY AVENUE

PEORIA, ILLINOIS

RADIO ENGINEERING

RCA Institutes offers a combined course of high standard embracing all phases of Radio. Practical training with modern equipment at New York and Chicago schools. Also specialized courses and Home Study Courses under "No obligation" plan.

Illustrated catalog on request

RCA INSTITUTES, INC. Dept. ST-34

75 Varick St., New York. 1154 Merchandise Mart, Chicago
Recognized Standard in Radio Instruction Since 1909



PANELS — BAKELITE — RUBBER — ALUMINUM

All Sizes Cut to Order **BAKELITE TUBING & RODS**
Drilling, Engraving & Special Work
ALUMINUM CANS—Stock sizes. Special sizes, made to order.
ALUMINUM CHASSIS—Threaded brass studs for 6/32 screws.
Length from 1/2" to 6"—price 5c to 30c.

Insulating bushings
for all size shafts

Couplings in brass
or Bakelite—15c

UNITED RADIO
MFG. CO.

Transmitting frames and racks
Est. 1923 191 Greenwich St., New York



JOIN THE LEAGUE!

See page 116

CQ—AMATEURS of the West

Just off the Press, send for your copy

1934 CATALOG

All Nationally advertised parts
for Transmitting and Receiving
Lowest Prices

RADIO SUPPLY CO.

H. A. DEMAREST, President

912-14 So. Broadway Los Angeles, Calif.
(W6FBI, located in Buildings)

PRECISION CRYSTALS



Crystal Holder

A Plug-in, dustproof holder included with each amateur band crystal purchased.

PRECISION Crystals are of the highest quality obtainable. Only after they have undergone a most rigid test and check up to the requirements of an A-1 crystal are they sent out to you with our guarantee of the finest obtainable.

PRECISION Crystals are X cut, one inch square from the finest quality of Brazilian quartz and carefully ground for maximum power output. They will be supplied to your specified frequency accurate to 0.1% and calibrated accurate to within .03%. It will pay you to buy these quality crystals. 1750 and 3500 kc. bands — \$4.50 ea. 7000 kc. band \$5.00. (Above prices include holder illustrated.) Holder alone — \$1.50. Jacks to plug holder into — .15 pair. (The holder will plug into a 5 prong tube socket when the springs are removed from the plugs.)

Crystals and overs for commercial use quoted on at your request. When ordering our product you are assured of the finest obtainable. Now in our 5th year of business.

PRECISION PIEZO SERVICE

427 Asia Street

Baton Rouge, La.

Make the Every of them Best make... Cornell Dubilier Corp. New York, N. Y.



CORNELL DUBILIER Devices

PRICE LIST
No. 126

1910 1934

The Answer to Consistent DX "Ham" Transmission

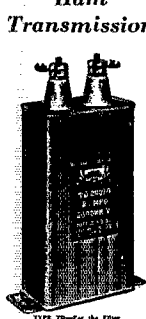

You Can Get All the "Dope" on These Units from Your Supplier. Ask Him for Catalog 126—Just Out

Dear OM:
The experience of nearly a quarter-century of specialization incorporated into the design and construction of our condensers can mean only one thing—that you get the very greatest value for your money.
Sigs. W2AFS

CORNELL-DUBILIER CONDENSERS

Made and Fully Guaranteed by the World's Oldest, Largest Exclusive Condenser Manufacturing Organization

CORNELL-DUBILIER CORPORATION
4378 Bronx Blvd., New York, N. Y.

WHEREVER QUALITY CONDENSERS ARE USED

with the exception that the local sections and the central bureau offices of the S.K.W. may make use of the amateur relay services. In foreign QSOs the international ham lingo is used, but in contacts within the Union the amateur can also transmit in Russian by means of the same code symbols. Certain letters or their equivalents are common to both the Latin and Russian alphabets. For example, the Russian "Ø" is equivalent to the "F" of the Latin alphabet and is designated by "ditditdahdit." All of the 26 code symbols for the English alphabet are used, as well as a number of the symbols for foreign letters (French é, German ä, etc.) to make up the 33 letters of the Russian alphabet. Thus, with one set of code characters the Russian amateur has at his disposal a choice of two alphabets.

In my visit to the Soviet Union I did not meet any amateur who spoke more English or German than I did Russian, which was about nil. The international amateur lingo and abbreviations were, of course, in common, but the pronunciation often was not. Accordingly, it was the rule to speak through an interpreter if one wished to do much extended conversing. But it was frequently possible to work directly by whistling the code. This was great sport and always a source of amusement to the interpreter that we had a language in common he couldn't "savvy." Nearly all of the abbreviations are interpreted in the same way as we do. Some have assumed a bit of variation, however. Thus, "TFC" does not signify messages, but merely a QSO.

Having visited a number of amateur stations, I expressed a desire to see a broadcasting station, and a visit was promptly arranged. The one visited is situated somewhat north of Moscow and required an auto trip of about 35 kilometers to reach it. The road to the station was a real workout for any car, and reminded me in places of a complex wave shape. The station house was found to contain a 100-kilowatt job using sixteen 50-kilowatt water-cooled tubes as a final envelope or essentially Class-B amplifier. It so happened that I had arrived at a time when the transmitter was not scheduled to be on the air. After inspecting the workings and being shown around in great style, the engineer turned on the station for a few minutes—100 kilowatts and all—to demonstrate its operation a bit more vividly. The rustling sound of water swirling through the tubes at full pressure and neon bulbs glowing at many points throughout the transmitter helped a lot to complete the picture. A 20-kilowatt short-wave broadcasting station was also situated in the same building.

During my trip of over 3000 miles in the Soviet Union the fact that I was a ham proved of great value many times. It opened the way for many contacts which helped make the trip more enjoyable. During a stay of three months in Germany the same was also true. One soon discovers that amateurs everywhere are the same fine group of fellows—always willing to go out of their way to be cordial and obliging. It is a real privilege to belong to such an international organization as is that of the "radio hams."



NUTS . . . are not the only things that come from Brazil . . .

Every piece of Crystal used in our laboratories is specially selected from the choicest BRAZILIAN Quartz which is the highest quality obtainable.

PIEZO ELECTRIC CRYSTALS

We guarantee our Crystals to be ground to an Accuracy of BETTER than .03% . . . BUT . . . No Crystal ever leaves our Laboratories unless it is ground to an Accuracy of BETTER than .01% of your specified frequency in order to meet OUR OWN Specifications.

"THE CRYSTAL SPECIALISTS"
Send for Booklet and Price List

Scientific
RADIO SERVICE
124 Jackson Avenue, University Park
Hyattsville, Maryland, Q-10

YOUR CREDIT IS GOOD AT DELAWARE RADIO

Modernize your amateur station on the Del-Rad Payment Plan, and assure yourself a real DX season.

THE NEW

NATIONAL HRO

List \$233.00 Net cash \$139.80

DOWN PAYMENT ONLY \$41.45

FBXA DOWN PAYMENT ONLY \$21.90

We are authorized distributors for all nationally known receivers, transmitters and parts.

THE NEW 1935 MODEL

HAMMARLUND SUPER-PRO

Complete with 15 tubes, external Power Supply, 2 r.f.-31F-AVC-PP output — 12" dynamic speaker, band switching.

LIST \$280.00

DOWN PAYMENT ONLY \$52.00

"Your present NATIONAL or HAMMARLUND will be accepted as a partial payment"

WE ALSO HAVE AN ATTRACTIVE PAYMENT PLAN ON

PATTERSON—RME9—COLLINS TRANSMITTERS—ROSS JUPITER—MCMURDO SILVER 5C—RCA DEFOREST—THORDARSON—GROSS and Many Others

Send for complete details at once, stating your needs

DELAWARE RADIO SALES COMPANY

405 Delaware Avenue

Established 1920

Wilmington, Delaware

IN STOCK

the new PATTERSON PR-12

latest 12 tube S.S. amateur receiver with all latest features at a very low price. Write for full information.

AND

the new NATIONAL HRO

10 tube S.S. amateur receiver with revolutionary improvements shown pages 71 and 72 of this QST at 40% off the list prices.

TRADE IN YOUR RECEIVER ON THE LATEST MODEL
Also all other National, Comet Pro, RME9D, Silver, and Sky rider receivers and all other amateur apparatus at the lowest wholesale prices. We buy, sell, trade used apparatus in good condition, too.

Every inquiry and order is personally attended to by Robert Henry, W9ARA; an active amateur for ten years; an E.E. from M. I. T.; and owner of Henry Radio Company selling amateur apparatus for six years. Your orders are valued and appreciated. Write for any information.

HENRY RADIO COMPANY

211-215 North Main St.

Butler, Missouri

Radio Operating Radio Servicing—



Prepare for the new Government Radio Operating license examinations; Radio Operator, Marine and Broadcasting. Also Radio Amateur Telegraph and Telephone. Resident courses.

Write for Booklet

NEW YORK YMCA SCHOOLS
4 West 63rd Street, New York City

THE PORTAPHONE

A TRANSMITTER-RECEIVER—

FOR THE 56-60 MC BAND

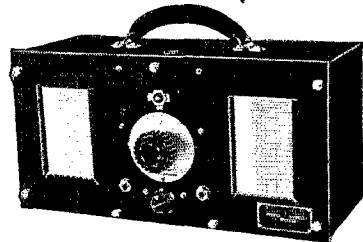

WITH SPACE FOR ALL BATTERIES
INCLUDING 150 VOLTS FOR "B" SUPPLY

Another new Haigis Circuit — Well designed, — Ruggedly Built — Carefully Tested — Leather Carrying Handle — Card holders for field notes or logs. Uses a 30 and a 33.

COMPLETE INSTRUCTIONS

\$13.50 NET

TYPE AM DELUXE MODEL

with all its additional features — capable of supplying .100 amp. to Antenne — As previously advertised in QST.

\$19.20 NET

THE HAIGIS LABORATORIES, INC.
MAPLE SHADE, N. J.

Help

THE NEW ELECTRAD CATALOG includes the latest developments in Resistors and a remarkable new replacement Volume Control, built on a radically improved engineering principle.

A copy FREE
FOR THE ASKING

Write Department Q-10



LOOK!!!

We will let these bargains do the talking for us

- Thordarson 210 Transformer
2-7½ volt @ 2¼ amp. 1-3 volt @ 7 amp.
550-0-550 at 140 MA..... \$1.95
- Thordarson T2387
2000-3000 C.T. 300-VA. 23 lbs..... \$7.45
- Thordarson T2230
115 volt Pri. 7¼ volt @ 4.7 amp..... \$1.95
- Thordarson T1998 choke
20 H. @ 200 MA..... \$1.25
- Thordarson T1700 choke
30 H. @ 150 MA..... \$.95
- Chicago Transformer
2¼ volt @ 10 amp. for 866's..... \$.95
- Thordarson T2099 choke
Double 25 H. 150 MA. each..... \$1.10
- Thordarson T3624E
730 V. C.T. @ 100 MA.
2¼ V. @ 3 amp. 2¼ V. @ 9 amp. 5 V. @ 2 amp. Static
shield..... \$2.45
- Thordarson T3952B
345-0-345 @ 105 MA.
2¼ Volt @ 12 amp. 5 Volt @ 2 amp..... \$1.95
- 15 Watt 210 Transmitting tubes @..... \$.75
- Corp. of America 2 mfd. @ 600 volt..... \$.49
- R. C. A. 800 Tube..... \$10.00
- R. C. A. 866A Tube..... \$5.00
- R. K. 20..... \$15.00
- Sylvania 830B..... \$10.00

These are examples of what we can furnish you. We also carry a complete line of standard brand parts. All merchandise carried in stock. No Substitutions! Four hour service! Write for new fall catalogue.

NEWARK ELECTRIC COMPANY

226 W. Madison Street Chicago, Illinois
Dept. Q John Wallace, Technical Adviser

Standard Frequency Transmissions

Date	Schedule	Frequency	Date	Schedule	Frequency
Oct. 3	BB	W9XAN		A	W9XAN
Oct. 5	BB	W6XK	Nov. 3	BX	W6XK
	A	W9XAN	Nov. 4	C	W6XK
Oct. 6	BX	W6XK	Nov. 9	A	W6XK
Oct. 7	C	W6XK	Nov. 16	B	W9XAN
Oct. 12	A	W6XK		B	W6XK
Oct. 19	B	W9XAN	Nov. 21	C	W9XAN
	B	W6XK	Nov. 23	B	W9XAN
Oct. 24	C	W9XAN		A	W6XK
Oct. 26	B	W9XAN	Nov. 28	BB	W9XAN
	A	W6XK	Nov. 30	BB	W6XK
Oct. 31	BB	W9XAN		A	W9XAN
Nov. 2	BB	W6XK			

STANDARD FREQUENCY SCHEDULES

Time (p.m.)	Sched. and Freq. (kc.)		Time (p.m.)	Sched. and Freq. (kc.)	
	A	B		BB	C
8:00	3500	7000	4:00	7000	14,000
8:08	3600	7100	4:08	7100	14,100
8:16	3700	7200	4:16	7200	14,200
8:24	3800	7300	4:24	7300	14,300
8:32	3900		4:32		14,400
8:40	4000				

Time (a.m.)	Sched. & Freq. (kc.)	
	BX	
6:00	7000	
6:08	7100	
6:16	7200	
6:24	7300	

The time specified in the schedules is local standard time at the transmitting station. W9XAN uses Central Standard Time, and W6XK, Pacific Standard Time.

TRANSMITTING PROCEDURE

The time allotted to each transmission is 8 minutes divided as follows:

- 2 minutes—QST QST QST de (station call letters).
 - 3 minutes—Characteristic letter of station followed by call letters and statement of frequency. The characteristic letter of W9XAN is "O"; and that of W6XK is "M."
 - 1 minute—Statement of frequency in kilocycles and announcement of next frequency.
 - 2 minutes—Time allowed to change to next frequency.
- W9XAN: Elgin Observatory, Elgin National Watch Company, Elgin, Ill., Frank D. Urie in charge.
W6XK: Don Lee Broadcasting System, Los Angeles, Calif., Harold Peery in charge.

WWV 5000-Kc. Transmissions

The 5000-kc. transmissions of the Bureau of Standards' station, WWV, are given every Tuesday continuously from 12:00 noon to 2:00 p.m., and from 10:00 p.m. to midnight, E.S.T. These transmissions are accurate to ½ cycle (one in ten million).

—J. J. L.

Silent Keys

It is with deep regret that we record the passing of these amateurs:

- Frederick E. Foggin, W1DAI, Melrose, Mass.
- Mrs. Eva G. Hines, W9JZT, Aurora, Ill.
- Charles F. Holsopple, W8CON, Johnstown, Pa.
- John Riddoch, W2BCQ, Pleasantville, N. Y.

***** THE RADIO SHACK *****
 PURE DC WITH
PYRANOL TRANSMITTING CONDENSERS \$2.50
 2 MFD-2000 V.
 Hams—Broadcast Stations and Laboratories, note: these will not be available for long

TRIAD TUBES

210.....	\$1.25
281.....	1.25
250.....	1.25
83.....	.55
46.....	.60
841.....	2.50
SYLVANIA 210..	5.75

5-METER SPECIALS

Audio Trans. with mike winding....	\$1.20
Output Trans.....	.90
4P D.T. Switch.....	.84
SICKLES 5-Meter KIT.....	1.20
KENYON K.R. 79 and 79M, each..	1.50

Bliley Mtd. Xtal. New Low Price...	\$3.95
866's H.D.....	\$1.69
2 1/2 V-12 Amp TRANSFORMER for 866's.....	\$1.25
V.T. 203A.....	\$9.00

***** COMPLETE STOCK OF CARDWELL *****

PARTS FOR ALL STAR SUPER IN STOCK

R.C.A. (Used) 219D....	\$15.00
R.C.A. (Used) 204A....	25.00
R.C.A. (Used) 849....	30.00

BALDWIN TYPE "C" PHONES....	\$ 2.50
R. C. A. 860 (used).....	12.00
R. C. A. 852 (used).....	14.00
TRIPLET METERS 0-5 to 0-500 mills. 3 1/2" Bakelite case.....	\$3.75

GAMMATRON No. 354.....	\$24.50
<i>Eastern Distributors</i>	
LIFETIME D.B. Mike.....	\$2.95

Mail Orders Filled
 Send Money Order or Check

THE RADIO SHACK
 46 BRATTLE STREET
 BOSTON, MASS.

Foreign friends, please note—
 we cannot ship C.O.D. Send
 Money Order or Draft

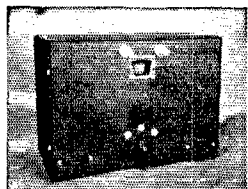

POWER and PORTABILITY
 19 TYPE CLASS B MODULATED
56 M.C. TRANSCEIVER
 As described in June Q.S.T. by Frank Jacobs, W2BSL

Equivalent of 5 Tubes — One 30, Two 19's
 Strong voice when Flea Power Signals fade out. Completely dry battery operated, 2 volts filament, 135 volts plate. Fil. voltage control compensates for battery deterioration. Rugged crackle finish metal case — 10 x 7 x 5 inches. Weight 7 1/2 pounds. Verner dial. — Cardwell tuning condenser.

All Orders Receive the Personal Attention of the Original Designer
 Net Price \$22.50 — 3-Raytheon Tubes, \$1.90
 20% with order — balance C.O.D.
RADIO TRANSCEIVER LABORATORIES
 8427-105 Street Richmond Hill, N. Y.

★ CONTINUOUS BAND-SPREAD ★

ALL-STAR FREE
 ALL-WAVE Superheterodyne CIRCUIT AND PARTS LIST

You can start for only \$2.50 and buy as you build. When done, you will own a super with these outstanding features — 6-Tube Super Circuit, Continuous Band-Spread, 10 to 500 meter (no skip) range, Airplane dial, Tone control, Built-in power supply for AC operation and many others.

Write for our free catalog

CAMERADIO
 603 GRANT ST.
 PITTSBURGH -- PA.

JOIN THE LEAGUE!
 See page 116

FASTEST WAY TO LEARN CODE

Easy, Fascinating
LEARN BY EAR
 to Be a Good Op!



The New MASTER TELEPLEX Code Teaching Machine is exactly what thousands are looking for. Has taught code to more operators in past 10 years than all other "systems" combined. No experience needed. Ideal for beginners — steps up w.p.m. for all ops. Teleplex doesn't merely "show" you code — it IS code! You actually HEAR the dots and dashes, any speed you want. You learn code the way you'll be using it — by **FREE BOOK SOUND!** Teleplex also sends back to you; impossible with any other system. Complete Code Course included, no extra charge. Used by U. S. Army, Navy, R.C.A., A.T. & T. Co., and others. Low cost, easy terms, *Money-Back Guarantee*. Send now for booklet Q. 22, no obligation. Postcard will do.

TELEPLEX COMPANY
 76 Cortlandt St. New York, N. Y.

THORDARSON

GET READY FOR FALL!

Put new pep into your "rig"
before the big transmitting
season starts!

When things start humming this fall, you will want to join the ranks of amateurs using the new THORDARSON Super Power Equipment. Whether you are planning to use a full kilowatt of power or a tiny transceiver for five-meter work, you will find the new fall THORDARSON line is more than complete—it introduces many important innovations in transformer equipment that will give you more distance per watt and more watts per dollar.

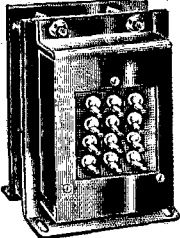

JUST OUT!

The new fall 1934 THORDARSON Catalog No. 343-A is now ready. It shows an even more complete line of Transmitting Plate, Filament, and Audio (Class A and B) Transformers. Ask your jobber or mail the coupon today for your FREE copy.

TRANSMITTING GUIDE

Thirty-two pages of worth while data! Contains circuit diagrams for modern, complete transmitters employing newest tubes in improved circuits. Get your copy FREE from your jobber with an order for THORDARSON Transformers, or mail 10c in stamps.



NEW SOUND EQUIPMENT

Use coupon below for full details of the new complete line of THORDARSON Public Address and Sound Amplifier Equipment.

Write for FREE Fall Catalog

THORDARSON ELECTRICAL MFG. COMPANY

500 W. Huron St. Dept. B Chicago, Illinois

Please send the following new THORDARSON Literature:

- FALL 1934 Transmitting Catalog No. 343-A (FREE)
- THORDARSON Transmitting Guide No. 344 (10c enclosed)
- New FALL Receiver Replacement Transformer Catalog No. 341-A (FREE)
- Sound Amplifier Equipment Catalog No. 345-A (FREE)

Name

Address

Ultra High Frequencies

(Continued from page 13)

CKV, Lowell; GMT, Newton; FZU, Fall River; DPW, Maynard; AIP, Fall River; HMA, Brockton; IFC, Worcester; DEI, Natick; KH, Weston; ZJ, Worcester; DPP, Concord; FEM, Danvers; IFB, Lawrence; AKE, Lowell; DDM, Framingham; XZ, Seabrook, N. H.; ACH, West Newton; BME, Medford; ZO, Medford; HTR, East Walpole; EAQ, Beverly. We also express our thanks to WIGUY and W1HDQ of Springfield, who spent many hours testing and observing on our behalf.

A PLEA FOR HELP

Now, all of this work is fine in its own way, but it is taking place, at present, in only one locality. What we want and want pronto, are enough fellows to duplicate these antennas so that we can begin to get observations over wide areas. How about some of you 56-mc. enthusiasts in other parts of the country getting into this so that we can begin to go places. We are getting results in our part of the country and getting them sufficiently consistently to lead to a strong suspicion that the rest of the gang can do similarly. Cleveland to Columbus is about the same distance; so is Columbus-Cincinnati, and Pittsburgh-Cleveland, and scores of other cities we can think of. For all we know, the range is actually much greater than our 130-odd mile maximum; Boston is as far away as our beam goes before it hits the Atlantic. We have no reason for thinking that the signals are not good for another 50, 100 or 200 miles more.³ That's where cooperation from you, gang, is needed. Get going and find out just what all this means and what we can do about it. And how about beginning to work up some inter-city trunk lines and maybe even a trans-con.! It may be impossible, but we should at least find out. A flock of directive antennas with some real effort and reports of all work being sent in here to Headquarters will enable us to get at the bottom of the matter in short order. We've always said that we hams have the advantage in such experimental work because of the great number of stations we can enlist in a given project. Here's one that offers all sorts of possibilities. Get going, gang!

³ As we go to press, an R6 report is received from W1EWN at Portland, Me.—200 miles or so.—EDITOR.

A New System of Reports

(Continued from page 19)

to copy through atmospherics. If fading is bad a report can be sent thus, "Ur RST 3 5/2 8." This shows that the signal fades from "very strong" down to "weak," making reading difficult, despite a good d.c. note. After the system has become well established the sending of "RST" before the numerals can be dispensed with, if desired. However, until such time, the sending of "RST" before the numerals is strongly urged, so that the listener may know what

MID-WEST RADIO MART offers you FREE WORLD'S LARGEST SHORT-WAVE CATALOG

4-Hour Service

From the big MID-WEST stocks. Every order shipped with guarantee of full satisfaction or your money back.

Send your order in today! No matter what your needs may be—we can fill them. Join our thousands of satisfied customers—from every state and many foreign countries!

Get this complete listing of every worth while short-wave part and receiver, including full data on NATIONAL, HAMMARLUND, RCA DEFOREST, THORDARSON, RAYTHEON, WESTON, ELECTRAD, AEROVOX, and countless others.

Be sure to see the hundreds of remarkable values it offers before buying your fall equipment!

MID-WEST RADIO MART

520 S. State St., Chicago, Ill.

Rush me a copy of the big MID-WEST RADIO MART Short-Wave Equipment Catalog with the public address supplement.

Name.....
Address.....

LEARN RADIO

70% Placement Last Three Years

At the oldest, largest and best equipped privately owned radio operating school in the East. Western Electric and RCA tube transmitters; 180 licensed graduates placed in past three years in broadcasting, shipping, police radio, aviation, service work, etc. Course prepares for all U. S. Government Telegraph and Telephone licenses. Send for 40-page catalog. Investigate. New classes every six weeks from Sept. 10th. Open all year around.

MASS. RADIO SCHOOL, 18 Boylston St., BOSTON
R. F. TROP, Treas. — EST. 1899 — G. R. ENTWISTLE, Pres.

ONE OF AMERICA'S LEADING RADIO SCHOOLS

CANADIAN AMATEURS

Have you received your 1934-35 Catalogue of

HAMMOND

Transmitting and Receiving Equipment?

IF NOT, WRITE TODAY — IT'S FREE.

Over 400 Stock Items —

Mic., Line and Interstage
Audios,
Class "B" Inputs and Out-
puts,
Plate and Filament Trans-
formers,

Input and Filter Chokes,
Replacement Transformers,
Wirewound Resistors,
R. F. Chokes, Racks, Panels,
etc.

MADE IN CANADA

HAMMOND MANUFACTURING CO.

GUELPH, ONTARIO, CANADA



WIRELESS and TELEGRAPH INSTRUMENTS

Signal Wireless Keys and Wireless Practice Sets and Telegraph Instruments are built to scientific specifications—and are used by amateurs and commercial operators the world over. Lasting quality. Low prices. Send for circular showing the complete Signal line.

SIGNAL ELECTRIC MFG. CO.
Menominee, Michigan

OFFICES IN PRINCIPAL CITIES

SIGNAL

MANUFACTURERS OF ELECTRICAL PRODUCTS

EXCELLENT

- PRECISION
- STABILITY
- ACCURACY

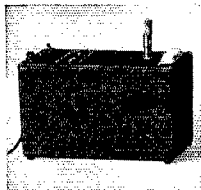

Wide acceptance of the Micrometer Frequency Meter dictates three new frequency ranges, plus the original amateur-band model. For any freqmeter application, investigate the MFM.

LAMPKIN LABORATORIES

146 W. McMillan St.

Cincinnati, Ohio

YOU Can Learn the CODE at Home—
Pass Any Code Test — Talk
with Real 'Hams' at 30 W.P.M.

Use INSTRUCTOGRAPH for Best Results. Code students everywhere disappointed in trying to learn the code from a Short Wave receiver, have turned to the Instructograph with pleasing results. It is almost beyond belief how quickly you learn the code and pick up SPEED this EASY, NATURAL way. Better than a personal instructor. No experience necessary. Instructions accompanying Instructograph make it EASY for beginners. TERMS AS LOW AS \$2 PER MONTH. Rent it a month.

Be convinced that the quickest, easiest way to learn the code and become a real operator is with the Instructograph. Rental may be applied on purchase price if desired. Send postcard for details NOW! No obligation.



INSTRUCTOGRAPH COMPANY

912 Lakeside Place Dept. Q-10 CHICAGO, ILL.

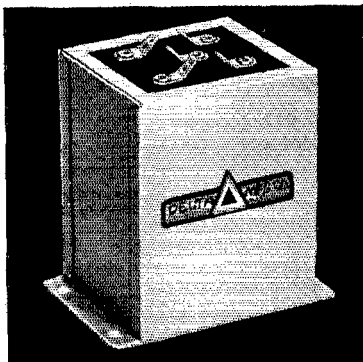

ACME-DELTA COUPLING TRANSFORMERS

R.K. R.K. R.C.A. SYLVANIA
20 18 800 830-B

Input Transformer	Out of	Into	List Price	Output Transformer	Into	List Price
AD 75	2-2A3	RK-18	\$7.50	AD-76	Class C, RF	\$15.50
AD 77	"	800	7.50	AD-76	Class C, RF	15.50
AD 78	"	830-B	7.50	AD-79	Class C, RF	30.50
AD 92	To couple one 45 to R.K. 20 suppr. grid.					7.50

Good power supplies are required with Class B audio. Write for catalog Bulletin QQ48-13. Delta Mfg. Co., 190 Willow St., Waltham, Mass.

F. S. Dellenbaugh, Jr.

Pres. &
Chief Engr.



G. E. M. Bertram
Treas. &
Gen. Mgr.

UNIT OF RAYTHEON MANUFACTURING COMPANY

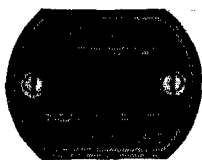

SANGAMO ACCURATE CONDENSERS

Available in 5000 volt construction
for use in short wave transmitters

Write for catalog sheet

SANGAMO ELECTRIC CO.
SPRINGFIELD, ILLINOIS

A GREAT MICROPHONE

... AT LOW COST
SHURE MODEL 5B FULL-SIZE
2-BUTTON MICROPHONE ...

especially produced for amateur
radio-telephone transmitters and low
cost sound systems. Large frames—
full-size precision adjustable buttons.
Diameter, 3 3/4" overall.
List Price \$10

SHURE MODEL 3A Two-Button
Microphone. List Price \$6.50

SHURE BROTHERS COMPANY
Microphone Headquarters

215 W. HURON ST. CHICAGO, U. S. A.

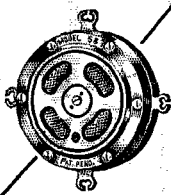

Subject to
Usual Discount
AT YOUR JOBBER

system is being used, and also to firmly establish the proper sequence in the sender's mind.

From the expressed opinions of many radio men and from experience gained in contacts with over six hundred different foreign amateur stations, it is my belief and hope that this new system will be favorably received by amateurs all over the world as a standard method of reporting signals. I wish to acknowledge appreciation to Mr. G. S. Wickizer, W2DOG, for many helpful suggestions during the preparation of this paper.

What the League Is Doing

(Continued from page 21)

in the telegraph division, because it has jurisdiction over all matters relating to record communication by wire, radio or cable, and to it has been assigned authority over the fixed service, the mobile service, amateurs, and almost all the others that the old F.R.C. grouped as "services other than broadcasting." Amateur radio, even though it may be telephony, operates under this division. Commissioner Irvin Stewart, formerly of the Department of State, is chairman of the telegraph division, the other members being Commissioners G. H. Payne and E. O. Sykes, the latter an ex-officio member in his status of chairman of the full Commission. Dr. C. B. Jolliffe has been named as chief engineer, and Lieut. E. K. Jett, long in charge of F.R.C. services other than broadcasting, has been renamed as assistant chief engineer for the telegraph division. Thus our affairs continue largely in the hands of those who have known us well. Commission organization is not yet complete at this writing; there is to be a division director and it is probable that an assistant general counsel will be assigned exclusively to this division. The Commission has reaffirmed all existing radio regulations as its own, and these days is devoting most of its attention to a study of the rates charged by commercial services.

A Pentode Output Transmitter

(Continued from page 27)

rig with the new tubes. The feature that seemed to cause the most interest was the extremely low excitation required by these tubes—that they could be fully excited with but 10 mils grid current for the pair!

The transmitter is now back home again, continuing its semiportable rôle on the 20-meter 'phone band on a farm just north of Boston—where the a.c. supply is from a small gasoline engine driven generator.



The velocity microphone operates to best advantage when held about eighteen inches from the mouth and when the operator is speaking in an ordinary tone of voice. If the mike is close to the mouth, lip noises become too prominent.

—W3ADI

*Technical
Training Station*

Phone C. W.

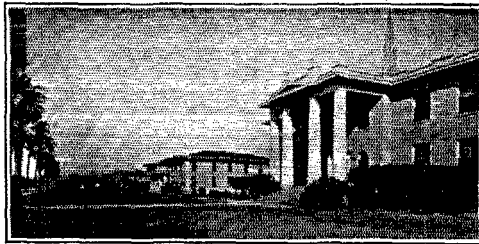

*Studio Technique
Guaranteed*

K P A C

**500-Watt 1260
Kilocycles**

In 3 to 7 months we train you to secure Commercial Telegraph Second-class, and Radiotelephone First-class government licenses. Course consists of Wireless Code, Radiophone, Microphone-Studio Technique, Service, Police, and Aeronautical Radio. We are authorized to teach RCA texts. At completion of course you receive practical studio technique experience in our commercial broadcast studios located in administration building, and experience as an operator on K-P-A-C (500-Watt Commercial transmitter located on the campus and owned and operated by the college), and WPA, 4000-Watt Commercial Wireless Station. Return coupon for details.

PORT ARTHUR COLLEGE

Port Arthur (world-known port) Texas

Name.....
Street or Box.....
City and State.....

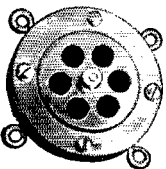

COMET MICROPHONE

A rugged double-button microphone having all the necessary qualities for amateur communication and sound reproduction. Pure 2 1/2 Kt. contacts. Chromium finish. Smooth and wide response. High output. Low hiss level. Money refunded if not completely satisfied. *If your jobber can not supply you, order direct.* Net price: \$2.95

COMET COMPANY
100 Glas Ave., South Bend, Ind.

HAVE YOU SEEN OUR NEW
All-Wave Aerial Kit?

Balanced Doublet System. Anyone can install. Efficient in operation. Local noises eliminated. Low in cost. *Ask us.*

PORCELAIN PRODUCTS, INC., Findlay, Ohio

THE ROSS "JUPITER"

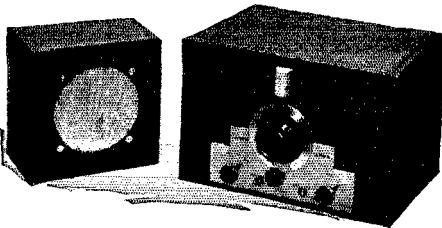

Quality at a moderate price — only \$69.50 (less tubes). A receiver for those who demand the finest in amateur band reception.

A. H. ROSS & COMPANY

Keswick Ave. and Waverly Rd., Glenside, Pa. (Near Phila.)

*There's More than Efficiency
in TRIMM FEATHERWEIGHT
HEADSETS*

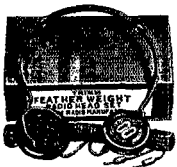

The scientifically designed cap and the lightweight feature allow the phones to be worn "on the ears" for hours without fatigue.

Your Jobber can supply you.

TRIMM RADIO MFG. CO.

The Pacemakers in Headphone Development

1528 Armitage Ave.

Chicago, U. S. A.

NEW ... BETTER

JOHNSON THRU-PANEL INSULATORS

Unusually high mechanical strength and freedom from breakage. High insulation value and long leakage path. **Low Absorption**, highly-vitrified glazed porcelain. Suitable for radio frequency and high voltage low frequency insulation. Milled nuts and nickel plated hardware.

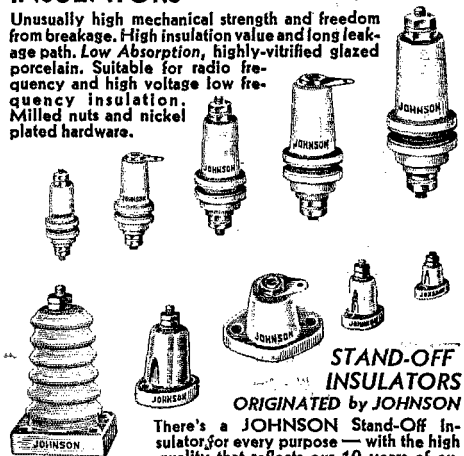

STAND-OFF INSULATORS

ORIGINATED by JOHNSON

There's a JOHNSON Stand-Off insulator for every purpose — with the high quality that reflects our 10 years of experience in their manufacture and development. Full Range of Sizes and Types.

These and other JOHNSON products are available from your regular Distributor.

E. F. JOHNSON COMPANY
Manufacturers of Radio Transmitting Equipment
WASECA, MINNESOTA, U.S.A.

HAM-ADS

(1) Advertising shall pertain to radio and shall be of nature of interest to radio amateurs or experimenters in their pursuit of the art.

(2) No display of any character will be accepted, nor can any special typographical arrangement, such as all or part capital letters be used which would tend to make one advertisement stand out from the others.

(3) The Ham-Ad rate is 15c per word, except as noted in paragraph (6) below.

(4) Remittance in full must accompany copy. No cash or contract discount or agency commission will be allowed.

(5) Closing date for Ham-Ads is the 25th of the second month preceding publication date.

(6) A special rate of 7c per word will apply to advertising which, in our judgment, is obviously non-commercial in nature and is placed and signed by a member of the American Radio Relay League. Thus, advertising of bona fide surplus equipment owned, used and for sale by an individual or apparatus offered for exchange or advertising inquiring for special equipment. If by a member of the American Radio Relay League takes the 7c rate. An attempt to deal in apparatus in quantity for profit, even if by an individual, is commercial and takes the 15c rate. Provisions of paragraph (1), (2), (4) and (5) apply to all advertising in this column regardless of which rate may apply.

Having made no investigation of the advertisers in the classified columns, the publishers of *QST* are unable to vouch for their integrity or for the grade or character of the products advertised.

MICROPHONE and meter repairs. Low prices. Quick service. Sound Engineering Corp., 416 N. Leavitt St., Chicago, Ill.

RADIO engineering, broadcasting, aviation and police radio, servicing, marine and Morse telegraphy taught thoroughly. All expenses low. Catalog free. Dodge's Institute, Byrd St., Valparaiso, Ind.

QUARTZ—Direct importers from Brazil of best quality pure quartz suitable for making piezo-electric crystals. Diamond Drill Carbon Co., 719 World Bldg., New York.

QSLs. W8AXD, Smethport, Penna.

BEAUTIFUL, complete rack job fone, 800's final, 800's Class B self-contained, ready for mike. Reasonable. McMinn, 97 Horatio St., New York City.

QSLs—our fifth year of printing. W2AEY.

ATTENTION—Learn code. Slightly used Teleplexes guaranteed perfect condition, with three long-playing punched tapes—only \$10, plus postage. Order today. Robert Brown, Sullivan St., Dolgeville, N. Y.

WANT National SW3 a.c. transmitter, monitor, cash, Meyers, Franconia, N. H.

REAL buy—new 50 watt, class B modulated phone. Write Wm. Mimna, Passaic Ave., Passaic, N. J.

QSLs, two colors. Samples. Printer, Corwith, Iowa.

SACRIFICE transmitting and receiving equipment, transformer, meters, tubes, filter condensers. All equipment in excellent condition. Will trade for high power telescope or spotting scope. Robt. W. Thielke, Ackley, Iowa.

QSLs? World's Finest! Made-to-order! Samples? Stamp, please. QSLs? W8DED, Holland, Mich.

CRYSTALS: \$1.35 Hipower oscillators 3500-1700-Kc. bands, close to your specified frequency. 7000 Kc. \$4.25. Crystal blanks 65¢. Ready for delivery. The new Hipower Molded bakelite holder. Threaded top cap, no screws, socket mounting. Complete with mounting \$1.00 Hipower has done it again. Send for price list and descriptive literature. Hipower Crystal Co., 3607 N. Luna Ave., Chicago, Ill. You cannot buy a better crystal than Hipower at any price.

SELL or swap surplus parts, including 1933 autodyne receiver 210 class "B" modulator with power supply. W2CVZ.

QSL cards, two color, cartoons, message blanks, stationery, snappy service. Write for free samples to-day. W1BEF, 16 Stockbridge Ave., Lowell, Mass.

WANTED—SW3. W9PNF, Morgan Hts., Marquette, Mich.

WANTED—FB7 and power supply. Will sell QSL hand press. J. Manship, W5ALE, Hultbert, Okla.

SELL two RCA 800 tubes, \$6. each new. Never opened. 19 Orchard Place, Buffalo, N. Y.

CLASS B transformers—Universal for two or four 46's, 210's, 800's, RK18's, etc., \$7.75 pair postpaid anywhere in United States. 70 watts of audio from 46's. Write for details. W8UD, Douglas, Michigan.

RCA Institute course complete. Teleplex, six tapes. Quantity surplus transmitting equipment. Sell or trade. W6CKS, Veterans' Hospital, San Fernando, Calif.

TRADE SS superhet and xmitting parts for piano accordion, portable typewriter, or cash. W. E. 212D, \$6. W9HMS, Shioc-ton, Wisc.

KRUSE (former "QST" Technical Editor) becomes Technical Editor "R/9", now much enlarged! \$1.50 yearly. Two year special, \$2.25. Foreign, \$0.50 extra yearly. Sample, 15¢. "R/9", 1455 Glenville, Los Angeles.

CRYSTALS, 160-80 meter. Trade for tubes, meters, transformers. Bill Threm, W8FN, 4021 Davis Ave., Cheviot, Ohio.

SELL surplus receivers, transmitters, power supplies. Write W8CWO.

SELLING out tubes, meters, transformers, and parts from 100 watt xmitter. Send card for sheet. W8EIV, Sugar Grove, Penna.

CRYSTALS: Guaranteed excellent oscillators, 160 or 80 meters, your approximate frequency, \$1.35 postpaid. Crystal Maker's blanks, 1"-65¢, dozen \$6.00, oscillating 90¢-dozen \$8.40. Irregular shapes, 25¢. Improved dust-proof Bakelite holders, non-exposed 1½" silvered electrodes, plugs into G.R. or tube socket mountings, any position, 75¢-dozen \$5.40. Fisher Laboratory, 4522 Norwood, San Diego, Calif. Formerly El Paso, Texas.

QSLs by Maleco. Finest in country. Free samples Maleco, 1512 Eastern Parkway, Brooklyn, N. Y.

TRADE for gud Vibroplex, two new and two used R3 recto-blubs. W1CAB, New Bedford, Mass.

INSULATION, wire, varnishes, supplies, etc. Send 3¢ stamp for bulletin. Autopower, 418 S. Hoyne Ave., Chicago.

TEN practical and low-cost changes converting Dodge 12-V. Ford T.A., Chevrolet Delco 6-V. generators into 100-500 watt capacity a.c. generators or into 32-110-V d.c. motor or generator. Dodge is 500-W self-excited. All in one book illustrated with complete simplified instructions and drawings for only \$1. Autopower, 416 S. Hoyne Ave., Chicago.

CRYSTALS, guaranteed 80, 160 meters, your approximate frequency, \$1. postpaid. Blanks 50¢. W9FHS, 4433 N. Kilbourn, Chicago.

TWO used 212Ds, \$20. or \$11. apiece, 852 \$15, 211 \$5, Thermometal strips with silver contacts fifty cents. T. H. Kemp, 89 Acqueduct Ave., Midland Park, N. J.

SELL—100 watt class B modulated rack-panel phone. Meters, power, tubes including 211 modulated amplifier, 160 coils, crystals. Power supply for, but no speech amplifier. No haywire. \$75. Dr. Carlton Crosby, W1DDM, Framingham, Mass.

CALLBOOKS—new Fall 1934 Radio Amateur Call Book hundreds of new DX hams, many pages of late W and VE calls is yours for \$1.10. Four issues for \$3.65 (in foreign countries \$1.20 and \$3.90, postpaid). W9FO-610 S. Dearborn, Chicago.

CRYSTALS: Inch square power-ground oscillators, unconditionally guaranteed, x-cut 80-160 meter bands, 5 kc. \$2; 2 kc. \$2.50. 40 meters 25 kc. \$3.75. Blanks, 65¢. Gentry Labs., 803 W. Maple, Independence, Mo.

QST—August: 56MC. Station equipment—Transmitter MOPA \$13.75; Modulator \$7.50; Power pack \$12.75; Receiver \$18.75; Ultra Midget Transmitter \$10.65; Tri-Tet page 28—\$25.00; Crystals \$1.25; 40Mtr. \$3.00; We build to order. Precision Radio Laboratories, 109 East 94 Street, Brooklyn, N. Y. 50 Watters, \$7.50; 203As and 854s, new. Amateur Service, Fairview, N. J.

CARBON anode 50 watt tubes, \$9.75 each. New, first quality and fully guaranteed. VTE Laboratories, Ridgefield, N. J.

SWAP—Radio Engineering Labs. five meter transmitter 297, receiver 296. Want commercial built transmitter or what. W2CIT.

SALE 03A xtal controlled Johnson, Western Union, Luverne, Minn.

FB7s, Teleplexes, Omnigraphs, meters, receivers, tubes, Vibroplexes. Banted, sold, traded. Ryan Radio Co., Hannibal, Mo.

GUARANTEED x cut xtals, \$2.50. 80 and 160 meters. W4KP.

TRADE xtals for meters, etc. W4KP.

CAMERA—Zeiss Maximar "A". Excellent condition. Filter, tripod, leather case. Cash offer or transmitting equipment. W2HBR, 1628 Lincoln Place, Brooklyn, N. Y.

QSLs, 75¢ a 100. 2 colors. W9DGH, 1816 5th Ave., N., Minneapolis, Minn.

WHAT the Amateur needs. Some place where he can sell for cash, trade for other merchandise, or buy standard or used parts and sets at bargain prices. We offer these services. Active Hams in charge. 9HWP, 9HWD, 9FIS. Largest stock of Ham parts in Mid West. National Hammarlund Collins Billey, McMurdo-Silver, Cardwell, Sylvania, Ward-Leonard Thordarson, Cornell-Dubilier, Walter Ashe Radio Co., St. Louis, Mo.

CRYSTALS—guaranteed. Approximate frequency. 160 and 80 meters, \$1.40 meters, \$2. Patsy, W8FAV, 235 Southern Ave., Muskegon, Mich.

SELL—duplicate original Lamb single-signal super complete. \$40. W9COJ.

QSLs. Samples. W9GOF.

SELL: National SW3, 20, 40, 80, coils, power pack, speaker; Westinghouse mg. 500V, 200 mls; perfect 203A; new 211D; make offer on all or any part. W3CRT, 2 S. Hanover Ave., Margate City, N. J.

TRANSMITTERS manufactured to order. Transmitters re-constructed. Holmes C. Miller, Box 105, Palo Alto, Calif.

FOR sale—1 kw. transformer, 2000, 2500, 3000 each side, \$11. 500 watt 1100-1500 each side \$7. 15 henry 500 mil choke, \$10. W3CGA.

CRYSTALS—unconditionally guaranteed. 80-160. 1" "x" within three kilocycles, \$1.95. Standard holders, 75¢. W2DBQ, 1104 Lincoln Place, Brooklyn, N. Y.

QST back numbers for sale. Schreiber, 630 Lexington Ave., New York.

CRYSTALS: approximately 1", 80 or 160 meter band, \$1.25; near specified frequency, 99.8% accurate. Dust proof holders, 75¢. Ed. M. Hlavaty, Western Springs, Ill.

QSTs for sale. November-1927 to October 1933, 72 consecutive issues. Make offer. W9CRG.

BACK copies QST. January, February, October 1922. May, September 1923. December 1926. Good condition, 25¢ each. Box 31, Charlotta, N. C.

CRYSTALS: 160-80 meters, approximate frequency, 1", \$1; 40 meters, \$2. Guaranteed. W8EBV, 1397 6th St., Muskegon, Mich.

WANTED: Supreme analyzer model 333, also Gernsback Radio Service Manual volumes I, II, III, IV. Pay cash. Luther Cansler, 708 W. Mountain St., Kings Mountain, N. C.

CRYSTALS, guaranteed. 160-80 meter, 1/8 to 1", X or Y, within 10 kc., \$1.35. 1", within 2 kc., \$2.25, oscillating blanks 75¢, blanks from the saw 50¢, grinding instructions 25¢, plug-in holders, \$1. Wm. Threm, W8FN, 4021 Davis Ave., Cheviot, Ohio.

CANADIANS—crystals, ur frequency guaranteed, \$5. Engineering Dept. CKOC, Hamilton.

FREE information to commercial stations and discriminating amateurs on precision crystals and frequency measuring services. Commercial Radio Equipment Company, Box 7022, Kansas City.

SIGNAL-Corps portable non-spilling Edison Storage Batteries, 3 cells in covered steel case 18 amp. hours, unused, \$1. Edison B headquarters. Transmitter power equipment, relay racks. See May display, following hamads. Rectifier Engineering Service, 4837 Rockwood, Cleveland, Ohio.

WANTED—bug. W8LGU.

QSLs, SWLs, 200, \$1. Cards with personality for results. Mikee, crystals, S000000. W8ESN 1827 Cone, Toledo, Ohio.

TRANSFORMERS—1350-1000 each side. Mounted, plenty core. Heavy wire. Guaranteed year. 300 watt, \$7; 400W, \$8. Spear Company, Waterville, Ohio.

SELL—200 watt crystal controlled transmitter complete. Write for details. A. M. Robson, Box 224, Winner, S. D.

RECEIVERS, Patterson, National, Hammarlund. Lyon-Wyatt Radio, Wichita, Kans.

PATERSON receivers, 5 models. Free dope. Lyon-Wyatt Radio, Wichita, Kansas.

LATEST standard air-tuned Hammarlund Pro, also Scott DeLuxe both receivers practically new and complete. First class in every respect. Write Glenn Watt, Chanute, Kans.

SELL 450 watt 75 or 160 meters phone. 851 final, 03A class B modulator; three power supplies, ten Weston, Jewell, meters, tubes, complete. Parts cost over \$500. Take best offer over \$225. Otherwise will knock down and sell parts at 1/2 list. Photographs, lists. W2EDW, 2244 New Haven Ave., Far Rockaway, N. Y.

QSLs! All original designs. Two color, 75¢; photographic, \$2.65. Stationery, delivery cards, etc. Free samples. W2FJE, 151 DeKalb Ave., Brooklyn, N. Y.

SURPLUS material—send for our list of bargains surplus and used material covering motors, generators, vacuum tubes, receivers and parts. Heintz and Kaufman, 311 California St., South San Francisco, Calif.

SELLING out. National SW3, d.c., tubes, \$12.50. Ditto a.c. model, \$12.50. Lamb Single-Signal Superhetrodyne, August 1932 QST, tubes, completed, not tested, \$20. National 58905 power pack, 300 volt model with tube for above receivers, \$14. National plug-in coils, 40 meter band spread, ditto 20 meter, 23-41 meter, 40-70 meter, \$1.75 set. 500-850 meter, \$2.50. Hatry Young HY7 superhetrodyne, tubes, all coils, \$22. Sperry Navy receiver SE1012 tube or crystal 50-1000 meters, \$20. Navy receiver CN597, 300-2500 meters, \$14. General Radio wavemeter, type 358, \$7.50. Omnigraph, extra records, \$10. Grebe CR18 receiver, 10-200 meters, \$12.50. Grebe 2 stage amplifier, \$5.50. A. Lukach, 35 East 84 St., New York City.



"E. H. Rietzke
SPEAKING!"



Mr. E. H. Rietzke, President of CREI, and originator of the first thorough course in Practical Radio Engineering.

Are You Trying to "Keep" Your Job . . . Or IMPROVE Your Job?

This is a great time for ambitious radio men to look to the future. Things are on the "up" in this great profession, and it's to the experienced technically trained men that executives are looking to fill ever-occurring important positions!

How Many of You Men Reading This Could Step Right Now Into a Responsible Engineering Job?

Few men are qualified to accept the big jobs and big salaries when they do come. You can't "bluff" your way in Radio. You've got to be TRAINED. The CREI courses are planned for experienced radio men who feel the need of more intensive training and engineering knowledge. Let us suggest the best course for you and easy ways of paying for it!

New 40-Page Booklet Mailed Free on Request

**CAPITOL
ENGINEERING**



**RADIO
INSTITUTE**

14th and Park Road, N. W. Washington, D. C.
Dept. Q-10

ED WILCOX now offers McMurdo-Silver's famous 5C SINGLE SIGNAL SUPER

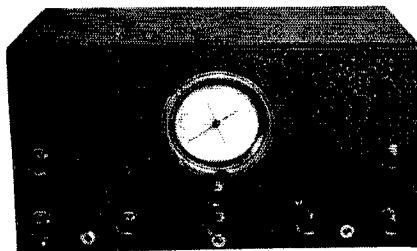

"In my opinion, McMurdo-Silver's 5C Professional Single Signal Super is away out in front of all competition. It's the choice of many who have tried them all. I offer the 5C on the most interesting easy TIME PAYMENTS you ever heard of. Write me at once for complete technical details of the 5C . . . and for particulars of my time payment offer for Chicago Amateurs. Hurry!"

WILCOX RADIO SALES

506 S. Wabash Ave. Phone Webster 4101 Chicago, U.S.A.

Your Nearest Dealer

Your nearest dealer is entitled to your patronage. You can trust him. He is equipped with a knowledge and understanding of amateur radio. He is your logical and safe source of advice and counsel on what equipment

Patronize the dealer nearest you—

<p>ALLENTOWN, PENNSYLVANIA Radio Electric Service Co. 1024 Hamilton Street Complete stocks transmitting equipment</p>	<p>CHICAGO, ILLINOIS Newark Electric Company 226 W. Madison Street Chicago's oldest radio parts store — established 1921 John T. Wallace, Technical Adviser</p>
<p>BALTIMORE, MARYLAND Radio Electric Service Co. 303 W. Baltimore Street Everything for the amateur</p>	<p>CLEVELAND, OHIO Northern Ohio Laboratories 2073 West 85 Street Wholesale Distr. for National, Hammarlund, Thordarson, Cardwell</p>
<p>BOSTON, MASSACHUSETTS Nutter & Cross, Inc. 99A Milk Street All OMs, OWs, and YLs welcome — W1HRF</p>	<p>CLEVELAND, OHIO Radio Servicemen's Supply Co. 206 Prospect Street Wholesale Distributors catering to Amateurs, Dealers, Servicemen</p>
<p>BROCKTON, MASSACHUSETTS Ware Radio Supply Company 913 Centre Street Hammarlund, Sylvania, Ohmite, Raytheon, Triplett Meters</p>	<p>DENVER, COLORADO Inter-State Radio & Supply Co. 1639 Tremont Place Amateur Radio Headquarters in the Rocky Mountain Region</p>
<p>BUFFALO, NEW YORK Dymac Radio 359 Capen Blvd. — Tel. Univ. 9380 Complete Stock Amateur Parts — Standard Discounts — W8AWK</p>	<p>DETROIT, MICHIGAN Radio Equipment Sales Co. 14036 Woodward Avenue, Highland Park A complete stock of amateur, shortwave and service parts</p>
<p>BUFFALO, NEW YORK Kronson Service Company 143 East Genesee Street Western New York's largest wholesale distributors — W8EHF</p>	<p>DETROIT, MICHIGAN Radio Specialties Company 171 E. Jefferson Avenue Ham Supplies — National & Hammarlund Sets and Parts</p>
<p>CHARLOTTE, MICHIGAN General Engineering Corporation Everything for the Transmitting Station</p>	<p>DETROIT, MICHIGAN Serlin 1419 Broadway Detroit's Pioneer Radio Merchants</p>
<p>CHICAGO, ILLINOIS Allied Radio Corporation 833 West Jackson Blvd. Complete standard lines always in stock — W9NRV — W9RZ1</p>	<p>ERIE, PENNSYLVANIA Jordan Radio Laboratory 1019 East Fifth Street Amateur, service parts, including Bliley, National, Raytheon. W8CXG</p>
<p>CHICAGO, ILLINOIS Chicago Radio Apparatus Company 415 South Dearborn Street (Est. 1921) "CHI-RAD" Operating W9RA and W9PST — Amateurs since 1909</p>	<p>HARTFORD, CONNECTICUT Radio Inspection Service Company 227 Asylum Street Yes, we'll take your old set in trade</p>
<p>CHICAGO, ILLINOIS Mid-West Radio Mart 520 S. State Street All standard lines carried in stock</p>	<p>HOUSTON, TEXAS Straus-Frank Company Distributors for nationally advertised amateur products RCA-DeForest transmitting tubes</p>
<p>CHICAGO, ILLINOIS Mid-West Radio Mart 520 S. State Street All standard lines carried in stock</p>	<p>JACKSONVILLE, FLORIDA Glover Weiss Co. Radio Headquarters for Southeast Distributors: RCA Victor, Stromberg-Carlson, Standard Ham Lines</p>

This advertisement is paid for by the firms listed above. Qualified dealers

Is Your Best Friend

you should buy. His stock is complete. He can supply your needs without delay. His prices are fair and consistent with the high quality of the goods he carries. He is responsible to you and interested in you.

You can have confidence in him

<p>KANSAS CITY, MISSOURI Burstein-Applebee Company 1012-14 McGee Street "Specialists" in supplies for the Amateur and Serviceman</p>	<p>ST. PAUL, MINNESOTA Lew Bonn Company 2484 University Avenue Rex L. Munger, W9LIP, Sales Engineer Radio Wholesaler Complete Stock</p>
<p>KANSAS CITY, MISSOURI Radio Laboratories 1515 Grand Avenue Amateur Headquarters — Complete Stock — Quality Parts</p>	<p>SAN ANTONIO, TEXAS Straus-Frank Company Distributors for nationally advertised amateur products RCA-DeForest transmitting tubes</p>
<p>MANCHESTER, NEW HAMPSHIRE Radio Service Lab. of N. H. 1008 Elm Street — Tel. 218-W Branches — Portland, Me. and Barre, Vt.</p>	<p>SAN FRANCISCO, CALIFORNIA Offenbach Electric Company, Ltd. 1452 Market Street "The House of a Million Radio Parts"</p>
<p>MILWAUKEE, WISCONSIN Radio Parts Company, Inc. 332 West State Street Complete stock Nationally Known products</p>	<p>SPRINGFIELD, MASSACHUSETTS T. F. Cushing 349 Worthington Street An amateur, endeavoring to sell good parts</p>
<p>NEWARK, NEW JERSEY Kaltman & Romander 62 Court Street Drop in for an over-counter QSO</p>	<p>SYRACUSE, NEW YORK Roy C. Stage, W8IGF Complete stock of standard Ham & BCL parts Standard Discounts. Free technical service</p>
<p>PEORIA, ILLINOIS Klaus Radio & Electric Co. 707 Main Street Amateur Radio Department</p>	<p>TORONTO, CANADA A & A Radio Service Supply 101 Queen Street, West Canada's foremost radio supply house</p>
<p>PHILADELPHIA, PENNSYLVANIA Freeland Radio Supply Co. 5 N. 7th Street "If it's radio we hav it"</p>	<p>TORONTO, CANADA Wholesale Radio Company, Limited 1133-39 Bay Street Canada's Largest Amateur Supply House</p>
<p>PHILADELPHIA, PENNSYLVANIA Radio Electric Service Co., Inc. N. E. Cor. Seventh & Arch Sts. All nationally advertised lines in stock</p>	<p>TRENTON, NEW JERSEY American Radio Co. 5 N. Broad Street Central Jersey's leading radio parts store</p>
<p>PHILADELPHIA, PENNSYLVANIA Eugene G. Wile 10 S. Tenth Street Complete Stock of Quality Merchandise</p>	<p>WASHINGTON, D. C. George's Radio Co. 816 F Street, N.W. Washington's largest distributor of radio parts</p>
<p>PROVIDENCE, RHODE ISLAND W. H. Edwards & Company 32 Broadway, Room 23 Amateur Equipment — National, Hammarlund, RCA Tubes</p>	<p>ZANESVILLE, OHIO Thompson Battery & Radio Service 128 Main Street Distributor radio equipment for amateurs and servicemen</p>
<p>ST. LOUIS, MISSOURI Walter Ashe Radio Company 1100 Pine Street W9FIS in charge of the oldest and largest parts store in St. Louis are invited to apply for rates, etc., to Advertising Department, QST</p>	

You Are Protected When You Buy From QST Advertisers

“Advertising for QST is accepted only from firms who, in the publisher’s opinion, are of established integrity and whose products secure the approval of the technical staff of the American Radio Relay League.”

Quoted from QST’s advertising rate card.

Every conceivable need of a radio amateur can be supplied by the advertisers in QST. And you will know the product has the approval of the League’s technical staff.

For Your Convenience

QST’S INDEX OF ADVERTISERS IN THIS ISSUE

A.R.R.L. Application Blank.....	116
Binder.....	103
Handbook.....	97
Publications.....	87
Supplies.....	85
Birnbach Radio Company, Inc.....	100
Bliley Electric Company.....	89
Burgess Battery Company.....	2
Cameradio Company.....	105
Candler System Company.....	100
Capitol Radio Engineering Institute.....	111
Cardwell Mfg. Corp., Allen D.....	95
Central Radio Laboratories.....	92
Collins Radio Company.....	Cov. 2
Comet Company.....	109
Cornell Dubilier Corporation.....	102
Delaware Radio Sales Co.....	86
Delta Mfg. Company.....	106
Electrad, Inc.....	104
General Electric Company.....	4
General Household Utilities Co.....	89
General Radio Company.....	62
Gross Radio Company.....	6, 7
Gulf Radio School.....	99
Haigis Laboratories.....	103
Hammarlund Mfg. Company.....	1
Hammond Mfg. Company.....	107
Harvey Radio Labs.....	98
Henry Radio Company.....	103
Hygrade Sylvania Corporation.....	115
Instructograph Company.....	107
Johnson Company, E. F.....	109
Kaltman and Romander.....	88
Lampkin Labs., G. F.....	107
Leeds.....	91
Littelfuse Laboratories.....	99
Lynch, Inc., Arthur H.....	99
Mallory & Co., P. R.....	63
Massachusetts Radio School.....	107
Midwest Radio Mart.....	107
National Carbon Company.....	90
National Company.....	61, 64-84, Cov. 3
Newark Electric Company.....	104
New York Y.M.C.A. Schools.....	103
Porcelain Products Co.....	109
Port Arthur College.....	109
Precision Piezo Service.....	101
RCA Institutes, Inc.....	101
RCA Radiotron Company, Inc.....	Cov. 4
Radio Mfg. Engineers.....	101
Radio Shack.....	105
Radio Supply Company.....	101
Radio Transceiver Labs.....	105
Raytheon Production Corp.....	96
Ross & Co., A. H.....	109
Sangamo Electric Company.....	108
Schwartz & Son, Maurice.....	99
Scientific Radio Service.....	102
Shure Bros. Company.....	108
Signal Electric Mfg. Company.....	107
Telex Company.....	105
Thordarson Electric Mfg. Company.....	106
Trimmm Radio Mfg. Company.....	109
Triplet Electrical Instrument Co.....	94
Union Carbide & Carbon Co.....	90
United Radio Mfg. Co.....	101
Universal Microphone Co.....	98
Weston Electrical Instrument Corp.....	93
Wilcox Radio Sales.....	111
Yaxley Mfg. Company.....	63

7,258 HOURS!

Sylvania favored

in Airway Communications

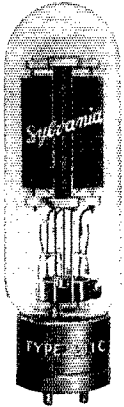

Sylvania Type 211-C Graphite Anode Transmitting Tube.

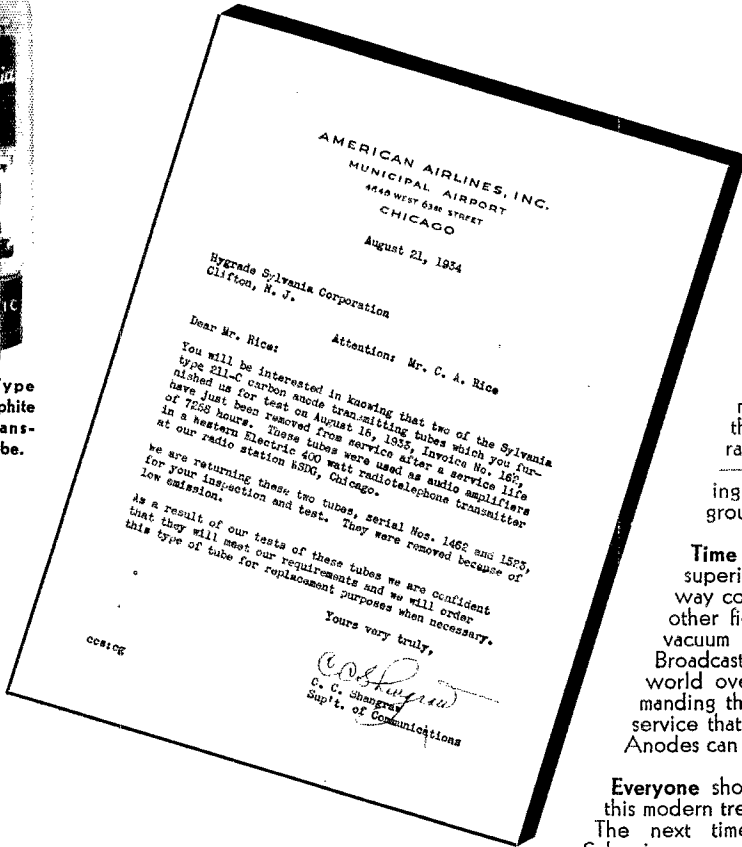

■ ■ ■ Enthusiasm prompted this letter from American Airlines.

Sylvania Graphite Anode transmitting tubes have earned high confidence in what might be termed "one of the most gruelling jobs a radio tube is subjected to" — the intermittent operating conditions of airway ground station traffic.

Time has proven Sylvania superiority — not only in airway communications, but in all other fields where transmitting vacuum tubes are employed. Broadcasters and amateurs the world over are vociferously demanding the highly enduring tube service that only Sylvania Graphite Anodes can give.

Everyone should keep in step with this modern trend in transmitting tubes. The next time you order, specify Sylvania.



HYGRADE SYLVANIA CORPORATION

Hygrade Lamps

ELECTRONICS DEPARTMENT

Sylvania Tubes

CLIFTON, NEW JERSEY

FACTORIES: SALEM, MASS. EMPORIUM, PA. ST. MARYS, PA. CLIFTON, N. J.

WAREHOUSE STOCKS IN
Portland, Oregon Atlanta, Georgia Philadelphia, Pa. Denver, Col. Pittsburgh, Pa. Chicago, Ill. Los Angeles, Cal. Salem, Mass. Dallas, Texas

YOU DEPEND ON A.R.R.L. FOR YOUR AMATEUR RADIO DO YOU SUPPORT THE LEAGUE WITH YOUR MEMBERSHIP?

For More Than Twenty Years

the A.R.R.L. has been the organized body of amateur radio, its representative in this country and abroad, its champion against attack by foreign government and American commercial, its leader in technical progress.

You Owe Your Amateur Radio of Today to A.R.R.L.

HAD IT NOT BEEN FOR THE LEAGUE

- ▶ amateur radio would never have reopened after the World War
- ▶ the swarming influx of broadcasters in 1922 and 1923 would have killed it off by legislation
- ▶ recent international conferences would have virtually wiped amateur radio from the face of the earth.

The A.R.R.L. could not have achieved these successes without the loyal support of the active amateurs of this country — without the presence of their names on its membership rolls.

YOUR name should be there. Without it, we lose your tangible support. Without it, you lessen our ability to act most effectively in the protection of your hobby.

▶ JOIN THE LEAGUE!

AMERICAN RADIO RELAY LEAGUE
West Hartford, Conn., U. S. A.

I hereby apply for membership in the American Radio Relay League, and enclose \$2.50 (\$3.00 outside of the United States and its Possessions, and Canada) in payment of one year's dues, \$1.25 of which is for a subscription to *QST* for the same period. Please begin my subscription with the..... issue. Mail my Certificate of Membership and send *QST* to the following:

Name

Street or Box

City and State

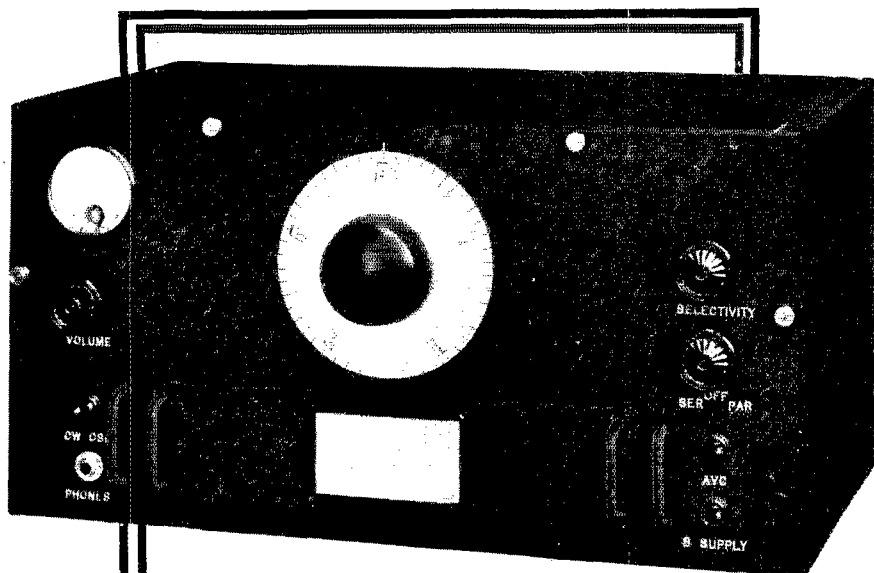

THE HRO

TWO STAGES PRESELECTION

TWO AIR-TUNED I.F. STAGES

CALIBRATED BAND-SPREAD

AUTOMATIC VOLUME CONTROL

FOUR-GANG CONDENSER

MICROMETER DIAL

SINGLE-SIGNAL FILTER

ET CETERA

"Et Cetera" is a big phrase, and includes many obvious essentials such as single-control tuning and C. W. beat frequency oscillator, as well as luxuries such as a Vacuum Tube Voltmeter for indicating carrier intensities and an additional model with built-in power supply (for the very few amateurs who prefer it). The National General Catalogue, bound into this magazine, describes the HRO in detail.

NATIONAL COMPANY, INC.

MIGHTY OAKS FROM LITTLE ACORNS GROW...

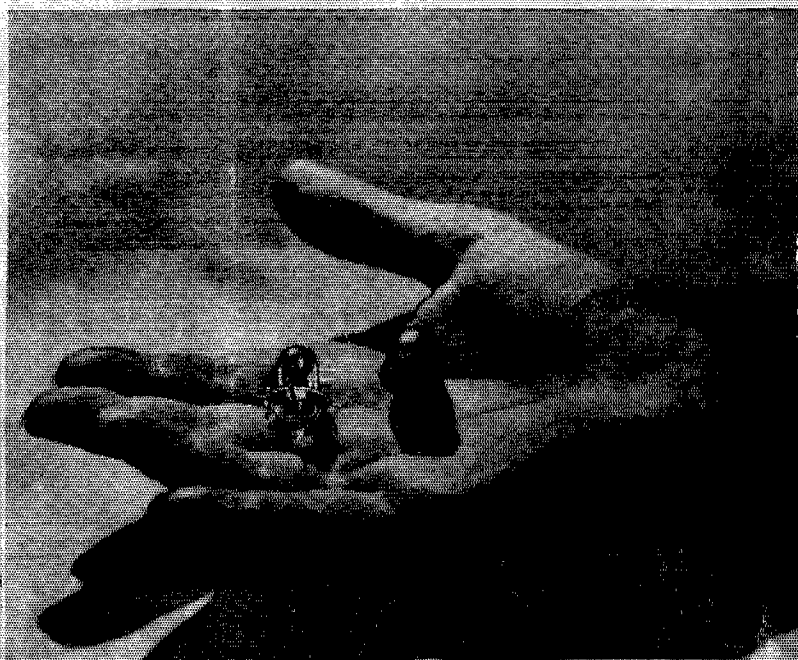
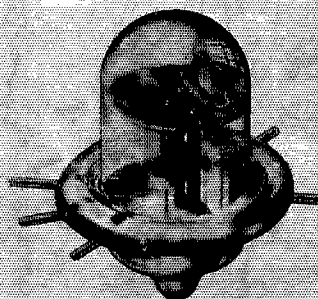

New **RCA-955** (*Acorn Type*) FOR ULTRA-HIGH FREQUENCY

At last a detector, amplifier, oscillator tube for the 110-megacycle band and higher frequencies. The new RCA-955 is an extremely small triode, having very low interelectrode capacitances and lead inductances, suitable for operation at frequencies up to 600 megacycles.

Although small in size, the RCA-955 is rated for a maximum plate voltage of 180 volts. It will amplify, detect, and oscillate at frequencies not practical with conventional tubes.

The RCA-955 opens up new possibilities for the amateur in the ultra-high frequency bands and provides a needed tool for the exploration and practical application of these bands. Amateurs will find it useful in both low-power transmitters and in receivers, for either fixed, portable or mobile stations. The RCA-955 is now available through your RCA deForest Distributor. Amateur Net Price—\$3.75, connecting clips included. For complete technical information, write to