

QST

devoted entirely to

amateur radio

June
1934
25 cents

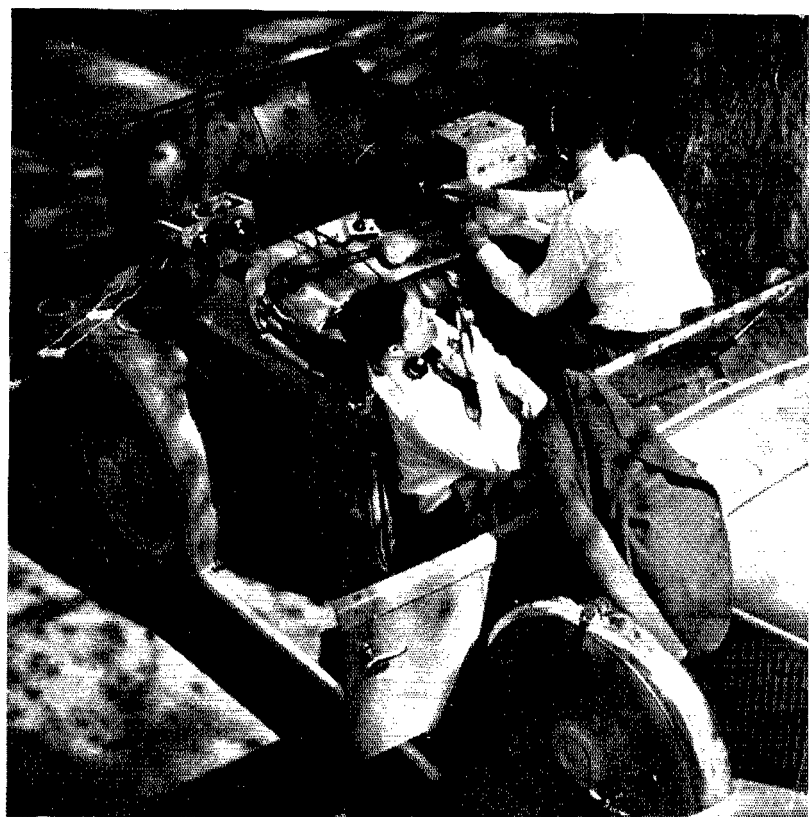

THE PERFECT COURSE

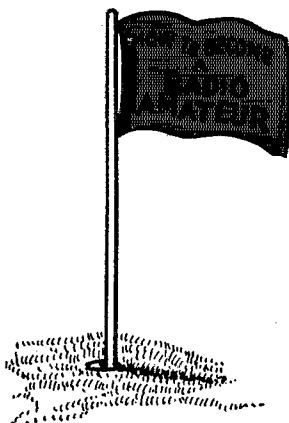

Get off to a good start with the current edition of "How to Become a Radio Amateur." It outlines the entire short wave field. Learning the code, building a simple station and getting it on the air are made easy by its many illustrations and simple wording. You will find it well worth the price, 25c.*

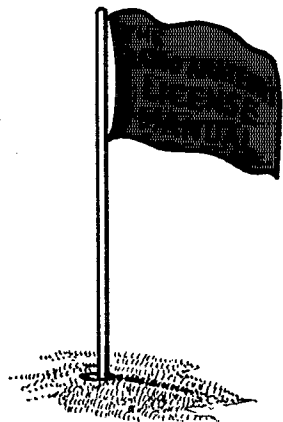

A necessity for the beginner—you need the manual for its instruction on how to get a license in the right way and for the typical license exam questions and answers. Equally indispensable for the already licensed amateur for its dope on renewal and modification procedure, the Class A exam, portable procedure, etc. All the dope on every phase of amateur licensing procedure and the complete text of the new regulations and pertinent extracts from the basic radio law. Order your copy to-day, 25c.*

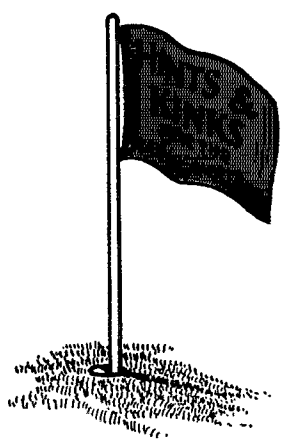

A publication that gives you the opportunity of profiting by the experiences of others. Its eighty pages are chock-full of money-saving dodges and workable ideas that you will appreciate. Chosen from the thousands submitted by the experimenters who have tried them, these ideas will give you the solution to many of your problems. Priced at 50c, you won't regret having a copy on hand.*

*Postpaid Anywhere

**AMERICAN
RADIO
RELAY
LEAGUE, INC.**

West Hartford
Connecticut

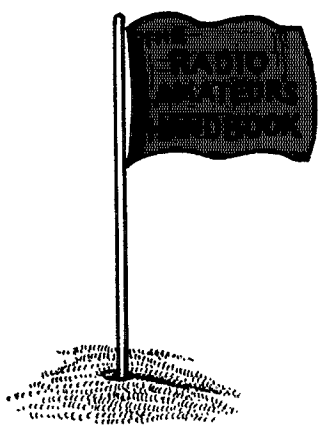

The HANDBOOK is to the radio amateur what a cook book is to the bride. It won't tell you how to make a cake that won't fall, but it does tell you how to raise the signal-noise ratio with modern receiver designs; how to build and operate efficient transmitters and — well, not enough room here to tell you all about it, but certainly a book that covers the field, from theory to operating practice, deserves the enviable position that it has attained. A big book at any price but sold for \$1.00 per copy.*

24 YEARS OF Leadership

THE prestige of Hammarlund Condensers was firmly established in 1910, when radio as we know it today was but a dream.

And the basic refinements which then made Hammarlund Condensers the choice of radio pioneers now make them still the unchallenged preference of today's leaders, who really know what good condensers should be.

They have changed in design, of course, according to the needs of the times. But the one thing which remains as fixed as Gibraltar is their quality.

Whether your condenser requirements are for receiving or transmitting, balancing, trimming, equalizing, padding or what not, remember there is a Hammarlund model to fit your exact needs — moderately priced and backed by a name and resources which guarantee your complete satisfaction.

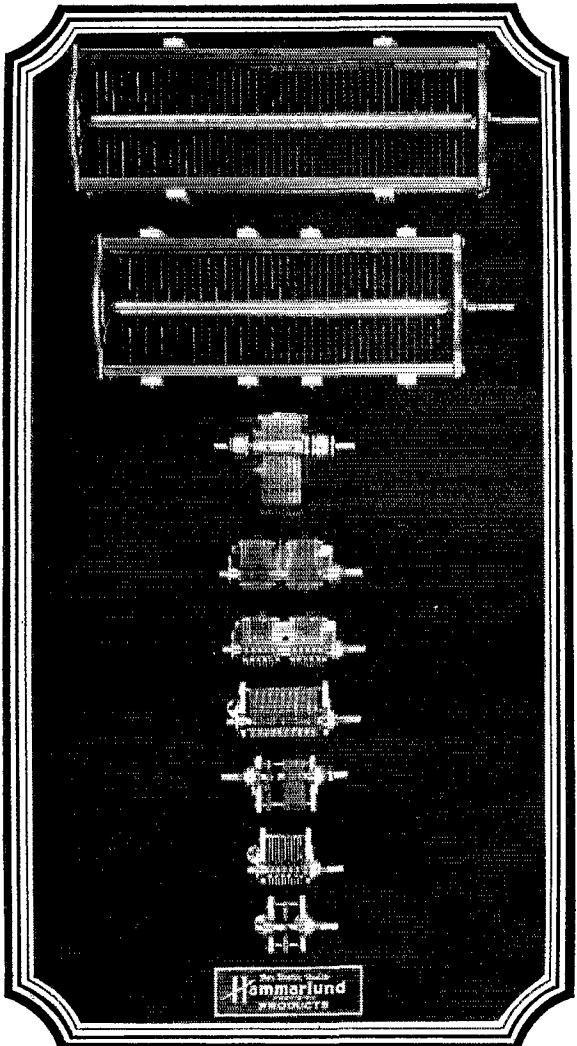

The above illustration shows only a few of the many Hammarlund Stock Model Condensers described in the new "34" catalog — for all purposes and in all ratings.

Mail Coupon for Your Copy



HAMMARLUND MANUFACTURING CO.
424-438 W. 33rd St., New York

—Check here for General Catalog "34" of condensers and other precision radio equipment.—Check here for booklet describing the famous COMET "PRO" 8 to 550 meter Superheterodyne Receiver.

Name.....

Address.....

.....Q-6

LATEST ADDITION

To a Famed Line of Transmitters

COLLINS 30FXB

A radiophone and telegraph transmitter embodying the latest refinements and developments of the past six months. The 30FXB meets all the requirements of a modern installation — plenty of power, high fidelity, and multiband operation without neutralization adjustment. Installation is simplicity itself — merely connect antenna, power, key and microphone, and you are "on the air."

Completely Self Contained

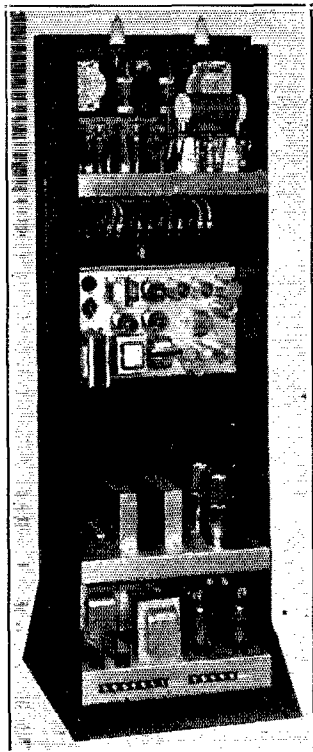

TECHNICAL DATA

POWER OUTPUT — 100 watts nominal rating (203A).

FREQUENCY RANGE — 1500 to 15,000 kc. (standard). New isolantite coil forms are used.

FREQUENCY CONTROL — Crystal oscillator with isolation of oscillator from amplifier by a buffer stage.

POWER SUPPLIES — 1000 and 1250 volts at 400 MA DC for modulators and power amplifier. 400 volts DC for crystal and buffer.

MODULATOR — Two 830B or 203A tubes are used in Class B.

FIXED NEUTRALIZATION — All neutralization adjustments in the 30FXB Transmitter are fixed at the factory so that the user does not have to do any balancing of the various circuits. Shifting from one band to another is merely a matter of changing the plug-in coils and setting the dials to the calibrated position.

SPEECH AMPLIFIER — The 7C Speech Amplifier designed primarily for use with a crystal microphone is furnished as an integral part of the 30FXB Transmitter. Thus, no external apparatus, except the microphone and telegraph key, is required and the installation is neat, self-contained and compact.

ANTENNA TUNING — The 2C pi Section Antenna Matching Network is furnished as standard equipment. This provision makes it possible to connect the 30FXB to any available antenna and to accomplish efficient energy transfer with proper attenuation of harmonics.

DIMENSIONS — 60" high, 20½" wide, 20" deep.

SURPRISINGLY LOW PRICED. WRITE FOR FULL INFORMATION

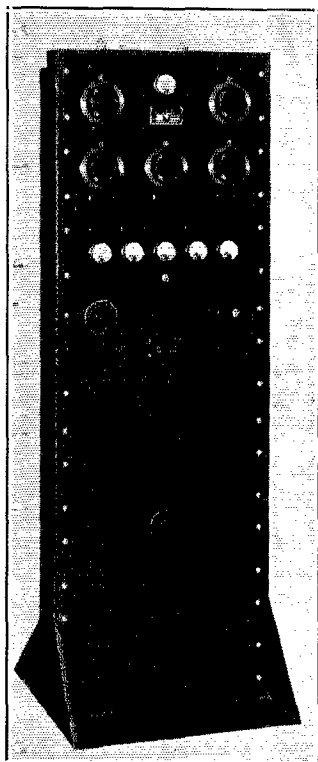

COLLINS RADIO COMPANY

CEDAR RAPIDS IOWA, U. S. A.

New York Office — 136 Liberty Street, N. Y. C.

QST

Published monthly, as its official organ, by the American Radio Relay League, Inc., at West Hartford, Conn., U. S. A.; Official Organ of the International Amateur Radio Union

devoted entirely to

AMATEUR RADIO

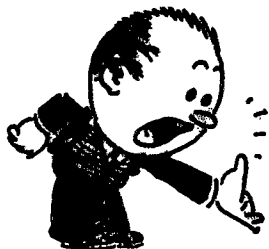

Editorials	7
Second Annual Field Day	8
What About the Simple Receiver <i>George Grammer</i>	9
Practical Transmitting Circuits for Suppressor-Grid Tubes <i>James J. Lamb</i>	14
Hamdom	17
A Simple Mounting for the Cathode-Ray Tube	18
Low-Cost Crystal Control for High Power <i>D. J. Tucker, W5VU</i>	19
A Medium-Power 56-Mc. Transceiver <i>Frank Jacobs, W2BSL</i>	21
Automatic Gain Control with Diode Detection <i>Wolcott M. Smith</i>	23
Flea Power in the Arctic <i>Philip L. Ennis, K7BWZ</i>	29
Iowa State Convention	30
A Ham Station Analyzer <i>D. A. Griffin, W2AOE</i>	31
The Ultra-Midget <i>Philip Rosenblatt, W2AKF and H. T. Miller, W2AIS</i>	33
Amateur Radio — A Century of Progress — 1934	34
Atlantic Division Convention	34
What the League Is Doing	35
Typical Technical Questions	37
Strays	38
Simplifying Split-Stator Final Amplifiers <i>Byron Goodman, W6CAL</i>	39
Experimenters' Section	
A.C. PRE-AMPLIFIER FOR CONDENSER MIKE — FREQUENCY-MONITOR WITH DUAL-PURPOSE TUBE — TUBE-BASE CRYSTAL HOLDERS — LINK COUPLING TO THE ANTENNA TUNER — KEYING THE LINK CIRCUIT TO PREVENT CLICKS — AN ECONOMICAL FILTER ARRANGEMENT — PORTABLE POWER SUPPLY KINKS — INCREASING C.W. SELECTIVITY	41
Amateur Radio Stations <i>W9DRD, W8IDJ, W4BGA, W6ETX</i>	45
I. A. R. U. News	47
Calls Heard	49
Hamericana 1934	50
Communications Department	66
"Marker" Stations	84
Standard Frequency Transmissions	86
Hamads	90
QST's Index of Advertisers	94

JUNE
1934

VOLUME XVIII
NUMBER 6

Kenneth B. Warner (Secretary, A.R.R.L.), Editor-in-Chief and Business Manager; Ross A. Hull, Associate Editor; James J. Lamb, Technical Editor; George Grammer, Assistant Technical Editor; Clark C. Rodimon, Managing Editor; David H. Houghton, Circulation Manager; F. Cheyney Beekley, Advertising Manager; Ursula M. Chamberlain, Assistant Advertising Manager.

Editorial and Advertising Offices
38 La Salle Road, West Hartford, Conn.

Subscription rate in United States and Possessions and Canada, \$2.50 per year, postpaid; all other countries, \$3.00 per year, postpaid. Single copies, 25 cents. Foreign remittances should be by international postal or express money order or bank draft negotiable in the U. S. and for an equivalent amount in U. S. funds.

Entered as second-class matter May 29, 1919, at the post office at Hartford, Connecticut, under the Act of March 3, 1879. Acceptance for mailing at special rate of postage provided for in section 1103, Act of October 3, 1917, authorized September 9, 1922. Additional entry at Concord, N. H., authorized February 21, 1929, under the Act of February 28, 1925.

Copyright 1934 by the American Radio Relay League, Inc.
Title registered at United States Patent Office.



—when you use **CARDWELLS!**

Don't take unnecessary chances with expensive equipment. Play safe, use a Cardwell wherever the specifications call for a condenser. Wherever the vital factor is Performance, there you'll find a Cardwell. Used the world over by men who know, used by the Army, the Navy and Coast Guard—surely they must have proved themselves a hundred

times over to gain such recognition.

Cardwell integrity is built into every condenser. Only the finest of materials ever find their way into the Cardwell factory, and Cardwell engineering design has long served as a model for the industry. Play safe, use Cardwells—for every tube and purpose.

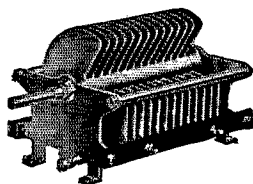

CARDWELL "STANDARD" MODELS FOR RECEIVERS
and MEDIUM POWER TRANSMITTERS

CARDWELL MIDWAY "FEATHERWEIGHT" CONDENSERS,
RECEIVING and TRANSMITTING

CARDWELL 16-B TRANSMITTING CONDENSERS
FOR LARGER TRANSMITTERS

CARDWELL HIGH VOLTAGE CONDENSERS
FOR COMMERCIAL RADIO-TELEGRAPH and
BROADCASTING STATIONS

CARDWELL S-2244 OIL DIELECTRIC FIXED CONDENSERS
FOR HIGH FREQUENCY FURNACES
and TUBE BOMBARDERS

The ALLEN D. CARDWELL MFG. CORP'N.
83 Prospect Street, Brooklyn, N. Y.

"THE STANDARD OF COMPARISON"

Section Communications Managers of the A.R.R.L. Communications Department

All appointments in the League's field organization are made by the proper S.C.M., elected by members in each Section listed. Mail your S.C.M. (on the 16th of each month) a postal covering your radio activities for the previous 30 days. Tell him your DX, plans for experimenting, results in 'phone and traffic. He is interested, whether you are an A.R.R.L. member or get your QST at the newsstands; he wants a report from every active ham. If interested and qualified for O.R.S., O.P.S. or other appointments he can tell you about them, too.

Eastern Pennsylvania	W3GS	ATLANTIC DIVISION	Jack Wagenseller	24 South Fairview Ave.	Highland Park, Upper Darby
Maryland-Delaware-District of Columbia	W3BAK		Edgar L. Hudson		Laurel, Delaware
Southern New Jersey	W3QL		Gedney Rigor	412 2nd Ave.	Haddon Heights
Western New York	W3DSP		Don Farrell	213 Hickok Ave.	Syracuse
Western Pennsylvania	W3CUG		C. H. Grossarth	R. F. D. 3, Eichler Rd.	Emsworth, Bellevue Pa.
		CENTRAL DIVISION			
Illinois	W9WR		Fred J. Hinds	6618 West 34th St.	Berwyn
Indiana	W9TE		Arthur L. Braun	911 Reiser St.	Indianapolis
Kentucky	W9OX		Carl L. Pfumm	P. O. Box 359	Louisville
Michigan	W8DVH		Kenneth F. Conroy	7538 E. Robinwood Ave.	Detroit
Ohio	W8BAH		Harry A. Tummonds	2073 West 85th St.	Cleveland
Wisconsin	W9FSS		Harold H. Kurth	2550 N. 8th St.	Milwaukee
		DAKOTA DIVISION			
North Dakota	W9JVP		Fred J. Wells	1022 11th St., S.	Fargo
South Dakota	W9PFI		Mike G. Strahon	601 S. Grange Ave.	Sioux Falls
Northern Minnesota	W9JIE		Robert C. Harshberger	1200 Fauquier St.	St. Paul
Southern Minnesota	W9DEI		Francis C. Kramer	W. Bluff St.	St. Charles
		DELTA DIVISION			
Arkansas	W5ABI		H. E. Velte	2918 West 15th St.	Little Rock
Louisiana	W5DWW		W. J. Wilkinson, Jr.	1624 Allen Ave.	Shreveport
Mississippi*	W5VJ		W. P. Allen	P. O. Box 66	Jackson
Tennessee	W4AFM		F. F. Purdy	P. O. Box 173	Kingsport
		HUDSON DIVISION			
Eastern New York	W2LU		Robert E. Haight	1080 Helderberg Ave.	Schenectady
N. Y. C. & Long Island	W2AZV		E. L. Baunach	7823 10th Ave.	Brooklyn
Northern New Jersey*	W2BZY		Robert Maloney	315 Watson Ave.	Perth Amboy
		MIDWEST DIVISION			
Iowa	W9FFD		George D. Hansen	3734 Summit St.	Sioux City
Kansas	W9FLC		O. J. Spetter	305 Western Ave.	Topeka
Missouri	W9EYG-JPT		W. Cannady	300 Sixth St.	Mason City
Nebraska	W9FAM		Samuel C. Wallace	Green St.	Clarks
		NEW ENGLAND DIVISION			
Connecticut	W1CTI		Frederick Ellis, Jr.	19 Merrill Rd.	Norwalk
Maine	W1CDX		John W. Singleton	10 High Street	Wilton
Eastern Massachusetts	W1ASL		Joseph A. Mullen	16 Mercier Ave.	Ashmont
Western Massachusetts	W1ASY-W1RB		Earl G. Hewinson	33 Cortland St.	Springfield
New Hampshire	W1APK		Basil Cutting		Pembroke
Rhode Island	W1QR		Albert J. King	66 Lisbon St.	Providence
Vermont	W1ATF		Harry Page	R. 1	Hinesburg
		NORTHWESTERN DIVISION			
Alaska	K7PQ		Richard J. Fox	Box 301	Ketchikan
Idaho	W7AVP		Don D. Oberbillig	P. O. Box 1271	Boise
Montana	W7AAT		C. W. Viers		Red Lodge
Oregon	W7ABZ		Raymond W. Cummins	4835 N. Amherst St.	Portland
Washington	W7AYO		Stanley J. Belliveau	Route 7, Box 387	Yakima
		PACIFIC DIVISION			
Hawaii	K6EWQ		Atlas O. Adams	21st Infantry Brigade	Schofield Barracks
Nevada	W6EAD		Keston L. Ramsay	1151 Buena Vista Ave.	Reno
Los Angeles*	W6BPU		Howell C. Brown	120 N. El Molino Ave.	Pasadena
Santa Clara Valley*	W6DBB		Barton A. Wood	R. 1, Box 722	Campbell
East Bay	W6ZX		P. W. Dann	1821 Chestnut St.	Berkeley
San Francisco	W6CAL		Bryon Goodman	141 Alton Ave.	San Francisco
Sacramento Valley	W6DVE		Geo. L. Woodington	716 Redwood Ave.	North Sacramento
Arizona	W6BIF-W6QC		Ernest Mendoza	1434 East Madison St.	Phoenix
Philippines	KA1XA		Newton E. Thompson	714 Tennessee	Manila, P. I.
San Diego	W6EOP		Harry A. Ambler	4101 Hamilton St.	San Diego
San Joaquin Valley	W6DZN		G. H. Lavender	Route 6, Box 425	Stockton
		ROANOKE DIVISION			
North Carolina	W4AVT		G. H. Wright, Jr.		Wendell
Virginia	W3AAJ		R. N. Eubank	2817 Montrose Ave.	Richmond
West Virginia	W8HD		C. S. Hoffmann, Jr.	100 20th St.	Warwood, Wheeling
		ROCKY MOUNTAIN DIVISION			
Colorado	W9BTO		T. R. Becker	1176 Gaylord St.	Denver
Utah-Wyoming	W6GQC-IDM		Arty W. Clark	260 So. 9th West	Salt Lake City, Utah
		SOUTHEASTERN DIVISION			
Alabama	W4KP		L. D. Elwell	1066 Waverly St.	Tarrant
Eastern Florida	W4NN		Ray Atkinson	4524 College St.	Jacksonville
Western Florida	W4MS		Edward J. Collins	1517 East Brainard St.	Pensacola
Georgia-So. Carolina-Cuba- Isle-of-Pines-Porto Rico- Virgin Islands	W4UT		George A. Love	50 Muscogee Ave.	Atlanta
		WEST GULF DIVISION			
Northern Texas	W5AUL		Glen E. Talbutt	1133 Amarillo St.	Abilene
Oklahoma	W5CEZ		Carter L. Simpson	2010 So. 4th St.	Ponca City
Southern Texas	W5BHO		David H. Calk	6726 Ave. Q	Houston
New Mexico	W5DUI		Dan W. De Lay	407 South Girard St.	Albuquerque
		MARITIME DIVISION			
Maritime	VE1DQ		A. M. Crowell	69 Dublin St.	Halifax, N. S.
		ONTARIO DIVISION			
Ontario	VE3GT		S. B. Trainer, Jr.	4 Shorncliffe Ave.	Toronto
		QUEBEC DIVISION			
Quebec	VE2GA		J. A. Robertson	245 Edison Ave.	St. Lambert, P. Q.
		VANALTA DIVISION			
Alberta	VE4GD		J. Smalley, Jr.	611 1st Ave., N. W.	Calgary
British Columbia	VE3AC		R. K. Town	1754 Graveley St.	Vancouver
		PRAIRIE DIVISION			
Manitoba	VE4GC		Reg. Strong	711 Ashburn St.	Winnipeg
Saskatchewan	VE4EL		Wilfred Skaffe	2040 McTavish St.	Regina

* Officials appointed to act until the membership of the Section choose permanent S.C.M.'s by nomination and election.



The American Radio Relay League

• **T**HE AMERICAN RADIO RELAY LEAGUE, INC., is a non-commercial association of radio amateurs, bonded for the promotion of interest in amateur radio communication and experimentation, for the relaying of messages by radio, for the advancement of the radio art and of the public welfare, for the representation of the radio amateur in legislative matters, and for the maintenance of fraternalism and a high standard of conduct.

It is an incorporated association without capital stock, chartered under the laws of Connecticut. Its affairs are governed by a Board of Directors, elected every two years by the general membership. The officers are elected or appointed by the Directors. The League is non-commercial and no one commercially engaged in the manufacture, sale or rental of radio apparatus is eligible to membership on its board.

"Of, by and for the amateur," it numbers within its ranks practically every worth-while amateur in the world and has a history of glorious achievement as the standard-bearer in amateur affairs.

Inquiries regarding membership are solicited. A bona fide interest in amateur radio is the only essential qualification; ownership of a transmitting station and knowledge of the code are not prerequisite. Correspondence should be addressed to the Secretary.

OFFICERS

- President*.....HIRAM PERCY MAXIM, W1AW
Hartford, Connecticut
- Vice-President*.....CHARLES H. STEWART, W3ZS
St. David's, Pennsylvania
- Secretary*.....KENNETH B. WARNER, W1EH
West Hartford, Connecticut
- Treasurer*.....ARTHUR A. HEBERT, W1ES
West Hartford, Connecticut
- Communications Mgr.*...F. EDWARD HANDY, W1BDI
West Hartford, Connecticut

General Counsel.....PAUL M. SEGAL, W3EEA
1010 Shoreham Building, Washington, D. C.

Address all general correspondence to the executive headquarters at West Hartford, Connecticut

DIRECTORS

- President*
HIRAM PERCY MAXIM,W1AW
Box 216, Hartford, Conn.
- Vice-President*
CHARLES H. STEWART,W3ZS
St. David's, Pa.
- Canadian General Manager*
ALEX. REID,VE2BE
169 Logan Ave., St. Lambert, P. Q.
- Atlantic Division*
EUGENE C. WOODRUFF,W8CMP
234 W. Fairmount Ave., State College, Pa.
- Central Division*
LOREN G. WINDOM,W8GZ-W8ZG
1375 Franklin Ave. Columbus, Ohio
- Dakota Division*
CARL L. JABS,W9BVH
1822 James St., St. Paul, Minn.
- Delta Division*
M. M. HILL,W5EB
P.O. Box 274, Natchitoches, La.
- Hudson Division*
BERNARD J. FULD,W2BEG
280 Broadway, New York City
- Midwest Division*
H. W. KERR,W9DZW-W9GP
Little Sioux, Iowa
- New England Division*
G. W. BAILEY,W1KH
74 Webster Road, Weston, Mass.
- Northwestern Division*
RALPH J. GIBBONS,W7KV-W7BIX
3134 N. E. 25th Ave., Portland, Ore.
- Pacific Division*
S. G. CULVER,W6AN
2962 Russell St., Berkeley, Calif.
- Roanoke Division*
H. L. CAVENESS,W4DW
State College Station, Raleigh, N. C.
- Rocky Mountain Division*
RUSSELL J. ANDREWS,W9AAB
1867 So. Lafayette St., Denver, Colo.
- Southeastern Division*
J. C. HAGLER, JR.,W4SS
2424 McDowell St., Augusta, Ga.
- West Gulf Division*
FRANK M. CORLETT,W5ZC
2515 Catherine St., Dallas, Tex.

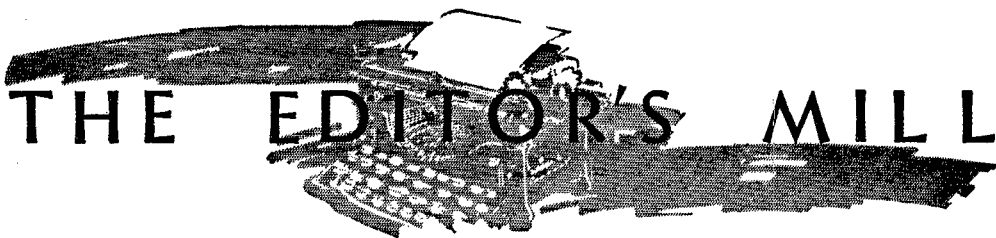

THE EDITOR'S MILL

THE editors of *QST* are firm believers in the ultimate high usefulness of the ultra-high frequencies. While they may seem to have no value for communication at customary amateur distances, that same thing was true of 200 meters back in 1912. Enterprise and initiative, and actually getting out and trying, resulted in the developments that have made present-day amateur radio technique. The great trek upwards from 1500 kilocycles was marked by many a pause beyond which it seemed the frequencies must be worthless. But they weren't. They were better—when we found out how to handle them. Isn't there good possibility that the ultra-high frequencies will turn out the same way?

We do not suggest that amateur radio prepare forthwith to move exclusively into the very short waves. But if these frequencies have inherent DX value we ought to be finding out more about them than we now know and we ought to be thinking now about the place that we will eventually want in that end of the spectrum. Other people are planning for their eventual occupancy. Some of the commercial companies have done some mighty interesting work on "microrays" of just a few centimeters length, and work on wavelengths of a few meters is going ahead astonishingly fast. Public-service systems employing automatic repeaters to extend the transmissions far beyond the optical limit of a single transmitter are under contemplation. Some radio engineers go so far as to suggest that the radio communication of the future will be almost altogether on these very high frequencies, with the region above 60 megacycles parceled out in neat little slices to a multiplicity of services. If they are right, some day we amateurs will regard the low frequency of 4000 kilocycles as just as uninteresting as we do 4000 meters to-day. That is one reason why the editors of *QST* have done as much as they could to stimulate interest in 30-mc. and 60-mc. work. For the same reasons the American Radio Relay League has a request before the Federal Radio Commission to extend amateur rights into the really ultra-high-frequency region now available only under experimental license, so that we may learn what 120 mc. is like—and 240 and 480 and 960!

We amateurs have done plenty of high-frequency work, more than all the other radio services combined. We have thousands upon

thousands of 5-meter stations engaged in practical communication. We have developed practical apparatus that is the basis for much of the commercial interest of to-day. We have been doing automatic relaying too, and chains of 5-meter amateur stations lend their services to one another to carry communications far beyond the range of any member of the chain—in a most interesting adaptation of the relay idea upon which our League is founded. The potentialities of this idea are enormous and it may be that for many a year we will find an outlet for our restless energies in some such plan.

But that is not the theme of this piece. There is, as we see it, a more fundamental problem into which the present splendid work has really not bitten at all. That problem is not the generation or detection of these high frequencies. It is the need for doing something to these waves to affect their radiation, so as to overcome their present restriction to the "optical distance." Before they become useful for communicating at longer distances some new method must be developed to make them perform in different fashion. It is a technical problem of the first magnitude but, we think, an immensely intriguing opportunity for the amateur experimenter. These waves may be reflected, focused, refracted, plane-polarized, circularly-polarized and otherwise operated upon as are light and heat waves. There is many an interesting idea in any physics text that might be applied to them to make them perform. The physicists amongst our ranks might investigate propagation in terms of quantum mechanics rather than wave motion. Somewhere in these things must lie the secret to the taming of the u.h.f.

Doesn't it seem odd that we still connect modern crystal-control transmitters and snigglesnooper receivers to perfectly ordinary pieces of copper wire representing the elementary Hertz antenna invented in 1888? True, the commercials have various types of beam antennas, of differing degrees of complexity, but they are only for the purpose of focusing the waves to give directivity and greater strength. In effect they still consist of a multiplicity of these elementary antennas, generally unimproved upon for many years. We pay much less attention to our antennas and their action than to our other apparatus. Almost blindly we hitch our elaborate gear to a quarter's

worth of antenna, with scarcely a thought to what it is doing. It is the weak link in our system.

Fortunately for convenience's sake, the radiating systems for ultra-high frequencies may be very small and experimental work is made easy. It is, we think, the most fascinating field of the radio of to-morrow. Not the least of its po-

tentialities lies in the thought that any scheme that makes the ultras good for DX will mean that any station can work at any desired distance on any given frequency.

Well, summer is here. How about a little ultra-high-frequency work?

K. B. W.

Second Annual A.R.R.L. Field Day Contest to Test Portables

June 9th-10th

ALL hams with *portable* stations, attention!! This is the annual League event which combines the possibilities for an outing, with the opening of the season for out-door radio activities. Starting Saturday, June 9th (4 p.m. local time) and ending Sunday, June 10th (7 p.m. local time) all U.S.A. and Canadian station owners are invited to schedule *field activities*. The operation of portable transmitters and receivers afield is a most enjoyable activity; in addition it facilitates operator preparation to render constructive service in time of emergency and encourages the development of equipment suitable for operation independent of interruptions of commercial power sources suitable for emergencies. Only portable stations, actually operated in the field (away from the "home" address) are eligible to submit field-day scores.

The object will be for each "portable" station to work as many other amateur stations as possible—each to count *one point* toward a score. These stations may be locals, fixed stations, other portables, or foreign amateur stations. *Any or all amateur frequency bands may be used*, voice or c.w. telegraph likewise.

All points must be made in the contest period given above. The *log* of operation, claimed *score*, and data on *power* and *frequency* band used for each contact should be sent in promptly at the conclusion of the test. Please note what was used as a source of plate and filament power, along with the "watts input" to final stage, too. Special credits: Scores may be multiplied by 2 if *either* receiver or transmitter is independent of commercial power supply, by 3 if *both* transmitter and receiver are supplied from an independent local source rather than from public mains. The following *additional* score multiplier will be used to give all stations an equal chance. If the power input to the final stage (plate current times plate voltage— $E \times I$) is:

- (a) Up to and including 20 watts—multiply score by 3
- (b) Over 20, and up to 60 watts—multiply score by 2
- (c) Over 60 watts—multiply score by 1

To comply with F.R.C. regulations for portable station operation, licensees in the U.S.A. have only to observe the instructions of pars. 387 and 384 of the Rules and Regulations, as respects advance notification of the locations in which the portable will be operated to the Inspector-in-Charge of the district, and as regards proper station identification. In the U.S.A. not only 28- and 56-mc. band portable work is permissible, but operation in *any* communicating amateur band. In Canada the new regulations permit portable sets to be operated *only* for 56-60 mc. and then only in the province in which the station is licensed.

The League's affiliated radio clubs (more than 400) have all been invited to encourage their members to build portables, and to arrange special Field Day activities for June 9th and 10th. Get together with your local ham club in plans for work with portables on these dates if you can. However, don't forget that every amateur is invited to take part, whether or not you are able to participate in club plans. Your portable transmitter can be a source of great pleasure for the whole summer season. Get it working now. Test it in the Field Day plans and *let us have your report*. Take it to the mountains or seashore later and make your summer complete. Keep an operative portable at hand *all the year*, so it will be where you can put it to work promptly in the event of disaster or public emergency. Don't forget to send your results for the report in *QST*—a postal card or letter will be most welcome, and please add any suggestions for the *next* Field Day, or for some "simulated emergency tests" before next year, if you want them.

—F. E. H.

What About the Simple Receiver?

The Conditions With Which It Must Contend and a Description of a Two-Tube Receiver Using an Improved Band-Spread System

George Grammer, Assistant Technical Editor

IN THESE days of low-priced superhets and tuned-r.f. receivers it might seem something of a problem to justify the home construction of simple regenerative rigs. A two-tube receiver must give something that the other sets don't or there would be no real justification for its existence. What, then, does the simple receiver have to offer? First, small cost; second, ease of construction; third, sensitivity—the once-familiar claim that a regenerative detector will bring in anything that a more complicated rig can pick up still seems to be true, given reasonable freedom from QRM and a fair break on artificial background noise; fourth, a means of covering a wide range of frequencies without a regiment of plug-in coils. This last alone justifies the existence of the two-tube as an adjunct to the ham-band superhet.

SELECTIVITY

These four make a pretty formidable list in favor of the simple receiver, especially since the ability to pick up distant signals is there in good measure. The "but"—somehow there always is a "but"—is the old bugbear, selectivity. A secondary "but" is that under certain conditions—or rather, lacking certain conditions—the two-tube set suffers by comparison with other types of receivers in stability.

In discussing selectivity for c.w. reception it is necessary to define some terms. We can conveniently classify selectivity into the "local" and "distant" variety.¹ Of all types of receivers except the kind having an untuned r.f. stage, the detector-audio type possesses the least "local" selectivity. Signals from near-by stations working on frequencies considerably beyond beat-note audibility with the desired signal can and do cause serious interference of a most annoying kind. So-called "shock" excitation of the detector by a local signal will cause interference-producing spurious harmonics on higher-frequency bands than the one on which the signal actually exists. The reverse can happen, too; harmonics of the oscillating detector can beat with a local signal on a higher frequency band to produce a second type of interfering signal which is not the fault of the transmitter. Also, the transmissions of near-by broadcast stations often will be bothersome, especially on the 1715- and 3500-kc. bands.

¹ For further discussion see, "Rationalizing the Autodyne," *QST*, January, 1933.

"Distant" selectivity for c.w. reception can be defined as the ability of the receiver to separate two signals of moderate strength operating on frequencies within audible beat of each other. The comparison between the two-tube and practically any other type except the Single-Signal for this kind of selectivity is not so unfavorable. The detector-audio set is every bit as good as the tuned-r.f. receiver, and generally speaking is as good as the ordinary "10-kc." superhet. The actual separation of the signals must be done by the ear through its ability to distinguish between different tones. A trained ear can do a pretty fair job. Although real distant selectivity is achieved

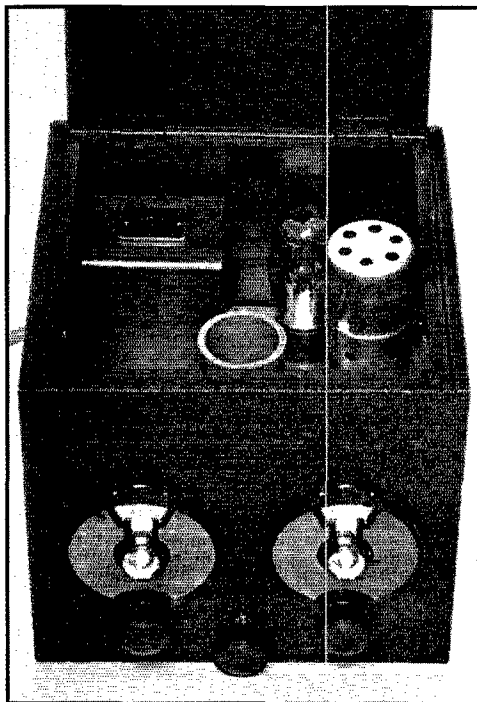

THIS TWO-TUBE RECEIVER HAS A CONTINUOUS FREQUENCY RANGE OF 1450 TO 41,000 KILOCYCLES AND GIVES COMPLETE BAND-SPREAD ON FIVE AMATEUR BANDS

It can be used with either 2.5- or 6.3-volt tubes without change in the wiring. The right-hand dial gives general coverage and that at the left gives band-spread around any frequency for which the general-coverage dial may be set.

only in the Single-Signal superhet, the amateur who performs must use less expensive equipment does not expect 100% reception all the time. Unquestionably such an amateur can do excellent work with simple equipment—in fact, he always has.

STABILITY

A detector coupled to an antenna is not exactly in a favorable spot for stable operation. With reasonable coupling between the detector and antenna a change in the constants of the latter is bound to be reflected as a change in the frequency of oscillation, which in turn causes a change in the beat note. This sort of instability can be overcome by using a rigidly-strung antenna, preferably located indoors so the wind cannot start an unwanted shimmy. Secondly, a detector operated at its most sensitive point—just beyond the start of oscillation—is readily controlled by a strong signal and is often pulled into synchronism with it. One of the most familiar manifestations of this is the case of a strong signal subject to fading; if the beat note is set when the signal strength is “down,” a rise in strength often will tend to pull in the detector and may cause the beat note to disappear entirely. If the fading is rapid the signal has a pronounced waver and is hard to copy. Ham signals do not often offend in this way with the two-tube, however, unless the receiving antenna is quite long. It is interesting to note that a stage of tuned r.f. only makes matters worse since it puts a too-strong signal at the grid of the detector!

A third factor is the inherent stability of the detector as an oscillation generator, especially its ability to maintain a single frequency during changes in plate voltage of the order encountered with a rectified-a.c. supply. The proper choice of circuit and constants can do much to improve this sort of stability, and it is not difficult to build a regenerative detector which is quite satisfactory in this respect.

Instability of a fourth type is peculiar to the oscillating detector coupled to an antenna, and evidences itself in the form of “body capacity” at the tuning controls. It results from coupling the

detector to an antenna system which is approximately resonant, through the capacity of the receiver and power-supply to ground, at the operating frequency, and is especially likely to be encountered at 14 mc. and higher frequencies. A short ground connection, in terms of wavelengths on the wire, is difficult to secure at such frequencies, especially when the “ground” connection is made to a water pipe or heating system.

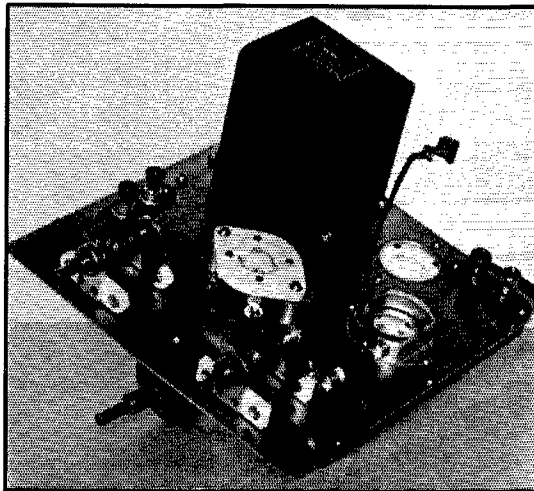

THE METAL BASE HOLDS ALL COMPONENTS—NONE ARE MOUNTED ON THE CABINET
Band-spread condenser C₁ is at the left, C₂ at the right.

The tuning controls and chassis of the receiver accordingly assume a potential different from that of the operator's body and hand-capacity effects result, often accompanied by an a.c. hum if the antenna is near power wiring. Addition or subtraction of a few feet in antenna length usually will move the resonance spot out of the band affected. Although an untuned coupling tube will eliminate this sort of antenna effect, the remedy may be worse than the disease because the

coupling tube introduces a background of tube hiss and accentuates cross-modulation and local interference effects.

TUBES AND CIRCUITS

Summing up, then, we find marks on both sides of the ledger for the simple receiver. If the local selectivity is poor, the distant selectivity is at least fair, and the sensitivity is very good. Although the stability is not as good as that of a good superhet, it can, with proper precautions, be made satisfactory. The cost of the two-tube set is low, and the frequency range that can be covered with comparatively few coils is great.

So far as tubes are concerned little, if anything, is to be gained by using special types. A screen-grid detector is still the most satisfactory, and for headphone reception nothing larger than a small triode is needed for the audio stage. More gain could be secured from a power pentode—but at the expense of rather high plate current, which in turn calls for the use of an audio output coupling device to prevent burning out the phones. The small tubes will produce more than enough headphone strength. For the detector, the 57, 58, 77, 78, 6C6 and 6D6 types are most satisfactory. The results are about the same with all of them. The 56, 76 and 37 are satisfactory audio amplifiers.

The screen-grid feedback circuit which has had wide application in tuned-r.f. receivers¹ is equally satisfactory for the two-tube set. The stability of this type of circuit is good, and the coils are conveniently made. Regeneration control through varying the detector screen voltage is smooth and easy to effect. Essentially, then, neither the tubes nor circuits are startlingly different. There is no good reason why they should be.

BAND-SPREADING

Most band-spreading systems are unsatisfactory from one standpoint or another. At the moment two methods seem to hold the stage to the exclusion of practically all others: the parallel condenser and the tapped coil. The first has the advantage of giving both band-spreading and general coverage with the same coil, but suffers the defect that the band-spread is not readily adjustable to meet the varying widths of different bands. A parallel condenser which tunes across the 1.75- and 3.5-mc. bands usually covers entirely too much territory on 7 and 14 mc. unless the padding capacity is inordinately large. Generally, too, if maximum band-spread is given first attention on the higher-frequency bands it will be found that a set of four coils will not give complete coverage from 15 to 200 meters with 100- μ fd. padding condensers; there will be gaps at one place or another. If the range is made continuous, complete band-spread has to be sacrificed. The tapped-coil method has the advantage of giving complete band-spread on any and all bands without special tuning condensers, but as generally used, at least in commercial receivers, requires one set of coils for ham-band coverage and an additional set for the in-between frequencies on which there is no band-spread.

Since the two-tube receiver is a simple affair, we can do some things which might run into the realm of the cumbersome when applied to receivers with more than one tuned circuit. One of the things that can be done is to incorporate a tuning system which not only will give continuous coverage over any range desired, but which also will give as much or as little band-spread as may be wanted on any amateur band—and this without any extra coils. The receiver pictured herewith has a continuous range from approximately 7.5 meters to 205 meters—41,000 to 1450 kilocycles—and gives practically 100-division band-spread on each of the five amateur bands included in that range. And it is done with only five plug-in coils, using four-prong coil forms.

The system is quite simple. Using a

100- μ fd. main tuning condenser, the inductances of the coils are chosen so that overlapping ranges are secured over the whole spectrum covered, an amateur band falling somewhere within the range of each coil. This is thoroughly conventional. Then, for band-spreading, a second 100- μ fd. tuning condenser is connected to an experimentally determined tap on the coil to give complete band-spread on this condenser's dial when the main tuning condenser is set at the proper capacity. Both condensers are brought out to panel controls. The method, it will be seen, is simply a logical extension of the tapped-coil band-spread system.

A PRACTICAL RECEIVER

The circuit diagram of a receiver built along these lines is shown in Fig. 1. Several views of the set are given in the photographs. The actual layout used is not particularly important except that, as always, it is desirable to have short leads in the r.f. circuit. Metal chassis construction is strongly recommended, since the shielding thus afforded is helpful in reducing capacity effects and in cutting out hum pickup from the induction fields which permeate most homes having a.c. wiring. For these same reasons a metal cabinet is advan-

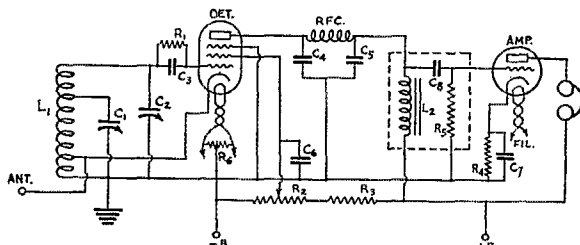

FIG. 1—CIRCUIT DIAGRAM OF THE TWO-TUBE RECEIVER

For 2.5-volt a.c. filament operation, the 57 and 58 are recommended as detectors and the 56 as the audio amplifier. For storage battery operation suitable detectors are the 77, 78, 6C6, and 6D6; audio amplifier, 76 or 37. These tubes also can be operated from a 6.3-volt transformer.

C₁, C₂—100- μ fd. midget variable (Hammarlund MC-100-S).

C₃, C₄, C₅—100- μ fd. fixed mica condenser (Aerovox Type 1460)

C₆, C₇—5 μ fd. or larger.

R₁—5 megohms.

R₂—50,000-ohm potentiometer (Frost) small size.

R₃—25,000 ohms, 10 watts (Ohmite).

R₄—75 ohms, center-tapped (Ohmite).

RFC—Universal wound short-wave choke (Hammarlund).

L₂, C₈, R₅—Screen-grid coupler (National Type S-101). Suitable values are; L₂, 500 henrys; C₈, .01 μ fd.; R₅, 0.5 megohm.

Frequency Range	Coil Data		
	Total turns, L ₁	Cathode Tap	Band-Spread Tap
1450 to 3400 kc. (1.75)	54 $\frac{1}{2}$	3 $\frac{1}{4}$	29 $\frac{3}{4}$
3050 to 7100 kc. (3.5)	27 $\frac{1}{2}$	1 $\frac{1}{4}$	11 $\frac{3}{4}$
6100 to 14,200 kc. (7)	13 $\frac{1}{2}$	3 $\frac{3}{4}$	4 $\frac{1}{4}$
10,600 to 24,000 kc. (14)	7 $\frac{1}{2}$	1 $\frac{1}{2}$	1 $\frac{1}{4}$
18,000 to 41,000 kc. (28)	3 $\frac{1}{2}$	1 $\frac{1}{8}$	1 $\frac{1}{2}$

All coils are wound with No. 24 d.s.c. wire on 1 $\frac{1}{2}$ -inch diameter forms, the length of the coil being 1 $\frac{1}{2}$ inches in all cases. The figure in parenthesis after each frequency range indicate the amateur band for which that coil is used. The taps are counted off from the lower or ground terminal. Assuming that the tuning dials have 100 divisions and that the 0 end of the scale represents maximum condenser capacity, the setting of C₂ to give amateur band coverage on C₁ will be approximately as follows, using appropriate coils: 1.75 mc., 44; 3.5 mc., 38; 7 mc. 28; 14 mc., 54; 28 mc., 78. See text on coil construction.

tageous, and since it is now possible to purchase metal boxes for less than the cost of the aluminum that would go into one of the same dimensions—to say nothing of getting a better mechanical job unless the builder is particularly handy with tools—this set was made to fit such a box, in this case a National Type C-SRR. The aluminum base or chassis on which all the parts, including the tuning condensers and the regeneration control, are mounted measures $7\frac{1}{2}$ by $7\frac{1}{2}$ inches. Quarter-inch square brass rods, drilled and tapped for 6-32 screws, are fastened along two edges of the base to furnish a convenient means of securing it in place in the cabinet.

The two tuning condensers are mounted along the front edge of the base with their shafts projecting beyond the edge so the dials can be fastened to them when the set is put in the box. Behind the tuning condensers is the socket for the plug-in coils, an isolantite socket mounted on metal pillars so the socket prongs clear the base. The grid condenser and leak are just behind the right-hand tuning condenser, the far end of the condenser being supported from the base by a small piece of bakelite drilled and tapped to serve as a mounting.

To the rear of the grid condenser is the detector tube socket, and in the rear right-hand corner the binding posts for the phones. The audio tube socket is next, and occupying the rear left-hand corner is the audio coupler. The antenna and ground terminals are along the left edge of the base. These terminals, incidentally, are an assembly of two push-type binding posts mounted on a bakelite strip, a convenient gadget which can be purchased at most radio stores. A similar terminal was first used for the headphone connections, but the push-posts proved to be unsatisfactory for holding phone tips and regular binding posts were substituted, retaining the insulating strip.

The coil socket is mounted so that the leads to the tuning condensers are short and convenient. The rear right-hand socket terminal (No. 4) is connected to the cathode of the detector tube; the wire from the coil socket drops down through a hole in the base and runs underneath to the tube socket. A wire from this same prong also runs through another hole in the base to the antenna post. The connection to the ground terminal is similarly made to the rear left-hand terminal (No. 2) on the coil socket. The feedback coil—the part of the coil included between the cathode tap and

ground—is thus made to serve as the antenna coupling coil as well. Experiment has shown that this method provides just about the right amount of coupling, keeping antenna effects to a minimum while providing plenty of signal strength.

FURTHER CONSTRUCTIONAL DETAILS

Parts mounted below the base include the regeneration control, the plate by-pass condensers and plate choke, and the screen and audio cathode by-pass condensers. This last is a double condenser having two sections of $0.5 \mu\text{fd}$. each. Increasing each to $1 \mu\text{fd}$. will reduce regeneration-control resistor noise and aid in amplification of the lower audio frequencies. The audio cathode resistor and the screen dropping resistor also are mounted underneath the base. The regeneration control resistor is mounted on a bracket made from half-inch brass strip, from which it must be insulated. An extension shaft gives the necessary length so that this resistor can be controlled from the panel.

Fitting the set to the box requires a little care, but presents no particular problems. The back and bottom of the box should be removed, after which the receiver can be pushed in from the rear. A space of about two inches between the bottom and the base will be sufficient; lines should be ruled along the inner sides of the box as guides so the chassis will be square with the box. Then the points at which the shafts of the tuning condensers and regeneration control go through the front should be marked and holes drilled to correspond. These may be made fairly large, and small inaccuracies will not matter. The next step is to drill small holes along the sides of the box for the screws which fit into the brass-rod mounting strips. Drilling and tapping of these rods for the side screws should be left until after the holes in the sides of the box have been drilled, so that their exact location can be easily spotted when the set is in its final position. The dials should not be fastened in place until all the other mechanical work has

been finished; if dials similar to those shown (National Type B Midget) are used, the drilling template should be lined up with the condenser shafts after the receiver is securely mounted in the box. This will avoid the embarrassment of having condenser shafts and dials refuse to line up. The only precaution to be observed in connection with the regeneration-control shaft is to see that it does not touch the box as it comes through.

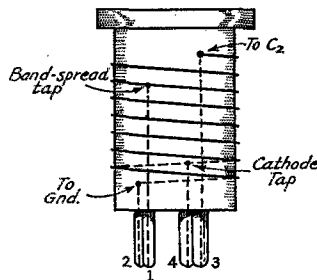
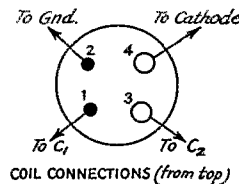

FIG. 2—COIL SOCKET CONNECTIONS AND THE METHOD OF BRINGING OUT COIL TERMINALS

COIL CONSTRUCTION

Fig. 2 shows how the connections are made on the coil forms, while the specifications are given under Fig. 1. In all cases the grid and ground ends of the coils come through the forms directly over their respective pins, and the tap specifications are given in turns and fractions of turns from the ground end. The length of the winding should be exactly $1\frac{1}{2}$ inches on all coils, and on all but the 1.75-mc. coil the turns should be separated to give an even spacing throughout. The 1.75-mc. coil is close-wound with the wire specified. Different brands of wire vary a bit in insulation thickness, so if the completed close-wound $1\frac{1}{2}$ -inch coil has a turn or two more or less than indicated in the coil table it is quite in line with what would be expected. A small variation in the total number of turns on this coil is unimportant so long as the taps are counted off from the ground end as specified. The turn spacing on the 3.5-mc. coil is adjusted by putting another winding of the same size wire between the turns of the actual coil, the auxiliary winding being removed after the coil terminals are soldered in place. Spacing on the higher-frequency coils is adjusted by hand. Taps are made by drilling a hole through the form at the proper point, cutting off the wire and running it down to the proper pin. A new piece of wire with its end fastened in the same pin continues the winding. When finished, the windings should be given a coat of clear Duco or coil dope possessing good adhesive properties.

With the coils specified, the band-spread is between 80 and 100 dial divisions on the band-spread condenser on all except the 3500-kc. coil. In this case the tap has been adjusted to spread the 400-kc. c.w. portion over the whole dial. Good spread on the 'phone portion is obtained by resetting the main tuning condenser, C_2 , so that the high-frequency end of the band is covered on C_1 .

Any desired degree of spread can be obtained by changing the position of the tap. Moving the tap toward the ground end will increase the spread—decrease the frequency coverage—on

C_1 , while moving the tap toward the grid end will make C_2 cover a wider frequency range. Unfortunately the position of the tap for a predetermined amount of band-spread cannot be readily calculated, and the work must be done experimentally.

ELECTRICAL POINTERS

So much for the mechanics of the set. Electrically, there are only two pitfalls to avoid. The first is to make sure that the part of the coil included between the cathode tap and ground end is as close to specifications as possible. It does not take much "tickler" in this circuit to provide all the needed feedback, and too much feedback not only reduces the sensitivity but also may lead to howls of astonishing proportions. Variation in the other direction is likewise bad, although there is of course some leeway.

The second thing to avoid is the use of a makeshift audio coupler between the detector and amplifier. While audio transformers often have been pressed into service as coupling impedances, a good many of them show a pronounced tendency to

produce fringe howl. This is not to say that an audio transformer cannot be used, but simply to point out that if one is used and the set has a fringe howl, the audio transformer is very likely the cause of it. Trouble of this sort can be sidestepped by acquiring a coupler made especially for the job of coupling a screen-grid detector to an audio amplifier. There are several of them on the market.

The receiver can be used with either 2.5- or 6.3-volt tubes of the types previously enumerated, and is suitable for either a.c. or storage-battery operation of the filaments of 6.3-volt tubes. Plate voltage can come either from a "B" pack or batteries, with voltages from 90 to 250 volts being satisfactory. Somewhat greater signal strength will be obtained at the higher "B" voltages.

The set should first be tested with the antenna disconnected to make sure that it goes into oscillation smoothly, and, incidentally, to make sure

(Continued on page 88)

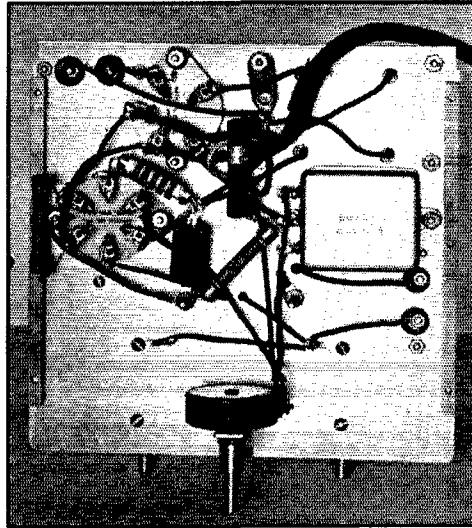

THIS UNDERNEATH VIEW SHOWS THE REGENERATION CONTROL RESISTOR AND THE VARIOUS BY-PASS CONDENSERS AND RESISTORS

The positive "B" terminal is on a small piece of fibre which insulates it from the base. Each filament lead in the six-wire cable consists of two wires soldered together to lower the voltage drop. All ground connections from the tuning condensers and coil are bonded together.

Practical Transmitting Circuits for Suppressor-Type Screen-Grid Tubes

High-Gain Amplifier and High-Power Tri-Tet Oscillator Arrangements for 'Phone and C.W.

James J. Lamb, Technical Editor

A SIGNIFICANT trend in the present phase of our crystal-controlled and oscillator-amplifier transmitter development is that towards simplification of multi-stage outfits, particularly towards reducing the number of stages necessary for the power output we want at the various amateur-band frequencies. One step in this progress has been in circuit development, of which the Tri-tet crystal oscillator is an example. Another step has now been made possible by tube development, as exemplified in the new pentode-type screen-grid tube introduced in May *QST*. After all, so far as output is concerned,

'phone operation where this element becomes a "natural" for application of the modulation.

The ratings and characteristics of this type tube were covered in the May article, and this story will be confined to practical transmitting circuits and their operating details. Principal among these arrangements are the r.f. power amplifier and high-power Tri-tet oscillator, both including provision for suppressor-grid modulation. It must be emphasized that the versions shown are intended as typical examples of simple transmitter assemblies, made up as modifications of familiar bread-board set-ups previously

described in *QST* so that the easy transition from old practices to new are plainly demonstrated. Even the minimum shielding that would ordinarily be used is deliberately omitted—to show the bare minimum that can be tolerated. More highly "engineered" construction may be used to advantage.

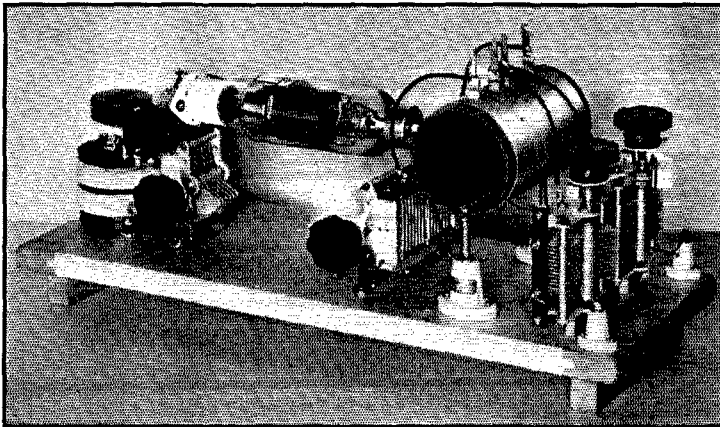

THE 65-WATT OUTPUT TRI-TET OSCILLATOR UNIT

Modulated for 'phone, it is capable of a 15-watt carrier with 100-percent amplitude modulation—and no frequency modulation. Cathode tank and crystal at the left, plate tank at the right.

A HIGH-GAIN R.F. POWER AMPLIFIER

The circuit of the experimental r.f. power amplifier unit is shown in Fig. 1. This unit resembles the Tri-tet oscillator shown in the illustration and actually has the

it is only the final stage of the transmitter that is really important; the preliminary stages, constituting the frequency-controlling and exciting units, are but auxiliaries. Hence, it must be our aim to minimize the complexity of these preceding stages, so far as we can, by using circuits and tubes that accomplish the maximum in frequency and power step-up per stage. The new pentode-type tube, by its high-power amplification or, conversely, by its small excitation requirement, promises to be a material aid to this simplification. The provision of an extra grid, the suppressor, makes for still further simplification in

bread-board 50-watt triode amplifier described by George Grammar in *QST* for December, 1933 (and in Chapter Seven of the current *Handbook*) as its basis. The only essential changes made in adapting the pentode to this unit were in substituting a five-prong socket, omitting the neutralizing condenser, and making the extra connections for the screen and suppressor grids. The circuit constants are generally the same as for the triode amplifier, being as given with the diagram.

The tuned grid and plate circuits are conventional and can well be as specified for the original

triode circuit. It is not necessary to use the "split" type tank circuit, which was an essential feature of the neutralizing arrangement with the triode, although it makes the output more adapted to coupling to a balanced load such as a two-wire transmission line or to the input of a push-pull high-power (250- or 500-watt) stage. A single-section tuning condenser (100- μ fd. or so) would be used with the unbalanced type tank, the coil being the same, and the rotor of the condenser would be returned to ground. As an alternative to the shorting system, with clips, here used to vary the plate tank inductance, the untapped coils specified for the parent rig could be used as well. The shorting arrangement is convenient in reducing the number of coils necessary to cover the various bands, however, and does not materially affect the overall efficiency.

In operation, there is little deviation from what would be experienced with ordinary amplifiers. The principal difference is in the excitation required with tubes of this type. More likely than not, the usual exciter will give too much excitation; that is, a driving stage putting more than about a watt into the grid circuit will cause output less than the 50 watts or more that should be obtained. This is simply remedied by reducing the coupling between the exciter's output and the pentode's grid circuit, or by reducing the driver's output. The latter would be readily accomplished by lowering the screen or plate voltage of the exciter, for instance. An especially excellent adjustment of excitation with a Tri-tet oscillator using a 59 in the exciter is obtainable by varying the voltage on the oscillator's suppressor grid; making it negative if necessary. A 24-A or 59 operating "straight" or as a doubler provides adequate excitation.

The leak, R_1 , may be used alone to furnish grid bias for the amplifier, with the C-minus and C-plus terminals shorted as indicated by the dash-line in Fig. 1, or some fixed bias may be connected in series with the leak. Battery bias of 45 volts or so will provide insurance against excessive plate dissipation in case of excitation failure or mis-adjustment during the tuning-up process. Since the grid current is relatively small, running

but 5 ma. or so for optimum conditions, the smallest type of B-battery can be used to advantage.

There is also considerable latitude possible in connection with supplying screen voltage. The recommended method is by means of a voltage

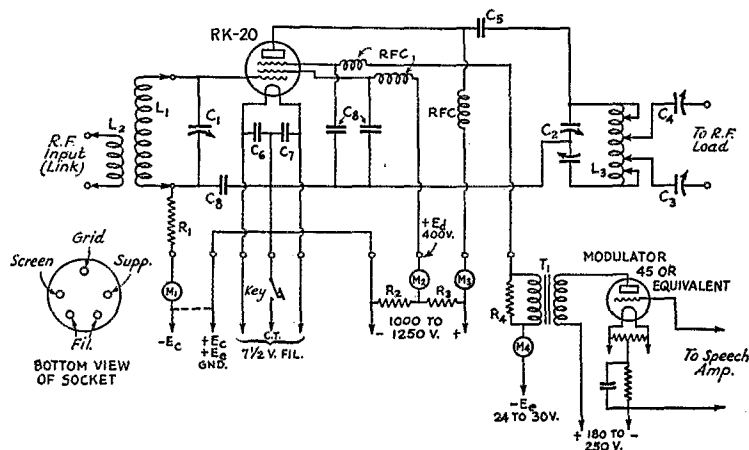

FIG. 1—THE AMPLIFIER CIRCUIT

With the following exceptions, specifications are the same as given in December, 1933, QST, and in Chapter Seven of the current Handbook:

- C_5 —0.001- μ fd. plate blocking condenser.
- R_1 —15,000- or 20,000-ohm 2-watt grid leak.
- R_2 —8000-ohm 25-watt resistor.
- R_3 —13,000-ohm 100-watt resistor.
- R_4 —5000-ohm 2-watt modulator stabilizing resistor.
- T_1 —1-to-1 Class-B input type transformer (See text).

divider, as shown in the diagram. However, screen supply from a separate power pack giving 300 to 400 volts has been used, as has also supply through a series resistor of 20,000 ohms (25-watt type) from the positive of the plate power pack. The divider arrangement is to be preferred, especially for 'phone where maintenance of the screen-to-plate-voltage ratio is of some importance. If a divider resistance combination different from that specified is used, the tap should be set to give a screen voltage of approximately 400 (or a screen current of approximately 30 ma.) with tuning adjustments for optimum output and with the suppressor voltage 45 volts positive.

If the amplifier is to be used at full output for c.w. or to drive a succeeding high-power stage, the suppressor voltage (E_s) should be set at approximately 45 volts positive. This voltage can be obtained from the same divider used to supply the screen voltage, or from small B batteries. The suppressor current will be approximately 4 ma. at this voltage, with the amplifier operating normally. In preliminary tuning up, however, it is advisable to set the suppressor voltage at 45 volts or so negative, thus limiting the plate current with the tank off tune. Once the approximately proper settings have been found for the grid and tank tuning condensers, by the usual plate-current dip for resonance and so on, the

suppressor voltage can be shifted to the positive side and the final adjustments made for full output. With plate voltage of 1000 to 1250 volts, and with optimum load coupling, the plate current will run between 85 and 100 ma.—and the output between 50 and 70 watts. Higher output,

efficiency than other systems of control-type modulation (such as the control-grid-bias system) and with considerably less critical adjustment. The power requirement in the modulator is small, so that almost any type of receiver power output tube is adequately capable of handling one or two of the new 50-watt type pentodes in the r.f. stage. In spite of their repute for distortion, even the audio pentodes, such as the 2A5, have been found to give decidedly good performance as suppressor-grid modulators.

The coupling is easily arranged, the transformer method specified in the diagram being the most generally suitable. The transformer may be of the input type commonly used for a 46 or 10 Class-B stage, although comparable results have been obtained with a receiver output transformer intended to work from a 2A5 pentode into a high-impedance speaker (4000-ohm load). The stabilizing resistor across the transformer secondary should be used if the full linear range of the suppressor characteristic, running to approximately 45 volts in the positive region, is to be used. The suppressor draws some current from zero up, demanding a little power, which makes this stabilizing necessary for

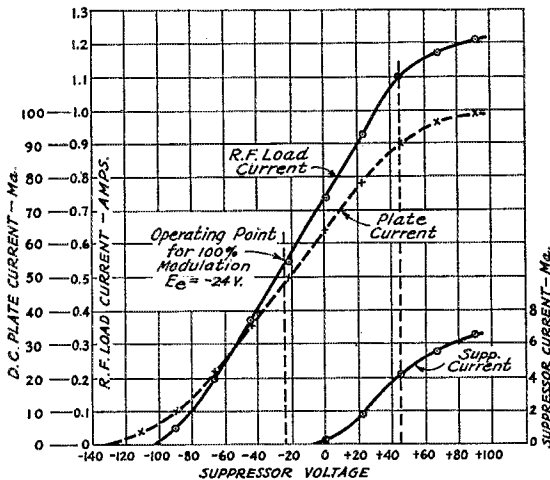

FIG. 2—TYPICAL MODULATION CHARACTERISTICS

can be realized, with correspondingly higher input, but not without some liability of doing damage. The extra few watts aren't worth the risk. In no case should the tube be operated with the plate showing color brighter than a faint pink. At least, that's our preference—with any tube.

MODULATION FOR PHONE

Although this type tube has the same possibilities for plate modulation as any screen-grid tube, or even somewhat better possibilities than non-pentode types, it is in the new rôle of suppressor-grid modulation that it has greatest interest. As has been pointed out in previous articles in our pages (particularly in March and May, *QST*), the suppressor or No. 3 grid is particularly fitted to use as the control electrode for applying modulation to the output of a pentode tube used as an r.f. amplifier—or even, as we shall see, as a sufficiently stable oscillator. When so used the suppressor serves as an effective gate controlling the r.f. amplitude linearly over the range for complete modulation, as shown in Fig. 2, doing the job with comparably better

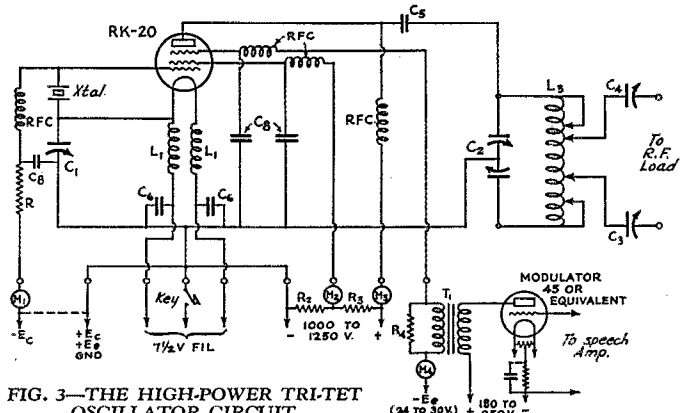

FIG. 3—THE HIGH-POWER TRI-TET OSCILLATOR CIRCUIT

Constants are as previously specified with following exceptions:

- L₁—Dual winding, two coils side-by-side on 2 3/4-inch diameter form. Each winding 10 turns No. 16 d.c.c. close-wound. Filament to upper ends, supply to lower ends.
- C₁—Excitation control—150- μ fd. receiving type condenser.

minimum distortion on the positive peaks.

To adjust the amplifier for 100-percent modulation, the full-power tuning and excitation adjustments are made as previously described, with the suppressor 45 volts positive. Then the suppressor is biased negative until the antenna current is halved. With the preliminary cylindrical-plate type tubes whose characteristics were given last month, this bias was around -24

(Continued on page 72)

H A M D O M



DR. BURTON T. SIMPSON, W8CPC, has one of the most unique practices in the history of medicine. He does not practice in Buffalo, the city where he lives, but does have a



consultation practice among radio amateurs throughout the United States and Canada, and sometimes in other parts of the world. They see him listed as an M.D. in the call book, and consult him concerning their physical ailments. His actual work is Director of the New York Institute for the Study of Malignant Diseases,

which is a research institution established for study into the causes and cure of cancer. It is the first institution to be established for this purpose in the world, and ranks as the foremost. His amateur career started in 1926, upon graduation from the B.C.L. set-builder class. The first outfit was a '10 in Hartley, followed in the same year by 3 '10's with crystal control—one of the first c.c. rigs in the vicinity. The present station has two transmitters, each with the maximum legal input, beautifully built in rack and panel style, with which he works 14 and 7 mc. c.w., and 14 and 4 mc. 'phone. Personal contacts and DX represent his main interest.

IT'S "Grandpa"

Kerr who represents the Midwest Division on the A.R.R.L. Board of Directors. He was dubbed with this nickname by Supervisor Hayes, who assigned him the call W9GP. "Gramp" got his interest in amateur radio while working as W. U. and railway Morse operator, back



in the days when sparks rent the ether in both auditory and electrical senses. Later, in the publishing business, as editor of a weekly newspaper, a litter of parts accumulated in the print shop and W9DZW resulted. W9GP continues from his home. To his weekly newspaper he has added

the publication of a ham sheet, and the print shop is as often as not in use preparing a circular to be distributed to the Midwest Division membership. "Gramp" (whose full name is Harry Wallas Kerr) served as S.C.M. of Iowa prior to his elevation to the Board, and also is active as the Radio Aide of the 7th C.A. for the A.A.R.S.



IN the QRR Log in the December, 1933, issue of *QST* we described briefly the work of Ed Thompson, W3CQS, during the Delmarva storm

and flood emergency work. We told how the emergency transmitter was set up in one of the booths in his restaurant, how the antenna was erected in the teeth of a fifty-mile gale, how the operators stuck to the key in knee-deep water through a night and a day until the regular wire lines were back in commission. Now we present W3CQS himself, leader of the daring and invaluable emergency relief work, formerly A.R.R.L. 3d district QSL manager, R.M. for his section, member of the A.A.R.S. and R.O.W.H., interested in amateur radio since 1913. He attends all the hamfests and conventions he can, and has a swell time at each. He even staged one highly successful

affair himself, with 131 delighted delegates in attendance. In between times the Collins 40B and Hammarlund Comet Pro keep his fist pretty steadily on the air.



IT TAKES a real operator to hold down the key at WLM, and Sergeant Ed Day is the man for the job. He takes

40 per with ease, and thrives on a routine which starts with skeds at 4 p.m. lasting until 3 and 4 a.m.—all in addition to being Capt. Garland C. Black's right hand man in running the Army Amateur Radio System. Twenty-seven years old,

(Continued on page 38)

A Simple Mounting for the Cathode-Ray Tube

AT FIRST glance the requirements for a cathode-ray tube mounting would seem to make construction difficult for the amateur. A tube rested in its packing case in the Lab for some weeks before it was mounted—for just that reason. We wonder if others are troubled

Three cracker tins served for our shield and a discarded universal joint from a periscope mounting became the swivel for our "trench mortar" type mount.

CONSTRUCTION

Two cracker tins of 5-inch diameter are used for the barrel of the mount. The ends are pried off both cans, leaving two cylindrical pieces of tin. One of the covers is saved to be used at the base. The rounded lip of one cylinder is unfolded to serve as a collar to slip over the other cylinder about $\frac{1}{4}$ inch. After a bit of sandpapering solder will flow over the surfaces readily. The barrel is now complete.

The hood is made of a 6-inch diameter cracker tin. The bottom is removed leaving the plain cylinder. The cover of the hood is placed right side up on a table, and the barrel is placed on it. Use this as a template and, after the barrel is centered on the cover, scribe a circle around the barrel. Then, with a pair of old shears, cut away the tin around a circle $\frac{1}{2}$ inch inside of the scribed line. Now cut slits about every half inch up to the scribed line. When the circle is completed these slits are bent back at right angles away from the cover.

This hood cover becomes the reducer after it has been placed on the barrel and soldered to it. If reasonable care has been taken the resulting barrel with soldered reducing cover should make a nice mechanical fit. The hood is a detachable part of the mount and can be removed at any time, as it fits into its cover.

The cover which was saved from one of the 5-inch tins is now used for the base of the barrel and as a mount for the 5-prong tube socket. As

(Continued on page 88)

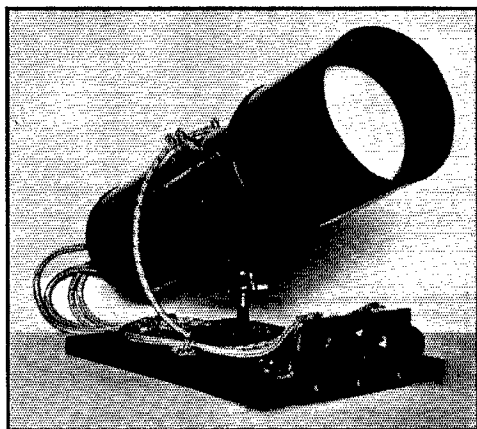

THE MOUNTING COMPLETE FOR ACTION

Only one set of deflection-plate terminals shows as the other set is on the opposite side of the barrel.

with the same problem. The mount to be described turned out to be a very simple and inexpensive mechanical job, and the finished product is highly respectable looking as well as acting.

Shielding must be non-magnetic and, to be of greatest utility, the mounting should be on a swivel joint. The tube we used was the 905, which is one size larger than the popular 906.

THE "TRENCHMORTAR" MOUNT PULLED APART

Note socket mounting on inside of cover as well as the cardboard ring mentioned in the text. All wiring used was high tension cable. The two controls may be seen on the bakelite panel at the right. Where the cover joins the barrel and where the hood fits on the barrel all paint has been scraped away to allow shielding to be complete over the entire mounting.

The tube has been pulled forward to show connections to the deflection-plate terminals.

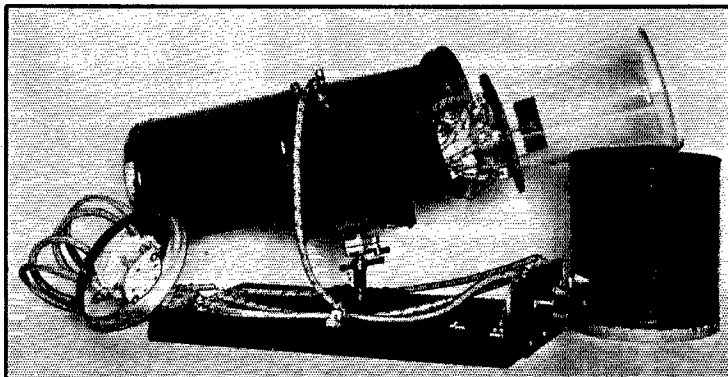

Low-Cost Crystal Control for High Power

♦ Applying the Crystal-Lock System in a 250-Watt Outfit

Durward J. Tucker, W5VU*

THE day has at last arrived when every amateur station is required to put out a decent note and it is encouraging to note that crystal-control stations are steadily increasing. Good low-powered crystal control can be accomplished with a very reasonable outlay of cash, as has been demonstrated by the fine articles in *QST* during the last year. However, any ham knows that crystal control for a 250-watt or a 500-watt transmitter means plenty of cash. All too often when a fellow must choose between a 10 crystal outfit or a 52 or 04-A TNT outfit, the high-powered TNT wins. Contrary to popular belief, all high-powered transmitters are not owned by fellows with plenty of ready cash; and crystal control for them constitutes a real problem. I fall within this class and it has kept me figuring for several months how I could change my 325-watt TNT transmitter over to crystal control at a very minimum cost. The TNT outfit consists of a W.E. 212-D with 1500 volts on the plate with an input of 325 watts. The probability of an intermediate amplifier of considerable power and corresponding power supply, following the crystal and doubler—to say nothing of a neutralizing condenser for the 212-D—did not look a bit good.

I finally hit upon the synchronization scheme mentioned in August, 1933, *QST*. A TNT self-excited oscillator is locked into synchronization with a crystal oscillator circuit. I was not overconfident that this radically different method of crystal control would prove satisfactory and fool-proof; so a very modest, but carefully constructed, 3500-kc. crystal oscillator and 7000-kc. doubler unit was built from parts out of a homemade short-wave receiver. Midget tuning condensers and plug-in coils were used for both crystal and doubler stages.

Since it was not convenient to couple the doubler tank coil directly to the TNT grid coil, a transmission line was used consisting of 2 feet of twisted lamp-cord wire and connected to three turns of the same wire on both the doubler tank coil and the TNT grid coil. The coupling in each coil is not critical and is "medium." The transmission line can be several feet long or only a few inches without any appreciable operating difference. The normal plate input of the doubler is about 15 watts without the transmission line connected. With the transmission line connected the plate input increases to about 18 watts.

* Box 181, Southern Methodist University, Dallas, Texas.

ADJUSTING THE CRYSTAL STAGE

In order to insure the stability of the crystal stage, the tank circuit should be tuned to a slightly higher frequency than that of the crystal. This should be accomplished by setting the tank condenser at minimum capacity and gradually increasing the capacity until the milliammeter dips to a minimum value; then the capacity of the condenser should be decreased slightly so

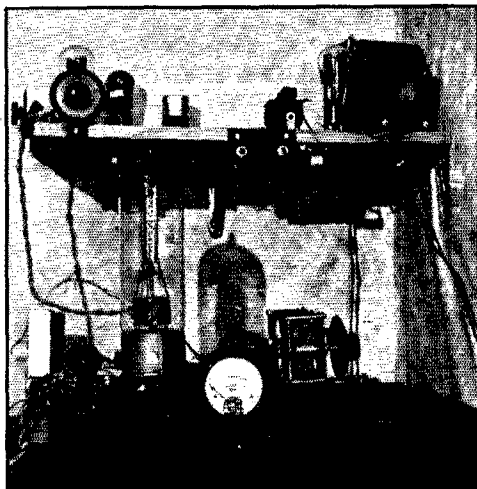

THE SYNCHRONIZED TRANSMITTER SET-UP

Left to right on the top shelf: 46 doubler; 112 xtal oscillator; xtal holder; doubler and xtal oscillator plate current jacks, 30-henry choke and 80 rectifier. The filter condensers are in the background and the power transformer in the foreground. Left to right on the bottom shelf: Transmission line leading from doubler to TNT; keying relay, W.E. 212-D tank circuit r.f. ammeter, tank coil, and the tank condenser (two Cardwell receiving condensers in series).

that the milliammeter reading increases two or three milliamperes. Should the condenser capacity be increased beyond the point of minimum dip the crystal stage stops oscillating easily and may not start every time it is turned on. Extreme care should be used to make the crystal circuit very stable with this method of crystal control.

SYNCHRONIZING

All adjustments of the crystal and doubler stages should be made with the TNT stage tube filament lit and plate supply connected but with the key open. After the crystal and doubler are

adjusted the signal is picked up with the monitor and logged. With the crystal and doubler power turned off, but not disconnected, the key in the TNT oscillator is pressed and the tank circuit adjusted, with the aid of the monitor, to a slightly lower resonant frequency than the crystal frequency. Next turn on the crystal and doubler again and press key of the TNT oscillator. If a single clear clean crystal note is heard in the monitor, then the circuits are in synchronism. If

chronizing the two circuits the limits should be determined and the TNT tank circuit tuned near the center of this band. The TNT tank circuit should be adjusted while it is drawing full load. If the TNT tank is tuned too close to the edge of the synchronizing band it may take a second or a fraction of a second for the two waves to synchronize each time the key is pressed. This will give the signal a peculiar chirp.

Attention is called to the fact that synchro-

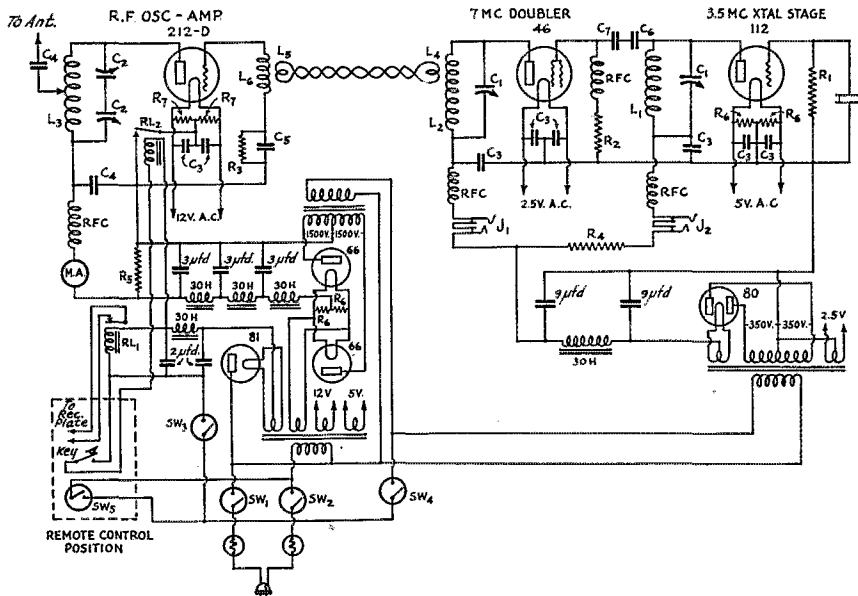

FIG. 1—DIAGRAM OF THE SYNCHRONOUS CRYSTAL CONTROLLED TRANSMITTER

- L₁—30 turns No. 20 enameled wire on 1½-inch form.
- L₂—20 turns No. 20 enameled wire space-wound on 1½-inch plug-in coil form.
- L₃—10 turns ¼-inch copper tubing, 2-inch inside diameter.
- L₄—3 turns lamp cord wrapped around L₂.
- L₅—3 turns lamp cord wrapped around L₆.
- L₆—16 turns No. 20 enameled s.c.c. wire on 1-inch bake-lite tubing.
- RFC—No. 30 s.c.c. wire wound for a length of 3½ inches on a ½-inch diameter wooden rod.
- C₁—13-plate midget receiving condenser.
- C₂—17-plate Cardwell receiving condenser.
- C₃—0.002-μfd. 600-v. fixed condenser.
- C₄—0.002-μfd. 5000-v. fixed condenser.
- C₅—250-μμfd. 600-v. fixed condenser.
- C₆—50-μμfd. 600-v. fixed condenser.
- C₇—250-μμfd. 600-v. fixed condenser.
- RL₁—Relay to break receiver plate supply when transmitting.
- RL₂—Keying relay.
- R₁—10,000-ohm 2-watt carbon grid leak.
- R₂—15,000-ohm 10-watt, wire-wound grid leak.
- R₃—10,000-ohm 75-watt wire-wound grid leak.
- R₄—5000-ohm 25-watt wire-wound dropping resistor.
- R₅—60,000-ohm 75-watt wire-wound bleeder resistor.
- R₆—10 ohms. R₇—50 ohms.
- J₁ and J₂—Plate milliammeter jacks.
- SW₁, SW₂, SW₃ and SW₄ are closed at beginning of transmission and left closed. The transmitter is then controlled from remote position by SW₄.

several or perhaps dozens of signals are heard, then adjust the TNT tank condenser for slightly greater or lower capacity and again listen for synchronism. A few tests will indicate whether the frequency of the TNT tank is being decreased when it should be increased or vice versa. If the monitor is tuned to the signal and the two circuits are exactly synchronized, the crystal signal will be heard when the key is up.

The point of synchronism is not sharp; it has been found that synchronism will occur within a band of from about 5 to 10 kc., the greater part of this band being below the frequency of the crystal. After one becomes familiar with syn-

nism, in this case, is more than tuning two radio-frequency circuits to the exact frequency where they go merrily on their sinusoidal way. The TNT circuit will actually abandon its own frequency and "jump" several kilocycles to assume the frequency of the crystal. Therefore, it is seen that synchronizing is not a hair's-breadth task of splitting cycles, attainable only in laboratories, but is something easily done by any ham.

DEPENDABILITY AND QUALITY

If the system is adjusted properly the load can be removed and synchronism still main-

(Continued on page 78)

A Medium-Power 56-Mc. Transceiver

A Battery-Powered Class-B Modulated P.P. Oscillator with Ten Times the Output of 30 Type Units

Frank Jacobs, W2BSL*

Arm-chair experimenters, in their eagerness to find something wrong with something, have enjoyed rapping the modulated-oscillator Type 56-mc. transmitter and the super-regenerative receiver. Probably they will continue to do so. The fact remains, however, that this type of equipment is still the only genuinely practical one for portable and mobile work. QST has long recognized the need for a reduction of frequency modulation on the 56-mc. band and will continue to advocate firmly the use of stabilized transmitters for fixed locations and in congested districts. At the same time, we strongly suspect that the stabilized transmitter for 56-mc. (or the still higher frequencies) will not involve application of an inefficient string of amplifier tubes. Much more modern and more promising methods are on the horizon. In the meantime we present another modulated-oscillator unit of proven effectiveness.—EDITOR.

IN HIS article, "Featherweight Sets for the Ultra High Frequencies," Ross Hull made a closing plea "that amateurs should consider these circuits and illustrations not as something to be rigorously copied but as suggestions of possible use in the development of new and better equipment." Bearing that in mind and taking hints from Reinartz on the use of dual tubes in unity-coupled transmitting circuits, I developed a dry cell operated transceiver having an output of 2.0 watts instead of the conventional 0.2 watt of the Type 30 transceiver. The result is a healthy signal that is comparable to that radiated by a medium power transmitter using push-pull 71-A type tubes; a popular combination in the past. Unlike the 30-type transceivers, this one employs a stage of audio amplification, permitting reception several feet from the phones. Only three tubes are used, a 30, and two 19's.

A Type 30 tube is employed in the dual rôle of interruption-frequency oscillator for receiving and speech amplifier or driver tube for transmitting. The manufacturers specify an output of 170 milliwatts from this tube when coupled to a Type 19 Class-B stage and operated with 135 volts on the plate and -9 on the grid. The Class-B stage delivers an undistorted power output (U.P.O.) of 2.1 watts when operated without bias, and with 135 volts of plate potential. As the practical or operating plate efficiency of Class-B systems is approximately 50 per cent¹ instead of less than 25 per cent characteristic of Class-A,² the plate batteries need not be enormous, making portable operation a reality. The total plate current of all tubes in the receiving position is normally 20 milliamperes; the total drain on

modulation peaks of transmission sometimes reaching 75 milliamperes. Type 30 transceivers when operated at 90 volts draw about 7 milliamperes on transmission, an input of 0.63 watts. The Type 19 has an input of 6.75 watts; 50 milliamperes at 135 volts; or over ten times that of the Type 30 transmitter. As the 30 type modulator tube delivers only 0.17 watts for modulating 0.63 watts oscillator input, and as the 19 Class-B gives an audio power of 2.1 watts for modulating an oscillator input of 6.75, the ratio of audio power to oscillator power is seen to be lower in the latter; or in other words the percentage of modulation is higher in the 19 Class-B combination. These values may not be exactly the same in all cases, but they will serve as a guide for comparison.

Change-over from transmitting to receiving is

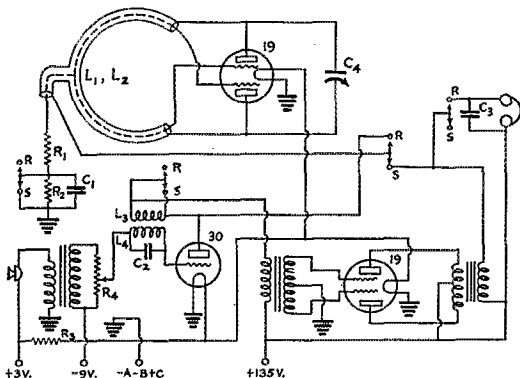

THE COMPLETE TRANSCIEVER CIRCUIT

- C₁—150- μ fd. fixed condenser.
- C₂, C₃—2000- μ fd. fixed condensers.
- C₄—35- μ fd. variable.
- R₁—20,000-ohm fixed resistor.
- R₂—0.5-megohm fixed resistor.
- R₃—1.5-ohm fixed resistor.
- R₄—0.5-megohm potentiometer.
- L₁, L₂—See text.
- L₃, L₄—Sickles interruption frequency coil unit.

* 8427-105th St., Richmond Hill, N. Y.

¹ Loy E. Barton, "High Audio Power From Relatively Small Tubes." *Proceedings of the I.R.E.*, vol. 19, p. 1131, July, 1931.

² Terman, *Radio Engineering*, p. 164.

made by the flip of a 4-blade anti-capacity switch. The 0.5-megohm resistor, R2, is shunted out when the switch is thrown to the sending position. Resistors up to 2 megohms may be used in this circuit with varying intensities of the characteristic super-regenerative rushing or hissing sound. Trial will determine the correct

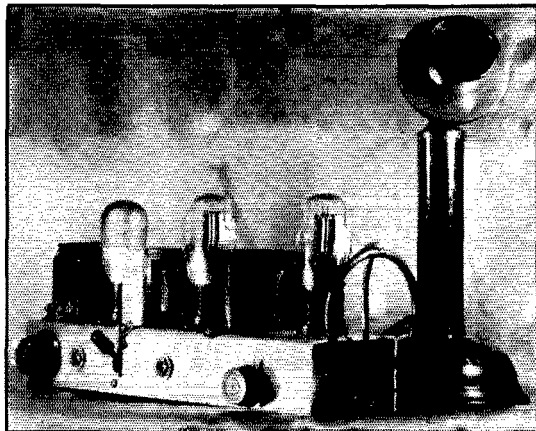

SET UP FOR ACTION

resistance for optimum smoothness of hiss.

The chassis is bent from a 7 by 14 by $\frac{1}{16}$ -inch aluminum panel. The completed unit is $3\frac{1}{2}$ by 12 inches on top by $1\frac{3}{4}$ inches high. Deep scratches are made on the inner sides of the panel before bending between two boards clamped together in a vise. Socket holes are cut with an expanding wood bit kept moist with oil. Sub-panel type sockets are employed. The photographs show the layout of the various parts.

The unity coupled inductance is held firmly in position at the end of the chassis. The ends of the copper tubing go through $\frac{1}{4}$ -inch holes in the bakelite end strip and are soldered directly to the oscillator socket plate prongs. The inner, or grid coil, leads cross over and connect directly to the grid terminals of the same socket.

The $\frac{1}{4}$ -inch copper tubing from which the inductance is made is first threaded with a piece of solid number 18 push-back wire that has been tapped in the center. The tubing is then bent to form a circle 3 inches in diameter, and the ends are bent perpendicularly to the plane of the circle formed by the tubing, for entering the holes in the bakelite end piece of the chassis. The plate lead is bent in the same manner and is soldered to the main inductance. As viewed from the end of the chassis

the inductance appears not unlike a 3-inch Greek letter Omega. Antenna coupling is provided by another copper coil bent to a diameter of about $2\frac{1}{2}$ inches. The ends terminate in porcelain stand-off insulators mounted on the wooden carrying case. Various antennas may be connected to these insulators whenever the user feels the urge to try what he thinks is a more efficient radiating system.

A 35- μ fd. Cardwell midget condenser is mounted directly on the copper tubing at its junction with the tube plate prongs by the use of brass strips. A $\frac{1}{4}$ -inch bakelite shaft, terminated on the outside of the chassis by a G.R. knob, is coupled to the condenser for tuning. Small size mica condensers bypass the Sickles interruption frequency coil, the receiving grid leak and the phones. In some cases it may be advisable to by-pass the B batteries or the primary of T_a . The values shown need not be copied exactly. Various values of capacity should be tried across the grid leaks until a smooth hiss is received. All ground connections are made to the aluminum chassis. Transformers similar to the ones used have been described in previous articles and can be made or purchased. In this particular transceiver T_1 is a Thordarson microphone transformer, and T_2 and T_3 United Class-B input and output transformers respectively. Phones and microphone plug into midget jacks, one of which controls the filament circuit; making a separate filament switch unnecessary.

The carrying case is made of oak and is covered with two coats of clear duco. One side is hinged, permitting access to the side of the chassis with its knobs and jacks. Three $9\frac{1}{2}$ -lb., 45-volt Layerbilt B batteries, two $4\frac{1}{2}$ -volt C batteries and two number six dry cells are carried in a separate



A LOOK UNDERNEATH

wooden box equipped with a handle and a strap for shoulder carrying. A four-wire cable terminated on each end by a four-prong tube base permits rapid change from one location to another without troublesome entangling battery wires. Both the transceiver chassis and the battery box are equipped with subpanel sockets for ready

(Continued on page 88)

Automatic Gain Control With Diode Detection

Using the Type-B7 Tube as a Combined I.F. Stage and Second Detector
in the S.W. Superhet

Wolcott M. Smith*

Although almost universally used in modern broadcast receivers, diode detection combined with automatic gain control is seldom found in the present amateur-band superhet. Why should this be so? Because the requirements of amateur and broadcast reception are so widely different, straight adaptations to s.w. receiver design of practices that are considered satisfactory in b.c. receivers do not always work out as improvements in our particular field. But recent tube developments and applications now fit diode detection to our special requirements and point the way to its practical use in our superhet receivers, as the author shows in this article. —EDITOR

ALTHOUGH the manufacturers of broadcast receivers have been using the diode detector with automatic gain or sensitivity control for the past several years, it has not yet established itself in high-frequency receiver design. Some consider this type of detector as excellent, while others do not agree with this view, declaring it insensitive. In its application a variety of circuit arrangements have been used, some decidedly inferior to others. The ultimate purpose of this article, which is based on two years of practical experience with diode detection in combination with several more or less technical papers on the subject, is to show how diode detection and automatic gain control can be used to best advantage in replacing the plate detection triodes commonly used in high-frequency superhet receivers.

DIODE ACTION

For many years the grid-leak and condenser detector has been used. Even to-day it is considered as one of the most sensitive of them all, although its use was discontinued in commercial receivers with the development of high r.f. gain. It interests us here because

* 117 East St., Windsor, Conn.

it is akin in action to the diode. In the diagram of Fig. 1-A is shown the usual circuit arrangement for the grid-leak detector. Fig. 1-B is the same circuit with the leak and condenser in the grid return circuit instead of the usual position in the grid lead of the transformer secondary. Fig. 1-C shows a special case in which the leak is directly

to cathode or to ground instead of shunting C_1 , the grid condenser. The arrangement of Fig. 1-D is identical with that of Fig. 1-B except that a dotted line is drawn through the center of the tube, the circuit on the left being fundamentally that of the diode rectifier.

Tracing the action, an incoming signal is rectified in this grid-cathode circuit in familiar fashion. As this signal increases, the rectified current increases and the bias on the amplifier portion of the tube also is increased. When this incoming signal becomes large enough, the tube as an amplifier becomes overbiased to such an extent that

severe harmonic distortion occurs. This results because the overbiasing causes plate rectification in addition to the previous rectification in the grid circuit so that the tube rectifies the modulation envelope all over again, cutting off

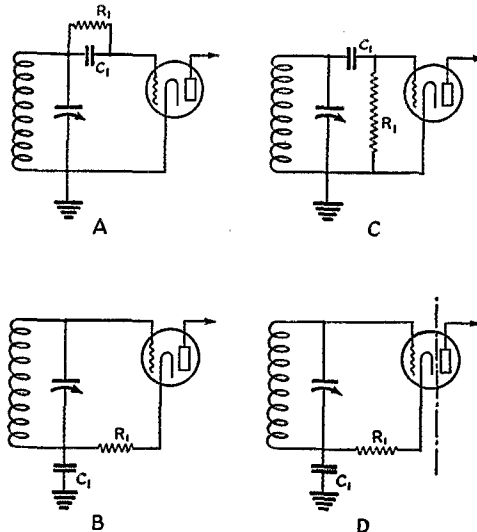

FIG. 1—DEVELOPMENT OF THE DIODE DETECTOR FROM THE FAMILIAR TRIODE GRID-LEAK TYPE
The grid acts as the diode plate.

the peaks, thereby causing harmonic generation. This means that not only the notes originally in the input are heard from the output, but also that strong harmonics of these notes appear. In other words, if a 1000-cycle note modulates the radio frequency input, there is an undesirable amount of 2000-, 3000- and 4000-cycle output in addition to that of the original 1000-cycle grid rectified component. As we all know, this type of distortion makes the set sound "mushy" or "harsh."

It is possible, by the simple expedient of leaving the amplifier functions of the tube to be performed in a separate tube or in a separate section of one of the new tubes, to eliminate this type of distortion. By proper operation of the diode circuit, any troubles likely to arise in its operation can be circumvented, or at least reduced to the point where they become negligible. The great advantages of diode detection lie in its wide tolerance and in the fact that it can readily be made to furnish rectified voltage for automatic gain control of the r.f. amplifier in the receiver.

There is another angle from which this diode detector action can be approached, starting out with the diagram of the Type 81 power supply of Fig. 2-A. This is the usual half-wave rectifier with its accompanying filter circuit. In Fig. 2-B the filter system, other than the filter condenser C_1 required to by-pass the load R_1 , is dropped and the positive instead of the negative side of the output is grounded. The circuit of Fig. 2-C shows the equivalence of the grid circuit of a triode to the circuit of Fig. 2-B. Comparing with Fig. 1-D, it is seen that we have again arrived at grid-leak, or diode, detection. They are essentially the same thing. Each is a half-wave rectifier with a small filter. In each a pulsating direct-current potential is built up across the load resistor, R_1 . In both, power is drawn from the circuit to which they are connected, just as in any rectifier. The difference between this rectifier and the usual power-supply rectifier is simply that the diode detector deals with radio frequency and must retain the modulation envelope essentially intact.

As the design of the circuit for diode detection is begun, it is best to consider perfection as the ultimate goal towards which to aim. Thus, the circuit must be so arranged that greatest efficiency is attained. Simultaneously, its sensitivity must be as high as possible. The audio output must be free from harmonics due either to improper matching of C_1 and R_1 ,¹ or to the use of too-heavy an audio load in parallel with the direct current load.² The formulas given later are quite tolerant, good results obtaining with as much as 25% variation in component values. When these formulas are closely applied, the detector output will be free from distortion with inputs having modulation up to at least 75% and within the

audio-frequency range for which the value of C_1 is selected. The autogain circuit will prevent excessive radio amplifier overload when the coupling from the last amplifier to the diode is near its optimum value.

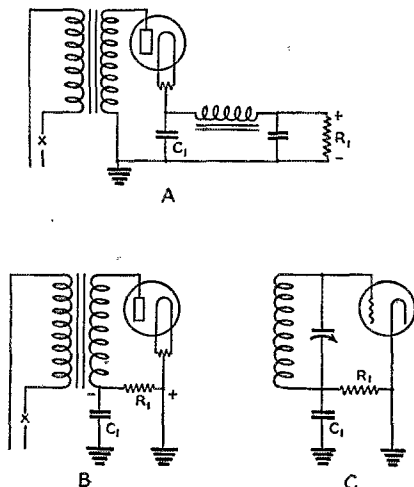

FIG. 2.—ILLUSTRATING THE RESEMBLANCE OF THE HALF-WAVE RECTIFIER, AS USED IN POWER SUPPLY CIRCUITS, TO THE DIODE DETECTOR

ADAPTING TO STANDARD CIRCUITS

This article is written with short-wave superheterodynes particularly in mind. These, especially from the viewpoint of autogain, are the most practical for such a second detector circuit arrangement. The usual plate detector employed acts as two tubes in one, first as a high-impedance input radio-frequency amplifier, then as a detector.³ Attempts to replace such detectors with a diode-triode type tube, such as the 55, have resulted in reduced receiver sensitivity and impairment of i.f. selectivity, because the usual loosely-coupled i.f. transformer is not adapted to loading by the relatively low-impedance diode circuit and because the gain provided by the triode section as an a.f. amplifier is insufficient to bring the output up to that obtained with the high-impedance input plate detectors. But with an additional i.f. stage particularly designed to work into the diode and provision of gain more than compensating for the lesser diode sensitivity would justify the adaptation to existing receivers of diode detection and the effective automatic gain control that goes with diode rectification. What we want is a single tube that combines a high-gain r.f. amplifier, a diode detector and a diode a.g.c. rectifier. Therefore the new diode-pentode tubes, the 2B7 and the 6B7, are the ones in which we are interested.

The manufacturers have done a fine piece of

³ *The Radio Amateur's Handbook*, Chapter Four.

¹ Nelson, J. R., *Proc. I. R. E.*, June, 1932.

² Kilgour and Glessner, *Proc. I. R. E.*, July, 1933.

work on these tubes, building three functions into one tube in a decidedly satisfactory manner. The screen-grid amplifier portion is a pentode with a plate impedance of 650,000 ohms, lower than most any of the other r.f. pentode amplifiers, and for this reason more easily matched by its load. In fact, with the diode detector properly arranged, very nearly ideal conditions can be realized. Besides the pentode portion there are also two diode plates, each capable of handling far more power than is ever required of them in a well designed diode detector fed by the pentode section. From this it is evident that a -B7 tube can replace the second intermediate amplifier and detector; or, better yet, it can be used to replace the usual triode or s.g. second detector, adding i.f. gain while providing real power detection. This application is the one utilized in the arrangements diagrammed in Figs. 3 and 4.

The 2B7 and 6B7 are identical except for their heater requirements, the 2B7 having a 2.5-volt 0.8-amp. heater intended for a.c. operation and the 6B7 having a 6.3-volt 0.3-amp. heater intended for either a.c. or d.c. operation. Maximum plate voltage is 250 and current 9 ma. Maximum recommended screen voltage (grid No. 2) is 125

volts, and screen current 2.3 ma., control grid bias being 3 volts negative. The suppressor grid (No. 4) is connected directly to the cathode internally. Referring to the standard pin arrangement (Chapter Five of *The Radio Amateur's Handbook*, eleventh edition, or page 30, March, 1933, *QST*), the connections are as follows: Pin 1, screen; Pin 2, pentode plate; Pins 3 and 4, heater; Pin 5, cathode; Pin 6, diode plate; Pin 7, diode plate; and cap, pentode control grid. Viewing the base from the bottom, the pin numbering progresses counter-clockwise (from left to right) with the heater pins identified as the two larger than the rest.

These circuits are adaptable to several standard superhets, such as the Hammarlund "Pro," and National AGS and FB7's, as well as to the S. S. Super described by J. J. Lamb in August and September, 1932, *QST*. The diagrams follow the lineup of the *QST* s.s. superhet particularly and are generally according to standard practice. Only the circuit elements actually involved in the detector and a.g.c. operation are shown in detail since other sections are conventional. The two detector arrangements are similar except that whereas that of Fig. 3 utilizes a choke as the

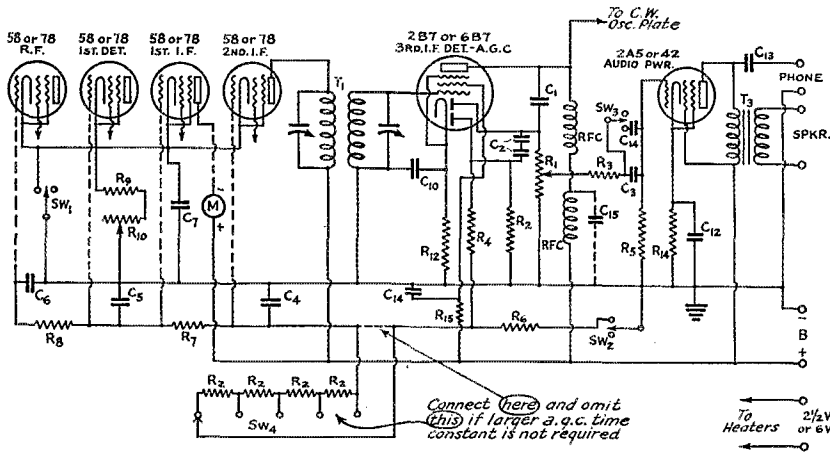

FIG. 3—AN ILLUSTRATIVE ADAPTATION OF THE -B7 TYPE TUBE AS A COMBINED I.F. AMPLIFIER DIODE DETECTOR AND SEPARATE DIODE A.G.C. RECTIFIER REPLACING THE USUAL TRIODE OR SCREEN-GRID SECOND DETECTOR OF A TYPICAL SUPERHET

In this arrangement the r.f. voltage applied to the diode circuits is taken off across the plate choke of the -B7. Circuit constants are usual except as specified below.

- R₁—2.0-megohm unshielded manual volume control. See text.
- R₂—3.0-megohm 1/4-watt, each.
- R₃—0.5-megohm 1/4-watt.
- R₄—4.0-megohm 1/4-watt.
- R₅—10.0-megohm 1/2-watt.
- R₆—50,000-ohm 1/4-watt.
- R₇—0.25-megohm 1/4-watt.
- R₈—0.25-megohm 1/4-watt.
- R₉—100-ohm 1/4-watt.
- R₁₀—Manual gain control, 1,000 ohms (approx.).
- R₁₂—500-ohm 1/4-watt.
- R₁₄—400-ohm 2.0-watt.
- R₁₅—60,000-ohm 1-watt.
- C₁—50-μfd. mica.
- C₂—100-μfd. each mica.

- C₃—250-μfd. to 50-μfd. mica.
- C₄, C₅, C₆—0.002-μfd. above 1500 kc., 0.005-μfd. below 1500 kc., 600-volt mica.
- C₇—0.5-μfd. 200-volt.
- C₁₀—0.1-μfd. or less, 200-volt (see text).
- C₁₂—10.0-μfd. 50-volt electrolytic.
- C₁₃—0.1-μfd. 600-volt.
- C₁₄—0.01-μfd. mica.
- C₁₅—250-μfd. mica (if used).
- RFC—10- to 30-mh. r.f. chokes.
- SW₁—S.p. cathode resistor shorting switch. See text.
- SW₂—A.g.c. on-off switch.
- SW₃—Audio tone control (Phone-c.w.).
- SW₄—A.g.c. time constant control.
- T₁—Standard i.f. transformer.
- T₂—Audio output transformer.

and here it must be said that the action of this condenser is exceedingly complicated. Briefly, when the modulation percentage is high it causes the generation of excessive harmonic distortion at certain frequencies above the audio frequency

Table I

Reactance at Radio Frequencies, Ohms				Reactance at Audio Frequencies, Megohms		
Cap., μ fd.	175 kc.	450 kc.	1,500 kc.	100 c.p.s.	2,000 c.p.s.	4,000 c.p.s.
0.00005	18,000	7,000	2,100	32.0	1.6	0.8
0.0001	9,090	3,500	1,050	16.0	0.8	0.4
0.00025	3,600	1,400	420	6.4	0.32	0.16
0.0005	1,800	700	210	3.2	0.16	0.08
0.002	450	175	52.5	0.8	0.04	0.02
0.005	180	70	21	0.32	0.016	0.008

chosen to find the value of X_c , besides which it by-passes some of the normal higher audio frequencies; and, being in series with the diode, it tends to lower the efficiency of the rectifier. The last feature has been shown, experimentally, to be negligible so long as the capacity (circuit capacity included) does not fall below 50 μ fd. with a load resistor of 1.0 megohm or more.

The value of C_2 , the a.g.c. load coupling condensers, will preferably be as small as it can reasonably be made, 50 μ fd. for both in series being generally an optimum value. C_1 should rarely be permitted to exceed 100 μ fd. with a 1.0 megohm load as R_1 ; nor should it exceed 50 μ fd. when the load resistance exceeds this value. Table I shows the impedance values of capacitances likely to be looked upon favorably by some who have seen the manufacturers' methods, but not their transformer design and other features. It is evident that the 500- μ fd. value is out of the picture for anything like reasonably high sensitivity, with simultaneously good audio fidelity. Too much trouble crops up, not only from harmonic troubles but also from losses in the upper audio register, when anything larger than 100 μ fd. is used here in a circuit intended for high sensitivity as well as good audio fidelity.

Thus, if the quantity X_c in the Table is taken as equal to R_1 , such troubles will be lessened; and, if R_1 isn't chosen altogether too high, the reproduction will be reasonably good. In Fig. 3, for example, the value of R_1 is 2.0 megohms. The capacitive reactance of C_1 for the highest audio frequency must come as near to this value as possible. Hence a capacitance of 50 μ fd. is chosen.

One thing must be watched in applying this value, however. The circuit capacitance should be well considered, since this adds to the value of C_1 , actually making it unnecessary to add quite this much capacitance. In fact the smallest practicable is this 50 μ fd. value. This will be

found satisfactory in any case, even though it isn't perfection. The way this value of C_1 is chosen is as follows:

The highest audio note from the loudspeaker is, let us say, to be about 4000 cycles. A few sets will deliver better than this, but most are poorer, so that this is a safe value. Hence we may design the detector to pass, without distortion due to harmonic addition, say, 2000 cycles, because the second and higher harmonics of 2000 cycles will be inappreciable. They just naturally don't get through the usual audio amplifiers. Sometimes sets will be found in which 1000 cycles can be used as the design frequency, although the 2000-cycle value is safe enough with the run of present-day commercial receivers and parts. You'll know it, quickly enough, if there is over 10% harmonic distortion out of the speaker.

The next point to be considered is the value of the audio coupling condenser, C_2 . This capacitance depends largely upon the value of the first audio grid-leak, R_2 . Kilgour and Glessner³ have shown that this circuit, $R_2C_2R_3$, being an audio shunt on the d.c. load R_1 , will cause harmonic distortion at high-percentage modulation unless it is of extremely high impedance in comparison to R_1 . For this reason R_2 is chosen as high as is practicable, about 10.0 megohms filling the bill, permitting about 90% modulation without excessive audio cut-off distortion.

Now C_1 reduces the upper audio response considerably, even when it is as small as 50 μ fd., and it is necessary to make some correction in order to have nearly a flat frequency response for the voltage across R_2 . To do this, the condenser C_3 is made to have about half the impedance of R_2 at 100 cycles, reducing the lower audio response to balance up the output to give a more nearly flat curve. For 'phone reception with a crystal filter in circuit, for instance, this arrangement will greatly improve the intelligibility of speech. When c.w. reception is desired, the switch SW_2 is closed, adding the capacity C_{14} to that of C_3 , increasing response to the lower notes and cutting out undesirable high-beat signals more completely. Thus the high selectivity of the crystal filter is made more useful for 'phone reception, as well as for code—and those 'phones can certainly jam at times.

Following out the formula, C_3 will turn out to be about 200 μ fd. or so. While this may seem small, the audio output at 2000 cycles is still about 92% available, although the response at 100 cycles has been reduced to about 50%. With a 50- μ fd. condenser across R_1 , the results show that the whole output is much more nearly flat from the 100-cycle point to the 4000-cycle value although there is still some drop in output between 400 and 4000 cycles which cannot be corrected easily. 'Phone articulation is improved, however, and that is what is needed. The added effect of side-band cutting caused by the extreme

selectivity of a crystal filter will, in effect, add so much more bass that we can even make C_3 as small as 50 $\mu\text{fd.}$ without doing any damage. The total volume loss is not serious even with so selective an intermediate amplifier, and the speech intelligibility is greatly improved.

The capacitance of C_4 , C_5 and C_6 may be about 0.002 $\mu\text{fd.}$ Some may consider this small in comparison with what previously has been used, but trial shows that it is sufficient. The higher the frequency, the better the by-pass, so that even smaller capacitance could be used were it not that the tuning range of the h.f. end of the set might be affected too much. The second i.f. bypass, C_4 , may be as small as 500 $\mu\text{fd.}$, thus increasing a.g.c. control speed.

The formula for R_4 depends upon the time factor of the a.g.c. circuit so it has been made dependent upon the total capacity of the entire set of by-passes, C_4 , C_5 and C_6 . The resistor R_3 also enters into this, and its value must be subtracted from the total permissible for optimum time factor. Then, by by-passing both the first detector and the first i.f. grid returns with the same condenser, (their respective voltages are out of phase, so don't regenerate), the resistor R_4 is again increased, lowering the audio load on the d.c. load R_2 , and lessening possibility of distortion reflecting back to the audio circuit. With all this, the effective time-factor, figured as usual by the time required to discharge a condenser 63%, is equal to RC , with R in megohms and C in microfarads. The 0.04 portion of the formula given is really the time-factor of this circuit. This seems satisfactory for most applications and makes R_4 (Fig. 3) take a value of about 4.0 megohms (exactly, 3.6) for the preferable value. Then R_7 and R_8 , the filtering resistors between controlled circuits, can be anything from 0.1 megohm to 0.25 megohm. In order that tuning with or without the a.g.c. feature will not differ excessively, the control voltage is sufficiently shorted out through the resistor, R_6 , which should be about 50,000 ohms, connected to ground through the switch SW_2 when a.g.c. is not wanted.

THE BETTER CIRCUIT

With all the important new features of the circuit shown in Fig. 3 taken care of, Fig. 4 comes up for scrutiny. In many ways it is the same, but introduction of the tuned transformer, T_2 , makes it necessary to note a few essential differences. The first of these is the coupling of the transformer windings. With standard 450- to 525-kc. transformers having "universal" windings of equal inductance, the separation between the two coils should not be greater than $\frac{1}{8}$ th inch and is preferably set at $\frac{1}{32}$ nd-inch for best all-around operation. This will permit use of a better grade of manual volume control for R_1 and, by having this control a shielded unit, the condenser C_1 is done away with. Any of the manufacturers

of such transformers can supply these with the proper value of L_m to suit the requirements (L_m approximately 80% or with nearly unity coupling); but if it should be impossible to buy one that is just right, any of the present transformers using a wooden or bakelite dowel can be rebuilt to these specifications. To do this, remove the coil assembly and drill lengthwise through the center of the dowel core with a number 36 drill. Then saw out a section of the dowel between the coils, as close to the coils as possible without danger of spoiling them. The ends of the form which are left can be further shortened by filing. A $\frac{1}{16}$ th-inch separation with the 500-kc. range intermediates will be found satisfactory, though, and this can be cut with the hack-saw, with care. When the forms are down to the required length, pin the two coils together with a match stick, cemented in place with celluloid dissolved in amyl acetate.

Capacitance across the control R_1 is no longer harmful. In fact, if this control is one of the shielded types, Electrad No. 206 for instance, no other capacitance will be needed. C_2 , however, will remain the same, because 50 $\mu\text{fd.}$ is about all that can be used. All the other component values are the same, the only major change additional to replacement of the tube itself being that of replacing the plate chokes L_9 and L_{10} of the original s.s. set with the tuned transformer. The transformer method of feeding the diodes will be found far more satisfactory in every respect than the choke-fed circuit arrangement, although good results will obtain with the latter if care is used in placing the parts to lessen capacity across the choice. This choke-feed system has been used several times with complete success in the writer's work.

FURTHER AUTOGAIN CONSIDERATIONS

When it is properly applied, diode detection with automatic gain control at the higher radio frequencies is unquestionably beneficial. Some consider that autogain on code reception is impracticable, but this does not apply always. If there is provision for increasing the time-factor of the a.g.c. circuit, this can be set so as to prevent excessive background rise between the individual dots and dashes, at least. When the incoming signal is readable at all, this background can be no worse than will be encountered when operating with manual sensitivity control, and the advantage of lessened fading is certainly beneficial. The switch, SW_4 , in the Figs. 3 and 4, is intended to accomplish this by adding resistance to the control circuit in 2-megohm steps, thus increasing the time constant. The switch SW_1 shorts out the fixed cathode bias for c.w. reception with a.g.c., since the operation of the c.w. beat oscillator places some r.f. voltage on the diode plates, thereby increasing the no-signal grid bias and reducing maxi-

(Continued on page 74)

Flea Power in the Arctic

The Story of a Low-Powered Emergency Transmitter Built from Junk

Philip L. Ennis, K7BWZ *

LAST year the author bettered the depression by taking a job in Alaska, but was unable to take a transmitter for the trip because of the expense of what was thought to be adequate equipment. However, a good a.c.-d.c. short-wave receiver, employing a 36 detector and two 37's for audio, was taken along. All "r.f." was discarded for circuit simplicity. Five minutes after the receiver was put on the air the writer regretted he had not brought along a transmitter.

Under the Northern Lights the whole world pounded in. W's from all districts were heard; ZL's, VK'S, K6's, J's and countless others. It was an ideal spot—a veritable ham's paradise, for reception at least. There was no local interference, no blanketing by neighbors, no "rock-crushers" filling the air with "gravel."

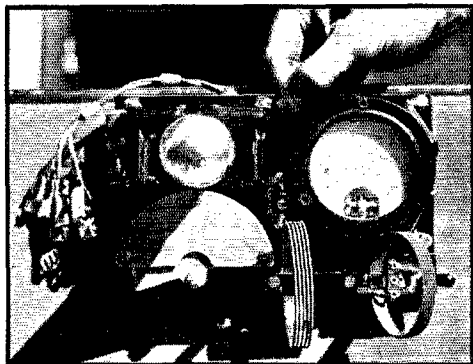

THE TRANSMITTER ABOVE IS THE SUCCESSOR TO THE ORIGINAL CIGAR-BOX MODEL

The 201-A shown installed can be replaced by a 10 when suitable plate and filament supplies are available. At the right is the cigar-box transmitter that worked Japan,—Australia and New Zealand from Alaska—with only 200 volts on the plate of a 201-A. The receiver at the right was used for press and ship work.

One evening while sitting in the radio shack and grousing because there was no transmitter available, I walked a fellow op, Charles Blair, full of optimism. We talked it over. Why not try out a custombuilt junk pile? It was finally decided to throw together a simple Hartley transmitter built entirely from "what have you"—or less. We did.

The most important need was, of course, for

* 477 Hudson St., Oakland, Calif.

power. We were able to round up just 210 volts. It was thought that this would be sufficient for local or Alaskan communication—provided we could hear any locals. A tough, chesty 201-A which lighted up like the Aurora Borealis was pushed through four holes in a cigar box—the box in lieu of a socket.

A condenser of 43 plates, built for 600-meter work, was "borrowed" from a long-wave receiver. Real ingenuity had to be used to obtain copper tubing for the inductances. A machinist who thought we really wanted to do a bit of "bootlegging" on the side finally surrendered a few feet on our promise to give him some of the first "distillation." Thus equipped we wound our inductances—believe it or not—around the peg-leg of a dock watchman. (The peg was just the right diameter.) The watchman held the tubing while we wound.

An Eskimo who owned a decrepit broadcast set loaned us a 250- μ fd. condenser, and for a grid leak we used a discarded audio transformer. A commercial operator at a shore station contributed a 5,000-volt 0.001- μ fd. blocking condenser to restrain our terrific plate voltage. An r.f. choke was wound by putting 120 turns of wire of unknown size on a clothespin borrowed from a squaw's laundry-bag. Another Eskimo had acquired a vintage of '76 telegraph key from some place, using it for a door clapper.

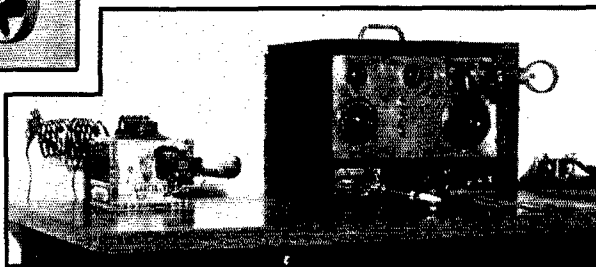

We acquired this for a package of cigarettes.

Not having the slightest insulation of any kind we had none about which to worry. Since no one volunteered to supply an antenna condenser we left that out also. An antenna which ranged in length, as nearly as we could guess, from 150 to 200 feet was connected to one end of the antenna coil. A 33-foot feeder was tied to the other end. The job was done.

It was with set jaws and a pulse hammering

at between 2 $\mu\text{fd.}$ and 110 degrees Centigrade that we connected the 210 volts of "high voltage" power supply and pressed down on the door clapper. Nothing happened. Finally the curtains were pulled down, and a mechanic was requested to whistle elsewhere. We took a last look at the Arctic night. The stars were all in place. The

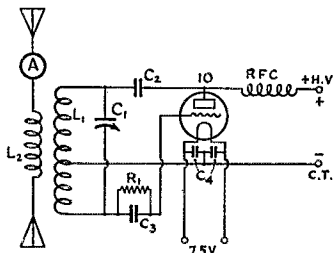

THE HARTLEY CIRCUIT USED IN THE TRANSMITTER

- C₁—250- $\mu\text{fd.}$ variable condenser.
- C₂—.001- $\mu\text{fd.}$ fixed condenser.
- C₃—250- $\mu\text{fd.}$ fixed condenser.
- C₄—.002 μfd fixed condensers.
- L₁—5 turns; diameter of coil, 3 inches; length of coil, $\frac{1}{2}$ inch.
- L₂—5 turns, diameter, 2 inches.
- RFC—Short-wave choke.
- A—0-1.5 r.f. ammeter.

Aurora was winking. The wind was ice-cold. All was set. Blair connected a flashlight bulb in series with the antenna. Glory to Marconi! It lighted!

We estimated our power at approximately 2 watts, and they were thin, anaemic and underfed waits at that. But the first contact was VE5JA. He gave us R6. Then, in turn, W6BFZ with an R7, W7BHV, R5; and VE4GM, R5. This was the start—and what a night it was!

During the month that followed our cigar-box transmitter—which took just twenty minutes to assemble, tune and get on the air—gave us the following contacts: K7CCL, K7IW, W5ATF, W6HOH, W7DBR, K7CPX, W7FS, W6FFP, W6AYQ, W9JKW, VE5HU, K6BOE, W7ALV, W7QI, W6FQY, W6FKC, W6ENV, W6LJX, W6AXF, VE5FE, W7CXL, W6HTQ, W6BVL, W6CLV, W6HOC, W6ZP, VK3HG, VE5EO, VK2IC, J1PO, ZL2LB, ZL3GU, W6BAY, W6DE, W6BFZ, W6FMP, W6HUL, W6CDV, W6FRH, W6EPH, K7ABQ, W6IXY, W9GUN, K7HP, W6AAP.

A report of at least R6 was received from every district and country mentioned except Hawaii, which gave us R5. Many gave us better than R6 in subsequent QSO's. Our maximum DX was, of course, New Zealand, Australia and Japan.

The performance of the haywire set was so amazing, everything taken into consideration, that it was duplicated in essential details, upon the writer's return to California. It is now in the form shown in the photograph, with proper coils, insulation, and grid leak. A 10 with top plate

contact has been substituted for the 201-A, permitting the use of higher plate voltage. The r.f. meter replaces the flash-light bulb. The set has more than justified itself.

Like its Alaskan brother, the new transmitter uses no variable antenna capacity. The tank condenser is turned to a suitable spot in the 40-meter band and locked. This leaves no parts to get out of adjustment. With plug-in coil and tube removed the entire transmitter is 2 inches high, 8 inches long and 4 inches wide. When used as a portable it slips into the battery compartment of the receiver. In case of extremely low power the meter is connected across the antenna coil to give a high reading.

It's a double-barreled nickel-plated cinch this little transmitter isn't going to ruin the night for a brother ham down the block, and when all is said and done it gets out just as far as anybody could want a transmitter to go. There is much more consideration and just as much thrill in a "flea-power" transmitter working efficiently as in a near-commercial job which drives everybody else off the air.

Indiana State Convention

(Central Division)

June 8, 9, 10 at South Bend, Ind.

THE Hotel Oliver is the place. The cost \$2.00. The old-timers who remember the last convention held in this city know what can be done, so make your plans to attend our affair and for which we extend to you all a cordial invitation.

Our speakers will be John L. Reinartz, Fred Schnell, Glenn West of Purdue University, Boyd Phelps, Director Windom and others. A good program is promised. Come over gang! More information may be obtained from S. J. Holland, Sec'y. St. Joseph Valley Amateur Radio Club, 2101 Lincoln Way, West, South Bend, Ind., under whose auspices the convention will be held.

Strays

Another one for the believe-it-or-nots. A neighbor of W8CYJ's reported that he could not tune out CYJ's 75-meter 'phone transmissions even with the b.c. receiver turned off. After hunting all over the house the voice was found to be loudest in the kitchen, and the "loud speaker" turned out to be the door bell!

W7CMF, after despairing of ever getting a WAC, discovered he already had one. His OW's initials are W.A.C.!

The real inventor of radio was Noah. He built an arc long before Hertz, Marconi, and the others ever were thought of!

—VESSA

A Ham Station Analyzer

A Multi-Purpose Gadget for R.F. and Audio Use

D. A. Griffin, W2AOE*

FROM time to time in the pages of *QST* a number of test instruments of more or less specialized nature have been described. However, the important measurements concerned in ham communication cannot be made in most amateur stations. Is the antenna the proper length? Is the amplifier completely neutralized? Was the proper harmonic selected? Is the modulation lop-sided? Just how does the 'phone signal sound as it leaves the shack? The amateur should be able to answer these and many other questions himself, without asking the opinion of others. Yet the amateur who can do so is as rare as a 56-mc. transcon.

For years, this amateur has done without a number of the facilities now provided by this analyzer. The satisfaction of being able to determine fairly precisely a number of the things hitherto subject only to guess has been more than sufficient recompense for the time and money spent in its development. Let us look into the little black box.

The basic circuit of the analyzer, shown in Fig. 1, is that of an elemental vacuum tube voltmeter. Inasmuch as most amateurs are interested in comparative tests, it is not necessary to calibrate it. This immediately simplifies construction and operation. When the $1\frac{1}{2}$ -volt cell is connected as shown, it supplies sufficient positive voltage to the plate of the tube to cause a plate current of approximately 80 microamperes to flow. If any audio or r.f. voltage is impressed on the grid, the plate current will increase as the applied voltage increases. As the one-milliamperemeter used has a resistance of approximately 30 ohms, by the I^2R law we find it takes only 0.00003 watt (30 microwatts) to give a full scale deflection. It is evident that it takes very little input to give an appreciable reading. In fact, full scale on the meter requires less input than it takes to give a one-division indication on a current-squared galvanometer. If a tuned circuit is connected to

the grid-filament, resonant at a desired radio frequency, it becomes apparent that we have a neutralizing meter *par excellence* at that frequency. In fact, it is so sensitive that it is all but impossible to get a minimum reading on the meter. Another point of interest is that the plate current is limited, since the plate potential is supplied by the filament cell. This makes it practically impossible to burn out the meter in a strong field. This is not true with instruments of the thermo-couple type, as many amateurs have found out to their sorrow.

Another important use is the comparative measurement of antennas. Putting an ammeter in the center of a Hertz antenna and then giving it a haircut (the antenna, not the meter) is a laborious process. If the analyzer is set up near the free end of the antenna, in order to get as far as possible from the field of the transmitter and feeders,

checking is much easier. If the amount of energy picked up is too small to give satisfactory readings, a short pick-up antenna may be connected to the grid side of the pick-up coil. The physical relation between the transmitting antenna and this wire should, of course, be kept constant during measurement. A crude indication of the field

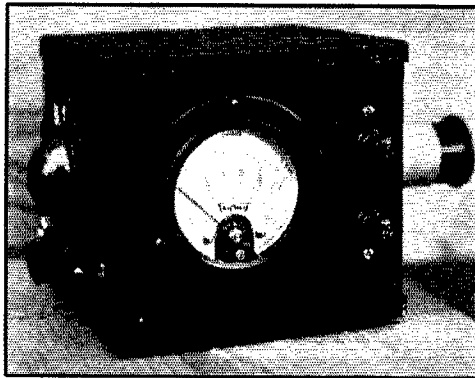

THE HANDY ANALYZER IN ITS LITTLE CASE

The tuning dial is at the left end, the plug-in coil at the right. The binding posts are for external connections to the 0-1 milliammeter.

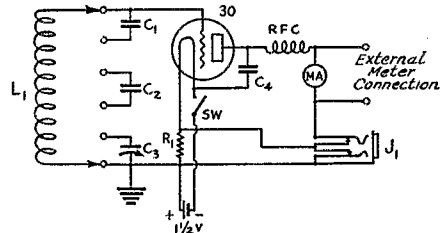

FIG. 1—THE SIMPLE CIRCUIT OF THE ANALYZER

- C_1 and C_2 —50- μ fd. fixed mica condensers.
- C_3 —35- μ fd. midget variable.
- C_4 —500- μ fd. fixed mica by-pass.
- RFC—8-millihenry r.f. choke.
- J_1 —Plate-battery jack, double circuit-closing type.
- R_1 —100,000-ohm $\frac{1}{2}$ - or 1-watt resistor.

* Leeds, New York City.

pattern may also be obtained by making checks of the meter readings at various points around the radiating system, thus putting the gadget to work as a field-strength meter.

With a resonant circuit required to develop the maximum voltage to secure the greatest sensi-

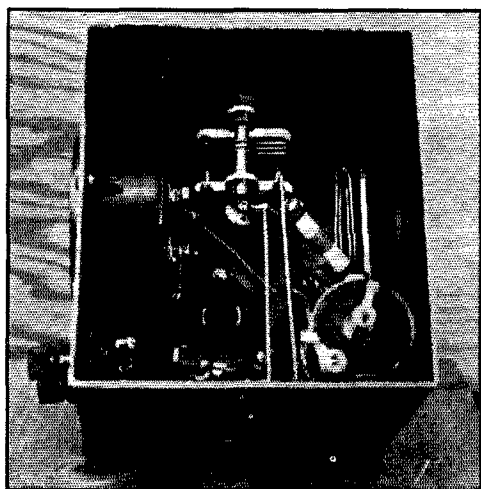

JUST TO GIVE AN IDEA OF WHAT'S INSIDE

tivity, it is evident that a calibrated absorption-type wavemeter is also provided as a feature at no additional cost. Some time ago this type of indicating device was the only one available for frequency measurement. Since the advent of the heterodyne type of frequency meter it has met with disfavor due to limited accuracy. While the heterodyne type of meter supplies a precisely-known fundamental frequency and a flock of harmonics, it is often a problem to identify the proper one. For instance, one well-known radio engineer in the Hudson Division CQ'd for three days on 30 meters until rescued by a near-by amateur. He had mistaken the third harmonic of his crystal for the second—which would never have happened if an absorption type wavemeter had been available. With both types of instrument available, off frequency operation is practically impossible.

BAND SPREAD

With the ultra-high frequencies coming into favor more and more, it was felt that the tuning of the meter should cover all amateur bands. The problem of doing this with good band spread on all bands was solved in a unique manner. Although the various band-spread circuits used are well-known, the method of changing over is new in that the coils themselves automatically change the tuning arrangements when they are plugged in. Six different combinations are used, demonstrating the flexibility of the system. Application

of the tuning method to receivers is suggested as a further possibility.

The 35- μ fd. variable condenser and the two 50- μ fd. fixed condensers are connected to the six prongs of the sockets used for the plug-in coils. The filament terminals of the socket also connect to the grid and filament of the tube and the winding, of course, always connects to the filament terminals of the coil forms. By use of straps inside the different coil forms, between the pins, a wide variety of combinations of series and parallel condenser connections is available. The various combinations and the bands for which they are used, together with the approximate spread of each, are shown in Fig. 2. When a large band spread is available, care must be taken with the

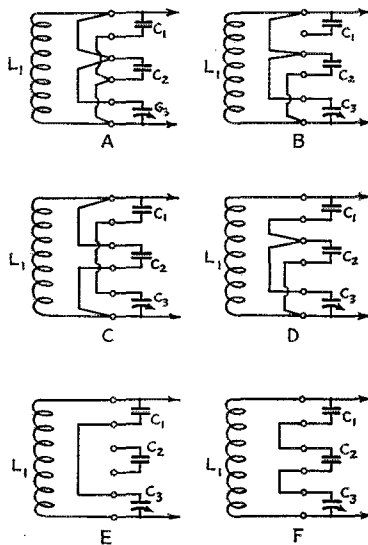

FIG. 2—PIN CONNECTIONS AND COIL DATA FOR BAND-SPREAD TUNING OF THE ANALYZER

Diagram	A	B	C	D	E	F
Band, Kc.	1750	3500	7000	14000	28000	56000
Turns L_1	50	27	12	7	4	1
Divisions Spread	95	80	70	80	60	70

turns spacing. After the proper spacing is determined, the coils should be doped so that the relation between turns will not change.

With this device the frequency to which a receiver is tuned may be determined by the familiar "resonance click" method. Conversely, this is the method used in calibrating the various coil ranges. For transmitter measurements, with tube turned on the milliammeter can be read with the analyzer at a considerable distance from the transmitter.

MODULATION MONITOR

Another important use is as an overmodulation indicator with which it is possible to determine

(Continued on page 78)

The Ultra-Midget

A 10-watt Transmitter of Miniature Dimensions

By Philip Rosenblatt, W2AKF* and Henry T. Miller, W2AIS**

ANOTHER midget? Yes! And truly a Lilliputian in comparison to most. When an iron shield-can measuring 5 by 5 by 6 inches can house a push-pull Hartley oscillator plus a 225-volt, well-filtered power supply, pretty nearly the ultimate in smallness for a practical transmitter has been achieved.

Carry it around in a small week-end bag, complete. Plug into a 115-volt a.c. supply, attach the antenna, insert the key and tubes and settle down to the best time you ever had with low power.

But getting down to dough, diagram and description: Cost, \$8.00. Fig. 1 shows all. Oscillating without any load, the ether buster draws 25 milliamperes. The plate voltage at 25 ma. is 260 volts. When connected to a Zepp and tuned to resonance an r.f. ammeter in one of the feeders showed a deflection of $\frac{1}{2}$ ampere. The plate current at maximum antenna current was 50

ma., plate voltage 225. Because of this small "keyed" voltage variation, the note was pure, minus chirps. The use of a plate milliammeter or r.f. ammeter was later found to be unnecessary, since resonance could be obtained by noting the increase or decrease in brilliancy of the mercury-vapor glow in the 82. This does not, however, serve as an excuse for dispensing with a monitor.

Rather skeptically the tiny mite was put on the air at W2AIS. A CQ by W2DXT was answered. He gave us p.d.c., QSA5, R8. Another CQ from 2EPZ was attended to, and he came right back, giving a d.c. report, QSA5, R7/8. Contact with W2EPZ held for a half hour, during which no changes were made on the transmitter. This lengthy contact was to determine the stability of the oscillator. W2EPZ gave us the encouraging report of a steady signal, no creeping.

Becoming a bit more bold. W9GPZ was called. Right back he came, giving the millimite a p.d.c. QSA3, R4/6, and very steady note. The final contact of the evening was W5HG. Enough to cherry the plates of the 45's with conceit, he gave them p.d.c., QSA4, R7!

The above contacts were made on the 40-meter band, between 9 and 11 p.m. Oscillation was steady and strong over the entire band. On the 20-meter band, only the frequency and stability were checked. FB all around.

The wiring is simple though awkward. Care must be used in making the high frequency leads short and rather heavy. For that reason the top cover, upon which are mounted the coil and tube sockets, is fastened to the box. Direct leads can then be soldered to the variable condensers and antenna posts. Enough slack wire is left dangling from the bottom of the can so that the power supply can be attached last. All filament leads as well as the high-voltage leads from the power transformer, must be twisted in their entirety. The laminations on transformer and choke coil must be screwed tight, and if convenient, dipped and baked in pitch to eliminate mechanical disturbance. Needless to say, all parts should be mounted securely and insulated properly where such insulation is needed. As an adjunct to quietness, the base of the transmitter may be equipped with small felt or rubber feet on each corner. The variable condensers, key jack and antenna posts must be insulated from the chassis. The easily procurable fiber washers handle the insulation problem.

Incidentally, in our model the can was left

* 834 Beck Street, Bronx, N. Y. C.

** 3110 Kingsbridge Terrace, Bronx, N. Y. C.



A REAL MIDGET, THIS!

Not only the oscillator but the power supply as well are contained in the almost-square metal chassis, the largest dimension of which is 6 inches. The 45 oscillator tubes plug in the top and the 82 rectifier in the back. The power transformer, in put choke and filter condenser are mounted on the removable bottom plate and are connected to the rectifier tube and oscillator by flexible leads.

What the League Is Doing

League Activities, Washington Notes, Board Actions—For Your Information

WE HEREBY open a new department in *QST*. In it we shall attempt to bring together, each month, the items that heretofore have been printed throughout the magazine concerning the current activities of the League, and to supplement them with additional information that may be of interest to you fellows in seeing what A.R.R.L. is doing for you.

We propose to be informal, but frequently we'll have to be almightily brief, for an analysis of all the things the League has in hand at any one time would fill innumerable pages.

We wonder how many of you fellows realize the extent of A.R.R.L.'s contacts at Washington. We're down there so often that we sometimes feel more like local Washington representatives than we do Connecticut residents. Sometimes we stay for three or four days, with so many things to look after that we have to write out a list of them. We have close contact with every branch of the government concerned with radio. When something comes up and we can't get away immediately, General Counsel Segal is on the other end of a private telephone line—we can get him in twenty seconds. There's nothing new about this; it has been that way for years, but many A.R.R.L. members do not appreciate it. Scores of times a year there are problems that offer some threat to amateur radio. Most of these are small things, quickly disposed of and never mentioned, but capable of growing into real dangers if we did not have an A.R.R.L. Some of them are bigger problems which occasionally find their way into a *QST* article. All of them of consequence have always been reported promptly to the directors. One of the aims of this department will be to supplement the efforts of the directors in keeping members informed on these things.

PHONE TELEGRAPHY BY 'PHONE STATIONS

A few months ago the F.R.C. ruled that amateur 'phone stations are licensed only for A3 transmission and therefore may not send telegraphy by means of a buzzer in front of the microphone (A2). The A.R.R.L. asked the Commission's reconsideration in view of the fact that this ruling would make impossible a continuance of the A.R.R.L. code lessons, which are still carried on by several dozen stations—and also because 'phone stations ought to have the right to sign their call letters in code before the microphone, for identification purposes. Acting upon our request, the Commission has now issued an

amended statement saying that "the prohibition against the practice of amateur radiotelephone stations using buzzers or audio oscillators or any form of tone modulation shall not apply in the case of amateur radiotelephone stations transmitting instruction in the International Morse Code when alternate transmissions of voice and code characters must be received on the same frequency with the same receiver; nor in cases where such emission is used to aid in the identification of the call letters of the transmitting stations. In no case does the Commission authorize a signal to be modulated in excess of 100 percent."

That last sentence, by the way, deserves the examination of all the voice brethren.

CLUB TRUSTEES

Several clubs have made inquiry as to what they might do to retain their call when some chap, serving as trustee for their station license, gets tired of the job or moves out of town. The Commission maintains the assignment of a call to an amateur station regardless of change of trustee. In fact, they insist upon it. Supposing that the new trustee is already a licensed operator, it is only necessary to ask for modification of the station license with respect to the name of the trustee.

OFFICIAL INTERPRETATION OF MADRID VS. WASHINGTON

In connection with recent hearings on the question of the ratification of the Madrid treaty, representatives of the Department of State and of the Federal Radio Commission made official statements of the attitudes of their agencies as concerns any differences between the amateur provisions of Madrid and those of Washington. Said Dr. Irvin Stewart, a member of the American delegation to Madrid, and in charge of radio matters for the Department of State:

"Under the present radio regulations, amateur stations may exchange messages relating to their experiments and unimportant remarks of a 'private nature.' The committee reports of the Washington conference which drafted the present regulations show that the most active members of the committee were intent upon protecting the revenues of the public telegraph service (in most countries a government monopoly) against competition by amateurs handling international messages free of charge. The official French term which was translated as 'private nature' is *caractere personnel*. The debates at the Madrid

conference showed that most governments interpreted this to mean remarks of a character personal to the two operators, i.e., as not permitting amateurs to exchange messages for third persons. The principal difference between the provisions now in effect and those against which a group of amateurs is protesting is this: Under the American interpretation of the present provisions, an amateur may exchange international third-party messages unless the exchange is prohibited by one of the interested governments; under the Madrid regulations he may exchange such messages only where both governments affirmatively permit. In both cases both governments must agree; the difference is in the way the agreement is indicated. In all other respects the language governing amateur stations is unchanged; and most governments insist that this is not a change but merely a clear statement of what is intended by the present regulations."

Dr. C. B. Jolliffe, chief engineer of the F.R.C., responded to interrogation as follows:

Question: "Under the present treaty, can amateurs of the United States transmit messages on behalf of third parties to amateurs of foreign countries?"

Answer: "If the foreign country has not notified the United States that amateurs of that country are prohibited from exchanging international messages, a liberal interpretation of the present treaty would permit an exchange of messages for third parties. European governments do not believe such an interpretation is justified under the Washington treaty."

This is just what A.R.R.L. and *QST* have said.

DELAYS

A.R.R.L. headquarters is receiving numerous complaints from members of delays in filling their orders for booklets, particularly where the fellow wants a License Manual immediately to prepare for an examination. The fault is not ours. We fill 95 percent of these orders the same day they are received, the balance not later than the following day. The delays are in the postal service, where economy measures and reduced personnel are causing wretched performance. We had a case recently where it took nearly three weeks for a License Manual to get to Nashville, another where it took eight days to Philadelphia, yet both were in our outgoing mail within 24 hours of receipt of the order. We are doing our best. What we need is a little facsimile transmission!

LOG KEEPING

The rule governing amateur logs is being variously interpreted by the different radio inspectors. We have heard of one who wants the amateur to make an entry for each change-over during a QSO, signing his complete name each time! Imagine two fellows working duplex 'phone; they would need court stenographers, working in shorthand, to keep their logs! A.R.R.L. has asked the Commission for an interpretation that will permit uniform and intelligent administration.

GROWTH

A.R.R.L. membership is at the highest point in its history and is steadily growing. The number of members at the end of recent months has been as follows:

October	18,382
November	19,219
December	19,330
January	20,136
February	20,399
March	20,440

The amount of dues paid by members during the first quarter of this year was 20 percent greater than during the same quarter of last year. The advertising income of *QST* increased 34 percent over the same period of last year, and this despite rigid adherence to a policy whereby *QST* declines thousands of dollars of advertising income every year (perhaps \$15,000 last year) from firms who cannot meet the A.R.R.L. standards. *QST* is our cooperative magazine, not

run to earn dividends for a commercial owner, and it is anything but interested in the immediate dollar at the expense of the member.

The present practice of the government in issuing three-year amateur licenses makes it impossible to get at the exact figures of amateur growth in this country. While casual examination of the figures might seem to indicate tremendous mushroom growth, analysis shows a much sounder condition. There are at the moment about 45,000 amateur station licenses in the United States. The Federal Radio Commission states that at least 10,000 of these are duplicate portable licenses taken out by amateurs who already had a "fixed" license prior to last October, when A.R.R.L. secured the right for every amateur to operate a portable at will without special authority. (That is some measure, by the way, of the extent of the great interest in five-meter work.) But still another factor must be taken into account. Our station licenses used to be for a period of one year, and each June we could compare the government figures with the previous year and watch our growth from 12,000 to 15,000, then to 18,000, then to 22,000. But a year ago last January the Commission decided to make amateur licenses for three years, and they issued a blanket extension of all existing licenses for two additional years. Since that time there have been no deletions from the list for failure to apply for renewal, and everybody who took out a station license in 1932 still has it whether he wants it or not. It will be next January before any of this deadwood is eliminated from the count, and meanwhile the figures have all that padding. We can get a much better idea of where we are by examining the number of licensed amateur operators. This figure last June was a little over 30,000, and to-day is about 35,000. But for some years back our operator licenses also have been for a term of at least two years, so that again this total includes a large number of people who have become inactive but who still possess licenses. The figure again is fictitiously high. The turn-over in amateur radio always has been great, and throughout the years there always have been thousands of licenses not renewed; it is necessary to make some allowance for those who have completely abandoned the game. We estimate that the number of hams in the United States, that is, the total of the persons to-day interested in practicing amateur radio, is approximately 28,000.

Not all of A.R.R.L. membership is in the United States. We have about 900 Canadian members and perhaps 1500 foreign ones. Our newsstand distribution of *QST*, of course, is chiefly in the United States, and we all know that it is absorbed chiefly by amateurs who, through the unfortunate economic times, are keeping themselves with us in spirit though unable to afford the outlay of a year's dues. Last year the average monthly total paid distribution of *QST* in the United States and possessions alone was approximately 30,000 copies. While we all know of occasional amateurs who profess not to be interested in A.R.R.L. or *QST*, and even occasionally encounter one who says he has never heard of our organization, A.R.R.L. "coverage" is substantially complete, and still growing. Everybody knows that only about a third of the licensed stations of the country are in commission at any one time. Even during the period of one-year licenses, government surveys never found over 40 percent of us capable of operating at any given moment. Simply because amateur radio is a hobby, our practice of it comes and goes with our pleasure—even though we always "come back." We have seen it suggested that A.R.R.L. is four-fifths a non-amateur association—that less than 20 percent of A.R.R.L. members are licensed amateurs. This is sheer twaddle. That would give us a non-amateur membership of, say, 16,000. Who do you suppose they might be? BCL's? Commercial engineers? We have some of each, but they are an infinitesimally small percentage of the whole. A.R.R.L. does not require actual ownership of a station or a license before accepting a member, but we all know that our League has no activities that appeal to other than the radio amateur and that *QST* concerns itself exclusively with amateur work. The percentage of active amateurs who belong to A.R.R.L. is so extremely heavy that it constitutes a perfectly swell showing.

BOARD MEETING

Complete report in this month's *QST*.

Typical Technical Questions Answered

Tuning for Maximum Power Output—Loading the Pentode Oscillator— Class-A Plate Current Decrease—Autogain with T.R.F.—Automatic Bias Resistance

ALTHOUGH the A.R.R.L. Technical Information Service answers all inquiries directly by mail, certain questions commonly asked warrant publication of the answers for the benefit of others who may have need of the same information. The following have been selected for this month:

Q. No. 1:

In tuning the transmitter, maximum antenna current and maximum plate current do not occur simultaneously. The tuning is conducted in the approved fashion, always retuning the tank condenser for minimum plate current as the last operation in the process. With maximum feeder current, the plate current in the final amplifier is about 275 ma., but further tuning of the antenna circuit will cause the final to draw 300 ma. with a 0.2 ampere reduction in the feeder current. What is the dope on this condition?

A. No. 1:

This trouble is probably due to overloading of the amplifier. As the antenna is tuned towards resonance, the plate current and feeder current rise together until a point is reached at which the amplifier is loaded to its limit and will deliver no more power into the antenna. In this case, the point of maximum power output is reached before secondary resonance is reached. As a result, tuning to complete resonance overloads the amplifier and the feeder current falls off. If excitation is insufficient an increase in the excitation should result in increased feeder current with increase in plate current; otherwise the coupling to the antenna should be reduced.¹

Q. No. 2:

In operating a Tri-tet oscillator, trouble is experienced when the pentode connection is used for operation at the crystal frequency. It is impossible to load the oscillator appreciably without stopping oscillation. Is there a remedy for this?

A. No. 2:

A reduction in the resistance value of the oscillator grid leak should remedy this situation. It is a good plan to provide two grid leaks in series, one having a resistance of 5000 ohms and the other 50,000 ohms. A switch may be provided for short-circuiting the 50,000-ohm leak for straight pentode operation. The coupling capacity

should also be kept low. A maximum of 50 μ fd. should be used.

Q. No. 3:

Regarding Question No. 184 in *The Radio Amateur's License Manual*, it seems to me that if the grid (of a Class-A speech amplifier) were being driven positive, this positive grid would accelerate the electron flow between the filament and plate and, therefore, the plate current would increase with excitation instead of decrease as the answer states.

A. No. 3:

The failure to understand the answer given in the *License Manual* lies in the fact that the point has been overlooked that a.c. and not d.c. is being applied to the grid. With correct adjustment, the potential of the grid is swung to equal amplitudes each side of a given operating point; as a result, the average change in grid potential is zero and the plate current remains steady at a value dependent upon the value of the fixed bias. However, with increased excitation, the grid tends to go into the positive region. When this happens the grid starts to draw current, requiring power. If, as the answer states, the driver is of the voltage amplifier type of high impedance, it cannot supply the power and therefore the positive peaks where power is drawn are of lower amplitude than the negative peaks and the result is a shift in the average grid potential in the negative direction which will, of course, reduce the plate current.

Q. No. 4:

Is it possible to use a.v.c. to any advantage with an ordinary regenerative receiver with a single stage of tuned r.f.?

A. No. 4:

It is not practicable to attempt to use a.v.c. in a receiver of this type. It would, of course, be of no use whatsoever with the detector oscillating for c.w. reception. A regenerative detector in itself provides a species of automatic volume control which would make additional automatic control in a single stage of tuned r.f. amplification unnoticeable.

Q. No. 5:

When the automatic cathode resistor biasing system is used, how is the value of resistance determined? Is it possible to bias an amplifier to plate current cut-off?

A. No. 5:

Since the cathode resistor of this system is

(Continued on page 80)

¹ For a more detailed explanation of this action, see "The Operation of R. F. Power Amplifiers", by H. A. Robinson, *QST*, April, 1934.



STRAYS



Specification of C_7 inadvertently was omitted from Fig. 1 on page 47, May, *QST*, in the article "Completing the Three-Stage Transmitter." C_7 is the neutralizing condenser for the 830, and has a maximum capacity of 25 μfd . The condenser used is a National Type SEU-25.

W9AFT, Millard Wyse, of Wayland, Iowa, would like to know how fellows who have cellar shacks keep dampness out during the summer months. His operating room is built of wallboard but has no special floor. The cellar is otherwise dry, but during hot weather moisture condensing on the apparatus keeps it from operating satisfactorily. Good suggestions will be welcomed.

A kink for 5- and 10-meter tuners: Twin phone-tip jacks, customarily sold riveted in a small piece of thin bakelite for "phono" connections, will mount very nicely across midget tuning condensers. Coils made of No. 14 wire will plug into them directly. Slight adjustment of inductance for tracking purposes in t.r.f. sets can be made by pushing the coils farther into the jacks.

—W1NB

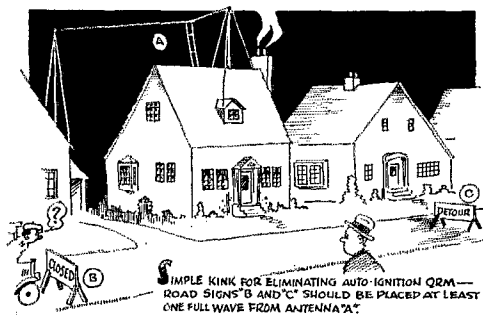

K6HLP writes that about half the cards he gets from the States have two- or three-cent stamps on them. One-cent postage is enough.

W3CNS solved the problem of hanging QSL's on the concrete walls of his cellar shack by using old phonograph needles as tacks. The needles can be driven in where ordinary tacks or nails only would bend. Loud needles are best.

Eugene Davis of Salina, Kansas, writes that in connection with the article, "Getting Power From the Winds," in March, *QST*, the Oklahoma Agricultural and Mechanical College issues an interesting bulletin, "Oklahoma Wind-Electric Power," which gives data on wind movement by

months and average kilowatt hours that can be generated per month for that state. It is Publication No. 10 of the Engineering Experiment Station, and is available on request.

In the midst of a QSP from OM1TB, W5CRS's dad pulled the fuses from the a.c. line to get the distracted ham to come out and milk the cows!

W7CAP suggests forming a "Punk Operator Club" for the benefit of those aigs who use r.a.c., QRM S.F. transmissions, and make nuisances of themselves generally. Two nominations would be sufficient to make the offender eligible for POC if a reasonable explanation is not forthcoming.

From the *Boston Herald*: "When you hear a dah de dah, that is dot and dash code by voice for the letter K which means 'Go ahead.' You may hear some hi diddle de dit which is the same thing!"

Recently a QSO took place between W1HUG and W9PET. Despite rumors to the contrary, their transmitters are still said to be intact and in perfect working condition!

—W1CRA

Confirming and adding to W1TX's antenna dope (Experimenters' Section, April, *QST*): When tuning up, adjust plate tank first, then antenna tank, but be sure to go back and retune the plate tank. Juggle the condenser settings until both tanks are correct, as shown by meters. Have also found that antenna length is rather critical for maximum output, though it will work with fair efficiency over a wide range. The best method of tuning is to cut the antenna over-long and then, with fieldmeter, chop off a foot at a time until the field is maximum.

—W6QF

Hamdom

(Continued from page 17)

he got his first ticket in '27—hadn't heard of radio before then, but it didn't take him long to reach the top. W3EC in 1927-28, then through Artillery School at Fort Monroe, and so to the Signal Corps. He's known to hundreds of amateurs through his operation of the Army Amateur national net control station on drill nights. His traffic totals run well up into the thousands; it's been over 3000 several times. And you can never call him but he's ready for more.

Simplifying Split-Stator Final Amplifiers

Byron Goodman, W6CAL*

THE advantages of using a split-stator condenser to tune the final stage of the transmitter have been pointed out in past issues of *QST*, but many an aspiring amateur has been reluctant to try the system for several reasons. High-voltage split-stator condensers are not always readily available, and home-made adaptations are not always symmetrical over the whole scale, tending to throw the neutralization

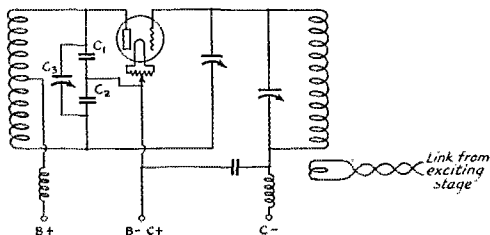

FIG. 1—NEUTRALIZED AMPLIFIER CIRCUIT USING FIXED CONDENSERS IN SERIES TO GIVE THE SAME TYPE OF PERFORMANCE AS A SPLIT-STATOR TANK CONDENSER

off at various points. A system in vogue among broadcast stations is readily adaptable to amateur use, and has, among others, the advantage of being inexpensive and simple.

As shown in the diagram, Fig. 1, two fixed condensers are shunted by the variable tuning condenser. The tuning condenser can be any well-spaced and well-insulated one, and the fixed condensers bring in the low cost and simplicity, as well as all the advantages of split-stator operation. The fixed condensers can be easily made from a few plates of aluminum and small porcelain stand-off insulators as shown in Fig. 2.

The capacity of the two fixed condensers in series should be of the same order as that of the variable one, and can easily be calculated from the formula:

$$C = \frac{1}{\frac{1}{C_1} + \frac{1}{C_2}}$$

The *Handbook* gives the relations for calculating the capacity of a parallel plate condenser

$$C = .0088 \frac{KA}{d} (n-1) 10^{-6} \mu\text{fd.}$$

where A = area of one side of one plate (sq. cm.)
 n = total number of plates
 d = separation of plates (cm.)
 k = specific inductive capacity of dielectric
 = 1 for air

* 141 Alton Ave., San Francisco, Cal.

An inspection of the circuit shows that once the system is neutralized, any irregularities in the variable condenser cannot affect the neutralization. An insulated shaft to the variable condenser should be used to eliminate any unbalance due to hand effects, etc. Somewhat lower C can be used with this system than with an ordinary split-stator condenser, since C_3 need only be large enough to tune across the bands used, and this capacity plus the capacity of the fixed sections in series will usually be smaller than that of the ordinary split-stator condenser employed.

EDITOR'S NOTE.—The use of a fixed split-stator condenser not only is justifiable as an economical proposition, but also in helping to maintain the neutralizing balance in single-ended amplifiers, especially those having tubes not designed especially for high-frequency work.

A skeleton diagram of the usual arrangement is given in Fig. 3A. The equivalent circuit, so far as tube capacities are concerned, appears as in 3B. It will be noted that the upper half of the split-stator tuning condenser is shunted by the plate-filament capacity of the amplifier tube; it is

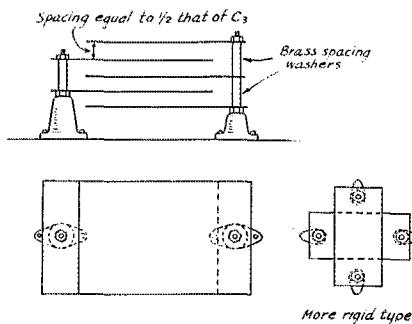

FIG. 2—HOW INEXPENSIVE FIXED AIR CONDENSERS CAN BE MADE

A capacity of 100 $\mu\text{fd.}$ in each fixed section, giving a total capacity of 50 $\mu\text{fd.}$ should be satisfactory for operation on ordinary frequencies. A 100- $\mu\text{fd.}$ section can be made with 11 plates having a useful area of 2 by 3 inches, spaced $\frac{1}{8}$ -inch apart. For other sizes of plates and spacing, the capacity will be directly proportional to the effective area and inversely proportional to the spacing.

obvious that this extra tube capacity becomes part of the tuned circuit. It is equally apparent that if the setting of the tank condenser is changed the capacity ratio between the two sections likewise changes to a degree dependent upon the relative values of the $g-p$ capacity of the tube and the actual condenser capacity in use. The capacity ratio between the two sections is the factor that

determines the setting of the neutralizing condenser.

If the amplifier tube has a fairly large plate-filament capacity (as in the 203-A, for instance), a considerable change in the tank condenser setting will throw the circuit out of neutralization. The effect is especially noticeable if the tank condenser is being worked near its minimum capacity, where a small change in the condenser setting will cause a large change in the capacity ratio. The output capacity of a 203-A tube with its associated socket and wiring probably will run in the vicinity of 25 $\mu\text{f.d.}$ or more, which is of the same order as the minimum capacity of one section of a split-stator condenser of considerable maximum capacity. To a great degree the change in capacity ratio with tuning can be overcome by proportioning the tank coils so that the resonance setting of the tank condenser will be near the maximum-capacity end of the scale, where the change in capacity ratio will be smallest for a given amount of condenser rotation. If the maximum capacity of one section of the tank condenser is 250 $\mu\text{f.d.}$ or more a satisfactory balance can be maintained over the higher-capacity part of the tuning condenser scale so that for ordinary purposes the tube will be sufficiently well neutralized, although *exact* neutralization will occur at only one point on the condenser scale.

As a result of the constant change in capacity ratio with tuning, the neutralizing procedure is likely to become somewhat confusing to those who have become accustomed to judge accuracy of neutralizing by the usual indicators—neon bulbs, lamploops, and grid meters. Under the conditions mentioned above, a grid-meter reading will not remain perfectly steady as the tank condenser is swung through resonance, except in a narrow range either side. If the condenser is swung very far off resonance the grid current will drop, and, for the same setting, a neon bulb or other indicator is likely to show the presence of r.f. in the plate circuit. In such a case the amplifier should be neutralized *at resonance*. The fact that r.f. shows up off resonance is of little importance, since the amplifier always is operated with its plate circuit properly tuned—or at least

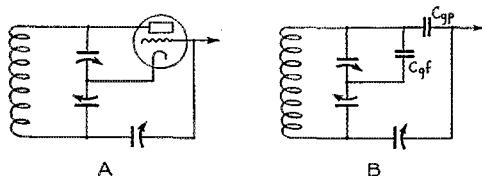

FIG. 3

it should be. A real disadvantage, however, is the fact that an amplifier which so behaves will not maintain neutralization when a new coil is plugged in for operation on a different band, unless the inductance of the coil is such that resonance at

the new frequency occurs with the condenser at the same setting. The effect is likely to be bothersome, however, only with tubes of high output capacity operating in conjunction with a tank condenser of low maximum capacity. High-frequency tubes such as the 852, 825, 800 and RK-18 rarely give any trouble of this sort except when the tank condenser is within a few degrees

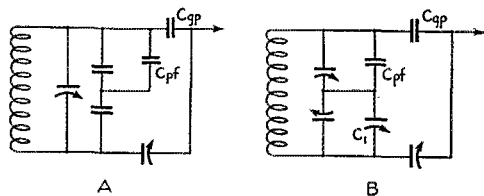

FIG. 4

of minimum capacity. The output capacities of these tubes are extremely low and—equally important—the plate leads to them do not have to go through sockets which in themselves can add considerable capacity to a circuit.

It can be readily appreciated that the fixed split-stator condenser arrangement suggested by W6CAL, shown in equivalent form in Fig. 4A, will overcome the varying-capacity-ratio with tank-condenser tuning, since only the fixed condensers affect the capacity ratio. This circuit should remain neutralized regardless of the setting of the variable tank condenser. A second method of accomplishing the same result is shown at 4B, where a small variable condenser, C_1 , is connected across the lower section of the ordinary split-stator variable and adjusted to equal the output capacity of the tube shunted across the upper section. The auxiliary condenser should have the same plate spacing as one section of the tank condenser and should be adjusted to the end that the circuit, when neutralized at resonance, will remain neutralized throughout the full range of tank-condenser tuning. Either arrangement should be useful with tubes of high interelectrode capacity if permanent neutralization is desired.

—G. G.

Strays

In connection with Schnell's article in February, *QST*, several fellows have written in to suggest that the weight of the dots can be adjusted simply by observing the plate current of the keyed stage, without going to the trouble of connecting up a special circuit for the purpose. But do it some time when the band is dead!

Who says the old ham spirit is dying out? W5ACA rode forty-two miles on a bicycle to visit W5AFW!



A.C. Pre-Amplifier for Condenser Mike

The circuit diagram of Fig. 1, an all a.c.-operated head amplifier for a condenser microphone, has been used very successfully by Fay Harwood, W6BHO, Santa Paula, Calif. Standard 2.5-volt tubes are used, and humless amplification is secured with a well-filtered power pack. W6BHO uses a regular National type 5880 supply.

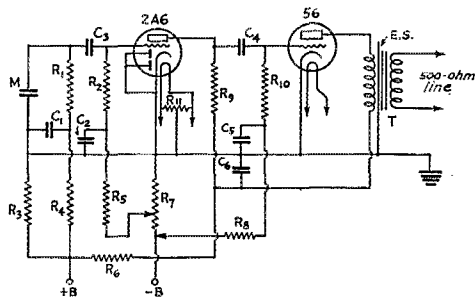

FIG. 1—AN A.C.-OPERATED HEAD AMPLIFIER FOR A CONDENSER MICROPHONE

- M—Microphone.
- C₁, C₂—0.5 μfd.
- C₃—0.005-μfd. mica condenser.
- C₄—0.01-μfd. mica condenser.
- C₅, C₆—5 μfd.
- R₁, R₂—250,000 ohms.
- R₃—20,000 ohms.
- R₄—1 megohm.
- R₅—250,000 ohms.
- R₆—20,000 ohms.
- R₇—1000-ohm semi-variable resistor.
- R₈, R₉—250,000 ohms.
- R₁₀—1 megohm.
- R₁₁—20 ohms, center-tapped.
- T—Tube-to-line transformer, 500-ohm output, with electrostatic shield.

The first tube is a 2A6, which is combination tube having a triode with an amplification factor of 100 and a pair of diode plates, the latter being unused in this case. The second tube is a 56. Resistance coupling is used from the microphone up to the output of the 56, where a transformer couples the amplifier to a 500-ohm line.

The entire amplifier is enclosed in a metal box, with a metal shelf inside for mounting the tubes. Grid leads should be as short as possible. The a.c. leads inside the box are in shielded cable with the shields grounded; the four external power-supply leads are in a single cable, also shielded. A good grade of resistors and mica coupling condensers must be used to prevent noise. It should be noted that the negative "B" lead should not be grounded, since there is a potential difference of several volts between it and the common ground

for the amplifier, which is attached to the tube cathodes.

The 1000-ohm bias resistor, R₇, should be of the semi-variable type. W6BHO uses a 25-watt Electrad resistor with the sliders set to put 1.3 volts bias on the 2A6 grid, and 13 volts on the 56 grid. The bias adjustment should be made with the aid of a high-resistance voltmeter.

Freqmeter-Monitor with Dual-Purpose Tube

V. L. Daniels, W9IZL, Webster Electric Co., Racine, Wisconsin, has worked out an interesting

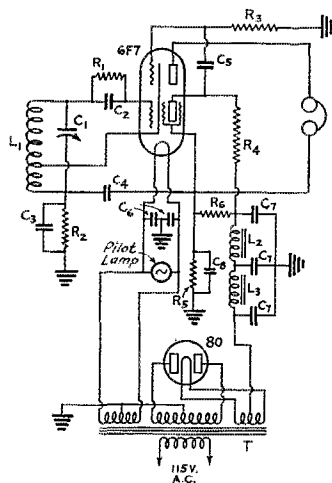

FIG. 2—FREQUENCY-METER-MONITOR USING THE 6F7 TUBE

- L₁, C₁—Oscillator tank circuit. Preferably should be adjusted to cover the 1715-2000-kc. band with slight overlap at ends of tuning scale. Suggested constants are: for L₁, 90 turns No. 30 d.s.c. wire on 1-inch form, tapped 30th turn from lower end; for C₁, band-spread condenser having a minimum capacity of 50 μμfd. and maximum of 80 μμfd. The number of turns on L₁ should be adjusted to give suitable band-spread.
- C₂—200 μμfd. mica condenser.
- C₃, C₄—.25 μfd.
- C₅—0.002 μfd. mica condenser.
- C₆—0.1 μfd.
- C₇—8 μfd. electrolytic filter condensers.
- C₈—1 μfd. electrolytic filter condensers.
- R₁—100,000 ohms, 1 watt.
- R₂—300 ohms, 1 watt.
- R₃—1 megohm.
- R₄—100,000 ohms, 1 watt.
- R₅—20,000 ohms, 2 watt.
- R₆—10,000 ohms 2 watt.
- L₂, L₃—20- to 30-henry, 25-ma. filter chokes.
- T—Power transformer; high-voltage winding, 150 volts each side center tap; also 5-volt winding for 80 rectifier and 6.3-volt winding for 6F7 tube.

application for the 6F7 tube as a combined electron-coupled oscillator and detector for the frequency-meter-monitor. The 6F7 is a new dual tube having a pentode and triode, entirely separate but using different sections of the same cathode, in one bulb. W9IZL uses the pentode portion of the tube as an electron-coupled oscillator and the triode as the detector. The circuit, complete with power supply, is given in Fig. 2. A little study of the diagram will show that it is equivalent to the two-tube frequency-meter-monitor arrangements described in January, 1933, *QST*, and in the eleventh edition *Handbook*.

W9IZL's frequency meter is contained in a metal box of small dimensions. The power-supply apparatus can be kept down in size because the current drain is very low. Midgeet chokes and power transformers will do very well, the total current required by the tube being less than 10 milliamperes. The pilot lamp across the filament of the tube serves as a reminder to turn off the power when the frequency meter is not in use.

Tube-Base Crystal Holders

The drawing of Fig. 3 gives the details of a tube-base crystal holder which, as its builder, Wilson Oliver, 53 Smith St., Detroit, Mich., says, "is simple to make and may be of use to somebody as a spare, if not as the one-and-only."

Continuing his description: "A standard-size four-prong tube base is used. Cut a piece of sheet copper or brass to fit inside the base as shown in Fig. 3. This forms the stationary plate. A wire is soldered to this and connected to both the grid and plate prongs. The part of the base between the brass plate and the shell is filled with melted sealing wax, in which is embedded a small bolt to hold the cover.

"The top plate is made of another piece of brass or copper, held in place by brass springs

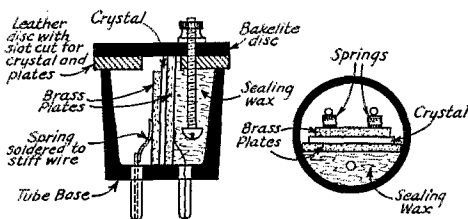

FIG. 3—CRYSTAL HOLDER MADE FROM AN OLD TUBE BASE

soldered to small pieces of stiff wire projecting from both filament prongs. Both plates are ground flat.

"The cover is made from a disk of fibre or bakelite. The tube base I used was not quite one inch deep, so a piece of leather about $\frac{1}{8}$ -inch thick

was cut as shown in drawing and glued to the back of the fibre disk. This keeps the cover from touching the crystal, which is one-inch square. A nut holds the cover in place.

"The holder is held in an ordinary tube socket, mounted vertically."

Another tube-base crystal holder, this one used by C. I. Tice, W7BEE, is shown in Fig. 4. It is intended to be used with a silvered crystal. W7BEE says this about it:

"This holder . . . should be FB for the ham who uses crystal control on a portable. No packing of the electrodes is necessary and shocks cannot do any damage unless they are hard enough to damage the tube base.

"The holder is one of the old 01-A tube bases, which are longer than the present bases—long enough to hold a $1\frac{1}{16}$ " crystal. The springs are brass wire, about 24 gauge. A single turn to the coil will give flexibility so the plates will make firm contact all along the crystal, and the end soldered to the plate is turned at right angles so

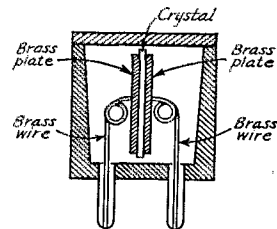

FIG. 4—A TUBE-BASE CRYSTAL HOLDER FOR USE WITH SILVERED CRYSTALS

The spring mounting makes the holder especially useful for the portable transmitter, since the crystal will be cushioned from mechanical shocks.

as to make more contact surface to hold the solder. The plate can be anything thin: copper, brass or monel metal, about 0.015" thick. The cover is cemented on with Dupont Household Cement. Four springs are used, one in each prong, and the tension can be adjusted to a certain extent in the process of soldering the spring in the tube prong."

Link Coupling to the Antenna Tuner

The gang here in Nevada are using a stunt which may be of considerable interest to others. W6UO at Yerrington, Nev., first tried the scheme on his t.p.t.g. 852 rig and it worked beautifully, so others of us have tried it with good results.

It seems to me that the proper place to terminate a pair of tuned feeders is at the point where they enter the building. This usually permits greater antenna height and precludes the possibility of r.f. feeding into power wiring, water pipes, etc. It is not always possible to place the transmitter exactly at the place where the feeders

enter the building, however; in my case the transmitter is ten feet from the feeder terminus.

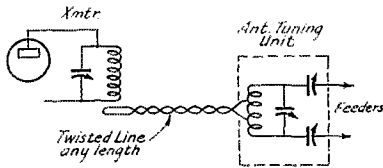

FIG. 5—LINK COUPLING BETWEEN THE TRANSMITTER AND ANTENNA TUNING APPARATUS

This system eliminates variable inductive coupling and permits placing the antenna tuning apparatus at any convenient point.

At W6AJP a single turn of wire around the cold turn of the output inductance and a single turn around the middle of the antenna tuning inductance are connected by a link of twisted lamp cord, as shown in Fig. 5. The twisted line has no external field and transfers more energy with less effect on tuning than the usual coupling coil. A small box mounted right at the point where the feeders enter the building contains the antenna tuning unit, with two series condensers, a parallel condenser, and the antenna coil of fourteen turns.

There seem to be so many advantages to this low-impedance coupling arrangement that many of the gang should try it. The twisted link can be run around picture molding, base boards, etc., since the length of the line doesn't affect its operation. For the experimenter, any number of transmitters can be built up using a common antenna tuning unit. With 100 watts output the r.f. volt-

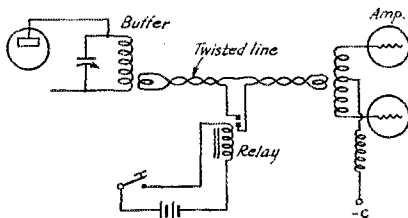

FIG. 6—KEYED LINK BETWEEN DRIVER AND AMPLIFIER

age in the line is very low and the energy transfer is complete. With self-controlled rigs, critical coupling is eliminated, with greater stability and output. It is necessary, of course, that the antenna be of the proper length, otherwise r.f. will show in one or both of the twisted wires.

—Tom J. Boland, W6AJP

Keying the Link Circuit to Prevent Clicks

The keying arrangement shown in Fig. 6 is being used successfully by Bob Potter, VE3TO, to eliminate key clicks from an m.o.p.a. transmitter with a pair of 10's in the final stage. The keying

relay is simply inserted in the twisted-pair coupling line between the final stage and its exciter. The keying is as clean as with other systems, and its efficacy in preventing clicks is demonstrated by the fact that VE3TO's transmitter causes no interference to a b.c. receiver whose antenna is parallel to and only seven feet away from the transmitting antenna.

The final amplifier must, of course, be provided with fixed bias to cut off the plate current when the excitation circuit is open. VE3TO also says that it is necessary to neutralize the amplifier carefully, otherwise the signals are likely to have "tails."

An Economical Filter Arrangement

When a single power supply is used for a high-voltage amplifier and low-voltage buffers, the circuit of Fig. 7 will provide adequate filtering for the high-voltage circuit with only a single filter condenser of maximum voltage rating. Usually a

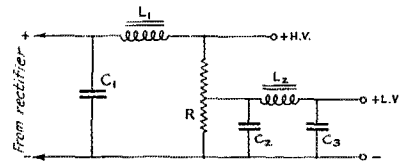

FIG. 7—A COMBINED HIGH- AND LOW-VOLTAGE POWER SUPPLY IN WHICH A LOW-VOLTAGE FILTER CONTRIBUTES TO THE SMOOTHING IN THE HIGH-VOLTAGE SECTION

C_1 is a single high-voltage condenser of rating suitable for the output voltage of the rectifier. Resistor R should be between 35,000 and 50,000 ohms, with the tap taken off at the proper point to deliver 500 volts to the driver tubes. Condensers C_2 and C_3 should be rated at 800 volts, C_2 being 4 μ f. and C_3 2 μ f. Choke values are as in ordinary filter circuits. An input choke may be used if desired. The choke and C_3 in the low-voltage circuit can be omitted, but provide additional filtering for the small tubes.

single high-voltage condenser is insufficient to give pure d.c. on the amplifier stage, and in many cases the expense of extra condensers is too great for a slim pocketbook.

In Fig. 7, the output of the rectifier feeds into the high-voltage condenser, C_1 , thence to the choke and the bleeder resistor, R . A tap is taken off R for the low voltage, and additional filter, using condensers of lower rating, is provided by C_2 , C_3 and the second choke. The low-voltage filter is thereby made to improve the smoothing in the high-voltage section. Condenser C_2 normally will have a rating of 500 to 800 volts and should have a capacity of about 4 μ f.

I have had this filter in operation for quite some time and can get the same T9 reports on either low or high voltage. With only one high-voltage condenser and choke, however, the note is harsh. The system is now in use at a number of St. Louis stations, and is a blessing to the ham who can't afford high-voltage filter equipment.

—Arbie Willis, W9NEV

Portable Power Supply Kinks

Since offering our attempt to get high power from a storage battery we have several letters from fellow members, and all have said, "No workie." After going into the rig here several interesting things have been found, so here's the dope.

1. There is a lot of difference in the current passed by different "Ford" coils. We've been suspecting shorted turns, so discarded the old

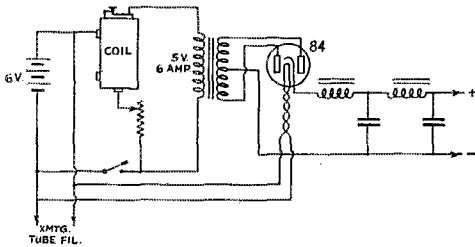

FIG. 8—REVISED CIRCUIT FOR THE PORTABLE POWER SUPPLY DESCRIBED IN THE EXPERIMENTERS' SECTION IN DECEMBER QST

It is necessary to determine how the coil primary is connected to the vibrator, since the current for the step-up transformer must go through the vibrator points. On some coils the top primary terminal is connected to the vibrating tongue and on others to the stationary contact; the connection to the 5-volt transformer winding in the above diagram must be made to the vibrator element which is not connected to the top post.

faithful and revamped the circuit for the new type that the rest of the gang seem to be wanting to use.

2. The coil change makes it impossible to pass enough current to use in the way described in the former article, so take the coil and hold open the points. Check the circuit from the top post on the side of the interrupter or vibrator and find which way to hook up the coil. The manufacturers vary, so find out first. Then follow Fig. 8, putting in a 6-ohm rheostat to limit the current. Connect the 5-volt winding as shown. If there is a low turns-per-volt ratio, don't use the transformer—six turns per volt is about as low as it is possible to go. Do not attempt to use a winding designed for a single 71-A tube either—this winding has to pass about six amps. If there is room on the high-voltage transformer put on a new primary of No. 14 d.c.c. using about 7 turns per volt. Then it will be possible to pass the necessary current.

3. If you must light the rectifier tube from the transformer, just remember that you can't pass more than six amperes through the coil points without burning and sticking. The best plan is to substitute the new type 84 tube (or 6Z4). Light it directly from the same battery that handles the other transmitter filaments. Let it warm up before you expect it to pass current, and also remember that its inverse peak rating is 1000 volts.

4. Limit the output and, if possible, use crystal control. A suitable portable set is the Tri-tet with 89's in place of 59's.

5. Use an a.c. voltmeter in the output of the interrupter circuit. Adjust the points to give maximum reading and then keep the pitch at about the same level. Also use a monitor, as some frequencies of the interrupter are more easily filtered than others.

—I. L. Brown, W8VJ-W8IDE

Increasing C.W. Selectivity

In tinkering around I have run across a little scheme that seems to me to have possibilities as an inexpensive way of increasing the selectivity of c.w. receivers.

The stunt is to take the audio output of an autodyne detector, put the beat note through a low-pass filter, then build up the pitch with one or more frequency doublers to a tone desirable to copy. If the low-pass filter cuts off at 200 cycles, we can then separate stations 200 cycles apart and two doublers will bring the maximum tone pitch up to 800 cycles. Fig. 9 shows a simple layout tried at W3CIJ.

The low-pass filter was the common tone control carried to the extreme. A push-push doubler was used to cancel out the fundamental tone. Cathode resistor bias was used to get linear amplification. It might seem that the low-pass filter is unnecessary, but if it is not used there will be a beat between each two actual signals.

Results obtained here were about what would be expected. The audio transformer (or transform-

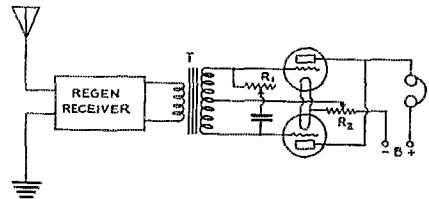
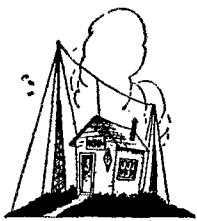

FIG. 9—AN AUDIO FREQUENCY-MULTIPLYING AMPLIFIER FOR USE WITH A LOW-PASS FILTER TO INCREASE SELECTIVITY IN C.W. RECEPTION

ers as another stage was ahead of the doubler) seemed to cut off at about 100 cycles. With the tone control cut down low there was a nice peak in this region. The 100-cycle tone, of course, doubled to 200 cycles with plenty of higher harmonics to make the pitch sound higher. The receiver when tuned sounded something like a single receiver with two crystals either side of zero beat, except that the tone of a pure c.w. signal was changed to something that sounded like the old rotary sparks and was pleasing to copy. This must have been due to the harmonics generated in the doubler. By jiggling the bias resistor and plate voltage on the doubler many changes in tone could be brought about.

—John P. Shanklin, W3CIJ



Amateur Radio STATIONS



W9DRD, Merriam, Kansas

A CHAMPION of low power is Herb Hollister, of Merriam, Kansas, who, in addition to keeping W9DRD on the air, finds it a pleasant job to do the same with WLBF, a Kansas City broadcasting station of which he is president and general manager. One of the pioneer 20-meter 'phone stations, W9DRD is well known to both 'phone and c.w. operators on that band. Hollister started in ham radio in 1914, did his share of spark work, and graduated like the rest of the old timers to c.w. The call W9DRD was acquired in 1925; two years later the station was crystal-controlled and was operating on 20-meter 'phone. The year '28 saw W9DRD's first 28-mc. contact (with a first district station) and the acquisition of a WAC certificate. All this was done with a single 210; in fact, Herb says that it is only this year that the high-power rage has forced him to go up in power—to the extent of adding a second 210 in the final stage!

In the accompanying photograph W9DRD occupies the table in the right foreground. At the extreme right is a Lampkin micrometer frequency meter; behind it is the metal rack which holds the audio-frequency equipment. On this rack is the speech amplifier, consisting of a 56 resistance-coupled to a second 56, with the latter transformer-coupled to a pair of 59's in push-pull. The last stage is the driver for a pair of 10's in Class B. Better than 60 watts of audio are available from the modulator.

Moving on to the left, next in line is the receiver, a Hammarlund Comet Pro. The microphone, a Western Electric 387-W, swings out on a telephone extension over the receiver. The radio-frequency end of the transmitter is at the left-hand edge of the table. It consists of a Tri-tet oscillator and 59 doubler (exciter unit) driving an 865 buffer stage. The final stage has a pair of 10's in push-pull, normally operated with an input of 55 watts. A seven-point switch selects any one of the same number of crystals for frequency changing. The antenna coupling and tuning apparatus is in the panel unit mounted on

the wall above the transmitter. Switches on the panel of this unit change the condensers from series to parallel when changing bands. The antenna is 66 feet long, cut in the center and fed with 50-foot tuned feeders.

The racks for the transmitter assemblies are made of Duralumin. The panels are aluminum, the finish being applied with a cork and carbondum grain with the aid of a drill press.

On the far table are a grid-dip meter, an aluminum cabinet containing a midget b.c.

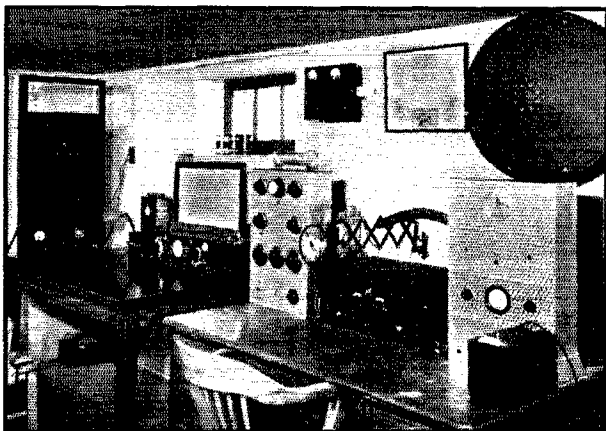

receiver, a b.c.-range e.c. oscillator, and a test oscillator for checking crystals. Beside this cabinet is a crystal oven, with a universal voltmeter sitting on top of it. The rack in the far corner contains monitoring equipment for WLBF.

Altogether an attractive station—and one which proves that high power isn't a necessity for doing good work.

W8IDJ, Oneonta, New York

ALTHOUGH W8IDJ is comparatively a new-comer on the air, having started operation in December, 1932, it is evident from the photograph of the station that a lot of progress has been made in a short time. Chauncey B. Moore, of 11 Hazel St., Oneonta, is the owner. The layout shown has developed from a 210 outfit with which all districts were worked soon after the station opened up.

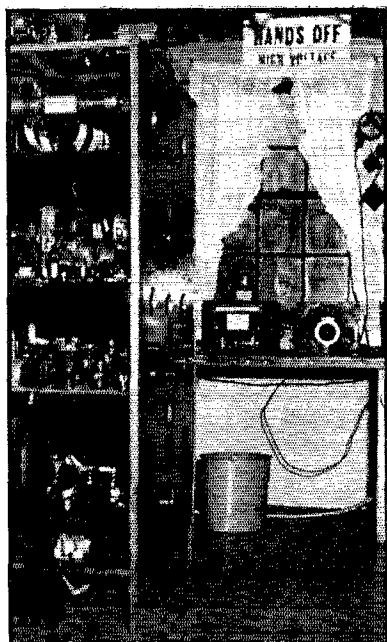

W8IDJ

The frame-mounted transmitter works with a full kilowatt input. The crystal tube is a 47, followed by a 46 doubler, a second 46 buffer, a Western Electric 242-A, an 852, and in the final stage a pair of 204-A's. Four power supplies take care of the plate requirements: a 350-

volt supply for the oscillator; a 500-volt supply for the 46 doubler and buffer; an 800-volt supply for the 242-A, using 866 rectifiers; and a 2300-volt supply for the 852 and 204-A's, this last having a bridge rectifier with four 866-A's. Oil condensers are used in the filters of all but the 350-volt supply.

The side view of the transmitter gives a fairly good idea of the layout. The high-voltage power supply is at the bottom; next above are the low-power stages and their power supplies, the 242-A and 852 buffer stages and the third power supply are next, followed by the final stage, antenna tuning condenser and harmonic suppressors.

Two receivers are in use; one is a National FBXA and the other a home-made t.r.f. job using a 58, 57, and 56. Separate transmitting antennas are used for 80- and 40-meter work.



W4BGA

For the lower-frequency band the antenna is slightly more than 131 feet long and has 55-foot feeders. The 7-mc. Zepp is approximately 65 feet long and has 33-foot feeders. A doublet with transposed feeders is used for receiving.

W8IDJ works mostly on 3530, 3784, and 7060 kc., but expects to put in a 75-meter 'phone in the near future. Cards reporting reception of the 80-meter sigs have been received from New Zealand and several European countries. The usual run of DX has been worked on 40. W8IDJ is a member of the U.S.N.R. and also holds an ORS certificate.

A Western Florida Station

A view of W4BGA, owned by M. S. Moore, of Pensacola, Florida, W4BGA opened up in the spring of 1932, snaffled a WAC certificate on 7 megacycles using a pair of 10's in push-pull and an SW-3 receiver, and then built a new outfit. The transmitter now in use consists of a 10 crystal oscillator, 10 doubler, and 860 final, the latter normally running with 135 watts input. The antenna is a 7-mc. Zepp supported between a 60-foot lattice mast and a 24-foot pole. An FB7A takes care of the receiving at W4BGA.

W4BGA operates chiefly on 7 megacycles, with an occasional excursion to 14 mc. Moore held the call 4QT in '23 and '24, but dropped out of the game for about eight years before getting back with W4BGA. Appointments as ORS and OBS are held.

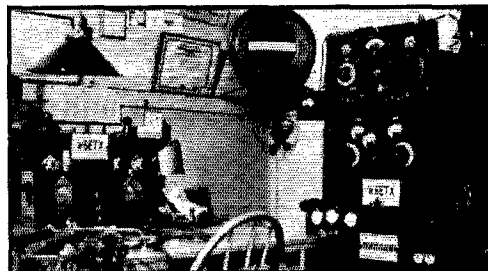

W6ETX

W6ETX, Los Angeles, California

W6ETX is owned by Earle C. Ward, of 639 No. Lafayette Park Place, Los Angeles. The

(Continued on page 80)

• I. A. R. U. NEWS •

Devoted to the interests and activities of the

INTERNATIONAL AMATEUR RADIO UNION

President: H. P. MAXIM

Vice-President: C. H. STEWART

Secretary: K. B. WARNER

Headquarters Society: THE AMERICAN RADIO RELAY LEAGUE, West Hartford, Conn.

MEMBER SOCIETIES

American Radio Relay League
Associazione Radiotecnica Italiana
Canadian Section, A.R.R.L.
Ceskoslovenskí Amatéri Vysilací
Deutscher Amateur Sende-und-Empfangs
Dienst
Experimenterende Danske Radioamatorer
Liga Mexicana de Radio Experimentadores

Nederlandsche Vereeniging voor Internationaal Radioamateurisme
Nederlandsch-Indische Vereeniging Voor Internationaal Radioamateurisme
New Zealand Association of Radio Transmitters
Norsk Radio Relé Liga
Polski Związek Krotkofalowcow
Radio Society of Great Britain
Rede dos Emissores Portugueses

Reseau Belge
Reseau Emetteurs Français
South African Radio Relay League
Suomen Radioamatöörlitto r.y.
Sveriges Sandareamatorer
Unión de Radioemissores Españoles
Union Schweiz Kurzwellen Amateur
Wireless Institute of Australia
Wireless Society of Ireland

Conducted by Clinton B. DeSoto

R.S.G.B.'s 21st:

On July 5th the R.S.G.B. will celebrate its "coming of age"—its 21st anniversary. The traditional British custom of celebrating a year and two decades of existence will be observed by a special June issue of the *T & R Bulletin*, and suitable activities in London.

On July 5, 1913, the Wireless Club of London was formed. It was from this small local club that the R.S.G.B. sprang. In 1925 a Transmitter's Section was formed within the distinguished parent society, and this section grew until now it is the whole of the R.S.G.B., and the Society has become truly transmitting amateur in character.

The special June issue will celebrate this important milestone in an appropriate manner. It will contain contributions from many early pioneer amateurs in Britain, and will do much to illustrate the enormous strides the Society has made in recent years. Copies will be sent free of charge to interested non-members.

Field Day:

For several years, now, the summer months have brought recurring excursions into the highways and byways on the part of radio amateurs, bearing transmitters and receivers, in an attempt to show amateur radio in the field as useful and diverting as amateur radio in the home.

In the United States 56-mc. field days are slowly growing into a tide. Elsewhere in this issue, a national field day is announced. Every amateur should investigate this event, participate if possible.

The R.S.G.B. announces that its Second Annual National Field Day will begin at 1600 G.T. June 9th, and will run until 1900 G.T. June 10th.

Over 30 British stations will be in operation, half on 1.7 and 3.5 mc., and the remainder on 7 and 14 mc. looking for international contacts. A special certificate will be awarded the overseas portable station giving the largest number of points to British portable stations taking part in the event.

British N.F.D. stations will call "Test NFD de" Claims for the special certificates must reach R.S.G.B. headquarters 53 Victoria St., London, S.W. 1, not later than June 30th.

They will use a maximum power of 10 watts on 1.7 mc., and 25 watts on the other three bands. The cooperation of the Egyptian B.E.R.U. group and the U.S.K.A. in having portables in the field during this event has already been offered, according to J. Clarricotts, secretary of the R.S.G.B., and it is hoped that other organizations and individuals will follow their example.

Tourists:

From Mogens Kunst, OZ5MK, comes a list of the English-speaking Danish hams, with the assurance that any of them will be delighted to welcome overseas visitors, to show them the delightful country of Denmark, and in general to exercise the traditional ham hospitality we have been preaching in these pages. The list:

OZ2H Haldor Berthelsen, Ulfborg St. (Jutland)
OZ2K E. Bork, Tagensvej 112, Copenhagen L
OZ3K Paul Andresen, Saltvarket, Kerteminde (Funen)
OZ8J Kund Langa-Jensen, Faaborg (Funen)
OZ9P Erik Petersen, (Radio Battalion), Ingeniorkasernen, Copenhagen

OZ5MK Mogens Kunst (Radio Battalion),
Ingeniorkasernen, Copenhagen
OZ7T Steen Hasselbalch (Radio Battalion),
Ingeniorkasernen, Copenhagen

In Saltillo, Mexico, the newly formed *Club Radio Experimentadores de Saltillo* says *hacia la vista* to the amateur world, and adds the magic words, "feed and drink gratis!" Get in touch with the secretary, Hipólito Aguirre, X2X, Hidalgo Norte No. 6, Saltillo, Coah, Mexico. Other officers are X2B, president, X2AM, treasurer, and X2AS, X2AO and X2U.

From an anonymous contributor come these "Hints to Travelling Hams":

"Happy were my thoughts, filled with visions of tall poles and a shack away from QRM and the congestion of hams and electrical noises. Ah, truly, Europe would be the ideal place for an amateur station.

"But, as always, there was a dinge in the cordwood, a reptile in the flora.

"Trying to buy junk to make up a decent-like rig began to remind me of the 1922 days back home. Most of the parts here are handmade. Meters may be bought at a price or borrowed from schools. The prices on other parts are similar to those in the U.S.; the difference is in the quality of the stuff. France and Holland rank first. The others are passable.

"The ham near the borders can smuggle in stuff. Crossing the border more than twice in the same place is about as good as walking into the jug. I had the experience in Hitler-land. Bread and sausage, with water to quench the gaps. Trying to convince the Nazi's that 56 mc. would get rid of the mice in the jugs was like telling it to a guard in a bughouse. It was as bad as trying to sleep in a car in the state of Mississippi. Or on the fields of Texas, where skeeters abound. Mice pick on the choice parts, while skeeters aren't so particular.

"But enough natural history. If more foreign hams would have confidence in the leading advertisers in *QST* I can say that it would be easier to send their orders direct to them, with a remittance large enough to cover postage and a small duty charge. The U.S. firm will be glad to cooperate, and to follow instructions in order to make the rate as low as possible. I tried it with satisfaction. If you can't write W language, use your own.

"Acquiring a ticket here isn't so easy, either. Some demand an examination. The Postoffice Department sends a bird out to look your stuff over and has you fill out an application blank which looks like a thesis, but the matter is finally closed by \$3.50 and you're good for a year.

"To the new ham arriving in port: Be sure to put the stuff on the bottom of the trunk and fork over a few dimes or marks or what have you to the porter before he takes the luggage to the revenue agent. He'll know what to do. Situation

is pretty amiable in Italy; variable condensers, resistors, and small fixed condensers may be passed as oil filters for cars. (A hint to that section of the peninsula.)

"The wisest countries are Spain, France, Poland and Bohemia, which are hard to get through. This does not apply to G, SM, or U.S.S.R., as I have had no experience there. I had a swell time in Bohemia with the wholesale dealers. With the aid of a few chemicals (beer, etc.), I bought a complete receiver. Wholesale dealers are under the supervision of the government, but cash payment means a lot to them these days. I found receivers made in 3- or 4-tube portables, like the SW3 or monitor size, will pass at a revenue fee of \$20 to \$40. Advise them it's for personal use. Transmitters made to appear like receivers are O.K. but otherwise will bring complications and confiscation.

"Good variables and blocking condensers are lacking in Europe. Since the dollar went down more foreign hams can buy U.S. parts, but confidence is lacking. I find *QST* in every country, even where the hams can't read it! The diagrams, and a dictionary, are enough.

"Hoping to see the gang at the Cairo convention. . . ."

The Polish postmark is authentic. Probably the dope is, too. At any rate, it's an intriguing document.

General:

PAODC's 3725 signals have been coming through each evening starting at 11:00 p.m. E.S.T. In connection with the claim of G. E. King, ZE1JF, for the low-power 'phone record, W1ABG recalls the report in this department of the November, 1929 issue of *QST* concerning the exploits of R. Picton, F8AXQ With inputs of 5 watts or less he was QSO all Europe, Algeria, Egypt, U.S.A., Australia and New Zealand—this all with "loop" modulation! Down in Uruguay a number of 14 mc. stations are getting active again, after layoffs amounting to as much as two or three years CX2AF (ex-CX1CI), CX2AK, CX2AM, CX1AN, CX1AZ, CX1BZ, CX1CG, CX2BM, and CX1CX are the stations now active The best time for W QSO's seems to be between 2000 and 0100 G.T., although stations have been heard during the day at odd moments QSL's should go to the U.S.W.C.G. (Uruguyan Short Wave Code Gang), Box 37, Montevideo, Uruguay Speaking of QSL Bureaus, G6YL informs us that J. H. Knowles, YI7RK, has been transferred from Iraq, and can no longer handle cards for that country His equipment has been taken over by Cunningham, YI7LC, who will probably handle cards as well The address is the same: W/T Section, Squadron 70 (BT), R.A.F., Hinaidi, Iraq



CALLS HEARD

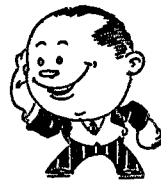

J2GX (Ex-J1DO), T. Yagi, 109 Omotemachi, Koishikawa, Tokyo, Japan

(7-mc. band between Dec. 18, 1933 and Jan. 25, 1934)
ce3ek ce7aa cmlnb cr1ah cr7ad cv5av d4bca d4bdt d4bdr d4bla d4bkk d4hku ear182 ear317 ea3as et3fa f8ny fm8ib g6cj g6cp g6vp haf3ap haf3fh haf8c hb9ac lu1ch lu1ec lu1ep lu2ca lu2dp lu3dd lu4bh lu4dj lu5bl lu5cz (fone) lu6ax lu6br lu6dj lu9hl ny2ay oklaw ok1pk ok1wx ok2dd ok2va pl5d pa0az py2bn splar splbc spl5d splir splde sulch sulec su6sw ve4ea vp5pz vpu2 vt2bn vq4kta un7uu wlaad wlaacm wz1z w2bkv w2xm w3dfs w3gbb w3hgu w3zj w4cby w4ei w4ms w4oi w8eo w8fpw w8jk x1aa x1an x2f yi7rk yp5bb yr5aa zc6ff zd2a zd2c zslb zslz zs2a zszf zs2x zsz4 zsz5 zsz6aa zszv zt1f zt1h zt2e zt2f zt2r zt5l zt5r zt5w zt6d zt6n zule zu5w zu6a zu6p zu6y

J2HZ (Ex-J1FF), M. Oshima, 19 Nihon-Enoki, Kanagawa, Yokohama, Japan

(7000-ke. band)

w1bn wisk w2foi w3ddo w4aaq w4ajx w8jk w9bpm w9elx w9blz w9hwi w9fhr w9nkr w9pqa lu1ck lu4bh lu5bl lu9axc lu9hp lu7an lu8bh ve4nd xlam oa4b z1con z1daj z1eci z1j3p z1l3q z1l3f z1l3m z14fw cr7ar fm8vk zule zt1c zt1t zt6d zt6j zt6x zsz5 zsz6

W6DIO, Jack Kilpatrick (Ex-W2EV), 703 Kensington Rd., Ocean Park, Calif.

ci1gu d4bar d4bmj ei8b f8eb f8cx f8wb g2ma g5by g5fv g5hb g6gc g6nj g6qz gi8qx on4bz pa9ce pa9ll pa9t z2a zslh

BRS 1338, D. W. Morgan, 15 Grange Rd., Kenton, Middlesex, England

(14-mc. 'phones)

k4sa oh2ne ve2dx ve2ca ve2bg w1dw w1ajz w1gbe w1dmm w1chi w1fz w1ahi w1dar w2ade w2ooe w2goq w2jm w2acg w2cp w2mo w2awt w2dvw w2md w2pt w2aie w2gve w2aih w2kr w2byt w2bci w2dc w2coj w3vx w3qv w3nk w3bih w3awt w3bek w3bog w8bae w8cvt w8pk w9bht w9gyk w9jy w9buy w9nw w9gia w9gtu w9jhy w9adq

Myron Goldstein, 13 Pinsker St., Tel Aviv, Palestine

(3.9-mc. 'phones)

w1adn w2nz w2doq w3byz w4ld w3blz w2au w1bes w8aya ve5ei w3dq w3zk w1dtj w4aiv w2bly

ON4CSL, Carroll R. Stegall, Lubondai via Tshimbulu, Kasai, Belgian Congo, Central Africa

(14-mc. 'phone)

w2mb w2got w2gaq w3my w3qv w3qz w4cre w6cne w8bae w8jk w9ld ve2dw

(14-mc. c.w.)

wladj wlavl w1bx w1bhq w1cab w1dbm w1ddb w1dhe w1dxi w1epc w1fpw w1gsa w1fh w1nw w1lz w1sz w1ve w1vw w1zd w1zi w2aok w2che w2cda w2emv w3byv w3ere w3ejg w3rg w4bfh w4cby w4eri w4tz w6cnk w6lce w7ek w8aa w8dhe w8doi w8oe w9jyz ve1de ve1dq ve2ax

W. Lockerby, P. O. Telegraph, H. M. Wireless Station, Khormaksar, Aden, Arabia

(7-mc. band)

w1ah w1ch w1djh w1fet w1fn w1fxc w1hs w1hsa w1si w2aa w2ag w2bh z w2bxu w2cwc w2dpg w2dtr w2dzj w2fop w2fvl w2oa w3anz w3bbf 3bet w3cfl w3cta w3dsk w3fpw w3zj w4ald w4azb w4bhw w4ci w4co w4cm w4ft w4we w5bzt w5dnp w6aor w8by w8cbz w8faw w9bof

(3.5-mc. band)

w1bf w1mk w3ask d4bbk

W9JDY, Jean Seymour, Salina, Kansas

(7-mc. band)

pk6ag j1ee j1ga j1dm j1do j1dn j2ce j2cl j2ij j2iw j2hz j2gw j2ec j3ct j3de j3df kalhr kalcm kalco kaljr kallj kalee

W6BLZ, Box 1000, Laguna Beach, Calif.

(Heard 40 miles off Fiji Islands, Nov. 12th, 5-6 p.m.)

w5jp w4ann 43ans w2ge w7lf w8qd vp5lf xul

E15F, H. Hodgens, Clonascleigh, Shankill, Co., Dublin

(7-mc. band)

w4ft w4kk w5tr cx1ft heljw lu1jh lu4djd lu5bl lu7az lu8cl lu9ax py2bn py2az ve1de veldl vk2px vk3dm vk5pw vk7ch vp5pz

J. S. Morrissey, Elkins Park, Pa.

(14-mc. 'phone)

lu8dr on4au py2ak py2bn k6baz ex1aa j1ec z12ec

W5ADZ, 2411 Crawford St., Houston, Texas

en8ata j1dh j1dm j1do j1dr j1dw j1dv j1dy j1ec j1ee j1ek j1el j1ep j1et j1ff j1fm j1fo j1fp j1fs j1ft j1ga j1gi j2ce j2cl j2gw j2he j2hb j3cg j3cr j3cx j3de j3dk j3dp j3du j3ek j3em j4cl j5cc j5ce j7cj pk3bq sulch zsa

BRS427, D. A. G. Edwards, Selwyn House, Chester Rd., Sutton Coldfield, Birmingham, England

(14-mc. 'phone)

ct1hb ea4n k4sa la1g ve1dq ve2ca ve2dx ve4kx w1akd w1bnm w1eav w1ehi w1dw w1eop w2adj w2afq w2byt w2cif w2coq w2dc w2dvw w2lv w2tp w3awt w3egq w3pc w3qv w3zx w4cby w4cf w8cvt(?) w8dlg w8fhe w9ark w9bht w9gtu w9jhy w9ld

Vic Bortow, W2DJY, Aboard S.S. Minnequa (Between Scotland and Leningrad)

(28-mc. band)

f8cd f8ol f8rj haf4d ok1aw sm6wl su6hl w4mr w8ccw w8fsk w9gxe w9lbb

(3.9-mc. 'phone)

vk2ns vk7ck w1avk w2bo w2ls w3blz w3cgt w4aaw w4pw w9jai xlg z14af z14gs

(3.5-mc. c.w.)

k6cib on4fe ve1et ve1bo ve2dx ve4en vu2lj w1fub w1glo w2oj w2ear w2gin w3cxl w3mc w4edl w8euc w9mir w9oj w9ojx x1q x1bl z12hy z12kz z13fo zsz6

G5KT, Kenneth T. Harvey, 33 Howard Rd.,
Westbury Park, Bristol 6, England

(3.5-mc. band during 1933)

cv5bcd ei2b haf3zz hb9x hb9y ly1aa ly1b oh1ba oh5nf
oh5nr sp1cf sp3ax su6hl ts4sax un7af un7kl ve1dc
veler ve2cx vo8d(?) w1aby w1adm w1adz w1aga 41as
w1ayn w1az w1bic w1bis w1blj w1bri w1cc w1cto w1dis
w1dvs w1ef w1emw w1fc w1fnw w1fu w1gd w1ij w1mk
w1vp w1zs w2bmb w2bwm w2bst w2byl w2cnw w2coj
w2cza w2dlk w2eay w2emu w2eos w2ol w2rg w2un w2edk
w3aty w3blz w3bra w3btm w3bym w3byu w3byv w3caz
w3cmr w3dd w3dpu w3drs w3hg w3kb w3mi w4avt w4adz
w4bam w4nc w4tr w8ata w8bdk w8enc w8hl w8idj xd4mfm
y16wg ym4dsg

(7-mc. band, January, 1934)

w5dqw w5tw w5bfy w6cmo w7ean

W6ENM, Allison Smith, 901 Bush St., San Fran-
cisco, Calif.

(3.5-mc. c.w. band)

zl2bn zl2fr zl2jq zl2ol zl3ag zl3ax zl3fo zl3jr zl4co

Charles B. Kindred, (Ex-W9FDJ), P. O. Box 13,
Atlanta, Ill.

om2aa u2gu j1gi j5zz nx1dl

W9SERZ, 10 Warren Ave., Auburn, N. Y.

(3.5-mc. band)

k7pq k6vr ny2ab ve5ca ve5ec ve5eo ve5fh ve5hw ve5is

(7-mc. band)

j1ee jleg yhlrv yhlvl

(14-mc. band)

pk1cx pk1wb

(14-mc. 'phone)

g5by on4au oa1b k6baz

G6YL, Miss B. Dunn, Felton, Northumberland,
England

(7-mc. band)

j3de ka1xa lu6ax vk2dy vk2ng vs6ab

(14-mc. band)

w5amz w5bno w5rr w6cip w6cne w6cp w6fet w6gri w6jjw
w6qd w6vq w7bac hc2jm k4sa (fone) ve5al

W4CKM, Joseph P. Guy, Fort Lauderdale, Fla.

(7-mc. band)

pk3of sulec sulch vu2bg j1ee ka1hr ka1na zeljb u2gu
u5kda

W9BYE, Earl Krainik, 2419 N. 56th St., Mil-
waukee, Wisc.

(7-mc. 'phone)

lu5bz

(14-mc. band)

cm2an ('phone) k4sa ('phone) lu8djo ('phone) oa1b
('phone) xu2ee zslb zs4m

W1ZI, Harris Fahnestock, Jr., 162 Coolidge Hill,
Cambridge, Mass.

(March 10-19th)

cn8ybq ez4sax (ff8sud) (ilki) (iltkm) (ka1na) (ly1j)
(oe1er) (on4csl) (sp1de) (splkx) sp1la (sulec) (vq4cro)
(ym4zo) (yp5bb)

W9KE, Walter Strauss, 6415 So. Maplewood
Ave., Chicago, Ill.

(14-mc. c.w.)

tf1ad rk2zh zu5kx vk5fm vk7jb

(14-mc. 'phone)

oa4b x1g x1q k6baz

(7-mc. c.w.)

rs2gy zk6cq zk6ba ru2au ka1fd

(7-mc. 'phone)

lu5cd hc2rl yv2am

W4CBD, A. D. Mayo, Jr., Aboard Schooner
"Buccaneer" Enroute Tampico to Vera Cruz,
Mexico

(14-mc. 'phone)

w1ajz w1caa w1feg w1kj w3awt w3ceo w4ef w5amz
w5dfa w5aqy w6cqq w6dda w6dzh w8blp w8ctn w8zm
w9eyn w9far w9fpa w9dfz w9gls oa1b ve3bb k4sa

Vera Cruz Harbor

w5aev w5ddp w5zzb w6dwa w8ctn w8cvt w9cta ve1bb

H. S. Bradley, Hamilton, N. Y.

(7-mc. 'phone)

ce1af ce3ag cm2mg ct1da cx1aa cx1ai ea8ab hj1abd hj3abd
hj4abb hke hr1ug oa4b oa4n py2ak x1u yv2am lu1ab
lu2ca lu2dp lu3dh lu5ar lu5bl lu5ez lu6bz lu8djc lu9ax

(14-mc. 'phone)

cm2an g5by g6li k4sa oa1b oa4b on4au x1ai x1u

Hamericana 1934

He believes that a bug in the hand is worth two meters in the set.

He abhors the idea of trying anything new until after some other local ham tries it out.

He thinks "3 x 3" is some new kind of beer.

He always says "QRM" when he really means "QRS."

He says "rrr" when he really thinks "sorri but didn't get a word."

He thinks because he has a crystal that his sigs are just perfect.

He thinks that an Old Timer is a feller who has been in ham radio a couple or three years.

He still believes that certain circuits are the only ones which will work at his place.

He believes that a sked for 9 a.m. means anything from 8:45 to 9:30.

He believes in letting the other fellow QSL first.

He still tunes his transmitter during local rush periods.

He rarely knows the legends of the Wouff Hong and the Rettysnitch, and cares less for the real traditions of Ham Radio.

He still says in response to a QRG—"Sorri OM batts dead in freqmeter."

He still believes that a multiplicity of switches adds to the glamor of ham radio.

He believes that hay wire still works better than a shipshape layout.

—A. D. M.

THE COMMUNICATIONS DEPARTMENT



F. E. Handy, Communications Manager
E. L. Battey, Assistant Communications Manager

Radiophone Traffic Handling

By K. G. Morrison, W6SQ-K7CJ*

THE handling of traffic by radiophone is rapidly becoming an important factor in amateur communications. Proper procedure is important and many phone men may profit by observing a few simple rules. It is the simplest thing in the world to send a message by radiophone. Receiving this message is another question and the receiving operator should be given primary consideration. He has to put your message down, letter perfect, at 15 to 25 words per minute for longhand or up to 45 or 50 words per minute if using a "mill." Normal conversation runs about 125 words per minute so discretion must be used. More deliberation and increased clarity of enunciation make better voice communication possible as well as permits of traffic exchange which requires "real communication" ability.

The transmitter speech quality should be as fine as possible. A drummy signal is hard to copy through QRM and fading, particularly when distortion fading is encountered and excessive "lows" should be avoided. Most intelligence is transmitted in the higher frequencies. Since the ear will replace missing fundamentals below 250 cycles a signal cutting the "lows" and transmitting 250 to 3000 cycles is best. *Intelligibility* is what counts most in message handling and amateur voice communication. In speaking do not approach the microphone closer than about one foot. This also tends to eliminate drummy quality and breath noises. The gain may be slightly increased to obtain normal output and modulation. Speak in a natural tone of voice, slowly, enunciating each character or syllable clearly. This is important. The push-button system of control (QST's "Push-to-talk" system) should be used if possible for break-in. This will put snap in your operating procedure and speed up traffic handling or general communication.

The preamble of the message should contain all the usual information (city, station-of-origin, number, date) so a message may be traced back if necessary. Between the preamble and the address the word "to" should be spoken, allowing a pause for the receiving operator to drop down a line for the address. All numbers occurring in the message should be read once and then repeated, giving each digit separately; for example, "one hundred ninety seven—one nine seven." Unusual words and proper names should first be pronounced and then spelled out. If your signal at the receiving station is weak or in any other way difficult to copy, it is wise to spell these words out using the Western Union code words. The W.U. list is simple to remember and the words are distinctive. Be consistent. Always use the same word to denote a given letter; it avoids confusion and makes it possible to recognize each letter although the signal may be barely intelligible. For

those who may not have the W.U. list, it is given below.

A—ADAM	J—JOHN	S—SUGAR
B—BOSTON	K—KING	T—THOMAS
C—CHICAGO	L—LINCOLN	U—UNION
D—DENVER	M—MARY	V—VICTOR
E—EDWARD	N—NEW YORK	W—WILLIAM
F—FRANK	O—OCEAN	X—X-RAY
G—GEORGE	P—PETER	Y—YOUNG
H—HENRY	Q—QUEEN	Z—ZEBRA
I—IDA	R—ROBERT	

Between the address and the body of the message, the word "text" should be spoken to distinctly separate them and to give the receiving operator time to drop down a line or two on the blank. The text should be sent in groups of three or four words which are spoken slowly and then repeated slowly, enough time being allowed between each group for the receiving operator to catch up. Each group should preferably contain a small phrase, if possible, so that the reception of the message is made more simple by the transmission of a complete intelligence. A sample sentence may be divided as follows: "Especially important work—that has a news value—should be sent direct—to League Headquarters—at Hartford." In the text, also, numbers, proper names and unusual words should be repeated and if necessary, be spelled out. The signature is given in the usual manner with the word "signed" mentioned before it.

Whenever the QRM or fading is especially bad the whole message may have to be spelled out using W.U. code words. This may seem a very laborious process but after once memorizing the code words, a word may be spelled rapidly. The words "as in," between the letter and the code word, are unnecessary. To spell the word RADIO, you say, "R Robert A Adam D Denver I Ida O Ocean." Soon you will be able to spell words in the code as fast as you can roll the code words off your tongue.

If messages are transmitted in groups, sufficient time should be allowed between the signature of one message and the preamble of the succeeding, for the receiving operator to insert a new blank in his "mill." This is one thing that transmitting operators very often forget. More time between messages will avoid fills and errors in the preambles of messages where the operator is trying to catch up. It is wise to ask for fills at the completion of each message so that the receiving operator may make corrections before the blank is removed from the typewriter and a new one inserted.

In receiving, the operator should place ten words on a line with a double space between the fifth and sixth words, and place a double line space between the fifth and sixth lines. In this way the text is divided into groups of fifty with a space between each five words. At a glance the check of the message is obtained without counting the words. Fills may be asked for by the number of the word desired. This is good procedure in either phone or C.W. work and speeds up operating considerably. When using "radio" count in checks, as in A.R.R.L. procedure, the address should be included in the first group of ten

* 2418 Ashby Ave., Berkeley, Calif.

words. When the text is reached the grouping is continued, but the first line appearing in the text contains only enough words to fill out the group of ten. Of course, the receiving operator should *not* write or count the words "to," "text," or "signed," as these are spoken only for the purpose of assisting him in typing out the message in its proper form.

Although the procedure described may seem complicated as you read it over, practice in its use will prove it superior to any other method in accuracy and speed, because fills are very seldom asked by the receiving operator. It has been used for the past three years on a six station commercial net in Alaska, where over one thousand paid radiophone messages are handled each month in English, Italian, German, Russian, and Spanish. It was rarely necessary to repeat back the messages to the sending station and fills were cut to a minimum.

EDITOR'S NOTE: Mr. Morrison's contribution contains suggestions which should assist 'phone operators in achieving more "100% QSOs." Our thought in presenting this material is *not* to encourage *more* traffic handling in the 'phone bands, but to assist the *accurate* dispatch of such traffic as is being handled on voice at the present time so it can be handled in *minimum* time. Also the suggestions should help in the broader field of general voice procedure. Station effectiveness can doubtless be improved by adoption of some of the operating ideas herein expressed. The use of systematized procedure can materially improve the *communicating power* of our two-way communicating stations, regardless of whether they use c.w. or voice modulation in transmission.

—F. E. H.

A.R.R.L. Traffic Routes

We present a few of the most reliable A.R.R.L. traffic Trunk Line routes. Each of these is operating efficiently as this issue goes to press.

Trunk Line "J," Florida to Illinois: W4AKJ (Tampa, Fla.)-W4APU (Birmingham, Ala.)-W9BAZ/W9OX (Louisville, Ky.)-W9ILH (Alton, Ill.)

Trunk Line "K," Texas to Illinois: W5BII (Dodd City, Tex.) and W5OW (Ft. Sam Houston, Tex.)-W5CEZ (Ponca City, Okla.)-W9HPG (Chicago).

Trunk Line "P," Pacific Coast: W7LD (Seattle, Wash.)-W7CZY (Everett, Wash.)-W7WY (Vancouver, Wash.)-W7HD (Portland, Ore.)-W6JAL (San Francisco, Calif.)-W6GXM (Los Angeles, Calif.). Also direct W7HD-W6GXM.

Trunk Line "B2," Coast to Coast: W1FIO (Norwalk, Conn.)-W9KG (Kansas City, Kans.)-W9ESA (Denver, Colo.)-W6BMC (Bard, Calif.).

Coast to Coast: W1CRA (West Newton, Mass.)-W8JTT (Fredonia, N. Y.)-W6GXM (Los Angeles, Calif.).

Coast to Coast: W1CRA, W3AQN, W3DXG and W1MK-W8GUF (New Kensington, Penna.)-W9GJQ (Aurora, Colo.)-W6GXM (Los Angeles).

Coast to Coast: W1MK (Hartford)-W9OX (Louisville, Ky.)-W9ILH (Alton, Ill.)-W9LEZ (Davenport, Iowa)-W9GJQ (Aurora, Colo.)-W6GXM (Los Angeles).

Portland, Ore., to Salt Lake City, Utah: W7DUE (Portland)-W6GQC (S.L.C.), also: W7DUE (Portland)-W7AVP (Boise, Idaho)-W7COH (Midwest, Wyoming)-W6GQC (S.L.C.).

Toronto, Ont., to Washington, D. C.: VE3GT (Toronto)-W8FTW (Detroit, Mich.)-W8GUC/WLTC (Kalamazoo, Mich.)-W3CXL/WLM (Washington). Also: VE3GT-W8FTW-W8EGI (Jackson, Mich.)-W8GUC/WLTC-W9DOU/WLT (Oak Park, Ill.)-W3CXL/WLM. This route is Army Amateur from W8GUC to W3CXL.

Michigan, Upper to Lower Peninsula: W9PDE (Ishpeming, Mich.)-W8AEQ (Traverse City, Mich.)-W8JO (Okemos, Mich.), or W9PDE-W8AEQ-W8DWB (Grand Rapids, Mich.)-W8JO, or W9PDE-W8AEQ-W8DWB-W8EGI-W8FTW (Detroit). Also: W9PDE-W8QT (Muskegon, Mich.)-W8GUC-W8EGI-W8FTW. Latter route is part of A.A.R.S. Net.

California Route Managers Net: The following stations operate a traffic net daily except Monday on 3605-kcs.:

W6EDW (San Pedro), W6FGT (Pomona), W6FQU/W6EFK (San Diego), W6GNM (Los Angeles), W6ZX (Oakland), W6BPU (Pasadena). W6GNM connects by 'phone with W6ETL and W6GXM, who maintain trans-Pacific and transcontinental schedules. W6BPU schedules VE5AC (Vancouver, B. C.), who in turn is on a trans-Canada chain. Stations with traffic for this net are forming the habit of adjusting frequency to 3605-kcs.

Seattle, Wash., to New Mexico: W7LD (Seattle)-W7ASQ (Helena, Mont.)-W9ESA (Denver)-W5CGJ (Chamita, N. M.). This connects at W9ESA with Trunk "B2."

Trunk Line "C" Routes: W1EF (Stonington, Maine)-W1GKC (Thomaston, Maine)-W1CHF (Portland, Maine)-W1VS (West Medford, Mass.)-W1AMG (Stamford, Conn.)-W3EZ (Haverford, Pa.)-W3CL (Philadelphia, Pa.)-W3AKB (Philadelphia, Pa.)-W3BWT (Washington, D. C.)-W4DW (Raleigh, N. C.), and W3BWT-W3BJX (Winchester, Va.). Connection to New York City: W1AMG-W2KI (Brooklyn, N. Y.). Connections from W3BWT to Maryland and New Jersey: W3BWT-W3BND (Fort Hoyle, Md.)-W3CWL (Morrisville, Pa.)-W2BCX (Elizabeth, N. J.).

Trans-Pacific Schedules: The following schedule K6EWQ (Schofield Barracks, Honolulu)-W6AZU (Long Beach, Calif.), W6FTL (Los Angeles), W3CXL (Washington), W5OW (Ft. Sam Houston, Tex.), W6ZG (San Francisco), W6GXM (Los Angeles). W6GXM also schedules KAINA (Olongapo, P. I.), W6CII schedules AC2RT. W6CUU schedules KAIEE, W6EJA (Point Richmond, Calif.) schedules KA1JR and KA1EE, W6ALU (Phoenix, Ariz.) schedules KA1HR. W6BZF (Santa Barbara, Calif.) schedules K6GUA. K6EWQ schedules KA1HR.

Canal Zone Schedules: W1TE (Portland, Maine) schedules NY1AB (Darien, C. Z.). W1MK schedules NY1AA (Balboa, C. Z.), W3CXL (Washington) schedules NY1AB. W4GI (Jefferson, S. C.) schedules NY2AB (Cristobal, C. Z.). W4GI may be reached via W8GUF.

Connection to Byrd Expedition, Little America: W3CXL/WLM, Net Control Station Army Amateur Radio System, maintains twice-daily schedules with KFZ at the Little America Base. Any station in the A.A.R.S. can route Byrd traffic to W3CXL, or same may be routed via W1MK-W3BWT-W3CXL.

Alaska schedules: W7AYV (Astoria, Ore.) and W7AYO (Yakima, Wash.) schedule K7PQ, Ketchikan, Alaska. K7PQ has regular contact with K7FF, K7EBR and K7VE. W7AYV may be reached through any of the following stations: W6ZG, W6GQC, W7CZY, W7DBR, W7BKL, W7DIZ, W7CFM, W7CCR, W7WR, W7CYW. W7AYO may be reached via W7CZY, W7DUE, W7AIG.

More reliable routes will be given next month, together with a complete list of all stations working on and in connection with the A.R.R.L. Traffic Trunk Lines.

1.75-MC. CODE PRACTICE

W9MJE, Chicago, Ill., sends code practice every Tuesday, Wednesday and Thursday from 6:45 to 7:15 p.m., local time, on 1810-kcs. W6HVX, San Rafael, Calif., 1952-kcs., sends code instruction Monday, Wednesday and Friday evenings at 7:00 p.m. under the auspices of the Marin Radio Amateurs. The following members of the Utica Amateur Radio Club send code lessons on frequencies between 1800- and 1900-kcs.: W8KOD, Mondays; W8HOU, Tuesdays; W8HNY, Wednesdays; W8HQX, Fridays; W5DGH, Pine Bluff, Ark., 1.75-mc. 'phone, announces that he will send code practice Mondays, Wednesdays and Thursdays from 5:30 to 6:00 p.m. CST.

YACHT ATLANTIC—WQBG

Operator Wilks, W2BC, of the *Atlantic*, WQBG advises that he will be on watch for amateurs in the 3.5-mc. band each day on the hour, usually in the morning. This yacht will be cruising the Atlantic coast between May 15th and October, with base in the vicinity of Newport, R. I. WQBG operates on 4145 and 5525-kcs. Watch for the *Atlantic* on those frequencies.

The following contribution by Mr. C. C. Anderson, W6FFP, wins the C.D. article contest prize for this month. Your articles on *any phase* of amateur communication activity are likewise solicited and may win you a bound Handbook or three logs, or equivalent credit applied toward other A.R.R.L. supplies. Let us have your article, and mark it "for the C.D. Contest," please.—F. E. H.

"Honesty - - - ?"

By Clyde C. Anderson, W6FFP*

THE heading is peculiar, but - - - just how many humans realize that they are not honest when they send one little letter that can mean *so* much if properly used, and can cause some mighty hard feelings if improperly used? So many articles and comments have been written about it, and in fact every radio ham that has a license has it because he is supposed to understand what that letter is, what it means, how it is sent, and of course its proper use. That little letter is one of the mainstays of radio communication and its significance is of such import that, with its use, time, power and money are saved. Hard feelings are saved, too. Can you guess what that letter is? Do you use it properly? Have you done otherwise and wondered why some ham with whom you were working said, "NM 73 QSK" just after you had, what looked at the start, prospects of a fine rag chew?

The all important letter is dit dah dit, "R," a dot dash and a dot!

Let's reread the above again, recalling at the same time that its International significance is—"acknowledgment." Webster says, "Acknowledgment—the act of acknowledging; a receipt" (QSL). He further states about acknowledgment ". . . admit the receipt of." Hence "R" means - - - "everything received okay" in ham and commercial radio vernacular.

Let us suppose you are QSO a new ham station; by that I mean, someone that is new to you and you haven't worked him before. He comes back at you "R"—say OM pse QRX a few minutes something has come up that I must leave you but will be back in few minutes and we can rag chew all you want hw? Maybe he sent it a little too fast for you because he was rushed, or QRM was so bad you got only the latter part about "rag chew all you want." But, nevertheless, you go back at him with an "R OK OM (and about your xmitter and receiver)" for about ten minutes. When you sign over to him he doesn't come back. What do you think of him? Also what does he think of you! He has heard your "R," he hears you start on your life history; he tries to BK you, but finally gives up and has to leave anyhow. Were you honest when you gave that "R"? You were not, for when you received your right to operate an amateur transmitter you swore that you were of the ability to understand, and did understand, International operating procedure, hence you were bluffing when you gave him that little big letter. At that instant, had you been honest, time, power and money could have been saved as well as the hard feelings. And that is just one instance where those three things could have been saved.

Now in case some of you are newcomers in the ham game, let us go over what you should know. "R," dit dah dit or any other sound that you use for it, when following your call on a comeback, should mean, "everything received and copied OK." Leave off the OK, for it distinguishes you, changes you from a lid to an operator in the other fellow's mind.

So let's put down a few rules on what to say when we do not receive anyone solid:

R - - - solid copy, everything received OK and understood!

*931 Orange Ave., Fresno, Calif.

"Part R" - - - - part received OK pse repeat given fills.
 "First part R" or "R to — word" - - - meaning first part to such and such a word received OK.
 "Last R" or "Fm — R" - - - meaning everything after such and such a word received OK.

Those four uses will cover everything and will certainly show that you are honest. *Be miserly with the use of R.*

In a direct bearing with the use of R is the use of the QSA numerals. Why give someone a QSA5 even if he is R9 when he is QRMed so badly that you can't read him? Thousands of you have experienced receiving—"Sorry OM QRM bad ur sigs QSA5R7 hr etc." Everytime a QSA5 report is received one naturally does not repeat each word twice even if he is only R3 or 4. That is, unless that one is a new ham. How many of you have listened to two fellows QSO each other and one give the other a QSA5R3 report, and be darned if the first guy doesn't come back sending double and everything else. And what do you think? You write down his call and are careful that you don't work him sometime.

QSA5— "perfectly readable" (even though R2 in audibility). Don't repeat each word twice when you receive a QSA5! Don't give one unless he is perfectly readable. QSA4—"Good; readable." Don't repeat each word twice. Don't report a station QSA4 unless the signal is readable. QSA3—"Fairly good; readable with difficulty." Don't repeat each word unless it is requested. Use this when intermittent QRM is on the signal you are working. QSA2—"Weak; readable now and then." Repeat each word twice. Expect a poor QSO even if the audibility is R9. QSA1— "Unreadable." Enough said! Even if you are R9 it means that receiving conditions make communication prospects unsatisfactory.

Now let's be honest and use "R" and the QSA signals honestly.

Coming Meetings

Second Annual Inland Empire Hamfest, Spokane, Wash., June 9th-10th, auspices of Spokane Radio Operator's Club. Wilbur L. Miller, Hamfest Chairman, 323 West 17th Street, Spokane, Wash.

Fifteenth Anniversary Celebration Lansdowne Radio Association, Lansdowne, Pa., June 16th, at clubhouse 16 No. Wycombe Avenue.

Alberta Hamfest, June 16th, auspices Lethbridge Amateur Radio Club. Write VE4OG or VE4EO for details.

Oklahoma Hamfest, or joint meeting of Tulsa Amateur Radio Club and Key Klickers Club of Ponca City, June 16th-17th, Hotel Alvin, Tulsa, Okla.

Hamfest of Tri-City Amateur Radio Club, June 17th, Blackhawk State Park, Rock Island, Ill. J. Keith Hunter, Chairman, 531 19th Street, Rock Island.

Connecticut Hamfest, June 24th, Oasis Club, East Hartford, Conn., auspices Hartford County Amateur Radio Association, Inc., in cooperation with the Manchester Radio Club.

Hamfest of Mississippi Valley Amateur Radio Club, June 24th, Carthage College Campus, Carthage, Ill.

Third Annual Hamfest Kennebunk (Maine) Amateur Association, June 30th, Narragansett Hotel, Kennebunk Beach, Maine. Activities start at 3:00 p.m. All amateurs invited. Banquet at 6:00 p.m. (daylight time). Tickets should be procured in advance to insure a seat at banquet—subscription \$1.50. Address all communications and make checks payable to Mrs. Roland Emery (Mrs. W1MN), Grove Street, Kennebunk, Maine.

Long Island Hamfest, Glenwood Landing, L. I., N. Y. (Karatsenyi's Pavilion), June 24th, auspices The Combined Long Island Clubs consisting of Northern Nassau Wireless Association, Sunrise Radio Club and Nassau Radio Club. Details available from K. T. Hill, W2AHC.

BRASS POUNDERS' LEAGUE

(March 15th-April 16th)

Call	Orig.	Del.	Rel.	Total
W2EKM	99	82	2052	2233
W9JWI	977	27	641	1645
W9KG	54	279	1310	1643
W3ESA	23	101	1386	1515
W3KY	88	100	1279	1467
W8EMW	142	208	1036	1386
W6ETL	102	269	988	1359
W6BMC	14	27	1315	1356
W6GXM	119	285	930	1334
W9DF	181	73	1018	1270
W9GJQ	129	92	1042	1263
W8GZ	46	94	1070	1210
K5AF	1117	36	10	1163
W8GUF	28	80	927	1035
W2BCX	183	122	724	1029
W7AYV	95	87	810	1002
W1VS	42	100	804	946
W5CEZ	70	81	774	925
W8ALU	160	304	406	870
W8BWL	59	240	456	755
K6JPT	591	91	46	728
W1ERQ	123	106	492	724
W9DOU	56	73	588	717
W3ADM	17	101	598	716
W1BVR	14	92	608	714
W1FO	44	186	478	708
W4AFM	10	20	646	706
W5BRI	10	14	870	694
W7CZY	35	90	563	688
W8AIE	65	41	552	658
W8FSY	119	170	364	653
W2AYJ	66	89	491	646
W2DBQ	37	248	360	645
W3AQN	13	102	428	645
W1AMG	107	152	356	615
W9BXX	32	38	534	604
W6AZU	97	419	80	596
KALRE	25	31	540	596
W2ENZ	27	16	552	595
W6CUU	15	32	612	589
W9EVJ	46	62	503	581
W9MZD	102	41	434	577
W6FYR	83	51	430	564
W3ALX	396	63	103	562
W6GNM	27	43	484	559
W7CCR	106	40	410	556
W3AAV	182	247	122	551
W2EGF	58	29	462	549
W3CL	45	287	214	546
W6DQN	29	65	450	544
W1CRA	59	67	412	529
W3BWT	57	106	364	527
KAINA	183	81	260	524
W3BYS	354	91	70	515
V6AAR	511	1	—	512
W8DVC	23	21	462	506
W8RN	131	51	322	504

MORE-THAN-ONE-OPERATOR STATIONS

W3CXL	420	740	3267	4427
K6EWQ	773	599	2922	4294
W6GZ	1114	346	1182	2642
KALHR	550	366	820	1736
W5OW	170	179	1354	1703
W1MK	62	364	340	766

These stations "make" the B.P.L. with totals of 500 or over. Many "rate" extra credit for one hundred or more deliveries. The following one-operator stations make the B.P.L. for *delivering 100 or more messages*: the number of deliveries is as follows: Deliveries count!

W6HZZ, 211	W2ELK, 129	KAILG, 110
W9KX, 178	W9QQC, 128	W8JTT, 109
W3BND, 161	W9NAQ, 124	W6NFCFN, 107
W9HPG, 153	W9IQJ, 119	VE3JT, 106
W9LTC, 151	W2FOP, 116	VE2HK, 102
W1CJD, 130	W4KV, 111	W7WR, 100

A total of 500 or more, or just 100 or more deliveries will put you in line for a place in the B.P.L. Make more schedules with reliable stations. Take steps to handle the traffic that will qualify you for B.P.L. membership also.

New W1MK Operator

There is a new "fist" at W1MK. Mr. Harold A. Bubb, W8DES/W3DPV of Jamestown, N. Y., and Sperryville, Va., has taken on the duties of Chief Operator of the A.R.R.L. Headquarters station. The operator "sine" is HAL, and he needs no introduction to SCMs and RMs, having made a name for himself during two years as Route Manager of the Western New York Section, A.R.R.L., and a short term as Chief RM, Virginia.

W1MK is now regularly on the air from 7:00 p.m. until 1:00 a.m. (Eastern Daylight Saving Time) each night except Wednesday and Saturday. In addition, quite some "unscheduled" operating is maintained at other times throughout each week, and the station is on the air for all special activities (RMNITE, ORS Parties, etc.). The frequencies generally used are as follows: 3575-kes. (Mon. and Tues.), 3825-kes. (Sun., Thurs. and Fri.) and 7150-kes. (each night of operation.) Schedules are maintained with W1EF, W1FO, W1GOG, W2BZZ, W2DBQ, W3BWT, W3CXL, W4AVT, W4AYV, W4DW, W6AM, W8GUF, W9BAZ, W9FO, W9ILH, W9MZD, W9OX, NY1AA and VP5MK.

Addressed messages to all A.R.R.L. members are sent "QST" from W1MK on the following schedules (all time E.S.T.): Sundays, 8:30 p.m. and midnight (3825- and 7150-kes.); Mondays, 8:30 and 10:30 p.m. (3575- and 7150-kes.); Tuesdays, 8:30 p.m. only (3575- and 7150-kes.); Thursdays, 8:30 p.m. and midnight (3825- and 7150-kes.); Fridays, 8:30 and 10:30 p.m. (3825- and 7150-kes.).

THE "CHAIN GANG"

Here is a description of the work done by a group of 1.75-mc. 'phones—I take off my hat to them! This "chain" was originally conceived by Jimmy Frye, W8IY, in early 1933, and has developed into the following system. The following stations are in the net: W8FYC, Belleville, N. Y.; W8FSY, Norwood, N. Y.; W1DQK, North Troy, Vt.; W1DMI, Lebanon, N. H.; W8EOL, Ithaca, N. Y.; W8FIM, Perry, N. Y.; and W8BHS, Brasher Falls, N. Y. Daily at 8:00 a.m. this group goes on the air on 1910-kes. As they start up, W8IY says, "Here eight messages" (or as many as he happens to have). Then he sends them all and all the rest of the gang copy. Suppose that two of the messages were going to Maine, three to Buffalo, N. Y., and three to Philadelphia. W1DQK or W1DMI would OK the Maine messages and attend to relaying them, W8FIM might OK the Buffalo traffic, and someone else would accept the three for Philadelphia. By the time each station has had his turn at sending traffic, there are usually about thirty messages on the chain. The percentage of deliveries is high because each station maintains good schedules. Each member of this gang holds A.R.R.L. Official Phone Station appointment, and their outfits are clean, dressy and efficient. They are all real hams.

The Chain Gang wants more outlets down east, in the Mohawk Valley, the New York City Area and in Philadelphia. 1.75-mc. 'phone men who wish to join the gang should write W8IY, 61 No. Main St., Homer, N. Y.

—ARNOLD M. WEICHERT, W8AOW,

Route Manager, Western New York.

BOL-INCA EXPEDITION

The Bol-Inca Mining Corporation is attempting to develop a series of placer gold claims on the east side of the Andes in the embattled country of Bolivia. These gold deposits are those whence the Incas mined the treasure which was robbed from them by Pizarro and the Conquistadores when they conquered Peru in the 16th century. Gordon Barbour, ex-W1ASR/ex-W3DHI, is radio operator with this expedition. Besides a Bolivian call issued for local company work it is expected an amateur call will be issued for personal correspondence with the United States. It is possible that amateur radio will be the only link with the outside world. If possible, the call CP1GB will be used. Scheduled tests with U. S. hams will be made as follows: Saturday, June 2d, 9th, 16th, 23d: 7300-kes. noon to 4 p.m. and 7 to 11 p.m. EST; Sunday, June 3d, 10th, 17th, 24th: 7300-kes. 5 a.m. to 8 a.m. and 8 p.m. to 10 p.m. EST, 14,400-kes. 8 a.m. to 12 noon and 2 to 4 p.m. EST; Tuesday, June 5th, 12th, 19th, 26th: 14,400-kes. 1 p.m. to 4 p.m. EST and 7300-kes. 7 p.m. to 10 p.m. EST; Thursday, June 7th, 14th, 21st, 28th: 14,400-kes. 5 a.m. to 9 a.m. EST, and 7300-kes. 7 p.m. to 10 p.m. EST. Operation will be 90 miles NNE La Paz. Address any mail to Gordon Barbour, Bol-Inca Expedition, Care Senior Carlos Bonilla, Guanay, Provincia Larecaja, Bolivia. Please report contacts or reception of this expedition to A.R.R.L. Headquarters.

New DX Records

Flash!! Word received under date of May 1st advises of the establishment of a new time record for "Working All Continents"—W6FYT, Ontario, Calif., snagged the following within 48 minutes: VK5HG, Oceania, 7 mc., 6:15 a.m.; LU6DD, South America, 7 mc., 6:25 a.m.; J3CX, Asia, 7 mc., 6:30 a.m.; ZT5R, Africa, 7 mc., 8:40 a.m.; OK1LM, Europe, 14 mc., 6:55 a.m.; W1DCI, North America, 14 mc., 7:03 a.m.; all PST. An enviable achievement, W6FYT!

W4EF claims to be the station on this end of the first Netherlands-U. S. A. 'phone contact (two-way). This took place on April 16th between PA0ZD and W4EF and lasted an hour and 15 minutes.

Believed to be the first CR6/W6 and HB/W6 QSOs are W6FYT's contacts, on February 6th with CR6AC, and on March 17th with HB9J.

A number of operators of 1.7-mc. 'phone stations have been experimenting in "rebroadcasting" each other's signals. W2DT's 'phone was recently successfully rebroadcast by both W2GJR and W2DXK, and was picked up from these stations by W8ACI. W2DT, 44 Court Street, Brooklyn, N. Y., is particularly interested in this work; others wishing to get in on some of these "rebroadcasts" should get in touch with him.

W4CI—FLORIDA STATE FAIR

Conducting an Amateur Radio Exhibit at a normal-sized exposition or fair is a problem, but running one at an affair that 500,000 people attend is hard work!! The amateurs of Tampa, Fla., knew that the Florida State Fair drew approximately half a million people, but that did not frighten them—not a bit! They installed and operated W4CI at the fair grounds during the eleven-day period, January 30th–February 10th. The primary purpose was to acquaint the general public with amateur radio activities—and the Tampa gang did a bang-up good job. The first few days brought so many weird questions that it was found necessary to have pamphlets printed explaining briefly the story of Amateur Radio. This did wonders! Traffic? They were literally "wading in it," to quote W4ALP. W4CI handled a total of 2525—some bunch for an eleven-day stretch! 500 or more messages had to be discarded due to insufficient addresses, illegibility, etc. The amateur radio booth was located just inside the main entrance, and everyone visiting the fair passed by—it was a common sight to see the aisle in front (which was approx. 25 ft. wide) so crowded passage was practically blocked. W4DZ stood the "graveyard" watches, and deserves beaucoup credit for doing so. Two c.c. transmitters were used, one on 3505 kc., one on 7014 kc. (We are grateful to W4ALP for a very complete report on activities at W4CI, from which the above summary was taken.—EDDOR.)

O. B. S.

The following is a supplement to the list of A.R.R.L. Official Broadcasting Stations in September QST (page 44): W2BLU, W3CWL, W6IHK, W9IWK, W9PSP, W9ZT, VE3MX.

Special Calls—A.A.R.S.

The holders of the following special calls in the Army Amateur Radio System are authorized by the Chief Signal Officer, U. S. A., to use these calls on the special Army channels, 3497.5 and 6990-kcs. The corresponding amateur calls are given so that these operators may be identified by their ham friends.

ARMY: WLM/W3CXL Army Net Control, WLMA/W3CXM Alternate A.N.C. (1), WLMB/W3BWT Alt. A.N.C. (2), WLMC/W3ASO Alt. A.N.C. (3), WLMD/W2CLA Chief Radio Aide, WLMZ Army Net "Net Call."

FIRST CORPS AREA: WLG/W1BVR 1st C.A. Net Control, WLGA/W1BD S.N.C. Vermont, WLGB/W1FFL

S.N.C. New Hampshire, WLGC/W1BKG S.N.C. Western Mass., WLGD/W1AAU S.N.C. Eastern Mass., WLGE/W1BOY S.N.C. Rhode Island, WLGF/W1CPG Alt. S.N.C. Western Mass., WLGG/W1BMP S.N.C. Connecticut, WLGH/W1BTG S.N.C. Maine, WLGI/W1FIO Connecticut, WLZG 1st C.A. "Net Call."

SECOND CORPS AREA: WLN/W2SC 2d C.A. Net Control, WLNA/W2PF Radio Aide, 2d C.A., WLN/B/W2DBQ 2d Alt. Corps Area N.C., WLN/C/W3JE S.N.C. Western New York, WLND/W3VE S.N.C. New Jersey, WLN/E/W3ZI Alt. S.N.C. New Jersey, WLN/F/W2DIU 1st Alt. C.A. N.C., WLN/G/W3HC S.N.C. Delaware, WLN/I/W3BME, AH. S.N.C. West. N. Y., WLN/Z 2d C.A. "Net Call."

THIRD CORPS AREA: WLQ/W3SN 3d C.A. Net Control and Radio Aide, WLQA/W3ADM Alt. C.A. N.C., WLQB/W3MC Alt. S.N.C. Pennsylvania, WLQC/W3OK S.N.C. Pennsylvania, WLQD/W3FJ S.N.C. Virginia, WLQI/W3CTD S.N.C. Maryland, WLQZ 3d C.A. "Net Call."

FOURTH CORPS AREA: WLR/W4KV 4th C.A. Net Control, WLRA/W4RS S.N.C. Alabama, WLRD/W5ZK S.N.C. Louisiana, WLRE/W5CLD S.N.C. Mississippi, WLR/F/W4EG S.N.C. North Carolina, WLRH/W4AFM Alt. C.A. N.C., WLR/I/W4BOZ S.N.C. Tennessee, WLR/J/W4RO Alt. S.N.C. Tennessee, WLR/Z 4th C.A. "Net Call."

FIFTH CORPS AREA: WLH/W8ZG 5th C.A. Net Control, WLHA/W8BBH Alt. C.A. N.C., WLHB/W8OK S.N.C. West Virginia, WLHC/W8CIO S.N.C. Ohio, WLHD/W9HAX S.N.C. Kentucky, WLHE/W9AET S.N.C. Indiana, WLHF/W8ED 1st Alt. S.N.C. West Virginia, WLHG/W8EIK 2d Alt. S.N.C. West Virginia, WLHI/W8UW Alt. S.N.C. Ohio, WLHJ/W9BWJ Alt. S.N.C. Kentucky, WLHK/W9CDA 2d Alt. S.N.C. Kentucky, WLHL/W9FYB Alt. S.N.C. Indiana, WLHM/W9JRK 2d Alt. S.N.C. Indiana, WLHZ 5th C.A. "Net Call."

SIXTH CORPS AREA: WLT/W9DOU 6th C.A. Net Control, WLTA/W9OUE Alt. C.A. N.C., WLTB/W9AFC S.N.C. Wisconsin, WLTC/W8GUC S.N.C. Michigan, WLTZ 6th C.A. "Net Call."

SEVENTH CORPS AREA: WLU/W9BNT 7th C.A. Net Control, WLUA/W5BMI 1st Alt. C.A. N.C., WLUB/W5IQ S.N.C. Arkansas, WLUD/W9EIV S.N.C. Iowa, WLUE/W9FLG S.N.C. Kansas, WLUF/W9BKK S.N.C. Minnesota, WLUG/W9FJV S.N.C. Missouri, WLUH/W9LFE S.N.C. Nebraska, WLUI/W9HJC S.N.C. North Dakota, WLUIJ/W9AZR S.N.C. South Dakota, WLUL/W5SI Alt. S.N.C. Arkansas, WLUM/W9GWC Alt. S.N.C. Iowa, WLUN/W9EFE Alt. S.N.C. Kansas, WLUP/W9ENF Alt. S.N.C. Missouri, WLUT/W9DKL Alt. S.N.C. North Dakota, WLUY/W9DZV-GP Radio Aide 9th C.A., WLUZ 7th C.A. "Net Call."

EIGHTH CORPS AREA: WLJ/W5OW 8th C.A. Net Control, WLJA/W5AUL Alt. C.A. N.C., WLJB/W6CDU S.N.C. Arizona, WLJC/W5BMU S.N.C. Oklahoma, WLJD/W9KNZ S.N.C. Colorado, WLJE/W5CGJ S.N.C. New Mexico, WLJF/W9ESA Alt. S.N.C. Colorado.

NINTH CORPS AREA: WLW/W6ZG 9th C.A. Net Control, WLVB/W6EJ Alt. C.A. N.C. WLVC/W6FII Alt. S.N.C. Northern Calif., WLVD/W6DVD S.N.C. Northern Calif., WLVE/W6DQA Alt. S.N.C. Central Calif., WLVF/W6CVL S.N.C. Central Calif., WLVG/W6AKW S.N.C. Southern Calif., WLWH/W6BMC Alt. S.N.C. Southern Calif., WLVI/W7GL S.N.C. Idaho, WLWJ/W7BAA Alt. S.N.C. Idaho, WLVM/W7AOD S.N.C. Montana, WLVN/W6UD S.N.C. Nevada, WLVO/W7AWH S.N.C. Oregon, WLVP/W7AXJ Alt. S.N.C. Oregon, WLWQ/K7FQ S.N.C. Alaska, WLVR/W6AJP Alt. S.N.C. Nevada, WLVS/W6ETL Foreign Contacts, WLWU/W6DPJ S.N.C. Utah, WLWV/W6EXL Alt. S.N.C. Utah, WLWV/W7BHH S.N.C. Washington, WLWX/W7CHH Alt. S.N.C. Washington, WLWY/W7HX S.N.C. Wyoming, WLWZ/W7AXG Alt. S.N.C. Wyoming.

HAWAIIAN DEPARTMENT: WVQB/K6EWQ Department Net Control.

PANAMA DEPARTMENT: WZAL/K5AF Dept. Net Control, WZAM/K5AZ Alt. Dept. Net Control.

ELECTION NOTICES

To all A.R.E.L. Members residing in the Sections listed below:
 (The list gives the Sections, closing date for receipt of nominating petitions for Section Manager, the name of the present incumbent and the date of expiration of his term of office.) This notice supersedes previous notices.
 In cases where no valid nominating petitions have been received from A.R.E.L. members residing in the different Sections in response to our previous notices, the closing dates for receipt of nominating petitions are set ahead to the dates given herewith. In the absence of nominating petitions from Members of a Section, the incumbent continues to hold his official position and carry on the work of the Section subject, of course, to the filing of proper nominating petitions and the holding of an election by ballot or as may be necessary. Petitions must be in Hartford on or before noon of the dates specified.
 Due to resignations in the Santa Clara Valley and Los Angeles Sections nomination petitions are hereby solicited for the office of Section Communications Manager in these Sections and the closing date for receipt of nominations at A.R.E.L. Headquarters is herewith specified as noon, June 14, 1934.

Section	Closing Date	Present SCM	Present Term of Office Ends
Saskatchewan *	June 1, 1934	Wilfred Skalfie	June 15, 1934
Santa Clara Valley	June 14, 1934	Bruce Stone
Los Angeles	June 14, 1934	F. C. Martin (resigned)
Iowa	June 14, 1934	G. D. Hansen (resigned)
Mississippi	June 14, 1934	Wm. G. Bodker	Jan. 15, 1933
Virginia	June 14, 1934	R. L. Eubank	Dec. 15, 1933
Eastern Florida	June 14, 1934	R. L. Atkinson	Dec. 15, 1933
Alaska	June 14, 1934	Richard J. Fox	Feb. 16, 1934
Nebraska	June 14, 1934	S. C. Wallace	July 1, 1934
Illinois	June 14, 1934	Fred J. Hinds	July 1, 1934
Western Penna.	June 14, 1934	C. H. Grossarth	July 1, 1934
Kansas	July 16, 1934	G. J. Spetter	July 28, 1934
Southern Texas	July 16, 1934	David H. Calk	Aug. 8, 1934
Nevada	July 16, 1934	K. L. Ramsey	Aug. 15, 1934
Oregon	July 16, 1934	R. L. Cummins	Aug. 15, 1934
Kentucky	Aug. 15, 1934	Carl L. Pflumm	Sept. 8, 1934
Tennessee	Oct. 1, 1934	F. F. Furdy	Oct. 14, 1934
Southern New Jersey	Oct. 1, 1934	Gedney Rigor	Oct. 14, 1934
San Joaquin Valley	Nov. 1, 1934	G. H. Lavender	Nov. 14, 1934
Colorado	Nov. 15, 1934	T. R. Becker	Nov. 30, 1934

* In Canadian Sections nominating petitions for Section Managers must be addressed to Canadian General Manager, Alex Reid, 169 Logan Ave., St. Lambert, Quebec. To be valid such petitions must be filed with him on or before the closing dates named.

1. You are hereby notified that an election for an A.R.E.L. Section Communications Manager for the next two-year term of office is about to be held in each of these Sections in accordance with the provisions of By-Laws 5, 6, 7, and 8.
 2. The elections will take place in the different Sections immediately after the closing date for receipt of nominating petitions as given opposite the different Sections. The Ballots mailed from Headquarters will list the names of all eligible candidates nominated for the position by A.R.E.L. members residing in the Sections concerned. Ballots will be mailed to members as of the closing dates specified above for receipt of nominating petitions.
 3. Nominating petitions from the Sections named are hereby solicited. Five or more A.R.E.L. members residing in any Section have the privilege of nominating any member of the League as candidate for Section Manager. The following form for nomination is suggested:

Communications Manager, A.R.E.L. (Place and date)
 38 La Salle Road, West Hartford, Conn.
 We, the undersigned members of the A.R.E.L. residing in the Section of the Division hereby nominate as candidate for Section Communications Manager for this Section for the next two-year term of office.

(Five or more signatures of A.R.E.L. members are required.)
 The candidates and five or more signers must be League members in good standing or the petition will be thrown out as invalid. The complete name, address, and station call of the candidate should be included. All such petitions must be filed at the headquarters office of the League in West Hartford, Conn., by noon of the closing date given for receipt of nominating petitions. There is no limit to the number of petitions that may be filed, but no member shall sign more than one such petition.

4. Members are urged to take initiative immediately, filing petitions for the officials for each Section listed above. This is your opportunity to put the man of your choice in office to carry on the work of the organization in your Section.

—F. B. Handy, Communications Manager

ELECTION RESULTS

Valid petitions nominating a single candidate as Section Manager were filed in a number of Sections as provided in our Constitution and By-laws, electing the following officials, the term of office starting on the date given.

Philippines	N. E. Thompson, KAIXA	Mar. 15, 1934
Alabama	L. D. Elwell, W4KP	Mar. 15, 1934
Utah-Wyoming	Arly W. Clark, W6QC-IDM	Apr. 16, 1934
South Dakota	Mike G. Strawn, W9PT	Apr. 16, 1934
Southern Minn.	Francis C. Kramer, W9DEI	Apr. 16, 1934
Quebec	J. A. Robertson, VE2GA4	May 1, 1934
North Dakota	Fred J. Wells, W9JVP	May 10, 1934

In the Hawaii Section of the Pacific Division Mr. Atlas O. Adams, KB6WQ, and Mr. Otis Hill, K1A, were nominated. Mr. Adams received 25 votes and Mr. Hill received 21 votes. Mr. Adams' term of office began April 23, 1934.

ATLANTIC DIVISION

EASTERN PENNSYLVANIA—SCM, Jack Wagenseller, W3GS—RM's 3MC-345 and ALX. Do not forget to QSO your RM's and SCM every Sunday between noon and 1:00 p.m. daylight time. See May QST for details. Let us have your suggestions. 3ADM-716, AQN-645, AAV-551, CL-546, and BY5-515 make BPL 3OK-443 has 48-hour service to Hawaii. 3EOH-21 and DIG-30 have been sick. 3EDA-53 is lined up for ORS. 3DWZ-56 has c.c. rig. 3MC, ADM, 8FLA-151 and 3ADX-152 are QRL Army Net. 3DYX-11 and ABZ-6 have trouble mixing moonlite, YL's and radio. 3AKG-19 is getting an 841. 3DXQ-90 leaves us for a job in Balto. 8IWT-48 is rebuilding. 3CUG reports for CHL-60. 3EZ-268 is now TLS. 3MG-10 will join ORS ranks. 8FKO-11 is DXing on 7 mc. 3DRO-60 says business is picking up. 3ID-3 wants schedules on 7 mc. 8VD-88 is installing Collins antenna. 3BUI is now 8LRI-7. 3AQN was visited by BLN. 8ION-7 reports for first time. 3GS-8 is QRL 56 mc. 3ZG has class A, telegraph second class and radio-phone first class licenses. 3ADE was QRL three contests. 3EIM is going on 56 mc. Many amateurs attended a big and FB Hamfest held by the Allentown Amateur Radio League, April 21st. 3DGM-273, SB-254, AKB-175, CIQ-158, QV-110, CBZ-67, EHZ-45, TX-12, 8CVS-9.

MARYLAND-DELAWARE-DISTRICT OF COLUMBIA—SCM, E. L. Hudson, W3BAK—W3CXL, W3CQS, RM's; W3BWT, Chief RM. The Washington Hamfest went over fine. 3CXL-4427 (3 oprs), BWT-527, RND-330 BPL again. 3CDQ (Elizabeth) schedules CM2AN. 3ADB has worked all U.S. districts. Baltimore BCL's say 3DKE comes in FB with 1.7-mc. 'phone. 3DML-19 wants ORS. 3BHE-7 reports Cumberland Radio Club doing nicely. 3CQS and BAK-84 (Ed & Jean) attended Stamford, Conn., Hamfest. Building new transmitters: 3BRS-3, AOO, CWE-8, CDG-43. New receivers: 3BMI, VJ, CRB, ZD-9. Putting up new mast: 3DRE-1. Working 56 and 28 mc.: 3BGI-30. 3ASO-53, CZ-43, EHW-34, AEZ-28, EIV-18.

SOUTHERN NEW JERSEY—SCM, Gedney Rigor, W3BAK—Greater Camden Radio gang held a swell hamfest. Twenty-five members of S.J.R.A. motored to Atlantic City, to attend a banquet given by Atlantic County Radio Assn., which was attended by members of Cape May County, Camden, D.V.R.A. and other clubs. 3AAV and BGP gave good addresses. A gang from S.J.R.A. and D.V.R.A. attended Eastern Penna. Hamfest sponsored by Allentown Radio Club; somewhere around 450 in attendance. 3QL-12 went haywire at the last three and won a prize at each one. 3ECE broke his arm. 3VE-150 and EDP-2 get ORS. 3APV-152 handled nice total. 3AEJ-15 keeps consistent schedules. 3DSC-70 has regular schedules. 3ARN wants ORS. 3BGP is DXing on 'phone. 3AN has new rig and shack. 3DRP reports 1000 volts accidentally on his crystal. New squeaks: 3EVJ, ENU, ENZ. 3ZI-169 gave nice talk at A.R. fest. 3CWL-239 gets OBS appointment. 3AZZ-16, BTS-2, DFE-1, DHX-6, DST-15, BUB-16, BQC-4, ZX-35, BFH-5, AVJ-6, CYI-2, DH-19. 2GWE-43.

WESTERN NEW YORK—SCM, Don Farrell, W8DSP—The Tri-County Radio Club is planning big picnic in June. The F.S.A.R.C. is going strong. A new club was recently formed in Syracuse, "Electronic Associates." 8AWM-2 is back. 8BGO-33 has new Collins 30FX. 8ACQ sends dope on Elmira Radio Amateur Assn. 8AON worked 30 foreign stations in DX Contest. 8IRH has antenna trouble. 8AYD-114 is working DX again. 8KBS-18 has tri-tet. 8KBT got a flock of crystals from DUW. 8BFF moved to Towanda, Pa. 8GBY sold his outfit. 8CSE-25 is on 3524 kc. 8VJ has been experimenting. 8AJE-658 and EMW-1386 turn in FB traffic reports. 8JJJ-10 moved to new location. 8LS-7 reports college and ham radio don't mix. 8BWY-12 stands by every day at 11:50 a.m. for Oneida traffic. 8AAR-3 has been doing lot of duplex work on 28, 56 and 1.7 mc. with 8DST. 8EWP-4 is working on 1.7-mc. 'phone. 8DHU-68 needs Oceana for WAC. 8DBX-386 will continue handling traffic all summer. 8BHK-10 increased power. 8BQJ-31

gets a bunch of DX cards. 8CQW-35 reports CDK has transmitter on exhibit at Electrical Show in Jamestown. 8EAC-33 is on 56 mc. 8AQE-6 is working on wind-driven generator. 8CBE is on 3.5 mc. 8CJQ moved to Newark. 8FSY runs 500 watts input '03As. 8BR-12 cancelled schedules. 8GWY-47 wants schedules. 8FMX-38 is on 1.7 mc. 8FDY joined Signal Corps. 8KMC-140 and KRS want ORS. 8AYD is teaching eight SWL's the code. 8AXE-4 has a pair of 800s. 8JQE-38 is joining. A.A.R.S. 8ERZ-27 spent several weeks in hospital with bad infection in jaw bone. 8CJJ-75 is back at work. The S.T.T.A. re-elected its old officers. 8DX has new tri-tet. 8FTB-7 is publisher and editor of "Radio Scout." 8AGS-3 is on 'phone. 8FYF-72 is busy with Army Net. 8JTT-440 is on fast trunk line. 8AWX-270 is building up his old traffic routes. 8GZM-20 is changing QRA. The Mohawk Valley Brass Poundingers held big feed on April 7th. 8BAI has new transmitter. 8GWZ has been to Florida. 8AKX has a type-59 tri-tet. 8EUY is on with a 60. 8XMR is working VKs. 8DZF has new sky-wire. 8AFM is doing regular amount of experimental work. 8CPC is our new Assistant Director. 8ERU is building Class "B" phone. 8KXA, GPV-134 and KBS are new reporters. 8BJO changed his QRA. 8FSY-653, GWT-136, FUG-70, KRC-30, GPT-14, JSD-12, JGX-6, EBR-8.

WESTERN PENNSYLVANIA—SCM, C. H. Grosarth, W8CUG—8GUF-1035 sure has what it takes. Naval Reserve activities supply 8BWL-755 with plenty of traffic. 8YA-200 says spring fever is getting the boys. 8KWA-177 is helping organize a trunk line. 8KOB-33 reports for KDM. 8ABS-16 is the Phone RM. 8CQA-14 says ESR and KYW joined USNR. 8AXD-12 wants ORS. 8FZG-8 is rebuilding. 8ITK-5 is putting '10 in final. 8JZZ-10 says FDD is proud papa of an 8½ pound Jr. 8GJM-2 says a bunch of SEBP&M boys attended Hamfest at E. Liverpool. 8AVY-2 was active during ORS party. 8DKL-2 has antenna trouble. 8ESR lost a ten. 8BSO-2 is trying to lick key clicks. 8KQQ wants DX QSOs. 8KSG is building portable transceiver. 8FKU's-1 Hartley works better than MOPA! 8CUG-22 is trying to iron wrinkles out of new rig. 8CFR has new receiver.

CENTRAL DIVISION

ILLINOIS—SCM, F. J. Hinds, W9APY-WR—RMs 1 9CRT, 9DDE, 9ERU. 9IEP-73 states the Starved Rock Radio Club will have a hamfest on Aug. 19th. 9OSQ-21 had about a dozen three-way QSOs. The buttons stuck on 9EQX mike. 9EVJ-531 resigned from A.A.R.S. 9EYI operates at EMN-27 sometimes. Nobody seems to hear 9FTX-5. 9FXE-15 has worked all continents. 9GKH-11 wants to know what CCC camps in 6th Corps Area have amateur stations. Grinding crystals down at 9HUX-2. 9RHB and RFB are new Chicago hams. 9JO-81 does fine A.A.R.S. work. 9PQM-1 says A.R.R.L. should have more DX contests. Transmitter trouble at 9PFJ. 9PIO will soon be c.c. 9EZV built a doubler. 9IYA-13 is rebuilding. 9SG-21 reports Egyptian Radio Club members sometimes have three-and-five-way QSOs at noon. 9NN-267 finds it hard to get reliable QSP stations. 9MIN-277 sticks to c.w. 9CZL-17 is off sick list. 9MJT-5 reports fine DX. 9IBC-5 received Class "A" ticket. 9DOU-717 says the leading Ill. traffic stations are usually A.A.R.S. men. Sub net C of the 2nd district Ill. A.A.R.S. net consists of 9DBO-53, OXA, NUI, MIN, NAG and OPT. 9AVB-10 and ACU try their luck in OPS party. 9BRX made WAC. 9BYZ-4 is experimenting on 28 mc. 9LOJ-3 has unofficial QAC now. 9LIV sports new tower. 9HUM-104 and KE send first report. 9AND-52 increases power 70% for contests. 9ERU says Rockford U.S.N.R. is again holding meetings. 9YH-314 did a lot of traffic originating for Elec. Show at Univ. of Ill. Crystal troubles at 9PVG. Marconi antenna at 9DLO. 9OXA joined A.A.R.S. 9FGN assures us there is activity in Aurora. New receiver at 9FYZ. 9HQH-85 is alternate LNCS for net F A.A.R.S. 9PNE-1 has done fine DX. 9MAJ-7 will build medium power rig. 9COW says traffic not plentiful on 14 mc. 9FWD-3 worked Poland. 9CSB, KJY-1467 and APY-WR went to Synton Hamfest at

Champaign. 9KWP and KJY are building portable receivers. 9AAY-2 has new Class "A" license. 9HPG-393, ILH-325, CJC-176, MLH-118, OMA-114, CGV-73, KEH-59, LZU-56, EZQ-ORT-55, MIM-33, ICN-25, FO-20, IU-15, CUH-12, MNB-8, PBQ-5, LNI-4, CEO-ENH-2.

INDIANA—SCM, Arthur L. Braun, W9TE—9AUT-32 wants ORS. 9BKJ-10 has the 'phone bug. 9CTT-62 worked GEJC. 9DET-118 has hat in ring for ORS. 9DGC-1 worked a ZL. 9DJU-110 has new '03A. 9EPT-106 handled lot of traffic. 9EGQ-3 blew power supply. 9EIJ-32 is A.A.R.S. 9GFS-1 has temp. control. 9HIU will tour western U. S. during summer. 9HTP-4 says the heavy ice broke his ant. 9HUF-21 has new Silver 5 B SS. 9HUU-38 does his part as ORS. 9HUV-9 has been DXing. 9HSF-9 sold his portable rig. 9JRK-246 changed to parallel '10s. 9JST has 59 tri-tet. 9KDD has new power supply. 9RLF is new at Terre Haute. 9LLV-20 is taking exam for Class A ticket. 9LSZ-9 has traffic schedules. 9LCL-1 is trying low power 1.75-mc. 'phone. 9MQQ-1 ops on 7 mc. 9MVS-18 is lining up schedules. 9OEC plans receiver changes. 9OXM-15 wants ORS. 9OXG blew up receiver. 9PLW and OMC report for first time. 9QG-1 added P.P. '45s to SW3. 9AKJ-3 is back in the picture. 9PQL plans portable work. 9EEO is building new receiver. 9JIW likes 7 mc. 9HDB uses P.P. '01As. 9PQQ is going to try new ant. coupling system. 9ERP-47 reported after all these years of holding out. 9MZZ and IDZ have a 100-watt 'phone-CW rig. 9ELX: DXing as usual. 9MPR has a Ford. In the future address ALL reports and mail for 9TE to 911 Reinsler. 9JIP-3, BCP-19, HPQ-8, HBK-2, LSB-58, MFW-34, MIG-1, YB-43.

KENTUCKY—SCM, Carl L. Pflumm, W9OX—Chief RM, 9BAZ-173 leads state. New ORS 9OMW-123 makes excellent showing. 9HAX-104 wants Ky. hamfest in Louisville. 9ETT-12 and OX-108 stay the fish at Herrington Lake. 9CHL-100, PXX-26, MWC-50, NEP-13 put on exhibition at Paducah Pageant of Progress. 9BWJ-90 landed several jobs at once. Business takes 9ARU-80 to Washington. 9EDQ-60 claims Louisville gang won't listen above 3600 kc. 9ELL-38 shows signs of activity. 9CDA-36 has lotsa fun with new mill. 9HBQ-35 is installing impedance-matching antenna. 9FQQ-29 wants to borrow a super for Ky. parties. 9OFE-38 plans to hobo to World's Fair, visiting hams enroute. 9IXN-25 craves renewal of schedule with JYO-6. 9BAN-24 hears more than he can work. 9ERH-17 reports pleasant visits with KOV-JLT-KTF-LH-CRJ-LZS-ROM-ETT. 9KCZ-15 wants sample of OXBZ. 9EOM-11 turned farmer. 9ACD-11 is partial to single-wire feed antenna. 9EYW-11 and FGK-10 want ORS. 4CCN visits 9EDV-10. 9PAZ-6 is new light in Owensboro; 9ALD-6 comes to surface in same town. 9EKB-4 is struggling with receiver. 9IFM-2 returns to 7 mc. Louisville police are always listening for 9FZV-2. 9CSO at Dix Dam promises to be on 3.5 mc. soon. Sex 9NBD to 9KTO, "you naasty ham." 9GNV migrated to 3.5-mc. 'phone. 9LBX, HCO-14 and MWR-13 are rebuilding. 9IXL-AWN-FKM-IPG-CNE-28-BOF-44-KOX-5 report, for "clippings" sake. 9AUH-61 made score of 23200 in ORS party. 9CIM-35, CKH-6.

MICHIGAN—SCM, Kenneth F. Conroy, W8DYH—8BGY is highest Mich. station in DX contest. 8AEEQ-459 is new RM of NW Lower Mich. 9DPE-313 is RM of the U.P. 9CWD-35 is Phone RM of U.P. THE MICHIGANGANG'S NINES: 9PDE has plans for an all U.P. Trunk Line well under way. 9ADY-224 runs a close second to PDE. 9EGF is QRL Jr. opr. 9ADY and CWR-18 report for the YLs at Isle Royale, 9PCU-132. 9NEZ-10 says lack of summer WX there makes for more radio work. 9CEX-4 is doing his bit in Dollar Bay. 8CEU-161 is at CCC No. 689 Singleton, Mich. The summer indefinite with 9HIS-32. 9MJW and MXN are about 100 feet apart. 9EQV-25 is working low power. 9OZM-17 entertains the BCLs. 9AAM-50 located the Conservation Dept's plan and kept parties concerned in constant contact. 9CWD is organizing U.P. 'phones into a net. 9CE-46 handles his portion of schedules. 9LUU-7 convinced c.c. rig to work. 9FBC-51 reports the Mohawkers still peppy. 9IOV-3 worked 6 countries and 3 continents in DX contest.

90XL-8 schedules OVX and OWG. MICHIGAN EIGHTS: 8DVC-506 is only man in BPL. 8IOR-21 wants more traffic. 8JNK-4 wishes his "sister" station in Ohio would get a stroke! 8GRB-13 has the ax out ready for his rig. 8BJ's-9 portable 37x1-'12-'10 will look good in his new V-8. 8DED-53 handled 7 HPM messages. 8NQ-1, KOX-136, FII-172, FDX-27 and 9HIS are campaigning for ORS appointments. 8DWB-280, LAL-136 and QT-188 are new ORS. 8EKT, KMT-20 and IIP-7 are after OPS appointments. 8EGI-122 wonders why he didn't use c.e. before. 8FTW-253 rebuilt. 8DNM-118 has c.e. 8IFE-1 is confounded with problem of budding ham next door. 8BRL makes everything oscillate but the crystal! 8KYS-13 claims that CPY-115 and Ludington gang are a bunch of softies! 8HBZ-6 will be at HNB this summer. 8AW-8 remarks, "You and your Police Dept." (Scout car crew accused 8AW of QRMing them—was an arc lite!) 8IKO-81 promises better report next month. 8GUC-433 has FB A.A.R.S. state net perking on 3700 kc. 8DIV-2 is editor of new Lakeland Radio Club *Bull-Ton*. 8IKZ-4 is knocking 'em off on 1980 kc. 8LAL wants to hear from ECB who is somewhere out on the Great Lakes. QSL. 8GQS-4 was lured onto 1.75-mc. 'phone by the voice of the YL at KWX. Yes, 8GRN-2, there's always room for one more ham in Detroit! 8LNA-10 reports LNW new in Grand Rapids. 8GQB-66 discarded the "Zilch Ant." 8IUP-2 reports UA, Wayne University, on air. 8CUX-6 spends his time "monkeying." 8ALJ-6 wants O.O. appt. 8ZC-9 plans to slap 1 kw on soon. 8FX-80, BMO-65, GSP-58, DZ-52, HL-43, EHD-28, DYH-26, FAV-24, ECB-23, CFZ-ETP-19, ARR-17, DUR-13, HFU-12, JTV-11, CFQ-10, AYO-7, ABH-HA-6, FXB-HSH-4, ICM-KPL-3, KSY-SH-2, DSQ-JSK-1, JO-50, 9BBP-2.

OHIO—SCM, Harry A. Tummonds, W8BAH—8GZ-1210 leads Section again. Mark your calendar: JUNE 3rd SUNDAY, 6 a.m. to 12 midnight, will be all-OHIO day on the air. SCM 8BAH-28 will donate crystal to Ohio station making most Ohio contacts. Contact counts 1 point. Message handling counts 5 points extra. Total possible per contact: 6 points. Reports of contest must be mailed to SCM 8BAH on or before June 10th. Dist. No. 4: RM 8UW-244 makes best showing. Dist. No. 1: RM W8BON-20 tries for commercial ticket. 8RN-504 will be on lakes soon. 8CIO-358 is among the high. 8DVL-119 spends 90% of time on traffic. 8BMX-44 reports by 'phone. 8HGE-42 has 200 watts input. Brooklyn Amateur Radio Club, 8KJK-28, gave community center group big thrill with transmitter exhibits. 8GUL-18 shines up portable transmitter. 8EYF-15, LKT, DAT-7 and BAC-8 report schedules. 8FGC-4 worked 11 countries. Listen for WUBM Army Airmail station, Cleveland Airport. This station is glad to make test schedules and QSO amateurs; glad to make 56-mc. tests also. Dist. No. 2: RM 8EEZ-3 organized club at Fairport. 8EJ-39 is installing 1000-watt transmitter. Hope 8ANU-10 recovers from illness. "Going sailing soon," reports 8INX-4. New c.e. rig at 8UX-1. Doublet at 8BDB. Three antennas at 8CGL. QSA5 R6 in ZL and VK reports 8IUG. 8EIW applies for OBS. Dist. No. 3: RM 8APC-5 may move to Cleveland. 8ZY worked 34 countries in contest. 8ESN-24 makes QSL cards. 8CMY-2 is at 518 W. Sandusky Ave., Findlay. 8JJK has a job. Dist. No. 4: 8HMH-42 is located at power company offices. 8ICC-82 joined A.A.R.S. 8IET-62 contacted 8UW and got schedule OK. 8PO-20 wants portable letters mailed back to him. Dist. No. 5: RM 8FGV-21. 8IOO applies for ORS. 8HCS-400 is new ORS. Welcome back 8AQ-12, now at 267 Highland Ave., Wadsworth. 8KJW-2 has new receiver. 8CJG-1 handled death message. Traffic scarce on 14 mc. reports 8BMK. Dist. No. 6: Acting RM 8GSO-48 wants lake job. 8BDY-45 reports via message. 8EQC-26 and ISK-125 get ORS. 8DZO-6 gets OPS. Slick message delivered in 15 minutes by 8LCO-6. 8JBI worked four continents and 8 countries in two days. 8GDC RM OPS is back at Columbus. Dist. No. 7: RM 8VP is rebuilding. 8EQB's-35 new rig looks like million bucks. Dist. No. 8: RM 8PV. 8KYQ is building new receiver. 8BKE-123 is now

ORS. 8GER-1 sends first report since 1924. 8BRQ-2 gets new '52. 8JFZ-20 will join A.A.R.R.L. soon. Dist. No. 9: RM 8DUV-3 wants help in this district. 8GGF, sec'y., reports that the YMCA Wireless Assn. of Ashtabula has call 8LSM. 8LCY-63, AMF-15, IKT-9, FSK-1, EPP-125. WISCONSIN—SCM, Harold H. Kurth, W8FSS—9HSK-319 leads once more. 9IQW-129 is coaching two beginners. 9ATO-122 is big traffic man. 9ETM-101 agrees that traffic is picking up. 9OKS-73 is looking for schedules. 9GVL-36 is again ORS. 9JCH-23 expects to be on 14-mc. 'phone. 9KPO-18 keeps two schedules. 9NSM-9 is on 3575 kc. 9OTL-8 wants to swap a crystal. 9PTE-7 wants schedule. 9FAW-3 is on four bands. 9DNU-2 has trouble with velocity mike. 9JDP-2 is experimenting. Following reported: 9PRL-3, LFK-17, GWK-20, GIT, PAQ-17 and PZN-2. 9AKY, PZN and EXH use Collins antenna. 9EJS visited Sheboygan hams. 9EQY installed an 825 final. N.W.R.C. will hold annual picnic in June. La Crosse Club is holding picnic and hamfest May 27th.

DAKOTA DIVISION

NORTH DAKOTA—SCM, Wm. A. Langer, W9DGS—9PAI-81 and PDC-65 have 1.7-mc. 'phones. 9JUJ has a Class A. 9OEL-41 is new ORS. 9PGO-12 reports a newcomer, PRH, and a visit from BTJ-5. 9JAR-11 is QRL spring work. 9AZV-9 is QRL college. 9PJT-3, KZL-10 and LHS are rebuilding. 9PRU reports for first time. 9KBE likes ORS parties. 9OVP is on 3.5 mc. 9HJC-84, DGS-65, FSP-6.

SOUTH DAKOTA—Acting SCM, C. B. Davis, W9AZR—Sioux Falls and Huron Radio Clubs are very active. 9FDD is in WU school in N. J. 9ORY-23 has two rigs. 9TY-21 visits OED and PGV. 9FOQ-16 has new Silver receiver. 9AJF has the bug again. 9IQD is rebuilding. 9FLO-21 has Hartley. 9PHD is going to 1.7-mc. 'phone. 9PHE moves to farm. 9RLM is new Huron ham. 9GYG-4 uses grid modulation on 1.7-mc. 9PFI-15 is new SCM. 9AZR-294, DGR-8.

NORTHERN MINNESOTA—SCM, Robert C. Harshberger, W9JIE—New A.A.R.R.L. members: 9GUX and HEN-7. 9HDN-116 is A.A.R.S. D.N.C.S. 9HDN won Section honors in SS. 9000-9 has s.s. super. 9FTJ-5 is putting in 800's. 9OOU-11 uses gas engine and a.c. generator. 9IGZ uses gas engine and 350-volt d.c. generator. 9HNS-57 is moving back to Nopeming. 9GBN, AZJ, CWB visited SCM. 9JIE-92, IPN-32, DOQ-32, IQZ-31, OMI-5, IPA-77.

SOUTHERN MINNESOTA—SCM, Francis C. Kramer, W9DEI—9BKX-604 keeps Section traffic total high. 9DEI-239 is modernizing transmitter for better traffic work. 9FCS-127 is building frequency meter. 9BN-67 renews ORS. 9AQH-66 handled important P. I. traffic. 9BNN-36 sends his 44th consecutive report! 9GNU-26 says medical profession QRMs radio. 9DCM-26 is 7-mc. traffic man. 9JBA-22 reports "all calm on the western front." 9DH-20 gets little time for radio. 9RAU-21 had 81 QSO's first month on the air. 9GLE-12 and OGU-10 have new 50-wattors. 9OAK-11 is newest ORS. 9FNK-11 blames local BCL QRM on new Airways station. 9PEV's-7 e.c. osc. is working nicely. 9RAB-5 sends first report. 9PJH-3 likes to experiment. 9EGG-2 bought out EPJ. 9DMA-2 and JUZ report by radio. 9AIR is working in KY. 9KDI's time is divided: 25% eating, 25% sleeping, and 50% QSOing blond YLs! 9CSY is operating portable phone in 5th district. 9LRP of Aledo, Ill., is attending Rochester Junior College. I wish to thank all members of the So. Minn. Section for their loyal support in making me SCM. With your cooperation we will make this one of the leading sections. 9EFK-18, PDL-16, MOV-7, BHZ-5, ZT-4, EYL-3.

DELTA DIVISION

ARKANSAS—SCM, Henry E. Velte, W5ABI—5BMI-694 is again star traffic handler. 5CVO-27 gave a demonstration of his station in action at a show given by his class at school. 5DRW-8 installed new power supply. 5DRY-18 is rebuilding. 5DYF uses a '47 and '46

in his rig. 5CCW is on 14 mc. 5DYX-11 relayed an important death message. 5AAJ-113 sent the news from his section. 5JF is c.c. 5CZA uses '71 with "B" batteries. Following are on phone in L.R.: 5DVR-27, DUS, and DVI. 5BED visited the SCM. 5BXM-55 gets out well. 5BJR-13 wants to report by radio each month. 5DWL wants dope on U.S.N.R. 5ABI completed c.c. rig.

LOUISIANA—SCM, W. J. Wilkinson, Jr., W5DWW—Wanted: Real live wire ORS and OPS. Drop a line to the SCM, if interested. 5DLD-21 has several fine traffic schedules. 5BID-8 is on 3.9 mc. phone and 7 mc. c.w. 5YW-5 is on 14 mc. phone. 5BZR-325 has whole flock of schedules. 5AXU-3 has new rig going. 5DAW-13 likes traffic. 5ZV-CQF-29 had several visitors. 5DMT-11 reports ECO new ham in New Orleans and EBB new in Baton Rouge. 5ACA reports from London, England. 5BPL is trying to get new antenna constructed. 5HR-22 is handling phone band traffic. 5CXQ has c.c. rig. 5JW knows his law. 5AOZ is DX hound. 5AEH has FR laboratory. 5DWC has SW3. 5BI is introducing Kid Whitey. 5DES has 56 mc. 5CJO is building c.c. rig. 5AJJ is active. 5DKR reported for the NOLA gang.

TENNESSEE—SCM, F. F. Purdy, W4AFM—4PL-14 is back after several weeks fishing and visiting hams. Our deepest sympathy to our friend, 4BIR, who recently lost his father. 4KA and CBS opened a radio service shop. 4IB is manufacturing 7 meter receiving rigs. 4BUD of Knoxville was visitor at meeting of Chattanooga club. 4BBT-229 entertained with a DX party—4ARP, CBA, and PL were present. Dunn of 4BIZ transferred to Panama. 4AYR is back from C.C.C. camp. 4BOZ is laboring with electric company. 4RO-299 is doing fine with Army-Amateur Radio Net. 4BQK-30 is proud papa of another YL. 4CJO is doing fine work. 4CHI is installing c.c. 4AAD is installing larger phone. 4AFM-706 moved QRA 300 feet west of AAD! The East. Tenn. Amateurs Radio Club passed a resolution to countermand the recent petition originated by the Minneapolis Radio Club. 4BMH says the Nashville Radio Club is doing fine. 4CRO is senior operator at Airway Radio Station, Donelson. 4ASC has new Young Squirt operator. 4AXN changed jobs again. Ex-4AQV got class B ticket. 4CTU is new ham in Jackson. 4JG is in Arkansas. 4FA is rebuilding. 4BWH, KQ, AEP of Memphis enjoyed big turkey dinner with 4AXN as the host. 4ABY was present also, but we understand he was under the table most of the time. 4FK operator at WMC. 4TM is getting fatter and fatter every day. 4ATW-11, BPE-14, OV-19, EX-12, BPC-10, BUC-10.

HUDSON DIVISION

EASTERN NEW YORK—SCM, R. E. Haight, W2LU—2EGF-549 is high traffic man. 2BJA-209 reports CJS-4 on 7 mc. 2BJX-80 is back on 3.5 mc. for traffic. 2DSH-56 desires N.Y.C., Conn. and N. J. schedules. 2RTH-54 has several different crystals. 2ENY-53 says ENG is on 3590 kc. 2FAM knocks off W6. 2SZ seeks WAC. 2IX is on 3.9 mc. phone. 2GTG has 300 watts input. 2CBN-33 finds crystals break. 2EQD-30 moved rig to Sun Parlor. 2EQC-2 joins A.A.R.S. 2GNI-28 handles a.m. schedules. 2BSH-16 reports via radio. 2GRY-16 is Ex-W2EGE. 2KW-11 has 25 lb. tuner unit for swap. 2FEQ-10 says FDN has completed 14 mc. tri-tet rig. 1EFM-10 puts away the skates for baseball. 2GFD reports Kingston hams holding low power consistent DX contest. 2GTC-8 is active on 3.5 mc. 2CC-7 keeps VK's in touch with White Plains. 2CLL-6 using 3 ft. Loop with 9CXX Ant. coupling QSO'd across Hudson River. 2ACY-4 worked his 40th country (Nigeria). 2GPB-4 applies for ORS. 2FXC-4 is active with N.C.R. 2AQN-3 delivered three messages for K5AA. 2FKL's-3 new QRA is 7 Jones St., Rochelle. 2AJE-3 spends lunch hour as code instructor. 2DYC-3 reports c.c. perking FB. 2DQT is tuning up for summer vacation. 2UL reports for Mt. Vernon. 2OA tries tri-tet. 2CFU puts hole in 7 mc. 2FSD reports arrival of new Junior opr. 2BPH is looking for VK's. 2EMK uses c.c. on 3506.4 kc. 2ESO will be back on

the air June 15th. 2QY QRT's code practice for season. 2CVL-2 reports that the Tri States Radio Club plans to broadcast "QSTs" on 56 mc. every Sunday at 3 p.m. starting May 20. Reports are requested. 2LU-243, BNR-8, BLL-7, BRS-2.

NEW YORK CITY AND LONG ISLAND—SCM, Ed. L. Baunach, W2AZV—2ELK-177 needs another op to help mail deliveries. 2AYJ-646 and DBQ-645 are running neck and neck. Spring fever has 2BGO-182. 2FKO is looking for any old '46s; send them to him, gang. Traffic takes up 2EKD's-135 time. 2EYQ-80 keeps 1FLO and 1DWJ in touch with home. 2FDQ is putting in '52. 2EGA's YF hangs clothes on his zepp feeders. 2CEH swears off relays. 2FHB is taking portable to college. 2EVS uses 450 volts on plate supply from receiver. 2FWN and GOV push out on 1.7 mc. phone. 2OQ and DXF live together. 2GLJ-35 is enthused over new receiver. 2PF-25 lives across the street from 2BEG. 2CSO-6 and ECL report good DX on 7 mc. 2FIP-22 relayed a message direct from CTIEB. 2DTE claims to be the youngest op holding a B.C. Radiophone first class ticket. 2CLD is in the fruit business. 2BPR plays the piano over WEOM. All 2BWL needs to get WAC is an Asian. 2BPR and ETE paid GWH-4 a visit. 2FLA's new rig will be c.c. 2FRZ, FJN, EXI are employed by telephone company. 2GTR spends his time announcing at B.C. station. 2GIY is main switch thrower at N.Y.C. police station. 2AUA is chief engineer at WAAE. 2QZ is a Wall Street runner. 2BPU made his YL the YF. Congrats, OM. 2US is trying grid modulation. 2DOG-1 is one of the OT's on L.I. 2UK had good luck during contest. 2BNJ is doing active duty with N.C.R. 2CAC-4 says SS receivers are FB. 2EEL is second op at 2CYA. 2LG-5 uses antenna matching network. 2FBE-5 gets out FB on 14 mc. We announce the engagement of 2ELB. Congrats, OM. 2BTF-11 has bad case of YLitis. 2FCQ-2 is back in the rush. 2GEL runs up electric bill on DX. 2DFW sends his report from Buffalo. 2FYD is on 1.7 mc. with class B. New reports 2BUV-5, GJH, GJS, ATD, GZR, GZS, BGS. 2BNL is on 3.9 mc. phone. 2DWW-21 operates from 2FTH, the 244 C.A., N.Y.N.G. 2ABN reports EXQ got married in March. 2CWP-17 is out for ORS. 2GOW reports HAV on 56 mc. 2GOV built 56 mc. portable in car. 2HN and ESR are on 56 mc. 2OV is working at Fire Island; his brother 2BHL is getting 100 watt c.c. job going at home. 2EAF-3 says c.c. is the thing. 2AIQ is waiting to get on the N.Y.C. police dept. 2DRG-10 enjoys ORS parties. In five days 2CHK-248 worked EA2AI, PAQOV, VK3JQ, VK5SX, CN8MO, D4BHR and YSNX, the Schooner Atlo. 2AZV continues to maintain west coast schedules on 3.5 mc. 2DJP-216, BGS-173, DQW-107, LB-45, DXF-42, EZV-40, ADW-30, GIC-28, BNJ-25, BAS-21, AEN-18, BYL-BKP-15, CCD-14, BMH-13, AZG-11, AA-ALD-EYB-10, AOV-BIK-9, BPJ-EYS-ATT-ATU-ENS-8, ECL-7, DJD-6, EVA-FAR-GZ-GYZ-BFA-CYA-5, CP-BVT-AGC-GOV-LR-4, CPY-AOB-BKY-3, AQQ-EDZ-2.

NORTHERN NEW JERSEY—Acting SCM, Robert Maloney, W2BPP—HAMFEST!—Northern New Jersey's annual big splash will be held June 16th at the Naval Militia Armory, Perth Amboy, by the Tri-County Amateur Radio Association. It is being held in honor of the League's 20th Anniversary and will be a most unusual affair. Souvenirs for everybody and a mob of big prizes. Admission only 75¢, plenty eats, and free—guess!! 2EKM-2233 does a wonderful one-man job in traffic. Four stations make BPL, 2EKM, BCX-1020, ENZ-595, and FOP-203. 2DIU is back with 500 watt job. 2DPA-71 increased to 450 watts. 2TP-47 schedules 6CNE and 5AEB daily on 14 mc. 'phone. 2DPB-16 scored heavily in DX tests. 2CGG-25 and GGW's-357 reports come via 2EKM. 2DVN-10 needs more time for traffic. 2CTT-9 has new MOPA. 2CIJ-9 is Newark's lonesome believer. 2CLM-1 is constructing 14 mc. 'phone. 2AFK-263 reports the Bayonne Tech School R.C. was assigned 2GYO. 2BSC-125 is ORS applicant. 2DCP-46 intends to handle traffic until he evaporates from this good earth and condenses in heaven, or vice versa. 2ECO-15 is on 3525,

2GVZ-12 is putting a 108A in final. Another of Verona gang reporting is 2DLF-7. 2GCV-2 is on 7303, c.c. with '10 final. 2FLP has fun with usual MOPA troubles. 2BPY-18 will be on every Saturday looking for section contacts, on 3503 kc. from one to three p.m., and on 7002 from three to five p.m. EDST. 2CJX-40.

MIDWEST DIVISION

KANSAS—SCM, O. J. Spetter, W9FLG—9KG and 9IOL CW RMs. 9ESL Phone RM. 9KG-1643, OQC-462, IQI-460 and LTG-332 make BPL. 9LGV is still at Sanitarium. 9ESL-1 handles message for Governor Landon. 9PUX QRL Jr. Op. 9APP-1 is working DX. 9GXD has new FBXA. 9OFR-7 doesn't like c.c. after ruining crystal. 9NI-30 uses phone for emergency work. 9AWP-34 reports local hams increasing rapidly. 9DMF has new Patterson Super. 9MWM-2, PKD-5, IOL-307, NJS-179, FLG-212 and LFN are using Tri-tet. 9HLD is forming Radio Club in Salina. W.A.R.C. held hamfest April 8th with 125 in attendance. KVRC committee is busy on Kansas State A.R.R.L. convention to be held Oct. 20-21. 9IEL-360, ICV-307, BYM-163, FRG-69, CMV-29, PB-25, BYY-20, LWP-13, AWB-3, COA-GDS-LRR-FMX-1.

MISSOURI—SCM, C. R. Cannady, W9EYG-JCP—9NNZ, BMA, CJR, and BGE RMs. 9JWI-1645 is at head of traffic men with MZD-577 second. 9MZD shows slight gain on CJR-331 for first in ACTIVITY CUP RACE. The race closes next month! St. Louis: O.B.P.: 9PW is back on air. 9RGE-14 and EZX are QRL spring "boat" cleaning. 9EFC returns to C.W. after phone experiment. 9AC is visiting in Racine, Wis. 9BMM builds racing cars. 9DLB is rebuilding for c.c. 9BZN gets 50 watts on 7 mc. 9ZK gets 3.9 mc. phone DX QSL thru error. ARF: 9GTK-12 is working on c.c. rig. 9LLN-12 and NNF are resting after DX. 9LTH gets back. 9GUQ works few EA's on 7 mc. 9NBV rebuilds using push-push doubler. 9NBE figures on 66 foot vertical antenna. 9KIK is on late at night—3.5. 9FAB gets c.c. osc. on. Independents: 9PYD gets DX on 7 mc. 9EBY is back after rest of two years. 9GSO has new job. 9HVP has FB new c.c. rig. 9HVN completely rebuilt. 9HVJ uses Tri-tet. 9HWF gets 400 watts to one kw in his '04A. 9ILL tries 56 and 1.7 mc. phone. 9ECT has trouble with 1.7 mc. phone. DX contest makes 9HUZ 34 countries. 9HVC-1 gets back for St. L.A.R.C. 9AAN-4 uses tri-tet with class B modulation. 9KEF's FB7 went haywire. Kansas City: 9RR-38 sends some more FB dope. 56 attended the first annual banquet of the H.A.R.C. Independence: 9HRG and DPF-52 get Class A tickets. The T.C.A.R.A. is putting the city on the map with cooperation with portable station and exhibit at Boy Scout Exhibit and Latter Day Saint Conference. C.C.R.C., Fayette: 9CUT makes schedule with home town. 9OEQ-27 schedules K.C. and St. Louis. 9MPG gets Class B. S.M.A.R.A.: The S.M.A.R.A. held 5th annual meeting with 18 present at Mt. Vernon. New officers: 9CJR, Pres.; IHE, Vice-Pres.; FYG-4, Secy.-Treas.; and ASV-60 Traffic and Contest Mgr. The Club voted to meet third Sunday in June at Joplin. 9HUG-30 says QRM sure bad! 9DTF tries 3.9 mc. phone. Central College gang visited 9MLR-5 in Moberly! 9KVN-70 adds keyer tube and antenna impedance matching. 9NNZ-234 uses c.c., 3812 kc. 9HNM-10 moves back to Browning. 9DCD-6 sends FB report on Clinton activities. 9JAP-25 gets in A.A.R.S. 9MZD wants State Net. 9EDK-5 is moving to Arkansas! 9BTD gets QSA5 R9 from ZL. 9JWI wants in Missouri Net! 9GBJ-4 gets an 800 as present. 9ENF-84 lost roof of shack in windstorm. 9LBA-14 tries low power. More on the Missouri Net will be announced next QST! 9NNZ, MZD, CJR, and JWI are key stations thus far! 73. 9XO-364, AIJ-171, NAQ-137, NP-127, FJV-101, EL-4, KTC-1. PWV-JOS-2, FEV-35, FNO-4, LLW-17, DPJ-18, PTS-1, BMA-28, OLC-10, HUG-31, LWG-2, FYM-10, MNH-4, DIC-75, PSM-5, JBV-3, KCG-14, JPT-6, EHS-1, CFL-17, ZZ-1.

NEBRASKA—SCM, S. C. Wallace, W9FAM—9DF-

1270 is working a very fine Trunk Line. 9FYP-182 works 1963 kc. schedules with HFD, JED, OPP, and KQX, all phone. 9JED-55 schedules OPP, FYP and IFE. 9OPP-48 reports for 9DHO who uses 4 watt phone on 1.7 mc. 9DI-14 says fine Convention being arranged for Aug. 31st and Sept. 1st. 9DGL has new rig going. 9CUY-106 says kids all had bad case measles. 9DEP has been working a little 1.7 mc. phone with 9DDP. 9PDH schedules 9OPP. 9DMY-70, EWO-26, FAM-23, IFE-135, GKZ-48, DLK-19, DHO-14.

IOWA—SCM, George D. Hansen, W9FFD—9HPA, 9ABE—Rms. 9HPA-115 cops the lead. 9EIV-93 is kept busy with AARS. 9LEZ-40 has good schedules. 9AHX-35 will operate in Montana this summer under call 7EIE. 9DEA-29 has daily schedules. 9GWT-15 schedules his cousin, 6CZC. 9NZW-10 is interested in ORS. 9NTW-6 reports for 9RDK-2, 9MXC, IOJ, and JUI. NEI Ham Club is very active. 9NTA-4 wants dope regarding XAR2AK in Greenland. 9ERY-2 gets class B ticket. 9BQG and CYL report. USNCR units at CR, DM, and SC are very active. 9ABE-54, CWG-51, FYC-36, FZO-13, GXU-FFD-8, GSY-3, LCX-2, 7EIE-5.

NEW ENGLAND DIVISION

CONNECTICUT—SCM, Fred A. Ellis, Jr., W1CTI—I wish to thank all Conn. stations that took part in the Twentieth Anniversary Relay for their fine cooperation. 1DOW-209 wins CBA Traffic for second time. BPLers are 1MK-766, FIO-708, AMG-615 and CJD-416. A junior op arrived at 1CTI-83. 1GC-46 has been experimenting. 1AKI-38 reported in person. 1FXQ-31 applied for ORS. 1CBA-16 changed frequency to 3875. 1SZ-16 handled traffic with ON4CSL. 1QV-16 works a 7-mc. current-fed antenna on all bands. 1GXT-10 has new receiver and transmitter. 1TD-9 is radio servicing. 1BWM-8 works DX on 3777 kc. 1BMP-162 is SNC for A.A.R.S. on 3497.5 kc. with call WLGG. 1HWT-4 sends first report. 1EWD-2 worked plenty DX. 1AQF-2 is opening up on 56 mc. Glad to hear that ICRK has recovered from operation. 1FMI joined the ranks of the benedicts. The Wallingford Radio Club's call is 1HYB. 1AVS-2 and HKF-1 are interested in traffic. 1EKD has new shack. 1CRG is experimenting with 28 mc. 1FRK returned to Yale. 1CER is getting out on 56 mc. 1FDU is on 7 mc. 1HXD-1 is reading up on traffic regs. 1APW moved to Bridgeport. 1EFW, GLG and FEF joined U.S.N.R. 1HWG, ex-1BMG, is on the air in Stafford Springs. 1HYF is a new ham in E. Norwalk. New ORS: 1HPI, GTW-5 and GKM-20. 1BDI-249, UE-182. GGX-95, DGG-47, GME-23, DBP-21, BHM-21, HSU-12, BNP-5, EAO-4, GUC-2, HAG-1, HJW-9, HOP-3.

MAINE—SCM, J. W. Singleton, W1CDX—1EF-215 is new Chief RM. 1GKC-262 is RM of district two. 1CHF-121 is pushing traffic. 1CDX-107 has been DXing. 1EBM-104 has 200 watts on 1.75-mc. c.w. 1BTG-63 handles traffic with his YL. 1TE-60 has schedule with Panama and Jamaica. 1FJP-50 is after OPS. 1VV-48 sends first report. 1DHH-40 says DRZ is getting married. 1GBM-43 was in ORS contest. 1ERB-41 is adding new amp. 1BFA-28 has phone on 1835 kc. 1EFA-21 says FB club started at Dover-Foxcroft. 1CRP-15 has nice schedules. 1BTA-6 fixed up his rig. 1AQW-10 is QRL college. 1FXA-2 installed Collins antenna coupling unit. DX contest sponsored by Queen City Club won by 1AWY on 3.5 mc., 1DHE on 7 mc. and 1BPX on 14 mc. 1EEY is back in Maine. 1HUX-1 gets out well. 1US-115 moved out to FWZ's shack. 1HYL is new Augusta ham. 1AQL-1, BNC-9, GIE-33.

EASTERN MASSACHUSETTS—SCM, Joseph A. Mullen, W1ASI—1VS-946 and CRA-529 make the BPL. 1KH-63 has been busy with correspondence re the Board meeting. 1ASI-16 is playing around 56 mc. The County Net is working into shape. 1ABG-35 is on 56 mc. 1WV has trouble with parasites. 1AGA-15 QSO'd PAQRP on 14-mc. phone. 1EVJ-106 handles southern end of County Net. 1BMW-21 warns the boys to get ready for a big blowout at Provincetown this summer when the fleet gets

in. 1RE-11 handles Norfolk traffic in County Net. 1BZO-50 is Master County Station in new net. 1FRO-162 rides up to the top with the crack stations. 1GCL-45 is doing FB job as ORS. 1FPO-52 re-applied for ORS. 1HLO is a YL op. 1AZF-153 sends in some Army traffic. How about you other Army Net men? 1DOF-8 has matched impedance antennae. 1VH and DAR are on 14 mc. 'phone. 1FYT-9 has a pair of '71s. 1DNF has plans for multi-stage c.c. job. 1ATE worked all U.S. districts on 1.7 mc. phone in 17 days. 1BFR-19 has been DXing. 1BEF-25 had a gala mast raising when the gang raised his 85' lattice job. 1COL has gone to 56 mc. 1EXT lined up some FB schedules. 1DNL and AF worked J2GX for WAC. 1CNA is working portable in New Bedford. The Metropolitan Radio Club elected officers: Pres., 1FSK; Vice-Pres., 1HFX; Secty., 1SN; Treas., Pro. Tem, H. L. Rinaldi, acting in place of 1DAI, who is tied up at the hospital after an operation. 1BJN is working on Melrose Police two-way job. 1EMF is active on 1.7 mc. 1HXY has Harvey 56-mc. transceiver. The Ultra High-Freq. job installed at WNAC-WAAB's transmitter is running under the call 1VA, but will shortly be christened 1XYN (Yankee Network). 1MP on 56 mc. is owned and operated by P. A. DeMars, Technical Director for the Yankee Network. 1CGM has a '04A final. The gang recommends Crimson as the color for 1UG's QSL cards. We have all heard of "split phone watches," but how does 1ZK listen on 1.75, 3.5 and 56 mc. all at the same time? 1BIO is teaching Radio Service at the Ware Radio Co.'s National Union classes. 1BRB worked his first VK. 1LM-16.

WESTERN MASSACHUSETTS—SCM, Earl G. Hewinson, W1ASY-W1RB—1BVR-714 strikes a new high total for this Section. 1FNY-386 sure put the steam on this month. 1DVW-241 says traffic flowing freely. Transcon traffic is handled by 1EOB-101. 1OF is back on his old love AWW-88. 1DCH-81 had a good month. 1BKJ-79 handles messages from Byrd. 1GUO tried spinning a gypo-scope in his antenna. 1EAX-51 is after ORS. 1BSJ-18 handled the highest total of messages on 56 mc. 1DDK-8 reports BZA writing weekly short-wave column for local paper. 1ZB-7 has new crystal pro. 1YK-4 is new call for W.P.I. 1APL-3 is working on a 28-mc. phone. 1HHR-33 is waiting to hear re his exam at Boston. 1HZK is new Hadley ham. 1ADF is home, and on 7 mc. 1ARE-41, 1BKQ-39, 1DLH-17, 1EFM-16, 1COI-9, 1DUZ-5, 1BWY-8.

NEW HAMPSHIRE—SCM, Basil Cutting, W1APK—1ERQ-724 has a fine net in and outside of the state. 1DUB moved to Nashua. 1BJF-3 dropped schedules. 1AUY-1 is on 56 mc. 1DMI-118 is a traffic pusher. 1ET is working the world. 1HJM-37 sends first total. A '10 passed out when 1CUN-78 dropped it on the floor. 1GKE is experimenting. DX was good to 1HFO-6. 1BEO-35 keeps Berlin on the map. 1GEY-39 won a Westinghouse Meter at hamfest. 1GHT-21 has MOPA. 1AGO and TA are on 56 mc. 1HQE has new '10. 1EJI-27 finds 14-mc. DX FB. An important message from K6CIB was delivered by 1CCM-5 in less than 24 hours after its start! Our dentist, 1SK, is busy pulling molars. 1AVL has the golf bug. 1AVG is on the air with brand-new rig. 1AVJ is building Tri-tet. The N.H. OPS state net is in operation on 3900-kc. band each Sunday a.m. at 9 o'clock. 1AUY is net control. 1EOU has a fine c.c. rig. 1UN-117, 1DDM-22, 1APK-23.

RHODE ISLAND—SCM, Albert J. King, W1QR—1AWG reports for Newport gang. 1HPE is on 1.7-mc. 'phone. 1BXS moved to Block Island. 1GV-96 reports traffic good. 1EOF-109 is Unit Com'dr for U.S.N.R. 1HRC-62 is taking part in Bell Tel. QSO contest. 1DDY-20 is still fishing for schedules. The PRA had an outing. 1QR-41 is rebuilding. 1CAB-44, 1GTN-7.

VERMONT—SCM, Harry Page, W1ATF—1ELR is secretary of Twin State Radio Club, office at White River Junction. 1AAK is activities manager of this club. 1AVP mourns the loss of his XYL. Accept our sincere sympathy, OM. 1GNF is rebuilding. 1DQK-213 installed '03As in parallel. 1GAE-9 and 1LH applied for ORS. 1EFC is on 7 and 14 mc. Vt. needs a Navy Net—write to 1BJP-73 for particulars. 1BD-105 had to drop OBS work. 1ATF-109, 1AXN-62, 1CCF-62, 1FPS-42, 1AZV-12, 1CGV-1.

NORTHWESTERN DIVISION

ALASKA—SCM, Richard J. Fox, K7PQ—7FF-66 reports transcon. report on 3.5 mc. on his pair of '71As. 7BZX-30 tried 14 mc. 7CSZ is building c.c. 'phone. 7EGC-13 is new ham at Angoon. 7BOE-86 says amateur radio prevents him from getting too much sleep. 7PQ-86 changed crystal stage to type 59. 7BNW-6, 1DJA-9, 7H-11, 7BZ-30, 7EBR-49.

IDAHO—SCM, Don Oberbillig, W7AVP—7GL has 350 watts input. 7CNA works 7 mc. for DX. 7BCU is on 14 mc. for summer. 7ATN visited Gem State Radio Club. 7DMT-21 reports a new doublet. 7DYP is new Caldwell ham. 7DBP is building directional antenna. 7EGU visited SCM. 7BLT-13 is moving to Joplin, Mo. 7BYW worked DX. 7AAJ-13 is first Idaho OPS. 7BAA-31 holds three-way QSO with 7BNU and 7L every night. 7AFT is back after vacation. 7DSL wins pint of Invisible Grid oil donated as prize for ZAG contest by 7BZJ. 7DEB sends FB report. 7AVZ has new 800s. 7NH-6 likes 800s, too. 7BKX motorcycles around town. 7CFX lives in neighborhood with six '52s! 7EFL's new rig shows exceptional craftsmanship. 7JW announces at KTFI. 7CSW-4 worked two "J's." 7EFB lost antenna in high wind. 7CP, 7EES, 7AFH, 7CJ, 7AXY on 1.75-mc. 'phone. 7CSP works DX. 7CZO is busy painting. 7ASA holds regular schedules. 7DDU schedules DBP. 7BAR has new job. 7KJ moved to Twin Falls. 7DAW has new rack and panel transmitter. 7BMF-190, 7BAA-18, 7AVP-367, 7BR-1.

MONTANA—SCM, O. W. Viers, W7AAT—Congrats to 7CCR-556 on BPL total. 7ASQ-119 comes second. 7BVE-15 is building new bug. 7BSU joined A.A.R.S. 7CNE operates KGSY. 7EEH has 830's. 7CRH-26, 7CEG-16 and 7CDK have daily 3-way QSO. 7AFS favors e.c. detector. 7BDS reports for Roundup gang. 7EDJ has new receiver. 7CPY handled a few. 7FL reports 13 licensed hams in Butte. 7CCR is OPS. 7AAT blew a transformer. 7BDS-42, 7AOD-37, 7BDC-19, 7DXR-18, 7FL-16, 7AAT/COX-139. (Feb.-Mar. 7BVE-52.)

OREGON—SCM, Raymond W. Cummins, W7ABZ—BPL: 7AYV-1002, and 7R-169. Rebuilding: 7AMF-25, 7CMK, 7BDN, and 7AV. 7COQ-7 and 7AXO-11 still pursue DX. 7BUB is experimenting with antenna. Following reported regular traffic totals: 7BUB-51, 7DP-38, 7AIG-82, 7BLN-51, 7HD-164, 7KL-4, 7CFM-33, 7CEB-5, 7ANX-6, 7ALM-3, 7BOO-2, 7BBO-1, 7BMA-10, 7COU-12, 7EBQ-2, 7CBA-14, 7BNK-18, 7DIZ-51, 7DXC-22, 7BXQ-6, 7BKL-56 and 7ABZ-5. 7LT-6 and 7CVR are c.c. 7AGZ-1 is 1.75-mc. 'phone. Among the active 'phones are 7AEZ-25, 7BOG, 7DDG, 7AVG, 7CNV, 7DAA, 7BEK, 7BUH, 7BGF, and 7MF-81. 7BWD-23 believes ORS should all be on one frequency. 7QY-10 leaves for Alaska. Applicants for official appointments: 7BDR, 7CXK, 7BUH, and 7BGF. 7CRK, 7AEJ, and 7CWH changed locations. The Third Annual Convention of OARA, at Eugene (auspices Valley Radio Club), was one of the finest conventions ever held in the Northwest. Among those attending were: 7DNP, 7KV, 7BEG, 7BIO, 7BPP, 7DIW-1, 7DKI-1, 7DEZ-1, 7CIK-34 and 7XYL, 7ABD-7, 7CVL-8, 7APG-1, 7AGQ. If interested in 56-mc. contest, send your QRA to the SCM for the July issue of *Parasitic*. 7DVX-2, 7CZD-16, 7AZJ-1.

WASHINGTON—SCM, Stanley J. Belliveau, W7AYO—7CZY-688 makes BPL for the "Nth" time. New ORS: 7DGN-65. New OO: 7AAX. 7DET-10 is trying to break some track records. 7RL-3 anticipates a K6 schedule. 7CND-1 is joining A.A.R.S. 7ALH-54 sends AHG's-4 report. 7DET, 7DGY-10, 7CWL, and 7DGN send news from their respective high schools to 7LD-311 which is broadcast over KJR. 7CQK-9 says receiving conditions are "nerdy." 7ECA-17 is trying to get the 1.75-mc. boys to play checkers. 7BHH-85 had a swell time on NCR cruise. 7DGN reports for EAU-15, 7ECM-1 and 7EEJ-3. 7ABU-100 blew an 83. 7DRK-10 handles his traffic on 1.75-mc. 'phone. 7AZI-14 keeps several schedules. 7IG-62 handled death message. 7DRD-18 has new rig. 7DRR-4 is at Pullman. 7AHQ-36 has good Alaskan route. 7EFV is new Spokane ham. 7DRY-14 was active at ORS party. 7BBK-8 put up a new "bird perch." 7AVM-1 has 10-tube receiver. CRM 7WY-165 finally went c.c. 7DNL-272

blew about everything blowable. 7ECX-3 annexes a c.c. rig. 7AVL-19 has new junior op. 7BEV-8 bought 29-ft. cabin cruiser. 7BBY gets R8 from Europe. 7BRG-18 won Spokane QSL contest. 7BCS-4, BUQ-5, BYB-1 are active at Yakima. Following report by radio: 7CWM-1, BYT-1, BG-9, CQI-191, CQI-1, BBB-85, DPU-16, AWJ-23, DZA-1, DDU-1 and UE-15. 7CAM-7 has ¼-kw. 'phone. 7AUP-3 clicked J, VK and KAI. 7AYO-261 was heading for the BPL 'til '66 went west. 7AQ-28 is operated by CYO-1, AFQ and DWC-1. 7AFJ and QW are QRL KIT. 7DJE-1 and BUX-1 are together a lot. 7DUJ-1 visited the Yakima gang. 7AYC-1 is working DX. Attention is called to the big Spokane hamfest in June . . . for more dope write W7AAN. Also the BIG NORTHWEST CONVENTION at Seattle in August. For more information write W7RT, 1921 Atlantic St., Seattle. 7AF-7 will be known as 7AF-BT7 in Alaska this summer. 7APS-83, CJN-12, CDC-6, CNC-2, NZ-DZH-1, AIT-8, DLN-6, AWF-82.

PACIFIC DIVISION

HAWAII—SCM, C. D. Slaten, K6COG—6JRN-3 has new cross rig. 6HZH is on high power. 6KCR purchased ELN's rig. New hams at Fort Kam: 6KCK-353 and KKA. 6COG-11 worked a different African every morning for a week. 6HOO built a new bug. 6FAB, EWQ-4294 and GQF-19 received heard cards from Poland. 6JPT-728, GUA-329, GZI-188, CIB-21, EDH-17, CRU-5.

NEVADA—SCM, Keston L. Ramsey, W6EAD—6HGL-24 has new Portable. 6BYR is building new phone. 6GFT-40 has new c.c. rig. 6CGO has new receiver and transmitter. 6AJP-49, UO-36, GYX-13, JVH-13, BTJ-4, AAX-37, BIC-10.

LOS ANGELES—Acting SCM, Howell C. Brown, W6BPU—Fine report this month. Thanks, gang. BPL: AZU-596, CUU-589, ETL-1359, GNM-559, GXM-1334, HZT-407, NF-CFN-476. New rigs: 6KBY-27, 100 w, GLZ-13, JGZ, PD-2 1KW, DGH-4. Rebuilding: 6JMJ-1, WT-1, GTE-8, COF-12 900 watts JSZ-6 C.C., AAE, c.c., IDW-1. Clubs: Arizona and San Diego join Federation. Eagle Rock Club discovers power leak and can hear static now. 6AGF-6 Pres., Glendale. Wilmington Club reports first time. New officers San Pedro, 6IVG Pres., IIK-15 Secy., ERT-21 Treas. BA activities. A.A.R.S.: 10th District had picnic at Long Beach. 6EK-23, HAI, DRQ, EDW-333, 7AJX and 7AEJ were there. New hams: 6KAO Glendale, KHE-1 Terminal Island, KCG-1 Santa Barbara. New QRA: 6HWM-25, CLY, INC, IID. Report but no traffic: 6AAE, ANN, BQF, CLY, COF, CVF, DBC, DZI, ERM, GYR, HXU, INC, JGZ, JKH. DX: 6JZS-2, AAK-7, BVZ-5, JWL-21, KBB-2, IRD-23. 6IVU hears ZL on 28 mc. phone. U.S.N.R.: New Section NR at 8 at Ventura. New appointments, ORS: 6FYT-22. OBS: IIK. New antennas: 6DZI new pole, DJS-36 has 70 footer. Quarterly Banquet at Whittier FB and had 675 in attendance. Bell and Long Beach Clubs tie for Club Banner. 6EK gets Beauty Ops Ticket. 6IDW working DX station when other fellows shack catches fire—must have been hot QSO! 6BPU-208, EAR-193, BLS-163, ETJ-152, BZF-141, FGT-107, EGJ-91, IOX-57, DEP-58, RZ-57, AKW-46, EQW-45, GFG-43, HID-43, DWP-42. DZR-DUC-JQS-40, LN-50, DJC-37, PYW-36, HOG-31, HJW-AUB-30, CV-29, AM-28, GWO-27, HHJ-23, EUV-DNA-22, EZK-18, DCJ-17, ZBJ-GSR-16, JYK-15, HFG-TN-HEM-14, FLC-13, DOK-12, CIP-12, CAH-RBY-11, BPP-GMA-10, CPM-CVV-9, GEX-CYS-8, HZM-CEM-AIF-BMN-CKR-7, HLF-BKY-AAN-6, IIA-BFL-MA-IFC-5, HCF-HDV-DYQ-LC-BPM-KEY-EIU-4, DYH-FXL-JXZ-IJV-VO-GM-FXL-3, FKW-ITK-HHG-DUX-KMO-EAN-ELU-FUS-KEI-ON-JNE-BQO-2, ALR-IZF-RCX-ILV-FJK-BGF-FSJ-HEW-JOJ-JGA-EJZ-1.

SANTA CLARA VALLEY—Acting SCM, Barton Wood, W6DBB—More jobs result in fewer schedules at 6YG-150. 6CUZ-61 received his WAC. 6DSE-21 stages a comeback. 6BMW-18 ops portable at Mr. Madonna Park. 6YX-16 will have 500 watt job soon. 6JUQ's-13

sister donated a crystal. 6YL's-9 traffic manager is now CSI. 6BSO-4 has nothing to squawk about! 6DBB-4 threatens to put his "50" on 1.7 mc. 'phone. 6GOZ-1 works DX with '45s. 6FUM was in DX contest. 6JBI had portable at Big Bar C.C. camp. 6FMT schedules her brother from San Diego. 6BCF is putting an 04A on 3.5 mc. 6HZW is c.c. on 'phone. 6JSB left the section for C.C.C. job. Fellows: Please send your reports on the 16th—no later. 6AUC-24, JYW-1.

EAST BAY—SCM, P. W. Dann, W6ZF—The SCM, 6ZX-225, shot his Anniversary Relay message direct to W3COZ. 6ITH gave the East Bay Section an interesting talk on Radio and the Bay Bridge. 6RJ-462 is busy as Aide in A.A.R.S. 6CTX is navigating officer of the new flag-ship of Naval Reserve. 6FII-389 and FAC-9 are only Napa boys reporting. 6GHD-181 and EJA-67 handle FB Traffic with the Orient. 6HRG and AIJ are combining. 6FKQ works plenty DX. 6IEW was QSO a VK. 6HRT is a newcomer at Burbank. 6HRN-30 went to Hollywood, but returned! 6CIZ-18 says OO work is getting lighter. 6DHS-11 is back on the air. 6FS-8 has new ticket. 6HEP (Truckee, Cal.) and 9PWG (Chicago) were visitors at SCM's. Mrs. 6ZX says she's going to hold open house for Hams over the week ends. 6CZQ has a new love (auto). 6AHI-25 traffic is all Transpacific. 6IY-20, YM-18, HH-6.

SAN FRANCISCO—SCM, Byron Goodman, W6CAL—6ZG-2642 again smashes all section records! RM 6JAL-247 is moving QRA. '52 rig of 6EKC-141 is working again. 6JPA-70 and JMR-70 keep three schedules. 6JDG-61 resumes his seven schedules. Starting after traffic: 6BVL-55, TA-46, JZB-20, JVU-10. 6HIR-21 will be off this summer. Class A ticket for 6HJP-15. 6FYS-15 reports on Eureka gang. 6DDO-14 schedules K7DOF nightly. Transpacific schedule wanted by 6GIS-14. 6HRY-14 reports from Arizona! Beginners, listen for code practice from 6HVX-14 on 1952 kc. at 7 p.m. PST. 6SG-13 schedules JMR. QRL DX: 6BIP-9, JQV-2, AZK-2, DTR-1, JQZ-2. QRL other interests: 6CAL-12, CIS-2, DJI-2, RH-4. 6CAL, JNM-1 and EID graduate as engineers from U. of C. 6DZQ-1 has eye on OPS. New rigs: 6JYB-11, UL-4, BIM-2, HSA-9, DZQ, FVJ-1, IPH-1, DTR, JWD-1. 6ERS-2 has turned BCL! 56 mc. claims 6ABB, AVO, EET, GKO-5. 6JNI-3 is USNR control station at Petaluma. Mourning at 6JQJ-2 over blown power transformer. Reporting with no traffic: 6JPE, ELF, HSQ, KNQ, ABB, COC, CBN, ZS. This is largest report in history of the Section! Thanks to all! This report prepared by 6JAL.

SACRAMENTO VALLEY—SCM, Geo. L. Woodington, W6DVE—6DVD-35 organized a traffic net. 6IGH is ex7ATQ. 6GAC-15 is visiting friends in Penna. 6DFT and ADS were tagged for RAC. 6FOD has keyless transmitter. 6HVM worked Cuba. 6KFY has worked all districts. 6JOR is repairing his rig. 6CKV is coming home on vacation. 6IMV worked a ZL and VK. 6IZE has a portable. 6BYB blew another 1KW jug. 6GDJ lost a ten. 6GHN is building super. 6EOU, ESZ, and FLR are on 1.75 mc. 'phone. 6IQH has new pole. 6BVK-38 is at Woodleaf, Calif. up on the mountain top. 6CGJ-52, BVK-38, DVE-17, EWB-20, GZY-2, DYT-18.

ARIZONA—SCM, Ernest Mendoza, W6BJP—This report by 6HEU-44. SCM 6QC-134 is still on National Guard detail. 6BLP, GGS, ALU-870 and DPS attended Federation banquet at Whittier as representatives of A.S.W.R.C. 6KGQ took trip to Southern Arizona on club business. 6GYM is coming on with c.c. 6BFA-31 schedules QC. Verde Valley Chapter of A.S.W.R.C. now has 21 members. 6HXX-16, DIJ are pounding brass at summer camps in the mountains near Prescott. 6GDF schedules EL. 6FZQ-27 reports 7 mc. schedules with N.Y.C. very satisfactory. 6KGQ, KGL-9 have a 1 kw rig. 6IIG-32-IIF need a pole pot for that new 62. 6FOH is working 7 mc. portable from Superior. 6AEK is assisting EL in Radio Department at Phoenix transient camp. 6FKX builds trans-receiver. 6GFC-4 increases power on portable. 6JFO gives c.w. a whirl. 6DJH has FB trans-receiver. 6CKF is attending school in L. A. 6JYQ con-

verts to MOPA. 6EBP tries to work three stations. 6IUQ has 28 mc. rig. 6JRK uses 700 volts on 45s. 6JIW changed QRA. 6GJC has 25 cycle worries. 6GZU-88 rebuilt c.c. rig. 6KOK is new ham. 6KKE has daily schedules with his son, DPS. 6ALU resumes schedules with WLM. 6HAX has new rig. 6ZZBC is out in the sticks. 6FGG-4 and CQF are on 14 mc. phone. 6HBF, HBQ and KMG are on 1.75 mc. 6KFC-4.

PHILIPPINES—SCM, N. E. Thompson, KAIXA—1LG and ME are on 3.9 mc. phone. 1JR is back after months off the air. 1FR-1736, EE-596, NA-524, CM-414, LG-293, CS-129, HS-97, JR-55, XA-40, TS-38, 4GR-46, 9WX-3.

SAN DIEGO—SCM, Harry Ambler, W6EOP—RMs: 6FQU, 6QA. Phone RM 6IBK. About 30 from San Diego Section attended Banquet at Whittier. The San Diego Radio Club is affiliating with A.R.R.L. 6BMC-1356 and DQN-544 make the BPL. 6FQU-200 says RM net working FB. 6EFK-170 has two schedules. 6BHF-60 says Phone Net working FB. 6GTM-59 and AKY were visited by DAFCE. 6BWI is on Phone. 6BOW-33 works 7 mc. and 1.7 mc. phone. 6IBK-27 will soon try 14 mc. phone. W6AXN-17 rebuilt. 6BLZ-9 has new portable. 6KBB-2 works DX. 6GNT-1 has 8 tube Super. 6PKT has new crystal. 6BAS has new transmitter. 6BAM made 2567 points in DX contest. 6ONK, BYZ, CMT, VT, are new Ops at KGHX police radio. 6IQA moved to Nuevo. 6EOP-8.

ROANOKE DIVISION

NORTH CAROLINA—SCM, G. H. Wright, Jr., W4AVT—The Raleigh Amateur Radio Club recently passed resolutions endorsing the League. Active in A.A.R.S.: 4BST-9, ABE-4, BHR-7, CJP-15, CGH-30, AVT-22, EG-94, ABT, ALT, TP. Interested in 'phone: 4AEH, BER, AHH-66, BYA-35. Looking for DX: 4MR-2, DW-117, EG, CGL-2, RE-7, AMC-2, CQC, IY-1. 4AEL-17 is back after years' absence. Remodeling: 4UB-38, ALK-15, ZH. 4CP-18 has new antenna. 28 mc. experimenting: 4AHH and MR. 4BJZ is trying 56 mc. New Rigs: 4CGL, CJP, BX-8. 4BRT-74 is after ORS. 4DW wants OPS. 4CTO-12 talks to his 'phone in Denver, Colo., almost every night on 14-mc. 'phone. 4CUB-240 is striking for BPL. 4AAK-4 took message from Hagerstown, Md., delivered same and got answer back in 30 minutes. 4AMC got his "J" card, but it had a Rocky Mount, N. C., postmark at the 4BTC-124, BRK-69, NC-46, CCF-30, BLN-23, BKS-22, VW-14, CSO-12, JB-8, TJ-6, BLU-6, OG-6, BXF-3, CFR-3, ALD-2, BXX-2, RA-2, CLB-1, AHF-1.

VIRGINIA—SCM, R. N. Eubank, W3AAJ—3DFS-22 and AAJ-9 handled important traffic. New reporters: 3AII, AIJ, DII, DZW-1, EHL-7, ELA-3, ELJ-5, WO-4, DWW, BRA, AHC-20. New calls: 3CQW, ENO, ENQ, ENR, EMX, ELA, ELJ, EKC, EMM. Rebuilding: 3DEH-10, ELA, DFU-1, BIW, EMX, EBM, BTR, BRA, AZU. 3CA has been very ill. New transmitters: 3DFS, BZE-13, EBK-10, CEY-9, WO, DZW, COO-1. New receivers: 3ALF-8, AKN-6. Added c.c.: 3CFV-15, CEY, CPN-2, EAP-2, DZW, EBD-1, DAM, EBM. New antenna: 3DSH-2, CIJ-8, DZW, EMX, BYA-40, DQB-18, BAI-52. DX hounds: 3DNR-41, ECQ-24, AG-16, BZE, CCU-10, DEH, AKN, CZJ-4, BTR, BSB-2, DSH, DRK-1, AAJ, WM-1, BWA-2, EAP, AU-64. Experimenters: 3CEY, AKN, DSH, AAJ, DFU, AIJ, EBM, CZX, AAF-9, BYA, BXX-4. Want schedules: 3CMJ-101, BAD-30, ECQ, EBD, DAM, AIJ (fone), CSI-3. New QRAs: 3AAR, Norton; DUG, Norfolk. All men in Va. with 56-mc. rigs please advise on next card. On 56-mc. 'phone: 3FV-69, CGR, DAM, GE-1, AAJ, DAO, BFS, AGY, BRA, AZU, EAP. Club news: 3AGY is planning 56-mc. tests with dub. Send stamped envelope to 3CZE, Washington, D. C., for Heard QSL cards. 3ALF and CPN have new freq. equipment. 1.75-mc. 'phones: 3BRD, CIJ, DZW, AIJ, AHC, CDW, FJ, ADJ, AHC, BLJ-4, AAF, DDG-20. 3.9-mc. 'phones: 3AHQ-58, ASK-18, CIJ, CNY-6, BIG-4, CZJ, ZA-4, AIJ, FJ, ADJ, AKZ, AZU, BRD. 3GY's-18 OPS Net is doing

fine Sundays 9:45 a.m.—3.9 mc. 3AHC's 'phone net is doing fine, Sundays 1:30 p.m.—1.75 mc. Va. Net—CW—2 p.m. to 5 p.m. Sundays—3.5 mc. 3CII visited CMJ. 3CZJ wants OPS. 3AEW-10 uses '04A. 3WO is working in Roanoke. 3BTR worked Egypt. 3EMX, Dot Lemmon, is new YL opr. in Va. Va. OPS challenge any other 'phone nets. 3AEI moved shop to Appalachia. 3BWA worked HAF3D. 3UVA has gone to West Coast. 3AG worked Siberia. 3EHL blew power supply. 3BAN-2 is still doing fine O.O. work. 3BIW was heard in Holland. 3AKZ is now OPS. 3CZX is Traffic Mgr. Roanoke Club. 3CSI is op. at CC Camp at Clifton Forge. 3BXN has Class A ticket. 3DWP-4, DVO-2, CXM-41, DCU-14, FE-75, DPV-54, BRY-19, EGD-9, BGS-4, APU-3, DQD-2, AMB-1, AUG-79, ADD-5, MQ-1.

WEST VIRGINIA—SCM, C. S. Hoffmann, Jr.—W8HD/WLHF—The W. Va. A.A.R.S. held Hamfest at SELJ, April 15th, with 8OK-50, EIK-252, ELJ-22, EZR, BDD-70, DMF-15, JZU, CHM-3, HBB, HUK-10, BIZ, KDP-36, KHB, KFZ, LSX, EWM-9 present, also Mrs. 8OK, EZR, BDD, EIK. Reports go that the next A.A.R.S. Hamfest will be held in Charleston. 8KSJ-3 uses collector radiation antenna on receiver. 8ELO-HCL-6, JWL: rebuilding. 8IB is leaving state to live in British Columbia with parents. 8BDD operates Police Station in Huntington. 8DFC worked 7DBR. 8EWM is building set for KBU. 8JM-26, GAD, GBF are conducting code classes at Fairmont High School. 8EYV applies for OPS. SKDP applies for ORS. 8DMF is installing '04-A job. Hams returning home from college to their stations this summer: SBOV, BTV, FQA, FQB-3, BKJ, JCB and ILY. New Henderson stations: 8LSJ, LSK. Heard on 1.7-mc. 'phone: 8AMX, CVK, ASI, HBL, CDV, DMU, ILY, KWI, EP. Heard on 3.9-mc. 'phone: 8JM, JQU-5, AHF. 3.5-mc. CW: 8KXC, KXV, KWU-47, GBF, GAD. 7 mc.: 8ESA, CVX, DPO, AZD, CWY, BDP, JEL. Reports would be appreciated by the SCM from all these stations. The SCM regrets to announce the resignation of W8TI as Official Observer. W8TI is one of the oldest appointees to date in this state. The SCM is also sorry to announce W8JM resigning RM-ship of the Northern District, due to business. Applications are invited to fill the vacancies. The W. Va. Bulletin and reporting cards will be sent to W. Va. Stations if they will write to W8HD/WLHF. 8HD-92, KKG-38, DOB-2, DFC-1.

ROCKY MOUNTAIN DIVISION

COLORADO—SCM, T. R. Becker, W9BTO—9JCQ is on in Pueblo. 9ESA-1515 continues as star traffic station: he has c.c. now. 9PVZ-uses '45s P.P. 9GJQ-1263 has FB bunch of schedules and reports an FB total. 9CDE-20 feels that it is about time that the gang get together and protect what rights we have left! 9JGF-6 scored 1976 points in DX contest. 9FYY is trying 56 mc. 9FYG is on 7 mc. 9BYU is in new quarters. 9CJJ is on 14 and 3.9 mc. phone. 9IJU changed QRA. 9BTO and GBQ are on 3.5 and 7 mc. 9BYK is trying 50 watters for Modulators. 9EMU has receiver trouble. 9KGR is on 14 mc. phone. 9GHY is on in Golden. 9AAB, our Director, left for West Hartford for the Board Meeting. 9EHC-5 has been QRL flu. 9DYP is grinding crystals. 9HDI is building new rig. 9LFE sold entire rig. 9EYN-150 is on 14 mc. phone. 9DNP is building Supr-Het. 9NKQ uses six '66s in rect. The P.P.A.R.A. attended a hamfest in Pueblo, and wishes to extend congratulations to the San Isabel Radio Club. 9JRV is working 14 mc. DX. 9PGS has new receiver. 9YL, HIR, GGN are on 14 mc. phone. 9AZT is a portable in Boulder. 9NRK is working on c.c. rig. 9LJF-7, NKQ-4.

UTAH-WYOMING—SCM, Arty W. Clark, W6GQC—Thanks, fellows, for electing me SCM. I will appreciate continuation of the splendid cooperation shown in the past and try to do my best in the future. Don't forget UTAH HAMFEST, Sunday, June 24th at Como Springs, near Ogden. Bring two-bits, YL, YF and lunch. 10:30 a.m.—sponsored by U.A.R.C. Sheridan Amateur Radio League was organized at Sheridan, Wyoming: 7CCC pres-temp, CPB sec-trea-temp, CPL, CRP, CSE, DCO

and two non-hams. 6FYR-564 leads Section again. Handling traffic great sport at 7CSE-43. 6HVU-2 is new reporter. Tri-tet "the berries" at 6DTB and 7COO. 7CBL is back on air. 6KDI-52 worked D, ON, F with pair '45s. 6FRN-2 worked G6, AC2 with 8 watts output, both 14 mc. 6DPJ-89 works 3.9 mc. phone schedule with 6APM. 7ADF gets splendid results on 3.5 mc. portable. 7NY has 65 ft. vertical antenna. 6DEM-6 is revamping receiver. 7COH-104 got snowed in and no "spuds." Hi. 6FYP-24 is working on new transmitter circuit. 6BTX is chief op for Army at Airport. New stations: 6KNC, KGR, KOP, KOZ, KON, KKG. 6GQC-360, GGA-52, GPJ-KJB-9, GQM-8, ITW-6, JVB-AFN-QGR-4, DGR 1. 7AMU-41, CPB-1.

SOUTHEASTERN DIVISION

ALABAMA—SCM, L. D. Elwell, W4KP—The big QSO party went off with a bang. 4BXZ hails from Anniston. 4APU-40 wins QSO Party Contest and is new RM for North Section. 4BOU-108 was runner-up. 4GL-115 is new RM for Southern Section. 4BLL is busy with the CQ amplifier. 4GP and OA are on fone. 4BXV is on 1.75-mc. 'phone. 4CBI is rebuilding for c.c. 4CQV puts most of his time on 14 mc. 4GL is building new receiver. 4DS-35 is the RM-in-chief. 4CCP is on 'phone and c.w. 4COA is now a member of the B'ham bunch. 4AJY works a lot of DX. 4BZG-13 made a fine score in contest using phone. 4AII-25 made a good score with low power. 4BMM, 'phone RM, is rebuilding. 4AJC-22 is now in Auburn. 4KP reports a new YL op. 4CJZ-190, COU-127, BJA-65, RS-60, BIW-39, CJG-9.

EASTERN FLORIDA—SCM, Ray Atkinson, W4NN—Let's get ready for the storm period with a good emergency net. 4AZB's '49 was going full blast. 4WS-24 reports new ham at Deland. 4CTH. 4BNI-8 is completing Class B 'phone. 4ASR-18 reports 4AS moved to Daytona Beach. 4BQD is on 1.7-mc. 'phone. 4BWZ broke his arm. 3DVF, portable, was at Daytona all winter. 4AGB-14 and NN-219 are equipping their boat with 56 and 10-mc. transmitter. 4UX is sailing Pacific. 4AKH is working 14-mc. DX. 4HY-9 is putting up new antenna. Don't forget Central Florida Hamfest at Orlando, June 22nd, 23rd. Many valuable prizes. Mail your \$3 fee to 4CCI, 1627 East Concord Ave., Orlando. Let's have a real get-together. 4TK-7.

WESTERN FLORIDA—SCM, Eddie Collins, W4MS—RMs 4ACB, 4AUW. The Hamfest at Valparaiso to be given by Mr. and Mrs. 4KB-26, June 30th and July 1st, tops the calendar, and we hope to see the gang there 100%. 4BSJ-2 has new High Angle Radiation system. 4CLP and CTZ keep Perry on the map. 4CRU has "Comet Pro." 4AUW-10 is busy with his new son. 4AUV is working on the club. 4BKD uses 'phone on 3.9 mc. 4QR has tri-tet. 4CQF is tearing up 3.5 mc. 4AQY is QRL State Road Dept. 4BFD installed remote control. 4BGA had measles. 4VR has FB7A. 4QK-3's brother is now 4CUV. 4ASV has MOPA. 4CTA bought old 4ZZAO. Ex-4MX is operating at WCOA. 4MS-16 has doublet antenna. 4CMJ is building trans-receivers. 4AXP-4, CDE-7, ACB-8.

GEORGIA-SOUTH CAROLINA-CUBA-ISLE OF PINES-PORTO RICO-VIRGIN ISLANDS—SCM, G. A. Love, W4UT—Asst. SCM, Bannie Stewart, W4CE. W4SS-10 (Mr. Director to you) says Naval Reserve stations may get the letter "N" as prefix for their calls. 4KV-460 leads the Section. 4BRG-24 wins SS award for this Section. 4TL is going on 14 mc. 4CMA has a YL secretary to make out his QSLs! 4AAZ-21 reports via A.A.R.S. 4ATZ's new rig works FB. 4VX-7 reports things QRL around Columbus. The Atlanta Radio Club is planning membership drive. 4UT will spend summer in Cuba. 9ZZAF is settling in So. Cal. 4BXT's OM is head of Physics Dept. at Ga. Tech! 4BW-2 carries on with A.A.R.S. 4AEI has a junior op now. 4BQM-3 has 205D's in final. 4CQS is Principal of Sumter High. 4CSV is new in Sumter, S. C. 4CQK-37 has Class A ticket. 4BZX-6 has FR 1.7-mc. 'phone. 4CPX has 825's in final. 4ANK-75 is looking for traffic schedules. 4BNN is on 1.7-mc. 'phone.

4COY is on 7 mc. 4ADD is putting c.c. on 7 mc. 4CE-39 started ham club in local High School works DX. 40W is starting club in Charleston, S. C. 4MN is known as the Dean of the S. C. hams. 4AZT operates at BC station. 4VL has high power. The Palmetto Amateur Radio Club of Columbia, S. C., meets at Sloan College University of S. C. every first and third Wednesday at 8 p.m. The Winyah Amateur Radio Club of Georgetown, S. C., has been organized. 4BZW-121, IR-59, AZT-16.

WEST GULF DIVISION

NORTHERN TEXAS—SCM, Glen E. Talbutt, W5AUL—5BII Chief RM. 5SP-8 Phone Activities Mgr. RM's 5ARS, BKH. The SCM, 5AUL-6, finally attained "gold braid" in the Fire Dept.; the new QRA is 1133 Amarillo St., Abilene. We regret the loss of RM 51A and P.A.M. 5BAY; these fellows are QRL. 5BII-319 leads as usual, with 5AW-240 second. 5CII-161 may join the Army. The "gold dust twins," 5CPB-144 and CPT-62, are going strong. 5NW-14 has schedule with "Little America." 5CMS-9 is rebuilding. 5CHJ-8 is LNCS for AA at Dallas. 5BVF-6 wants a 1.5 to 28 "megohm" receiver. 5BKC-6 says BRC moved to "Tax." 5DMA-6 has '59 tritet. 5DMD-2 is on 'phone. 5DXA-2 reports AXK and EAV at Childress. 5BKH-60 and ARS-71 want more traffic stations. 5ZD-93 and DYH-3 report from Dallas. 5ANU-38, BCW-58 and IT-4 are going and coming. 5BAY has new portable. 5BZT is WAC. 5CYU can't make crystal work. 5DST is going c.c. 5ARV WAC'ed twice. 5COX reports first time in "years." 5CPU and BKJ report Ennis Club. "YF" 5DUR says "Hoorary," the old appendix didn't have to come out after all. 5COJ is new Prexy. Wichita Falls Club: the banquet was a success. 5AUJ, CAV, DWR, QA, DYU, AZB are active. 5DAA-44 reports the Terrell gang, 5CEL, CAE, CZZ, GO. Keep the reports coming, gang, and thanks.

OKLAHOMA—SCM, Carter L. Simpson, W5CEZ—New traffic reporters: 5CPI-10, CYV-10, DDD-2 and DTC-13. 5ATB and AVB apply for OPS. 5ASQ-174 is new OO. 5RF-108 gets ORS. 5BAR-84 handles fast traffic pertaining to serious illness. New Edmond hams: 5DZU and EBC. New tickets at 5AVR, CAT, DDW and DEN. 5CZS moved to Winslow, Arizona. 5ATB and ABT have new Patterson receivers, and CPI an FB7A. 5BAT has a pair of '52s. 5BLF gets out FB. 5RU has a new 50 Final. 5CGH and ALI are rebuilding. 5BJE is QRL delivering mail. 5CYV is op. for Santa Fe. 5BOO is giving code lessons. 5ALJ is on 1.75 mc. 5AMC-8 is practising on trumpet. 5BDX-133 says QRN is running him nertz. The Key Checkers Club at Ponca City sent in 12 subscriptions to A.R.R.L.-QST, making the club 100% A.R.R.L. members. Route Manager appointments are going to be made. Who wants the job? 5CEZ-925, BQZ-203, AKX-91, AJF-73, DQV-33, BWN-30, BJG-13, CUX-6.

SOUTHERN TEXAS—SCM, D. H. Calk, W5BHO—5OW-1703 reports traffic holding up. 5MN-182 has several schedules. 5CVW-12 is member of Gulf Coast Storm Net. 5PF-2 reports San Antonio Club getting Convention plans lined up. 5DBN-8 worked VK7. 5MS-12 worked 23 countries this month. 5BXK-37 reports two schedules. 5DPX-15 uses '10s final. 5BKX-9 has taken unto himself a life partner. Congrats, Beak. 5BFA-42 wants schedules with Houston or Corpus Christi. 5CET-3 worked lots of DX in contest. 5BB-31 is on 1.7- and 3.9-mc. 'phone. 5VV-14 will be in Europe again this summer. 5DIG is the Galveston Amateur Radio Club's new 50-watt c.c. rig. 5DTB is rebuilding to pair '10s. 5CDD has erected new antenna. 5CPR has new 7-mc. rig. 5CPA is building metal rack and panel rig. 5BTK operates 50-watt c.c. rig. 5YH uses five-band exciter unit. 5YL-BWM-2 will be on 3.9-mc. 'phone soon. 5ADZ-12 reports lots of DX. 5AFV worked 19 countries during DX contest. 5DPA, the Houston Amateur Radio Club transmitters, were busy in a booth in the 5th Annual Oil and Equipment Exposition. 5CVQ works A.A.R.S. schedules. 5TG put in 14-mc. 'phone. 5LS is on 14- and 1.7-mc. 'phone. 5BVX, DLT and BXS are on 1.7-mc. 'phone. 5BEF-21.

NEW MEXICO—SCM, Dan W. De Lay, W5DUI—5ZM-215 rides first place in traffic. SCM-84 sneaked in second. 5DLG-42 boasts of new SW3. 5AOP-4 wants some schedules. 5BNT-1 is rebuilding receiver. 5DZY is QRL new Jr. op. 5DZH is new ham in Madrid. 5AAX-15 worked Spain. 5EAO has bugs in C.C. rig. 5DPVX-30, DSN-1.

CANADA MARITIME DIVISION

NOVA SCOTIA—SCM, A. M. Crowell, VE1DQ—1DE-77 was heard in VK during B.E.R.U. tests. 1GL-60 keeps five schedules daily. 1BV-10 is trying vertical antenna. 1EX-45 schedules 1CF daily. Daily ragchews are held by 1AI, CV, FE, GR on 1.75-mc. 'phone. 1EO is on 7 mc. 1AO is 100% for 1.75 mc. 1BB is active on 3.5. 1AG-9 schedules 1CA and CI daily on 3.9-mc. 'phone. Active on 3.9-mc. 'phone. 1EI, CO, FW, GT, IFB-1, QSL Mgr. this dist., reports new ham, 1GY. 1EP-11 worked YM4ZO. 1DQ-4 worked a YI in DX tests. 1ET is busy with R.C.M.P. 1EA-15 works Europe regularly. 1FE is active on 7 mc. and 1.75 mc. NEW BRUNSWICK—1CL is going to rebuild the 1.75-mc. 'phone. 1AJ is building new receiver. 1BX is on 7 mc. 1BO lost power packs during flood in cellar. 1FZ is building MOPA. 1FX is getting set for 1.75-mc. 'phone. 1AC is on the air at Summerside, P. E. I., with c.c. on 3.5 mc. NEWFOUNDLAND—via VO8Y—VO8Y piled up 2804 points in contest on 14 mc. Following are active "VO" stations on 3.9 mc.: 8S, 8K, 8Z, 8LC, 8M, 8HK. 8AW says QRM phone experiments. Drop a card to 1DQ and have YOUR station included in our Division report.

ONTARIO DIVISION

ONTARIO—SCM, S. B. Trainer, Jr., VE3GT—3JT-458 leads in traffic. 3SZ-18 and MB-21 are looking for schedules. 3TM-231 is going to get even. 3JV worked VQ4. 3DU-1 and AD moved. 3GT-291 and WB-1 were heard in Moscow, and VX in Poland. 3GI-29 is after commercial ticket. 3WK-68 plugs away at traffic. 9AL-39 never fails to report. 3GH's wife "April-fooled" him—baby girl. 3QB-58 and YB get out with flea power. 3FH is new opr in Beamsville. 3QK-1 is the flea on the hot griddle. 3RO and WJ are rebuilding. 3WA is now WAC. 3PT, IH and BZ like 7 mc. Present at 1st Annual No. Ont. Convention were: 3CX, CH, DX, RA, GB, LY, FW, FQ, GS, UE, UA, and RI, KN, QP, OZ, GG and HA. 3QI's-4 antenna has become a ground. 3XO-52 wanders between Orillia and Toronto. 3QM-8 is after a better rig. 3LJ, HY, and BG pound away at 3HW's. 3SG-22 has been making out our income tax bills. 3HW played the golds. 3OO is cruising in southern waters. 3OO, RL, NU, PM, LN, LL, HF, CF, YO, NM and LR were at birthday party at 3IB's. 3DC is experimenting with the radio knife. 3ZA, ZR are new stations in Seaforth. 3NX will be on 3.5 mc. during the summer. 3DD has gone into training for Ont. Forestry job. 3LY won a crystal in a grab bag. 3CX-72 pounds away on schedules. 3WH blew the works. 3GS has ¼ KW on 3.5 mc. 3OZ gives DX and RA a chance to work out. 3KN is QRL the ivories in his band. 3FW knocked enough off crystal to fit small holder. 3IP lapsed into 3ZF. 3HA-5, GB, and LY are working on 56-mc. transceivers. 3GG entertained the club with amusing stories. 3QP is ironing out the bugs. 3CH helps the gang out. 3JI-169 is on 3.9-mc. 'phone. 3TO is new OBS. 3DJ-1 reports 3NB and YY worked the same "X" the same evening. 3SA-71 is getting 100-watt 'phone into action. Officers of Brantford Radio Amateurs Club: Pres., 3PS; Vice-Pres., A. H. Ellis; Secy.-Treas., 3SL. 3RK-216, GO-204, LZ-68, NO-LI-66, IB-58, DW-38, WX-32, HP-22, IQ-6, XK-1.

QUEBEC DIVISION

QUEBEC—Acting SCM, J. A. Robertson, VE2GA—Thanks, gang, for the support you have given me in preparing my first report. Interesting tests were carried out on April 14th and 15th on 56 mc. at St. Hubert Airport. A plane piloted by 2AL with EM as operator experimented with 2HI—our lady "ham"—who was in

charge of ground station. Two-way contact was maintained over distances up to 40 miles; 2BG and EL were also worked. 2AX and EE made excellent showing in DX contest. 2AB-23 building 200-watt rig. 2HG works plenty DX. 2HK-461 is star traffic man and makes BPL! FBXA's at 2BG, AB, FE, HM, EM and DU. 2CA works DX with antennae down. 2DR-80 relayed traffic for Mr. Maxim. 2BF is selling out on account of health. 2HT handles traffic on 3.5-mc. 'phone. 2HQ flew out of Anticosti and visited local hams. 2GO and DG-7 work VK's and ZL's. 2EX is selling high-power equipment. 2GA burnt out generator. 2DY and HN are on 3.5-mc. 'phone. 2CG-46, ORS appointment pending. 2EM is building 50-watt rig for summer residence. 2AP-11 resigns ORS appointment. 2AW is building c.c. rig. 2BU-17 keeps in daily touch with wife by radio while she visits Toronto. 2BB-37, DG-7, AC-19, BU-17, CX-53.

VANALTA DIVISION

ALBERTA—SCM, J. Smalley, Jr., VE4GD—4EW and 4EA are with CFTP. 4GY uses c.c. 4QX-15 works traffic and DX. 4PH-6 worked three K6's. 4EX is the Edmonton YL. 4HM is Alberta's first OPS. 4FI and HW have gone 'phone. 4DX-3 is resting his tonsils. 4GD-64 is once more in traffic column. 4AX, NH, and KG-20' are working for ORS. 4CY returned to 14-mc. 'phone. 4LK uses low power. 4AW-10 likes '46s. 4CJ and OG are building c.c. 4JX chases DX. 4AF-35 is new ORS. 4AA is new ham. 4EO-4 wants answers to his QRZ after OBS schedule. 4OF likes 14 mc. 4OZ loads up his '10. 4OI is experimenting. 4JJ added a pair of '10s. Ex4GP is organizing the Medicine Hat Club. 4BZ-111 finds time between schedules to work 'phone. 4GM lives, eats, and sleeps Pattersons. 4DR has DX cards awaiting envelopes. 4LX-8 has high-power c.c. rig. 4DQ is building super. 4NB has battery-powered c.c. rig. 4AS is active at Milk River. 4JP is rigging for 3.9-mc. 'phone.

BRITISH COLUMBIA—SCM, R. K. Town, VE5AC—5DF-43, JF-39 and AC-59 handled death messages. 5FG-17 keeps HBC post in touch with civilization. 5EJ-14 holds plenty schedules. 5AO-4 works all districts on 1.7-mc. 'phone. 5JK's-6 son objects to being called a daughter—my error. HI. 5GH moved his heap to Pavilion. B. C. 5AK is new call. 5EX operates from mining camp. 5AV takes his rig to a logging camp. 5AL-7 wields a wicked Ping Pong racket. 5FO goes c.c. 5CZ works W2CZ. 5KV-2 works a J. 5KB works some DX. 5EW got on at last! 5CL wrecks receivers. 5KY-16 has MOPA 'phone. 5FM wants traffic schedules. Don't forget the Official Broadcasts, Sunday noon and Wednesday, 7 p.m. 5DO-14, HP-53, IM-54, EP-34, JA-45, CA-25, EU-17, AG-10, HC-20, GS-1.

PRAIRIE DIVISION

MANITOBA—SCM, Reg. Strong—The M.W.E.A. held successful booth at World's Model Fair. 4AE-512 has a BPL total. 4AG and MV directed the M.W.E.A. booth. 4GL, DU, KX-37, FU, DZ, DJ-26, MY, KY and LH took traffic from the booth; 4QD, KU, NT, RF, GC-34, FP, BG, MW, NW assisted. 4MJ has worked all districts. 4NI-35 had a junior op. 4FT is rebuilding. 4CP uses grid bias modulation. 4RO has some sky wire.

SASKATCHEWAN—SCM, Wilfred Skaife, VE4EL—The Regina-Kimberley hockey game was handled by radio via 4EU to 5FL. 4BF tried to make a 211 perk which 4EU had returned to the sellers as NG! New phones: 4OT, Nipiwan; 4AR, Melfort; 4QM, Weldon; 4PX, Weyburn. CW 4BD, Weldon. 4KB is rebuilding rack job. 4KV is doing fine on 3.5 mc. 4FA-2 is active on 1.7 and 14 mc. Had visits from 4PA, GA-19 and later visited 4GA. 4NK is tearing air in 3.5 mc. 4KA worked a PY. 4IG-1 was heard in Japan. 4IV has trouble with Tri-tet. 4OD is on 28-mc. 'phone. 4FY is moving to 14-mc. 'phone. 4EH visited MJ gang one week-end. 4MH-73 schedules 4BZ and GR-16 daily. 4MN visited QK-5 for few days DX. 4BN heard lots DX in contest. 4IE is all set with rack job. 4EL-16 is now on 3.5-mc. 'phone. 4OR-8.

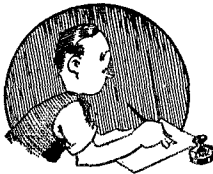

CORRESPONDENCE

The Publishers of QST assume no responsibility for statements made herein by correspondents

The Old Geezer Is Still Alive

A.R.R.L. RADIOGRAM
from somewhere west of Connecticut
(Preamble deleted)
APRIL 27, 1934

K B WARNER

A R R L

WESTHARTFORD CONN

SAY SON I HAND IT TO YOU ON THAT TWENTI-
ETH ANNIVERSARY NUMBER ITS A HOOTIN
TOOTIN RINGTAILED SNORTER AND SURE DID
BRING BACK MEMORIES OF THE OLD DAYS IT
DOES YOU CREDIT DONT LET THE MUDSLING-
ERS BOTHER YOU I WILL ATTEND TO THEM IN
DUE TIME.

THE OLD MAN

More Birthday Greetings

Department of Marine,
Radio Branch,
Ottawa, Canada

Dear Mr. Warner:

I am pleased to note that the American Radio Relay League is about to celebrate its twentieth birthday.

Owing to their geographical situation amateurs in both our countries have a great deal in common, and there would seem to be no better proof of the harmonious relations that exist, than the set-up of your organization which includes a Canadian on its board of directors and which has stood the test of time from the "pioneer" years of amateur radio until to-day.

I feel that your organization and especially its official organ *QST*, which by the way we have always found time to scan ever since it was first garbed in blue and edited by Mr. Tuska, has exerted a beneficial influence in the amateur field, particularly with newcomers to the game who being for the most part of the younger generation are not always amenable to regulation.

I am very glad to take this opportunity of congratulating the American Radio Relay League on attaining its twentieth anniversary and of extending my best wishes for its continued success.

—C. P. Edwards, Director of Radio

Headquarters:
British Empire Radio Union,
53, Victoria Street,
London, S. W. 1

Dear Mr. Warner:

I understand the American Radio Relay League is about to celebrate its twentieth anni-

versary and I am writing on behalf of the members of The Radio Society of Great Britain to wish you many happy returns of your birthday and prosperity in the future.

The amateurs of the world have made wonderful progress during the past twenty years, especially when one considers that during five years we were marking time.

To-day more than ever is it necessary for the amateurs of every country to work together for the safeguarding of our rights and privileges, and we are ready at all times to cooperate with you to this end.

—Arthur E. Watts, President

Good Idea

201 North Front Street,
Camden, New Jersey

Editor, *QST*:

Several nights ago, while listening on the 80-meter 'phone band, I heard what seemed to me an excellent stunt. This station announced "This is W8— testing for broadcast interference. If anyone hears this announcement on their regular broadcast receivers, will they please call (telephone number). Your trouble can be eliminated."

Would not a more general use of such an announcement eliminate many complaints from broadcast listeners and enhance the amateur's standing in his community?

—E. C. Hughes, Jr., W3EHS

56-Mc. QRM

One Wall St., New York

Editor, *QST*:

Many years ago, I recall an article by T.O.M. entitled "Rotten QRM," and it occurs to me that a new form of this has arisen on the 56-mc. band. . . .

. . . 56-mc. work is of strictly local character and the average station knows the radius of its transmitter. It would seem only fair that with the number of stations increasing daily and with receivers only quasi-selective, that the men would pick a "hole" in the band which would not QRM other stations. If all would do this the duplex feature for which the band is famous would not be lost. At my station some twenty 56-mc. stations can be heard almost every night, and most of them, for some unknown reason, "gang up" at

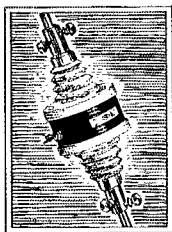

During the past few months we have been aware of a rapidly increasing interest in the 56-megacycle band. Most newcomers are using transceivers. Undoubtedly this is the easiest and most inexpensive way to get started. While this is nice for us, as manufacturers of transceivers, we think it only fair to say that they are not suitable for permanent station equipment. They are portables, pure and simple, and much is sacrificed to that end. Having only two tubes, during reception they radiate badly and lack selectivity. During transmission they lack frequency stability and show an unfortunate degree of frequency modulation. When used in remote locations these points can be overlooked. But as permanent equipment in metropolitan districts transceivers produce QRM of undesirable proportions.

Fortunately, the majority of active five meter amateurs are constructing more pretentious equipment, and the results seem to justify the effort. One circuit we have developed in our laboratories has been used by a number of local amateurs with excellent results. A single 53, used as two separate triodes each doubling or tripling, acts as the frequency multiplier. This arrangement makes possible the use of a 20-, 30- or 45-meter crystal for 56-m.c. control. — And used with one of the new transmitting pentodes like the RK-20, we have a 50-watt crystal-controlled phone reduced to four tubes. Try it!

Another thing — the Pickard antenna seems to be universally regarded as independent of feeder length, spacing, etc. Our experience does not bear this out, and we suggest trying tuned feeders, or even just altering length and spacing. The results are generally startling.

Our interest in 56-m.c. crystal transmitters may seem noble and unselfish, as we don't make them. Honesty compels us to say our interest is not unselfish. We are looking forward to making a really good 56-m.c. receiver, — a sensitive, selective superhet, — when conditions warrant. Three years ago we placed such a receiver on the market but it was much too far ahead of its time. While it gave almost unbelievable results with stable transmitters, it was the "bad news" with the universally-used modulated oscillators. But the day of the stabilized 56-m.c. transmitter is coming, and with it the 56-m.c. superhet. We hope that day will be soon, — for everybody's sake.

JAMES MILLEN



BACK COPIES OF QST

WITH INDEXES

THE LIST given below shows many exceptions, and as time goes on each yearly list becomes more incomplete. You'll be sorry some day if you don't stop, look and ACT now — Right Now!

HERE THEY ARE

1923—Only May and November issues	\$ 5.00
1924 — Only November and December issues.....	50
1925 copies (except January, March, May and July).....	2.00
1926 copies — complete.....	2.50
1927 copies (except January and July).....	2.50
1928 copies (except January, February, March and August)....	2.00
1929 copies (except February, March, April and May).....	2.00
1930 copies (except January, February and July).....	2.25
1931 copies — complete.....	2.50
1932 copies — complete (except August, September and October).....	2.00
1933 copies — complete.....	2.50
1934 copies — as issued.....	25c ea.

Complete Set of Copies as Listed \$15.00
Single Copies 25c Each

ALL PRICES INCLUDE POSTAGE

New binders to keep these files in order are \$1.50 each, postpaid. Each binder holds 12 issues of QST and index, and does not mutilate the copies.

AMERICAN RADIO RELAY LEAGUE

West Hartford « » Connecticut

one particular part of the band in spite of the fact that there are large "dead spaces." . . .

It will be found in almost every location that some station has logged every other station, and simple coöperation between that station and the new transmitter ought to help put the newcomer in a spot which he can enjoy by himself. . . .

—Karl A. Kopetzky, W2GOW

Rotten Humor

204 City St., San Antonio, Tex.

Editor, QST:

Occasionally there springs up in the amateur ranks a pest — or better, a parasite. . . .

The latest one is the fellow who proceeds to hunt out a pure T9 CQ and then answer it, telling the sender that he is "way out" of the band, that his signal is anything from "r.a.c. 60 cycle" to a T6, and that his signal creeps and what not.

On a few occasions, I have had a fellow-amateur call and ask me to give him a report on his signal, and then he would tell me that W9-so-and-so had given him a punk report. And then, on a careful check, absolutely nothing was wrong — just gave the fellow something to worry about.

One morning not long ago I had just sent a CQ hoping to raise some far and distant land . . . when lo and behold here comes a W9 — (whose location, by the way, is Minneapolis), who proceeded to tell me my T4 signal was out of the band and wobbling back and forth, besides a few other discrepancies. . . . Now my own frequency meter and monitor told me, even while I was working this bird, that my note was T9 and that my wave was very near 7138 kc., and I later verified it by further communication with other hams. . . . Now, when a fellow gets literally hundreds of T9 reports and several "OK frequency" checks, *why* does some joy killer have to come along and try to see how much worry he can deal out to a fellow who is trying to play the game? . . .

I would like to hear from some of the boys who have had this experience, as I want to make a list of all the stations guilty of such a contemptible act. . . .

— Roy E. Finley, W5DDX

"Brother! Are You a Duck?"

Oak Harbor, Ohio

Editor, QST:

The fact that too many hams give you "QRU" after having reported what kind of a signal you are putting out grieves many of us rag chowers, for they remove most of the personal interest from radio communication.

Let's break a good many of them of that characteristic by giving them a name. A name easy to transmit would be good. For instance, when you want to talk to them they duck. Then, if I didn't want one of their kind to answer me I



ANNOUNCING

New and Larger Facilities
for Delta Service to Amateurs

DELTA
WALTHAM

MFG. CO.
MASS. U.S.A.

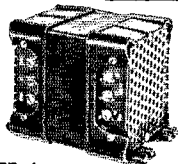

TYPE A

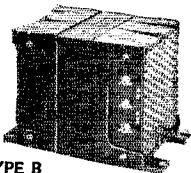

TYPE B

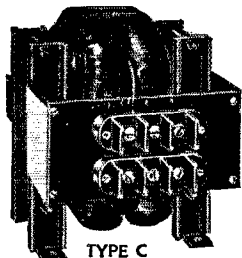

TYPE C

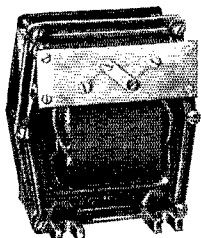

TYPE E



TYPE F



TYPE G

The Delta Manufacturing Company has moved into its new factory at Waltham, Massachusetts. It is about nine times the size of the former Delta plant.

Ever since the old Acme Apparatus Company was taken over by Delta about two and a half years ago, Delta has worked hard in its own chosen field; — that of turning A.C. into D.C. This work began in the laboratory, and among the fundamental developments already pioneered and published for the benefit of the Fraternity, under the direction of Delta's president and chief engineer, Frederick S. Dellenbaugh, Jr., have been:

Determination of voltage, current and power relations in rectifier circuits (QST, Feb. '32) and from these relations establishment of input choke design fundamentals (QST, Mar. '32); development of the Swinging Choke (QST, Mar. '32); establishment of allowable ripple and methods of ripple calculation and measurement (QST, April '32); plate transformer rating in terms of D.C. output (Delta Bul. 200-A, May '32); new procedure for economical design of smoothing filters (QST, April '32 and Feb. '33); design of choke coils and their rating by bridge measurements giving actual inductance under stated conditions (Delta Bul. 200-A, May '32); and a study of tunable hum and of methods for its elimination (QST, Jan. '33).

There has been a gratifying recognition of the fundamental soundness of Delta research and of the newer and better Delta products which have followed from it.

Delta's new plant is needed to supply the increasing demand from Amateurs for Acme-Delta Transformers, Chokes, Coupling Transformers, and Rectifiers; — to build Delta Rectifiers for Broadcast Stations, Theatres, and other users, — and to make Delta Voltage Regulators for a wide range of technical and industrial applications.

In its new laboratories, larger than Delta's entire former plant, Dr. Dellenbaugh with new facilities and equipment can work still more effectively toward a better understanding of power supply problems. And the new factory with its machinery of the latest type, its modern layout and improved working conditions will aid in turning this research into still better power-equipment for the Amateur.

DELTA MANUFACTURING 190 WILLOW STREET *Company* WALTHAM-MASS.

ELECTRICAL ENGINEERS AND MANUFACTURERS

F. S. Dellenbaugh, Jr.
President and Chief Engineer

G. E. M. Bertram
Treasurer and General Manager

A Unit of Raytheon Manufacturing Company

AMATEURS: Send for Delta Bulletin DL48-13, which lists new Delta Coupling Transformers for use with the new tubes and developed since the publication of our catalogue in QST, Dec. '33. We are ready with new transformers for use with the new sensational RK-20. Ask us about them.

BROADCAST ENGINEERS: Send for Delta Bulletin DL48-43, describing Delta Rectifier A.C. High Voltage Power-Supplies and C Supplies, for replacing motor generators in Broadcast Transmitters.

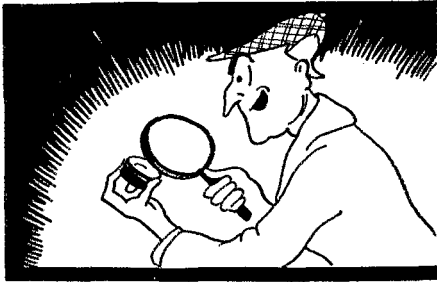

"Ah, my dear Watson, . . .

THERE'S no mystery about the popularity of this new RADIOHM for replacement jobs. You'll detect it at once . . . for it offers smoother, easier, better attenuation than ever before. Try a RADIOHM on that next job.

Note the protecting metal strip that "makes contact" with the resistance strip—noiselessly, smoothly, surely.

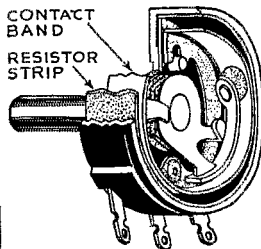

Every Radio Service Man should be a member of the Institute of Radio Service Men

Centralab RADIOHM

Central Radio Laboratories
Milwaukee, Wis.

would make it "CQ CQ de W8KQZ. No ducks, ark." Soon it would be "No dux" and you would hear it on every band if the idea is sound enough to work out. That is the question. Anyway this is a start, and maybe some one can perfect it so that we can eliminate a few of these "engineers' reports" and get a little communication started.

—R. F. Cutting, W8KQZ

A Plea for a Sense of Humor

Hanna, Alta.

Editor, *QST*:

Since Warner's reproof to 'phone hams using Philip's code appeared in *QST*, the doleful chorus has been taken up by hams who suffer from . . . an irrepressible desire to act as a . . . "corrective" influence bent on the uplift of the base notions, mannerisms and ethics of hams in general. The latest thing of this sort appears in a recent O.P.S. bulletin. We are told not to ask the usual questions on hum, modulation. . . . We must not use abbreviations used in code work. We must not tease, kid, laugh, rag-chew nonsensically because the BCL and SWL will get the impression the hams are not the serious, useful members of society that they should be. . . . We are told traffic's the thing. . . .

Now traffic has its place. I've handled lots of it. One percent of it was useful to somebody while the rest was plain bunk and a waste of time and money. However, if a ham wants to make the BPL I'm not getting in his way. That's his business. Emergency work is different. I take my hat off to any ham who does his stuff when the pinch comes. But the point is, the rag-chewing, nonsensical, laughing, kidding ham is every whit as valuable to his community when emergency work is to be done. In the recent flood work in the northwest states 'phone hams whose names have never appeared in traffic total lists rendered yeoman service.

Amateur radio is my hobby. In its pursuit I find the balm of Gilead. The ordinary life of the ordinary people from whence springs the great majority of hams is a dull, drab and somewhat dreary struggle. . . . There's seldom anything funny in it. It's too darn serious! To escape from it for a short time we all eagerly pursue various avenues of pleasurable enjoyment. . . . And so, please, Messrs. Warner and Handy, and a few others, please allow us to play our game our way so long as we abide by the rules. Let us laugh, live and have our being. The ham game is for hams. If the SWL doesn't understand the meaning of QRX or QRM let him become a ham and find out. . . . The plain truth is that the SWL gets a bigger kick out of a couple of hams rag-chewing nonsensically than he does out of a highly "proper" or traffic QSO. . . . The most popular programs on the h.c. band are the nonsensical—Amos and Andy, the Baron, Cantor, the Firechief. . . . The leopard doesn't change his spots, and neither does the BCL loose his sense of hu-

The GROSS "CW-25" Crystal Control Transmitter Kit . . . \$13.95

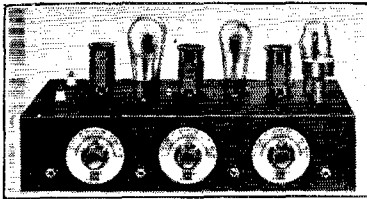

The "CW-25" transmitter kit due to its low cost makes it possible for anyone to own a modern crystal controlled station. A schematic hook-up and parts layout sheet as well as tuning instructions are furnished, thus enabling the most inexperienced operator to wire and put the set on the air, for real results. The "CW-25" is supplied with a shrivel finished sturdy metal chassis under which all parts are mounted, making the wiring and components dustproof. A plug-in crystal holder is furnished with the kit. Only one milliammeter is required for tuning the transmitter and each stage is provided with a jack for this purpose.

The "CW-25" uses one '47 as crystal oscillator, one '46 as buffer or doubler and two '46's in the amplifier stage. One set of three coils is supplied with the kit for 20, 40, 80 or 160 meter band. Any additional coils are 75 cents each.

The "EAGLE" Three-Tube Short Wave Receiver

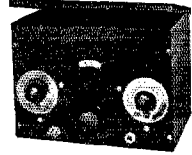

"Band Spread" over any portion of the tuning range — only finest material used thruout. Employs one '32 R.F., one '32 detector and one '33 Pentode Audio — 15 to 200 meters — four coils supplied. The "EAGLE" is economical — two dry cells will operate the filaments. See March or April QST for full description of this most excellent value in short wave receivers.

"Eagle" completely wired and tested. . . \$11.95 Three tubes tested in your receiver. . . \$3.00

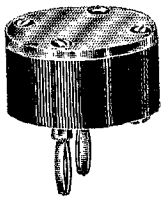

GROSS CRYSTAL HOLDER ONLY \$1.00

A commercial type crystal holder for half the price you have to pay for ordinary holders. New type pressure spring, square inside to prevent movement of crystal, one piece molded body — dustproof — will take crystals up to 1 3/8" square or round. Plugs standard 3/4" spacing. This holder must be seen to be appreciated for the extraordinary value offered.



Hoyt Antenna Meter

Hot wire antenna meters, 2 1/4" mounting hole, flange 3" diameter, supplied in 1 1/2, 3 and 5 ampere ranges. Why work without antenna meters when you can buy them at this special price? . . . \$2.95

Hoyt Milliammeters and Voltmeters

Perfectly damped meters at a price. These are not to be confused with the usual inexpensive meters. 2" mounting hole, flange 2 1/4" diameter, supplied in the following sizes: 10 ma, 25 ma, 50 ma, 100 ma, 150 ma, 250 ma, 300 ma, 4 V. A.C., 10 V. A.C., 15 V. A.C., 10 V. D.C. Price each \$1.30, 3 for \$3.60.

GROSS CASED POWER TRANSFORMERS

- 650 v ea. side C.T. 350 ma fila. 2-7 1/2 v C.T. and 1-5 v will give 500 v with choke input using 1-83 or 5Z3. You can run your entire R.F. and class B off this trans. \$5.50
- 750 v ea. side C.T. 300 ma fila. 2-7 1/2 v C.T. and 1-5 v. \$5.75
- 750-1000 v ea. side of C.T. 300 watts. \$6.65
- 850-1350-1500 v ea. side of C.T. 400 watts. (the ideal job to give 750-1000-1250 v D.C. with choke input) \$8.70
- 850-1350-1500 v ea. side of C.T. 550 ma. \$12.50
- 1500-2000 v ea. side of C.T. 800 watts \$11.70

FILAMENT TRANSFORMER FOR BRIDGE RECTIFIER

using 83 tubes 5 v-5 v-5 v at 3 amps C.T. — 3000 v insulation. \$2.15

Cased Combination Filament Transformer

- 2 1/2 V. C.T. 10 amps for 866's
- 10 V. C.T. 7 amps for '50's or '52's
- 10000 volts insulation. \$3.24

Filament Transformers shielded in metal cases, center tapped secondaries.

- 2.5 Volt 10 amperes for 866's \$2.25
- 10 to 12 Volts at 8 amperes. \$2.25
- Special 10-12 Volt 7.5 ampere filament transformer, extra special. \$9.95

Mounted Center Tapped Filament Transformers

- 2 1/2 v 8 a — 2 1/2 v 3 a — 5 v 3 a. \$1.29
- 2 1/2 v 4 a — 7 1/2 v 2 1/2 a — 7 1/2 v 2 1/2 a. \$1.29
- 2 1/2 v 4 a — 5 v 3 a — 7 1/2 v 2 1/2 a. \$1.29
- 5 v 3 a — 7 1/2 v 2 1/2 a — 7 1/2 v 2 1/2 a. \$1.29
- 2 1/2 v 6 a — CT (midget). \$7.74
- 5 v 3 a — CT (midget). \$7.74
- 6.3 v 1.5 a — CT (midget). \$6.69
- 7 1/2 v 3 a — CT (midget). \$8.89

The only **HARD DRAWN SPECIAL ENAMELLED COPPER WIRE** on the market. Made up to Western Union specs. This enameling is weather proof and fire proof. You can run 500 feet of this No. 14 wire without any appreciable stretch. Due to the great tensile strength of this wire larger than No. 14 is not required. Any length up to 1000 feet in one piece, per 100 ft. \$5.50

- 4 Section RF Chokes 125 ma — 2.5 mh — 50 ohms dc res. Isolantite form pig-tail mounting spec. \$3.99

EXTRA SPECIAL!!

866 tubes that carry our full guarantee — ISOLANTITE top — Heavy duty rectifiers. \$1.45

GROSS CASED CLASS "B" TRANSFORMERS

Heavy Duty — for use with 10's, 46's or 4-46's in push pull par. per pr. \$7.50
For 2-46's only, per pr. \$4.65

THORD. Cased Class B 210 Trans.

- T 5100 Input. \$2.94
- T 5101 Output. \$3.55
- Thord. 15 H 250 MA chokes. \$2.95
- Thord. 30 H 500 MA chokes. \$8.95
- Gross 30 H 200 MA cased chokes. \$1.94

HIGH QUALITY CASED COND.

- 2 mfd 2000 V. working. \$3.95
- 2 mfd 1000 V. working. \$2.10

GUARANTEED TUBES

- Gross 210 Thoriated filament. \$1.49
- 59's.98
- 888 or 871 Isolantite top.95
- 83, 47's, 46's.65
- 81's.80
- 3/4, 1/2 and 1 watt Neon Bulbs.35

510 Type Tube Isolantite Base

Lava bar insulation — Thoriated filament — the kind of tube we like to sell. Will take 750 volts on the plate. Ideal for the higher frequencies. Special. \$2.59

- JOHNSON Transposition Insulators. \$.09
- Airplane Strain Insulators.05
- 12" Antenna Insulators.45
- White or black 1/2" and 1" Stand offs, doz.50
- White or Brown Beehive Ins., doz.45
- Isolantite spreaders 3" long, 10 for.35

WARD LEONARD Vitreous Resistors 160-Watt 8 1/2" Long with Variable Sliders.

- 1000 ohms. \$.99
- 2500 ohms. 1.05
- 5000 ohms. 1.05
- 10000 ohms. 1.11
- 15000 ohms. 1.20
- 25000 ohms. 1.29
- 35000 ohms. 1.35
- 50000 ohms. 1.44
- 60000 ohms. 1.49
- 80000 ohms. 1.59
- 100000 ohms. 1.65

Universal Antenna Coupling System Inductances

Wound on threaded double X natural bakelite tubing, can easily be tapped with clip supplied, ea. \$1.75
(use one coil for single-wire feed and two coils for two-wire systems)

Low C 40-80-160 Meter Amplifier Coils

(see transmitter by GRAMMER page 46 May QST) Plug-in, wound on threaded Natural bakelite tubing, will tune with 50 or 75 mmf condenser any size, each. \$2.00

WARD LEONARD special keying relay works on 2 1/2 V. D.C. or 7 1/2 V. A.C. \$4.20

GROSS uncased Class B transformers for '46's or '53's special per pair. \$3.85

SHURE double button microphone. \$3.90

AEROVOX cased 1 mfd 400 V. D.C. working. \$.48

NEW!! RAYTHEON RK-20 Tube \$15.00 see page 71 May QST

20% deposit with all C.O.D. orders. Remit by M.O. Include postage

GROSS RADIO, INC.

51 VESEY STREET

NEW YORK CITY

For Beginners' RECEIVERS

The Eveready Air Cell "A" Battery is the best form of primary battery energy for use with beginners' receivers. Used with the beginner's TRF receiver*, it will give over 1300 hours service at a lower cost per hour than dry cells. And it eliminates continual adjusting of the rheostat because of falling "A" battery voltage.

*Described in March QST.



If your investment restricts you to the use of a pair of dry cells, then use the best on the market... Evereadys!

**WITH THE
METAL
SEAL TOP**

A patented Eveready feature. Protects against leakage, bulging, breakage and insures long service life.

EVEREADY
COLUMBIA
BATTERIES

NATIONAL CARBON COMPANY, INC.

General Offices: New York, N. Y.

Branches: Chicago, San Francisco



Unit of Union Carbide and Carbon Corporation

mor when he becomes a SWL. So why frown upon ourselves? . . . Let's be natural! Let's be human!

—W. R. Roberts, VE4GM

GBA

3645 Rowena Ave., Los Angeles, Calif.

Editor, QST:

I feel the urge to get a few words off my chest in regard to an evil in amateur traffic handling. Too many messages come through with no other address than a 'phone number!! It is the duty of every station originating a message to get the complete name and address — plus the telephone number, if it's available — on each message he accepts for transmission.

A few weeks ago a W9 gave me a message addressed: "Mr. G. Brown, Phone Morningside 1254," neglecting to give the street address or even the city of destination! When asked about the rest of the address he repeated the text four more times, and wound up by asking if my QRA is Los Angeles. He could not GBA, and the message is still undelivered because of an incorrect 'phone number. I still have 347 Browns to call and ask if they know anyone in Podunk who might send them a radiogram. If I connect with the right one, the message will be too old to be of any value. Give the man at the *delivery* end a chance.

— Robert O. Cook, W6WV

Practical Transmitting Circuits for Suppressor-Type Screen-Grid Tubes

(Continued from page 16)

volts. With the later box-type plate models, however, the bias is approximately —45 volts. The carrier power output is now quartered, as with a Class-B linear amplifier—and modulation is in order. There are no other adjustments to be made in the r.f. circuits.

HIGH-POWER TRI-TET OSCILLATOR

The small excitation requirement previously mentioned especially fits this tube as a high-power Tri-tet oscillator that is actually easier on the crystal than the usual circuits using small tubes. The circuit of the arrangement shown in the photograph, from which we obtain 65 watts on the fundamental and 30 watts on the second harmonic with a 3500-ke. crystal, is given in Fig. 3. Except for its grid-filament portion, it is identical with the amplifier arrangement. This is a conventional Tri-tet circuit adapted for a filament-type tube, the cathode coil consisting of two sections effectively in parallel for r.f. As with any Tri-tet, the cathode tuning should be adjusted for maximum plate output (*not* for maximum cathode tank current or for maximum grid r.f. voltage). Maximum output occurs with d.c. grid current of only 5 ma. and crystal r.f. current of less than 50 ma., by actual measurement. And the output is free from frequency modulation when used for 'phone, with the same adjustment procedure just given for the amplifier. Could a completely modern and perfectly legal 15-to-20-watt 'phone be much simpler?

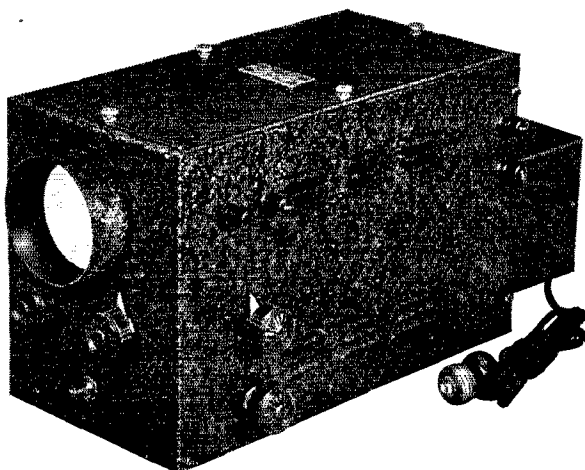

CATHODE RAY OSCILLOSCOPE

Direct and easily interpreted indication of Percentage Modulation, Signal Distortion and Peak Voltage, make the Cathode Ray Oscilloscope an almost indispensable tool in adjusting the modern transmitter. Your dealer has it in stock. The net price, less tubes, is \$17.70 (40% off \$29.50 List Price).

NATIONAL COMPANY, INC., MALDEN, MASS.



THE IMPROVED CATHODE-RAY OSCILLOSCOPE

Linear sweep model for broadcast stations and advanced amateurs, physics labs., etc.

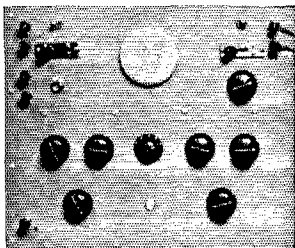

This instrument embodies all features ordinarily contained in only the highest priced Cathode Ray equipment.

- Controlled linear sweep 0-150,000 C.P.S.
- Controlled external sweep.
- Freq. locking device for sweep frequency.
- Picture centering adjustments.
- Wide range focus adjustments.
- Complete component shielding.
- Unit is self contained and includes batteries and 110V-60 cycle power supply.
- Tubes RCA 906-885-234-281-280.

COMPLETELY EQUIPPED READY TO USE

F.O.B. Newark—\$85.00

TUBES

to fit the depression pocketbook of the amateur fraternity. These tubes are first class products and carry our absolute guarantee for 90 days.

281	\$.90	866 HD	\$1.50
281 Mercury ..	1.35	203A	9.35
210 — 15W ..	1.15	211	8.75

FILTER CONDENSER SPECIAL

Dubilier 903 — 6 mfd—900V.....\$.73

The revolutionary
HAIGIS DUPLEX
5-METER TRANSCEIVER...\$17.40

FILAMENT TRANSFORMER — 2 windings — 2½V @ 3A — 7½V @ 3 Amp.....\$1.45

PLATE TRANSFORMER — two 7½ and two 2½ volt fil. windings — 750-750-160 mils.....\$3.50

DUPLEX POWER SUPPLY

1100 v. 250 ma. and 550 v. 250 ma.

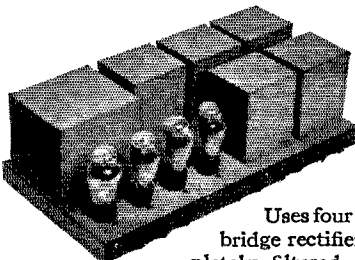

\$35.00

Uses four 83's in a bridge rectifier—completely filtered in both voltage legs.

These units can be had on special order in any size mounting or form

We are specializing in transmitter construction to customers' orders and specification. Write for quotation on your favorite transmitter.

Special code classes for beginners. No charge. Telephone for appointment.

KALTMAN & ROMANDER
62 Court St. Newark, N. J.

Strays

W9NHN constructed an inexpensive and good-looking transmitter rack by purchasing a metal household utility cabinet, substituting a wood panel for the back, and painting with black shoe dye, a non-conductor. These cabinets come in sizes suitable for transmitter racks and have five or six metal shelves. The hinged doors form the back of the rack, and the transmitter is shielded and protected.

Lives there a ham with soul so dead
Who never to himself has said:

"What in heck has that mailman done

With the card from Contact Number One?"

—WIABG

Among the articles carried by Col. Lindbergh on his recent tour of the countries bordering on the North and South Atlantic, and now on display at the American Museum of Natural History in New York, is a red-covered copy of *The Radio Amateur's Handbook*.

—Harry J. Johann

Automatic G. C. With Diode Detection

(Continued from page 28)

mum sensitivity. It may be found that it is advantageous to make R_1 adjustable, with SW_1 shorting out all but part of it. All sets will not be alike in this respect, so a trial will be necessary to determine, by using the tuning meter, the exact change in cathode bias required to keep the meter reading the same with the c.w. beat oscillator on and off.

This reminds us of one feature, the tuning meter, which manufacturers have discontinued in the scramble for cheaper sets. *The tuning meter is absolutely essential to obtaining the utmost from a set using a.g.c.* Tuning without one is mostly guess-work on 'phone reception. The meter doesn't need to be highly accurate, either. One of the higher-resistance type (sold as voltmeters) which will carry the proper current (approximately 10 ma.) at full scale will do quite nicely. For a 58 or 78 tube this can be a Readrite Type 55 (No. 310) or its equivalent. The screen bias of the tube with which it operates can be varied a little until the desired reading is obtained at full sensitivity. Since it is not the purpose of this article to sell anything, it might be well to say that if there is a more expensive 10-ma. meter around that you don't mind tying up this way, why go to it. The mechanical placing of the meter on the panel of the set is a matter of personal preference, but it is advisable to have it as close as possible to the tuning dial, so that it can be seen simultaneously with the latter.

There is another use for the tuning meter which should appeal to all. It makes an excellent

THE MOST COMPLETE BOOK ON AMATEUR RADIO EVER PRINTED

the eleventh edition

RADIO AMATEUR'S HANDBOOK

The new eleventh edition of the Radio Amateur's Handbook is a complete revision and enlargement from the previous edition. It is the standard of the world as the textbook of Amateur Radio. Its 260 pages and 224 illustrations are a complete education in the technique and practices which have been developed through the years—right up to now.

*It is the Radio Amateur's
No. 1 piece of equipment—
order your copy today*

Price

\$1

postpaid anywhere

(in buckram binding, \$2)

THE AMERICAN RADIO RELAY LEAGUE, INC.
West Hartford, Connecticut

HERE THEY ARE!!



REALLY PORTABLE TRANSCEIVERS with battery space in same case

This feature will be appreciated by anyone doing serious 5 meter work in the field.

SOLD AT PRICES YOU WOULD LIKE TO PAY BUT NOT BUILT DOWN TO THOSE PRICES

NATICO transceivers can be supplied in three models, all of which have the same outward appearance.

Type TR-1: Battery Model **\$10.95** (less tubes and batteries)

This NATICO 5 meter transceiver is strictly portable, allowing two way communication even when being carried. This is accomplished by the fact that the two dry cells and 90 to 135 volt B battery are self contained in the one case.

TUBES REQUIRED: One 30 and One 33

Type TR-2: Mobile Model **\$11.95** (less tubes, battery or eliminator)

Specially designed for automobile use or wherever a 6 volt battery is available. The case has sufficient space to hold the 135 to 180 volts of B battery or a 6 volt B Eliminator which eliminates the necessity of all B batteries.

TUBES REQUIRED: One 76 and One 41

Type TR-3: A.C. Model **\$16.95** (including power supply, less tubes)

Here you have a portable A.C. transceiver which includes power supply in the same case (size only 6½" x 7¾" x 12¾"). It can be operated anywhere that 110 volt A.C. is available.

TUBES REQUIRED: One 76, One 41 and One 80.

ACCESSORIES:

Matched Tube Kits for —

TR-1	\$ 1.95
TR-2	1.75
TR-3	2.15
6 VOLT B Eliminator for TR-2	11.50

Natico's Exclusive Distributors:

GROSS RADIO INC.
51 VESEY ST. NEW YORK CITY

R-meter for making carrier strength comparisons. For this purpose the maximum-signal plate current of the tube with which it is operated is "9" on the meter scale, with just enough points between here and 0 (maximum sensitivity) to give the required R-calibration. To mark the scale, remove the glass with its retainer just in front of the panel bezel with a small screw driver. With a little care, this can be accomplished without scratching the meter, leaving no visible marks to show that the instrument was ever apart. Then, when John Jones over in Jonesburg asks how he's coming through, you can tell him he's only R7 to-day instead of his usual R8, and know it's so.

In conclusion, it is sincerely hoped that the diode-pentode system with automatic gain control has been explained here so that others will be able to use it and to go ahead with further improvements. The footnote references given, if carefully studied and coordinated, will be found to give essentially the same results as have been shown in this article.

Ham Station Analyzer

(Continued from page 38)

easily whether the modulated amplifier or linear output amplifier is being operated properly. This is the reason for the cathode or filament bias resistor and the closed circuit jack which normally shorts out this resistor. If 135 volts of B battery are plugged into the jack, the bias resistor is automatically connected in the circuit and we have a linear detector. The plug should be in the jack before the battery is connected, as otherwise the batteries will short-circuit when the plug is inserted. Close coupling of the analyzer to the transmitter must now be avoided as the added plate potential supplies an ever-waiting current capable of wrapping the needle around the pin. "Kicks" with modulation show that there is over-shooting. It is obvious that by connecting 'phones in series with the batteries, an excellent listening monitor for 'phone is provided. It is no longer necessary to get the other fellow's opinion of the transmitted signal. He may be confused by fading, static, or interference. In all likelihood, he doesn't know as much as you do about good quality anyway.

OUTPUT METER

Still another use is as an output meter for receiver testing. By removing the coil and substituting a suitable resistance coupling unit, receivers of the superhet type may be readily aligned. Hum level may be checked and any improvement read directly on the meter. In fact, most any kind of vacuum-tube voltmeter measurement can be made. As stated before, most amateurs are interested in comparative rather than quantitative measurements. It is quite easy, however, to calibrate the instrument and secure accurate readings which may be kept for reference.

Constructional details require little comment due to the simplicity of the analyzer. The only precaution necessary in the wiring to the coil socket, tube, and tuning condensers is to make all

The Name behind the Product

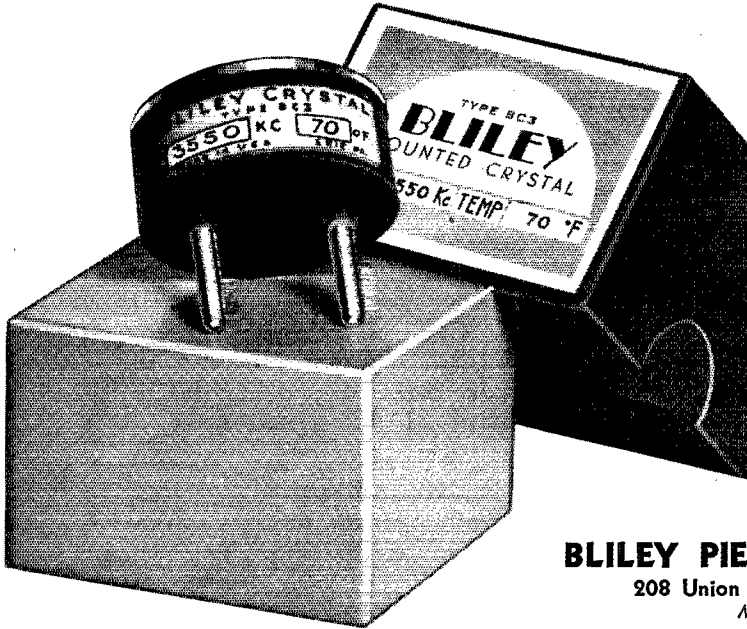

TODAY'S exacting spotlight focuses on quality. A new age, with its keener valuation of worth, has set up new standards. "We thought the first Bliley Crystal was made as good as was possible to make it. Our crystal today shows material improvement over that first one. We shall constantly strive to better this one. "But of this you may be assured: our products always bear the name "BLILEY" . . . a name which to you is a guarantee of quality and satisfaction, and which to us is a pledge of faith between this company and the users of its products.

BLILEY PIEZO-ELECTRIC CO.

208 Union Station Bldg., Erie, Pa.

Mfg. under NRA

PANELS — BAKELITE — RUBBER — ALUMINUM
All Sizes Cut to Order **BAKELITE TUBING & RODS**
Drilling, Engraving & Special Work
ALUMINUM CANS—Stock sizes. Special sizes, made to order.
ALUMINUM CHASSIS—Threaded brass studs for 6/32 screws.
Length from 1/4" to 6"—price 5c to 30c.

Insulating bushings for all size shafts
Bakelite Tubing Threaded to Specifications.
UNITED RADIO MFG. CO. *Est. 1923* 191 Greenwich St., New York

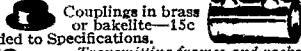

No Amateur Can Afford to Miss a Single Issue of This Publication!

Subscribe Now

50c
Per Year—
(12 issues)



A Valuable
Addition to
the Library of Every Amateur

The monthly technical periodical, published by the Aerovox Corporation, the world's largest and leading manufacturer of condensers and resistors, for radio servicemen, experimenters, technicians, and engineers, gives first hand, authoritative information on the latest developments in radio and the proper uses of condensers and resistors in various circuits. Articles appearing regularly in each issue contain non-commercial information on subjects covering many of the important problems met with in everyday radio practice, and are not found in any other publication of its kind.

Send for a Free Sample Copy or Mail This Coupon with 50c for a One Year Subscription

AEROVOX CORPORATION (QST 634)
73 Washington Street, Brooklyn, N. Y., U. S. A.

Gentlemen:

Kindly enter my name on the RESEARCH WORKER mailing list for one year beginning with the next issue for which I am enclosing \$..... 50c per year in U. S. A., 60c in Canada and Foreign Countries.

Send me a FREE Sample Copy of the RESEARCH WORKER.
 Send me the latest 1934 Catalog of Aerovox Products.

Name.....
(PLEASE PRINT)

Address.....City.....State.....

Kindly check classification of your connection in Radio.
Manufacturer Engineer Dealer Jobber Serviceman Amateur Student Broadcast Station Research Lab.

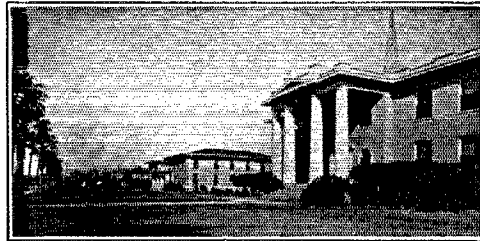

In 3 to 7 months we train you to secure government license. Course consists of Wireless Code, Radiophone, Microphone-Studio Technique, Television, Service, Police, and Aeronautical Radio. We are authorized to teach RCA Institutes, Inc., texts. Return coupon for details.

Name.....
Street or Box.....
City and State.....

PORT ARTHUR COLLEGE

PORT ARTHUR, TEXAS



RK-20



THE NEW RF PENTODE POWER AMPLIFIER

Designed for Suppressor Grid Modulation
R.F. Output 50 Watts

REQUIRES APPROXIMATELY
ONE WATT EXCITATION AS RF
AMPLIFIER AND LESS THAN
ONE WATT AUDIO POWER FOR
100% MODULATION

*For complete information
see your amateur supply
dealer or write to the
Raytheon office near you*

AMATEUR NET PRICE

\$15

**RAYTHEON PRODUCTION
CORPORATION**

30 E. 42nd Street New York, N. Y.

or

San Francisco — Chicago — Newton, Mass.

leads as short and direct as possible. The various pin straps within the coils should also be short, particularly in the high-frequency coils. The meter should be mounted and wired in last to eliminate chance of damage to the meter during construction. The circuit should be carefully checked before inserting the tube and turning on the battery, as one mistake will convert the meter into a corpse for lamentation.

We have in the completed instrument a compact device, completely self-contained for most measurements. External connections to the milliammeter alone are provided by means of the two insulated binding posts. All of the uses mentioned concern radio or audio frequencies. But every amateur is also interested in the various d.c. currents and voltages around the shack, not forgetting resistances which have a habit of losing their labels. Hence the one-mil meter used is a stock Triplett type which has, in addition to the usual linear scale, a number of voltage scales, together with an ohmmeter scale. A companion unit, also utilizing this meter, provides voltage, current, and resistance measurements covering practically every amateur requirement.

Strays

If bakelite rod is not available, celluloid knitting needles, purchasable at any dry-goods store, will make a good substitute. They can be obtained in thicknesses from one-eighth to one-quarter inch.

Dry-goods store also can furnish darning needles, which are a great help in chasing fine wires through the pins in coil forms.

— T. Bruce Kingsford

Weird wireless wisdom is not confined to this country. ON4MO reports that the head man of his local b.c. station explained the wobble in the carrier frequency by the fact that two powerful stations on either side of him were trying to elbow him out of the b.c. band. His weak carrier couldn't stand the pressure and was wiggled back and forth!

Low-Cost Crystal Control

(Continued from page 20)

tained. However, it is not recommended that the system be adjusted with no load and then the load applied for, although it may not shift the frequency of the TNT tank out of the allowable band, it may place such a strain on the system that any additional strain may throw the system out of synchronism. Once the system is adjusted it does not need the "retouching" at the beginning of every working period that some fellows give their crystal transmitters. At W5VU the transmitter stays in synchronism from day to day with as much, if not more, fidelity than the ordinary crystal system. As a safeguard the frequency is checked at the beginning of each transmission, of course. The rougher the TNT's own note the easier it synchronizes.

... A Statement of Policy

Of course we sell our merchandise at a profit, otherwise we could not stay in business, BUT we keep our prices as low as it is possible.

MOST IMPORTANT—We guarantee every piece of radio apparatus 100%. If, after five days, you are not satisfied with any purchase you make from us, return it for a cash refund. No questions asked.

TUBES

VTE 203A (A real 50 watter).....\$9.00
RS 830 (40 watter)..... 5.95
866's (750 V. Inverse Peak)..... 1.69
841 (Triad)..... 2.50
R.K. 18..... 10.95
R.C.A. 80..... 10.00

Guaranteed 90 days

VALPEY CRYSTALS

1750 K.C. } \$2.25
3500 K.C. } .05%
7000 K.C. } Accuracy \$3.50

CRYSTAL HOLDER with 40 and 80 M. electrode plugs in G.R. jacks. Very Fine Business.....\$1.00
NATIONAL SETS AND PARTS 40% DISCOUNT

PYRANOL CONDENSERS 2 MFD

2000 VOLTS \$2.50

Operating these condensers is a lifetime proposition. Buy these and forget filter troubles.

Go-Devil Bug.....\$5.95

866 Fil. Trans. 2.5 V.—10 Amps.....\$2.75

1000 Mill. R.F.C.....\$9.00

CARDWELL

164B—220 MMFD—.07.....\$2.40
147B—440 MMFD—.07..... 4.20
T—199—330 MMFD—.248 6.00
T—183—110 MMFD—.171 5.40
519—Neutralizer 852..... 2.16
156B—Split Stator..... 3.60
157B—Split Stator..... 4.80

Full line in stock 40% Discount

Plate and Filament Transformers

600-0-600—150 Mills—7.5 V.C.T. at 3 amps—5V. at 3 amps.....\$5.50
600-0-600—2.5 C.T. at 3 amps—5V. at 3 amps.....\$5.50
750-0-750—300 Mills—7.5 C.T. at 3 amps—5 V. at 3 amps.....\$7.50
2.5 V. 5 A. \$1.00; 7.5 V.T., 3 A. \$1.00;
6.3 V. 5 A. \$1.45.
30 H. 200 M ch. \$2.50; 20 H. 200 M ch \$2.25; 20 H. 150 M ch \$1.25.

TRIPLETT METERS

0-100 mills. D.C.; 0-200 mills. D.C.;
0-300 mills. D.C.; 0-500 mills. D.C.;
0-15 A.C. Volts.....\$3.85
0-1. 0-2.5 Thermo— Couple Ammeter.
All 3 1/4 Bakelite Cases.....\$6.66
TOBE 5 MFD., 1000 V. Condenser.....\$2.50

Johnson Stand Offs......06
.00014 Variable Cond......90

5 METER SPECIALS

Audio Trans. with mike winding \$1.20
Output Transformer......90
Siekles 5M. Kit..... 1.20
4 Pole D.P. Toggle switch......84
K.K. 3" Vernier......49
R.C.A. S.B. Hand Mike..... 1.19
Aluminum Finished Can.
4 1/4" D x 7 1/4" x 5 3/4" H......39

Mail Orders Filled—Include Postage
Prompt Service on All Orders

THE RADIO SHACK

46 BRATTLE STREET
BOSTON, MASS.

COMPLETE 50 WATT C. W. TRANSMITTER

\$110.00

On rack 18" wide 30" high—59 xtal osc. 841 driver 830 amplifier. A splendid job. Picture and description on request.

CQ—AMATEURS of the West

Just off the Press, send for your copy

1934 CATALOG

All Nationally advertised parts
for Transmitting and Receiving
Lowest Prices

RADIO SUPPLY CO.

H. A. DEMAREST, President

912-14 So. Broadway Los Angeles, Calif.
(W6FBI, located in Building)

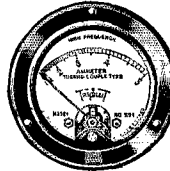

TRIPLETT METERS

AC—DC—RF
IN STOCK FOR
IMMEDIATE SHIPMENT

HAMMARLUND "PRO"
AND "FBXA" NATIONAL

Write for free catalog

CAMERADIO

603 GRANT ST.
PITTSBURGH -- PA.



FREE Holder with each crystal purchased

Prices of crystals ground to your specified frequency in the amateur bands accurate to 0.1%. Calibration accuracy 0.03%.

1750 & 3500 kc. bands..... \$4.50 each
7000 kc. band..... 5.50
Bakelite, plug-in holder..... 1.50
(Holder free with each crystal purchased)
Jacks to plug holder into..... .15 pair

Temperature controlled ovens and crystals for commercial use quoted on at your request.

USE CRYSTALS OF PROVED DEPENDABILITY

—the result of 5 years of specializing in this field

When you want efficiency in your transmitter—start at the crystal stage by using PRECISION CRYSTALS. They give more power from the crystal oscillator unit which is so important with the transmitter of just a few stages.

Don't practice false economy by purchasing ordinary crystals—it will pay you to buy PRECISION CRYSTALS.

PRECISION CRYSTALS are X cut, one inch square from the best grade of Brazilian quartz, scientifically ground for maximum power output and thoroughly tested.

When ordering a PRECISION CRYSTAL you are assured of the finest obtainable. Use the best.

Not a dissatisfied customer in 5 years.

PRECISION PIEZO SERVICE

427 Asia Street

Baton Rouge, La.

AT YOUR FINGERTIPS



ALL

- ▶ developments in the high-frequency field
- ▶ transmitting and receiving circuits of interest to you
- ▶ regulations governing amateur radio communication
- ▶ good practical ideas of active amateurs

will be found in your file of *QST*, but — are yours in any semblance of order? Can you say that you can find information you need without a great deal of research? If you cannot, you need *QST* in *BINDERS* — properly indexed. You will find that they will more than pay for themselves. Single copies may be removed at will but because of the way that the binder opens (so that the copy is flat and easily read) there should seldom be a need to do this.

Each *QST* *BINDER* holds twelve issues of *QST* and the yearly index. It is a good-looking binder, sturdily constructed to not only keep your file in order but also to keep your copies in good condition. You will find it a good investment.

Priced at

\$1.50 postpaid

AMERICAN RADIO RELAY LEAGUE
West Hartford, Connecticut

The crystal note obtained from a crystal transmitter of this type is governed by the same factors that govern any other crystal set. The outfit has been in operation since early in August and it has never failed during a transmission; and ninety-five per cent of the contacts have been "XPDC" and the remaining five per cent "PDC." The number of QSA5 R8 and R9 reports has increased about twenty per cent and ease of contacting has improved. The wave is much sharper. Local stations that had trouble working at all while the TNT was in operation report that the crystal controlled TNT covers only a small portion of the dial.

In summing up the results it can be said that the system has proved itself beyond all skeptical expectations. It is not "tricky" and is just as reliable as any other crystal system if care is used in its adjustment. Since the TNT oscillator furnishes most of its own excitation, the doubler does not furnish any great excitation to the TNT oscillator. For this reason the '46 would probably control a one-kilowatt transmitter just as easily as it controls the 212-D and there is no worry about sufficient excitation. The subsequent locking of the two circuits in synchronism slightly increases the plate current of both tubes.

If any difficulty is experienced in keeping the TNT synchronized with the crystal, and the crystal and doubler have been checked and found to be functioning properly, the trouble can probably be attributed to insufficient radio frequency synchronizing current. This can be remedied by increasing the coupling between the doubler tank and TNT grid circuits.

W6ETX

(Continued from page 46)

XYL, who also holds the call W6CTZ, is second operator. The transmitter is a 40-meter crystal-controlled rig using a 47 oscillator, 47 doubler, 10 buffer and 203-A final. A 1500-volt plate supply for the last stage permits inputs in the neighborhood of 300 watts. A 40-meter Zepp, 40 feet high, gets the signals out into space. The receiver is a tuned-r.f. outfit using two-volt tubes — 32 r.f., 30 detector, and two audio stages with 30's.

DX worked on 7 mc. includes all states, Mexico, Cuba, Japan, Canada, Hawaii, and New Zealand.

Technical Questions Answered

(Continued from page 37)

connected between cathode (or filament center-tap) and negative high voltage, the total plate current of the tube flows through the resistor, causing a voltage drop across the resistor. If the grid return is connected to the negative high voltage end of the resistor, there will be a difference of potential between grid and filament equal

Dependable

INDICATION

WESTON Radio Instruments

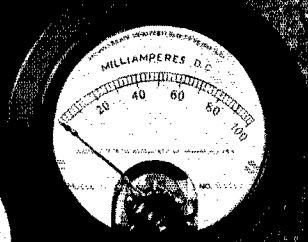
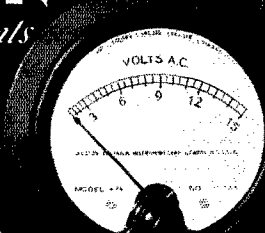
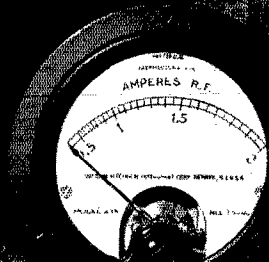

Weston Electrical Instrument Corp.
602 Frelinghuysen Avenue
Newark, N. J.

WESTON ELECTRICAL INSTRUMENT CORPORATION
602 Frelinghuysen Avenue, Newark, New Jersey

Send *Name*.....
Bulletin on *Address*.....
Weston Radio *City and State*.....
Instruments.

NEW! Wing produces an improved 5-meter transmitter-receiver, available shortly. Built with the basic features of earlier models yet improved to give still better performance. Porcelain antenna bushings with direct connections. Same model may be used with DC or AC. Higher output. No connections to back of case and complete unit may be lifted by unscrewing four thumb screws. Same solid aluminum box and attractive black wrinkle lacquer finish. An improved outfit at the same cost — only \$16.50 less tubes.

CHAUNCEY WING'S SONS GREENFIELD, MASS.

GULF RADIO SCHOOL

Radiotelegraphy Radiotelephony
Radio Servicing

SECOND PORT } 1007 Carondelet Street
U. S. A. } NEW ORLEANS, LA.



NEW GAMMATRON TRANSMITTING TUBE

Many distinctive new advantages, plus PIONEER DEPENDABILITY. 100 watts plate dissipation. Write for prices and free circular.

HEINTZ AND KAUFMAN LTD.

Radio Engrs. and Mfrs. since 1919

311 California St., SAN FRANCISCO, CAL.

FOR

finicky

PEOPLE

The
Radio Amateur's

HANDBOOK

in stiff Buckram covers

\$2.00 postpaid

THE AMERICAN
RADIO RELAY LEAGUE, INC.

West Hartford, Conn.

A.R.R.L. EMBLEM

—insignia of the radio amateur



In the January, 1920, issue of QST there appeared an editorial requesting suggestions for the design of an A.R.R.L. emblem—a device whereby every amateur could know his brother amateur when they met, an insignia he could wear proudly wherever he went. There was need for such a device. The post-war boom of amateur radio brought thousands of new amateurs on the air, many of whom were neighbors but did not know each other. In the July, 1920, issue the design was announced—the familiar diamond that greets you at the top of this page—adopted by the Board of Directors at its annual meetings. It met with universal acceptance and use. For fourteen years it has been the unchallenged emblem of amateur radio, found wherever amateurs gathered, a symbol of the traditional greatness of that thing which we call Amateur Spirit—treasured, revered, idealized.

DO YOU WEAR THE A.R.R.L. EMBLEM?

THE LEAGUE EMBLEM, IN HEAVY ROLLED GOLD AND BLACK ENAMEL, IS AVAILABLE IN EITHER PIN OR BUTTON TYPE.

There are three special colors for Communications Department appointees. . . .

- ▶ Red background for the SCM
- ▶ Blue background for the ORS
- ▶ Green background for the RM

Red and green available in pin type only; blue may be had in either pin or button style. All Emblems priced the same. . . . \$1.00, postpaid.

American Radio Relay League
West Hartford, Connecticut

to the voltage drop across the resistor and the grid will be negative by this amount in respect to the filament. Neglecting grid current which also flows through the resistor, the voltage drop across the resistor, in other words the grid bias voltage, will be equal to the product of the value of the resistance in ohms and the plate current in amperes. The actual bias will be somewhat higher than this calculated value due to the grid current previously mentioned in the case of all but Class-A amplifiers. The calculated value, will, however, be satisfactory for all practical purposes.

From the above, it follows that bias to complete plate current cut-off cannot be obtained, since at cut-off the plate current is zero and with zero plate current no voltage drop could be developed across the biasing resistor. The proper resistance in ohms for Class-C operation will be equal to the biasing voltage necessary for Class-C operation divided by the plate current in amperes; and the necessary wattage rating for the resistor may be determined from the product of the plate current in amperes squared and the resistance of the resistor in ohms. This method may be used, of course, for either transmitters or receivers. For transmitters, it is usually advisable to make the resistor variable for final adjustment. It should be remembered that, when using this system of biasing, the available plate voltage is lowered by the amount of biasing voltage used.

—D. H. M.

What About the Simple Receiver?

(Continued from page 13)

that the plate power-supply, if an eliminator, is free from tunable hums. If the receiver is quiet and stable throughout the entire range, the antenna may be connected. If hum and body capacity now appear at some part of the range, the antenna length should be investigated, as described previously. It should not be difficult to find a length which will permit stable operation in the amateur bands at least.

RESULTS

Despite inherent shortcomings, particularly with respect to selectivity, the service-per-dollar ratio of a two-tube receiver of this type can be satisfyingly high. Listening in on the gadget restores one's faith in the ability of inexpensive apparatus to do a good job for the amateur who makes up in enthusiasm and operating ability what he lacks in cash. The operating ability, in fact, is bound to be acquired; one can't do the concentrating required to pull a wanted signal out of a mess of QRM without learning something. There are plenty of times, though, when QRM is not much of a problem, and at such times the two-tuber can hold its own with the best of them. Don't be surprised if the signal strength is considerably more than "comfortable" headphone volume; modern receiving tubes have a real punch. And the DX still rolls in on a detector-and-one-step.

ALUMINUM BOX SHIELDS

Genuine
"ALCOA"
stock

SPECIAL \$1.15
6" x 5½" x 6"

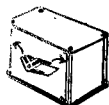

Something New!

Your call letters, or any marking for your panel, on BLACK aluminum ribbon. Looks like engraving on bakelite. 5c up to 2 inches, 5c each additional inch. Sample 8c.

PAWOOD CIRCLE CUTTER

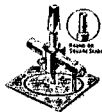

Simplifies cutting of Meter and Socket Holes, etc. Heavy duty tool equipped with tool steel cutter, for use in hand brace or drill. Cuts aluminum, and other metals, hard rubber, bakelite, etc. Adjustable 1" to 5½" diameter.

PAYS FOR ITSELF ON FIRST JOB in time and labor saved. Does a perfect job in a few minutes.

ARGON Lamps, 50c

BLAN, the Radio Man, Inc. 177A Greenwich Street
New York City

HOW'S YOUR SUPPLY OF —



MEMBER'S STATIONERY

Write your radio letters on League stationery — it identifies you. Lithographed on 8½ x 11 heavy bond paper. Postpaid. 100 sheets, 50c; 250 sheets, \$1.00; 500 sheets, \$1.75.

Neatest, simplest way to deliver a message to a near-by town. On U. S. stamped postals 2c each. On plain cards (for Canada, etc.) 1c each postpaid.

MESSAGE DELIVERY CARDS

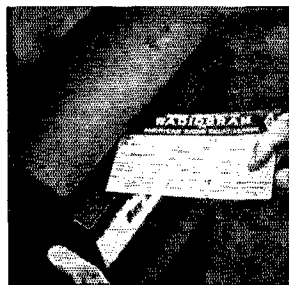

THE AMERICAN RADIO RELAY LEAGUE—WEST HARTFORD, CONN.

RADIO ENGINEERING

RCA Institutes offers a combined course of high standard embracing all phases of Radio. Practical training with modern equipment at New York and Chicago schools. Also specialized courses and Home Study Courses under new "No obligation" plan.



Illustrated catalog on request

RCA INSTITUTES, INC. Dept. ST-34

75 Varick St., New York. 1154 Merchandise Mart, Chicago
Recognized Standard in Radio Instruction Since 1909

LOW PRICES

"Go-Devil Bug".....\$6.00
Franklin filament transformers: 2½ v. c.t. 6 A.; 2½ v. c.t. 9 A.; 7½ v. c.t. 3 A.; and 6.3 v. c.t. 3 A., each.....\$.89
Stancor Power Transformers, horizontal mtg., 4 tube 84c; 5 tube 89c; 6 tube \$1.30; 7 tube \$1.49; 8 tube.....\$1.95
Bruno velocity microphone kits.....\$5.88
Bruno condenser microphone kits.....\$2.94
Franklin fila. transf. 2½ v. c.t. 12 A., 5 v. 3A. c.t.....98c
Franklin fila. transf. 2½ v. c.t. 12 A.; 2½ v. c.t. 3 A.; 5 v. 3 A.....\$1.19
Franklin power transf. 660 v. c.t.; 60 m.a.; 2½ v. c.t. 12 A.; 5 v. 3 A.....\$1.35

A complete line of parts for the amateur stocked. 20% with order, balance C.O.D. Postage extra. Remit by M.O.

Maurice Schwartz & Son

710-712 Broadway Schenectady, N. Y.

TRUVOLT RESISTOR

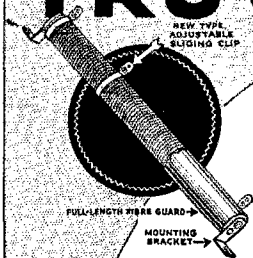

1,000
Volt
Breakdown

THAT means absolute safety for amateur work, plus these extra exclusive features:

1 — Patented design permits larger wire and open-air cooling. 2 — Double spiral winding insures perfect electrical contacts. 3 — Sliding clips provide exact adjustments to desired voltages. 4 — Full-length protective guard.

All Standard Sizes

Write Dept. Q-6 for Catalog and FREE Vest-Pocket Volume Control Guide

175 Varick St., New York, N.Y.
ELECTRAD
INC.



Say You Saw It in QST — It Identifies You and Helps QST

KEEPING A LOG

FEDERAL Radio Commission regulations require that every amateur station keep an accurate log of each transmission. The well-kept log is invaluable in checking your station operation. It is a permanent record and is a source of enjoyment in reviewing. The ARRL Log Book has been designed to meet all requirements. As will be seen by the illustration below, it provides for everything.

AMATEUR RADIO STATION LOG									
DATE	FREQUENCY	MODE	CALLED	CALLED BY	STATION HEARD			MESSAGE, REPLY, ETC.	
					TIME	CLASS	CALL		

Bound with heavy paper covers. 8 1/2 x 10 3/4. Contains 39 log pages, and same number of blank pages for miscellaneous notes. Also list of Q signs, message number sheet and sheet of cross-section paper. 40c each or 3 for \$1.00. Postpaid.

DELIVERING MESSAGES

GOOD operating practice demands neatness in message deliveries. We believe there is no better way to accomplish this than to make deliveries on official ARRL radiogram blanks. Designed by the Communications Department, they meet your needs. If a message is worth taking it is worth delivering in the best possible manner. Use the ARRL message blanks for deliveries and they will contribute to the prestige of your station.

THE AMERICAN RADIO RELAY LEAGUE			
HEADQUARTERS WEST HARTFORD CONN. U. S. A.			
RADIOGRAM			
CITY OF ORIGIN HARTFORD CONN.	STATION OF ORIGIN W1KC	NUMBER 324	DATE MARCH 26
TO CARL FRANK WOODS 14 NINTH STREET W B ROCHESTER MINN.		THIS MESSAGE WAS RECEIVED AT AMATEUR RADIO STATION NAME STREET ADDRESS CITY AND STATE	
KINDLY ADVISE PRESENT STATUS OF THE ORIENTAL TRAFFIC ROUTE RUNNING FROM THE EAST COAST TO THE ORIENT STOP IS WCKL STILL A MEMBER OF THIS CHAIN QUERY LATEST ROUTE MANAGERS BULLETIN MAILED TODAY 72 E L BARTY			
Rec'd	FROM STATION	LOCATED AT	DATE
Sent	W0CD	MEMPHIS, TENNESSEE, PA.	3/26/33
			8:54 P. M.
			RP

Message Blanks. Most convenient form. A real radiogram form. Well printed on good bond paper. Size 8 1/2 x 7 1/4. Put up in pads of 100 sheets. One pad postpaid for 35c or 3 pads for \$1.00

American Radio Relay League
West Hartford, Connecticut

"Marker" Stations

FOR calibration of a frequency meter, the accurate transmissions scheduled for this purpose by A.R.R.L. Standard Frequency Stations (W1XP, W9XAN and W6XK) and the Bureau of Standards 5000-kc. transmissions from WWV serve amateurs most excellently. Many broadcasting station standards of frequency are also kept in excellent condition and check-measurements may, therefore, be based on some broadcast band transmissions with expectation of only very small deviations.

Some, not all, commercial and government stations, especially some of those operating adjacent to the amateur bands, likewise serve as most useful guideposts, for checking receiver and frequency meter calibrations. Those stations which identify themselves frequently, whose transmissions may be widely heard because of consistent regular operation (and dependent on power and frequency, too), make the best "markers" of this type. A.R.R.L. recently submitted a long list of stations to the League's Official Observers requesting comments as to which stations could be heard in each section of the country, as well as information on the observed constancy of frequency, which is, of course, a matter of vital concern in making up a list of the best marker stations. Thanks are due all O.O.'s, with particular credit to Mr. Hannah of W2US for helpful data on "marker stations." — F. E. H.

SKELETON LIST

Call Frequency	Call Frequency
NAA 3475	W1Y 13867
NAA 4015 ± 1/2 kc.	WQP 13900
	WQS 13915
GBS 6905 ± 1/2 kc.	WIK 13929
WEE 6920 ± 1 kc.	KWT 13950 ± 3 kc.
WKP 6950 ± 1 kc.	GMR 14415 ± 1 kc.
WIZ 6965 Good.	GBW 14440 ± 1/2 kc.
WLM 6990 Good.	WNC 14470 ± 1/2 kc.
DHE 7324	WQL 14815 ± 1/2 kc.
WEM 7400 ± 1 kc.	HHH 16040 ± 1/2 kc.
WEV 7730 ± 1 kc.	

SUPPLEMENTARY LIST

Police Stations 1712	WEA 10610
CGZ/CGH 2020	WEX 13450
WED 3275	WHR 13420
W1XJ 3492.5	WKD 13435
WQN 5260	WEX 13450
WQO 6725	WKC 13465
WEJ 6740	WGT 13705
KEN 6845	WAJ 13480
KEB 6890	WEB 14770
TIR 6980 ± 6 kc.	WQV 14800
HPC 6985 ± 6 kc.	WQL 14815
WEZ 8075	WKM 18860
WEC 8930	WDS 18900
WKL 8940	WTT 18940
WEL 8950	WKW 19020
WES 9450	WQQ 20260
WKJ 9460	WQA 21220
WET 9470	WQW 21300



ALL Dressed Up
... and Going Places

NEW Type TD OIL*
X-mitting Condensers

*Special high-voltage breakdown oil impregnation; large glazed porcelain insulators; handsome silver-finished case. In a word, a real "ham" job!



Type No.	Cap.	Mfd.	Size (H-W-D)	List Price	Your Cost*
Working Voltage 600 V D.C., (440 Rect. A.C.)					
TD-6010	2	2 1/2	13/16x1 1/16	\$1.75	\$1.05
TD-6020	2	4 1/2	13/16x1 1/16	2.75	1.65
TD-6040	4	4	13/16x1 1/16	4.50	2.70
Working Voltage 1000 V D.C., (750 Rect. A.C.)					
TD-10010	2	2 1/2	13/16x1 1/16	2.50	\$1.50
TD-10020	2	4	13/16x1 1/16	4.50	2.70
TD-10040	4	4 1/2	13/16 x 1 1/2	7.00	4.20
Working Voltage 1500 V D.C., (1000 Rect. A.C.)					
TD-15010	1	2 1/2	13/16x1 1/16	3.75	\$2.25
TD-15020	2	4 1/2	13/16x1 1/16	6.25	3.75
TD-15040	4	4 1/2	13/16 x 1 1/2	11.00	6.60
Working Voltage 2000 V D.C., (1500 Rect. A.C.)					
TD-20010	1	4 1/2	13/16x1 1/16	5.25	\$3.15
TD-20020	2	4 1/2	13/16 x 1 1/2	8.00	4.80

*Available from your supplier anywhere in the U. S. at 2% cash discount.
NOW AVAILABLE—"Ham" Catalog No. 126—Write for it
CORNELL-DUBILIER CORPORATION
JOBBERS' DIVISION
4373 Bronx Blvd. New York City



**FOR CLEAN
MODULATION**

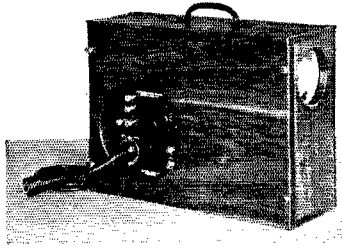

You can check modulation patterns as easily as current or voltage with an electron oscillograph.
Type 635-B is entirely self-contained, operates from 60-cycle line — 3-inch screen, 75 volts per inch sensitivity — price includes tubes.

Price \$80

BULLETIN EX-3307-Q

GENERAL RADIO COMPANY
Cambridge, Massachusetts

**Radio Operating
Radio Servicing —**



Prepare for the new Government Radio Operating license examinations; Radio Operator, Marine and Broadcasting. Also Radio Amateur Telegraph and Telephone. Resident courses.

Write for Booklet

NEW YORK YMCA SCHOOLS
4 West 63rd Street, New York City

ADJUSTO HM
1 to 100,000 OHMS

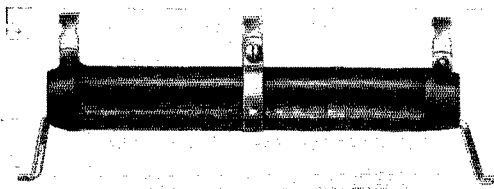

THE ADJUSTABLE RESISTOR

therefore may be used as a Bleeder, Voltage Divider, Grid Bias, Blocked Grid Keying, Grid Leak, or Voltage Dropper. Loosening the screw on the band permits adjustment of the resistance. Potentiometer connections can be obtained by using end terminals and band connections. Send for FREE descriptive booklet 507.

WARD LEONARD ELECTRIC COMPANY
41 South Street, Mount Vernon, N. Y.

Please send me free copy of booklet 507.

Name

Street

City and State

Call Signal

EVERYTHING FOR THE HAM

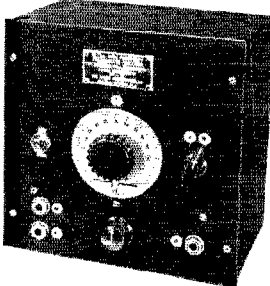

**No Summer QRN
on 5 Meters**

Through actual test it has been found that the 5-meter band is quietest for summer work. Distances as great as 17 miles have been covered by the new Haigis Ultra High-Frequency Portable Combination Transmitter-Receiver. An entirely new and highly efficient cir- \$17.40 cuit.

M. & H. Sporting 512 Market
Goods Co. Phila., Pa.

SEND FOR CATALOG

To Our Readers who are not A.R.R.L. members

YOU should become a member of the League! That you are interested in amateur radio is shown by your reading of *QST*. From it you have gained a knowledge of the nature of the League and what it does, and you have read its purposes as set forth on the page opposite the editorial page of this issue. We should like to have you become a full-fledged member and add your strength to ours in the things we are undertaking for Amateur Radio. You will have *QST* delivered at your door each month. A convenient application form is printed below — clip it out and mail it today.

*A bona fide interest in amateur radio is the
only essential qualification for membership*

AMERICAN RADIO RELAY LEAGUE
West Hartford, Conn., U. S. A.

I hereby apply for membership in the American Radio Relay League, and enclose \$2.50 (\$3.00 outside of the United States and its Possessions, and Canada) in payment of one year's dues, \$1.25 of which is for a subscription to *QST* for the same period. Please begin my subscription with the issue. Mail my Certificate of Membership and send *QST* to the following name and address.

.....
.....
.....

Do you know a friend who is also interested in Amateur Radio, whose name you might give us so we may send him a sample copy of *QST*?

.....

Thanks

A Medium Power 56-Mc. Transceiver

(Continued from page 28)

insertion of the battery cable prongs. If more than 3 volts are required for the microphone, a five-wire cable with five-prong sockets and the tube bases should be used—the extra wire being employed for the higher microphone voltage.

The total filament current is 0.56 amperes and the microphone current anywhere from 20 to 60 milliamperes, depending on the resistance of the microphone used. If long periods of operation are contemplated in a semi-portable setting an air-cell battery might be used, or it might be desirable to replace the 30 with a 19, connect all filaments in series, and operate them from a four-cell, 6-volt, hot-shot dry battery, or from a storage battery. Two dry cells will have a life of about 60 hours with intermittent use however—all that is needed for portable work.

Standard Frequency Transmissions

Date	Schedule	Frequency	Date	Schedule	Frequency
June 1	B	W9XAN	July 4	(Holiday—No transmission)	
	B	W6XX			
June 6	C	W9XAN	July 6	B	W9XAN
June 8	B	W9XAN		A	W6XX
	A	W6XX	July 11	BB	W9XAN
June 13	BB	W9XAN	July 13	BB	W6XX
June 15	BB	W6XX		A	W9XAN
	A	W9XAN	July 14	BX	W6XX
June 16	BX	W6XX	July 15	C	W6XX
June 17	C	W6XX	July 20	A	W6XX
June 22	A	W6XX	July 27	B	W9XAN
June 29	B	W9XAN		B	W6XX
	B	W6XX			

STANDARD FREQUENCY SCHEDULES

Time (p.m.)	Sched. and Freq. (kc.)		Time (p.m.)	Sched. and Freq. (kc.)	
	A	B		BB	C
8:00	3500	7000	4:00	7000	14,000
8:08	3600	7100	4:08	7100	14,100
8:16	3700	7200	4:16	7200	14,200
8:24	3800	7300	4:24	7300	14,300
8:32	3900		4:32		14,400
8:40	4000				

Time (a.m.)	Sched. & Freq. (kc.) BX
6:00	7000
6:08	7100
6:16	7200
6:24	7300

The time specified in the schedules is local standard time at the transmitting station. W1XP uses Eastern Standard Time, W9XAN, Central Standard Time, and W6XX, Pacific Standard Time.

TRANSMITTING PROCEDURE

The time allotted to each transmission is 8 minutes divided as follows:

2 minutes—*QST QST QST de* (station call letters).

3 minutes—Characteristic letter of station followed by call letters and statement of frequency. The characteristic letter of W1XP is "G"; that of W9XAN is "O"; and that of W6XX is "M."

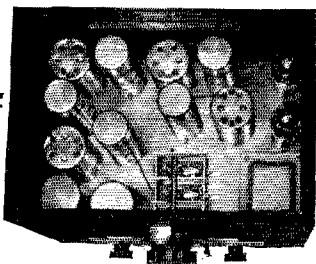

FOR AMATEURS ONLY!

Here you are — the Ross Jupiter — a set designed specifically for the radio amateur. NOT an all-wave receiver with a few concessions to the amateur but a true precision instrument that will bring you a new thrill in reception on the four popular amateur bands.

You'll get a real kick out of operating it. You'll be proud to show it to friends. Moderately priced.

Write for free descriptive folder

A. H. ROSS AND COMPANY

Keswick Ave. & Waverly Rd.

GLENSIDE, PENNA.

(Suburb of Philadelphia)

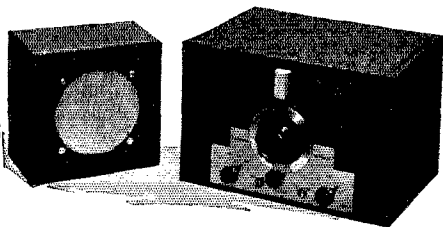

For Sale

Complete station, all equipment. One crystal-controlled xmtr, 500-watt c.w., 200-watt phone, 226 osc., 210 buffer, 210 amplifier, 845 modulator, 2-204As in linear amplifier. 866 power supply, 3 stages speech, KK Universal mike — 13 Jewell meters.

2 receivers — RCA Superhet and converter.

1 T.P.-T.G. 175-watt C.W. set with 2-852s push-pull — coils for 20, 40 and 80 meters — with bug.

This station is one of the finest custom-built jobs in the Eastern States. Both xmtrs have worked all kinds of DX. Ideal for Police Work. Cost over \$1500 to build. Will sell complete for \$700 F.O.B. Brookline, Mass.

GEO. J. HILL, JR.

40 Heath Hill

Brookline, Mass.

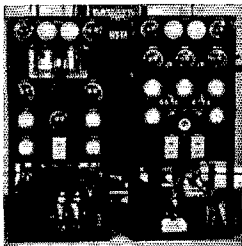

1 minute—Statement of frequency in kilocycles and announcement of next frequency.

2 minutes—Time allowed to change to next frequency.

W1XP: Massachusetts Institute of Technology, Round Hill Research, South Dartmouth, Mass., Henry G. Houghton in charge.

W9XAN: Elgin Observatory, Elgin National Watch Company, Elgin, Ill., Frank D. Urie in charge.

W6XK: Don Lee Broadcasting System, Los Angeles, Calif., Harold Peery in charge.

WWV 5000-Kc. Transmissions

The 5000-kc. transmissions of the Bureau of Standards' station, WWV, are given every Tuesday continuously from 12:00 noon to 2:00 p.m., and from 10:00 p.m. to midnight, E.S.T. These transmissions are accurate to $\frac{1}{2}$ cycle (one in ten million).

—J. J. L.

A Simple Mounting for the Cathode-Ray Tube

(Continued from page 18)

a precaution a piece of three-ply wood served as a base for the tube socket. This is shown in the photograph. Shielded ignition cables carry the socket connections from the tube to four Fahnestock clips on the breadboard base.

It is now time for a coat of black Duco over the entire exterior of the mount. The inside of the hood is also given a coat to help keep from reflecting light on the tube screen.

A "doped" piece (for rigidity) of heavy cardboard serves as a ring to center the tube in the barrel. Our tube needed a ring with an outside diameter of $4\frac{1}{8}$ inches and $2\frac{3}{4}$ inches inside diameter with slots to slide over the deflecting plate terminals of the 905. The 906 tube has these terminals at the base. The external connections of the deflecting plates are 2 sets of Type 274-Y and 138-VD GR bushings and terminals. The center or fifth terminal is the grounded positive high voltage terminal which grounds to the metal shield. The high resistance resistors are connected inside the barrel at the base of the GR terminals. Unshielded ignition cable is used between the tube deflecting plate terminals and the terminals on the barrel. With the 906 tube this would not be necessary, for these terminals would be at the base of the tube, logically mounted on the back of the barrel cover.

The swivel joint is just an added feature and, while convenient, is not absolutely essential. It is mounted on a block of wood above and screwed into a block of wood mounted on the breadboard at the base. A "saddle" of aluminum strip is formed to go partially around the barrel and bolted to the latter, serving to fasten the swivel to the barrel.

With the addition of the rectangular bakelite panel to carry the two control resistors of the oscilloscope, the mounting is complete. The separate power-supply and sweep-circuit units are conventional, following designs given in March and April *QST*.

—C. C. R.

QST Oscillating Crystals

"SUPERIOR BY COMPARISON"

All "Scientific Radio Service Crystals" are accurately ground to an accuracy better than .03% on equipment tested regularly by the U. S. Bureau of Standards standard frequency signals.

BROADCAST and COMMERCIAL BANDS

Mounted in our Standard Holder and ground to our usual high degree of accuracy \$35.00 each. Mounted in our NEW Isolantite Monel Metal Crystal Holder \$45.00 (adjustable air gap). Prices for other Frequency Bands quoted upon application.

AMATEUR BAND

Ground to within FIVE Kilo-cycles of your specified frequency in either 80 or 160 meter bands \$15.00 each. Accurate calibration with each crystal.

Free! Send for New Illustrated Folder—Free!

PROMPT SHIPMENTS ASSURED

Scientific Radio Service



"The Crystal Specialists" Since 1925

124 Jackson Ave., University Park
Hyattsville, Maryland Dept. Q-6



"E. H. Rietzke
SPEAKING!"



Mr. E. H. Rietzke, President of CREI, former chief instructor at Naval Research Laboratory, and today an outstanding figure in the radio profession.

A YEAR'S TRAINING AT CREI RESIDENCE SCHOOL IS THE WISEST INVESTMENT

ANY AMBITIOUS RADIO MAN COULD MAKE

If you are really serious about advancing in Radio—if you realize that Technical Training is essential—then you are the type of man that CREI can "make"! The next 1-year Residence Course begins in September—enroll now!

Write for Our New Complimentary 40-Page Booklet

With pictures and full details of our courses and laboratories.

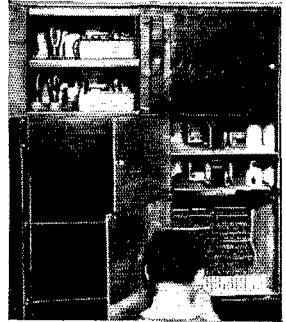

Actual photo in one of our modernly-equipped laboratories shows student shooting trouble on a Speech Amplifier.



CAPITOL RADIO ENGINEERING INSTITUTE

14th and Park Road, Washington, D. C.

Dept. QS-6



THE INSTRUCTOGRAPH (Code Teacher)

The Scientific, easy and quick way to learn the code. Send a post card today for literature. Machines, tapes and complete instructions for sale or rent. Terms as low as \$2.00 per month. Rental may be applied on purchase price if desired. Rent for a month. If the Instructograph meets every requirement, buy it. If not, send it back.

INSTRUCTOGRAPH CO., 912 Lakeside Place, Chicago

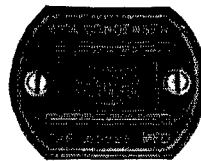

SANGAMO ACCURATE CONDENSERS

Available in 5000 volt construction for use in short wave transmitters

Write for catalog sheet

SANGAMO ELECTRIC CO.
SPRINGFIELD, ILLINOIS

NEW ULTRA-HIGH FREQUENCY PORTABLE COMBINATION TRANSMITTER-RECEIVER

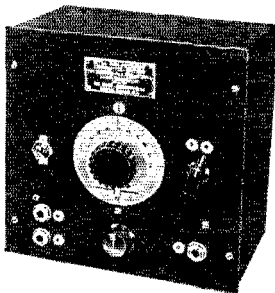

NEW
HIGHLY EFFICIENT
CIRCUIT
Many New Built-In
Features

Tone Telegraph and Voice—Silestone in Phones on Transmission—Rheostat, On-Off Switch, Real Jacks—Complete Instruction Book—Uses One Type 30 and One Type 33—Size 7 1/2" square, 5" deep, Weight 7 lbs.—Black Wrinkle Finish

PRICE
\$17.40 NET

At Your Nearest
Dealer or Our Factory

The HAIGIS LABORATORIES, INC.
MAPLE SHADE, N. J.

Pioneers in the Ultra-High Frequency Field

Another Reason Why



The TRIMM FEATHER-WEIGHT phones will bring in weaker signals. The great number of turns of wire on the Electro Magnet, together with the specially treated Magnetic iron in the core, results in a greater change in the Magnetic flux causing more strength to the weak signals.

DX in comfort with Trimm Featherweight phones.

Buy from your local dealer

TRIMM RADIO MFG. CO.

1528 Armitage Ave.

Chicago, Ill.

HAM-ADS

(1) Advertising shall pertain to radio and shall be of nature of interest to radio amateurs or experimenters in their pursuit of the art.

(2) No display of any character will be accepted, nor can any special typographical arrangement, such as all or part capital letters be used which would tend to make one advertisement stand out from the others.

(3) The Ham-Ad rate is 15¢ per word, except as noted in paragraph (6) below.

(4) Remittance in full must accompany copy. No cash or contract discount or agency commission will be allowed.

(5) Closing date for Ham-Ads is the 25th of the second month preceding publication date.

(6) A special rate of 7¢ per word will apply to advertising which, in our judgment, is obviously non-commercial in nature and is placed and signed by a member of the American Radio Relay League. Thus, advertising of bona fide surplus equipment owned, used and for sale by an individual or apparatus offered for exchange or advertising inquiring for special equipment, if by a member of the American Radio Relay League takes the 7¢ rate. An attempt to deal in apparatus in quantity for profit, even if by an individual, is commercial and takes the 15¢ rate. Provisions of paragraph (1), (2), (4) and (5) apply to all advertising in this column regardless of which rate may apply.

Having made no investigation of the advertisers in the classified columns, the publishers of *QST* are unable to vouch for their integrity or for the grade or character of the products advertised.

MICROPHONE and meter repairs. Low prices. Quick service. Sound Engineering Corp., 416 N. Leavitt St., Chicago, Ill. **RADIO** engineering, broadcasting, aviation and police radio, servicing, marine and Morse telegraphy taught thoroughly. All expenses low. Catalog free. Dodge's Institute, Byrd St., Valparaiso, Ind.

QUARTZ—Direct importers from Brazil of best quality pure quartz suitable for making piezo-electric crystals. Diamond Drill Carbon Co., 719 World Bldg., New York.

1000 watt transformers, General Electric, 1100-2200-4400 each side center. Mounted on marble, oilless, \$13.50. Dawson, 5740 Woodrow, Detroit, Mich.

GENERAL Electric 24/1500 volt Dynamotors \$35; 24/750 volt \$25. Westinghouse 27½/350 volt \$10. Mounted pair \$15. 6-15 volt 500 watt Aircraft with propeller \$10. 500 cycle 500 watt with exciter 110-220 volts \$7.50. Dynamotors give pure DC outputs. Perfect results from battery plants. Crocker-Wheeler 25/275 volt generator, \$7.50. Henry Kienzle, 501 East 84th Street, New York.

QST's, complete file from December 1925 to December 1930. Make offer. Bates Radio, 274 Main St., Worcester, Mass.

QST's back issues. List and prices on request. W9LBI.

SELL—new 160 meter phone transmitter; 25 watt carrier; 100% modulation. Stamp for description. R. Howard, W9UW, 314 N. Pine Ave., Chicago.

866s—1000 hour guarantee, \$1.49; 825s, carbon plate 210s (800v) \$4.95. Transformers; chokes. Complete transmitters. Lists 3¢. Howard Radio, 314 Pine Ave., Chicago.

WANTED: old radio magazines, also engineering subjects. Write list and price. Jacques A. Kurtz, 100 E. 18th St., Brooklyn, N. Y.

CRYSTALS inch square x cut 80-160 meter bands within 5-ke. your specified frequency \$2. Unconditionally guaranteed. Gentry Labs., 803 W. Maple, Independence, Mo.

WANT: power supply for 800. Trade golf clubs, guns. W2GSI, Passaic, N. J.

FB7s, Omnigraphs, Teleplexes, receivers, meters, Vibroplexes. Bought, sold, traded. Ryan Radio Co., Hannibal, Mo.

ELECTRIC counter, \$1; telephone mike, 50¢; other parts. List, stamp. R. White, 11030 Hermosa Ave., Chicago.

QSLs, SWLs, W6DOU, Hayward, Calif.

QSLs, two color. Samples, Printer, Corwith, Iowa.

TRADE—auto, Spanish course, camera. Want 2-204As, 2000 volt power supply, or? Box 536, Forest City, N. C.

QSLs! SWLs! **QSLs!** For particular hams. No cheap trash. Stamp for samples. W8DED, Holland, Mich.

COMET Pro coils and tubes. Sixty-eight dollars. W5BSK, 4712 East 4th St., Tulsa, Okla.

TRADE B flat Wurlitzer trumpet, dull silver, gold bell, in case, original price \$85, for National SW3 and pack, or what have you? Make offer. W9CER, Jefferson, Wisc.

TRADE new automatic record changer with pickup in carrying case for amplifier, microphones, radio or sound equipment. Also have UX852. Write Platten Radio, Green Bay, Wisc.

QSLs by Maleco. Finest in country. Free samples. Maleco, 1512 Eastern Parkway, Brooklyn, N. Y.

SALE or trade. All or any section of unit transmitter. Photographs. All letters answered. W6CIN, Childress, Tex.

BROADCAST quality condenser microphone for your phone transmitter only \$25.00 net. Fully factory-assembled-and-tested-head (same head used Shure Model 40C Studio Type Condenser Microphone) and all essential parts (no case, chassis or cable) for two-stage head amplifier using '30 tubes. Kit includes factory-assembled head, two marked sockets, all necessary resistors, couplings and by-pass condensers, 200/50 ohm output transformer, wiring diagram and complete instructions. Fully guaranteed. Half cash with order, balance C. O. D. Shure Brothers Company, "Microphone Headquarters," 215 West Huron Street, Chicago, U. S. A.

SELL long wave receiver. W9DIB, Mitchellville, Iowa.

TRANSMITTERS manufactured to order. Transmitters re-constructed. Holmes C. Miller, Box 105, Palo Alto, California. **SWAP** aluminum for fone equipment, etc. W8BKH.

CRYSTALS: \$1.35 Hipower oscillators 3500-1700 Kc. Bands close to your specified frequency, 7000 Kc. band \$4.25. Plug-in holders with mounting, \$1.00. Blanks 85¢. Immediate delivery. Send for complete price list and bulletin. Crystals for broadcast stations. Prices on request. Hipower Crystal Co., 3607 N. Luna Ave., Chicago, Ill. You cannot buy a better crystal than Hipower at any price.

QSL cards, two color, cartoons, message blanks, stationery, snappy service. Write for free samples to-day. W1BEF, 16 Stockbridge Ave., Lowell, Mass.

STAMP collecting amateurs, American and foreign, write W8DYM.

PHOTO stamps—lickem, stickem on any card. 25, 50¢; 50, 75¢; 100, \$1. Samples. 3¢ stamp appreciated. W8KVY, 441 Prospect St., Muskegon, Mich.

SELLING—pp-t-p.t.g. 10 transmitter. Write for details. W9JWH.

CLASS B transformers—Universal for two or four 46's, 210's, 800's, RK18's, etc. \$7.75 pair. 70 watts of audio from 46's. Write for details. W8UD, Douglas, Michigan.

METER repairing, can increase sensitivity. Fine welded thermo units as low as \$2. John Wright, 5214 S. E. 87 Ave., Portland, Ore.

CALLBOOKS—new summer 1934 Radio Amateur Call Book, hundreds of new DX hams, many pages of late W and VE calls, is yours for \$1.10. Four issues for \$3.65 (in foreign countries \$1.20 and \$3.90). W9FO-610 S. Dearborn, Chicago.

KAINA for sale. 5 stage transmitter only, with 9 tubes and crystal. Up to 800 watts input to final. Worked 9 districts during contest. Heard in every state. Best cash offer by July 1 wins.

QSL and SWL, 200 one color \$1, two color, \$1.25. Crystals, mikes. W8ESN, 1827 Cone, Toledo, Ohio.

AMERICA'S finest **QSLs!** Snappy. Bright. 200 two colors, \$1. Free Samples. W5AUB, 410 N. Green, Tupelo, Miss.

CRYSTALS, 160-80 meters. Trade for tubes, meters, transformers. Bill Thren, W8FN, 4021 Davis Ave., Cheviot, Ohio.

TRANSRECEIVER 5 and 10 meters, \$15.50; frequency meter April **QST**, \$17.50; power crystals with holder. 80, \$3.75; 40, \$4.75. Write for new catalog. We build to order. Precision Radio Labs., 109 E. 94 St., Brooklyn, N. Y.

CANADIANS. Crystals, ur frequency guaranteed, \$5. Engineering Dept. C.K.O.C. Hamilton.

CRYSTALS: Guaranteed excellent oscillators, 160 or 80 meters, your approximate frequency, \$1.35, postpaid. Crystal maker's blanks, 1", 65¢; dozen \$6. Irregular shapes, 25¢. Improved dust-proof bakelite holders, 1½" silvered electrode increased efficiency, plugs into G.R. or tube socket mounting, any position, no exposed electrodes, 75¢; dozen \$5.40. Fisher Lab., 4522 Norwood, San Diego, Calif. Formerly El Paso, Texas.

TRADE—Westinghouse type SK, 125 volts, 3 kw. Direct current generator for Comet Pro or similar receiver. W9HCH.

SELL—several 50 watters, 210s, F108A, meters, plate transformers, filter condensers, other good transmitting parts cheap. List. D. C. Akers, W2FL, 181 Greenwood Ave., East Orange, N. J.

AMATEURS, data, circuits, bulletins, 50¢. 75¢ beyond Rockies. Resume, 10¢. Kladaglabs, Established 1921, Kent, Ohio.

NEW Universal "KK" mike complete with chrome stand, \$25. Standard 5 foot, 19 inch rack drilled and tapped, \$8. H. Snyder, 9208 Frankstown Road, Wilkinsburg, Penna.

CRYSTALS: 160-80 meters, approximate frequency, 1", \$1; 40 meters, \$2. Guaranteed. W8EBV, 1397 6th St., Muskegon, Mich.

QSLs! Unsurpassed. Quality. Inquire. W6FZQ, Box 1804, Phoenix, Arizona.

SELLING out all equipment of W2DYJ—need cash—Bar-gains in meters, chokes, tubes, transformers, condensers, crystals, etc. Send for list. Michael Solomon, 24 East 23 Street, N. Y. C.

TRANSMITTER, xtal controlled, Gross-built GC-100, three stages, 50 watt final with three Weston meters, in black metal can. Less tubes and power supply. First \$23 money order takes it. Michael Solomon, 24 East 23 Street, N. Y. C.

PHOTOGRAPHIC QSLs. \$2.15 per hundred. W2FJE, 151 DeKalb Ave., Brooklyn, N. Y.

BARGAIN dollar sale; overstock 872s. One at \$17.50, two for \$18.50. Guaranteed. 410 S. Marengo, Alhambra, Calif.

NEW EAGLE tubes, pair Baldwins, ten dollars. W9GKF, Geneseo, Ill.

LOTS of ham supplies, new low prices, catalog. Lyon-Watt Radio Co., Wichita, Kans.

POWER equipment for 100% QSLs. More watts for less outlay. Our 25 years experience at your disposal in designing your station. Relay racks, panels, to give it that prized commercial touch. Edison battery headquarters. Aeroplane wind-mill propellers per March QST. See May display advertisement. Rectifier Engineering Service.

TRANSMITTING tubes repaired. New tube guarantee. New filaments 203A, \$3; 852, \$11; 204A, \$30, postage not included. Tubes returned C.O.D. Will quote on any type tube. If the glass is cracked or broken, tube can be rebuilt for following additional charges—203A, 50¢; 852, \$1.50; 204A, \$3. New half wave mercury vapor rectifiers 10,000 volt peak inverse. 1 1/2 amp. forward current 2 1/2 volt 6 amp. filament, 1000 hour guarantee, \$2.75. Universal Engineering Co., 1331 Fifth Ave., Pittsburgh, Pa.

TRANSMITTING and rectifying tubes restored normal plate current. Stamp for information. Guaranteed. W5BDB, Texarkana.

ESCO 1000 volt 650 ma. motor-generator for cash or high power equipment. W5BDB.

IN stock—shipped prepaid: Patterson PR-10s complete, \$70.25. Patterson preselectors, tune 15-550 meters, complete \$18. Comet Pros, \$85. Crystal \$23.52 extra. AVC \$17.64 extra. Astatic crystal mikes D104 \$12.25. Trimm featherweight phones, \$5.88; Sprague transmitting condensers; all Bliley crystals and holders. The following not prepaid: National Oscillographs, \$17.70; FB7As, \$34.20; FBXAs, \$47.70, coils \$6, 5897ABs, \$15.90; SW3s \$17.70, coils \$3; preselectors \$11.40, coils \$3.60; RME9D Supers, \$112.50. Trade in your old receiver. 40-2% of Thordarson, Hammarlund, McMurdo-Silver, Cardwell, Universal, Johnson, Ohmite, others. Code machines rented. Write Henry's Radio Shop, Butler, Mo.

QSLs, message blanks and cards. Samples? W8DDS, 2155 West 81st St., Cleveland.

10,000 volt mesh filament 866s, \$2.50 new. 872s, \$7.50. 212Ds, \$10. Universal quarters, \$15. Mikes repaired, bought, exchanged. Ewing, 1057 Pratt, Chicago.

203A fifty watters, \$9.75 each. New, first quality and fully guaranteed. Also 211s and 845s. VTE Labs., Ridgefield, N. J.

PATTERSON PR-10—\$70.25; Patterson All-wave (15 to 575) ten tube super-hets beautiful consoles \$59.70; Sargent, Sky-Rider, Postal—lowest prices—Transportation Allowance; Free Call Book, A.R.R.L. Handbook each receiver. Taylor Tubes—866 \$1.65; 800, 845B, 203B \$7.50; 825 \$4.95; 203A, 211, \$12.50; others. Raytheon Tubes—RK15, RK16, RK17, VG27, R806A \$5.00; RK18 \$10.95; RK19 \$7.50. All Postpaid. "Marine" Crystals—best by test—40, 80, 160 approximate \$2.45. Ross steel towers, vertical antennae, power equipment. Sprague oil condensers—1000v. 1 Mfd. \$1.47; 2 Mfd. \$2.65; 2000v. 2 Mfd. \$4.70. Catalogs all above. New monthly bulletin "Amateur Transmitter." L. I. Marine & Electric Co., 163-18 Jamaica Avenue, E. Jamaica, N. Y.

WANTED—ink recorder for code; will buy or trade. A. H. Dreesen, Mansfield Centre, Conn.

LOW RANGE FUSES

- **Littelfuses for Instruments:** Amps: 1/100, 1132, 1/16—20c ea. 1/8, 1/4, 3/8, 1/2—15c ea. 1, 2—10c ea. For milliammeters, ham rectifiers, etc. Use 1/8 for radio B circuits. **High Voltage**
- **Littelfuses:** 1000, 5000, 10,000 volt ranges in 1/16, 1/8, 1/4, 3/8, 1/2, 3/4, 1, 2 amp. Renewable. Price 35c to \$1.25 ea. **NOW—\$100 PROTECTION GUARANTY.** Get New Cat. #5.
- **LITTELFUSE LABS.** 4509 Ravenswood Ave., Chicago

"Quicker than a Short circuit!" **LITTELFUSES**

Say You Saw It in QST — It Identifies You and Helps QST

Are You "Stuck"? LEARN CODE QUICKLY AND EASILY and become a Skilled Amateur or Radio Operator . . . AT HOME

Watson, WIBGL, op Bear of Oakland, Byrd Expedition, says: "Candler training enabled me to pass rigid competitive tests for this position."

Many Instructors and ops in U. S. Army, Navy and Aviation are Candler trained.

The **FASTEST** and most **SKILLED** Amateurs and Commercial ops during the past 22 years were Candler trained. 9 year old girl wins championship in Class "E" 2 months after beginning our Code Course for Beginners.

If you're wise you'll get your **SPEED** where the champions got theirs and prepare for that Amateur or Commercial Ticket the **CANDLER SCIENTIFIC WAY**. It's **EASY** and **INTERESTING**.

CANDLER STUDENTS NEVER FLUNK. Tell us what ticket you're preparing for and we'll show you how easy it is to get.

SEND FOR BOOK OF FACTS for Radio Ops, Amateurs and Beginners. Your questions answered promptly. No obligation.

CANDLER SYSTEM CO.

Dept. Q-6 6343 S. Kedzie Avenue, Chicago

Candler System Code Guild

An organization of **CANDLER** trained ops sending practice programs daily from their stations all over the U. S.

Become a **CSCG** Member. We furnish Schedules listing all **CSCG** stations, time on the air, speed 8 to 45 wpm.

You can bring in **CSCG** Practice Programs with your **S.W. Receiver**. This is **REAL** practice that costs you nothing. There is no substitute for it. **CANDLER** trained ops will help you develop your code technique.



University Course in RADIO COMMUNICATION

Open to high school graduates. Complete in nine months. High standard of instruction and equipment. Fall term opens September 14.

UNIVERSITY OF WISCONSIN—Extension Division
623 West State Street Milwaukee, Wisconsin

METAL-WORKING

LATHE

New designs and mass production methods make this amazing bar-lathe possible. Complete metal working lathe with compound slide-rest, improved three-jaw chucking device, 6" swing, 24" overall length, 20 lbs. Send postcard for catalog and 10-day trial offer, or save time and send \$1. balance plus express C.O.D. Wood-turning lathe \$4.50. Extra bed-lengths, 60c per ft. Attachments for milling, grinding, sanding, saw-table, etc., available at low prices.



AMERICAN MACHINE & TOOL CO., Dept. Q

200 BROADWAY NEW YORK

New BIRNBACH Standoff FEATURES

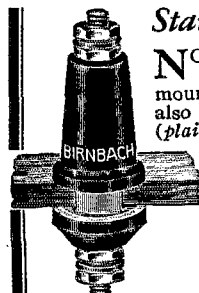

NOW equipped with cork washers to prevent injury when tightly mounted. All standard types—also new **FEED-THRU** models (plain or jack) with porcelain insulating collar for metal-panel mounting.

Highest grade, highly glazed porcelain and nickel-plated brass hardware. Compact—rugged—safe! Write for Bulletin Q-6.

BIRNBACH RADIO CO., INC.
145 Hudson St., N.Y.C.



Your Nearest Dealer

Your nearest dealer is entitled to your patronage. You can trust him. He is equipped with a knowledge and understanding of amateur radio. He is your logical and safe source of advice and counsel on what equipment

Patronize the dealer nearest you—

<p>ALLENTOWN, PENNSYLVANIA Radio Electric Service Co. 1024 Hamilton Street Complete stocks transmitting equipment</p>	<p>CLEVELAND, OHIO Northern Ohio Laboratories 2073 West 85 Street Wholesale Distr. for National, Hammarlund, Thordarson, Cardwell</p>
<p>BALTIMORE, MARYLAND Radio Electric Service Co. 303 W. Baltimore Street Everything for the amateur</p>	<p>CLEVELAND, OHIO Radio Servicemen's Supply Co. 206 Prospect Street Wholesale Distributors catering to Amateurs, Dealers, Servicemen</p>
<p>BOSTON, MASSACHUSETTS Nutter & Cross, Inc. 99A Milk Street All OMs, OWs, and YLs welcome — W1HRF</p>	<p>DENVER, COLORADO Inter-State Radio & Supply Co. 1639 Tremont Place Amateur Radio Headquarters in the Rocky Mountain Region</p>
<p>BROCKTON, MASSACHUSETTS Ware Radio Supply Company 913 Centre Street Everything in parts. Comet Pro in stock with crystal filter</p>	<p>DETROIT, MICHIGAN Radio Equipment Sales Co. 14036 Woodward Avenue, Highland Park A complete stock of amateur, shortwave and service parts</p>
<p>BUFFALO, NEW YORK Dymac Radio 359 Capen Blvd. — Tel. Univ. 9380 Complete Stock Amateur Parts — Standard Discounts — WBAAK</p>	<p>DETROIT, MICHIGAN Radio Specialties Company 171 E. Jefferson Avenue Ham Supplies — National & Hammarlund Sets and Parts</p>
<p>BUFFALO, NEW YORK Kronson Service Company 143 East Genesee Street Western New York's largest wholesale distributors — WBHF</p>	<p>ERIE, PENNSYLVANIA Jordan Radio Laboratory 1019 East Fifth Street Amateur, service parts, including Bliley, National, Raytheon. W8CXG</p>
<p>CHARLOTTE, MICHIGAN General Engineering Corporation Everything for the Transmitting Station</p>	<p>HARTFORD, CONNECTICUT Radio Inspection Service Company 227 Asylum Street Yes, we'll take your old set in trade</p>
<p>CHICAGO, ILLINOIS Chicago Radio Apparatus Company 415 South Dearborn Street Dependable Radio Equipment. Established 1921. All Standard Lines</p>	<p>HOUSTON, TEXAS Straus-Frank Company Distributors for nationally advertised amateur products RCA-DeForest transmitting tubes</p>
<p>CHICAGO, ILLINOIS Mid-West Radio Mart 520 S. State Street All standard lines carried in stock</p>	<p>KANSAS CITY, MISSOURI Burstein-Applebee Company 1012-14 McGee Street "Specialists" in supplies for the Amateur and Serviceman</p>
<p>CHICAGO, ILLINOIS Newark Electric Company 226 W. Madison Street Chicago's oldest radio parts store — established 1921 John T. Wallace, Technical Adviser</p>	<p>KANSAS CITY, MISSOURI Radio Laboratories 1515 Grand Avenue Amateur Headquarters — Complete Stock — Quality Parts</p>
	<p>LOS ANGELES, CALIFORNIA Radio Manufacturers Supply Co., Inc. 1000 S. Broadway Amateur Headquarters of the Pacific Coast</p>
	<p>MANCHESTER, NEW HAMPSHIRE Radio Service Lab. of N. H. 1008 Elm Street — Tel. 218-W Branches — Portland, Me. and Barre, Vt.</p>

This advertisement is paid for by the firms listed above. Qualified dealers

Is Your Best Friend

you should buy. His stock is complete. He can supply your needs without delay. His prices are fair and consistent with the high quality of the goods he carries. He is responsible to you and interested in you.

You can have confidence in him

<p>MILWAUKEE, WISCONSIN Radio Parts Company, Inc. 332 West State Street Complete stock Nationally Known products</p>	<p>SAN ANTONIO, TEXAS Straus-Frank Company Distributors for nationally advertised amateur products RCA-DeForest transmitting tubes</p>
<p>NEWARK, NEW JERSEY Kaltman & Romander 62 Court Street Drop in for an over-counter QSO</p>	<p>SAN FRANCISCO, CALIFORNIA Offenbach Electric Company, Ltd. 1452 Market Street "The House of a Million Radio Parts"</p>
<p>PHILADELPHIA, PENNSYLVANIA Freeland Radio Supply Co. 5 N. 7th Street "If it's radio we have it"</p>	<p>SHANGHAI, CHINA Amateur's Home, Ltd. 323 Kiangse Road Radio Manufacturer, Wholesaler and Retailer</p>
<p>PHILADELPHIA, PENNSYLVANIA Radio Electric Service Co., Inc. N. E. Cor. Seventh & Arch Sts. All nationally advertised lines in stock</p>	<p>SPRINGFIELD, MASSACHUSETTS T. F. Cushing 345 Worthington Street An amateur, endeavoring to sell good parts</p>
<p>PHILADELPHIA, PENNSYLVANIA Eugene G. Wile 10 S. Tenth Street Complete Stock of Quality Merchandise</p>	<p>SYRACUSE, NEW YORK Roy C. Stage, W8IGF Complete stock of standard Ham & BCL parts Standard Discounts. Free technical service</p>
<p>PITTSBURGH, PENNSYLVANIA Cameradio Company 603 Grant Street Tri-State "Ham" Headquarters Standard Apparatus- Standard Discounts</p>	<p>TORONTO, CANADA A & A Radio Service Supply 101 Queen Street, West We specialize in service! Try it!</p>
<p>PROVIDENCE, RHODE ISLAND W. H. Edwards & Company 32 Broadway, Room 23 Amateur Equipment — National, Hammarlund, RCA Tubes</p>	<p>TORONTO, CANADA Wholesale Radio Company, Limited 355 Danforth Avenue Canada's Largest Amateur Supply House</p>
<p>ST. LOUIS, MISSOURI Walter Ashe Radio Company 1100 Pine Street W9FIS in charge of the oldest and largest parts store in St. Louis</p>	<p>TRENTON, NEW JERSEY American Radio Co. 5 N. Broad Street. Central Jersey's leading radio parts store</p>
<p>ST. PAUL, MINNESOTA Lew Bonn Company 2484 University Avenue Rex L. Munger, W9LIP, Sales Engineer Radio Wholesaler Complete Stock</p>	<p>WASHINGTON, D. C. George's Radio Co. 816 F Street, N.W. Washington's largest distributor of radio parts</p>
<p>ST. PAUL, MINNESOTA Lew Bonn Company 2484 University Avenue Rex L. Munger, W9LIP, Sales Engineer Radio Wholesaler Complete Stock</p>	<p>WILMINGTON, DELAWARE Wilmington Electric Specialty Co., Inc. 405 Delaware Avenue Amateur headquarters — Collins, Hammarlund, National, etc.</p>
<p>ST. PAUL, MINNESOTA Lew Bonn Company 2484 University Avenue Rex L. Munger, W9LIP, Sales Engineer Radio Wholesaler Complete Stock</p>	<p>ZANESVILLE, OHIO Thompson Battery & Radio Service 393 West Main Street Distributor radio equipment for amateurs and servicemen</p>

are invited to apply for rates, etc., to Advertising Department, QST

Say You Saw It in QST — It Identifies You and Helps QST

You Are Protected When You Buy From QST Advertisers

¶ "Advertising for QST is accepted only from firms who, in the publisher's opinion, are of established integrity and whose products secure the approval of the technical staff of the American Radio Relay League."

Quoted from QST's advertising rate card.

Every conceivable need of a radio amateur can be supplied by the advertisers in QST. And you will know the product has the approval of the League's technical staff.

For Your Convenience

QST'S INDEX OF ADVERTISERS IN THIS ISSUE

Aerovox Corporation.....	77
American Machine & Tool Co.....	91
A.R.R.L. Application Blank.....	86
Back Copies.....	68
Binder.....	80
Emblem.....	82
Forms.....	83, 84
Handbook.....	75, 81
Publications.....	87, Cov. 11
Birnbach Electric Co.....	91
Blan, The Radio Man, Inc.....	82
Bliley Piezo Electric Co.....	77
Cameradio Company.....	79
Candler System Company.....	91
Capitol Radio Engineering Institute.....	89
Cardwell Mfg. Corp., Allen D.....	4
Central Radio Labs.....	70
Collins Radio Company.....	2
Cornell-Dubilier Corp.....	85
Delta Mfg. Company.....	69
Electrad, Inc.....	83
General Electric Company.....	96
General Radio Company.....	85
Gross Radio Company.....	76, 71
Gulf Radio School.....	81
Haigis Laboratories.....	89
Hammarlund Mfg. Company.....	1
Harvey Radio Labs.....	87
Heintz and Kaufman.....	81
Hill, Jr., Geo. J.....	88
Instructograph Company.....	89
Johnson Company, E. F.....	87
Kaltman and Romander.....	74
Leeds.....	95
Littelfuse Labs.....	91
Lynch Mfg. Company.....	87
M & H Sporting Goods Co.....	85
Massachusetts Radio School.....	87
National Carbon Company.....	72
National Company.....	67, 73, Cov. 111
New York YMCA Schools.....	85
Port Arthur College.....	77
Precision Piezo Service.....	79
RCA Institutes, Inc.....	83
RCA Radiotron Company, Inc.....	Cov. 114
Radio Shack.....	79
Radio Supply Co.....	79
Raytheon Production Corp.....	78
Ross & Co., A. H.....	88
Sangamo Electric Co.....	89
Schwartz & Son, Maurice.....	83
Scientific Radio Service.....	89
Teleplex Company.....	87
Trimm Radio Mfg. Co.....	89
Union Carbide & Carbon Co.....	72
United Radio Mfg. Co.....	77
University of Wisconsin.....	91
Ward Leonard Electric Co.....	85
Weston Electrical Instrument Corp.....	81
Wing's Sons, Chauncey.....	81

HERE THEY ARE!

First we have a 5- and 10-meter oscillator and amplifier combination. Use them "bread-board" style if you wish, mount them in a wooden frame or bolt them together and fasten them to a standard 19" rack panel as shown with the speech amplifier and modulator units, for a real "commercial" job. No lost motion or parts to discard.

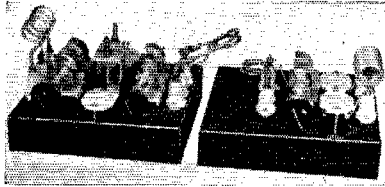

DB-5 AMPLIFIER

designed for 210 tubes in push pull with class B modulator. Split stator tuning of both grid and plate circuits. Double spaced plate and neutralizing condensers eliminate possibility of "flash-over." Ceramic insulation of course.

DB-5 Amplifier **\$14.50**

10-meter coils . . . **\$1.00**

PUSH-PULL TNT HI C OSCILLATOR

for 245 tubes. Ceramic insulation throughout insuring lowest losses. Plug-in coils permit operation on 5 or 10 meters. Start in with this unit and add the amplifier later to secure frequency stability. DB-5 Oscillator wired and tested **\$7.75**

10-meter coils . . . **\$1.00**

WE ARE PROUD

of our new speech amplifier, because it does so much with so little. A 53 cascade resistance coupled audio (2 tubes in one) drives a pair of push pull 45 tubes class "A." A double button mike easily overloads the 45's as the 53 has a voltage gain of 720! Slight modification will permit the use of a crystal or other low level microphone without pre-amplification. DB-5 Speech Amplifier with double button microphone input transformer less 45 output transformer, wired and tested **\$12.25**



CLASS B MODULATOR UNIT

for 210 tubes.

Output between 40 and 60 watts depending on plate voltage applied. Secondary of output transformer carries r.f. plate current. 5000 and 10000 ohm output taps furnished. DB-M 210 wired and tested **\$12.25**

PERHAPS YOU WANT TO "ROLL YOUR OWN"

LEEDS demi-bases, 20-gauge steel 8 x 8 1/2 x 2" with bottom cover plate, black finish. **55c**

Full base units, 18-gauge steel, 8 x 17 x 2" for **\$1.00**

LEEDS standard 19" rack panels 1/8" aluminum black crystalline finished front, plain black on back with standard slots for mounting.

5 1/4 x 19 — **\$2.15** 7 x 19 — **\$2.45**
8 3/4 x 19 — **\$2.75**

Special RELAY Bargain

Operates on one dry cell, two pole. One pole make and break, the other break only. Contacts with handle 250 MA. A BUY at, each. **\$.29**

NAVY TYPE TELEGRAPH KEY

List \$3.60. Navy knob — 1/8" Tungsten contacts. Only a few left at **\$1.15**
With regular knob **\$.95**
Leeds transmitting key, spec. **\$.65**

All sizes unmounted Honeycomb coils in stock

LEEDS CRYSTALS are going like "hot cakes." Quality plates, unconditionally guaranteed. At our new price schedule announced in May QST tells the story.

"RUBBER WIRE" — Punk for Antennas — that's why we sell plenty of the "stretchless" kind described in the May issue.



45 VESEY STREET, NEW YORK CITY

New York Headquarters for Transmitting Apparatus and Short Wave Equipment

Say You Saw It in QST — It Identifies You and Helps QST

LEEDS Frequency Measuring Equipment

is designed to fill every Amateur requirement. Quality units at lowest prices. See page 101, May 1934 issue QST.

Genuine Baldwin Type C phones . . . **\$3.75**

Western Electric Type P-11 Signal Corps phones **\$3.95**

Still a few left. Jewell No. 190 — two-inch A.C. Voltmeters. 0-8; 0-10; 0-15; each **\$2.95**

No. 165 two-inch 0-1 Thermo-ammeters, **\$4.45**

All metal cased instruments

R.C.A. Chokes 18 H. 125 M.A. **49c**
Special **49c**

HAMMARLUND CONDENSERS

No.	Plates	Mmf.	Price
MC-140M	19	140	\$1.25
MC-100M	14	100	1.13
MC-50M	7	50	.80
MC-35S	5	35	.75
MC-20S	3	20	.70
MCD-140S Dual			2.00
MCD-140S Dual			1.75
MCD-35 Dual			1.75
CH-500 Choke88
CHX38

SYLVANIA GRAPHITE ANODE TRANSMITTING TUBES

No. 210 **\$5.75**
No. 830 **8.75** 203A } **\$17.50**
No. 830B **10.00** 211 }

5-METER RECEIVER

Our new 5A receiver sets a new standard for super regeneration frequency performance. Compact 5 x 6 x 9 metal cabinet, sensitive, employs a 77 RF pentode detector with cathode regeneration. Low rush level — made possible by the use of a 77 E.C. interruption frequency oscillator. Loud speaker volume — assured by the use of a 41 pentode and plate supply voltage between 180 and 250 volts. We recommend the 6-volt tubes; however two 57's and a 2A5 can be used without wiring changes with our type 1-E power supply. Receiver less tubes **\$13.75**

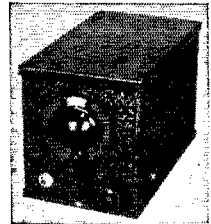

CARDWELL CONDENSERS

No.	Plates	Mmf.	Price
193B	21	480	\$2.00
164B	21	220	2.00
147B	43	440	3.50
T-199	37	330	5.00

Split Stator Condensers

156B	42	1000	3.00
197B	18	160	2.50
157B	42	420	4.00
512B	22	100	5.00

FOREIGN SERVICE

To date LEEDS foreign service has reached 36 countries. The letters of praise we are receiving daily from our far distant friends is most gratifying. We are constantly on our toes to keep Leeds service at 100%. That's why LEEDS always leads.

READY TO "Go places"

THE INSTANT IT'S INSTALLED

These features are "standard equipment" with the G-E K-80 All-wave Radio.

- Range (540 to 18,000 kc.)
- Speaker (high-grade dynamic)
- Power pack (humless)
- Pre-selector (image-erasing cascade type)
- Doublet-antenna provision
- Super-vernier tuning
- Full set of tubes

The K-80 receiver is 100 per cent complete for

- amateur phone
- broadcast
- S. W. broadcast

For C. W.?

You bet!—adapted without cutting a wire.

See the coupon.

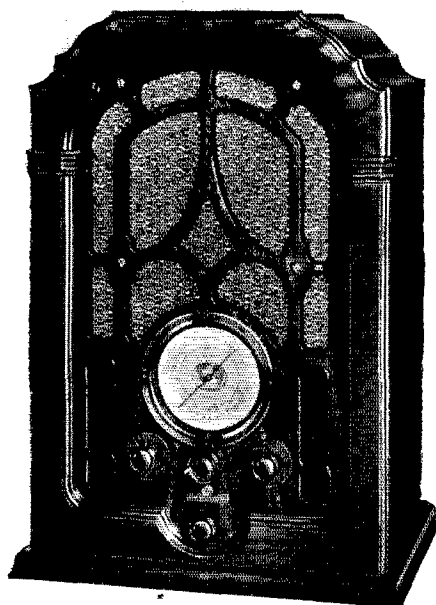

General Electric All-purpose receiver, Model K-80. Price \$92.50. Prices slightly higher in West, Mid-west and South. Subject to change without notice.

"Now is the time to buy"



GENERAL ELECTRIC RADIO

GENERAL ELECTRIC COMPANY
Radio Sales Section, R-676, Bridgeport, Conn.

Kindly send me, without charge, full technical details of the K-80 receiver. My special interests are checked below.

- New receiver antenna data Using the K-80 for C. W.
 I do radio service work

Name.....

Street.....

City..... State.....



"AGS" and "AGS-X" Communication Type Receivers

GENERAL DESCRIPTION. A professional receiver in which considerations of price are entirely subordinate to those of performance and reliability, the AGS has been designed in co-operation with the Airways Division of the U. S. Department of Commerce, to provide high usable sensitivity and selectivity, easy operation, and permanent frequency calibration.

Particularly important is its unusual preselector circuit, which is largely responsible for its exceptionally high frequency signal-to-noise ratio and almost complete image suppression.

CIRCUIT. Both AGS and AGS-X employ nine tubes in a superheterodyne circuit, comprising a pre-selector stage of tuned R.F. amplification, a first detector, a high frequency oscillator; two stages of high-gain I.F. amplification; I.F. power detector; and Pentode output with provision for either phones or loudspeaker. Details typical of its electrical refinements are the use of electron-coupled air-padded oscillators, air-dielectric tuning condensers in I.F. amplifier, single dial tuning, automatic or manual volume control, C.W. beat-frequency oscillator and calibrated band-spreading.

The AGS-X illustrated above offers a still further refinement in the use of a Lamb single signal circuit preceding the I.F. amplifier. With this device selectivity is measured in cycles rather than kilocycles, resulting in an almost complete elimination of interference from unwanted signals, and a marked reduction in static. Front-of-panel controls provide for smooth variation of single-signal selectivity, as well as rejection of the filter for phone reception.

CONSTRUCTION. The mechanical construction of the AGS Receivers is particularly rugged, heavy aluminum plate being used throughout. All parts are designed for continuous duty under commercial operating conditions, and are easily accessible for inspection. The panel is designed for standard relay rack mounting though a walnut cabinet for table mounting will be supplied on special order.

A booklet describing this receiver in detail will be mailed on request

NATIONAL COMPANY, INC., MALDEN, MASS.

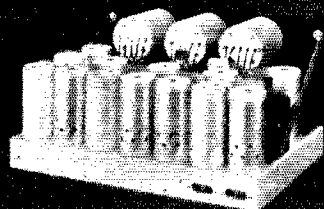
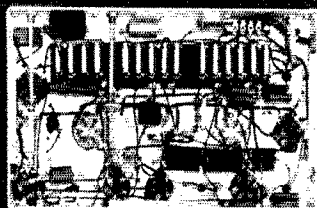
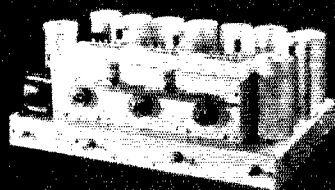

RCA-841 RCA-842

NOW ONLY

**\$3.25
EACH**



RCA-841 is a three-electrode tube of the high- μ type, and is particularly useful in radio amateur transmitters as a radio-frequency doubler, r-f power amplifier or oscillator (self-excited or crystal-controlled). It may also be used as a voltage amplifier in resistance-coupled a-f circuits. Filament voltage, 7.5 volts. Filament current, 1.25 amperes. As Class C r-f amplifier, maximum unmodulated d-c plate voltage is 450 volts, maximum d-c plate current, 60 ma.

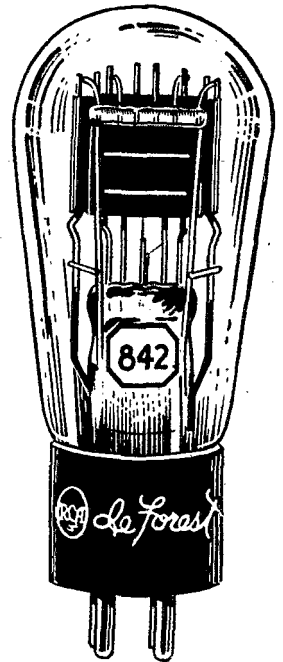

RCA-842 is a three-electrode tube of the low- μ type well suited as a modulator and Class A power amplifier type in amateur transmitters. Filament voltage, 7.5 volts. Filament current, 1.25 amperes. Maximum d-c plate voltage, 425 volts.

RCA-841 resembles type 10 in operating characteristics and rating, while RCA-842 resembles type 50.

Now that these tubes are priced at only \$3.25 each, net to the amateur, they deserve the particular attention of those who want the most for their money.

RCA-841 and RCA-842 carry a rating of 15 watts maximum plate dissipation and may be used to advantage in applications ordinarily suggesting the 10 or 50 respectively.

For complete technical information on RCA-841, RCA-842 or other RCA-deForest types, see your RCA-deForest distributor or write to

RCA deForest AMATEUR RADIO DIVISION

RCA RADIOTRON CO., INC.

CAMDEN

NEW JERSEY

The 1934 Meeting of the Board

ONE of the longest and most important meetings of the Board of Directors of the American Radio Relay League ever held took place in Hartford on May 11th and 12th. For two whole days the Board was in session, with every director present and with the officers and general counsel of the League in attendance. As every radio amateur knows, this annual meeting of the Board is the high point in amateur affairs of the year, for at this time the policies of the League are gone over in minute examination, responsive to the wishes of the majority of the members, and new plans made for a coming year.

With every director present, fully conversant with the wishes of the amateurs in his region, it was possible to make a thoroughly intelligent survey of all the affairs of amateur radio. All the officers had previously submitted extensive reports to the directors, and brought their records to the meeting. Each director in turn submitted a report for the information of all of the others on conditions in his home territory, and then the Board went to work. Meals were served in a room adjoining the meeting room, so that there would be as little lost time as possible for the necessities of life, and all in all the Board was in session nearly nineteen hours.

This report will conclude with the actual minutes of the meeting, but because such minutes are necessarily in a somewhat abbreviated form and are rather stuffy reading, perhaps a narrative account of some of the highlights will be of interest.

Perhaps the most important actions of the Board were the making of certain constitutional changes in the by-laws. A.R.R.L. Boards have sought for many years a workable method whereby the voting power in the League would be confined to licensed amateurs. Many ideas to this end have been examined but not until this year was one developed that was feasible of administration. Now we have a new by-law: that in elections for director the votes will be counted only when they come from members who are licensed amateurs or who have a proprietary vote by reason of having been a member of the League prior to this change. (By-laws cannot be amended to deprive any member without his consent of any right that he had at the time he joined the League.) Members in that category will be entitled to vote so long as they maintain

their League membership without lapse, regardless of whether they have amateur licenses, but no new member of the League will have his vote counted unless he is in fact an amateur. In the past it has also been provided in our by-laws that members in arrears shall be counted as members for a period of ninety days thereafter and permitted to vote during that period. This figure the Board also amended to read thirty days hereafter. One result of this is that old non-licensed members of the League having a proprietary vote will lose the same if they do not renew their membership within thirty days after expiration, since after that time they will be regarded as new applicants and will not possess the right to vote unless they are in fact at the time of voting licensed amateurs. The result of this provision will be the gradual elimination from the League rolls of the proprietary votes. From the practical standpoint the matter is not of immense importance since there has never been any appreciable non-amateur participation in A.R.R.L. elections; but there is indeed a pleasant feeling in knowing that our by-laws are now so worded as to obviate any possibility of the control of any A.R.R.L. affairs by other than licensed amateurs.

The Board also adopted a provision for alternate or vice-directors. The function of a director is personal and although there has been a provision to send an alternate to a meeting of the Board if the director be ill or otherwise unable to attend, the director has been unable to transfer his vote to the alternate and on those occasions the division has had no vote. This would be overcome if a vice-director were elected with the constitutional right to cast the division's vote if requested by the director to attend the meeting for that purpose. This has now been accomplished. At the elections this autumn, vice-directors will be elected at the same time as directors, in half of our divisions, and next year there will be similar elections in the other half. The Board also examined with much care the possibilities for making an improvement in the composition of the A.R.R.L. Executive Committee, which now consists of the five officers. The salaried officers of the League do not relish the present arrangement except that it provides an opportunity for quickly getting the judgment of five men on important questions and avoids the possibility of "one-man control" of anything. Different

schemes were examined but nothing was developed that did not actually handicap these aims rather than assist them, and the question went over for further study. An important change was made with respect to the affiliation of local societies, in keeping with the general trend to solidify A.R.R.L. administration in strict terms of licensed-amateur control: the Board declared it to be its policy neither to affiliate any society nor to continue an existing affiliation except where the club is so constituted that control of its affairs is vested in licensed amateurs, of whom at least sixty percent are also members of A.R.R.L. A move to undertake a complete revision of the A.R.R.L. constitution was rejected as altogether unnecessary.

Many of the amateur operating regulations were examined and a number of requests made of the Federal Radio Commission: that the Commission open to mobile amateur operation all of the amateur frequencies above 56 megacycles; that the Commission assign to amateurs exclusive harmonic-family bands at 112 mc., 224 mc., 448 mc., 896 mc., and 1792 mc., that we may have our place in the ultra-high frequency spectrum; that the Commission arrange for Class A and B amateur examinations at cities normally visited by the inspectors and at amateur conventions; that the Commission take such steps as are possible to eliminate automobile ignition interference with high-frequency work; and that the regulations be amended to permit much simpler station logs, without all the "bookkeeping".

This meeting was no exception to the record of recent Board meetings in devoting a very great deal of consideration to 'phone questions. This year it was the 14-mc. band that received the attention. A great many of the directors felt that it was desirable to have the 'phone allocation in this band at one end or the other of the band, and many of them believed that it should be increased in size. Proposals were made and passed, reconsidered and rejected, new proposals made and the whole question studied for several hours. At length, chiefly because the Canadian 'phone allocation does not coincide with ours and any movement of our 'phone allocation to one end or the other would result in virtually the entire band being devoted to 'phone, the Board decided to leave the allocation just as it is for another year; and in the meantime it directed the communications manager to make a complete survey of 'phone-telegraph operation in all of the bands. It was proposed at the meeting that we ask the Commission to make the 'phone allocations ex-

clusive to 'phone, as some members and clubs had requested, but there is an excellent legal argument against this as causing a fundamental weakness in the amateur position; and in lieu of such action the Board directed the Communications Department to appeal to the sportsmanship of c.w. telegraph operators to confine their operation to the portion of the bands not open to 'phone work. The editor of *QST* was requested to open a special department for 'phone, if feasible, and *QST* was specifically directed to endeavor to work up data on the use of low-pass filters for 'phone, to reduce mutual interference.

Other important actions: The Board approved the request of the Navy Department whereunder, subject to suitable regulations, amateurs who are members of the N.C.R. may attain the right to use the "N" prefix in lieu of "W". For the specific recommendations made by the Board on this subject, the minutes should be consulted. The secretary of the League and the technical editor of *QST* were ordered to attend the third meeting of the C.C.I.R. in Lisbon this autumn to represent amateurs in the name of I.A.R.U. It was voted to collaborate with the National Broadcasting Company on a series of brief programs intended to give favorable publicity to amateur accomplishments. The general counsel and secretary were instructed to proceed with plans for obtaining more amateur frequencies at the Cairo conference. The Board went on record as opposed to the elimination of the code requirement for any amateur licenses. A petition from members in the Los Angeles, San Diego and Arizona sections of A.R.R.L. to create a new A.R.R.L. division was rejected by a vote of ten to six, one less than the two-thirds required to amend the by-laws to that effect. Thanks and appreciation were voted the Standard Frequency Stations and the District QSL Managers for their loyal services to amateur radio; and to the officers and employees for their efforts in producing the anniversary number of *QST*. Finally, Mr. Hiram Percy Maxim and Mr. Charles H. Stewart, veteran president and vice-president, respectively, were reelected for two years, each being the only nominee for his office.

The Board gave careful consideration to the problem of better contact with the members and the supplying of fuller information on what the League is doing—inadequacies which in the past year have resulted in misunderstandings and criticisms. The secretary was directed to maintain in *QST* a department to supply members with fuller information on what the League is doing—

information which in the past has been supplied in large quantities to the directors but which many of them have been unable to pass on adequately to all the members. Money was appropriated to allocate a fund to each territorial director to be disbursed at his discretion for legitimate expenses of A.R.R.L. administration. With each director provided with the necessary working funds, there should be tremendous improvement in knitting us all closer together and avoiding these misunderstandings. Perhaps this is a good place to say that a new "headquarters movie" is under preparation for the use of the affiliated clubs and, although it will be many months before time can be found to complete it, advantage was taken of the presence of the directors in Hartford to get pictures of the directors and of the Board in action. As every member knows, a few months ago there was much criticism of A.R.R.L. headquarters and the officers, the secretary getting the brunt of it, with resolutions and circular letters and letters to directors condemning policies, criticizing officers, demanding investigations, etc. The Board took cognizance of these matters by constituting itself a sort of court of inquiry. It examined carefully into the whole matter, interrogated officers, examined records, scrutinized salaries, studied the Madrid and "continental channels" matters. It found no justification for any of the charges that have been disturbing members, and voted hearty commendation of the secretary and other officers for their conduct of League affairs. With the thorough airing given every detail of League administration, with everything examined and found above reproach, with the fuller information that every director is able to take home to his members after this meeting, and with the improvements that this meeting effected in League organization, it is hoped that our period of unrest and baseless criticism is over and that we shall now be able to put all of our shoulders to the wheel and carry on together for amateur radio.

These, obviously, are only the highlights of a two-day session. Your director can give you more detailed information on any subject that particularly interests you. The complete minutes follow:

Minutes of Annual Meeting of Board of Directors, American Radio Relay League, May 11 & 12, 1934

In compliance with the constitution and responsive to due notice, the Board of Directors of the American Radio Relay

League, Inc., convened in regular annual meeting at the Hartford Club, Hartford, Conn., on May 11, 1934. The meeting was called to order by President Maxim at 10:06 a.m., d.s.t. After a brief address by the president, the roll was called, with the following directors present:

Hiram Percy Maxim, President, Chairman
Charles H. Stewart, Vice-President
Alex. Reid, Canadian General Manager
Russell J. Andrews, Rocky Mountain Division
G. W. Bailey, New England Division
H. L. Caveness, Roanoke Division
Frank M. Corlett, West Gulf Division
S. G. Culver, Pacific Division
Ralph J. Gibbons, Northwestern Division
J. C. Hagler, Jr., Southeastern Division
M. M. Hill, Delta Division
Carl L. Jabs, Dakota Division
H. W. Kerr, Midwest Division
Loren G. Windom, Central Division
Eugene C. Woodruff, Atlantic Division

Absent: Bernard J. Fuld, Hudson Division. There were also present Secretary K. B. Warner, Treasurer A. A. Hebert, Communications Manager F. E. Handy, and Assistant Secretary A. L. Budlong.

Moved, by Mr. Culver, that a verbatim stenographic record be made of the proceedings of this meeting and supplied the members of the Board but available for inspection by any member of a division. Seconded by Mr. Jabs. After round-table discussion during which most directors opposed such record as unnecessary, too expensive and an impediment to free discussion, the motion was rejected, Messrs. Culver and Jabs voting in the affirmative.

During the above discussion Mr. Fuld and General Counsel Paul M. Segal entered the meeting, at 10:22 a.m.

On motion of Mr. Reid, VOTED that, without reading, the minutes of the last meeting of the Board are approved in the form in which they were issued by the secretary. Messrs. Culver and Jabs requested to be recorded as not voting because they had not been present at the previous meeting.

On motion of Mr. Windom, unanimously VOTED to accept the annual reports of the officers and other officials as submitted to the Board of Directors and place the same on file.

On the question of the election of a new president and new vice-president, on motion of Mr. Windom, unanimously VOTED that these elections go over as the last item of business of this meeting.

Moved, by Mr. Windom, that all acts performed and all things done by the Executive Committee since the last meeting of the Board, and by it reported to the Board, be ratified and confirmed by the Board as the actions of the Board. Moved, by Mr. Culver, to amend the motion to have read to the Board, before approving, the Executive Committee acts of the entire year except affiliations of clubs.¹ After discussion, the motion to amend was lost, 5 votes in favor, 9 opposed. The original motion was then ADOPTED without dissenting voice, Mr. Culver asking to be recorded not voting.

Mr. Reid presented his report as Canadian General Manager. In turn, every division director rendered a report on conditions in his division.

The Board recessed for luncheon at 1:03 p.m., reconvening at 2:21 p.m. with all directors and officials in attendance.

¹ For the information of members it should be stated that full minutes of all Executive Committee meetings throughout the year are sent to all directors immediately after each meeting.—Editor.

On motion of Mr. Andrews, it was unanimously VOTED that the sum of twenty-eight hundred dollars (\$2800) is hereby appropriated from the surplus of the League, as of this date, for the purpose of defraying the expenses of holding this meeting of the Board of Directors, any unexpended remainder of this sum to be restored to surplus.

On the question of the Navy Department's desire to arrange for the use of the prefix "N" for N.C.R. amateurs, after extended discussion during which several suggestions were made and withdrawn, it was, on motion of Mr. Bailey, VOTED that the League approves the request of the Navy Department to the Federal Radio Commission for the adoption of the following amateur regulation:

In the case of an amateur licensee whose station is owned by a regularly commissioned or enlisted member of the United States Naval Reserve, the commandant of the naval district in which such reservist resides may authorize in his discretion the use of the call letter prefix "N", in lieu of the prefix "W" assigned in the license issued by the Commission, provided that such "N" prefix shall be used only when operating in the frequency bands 1715-2000 kilocycles and 3500-4000 kilocycles, and provided further it shall be used only for communication between stations licensed to regularly commissioned or enlisted members of the Naval Reserve, or for Naval Reserve communication with naval radio or Naval Reserve radio stations in accordance with instructions issued by the Navy Department.

After further discussion, on motion of Mr. Corlett, VOTED that the League advises the Navy Department and the Federal Radio Commission of its willingness to expand the above arrangement to permit the use of the "N" prefix by such authorized stations not only when communicating with each other but also when communicating with "W" and "K" stations that are not members of the Naval Communications Reserve, in these two frequency bands.

The Chairman then requested the Board to give consideration to matters of unrest within the League organization. Mr. Windom introduced and moved the adoption of a resolution intended to terminate the affiliation with the League of the Santa Clara County Amateur Radio Association and to recall its charter because of false statements circulated by it against the League, inconsistent with the spirit of affiliation as defined in the by-laws. Messrs. Culver and Jabs spoke against the resolution; the Chairman urged a tolerant attitude; whereupon Mr. Windom, with the permission of his second and the consent of the assembly, temporarily withdrew the resolution.

On the question of ways and means to insure the control of League affairs by licensed amateurs, after discussion, moved, by Mr. Gibbons, that By-Law 16 be amended by inserting after the 32nd line in the printed edition thereof the following language:

No ballot shall be counted unless it shall affirmatively appear either from such ballot or the envelope in which it is contained that the member submitting it either is at the time the holder of an amateur radio station or operator's license or has been continuously since May 15, 1934, a member of the League.

The yeas and nays being ordered, the said question was decided in the affirmative: yeas, 16; nays, 0. Every director voted in the affirmative. So the by-law was amended.

Moved, by Mr. Windom, that By-Law 2 be amended by striking out the word "ninety" and substituting therefor the word "thirty". The yeas and nays being ordered, the said question was decided in the affirmative: yeas, 16; nays, 0. Every director voted in the affirmative. So the by-law was amended.

Moved, by Mr. Culver, that By-Law 16 be amended by

striking out the words "in secret, but". The yeas and nays being ordered, the said question was decided in the affirmative: yeas, 16; nays, 0. Every director voted in the affirmative. So the by-law was amended.

Moved, by Mr. Andrews, that By-Law 16 be amended by striking out the words "after the twentieth day of December" appearing in the 34th and 35th line of the printed edition thereof, and substituting therefor the word "thereafter". The yeas and nays being ordered, the said question was decided in the affirmative: yeas, 16; nays, 0. Every director voted in the affirmative. So the by-law was amended.

On the question of arrangements whereby an alternate for a director attending a meeting of the Board might be able to cast a vote for the division, the Chairman, without objection, requested the general counsel to draft language whereby, for each director of the League, there would be a vice-director who would have the right to attend meetings in lieu of the director and cast a vote for the division.

The Board engaged in extended round-table discussion of the composition of the Executive Committee. Various suggestions were considered but the Board found no practicable plan for a modified composition of the committee. It was agreed to let the question go over for further study.

After a discussion of various methods for conveying to amateurs a fuller appreciation of what the League is doing, on motion of Mr. Fuld, unanimously VOTED that the Secretary is instructed to conduct in QST a department for the purpose of informing the membership what is going on in League affairs.²

The Board recessed for dinner at 7:04 p.m., reconvening at 8:43 p.m. with all directors and officials in attendance.

The Board addressed itself to an examination of the criticism of the headquarters establishment. Mr. Bailey proposed that the Board express its attitude on the officers of the League, and moved that it is the sense of this Board that K. B. Warner is an honest, competent and trustworthy officer and that the Board heartily commends his conduct of League affairs and heartily commends the other officers of the League. After extended discussion, during which the entire question of unrest in the membership was examined, the motion was adopted without dissenting voice. Mr. Jabs stated that because he had not yet had opportunity to examine the books and records of the League³, he wished to reserve his vote and to be so recorded. Mr. Culver requested to be recorded as splitting his vote to endorse Mr. Warner's honesty and integrity but not his judgment and competency. Moved, by Mr. Hill, that Messrs. Culver, Jabs and Kerr be appointed a committee to list all specific accusations against the officers, for investigation by the Board. Moved, by Mr. Gibbons, to amend the motion by substituting the following text:

Resolved: that the Board is of the opinion that its constitution is such that it is not only authorized but is actually under the duty of investigating any accusation that any member of the Board may make against any officer or employee of the League; and that it now declares its agenda open at this time for the tendering of any specific accusation any member of this Board may desire to make.

Mr. Hill with unanimous consent accepted this text in lieu of his own, whereupon the same was unanimously ADOPTED. The Board thereupon constituted itself a court of inquiry. Through the Chairman, Mr. Warner volunteered himself for examination, and was interrogated by Mr. Jabs.

² The Secretary reported at the meeting that he had already experimentally started such a department in the June issue of QST.—Editor.

³ Which he did at the conclusion of the meeting.—Editor.

An extended general discussion ensued during which all available criticisms were examined and the fullest possible attempt made to discover acts or omissions deserving the attention of the Board, but without result.⁴

On motion of Mr. Caveness, the Board adjourned at 11:34 p.m., subject to an order to reconvene at 9 a.m. on the morrow. The Board reassembled at the same place on May 12, 1934, and was called to order at 9:17 a.m. with all directors present and all officials in attendance except Messrs. Hebert and Segal.

Moved, by Mr. Jabs, that the secretary be instructed to maintain in *QST* a department intended more for beginning amateurs. After discussion, Mr. Gibbons proposed an amendment *in toto* which, with the assembly's permission, was accepted by Mr. Jabs in lieu of his wording, as follows:

That, for the purpose of stimulating the contributing of *QST* articles of the practical-application type by members of the League and published in *QST* only, the Board of Directors at each annual meeting commencing in 1935 award the sum of twenty-five dollars (\$25) to the best article published in *QST* during the previous twelve months under each of the following eight headings by members of A.R.R.L.:

- 1) Antennas
- 2) Ultra-high-frequency communication
- 3) 'Phone transmission
- 4) C.W. transmission
- 5) Simple receivers
- 6) Superheterodyne receivers
- 7) Power supplies
- 8) General-interest (non-technical) articles

and that the technical editor of *QST* be requested to supply each meeting of the Board henceforth with his recommendations for these awards, for the information of the Board in their study.

After further discussion, the said motion was rejected.

Moved, by Mr. Gibbons, that for the purpose of recognizing amateur achievement, there hereby be established an award of two hundred fifty dollars (\$250), to be known as the Hiram Percy Maxim Award, to be awarded annually by each meeting of the Board of Directors commencing in 1935, to that person who during the previous twelve months in the opinion of the Board has made the most meritorious contribution to the advancement of amateur radio. After discussion, the said motion was rejected.

On the question of supplying needed funds for directors for necessary expenses in their division: after discussion, on motion of Mr. Culver, VOTED that there is hereby allocated to each division director of the League and to the Canadian General Manager the sum of one hundred fifty dollars (\$150) for legitimate A.R.R.L. expenses in his area; and that there is hereby appropriated from the surplus of the League, as of this date, the sum of twenty-one hundred dollars (\$2100) for the purpose of defraying this expense, any unexpended remainder of this fund on the date of the next Board meeting to be restored to surplus; this action to be regarded as an experimental program for one year, its results to be subject to review at the next meeting of the Board.

During the above discussion Mr. Hebert entered the meeting, at 10:02 a.m.

On the question of participation in the next meeting of the C.C.I.R., on motion of Mr. Hill, unanimously VOTED (a) that the secretary of the League and the technical editor of *QST* are authorized and instructed to attend the third meeting of the C.C.I.R. in Lisbon and participate in the

name of the International Amateur Radio Union; and (b) that the sum of thirty-five hundred dollars (\$3500) is hereby appropriated from the surplus of the League, as of this date, for the purpose of defraying the traveling expenses of these representatives and the participation costs of the meeting, any unexpended remainder of this sum to be restored to surplus.

Moved, by Mr. Jabs, that the communications department in *QST* be reduced to contain only articles and traffic totals, eliminating reports of individual activities, and that the space thus saved be used for the publication of letters of constructive suggestion received at headquarters from members. After discussion, with the unanimous consent of the assembly, Mr. Jabs accepted an amendment by Mr. Culver to leave the communications department reports intact but, in the *QST* space normally devoted to a correspondence department, to show a "Vox Pop" attitude and publish both sides of arguments. After further discussion, the said motion was rejected, 5 votes in favor, 7 votes opposed. Mr. Windom requested to be recorded as having voted in favor of the motion.

On motion of Mr. Fuld, unanimously VOTED that more space in *QST*, at the discretion of the editor, be devoted to 'phone matters and to clubs.

On the question of collaborating with the National Broadcasting Company on a series of programs devoted to amateur radio, after discussion, on motion of Mr. Reid, VOTED that the League collaborates with the said company on the plan as previously outlined to directors. Mr. Jabs requested to be recorded as voting opposed.

On the question of the nature of the five-meter apparatus to be described in connection with the collaboration on the above program, on motion of Mr. Hill, unanimously VOTED that this question is left to the technical department of *QST* with the approval of the Executive Committee.

During the above discussion Mr. Segal entered the meeting, at 11:25 a.m.

On motion of Mr. Fuld, unanimously VOTED that the editor of *QST* is instructed to undertake a policy of urging, through its columns, the use of low-pass filters to limit 'phone modulation frequencies to about 3000 cycles in order to reduce interference without preventing understandable communication.

On motion of Mr. Corlett, unanimously VOTED to add to the agenda of this meeting the question of the 20-meter 'phone allocation.

On the question of automobile ignition interference with ultra-high frequency reception, on motion of Mr. Hill, voted that the A.R.R.L. requests the Federal Radio Commission to enact such legislation as is possible to eliminate automobile ignition interference; and that manufacturers be encouraged to attain this in the design and manufacture of new automobiles; and that articles appear in *QST* which will cure most causes of interference in automobile electric systems. Messrs. Woodruff and Fuld requested to be recorded as voting opposed. After further discussion, on motion of Mr. Corlett, unanimously voted to reconsider the said motion. Upon reconsideration, the said motion was rejected. After further discussion, on motion of Mr. Culver, unanimously VOTED that the A.R.R.L. goes on record as calling upon the Federal Radio Commission to take such steps as are possible to eliminate automobile ignition interference.

On the question of show-station traffic, moved, by Mr. Windom, that the communications department be authorized to conduct an educational program by preparing such bulletins or circulars as may be necessary, to clarify or modify the show-station traffic situation.

At this point the Chairman requested the assembly to

⁴ All in all, the Board devoted approximately five hours to the study of criticisms.—Editor.

hear the report of Mr. Segal, who was under the obligation of leaving the meeting soon. Mr. Segal, responding to the request made the previous day, presented a suggestion for accomplishing the appointment of vice-directors who would be authorized to vote for the division. He also outlined the status of what have been referred to as abandoned continental channels, explaining why they are not available for American amateur use as is commonly and erroneously believed. In response to inquiry, he also discussed the situation for the Cairo conference.

On motion of Mr. Windom, unanimously VOTED that the Board instructs the general counsel and secretary to proceed with preparatory plans for the Cairo conference intended to increase the frequency allocations of amateurs, and directs them to advise the Board of any action necessary or desirable to this end on the part of members in the field or members of the Board.

Mr. Segal here retired from the meeting, at 12:10 p.m. Resuming consideration of Mr. Windom's motion regarding show-station traffic, the same was then unanimously ADOPTED.

Pursuant to the recommendations of Mr. Segal, moved, by Mr. Jabs, that the by-laws be amended as follows:

After By-Law 10, introduce the following new text:

10a. From each division of the League in the United States and Possessions, an alternate director shall be elected at the same time as the director is elected. Such election shall be subject to all the terms and requirements of these by-laws with regard to directors, both as to qualifications of candidates and the methods of voting. No person may simultaneously be a candidate for the office of both director and alternate director.

Amend By-Law 12 to read as follows:

12. The directors shall have the authority to appoint committees and assistants to aid them in the discharge of their duties. In case of inability of any director to attend a meeting of the Board of Directors, he shall so notify the secretary and, with the giving of such notice, the alternate director shall assume all the powers and duties of director and shall attend such meeting with full powers of a director.

The yeas and nays being ordered, the said question was decided in the affirmative: yeas, 15; nays, 1. All the directors voted in the affirmative except Mr. Windom, who voted opposed. So the amendments were adopted.

On the question of the creation of a Southwestern Division to consist of the A.R.R.L. sections of Arizona, Los Angeles and San Diego, Mr. Culver spoke in favor of the petitions that had been received. Moved, by Mr. Culver, that By-Laws 4 and 17 be appropriately modified to establish a Southwestern Division effective January 1, 1935, the election of new director therefor to be held in the coming autumn so that the new director may take office January 1, 1935. After discussion, the yeas and nays being ordered, the said question was decided in the negative: whole number of votes cast, 16; necessary for adoption, 11; yeas, 10; nays, 6. Those who voted in the affirmative are Messrs. Maxim, Bailey, Corlett, Culver, Hill, Jabs, Kerr, Reid, Stewart and Windom. Those who voted in the negative are Messrs. Andrews, Caveness, Fuld, Gibbons, Hagler and Woodruff. So the proposal was rejected.

By request, the chairman read a letter from John L. Reinartz expressing confidence in the secretary; which letter, upon motion, was ordered filed. Mr. Bailey read a telegram of similar import from John M. Clayton, which was ordered filed.

The secretary briefly expressed his appreciation for the confidence expressed in him by the Board, and pledged the continuation of his best efforts on behalf of A.R.R.L.

On the secretary's suggestion of a request for ultra-high-frequency assignments, after discussion, on motion of Mr. Culver, unanimously VOTED that this League requests the Federal Radio Commission to assign bands of frequencies exclusively to amateur stations in the ultra-high-frequency region, in harmonic relation to existing amateur bands, as follows: 112 to 120 mc., 224 to 240 mc., 448 to 480 mc., 896 to 960 mc., 1792 to 1920 mc.

On further motion of Mr. Culver, unanimously VOTED that, in the event the request made in the previous motion is denied, the secretary is authorized to notify the Federal Radio Commission that the League will accept the proposed shared basis from 112 megacycles up, until such time as exclusive assignments are available.

On motion of Mr. Kerr, unanimously VOTED that the warm thanks of the League and the Board of Directors are extended to the Standard Frequency Stations and to the District QSL Managers in appreciation of their splendid services on behalf of amateur radio.

The secretary presented a communication from the Staten Island Amateur Radio Association, proposing reduction of maximum power to 100 watts, which letter was ordered filed. The secretary read a communication from the Butte (Montana) Radio Club concerning portable operation, which, on motion, was ordered filed. The secretary read a second communication from the Butte Radio Club concerning examination points. After discussion, on motion of Mr. Gibbons, unanimously VOTED that the Federal Radio Commission is requested to expand the number of points at which examinations are held for Classes A and B amateur examinations by causing the holding of examinations at the various other large cities necessarily visited by the inspectors in the course of their duties. On motion of Mr. Kerr, unanimously VOTED that the Commission is requested to consider the holding of examinations at divisional and state amateur conventions wherever practicable. Mr. Gibbons read a letter addressed to the Board of Directors by the Amateur Radio Club of Seattle and transmitted via him. In the belief that the matters mentioned in this letter would have the Board's consideration before adjournment, no action was taken.

On motion of Mr. Fuld, VOTED that the Board give a brief audience to former Hudson Division Director Lawrence J. Dunn after luncheon.

Without objection, the Board recessed for luncheon at 1:26 p.m., reconvening at 2:42 p.m. with all directors present except Mr. Woodruff and with all officials in attendance except Mr. Segal.

Pursuant to special order, Dr. Lawrence J. Dunn, former director of the Hudson Division, briefly addressed the meeting on the subject of loyalty to A.R.R.L.

On the question of radiotelephone assignments in the 14-megacycle band, moved, by Mr. Hill, that the Federal Radio Commission be requested to permit 14-megacycle 'phone operation from 14,000 to 14,200 kc. After discussion, moved, by Mr. Corlett, to amend the figures to read 14,000 to 14,250 kc.; but there was no second, so the motion for amendment fell. Moved, by Mr. Fuld, to amend the figures to read 14,200 to 14,400 kc.; but there was no second, so the motion for amendment fell. The question of requesting a 'phone allocation from 14,000 to 14,200 kc. then being called for, the same resulted in a tie vote, 6 in favor and 6 opposed, whereupon the Chairman declared the motion lost. Moved, by Mr. Jabs, that the Federal Radio Commission be requested to move the 'phone allocation to read 14,000 to 14,100 kc. Moved, by Mr. Fuld, to amend the figures to read 14,000 to 14,150 kc.; which proposal for amendment, being put to vote, was rejected. The main question then being voted upon, the same was adopted, 6 votes in favor and 5

votes opposed; namely, to request the removal of the 'phone band to 14,000-14,100 kc. Moved, by Mr. Fuld, that the Board recommend to the Federal Radio Commission that the 14-megacycle 'phone allocation be enlarged so as to include the frequencies between 14,000 and 14,150 kc. A record vote being demanded, the yeas and nays were ordered, resulting in the rejection of the motion: whole number of votes cast, 13; necessary for adoption, 7; yeas, 5; nays, 8. Those who voted in the affirmative are Messrs. Caveness, Corlett, Fuld, Gibbons and Hill; those who voted opposed are Messrs. Andrews, Bailey, Caveness, Corlett, Fuld, Gibbons, Hagler, Jabs, Kerr, Stewart and Windom; absent, Mr. Woodruff; not voting, Messrs. Reid and Maxim. After further debate, moved, by Mr. Windom, to reconsider the vote to request the moving of the 14-megacycle 'phone allocation. A record vote being demanded, the yeas and nays were ordered, resulting in the adoption of the said motion to reconsider: whole number of votes cast, 14; necessary for adoption, 8; yeas, 13; nays, 1. Those who voted in the affirmative are Messrs. Andrews, Bailey, Caveness, Corlett, Culver, Fuld, Gibbons, Hagler, Jabs, Kerr, Stewart, Windom and Maxim; Mr. Hill voted opposed; absent, Mr. Woodruff; not voting, Mr. Reid. So the question was reconsidered. Upon reconsideration of the proposal to request the Federal Radio Commission to move the 14-megacycle 'phone allocation to read 14,000 to 14,100 kc., after further discussion, a record vote being demanded, the yeas and nays were ordered, and the said question was decided in the negative: whole number of votes cast, 14; necessary for adoption, 8; yeas, 4; nays, 10. Those who voted in the affirmative are Messrs. Corlett, Fuld, Gibbons and Hill; those who voted opposed are Messrs. Andrews, Bailey, Caveness, Culver, Hagler, Jabs, Kerr, Stewart, Windom and Maxim; absent, Mr. Woodruff; not voting, Mr. Reid. So the motion was rejected, and the Board made no recommendation to the Federal Radio Commission for changes in the 14-megacycle 'phone allocation.

On motion of Mr. Windom, VOTED that the communications department is directed to make a 'phone-c.w. survey on all amateur bands over the coming year and report the results to the Board at its next meeting.

Moved, by Mr. Corlett, that the Federal Radio Commission be requested to make the 14-megacycle 'phone sub-allocation (14,160 to 14,250 kc.) exclusively 'phone. But there was no second, so the motion was lost. On motion of Mr. Caveness, unanimously VOTED that the Communications Manager is instructed to undertake a vigorous campaign to confine c.w. telegraph operation to the non-'phone portions of the amateur bands.

On the question of the desirability of encouraging mobile work on the ultra-high frequencies, on motion of Mr. Caveness, unanimously VOTED that the Federal Radio Commission is requested to authorize amateur mobile operation on all frequencies open to amateurs above 56,000 kilocycles.

On the question of simplification of log-keeping, on motion of Mr. Fuld, VOTED that the secretary is instructed to endeavor to secure an amendment of regulations that will simplify the keeping of station logs.

Moved, by Mr. Gibbons, that the Board adopt the policy that all affiliated clubs be required to limit convention registration fees to a maximum of three dollars (\$3) for division conventions and one dollar fifty cents (\$1.50) for state conventions. But there was no second, so the motion was lost.

Moved, by Mr. Gibbons, that the "Calls Heard" department be restored to its original status in *QST*. But there was no second, so the motion was lost.

Mr. Gibbons requested the presence of Mr. A. L. Budlong as headquarters representative at the Northwestern

Division convention this summer. Without objection, the question was referred to the Executive Committee.

On motion of Mr. Kerr, unanimously VOTED that the Board puts itself on record as being opposed to the elimination of code tests from amateur examinations.

On motion of Mr. Kerr, the Board unanimously extended a vote of appreciation to the officers and employees for their untiring labor which brought forth the May anniversary number of *QST*.

Moved, by Mr. Kerr, that the present voluntarily-reduced salaries of the officers and reduced salaries of the headquarters employees be fixed by the Board as their respective authorized salaries. After extended examination of the subject, Mr. Kerr, with the permission of his second and the unanimous consent of the assembly, withdrew his motion.

After discussion of affiliated clubs, on the joint motion of Messrs. Corlett and Culver, the following resolution was unanimously ADOPTED:

Resolved: (a) that it is the policy of the League not to grant affiliation to any amateur society unless the articles of the applicant society lodge the control of its affairs in licensed amateurs; nor unless 60 percent of the licensed amateurs belonging to the applicant society are also members of the League; (b) that the communications manager is hereby directed to make a suitable survey of the affiliated clubs at the end of each year; and (c) that it is hereby declared to be the policy of the League to terminate the affiliation of any society found by such survey not to comply with these conditions.

Mr. Corlett read to the meeting a letter of suggestions from the Abilene (Texas) Amateur Radio Club.

Moved, by Mr. Culver, that the League request the government agencies to remove as many as possible of their affiliated amateur stations outside the amateur bands. But there was no second, so the motion was lost.

Responsive to resolutions adopted by the San Jose convention of the Pacific Division, moved, by Mr. Culver, that the Board appoint a committee from its number to draft a new constitution vesting the voting power in the League solely in licensed amateurs, with a minimum age limit; changing the organization of the League to consist of local chapters, divisional organizations and national organization; incorporating the principles of initiative, referendum and recall; and providing for adoption and amendment of the constitution by direct vote of the membership; the said committee to report to the Board at its next meeting. After discussion, a record vote being demanded, the yeas and nays were ordered, and the said question was decided in the negative: whole number of votes cast, 15; necessary for adoption, 8; yeas, 1; nays, 14. Mr. Culver voted in the affirmative; those voting opposed are Messrs. Andrews, Bailey, Caveness, Corlett, Fuld, Gibbons, Hagler, Hill, Jabs, Kerr, Reid, Stewart, Windom and Maxim; absent, Mr. Woodruff. So the motion was rejected.

Mr. Culver requested permission to turn over throughout the year, to members of the League in his division who publish certain magazines, all non-confidential A.R.R.L. information received in minutes, secretary's letters, etc. There was extended discussion, the sentiment of the meeting being that such right is the individual director's privilege, at his discretion, and his responsibility.

Moved, by Mr. Culver, that the mailing department and communications department be ordered to send to the section communications managers card files of the membership in their respective sections, and that these lists be kept up to date. It was pointed out that such lists are already available, and there was no second to the motion.

On motion of Mr. Culver, VOTED that the general coun-

sel is requested to examine the legality of an arrangement whereunder, when two members of the same family are members of the League, the dues in the one case will be the usual figure of \$2.50 per year including *QST* subscription and in the other case \$0.50 per year with no subscription to *QST*; and, if he finds such arrangement legal, he is requested to draft suitable amendments to by-laws to accomplish it, for the further consideration of the Board.

Moved, by Mr. Jabs, that important questions of League policy arising between meetings of the Board of Directors be voted upon by the general League membership. But there was no second, so the motion was lost.

Mr. Hill suggested the desirability of spreading upon the minutes of the meeting a motion to show that the charges contained in the so-called Minneapolis circular had been investigated by the Board and found baseless. Mr. Culver pointed out that such further action was unnecessary in view of the vote of confidence in the officers that had been passed.

Mr. Caveness understood that the Minneapolis Radio Club has applied for affiliation, and proposed that the Board pass upon that application. In view of a disposition to deny affiliation, Mr. Jabs spoke in favor of their affiliation as helpful in solving present misunderstandings. The Chairman recommended a tolerant viewpoint. Mr. Reid suggested that the report that Mr. Jabs takes home from the Board meeting will show the members of that club that their circular was incorrect and ill-advised, and that conditions

in the League are not as they imagined. The question of their affiliation was left to the Executive Committee, as is the usual custom.

On the election of a new president and vice-president, Messrs. Maxim and Stewart retired from the meeting, Mr. Corlett, senior director, assuming the chair. Mr. Kerr nominated Hiram Percy Maxim for president for the 1934-1935 term. On motion by Mr. Bailey, adopted without dissent, the secretary cast one ballot to elect Mr. Maxim as president; which done, the chairman declared him duly elected. Mr. Maxim returned to the meeting, amidst applause, spoke briefly in appreciation, and resumed the chair.

Mr. Fuld suggested future thought to a change in the constitution to provide for an additional vice-president. Mr. Bailey nominated Charles H. Stewart for vice-president of the League for the 1934-1935 term. On motion of Mr. Bailey, adopted without dissent, the secretary cast one ballot to elect Mr. Stewart vice-president of the League; which done, the Chairman declared him duly elected. Mr. Stewart was thereupon recalled to the meeting and spoke briefly in appreciation.

On motion of Mr. Bailey, the Board adjourned, *sine die*, at 8:45 p.m. Total time of sessions, 18 hours, 43 minutes.



Secretary.